

BYTE®

the small systems journal
A MCGRAW-HILL PUBLICATION

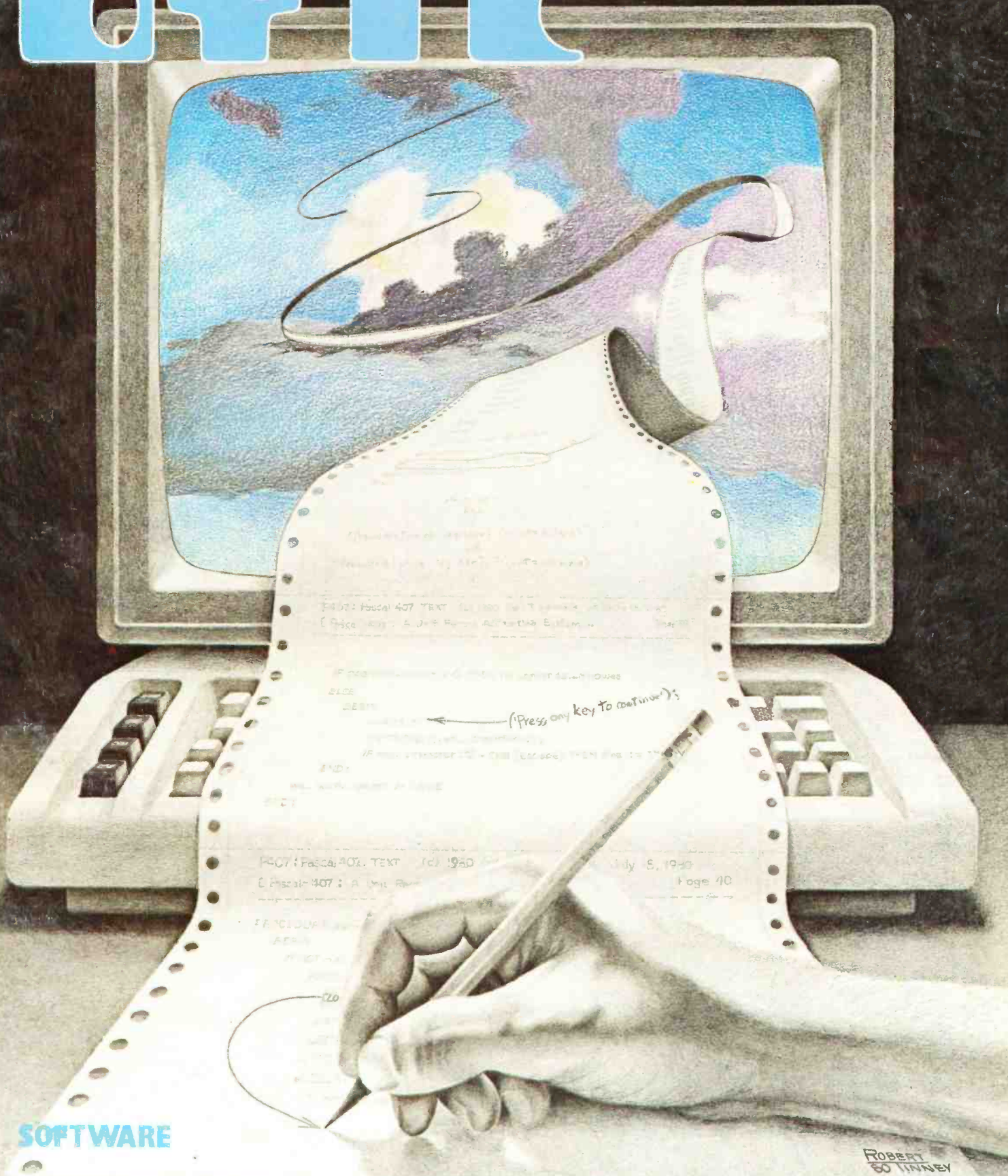

SOFTWARE

ROBERT
BO TINNEY

OFTEN FIRST - ALWAYS THE BEST

When we introduced the "S" system last year we knew that we were ahead of the industry. We didn't realize just how far.

WE KNEW THE NEEDS—

When we began designing the S/09 computer, we knew that the normal eight-bit microprocessor system was not adequate for any but the smallest, single user business applications. What was worse there was little that could be done to expand the capabilities of the system if the customer needed it. There is nothing much worse to a business customer than a "dead end" system.

MEMORY IS THE KEY—

Obviously a business system should be able to operate with multiple terminals if needed. It should also be able to do a variety of jobs; not just data processing, but also word processing and computer aided instruction. With a system limited to 64K bytes of memory addresses such a system is just not practical. The amount of user memory available to each terminal is too small for useful work.

HOW DO YOU GET IT—

The common solution to this problem is called bank switching. This process is similar to a selector switch that turns on the bank of memory that you want to work with. This, however, has a few problems. It is inefficient, therefore expensive, plus being slow. It is also extremely clumsy when data must be exchanged between two different programs. Besides with all this you still cannot use more than 64K of memory for any one program. So what is the alternative?

DO IT RIGHT—

The alternative is an address bus with more than the normal 16 bits found on eight-bit microprocessors. By using 20 address bits you can, for instance, address up to a million memory locations directly.

This way you have access to any part of memory at any time without any intermediate processes. Program interaction is now no problem at all.

SOFTWARE MUST MATCH—

So far we have a computer system with a large memory capacity and the ability to operate with many terminals, but this is not enough. You need an operating system just as sophisticated as the

hardware to complete the job. It must be a multi-tasking (therefore multiuser) operating system and it must be fast if it is to be useful with multiterminal systems. UniFLEX[®] fills these requirements and more. It also has multiple directories, log-in and password features. UniFLEX[®] was patterned after UNIX[™], which is one of the most highly regarded operating systems around.

PERIPHERALS TOO—

To complete the system we offer our smart terminals, and a variety of disk systems. We have everything from a 390K byte floppy to a 40 Meg/byte Winchester drive. All peripherals are compatible and so you can start with a small single terminal system and upgrade if necessary to a fully expanded system—16 terminals, 768 bytes of RAM memory and 96 Meg/bytes of disk storage.

GET THE WHOLE STORY—

If you are planning to install, or sell business systems you should get our information package on the most versatile and cost effective system on the market, the S/09. You can get a 128K system (less printer) for a little over \$5,000.00.

**UNIX is a Trademark of Bell Laboratories.*

SYSTEM SOFTWARE

Languages	Operating Systems
Assembler	FLEX*
BASIC	UniFLEX
FORTRAN	
Pascal	
PILOT	
Data Processing	Word Processing
General Ledger	Word Processing Editor
Accounts Receivable	Text Processor
Accounts Payable	
Payroll	Utilities
Jobcost	Debug Package
Inventory	Sort-Merge
Mail List	Diagnostics

**Supplied with over 40 utilities*



SOUTHWEST TECHNICAL PRODUCTS CORPORATION
219 W. RHAPSODY
SAN ANTONIO, TEXAS 78216 (512) 344-0241

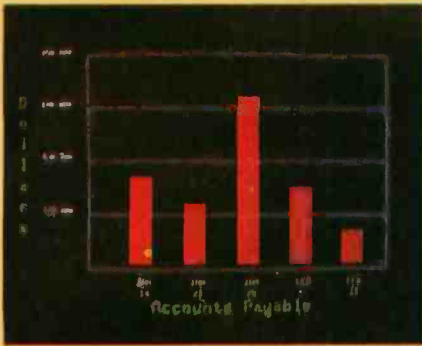

Management Information Display

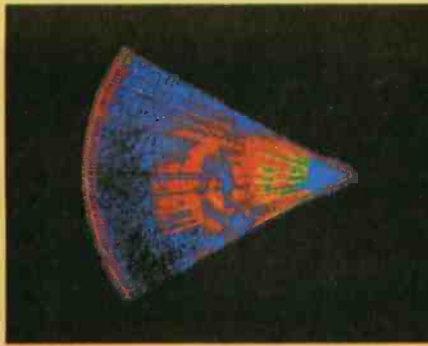

Ultrasonic heart sector scan



High-resolution display with alphanumerics

Get the professional color display that has BASIC/FORTRAN simplicity

LOW-PRICED, TOO

Here's a color display that has everything: professional-level resolution, enormous color range, easy software, NTSC conformance, and low price.

Basically, this new Cromemco Model SDI* is a two-board interface that plugs into any Cromemco computer.

The SDI then maps computer display memory content onto a convenient color monitor to give high-quality, high-resolution displays (756 H x 482 V pixels).

When we say the SDI results in a high-quality professional display, we mean you can't get higher resolution than this system offers in an NTSC-conforming display.

The resolution surpasses that of a color TV picture.

BASIC/FORTRAN programming

Besides its high resolution and low price, the new SDI lets you control with optional Cromemco software packages that use simple BASIC- and FORTRAN-like commands.

Pick any of 16 colors (from a 4096-color palette) with instructions like DEFCLR (c, R, G, B). Or obtain a circle of specified size, location, and color with XCIRC (x, y, r, c).

*U.S. Pat. No. 4121283

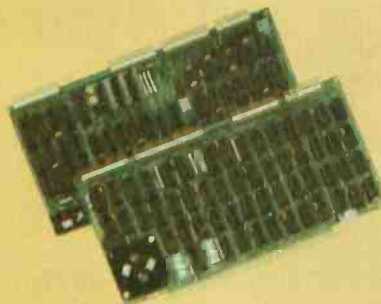

Model SDI High-Resolution Color Graphics Interface

HIGH RESOLUTION

The SDI's high resolution gives a professional-quality display that strictly meets NTSC requirements. You get 756 pixels on every visible line of the NTSC standard display of 482 image lines. Vertical line spacing is 1 pixel.

To achieve the high-quality display, a separate output signal is produced for each of the three component colors (red, green, blue). This yields a sharper image than is possible using an NTSC-composite video signal and color TV set. Full image quality is readily realized with our high-quality RGB Monitor or any conventional red/green/blue monitor common in TV work.

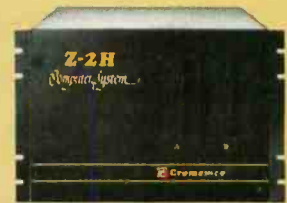

Model SDI plugs into Z-2H 11-megabyte hard disk computer or any Cromemco computer

DISPLAY MEMORY

Along with the SDI we also offer an optional fast and novel two-port memory that gives independent high-speed access to the computer memory. The two-port memory stores one full display, permitting fast computer operation even during display.

CONTACT YOUR REP NOW

The Model SDI has been used in scientific work, engineering, business, TV, color graphics, and other areas. It's a good example of how Cromemco keeps computers in the field up to date, since it turns any Cromemco computer into an up-to-date color display computer.

The SDI has still more features that you should be informed about. So contact your Cromemco representative now and see all that the SDI will do for you.



Cromemco
incorporated

280 BERNARDO AVE., MOUNTAIN VIEW, CA 94040 • (415) 964-7400
Tomorrow's computers today



Here's the state of the art in low-cost hard-disk computers

11 MEGABYTES OF FAST HARD-DISK STORAGE

Yes, the Cromemco Model Z-2H is in a class by itself in the computer field.

These Z-2H features tell you why:

- 11 megabytes of hard-disk storage
- 64 kilobytes of fast RAM
- Two dual-sided floppy disk drives
- Z-80A type processor
- Fast 4 MHz operation—150 nanosecond access time
- Fast hard-disk transfer rate of 5.6 megabits/second
- Low cost

And that's not all you get. Not nearly.

BROAD SOFTWARE SUPPORT

You also get Cromemco software support—the broadest software sup-

port in the microcomputer field. Software that Cromemco is known for. Like this:

- Structured BASIC
- FORTRAN IV
- RATFOR (RATional FORtran)
- COBOL
- Z-80 Macro Assembler
- Word Processing System
- Data Base Management

And more all the time.

FIELD PROVEN

The Z-2H is clearly in a class by itself. We introduced it last summer. It's field proven. It's reliable.

And it's rugged. Housed in a sturdy, all-metal cabinet.

EASILY EXPANDABLE

As always with Cromemco, you get expandability. The fast 64K RAM in this Model Z-2H can be expanded to 512 kilobytes. That amount of RAM combined with 11 megabytes of hard-disk storage gives you enormous

computer power—the equal or even beyond what much larger computers sometimes offer.

What's more, this computer gives you a 12-slot card cage. That's to plug in your special circuits as well as additional RAM and interface cards.

This expandability is supported by still more Cromemco value—the Z-2H's heavy-duty power supply that gives you 30A at 8V and 15A at $\pm 18V$ to support plug-ins.

LOW COST — SEE IT NOW

The Z-2H is real. It's been in the field for many months. It's proven itself.

You should see the Z-2H now. Contact a Cromemco representative and arrange for a demo. Learn that Cromemco is a survey-winner for reliability.

And learn that the Z-2H is under \$10K.

In the long run it always pays to get the best.



Cromemco
I n c o r p o r a t e d

280 BERNARDO AVE., MOUNTAIN VIEW, CA 94040 • (415) 964-7400
Tomorrow's computers today

Circle 1 on Inquiry card.



Page 24

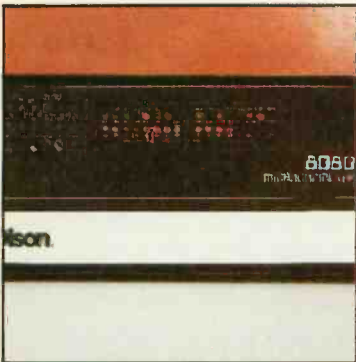

Page 62



Page 90



Page 172

Foreground

62 AN 8088 PROCESSOR FOR THE S-100 BUS, Part 2

by Thomas Woodward Cantrell

The second part of this article describes techniques for interfacing to the S-100 bus.

96 SORTING WITH BINARY TREES by Bill Walker

This data-storage structure makes it easy to insert or delete items in the file.

196 FLOPTRAN-IV: A TINY COMPILER by Mark Zimmermann

Commodore PET's BASIC interpreter is a handy foundation for a tiny compiler.

232 SYMBOLIC MATH USING BASIC by David R Stoutemyer

Here's an introduction to symbolic computer mathematics.

282 THE 6502 GETS MICROPROGRAMMABLE INSTRUCTIONS

by Dennette A Harrod

A simple circuit and some clever programming make enhancing this processor's instruction set possible.

286 VECTOR GRAPHICS FOR RASTER DISPLAYS by John Beetem

When plotting a line on a raster display, there is more logic involved than moving from point A to point B.

Background

24 MAKE LIQUID-CRYSTAL DISPLAYS WORK FOR YOU by Steve Ciarcia

With appropriate interfaces, these displays are suitable for many applications.

114 AN INFORMATION-RETRIEVAL SYSTEM by Robert W Elmore and Krishna K Agarwal

This system is capable of maintaining a file of related records and printing a selective list based on given criteria.

154 ADD MACRO EXPANSION TO YOUR MICROCOMPUTER, Part 1

by David C Brown

A macro assembler is often a valuable tool when developing large assembly-language programs.

266 MACHINE PROBLEM SOLVING, Part 2: Directed Search Using Cryptarithmic by Peter Frey

The best problem-solving programs often apply a combination of human and computer methods.

274 THE FORTH STANDARDS TEAM by William Ragsdale

Using a standard dialect of the FORTH language keeps costs down in the long run.

Nucleus

- | | |
|------------------------------|---------------------------|
| 6 Editorial: Who Reads BYTE? | 306 Ask BYTE |
| 16, 294 Letters | 325 BYTE's Bits |
| 42 Product Review | 328 Software Received |
| 50 Desk Top Wonders | 329 Clubs and Newsletters |
| 90 Education Forum | 330 Books Received |
| 172 Product Description | 334 Event Queue |
| 182 Technical Forum | 338 What's New? |
| 186 BYTELINES | 348 Tom Sloan Cartoon |
| 192 Languages Forum | 398 Unclassified Ads |
| 273, 314, 332 Book Reviews | 399 BOMB, BOMB Results |
| 278 Programming Quickies | 400 Reader Service |
| 302, 332 BYTE's Bugs | |

Publishers

Virginia Londoner,
Gordon R Williamson
Associate Publisher
John E Hayes
Assistant
Cheryl A Hurd

Founding Editor

Carl T Helmers Jr

Editor-in-Chief

Christopher P Morgan

Editors

Richard S Shuford, Gregg Williams,
Curtis P Feigel, Harold Nelson

Consulting Editor

Mark Dahmke

Book Editor

Bruce A Roberts

Chief Copy Editor

David William Hayward

Copy Editors

Faith Hanson, Warren Williamson,
Robin M Moss, Anthony J Lockwood

Assistant to the Editors

Faith Ferry

Assistants

Debe Wheeler, Karen A Cilley

New Products Editor**Clubs, Newsletters**

Charles Freilberg

Drafting

Jon Swanson

Production Director

Nancy Estle

Assistant Production Director

Christine Dixon

Production/Advertising Coordinator

Wai Chiu Li

Production Art

Holly Carmen LaBossiere,

Deborah Porter

Chief Typographer

Sherry McCarthy

Typographers

Debi Fredericks, Donna Sweeney

Advertising Director

Thomas Harvey

Assistants

Ruth M Walsh, Ms. Marion Gagnon

Barbara J Greene, Janet Ames

Special Projects Coordinator

Jill E Callihan

Marketing Coordinator

Laura A Hanson

Circulation Manager

Gregory Spitzfaden

Assistants

Agnes E Perry, Melanie Bertoni,

Barbara Varnum, Louise Menegus,

Andrew Jackson

Dealer Sales

Thomas Yanni

Controller

Daniel Rodrigues

Assistant

Mary E Fluhr

Accounts Receivable Specialist

Karen Burgess

Accounts Receivable Assistant

Jeanne Cilley

Receptionist

Jacqueline Earnshaw

Traffic Department

Mark Sandagata, Rob Hannings

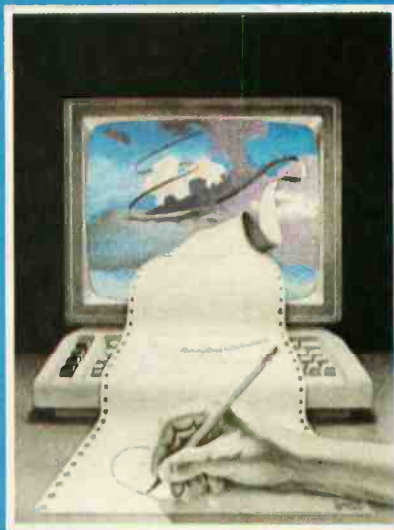

IN THIS ISSUE

Our main topic this month is Software — a perennial favorite among BYTE readers. This month's cover painting by Robert Tinney illustrates the colorful road that programmers often travel in search of bug-free code.

The software articles include: a tiny compiler that handles floating-point operations; machine problem-solving using cryptarithmic; sorting with binary trees; a macro assembler for your computer; adding to the 6502's instruction set; an easy-to-use information retrieval system; and symbolic math using BASIC.

Also this month: Steve Ciarcia's explanation of how to use liquid-crystal displays; a description of some vector graphics for raster-scan displays; a follow-up on FORTH; and the second part of a three-part discussion of an 8088 processor for the S-100 bus.

Officers of McGraw-Hill Publications Company: Paul F McPherson, President; Executive Vice Presidents: James E Boddorf, Gene W Simpson; Group Vice President: Daniel A McMillan; Senior Vice President-Editorial: Ralph R Schulz; Vice Presidents: Kemp Anderson, Business Systems Development; Stephen C Croft, Manufacturing; Robert B Doll, Circulation; James E Hackett, Controller; William H Hammond, Communications; Eric B Herr, Planning and Development; John W Patten, Sales; Edward E Schirmer, International.

Officers of the Corporation: Harold W McGraw Jr, President, Chief Executive Officer and Chairman of the Board; Robert F Landes, Senior Vice President and Secretary; Ralph J Webb, Treasurer.

BYTE is published monthly by BYTE Publications Inc, 70 Main St, Peterborough NH 03458, a wholly-owned subsidiary of McGraw-Hill, Inc. Address all mail except subscriptions to above address: phone (603) 924-9281. Address subscriptions, change of address, USPS Form 3579, and fulfillment questions to BYTE Subscriptions, PO Box 590, Marltonville NJ 08836. Controlled circulation postage paid at Waseca, Minnesota 56093 - USPS Publication No. 528890 (ISSN 0360-5280). Canadian second class registration number 9321. Subscriptions are \$18 for one year, \$32 for two years, and \$46 for three years in the USA and its possessions. In Canada and Mexico, \$20 for one year, \$36 for two years, \$52 for three years. \$32 for one year air delivery to Europe. \$32 surface delivery elsewhere. Air delivery to selected areas at additional rates upon request. Single copy price is \$2.50 in the USA and its possessions, \$2.95 in Canada and Mexico, \$4.00 in Europe, and \$4.50 elsewhere. Foreign subscriptions and sales should be remitted in United States funds drawn on a US bank. Printed in United States of America.

Address all editorial correspondence to the editor at the above address. Unacceptable manuscripts will be returned if accompanied by sufficient first class postage. Not responsible for lost manuscripts or photos. Opinions expressed by the authors are not necessarily those of BYTE. Entire contents copyright © 1980 by BYTE Publications Inc. All rights reserved.

BYTE® is available in microform from University Microfilms International, 300 N Zeeb Rd, Dept PR, Ann Arbor MI 48106 USA or 18 Bedford Row, Dept PR, London WC1R 4EJ England.



Subscription WATS Line: (800) 258-5485

Office hours: Mon-Thur 8:30 AM - 4:30 PM, Friday 8:30 AM - Noon, Eastern Time

NATIONAL ADVERTISING SALES REPRESENTATIVES:

NORTHEAST (617) 444-3946

Hajar Associates
280 Hillside Ave
Needham Heights MA 02194

MIDWEST (312) 864-3467

Hajar Associates
2405 Lawndale
Evanston IL 60201

EAST & SOUTH (212) 682-5844

Hajar Associates
521 Fifth Ave
New York NY 10017

SOUTHWEST (714) 540-3554

NORTHWEST (415) 964-0706
Hajar Associates
1000 Elwell Ct, Suite 227
Palo Alto CA 94303

MICROANGELO

HIGH RESOLUTION GRAPHICS SINGLE BOARD COMPUTER

by

SCION
CORPORATION

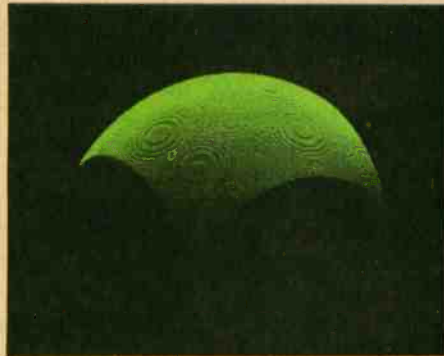
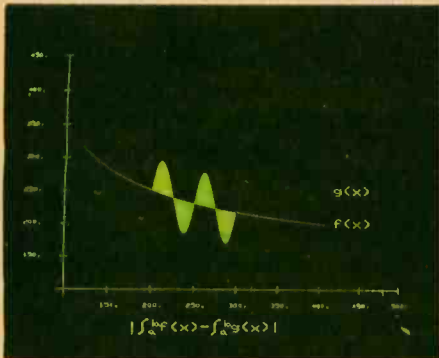
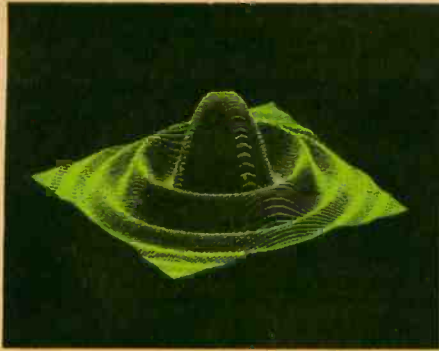

RS-170 composite or direct drive output

Local or external sync generation

4 or 5 Mhz Z80 micro-processor

60 hertz real-time clock

8 level interrupt tie-in

IEEE S100 bus compatible

Light pen interface

Time multiplexed refresh

4K resident Screenware™ Pak I operating system

32K RAM isolated from host address space

High speed communications over parallel bus ports

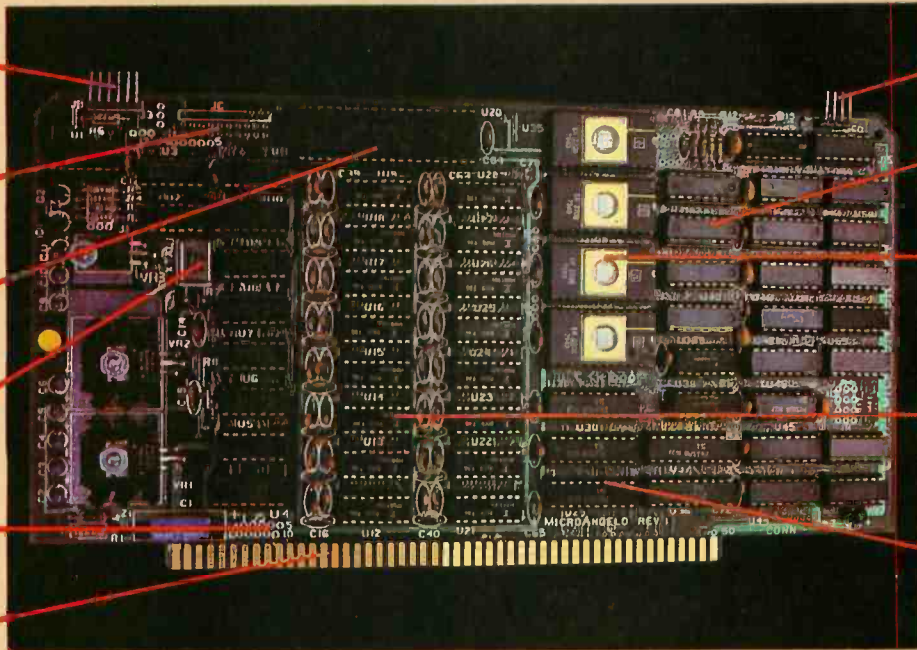

Screenware™ Pak I

A 4K byte operating system resident in PROM on MicroAngelo™ Pak I emulates an 85 character by 40 line graphics terminal and provides over 40 graphics commands. Provisions exist for user-defined character sets and directly callable user extensions to Screenware Pak I.

Host Resident Terminal Software

An interface software package that coordinates input/output from the MicroAngelo™ graphics board, the MicroAngelo™ keyboard, and your computer. The result is a flexible, yet sophisticated graphics terminal.

SCION Corporation
8455-D Tyco Road
Vienna, Va. 22180
(703) 827-0888

European Distributor:
Micro Diversions UK Ltd.
17/19 Mesnes Street
Wigan, England WN1 1QP
09-423 4311

Hire a fast thinker.

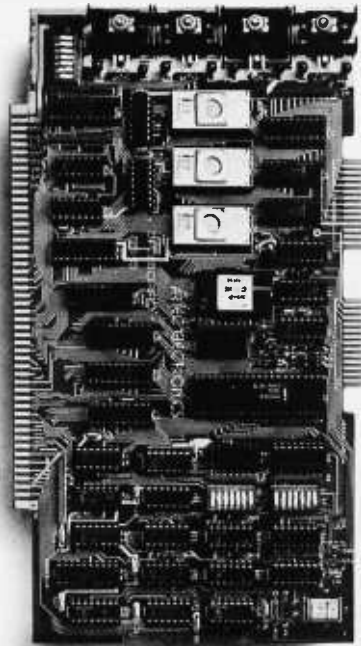

5 MHz CPU Card

- Intel 8085A-2 microprocessor ■ Hardware floating point ■ Performs calculations six times faster than other CPUs ■ On-board monitor in PROM ■ 1K RAM scratch pad ■ Keyboard or RS232C terminal ■ Variable clock frequency

PRICE—\$850

(California residents add 6% sales tax)

Call or write Artec for details.

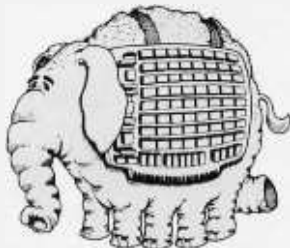

ARTEC ELECTRONICS, INC.

605 Old County Rd., San Carlos, CA 94070
Telephone (415) 592-2740

Editorial

Who Reads BYTE?

by Carl Helmers

In this month's editorial we will summarize some of the key results of a recent BYTE reader survey, performed by the McGraw-Hill Research group. A six-page questionnaire was mailed to 2000 BYTE subscribers earlier this year. The subscribers were selected from our mailing list on an every-*n*-th-name basis. Of the 2000 questionnaires mailed, 1445 were completed and returned within the six-week deadline. The 73.5% response to this survey request was exceptional. Such a large response to a detailed six-page form by itself indicates the enthusiasm and interest of our typical reader.

A major objective of the survey was to analyze the reading habits of our readers; a second objective was to obtain hard information about the professional orientation of our readers; and a third was to determine demographic data.

Dear to our editorial convictions, our survey contained a major section on programming languages. Next, we wanted to characterize the impact of microcomputing on the reader's personal life. Some miscellaneous information about present and future computing-equipment ownership completed the survey design. The form of the survey followed that of the two previous surveys we have done. The layout of the questionnaire was designed and executed by Nancy Estle and her associates in the BYTE production department. In this editorial, we can cover only some selected results from the survey. The complete computer-tabulated results take much more room than the space available in a single issue of BYTE.

We found that the typical BYTE reader is a professional who uses a computer as part of his or her job. Of the entire sample, 85% use computers in their everyday work.

One question we asked was "What is your principal occupation?" Almost 40% of the readers responded that they were engineers or scientists. Programmers or analysts (in the traditional data-processing sense of the terms) comprised 18% of the response. Some 13% classified themselves as owners or managers of a business. Table 1a shows the seven categories on the questionnaire and their percentages.

As an alternative approach to the same truth, we asked respondents to list their exact job title. The survey's analysis classified responses to the question in several categories. Table 1b shows the categories that received 1% or more in ratings.

As in the two previous surveys, the results showed a highly educated reader. In this year's survey, 10% indicated completion of a PhD (7%) or other advanced professional degree (3%), 18% have master's degrees, 19% have had some graduate school, and 21% indicated completion of a four-year college degree. This gives a total of 68% of BYTE readers who have completed a bachelor's degree or higher. If we extend the categories to "some college" (17%) and "associate's degree" (8%), we find that 93% of BYTE's readers have achieved some educational accomplishments beyond high school.

Consistent with this educational background and professional orientation, the typical BYTE reader is fairly well-paid for the work he does. In this year's survey, we found an average personal income of about \$29,000 and an average household income of about \$36,000. If this is the average, we should expect that a fair amount of discretionary money is available for personal computing and other trappings of the modern middle-class life. And so it is.

Essentially all (98%) of BYTE readers have high-fidelity audio equipment averaging \$619.33 in cost. Having such equipment, 99% of our readers indicated that they purchase an average of 9.13 records or tapes during a year's



“For reliable data storage, you can’t beat Shugart’s Minifloppy.”TM

Raymond Schlitzer, Owner—
Computerland, San Francisco

“I sell systems my customers can depend on. That’s why most of the personal and small business computer systems sold here feature Minifloppy disk drives. I know from experience I can rely on the Minifloppy.”

Since 1976 Shugart’s Minifloppy has been used by more small computer system manufacturers than any other drive. In fact, more than half-a-million Minifloppys

have been installed. The Minifloppy looks small—but it stores a lot of data. 250 kilobytes on one side, or up to 500 kilobytes in the double-sided model. That’s about 50 pages of printed information on a single-sided Minidiskette, and twice that on the double-sided version. You’ll have plenty of storage capacity for your programs, letters, forms, or ledger entries. And you find your data fast, too, because the Minifloppy is a random access device

that eliminates the need to search for your data serially as you must with a tape cassette unit.

No matter what problem you’re solving with your computer system, you can rely on Shugart’s Minifloppy for data storage. We’re known as the Headstrong company for good reason. We’re Headstrong about reliability, quality, and value. Ask your dealer. He knows us.

Rely on the Headstrong Company.

 Shugart

475 Oakmead Parkway, Sunnyvale, California 94086

Occupation	Percent
Programmer/Analyst	18
Engineer/Scientist	39.5
Business Owner/Manager	13
Educator	4.5
Student	8
Professional (law, medicine, accounting, etc)	5.5
Other	11.5

Table 1a: "What is your principal occupation? (check one)"

Title	Percent
Engineer	20
Manager or Director	17
Engineering Technician	11
Executive or Official	10
Programmer	6
Professional (Lawyers, Doctors, etc)	5.5
Teacher, Professor, or Educator	5
Systems Analyst	3.5
Student	3
Scientist	3
Consultant	2
Financial	1
All other titles	11
None or Unemployed	2

Table 1b: Classifications of job titles. This table shows how McGraw-Hill Research classified open-ended responses to the question "What is your exact title?" as found in the 1980 BYTE Reader Survey. The table shows only those classifications which had 1% response or more. Percentages are rounded to the nearest half percent.

time. Many BYTE readers have spent significant sums on photographic equipment; 48% of those surveyed spent between \$201 and \$1000 on cameras and related equipment. But only 12% of BYTE readers as of this survey indicate possession of a videotape recorder.

Fortunately for the quality of air at conventions and other meetings where BYTE readers are likely to be seen, 78% of our readers are nonsmokers. One quarter of our readers never drink wine, and 38% drink wine only occasionally (1 to 4 times per month; the average BYTE reader drinks wine 4.65 times per month). We did *not* ask a complementary question regarding personal tastes which is suggested by these low figures for smoking and drinking: "How many hours a day do you spend doing intense exercise activities (walking, bicycling, jogging, playing tennis or racquetball, swimming, calisthenics, etc)?" We suspect that the responses would be fairly high to this category of question.

Continuing with demographic data, we learned that our typical BYTE reader is 35 years of age, male, and head of a household with four members. Overall, 98% of the readers sampled were male. Some 79% of the readers indicated that they were the head of a household. In response to the "marital status" question, 62% indicated that they were married, 31% indicated they were still single, 5% indicated that they were divorced or separated. The question "How many people are there in your household?" found 3.95 as the mean response. Some 52.1% of the readers sampled indicated that there were 3 or more members of their household. One can



PASCAL/Z™ - Q.E.D.

Ithaca InterSystems PASCAL/Z is the most powerful CP/M™ compatible Z-80™ Pascal compiler ever . . . and here's why:

PASCAL/Z generates true Z-80 native code — ROMable and re-entrant — 5-10X faster than P-code interpreters; permits separate compilation; supports Direct File Access and variable length STRINGS; utilizes fast one-pass recursive descent organization; the macro-assembler generates relocatable object modules; and much, much more.

Complete package includes compiler, macro-assembler, linker/loader and source for the full library on one disk; with free copy of Jensen/Wirth book and complete documentation. Only \$395.00.

IT'S DEMONSTRABLE!

Don't just take our word for it. Ask for a demonstration of these features and more today at Computerland® and other full-service computer stores.

Ithaca InterSystems Inc., 1650 Hanshaw Road
P.O. Box 91, Ithaca, N.Y. 14850. Phone (607) 257-0190

Computerland is a registered trademark of Computerland Corporation. CP/M and Z-80 are trademarks of Digital Research Corp. and Zilog, Inc. respectively. PASCAL/Z and InterSystems are trademarks of Ithaca InterSystems Inc.

InterSystems™
Ithaca InterSystems Inc.

Micros for bigger ideas.



Outside of the garden you need a computer that can grow.

For the average garden-variety home and hobby operation, a high quality personal computer is a real temptation. But let's face it: in the world of business, engineering and scientific applications you need a system that can keep up with bigger ideas.

Bigger ideas today mean the power and flexibility to move the micro up to and beyond the level of yesterday's minis. More memory to hold bigger data bases. More flexibility to handle a variety of data entry devices. More programming and computing power for numbercrunching and applications development. And easy upgrade to 16 bit operation when you need it.

Intersystems has that, and more. The power and flexibility of the versatile S-100 bus, with 20 slots of expandability for up to 16 individually-addressable DMA devices and up to 1 Megabyte of memory, fully accessible to all users via our unique memory management system. Plus reliable Intersystems design and manufacture, and the support of our PASCAL/Z™...the most powerful Z-80™ compiler ever.

For really serious computing, our front panel provides a powerful diagnostic tool for debugging or development. Combined with a scope, it allows you to look at any location in the circuitry, set breakpoints, trigger and view one-shot events, and many other activities usually possible only with expensive logic analyzers. No wonder it's fast becoming the tool of choice for repair technicians and custom hardware designers.

Intersystems Series II is the most complete line of fully IEEE 696 compatible S-100 boards...easily upgradeable to our MPU 8000™ or other 16 bit S-100 CPU's as they become available...so you're never locked out of rapid expansion, or locked into obsolescence, by dependency on a proprietary product line.

So if you've left those garden-variety applications behind, come to Intersystems and get a system that will grow as big as your next idea. Get it from the people who know small computers...your Computerland store...or other fine full service computer dealers.

Ithaca Intersystems Inc., 1650 Hanshaw Road
P.O. Box 91, Ithaca, N.Y. 14850.
Phone (607) 257-0190 TWX: 510 255 4346.

Z-80 is a trademark of Zilog, Inc.
PASCAL/Z, MPU 8000 and InterSystems are trademarks of Ithaca Intersystems Inc.

InterSystems™
Ithaca Intersystems Inc.

Micros for bigger ideas.

Cost of System	Percentage
Less Than \$500	9.7
\$500 to \$1000	18.3
\$1100 to \$2000	17.9
\$2100 to \$3000	11.7
\$3100 to \$4000	9.7
\$4100 to \$5000	8.2
\$5100 to \$7500	7.7
\$7510 to \$15000	6.8
Over \$15000	10.0

Table 2: Distribution of approximate cost of personal-computer systems. The approximate costs of personal-computer systems owned by BYTE readers were classified into 9 bins. In each bin, we show a percentage response of the total number of those readers who stated a cost of their systems in the survey.

thus draw the conclusion that most of BYTE's readers are family-oriented.

One of the most frequently asked questions we hear is "How many people have personal computers?" In terms of the BYTE survey's results, the percentage is 71%. The mean system price is \$7415, based on the 792 respondents who gave a cost figure in response to the question "What is the approximate cost of your system?" From this mean price, ignoring any deviation in the distribution, we can extrapolate the economic effects of the approximately 160,000 BYTE readers to the ballpark figure of \$842 million over the time period in which this equipment was being acquired. Seven-eighths of a billion dollars is no small amount.

	Frequent (F)	Occasional (O)	Intended (I)	1980 Literacy F + O + I	1978 Literacy F + O + I	Change
BASIC	47	25	14.5	86.5	86	+ .5
Assembly Language	33	26	13	72	76	- 4
FORTRAN	21	39	12	72	79	- 7
Machine Object Code	18.5	34	13.5	66	74	- 8
Pascal	6.5	6	28	40.5	14	+ 26.5
COBOL	8	16	11	35	36	- 1
PL/I	5	12	10	27	31	- 4
APL	2	9	11	22	30	- 8
ALGOL	1.5	9	9	19.5	23	- 3.5
C	3	2	7	12	NA	NA
PL/M	2	2.5	6.5	11	11	0
FORTH	1.5	1.5	7	10	4	+ 6
LISP	.5	2	1.5	4	NA	NA
RPG	1	2	1	4	NA	NA
SNOBOL	.5	2.5	.5	3.5	NA	NA

Table 3: Ranking of language literacy. The first three columns contain raw data expressed as a percentage of the total number of returned survey forms in the 1980 survey. Defining literacy in a computer language as "knowing enough about it to use it" or "a desire to use it," we formed the fourth column as a sum of responses to frequent use, occasional use, or intended use. This gives a ranking of the various language options available for small computer users. The most significant change relative to the earlier (1978 survey) data is the movement of Pascal into fifth place in the ranking from its previous ninth-place ranking in our 1978 survey. The questions in both surveys were identical except that in the later one we added several languages to the list. Thus "NA" in the 1978 column indicates a language which was not mentioned explicitly in the earlier survey; no entry is shown in the change column for these languages.

Rank	CATEGORY	Mean
1.	Applications to Every Day Life	6.42
2.	Computer Control of Mechanics	6.21
3.	The Art of Programming	6.20
4.	Applications to Engineering	6.05
5.	The Art of Hardware Design	5.87
6.	Household Automation	5.75
7.	Personal Data Base Design and Implementation	5.73
8.	Applications to Personal Business	5.72
9.	Text Editing and Processing	5.67
10.	Computer System Design	5.58
11.	Graphics Software Design	5.52
12.	Computer Communications Networks	5.39
13.	Logical (Thinking) Games	5.25
14.	Educational Uses	5.15
15.	Voice Recognition	5.05
16.	Experimentation with Designs	4.94
17.	Design of Information Structures	4.90
18.	Simulations	4.87
19.	Voice Synthesis	4.86
20.	Applications to Physical Sciences	4.78

Table 4: Rankings of interest areas. A list of 38 categories was presented as part of the survey. Respondents were asked to give a personal preference ranking from 0 (no interest) to 10 (highest interest). The data from this question was tallied and the mean ratings for each computed. This list shows the top 20 categories ranked by this mean. The lowest ranking of the 38 categories shown in the question was 2.24.

Table 2 shows the distribution of costs. Note that approximately 43% of those who specified an approximate cost of their personal systems indicated \$3100 or more had been spent. The average amount spent was computed using the raw data for this question, prior to creation of this table. It is thus clear that the deviation between the average and the median is caused by a few expensive machines in the last, open-ended category of "over \$15,000."

A result of the high average cost of the present-day personal-computer system is that such systems are becoming more and more elaborate. No longer do we see as much use of a bare machine, without peripherals or mass storage. The typical \$7415 machine can and does support a significant amount of computing power. Nowhere is this more evident than in our continuing survey of that crucial part of computing, computer language literacy. Table 3 summarizes the respondents' use of various languages. As in previous versions of the survey, each language was associated with a mutually exclusive set of five states of language use: frequent, occasional, intended, no knowledge, and the catch-all "don't know or no answer." The interesting point to make here

Why not kill two birds with one stone?

If you have an Apple* and you want to interface it with parallel and serial devices, we have a board for you that will do both. It's the AIO.TM

Serial Interface.

The RS-232 standard assures maximum compatibility with a variety of serial devices. For example, with the AIO you can connect your Apple* to a video terminal to get 80 characters per line instead of 40, a modem to use time-sharing services, or a printer for hard copy. The serial interface is software programmable, features three handshaking lines, and includes a rotary switch to select from 7 standard baud rates. On-board firmware provides a powerful driver routine so you won't need to write any software to utilize the interface.

Parallel Interface.

This interface can be used to connect your Apple* to a variety of parallel printers. The programmable I/O ports have enough lines to handle two printers simultaneously with handshaking control. The users manual includes a software listing for controlling parallel printers or, if you prefer, a parallel driver routine is available in firmware as an option. And printing is only one application for this general purpose parallel interface.

Two boards in one.

The AIO is the only board on the market that can interface the Apple to both serial and parallel devices. It can even do both at the same time. That's the kind of innovative design and solid value that's been going into SSM products since the beginning of personal computing. The AIO comes complete with serial PROM's, serial and parallel cables, and complete documentation including software listings. See the AIO at your local computer store or contact us for more information.



2190 Paragon Drive
San Jose, California 95131
(408) 946-7400

*Apple is a
TM of Apple
Computers,
Inc.



Maybe we can save you a call.

Many people have called with the same questions about the AIO. We'll answer those and a few more here.

Q: Does the AIO have hardware handshaking?

A: Yes. The serial port accommodates 3 types—RTS, CTS, and DCD. The parallel port handles ACK, ACK, BSY, STB, and STB.

Q: What equipment can be used with the AIO?

A: A partial list of devices that have actually been tested with the AIO includes: IDS 440 Paper Tiger, Centronics 779, Qume Sprint 5, NEC Spinwriter, Comprint, Heathkit H14, IDS 125, IDS 225, Hazeltine 1500, Lear Siegler ADM-3, DTC 300, AJ 841.

Q: Does the AIO work with Pascal?

A: Yes. The current AIO serial firmware works great with Pascal. If you want to run the parallel port, or both the serial and parallel ports with Pascal, order our "Pascal Patcher Disk."

Q: What kind of firmware option is available for the parallel interface?

A: Two PROM's that the user installs on the AIO card in place of the Serial Firmware PROM's provide: Variable margins, Variable page length, Variable indentations, and Auto-line-feed on carriage return.

Q: How do I interface my new printer to my Apple using my AIO card?

A: Interconnection diagrams for many popular printers and other devices are contained in the AIO Manual. If your printer is not mentioned, please contact SSM's Technical Support Dept. and they will help you with the proper connections.

Q: I want to use my Apple as a dumb terminal with a modem on a timesharing service like The Source. Can I do that with the AIO?

A: Yes. A "Dumb Terminal Routine" is listed in the AIO Manual. It provides for full and half duplex, and also checks for presence of a carrier.

Q: What length cables are provided?

A: For the serial port, a 12 inch ribbon cable with a DB-25 socket on the user end is supplied. For the parallel port, a 72 inch ribbon cable with an unterminated user end is provided. Other cables are available on special volume orders.

The AIO is just one of several boards for the Apple that SSM will be introducing over the next year. We are also receptive to developing products to meet special OEM requirements. So please contact us if you have a need and there is nothing available to meet it.



SSM Microcomputer Products
2190 Paragon Drive
San Jose, California 95131
(408) 946-7400

The man, the wi



ing and the Apple.

If you could talk to Orville Wright, he'd tell you the problems he faced as a turn-of-the-century engineer. You could tell him all about the technological solutions available to today's engineer and scientist... particularly a 20th century phenomenon that tests assumptions and defines models before a project gets off the ground. The Apple personal computer.

Computation, calculation, analysis...the power to pilot your projects.

With a highly-integrated system from the extensive Apple personal computer family, Orville and brother Wilbur would have increased their productivity. Perhaps even launched the Kitty Hawk Flyer well before 1903.

An Apple in their hangar would have freed them from the time and tedium of crunching numbers by hand.

An Apple in your lab or office will give you the problem-solving capabilities you demand from a big computer...without the time-consuming problems typical of remote processing.

But the Apple system solution doesn't stop there. It keeps on soaring with proven performance, power and expandability

100 companies also supply peripherals for Apple because Apple is the most popular personal computer with the least complicated interface.

Want an efficient system of data storage and access? Apple's 5 1/4" disk drive not only offers you increased application versatility, but high density (143K bytes), high speed and low cost. You can even add up to four or more drives to your Apple system. With proven reliability, no wonder it's the most popular drive on the market today.



Wilbur determined that birds didn't have to constantly flap their wings to fly. With an Apple, he could've determined the fixed-wing design of the Kitty Hawk Flyer much faster.

FORTRAN that helped to design a 20th century flying machine.

Fluent in the same language that helped to design the 747, Apple FORTRAN lets you tackle differential equations at the touch of a key. And since more the 170 companies also offer software for the Apple family, you can have one of the most impressive program libraries ever...including vast subroutine libraries for math, science, engineering and statistics. When you write

parts selection. Learn why Apple emerges as the technological leader of reliable personal computer products that increase your productivity.

Let the Apple dealer show you how, by putting the system of your choice through its paces. He'll tell you about our extended warranty, support and service. And he'll prove that a personal computer is not just a flight of fancy but a serious solution. Don't let history pass you by. Visit your nearest Apple dealer, or call 800-538-9696. In California, 800-662-9238.

your own programs, the Apple also speaks in languages other than FORTRAN: Pascal, BASIC, PILOT and 6502 assembly language.

Where to learn more about Apple, the small-yet-serious solution.

Let your imagination soar with Apple.

Discover the 20th century tool versatile enough to monitor quality controls and manufacturing schedules, orchestrate tolerance tests and determine alternative

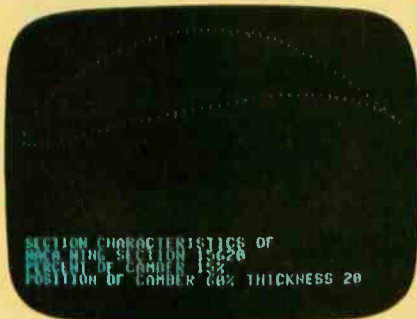

Apple's existing software library includes a program that plots the shape of an airfoil, given its parameters.

that's unparalleled for analyzing alternative paths of design and modeling a wide variety of physical processes.

Want more memory? Depending on your choice of system, Apple has memory expandable to 64K bytes or 128K bytes. Prefer wide displays? Choose 40 or 80 characters. Need to control instruments in the lab? Get on the IEEE 488 bus. Over

 apple computer



is the change between this year's survey and the 1978 survey.

In particular, due to the dominance of BASIC-oriented personal-computing machinery, BASIC remains unchanged at the top of the list in terms of literacy. (Literacy is defined here as the sum of the responses that indicated sufficient knowledge to use, or intend to use, the language.) But also significant was the change in the perception of Pascal on the part of readers. The ranking of this language by literacy has advanced 26.5 percentage points since the previous survey in January 1978. This is undoubtedly due to the increasing size of the typical machine and the wide availability of computer systems with the UCSD Pascal Software System (now marketed by SofTech Microsystems of San Diego, California).

Articles Policy

BYTE is continually seeking quality manuscripts written by individuals who are applying personal computer systems, designing such systems, or who have knowledge which will prove useful to our readers. For a more formal description of procedures and requirements, potential authors should send a large (9 by 12 inch, 30.5 by 22.8 cm), self-addressed envelope, with 28 cents US postage affixed, to BYTE Author's Guide, 70 Main St, Peterborough NH 03458.

Articles which are accepted are purchased with a rate of up to \$50 per magazine page, based on technical quality and suitability for BYTE's readership. Each month, the authors of the two leading articles in the reader poll (BYTE's Ongoing Monitor Box or "BOMB") are presented with bonus checks of \$100 and \$50. Unsolicited materials should be accompanied by full name and address, as well as return postage.

Software advertisements in BYTE for Pascal compilers or systems today number in the vicinity of a half a dozen, a significant indicator of interest in that language on the part of vendors.

We'll conclude by presenting one more table (table 4) which was derived from the survey responses. This table is a ranking of the top 20 areas of personal interest in the application and use of computers. Finally, to all those readers that responded to this survey with such enthusiasm, the entire staff of BYTE thanks you. ■

READ AMERICA'S NUMBER 1 NON-SELLER.

To get your free copy, just write:

**CONSUMER INFORMATION
CENTER,
DEPT. E
PUEBLO, COLORADO
81009**

NEW EATON 7000+ PERSONAL COMPUTER PRINTER

Now you can add hard copy capability to your computer with plug-in simplicity that matches up to any micro system. And with the Eaton 7000+ dot-matrix printer, you get complete printout versatility at an affordable price.

Interfaces with any personal computer

Apple, Commodore Pet, TRS-80, Northstar and others — no matter what type of computer you have or are thinking of buying, Eaton 7000+ fits. Just plug it in and start printing. You'll get virtually maintenance-free operation with a minimum of moving parts. And minimum life of 100 million characters with Eaton's newest printhead, while the print



mechanism is designed for a minimum of 10 million cycles.

High performance design

The 7000+ features uni-directional printing at a speed of 1.25 lines per second. It accepts any standard single or 2-ply roll paper from ¼" to

**PLUG IN AND
PRINT OUT —
IN SECONDS!**

3⅞" wide and prints 3⅞" line with 40 to 64 adjustable character capacity.

For immediate information call: Eaton Printer Product Operations, 307/856-4821.

For descriptive literature and the name of your nearest dealer write Eaton Corporation, Count Control/Systems Division, 901 South 12th St., Watertown, WI 53094.

Dealer inquiries invited.

EATON
Printer Products

TRS-80* Model I Computer Owners

Store More Data on a 5"-Disk Than on an 8"-Disk

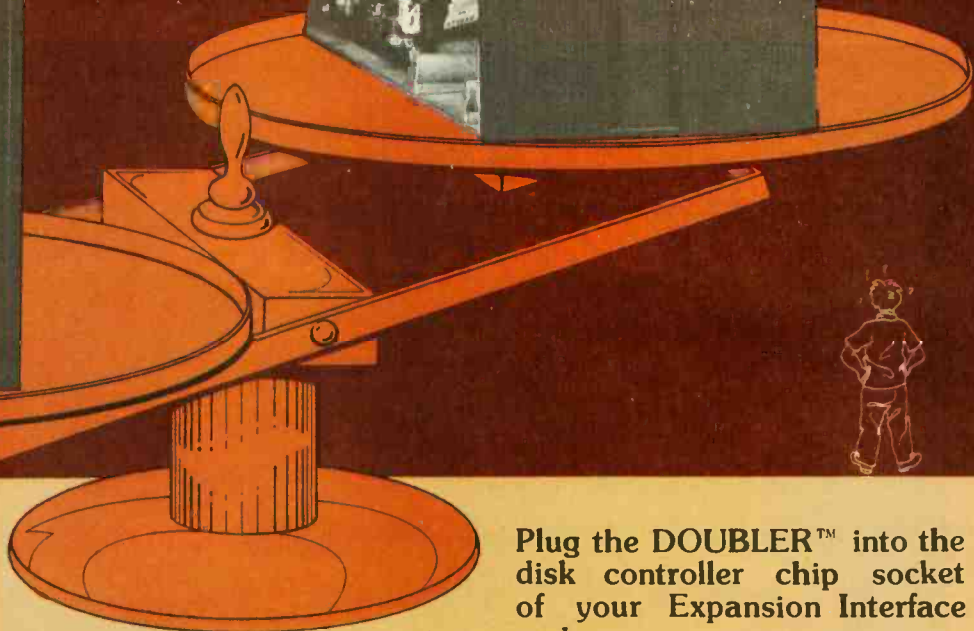
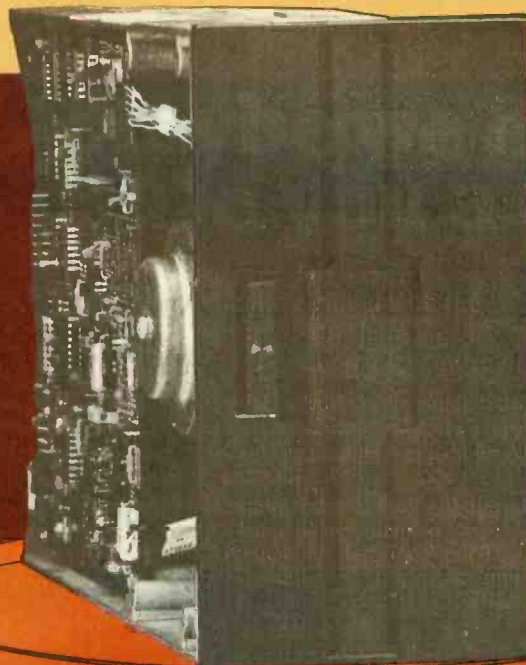
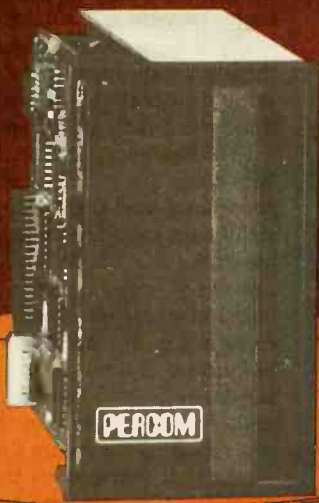

The Doubler™: Percom's new proprietary double-density adapter for the TRS-80* computer.

Plug the DOUBLER™ into the disk controller chip socket of your Expansion Interface and . . .

Store up to 354 Kbytes of formatted data on five-inch disks.

- Increase formatted storage capacity of your minidiskettes from 1½ to almost 4 times.
- Use with standard 5-inch drives rated for double-density operation.
- The DOUBLER™ reads, writes and formats either single- or double-density disks.
- Proprietary design allows you to continue to run TRSDOS*, NEW-DOS†, Percom OS-80™ or other single-density software without making any changes to software or hardware.

- Includes DBLDOS,™ a TRSDOS* compatible double-density disk operating system.
- CONVERT utility, on DBLDOS™ minidiskette, converts files and programs from single- to double-density or double- to single-density.
- **Plug-in installation:** No strapping. No trace cutting. Restore your Expansion Interface disk controller to original configuration by simply removing the DOUBLER™ and re-installing the original disk controller chip.

- The DOUBLER™ circuit card includes high-performance data separator, write precompensation circuits for reliable disk read operations — even on 77-track drives.



Introductory price, including DBLDOS™ and format conversion utility on minidiskette, only \$219.95. Use the coupon for even greater savings.

Call toll-free, 1-800-527-1592, for the address of your nearest dealer, or to order direct from Percom.

†Percom TFD-200™ drive, OS-80D™ operating system



Mini-Disk Systems

More storage capacity, higher reliability — from Percom, the industry leader. One-, two-

and three-drive configurations in either 40- or 77-track format, starting at only \$399.

PRICES AND SPECIFICATIONS SUBJECT TO CHANGE WITHOUT NOTICE.

PERCOM DISCOUNT COUPON
worth \$20
toward
The Purchase of a
DOUBLER™
Coupon No. B10101
Expires December 30, 1980
Void where prohibited by law.

PERCOM

PERCOM DATA COMPANY, INC.
211 N. KIRBY GARLAND, TEXAS 75042
(214) 272-3421

™ trademark of Percom Data Company, Inc.
* trademark of Tandy Radio Shack Corporation which has no relationship to Percom Data Company.
† trademark of Apparat Company, Inc.

Letters

Software Privateers

Personal computing today is confronted with one problem: software. Individual users can, with a few trivial commands, copy and give away any large, complex program. The result is a tremendous economic "disincentive" to the potential creators of great software. No one would spend years of his life

creating an algorithmic masterpiece, only to see it stolen upon release.

The solution to this problem is not unenforceable threats to prosecute thieves; one can go to any computer-club meeting and see how seriously those threats are taken, as users swap disks with abandon.

Some manufacturers are trying another approach. They are making

their machines hard to program, so that users must buy plug-in software that cannot be copied. This attempt to establish a monopoly, however, tends to fail: few people write programs for such machines, so they are unattractive to users, they do not sell well, and eventually they drop out of sight. By cutting themselves off from the vast, invisible army of user-programmers, makers of these machines cut their own throats.

I have a modest suggestion that may help solve this problem of software, economics, and theft. A producer of significant software must have the assurance that his creation, when sold to one user, cannot be given to another user to run for less than the original purchase price. There must be something unique (or at least distinctive) about the legitimate buyer's central-processing unit, so that his copy of the program can recognize its owner's computer, and work for it, but not for the thief's machine. (The program should be something like the giant's purse in "Jack and the Beanstalk," which cried out when stolen.)

I suggest that microprocessor manufacturers design into their processors a new command, IDENTIFY. When executed, the ID instruction would put some identifying number into one or several machine registers or memory locations.

After that, everything is up to the software producer. He must take the identifying number, manipulate it, move it around the programmable memory space, and otherwise so embed it in his program that any attempt to remove it will cost far more labor than the price of the program. When a user orders the program, he specifies his central-processor identifying number, and receives a personalized copy of the software. The backup copies that he makes will all run perfectly for him, as will the original program. They just won't work on a machine with a different identity.

Trustworthy, bonded distributors of the software, such as retail computer stores, can be given instructions (in the form of master programs) as to how to create personalized copies for purchasers. No radical changes in the software distribution system that currently exists would be necessary.

Even if microprocessors only give distinctive and not unique identifying numbers perhaps only 8 bits long, this system for discouraging software theft could still work well. If there is only one

NEW OPEN FRAMES AND SWITCHERS...

at our same old low prices!



More new open frames to choose from - plus new special-purpose models for specific applications such as Microprocessor and Floppy-Disk systems. Also, Power-One now offers a growing line of switching D.C. Power supplies with the same high quality and reliability as our open frame models.

FREE!

New 1980-81
Product Catalog...
plus our new
Tour Guide.
Phone or write for
your copies today!



POWER-ONE D.C. POWER SUPPLIES

Power-One, Inc. • Power One Drive • Camarillo, California 93010
Phone: (805) 484-2806 • (805) 987-3891 • TWX: 910-336-1297

INTRODUCING THE NEW INTERTUBE III™



In late 1978, Intertec conceived the idea of the InterTube Video Display Terminal. Since that time, we've greatly enhanced its operation with the addition of many new exciting features. But perhaps the most significant announcement in the InterTube line of video terminals is our new InterTube III.

The new \$895* InterTube III obsoletes dumb terminals and out-performs the smart ones. Powerful standard features include: a full 24 line by 80 character display, 128 upper and lower case ASCII characters, reverse video, complete cursor addressing and control, an 18 key numeric pad, user-defined function keys, blinking, a self-test mode, protected and unprotected fields, below-the-line descenders, automatic key repeat, twin RS232 serial ports and character and line insert/delete. Incredible!

InterTube III also boasts newly designed processor, video and power supply circuits. All in all, the InterTube III is what we believe to be the most powerful, reliable video terminal available today. And it costs less than its predecessor - our popular InterTube II.

InterTube III users will appreciate the many painstaking hours of human engineering which insure effortless operation without operator fatigue. InterTube III's new high resolution, non-glare CRT provides the sharpest possible display image. And our newly designed keyboard has that expensive "feel" you normally find only on terminals costing two to three times as much. But, most importantly, the InterTube III features state-of-the-art design with just three easily removable modules. So, with only a common screwdriver, servicing is a snap!

Better yet, we've got a nationwide service network with outlets located in over 50 cities to provide fast and efficient on-site or depot maintenance. Plus, an extended warranty program is also available.

If you're an existing InterTube user, you no doubt have discovered the exceptional value the InterTube really is. And, if you're not, why not call or write us today for the name and address of your nearest InterTube III dealer. Intertec video terminals are distributed worldwide and may be available in your area now.

 **INTERTEC
DATA
SYSTEMS®**

2300 Broad River Rd, Columbia, SC 29210
(803) 798-9100 TWX: 810-666-2115

chance in 256 that a bootleg copy will run, a lot less copying will occur. Producers of large programs can charge less for their software and still get a good return on their investments; lower prices for good software, in turn, will further reduce the pressure to steal it, etc.

The hardware/software combination approach to protecting programmers' property rights is simple and has many advantages. It can protect work done in high-level languages as well as machine-language products. It encourages users to develop and distribute their own programs. Most importantly, it works with economic forces instead of against them, unlike other anti-theft techniques. A relatively free market in computers has led to the miracle of constantly cheaper and more powerful machines for the past few decades. If software can fit into the same market system, I foresee an explosion in the release of creative human energy in that field too.

Mark Zimmermann
9410 Woodland Dr
Silver Spring MD 20910

While attempts to eliminate software piracy are commendable, they very often fail because of the cleverness of personal-computer users; many take the anticopy measures as a challenge. The

problem lies in making the protection scheme easy enough to be affordable, but complex enough to work.

Serial number protection is easy to defeat, since all the program is looking for is a number. A program similar to an interpreter can be written that supplies numbers sequentially, when the protect code is requested. Who cares if the computer must iterate through 256 or more combinations until it finds the key?... CPF

Saving Fingers

I was interested to read Rod Hallen's article "My TRS-80 Talks to My Cromemco Z2," June 1980 BYTE, page 88. My organization markets engineering design packages, mainly for structural engineering, which have been developed on large minicomputers and mainframes in BASIC and FORTRAN. We convert these into CP/M-compatible languages and distribute them on ALTOS, Cromemco, and similar computers.

We recently faced the grim prospect of having to hand-key 3500 lines of very complex FORTRAN IV program code for STRESS, a frame analysis program, but, on giving the matter careful thought, we organized the direct transfer of source code files from a large

minicomputer into CP/M disk files using the PIP facility.

The steps we took were as follows:

1. Load ASCII (American Standard Code for Information Interchange) source file tape on a Varian V77 operating under MP3.
2. Using the ALTOS in stand-alone mode, we loaded PIP, the CP/M transfer utility program. The command CON: = <filename.FOR> was entered. In this case, if the source tape had a set parity bit then the PIP command could have been extended to strip it off.
3. The video terminal cable to the ALTOS was disconnected.
4. A video terminal cable with the RS-232 pins 2 and 3 (TX,RX) reversed was connected between the Varian terminal-controller outlet and the ALTOS terminal connection. A patch box came in very handy here to check pin status.
5. The Varian was then given a command to read a named ASCII source file from tape and display it on the terminal selected for the transfer.
6. The data was then read into the ALTOS memory, 64 K bytes in this case.
7. On completion of the data transfer, the Varian terminal cable connection at the ALTOS was replaced with its own video terminal cable.
8. Control Z was entered on the ALTOS video terminal which caused the transfer of data from the ALTOS memory to the disk file named in the PIP command.

We repeated this activity until all the programs and libraries were transferred. The whole activity took about 1 hour. This compares very favorably with our estimate of at least 120 hours and indeterminate debugging of entry errors.

J Morton-Robertson
Engineering Systems Manager
Hill Price Davison
(Engineering Services) Limited
Walham House, Walham Grove
Fulham SW6 1QP, England

Blaise Trees

The article "Understanding ISAM," by Reginald Gates (June 1980 BYTE, page 108) was interesting and informative. Unfortunately, the article does not mention alternative ISAM organizations based upon B-trees. Such ISAM files do not suffer from disadvantages of reorganization as described in the article. An article in the *ACM Computer Surveys* (June 1979) describes the principles involved in the operation of B-tree files. One important property of these file structures is that reorganization is done as the file is created and changed.

ARTIFICIAL INTELLIGENCE For Your C/PM[®] or S-100 SYSTEM

"SHIVA[®]" is a highly-sophisticated VIRTUAL-PERSONALITY[®] multi-level multi-user multi-tasking executive (operating system) for S-100 based systems. It provides your microcomputer system immediately with power comparable to that of large-frame maxi-computers for a remarkably small price, yet SHIVA[®] requires surprisingly little R.A.M. area, and is conversational!!! SHIVA's[®] English-like input/output is interactive, dynamic, and may be reconfigured or expanded by the user. And SHIVA[®] gives you the freedom to expand indefinitely... with tremendous hardware and software choice: SHIVA[®] supports hard disks and floppies... R.A.M. addressing beyond 64 kilobytes... time-sharing... multi-level user-reconfigurable password protection... and features shell-commands similar to UNIX[®] in structure!! SHIVA[®] is compatible with C/PM[®] and C/DOS[®] for easy implementation and near universal software support!!! SHIVA[®] is available for 8080, 8085, MC6800, 6502, and Z80[®]-based systems.

Versions are in development for ZILOG Z8000[®] 16-BIT, INTEL 8086[®] and INTEL 88002[®] 32-BIT PROCESSORS...

And Omega Research[®] is dedicated to non-obsolescence and system superiority in software choice... SHIVA[®] supports BASIC, FORTRAN, COBOL, a MACRO-ASSEMBLER, DATA BASE MANAGEMENT, ALGOL-60, PASCAL... interfaces in development for UNIX[®], C, LISP, PL/I, APL, and RT-1[®].

And needless to say, SHIVA[®] is very fast... SHIVA[®]... \$350 -- Available on 8" I.B.M. Soft-Sector Diskettes and 5" C/DOS[®] (Cromemco) Diskettes. Includes complete Documentation... M.C. & Visa orders accepted

"SHIVA[®]," "VIRTUAL-PERSONALITY[®]," and "OMEGA RESEARCH[®]" are trademarks of OMEGA RESEARCH. "RT-1[®]" is a trademark of DIGITAL EQUIPMENT CORPORATION. "UNIX[®]" is a trademark of BELL LABORATORIES. "CP/M[®]" is a trademark of DIGITAL RESEARCH OF CALIFORNIA. "C/DOS[®]" is a trademark of CROMEMCO, Inc. "Z-80[®]" and "Z-8000[®]" are trademarks of ZILOG, Inc. "INTEL[®]" is a trademark of INTEL CORPORATION.

No shipments prior to return of signed software license agreement. For detailed information on "SHIVA[®]," send \$1.00 postage and handling to:



CALIFORNIA RESIDENTS ADD 6% SALES TAX



OMEGA RESEARCH

P.O. Box 479
Linden, Ca. 95236
(209) 334-6666

9am to 5pm Mon.-Fri.

Mountain Hardware makes more peripherals for the Apple Computer than Anybody.

and ...
a place to put them

INTROL X-10

Intelligent Home Controller for lights and appliances. Real-time schedules and energy conservation. Complete applications software package. Home security with random scheduler. Power usage accounting package for home energy cost control. No wiring required.

APPLE CLOCK

Real-time and date information. Interrupts permit Foreground/Background operation of two programs simultaneously. Battery back-up. Crystal-controlled for $\pm .001\%$ accuracy. Onboard ROM for easy access from BASICs. Supports PASCAL. Time from one millisecond to one year.

SUPERTALKER SD200

Input/Output Speech Digitizer. Permits talking programs. I/O capability allows interactive programs with speech-prompted inputs. Use output for speech directed activities in business systems, announcements in a control-room, or sound effects in entertainment programs. Easy to use because input as well as output is under user control with special software operating system.

ROMWRITER

Program your own EPROMs. Create your own firmware. Programs 2K, 2716 5V EPROMs. Disk software package provides easy EPROM programming. EPROMs are verified after BURN. RUN your programs from on-board socket or install them on ROMPLUS+.

ROMPLUS+

More power for your system through firmware. Six sockets accept 2716 EPROMs or ROM equivalents. Six or any combination can be used at once. Scratch-pad RAM and two TTL connectors. Special 2K ROMs available for powerful system enhancement: Keyboard Filter ROM—COPYROM—Others coming soon.

MusicSystem

Sophistication previously available only on experimental mini and mainframe computer synthesizers. Digital instrumental music synthesizer system. 16 voices in stereo. Instrument definitions simulate the sound of real instruments—and more. Fully programmable waveforms. Envelope Control. Composition system—sheet music input using standard music notation. Chords and multi-part scoring up to 16 voices. A true instrument that anyone with an Apple can play.

A/D+D/A

16 channels analog to digital input. 16 channels digital to analog output. Eight bit resolution. Super-fast 8μ sec. conversion time. Monitor and output to the real world. All on one card.



EXPANSION CHASSIS

By popular demand! Eight more slots for your Apple. Attractive sturdy enclosure. Its own heavy duty power supply. Easy to use. Address cards in Expansion Chassis the same way as in your Apple. Only one additional command to specify in Apple or in Expansion Chassis. Compatible with all Apple peripherals.

MOUNTAIN HARDWARE has the most comprehensive line of Apple peripherals available. Anywhere. From anybody. We know the Apple inside and out and are committed to providing the most innovative and unique products to expand and enhance its capabilities and use. After all, we were the first company to make an Apple peripheral—except Apple Computer.

The message is simple. If you have an Apple, you need to know MOUNTAIN HARDWARE.

Available at Apple Dealers worldwide.



Mountain Hardware

Leadership in Computer Peripherals
A Division of Mountain Computer, Inc.
300 Harvey West Blvd.
Santa Cruz, CA 95060 (408) 429-8600

MORE PERIPHERALS? Send me information.

NAME _____

ADDRESS _____

CITY _____ STATE _____ ZIP _____

Apple is a trademark of Apple Computer Inc.

There are several successful implementations of ISAM files using these structures. We have implemented a UCSD Pascal Unit for ISAM using a modified B-tree approach on file organization and maintenance. An index to a file is treated as another indexed file, so the system can handle any level of indexing and any size file. A primary key can be made up of several parts of the record, and secondary keys can also be defined on the record.

There are many extra features not normally available to ISAM users that increase our implementation's utility. Some of these are: an empty file does not need special handling, there is a read forward and a read reverse, there is an efficient block delete, there are various options on backup for the prime blocks and index blocks, and there are several utilities available for reorganization, creation, statistics, and recovery. The file scheme works equally well without an index and can be used for small tables.

The unit is being packaged and sold by ERA Computers, POB 500, Fyshwick, Canberra, 2609, Australia; further information can be obtained from them. ERA is also marketing another of our packages which enables FORMS for screen and printers to be easily created and manipulated. This also runs as a Unit in UCSD Pascal. It is a considerable advance on other known FORMS packages.

K Cox and Trevor Lawrence
School of Information Sciences
Canberra College of Advanced Education
POB 1, Belconnen A.C.T., 2616, Australia

Prime Performance

As a TRS-80 owner, I read with some amazement the results of a performance evaluation submitted by Charles H Porter and highlighted in the Technical Forum, on page 216 of the July 1980 BYTE. (See "TRS-80 Performance, Evaluation by Program Timing," March 1980 BYTE, page 84 and "Some More on Performance Evaluation," by Carl Helmers, respectively.) Inspecting Mr Porter's program revealed the algorithm to be the Sieve of Eratosthenes, and as written, won't work! Line 110 should read:

```
110 IF A(X)=0 THEN 100 ELSE 90
```

One can also eliminate line 50 and change line 60 to read:

```
60 DIM A(L)
```

Also, consider the following: In the process of DIMensioning an integer array, Level II BASIC initializes the elements to 0. Why bother to reinitialize them to 1

only to later set them back to 0 to flag that the element's subscript is *not* prime? Instead, eliminate the array "initialization" in line 70 and set the *nonprime* elements to 1. The result will be that all *prime* subscripts are represented by element values of 0. (Negative logic is often more appropriate or efficient, as in this case.) Eliminating the initialization loop from the program cuts another 55 seconds off the already impressive 6 minute 12 second execution time.

I also take issue with Mr Porter's use of Level II error trapping to implement the algorithm. A simple test of the value of X+2 exceeding the array limit would have sufficed as well as made the program more readily understandable.

The following version of Mr Porter's program will thus execute faster as well as include the "missing" prime not displayed in the original. Non-DISK BASIC users should eliminate lines 20 and 70.

```
10 DEFINT A-Z
20 S$ = RIGHT$(TIME$,8)
30 L = 10000 : X = 2
40 DIM A(L)
50 FOR I = 2 * X TO L STEP X : A(I) = 1 :
  NEXT
60 X = X + 1 : IF 2 * X <= L THEN IF
  A(X) = 1 THEN 60 ELSE 50
70 PRINT "START " ; S$ : PRINT "STOP " ;
  RIGHT$(TIME$,8)
75 INPUT "DISPLAY PRIME NUMBERS " ; X$
  : IF LEFT$(X$,1) < "Y" THEN END
80 FOR I = 1 TO L : IF A(I) = 0 THEN
  PRINT I,
90 NEXT
99 END
```

Les Parent
35 Barnesdale Rd
Natick MA 01760

Treasure-80

Different strokes for different folks. Here is one TRS-80 customer that thinks the Tandy Corporation does just fine in the software department. The TRS-80 is not just another CP/M machine, thank goodness. For my money, TRSDOS is a slicker, easier to use, and more modern operating system. And NEWDOS, the highly touted modified version of TRSDOS, is mainly notable for its incompatibility. If it weren't for NEWDOS, users wouldn't need SUPER-ZAP to apply all those machine-language patches to get their software to run. I haven't seen a word-processing package that can touch SCRIPSIT. I spent good money for the Microsoft macroassembler, then went back to using EDTASM. The list goes on.

Personal-computer magazines need to look at the TRS-80 in a new light, and view it as an entity unto itself, not an aberration to be forced into the familiar CP/M mold. CP/M may be familiar to some, but TRSDOS is familiar to me,

Industrial quality components for S-100 system builders, from California Computer Systems.

2422 Disk Controller. Single and double density controller for up to four 5¼" or 8" single-sided drives, or two double-sided drives. Shipped with CP/M 2.0, the controller reads and writes IBM-standard single density. Automatically determines disk density—single or double. Supports PerSci auto eject, plus fast-peek for voice coil systems.

2810 Z80 CPU Board. Capable CPU for S-100 Systems operates at 2 or 4MHz, is fully Altair/Imesai compatible. Z-80 monitor is available separately. Includes auto addressing to 4K boundaries, plus a serial port for serial devices, including terminals and printers. Supports both front-panel operation and power-on memory jump, plus wait-state generation for slower memories. Compatible with proposed IEEE S-100 standards.

2032A 32K Static RAM. Fast static memory operates without wait states at a full 4MHz. Supports full and partial bank select, for expansion beyond 64K. Addressable in 8K blocks at 8K boundaries. Address and data lines are fully buffered, and there are no DMA restrictions.

2016 16K Static RAM. Fully buffered board features 2114 static RAMs for +5v operation. Bank select available by bank port or bank byte, for system expansion beyond 64K. Addressable in 4K blocks at 4K boundaries. LED indicators for board selection and bank selection. Available in 200, 300, or 450 nsec versions. All versions support 4MHz operation with no wait states.

2200A Mainframe. Rock solid, heavy gauge cabinet includes 12-slot, actively terminated S-100 motherboard, fan, and power supply. Power supply features 105, 115, or 125 volt AC input power; provides +8vDC at 20 amps, ±16v DC at 4 amps. Available in five colors. Includes convenient, front mounted, lighted reset switch.

2501A Mother Board. 12 slots, actively terminated, with all S-100 connectors included. Distributed power line bypass, low inductance interconnect—extremely low bus noise.

Prototype Boards. Four high quality prototype boards: Solder Tail, Extender/Terminator, Wire Wrap, and Etch.

P2802AA 6502 CPU. Stand-alone CPU generates fully S-100 compatible I/O signals; executes 6502 machine language. Operates at 2MHz; capable of DMA operation.

Available nationally.

California Computer Systems industrial quality S-100 products are available at over 250 computer retailers. Volume customers should contact the marketing department at CCS.

CCS. Industrial standards.

We see the S-100 a little differently.



**We mass-produce S-100
products to deliver industrial
quality, at industrial prices.**

You systems builders who need top quality, full featured, *workhorse* S-100 building blocks at the most competitive prices now have a source. California Computer Systems.

Industrial quality means top grade materials, components, and assembly, plus complete testing for absolute reliability.

Industrial quality means solid designs, a full complement of the important features you require, and a product line that delivers performance.

Industrial pricing comes from mass production. We buy at the right prices, and build *in quantity*, using state-of-the-art facilities and techniques. Including complete burn-in, for full performance right off the shelf.

Our industrial point of view means you get higher performance, greater reliability, and lower prices. If these are features you would like to see in your S-100 system, see things our way.

Because for serious users with serious uses for the S-100, these are the industrial standards.



California Computer Systems

250 Caribbean Sunnyvale, CA 94086 (408) 734-5811

and the CP/M-based software I have seen thus far is clumsy and old-fashioned by comparison to the newer products. CP/M is touted as "the software bus." Let us take note of the obsolescence of the S-100 bus standard. It will soon be replaced by a new standard. Is not CP/M in the same position?

Many years ago, IBM's customer base insisted that IBM retain its old familiar operating systems. Those customers today suffer from obsolete, clumsy, inefficient, and troublesome software that is truly laughable by today's standards. There is a lesson here for the microcomputer world. Nostalgia is a luxury we cannot afford.

John R Culleton Jr
Culleton Group
2401 Haight Ave
Sykesville MD 21784

Superb Brain

For any BYTE readers who may have had problems with the Intertec Superbrain operating systems, I would like to recommend the services of Information Engineering, POB 198, 8 Bay Rd, Newmarket NH 03857, (603) 659-5891.

I am a writer who bought a Superbrain for use with Micropro's Word Star software as a word-processing system. A

bug was present from the beginning. After saving a file and calling it back for editing, I was always confronted by several lines of garbled text (usually about 28 lines into the file). I had difficulty meeting deadlines because overcoming the bug, which happened in every file, proved time-consuming. I thought that the fault lay with Word Star, but Word Star proved blameless. Both my software and hardware vendors tried to help, but neither succeeded.

Intertec listened to my description of the problem and offered two suggestions. The first: that I should have my local dealer replace the EPROM (erasable programmable read-only memory) that came in my Superbrain. The Intertec representative suggested that \$125 would be a reasonable fee for this replacement. The second suggestion: that I should have a \$1500 hardware "upgrade." When I asked my local dealer, he knew nothing about the replacement EPROM. He said calls to Intertec provided no clarification. As for spending \$1500 to "upgrade" a two-month-old computer that never worked correctly, I considered that suggestion tantamount to an admission that something was wrong with the computer as originally sold.

My hardware vendor heard about Information Engineering and gave me the

telephone number. I called, and Mark Klein answered. He asked me a few questions that indicated familiarity with the kind of problem I was having. He took down the serial number of my Superbrain and my phone number. Later he called and said that he could definitely fix the problem. Information Engineering made and sent me an EPROM to replace the one supplied by Intertec. Together with an operating-system patch supplied by Information Engineering on disk, the Information Engineering EPROM fixed the Superbrain at once. Not only did Word Star and CBASIC run perfectly, but the disk drives operated much more quickly and quietly.

I have written this letter because I would like other Superbrain owners to know that they can get help from Information Engineering if they experience problems like the one that I did.

Philip Lemmons
201 E 36th St
New York NY 10016

I talked with Mark Klein of Information Engineering, and learned that the problems encountered by Superbrain users were frequently due to software. In most cases, a new EPROM (erasable programmable read-only memory) and a patch to the CP/M BIOS (the input/output handler for CP/M) cures the problem. According to a flyer put out by Information Engineering, the cost of the fix is \$150, and the following advantages are gained:

- improved disk handling;
- use of all available space on disk;
- ability to run programs larger than 30 K bytes;
- keyboard type-ahead;
- ADM-3A cursor- and screen-control codes available; and
- serial number keyed to machine serial number. . . .CPF

A SwTPC 6800 User Needs Help

I own a Southwest Technical Products (SwTPC) 6800 development system, with which I need to program some PROMs (programmable read-only memories). I have not been able to successfully load my memory-resident PROM-programming code using my cassette interface. Can a reader of BYTE send me a listing of this PROM-programming program, so that I can compare it against the code in my system's memory? Thanks.

Bob Abbott
3333 Toledo Ave
Lubbock TX 79412

Letters continued on page 294

A CREATION OF COMPUTER HEADWARE

WHATSIT?™

(Wow! How'd All That Stuff get In There?)

A sophisticated, self-indexing filing system—flexible, infinitely useful and easy to use, that adapts to your needs.

WHATSIT comes ready to run on your Apple, NorthStar, or CP/M computer. See your dealer... or write or call:

NEW! Now available for AlphaMicro users. All the standard WHATSIT features... plus SORT capabilities.

HARDHAT Software

P.O. Box 14815 • San Francisco, CA 94114 • Tel: (415)621-2106

Thousands of SoftwareHows™ users agree — SoftwareHows products set a new standard of excellence for solution-oriented software. Instant installation for your system, powerful “word processing-like” editing facilities and consistent operating features make this SolutionWare™ the only serious choice for your needs.

Why settle for a piece when you can have the whole pie?!

At last! An integrated system of business software ideal for you!

How often have you purchased software only to be disappointed by its features or frustrated by the inability of the different programs to work together? Are you tired of entering the same data into your Purchase Ordering System when a part is ordered, into Inventory when it arrives, Payables when it's invoiced and General Ledger when it's paid for? Can you easily link your Accounting Data Base with your word processing software to create personalized letters, reports, notices and announcements? Does your Point of Sale, Order Entry software also save a keyed file which may later be Sorted for over 60 customer characteristics and used to generate personalized sales literature?

If you don't like your answers to these questions, your accounting software is costing you money!

The Data Base Integration™ System from SoftwareHows™ does all this and much more! This newest software product offers the perfect blend of performance, price and flexibility. Every single transaction feeds your master records. This common data base approach organizes all your business information so that every module is fully interactive. The result of this vast and easy to use data base is unique. You'll be amazed at how much better you'll understand the operation and cash flow of your business! And better understanding means better planning — and higher profits for you!

The Data Base Integration System is built around the basic four accounting tools: General Ledger provides those all important balance sheets and income statements, Accounts Receivable and Payable take care of invoice control in a jiffy, while Payroll with Cost Accounting does your payroll and provides cost effectiveness data. All packages fully interact and are self-checking. The amazing Order-Right™ order entry system and MicroDaSys Inventory, give you one of the most complete sales management and material requirements systems available. Output is processed with lightning speed and meticulous accuracy: invoices, shipping labels, charge slips and COD tags. Orders automatically interact with Inventory and Receivables. If your stock is too low, Inventory recommends the best source of supply and approximate prices to pay. Upon authorization, a purchase order is generated. The receiving department verifies receipt and the invoice is transferred to Accounts Payable.

The Data Base Integration Business System is \$2500. And that's for all seven packages! Now there's a deal too good to pass up! It includes over 1500 pages of user documentation, and a supply of computer forms. With our unique DBI Installation Program, getting the complete package up and running on your system is a breeze. Best of all, complete CBASIC source code is included with every CBASIC package. Current disk formats include 8" soft-sectored, 5" hard- and soft-sectored.

Call or Write for the SolutionWare™ to meet your software needs — today!

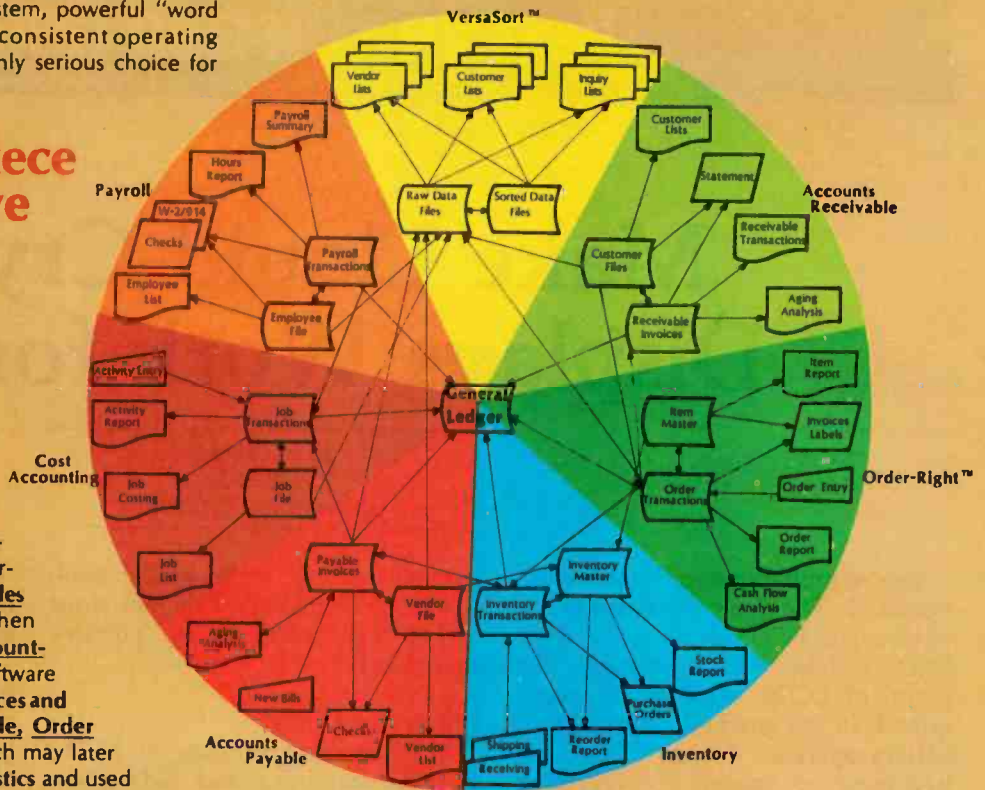

- Ask your dealer why our business software is the best!
- A Complete 200 page Overview of all SoftwareHows SolutionWare is yours for just \$75, refundable with purchase.

SOFTWARE HOWS™ a division of MicroDaSys

PO Box 36275 Los Angeles, CA 90036
(213)731-0876 TWX:910-321-2378

Make Liquid-Crystal Displays Work for You

Steve Ciarcia
POB 582
Glastonbury CT 06033

You've probably seen the abbreviation LCD. The chances are that many of you own LCD calculators or wear LCD watches. Liquid-crystal displays, or LCDs, are enjoying rapid growth in key markets, especially in battery-operated devices. They are beginning to appear in everything from computer games to handheld terminals.

Rather than emitting light, as in the case of LEDs (light-emitting diodes), LCDs are light reflectors. They are primarily used in high-ambient-light situations and require external "backlighting" for low-ambient-light use. Since they are non-illuminating, they consume very little power and can be driven directly from CMOS

(complementary metal-oxide semiconductor) circuitry. This fact alone makes them valuable for portable equipment.

What Are LCDs?

They are two families of LCDs: *dynamic-scattering* and *field-effect*. *Dynamic-scattering* devices harness the intermolecular turbulence created when a current flows through liquid-crystal material. This turbulence produces a frosty characteristic on a clear or reflective background. Dynamic-scattering LCDs were the first type of LCDs to be developed, and they have some built-in problems.

Besides having a high threshold voltage (12 V to 15 V), there is a

"Catch 22" associated with their operating principle. Small impurities are added to facilitate current flow. These impurities, which are susceptible to humidity, oxygen, and the ultraviolet component of sunlight, break down. As they break down, current flow increases, causing further contamination. These early displays lasted only about a year in normal operation. They are not widely used anymore.

Second-generation LCDs utilize *field-effect* technology. In contrast to the current-operated dynamic-scattering devices, field-effect LCDs are voltage-operated.

The liquid-crystal material is an organic compound with *nematic* properties. The long axes of the molecules are parallel but are not arranged in distinct layers. Within specific temperature ranges they exhibit properties of both liquid and solid states. The long and cylindrical molecules, when brought in contact with a treated glass surface, align themselves along a specific axis to form a polarizing filter.

There are three types of LCDs: *reflective*, *transmissive*, and *trans-reflective*. The *reflective* LCD consists of a vertical polarizer, the liquid-crystal material, a horizontal polarizer, a reflector, and indium-oxide electrodes all mounted in a glass sandwich (see figure 1). The vertical polarizer, which works like a Polaroid sunglass lens, permits light only with a particular orientation to pass through.

When the display is unenergized, this light passes through the liquid-crystal material and is twisted 90°

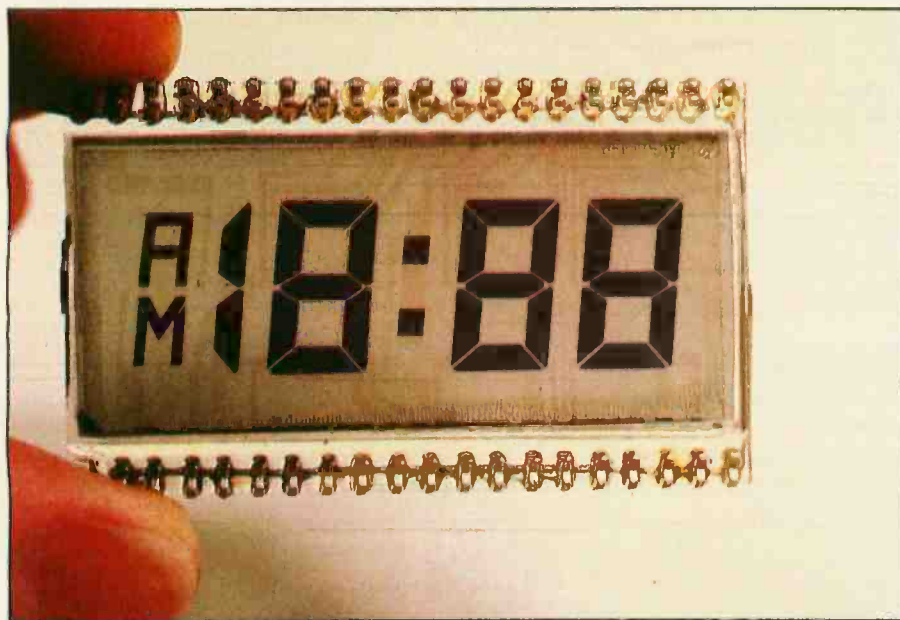

Photo 1: Standard three-and-a-half-digit clock/multimeter display. The unit shown is transmissive and has no rear reflector. All segments are energized in this photo.



The most far-reaching business tool since the telephone.

Nixdorf's LK-3000 with RS232 interface.

It's the world's first truly portable remote multi-function mini-terminal. Specially designed for executives, field service personnel, sales reps, any business person who needs to enter or receive information from a central computer over ordinary telephone lines. In effect, it makes any business computer a computer network as far-reaching as the world's telephone systems.

The remarkable LK-3000 with RS232 interface and acoustic coupler can do anything a standard terminal can do, yet it weighs only three pounds, fits comfortably in any briefcase, and is so inexpensive, every business person with a computer and a telephone should have one.

How it works.

Simply dial your own computer directly, place the telephone handset into the acoustic coupler, and

you're in business. You can enter or receive any information you choose. Directly from a client's office, your home or hotel room. Anywhere there's a phone. Anytime there's a need.

The RS232 module operates at 110 or 300 bits per second, asynchronous with simple self contained protocol software. Optimal features such as odd/even parity and Baud rate are selected through the LK-3000 keyboard. 300 Baud is achieved through a Nixdorf LK-4040 acoustically coupled modem.

Other specifications include 80-character display buffer, optional half or full duplex, 8-bits word length including parity, and three stop bits. **Multi-function personal computer.** In addition to interfacing with a central computer, the Nixdorf LK-3000 is a multi-function personal computer in its own right. It's specially designed to accept a wide variety of other

interchangeable function modules. Simply switch modules, and it becomes a language translator (new language modules will soon be added to the 11 already available), a five-function calculator, or a system for indexing files. There's even a programmable "electronic notepad" module that allows you to record any information you choose. Names, dates, appointments, tax data and much more.

With RS232 interface module, the Nixdorf LK-3000 is a mini-terminal that turns every telephone into your personal computer. With its many other function modules, it's the most versatile personal computer ever developed. And the only portable personal computer offered by a professional computer company.

For more information, write Nixdorf Computer Personal Systems, 168 Middlesex Turnpike, Burlington, MA 01803, or call toll free **(800) 225-1992.**

NIXDORF
COMPUTER

1a

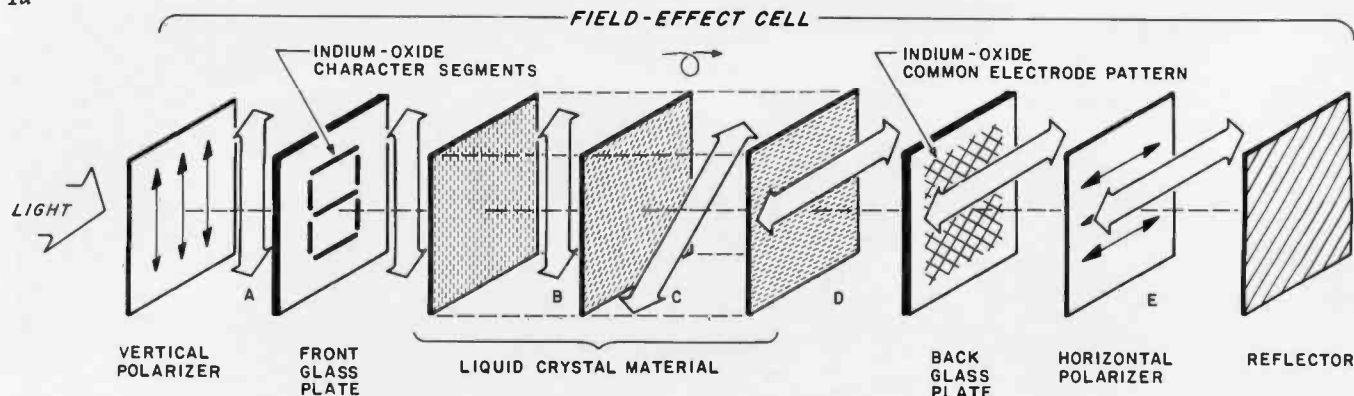

1b

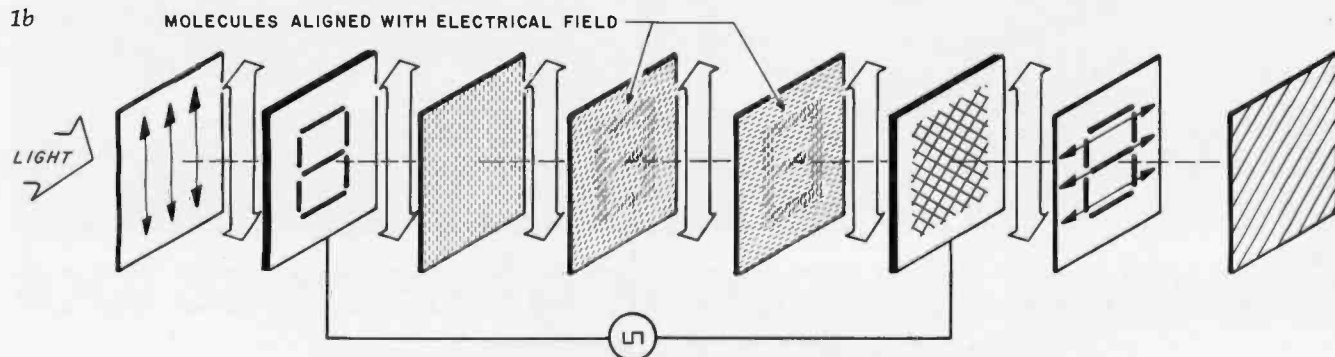

Figure 1: Block diagram of a field-effect liquid crystal. Field-effect liquid crystals are voltage-operated.

In the unenergized case (figure 1a), light enters a vertical polarizer at the front, and proceeds through the front glass plate containing indium-oxide electrodes, in the shape of a seven-segment display in this case. (Note: The electrodes are shown darkened in this illustration for clarity. In actual operation, they are transparent.) The light is then twisted 90° through the liquid-crystal material, proceeds through the horizontal polarizer, and is reflected back through the entire assembly. The viewer sees a blank display.

In the energized case (figure 1b), the indium-oxide electrodes are activated and the corresponding portions of the liquid crystal align themselves with the electrical field. Thus, they no longer twist the light going through them by 90°. Light passing through these segments cannot pass through the horizontal polarizer, and these portions look dark to the viewer.

Never so fast . . . Never so easy!

Animation for the Apple II

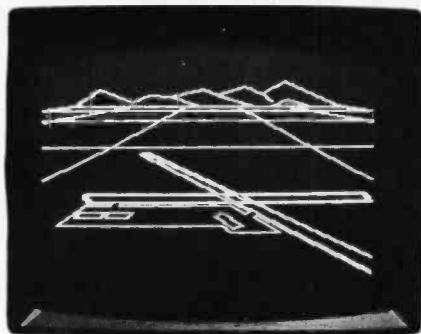

With SubLOGIC's A2-3D1 high-speed 3D animation package for your Apple, you can • generate scenes or drawings • view them from any distance or angle and, yes • even rotate them. All you need is 16K RAM and the creative urge.

116 pages of documentation included to guide the beginner through scene creation, storage, retrieval, movement, and advanced applications.

Special Features:

- 100-150 lines-per-second projection rate
- Dual page flicker free animation
- Scenes created with standard coordinates
- Easy use with BASIC programs

Cassette \$45 or disk \$55. See your dealer or order direct (include \$1.75 for UPS or \$2.50 for first class mail). Illinois residents add 5% sales tax. Visa and Mastercard accepted.

The engineering and graphics experts opening a new era in computer simulation.

subLOGIC
Distribution Corp.
Box V, Savoy, IL 61874
(217) 359-8482

ATARI® PERSONAL COMPUTER SYSTEMS THAT GROW WITH YOU



modulator and FCC approval for connection to any TV. Plus, nationwide Atari Authorized Service Centers. And more.

Add memory. The ATARI 800™ is supplied with 16K of memory. You can expand up to a full 48K of RAM with 8K or 16K Memory Modules™ you install yourself. In less than a minute. The ATARI 400's™ 8K of RAM may be expanded to 16K at Authorized Service Centers. Both may be expanded to 26K of ROM with slip-in ROM cartridge programs.

Add peripherals. The ATARI 410™ audio-digital program recorder. Single or dual density* disk drives. The ATARI 800 individually addresses up to four drives. Add the ATARI 850™ RS232 Interface Module. Add high speed 40 or 80-column printers. Add an acoustic modem for remote data access. Add a light pen.* And there are more Atari peripherals on the way.

Add programs. Choose among dozens of programs in Atari's rapidly expanding software library. Programs categories include:

- Personal Finance & Record Keeping
- Personal Interest & Development
- Professional Applications
- Education
- Information & Communication
- Entertainment
- Programming Languages
- Small Business Accounting

Add it up. With Atari, you start with more. And you can build to more. Because Atari offers you personal computer systems that grow with you. Ask your Atari retailer to give you a full demonstration of Atari computers, peripherals and programs. Complete systems. Because when other people were thinking hardware and software, Atari was thinking systems.

* Available Fall, 1980



PERSONAL COMPUTERS

1265 Borregas Avenue, Sunnyvale, CA 94086

Call toll-free (800) 538-8547 (Except Alaska and Hawaii)

(In California: (800) 672-1404) for the name of your nearest Atari retailer.

Start with a better computer.

Atari computers have built-in capabilities you can't even add onto many other personal computers. Three programming formats (ROM cartridge, disk and cassette). A 57 key upper/lower case ASCII keyboard with 29 keystroke graphics symbols. 128 colors and hues. Four separate sound channels and a built-in speaker. Four controller ports. A built-in RF

© 1980, Atari, Inc.

A Warner Communications Company
Atari reserves the right to make changes to products or programs without notice.



CHOOSE...

Choose an Apple Desk



A compact bi-level desk ideal for an Apple computer system. This 42" x 31 1/2" desk comes with a shelf to hold two Apple disk drives. The top shelf for your TV or monitor and manuals can also have an optional paper slot to accommodate a printer.

Choose a Micro Desk



Get your micro computer off the desk top and into the micro shelf under our Designer Series desks. Suitable for the North Star, Dynabyte, Vector Graphics, and Altos computers. The desks come in a variety of sizes and colors.

Choose a Mini Rack



Mini racks and mini micro racks have standard venting, cable cut outs and adjustable RETMA rails. Choose a stand alone bay or a 48", 60", or 72" desk model in a variety of colors and wood tones. A custom rack is available for the Cromemco.

Choose a Printer Stand



The Universal printer stand fits the:

- | | |
|--------------------|------------------------|
| Centronics 700's | Diablo 1600's & 2300's |
| Dec LA 34 | T.I. 810 & 820 |
| NEC Spinwriter | Okidata Slimline |
| Lear Siegler 300's | Anadex 9500's |

Delivery in days on over 200 styles and colors in stock. Dealer inquiries invited.

ELECTRONIC SYSTEMS FURNITURE COMPANY

17129 S. Kingsview Avenue
Carson, California 90746
Telephone: (213)538-9601

with respect to the vertical polarizer. Shifted in this way, the light passes through the horizontal polarizer, which has a similar polar orientation. The result is that light passes freely through the cell and the LCD appears transparent.

When the display is energized, the molecules in the liquid-crystal material align themselves with the electrical field, and polar rotation no longer occurs in the region of the character-pattern elements. The vertically-polarized light conforming to the image produced by these elements cannot pass through the horizontal polarizer, and is absorbed by it instead. The energized display elements therefore appear as black images against a light-colored background. The reflector is placed behind the display to take advantage

of ambient light and reflect the pattern image back to the viewer.

The *transmissive* LCD has no reflector and appears as plain glass when unenergized. Both reflective and transmissive LCDs are shown in photo 2. To view the characters on this unit properly, a light source must be placed behind the display. A *transflective* LCD combines the properties of both. It has a reflector for daylight operation, but the reflector is thin enough to allow back lighting in the dark. An example is an LCD display in a wristwatch.

Using LCDs

Basically, LCDs are low-voltage AC (alternating current) devices. They typically operate within the range of 3 to 12 V RMS (root mean square). (Some circuits run on 1.5 V

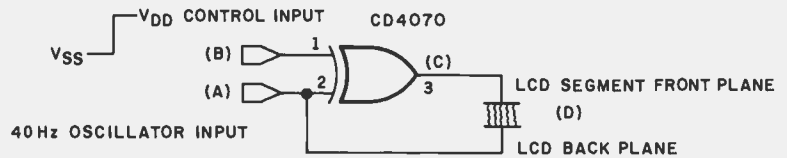

Figure 2: Liquid-crystal driver technique. LCDs are driven using symmetrical square waves with less than 50 mV DC offset. The low-offset AC drive is obtained in all LCD drivers by the use of exclusive-OR outputs. The configuration shown will result in a low-DC-offset AC drive with $2 \times V_{DD}$ peak value, or an RMS value of V_{DD} for the LCD.

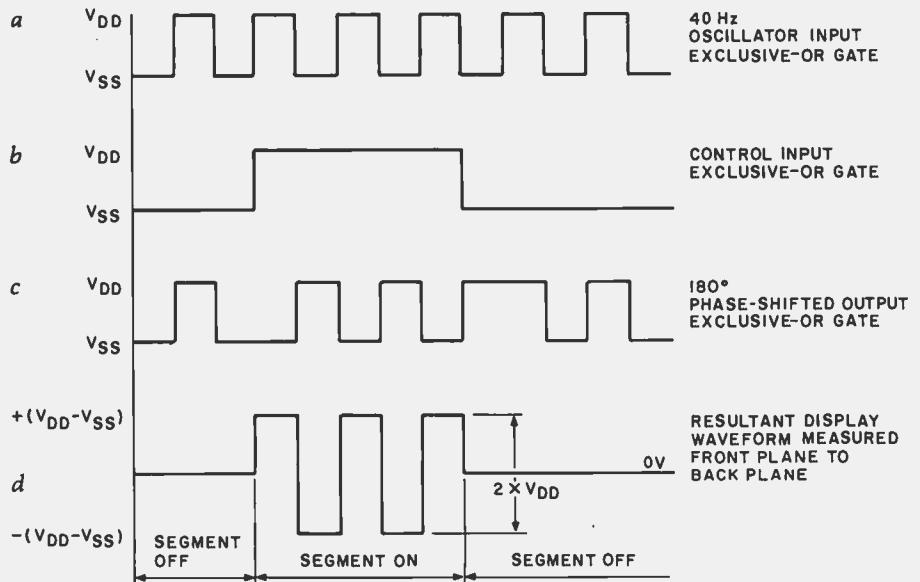
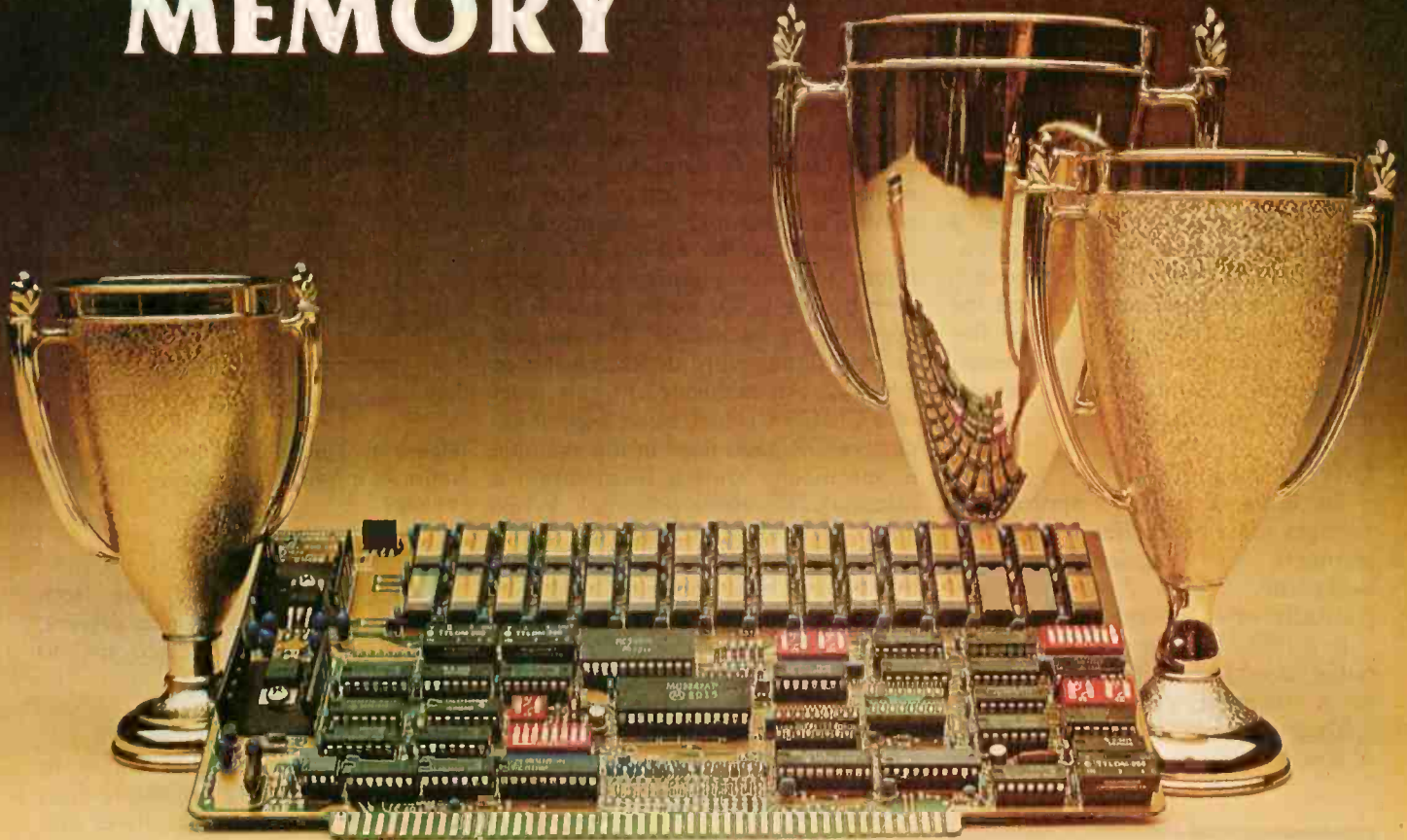

Figure 3: Waveforms occurring during typical LCD operation. To drive an LCD, appropriate voltages must be applied to the "on" segments, the "off" segments, and the backplane. Here an exclusive-OR logic gate is used to drive one of the segment electrodes, as shown in figure 2. Waveform (a) is a 40 Hz 50%-duty-cycle square-wave input to the exclusive-OR gate. (b) is the segment on/off control input. When the control input is high, (c) is the output of the exclusive-OR; (d) is the waveform seen by the LCD, measured with respect to the backplane. It is an AC signal with a peak RMS value equal to $2 \times V_{DD}$.

THE UNBEATABLE S-100 MEMORY



That's the MEASUREMENT systems & controls DMB Series of S-100 bus memory modules, fully compatible with **ALPHA MICRO, CROMEMCO, NORTH STAR, MP/M,** and most other S-100 systems.

Definitely a winner, the DMB Series is available with Bank Select (DMB6400) or without (DM6400) and utilizes industrial quality construction, provides outstanding reliability, and is backed by dedicated customer service and a one year guarantee.

The DMB6400 uses I/O port addressing for the bank select feature. A switch provides the ability to select any one of the 256 I/O ports for addressing the memory banks. The memory is configured as four totally independent 16K software selectable banks, with each bank addressable on any 16K boundary.

Outstanding features such as those listed below make the DMB series the UNBEATABLE S-100 Memory.

- Four independent 16K software selectable banks.
- Each bank is independently addressable on any 16K boundary.
- Switch selectable bank sizes — from 16K to 64K in 16K increments.
- Eight banks (512K) per I/O port for each of the 256 ports.
- Z-80 4MHz operation with no wait states using transparent refresh.
- On-board diagnostic LED's.
- Low power — 8 watts maximum.
- Reliable, tested and burned-in memory.
- IEEE S-100 compatible timing.
- One year guarantee.
- Attractive Dealer & OEM Prices.

See your nearest computer dealer, or contact us for the complete story on the UNBEATABLE S-100 Memory.

Systems Group

A Division of MEASUREMENT systems & controls
Incorporated

867 North Main St. / Orange, Calif. 92668 / (714) 633-4460
TWX/TELEX: 678 401 TAB IRIN

but incorporate a voltage doubler or tripler for the display.) Higher peak voltages are allowed, but it is the RMS value that is important. The DC (direct current) offset potential of the drive signal must be less than 50 mV; DC tends to degrade the liquid-crystal material.

Also, since the device consists of two conductors separated by a dielectric (ie: insulating material), it functions electrically like a capacitor. The frequency of the AC drive signal, while not critical, does have a preferable range. A property of capacitors is that the higher the frequency, the lower the reactance, and the greater the current drain. If the frequency is too low, flicker will result. In general, 25 Hz should be the minimum frequency.

Driving the LCD

To drive a display, appropriate voltages must be applied to the "on" segments, "off" segments, and the backplane. Figure 2 shows schematically what this entails.

In a typical driver circuit, the output of an exclusive-OR logic gate goes to a segment electrode. This is analogous to one of the seven inputs of a seven-segment LED display. The

oscillator input, which also cycles the exclusive-OR gate, is connected to the LCD backplane terminal. This connection is roughly equivalent to the common cathode on an LED display. To turn the segment on, simply apply a logic 1 to the control input (pin 1); to turn it off, apply a logic 0.

Figure 3 illustrates the resultant waveforms. Figure 3a is a 40 Hz 50%-duty-cycle square-wave input to the exclusive-OR gate; 3b is the segment on/off control input. When the control input is high, waveform 3c is the output of the exclusive-OR. In figure 3d, the waveform is shown as seen by the LCD, measured with respect to the backplane. The result is an AC signal with an RMS peak of $2 \times V_{DD}$. An exclusive-OR gate (part of a CMOS CD4070 quad 2-input exclusive-OR gate) used in the example is specifically chosen to maintain a minimal DC offset potential. While TTL (transistor-transistor logic) devices will work in theory, the 200 mV typical offset potential will considerably shorten the life of the LCD and should not be used. To connect LCDs to TTL, the preferred method is to use a CMOS BCD (binary-coded decimal) latch/decoder/LCD-driver such as the MC14543. A schematic diagram of a typical circuit is shown in figure 5.

For larger displays, such as in a four-digit multimeter, we could add three more MC14543s or use a single Siliconix DF411 four-digit LCD driver. (Figure 6 demonstrates this application.) Rather than four separate BCD inputs, totaling sixteen lines, the DF411 relies on a multiplexed data input. Each digit is sequentially loaded by setting the 4-bit BCD code lines on B0 thru B3 and

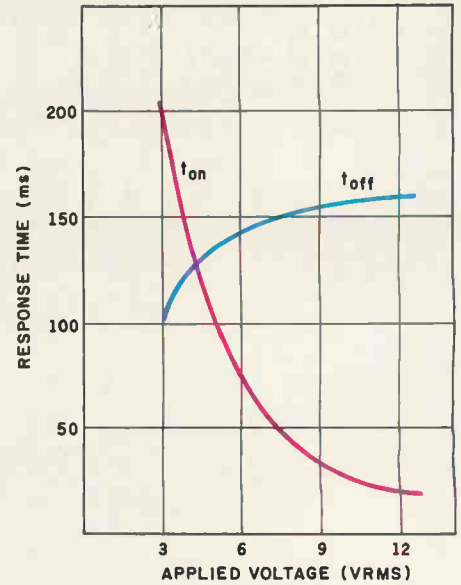

Figure 4: Typical LCD on/off response times as a function of applied AC input voltage.

strobing the proper digit line. Both examples utilize static display drivers. This is the least complicated method to use.

Multiplexed LCD Displays

The first thought that comes to mind when using multiple-digit displays is to use a single driver unit and multiplex it among the digits. This is the classic method used in LED displays. With LCDs, however, there are some extra considerations.

Of the two basic types of LCDs, the

	Function	Pin Number
digit 1	a1	37
	b1	38
	c1	39
	d1	40
	e1	2
	f1	4
	g1	3
digit 2	a2	6
	b2	7
	c2	8
	d2	9
	e2	10
	f2	12
	g2	11
digit 3	a3	13
	b3	14
	c3	15
	d3	16
	e3	17
	f3	19
	g3	18
digit 4	a4	20
	b4	21
	c4	22
	d4	23
	e4	24
	f4	26
	g4	25

Table 1: Pin functions of the Siliconix DF411 four-digit LCD driver used in figure 6.

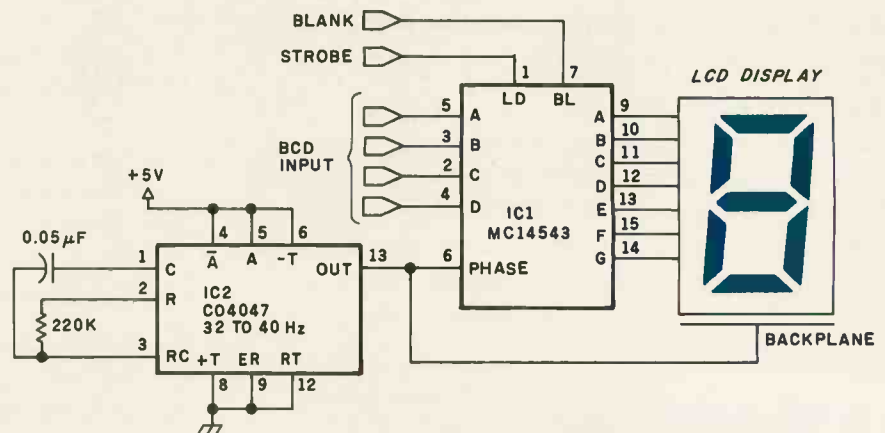

Figure 5: A single-digit, seven-segment LCD driver circuit.

Hard and Fast...



...Bulk Storage from Industrial Micro Systems

THE NEW MODEL 16

The new Industrial Micro Systems Model 16 Hard Disk Subsystem is a "fixed-removable" high speed, bulk storage device providing from 32 megabytes (32 million characters) to 96 megabytes of on-line storage for the Industrial Micro Systems 8000 or Series 5000 microcomputer systems. The Model 16 includes a credenza enclosure that provides a quiet, strong and attractive package for office or industrial applications where large memory is required. The Model 16 also includes a fully buffered DMA S-100 bus controller for fast and easy interfacing.

WINCHESTER TECHNOLOGY WITH BUILT-IN BACKUP

The Model 16 includes a 16 megabyte removable cartridge and a 16, 48, or 80

megabyte fixed media that employs Winchester 3340 technology. Files and programs may be copied between the fixed media and the removable cartridge for fast, easy backup and archival storage.

FAST ACCESS

The interface between the Model 16 hard disk and the Industrial Micro Systems computer is provided by the Hard Disk Controller. The Hard Disk Controller utilizes Direct Memory Access (DMA) for fast data transfer with minimum processor intervention. The maximum data transfer rate is 1.2 megabytes per second and the controller fully buffers the data, a sector at a time, to and from the disk. Available in 220 V, 50 HZ Versions



Now you don't have to look hard for fast computing power. Contact your Industrial Micro Systems Dealer today.

INDUSTRIAL MICRO SYSTEMS

Marketing

628 N. Eckhoff, Orange, CA 92668
(714) 978-6966

Manufacturing

2800 Lockheed Way, Carson City, NV 89701
(702) 883-7611

See us at Comdex '80 Nov. 18-21, 1980 Las Vegas Convention Center.

NEW FROM QT

Disk Cabinet for Single 8" Drive

STOCK



+ 110V to 125V or 200V to 250V + 50 or 60 HZ + Data Cable + Fan + Accepts Perci, Shugart, Siemens, Remex DDC-8+ \$250.00

APPLE CLOCK CALENDAR+

STOCK

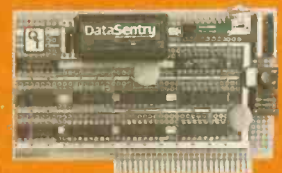

+ Day month year + Day of week + 2400 hour time or 12 hour AM PM (selectable) + Leap year + Interrupt timer 4 interval: 1024 Hz (approx 1 millise), 1 sec, 1 min, 1 hour + On board backup battery + Simple setting of time and date + Simple software interface + Time advance protection while reading
Bare Board (with manual) \$45.00
Kit \$100.00 Assembled & Tested \$150.00

RAM 16+

STOCK



+ Addressable in 4K steps by easily accessible DIP switch. + Memory protection in 1K increments defined by an easily accessible DIP switch. Protection may be from the bottom board address up or from the top down. + May deactivate up to six 1K segments of the board to create "holes" for other devices. Accomplished with jumpers. + Wait states selected by DIP switch. + 8 bank select lines provided for expansion into 1/2 million byte systems. + All data, address, and control lines input buffered. + Ignores I/O commands at board address. + Assembled, tested, and burned-in at factory. + 1.3 A typical current consumption.

Bare Board \$ 20.00 4 MHZ Kit \$180.00
2 MHZ Kit \$160.00 4 MHZ A&T \$210.00
2 MHZ A&T \$190.00

S-100 (SMART) PROTO BOARD+

STOCK



+ Wire Wrap or Solder Sockets + Accepts All Standard Sockets (.30" & .50" CTR) + Allows Grid Distributed Power + 3 Voltage Regulators + Kluge Area for Discretes, External Drives + 2 Bus Bars for ± Voltages (Internal & External) + Accepts Standard Edge Connector on .1" CTR + Kit Includes 3 Reg/3 Heat Sinks/ Filter Caps/2 Bus Bars/Manual
Bare Board \$30.00 Kit \$50.00

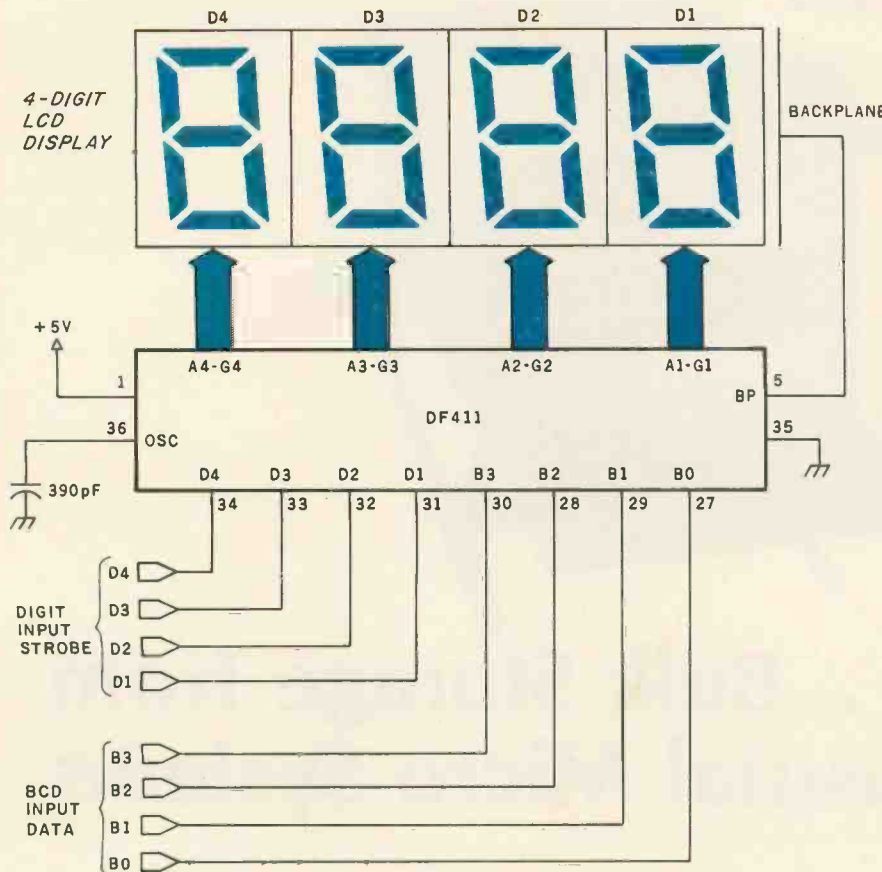

Figure 6: A four-digit LCD driver circuit, the DF411, made by Siliconix, Inc, 2201G Laurelwood Rd, Santa Clara CA 95054.

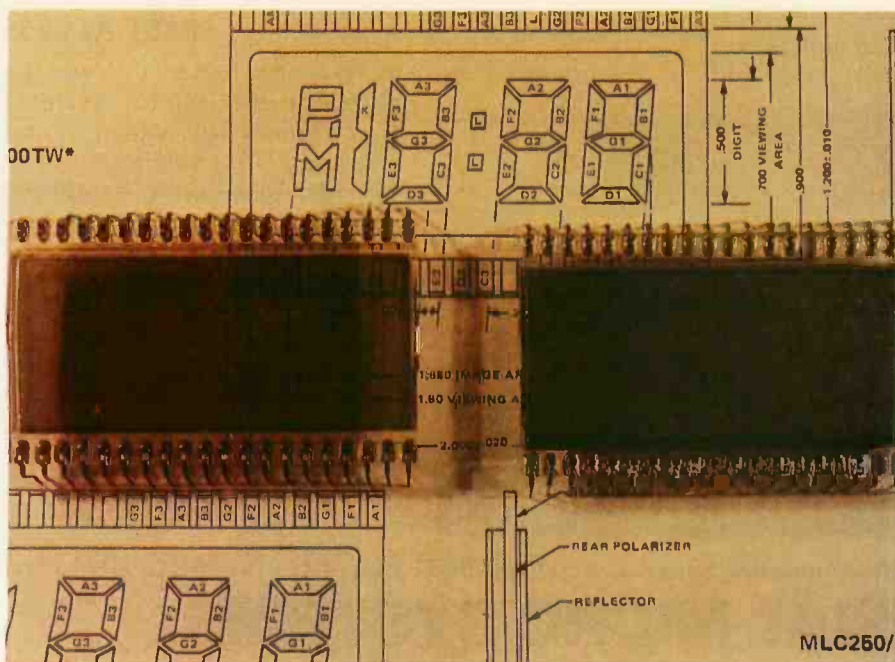

Photo 2: Comparison of two types of LCDs. At left is a transmissive display; at right is a reflective display. Both units are unenergized in the photo.

LOOK TO FOR THE ... **BIG+**

WARRANTY:
1 year against
defects in material
and workmanship
from date of shipment
on all QT products.

EXPANDABLE + DYNAMIC MEMORY (16K to 64K)



+ Works with the following Z-80 CPU Boards: Cromemco Systems, S.D. Systems, SSM (CB2A), Jade (Big Z), Q.T. (Z+80) and many others
+ Uses 3242 Refresh Chip with delay line + Four layer PC Board insures a quiet board + Supports 16K, 32K, 48K or 64K of memory + 24 Address lines per IEEE specifications + Optional M1 Wait state allows error-free operation with faster processors + Optional PHANTOM disable + Uses Z-80 Refresh signal + Bank on/off signal selected by I/O port 40 (Hex) per industry standard. + Bank in use determined by convenient DIP switch selection of data bus bits. + Low power consumption - 5 watts.
+ Convenient LED indication of bank in use
Typical access time of board - (1) using (4116-200ns) (4Mhz) 240ns
- (2) using (4116-150ns) (6Mhz) 200ns

Bare Board	\$ 70.00
16K Kit	\$280.00
16K A&T	\$325.00
32K Kit	\$360.00
32K A&T	\$425.00
48K Kit	\$480.00
48K A&T	\$550.00
64K Kit	\$525.00
64K A&T	\$625.00

STOCK

Z+80 CPU REV II



+ 1K RAM On board + 2 Programmable Timers + Power On Jump to On-Board 1K or 2K EPROM (2708-2716) Can be Addressed on any 1K or 2K boundary + 2 separate parallel ports - full TTL buffered - one input and one output + Programmable Baud Rate Selection (110 to 9600)
+ On-Board EPROM May be Used In Shadow Mode, Allowing Full 64K RAM to be Used + On-Board USART for Synchronous or Asynchronous RS-232 Operation (Serial I/O Port) Configured for direct connect to terminal satisfies requirements of all modem signals in terminal device.

Bare Board	\$ 60.00
Kit	\$190.00
A&T	\$280.00
1K Memory Kit	\$ 12.00

STOCK

CLOCK CALENDAR +



+ Time of Day in Hours, Minutes and Seconds + 24 Hour Time Format
+ Month and Day Date Function + Simple Read Instructions Allow Simple Interface to Basic, CPM, Etc. + Will Run With 4MHZ Processors
+ Can be Located at any Group of 4 I/O Port Addressed + On Board Battery Back-up

Bare Board	\$ 45.00
Kit	\$100.00
A&T	\$150.00

STOCK

I/O +



+ Two Independent SYNC/ASYNCR Serial Ports + One Strobed Eight Bit Parallel Input Port With Handshaking + Three Eight Bit Parallel Ports (Undedicated, User Configured) + Three Independent Sixteen Bit Timers
+ Eight Level Priority Interrupt Controller + Large Prototyping area has regulated +5VDC, +12VDC, -12VDC + Two software programmable baud rate generators with crystal controlled frequencies ($\pm .01\%$)

Bare Board	\$ 69.00
Kit	\$275.00
A&T	\$375.00

STOCK

SILENCE + MOTHER BOARDS



+ No Need for Termination + Very High Crosstalk Rejection + LED Power Indicator + Fits in Most Mainframes + 8, 12 and 18 Slots Available
+ Has Operated to 14 MHZ Quietly

	6-SLOT	12-SLOT	18-SLOT
Bare Board	\$24.95	\$29.95	\$ 49.95
Kit	\$39.95	\$69.95	\$ 99.95
A&T	\$49.95	\$89.95	\$139.95

STOCK

QT MAINFRAME +

MF +

Includes cabinet, 30 amp power supply, and the IEEE S-100 motherboard (12 or 18-slot). The QT MF+ is fan-cooled, has AC line filter to eliminate EMI, and is fully-assembled and factory-tested. Power and reset switches are located on front panel.

MF+12	\$450.00	MF+18	\$500.00
MF+ Without Mother Board			\$350.00



STOCK

MF + MD

(Accepts 2 each 5 1/4" Disk Drives)

Includes cabinet, 18 amp power supply, IEEE S-100 Motherboard (6-12-slot) and dual-mini-disk provision with disk drive power supply. The QT MF+MD is fan-cooled, has AC line filter to eliminate EMI, and is fully-assembled and factory-tested. Power and reset switches are located on the front panel.

MF+MD12	\$500.00	MF+MD6	\$450.00
MF+MD Without Mother Board			\$400.00



STOCK

QT SYSTEM +



+ Main frame W/P.S. and fan + Televideo #920B Terminal + CPU - Z80 - 4MHZ
+ 2-8" Disk Drives (801R Shugart) + Floppy Disk Controller (Double Density) + Dynamic Memory (48K - Expandable to 64K) + 2K Monitor Program and Disk Bios on 2716 EPROM + RAM/ROM/PROM, up to 8K in any combination on CPU + Hard Disk Compatible + 2 Serial/2 Parallel Ports + Real Time Clock + EPROM Programmer + CPM, 2.2 or 1.4 Operating System + MPM Compatible + Full line of business software available

SYSTEM+SS	\$4500.00 (DBL DEN SINGLE SIDED)
SYSTEM+DS	\$5500.00 (DBL DEN DUAL SIDED)



STOCK

**SEE QT PRODUCTS AT THE
NORTHEAST PERSONAL AND
BUSINESS COMPUTER SHOW
IN BOSTON - NOV. 20-23
BOOTH #408**

**QT TECHNICAL HOTLINE
(213) 973-2619**



15335 South Hawthorne Boulevard
Lawndale, California 90260
(213) 970-0952
800/421-5150 (Continental U.S. Only)
(Except Calif.)



Dealer Inquiries Invited

excitation and threshold voltages of the field-effect device are lower and more suitable for multiplexing. The threshold voltage is defined as the level at which the segment switches from "off" to "on." In a multiplexed

driver arrangement, the effective threshold voltage varies as a function of the duty cycle. In effect, as the number of multiplexed digits increases (while the duty cycle decreases), the power-supply voltage

must increase.

To overcome this difficulty while still reducing the number of connections and drivers, several special techniques are used. The most common is called the voltage-select or "V/3" method which operates the nonselected display-pattern segments just below the threshold voltage and the selected segments just above it. Most eight-digit liquid-crystal calculator displays use this scheme.

A common misconception is that relatively slow LCD response times preclude conventional multiplexing approaches (see figure 4). This is because an LCD is essentially a capacitor that can be "charged" (turned on) by a series of pulses over a period of time (presuming constant data input during this time).

The integration of the pulses is accomplished by the long *time constant* of the LCD itself. (In reading an LED display, the eye performs the integration of the short-duty-cycle images.) It may take a half second for an LCD display to settle out the displayed image. This is not a problem with slowly changing data, such as a clock display. An arrangement like this would be unacceptable for use with data that updates ten times a second, however. Only a static driver could be effective at that rate.

The real problem is not with multi-digit displays, but rather with dot-matrix LCD displays like the one shown in photo 3. This particular display is a 14-by-20 dot matrix from a "Mini Vid" space-war game by Megco. I didn't care much for the game, but the display was fun to experiment with and less expensive when salvaged from a toy rather than purchased directly from an LCD manufacturer. The popular MicroVision games from Milton-Bradley use a similar display with a 16-by-16 matrix.

With a matrix-addressed LCD, each segment plus its associated backplane is electrically equivalent to a lossy, nonlinear, voltage-dependent capacitor. In fact, the entire array may be represented schematically as rows and columns interconnected by capacitors at each intersection. A series of "select" pulses drives each row, while a series of data pulses, which are either in phase or out of phase with the select pulses, drives each column.

LCDs have electro-optical char-

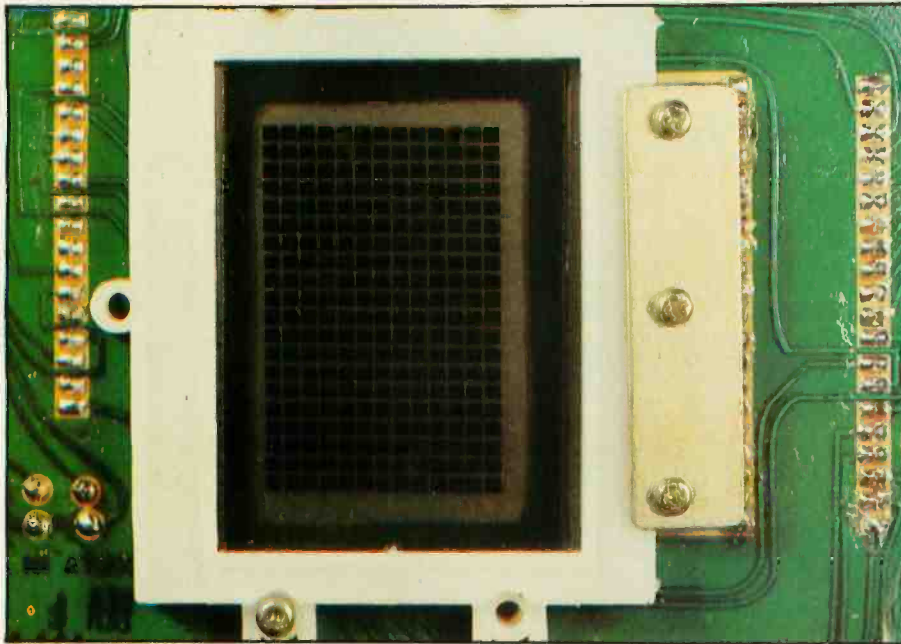

Photo 3: A 14-by-20 LCD dot-matrix display taken from a Megco Mini-Vid space-war game. The unit is shown with all dots turned on.

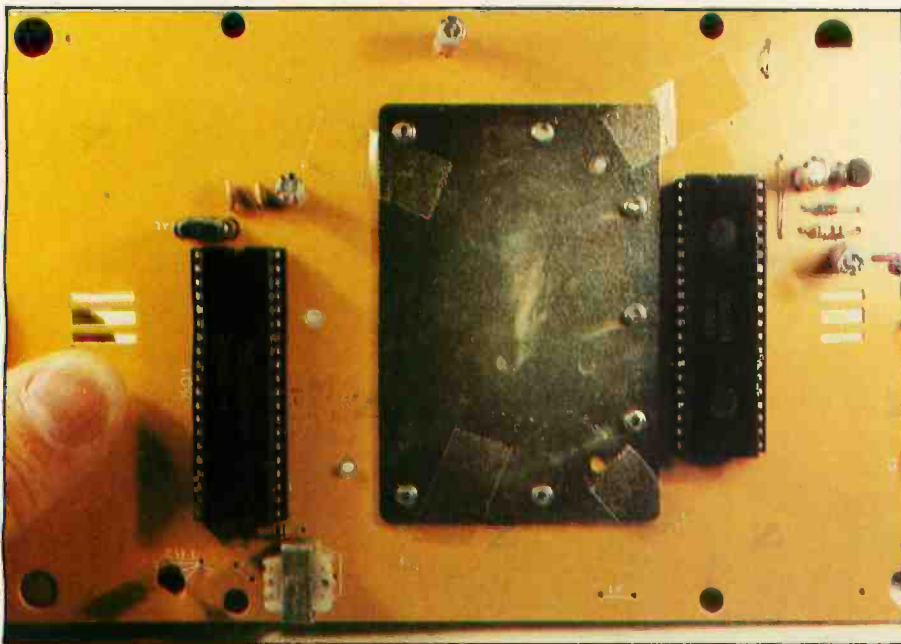

Photo 4: Rear of the printed-circuit board used in the Megco Mini-Vid game, revealing the location of the liquid crystal display shown in photo 3. The complete electronic circuitry for the game is visible. The integrated circuit on the left is an Intel/NEC 8048 8-bit microcomputer. At the right is a custom LCD dot-matrix driver component. The three sets of discrete components (clockwise from top right) are a voltage regulator, an audio amplifier, and a 6 MHz clock circuit. I bought the game on sale for \$24.95.



```
PROGRAM Reduce_Software_Costs
  BEGIN
    IF Choose_MICROPROCESSOR_PASCAL
      THEN CASE (Benefits) OF
        A : Software_Costs := Lower;
        B : Redesign := Easier;
        C : Design_Cycle := Shorter;
        D : 16_Bit_Avail. := Now;
        E : Multitasking := from_HLL;
      END;
    FOR microprocessors TO minicomputers
      DO MICROPROCESSOR_PASCAL;
    END[HAPPY].
```

The program to reduce software costs. Microprocessor Pascal System. New. From Texas Instruments.

Learnability. Transportability. Maintainability.

The features of Pascal, plus the benefits of TI's learning curve experience, are offered in the new Microprocessor Pascal system.

A system designed for microprocessor applications.

A system developed for the 16-bit 9900 Family, including the TM990 microcomputer modules, and 990 minicomputers.

A system to effectively lower your software costs today. And keep them low tomorrow.

At TI, Pascal is the first and only corporate-wide approved high-level programming language. For a lot of good reasons.

Pascal lets you solve your application without getting involved in the intricacies of machine architecture. And, Pascal's block structure results in fewer

programming errors, because the code is easier to write, read and modify.

TI's Microprocessor Pascal system consists of six parts and provides the most Pascal capability ever offered:

- Source Editor — specifically designed to create/edit Pascal programs and check program syntax.
- Compiler — compiles conventional Pascal programs as well as TI's Pascal concurrent extensions into interpretive code, which can then be executed directly, or converted into 9900 native machine code.
- Host Debugger — over fifteen options for tracing variables and modifying data.
- Configurator — enables the target system to retain only the parts of the run-time support necessary for program execution.

• Native-Code Generator — converts Pascal interpretive code into 9900 native machine code.

• Run-Time Support — both interpretive and native-code execution provide a speed/memory trade-off.

TI's continuing commitment to innovative, cost-effective 16-bit microprocessor software means an increased applications capability and decreased development time for you.

Find out how you can reduce your present and future software costs. Put the new TI Microprocessor Pascal system to work for you, today.

For more information, call your nearest TI field sales office or authorized distributor, or write to Texas Instruments, P.O. Box 1443, M/S 6404, Houston, Texas 77001.



TEXAS INSTRUMENTS
INCORPORATED

acteristics independent of the direction of the applied voltage. The fact that they have no polarity or diode action presents a fundamental constraint, because "cross talk" would exist between selected and nonselected segments in a conventional multiplexing scheme. The successful use of a dot-matrix LCD results only from a complicated trade-off between operating voltage, threshold voltage, contrast ratio,

viewing angle, and multiplex frequency.

Both Meگو and Milton-Bradley use the same custom integrated circuit to drive the dot-matrix display. Already aware of the problems associated with standard drive electronics, I had hoped to adapt one of these games as a computer peripheral for this article. This was easier said than done.

The custom integrated circuit used in the game is a forty-pin CMOS LSI

(large-scale integration) component. Thirty-four pins go directly to the matrix, two pins are for the power supply and ground, and four lines are used for control signals from the microprocessor. One seems to be a data strobe, two appear to be row and column incrementers, and one is data. Even though both games use the same controller, the display quality is considerably better on the Milton-Bradley device. This led me to believe that the timing of the signals is as important as knowing which line is which.

Rather than writing something which might risk my credibility, I contacted Milton-Bradley and asked for the timing and control sequence of this device. Apparently, because the toy industry is very competitive, they were reluctant to divulge any information. This is quite the opposite from the response I usually get when I contact electronics manufacturers. The only alternative was to persuade the company that made the device to provide more information, or disassemble the game program and see what goes out on these four lines. I decided it wasn't worth it.

General Limitations

LCDs will probably never replace LEDs or gas-discharge displays. More likely they will dominate applications in which power and ambient light are the prime considerations. There are limitations, however.

Field-effect LCDs properly sealed in hermetic packages and employing stable compounds with high initial purity are inherently reliable. Early problems were due to poor sealing techniques and chemical reactions within the liquid-crystal material.

LCD response time, while not a deterrent in multiplexing, is long by normal electronic-component standards. Some users find these response times annoying. As figure 4 shows, the turn-off time can be as much as 200 ms. The effect is that the segment image appears to fade out rather than snap off. Increasing the drive voltage, making the cell thinner, and using less-viscous liquid-crystal materials are ways to increase the speed. I expect reasonable progress, but in my opinion it will be a long time before the microsecond range necessary for flat-screen television will be achieved while keeping the LCDs competitively priced.

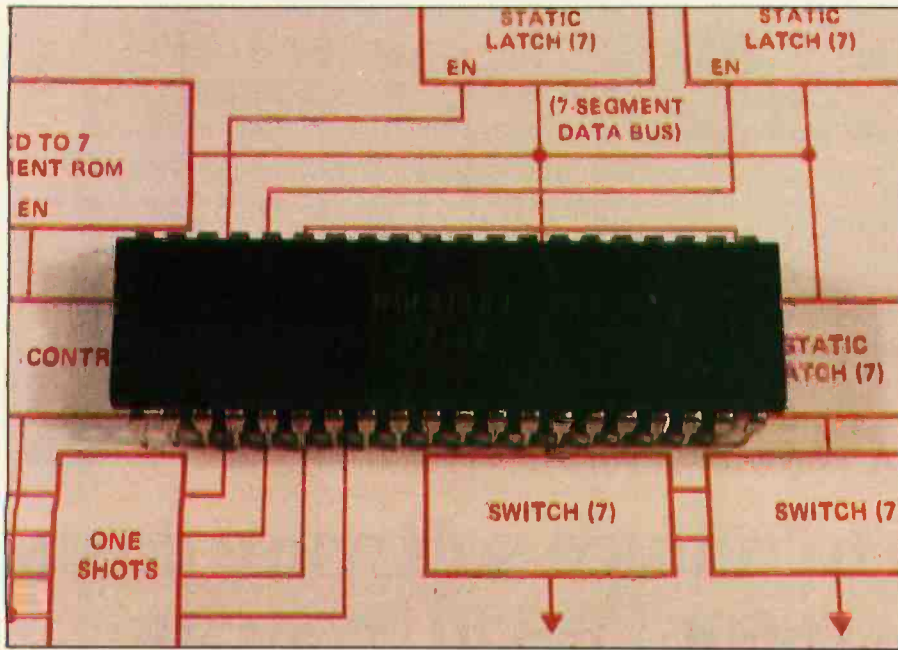

Photo 5: The Siliconix DF411 four-digit direct-drive LCD driver integrated circuit.

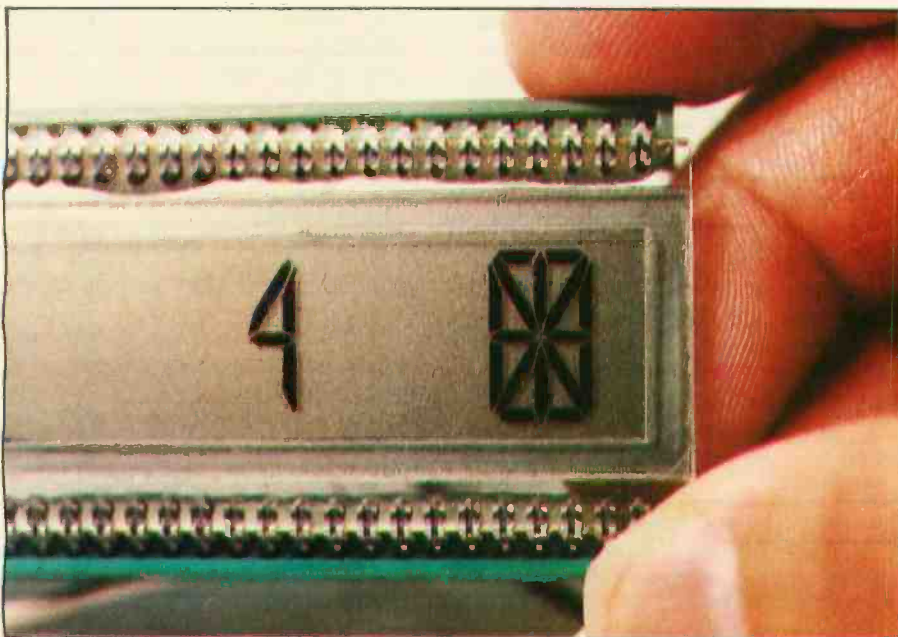

Photo 6: An LCD designed to display both letters and numerals.

Chief Relief

For years many small business system buyers thought that in order to get "real" performance and enough storage to be a "real" business system they would have to sacrifice the family jewels.

But with the introduction of the Smoke Signal Chieftain series office computers a lot of people's minds have been changed.

Because we designed the highly reliable Chieftain small business system with the most innovative combination of performance and efficiency around.

At your fingertips there are 64,000 characters of random access memory and you can address anywhere from 740,000 characters to 2 million characters with Smoke Signal's new double density controller. For larger concerns, there's a 20M byte hard disk available.

At a time when other small computer manufacturers tell you "you're on your own", Smoke Signal offers an abundance of easy-to-use software programs such as order entry, inventory control,

accounts receivable, invoice entry, payroll, word processing and much, much more. There's BASIC, COBOL and FORTRAN — even a multi-user BOS (Business Operating System) that allows for numerous users simultaneously.

Chieftain systems starting at under \$200.00 per month display performance on par with systems costing twice to three times as much.

So call (213) 889-9340 for your nearest authorized Smoke Signal dealer — he'll be glad to demonstrate the Chieftain's high reliability and ease of operation.



For dealers only, circle 22
All other inquiries, circle 21

SMOKE SIGNAL



BROADCASTING

31336 Via Colinas, Westlake Village, California 91361. (213) 889-9340



Also, the operating-temperature range, especially at the low end, is not broad enough to serve some key applications, such as automotive use. Present low-temperature limits are around -10°C (18°F), at which point the turn-off time can be as high as one second. Cold does not harm the display, but it does make it temporarily inoperative. This limitation is not easy to overcome because the fundamental properties of the device are involved. An optimum lower

limit of -40°C (-40°F) will require major technological breakthroughs.

The Future

LCD technology is advancing at a pace consistent with the rest of the electronics industry. The dot matrix used in some computer games is essentially a first-generation device, complete with all the problems that go with using new devices. Larger matrices, say 256 by 256, will not use 512-pin custom LSI chips. Future

devices will depend on a return to simulated static operation such as that used on a single-character display. To attain this sophistication, it will be necessary to etch the drive electronics directly onto the LCD. This is the only way that the thousands of transistors which combine to function as exclusive-ORs and other building blocks can be connected to large matrices. Work in this area has begun, and companies like Kylex in Mountain View, California have already produced forty-character dot-matrix LCDs which are loaded like programmable memory buffers. Perhaps I will use one in a future article.

Even though I've painted a tough picture for LCDs, their price/performance ratios continue to improve, especially in large-character displays. With their high versatility, increasingly competitive cost, low power requirements, and high readability, LCDs will continue to compete head-to-head with LEDs and gas-discharge displays for many general applications. As the drive circuitry becomes less complicated through technological advancements, they will undoubtedly add new dimensions to personal computing. ■

Next Month:

Would you like your computer to have the ability to judge distance? It can acquire this ability by use of the Polaroid sonar autoranging unit.

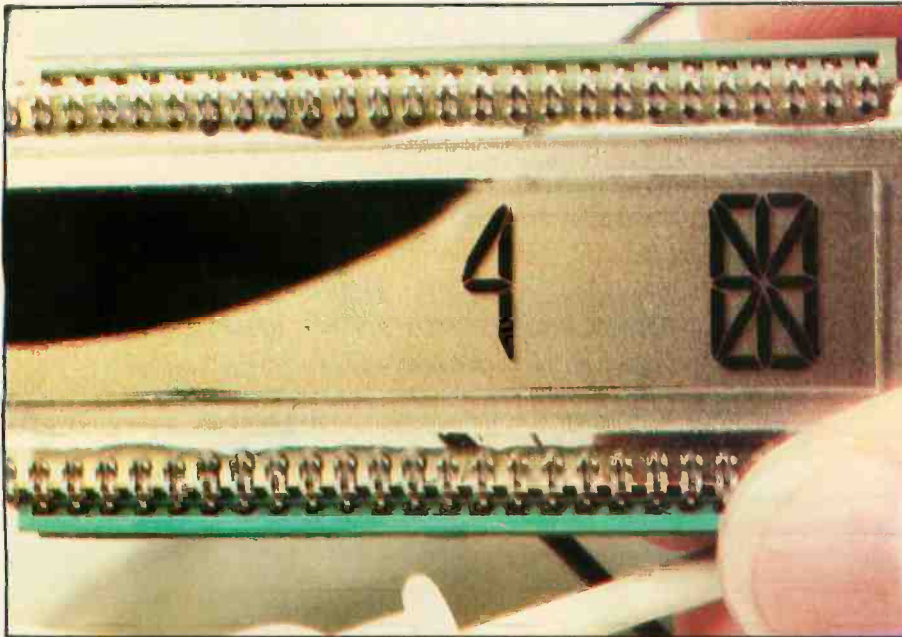

Photo 7: LCD turning black as a result of the hot lights used to take the picture. LCDs are sensitive to heat, but recover immediately upon cooling.



Photo 8: Typical eight-digit, seven-segment LCD calculator display.



More than meets the eye.

The new Series 5000 is mighty for its size. In more than several thousand ways!

In fact, it's the first small system offering over a megabyte of integrated mini-floppy capacity. And with its super memory management, you can have better than 300k of RAM in desk or desktop versions. But hardware is just the beginning of the story.

It's the wide selection of software that really makes this system mighty.

Operating systems? Choose CP/M* with CBASIC†—the most widely accepted small computer operating system ever. Or MVT-FAMOS,** a multi-user, multi-tasking operating system with file management like the big guys, Or MICROCOBOL,††

also for multiple users, but implemented in COBOL, familiar to commercial users the world over.

And applications programs for these operating systems number in the thousands. From real estate to accounting, taxes to inventory control, they're all available at low cost—ready to run.

When you add these software and hardware features to Industrial Micro Systems' reputation for rugged, reliable quality products you'll begin to see it all. A lot more systems than your first glance reveals.

See even more at your dealer. Call us to find out the name of your nearest dealer. He'll tell you everything you need to know. And really open your eyes!

*Trademark of Digital Research Inc.

**Trademark of MVT Microcomputer Systems Inc.

†Trademark of Software Systems

††Product of CAP-CPP

INDUSTRIAL MICRO SYSTEMS

628 N. Eckhoff St., Orange, CA 92668, (714) 978-6966
2800 Lockheed Way, Carson City, NV 89701

ALLOS
COMPUTER SYSTEMS



ALLOS
COMPUTER SYSTEMS



Build to Dependability

ALLOS

PROVEN VALUE

QUALITY DELIVERY

RELIABILITY BRAND

COMPUTER SYSTEMS

PRODUCED IN THE HEART OF SILICON VALLEY, CALIFORNIA U.S.A.

FRESH IDEAS ARE GROWING AT ALTOS

Silicon Valley, California. At one time few places in the world were as abundant with orchards. Today, no other area is as technologically fertile. And nowhere on earth is the business climate as prolific with computer innovation.

Yet within this competitive environment, one microcomputer firm continues to grow above the rest. Altos Computer Systems. Recognized as a world leader in single board microcomputer technology, Altos flourishes on its ability to produce ideas and deliver them to the market while they're still fresh and packed with price performance value.

Fresh ideas like Altos' new ACS8000-6/MTU single board microcomputer system with a DEI ¼-inch cartridge tape back-up drive, and Shugart's 8-inch floppy and 14-inch Winchester hard disk drives, with total on-line capacities from 14.5 MBytes to 58 MBytes.

The ACS8000-6/MTU joins Altos' growing family of products that branch out to a multitude of single board system configurations to serve the OEM, the business sector, and many other end users. These systems range from the ACS8000-2 with its dual 8-inch floppy disk drives, to the powerful ACS8000-5, which is upgradable to any of Altos' hard disk and multi-user systems.

Altos supports three industry standard operating systems: single/multi-user CP/M*, OASIS† and Altos' proprietary AMEX.™ Seven high level programming languages are offered which are CP/M or AMEX compatible.

Ideas aren't the only things growing at Altos. In three years over 4,000 field-proven microcomputer systems have been shipped worldwide to an ever-increasing customer base of over 300 companies. And recently a new facility has been acquired, expanding Altos' plot to over one-and-a-half acres of production facilities.

Weed through the microcomputer system alternatives. No matter what your application, you'll pick Altos.

For specific details about pricing or performance, call or write: Altos Computer Systems, 2360 Bering Drive, San Jose, CA, 95131, (408) 946-6700, Telex 171562 ALTOS SNJ.

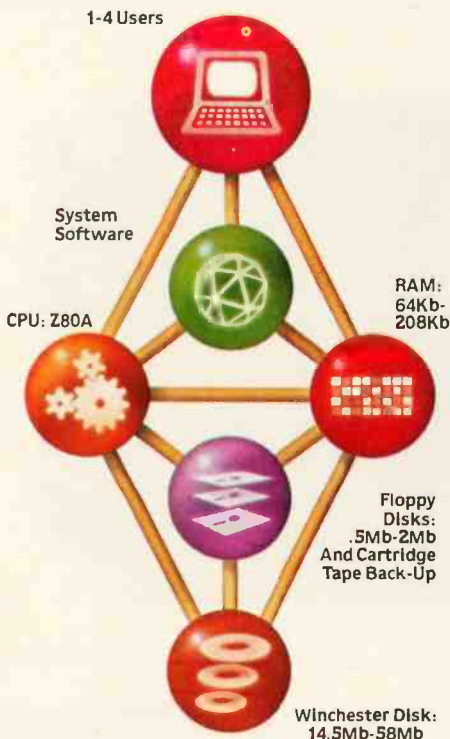

**Packed with
Fresh Ideas**

ALTOS
COMPUTER SYSTEMS

*CP/M is a registered trademark of Digital Research, Inc.
†OASIS is a registered trademark of Phase One Systems, Inc.
© 1980 Altos Computer Systems

Synertek Systems KTM-2 Terminal-on-a-Board

Phil Nowes, 823 Whitethorne Dr, San Jose CA 95128

The KTM-2 Terminal-on-a-Board developed by Synertek Systems provides a data entry and display system for the serious computer user. Having used both the CT-1024 and CT-64 terminals offered by Southwest Technical Products (SwTPC), I was rather skeptical of the claims made by Synertek Systems for their dual microprocessor terminal, which costs just \$349. After using the KTM-2, though, every word Synertek said about it is justified.

The board provides a 24-line by 40-character scrolling display of exceptional quality, and interfaces over one of its two serial input/output (I/O) ports. Not only does the

board provide the 128-character ASCII (American Standard Code for Information Interchange) set and some special characters (such as Greek Σ and π), but it also generates 128 graphic characters—a feature not available on some systems that cost twice as much.

But, just what is KTM-2? It's a circuit board that measures 40.6 cm (16 inches) long and 17.1 cm (6.75 inches) wide, with a full 54-key array. It also contains all the circuitry necessary to provide a composite-video output, two serial ports (with switch-selectable data rates from 110 to 9600 bps), and relative and absolute cursor control. The board draws about 1.4 amperes and



Photo 1: The KTM-2 board. The board contains a 54-key array, with all the circuitry necessary for composite-video output. This 40-character per-line version requires 1.4 A at 5 V. The 80-character version draws 1.6 A. Both are able to provide RS-232-compatible outputs with the addition of extra power supplies.

"Our inventory is our existence. Think we'd trust it to anything less than Scotch® Brand Diskettes?"

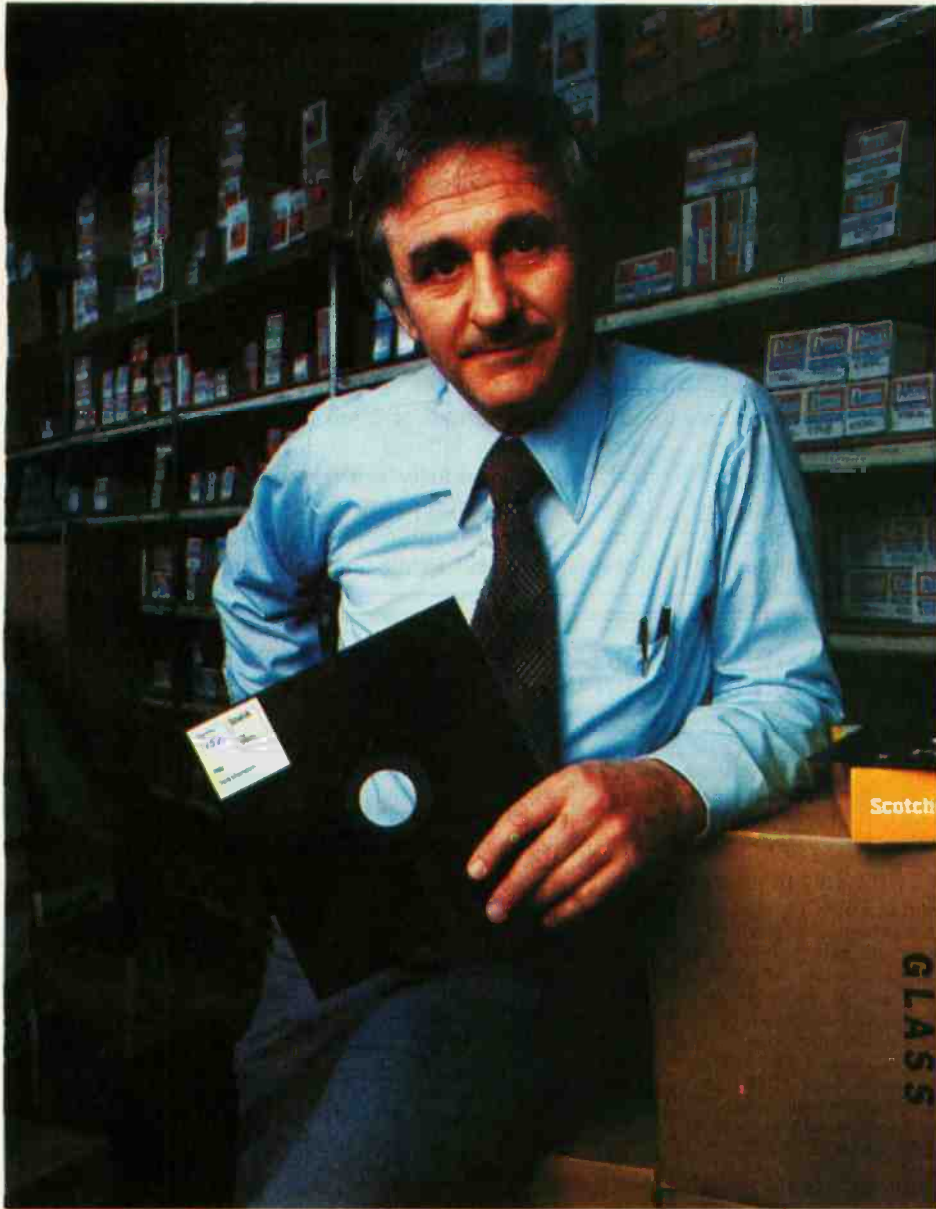

Don Stone, President,
Mass. Auto Supply Company,
Inc., Boston, Mass.

Scotch Diskettes are the diskettes you can depend upon with the information *your* business depends upon.

Each one is tested and certified error-free before it leaves our factory. Because we know nothing less than perfection is acceptable for *your* vital business data.

Scotch Diskettes are available in regular or mini sizes, compatible with almost any system.

To find out where you can purchase Scotch Diskettes, call toll free: 800-328-1300. (In Minnesota, call collect: 612-736-9625.) Ask for the Data Recording Products Division. In Canada, write 3M Canada Inc., London, Ontario, N6A 4T1.

If it's worth remembering,
it's worth Scotch
Data Recording Products.



3M

operates from a single +5 V power supply.

There is another version, the KTM-2/80, which provides a 24-line by 80-character display for \$424. This board draws about 1.6 A and operates at a much higher clock frequency—7.2 MHz versus 3.6 MHz for the KTM-2. Because of the higher clock frequency, a high-quality video monitor must be used with the KTM-2/80, while the KTM-2 could use an ordinary television set with an RF (radio-frequency) video modulator. For our purposes here, all comments will pertain to the KTM-2 system with the 40-character per line capability.

Removing the board from the carton and setting it up are relatively simple procedures—there is very little assembly required. It is only necessary to wire the power supply to the proper connector, connect a video monitor or RF modulator to the composite video output, and set the desired serial port data rate. Because it can operate in *self-check mode* (transmit-data output can be fed back into the receive-data input), the board can be tested immediately to ensure that it is functioning properly, before connecting it to the rest of your computer system.

To operate the board in local mode, the transmit and receive pins of serial port 1 must be connected to each other, then the Clear-to-Send pin of the port must be asserted. Since there is no computer to assert the pin in this mode, the pin must be connected to a voltage source greater than three volts and less than twenty-five volts; this can be done by connecting the pin to the Request-to-Send line, which is always at +5 V. Once these connections are made and power is applied, the terminal is ready

for test in a stand-alone mode.

Basic functions of the keyboard are identical to most of the terminals made today—both uppercase and lowercase characters are available, as well as reverse video of the uppercase characters. There is no shift-lock key; however, the board does have a CAPS-lock key that provides only uppercase alphabetical characters plus the normal numbers and symbols available during lowercase operations. Switching between normal and reverse video is accomplished by hitting the escape (ESC) key and entering an uppercase R. To return to normal video from the reverse mode, just press the ESC key and then enter a lowercase r.

As mentioned earlier, graphics characters are available to the user. These are just as accessible as reverse video—just press the ESC key and then enter uppercase G to change into the graphics mode. To exit the graphics mode, just type ESC, g. Reverse video is also available in the graphics mode. Both the alpha mode and the graphics mode can be intermixed on the screen simply by typing the desired sequence of control functions. All of these modes can be computer controlled; all the computer has to do is send out the same sequence of ASCII codes on the serial port.

I mentioned earlier that the KTM-2 has two serial ports, these are labeled 1 and 2. Port 1 is the main port and is used primarily with a computer for information transfer. The other port acts as an auxiliary port, primarily for a printer, so that hard copy can easily be obtained without using one of the other computer ports.

CP/M^{®1} – based Business Software for TRS-80^{®2} computers on the fastest Mod-II CP/M with the most features!!!

- Over 610,000 bytes/disk
 - Downloading package included
 - 1,200 baud operation of serial printers without data loss
 - Single drive backup
 - Mixed single/double density on any of 4 drives (even a 1-drive system)
 - Ultra-fast disk operation
 - Emulation of cursor addressing for any of several "dumb" CRTs
 - Auto-LF printer support & ASCII top-of-form software (LP11)
 - Supplemental document describing our implementation
 - User-settable function keys
- MOD-II CP/M** \$250.00 **MOD-I CP/M** \$150.00 **CBASIC2^{®3}** (Mod I or II) \$110.00

The following software for Mod-II CP/M only unless otherwise stated (*-requires CBASIC2):

RM/COBOL^{®4} – Only COBOL for CP/M with alternate keys (multi-key ISAM), CRT screen handling, interactive debug, Z80 code, and the most useful Level 2 features. **Compatible with Tandy's COBOL—but runs faster!** \$495.00

PMS (Property Management System) - Interactive, menu-driven system includes full G/L, budgeting, cash journal, delinquency list, tenant activity/rent roll, complete audit trail and reports on vacancies, lost rent, and vendors \$650.00*
 demo disk & manual 75.00*

APH (Automated Patient History) - General-purpose question-asking, answer-printing system furnished as self-administered review-of-systems general patient history (Mod-I also) ... \$175.00*

MAGIC WAND^{®5} – Full-feature word processing, true proportional spacing, file merging, and use of full-screen editor for source programs or data \$400.00

RPA (Residential Property Analysis) - Analyzes income and expense, financing, taxes, inflation and depreciation on home, condo, or apartments over a user-selectable time. Shows payoff in terms of ROI, Cap rate, cash-on-cash. Amortization schedules and worksheet \$300.00*
 demo disk & manual 35.00*

RBC (Rent/Buy Comparison) - Sales or investment tool to compare renting and savings account investment vs. purchasing a particular property \$250.00*
 demo disk & manual 35.00*

Osborne & Assoc. CBASIC source programs (Mod-I also):

Payroll w/Cost Accounting \$250.00*
Accts. Payable/Accts. Receivable \$250.00*

General Ledger w/Cash Journal \$250.00*
O&A CBASIC Books (ea.) \$ 20.00

Verbatim^{®6} media: (Qty. 100 prices)

5¼" single density \$2.50 ea.
 8" certified double density \$4.00 ea.

8" single density \$ 3.00 ea.
 450' tape cartridges \$20.00 ea.



8041 Newman Ave., Suite 208
 Huntington Beach, CA 92647
 (714) 848-1922

- Registered trademark of:
- ¹Digital Research
 - ²Tandy Corp.
 - ³Complier Systems, Inc.
 - ⁴Ryan-McFarland Corp.
 - ⁵Small Business Applications, Inc.
 - ⁶Verbatim Corp.



Distributed in U.K. by:
 Microcomputer Applications Ltd.
 11, Riverside Court,
 Caversham, Reading, England
 TEL: (0734) 470425

In this age of runaway inflation...

Look what \$795* will buy



The HIPAD™ digitizer

Inexpensive Input to your computer

The HIPAD™ digitizer can be used for both converting graphic information into digital values and as a menu. Utilizing either the stylus or the optional cursor, the operator can input graphic data into the computer by locating individual points on the digitizers 11" x 11" (28cm x 28cm) active area. In the "stream mode" a continuance of placements of coordinate pairs may be input.

Not a kit, the HIPAD™ comes complete with both RS-232C and parallel interfaces and has its own built-in power source. The origin is completely relocatable so coordinates may be positive or minus for a true reference value and oversized material may be input by simply resetting the origin.

Accurate positional information, free form sketches, even keyboard simulation

All can be entered using the multi-faceted HIPAD™ digitizer. Its capabilities and low price make the UL listed HIPAD™ a natural selection over keyboard entry, inaccurate joysticks, or expensive approximating light pens. It's perfect for inputting isometric drawings, schematics, X-rays, architectural drawings, business graphs, and many other forms of graphic information, as well as creating your own graphics.

Use it with Apple II™, TRS-80 Level II™, PET™ or other popular computers

The HIPAD's™ built-in RS-232C and parallel 8 bit interfaces make it all possible. (For Apple II order DT-11A, for TRS-80 or PET order DT-11). Furthermore, you get English or metric scaling, data format (Binary/BCD/ASCII), selectable baud rates, and resolution of either .005" or .01".

For complete information contact Houston Instrument, One Houston Square, Austin, Texas 78753 (512) 837-2820. Outside Texas call operator #5 toll free 1-800-531-5205. In Europe contact Houston Instrument, Rochesterlaan 6 8240 Gistel, Belgium. Telephone 059/277445.

Visit us at WESCON, booths 2330, 2332 and 2336.



The ideal input device for the small system user.



Available with stylus or optional cursor.



Available with optional display.

*U.S. Suggested retail price

TM HIPAD is a trademark of Houston Instrument
TRS-80 is a trademark of Tandy Corporation
APPLE is a trademark of Apple Computer Inc.
PET is a trademark of Commodore Business Machines, Inc.

Circle 26 for literature
Circle 27 to have a representative call

houston instrument

GRAPHICS DIVISION OF
BAUSCH & LOMB



Traditional

NEW

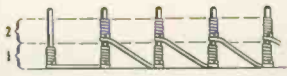

Wire-Wrapping

JUST WRAP



Wire-Wrapping

**WHY CUT?
WHY STRIP?
WHY NOT ...**

JUST WRAP™

WIRE WRAPPING TOOL

- AWG 30 Wire
- .025" Square Posts
- Daisy Chain or Point To Point
- No Stripping or Slitting Required
- JUST WRAP™
- Built In Cut Off
- Easy Loading of Wire
- Available Wire Colors:
- Blue, White, Red & Yellow

PATENTED U.S.A.
FOREIGN PATENTS PENDING

JUST WRAP TOOL WITH ONE 50 FT. ROLL OF WIRE		
COLOR	PART NO.	U.S. LIST PRICE
BLUE	JW 1 B	\$14.95
WHITE	JW 1 W	14.95
YELLOW	JW 1 Y	14.95
RED	JW 1 R	14.95
REPLACEMENT ROLL OF WIRE 50 FT.		
BLUE	R JW B	\$ 2.98
WHITE	R JW W	2.98
YELLOW	R JW Y	2.98
RED	R JW R	2.98
JUST WRAP-UNWRAPPING TOOL		
	JW 1	\$ 3.49

*Minimum billings \$25.00, add shipping charge \$2.00/New York State residents add applicable tax



OK Machine & Tool Corporation

3455 Conner St., Bronx, N.Y. 10475 U.S.A.
Tel. (212) 994-6600 Telex 125091



Both of these serial ports are full duplex, permitting information to be sent and received simultaneously. The serial data format consists of a start bit, seven data bits, a parity bit, and either one or two stop bits. Data can be transmitted at one of eight rates, switch selectable from 110 to 9600 bps (bits per second).

The serial ports are set up with TTL (transistor-transistor logic) interface levels, but are format-compatible with the RS-232 standard. The interface can easily be modified to provide full RS-232 compatibility, but two more power supplies must be added to provide

KEYS DEPRESSED	ASCII CONTROL CODE (Hexadecimal)	ACTION TAKEN BY KTM-2
CTRL G CTRL g CTRL '	07	Bell output
CTRL H CTRL h CTRL (08	Cursor back one space (backspace)
CTRL I CTRL i CTRL)	09	Cursor right one space (horizontal tab)
LINE FEED CTRL J CTRL j CTRL *	0A	Cursor down one space (line feed)
CTRL K CTRL k CTRL +	0B	Cursor up one space (vertical tab)
CTRL L CTRL l (alpha) CTRL ,	0C	Clear display and move cursor home (upper left) (from feed)
RETURN CTRL M CTRL m CTRL —	0D	Cursor to beginning of the same character line (carriage return)
CTRL S CTRL s CTRL: 3	13	Set DC low
CTRL T CTRL t CTRL 4	14	Set DC high
ESC CTRL ; CTRL [1B	Begin ESCAPE sequence (see ESCAPE SEQUENCE)
CTRL space CTRL @ CTRL shift return	—	Reset KTM-2, clear screen and read option switches
CTRL ALPHA	—	Special—no output is sent over Tx; local clear screen
All Others		Ignored

Table 1: Many special functions are available to the user of a KTM-2 Terminal-on-a-Board, as demonstrated by this chart of control codes. Control may be asserted manually or by software.

For your Horizon —



North Star
Horizon Computer
with 5" Floppy Disks



Display
Terminals



Printers

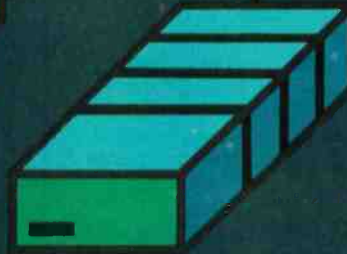

Up To Four
Hard Disks

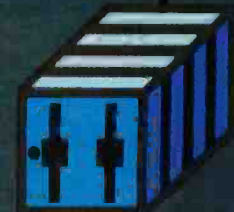

Up To Four 8"
Floppy Disks

More power, work, flexibility!

JOEDOS™ — Jointly Operate Everything Disk Operating System. Switch from North Star BASIC to CP/M™ and back again with a simple command. Floating point and standard 8, 10, 12, and 14 digit precisions of North Star BASIC, as well as Digital Research's CP/M all on the same hard disk unit.

Designed to operate with the DISCUS M26™ 26.5 megabyte (formatted) Winchester-technology hard disk unit and North Star's Micro Disk System, JOEDOS brings you large mainframe performance at microcomputer cost and reliability. CP/M disk activity is amazingly quick through JOEDOS; access to North Star BASIC programs and files is unbelievable!

Speed and enormous storage capacity (as much as 106 megabytes) are only the beginning. Through JOEDOS, each hard disk unit may appear to be one drive or many different "drives" (as many as 147 double density 180K North Star 5¼" drive-size segments). As many as seven of these segmented "drives" may be addressed at any particular time. Segment size, file size and directory size are variable according to user's requirements. Maximum file size is 16 megabytes, while the maximum directory size for each segment is 8,160 entries.

JOEDOS — Micro Mike's hard disk operating system. Requires DISCUS M26 hard disk unit and controller and North Star Micro Disk System for operation. Includes CP/M.

JOEDOS AND MANUAL \$495

JOESHARE™ — North Star Horizon™/DISCUS Hard Disk Timesharing System. Micro Mike's popular interrupt-driven, bank switching timesharing for North Star Horizon computer is now available with all the features of JOEDOS hard disk operating system. JOESHARE allows multiple users to access as many as four 26.5 megabyte hard disk units, simultaneously operating programs in North Star Basic or through CP/M.

JOESHARE — Micro Mike's North Star Horizon time-sharing/DISCUS hard disk operating system. Requires North Star Horizon and DISCUS M26 hard disk unit for operation. Includes CP/M.

JOESHARE and manual \$995

HDSHARE™ — North Star Horizon/North Star Hard Disk Time-sharing System. A version of JOESHARE with all of the features of JOESHARE using the North Star hard disk. HDSHARE allows multiple users to access as many as four 18 megabyte North Star hard disk units, simultaneously operating programs in North Star BASIC or through CP/M.

HDSHARE — Micro Mike's North Star Horizon time-sharing/North Star hard disk operating system. Requires North Star Horizon and North Star hard disk system for operation. Includes CP/M.

HDSHARE and manual \$995

5.2SHARE™ — North Star Horizon/Floppy Disk Timesharing System. Micro Mike's floppy disk timesharing system has some new enhancements. 5.2SHARE now supports 8, 10, 12, and 14 digit floating point and standard North Star BASIC with as many as four DISCUS 8" drives, operating in conjunction with the Horizon's 5¼" drives to provide in excess of 5 megabytes of external storage.

5.2SHARE — Micro Mike's interrupt-driven, bank switching timesharing for the North Star Horizon computer. Includes 8" drive software interface. For double density or quad capacity systems only.

5.2SHARE and manual \$395

DOSCHG — Micro Mike's 8" drive interface to North Star DOS and BASIC. Requires North Star Micro Disk System and DISCUS 8" drives and controller for operation.

DOSCHG and manual \$150

Program operation manuals are available for preview before software purchase.

Program Operation Manuals for each program \$25

Programs are available in double density/quad capacity format only. Prices are subject to change without notice.

Contact your North Star dealer or Micro Mike's.

JOEDOS, JOESHARE, HDSHARE and 5.2SHARE are registered trademarks of Micro Mike's, Incorporated
Horizon is a registered trademark of North Star Computers, Inc.
DISCUS and M26 are registered trademarks of Morrow Designs, Inc.
CP/M is a registered trademark of Digital Research, Inc.

Mike's
Micro Mike's, Inc.

905 South Buchanan Amarillo, Texas 79101 USA Telephone: 806/372-3633

making technology uncomplicated... for People

SEQUENCE OF CODES RECEIVED BY KTM-2	ACTION TAKEN BY KTM-2
ESC E	FORM FEED: Display is cleared to spaces and cursor moved to first position of first line (the HOME position).
ESC H	HOME: Cursor is moved to HOME.
ESC J	CLEAR EOS (End of Screen): Every position on the screen from the current position of the cursor to the last position of the last line, inclusive, is cleared to spaces. The position of the cursor does not change.
ESC K	CLEAR EOL (End of Line): Every position from the current position of the cursor to the end of the line occupied by cursor, inclusive, is cleared to spaces. The position of the cursor does not change.
ESC R	BEGIN REVERSE: All uppercase letters and all graphics characters received subsequent to reception of the ESC R sequence will be displayed in reverse video.
ESC r	END REVERSE: All displayable characters received subsequent to reception of the ESC r sequence will be displayed in normal video.
ESC G	BEGIN GRAPHICS: Each displayable character received subsequent to reception of the ESC G sequence will cause one of the graphic characters to be displayed.
ESC g	END GRAPHICS: Return to normal display mode.
ESC L	AUX ON: Auxiliary serial port transmission is enabled on-line.
ESC l(alpha)	AUX OFF: Auxiliary serial port transmission is disabled.
ESC +	RELATIVE CURSOR ADDRESSING
ESC =	ABSOLUTE CURSOR ADDRESSING

Table 2: Special operations, such as reverse video and graphics control, are accessed through the use of the ESCAPE key (ESC) and certain uppercase and lowercase keys.

SEQUENCE OF CODES RECEIVED	EFFECT ON CURSOR
ESC = SP SP	Cursor to HOME
ESC + SP SP	Position unchanged
ESC + * ,	Cursor down 10 and right 12
ESC + 7G	Cursor down 23 and right 39 (or effectively, cursor up 1 and left 1 for a 24-x-40 character display)
ESC = , 4	Cursor to line 12, column 20

Table 3: The cursor may be addressed in either relative or absolute mode. Vertical addresses are treated modulo 24, while horizontal addresses are interpreted modulo 40 (modulo 80 for the KTM-2/80). This means that any cursor address that would be off the screen actually wraps around.

the ± 12 V levels. The data transfer rate is selectable via three option switches, but five additional switches provide selectable options such as: even, odd, or no parity; interlaced or noninterlaced screen; line truncation or wraparound; and 60 or 50 Hz frame rate.

The system I connected to the KTM-2 was a Ball Brothers Research video monitor (9-inch diagonal), which has a composite video input that responds to a signal between 0 and 1 V (the KTM-2 can also be jumper set by removing a jumper to deliver a 0 to 2.4 V signal). The computer I used consists of an old IMSAI 8080 microcomputer with 48 K of programmable memory, and some disk drives. Communication to the computer used a dual serial I/O card, and hard copy was provided by a Texas Instruments thermal printer. The printer did not have graphics capability, so I was able to view the graphics display only on the video monitor screen.

Operation of the serial interface requires that the KTM-2 check to see if the CTS line on the main port is asserted before each character transmission. If the signal is not asserted, the KTM-2 will wait until it is—this can be seen on the video display when the cursor stops blinking. When the line is asserted, the waiting character will be transmitted and the cursor will resume blinking.

The keyboard has many control functions available, as shown in table 1. More than one control code is available for a specific operation. There are also many special operations that can be done by use of the ESC key on the KTM-2. These operations are defined in table 2.

One of the special features of the KTM-2 is its capability to perform either *relative* or *absolute* cursor addressing (positioning). Relative cursor addressing causes a vertical displacement supplied by the computer or keyboard to be added to the current cursor vertical address; likewise, a horizontal displacement is added to the current cursor horizontal address. In absolute addressing, the decimal values of two ASCII characters are used to calculate the absolute position of the cursor referenced from the home position in the upper left-hand corner of the screen.

The instruction sequences for absolute and relative cursor addressing modes are shown in table 3 along with some simple positioning examples. All cursor vertical addresses are interpreted as modulo 24, while horizontal addresses are modulo 40 for the KTM-2 and modulo 80 for the KTM-2/80. Modulo implies that the cursor "wraps around"; attempting to position the cursor beyond the end of a line causes it to wrap around to the beginning of the line, and positioning it below the bottom of the screen causes it to appear at the top of the screen.

The KTM-2 manual offered by Synertek Systems is reasonably complete, and it even includes some minor troubleshooting hints. Aside from having to provide your own monitor, power supply, and cabinet, the KTM-2 is a very complete system. There are features lacking that some people might desire for convenience, such as a screen read capability, a parallel ASCII output, or a separate numeric keypad. Aside from this, however, the KTM-2 really seems like a complete solution to the computer user's needs: a low-cost, but powerful, data entry and display system.

For further information, Synertek Systems can be contacted at POB 552 Santa Clara CA 95052, (408) 988-5689. ■

COMPUSTAR™

INTERTEC'S NEW \$2500 MULTI-USER SMALL BUSINESS COMPUTER

At last, there's a multi-user micro-computer system designed and built the way it should be. The CompuStar™. Our new, low-cost "shared-disk" multi-user system with mainframe performance.

Unlike any other system, our new CompuStar offers what we believe to be the most practical approach to almost any multi-user application. Data entry. Distributed processing. Small business. Scientific. Whatever! And never before has such powerful performance been available at such modest cost. Here's how we did it . . .

The system architecture of the CompuStar is based on four types of video display terminals, each of which can be connected into an auxiliary hard disk storage system. Up to 255 terminals can be connected into a single network! Each terminal (called a Video Processing Unit) contains its own microprocessor and 64K of dynamic RAM. The result? Lightning fast program execution! Even when all users are on-line performing different tasks! A special "multiplexor" in the CompuStar Disk Storage System ties all external users together to "share" the system's disk resources. So, no single user ever need wait on another. An exciting concept . . . with some awesome application possibilities!

CompuStar™ user stations can be configured in almost as many ways as you can imagine. The wide variety of terminals offered gives you the flexibility and versatility you've always wanted (but never had) in a multi-user system. The CompuStar Model 10 is a programmable, intelligent terminal with 64K of RAM. It's a real workhorse if your requirement is a data entry

or inquiry/response application. And if your terminal needs are more sophisticated, select either the CompuStar Model 20, 30 or 40. Each can be used as either a stand-alone workstation or tied into a multi-user network. The Model 20 incorporates all of the features of the Model 10 with the addition of two, double-density mini-floppies built right in. And it boasts over 350,000 bytes of local, off-line user storage. The Model 30 also features a dual drive system but offers over 700,000 bytes of disk storage. And, the Model 40 boasts nearly 1½ million bytes of dual disk storage. But no matter which model you select, you'll enjoy unparalleled versatility in configuring your multi-user network.

Add as many terminals as you like - at prices starting at less than \$2500. Now that's truly incredible!

No matter what your application, the CompuStar can handle it! Three disk storage options are available. A tabletop 10 megabyte 8" winchester-type drive complete with power supply and our special controller and multiplexor costs just \$3995. Or, if your disk storage needs are more demanding, select either a 32 or 96 megabyte Control Data CMD drive with a 16 megabyte removable, top loading cartridge. Plus, there's no fuss in getting a CompuStar system up and running. Just plug in a Video Processing Unit and you're ready to go . . . with up to 254 more terminals in the network by simply connecting them together in a "daisy-chain" fashion. CompuStar's special parallel interface allows for system cable lengths of up to one mile . . . with data transfer rates of 1.6 million BPS!

Software costs are low, too. CompuStar's disk operating system is the industry standard CP/M*. With an impressive array of application software already available and several communication packages offered, the CompuStar can tackle even your most difficult programming tasks.

Compare for yourself. Of all the microcomputer-based multi-user systems available today, we know of only one which offers exactly what you need and should expect. Exceptional value and upward growth capability. The CompuStar™. A true price and performance leader!

**INTERTEC
DATA
SYSTEMS®**

2300 Broad River Rd. Columbia, SC 29210
(803) 798-9100 TWX: 810-666-2115



NOW YOU'RE TALKING!

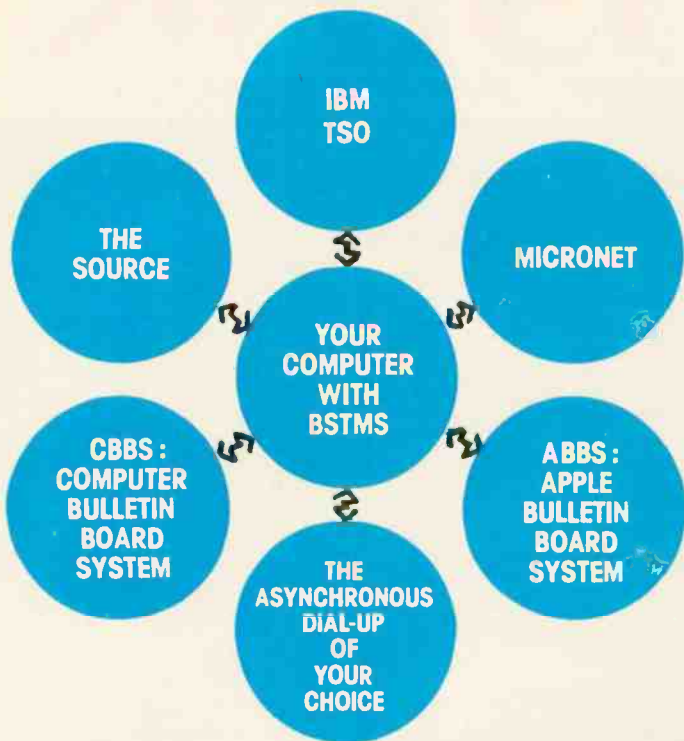

"BSTMS"

Byrom Software Terminal Monitor System

The missing link between your CP/M system and remote computers everywhere!

- talks to most dial-up remote computers.
- stores data from remote computers in CP/M files.
- copies data to CP/M list device if desired.
- transmits files to the remote computer.
- it will even "talk" to another CP/M console.
- features EXPAND and COMPRESS programs to translate binary files into character files and vice versa.
- uses the same simple installation procedure as BSTAM.

This system is great for recording data from remote time-sharing systems! It makes it possible to do local processing of data on a micro and then transmit it to the mainframe.

\$200 per computer.

\$15 for manual alone.

Prices reflect distribution on 8" single density diskettes. If a format is requested which requires additional diskettes, a surcharge of \$8. per additional diskette will be added.

Apple is a trademark of Apple Computer. MicroNET is a trademark of CompuServ. CP/M is a trademark of Digital Research.

Lifeboat Associates

1651 Third Avenue, New York, N.Y. 10028
(212) 860-0300 Telex: 220501

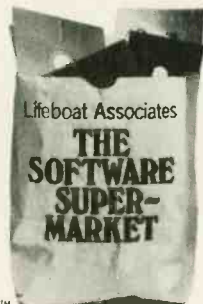

Desk Top Wonders

Darth Vader's Force Battle for the TI-59

Clete Jackson, 1715 Dogwood Dr, Rock Hill SC 29730

After purchasing a Texas Instruments TI-59, I realized I owned one of the most capable pocket calculators in the world. I wrote the following program, and allowed several of my friends to play it. They agreed it was the most exciting calculator game they had ever played. The program also uses capabilities of the TI-59 that Texas Instruments does not advertise.

Texas Instruments gives the TI-59 a capability of seventy-two labels. With the following keystrokes, you can add nine more labels that are accessible only through the program; the keystrokes are:

LBL, STO, STO, XX.

Now go back and delete the two STO instructions.

Any of the following can go into the XX location as the label:

62=Pgm Ind, 63=Exc Ind, 64=Prd Ind,
72=STO Ind, 73=RCL Ind, 74=SUM Ind,
83=GTO Ind, 84=OP Ind, 92=INV SBR.

The TI-59 has a decrement and skip branching capability with memories 0 thru 9. With the following keystrokes, this ability can be given to all 100 memories except memory 40, since it implies indirect: DSZ, STO, XX, Y, STO, YY, followed by deleting the two STOs. The XX refers to any memory register except 40. The Y by itself is the hundreds digit of the address to be

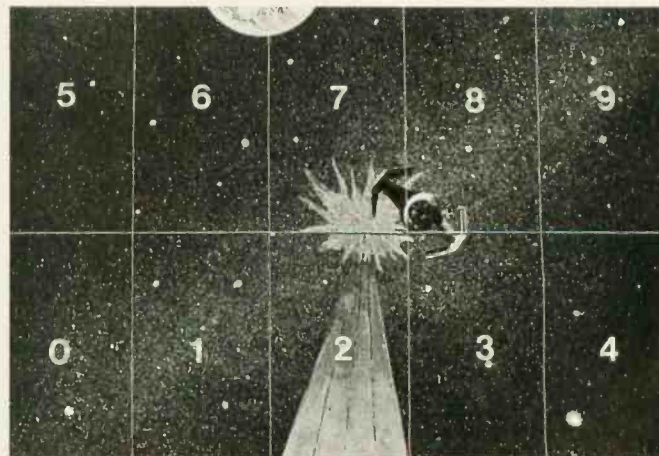

Photo 1: Battle sector map for Darth Vader's Force Battle. To fire into a sector, you wait for the number to appear on the Texas Instruments TI-59 display, press R/S to lock onto it, and press A. See text for further game details.

COMPUTERS—TERMINALS—MODEMS!

NEW!

TI-99/4 Home Computer



Optional color monitor
\$449

Main console unit
\$889

(Includes RF modulator for use with any TV)

Write for a list of extensive program modules available—everything in games, education, and home computer applications.

NEW!

From Perkin-Elmer 1250 Super Owl

\$1799



Intelligent CRT

Incredibly powerful and flexible

- 24 fully programmable function keys
- Full screen editing capabilities
- RAM memory for down line loading by host computer
- Built-in printer port
- Full polling capabilities
- Detachable keyboard
- Optional light pen
- Much more!

Penril 300/1200 Modem

Connect any computer or terminal to the phone lines.

- 1200 Baud—Bell 212A **\$799**
- 300 Baud
- Originate/Auto answer
- Full duplex
- RS232
- 1 year warranty



Direct connection to the phone lines via RJ11C standard extension phone jack

USR-330 Modem

- 0-300 Baud—Bell 103/113
- Originate/Auto answer
- Half/Full duplex
- RS232
- 1 year warranty

\$339



Direct connection to the phone lines via RJ11C standard extension phone jack

USR-1600P Computer

NEW!

\$4099



PASCAL

With power and speed for business, educational, and scientific applications.

W.D. Microengine™-based single board computer with 64K RAM

- 1 megabyte of floppy disc
- 2 parallel ports
- 2 serial ports
- Floppy disc controller with DMA
- File manager
- Screen oriented editor
- Single cabinet design
- Includes power supply

Perkin-Elmer Bantam 550 CRT

\$749



- Transparent mode
- Addressable cursor
- Editing functions
- Upper/lower case
- Compact

The Phone-Link Acoustic Modem **NEW!**

- Sleek, low profile
- 0-300 Baud
- Originate/Answer modes
- Half/Full duplex
- Self-test
- RS232—Will work with any RS232 computer or terminal
- LED displays of all functions
- 1 year warranty
- At your computer store now!



\$179

Perkin-Elmer 650/655 CRT Page Printer

- 100 CPS
- Quiet
- Compact
- RS232

Can be added to any CRT with our interface option.

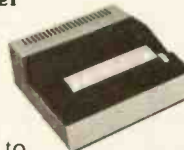

\$999

The printer designed to give you rapid, reliable, hard copy of your CRT screen display.



DEC LA34

\$995

- Teletype 43 plug compatible
- Variable character sizes
- Full width paper
- Many more features
- Write for print sample

Teletype Model 43KSR **\$1049**
Microterm Mime IIA CRT **\$819**
Microterm ACT VA..... **\$779**



We offer full service, on-site maintenance plans on all equipment. Any product may be returned within 10 days for a full refund.

U.S. ROBOTICS INC.
203 N. WABASH SUITE 1718 CHICAGO, ILL 60601

SALES
GENERAL OFFICES
SERVICE

(312) 346-5650
(312) 346-5651
(312) 733-0497

Listing 1: Darth Vader's Force Battle for Texas Instruments TI-59 calculator. Shaded entries indicate that two keystrokes are needed to enter the number. See text for details on how the game is played.

Location	Keys						Commentary
000	LBI	A	x=t	1	39	STO	Firing and positioning subroutine
006	19	SUM	20	-	1	=	
012	x=t	0	26	+	2	=	
018	x=t	0	26	INV	DSZ		
023	CLR	2	B'				Memory address 217
026	RCL	5	+	π	+	RCL	Random number generator
032	20	=	X	7	y'		
037	9	÷	1	0	y'		
042	5	=	INV	INT	x		
047	1	0	=	INT			
051	SUM	19	STO	20	x=t		
056	Exc Ind	19	Pause	DSZ	19	0	Display subroutine
062	56						
063	if flg	0	1	26			
067	2	Pause	2	Pause	2	Pause	Subroutine to indicate you are losing
073	2	Pause	2	Pause	2	Pause	back position
079	2	Pause	2	Pause	2	Pause	
085	2	Pause					
087	CLR	St flg	0	5	STO	25	
093	GTO	0	26				
096	1	Pause	1	Pause	1	Pause	Subroutine to indicate you are gaining
102	1	Pause	1	Pause	1	Pause	preferred back position
108	1	Pause	1	Pause	1	Pause	
114	1	Pause					
116	CLR	5	STO	25	INV	St flg	
122	0	GTO	0	26			
126	0	0	0	0	0	0	Subroutine to indicate you are
132	0	0	0	0			being shot down
136	Pause	GTO	1	26			
140	if flg	0	1	26			
144	5	0	5	Pause	GTO	1	Subroutine indicating enemy hit
150	44						
151	LBI	E	STO	20	2	STO	
157	01	5	STO	02	8	STO	
163	03	4	STO	04	9	STO	
169	00	8	STO	05	3	STO	
175	06	6	STO	07	2	STO	
181	08	9	STO	09	1	STO	
187	10	7	STO	11	1	STO	
193	13	4	STO	14	7	STO	
199	15	6	STO	16	8	STO	
205	17	5	STO	18	STO	25	
211	INV	St flg	0	GTO	0	26	
217	if flg	0	0	96	GTO	0	
223	67	LBI	C	GTO	0	02	

branched to. The YY is the tens and units digits of the address to be branched to.

the range 0 thru 999999999), then press E. The game begins.

The Program

I wrote the *Darth Vader's Force Battle* program at least a dozen times before I obtained the speed of execution and realism that I desired.

Imagine yourself in the computer battle scene in photo 1, and that you are the pilot of an X-wing fighter. You are in combat and on the trail of the nefarious Darth Vader. Digits flashing on the display indicate that Darth Vader is making evasive moves to outwit you and sneak in behind your fighter for the kill. You lock on to his location by

After programming the TI-59, enter a seed number (in

SYNCHRO-SOUND

The ORIGINAL Computer People
who KNOW Computers
and offer EVERYTHING you need
in Small Computer Systems



TERMINALS
ADDS Regent 25

LEAR SIEGLER
ADM 3A
ADM 31
ADM 42



SOROC Technology
IQ 120
IQ 140



PRINTERS

QUME Sprint
5/45 KSR
5/55

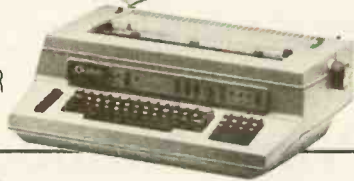

DECwriter IV
LA 34

TELETYPE
43

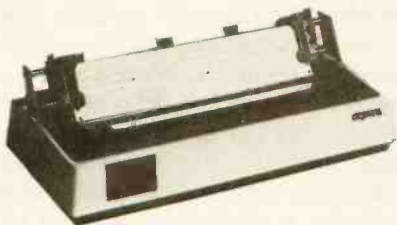

OKIDATA
Microline 80

**A PERFECT
SUPER SPECIAL MATCHED PAIR!**



Texas Instrument
810 Multi Copy
Impact Printer
150 characters per sec.
bi-directional printing



Intertec
Super Brain
Computer Terminal
Dble. Density Dual Mini-
Floppies, CPM based
Development or Business System

ONLY \$4295.

COMPUTERS

DIGITAL SYSTEMS

HDS 4004
14 Megabyte
Hard Disk



NORTHSTAR
HORIZON II
HORIZON II Quad

CROMEMCO
System 3

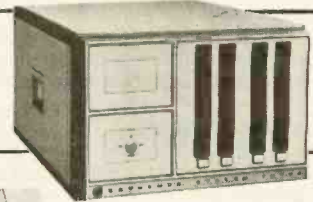

ATARI
400
800

MORE SPECIALS

Okidata SL125	\$2595.00	Livermore Acoustic Coupler	\$195.00
Okidata SL300	2995.00	Centronics Micro Printer	349.00
Persci 277	1395.00	5" Scotch Diskette Box	34.95
Integral Data Systems Paper Tiger Printer	895.00	8" Scotch Diskette Box	39.95
Televideo 912	825.00		
Televideo 920	895.00		

MANY OF OUR PRICES ARE TOO LOW
TO ADVERTISE. PLEASE CALL OR WRITE

We carry a full line of Alpha-Micro Products.
We have a full staff of Programmers and Computer
Consultants to design, configure and deliver a Turnkey
Computer System to meet your specific requirements.



SYNCHRO-SOUND ENTERPRISES, INC.

THE COMPUTER PEOPLE

193-25 Jamaica Ave., Jamaica, New York 11423 • TWX 710-582-5886

PHONE ORDERS, CALL:
New York 212/468-7000
Los Angeles 213/261-1808
Chicago 312/641-3010
Dallas 214/742-6090

WE DELIVER!

Osborne Business Software

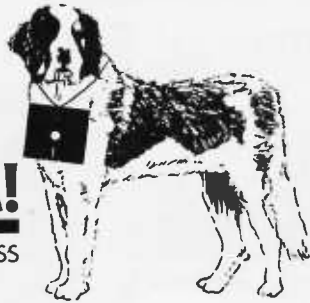

Before you buy the programs that your company is going to depend on for its accounting, ask the following questions:

- Do I get the source code?** (Don't settle for less. You cannot make the smallest change without it.)
- Is it well documented?** (The Osborne documentation is the best.)
- Is it fully supported?** (If not, why not? What are they afraid of?)

The Osborne system is the industry standard accounting package, with literally thousands of users. We offer an enhanced version of that package that will run on most systems without recompiling.

CRT INDEPENDENCE. The original programs were designed to run on a Hazeltine terminal. To use a different CRT, you had to modify and test two modules — and recompile every program! With the Vandata package, you simply pick your CRT from a menu and run.

FILE/DRIVE MAP. The original package had all data files on the same drive as the programs. Ours allows you to dynamically specify the drive assigned to each file. In fact, you can change the drive assignments whenever you wish, to accommodate expanded file sizes or new hardware — all without recompiling!

INTEGRATION. The original AR and AP systems had to be changed and recompiled to feed journal entries to GL. Our installation program eliminates this hassle. It simply asks you if you want the systems integrated, and what your special account numbers are.

SPEED. The original programs used a binary search to access the GL account file. We use an enhanced technique that greatly cuts down on disk accesses, thus speeding up account lookups significantly in the GL, AR and AP systems.

BUGS. We have corrected a number of bugs in the original programs. If you find a bug in our programs, we'll fix it — and send you a \$20 reward! Our users are sent bug fixes in source form.

MORE! We have made many minor enhancements, and fixed many minor problems. We are committed to the ongoing support of our package. Vandata has been an independent software supplier for over seven years. Quality and support are our way of doing business.

General Ledger with Cash Journal	\$95
Accounts Receivable	\$95
Accounts Payable	\$95
Payroll with Cost Accounting	\$95
• All Four Packages (GL, AR, AP, PR)	\$295
Magic Wand (Super Word Processor!)	\$345
Pearl Level III (best prog. tool available)	\$645
CBASIC-2	\$110
TRS-80 MOD II CP/M 2.2 (Pickles & Trout)	\$185
H89/Z89 CP/M 2.2 (Magnolia inc. h/w mod)	\$295

Formats: Std. 8", 5" NorthStar DD, TRS-80 MOD II Im, H89/Z89, Superbrain DD. Manuals for GL, AR/AP, and PR are not included in price — add \$20 per manual desired (AR/AP are in one manual). CP/M and CBASIC-2 required to run accounting software. Users must sign licensing agreement. Dealer inquiries invited.

To order call: (206) 542-8370
or write: **VANDATA**
17541 Stone Avenue North
Seattle, WA 98133

VISA/MC Welcome — TRS-80 is a registered tm of Radio Shack, Inc.

choosing one of the flashing digits and pushing R/S, which locks that digit in the display. You fire into that section by pushing A. But remember that Darth Vader has the force, and he may or may not be at that location by the time you fire. You might use your own force (otherwise known as ESP) and enter a different number by pressing any number 0 thru 9, then fire by pressing A.

If you wait too long before firing, he will outmaneuver you and come in from behind. This is indicated by a string of twos walking across the display. Once Darth Vader is behind you, the flashing digits on the display represent the areas he is firing into. Your flight computer is no match for Darth Vader's force, so you must manually pilot your ship through its maneuvers. You change your position by first pushing R/S. This will lock a digit into the display; pushing C changes your position to the entered location. Remember, your maneuvers will appear on Darth Vader's battle screen just as his did on yours. Once he is behind you, there must be little time wasted in your maneuvers or else you will become just another one of his victims.

Both contestants receive a minimum of 5 shots at each other (ie: if the proper evasive maneuvers are made). A walking display of ones indicates that you have outmaneuvered Darth Vader and he is again in your gun sights. A flashing 505 (SOS) indicates that Darth Vader has been hit. A flashing 0000000000 indicates that you have been hit. To start a new game push R/S, enter a seed number, and push E.

The only way you can consistently conquer Darth Vader is if your ESP is strong (otherwise known as luck). Have fun and may the force be with you. ■

Prime Numbers on the HP-19C

Wilfred Aslan, 26 Twin Brooks Dr, Willow Grove PA 19090

A few months back, a neighbor proudly showed me a program she had developed for her first computer science course. As James R Lewis speculated in his article "TRS-80 Performance Evaluation by Program Timing" (see March 1980 BYTE, page 84), the program concerned the determination of prime numbers. Intrigued, I spent some time on this subject working with my little Hewlett-Packard HP-19C programmable printing calculator. Assuming that Lewis has rekindled interest in the competitive programmer's desire for fast programs, I offer a more efficient means for the test of a prime number.

In the classic algorithm, the number being tested is always odd, because even numbers are divisible by 2. The number being tested is divided by a series of odd numbers, starting with three, and progressing by twos. If the remainder of each successive division includes fractions, the number must be prime. The trick, of course, is knowing when to stop dividing.

A moment's reflection will show that as the value of the divisor progresses beyond the square root of the number under test, the quotients will all be smaller than the square root. Since numbers less than the square root have already been tried, further testing is pointless.

When It Comes To Add-on Memory...

LOBO Has It All.

LOBO DRIVES manufactures a full line of S-100 computer compatible disk drives. All drives are software compatible with most S-100 disk operating systems and applications software programs. Only LOBO DRIVES offers you the variety and choice of floppy and fixed disk drives. Choose from 5¼ and 8-inch floppies, 5¼ and 8-inch Winchester technology fixed disk drives, and several Floppy/Fixed disk combinations. Each LOBO DRIVES system is thoroughly tested and burned-in and has the famous LOBO DRIVES One Year, 100% Parts/Labor Warranty.

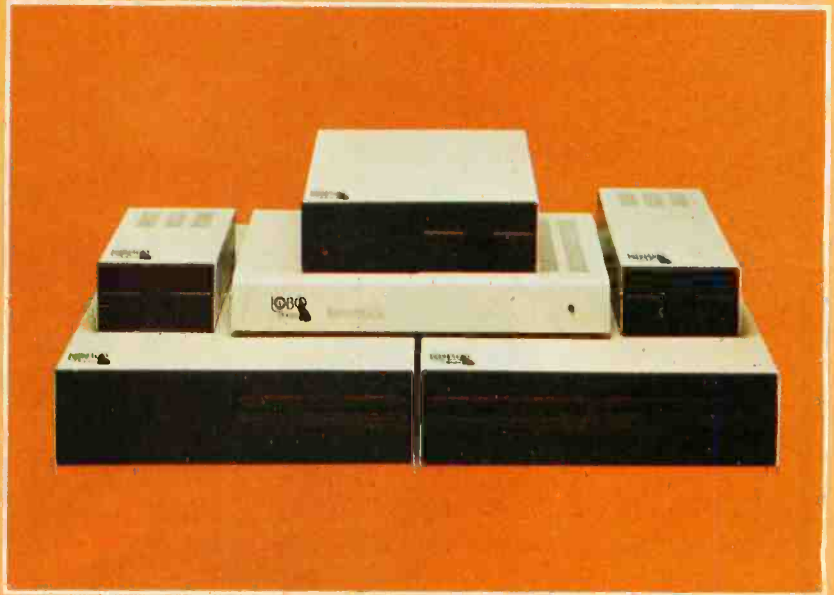

MODEL 400 5¼-INCH FLOPPY DISK MEMORY SYSTEM

A high-speed (298) Msec Access), high-reliability (8000 hrs MTBF), low-cost floppy disk memory system. It is available in both soft and hard sector formats, and a choice of single or double density configurations.

- Up to 220 KBytes Capacity
- Single/Double Density
- Soft Sector Format
- Complete Software Compatibility

MODEL 800/850 DUAL FLOPPY DISK DRIVE MEMORY SYSTEM

LOBO DRIVES offers you a choice of single-sided, single or double density (Model 800) or double-sided, single or double density (Model 850) dual 8-inch memory subsystems. Each system comes complete with chassis and power supply, cables, controller and interface.

- Compatible with Most S-100 DOS Systems
- Up to 3.2 MByte Capacity

MODEL 1850 DUAL FLOPPY/FIXED DISK MEMORY SYSTEM

No more worries about back-up. LOBO DRIVES has combined the latest state-of-the-art Winchester technology with the proven reliability and dependability of its Model 850 8-inch floppy disk drive to bring you the ultimate in memory expansion for your S-100 computer. The Model 1850 is the ideal memory system for small business and word processing applications.

- 5 or 10 MByte Fixed Disk Capacity
- 1.6 MByte Floppy Disk Capacity
- Software Compatibility
- Sealed Environment
- Winchester Reliability
- 70 Msec Average Access Time

MODEL 950 DUAL FLOPPY/FIXED DISK MEMORY SYSTEM

All the advantages of Winchester technology fixed disk memory: large capacity (6.38 MBytes), high speed (170 Msec avg. access time), and extended reliability, combined with the convenience of a built-in floppy disk back-up in one cabinet. Only LOBO can bring you the storage capacity of 16 mini-floppies at a fraction of the price.

- The Storage Capacity of 16 Mini-Floppies
- Built-in Back-up
- 170 Msec Access (Avg)
- Software Compatibility

See your nearest dealer, call, or write for the complete LOBO DRIVES story...
find out just how competitively priced a quality drive can be.



935 Camino Del Sur
Goleta, California 93017
(805) 685-4546
Telex: 658 482

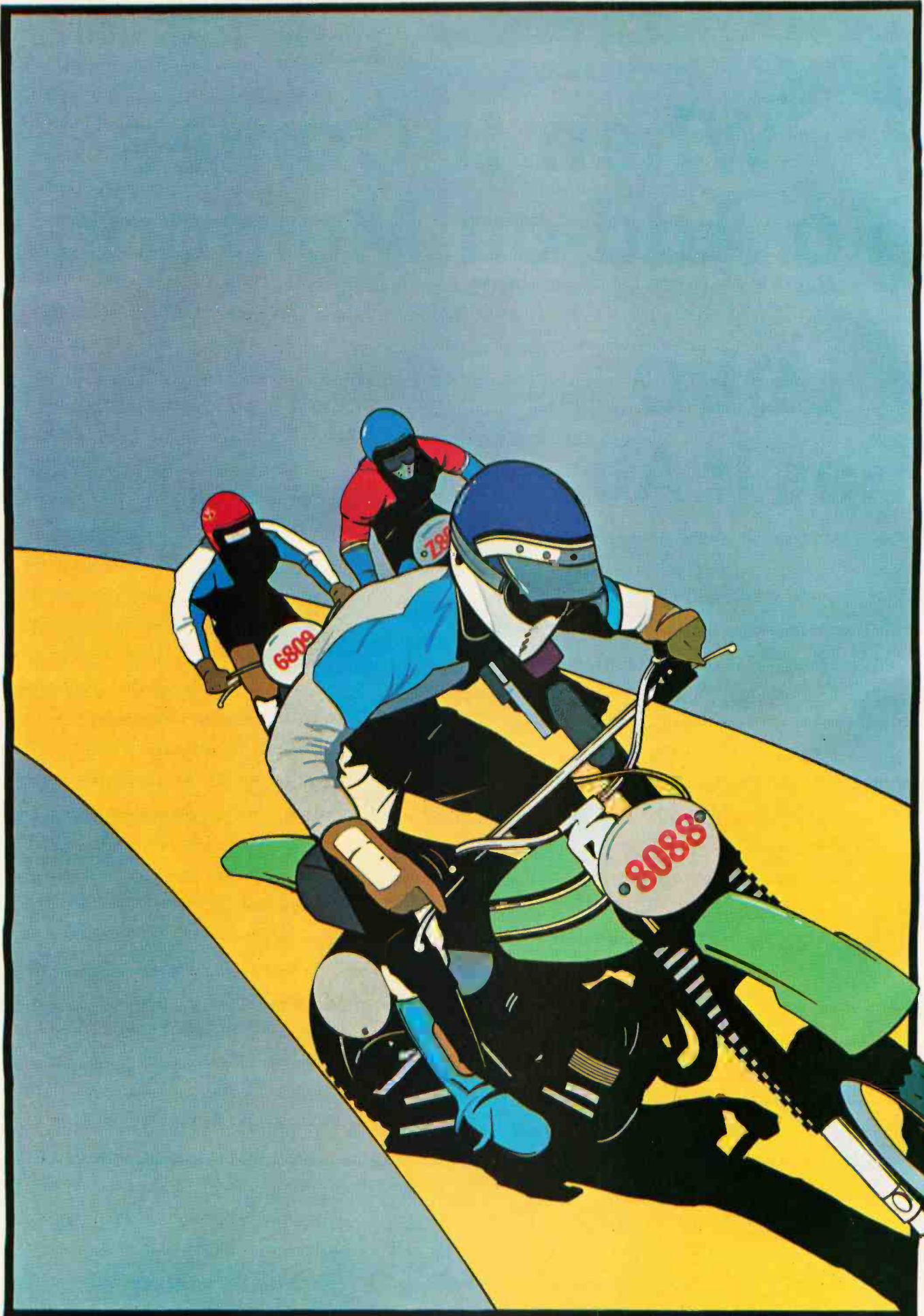

8-Bit Champion

In price-performance, look to Intel's powerful iAPX 88 microprocessor to leave the pack behind. Both now and down the road.

In price-performance races, the iAPX 88 is the one to beat. It's two times faster than the Z-80A and the 6809. And recent benchmark tests show that the iAPX 88, with its 8088 CPU, consistently outperforms its closest competitors in memory efficiency, ease of programming and throughput—by as much as 4 to 1. This is especially important in high-performance tasks such as block moves, character searches, word shifts, and 16-bit multiplies. All critical for applications like word processing, terminal control, scientific instrumentation and industrial control.

And because it's the only 8-bit microprocessor that addresses up to 1 million bytes of memory, the 8088 can take on large programs. Without having to slow down due to overlays or memory bank switching, like other 8-bit processors.

Tough price competitor

In price competition with other 8-bit microprocessors, the iAPX 88 has become the front runner.

You save dramatically on

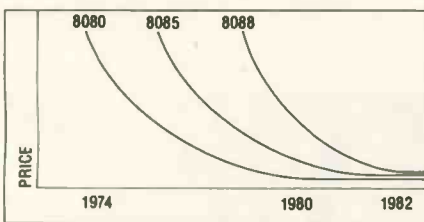

8-bit Microprocessor Price Trends

memory chips, too. The iAPX 88 takes—on the average—30% less memory than competitors for the same programs. Then too, it allows you to use lower cost memory to get the same throughput as competitors. With a 5MHz 8088, you can use our 450ns memories and still outperform a 4MHz Z-80 requiring 250ns chips. Depending on

the application, your cost savings here can be substantial.

No contest now with new Intel software

To unleash the new power that the iAPX 88 puts in your hands, it takes more powerful software—



the kind only Intel delivers today. Software that produces object code directly and gives you important extensions that allow you to fine-tune the software to your application.

Software such as PASCAL-88, the block-structured application language rapidly becoming the one most widely used. With our PASCAL-88, you can do direct port I/O and interrupt handling, as well as independent program module compilation. And produce code that runs faster than other, P-code interpreter versions.

Along with PASCAL-88, you get PL/M-88, our systems implementation language, our ANSI-compatible FORTRAN, and our ASM-88 macroassembler. So with more software capability than you've ever had before, now you

can choose the right language tool for each application—whatever it calls for.

Get out in front with complete development support

All the development support tools you need are ready to go today from Intel. Start with the Intellec® Microcomputer Development System. Add to that our ICE-88™ in-circuit emulator. Together they give you CPU emulation in real time, plus features like symbolic debugging, diagnostic commands and program trace capability. With these tools you'll get your products to market faster than by any other route.

Looking down the road

Best of all, with the iAPX 88, your investment in today's solution is protected. Since the 8088 is 100% object-code compatible with the 16-bit 8086—plus its future generations, the iAPX 186 and iAPX 286—you have the industry's only guaranteed headstart on the path to the future. Regardless of which language you're writing in.

So if you want to outdistance the pack, choose the iAPX 88—available today from your local Intel distributor. To get your copy of benchmark results, contact your local Intel sales office or distributor. For more information write Intel Corporation, 3065 Bowers Avenue, Santa Clara, CA 95051. Or call (408) 987-8080.

intel delivers solutions.

Europe: Intel International, Brussels, Belgium.
Japan: Intel Japan, Tokyo. United States and Canadian distributors: Alliance, Almac/Strom, Arrow Electronics, Avnet Electronics, Component Specialties, Hamilton/Avnet, Hamilton/Electro Sales, Harvey, Industrial Components, Pioneer, L.A. Varah, Wyle Distribution Group, Zentronics.

Listing 1: A program which calculates the prime numbers to 10,000, using the square-root test limit. This listing is for the HP-19C calculator, which finished the job in just over fifteen hours.

```

01 *LBL0 25 14 00      24  2      02
02  1      01      25 ST+1 45 41 01
03 PRTX      65      26 RCL1  55 01
04 ST01      45 01    27 RCL3  55 03
05  2      02      28 X>Y  11
06 PRTX      65      29 X≠Y? 16 31
07  3      03      30 GT03  14 03
08 PRTX      65      31 RCL2  55 02
09 ST02      45 02    32 PRTX      65
10 EEX      23      33  1      01
11  2      02      34 ST01  45 01
12 ST04      45 04    35 GT01  14 01
13 *LBL1 25 14 01    36 *LBL3 25 14 03
14  2      02      37 RCL2  55 02
15 ST+2 45 41 02    38 RCL1  55 01
16 RCL2  55 02      39 =      61
17 JX      16 53     40 FRC      25 52
18 ST03  45 03      41 X#0?  25 51
19 RCL4  55 04      42 GT02  14 02
20 X>Y?  16 41      43  1      01
21 GT02  14 02      44 ST01  45 01
22 R/S      64      45 GT01  14 01
23 *LBL2 25 14 02    46 R/S      64
  
```

Listing 2: The beginning and end of the program when run to calculate all primes up to 10,000.

```

1.      97. ***      9769. ***
2.      101. ***     9781. ***
3.      103. ***     9787. ***
5. ***      107. ***     9791. ***
7. ***      109. ***     9803. ***
11. ***     113. ***     9811. ***
13. ***     9813. ***     9817. ***
17. ***     9819. ***     9829. ***
19. ***     9823. ***     9833. ***
23. ***     9829. ***     9839. ***
29. ***     9831. ***     9851. ***
31. ***     9843. ***     9857. ***
37. ***     9849. ***     9859. ***
41. ***     9861. ***     9871. ***
43. ***     9877. ***     9883. ***
47. ***     9879. ***     9887. ***
53. ***     9889. ***     9901. ***
59. ***     9897. ***     9907. ***
61. ***     9719. ***     9923. ***
67. ***     9721. ***     9929. ***
71. ***     9733. ***     9931. ***
73. ***     9739. ***     9941. ***
79. ***     9743. ***     9949. ***
83. ***     9749. ***     9967. ***
89. ***     9767. ***     9973. ***
  
```

By limiting the tests in this way, the number of loops necessary may be reduced significantly. In the "Lewis Test" of numbers to 10,000, the largest prime number is 9973, and his program uses test divisors to half that (4986.5), requiring 2491 executions of the loop. By using a divisor limit of 99 (the square root is actually 99.86), the loop need only be executed forty-eight times. On the

HP-19C, this gives times of 38 m 18.1 s (for the original test) versus 46.4 s (testing only to the square root limit). For the complete computation of primes up to 10,000, the little calculator finished the assignment in 15 h 16 m 22.7 s, using the square-root limit. Listing 1 shows the program; listing 2 contains the beginning and end of my list of prime numbers. ■

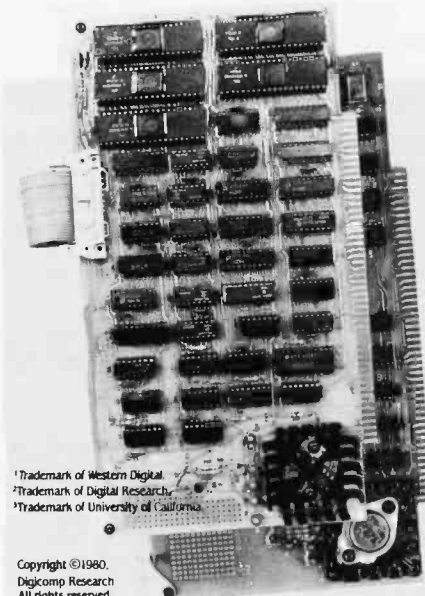

New PASCAL-100™ CPU mates today's popular UCSD Pascal language to your S-100 system. With both a Z80 processor and the Pascal Microengine¹ aboard, PASCAL-100 gives you the power of software data structuring without sacrificing speed, memory space—or even your current Z80, 8080 and CP/M² software.

Greater Speed. Up to 5 to 10 times faster than usual S-100

For complete information—fast—mail this ad or call us.

Name _____ Title _____
 Company _____ Phone _____
 Address _____
 State _____ Zip _____



Digicomp Research Terrace Hill, Ithaca, N.Y. 14850 (607) 273-5900

implementations of UCSD Pascal.³

PASCAL 100™

More Memory. Up to 128K bytes of memory, plus an optional 1M extended address feature.

Better Performance. Complies with the new IEEE standard—PASCAL-100 has upward compatibility built in.

Dealer/OEM inquiries welcomed



Our Printers

MEAN BUSINESS!



ANACOM 150

DOT MATRIX PRINTER

FEATURES:

- 150 Characters per second
- Bidirectional printing, logic seeking
- 9 x 9 Dot matrix
- Upper and lower case with decenders
- Double width characters
- 10 Characters per inch – horizontal
- 6 or 8 Lines per inch – vertical
- Adjustable tractors
- Original and 4 copies

OPTIONS:

- Extended life head
- Paper out sensor
- Bell, programmable
- 240 Vac 50 Hz
- Extended Factory Service

Circle 36 on Inquiry card.

The ANACOM - 150 is a highly dependable receive only printing terminal. It's modular construction combines rugged quality with convenient serviceability. It is factory warranted for 90 days with an extended service contract available for continued customer protection.

Suggested list price

\$1,350.00

Includes:

Serial or parallel interface

ANACOM GENERAL CORPORATION

1116 E. Valencia Dr.

Fullerton, Calif. 92631

(714) 992-0223

DEALER INQUIRIES INVITED

PASCAL

FROM START TO FINISH

The BYTE Book of Pascal

*Edited by
Blaise W. Liffick*

Based on the growing popularity of Pascal as a programming language, numerous articles, language forums and letters from past issues of BYTE magazine have been compiled to provide this general introduction to Pascal. In addition, this book contains several important pieces of software including two versions of a Pascal compiler - one written in BASIC and the other in 8080 assembly language; a p-code interpreter written in both Pascal and 8080 assembly languages; a chess playing program; and an APL interpreter written in Pascal. \$25.00
Hardcover pp. 342
ISBN 0-07-037823-1

Beginner's Guide for the UCSD Pascal System

by Kenneth L. Bowles
Written by the originator of the UCSD Pascal System, this highly informative book is designed as an orientation guide for learning to use the

UCSD Pascal System. For the novice, this book steps through the System bringing the user to a sophisticated level of expertise. Once familiar with the System, you will find the guide an invaluable

reference tool for creating advanced applications. This book features tutorial examples of programming tasks in the form of self-study quiz programs. The UCSD Pascal Soft-

ware Systems, available from SofTech Microsystems Inc, 9494 Black Mountain Road, San Diego CA 92126, is a complete general purpose software package for users of microcomputers and minicomputers. The package offers several interesting features including:

- Programs which may be run without alteration on the General Automation or DEC PDP-11 minicomputers, or on an 8080, 8085, Z80, 6502, 6800, or 9900 based microcomputers.
- Ease of use on a small, single-user computer with display screen and one or more floppy disk drives.
- A powerful Pascal compiler which supports interactive applications, strings, direct access disks, and separately compiled modules.
- A complete collection of development software: operating system, file handler, screen oriented text editor, link editor, etc.



Please send

- _____ copies of Beginner's Guide for the UCSD Pascal System
 _____ copies of The BYTE Book of Pascal



Name _____ Title _____ Company _____

Street _____ City _____ State/Province _____ Code _____

- Check enclosed in the amount of \$ _____
 Bill Visa Bill Master Charge
 Card No. _____ Exp. Date _____
 Add 60¢ per book to cover postage and handling.

**BYTE
BOOKS**

70 Main Street, Peterborough, NH 03458

B10

\$11.95
ISBN 0-07-006745-7

WordPro™

"WordPro is the most sophisticated Word Processing Software package available for the Commodore Computer line."

Solve Your Paperwork Problem . . . Let WordPro Software Do The Work

Using standard typing methods, hundreds of valuable hours are spent erasing, revising, and retyping letters and documents as you work towards a final draft copy. The second, third, or fourth drafts take just as long to type as the first!

With WordPro word processing software you can transform your Commodore computer into a "state of the art" word processing machine with sophisticated word processing features at an affordable price.

There are four versions of WordPro, ranging from the simple to the sophisticated. WordPro 1 on cassette will give computer enthusiasts a full range of text editing capabilities with cassette file storage. WordPro 2 is disk based and allows fast and easy file handling and manipulation. WordPro 3 was designed for professionals and contains the many features required in a business environment such as global search and replace, headers, footers, decimal tabulation, repagination, merging capabilities, and much, much more. WordPro 4 is our best. WordPro 4 runs on the new Commodore 8032, 80-column display computer. WordPro 4 has all the features of WordPro 3, plus additional features usually found only on the most sophisticated and expensive word processing equipment.

WordPro is a new breed of word processing software. Powerful, sophisticated, and easy to use, WordPro was field-tested by dozens of attorneys and commercial customers during 1979. WordPro is now installed and is saving its owners valuable time and money in hundreds of offices nationwide.

WordPro was designed with the user in mind. WordPro's unique "STATUS LINE" constantly interacts with the user by displaying the status of the system. Editing, storing documents, recalling letters, even the most sophisticated commands, are accomplished by a few, easy to remember, keystrokes.

You may find that WordPro alone is reason enough to own a computer. WordPro can be found at most Commodore dealers worldwide. Call us for the number of the dealer nearest you. If you cannot locate a stocking WordPro dealer you may place an order with Professional Software via check or VISA/MasterCharge.



Actual Photograph of WordPro on CBM Model 8032
The many features of WordPro 1 - 4:

WordPro 1 - Cassette based • Status line • Text Editing • Insert/Delete • Screen Scroll Auto Repeat • String Search • Erase Functions • Link Files • Margin Controls • Tab Functions • Justification • Page Length

WordPro 2 - Most WordPro 1 Functions Plus + Disk Based • Paragraph Indent • Centering • Text Transfer • Hyphenation • Appending • Margin Release • Variable Blocks (Form Letters) • Multiple Copies • Automatic Disk Commands • Complete Disk File Handling

WordPro 3 - Commercial Disk Version for 40 Columns • WordPro 2 Functions Plus + Global Functions (Search/Replace/Copy) • Merging Disk File Linkage • 10 or 12 Pitch • Repagination • Duplicate Lines • Auto Delete Word/Sentence/Range • Numeric Mode • Underlining • Continuous Print • Headers/Footers • Auto Page Numbering • Proportional Justification • Forced Paging • Non-Print Comments • BASIC Language File Compatibility

WordPro 4 - Commercial Disk Version for 80 Columns • WordPro 3 Functions Plus + Displays and Formats Text to Screen for Review

WordPro 1 — For 8K RAM units. Requires C2N Peripheral/integrated cassette drive - **\$29.95**

WordPro 2 — For 16K RAM units with 40 column screen. Requires 2040 disk drive - **\$99.95**

WordPro 3 — For 32K RAM units with 40 column screen. Requires 2040 disk drive - **\$199.95**

WordPro 4 — For Model 8032 with 80 column screen. Requires 2040 or 8050 disk drive - **\$299.95**

All four versions of WordPro are written in 6502 machine code.

Professional Software Inc.
166 Crescent Rd., Needham, MA 02194
(617) 444-5224

WordPro Dealer Inquires Invited

WordPro was developed by Steve Punter of Pro-Micro Software Ltd., and is marketed exclusively by Professional Software Inc.

WordPro is a registered trademark of Professional Software Inc. CBM is a registered trademark of Commodore Business Machines.



An 8088 Processor for the S-100 Bus

Part 2

Thomas Woodward Cantrell
2475 Borax Dr
Santa Clara CA 95051

Last month I talked about the Intel 8088 micro-processor (a 16-bit processor with 8-bit connections to the outside world), its associated support devices, and the general subject of doing 16-bit processing on the S-100 bus. In this portion of this three-part article, I will present the design of my 8088-based S-100 processor board. In part 3, I will describe MON88, a machine-language monitor for this processor board.

Interfacing

While the processor board presented here is compatible with the S-100 boards in *my* system, it does *not* fully conform to the proposed IEEE (Institute of Electrical and Electronics Engineers) standard. By devoting a little additional design effort, an interested reader should be able to make the board as IEEE-compatible as he wishes and can implement features I chose not to include. Refer to figure 1, the schematic diagram for the processor board on pages 66 and 67, throughout the following section.

The adaptation of the basic computer to the S-100 bus can be broken up into four necessary tasks:

- providing a buffered, demultiplexed address bus;
- providing for separate 8-bit buffered input and output data buses;
- generating a buffered command/control bus;
- producing the required status signals.

The Address Bus

It is necessary to demultiplex and buffer the address bus of the 8088 to communicate with the rest of the system. An immediate question is how to deal with twenty address bits instead of the traditional sixteen. The IEEE S-100 standard defines certain pins for *extended addressing*. However, some popular memory boards use bank-switching techniques, which are ill-defined between various manufacturers. My solution is to simply ignore the problem by using only the lower 16 address bits. A 64 K-byte address space is more than adequate for my current needs; and besides, none of the spare memory boards I will be using have either extended addressing or bank-select capability.

Looking at the schematic in figure 1, we see that IC6 and IC7 solve the problem. These are 8282 octal latch buffers, which are much like the familiar 8212 device (see figure 2). Two differences are that the drive capability of the 8282 is greater than that of the 8212, and it comes in a narrow twenty-pin package (versus the wider twenty-four-pin package of the 8212).

In the case of lines AD0 thru AD7, the 8282 also does the required demultiplexing of data and address information. By tying the 8282 STB (strobe) input line to the 8088 ALE (address latch enable), IC7 serves to latch the address. Since A8 thru A15 are only address information, the STB input of IC6 can simply be tied high. Also note the presence of S-100 signal ADSB* (address disable) at the OE* (output enable) pins of both IC6 and IC7. (The asterisk indicates an active-low signal.)

Each basic bus (address, data, status, and command/control) has a signal that can be used to cause the bus to go into its "disconnected" high-impedance state. This is important for DMA (direct memory access) -type functions in which different bus masters (processor, DMA controller, etc) must take control of the system. By causing the bus of the processor board to go into its high-impedance state, the whole processor board effectively "disappears" as far as the rest of the system is concerned. ADSB* performs this disappearing act for the address bus of the 8088 by pulling the 8282 OE* (output enable) pins high.

As a final note, the IEEE S-100 extended-addressing standard could be easily implemented by feeding lines A16/S3 thru A19/S6 into another 8282, demultiplexing the information with the ALE line, and bringing the appropriate outputs onto the defined S-100 lines.

Data Buses

IC8 (another 8282) buffers the data-output bus. Note that the S-100 signal DODSB* (data-out disable) serves to disconnect the output data bus for DMA, just as ADSB* did for the address bus. IC9 (an 8282) buffers the input data bus. Notice here that:

- There is no DIDSB* line. The purpose of the four bus-disable signals ADSB*, DODSB*, SDSB* and CDSB* (address-, data out-, status-, and control-disable lines) is to make the processor disappear from the bus, so that another processor can take control. Consequently, the only buses that need to disappear are ones that drive the bus (hence only output buses).
- IC9's OE* connection (B) is the output of some TTL (transistor-transistor logic) at the top of the schematic which serves to disable IC9. (Rest assured that I will explain what is going on in more detail.) Whenever we are reading from the on-board memory and I/O (input/output) ports (8185-2 and 8755A-2), this disconnects the data-input bus from the 8088, thereby eliminating a potential for bus contention.

"We designed a computer family that multiplies dealer sales."



Geof Karlin
Director of Systems Development

"At ADDS, we've just designed a unique computer family that multiplies your selling power because it expands customers' computing power.

"We call it ADDS Multivision—a trio of stacking, CP/M®-compatible computers that lets users upgrade without any change in their programs. It works like this:

"MULTIVISION 1 (top module) is a get-started computer with a 5 MHz processor, 64K bytes of RAM and mini disk storage capacity of 700K bytes. It lists for \$3,785 without terminal.

"MULTIVISION 2 (top and bottom modules) provides 5M or 10M bytes of hard-disk storage. Priced thousands less than other hard-disk systems, it lists for \$7,995 with 5M bytes of disk.

"MULTIVISION 3 (entire stack) tops off the line, giving you a multi-user system with up to 256K bytes of RAM that supports up to four display terminals simultaneously.

"We even offer an ADDS-developed package that lets Multivision function as a word processor.

"Since its introduction at the NCC, thousands have inquired where to buy Multivision. We'd like to give them your name."

For information on dealer opportunities, write: S. Eric McErlain, Systems Division, Applied Digital Data Systems Inc., 100 Marcus Boulevard, Hauppauge, N.Y. 11787.

CP/M is a registered trademark of Digital Research, Inc.

ADDS

SOMETHING EXTRA IN EVERYTHING WE DO

MULTIVISION

- The eight 1 k-ohm pull-up resistors have a number of effects. First, accessing nonexistent memory or I/O devices will always yield hexadecimal OFF (all 1 bits). Second, it is easier and faster to pull a normally high signal low than the other way around. Most important, the S-100 bus traditionally allows boards that drive the input data bus of the processor to use either TTL three-state drivers or open-collector drivers. The S-100 standard requires the existence of 1 k-ohm pull-up resistors to +5 V somewhere on the open collector lines. Here they are.
- "IC10" is a sixteen-pin socket with the eight address/data lines wired across it. This is for connection to the diagnostic front panel.

So far, everything has been pretty straightforward. Now comes the interesting part of the design effort. The question is how hard is the design, and how much TTL "glue" will it take to emulate the required status and control signals.

The Control Bus

Another 8282 buffer (IC5) is used to drive four control output signals (pHLDA, pWR*, pDBIN and pSYNC):

- **pHLDA:** The processor hold-acknowledge line is used when a DMA controller (or other bus master) wishes to take control of the system bus. It does this by asserting the HOLD* command to the current processor (bus master). Then the processor turns off its own address, data, and status output buses using ADD ADSB*, DODSB*, and SDSB* lines. When the processor is ready to "get off" the bus, it will assert pHLDA, which informs

the processor "getting on" the bus that the final transfer of bus control can take place. At this point, the new master completes the transfer by turning off the old master's control bus (via CDSB*).

The 8088 HLDA pin provides the S-100 bus pHLDA function.

- **pWR*:** The processor write line is the general-purpose write or output strobe for transmitting data to system memory or peripherals. The 8088 WR* pin provides the S-100 bus pWR* function.

- **pDBIN:** The processor data-bus-in signal is the general-purpose read or input strobe for transmitting data from system memory or peripherals.

The 8088 RD* pin, inverted by IC11, provides the S-100 bus pDBIN function.

- **pSYNC:** The processor sync signal tells the rest of the system when a new bus cycle is starting. This makes possible processor designs that are independent of the number of intrinsic bus cycles per machine cycle. Many 8-bit machines have three bus cycles for each machine cycle. The 8088 has four bus cycles per machine cycle. Any bus slave that is concerned with what cycle the bus is in can synchronize pSYNC, regardless of the processor being used.

The 8088 ALE signal correctly identifies the start of a bus cycle and can be used for the S-100 bus pSYNC signal.

The control input bus lines are scattered on the right side of the schematic and consist of the RDY, XRDY, INT* and HOLD* signals. (See figure 1.)

- **RDY and XRDY:** These lines serve essentially the same purpose, to force the processor to execute wait states. RDY is traditionally used by slow memory or I/O devices, while XRDY is used by front panels to implement run/stop and single-step capabilities. Both lines are pulled up by 1 k-ohm resistors, and if either goes low, IC12 and IC13 bring the 8284 line RDY2 low and the information goes through the 8284 to the 8088 (via their READY lines).

- **HOLD*:** The HOLD* line on the S-100 bus is equivalent to the HOLD line on the 8088 when it is inverted by IC12.

- **INT*:** The INT* line on the S-100 bus is equivalent to the INTR line on the 8088 when it is inverted by IC11.

The Status Bus

The question here is how closely the status outputs of the 8088 correspond to those needed by the system. This can be a real problem in interfacing processors to buses for which they were not designed. After all, it is a fundamental architectural decision about what a given processor will tell the rest of a system about its activities and when. Creating status signals with TTL devices can be quite a problem.

In this case, we are very fortunate with the 8088. Consistent Intel design philosophy is apparent here, easing our interface task. Looking back at table 2 of Part 1 last month, we recall that the states of three pins (IO/M*, DT/R*, and SSO*) fully encode the 8088 status. The timing diagram shows that status is valid at the right time, shortly after the start of the bus cycle. Using an 8205 1-of-8 decoder (IC3), the decoded status can be fed to the bus through a buffer (IC4). IC4 is not an 8282; it is an 8283, which is an 8282 with inverted outputs.

Text continued on page 68

FLOPPY DISK FACTORY DIRECT FLOPPY DISK FACTORY

FLOPPY DISK FACTORY DIRECT FLOPPY DISK FACTORY

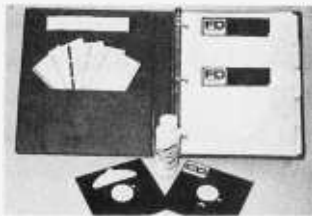

- Buy factory direct from the manufacturer of floppy disks sold exclusively under other well-known brand names.
- Save distribution costs on reversible 5.25" floppy disks, which are 100% certified for 40 track, dual side, double density and all other standard applications.
- **50%** savings on 5.25" floppy disks with new factory-direct 2.2 megabyte capacity "Diskit".
- Factory-direct "Diskit", includes twelve floppy disks and accessories, plus a head cleaner disk and solution packaged in a bookcase binder for easy access, handling and storage. "Diskit" complete for the introductory price of only \$49.50 plus \$2.50 freight and handling. Normal price \$59.50. **Order now and save \$10.00** (CA residents add 6 1/2% sales tax).
- Available in hard and soft sector configurations; when ordering indicate number of sectors — 1, 10 or 16.
- Send check or money order to:

Factory Direct

P.O. Box 60759
Sunnyvale, CA 94088

For VISA or MasterCard call toll-free

(800) 824-7888

In Calif. (800) 852-7777

In Alaska & Hawaii (800) 824-7919

Ask for Operator 98

FLOPPY DISK FACTORY DIRECT FLOPPY DISK FACTORY

THE KURTA GRAPHIC TABLET

A VERSATILE INPUT DEVICE FOR SMALL COMPUTERS

- 8½" x 11" TABLET SURFACE
- PEN
- COMPATIBILITY WITH 7" x 9" DISPLAYS
- MINIMUM INTERFACE AND SOFTWARE REQUIREMENTS

KURTA Graphic Tablets provide the small computer user with a method of enhancing his or her present setup without making a large expenditure. For example, because of the recessed tablet surface, an 8½" x 11" pad of paper fits snugly, virtually eliminating

re-location problems. Hard copy is easily obtained using the pen with replaceable ball point cartridge. The KURTA Graphic Tablet is directly compatible with standard 7" x 9" display screens and since the tablets' data output directly matches the computer capabilities, the interface and software requirements are minimized. KURTA is "the new leader in graphic message input and delivery."

For more information about the KURTA Graphic Tablet see your nearest computer dealer or contact us direct.



206 S. RIVER DR.
TEMPE, ARIZONA 85281
(602) 968-8709

A simulation



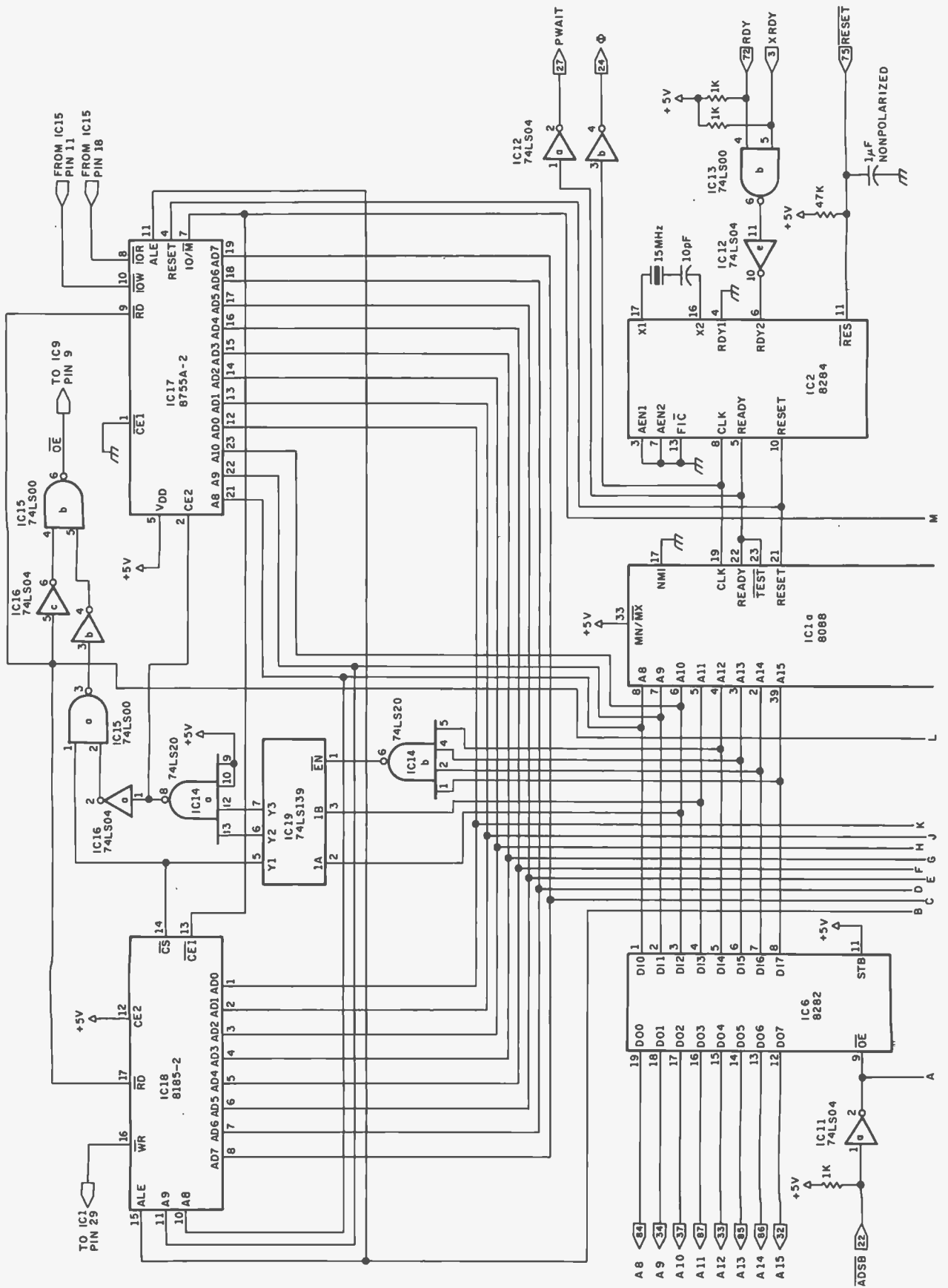

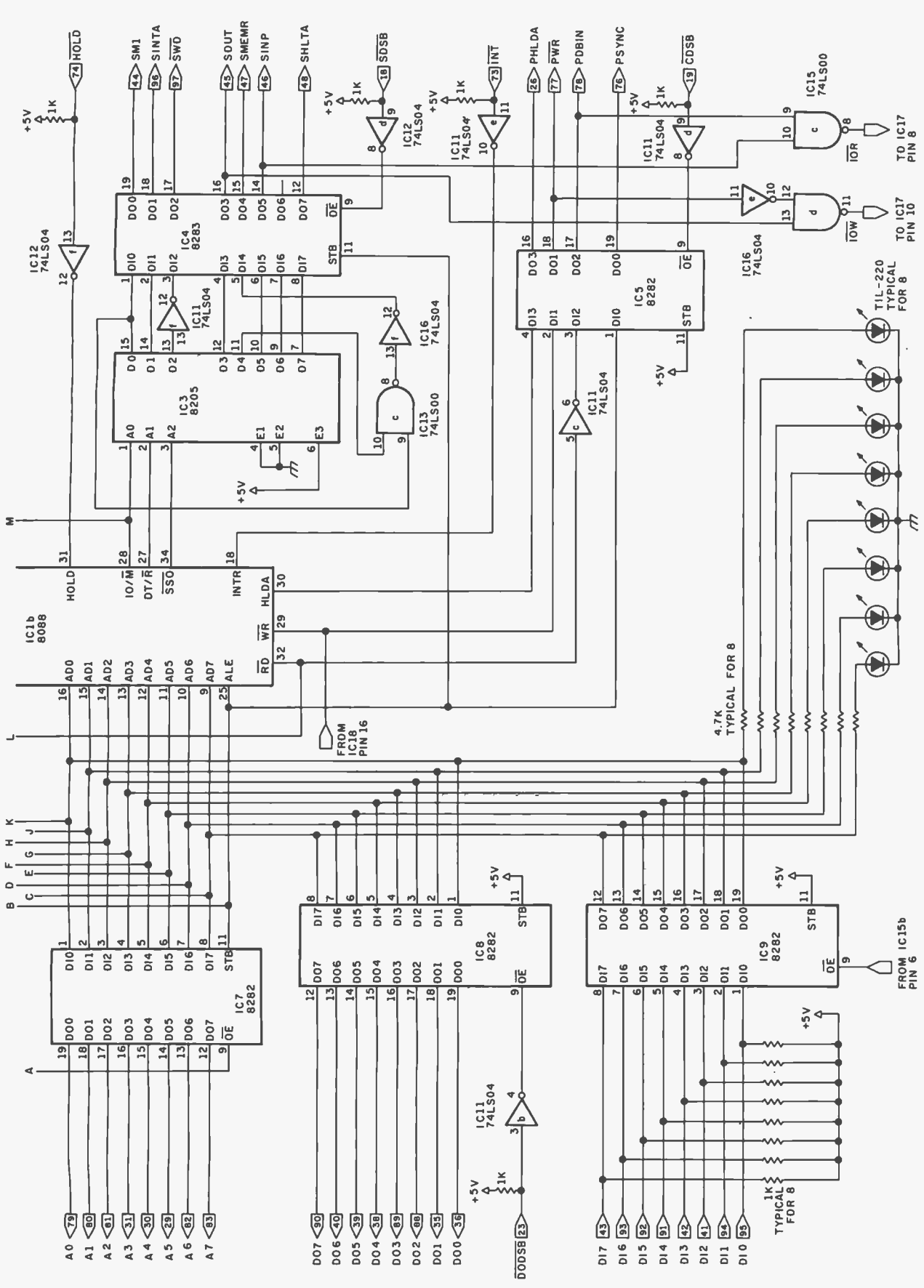

Figure 1: Schematic diagram of the 8088 processor board for the S-100 bus. The necessary status signals and buffers the control bus. Power connections for this shows the logic necessary to provide a buffered, demultiplexed address bus, and input and output buses for the S-100 standard. Logic also produces the necessary status signals and buffers the control bus. Power connections for the integrated circuits are given in table 1.

NEW from Wiley's popular paperback line



USING CP/M*

Judi N. Fernandez & Ruth Ashley
This detailed, self-paced introduction to Control Program/Microcomputers—the most widely used microcomputer operating system—lets you use CP/M to get maximum capability and efficiency from your micro.

"A marvelous addition to the CP/M literature... I only wish that I had had the book when I was starting out!"

—Alan R. Miller, *New Mexico Tech and Software*

Editor, *Interface Age*

0 471 08011-X Sept. 1980 approx. 320 pp. \$8.95



BACKGROUND MATH FOR A COMPUTER WORLD, 2nd Ed.

Ruth Ashley in consultation with Nancy B. Stern
Here are all the basic mathematical techniques, concepts, and facts you need for productive, intelligent interaction with your computer using any computer language. The new edition of this popular manual includes an entirely new chapter on trigonometry.

0 471 08086-1 1980 308 pp. \$7.95



WHY DO YOU NEED A PERSONAL COMPUTER?

Lance A. Leventhal & Irvin Stafford
Whether you're considering buying a personal computer or already own one, this is the book for you! Both consumer handbook and practical manual, it's more comprehensive, detailed, and up-to-date than any other work of its kind. It includes sensible guidelines on the advantages and drawbacks of each model, plus technical advice and sources of equipment and information. Find out how to use the personal computer to manage your finances, analyze stock market trends, serve as appliance controllers, much more!

0 471 04784-8 Nov. 1980 approx. 320 pp. \$8.95



FORTAN IV, 2nd Ed.

Jehosua Friedmann, Philip Greenberg, & Alan M. Hoffberg

A revolutionary new edition of the standard FORTRAN guide—now heavily oriented to personal computers. You'll start writing basic FORTRAN immediately, then progress smoothly to standard extensions and advanced options. Whether you use FORTRAN 77 or FORTRAN IV, the authors clarify the differences—with comparative tables—so you can follow whichever version is right for your machine. Users of mainframe computers will also find the book totally applicable.

0 471 07771-2 Oct. 1980 approx. 452 pp. \$8.95



TRS-80 BASIC

Bob Albrecht, Don Inman, & Ramon Zamora
Packed with games, graphics, and practical applications, this eagerly awaited guide leads you step by step to maximum use and enjoyment of your new TRS-80.

"The book is OUTSTANDING and is perfect for all LEVEL II owners... Geared toward the beginner, but does contain a wealth of information for more advanced programmers... TRS-80 BASIC is the best thing to happen to LEVEL II owners!"

—*Computronics Monthly News Magazine*

0 471 06466-1 1980 351 pp. \$8.95



JOHN WILEY & SONS, Inc.

605 Third Avenue, New York, N.Y. 10158

In Canada: 22 Worcester Road, Rexdale, Ontario

Wiley Self-Teaching Guides also teach COBOL, Job Control Language, Flowcharting, and other computer skills. Look for them at your favorite bookshop or computer store, or send your check (including state sales tax) to Pam Byers, Dept. 1-7150

Prices subject to change without notice

Number	Type	+ 5 V GND	
IC1	8088	40	1
IC2	8284	18	9
IC3	8205	16	8
IC4	8283	20	10
IC5	8282	20	10
IC6	8282	20	10
IC7	8282	20	10
IC8	8282	20	10
IC9	8282	20	10
IC10	7474	14	7
IC11	74LS04	14	7
IC12	74LS04	14	7
IC13	74LS00	14	7
IC14	74LS20	14	7
IC15	74LS00	14	7
IC16	74LS04	14	7
IC17	8755A-2	40	20
IC18	8185-2	18	9
IC19	74LS139	16	8

Table 1: Power connections for the integrated circuits in the schematic diagrams of figure 1 and figure 5.

Text continued from page 64:

As usual, the OE* of IC4 is tied to the appropriate disable signal (in this case, S-100 SDSB*, or status disable).

Thus, 8088 pins IO/M*, DT/R*, and SSO* are fed as inputs to the 8205 decoder (IC3), and the status appears through the inverting 8283 (IC4):

- sM1: The status M1 signal indicates to the system that an op-code fetch (8080A style) is taking place. The reason I say "8080A" style is that sM1 for an 8080A is different from the status instruction fetch of the 8088.

For example, on an 8080A, you must use 3 bytes when you want to load a register (pair) with a 16-bit data item. The first is the instruction itself, while the second and third bytes are the data. The 8080A treats only the first byte-fetch as an instruction fetch; the second 2 bytes are operand fetches. The 8088, on the other hand, treats all three fetches as instruction fetch (ie: sM1).

This signal is not required by any of the boards I plan to use in the system, so the only real difference I notice is that the 8088's front-panel sM1 light seems brighter than the one on the IMSAI (due to its being on more often).

- sINTA: The S-100 status interrupt-acknowledge line indicates that the processor is in an interrupt-acknowledge sequence. 8088 interrupt-acknowledge status works just fine.

- sWO*: The S-100 status write/output signal is used to tell slave units that the processor is sending data to them. Commonly, the signal, in conjunction with address-decoding circuitry, acts as a select signal for other boards in the system. Since this signal is active low, the inverter at IC11 conditions the 8088 status.

- sOUT: The status output line tells the rest of the system that the processor is transferring data to an output port. The derived "write I/O" line from the 8088 is used to implement the S-100 sOUT line.

- sMEMR: The S-100 status memory-read line is used to select memory boards for input. On the 8080A, sMEMR is generated for all memory accesses including code, operand, and data (stack operations). On the 8088, status memory-read is generated only for data movement (eg: MOV MEMPOINTER, 0) and stack operations (eg: POP AX).

THE

SOFTWARE THAT THINKS FOR ITSELF

Before The **THINKER™**, microcomputer business systems have fallen short in two distinct areas: *FLEXIBILITY* and *INTEGRATION*. Every business is different and requires software to be pre-set to fit its own particular needs. A nip here, a tuck there, and files are extended to where the business was expected to be. . . But, a single file too short can cause the system to fail, or a single file too long wastes costly disk space. The **THINKER™** takes the guess work out of your business data processing by thinking for you.

EASY TO USE—FULLY INTEGRATED ACCOUNTING SYSTEM

The **THINKER™** consists of 7 comprehensive *interactive* modules, with all transactions applied immediately and the results are instantaneously accessible. They are;

- ACCOUNTS RECEIVABLE • ACCOUNTS PAYABLE
- SALES ORDER ENTRY • PURCHASE ORDER ENTRY
- INVENTORY CONTROL • GENERAL LEDGER • MAILING LIST

FLEXIBILITY SOFTWARE THAT GROWS WITH YOUR BUSINESS

The **THINKER™** utilizes the **DYNAFILE™** *Keyed File Allocation Scheme* which dynamically manages file length and records to meet the businessman's needs and will automatically extend itself to work on hard disks without any program modification. No disk space is wasted because the system automatically recaptures space when records are deleted. **DYNAFILE™** utilizes a sophisticated indexing scheme, allowing direct access to any record. Machine language programming insures **DYNAFILE™** speed, reliability, and integrity.

The **THINKER™** is currently available for 6502 based microcomputers. 80 column PET/CBM Computers
80 column Apple Computers (Available Nov.)

Introductory Price \$595

See The **THINKER™** at your local computer store,
or send check or money order, plus \$3.00 shipping to:

**DEALER
INQUIRIES
INVITED**

USA UNITED
SOFTWARE
OF
AMERICA

(212) 682-0347
Telex 640055

750 THIRD AVE.
NEW YORK NY 10017

*The **THINKER** and **DYNAFILE**
are trademarks of USA Software.

INTELLIGENT ACCOUNTING SYSTEM

THINKER

TM

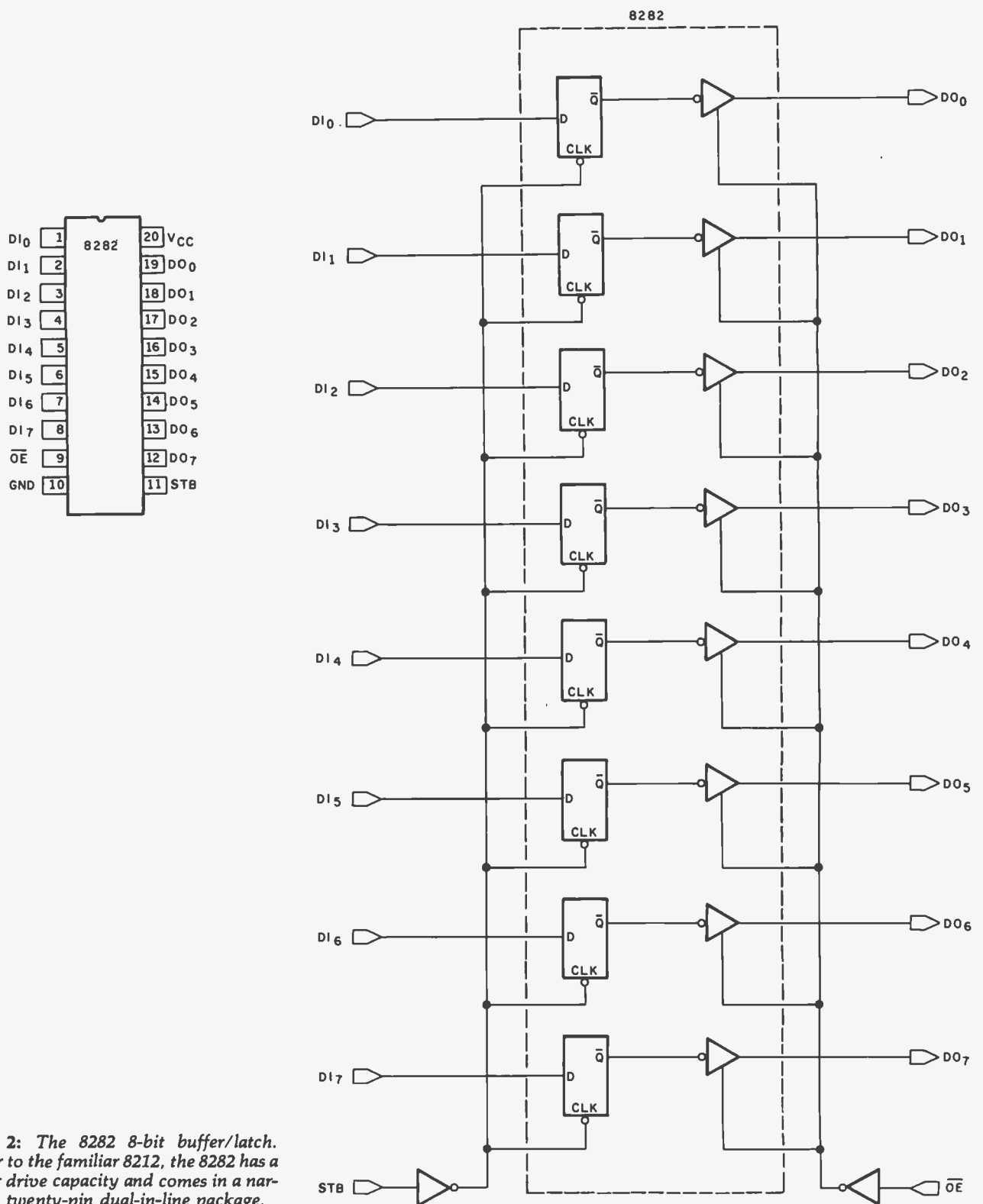

Figure 2: The 8282 8-bit buffer/latch. Similar to the familiar 8212, the 8282 has a greater drive capacity and comes in a narrower, twenty-pin dual-in-line package.

Examining the schematic, we see that IC3 output 0 (indicating code access) and IC3 output 4 (indicating memory-read) are gated into NAND gate IC13, and the result is fed through inverter IC16 before being brought out as sMEMR via IC4. This allows sMEMR to be generated by the 8088's read-memory status, but it also

insures that sMEMR is asserted whenever the 8088 status is "code access" (ie: sM1).

- **sINP:** This status input line tells the rest of the system that the processor is requesting data from a port; this signal is easily implemented with the 8088 "read I/O" derived status signal.

MICROTEK

SO RELIABLE WE GIVE YOU

365 DAYS WARRANTY

360 361 362 363 364
355 356 357 358 359
350 351 352 353 354
345 346 347 348 349
340 341 342 343 344
335 336 337 338 339
330 331 332 333 334
325 326 327 328 329
320 321 322 323 324
315 316 317 318 319
310 311 312 313 314
305 306 307 308 309
300 301 302 303 304
295 296 297 298 299
290 291 292 293 294
285 286 287 288 289
280 281 282 283 284
275 276 277 278 279
270 271 272 273 274
265 266 267 268 269
260 261 262 263 264
255 256 257 258 259
250 251 252 253 254
245 246 247 248 249
240 241 242 243 244
235 236 237 238 239
230 231 232 233 234
225 226 227 228 229

TOTAL PEACE OF MIND.

We are business people, just like you. We wouldn't stick our neck out unless we were certain we could back our claims and promises to the last letter. We wouldn't offer a legally binding long-term warranty on our Microtek MT-80, unless we were positive of its solid reliability.

We are sure that our versatile, alphanumeric line printer will provide you consistent, dependable performance. This is why we give you, not the usual 90-days in fine print, but an incredible 365-days warranty. We stand behind every product we make.

LOADED WITH INNOVATIONS

- 40, 80 or 120 columns (software selectable)
- Non-thermal paper, pln feed
- 125 CPS, 70 lines per minute
- 9 x 7 dot matrix
- Vertical format unit
- 96-character ASCII (upper and lower case)
- Adjustable forms width to 9 1/2"
- Parallel and serial (RS-232C) interfaces available

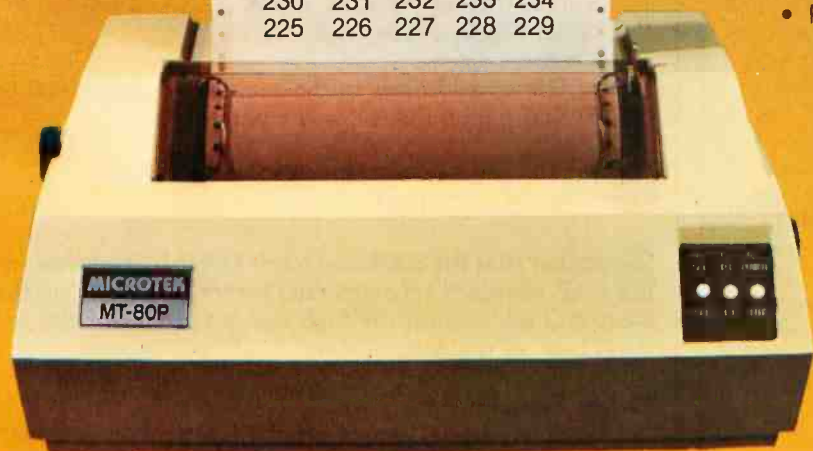

OUR UNIT PRICE

\$795 Parallel

\$895 Serial (RS-232C)

For more information contact:
MICROTEK, Inc.
9514 Chesapeake Dr.
San Diego, CA 92123
Tel. (714) 278-0633
TWX 910-335-1269

RELIABILITY

FORTH

A full, extended FORTH interpreter/compiler produces COMPACT, ROMABLE code. As fast as compiled FORTRAN, as easy to use as interactive BASIC.



SELF COMPILING

Includes every line of source necessary to recompile itself.

EXTENSIBLE

Add functions at will.

CP/M* COMPATIBLE

Z80 or 8080 ASSEMBLER included

Single license
Supplied with extensive user manual and tutorial:
\$150.00
Documentation alone: \$25.00

OEM's, we have a deal for you!

CP/M Formats: 8" soft sectored,
5" Northstar, 5" Micropolis Mod II,
Vector MZ, TRS-80 Mod II

Please specify CPU type.
Z80 or 8080

All Orders and General Information:
SUPERSOFT ASSOCIATES
P.O. BOX 1628
CHAMPAIGN, IL 61820
(217) 359-2112
Technical Hot Line: (217) 359-2691
(answered only when technician is available)



SuperSoft
First in Software Technology

*CP/M registered trademark Digital Research

● **sHLTA:** The S-100 status halt-acknowledge signal is asserted when the processor enters a halt state. The 8088 "halt" decoded status line provides this function.

Design Details

The S-100 system-clock signal (Φ , pin 24) is sent from the CLK output of the 8284 through an inverter in IC12 that serves to invert and buffer the 5 MHz signal.

Another signal, PWAIT, is the logical inversion of the READY input to the processor. This is brought out to S-100 pin 27. I use this to observe READY status on the front panel.

A front panel RESET switch (closure to ground) comes onto the board through the RC (resistor/capacitor) timing network (47 k-ohm resistor, 1 μ F capacitor) and is connected to the 8284 RES* input.

The bottom-right of figure 1 contains a couple of gates and an inverter. This circuit determines if an I/O READ or I/O WRITE is taking place and properly controls the IOR* and IOW* inputs to the 8755A-2. These signals are used when the two 8-bit parallel ports it contains are accessed.

Finally, the circuit containing IC19, IC14, and various inverters (these appear in the upper-middle portion of the schematic) fully decodes (ie: with no wasted address space) the address for the 2 K bytes of EPROM (erasable programmable read-only memory) and 1 K bytes of programmable memory on the processor board (8755A-2 and 8185-2). The 2 K bytes of EPROM are addressed from hexadecimal XF800 to XFFFF, and the 1 K bytes of user memory are addressed from hexadecimal XF400 to XF7FF.

Since only sixteen address lines are used, the contents of the upper four address lines are not important, hence the X in the above hexadecimal numbers. Some I/O space is wasted though; the 8755A-2 uses the state of address lines AD0 and AD1 to determine whether to utilize port A or port B during I/O operations. With my decoding, I/O addressing is such that port A will be accessed with port addresses between hexadecimal F800 and FFFF, which map into the following address pattern:

Port A address = 1111 1XXX XXXX XX00
(ie: 0F800, 0F804, etc)

Port B uses addresses in the same range (ie: 0F800 to 0FFFF) that match the following pattern:

Port B address = 1111 1XXX XXXX XX01
(ie: 0F801, 0F805, etc)

Remember that the 8088 uses a full 16-bit I/O address (as the IEEE standard recommends) rather than echoing the 8-bit I/O address on the high and low bytes of the address bus (as the 8080A does).

Other Signals: Pins 1 to 50

I have left some signals off the board that you may want to use, so before you start building, you may want to pencil in a few of your own design additions. Some of the missing signals relate to the IEEE standard and some are old standbys that appear on many boards. The following is a general summary of my usage (or non-usage) of all S-100 lines.

● **XRDY:** Pin 3 on the S-100 bus is one of the two

Now You Can Put a TRS-80[®] Computer In Your Pocket!



For Only **\$249***

SHOWN ACTUAL SIZE!
(5/8 x 2 3/4 x 6 7/8")

WEIGHS ONLY 6 OUNCES!

Another Radio Shack Personal Computer Breakthrough!

Now you can carry computer power wherever you go. And with the TRS-80 Pocket Computer, you can create your own programs or purchase ours. These are available now: Civil Engineering, Aviation, Business Statistics, Games, Personal Finance, Math Drill, and Real Estate.

Look At These Exciting Features! 57-key alphanumeric keyboard. Big LCD display that scrolls left and right for program line entry and editing, and steps up and down for program listing. Programmable in an enhanced, easy-to-learn BASIC language. Built-in arithmetic functions including trig and inverse trig (with readout in degrees, radians or gradians) log, exponent, square root, angular conversions, integers and absolute values. Accuracy is to 10 digits and it can handle 2-digit

exponents. With array and 7-character string-handling ability you've really got a handful of computational power!

Programs and Data Retained in Memory When Power Is Off! The 1424-step memory is automatically partitioned for program and data storage. There's a 26-data element memory and 48-step reservable memory.

Available Now! Exclusively at Radio Shack stores, dealers and Computer Centers. Complete with carry case, manual, batteries. Hurry, because everyone will want this sensational new computer. And what could make a better or more unique Christmas gift?

Nothing Else You Can Put In Your Pocket Can Do All This!

```
10 Print "SHELL METZNER SORT": FOR X = 1 TO 100:
  PAUSE "DATA ITEM #"; X: INPUT A(X + 100): IF A(X + 100)
  < 0 GOTO 25
20 NEXT X
25 M = X - 1
30 M = INT(M/2): IF M = 0 GOTO 107
40 J = 1: K = X - M - 1
50 I = J
60 BEEP 1: L = I + M: IF (A(I + 100) <= A(L + 100))
  GOTO 100
70 T = A(I + 100): A(I + 100) = A(L + 100):
  A(L + 100) = T: I = I - M: IF I < 1 GOTO 100
90 GOTO 60
100 J = J + 1: IF J > K GOTO 30
105 GOTO 50
107 BEEP 5: INPUT "PRESS ENTER FOR LIST": A
110 FOR I = 1 TO X - 1: J = I + 100: PAUSE "DATA ITEM #":
  USING "####"; I: " "; A(J): NEXT I
```

Send Me Your FREE TRS-80 Computer Catalog!

Radio Shack, Dept. 81-A-21
1300 One Tandy Center
Fort Worth, Texas 76102

NAME _____

TITLE _____

FIRM _____

STREET _____

CITY _____

STATE _____

ZIP _____

PHONE _____

*Retail prices may vary from store to store. Optional Cassette Interface, \$49. Miniset-9 Cassette Recorder, \$79.95.

Radio Shack[®]

The biggest name in little computers[™]



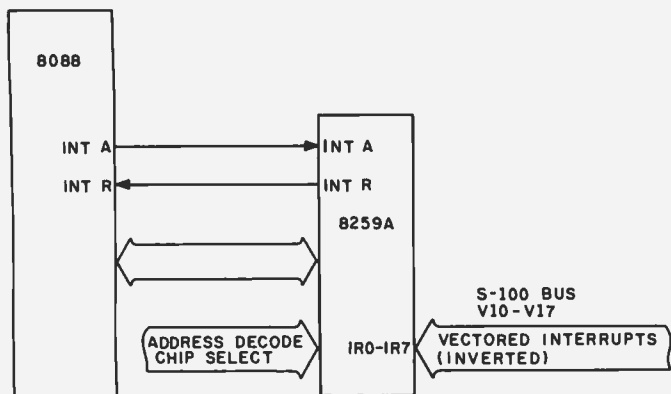

Figure 3: An 8259A Programmable Interrupt Controller can be added to the system by following this logic diagram. The 8259A requires access to the demultiplexed bidirectional data bus of the processor in order to properly interpret vectored interrupts from the S-100 bus.

"ready" inputs used (the other is RDY, pin 72). In particular, XRDY is meant to be used by front panels, as opposed to slow memory or I/O devices. I use this signal for just this purpose, allowing the implementation of run/stop and single-step functions.

● **V10 thru V17:** S-100 pins 4 thru 11 are dedicated to eight different vectored-interrupt inputs. These were originally designed around Intel's 8259A PIC (Programmable Interrupt Controller). Without going into a lot of detail, the use of a PIC allows flexible assignment of

priorities for eight levels of interrupts and a programmable definition of the processor response to each. While the basic method of operation of an 8259A with the 8088 is slightly different from its operation with an 8080A or 8085A, the 8259A is still the interrupt controller to use.

I have not implemented an 8259A in my design, but it is a logical and easy addition. All that is required is that the V10 thru V17 inputs (inverted) be tied to IR0 thru IR7 on the interrupt side of the 8259A. Then the INT output of the 8259A is tied to the INTR input of the 8088 (see figure 3). On the programmable side of the 8259A, we need to connect the data bus of the processor (D0 thru D7, the demultiplexed data bus). In addition, address decoding and chip-select logic that meets your needs (ie: hardwired or switch-selectable) is needed to access the 8259A.

● **NMI*:** S-100 pin 12 is a nonmaskable interrupt line. As the name implies, this is an interrupt input to the processor that cannot be masked in software. All that is necessary to use this input is to run the S-100 NMI* line through an inverter and into the NMI input of the 8088. Nonmaskable interrupts are usually reserved for catastrophic occurrences that require immediate processor attention (such as impending power failure or recurring bus errors).

● **PWRFAIL*:** The IEEE standard specifies pin 13 as a power-failure signal, an input that indicates impending power failure. Noticing the physical proximity to pin 12 (NMI*) and the same inverted-logic convention, the intention is to jumper pin 12 to 13 and use PWRFAIL* to generate an NMI before a power interruption. In this case, the NMI routine of the processor could save critical system-status parameters (register contents, stack pointer and contents) in battery-powered programmable memory, then perform a software halt to prevent the processor from causing the system to crash as it "dies."

● **DMA0 thru DMA3:** The IEEE standard uses pins 55, 56, 57, and 14 for DMA-priority arbitration. This allows resolution of requests for use of the bus by up to 16 would-be bus masters. As I had no use for this feature, these lines are not used in this design. The traditional HOLD/HLDA (hold, hold acknowledge) protocol using pins 74 and 26 is implemented, however.

● **A16 thru A23:** As mentioned before, the IEEE standard does provide for an extended addressing scheme. Since I have chosen to use only sixteen address lines (A0 thru A15), none of the extended lines are used. If you have memory boards that support the IEEE standard, it is a simple matter to bring the upper four address lines of the 8088 (A16/S3 thru A19/S6) onto the S-100 bus using an additional 8282 latch. Remember to demultiplex the address and status information on these lines using the 8088 ALE connected to the strobe input of the 8082 (STB, pin 11).

● **SDSB*, CDSB*, ADSB*, and DODSB*:** The status-, control-, address-, and data-out-disable lines are used as they are intended, namely to disable the associated buses by causing them to change to their high-impedance state.

● **pSTVAL*:** The IEEE standard calls for a processor-status-valid signal used to latch the processor status. Since none of my boards require the presence of this signal, it is not implemented. If you need pSTVAL*, some massaging of the 8088's ALE signal with the system clock (Φ) will probably do the trick.

6809 S-100

SINGLE-BOARD COMPUTER

- Meets IEEE S-100 Standard
- Uses Motorola's Powerful MC6809 CPU
- 4K/8K/16K ROM • 2K RAM
- ACIA, PIA, 8080 Simulated I/O
- RS-232 Handshake • 8 Selectable Baud Rates
- Manual includes: 11x17" Schematic, Parts List, User Notes, Software Listings & More!

AND NOW Microware's

*OS-9

6809 MULTI-TASKING OPERATING SYSTEM

CONFIGURED FOR THE ADS 6809 S.B.C.!

- Interrupt Driven Multi Device I/O
- Full Memory Management Capability
- Complete Array of OS-9 System Software
- Much More

* OS-9 trademark Microware, Inc. & Motorola

WRITE FOR COMPLETE DETAILS

6809 P. C. Board & Manual \$69.95
 Shipping \$1.50 Ill. Res. Add Sales Tax

ACKERMAN DIGITAL SYSTEMS, INC.

110 N. York Rd. • Suite 208 • Elmhurst, Illinois 60126 • (312) 530-8992

Tax Practitioners / CPAs: Successful Tax Professional Reveals Effective Practice Development Formula....

NEW!

“Every tax professional...whether he is desirous of expanding his practice, or just better serving his existing clientele (or both)...can profit from this system.”

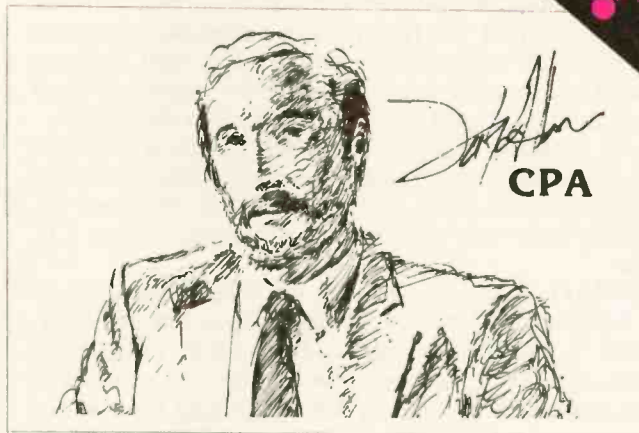

Are you satisfied with the growth of your tax practice?

Successful practice development is a perplexing problem facing all tax professionals today. The field tested MICROTAX professional tax preparation software package can provide you with an innovative solution...and at the same time enable you to serve your existing clientele in a more professional and timely manner.

Consider the advantages this state-of-the-art package can bring to your practice:

• **Complete System...**

...containing Federal Individual, Corporate AND State Individual returns. The system is designed to accept information, summarize the data, compute the tax, and print the returns; including **all** forms and schedules required by the I.R.S.

• **Versatile**

MicroTax is cost-efficient for practices preparing as few as 20 returns per tax season...but comes with a fast mode, capable of processing 2,000 returns—or more!

• **Best Of All...**

...and this is really exciting...MicroTax allows you to offer **preyear-end tax planning** to your clients—enabling you to predict the potential liability and take steps to minimize the tax in a timely manner.

• **Complete In-Office Security**

—no risk of sensitive client information falling into the wrong hands.

• **Saves Time**

Compared with conventional service bureaus, MicroTax offers virtually instant turn-around time.

• **More Professional**

Greater range of services allows you to present a more professional appearance to your clients.

• **Requirements:**

CP/M, Microsoft Basic & 48K Memory

• **Introductory Price (till Dec. 1, 1980)**

MicroTax is available as a three part system:

Federal Individual	\$750.00	Annual Updates
State Individual	250.00	Are Available
Corporate	250.00	

MicroTax is a versatile and money-saving tool that **NO** tax professional should be without (it's been selected for use by COMPU-TAX of Utah).

INTERESTED? Call or write today for additional information, or your nearest dealer. Problems that can't wait? Call Don White our V.P. of Research and Development, direct, at (213) 668-0238.

microTAX

Income Tax Software Specialists

Exclusive Distributor

S.O.F.T.W.A.R.E.†, Inc.

3600 WILSHIRE BOULEVARD, #1510, LOS ANGELES, CALIFORNIA 90010 • (213) 738-9972

Available at most
Professional computer retailers

Circle 46 on inquiry card.

● **SS, SSW DSBL***, and **RUN**: The IMSAI uses pins 21, 53, and 71 for single-step, a sense-switch-disable signal and a run indicator. These are all officially archaic according to the IEEE standard and are not used.

● **PROTECT, UNPROTECT and PROTECT STATUS**: S-100 pins 70, 20, and 69 represented a short-lived attempt by some manufacturers to implement memory protection and unprotection in software. It was soon noticed that the first thing a "crashing" program always does is to randomly produce the right code sequence to unprotect your memory. So much for these three signals. They are not implemented in my design.

● **Φ**: Another holdover from the 8080A is the two-phase clock. The other phase is almost an inversion of the Φ (main system) clock, but not quite. If you need φ1 (probably not), you will need to synthesize it using TTL devices.

● **PWAIT**: One leftover from the IMSAI that I did retain is the processor-wait-control output line (PWAIT, pin 27). I use this to light a front-panel LED (light-emitting diode) so I know if the processor is running or has stopped. It is also handy for monitoring the reaction of the processor to memory slow enough to need wait states.

The remaining signals (thru pin 50) are used as intended, and specified by the IEEE standard with an exception for the definition of sM1 and the deletion of **CLOCK**:

● **sM1**: Pin 44 is used for a status M1 signal, generally occurring during an op-code-fetch cycle. A potential problem occurs here in that the 8080A's op-code fetch is different from the code-access status signal of the 8088 as

decoded from **IO/M***, **DT/R*** and **SSO***.

As I mentioned earlier, allowing sM1 to occur for both op-code and operand fetches causes no problems.

Looking over the schematics for some of the boards I own, I noticed that sM1 is rarely used except by some front-panel controllers. Front panels use it to insure that the STOP part of the RUN/STOP function always occurs at the first byte of an instruction. I have used the 8088's status-code access as a substitute for sM1 without problems.

● **CLOCK**: This line (pin 49) is specified as a 2 MHz clock running asynchronously with the main processor and thereby independent of its clock frequency. I/O boards may use this for data-rate generation. If I ever need to implement **CLOCK**, I will probably use a 2 MHz crystal oscillator circuit, since it is not obvious how to generate 2 MHz from 5 MHz. (Let's see, where's that divide by two-and-a-half circuit?) Now if the 8088 could run at 8 MHz, we could just divide PCLK (you remember the 8284 peripheral-clock output) by 2 and have our 2 MHz **CLOCK** signal.

Other Signals: Pins 51 to 100

Here are some more S-100 bus signals you may want to add to your design:

● **SLAVE CLR***: S-100 pin 54 is meant to be kind of a reset for bus slave devices (primarily I/O boards) so they can reset counters or whatever. If you want to implement **SLAVE CLR*** use either a separate front-panel switch or the other side of the master **RESET** switch (as the IMSAI computer does).

● **PHANTOM***: Pin 67 is the much maligned PHAN-

BUILD YOUR COMPUTER BREADBOARDS & INTERFACES FASTER AND EASIER WITH NEW VECTOR PLUGBORDS

EASY TO USE!

COST EFFECTIVE!

CLEAN HOLES!

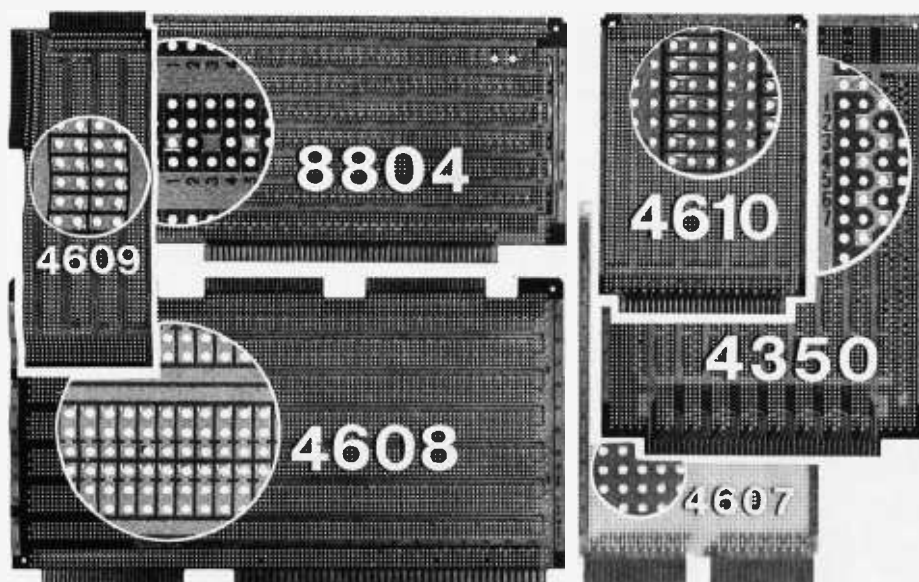

4610 Series - For STD-BUS-WW, solderable and unpatterned models

4608 Series - For Intel/National SBC/BLC 80-WW/ solderable, or unpatterned

8804 Series - For S100 - 5 models available

4607 - For DEC LSI 11/ PDP8-11, Heath H-11

4609 - For Apple II, SuperKim, Pet Commodore with Expandamem

4350 - For TI 980 Computer



Vector Electronic Company INCORPORATED

12460 Gladstone Ave., Sylmar, CA 91342 (213) 365-9661 TWX (910) 496-1539

Available through Distributors or Factory Direct If not available locally.

74801

The **MAGIC WAND**TM is
**ALMOST
PERFECT.**

We've been saying it for a few months now, and the reviewers seem to agree.

“ Until I saw the Magic Wand, if I were allowed to own one and only one editor, Word Star* would have been it. . . . My personal preference is for Pencil or Magic Wand for text creation. ”

Jerry Pournelle

On Computing, Summer 1980

“ The basic functions of the Magic Wand editor are as easy to learn as those of Electric Pencil*. . . . Magic Wand dominates in the area of print formatting. ”

Larry Press

On Computing, Summer 1980

“ Of all the word processors I have used (and that includes a dozen or more), the Magic Wand is the most versatile. The Wand has almost all of the features of other processors, plus many new ones of its own. It measures up to even the word-processing software running on the largest mainframe computers. ”

Rod Hallen

Microcomputing, June 1980

“ The Magic Wand is one of the most flexible word processing packages available, and should be considered by any potential word processing purchaser. ”

Glenn A. Hart

Creative Computing, August 1980

Available for both the CP/M® and OASIS operating systems

small business applications, inc.

3220 Louisiana • Suite 205 • Houston, Texas 77006 • 713-528-5158

Electric Pencil is a trademark of Michael Shroyer Software, Inc.
WordStar is a trademark of Micro Pro International, Inc.
CP/M is a registered trademark of Digital Research Corp.

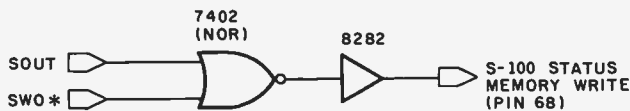

Figure 4: The MWRT (memory write) signal required by S-100 systems can be provided by simple logic, if it is not generated elsewhere in the system.

TOM* line. It was originally developed to resolve the conflict between the reset start address of 0 on the 8080A and the fact that most people prefer processing to begin at some higher address (to support ROM and EPROM monitors in high memory). Without going into a lot of detail, PHANTOM* is used to make a programmable memory board addressed at memory location 0 "disappear" while it is "replaced" by a read-only memory at some higher address. Consequently, when the computer starts executing at location 0, it is actually executing the first few instructions in the read-only memory. This is usually a JMP instruction to the actual address of the read-only-memory board. Since the 8088 nicely begins executing in high memory at absolute address hexadecimal OFFF0, which is treated as hexadecimal OFFF0 by my machine (remember, only sixteen address lines are currently used), the problem resolves itself and PHANTOM* is not needed.

● **MWRT:** S-100 pin 68 is used for the memory-write status line. This is simply a logical combination of two existing status signals (sWO*, status write out; and sOUT, status out). MWRT can be a real problem if you

are not careful. The basic problem is that MWRT is not required to be generated by the processor, but it must be present somewhere in the system. It seems that every manufacturer does you a favor by providing MWRT capability on their board. I have seen MWRT on front-panel boards, memory boards, processor boards, disk controllers, etc. Ensure that there is one and only one MWRT in your system. If it does not exist, let me recommend that you add a 7402 NOR gate and use one of the unassigned outputs of the 8282 (IC5) for buffering as shown in figure 4. In my case, MWRT is generated on the BYT-8 motherboard.

● **SSTACK and ERROR*:** Pin 98 on the IMSAI was used for the 8080A-dependent signal, status stack-access. It indicates that the stack is being accessed (ie: via PUSH or POP) and is never used for anything. In a segmented-memory machine like the 8088, however, it might be of more interest to know if the stack is being accessed. By decoding S4 and S3 (equivalent to A17/S4, A16/S3 on the 8088), this can be determined.

Realizing the nebulous virtues of SSTACK, the IEEE standard uses pin 98 as a general-purpose ERROR* indicator. When memory boards with parity capability are widely used, ERROR* could be used to indicate parity errors. ERROR* could then be tied to NMI*, and the processor's nonmaskable-interrupt routine could call for a rerun of the failing bus cycle. Since none of this grandiose scheme is currently implemented on my board, pin 98 is not used.

● **POC*:** Pin 99 is defined as power-on-clear line, which is supposed to exercise both master RESET* (pin 75) and SLAVE CLR* (pin 54) upon system power-up. Since the RC timing network I use on RESET* does the trick for resetting the 8088, and SLAVE CLR* is not used; there is no need for POC*.

Before you go overboard trying to implement a lot of the above, I want you to know that most of it is probably not needed. The current design works just fine with all of my boards, including:

- Wameco 8 K 2102 memory boards (and others of similar design)
- Godbout 16 K and 32 K 4044 (or equivalent) based memory boards
- SSM Parallel I/O board
- SSM VB1 Video Interface
- Cromemco Bytesaver 2708 board
- TDL VDB Video Interface
- Tarbell Cassette Interface
- Tarbell single-density floppy-disk controller
- Vector Graphics 2708 programmable read-only memory board

Implementation

Start by looking at the photos of the front and back of the board (see photos 1a and 1b on page 80). Regarding the back side, all I can say is "functional is beautiful." It is not really as formidable as it seems. I will proceed to give some hints that may prove useful.

Remember, patience is a virtue. I used a CCS (California Computer Systems) wire-wrap board for a number of reasons. The provision for voltage regulation (and filtering) and the ground plane around the edge of the board are nice. The board is uncommitted to any particular device size, allowing any combination of dual-in-line sockets. In addition, the feed-through holes are all plated,

September, October Super Special
Apple II 16K
\$950.00 reg. 1195.00

<p>INTEGRAL DATA SYSTEMS</p> <p>440G: Paper Tiger with Graphics; 2K Buffer \$950 <small>reg. \$1095</small></p> <p>460: Word Processing Quality \$1099 <small>reg. 1295</small></p> <p>460G: IDS 460 w/Graphics \$1199 <small>reg. 1395</small></p>	<p>Centronics 737 High Quality Dot Matrix \$895 <small>reg. 995.00</small></p> <p>Apple Silentype Includes interface and graphic capabilities \$535 <small>reg. 595.00</small></p> <p>Apple Parallel Int. \$160 <small>reg. \$180</small></p> <p>Apple Serial Int. \$175 <small>reg. \$195</small></p> <p>Centronics Parallel Int. \$185 <small>reg. \$225</small></p>
<p>DOUBLE VISION \$295.00</p> <p>DISK II with controller \$525.00 without controller \$445.00</p> <p>MICROMODEM \$325.00</p> <p>PASCAL \$425.00</p> <p>LEEDEX MONITOR \$140.00</p> <p>KG-12C \$275.00 <small>Green Phosphor 12" Screen w/Glare Cover 18 MHz bandwidth</small></p>	<p>16K RAMS for APPLE II TRS-80 \$59</p> <p>VERBATIM DISKS 10 for \$27</p>

The Computer Stop
 16919 Hawthorne Blvd.
 Lawndale, CA 90260
(213) 371-4010

MON. - SAT. 10-6

FINALLY AN ALTERNATIVE TO DISKS THE EXATRON STRINGY FLOPPY (MASS STORAGE SUBSYSTEM)

LOW COST
RELIABILITY
SPEED

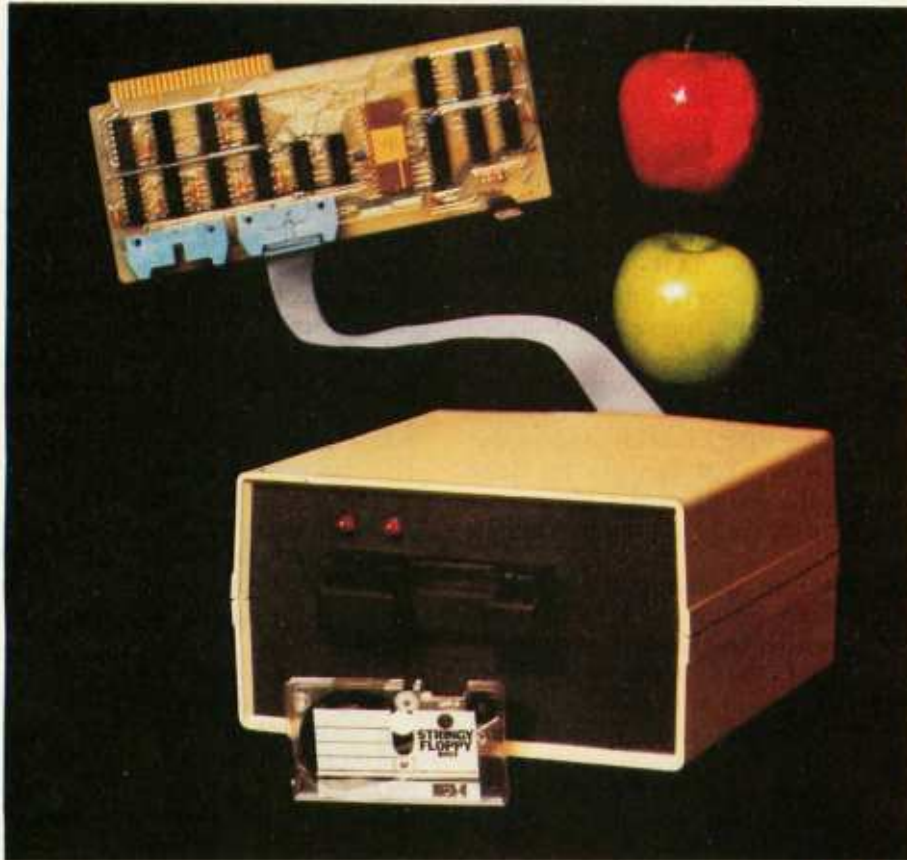

\$299.50

INFORMATION PACKAGES AVAILABLE NOW FOR:
APPLE OSI RS-232
PET KIM/SYM/AIM STD-BUS
TRS-80 S-100 OEM



CALL OUR HOT LINE TODAY 800-538-8559

TO REQUEST AN INFORMATION PACKAGE

EXATRON, INC. ■ 181 COMMERCIAL STREET ■ SUNNYVALE, CA 94086

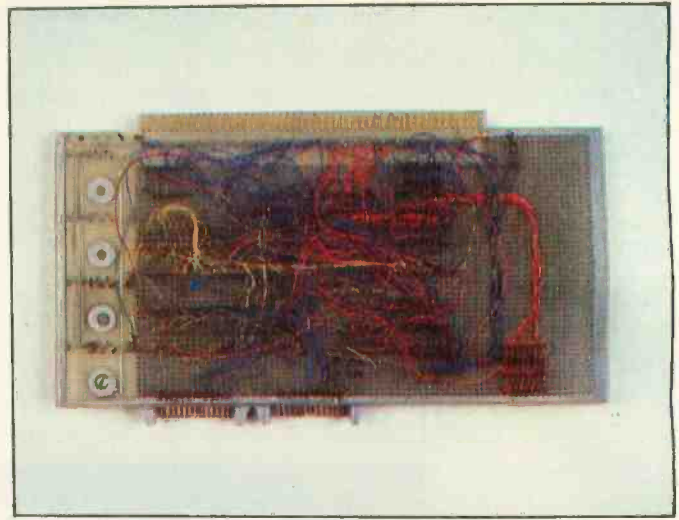
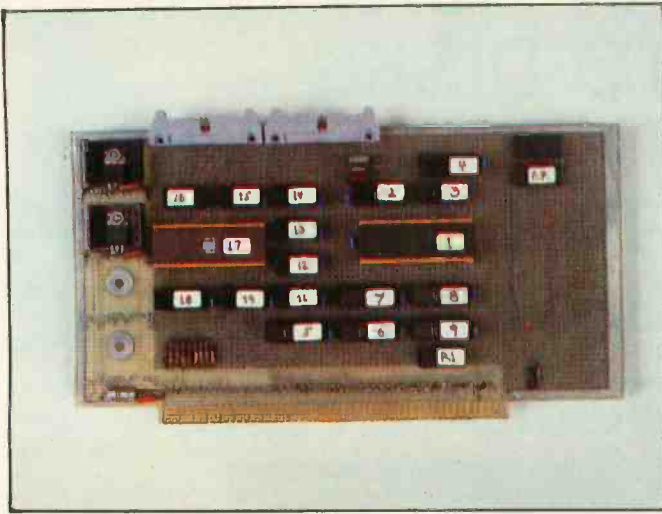

Photo 1: The processor board from front (photo 1a) and back (photo 1b). There is a large area left for design additions. Note that upper pins on dual-in-line connectors are soldered to the ground plane for shielding. Multi-colored wiring makes debugging easier.

facilitating soldering when necessary.

Probably the most important feature is that all the S-100 lines are labeled at the bottom of the board. Unless you enjoy doing a table-lookup every time you try to associate an S-100 signal with its pin number, get a board with the lines labeled.

Try to use a wire-wrap tool with daisy-chaining capability. This will allow you to connect common signals (like ALE, RD*, and WR*) quickly and easily, with less possibility for error. You can use the same technique for connecting the multiplexed address/data bus of the 8088 (AD0 thru AD7) to all the bus buffers (IC7, IC8, and IC9).

Be careful, though, because connect-and-wrap tools sometimes forget the connect operation. Whenever the wiring of one signal is complete, check each connection in the chain. It is easier to find a bad connection this way than by waiting until you are done. If you need more convincing, simply look at photo 1b and imagine hunting in that jungle of wires.

Important precaution: once you have wired the board, *test the power supply before you plug in any integrated circuits!* Measure the resistance between pins 1 and 51 (+8 V) and pins 50 and 100 (ground). If there is zero resistance, find the short before continuing. Make sure that the +5 V regulators are regulating, then check the power and ground pins of every socket for the correct value. Use the proper technique when handling MOS (metal-oxide semiconductor) devices. If you ruin an 8088, you will be sad.

The Board

On the left border of the board is the power-supply section. (See photo 1a.) At the bottom are a couple of capacitors (15 pF and 0.1 μ F, both rated at 12 V) that filter the +8 V power supply from the system (this comes onboard via pins 1 and 51). At the top are two 7805 voltage regulators (+5 V) with heat sinks. Each uses a 0.1 μ F bypass capacitor between the +5 V regulator outputs and ground (note: S-100 ground is pins 50 and 100). At the top center of the board, we see two 25-pin flat cable connectors. These are used as I/O-port connections to both parallel I/O ports (ports A and B) on the 8755A-2

EPROM-I/O circuit. Both ports could be wired to one connector, but I chose to shield each I/O line with a ground line. I did this by soldering the top row of connector pins to the ground plane, which runs around the circumference of the board.

Lower on the board, the 40-pin 8755A-2 (in the package labeled 17) is surrounded by eight dual-in-line packages. IC18 (labeled 18) is the 8185-2 static programmable memory. The other seven circuits complete the TTL circuitry required for this board. The schematic reveals that TTL devices are used for two basic functions. One is to decode the addresses for the on-board memory and I/O (ie: the 8755A-2, 8185-2 pair). The second is for the miscellaneous inversion and simple gating of signals necessary to successfully interface the processor card to the S-100 bus.

At the bottom are nine 1 k-ohm resistors used to pull up various processor input control-bus signals (the bus-disable inputs, RDY, HOLD*, etc).

To the right are IC6 thru IC9. These are all 8282s that serve to buffer the address bus, the input and output data buses, and the control bus. Immediately below IC9 is a resistor pack (labeled R1, containing eight 1 k-ohm resistors) used to pull up the input data bus of the processor. Remember that some I/O boards may have open-collector drivers (per the IEEE standard); thus, these pull-ups are necessary.

Higher on the board, IC1 is the 8088 microprocessor. Above the 8088, are IC2, IC3, IC4, a capacitor, two crystals, and a jumper. IC4 is the 8283 (inverting 8282) buffer for the status bus. IC3 is the 8205 1-of-8 decoder used to decode the processor status. IC2 is the 8284 clock generator. The capacitor (10 pF) is used between the crystal input and pin X2 of the 8284.

Why two crystals? While the 8088 is impressive at 5 MHz, faster is better, right? Ignoring manufacturer's specs is a "do at your own risk" proposition, but when I saw the 18.432 MHz crystal lying in my junk box, I could not resist. Under normal operating conditions, my 8088 has no problems running at 6.1 MHz (remember, the 8284 divides the crystal frequency by 3 to get the operating frequency of the 8088). The jumper selects between the 15 and 18.432 MHz crystals.

Think system. Grow systematically. HP-85.



The Personal Computer For Professionals: HP-85 specifications: Memory—16K RAM expands to 32K. 32K ROM expands to 80K; CRT—32 chars./line. 16 lines; graphics—256 X 192 dots; thermal printer—2 lines/sec.; magnetic cartridge capacity—200K; I/O—HP-IB (IEEE 488), RS-232, 16-bit GP-IO, BCD; Application Pacs include Statistics & Regression Analysis, Finance, Math, Linear Programming, Text Editing, Waveform Analysis, Circuit Analysis, BASIC Training, & Games.

A COMPLETE COMPUTING SYSTEM

Encapsulated in a mere 20 lb. package, is a complete computing system. Keyboard, tape unit, CRT with alphanumerics and integrated graphics, printer and read/write memory—all ready for instant use. Just turn it on. That's all. Its language is powerful HP BASIC. The HP-85 is simple to use. Extremely effective. Highly productive. In brief, very professional.

"INSTANT INTERFACE" FOR EASY GROWTH

Now the HP-85 can be configured even further to accommodate your increasing demands. Instantly. Just plug in the HP interface bus and handle up to 14 peripherals or instruments. There's no need to write special operating programs. HP's peripheral ROM's do it for you. Options available now include flexible disc drives, additional read/write memory, graphics plotter, full-width printer, many software Application Pacs. More options are under development. Indeed, Hewlett-Packard is committed to providing solutions that meet your varied and changing needs.

ONLY FROM HEWLETT-PACKARD

There is no comparable computing system in the marketplace that offers you this combination of power, sophisticated growth potential, software, lightweight portability, convenience and ease-of-use. In addition, HP maintains service facilities throughout the world. On-site service, if you wish. For details and address of nearest dealer, CALL TOLL-FREE 800-547-3400, Department 276D; except Hawaii/Alaska. In Oregon, call 758-1010. Or write Hewlett-Packard, 1000 N.E. Circle Blvd., Corvallis, OR 97330, Dept. 276D.

610/16



**HEWLETT
PACKARD**

Circle 51 on inquiry card.

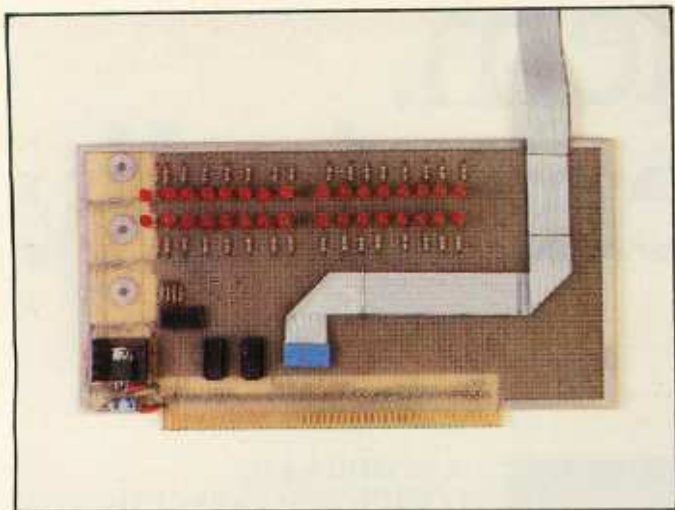

Photo 2: Circuit board for the front panel. This board contains the LED assemblies (see figure 5) that monitor the states of selected lines on the S-100 bus.

At the bottom right is the resistor/capacitor timing network (47 k-ohm, 1 μ F) connected to the RESET* input (pin 75).

Finally, at the upper right (above the package marked FP) is the dual-in-line socket for connecting the data bus of the processor to the front panel.

The Front Panel

"And now I see with eye serene
The very pulse of the machine"
William Wordsworth

As I said before, I am trying to avoid experimenting with my IMSAI. The IMSAI front panel will not work with my 8088 board, and it provides more functionality than I really need; therefore, I decided to build my own front panel (see figure 5).

The front-panel switches allow the system to be reset and allow the processor to be placed in run, stop, or single-step mode. It also allows monitoring of the address bus, the data bus, and the status bus. These few functions, in conjunction with a logic probe, are all that are needed for debugging the system.

Looking at photo 3 and figure 5 (on page 84), you can see that the front panel is really very simple. Additional controls and LEDs can be added to suit your own needs. One function I plan to add is a slow-step control, utilizing a simple timer (555-based) and the existing single-step circuitry. If you decide to use the upper four address bits, LEDs can be added to monitor them and other status and control lines.

Looking at the left-hand portion of the front-panel card in photo 2, we see the 7805 +5 V regulator and its filtering capacitors. This is used to power the 7400 and 7474, which implement the run/stop and single-step circuitry. Above this are the thirty-two LEDs that are tied to the appropriate S-100 bus lines through 4.7 k-ohm current-limiting resistors. The socket at the lower left is used to connect to the front-panel run/stop and single-step switches via a dual-in-line plug, allowing easy removal of the panel if necessary. The ribbon cable running across,



Photo 3: Assembled front panel for the 8088-based computer. Two toggle switches and a push-button switch have been added to the LED assemblies shown in photo 2.

then off, the board connects to the dual-in-line socket on the processor card, allowing the 8088 data bus to be monitored.

Connecting the 8088 RDY input and TEST* input on the processor card results in a simple, yet powerful, debugging feature. By placing a WAIT instruction in a program, full-speed execution of the program can be stopped. Then a specific routine can be single-stepped through, if necessary, for debugging purposes.

The TEST* input is a very powerful tool. A variation of the above strategy would be to add a switch to the front panel dedicated to controlling the TEST* input. This would allow WAIT instructions to be selectively ignored. However, the automatic stopping feature might then require some agile manipulation of the TEST* switch at the appropriate time.

Check out the front panel as thoroughly as possible. Ensure that all the LEDs work, and verify that the run/stop and single-step switches exercise the S-100 XRDY line correctly.

Debugging the Front Panel

Initially, install only the processor board and the front panel in your motherboard. This will minimize the number of variables to deal with at one time.

Place the run/stop switch in the stop position and apply power. Hit the reset switch; at this point, the lights on the front panel should reflect the following:

- The address bus should show hexadecimal OFFF0.
- The status bus should show sM1 and sMEMR.

Note that in my case, I am using the SSTACK light to show run/stop status (stopped = LED on) so SSTACK is also lit.

The state of the data-bus LEDs depends on the program in your 8755A-2 EPROM. At this point, the 8088 is reading the hexadecimal address OFFF0, which is in the on-board 8755A-2 EPROM. If your EPROM is erased, the data bus display will be hexadecimal OFF, which is not very helpful. For instance, if the EPROM address/chip-select circuitry is incorrect, you may well see hexadecimal



BASIC SOFTWARE LIBRARY

NOW ★ 10 ★ Volumes and Growing

IS SPONSORING A

\$10,000.00 Give Away

WHY Pay hundreds of dollars for Software that does Not work when WE offer the BEST available Software for only a few dollars a program. And what is better OURS WORKS!

We have over 100,000 in circulation since 1975 and we are still around and That's more than Anyone else can say. We used to sell hundreds of programs individually, the programs in Volume X were sold for several years at over \$10,000, in Volume III for over \$6,000 but a few years ago we decided to promote software to the mass public and it was an instant success.

For Homeowners, Businessmen, Engineers, Hobbyists, Doctors, Lawyers, Men and Women

Vol. I \$24.95	Vol. II \$24.95	Vol. III \$39.95	Vol. IV \$9.95	Vol. V \$9.95	Vol. VIII \$19.95	Vol. IX \$19.95	Vol. X \$69.95		
Business & Personal Bookkeeping Programs	Animals Four Astronaut Bagel Bio Cycle Cannons Checkers Craps Dogfight Cyclic Decision 1 Decision 2 Depreciation Efficient Flow Installment Interest Investments Mortgage Optimize Order Pert Tree Rate Return 1 Return 2 Schedule 1	Binomial Chi-Sq. Coeff. Confidence 1 Confidence 2 Correlations Curve Differences Dual Plot Exp-Distri Least Squares Paired Plot Plotpts Polynomial Fit Regression Stat 1 Stat 2 T-Distribution Unpaired Variance 1 Variance 2 XY.	Beam Conv. Filter Fit Integration 1 Integration 2 Intensity Lola Macro Naval Optical Planet PSD Rand 1 Rand 2 Sphere Trian Stars Track Triangle Variable Vector	Billing Inventory Payroll Risk Schedule 2 Shipping Stocks Switch	Bingo Bonds Bull Enterprise Football Funds 1 Funds 2 Go-Moku Jack Life Loans Mazes Poker Popul Profits Qubic Rates Retire Savings SBA Tic-Tac-Toe	Andy Cap Baseball Compare Confid 10 Descrip Differ Engine Fourier Horse Integers Logic Playboy Primes Probal Quadrac Red Baron Regression 2 Road Runner Roulette Santa Stat 10 Stat 11 Steel Top Vary Xmas	1040-Tax Balance Checkbook Instol 78 Deprec 2 APPENDIX C Favorites	Auto Cypher Hurrtac ID Lorana Map Navigate Omega Patterns Radar RDF	Intro. A/R A/P Mer Inv Check Assets Payroll Bal Sh P/L Year End Data Base Tax Up Basic St.
A. Newman J. F.K. Linus Ms. Santa Nixon Noel Noel Nude Peace Policeman Santa's Sleigh Snoopy Virgin	APPENDIX A	APPENDIX B	APPENDIX C	APPENDIX D	APPENDIX E	APPENDIX F	APPENDIX G		

Volume VI — Disk programs are compatible with TRS-80 disk basic. The disk programs in Volumes VI, VII and X are written in (CP/M) M Basic and Disk Extended Microsoft Basic. Other programs written in 8K Basic.

FIRST DRAWING — September 11, 1980 and every week thereafter until December 18, 1980. Winners will be notified within one week. For a list of winners send a self-addressed stamped envelope with a request for the winners list. No PURCHASE Necessary, to enter send name & address on a 3 x 5 card. You are automatically entered every time you make a purchase from us. Void where prohibited by LAW.

Unconditional Money Back Guarantee.

Add \$1.50 per volume handling, all domestic shipments sent U.P.S. except APO and F.O. Box which go parcel post. Foreign orders add \$6.00/volume for air shipment and make payable in U.S. dollars only.

AVAILABLE AT MOST COMPUTER STORES
Master Charge and Bank Americard accepted.
Our Software is copyrighted and may not be reproduced or sold.

Unlike others we have NOT raised our prices in five years

KEMCO, LTD.
P.O. Drawer 2208L Petersburg, VA 23803
804-798-1147

IN GERMANY
Ing. W. Hofacker, GmbH
Holzkirchen, W. Germany

IN HOLLAND
Nanton Press B.V.
Bilthoven, Holland

OVER 116,000 IN USE TODAY

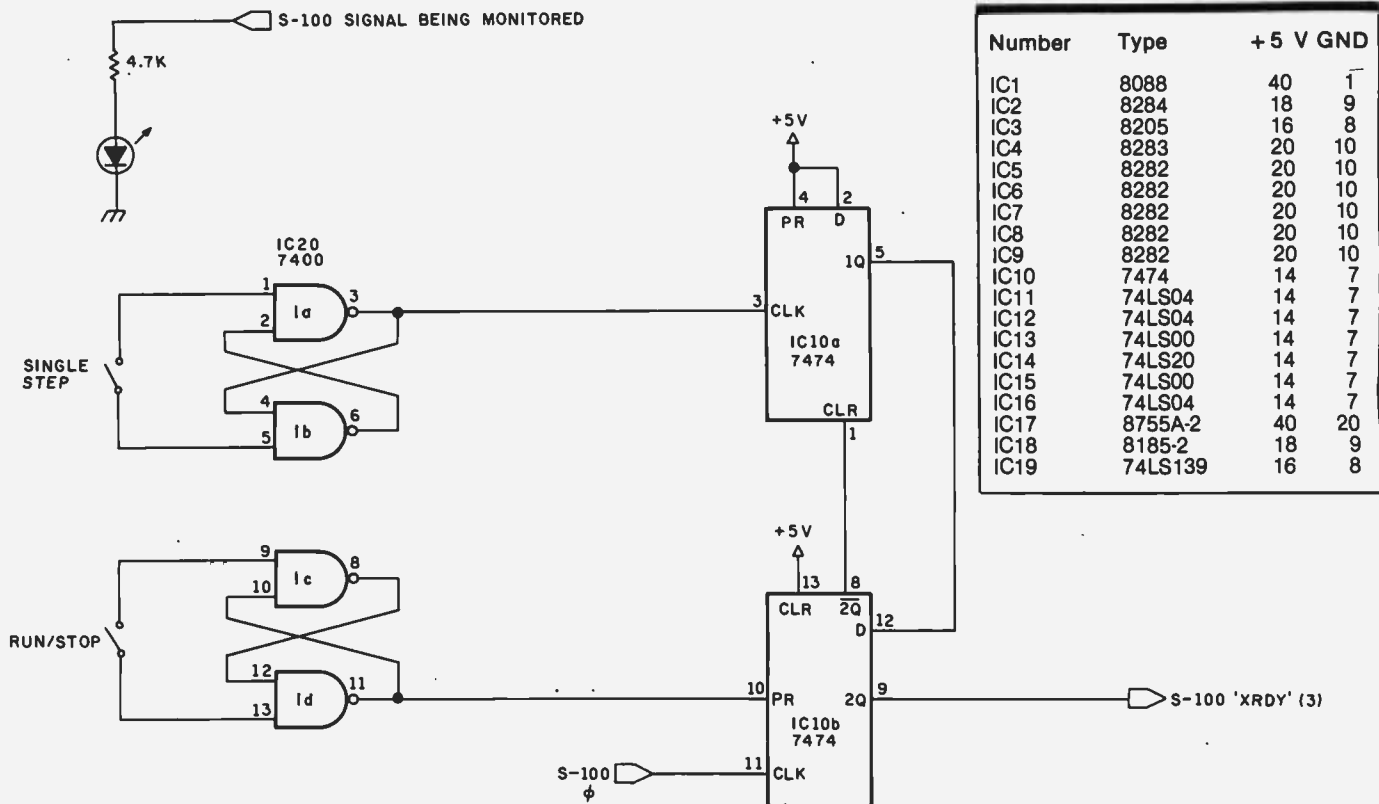

Figure 5: The front panel design is simple and requires little in the way of hardware. The utilitarian controls can be augmented if necessary, but the functions shown are almost universally accepted as the only ones needed for basic debugging. The author connects one of the LED assemblies to each of the S-100 bus lines being monitored. Power connections for the integrated circuits are given in table 1.

DISCOUNT PRICES

APPLE II COMPUTERS

16K APPLE II	959.00
32K APPLE II	1024.00
48K APPLE II	1089.00
DISK W CONTROLLER	520.00
DISK ONLY	450.00
APPLESOFT CARD	159.00
INTEGER CARD	159.00
PASCAL SYSTEM	440.00
SILENTYPE PRINTER	525.00

RAM MEMORY
FOR TRS-80, APPLE II
16K SET 4 116's

65.00

NORTH STAR COMPUTERS

HRZ-1D-32K-KIT	1545.00
HRZ-1D-32K-ASM	2045.00
HRZ-2D-32K-KIT	1895.00
HRZ-2D-32K-ASM	2360.00

VERBATIM DISKETTES
BOX OF 10 5 1/4" 29.50
BOX OF 10 8" 39.50

FREDERICK COMPUTER PRODUCTS
MUNICIPAL AIRPORT
FREDERICK, MD. 21701
(301) 694-8884

OFF anyway, due to the pull-up resistors on the data bus. I suggest that for initial testing you have the 8755A-2 EPROM burned with a short diagnostic program that exercises some of the functions of the processor board. This program should allow testing of the on-board programmable memory and I/O ports. By single-stepping, each function can be tested. You may want to add instructions to test the S-100-interface portion of the design (such as moving data from and to external memory, and data transfer to and from external I/O ports).

If what your front panel displays is only slightly different from this description, there cannot be much wrong. For instance, if the address bus shows hexadecimal OFFE8, you can suspect that address lines 3 and 4 have been swapped on the processor board or the front panel. If the display shows hexadecimal OFFF8, look for a short between the same address lines, etc. In fact, if you have a problem at this point, a good strategy is to verify that the front panel is correctly monitoring the processor. With the processor stopped and reset, insure that the outputs of the address, data, and status bus buffers on the processor board are correctly reflected on the front panel. If they are not, the front panel still has problems. Fix these before continuing.

If the front panel is correctly interpreting the outputs of the processor board, and your LED display is still incorrect, the problem lies on the processor board itself.

Debugging the Processor Board

When a new hardware design fails to work, the problem usually lies in one of three areas:

...the new wealth is information. NEWSWEEK

SYBEX Brings You a Wealth of Books...

Your First Computer by Rodnay Zaks

A new edition of one of the most popular and widely acclaimed introductions to computing and microcomputers. Includes a detailed guide for selecting basic hardware. "An excellent book for anyone new to computing. —On Computing. \$7.95, 280 pp., 150 illustr., 2nd Ed.

The CP/M Handbook (with MP/M) by Rodnay Zaks

CP/M — the industry standard in operating systems. The handbook goes step-by-step from basic commands through the editor and assembler to CDOS and multi-user MP/M. For everyone from input typists to applications programmers. \$13.95, 304 pp., 110 illustr.

Programming the 6502 by Rodnay Zaks

Written as a progressive course designed to test the reader at every step, this book covers the essentials of programming the 6502 from basic concepts to advanced data structures. "Thoroughly recommended." —PET Gazette. \$12.95, 392 pp., 200 illustr., 2nd Ed.

6502 Applications by Rodnay Zaks

This second book in the 6502 series presents real life applications techniques for any 6502 based microcomputer board. Programs range from home alarm systems to industrial applications including analog/digital conversion. The I/O book for the 6502. \$12.95, 288 pp., 200 illustr.

6502 Games by Rodnay Zaks

Third in the 6502 Series, this educational text shows how to program the complex algorithms for ten computer games, and how to use the 6502 addressing modes. All programs have been thoroughly tested. \$12.95, 250 pp., 150 illustr.

Microprocessors: From Chips to Systems by Rodnay Zaks

From the ground up, the components (ROM, RAM, MPU, UART, PIO), internal operation, comparative evaluation, PDP system interconnect, applications, interfacing, programming, system development and more. "Essential reading." — Personal Computer World. \$10.95, 420 pp., 200 illustr., 3rd Ed.



Microprocessor Interfacing Techniques by Austin Lesea, Rodnay Zaks

How to connect a microprocessor to the outside world. Covers the peripherals, from key board to CRT and floppy disk, I/O techniques, A/D conversion, standard buses and troubleshooting. "Clear and eminently readable." — Interface Age. \$15.95, 464 pp., 320 illustr., 3rd Ed.

Programming the Z-80 by Rodnay Zaks

Readable and informative, this book is both an introductory course on programming and a self-contained reference text offering a comprehensive description of the Z80 instruction set and a thorough account of its internal operations. \$14.95, 620 pp., 200 illustr., 2nd Ed.

Programming the Z8000 by Richard Mateosian

A comprehensive introduction to assembly level programming in the language of the Z8000. The detailed description of the Z8000 architecture and its family of support chips is indispensable for engineers, students and PDP-11 users. \$15.95, 420 pp., 130 illustr.

PLEASE SEND ME THESE BOOKS:

- YOUR FIRST COMPUTER \$7.95
 THE CP/M HANDBOOK WITH MP/M \$13.95
 PROGRAMMING THE 6502 \$12.95

- 6502 APPLICATIONS \$12.95
 6502 GAMES \$12.95
 MICROPROCESSORS FROM CHIPS TO SYSTEMS \$10.95

- MICROPROCESSOR INTERFACING TECHNIQUES \$15.95
 PROGRAMMING THE Z80 \$14.95
 PROGRAMMING THE Z8000 \$15.95

MAIL TO:



DEPT. B10
2344 SIXTH STREET,
BERKELEY, CA 94710
PHONE ORDERS: 415/848-8233

NAME _____
 ADDRESS _____
 CITY _____ STATE _____ ZIP _____
 PLUS \$1.50/book UPS or 75¢/book 4th class mail (CA add tax)
 TOTAL AMT. ENCLOSED _____ OR CHARGE MY VISA MC AM. EX.
 CARD # _____ EXP. DATE _____
 SIGNATURE _____

PLEASE SEND ME YOUR FREE CATALOG

- design errors,
- wiring errors, or
- component failure.

Note that this is closely related to the system environment in which the processor board is operating. In particular, I have given interrupt handling and DMA handshaking only cursory examination since none of the boards I use exercise these functions. The addition of your favorite Brand XYZ interrupt-driven DMA Video Board may uncover design errors I am not aware of. (I would appreciate correspondence in this matter.)

Wiring errors are the most likely culprit. Checking connections as you go can prevent a lot of these. Sometimes, the problem is a bad component. Fortunately, these problems usually produce distinct, easy-to-diagnose symptoms.

The strategy now is to start with the basic computer (8284, 8088, 8755A-2, and 8185-2) and work outwards until all problems are corrected.

Start by checking for fundamental signs of life. At the 8284, look for the presence of the 15 MHz crystal signal on the X1 and X2 inputs. Ensure that the 5 MHz clock signal is present on the CLK output of the 8284. The RESET switch should pull the 8284 RES* input low for at least 1 μ s, and it should produce a high-going pulse on the RESET output of the 8284. The RDY2 input and READY output of the 8284 should correctly reflect the state of the front panel run/stop and single-step switches.

Moving to the 8088, first verify that the CLK, READY, and RESET outputs of the 8284 are getting to the CLK,

READY, and RESET inputs of the 8088. If not, find the wiring error. The HOLD, INTR, and NMI inputs should all be low. The MN/MX* input should be tied high.

With the 8088 reset and running, look for activity on the ALE line of the 8088; address lines; data lines, and status and control lines should all show basic signs of life.

Once things are operating properly, stop and reset the system and probe the output buses of the 8088 with a logic probe. The sixteen address outputs should reflect the hexadecimal 0FFF0 RESET start address, and the status lines (IO/M*, DT/R* and SSO*) should correspond to op-code-fetch status. Make sure that the correct status output at the decoder (IC3) results from the three status inputs.

Next, make sure that the outputs of the 8088 are getting to the appropriate output buffers. For example, the inputs to 8282 IC6 (pins 1 thru 8) should be the same as the A8 thru A15 outputs of the 8088, and so forth for the other output buses. If not, find the wiring error. The outputs of all the buffers should reflect the inputs. If not, suspect a bad buffer or faulty STB (strobe) or OE* (output-enable) connections.

Wiring errors are the most likely culprits in a project such as this. TTL circuits are easy to debug. Swapping components and looking for resulting symptomatic changes is a useful debugging technique. You probably have extra TTL circuits available, and the five 8282s can be swapped. As a last resort, the MOS chips can be swapped. Try to borrow an 8088 and an 8284 to swap; the 8755A-2 and 8185-2 are not necessary for initial debugging. The risk is that a wiring error can damage

PRINTERS & CRT'S

From **Orange Micro**



base inc.
2^o

IMPACT PRINTER



\$649.00

(LIST \$699.00)

"The BASE 2 outperforms every printer in its price range. Do a comparison and see for yourself..."

★ GRAPHICS ★ TRACTORS / FRICTION FEED

• 2K Input Buffer • RS-232 Serial, Centronics® Parallel, IEEE-488, 20 ma • TRS-80 Cable option • 60 LPM - 100 CPS • Fast form feed • User programmable character set • 64, 72, 80, 96, 120, 132 Columns / line • Expanded characters • 9.5" wide paper • Automatic skip-over-perforation • Horizontal & Vertical tabs • Programmable vertical line spacing • Intel 8085 Microprocessor — over 40 software commands • Self test • 15 Baud rates to 9600 Baud • Optional foreign character sets

Interfaces to TRS-80, Apple, Atari, PET, Northstar, and most other computers

Circle 54 on Inquiry card.



**TELEVIDEO CRT'S
PRICES SLASHED!**

TVI 912C } Please Call Toll Free
TVI 920C } Prices are too low to
advertise

PRINTERS

ANACOM 150	150 CPS, wide carriage, 9 x 9 dot	(List \$1350)	\$ Call
CENTRONICS 737	Text processing dot matrix (Radio Shack LP IV)		\$ Call
CENTRONICS 730	(Radio Shack Line Printer II)		639
COMPRINT 912	225 CPS Electrostatic	(List \$660)	529
OKIDATA MICROLINE 80		(List \$800)	599
EPSON	Dot graphics, serial, parallel		\$ Call
MALIBU	Dot graphics, 132 Col, Letter quality		\$ Call
PAPER TIGER IDS 440	w/graphics & 2K buffer	(List \$1094)	939
QUME 5/45	Typewriter quality	(List \$2905)	2499

INTERFACE EQUIPMENT

APPLE II — BASE 2	parallel graphics interface board		160
SSM AIO BOARD	Serial/Parallel interface board	(List \$225)	199
TRS-80 CABLES	expansion interface or direct		\$ Call

TOLL FREE (800) 854-8275

CA, AL, HI (714) 630-3322

Call for FREE CATALOG

Phone orders WELCOME. Same day shipment for VISA, MASTER CHARGE, and AMERICAN EXPRESS. Personal checks require 2 weeks to clear. Add 3% for shipping and handling. California residents add 6%. Manufacturer's warranty included. Prices subject to revision.

**Orange
Micro**

3148 E. La Palma, Suite E
Anaheim, CA 92806





INTRODUCING VIDEOPRINT: The picture perfect peripheral.

Videoprint 3000 is the convenient economical means of obtaining distortion-free hardcopy from your Apple computer graphics display in full, brilliant color. The entire system is self contained in the convenient desk-top unit shown above.

Videoprints eliminate such off-the-screen photography problems as barrel distortion, color desaturation and loss of color fidelity. Videoprints also minimize the effects of raster lines and video noise.

Videoprints are instantly produced with Polaroid® SX-70 or Polacolor 4" x 5" films, as well as with conventional color negative or 35mm slide transparency films, offering you a range of handy sizes. The pictures are made at the push of a button.

If you've ever wanted to distribute copies of computer

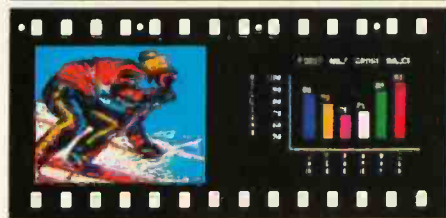
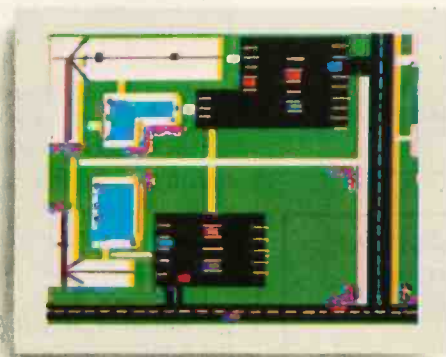

graphics or file them in your permanent records, or send them through the mail or project them as slides, you need Videoprint.

Hook up to one single cable and you're ready to capture any image on the Apple monitor screen. Other personal computers with color graphics capability work with the Videoprint 3000, too.

In fact, if you use computer graphics in any form, you really need Videoprint 3000. Find out all about this exciting new tool. Write or call us today for your local dealers' location.



**IMAGE
RESOURCE**

The Videoprint People.

Image Resource Corporation
2260 Townsgate Road, Westlake Village, CA 91361
(805) 496-3317

Videoprints shown were produced by an Apple II with graphics tablet, or by live images on 3/4" videotape.

these circuits.

Once the processor and front-panel boards are operating, you can begin integrating and testing other boards. Insert one board at a time and try to verify its operation before continuing.

Hints

Watch out for I/O boards that use the upper eight address lines to enable the board; my SSM parallel I/O board does this. The problem can be corrected by software, as an example will show:

The 8088 has two forms of input instructions. One is much like the 8080A IN instruction (the same holds for output). Its form is

IN Accumulator, 8-bit port address

The second form is an indirect input instruction that allows access to the extended I/O addressing of the 8088 (ie: 64 K port addresses).

MOV DX register pair, 16-bit port address
IN Accumulator, DX (port address is in DX register pair)

The first form of input instruction zeroes out the upper eight address bits. For example:

IN A, 60H

will place hexadecimal 0060 on the sixteen address lines.

Now assume there are two I/O boards in the system. One decodes the lower eight address lines and is addressed at hexadecimal 60. The other (like the SSM parallel I/O board) decodes the upper eight address lines and is addressed at 0.

The problem occurs if we try to use the short form of the input instruction to read from the I/O board addressed at hexadecimal 60 with the instruction:

IN A, 60H

The address bus will contain hexadecimal 0060 (ie: binary 0000 0000 0110 0000). Now the board at hexadecimal address 60 will correctly decode the lower eight address lines and select itself. Unfortunately, the other board (addressed at 0) will see the high-order part of the address and select itself. The result is that both boards will try to drive the data bus at the same time...bus contention being the result.

The solution is to use the indirect form of I/O. To read from port hexadecimal 60, use:

MOV DX, 6060H
IN AL, DX

If you are sure you will never want to use an I/O board that decodes the upper eight address lines, the short form I/O instructions are valid; otherwise, use the indirect form of I/O.

Once the 8088 processor board is solidly up and talking with all the other boards via the S-100 bus, there are still a few problems to be considered. All that hardware is nothing more than a "wall socket tester" without the software to make it do something. As in the case of large mainframes, the hardware advances are progressing far more rapidly than our ability to generate useful software.

Next month, in the third and final part of this article, we will look at MON88, a machine-language monitor for the 8088-based processor board described here. ■

Editor's Note: The author is planning to make printed circuit boards available through Microfuture, POB 5951, San Jose CA 95150. The boards will use more common 2708 read-only memory circuits in place of the 8755, and 2114 programmable memory instead of the 8185. Twenty address lines are implemented per the IEEE standard. Price is expected to be \$59.95; Microfuture can be contacted at (408) 249-0560.

DISK DRIVE WOES? PRINTER INTERACTION? MEMORY LOSS? ERRATIC OPERATION? DON'T BLAME THE SOFTWARE!



ISO-1



ISO-2

- Power Line Spikes, Surges & Hash could be the culprit! Floppies, printers, memory & processor often interact! Our unique ISOLATORS eliminate equipment interaction AND curb damaging Power Line Spikes, Surges and Hash.
- *ISOLATOR (ISO-1A) 3 filter isolated 3-prong sockets; integral Surge/Spike Suppression; 1875 W Maximum load, 1 KW load any socket \$56.95
 - *ISOLATOR (ISO-2) 2 filter isolated 3-prong socket banks; (6 sockets total); integral Spike/Surge Suppression; 1875 W Max load, 1 KW either bank \$56.95
 - *SUPER ISOLATOR (ISO-3), similar to ISO-1A except double filtering & Suppression \$85.95
 - *ISOLATOR (ISO-4), similar to ISO-1A except unit has 6 individually filtered sockets \$96.95
 - *ISOLATOR (ISO-5), similar to ISO-2 except unit has 3 socket banks, 9 sockets total \$79.95
 - *CIRCUIT BREAKER, any model (add-CB) Add \$ 7.00
 - *CKT BRKR/SWITCH/PILOT any model (-CBS) Add \$14.00

PHONE ORDERS 1-617-655-1532

Electronic Specialists, Inc.

171 South Main Street, Natick, Mass. 01760

Dept. BI

THANKS FOR HELPING TO KEEP UNITED WAY IN BUSINESS.

Every year, United Way successfully continues to support local human service agencies in communities all across the United States.

And by operating like any other modern, well-run business enterprise, United Way succeeds in delivering the maximum in human services for the dollars that are collected.

Thanks again for *your* help.



Thanks to you it works. for all of us. **United Way**



A Public Service of This Magazine & The Advertising Council

Economy Sized Computers™ don't stunt your growth.



A lot of small business computers are like our ads—they start out small and stay that way.

But Vector's Economy Sized Computers grow as you grow. Whenever you need to, you can have up to 4 more terminals, more power, more memory.

With Economy Sized Computers, you get data and word processing capabilities you only expect from much larger computers. All for the price of a new copying machine—just \$10,463 suggested retail price.

See the Vector Economy Sized Computers at your nearest computer dealer.

Because no matter how small they may look, their performance grows on you.

VECTOR
VECTOR GRAPHIC INC.

Economy Sized Computers

31364 Via Colinas, Westlake Village, CA 91361, 213/991-2302

A Multiple-Machine Loader for Classroom Computers

Richard C Hallgren, Assistant Professor, Michigan State University, Department of Biomechanics, East Lansing MI 48824

Many educators are becoming aware of the impact that personal computers can have by providing a learning experience, and the combined factors of decreasing cost and increasing capability are prompting many school systems to include the personal computer in their curriculum. Ideally, each instructional system should have its own floppy-disk drive, but the present cost of drives can inflate the cost of an individual system by 50%. The alternative is to supply every system with a low-cost cassette recorder. Unfortunately, the most frustrating phase of computer operation can be associated with reading a tape into a computer from a cassette recorder. The problem is greatly magnified when the cassette recorder being used

to load the program tape is not the recorder that was used to create the program tape. The problem becomes unmanageable when twenty students are attempting to load twenty tapes from twenty cassette recorders.

A simple solution is to build an interface which will load a program into a number of peripheral computers from a single source. Figure 1 shows the basic approach. The instructor has a system with a floppy disk containing all the instructional programs to be used; all the students' computers are connected in parallel to a two-conductor shielded cable coming from the interface. The instructor first loads the desired program into his computer from the disk, and then the program is transferred over the cable to the students' computers. Three specific examples of the interface will be described, but the concept can be extended to almost any personal computer system.

Multiple-machine loading transfers the program data by connecting the cassette-output port on the instructor's computer to the cassette-input port on the students' computers, through the interface circuitry. The interface matches the respective impedances and provides the necessary signal conditioning.

Acknowledgment

This project was supported by Independent School District #196 in Rosemount, Minnesota.



Photo 1: The multiple-machine loader in use at a school administrators' workshop, where computer-aided instruction programs were being evaluated. This network-like system can involve up to twenty-four TRS-80s, Apple IIs, or Commodore PETs.



EVERYONE WINS

Selecting software for your Ohio Scientific computer is a chancy task at best. There are few trustworthy vendors with a national reputation. There are no consistent quality standards and the documentation is often cryptic and inaccurate. If you are lucky enough to find a good package, there's no guarantee of ongoing support. A wrong choice results in months of wasted time, effort, and money.

With the Software Federation, you no longer take that risk. The Software Federation was formed by three of the largest Ohio Scientific hardware dis-

tributors to select and market quality software through reputable dealers nationwide.

DEALERS

The Software Federation solves the dealer's problems by providing low cost access to high quality software with the sort of demonstration packages, documentation, and support that the dealer needs to successfully sell machines.

AUTHORS

The Software Federation solves the independent vendor's problems by providing a proprie-

tary method of software protection, aggressive enforcement of software licenses, a strong dealer base, primary support, and national advertising.

END USERS

The Software Federation solves the user's problems by providing quality software, exceptional documentation, after-the-sale support, and optional software maintenance services.

Why risk making the wrong choice? With the Software Federation, everyone wins!

See the dealer in your area for a complete turnkey demonstration.

Software Packages

BUS-I Original of popular series, sold "as is" \$99
BUS-II Unlicensed version of BUS-I \$150
BUS/DMS Most current version of BUS series, completely reworked, DMS compatible \$850
Fig-FORTH A complete Forth Interest Group version for OSI. Not a kludge \$175
MEMTEST/2 New edition of popular memory test \$50
WP-INT Interface between WP-2 and OSI-DMS for form letters \$80
Amway Distributors Package \$995
DATA DIRECTOR Complete rewrite of OSI-DMS Nucleus by BBS, command oriented, very interactive \$995
System Exerciser Self-prompting test routines for end user troubleshooting \$60
Med-Bill/Faragher Single doctor client billing \$995
Manufacturing Control System Hard disk based. Standalone inventory with job costing and bill-of-materials \$3500
Fast Floppy Dumper Floppy disk backup for hard disk systems \$125
WP6502 65U word processor from DQFLS \$125
USUS Software Exchange Library 6 disk set of UCSD Pascal programs, includes USUS membership \$80

Affiliated Dealers

TriComp Inc. Denver, CO 80221
Total Data Systems Ft. Collins, CO 80525
Data Services Computer Corp. Denver, CO 80239
Tra-Sta Computer Shoppe Pueblo, CO 81005
Business Data Systems, Inc. Boulder, CO 80301
Tek-Aids Industries Inc. Arlington Hts., IL 60004
KMH Galesburg, IL 61401
Practical Computer Springfield, IL 62703
Databus Grayslake, IL 60038
MAP Systems Peoria Hts., IL 61614
Business Computer of Joliet Cresthill, IL 60435
Cybertronics Houston, TX 77084
CSB Houston, TX 77057
Computer Management Systems Mitchell, SD 57301
Frisch Computer St. Paul, MN 55113
Farrogher & Assoc. Milwaukee, WI 53213
Specialized Computer Systems Jackson, MI 49204

Software Federation

44 University Drive
Arlington Hts., IL 60004
Phone: 312/259-1355



Figure 2a shows the waveform from the cassette-output port of a Radio Shack TRS-80 after the user types CSAVE and Enter, and figure 2d shows the waveform that the TRS-80 expects to see at the cassette input port after the user types CLOAD and Enter.

Figure 3a is a diagram of the interface circuitry. The cassette-output signal from connector J3-5 on the instructor's computer is buffered and amplified by the RCA CA3140T operational amplifier to drive the power transistor. The signal from the MJE 3055 transistor is connected to J3-4 on the students' computers and provides drive capability for twenty-four units. Power for the interface is obtained from the +19.8 V output of a TRS-80 AC adapter. The LM340 regulator is set via the 1.2 k-ohm and 560-ohm resistors to supply approximately 9.5 V.

Figure 2b shows the waveform coming from the cassette-output port of an Apple II after the user types SAVE and Return, and figure 2e shows the waveform that the Apple II would like to see at the cassette-input port after typing LOAD and Return. Figure 3b shows a diagram of

the interface circuitry. There are two factors which make the interface design easier for the Apple II than for the TRS-80:

- The Apple II has eight peripheral connectors on the computer's motherboard, thus allowing the interface to reside inside the computer and use the computer's 5 V power supply.
- The input impedance of the Apple II cassette circuitry is high (12 k-ohm). Even a number of computers in parallel presents only a small load; thus the need for the driver transistor is eliminated.

The cassette-output signal from the instructor's Apple II is amplified by a factor of one hundred by the CA3140T operational amplifier, and is connected to the cassette input jacks on a maximum of twenty-four student computers.

Figure 2c shows the waveform from cassette-output port number 2 of a Commodore PET computer after the user types SAVE 'NAME', 2 and Return. Figure 2f shows

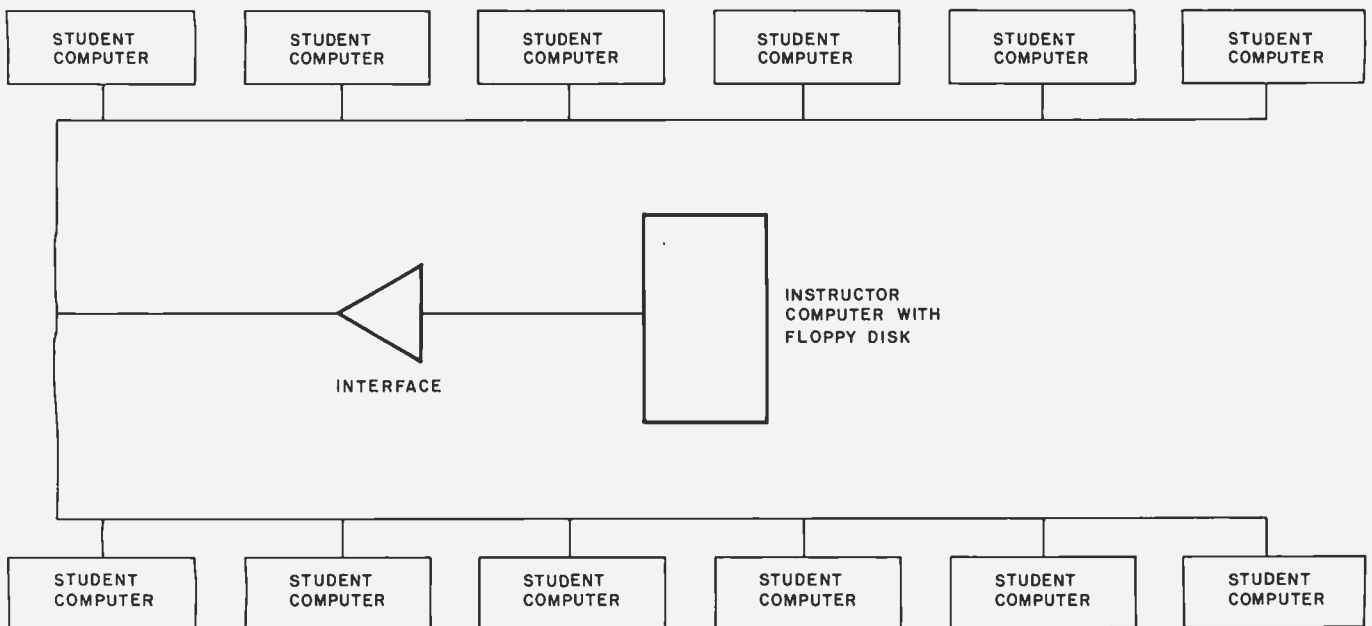

Figure 1: Block diagram of a multiple-machine loader system. The network is composed of an instructor's computer, a cable-driver interface, and up to twenty-four student computers.



PRICE: \$139.00

We also carry the SYM-1 Microcomputer with manuals \$229.00

VAK-1 MOTHERBOARD

- Designed specifically for use with the AIM-65, SYM-1, and KIM-1 microcomputers
- Standard KIM-4* Bus
- Fully buffered Address and Data Bus
- Provides 8 expansion board slots
- Complete with rigid card-cage
- All IC's are socketed
- Provides separate jacks for one audio-cassette, TTY, and Power
- Completely assembled (except for card-cage)

We manufacture a complete line of high quality expansion boards. Use reader service card to be added to our mailing list, or U.S. residents send \$1.00 (International send \$3.00 U.S.) for airmail delivery of our complete catalog.

*Product of MOS Technology



2951 W. Fairmount Avenue • Phoenix, AZ 85017 • (602) 265-7564
Please note new address

PROBLEM.

$$\text{INT}(X^N + X * \text{SIN}(X^2), X)$$

SOLUTION.

Surprised? You should be. Because until now, no software could solve anything but the most basic arithmetic problems without a series of complicated steps.

A big disadvantage? If you use a microcomputer for scientific, educational or engineering applications, you bet it is. That's why Microsoft has come up with a solution of its own. muMath.

muMath is a symbolic math package you'll recognize immediately as a major advance in microcomputer software.

muMath lets you efficiently and accurately perform the most complex mathematical operations: Exact, infinite precision rational arithmetic. Unbound variables. Complex expressions (even equations may be included). Exact solution of algebraic equations. Plus logarithmic, exponential and trigonometric simplifications and transformations.

That's right. It does in an instant what took you years

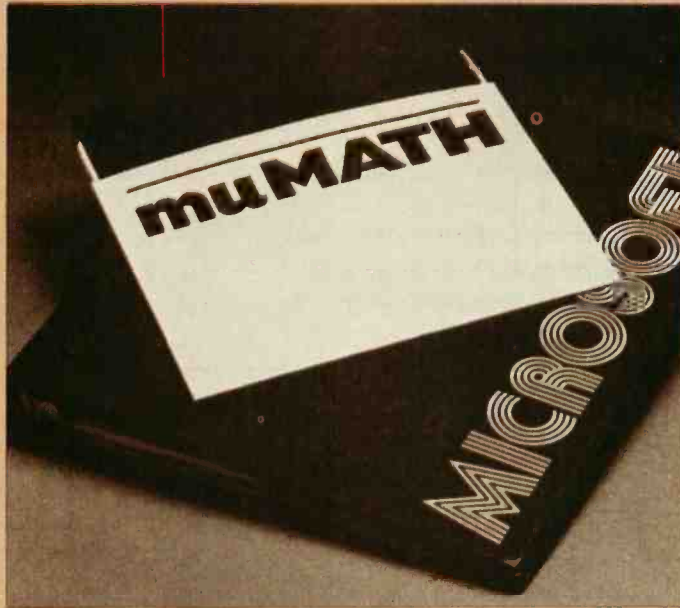

to learn at school. Rational arithmetic. Algebra. Trigonometry. Transcendental functions. Symbolic differentiation (including ordinary and partial derivatives.) Symbolic integration of indefinite and definite integrals. Matrix arithmetic and algebra.

Trigonometric simplification? But of course. Just type:

?SIN(2*Y)*(4*COS(X)^3 - COS(3*X) + SIN(Y)*COS(X+Y+#P1) - COS(X-Y));
Then instantly muMath returns:
@4*SIN(Y)*COS(X)*COS(Y).
Adding fractions? Need you ask?
?1/3+5/6+2/5+3/7;
@419/210.

muMath is written in muSIMP, which is included in the muMath package.

muSIMP is an applicative, recursive language, ideal for describing complex mathematical concepts.

Because of its highly interactive nature and hierarchical structure, muMATH is an excellent math teaching device, from simple arithmetic to calculus.

muMATH is currently available for the CP/M® operating system.

The complete system, including muMATH and muSIMP on disk and documentation is \$250. Runs under CP/M.

Just what you need? We thought so. Shoot some questions at us about muMATH. We have all the answers.

Also new from Microsoft: the muLISP interpreter for CP/M. An efficient and reliable LISP system fully capable of supporting serious artificial intelligence efforts. \$200.

CP/M is a registered trademark of Digital Research.

MICROSOFT

10800 NE Eighth
Suite 819
Bellevue, WA 98004
206-455-8080
Telex 328945

We set the standard.

the waveform form that the PET would like to see at cassette-input port number 2 after typing a LOAD "NAME",2 and Return. Figure 3c shows the diagram of the interface circuitry. Cassette-interface connector number 2 on the back of the PET is used to gain access to input and output lines. The single integrated circuit is mounted in the connector hood at the instructor's machine so as to make the installation as simple as is possible.

Operation of each system is quite simple:

1. The instructor loads the desired program from disk into his computer.
2. All students that are to use this particular program are instructed to type CLOAD and Enter (LOAD and Return for the Apple II; LOAD "NAME",2 and Return for the PET) as if they were loading a program from cassette tape. Their computers will now wait for a program to be loaded.
3. The instructor types CSAVE and Enter (SAVE and

Return for the Apple II; SAVE "NAME",2 and Return for the PET) as if a program were being saved on cassette tape.

4. The program is automatically transferred from the instructor's computer to the students' computers.
5. After the program is transferred, control of the computer is returned to the students.

Results from using the interfaces described have been quite encouraging. Not only have the problems of loading programs from twenty different cassette recorders been eliminated, but the process of generating twenty program tapes containing material updates has also been avoided. ■

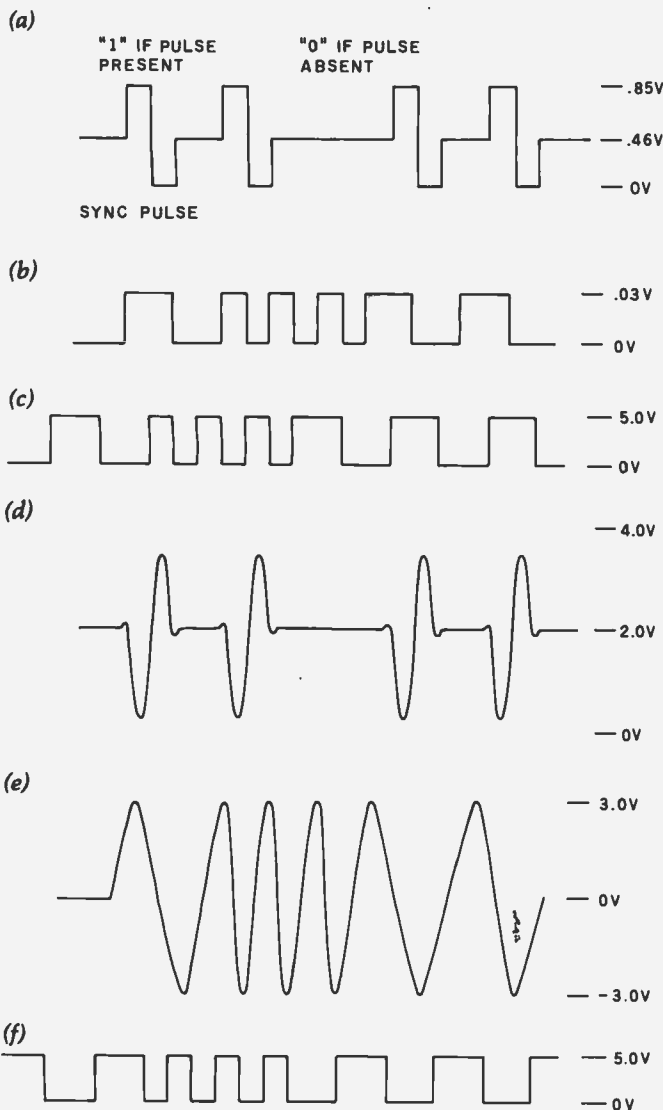

Figure 2: Cassette-interface output of the Radio Shack TRS-80 Model I (a), Apple II (b), and Commodore PET (c). The respective cassette-interface inputs expect to receive the waveforms of d, e, and f. Different specimens of these computers may produce slightly different waveforms from those shown here.

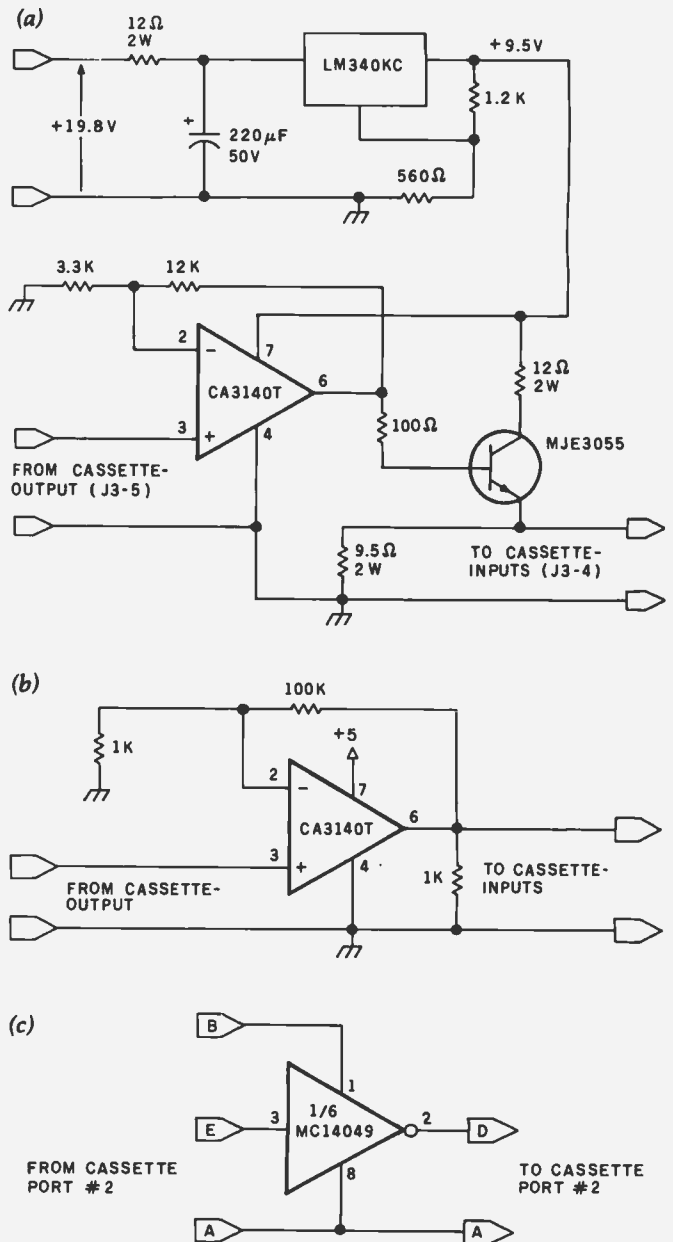

Figure 3: The various interfacing circuits necessary are shown at a, b, and c. The low input impedance of the TRS-80 (a) presents the greatest load, and so requires a power transistor to achieve the proper drive. The interface circuit for the Apple II (b) requires much less power, and so it can use the power supply in the instructor's computer, as can the PET interface (c).



• MODEL 800 • WITH SUNFLOWERS •

A NEW MASTERPIECE IN PRINTERS

The MODEL 800 MST is certainly pleasing to look at, but its true beauty lies beneath the surface. A glimpse at its features reveals why it is rapidly becoming the most sought after printer in the world . . .

- Four standard interfaces:
 RS-232 (15 baud rates)
 Centronics compatible parallel
 IEEE-488
 20ma current loop
- Six line densities: 64, 72, 80, 96, 120, 132
- 100 CPS at all six densities
- Unidirectional or bidirectional printing
- Sixteen horizontal and ten vertical tabs
- Elongated characters in all six densities
- 1920 character buffer
- Uses either perforated or roll paper
- Fully adjustable tractors to 9½"
- Auto self-test
- Up to 10 character fonts
 Standard 96 character ASCII
 User defined character font
 Provision for up to eight additional fonts
- Dot resolution graphics in six densities
- Variable line spacing control from 0 to 64 dots in half-dot increments
- Auto form-feed for any form length at any line spacing
- Heavy-duty all aluminum chassis
- 110vac or 220vac, 50/60Hz.
- 100 million character printhead
- Measures only 15" wide, 3" high, and 11" deep
- Weighs only 15 lbs.

. but maybe its most attractive feature is the price \$699.00.

Sorting with Binary Trees

Bill Walker
University of Oklahoma
School of Electrical Engineering
and Computer Science
202 W Boyd
Norman OK 73019

Of the numerous sorting techniques known to the average computer user, one that is seldom talked about is the *binary sort*. This is probably because, at first glance, it seems unnecessarily complicated when compared to, say, the common *bubble sort*. (The bubble sort is so-called because a new element reaching its proper position in a sorted list does so by being compared successively with each element already in the list, rising like a bubble from the bottom of the list.) Nonetheless, I was curious enough about the binary sort to compare it to the more common bubble sort in a practical demonstration. The results were interesting enough to warrant further study. First, let me describe the experiment.

The program of listing 1 (with line 5 deleted) was used to implement a binary sort on an 8 K Commodore PET. Timing comparisons were made, using the PET's internal real-time clock, for both this program and a bubble-sort program (not listed in this article), both of which were instructed to sort a random list of 100 integers. The binary sort took approximately half as long as the bubble sort to order the random list of numbers. However, the real payoff came when the computer was told to either add to or delete from the list, and then print the new sorted list. The bubble sort took the same amount of time it took to do its first sort, but the binary sort was finished before the display had time to record the fact.

It is on this seemingly amazing note that we begin a discussion of binary sorts.

Figures 1 and 2 are examples of what are called *trees*. They are extremely useful in several branches of mathematics and figure largely in the construction of a binary search. Trees are made of *nodes* (the circles in

figures 1 and 2), each of which usually contains information. The single node in the top row is called the *root*. A given node can be connected to one or more nodes on the next level below it; if this is the case, the higher node is

called the *parent node* (or parent), and the lower nodes directly connected to it are called its *children*.

For years, mathematicians have known many properties of tree diagrams. Most of these properties

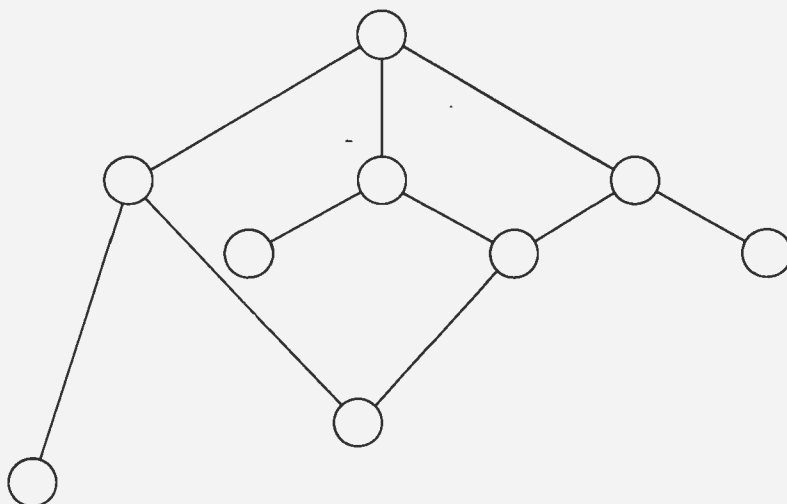

Figure 1: A generalized tree. A tree is characterized by having only one root node (the one at the top) and by each node (represented here as a circle) having zero or more nodes connected to it by a straight line. The nodes below the given node connected directly by one line segment are called child nodes; the node itself is called the parent node.

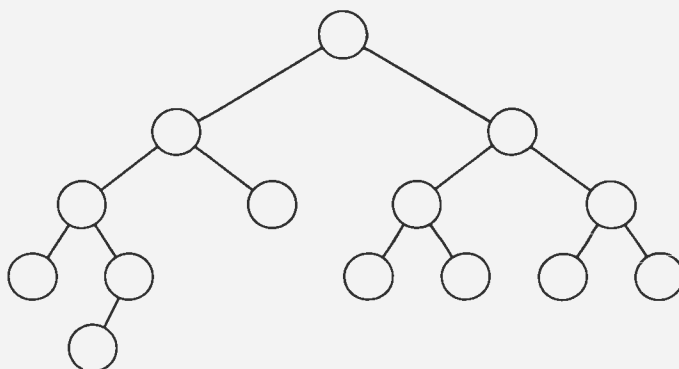

Figure 2: A binary tree. This tree is characterized by the properties that a given parent node can have, at most, two child nodes, and that each non-root node has exactly one parent. The child nodes are called the left child node and the right child node.

Introducing quality print at matrix speed. For only \$1295*.

Until now, word processing output was a slow, expensive proposition. You could pay thousands for a slow, letter-quality character printer. Or give up print quality for matrix speed and price.

But that was before Paper Tiger™ 460 offered you a better choice.

The new Paper Tiger 460 is the first matrix printer with high-density dot matrix characters plus high speed. At a low price.

The secret? A unique nine-wire, staggered matrix head provides overlapping dots in both horizontal and vertical planes. The result is dense, high-quality characters you'll be proud to show off.

What's more, Paper Tiger 460 gives you a combination of features simply not available on any other printer, at any price. Like bi-directional, logic-seeking printing at speeds in excess of 150 characters per second. Micro-processor electronics, with built-in diagnostics and self-test. Proportional spacing. Automatic text justification. DotPlot™ high

Integral Data Systems stands reperformance printers ideally su printer, the IDS 460, offers feat

Automatic proportional spacing, processing systems, plus the cap resolution of 84 by 84 dots per

Paper Tiger 460 Print Sample

resolution graphics option. RS232 and parallel interfaces. And more.

But its most important feature is high reliability. Paper Tiger 460 is designed to be tough and dependable. It has rugged, stepper-motor head and paper drives. A new rugged ballistic-type print head.

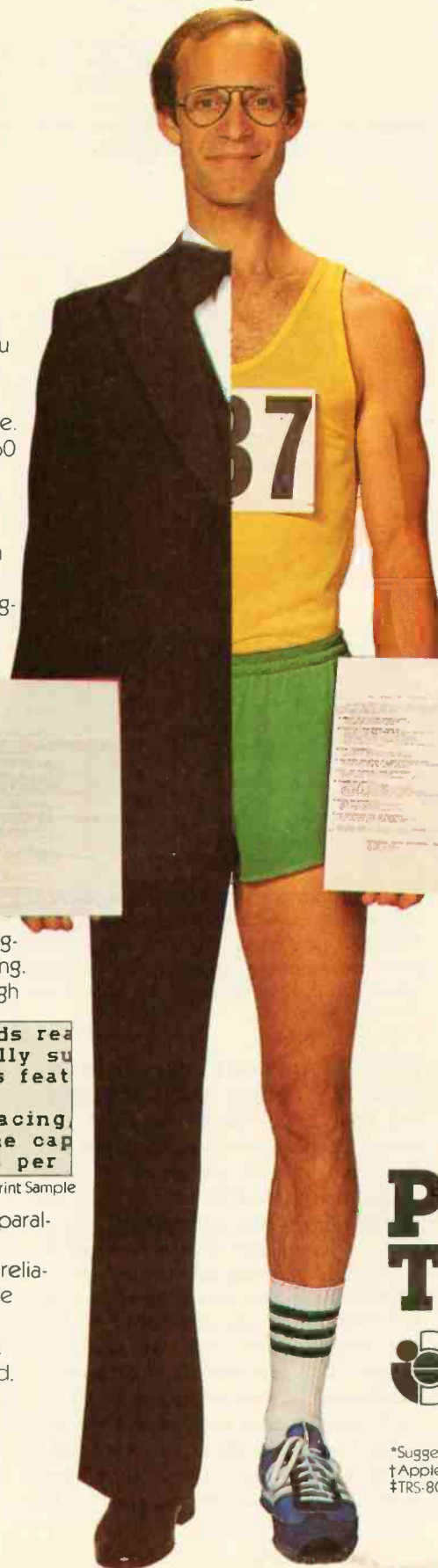

And its simple, chassis-mounted cartridge ribbon lasts up to four times longer than cassette or spool ribbons.

Paper Tiger 460 is the one printer that gives your Apple,† TRS-80,‡ or other small business computer both data processing and word processing output. At a price you can afford.

Get your paws on Paper Tiger 460, and join the tens of thousands of satisfied Integral Data Systems users. For the name of the Paper Tiger dealer nearest you, call us toll-free: 800-343-6412 (in Massachusetts, Alaska, and Hawaii: (617) 237-7610). Or, write for complete specifications. Integral Data Systems, 14 Tech Circle, Natick, Massachusetts 01760.



Paper Tiger 460

 Integral Data Systems, Inc.

*Suggested single-unit U.S. retail price.

†Apple is a trademark of Apple Computer Inc.

‡TRS-80 is a trademark of Radio Shack, a division of Tandy Corp.

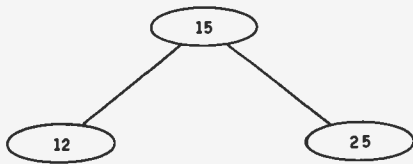

Figure 3: A simple binary tree. Data is arranged within a binary tree so that the sequence right child, parent, left child gives the contents of the tree in sorted order. Here, the sorted order is 12, 15, 25.

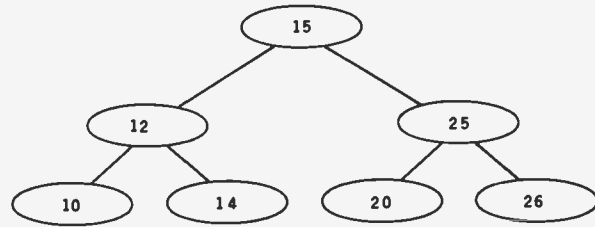

Figure 5: Example of a binary tree. Here, more nodes have been added, giving the sequence 10, 12, 14, 15, 20, 25, 26.

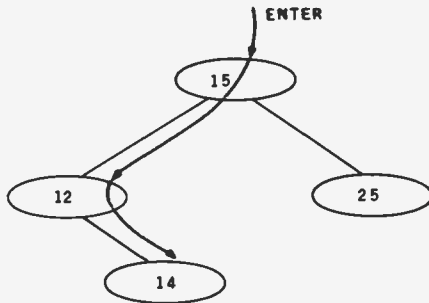

Figure 4: Adding to a binary tree. The colored arrow shows the direction of search when placing a new node in a binary tree. Here, 14 is greater than 12, so it is placed as a right child of 12. Here, the sorted order is 12, 14, 15, 25.

are complex or so general as to be of little practical use. But if we restrict ourselves to a specific subset of trees with a given structure, these properties become readily understandable and usable. Figure 1 shows a general tree; figure 2 is an example of the type of tree that we will be studying, a *binary tree*.

A binary tree is characterized by the restriction that each parent node can have, at most, two children, and that any node (except for the root node) must have exactly one parent node. Later we will see that this kind of tree is well suited to representation in a digital computer, where the binary nature of decisions (answered with yes or no) goes hand in hand with the maximum of two child nodes allowed each parent node.

How does this structure enable us to perform searches and sorts? If we define *less than* as meaning to the left and down and *greater than* as meaning to the right and down, this gives us an ordering that can be used to store members of a sorted list as nodes of a binary tree.

Suppose we start with three numbers: 15, 12, and 25. Since 15 is the first number encountered, we will designate it as the root of our tree.

6a

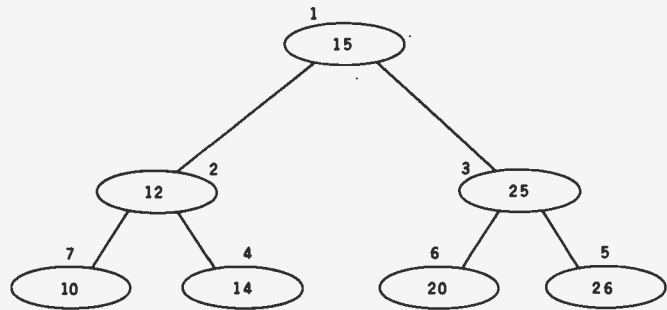

6b

NODE	KEY	LEFT POINTER	RIGHT POINTER
1 (ROOT)	15	NODE 2 (12)	NODE 3 (25)
2	12	NODE 7 (10)	NODE 4 (14)
3	25	NODE 6 (20)	NODE 5 (26)
4	14	NIL	NIL
5	26	NIL	NIL
6	20	NIL	NIL
7	10	NIL	NIL

Figure 6: Example of a binary tree. Here (6a), the binary tree of figure 5 is reproduced with numbers above each node that give the order in which the nodes were added to the tree. The table below (6b) gives the node number, key, left pointer, and right pointer of each node; both pointers refer to the node number of a node, not its key value. The word NIL indicates there is no node in the direction given by the pointer.

Since 12 is the next number in the list, we attach it below and to the left of the root node (12 is less than 15). Since the next number, 25, is greater than the root, 15, we attach it below and to the right of the root. This gives us the binary tree in figure 3.

Now let us add a new number to the list: 14. We can add this to the existing binary tree as follows: start at the root node, 15, and move to the left because the node we want to insert, 14, is less than 15. At the node numbered 12, we compare 12 to 14 and conclude that we should go to the right. Since no node exists to the right of 12, we can place a new node there with the value of the number to be

added, giving us the binary graph in figure 4. Similarly, we can add the numbers 26, 20, and 10 to our tree, giving us the tree in figure 5.

Given the tree in figure 5 as a "sorted" tree, this implies that there is some procedure that allows us to extract the sorted list of numbers from the "sorted" binary tree.

If we were presented with the diagram of figure 3 and asked to read it in proper order, we would do so by first reading the leftmost node, then the parent, then the rightmost node. We note that the far more complicated trees of figure 4 and figure 5 can be read in a similar fashion by

Text continued on page 102

The best in data base management for your micro-computer

Get the most out of your micro-computer. Use our advanced and progressive data management system.

HDBS is an extended hierarchal data base system offering

- fixed length records
- file-level read/write protection
- one-to-many set relationships

MDBS is a full network data base system offered as an upgrade from HDBS... or it may be ideal as your initial system. **Unique and versatile**, it adds these features:

- full network CODASYL-oriented data structures
- variable length records
- multiple levels of read/write protection
- one-to-one, many-to-one, and many-to-many sets
- non-redundancy of data, easy updating
- occurrences of a record type may own other occurrences of the same type
- a single set may have multiple owner and member record types

MDBS-DRS. As an add-on to MDBS, the DRS system offers extraordinary flexibility in data base restructuring to meet new needs.

- Item, record, and set types can be added, deleted, or renamed in an existing data base as well as other data base characteristics. You can redesign the data base after it is already on-line!

MDBS-RTL. As an add-on to MDBS, the RTL (Recovery Transaction Logging) logs all data base transactions, so that in the event of a system failure, the data base can be recovered with minimal loss of information.

- The recovery processor permits selective reloading of the data base from the transaction file. Users can log messages, indicate complex transaction sequences, and effect selective control over the recovery process.

MDBS-QRS. An interactive Report-Writer/Query-System for HDBS/MDBS data bases. Features...

- may be customized for non-technical users
- complex retrieval conditions may be specified
- detailed reports can be quickly generated
- wildcard and "match-one" string specifications included

HDBS and MDBS Packages Include:

- DDL data definition language analyzer/editor
- 260-page users manual
- DMS data management routines callable from host language
- Sample application program and DDL files
- Relocator to re-org all routines
- System specific manual for bringing up our software



Coming soon: Multi-User Versions of MDBS, and a Z8000 Version.

54-page "primer" on data base systems for micro-computers — only \$10.00 per copy.

Both HDBS and MDBS Systems . . .

- Run under . . .
 - CP/M with CBASIC; Microsoft BASICs, FORTRAN or COBOL; InterSystem PASCAL/Z; Sorcim PASCAL/M; Micro Focus CIS COBOL; Digital Research PL/I
 - MVT/FAMOS with BASIC
 - OASIS with BASIC
 - TRSDOS and NEWDOS (Models I and II) with Disk BASIC
 - North Star DOS with North Star BASIC
 - Apple DOS and Applesoft BASIC
 - Machine Language Interface available on all above systems.
- Up to 254 record-types definable in the data base; each record-type may contain up to 255 item-types; each item-type may be up to 9,999 bytes in length.
- Names of data items, records, sets, and files are wholly user definable.
- Commands to add, delete, update, search, and traverse the data base.
- Straightforward use of ISAM-like structures.
- Records can be maintained in several sorted orders.
- Written in machine language for maximum execution efficiency and minimal memory usage.
- Independent of types and sizes of disk drives. Support data base spread over several disk drives (max.8); disks may be mini- or full-sized floppies or hard disks.
- Available versions: Z80 (requires approx. 18K), 6502 (approx. 26K), 8080 (approx. 22K)
Total memory requirement must allow for buffer areas.
- 8086 version available. (Call or write for details and prices.)

Ordering information (applicable to Z80, 8080 and 6502 versions):

HDBS	\$ 300.00	When ordering, specify intended use with . . .
MDBS	900.00	
DRS	300.00	1. North Star DOS and BASIC
RTL	300.00	2. CP/M - CBASIC
QRS	300.00	3. CP/M - Microsoft BASIC 4.XX
HDBS upgrade to MDBS	650.00	4. CP/M - Microsoft BASIC 5.XX
MDBS with DRS, RTL, and QRS	1500.00	5. CP/M - Microsoft BASIC or FORTRAN Compiler
HDBS/MDBS Manual	35.00	6. CP/M - Microsoft COBOL-80
DRS Manual	5.00	7. CP/M - InterSystem PASCAL/Z
RTL Manual	5.00	8. CP/M - Sorcim PASCAL/M
QRS Manual	5.00	9. CP/M - Digital Research PL/I
System Specific Manuals (each)	5.00	10. CP/M - Micro Focus CIS COBOL
		11. TRSDOS/NEWDOS and TRS Disk BASIC (Models I and II)
		12. Apple DOS and Applesoft BASIC
		13. MVT/FAMOS and BASIC
		14. OASIS and OASIS BASIC
		15. Machine Language Programs (Specify operating system.)

Within a given operating system, add \$125.00 for each additional language selected.

For prices outside the U.S. and Canada, please ask for price lists.

Add \$2.50 handling fee for non-cash order (\$5.00 outside U.S.).

Indiana residents add 4%.

We accept Visa and Master Charge.

Setting standards of excellence for data base software . . . worldwide.

Micro Data Base Systems, inc.

Box 248, Lafayette, Indiana 47902
317-742-7388 or 317-448-1616



Listing 1: BASIC program for sorting a threaded binary tree. This program allows the user to create, add to, delete from, and list a binary tree. The tree is threaded in that it is possible to print the tree sorted in ascending key sequence by using the pointers associated with each node. This version is written in Microsoft BASIC and currently runs on an Apple II. With the deletion of line 5, it has also been run on the Commodore PET, the Radio Shack TRS-80, and a PDP-10. It should also run without modification on any other computer using Microsoft BASIC.

```

5 CALL -936
10 DIM KEY(125),RLINK(125),LLINK(
125)
12 FALSE=0:TRUE=1:N=0:ROOT=1:NIL=
0
14 EMPTY=FALSE
16 PRINT "THIS PROGRAM GENERATES 10
0 RANDOM NUMBERS AND SORTS THEM
USING"
18 PRINT "A BINARY SEARCH TREE. IT
ALSO ALLOWS DELETIONS FROM, OR
ADDITIONS"
20 PRINT "TO THE TREE. "
22 REM ** GENERATE DATA **
24 FOR N=1 TO 100
26 KEY(N)=RND(100)
27 LLINK(N)=NIL
28 RLINK(N)=NIL
29 Q=N
30 GOSUB 580
32 NEXT N
34 PRINT : PRINT "ELEMENTS AS THEY
WERE GENERATED ARE :": PRINT
36 FOR I=1 TO 100: PRINT KEY(I)

```

```

: NEXT I
38 PRINT
100 PRINT : PRINT "DO YOU WANT TO:"
110 PRINT " 1. ADD A NODE"
120 PRINT " 2. DELETE A NODE"
130 PRINT " 3. LIST THE TREE"
132 PRINT " 4. END"
140 INPUT X
150 IF X=1 THEN 160
151 IF X=2 THEN 200
152 IF X=3 THEN 300
153 IF X=4 THEN 9999
154 GOTO 100
160 N=N+1
162 IF EMPTY THEN 164
163 GOTO 170
164 FOR I=1 TO N
165 LLINK(I)=NIL
166 RLINK(I)=NIL
167 NEXT I
168 N=1
169 ROOT=1
170 INPUT "GIVE KEY ",KEY(N)
175 Q=N
180 GOSUB 580
190 GOTO 100
200 INPUT "GIVE KEY TO BE DELETED "
,P
205 ALPHA=P
210 GOSUB 1390
212 P=SEARCH
220 GOSUB 3000
230 GOTO 100
300 PRINT : PRINT "TREE FOLLOWS:"
: PRINT
310 GOSUB 980
320 GOTO 100
580 REM ** SUBROUTINE BILDER **
582 EMPTY=FALSE
600 IF N=1 THEN 830
630 P=ROOT
640 INSERT=FALSE

```

```

650 IF KEY(Q)<=KEY(P) THEN 740
660 IF RLINK(P)<=NIL THEN 690
670 P=RLINK(P)
680 GOTO 810
690 RLINK(Q)=RLINK(P)
700 RLINK(P)=Q
710 LLINK(Q)=NIL
720 INSERT=TRUE
730 GOTO 810
740 IF LLINK(P)<>NIL THEN 800
750 LLINK(P)=Q
760 LLINK(Q)=NIL
770 RLINK(Q)=-P
780 INSERT=TRUE
790 GOTO 810
800 P=LLINK(P)
810 IF INSERT=FALSE THEN 650
830 RETURN
850 REM ** SUBROUTINE FIX **
890 I=1
900 IF I<=N THEN 920
910 GOTO 960
920 LLINK(I)=NIL
921 RLINK(I)=NIL
940 I=I+1
950 GOTO 900
960 RETURN
980 REM ** SUBROUTINE LIST **
1000 PRINT
1020 IF EMPTY=FALSE THEN 1030
1022 PRINT "TREE EMPTY"
1023 GOTO 1220
1030 RET=FALSE
1040 R=ROOT
1050 PRINT "ELEMENTS IN ORDER"
1070 IF LLINK(R)=NIL THEN 1115
1100 R=LLINK(R)
1110 GOTO 1070
1115 B=R
1120 IF ((RLINK(B)<>NIL) AND (RET=
FALSE)) THEN 1140
1130 GOTO 1200
1140 PRINT KEY(B),
1145 P=B
1150 GOSUB 1240
1151 B=SUC
1160 IF B<>NIL THEN 1120
1170 RET=TRUE
1180 GOTO 1120
1200 IF RET THEN 1220
1210 PRINT KEY(B)
1220 RETURN
1240 REM ** SUBROUTINE SUCCESSOR **
1280 Q=RLINK(P)
1290 IF RLINK(P)>NIL THEN 1320
1300 Q=-Q
1310 GOTO 1360
1320 IF LLINK(Q)=NIL THEN 1360
1340 Q=LLINK(Q)
1350 GOTO 1320
1360 SUC=Q
1370 RETURN
1390 REM ** SUBROUTINE SEARCH **
1450 P=ROOT
1460 F1=FALSE
1470 IF ((P<>NIL) AND (F1=FALSE)
) THEN 1490
1480 GOTO 1600
1490 IF ALPHA=KEY(P) THEN 1580
1500 IF ALPHA<KEY(P) THEN 1560
1510 IF RLINK(P)<=NIL THEN 1540
1520 P=RLINK(P)
1530 GOTO 1470
1540 P=NIL
1550 GOTO 1470
1560 P=LLINK(P)
1570 GOTO 1470
1580 F1=TRUE
1590 GOTO 1470
1600 SEARCH=P
1610 RETURN
2480 REM ** SUBROUTINE PAR **
2530 F1=FALSE
2540 R=ROOT
2550 IF P<>ROOT THEN 2560
2555 F1=TRUE:R=NIL
2560 IF ((LLINK(R)=P) OR (RLINK(
R)=P) OR (F1=TRUE)) THEN 2630
2570 IF KEY(R)<KEY(P) THEN 2600

```

TRS-80, PET, APPLE, SORCERER Communications Interface Systems



- Send & Receive Morse Code / Radioteletype
- Teaches Morse Code! / Copies wire services!
- Complete Hardware & Software Package
- Extensive User Manuals
- From \$129

Write or call for complete catalog

MACROTRONICS, inc.®

1125 N. Golden State Blvd. / Suite G
Turlock, CA 95380 (A)
(209) 667-2888 / 634-8888

California residents add 6% tax

We are experiencing telephone difficulties, please keep trying.



Listing 1 continued on page 102

slaving too long over a hot computer?



**AUTOMATED
SIMULATIONS**

The Temple of Apschai

First in the Dunjonquest™ series. Undertake heroic acts within a labyrinth filled with treasures and fantastic monsters who guard these treasures and move in real time. The Book of Lore (included) fills in the background and describes the appearance of the temple. Over 200 rooms and 30 monsters. There are 16 million kinds of characters! The best of the dungeon computer games.

For TRS80 Cassette: 16K, Level II; Disk: 32K, TRSDOS • Apple Cassette: 48K Applesoft in cassette or in ROM; Disk: 48K Applesoft in ROM • Pet Cassette: 32K, old or new ROMs.

\$24.95 cassette • \$29.95 disk

Starfleet Orion

Fight space battles in your living room with 12 game scenarios (data files) using 2 to 15 spacecraft. Infinitely expandable, invent more game versions of your own. For 2 players. Includes Battle Manual and Ship Control Sheets.

For TRS80 Cassette: 16K, Level II; Disk: 32K TRSDOS • Apple: Cassette: 16K or 32K, integer BASIC in ROM; Disk: 32K, integer BASIC in ROM • Pet Cassette: 8K, old or new ROMs.

\$19.95 cassette • \$24.95 disk

The Datestones of Ryn

Dunjonquest #2. Recover the datestones from the rogue Rex the Reaver and his cutthroats — who've stolen the stones from the calendar — before time runs out. Competitive scoring system: How well can you do compared to other players?

For TRS80 Cassette: 16K, Level II; Disk: 32K, TRSDOS • Apple Cassette: 32K Applesoft in ROM or 48K Applesoft on cassette; Disk: 48K Applesoft in ROM • Pet Cassette: 16K, old or new ROMs.

\$14.95 cassette • \$19.95 disk

Rescue at Rigel

New! Brings the Dunjonquest series to the final frontier. As Sudden Smith, with force shield and power gun, you make your way through several levels and scores of rooms to find and beam to safety the prisoners held by the evil High Tollah. Quickly, before your power pack dies and the Tollah and his minions can get to you!

For TRS80 Cassette: 16K, Level II; Disk: 32K, TRSDOS • Apple Cassette: 32K Applesoft in ROM or 48K Applesoft on cassette; Disk: 48K Applesoft in ROM • Pet Cassette: 16K, old or new ROMs.

\$19.95 cassette • \$24.95 disk

then it's time for a fun break!

TRIPLE WARRANTY

10 Money back guarantee: If you don't like the game for any reason whatever, return it intact within 10 days of receipt for a complete refund. No questions asked.

30 Defective warranty: Cassette not functioning within 30 days of receipt? Return it to us and we'll exchange it. No charge, of course.

forever Limited lifetime warranty: No matter what happens to your cassette: the dog chewed it...you left it out in the rain...whatever. No matter when it happens. Return the remains to us (with \$5.00 to cover all handling and shipping) and we'll send you a brand new cassette.

We believe that computer games should be fun, challenging, intellectually stimulating...and provide you with many alternatives and ways to affect the outcome. So our games are more complex in planning your playing strategy. But not in the mechanics and rules of play. With all these games, you take command. You determine the course of history.

Invasion Orion

Pit your skills against the computer! Same game system as "Starfleet Orion" but you can play it solo. 3 skill levels; the computer plays either side and takes care of the details. It has 10 fictional scenarios, 30 ship types, and 3 weapon systems.

For TRS80 Cassette: 16K, Level II; Disk: 32K, TRSDOS • Apple Cassette: 32K Applesoft in ROM; Disk: 48K Applesoft in ROM • Pet Cassette: 16K, old or new ROMs.

\$19.95 cassette • \$24.95 disk

Morloc's Tower

Dunjonquest #3. You'll find 3 kinds of rings, a magic sword, 2 amulets, 6 or so other treasures, 30 rooms, 18 real-time command options...and a dozen types of monsters including the heinous Morloc. Easy to learn, a challenge to master. Includes game program, 1.2 KB data file, 16 page manual.

For TRS80 Cassette: 16K, Level II; Disk: 32K, TRSDOS • Apple Cassette: 32K Applesoft in ROM or 48K Applesoft on cassette; Disk: 48K Applesoft in ROM • Pet Cassette: 24K, old or new ROMs.

\$19.95 cassette • \$24.95 disk

AUTOMATED SIMULATIONS

Please send me the following games:

Cass.	Disk	Game	
___	___	Temple of Apschai	\$ _____
___	___	Starfleet Orion	\$ _____
___	___	Invasion Orion	\$ _____
___	___	Datestones of Ryn	\$ _____
___	___	Morloc's Tower	\$ _____
___	___	Rescue at Rigel	\$ _____
Plus Shipping & Handling			\$ 1.00
Sales Tax*			\$ _____
Total			\$ _____

My computer is _____

I enclose my check in the amount of _____

Please charge to my

Visa Master Charge:

_____ expires _____

Name _____

Address _____

*California residents: add 6 or 6.5% tax

TO ORDER:

Master Charge or Visa card holders: charge these to your credit card. Just call the appropriate toll free number: (800) 824-7888, operator 861.

In California: (800) 852-7777, op. 861.

In Hawaii or Alaska: (800) 824-7919 op. 861.

Or use the handy coupon:

Automated Simulations

Department OM3

P.O. Box 4247

Mountain View, CA 94040

Listing 1 continued:

```

2580 R=LLINK(R)
2590 GOTO 2610
2600 R=RLINK(R)
2610 IF R=NIL THEN F1=TRUE
2620 GOTO 2560
2630 PAR=R
2640 REM
2650 RETURN
3000 REM *** SUBROUTINE DEL ***
3010 IF P=ROOT THEN GOTO 7000
3020 REM CASE II
3030 GOSUB 2480
3035 Q=PAR
3040 IF LLINK(Q)=P THEN GOTO 6000

3050 REM CASE II GROUP B
3060 IF RLINK(P)>NIL THEN GOTO 3200

3070 IF LLINK(P)<>NIL THEN GOTO
3110
3080 REM SUBCASE 1
3090 RLINK(Q)=NIL
3100 GOTO 9000
3110 REM SUBCASE 3
3120 RLINK(Q)=LLINK(P)
3130 R=LLINK(P)
3140 IF RLINK(R)=-P THEN 3150
3145 R=RLINK(R)
3147 GOTO 3140
3150 RLINK(R)=RLINK(P)
3160 GOTO 9000
3200 IF LLINK(P)<>NIL THEN GOTO
3240
3210 REM SUBCASE 2
3220 RLINK(Q)=RLINK(P)
3230 GOTO 9000

```

```

3240 REM SUBCASE 4
3250 RLINK(Q)=RLINK(P)
3260 R=RLINK(P)
3270 IF LLINK(R)=NIL THEN 3280
3275 R=LLINK(R)
3277 GOTO 3270
3280 LLINK(R)=LLINK(P)
3320 R1=LLINK(P)
3330 IF RLINK(R1)=-P THEN 3340
3335 R1=RLINK(R1)
3337 GOTO 3330
3340 RLINK(R1)=-R
3350 GOTO 9000
6000 REM CASE II GROUP A
6010 IF RLINK(P)>NIL THEN GOTO 6150

6020 IF LLINK(P)<>NIL THEN GOTO
6060
6030 REM SUBCASE 1
6040 LLINK(Q)=NIL
6050 GOTO 9000
6060 REM SUBCASE 3
6070 LLINK(Q)=LLINK(P)
6080 R=LLINK(P)
6090 IF RLINK(R)=-P THEN 6100
6095 R=RLINK(R)
6097 GOTO 6090
6100 RLINK(R)=-Q
6110 GOTO 9000
6150 IF LLINK(P)<>NIL THEN GOTO
6190
6160 REM SUBCASE 2
6170 LLINK(Q)=RLINK(P)
6180 GOTO 9000
6190 REM SUBCASE 4
6200 LLINK(Q)=RLINK(P)
6210 R=RLINK(P)
6220 IF LLINK(R)=NIL THEN 6230
6225 R=LLINK(R)
6227 GOTO 6220

```

```

6230 LLINK(R)=LLINK(P)
6270 R1=LLINK(P)
6280 IF RLINK(R1)=-P THEN 6290
6285 R1=RLINK(R1)
6287 GOTO 6280
6290 RLINK(R1)=-R
6300 GOTO 9000
7000 REM CASE I
7010 IF RLINK(P)>NIL THEN 7150
7020 IF LLINK(P)>NIL THEN 7070
7030 REM SUBCASE A
7040 EMPTY=TRUE
7050 N=0
7060 GOTO 9000
7070 REM SUBCASE C
7080 ROOT=LLINK(P)
7090 R=LLINK(P)
7100 IF RLINK(R)=-P THEN 7130
7110 R=RLINK(R)
7120 GOTO 7100
7130 RLINK(R)=NIL
7140 GOTO 9000
7150 IF LLINK(P)>NIL THEN 7190
7160 REM SUBCASE B
7170 ROOT=RLINK(P)
7180 GOTO 9000
7190 REM SUBCASE D
7200 ROOT=RLINK(P)
7210 R=ROOT
7220 IF LLINK(R)=NIL THEN 7250
7230 R=LLINK(R)
7240 GOTO 7220
7250 LLINK(R)=LLINK(P)
7260 R1=LLINK(P)
7270 IF RLINK(R1)=-P THEN 7300
7280 R1=RLINK(R1)
7290 GOTO 7270
7300 RLINK(R1)=-R
9000 RETURN
9999 END

```

Text continued from page 98:

first visiting the leftmost node in each branch, then moving to the parent, then to the rightmost node, then moving to the next group and repeating the sequence.

Unfortunately, such a description, while easy for people, is tough for computers, because computers lack the ability to observe spatial placement of nodes. It becomes necessary for us to provide the computer with a series of pointers that indicate the relationships between nodes. Each node is provided with two pointers, one of which points to the left child of the node, while the other points to the right child of the node.

In figure 6, we have listed the nodes (in the order encountered) and the left and right pointers of each parent node. Note the presence of the word "NIL" for the four children at the bottom of the branches. These represent pointers to possible future nodes that have not yet been added to the tree.

To properly pass through the computer representation of the tree, we have to supply it with the proper information as to the relationship of the nodes to each other. This can be done economically by assigning four numbers to each node, as shown in figure 7. The four numbers are the

number of the node, the value or key of the node, and the left and right pointers to the node numbers (not to their keys).

Some explanation should be given of the values that can be assumed by the left and right pointers. The left pointer always points to either a node number (greater than zero) or zero (denoting the end of one "branch" of the tree in the leftward direction).

The right pointer can assume either positive or zero values with the same meanings as above. In addition, it can

be negative; this is an upward pointer to the node that is the next node in the ascending key sequence. (The node with the upward pointer is the rightmost node of a left subtree; the node being pointed to is the parent node of this same left subtree.) An example of this in figure 7 is the upward pointer from node 4 to node 1; the upward pointer denotes that the subtree of nodes 2, 4, and 7 has been listed already.

The upward pointers in figures 7

Text continued on page 110

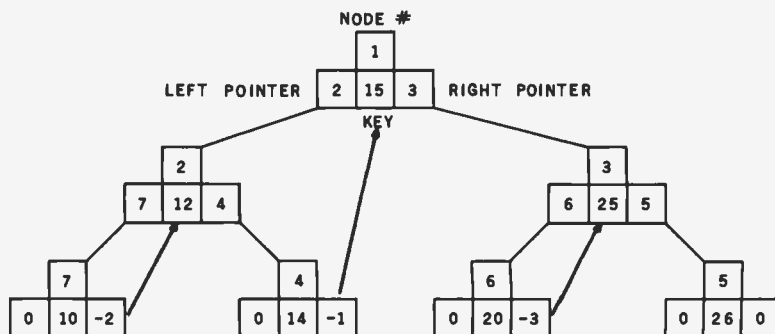

Figure 7: Computer representation of a binary tree. In the BASIC program of listing 1, each node is represented by four numbers: the node number (given for purposes of illustration only), the key, and the right and left pointers. To "thread" the tree so that a thread of pointers runs through the nodes in their sorted-key order, a right pointer, when negative, points not to a right child node but to the ancestor node that follows the current node in the sorted sequence; these upward right pointers are drawn in color.

You'll be a little richer after building one of these.

H-19 Professional Video Terminal



H-8 Personal Computer with Dual Floppy Disk Storage



H-11A 16-Bit Computer with Dual Floppy Disk Storage



H-89 All-In-One Computer with Floppy Disk Storage



H-14 Serial Printer



Self-Instruction for Assembly and BASIC Programming

Richer in knowledge

Once you build your own computer, you'll know it inside out. You'll know how to make it work for you, how to make it grow as your skills grow.

Richer in savings

Build-it-yourself kits cost less – about 30% less than comparable assembled computers. And you'll probably never need to pay someone for service because no one will know your computer better than you.

Is it hard?

Not at all. Heath makes it simple with easy-to-assemble designs and with step-by-step manuals that guide you from unpacking to final plug-in. And a Heathkit helping hand is always just a phone call away.

Innovative software

Heath offers you innovative programs for running your home or business, and exciting games for your family. You can have Microsoft™ BASIC™, one of the most powerful and widely used languages.

Heath User's Group (HUG) will share with you a library of over 500 programs to make your computer serve you in ways you never imagined.

Complete hardware

Choose from three computer systems:

The H89 All-In-One Computer gives you everything in one compact, convenient unit.

The flexible H8 gives you the freedom to combine memory and interfacing for exactly the system you require.

And the powerful H11A gives you 16-bit

power for your most complex programs.

The Heathkit line includes video terminals, matrix and letter-quality printers and a complete selection of accessories. You'll even find award-winning self-instruction packages to teach yourself programming in BASIC or Assembly.

FREE CATALOG



It's all in the new 104-page Heathkit Catalog, along with nearly 400 electronic kits for your home, work or pleasure. Send for your free catalog today, or pick one up at your Heathkit Electronic Center.*

Heathkit®

*Visit your Heathkit Electronic Center in the U.S. or Canada where Heathkit Products are displayed, sold and serviced. See your white pages for the location nearest you. Heathkit Electronic Centers are units of Veritechnology Electronics Corporation in the U.S.

Write to Heath Company, Dept. 334-704, Benton Harbor, MI 49022
(In Canada write Heath Company, 1480 Dundas St. E., Mississauga, Ont. L4X 2R7)

Rx AVAILABLE WITHOUT PRESCRIPTION!

THE ONLY SYSTEM OF ITS KIND YOUR MICROCOMPUTER WILL EVER NEED!

GLOBAL™ DATABASE MANAGEMENT SYSTEM

for PROGRAMMERS, ACCOUNTANTS, BOOK-KEEPERS, DOCTORS, LAWYERS, PUBLISHERS, SCIENTISTS, MANUFACTURERS, WHOLESALERS, RETAILERS, MANAGERS, LANDLORDS, REAL ESTATE AGENTS, TEACHERS, STUDENTS, ETC.

Extremely comprehensive, versatile user-oriented management system for database creation and list maintenance. Runs under CP/M* and CBASIC2** on a microcomputer system in only 40K RAM.

Completely user-defined file structure with sequential, random and linked file maintenance; user-defined number of fields; data transfer between records; automatic high speed search algorithms with global search function; built-in ISAM; fast sort/merge utility; record selectable output can be formatted (with/without headings, column titles, totals, etc.) and printed on various forms (labels, envelopes, preprinted forms, etc.); links to CP/M commands or programs with automatic return to Global; provides status reports on diskette, data file and hardware environment; disk used as extended memory.

Supplied on standard 8" IBM disk (inquire about other formats), complete with BASIC subroutine library in source code, with comprehensive manual.

\$295

MANUAL ONLY...\$25

*Trademark of Digital Research
 **Trademark of Software Systems

DEALER INQUIRIES INVITED



1505 Ocean Ave., Brooklyn, N.Y. 11230
 212/252-5002

Listing 2: Running the program of listing 1. In this listing, a hundred random numbers are generated, used to create a binary tree, and listed in sorted key sequence. The node containing key value of 8 is deleted, a node with key value of 39 is added, and the tree is listed again.

```
>RUN
THIS PROGRAM GENERATES 100 RANDOM NUMBERS AND SORTS THEM USING
A BINARY SEARCH TREE. IT ALSO ALLOWS DELETIONS FROM, OR ADDITIONS
TO THE TREE.
ELEMENTS AS THEY WERE GENERATED ARE
64 22 76 30 15 85 98 69 76 33
53 9 91 30 3 15 34 75 16 97
50 28 53 10 71 23 99 28 27 41
99 28 8 94 69 6 26 13 76 21
6 55 90 82 24 92 19 96 43 97
78 7 66 81 97 36 32 37 58 47
21 60 97 86 50 99 72 35 32 62
96 14 37 99 89 78 38 42 46 92
47 49 56 91 22 88 63 67 5 34
26 22 65 33 10 73 54 38 11 45
```

```
DO YOU WANT TO:
1. ADD A NODE
2. DELETE A NODE
3. LIST THE TREE
4. END
```

I will delete the circled element.

```
?3
TREE FOLLOWS:
ELEMENTS IN ORDER
3 5 6 6 7 9 10 10 11 13
13 14 15 15 16 19 21 21 22 22
22 23 24 26 26 27 28 28 30 30
30 32 32 33 33 34 34 35 36 37
37 38 38 41 42 43 45 46 47 47
49 50 50 53 53 54 55 56 58 60
62 63 64 65 66 67 69 71 72 72
73 75 76 76 76 78 78 81 82 85
86 88 89 90 91 91 92 92 94 96
96 97 97 97 97 98 99 99 99 99
```

```
DO YOU WANT TO:
1. ADD A NODE
2. DELETE A NODE
3. LIST THE TREE
4. END
```

```
?2
GIVE KEY TO BE DELETED ?8
```

```
DO YOU WANT TO:
1. ADD A NODE
2. DELETE A NODE
3. LIST THE TREE
4. END
```

```
?3
TREE FOLLOWS:
ELEMENTS IN ORDER
3 5 6 6 7 9 10 10 11 13
14 15 15 16 19 21 21 22 22 22
23 24 26 26 27 28 28 28 30 30
32 32 33 33 34 34 35 36 37 37
38 38 41 42 43 45 46 47 47 49
50 50 53 53 54 55 56 58 60 62
63 64 65 66 67 69 71 72 73 73
75 76 76 76 78 78 81 82 85 86
88 89 90 91 91 91 92 92 94 96
97 97 97 97 98 99 99 99 99 96
```

```
DO YOU WANT TO:
1. ADD A NODE
2. DELETE A NODE
3. LIST THE TREE
4. END
```

```
?1
GIVE KEY ?39
```

```
DO YOU WANT TO:
1. ADD A NODE
2. DELETE A NODE
3. LIST THE TREE
4. END
```

The circled element has been added.

```
?3
TREE FOLLOWS:
ELEMENTS IN ORDER
3 5 6 6 7 9 10 10 11 13
14 15 15 16 19 21 21 22 22 22
23 24 26 26 27 28 28 28 30 30
32 32 33 33 34 34 35 36 37 37
38 38 39 41 42 43 45 46 47 47
49 50 50 53 53 54 55 56 58 60
62 63 64 65 66 67 69 71 72 72
73 75 76 76 76 78 78 81 82 85
86 88 89 90 91 91 92 92 94 96
96 97 97 97 97 98 99 99 99 96
```

```
DO YOU WANT TO:
1. ADD A NODE
```

Listing 2 continued on page 106

Buy now and get **FREE Solid State Software™ Libraries.**

TI Programmable 59 — \$300*

\$40
or more value
1 FREE module†
with purchase
of a TI-58C



\$98
or more value
2 FREE modules† &
PPX Membership
with purchase
of a TI-59

TI Programmable 58C — \$130*

Choose from these.



TI Programmables lead the field in performance, quality and value. When you're choosing a programmable calculator consider: Power. Total software support. Flexibility. And price/performance. You'll discover a clear-cut answer. A TI Programmable 58C or 59.

The TI-59 has up to 960 program steps or up to 100 memories. Magnetic card read/write capability lets you record your own custom programs or those received from PPX (Professional Program Exchange).

The TI-58C features up to 480 program steps or 60 memories. And it has TI's Constant Memory™ feature that retains data and program information even when the calcula-

tor is turned off.

And now free modules give you that added productivity you need. From August 15 to October 31, 1980 is your special opportunity to purchase one of the world's most advanced programmable calculators. And get a minimum of \$40 worth of free software modules with a TI-58C. Or, when you buy a TI-59, get a minimum of \$80 worth of software modules and an \$18 one-year membership in PPX. This will allow you to select up to 3 programs (from over 2,500) written by professionals in your field.

Visit your TI retailer for more information, and let him help you select the TI Programmable and free software that's right for you.

- I've bought a TI-58C, send me my free module. Here is my first choice and an alternate.
- I've bought a TI-59, send me my two free modules and my membership (which entitles me to select three programs from the source catalog at no charge). Here are my module choices and an alternate.

1. _____ 2. _____

3. _____
Send to: TI Library Offer, P.O. Box 1984, Lubbock, TX 79408.

Return this coupon: (1) with customer information card (packed in box), (2) a dated copy of proof of purchase, between Aug 15 and Oct 31, 1980 — items must be post-marked by Nov 7, 1980.

Name _____
Address _____
City _____ State _____ Zip _____ BY _____

Calculator Serial Number (from back of unit)
Please allow 30 days for delivery. Offer void where prohibited. Offer good in U.S. only.
TI reserves the right to substitute modules.

†U.S. suggested retail for all Libraries is \$40, except Farming, \$55, and Pool Water Analysis, \$45.
**For use with TI-59 only



Texas Instruments technology — bringing affordable electronics to your fingertips.

TEXAS INSTRUMENTS
INCORPORATED

*US suggested retail price.
© 1980 Texas Instruments Incorporated

Circle 69 on inquiry card.

SPECIALS

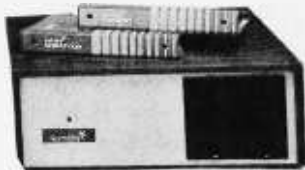

NORTH STAR HORIZON:

HRZ-2-32K-DD-ASM.....\$2275
 HRZ-2-32K-Q-ASM.....\$2675
 NORTHWORD DQ.....\$ 295
 MAIL MANAGER.....\$ 235
 INFO-MANAGER.....\$ 365
 GENERAL LEGER.....\$ 775
 ACC. REC. OR ACC. PAY..\$ 445
 WORD STAR.....\$ 320

COMMODORE (PET):

2001 32K.....\$1090
 8032 (80 COLUMN SCREEN)\$1599
 2040 DUAL DRIVE.....\$1090
 8050 DUAL DRIVE (1MEG)..\$1499
 2022 TRACTOR PRINTER...\$ 749

APPLE II PLUS CALL FOR PRICE

ATARI 800.....\$ 849

TI 99/4 CONSOLE&MONITOR..\$ 989

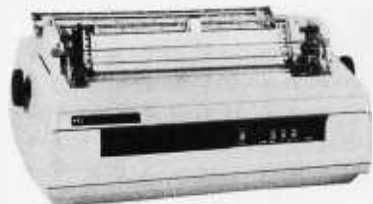

SPINWRITERS FROM NEC:

5510 RO OR 5530 RO \$2490
 5520 KSR SERIAL.....\$2790

CENTRONICS:

730.....\$ 659
 737-1 (LETTER QUALITY) \$ 879
 (WE CARRY THEIR COMPLETE LINE)
 PAPER TIGER 440G.....\$ 990

BASE II 800MST.....\$ 649

OTHER PRINTERS WE STOCK:

ANADIX, COMPRINT, EATON, EPSON,
 TELETYPE, TI, ETC-CALL FOR PRICE
 DISPLAY TERMINALS

HAZELTINE 1420.....\$ 949
 1500.....\$ 999
 (WE CARRY THEIR COMPLETE LINE)
 INTERTUBE II.....\$ 775

TELEVIDEO 914.....\$ 850

MOST ITEMS IN STOCK.
 PRICES SUBJECT TO CHANGE

MULTI-BUSINESS COMPUTER SYS.
 28 MARLBOROUGH STREET
 PORTLAND, CONN. 06480

(203)342-2747 TWX 710-428-6345
 M-F 9-6 SAT.9:30-3:00

Listing 2 continued:

2. DELETE A NODE
3. LIST THE TREE
4. END

?4

Listing 3: Pascal program for sorting a binary tree. Due to the nature of the program, the binary tree does not need to be threaded; this simplifies most of the procedures and functions of the program. Program details are given in the text. This program, written to run on a Digital Equipment Corporation PDP-11/70, should run in UCSD Pascal without modification.

```

program tree (input,output);
const nul =0;
      n=20;
      n1=10;

var top,p,parent,value,node,root,r:integer;
    full,found,fulltree,empty,quit,emptytree,insert : boolean;
    stack :array [1..n] of integer;
    l,r,data : array [1..n1] of integer;

procedure initstack;
begin
  begin
    full:=false;
    empty:=true;
    top:=n;
  end;
end;

procedure push(p:integer);
begin
  empty:=false;
  if not full then
    begin
      stack[top]:=p;
      top:=top-1;
      if top=0 then full:=true;
    end
  else
    begin
      writeln ('stack overflow !!!');
      quit:=true;
    end;
  end;
end;

function pop:integer;
begin
  full:=false;
  if not empty then
    begin
      top:=top+1;
      pop:=stack[top];
      if top=n then empty:=true
      else;
    end
  else;
end;

procedure moveleft;
begin
  if not full then
    repeat
      begin
        push(p);
        p:=l[r];
      end
    until (p=nul) or full
  else
    writeln ('overflow stack');
  end;
end;

procedure moveright;
begin
  repeat
    begin
      p:=pop;
      writeln (data[p]);
    end
  until (r[p]<>nul) or empty;
end;

```

Listing 3 continued on page 108

ENHANCED 'TINY' PASCAL

We still call it 'Tiny' but it's bigger and better than ever! This is the Famous Chung/Yuen 'Tiny' Pascal with more features including recursive procedures/functions & disk I/O.

'Tiny' Pascal is fast. Programs execute up to ten times faster than similar BASIC programs.

SOURCE TOO! We still distribute source, in 'Tiny' Pascal, on each discette sold. You can even recompile the compiler, add features or just gain insight into compiler construction.

'Tiny' Pascal is perfect for writing text processors, real time control systems, virtually any application which requires high speed. Requires: 36K CP/M. Supplied with complete user manual and source on discette: \$85.00 Manual alone \$10.00

StackWork's FORTH

A full, extended FORTH interpreter/compiler produces COMPACT, ROMABLE code. As fast as compiled FORTRAN, as easy to use as interactive BASIC.

SELF COMPILING: Includes every line of source code necessary to recompile itself.

EXTENSIBLE: Adds functions at will.

Z80 or 8080 ASSEMBLER included

Single license, OEM licensing available

Please specify CPU type: Z80 or 8080

Requires: 32K CP/M.

Supplied with extensive user manual and tutorial: \$150.00

Documentation alone: \$25.00

Protect your software investment by buying source! Prevent obsolescence, create custom versions, or use our systems as sources for 'library functions.'

The source code for all our programs, including the ones on this page, is available from us, either at additional cost, or if noted, included in the price. The programs on this page are distributed with machine readable source at no additional cost.

SUPERSOFT

Your Source for SOURCE

TFS — Text Formatting System

An extremely powerful formatter. More than 50 commands. Supports all major features including:

- left & right margin justification
- user defined macros
- dynamic insertion from disk file
- underlining and backspace

TFS lets you make multiple copies of any text. For example: Personalized form letters complete with name & address & other insertions from a disk file. Text is not limited to the size of RAM making TFS perfect for reports or any big job.

Text is entered using CP/M standard editor or most any CP/M compatible editor. TFS will link completely with Super-M-List making personalized form letters easy.

Requires: 24K CP/M

Source to TFS in 8080 assembler (can be assembled using standard CP/M assembler) plus user manual: \$250.00.

Object code only with user manual: \$85.00

Manual alone: \$20.00

TERM

A complete intercommunications package for linking your computer to other computers. Link either to other CP/M computers or to large timesharing systems. TERM is comparable to other systems but costs less, delivers more and source is provided on discette!

With TERM you can send and receive ASCII and Hex files (COM too, with included conversion program) with any other CP/M computer which has TERM or compatible package. Allows real time communication between users on separate systems as well as acting as timesharing terminal.

- Engage/disengage printer
- error checking and auto retry
- terminal mode for timesharing between systems
- conversational mode
- send files
- receive files

Requires: 32K CP/M.

Supplied with user manual and 8080 source code: \$110.00

Manual alone: \$15.00



CP/M Formats: 8" soft sectored, 5" Northstar, 5" Micropolis Mod II, Vector MZ

*CP/M REGISTERED TRADEMARK DIGITAL RESEARCH

SUPERSOFT ASSOCIATES • P.O. BOX 1628 • CHAMPAIGN, IL 61820
(217) 359-2112

MTI stocks 'em all for faster delivery.

VIDEO TERMINALS

VT100 DECscope.....	\$ 1895
VT132 DECscope.....	2295
ADM-3A (dumb terminal)	*
ADM-3A+ (dumb terminal)	*
ADM-31 (2 page buffer)	*
ADM-42 (8 page buffer avail.)	*
1410 (Hazeltine dumb terminal)	825
1420 (dumb terminal)	895
1421 (Consul 580 & ADM-3A comp.)....	895
1500 (dumb terminal)	1045
1510 (buffered)	1145
1520 (buffered printer port)	1395
1552 (VT-52 compatible)	1350

300 BAUD TELEPRINTERS

LA34-DA DECwriter IV	1045
LA34-AA DECwriter IV	1295
Teletype 4310	1085
Teletype 4320	1225
Diablo 630 RO	2295
Diablo 1640 RO	3085
Diablo 1640 KSR	3285
Diablo 1650 RO	3185
Diablo 1650 KSR	3385
TI 743 (portable)	1190
TI 745 (portable/built-in coupler)	1585
TI 763 (portable/bubble memory)	2690
TI 765 (port/bubble mem/b-i coupler) .	2895

600 BAUD TELEPRINTERS

TI 825 RO impact	1565
TI 825 KSR impact	1645
TI 825 RO Pkg.	1750
TI 825 KSR Pkg.	1895

1200 BAUD TELEPRINTERS

LA120-AA DECwriter III (forms pkg.)	2245
LA180 DECprinter I	2195
TI 783 (portable)	1745
TI 785 (port/built-in coupler)	2395
TI 787 (port/internal modem)	2845
TI 810 RO impact	1800
TI 810 RO Pkg.	2047
TI 820 KSR impact	2057
TI 820 KSR Pkg.	2275
TI 820 RO	1895
TI 820 RO Pkg.	2047

2400 BAUD

Dataproducts M200 (2400 baud)	2595
-------------------------------------	------

DATAPRODUCTS LINE PRINTERS

8300 (300LPM band)	5535
8600 (600LPM band)	6861
2230 (300LPM drum)	7723
2260 (600LPM drum)	9614
2290 (900LPM drum)	12655

ACOUSTIC COUPLERS

A/J A242-A (300 baud orig.)	295
A/J 247 (300 baud orig.)	315
A/J AD342 (300 baud orig./ans.)	395
A/J 1234 (Vadic compatible)	895
A/J 1245 (300/1200 Bell comp.)	695

MODEMS

GDC 103A3 (300 baud Bell)	395
GDC 202S/T (1200 baud Bell)	565
GDC 212-A (300/1200 baud Bell)	850
A/J 1256 (Vadic compatible)	825

CASSETTE STORAGE SYSTEMS

Techtran 816 (store/forward)	1050
Techtran 817 (store/for/speed up)	1295
Techtran 818 (editing)	1795
Techtran 822 (dual)	2295
MFE 5000 (editing)	1495

FLOPPY DISK SYSTEMS

Techtran 950 (store/forward)	1395
Techtran 951 (editing)	1995

*Please call for quote.



Applications Specialists & Distributors
Great Neck, New York/Cleveland, Ohio.

N.Y.: 516/482-3500 & 212/895-7177
800/645-8016, Ohio: 216/464-6688

Listing 3 continued:

```

if (rP[P]=nul) and empty then quit:=true else
  begin
    P:=rP[P];
    moveleft;
  end;
end;

Procedure scan;
begin
  if not emptytree then begin
    quit:=false;
    P:=root;
    moveleft;
    while not quit do moverisht;
  end
  else writeln ('tree empty');
end;

Procedure initree;
begin
  emptytree:=true;
  root:=nul;
  fulltree:=false;
  for P:=1 to n1 do
    begin
      lP[P]:=nul;
      rP[P]:=nul;
    end;
end;

Procedure addnode(a:integer);
begin
  if emptytree then
    begin
      root:=a;
      emptytree:=false;
    end
  else
    begin
      P:=root;
      insert:=false;
      while not insert do
        begin
          if data[a]<=data[P] then
            begin
              if lP[P]=nul then
                begin
                  insert:=true;
                  lP[P]:=a;
                end
              else P:=lP[P];
            end
          else
            begin
              if rP[P]=nul then
                begin
                  insert:=true;
                  rP[P]:=a;
                end
              else P:=rP[P];
            end;
          end;
        end;
      end;
end;

end;
end;

Procedure search;
begin
  node:=0;
  found:=false;
  parent:=0;
  P:=root;
  while not found do
    begin
      if value=data[P] then
        begin
          found:=true;
          node:=P;
        end
      else
        begin
          if value < data[P] then
            if lP[P]<>nul then
              begin
                parent:=P;
                P:=lP[P];
              end
            else
              begin
                parent:=P;
                P:=rP[P];
              end
            end;
        end;
    end;
end;
end;

```

Text continued from page 102:

and 8 are highlighted for clarity. Note that only one node in the tree, the rightmost node (containing the largest entry in the sorted list), has a right pointer with a value of zero. This is a signal that the end of the tree has been reached.

Let us look at the process of reading the sorted numbers from the tree in figure 7. We enter the tree at the root node, which contains the integer 15. We move left down the tree until we encounter the first node with a left pointer of zero (which we

Text continued on page 250

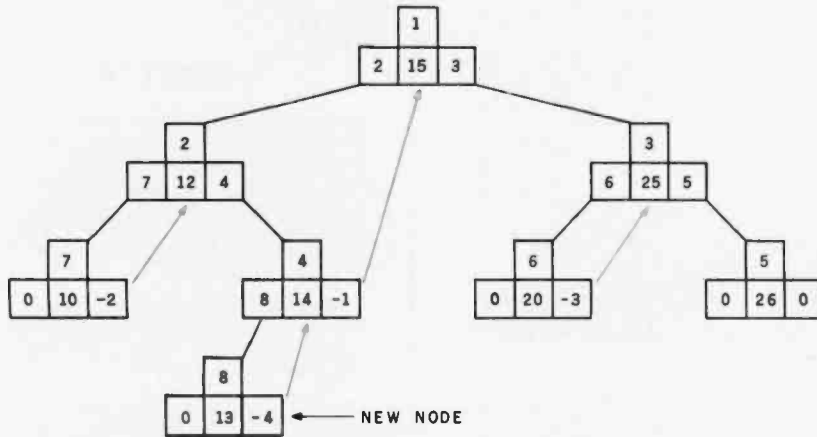

Figure 8: Addition of a node to a binary tree. Using the notation of figure 7, this figure shows the addition of node 8, which has a key value of 13. The left pointer of node 8 is 0, denoting no left child. The right pointer of node 8 is -4, denoting two things: first, that node 8 has no right child; and second, that the node whose key follows the key of node 8 in the sorted-key sequence is node 4. The upward right pointers are shown here in color.

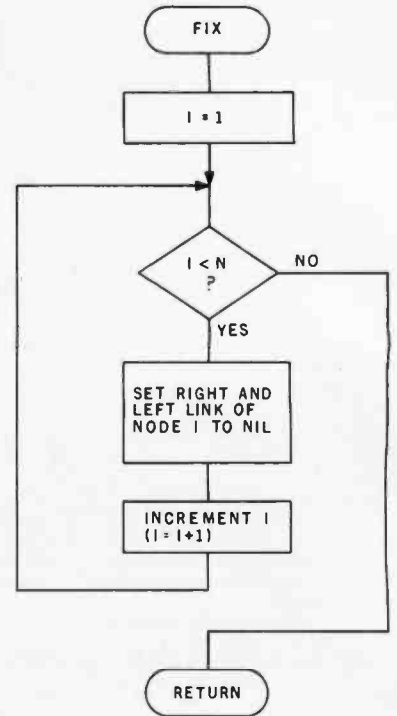
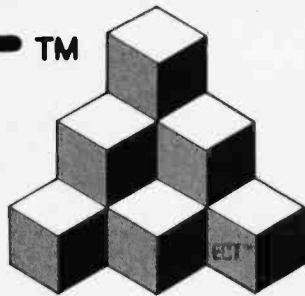

Figure 9: Flowchart for subroutine FIX. This subroutine initializes storage space in a computer for later use as a threaded binary tree.

ECTTM



Building Blocks for Microcomputer Systems, Dedicated Controllers and Test Equipment.

5th Anniversary Sale

SAVE 10% ON ALL ECT PRODUCTS INCLUDING THESE POPULAR ITEMS

Offer expires September 30, 1980

R²I/O
S-100 ROM,
RAM & I/O
BOARD

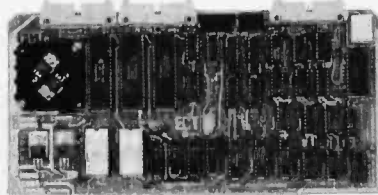

RM-10
S-100
RACK MOUNT
CARD CAGE

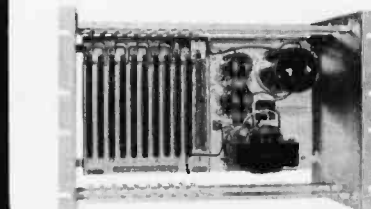

Specializing in Quality Microcomputer Hardware
Industrial • Educational • Small Business • Personal

Card Cages, Power Supplies, Mainframes, CPU's, Memory, I/O, OEM Variations

ECTTM

ELECTRONIC CONTROL TECHNOLOGY (201) 686-8080

763 Ramsey Ave., Hillside, NJ 07205

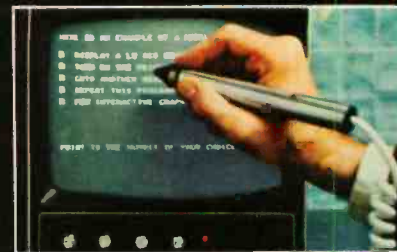
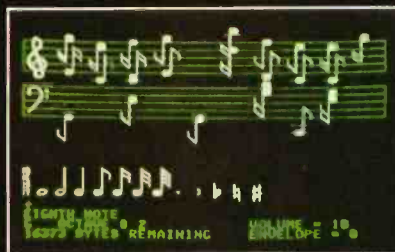
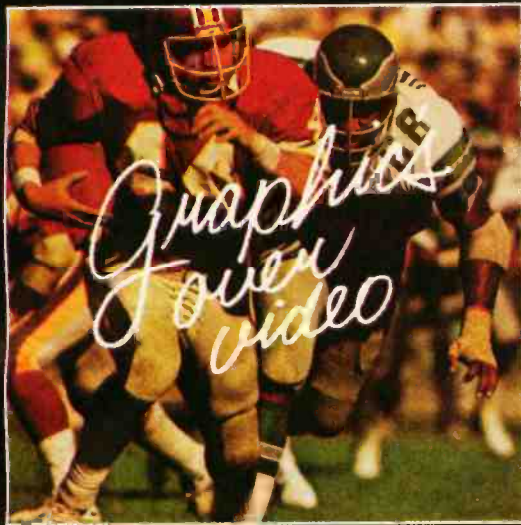

APPLE POWER

VIDEO DATA PROCESSOR

Called the VDP, comes complete with 16K memory, its own color text and graphics generator and is designed to superimpose its graphics and text over incoming video signals from video tape, video disk, TV camera, Apple Video or Broadcast • Color text and graphics on an independent screen • Video titling or video interactive training uses. It's like your own TV station, works with OUR Light Pen too! Available directly from Symtec at \$1500.00.

SPECIAL PROBLEMS

We can help. Symtec does custom engineering, fabrication, hardware and software design for microprocessor. Beginning at \$1500, these services can solve your custom application needs for industrial, scientific, medical, engineering or personal uses.

SUPER SOUND GENERATOR

Apple Music Power with a plus • 3 voices, 6 in stereo version • Noise generator • Independent control of volume, envelope and shape by channel • Full power, easy to use software to compose, edit, play in hi-res graphics, PLUS, input and output ports allow extra uses: • Printer interface • Remote ASCII or music keyboard interface • and, optional BSR X-10 Adapter is available. Suggested retail \$159.95 mono, \$259.95 stereo.

SYMTEC X-10 CONTROL

Now for the Apple II, a low cost control to link your computer to the BSR X-10 Home Control System. Control your home or office lighting and appliances • Energy management • Display lighting Security and more. Suggested retail \$49.95.

LIGHT PEN

A professional quality, full feature light pen for the Apple II Computer • Hi-resolution — draw on the screen • X, Y and sensitivity adjustments — fits any standard TV • Sync adjustment for remote video source • Touch switch sets interface flag • Rugged metal case • Recommended by Apple. Complete, ready to go, the Symtec Light Pen is provided with software and documentation in Basic, Applesoft and machine code. Muse's Pilot II Language using the Symtec Light Pen is also available. The Light Pen is useable for graphics, games, education, exhibits, freedom from the keyboard. Suggested retail \$249.95.

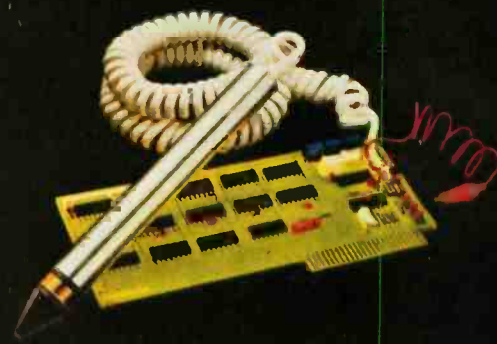

See your Apple Dealer for a demonstration of the Symtec Light Pen, Supersound Generator or Symtec Apple X-10 Control. Other products and services are available directly from Symtec. Apple is a trade mark of Apple Computer Inc. BSR System X-10 is a trade mark of BSR Ltd. Muse is the trade mark of Micro Users Software Exchange, Inc.



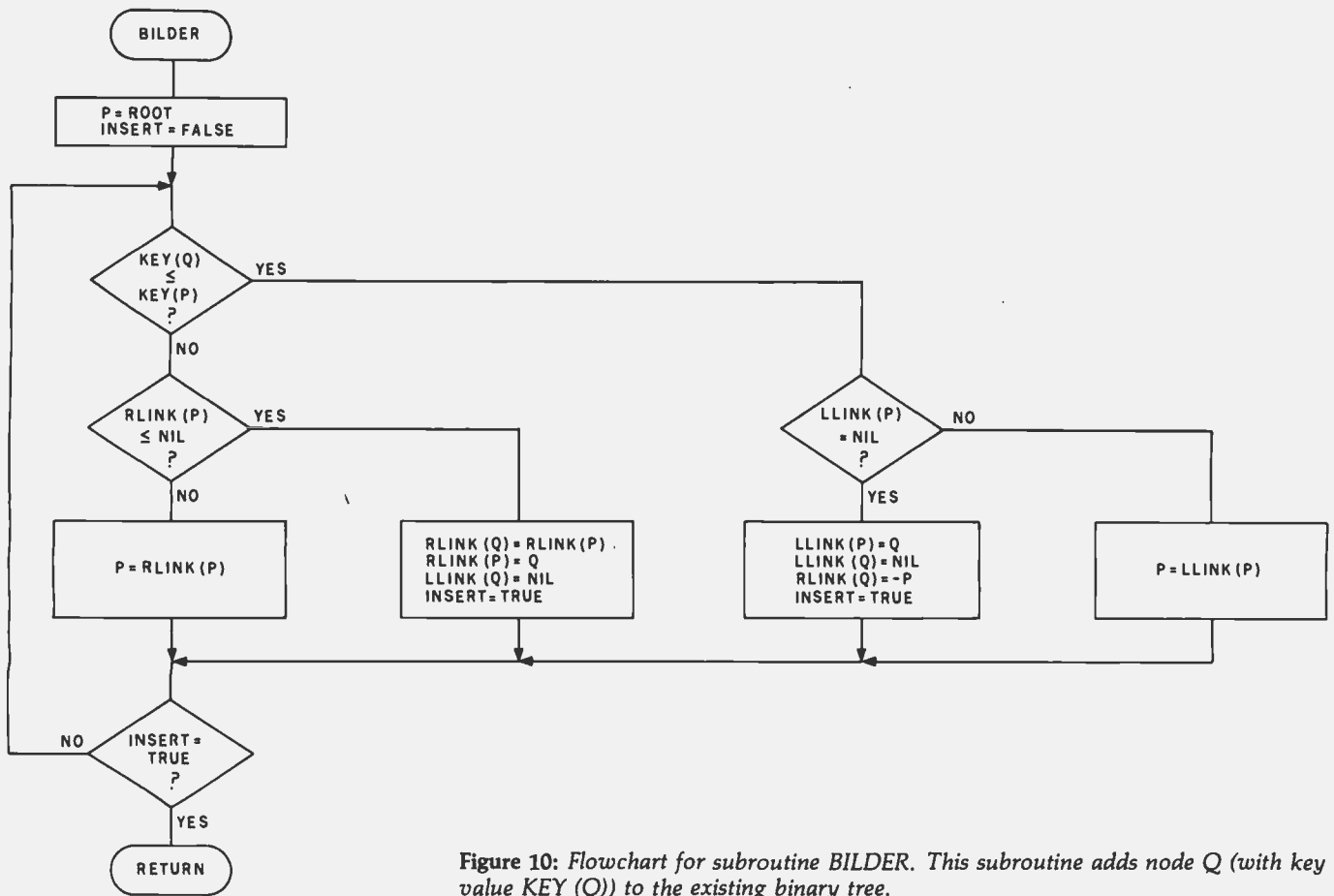

Figure 10: Flowchart for subroutine BILDER. This subroutine adds node Q (with key value KEY(Q)) to the existing binary tree.

Anti-Static Dust Covers

Protect your computer and accessories.

- Anti-static vinyl helps prevent static from damaging sensitive components and causing faulty operation.
- Double-fold stitching will not rip out and is unmatched for strength and long life.
- Heavy gauge textured vinyl blends with any decor and folds easily for convenient storage.
- Over 1000 custom designs guaranteed to fit precisely.
- 100% satisfaction guarantee means we stand behind our product.

Yes, there are differences in Dust Covers. Differences which can be vitally important to the proper functioning of your system.

At Cover Craft we've manufactured the highest quality Dust Covers for the electronics industry for more than six years. We've been selected by major equipment manufacturers to make covers for their products. Our covers are in use in every state and in more than 50 countries. We know what it takes!



THE BEST
DUST COVERS
AT ANY PRICE

MOST PRICED
\$7.95 to \$11.95
PLUS POSTAGE AND
HANDLING
VISA-MasterCharge

So visit your dealer or contact Cover Craft for our latest catalog and list of over 200 dealers.

COVER CRAFT
P.O. BOX 555 • AMHERST, NH 03031 • (603) 889-6811

WHEN OPPORTUNITY KNOCKS ...

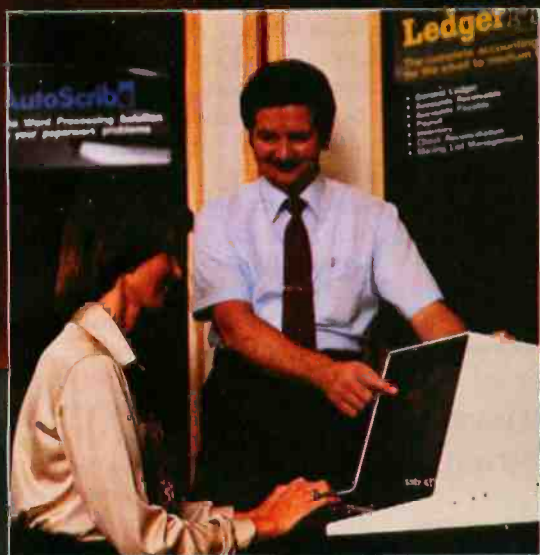

Open the door, and experience the dream. Your own business, the one you've always yearned for. No more limits on your creativity or earning potential. No more working for someone else.

If you're a successful computer professional and have access to some capital, chances are you could own a MicroAge Computer Store. MicroAge Computer Stores are built around a whole new concept of what a computer store should be. Designed to provide solutions, not just sell hardware.

MicroAge Computer Stores are firmly positioned in the business and professional marketplace. And as a MicroAge Computer Store owner, you'll be backed by one of the acknowledged leaders, industry pioneers in microcomputing. Contact the Director of Franchising today to receive a complete Franchise Information Package free of charge and at no obligation. Opportunity is knocking... you'll see what we mean.

MicroAge
COMPUTER STORE

1425 W. 12th Place • Tempe, AZ 85281 • (602) 967-1421

An Information-Retrieval System

Robert W Elmore
4202 Vassar
Dearborn Heights MI 48125

Krishna K Agarwal
Department of Computer Science
Wayne State University
Detroit MI 48202

Much has been said in recent years regarding the reduction in size and increase in the capabilities of computing equipment. Manufacturers appear to be flooding the marketplace with ever more and more sophisticated small systems. One result of this expansion is that small computers of adequate capability are now within the financial reach of smaller businesses which previously could not justify the expense associated with the use of larger systems.

Unfortunately, the prospective buyer of such hardware may still be faced with a serious problem. He must, quite probably, pay someone to develop the software required by his particular application. This expense may be substantial since software development costs have taken a trend opposite to the cost of hardware.

An information-retrieval system is a fairly common software need. This usually must be tailored to a very specific application—an employee file or an inventory file, for example. Further, it is frequently the case that the user of the information-retrieval system is not a programmer, and may find that the system is confusing and therefore difficult to use.

The preceding provides the motivation for the concepts and software described in this article. In writing this article, we have kept in mind four goals:

- to present a method of organizing data such that its manipulation by the algorithms presented is, to a high degree, independent of the data itself;
- to describe a high-level query-answering language that may be used by nonprogrammers with minimal difficulty;
- to demonstrate the feasibility of implementing such an information-retrieval system on a small computer system; and
- to show that such an implementation can be relatively system-independent and therefore transportable.

Frequently, the user of the information-retrieval system is not a programmer.

An attempt has been made to make the system as easy to use as possible. This has been facilitated through the use of highly interactive programming. Although the user must give careful consideration as to how he wishes to use his data (since this will affect its organization), the program that creates and organizes files simply prompts the user for information which he should have already determined, eg: file size and record length. Data input requires little more than the data itself; the user is prompted for the values to be placed in a

record. Formatting of the data for storage is accomplished through the use of information supplied when the file was created.

The query-answering language has been modeled after the PL/I structure declaration. It may be entered in free format, and its syntax has relatively few restrictions. We believe that this form is well suited for use by persons with little or no programming experience.

Implementation of the information-retrieval system described was accomplished using a Hewlett-Packard System 1000 minicomputer with the RTE-III operating system. All output examples were generated on this system, and all programs were written in Hewlett-Packard's implementation of FORTRAN IV. Since this language enjoys such widespread use, system dependencies are largely confined to calls to file-management routines, and modifications necessary to adapt the software to another system should be relatively minor.

Defining the File

The key to the manipulation of data bases in the manner described is the organization of the data itself. The structure used is that of a *flat file*, which is self-defining. A flat file may be thought of as a simple two-dimensional array of data elements. This organization is made self-defining by storing all necessary descriptive infor-

MICROWORLD[®]

MAIL ORDER SPECIALS

FREE FREIGHT • CALL TOLL FREE: 1-800-528-1418

TI 99/4 HOME COMPUTER



The TI 99/4 from MicroWorld ... now with FREE speech synthesizer and FREE speech editor! But that's not all ... TI has a special limited-time offer if you buy the 99/4 now! A \$100 cash rebate PLUS more than \$100 worth of FREE Command Module Software! You can't afford to miss out on these spectacular savings! Offer expires October 31, so act fast!

The 99/4 is packed with features ... superior sound, 16-color graphics, powerful TI BASIC and a total memory capacity of 72K!

MicroWorld carries all the peripherals and accessories for the 99/4, too! In addition to the 99/4 console, we have 13" color monitors designed by Zenith especially for the 99/4, cassette cables, speech synthesizer (which you get free!), modem, 32" column printer, disk drives and controller, joysticks, and more! Low price includes 13" color monitor and TI BASIC ... act now and SAVE!

\$949.00



OKIDATA MICROLINE 80

Compact, low-cost 80 cps printer; 9x7 matrix, friction or pin feed! 132 col. w/compressed print, graphics, and more! Tractor feed optional.

CALL FOR PRICE!



CENTRONICS 737

Low-cost 50-90 cps RO printer. Proportional spacing, generates full ASCII, prints sub- and superscripts, underline!

CALL FOR PRICE!



ZENITH-HEATH Z-89 ALL-IN-ONE COMPUTER

FREE HDOS and 48K memory! Built-in minifloppy drives, smart terminal with 25 x 80 display!

CALL FOR PRICE!



LIVERMORE STAR

Exclusive triple seal allows for superior acoustic isolation! 0 to 300 baud, locks into standard headset. Full duplex/test/half duplex modes.

CALL FOR PRICE!



TELEVIDEO 912

Low-cost terminal loaded with features; full editing capabilities, tabbing, numeric pad, baud rates to 9,600 and much more!

CALL FOR PRICE!

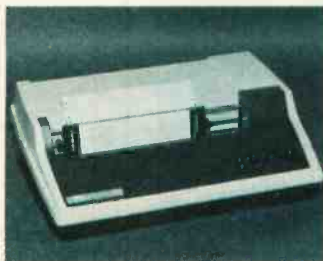

TI 810 FULLY LOADED!

RO printer; low price includes full ASCII, vertical forms control, compressed print, 150 cps, RS232, tractors, 3" to 15" form width, bidirectional printing!

CALL FOR PRICE!



ATARI 800

FREE joysticks and FREE Star Raiders game! System features expandable memory, advanced components and comprehensive software library ... a "timeless" home computer! Plus, all peripherals for the Atari 800 are available from MicroWorld!

CALL FOR SPECIAL PRICE!

mation about data in the file in a location within the file itself. Since this location is fixed, programs that access the file can determine the location and nature of file data by referencing this descriptive information. No input from a user regarding the physical organization of a file is needed once that file has been defined.

Figure 1a illustrates the organization of descriptive information and the data itself within a self-defining file. Region 1 contains five fields (this

will be true for any file) as listed in table 1. Region 2 contains aggregates (the number of which is defined in field 4 of region 1) consisting of four pieces of information, as listed in table 2. Region 3 and those following contain the records of the file. The fields are concatenated as shown, and their order corresponds to that of the descriptive aggregates stored in region 2.

To better illustrate this file organization, an example of a specific

application will be considered in detail. The application is that of a personnel data base that is used to store the job applications submitted by prospective employees. Records such as this would typically be maintained by a manual filing system, which might be large and restricted to one pattern of organization (eg: filed alphabetically by name). We will demonstrate that, with a minimal amount of preparation, an easily maintained data base can be constructed for this information. This will allow the user the capability to search for and quickly locate records satisfying a great number of different criteria.

Figure 1b illustrates one possible record description for this data base. Each record consists of twelve fields, each of which is described in the figure. The type of each field (alphanumeric or digital) and its length in characters are shown. The total record length is 130 characters. It should be emphasized that the field and record lengths are, to a certain extent, arbitrary. The record could have been defined with a different number of fields and different field and record lengths.

Listing 1a shows regions 1 and 2, as well as the file data for the personnel data base in an unformatted form (ie: just as it is stored), which was created using the information-retrieval system. Listing 1b is a partial listing of the file data formatted in a readable form. This is simply accomplished by making use of the field positions and length information stored in region 2.

Text continued on page 126

1.	Date of creation: the date on which the file was created.
2.	Date of last update: each time a record is added to or deleted from a file, the current date is inserted.
3.	First free region: this is a pointer to the next location that may be used for inserting a new record. Since records are stored sequentially and kept compacted, this pointer will be incremented for each addition and decremented for each deletion of a record.
4.	Number of tags: this defines the number of fields within a record, which is also the number of field-description aggregates contained in region 2 (see table 2).
5.	Record length: the length of records (fixed) contained in the file.

Table 1: Descriptive information for a self-defining file. The five fields listed here make up region 1 of a self-defining file. Any program that wants to reference or update information in this file must first read regions 1 and 2 in order to know the organization of the file.

COPYROM extends the power of your Apple II with machine resident programs to duplicate diskettes and provide a more complete "CATALOG"—without loading programs from disk! No fumbling for diskettes with COPY programs or special catalog information.

COPYROM installs on our ROM-PLUS+ card and is fully compatible with Keyboard Filter. Operates under all Apple DOS versions and is compatible with all BASICS. COPYROM is self-documenting and user input is clearly prompted.

Command functions:

- *Identify disk volume number and amount of unused sectors on diskette.
- *Determine active drive or change active drive.
- *"Catalog" gives name of file, length expressed as number of sectors, file type, and for binary files—stored load address and length expressed as bytes—either in decimal or hexadecimal.
- *Copy diskettes either SINGLE or DUAL drive, single or dual controller, thirteen or sixteen sector and non-VIIOC diskettes.

Mountain Hardware
LEADERSHIP IN COMPUTER PERIPHERALS
A Division of Mountain Computer, Inc.
300 Harvey West Blvd., Santa Cruz, CA 95060
(408) 429-6600

1.	Tag; a short character identifier for the <i>i</i> th field in the records.
2.	Type: a "flag" that indicates whether the <i>i</i> th field contains an alphanumeric or digital value.
3.	Length: the length of the <i>i</i> th field within a record.
4.	Starting position: the location within a record which marks the beginning of the <i>i</i> th field.

Table 2: Descriptive information for field definition. The four fields here are repeated for each field in the record. Together, they make up region 2 of a self-defining file. The four fields here completely describe a field within the defined record.

4th ANNUAL NATIONAL SMALL COMPUTER SHOW

A NEW WORLD OF SMALL COMPUTERS IS AT YOUR FINGERTIPS THIS FALL

When we say "fingertips" we mean just that: a hands-on-inspection opportunity for you to try the small computers and systems that will write the history of microprocessing in the 1980's.

Manufacturers will fill over 30,000 square feet with computers, software and peripherals. Amazing strides in technology are reflected in exhibits and lecture series.

New hardware and software for business, education, the sciences and professions, graphics and personal use are being gathered for the largest and most beautifully presented National Small Computer Show ever produced.

As always, the show contains attractions for the seasoned computer professional, as well as those who wish an introduction to the exciting world of small computers for business, professional or personal use. In just a short time, you can discuss your interest with many industry leaders, vendors, technologists, and our expert lecturers.

Registration fee is only \$10 per day, and all registrants have free access to the hourly lectures.

LECTURE PROGRAM

A schedule of free lectures is available to all visitors. Lectures run about 50 minutes each, including, in most cases, some time for questions from the floor. Some topics are given twice, and, in some cases, topics of related interest are given on the same day for the visitor's convenience. (Program is subject to change without notice, but lectures will be posted daily in the show lobby.)

THURSDAY, OCTOBER 30

- Noon Introduction to Small Systems for Business, Stan Veit, Associated Computer Industries
- Noon Mailing Lists: Several Directions, Dr. Norman I. Agin, Mathtech, Inc.
- 1 p.m. Selecting a Small Computer for Business, David Benevy, Computer Mart of New Jersey

- 1 p.m. Evaluating and Improving Your Computer's Performance, Philip Grossman, Raytheon Co.
- 2 p.m. Law Office Systems Aspects of Word Processing, Bernard Stiernin
- 2 p.m. Future Smart Machines: 2000 A.D. and Beyond, Dr. Earl Joseph, Sperry Univac
- 3 p.m. Computer Contracts—Facing the issues, Alan C. Verbit, Verbit and Company
- 3 p.m. Accounts Receivable/Accounts Payable/General Ledger
- 4 p.m. Using FORTRAN on a Microcomputer, Richard A. Zeillin
- 4 p.m. Investment Analysis of Stocks and Commodities on a Microcomputer, Fred Cohen, Shearson Loeb Rhoades, Inc.

FRIDAY, OCTOBER 31

- Noon Introduction to Small Systems for Business, Stan Veit, Associated Computer Industries
- Noon BASIC Programming, Michael Mulcahey, Worcester State College
- 1 p.m. Selecting a Small Computer for Business, David Benevy, Computer Mart of New Jersey
- 1 p.m. Videoprints: Full-Color, Low-Cost, Hard-Copy Computer Graphics, Warren Sullivan, Image Resource Corp.
- 2 p.m. Mailing Lists: Several Directions, Dr. Norman I. Agin, Mathtech, Inc.
- 2 p.m. Business Applications Software Development via Data Base Management, Dr. Andrew Whinston, Micro Data Base Systems
- 3 p.m. Application of PASCAL to Small Systems for Business, Panel, Stan Veit, Moderator, Associated Computer Systems
- 3 p.m. Investment Analysis of Stocks and Commodities on a Microcomputer, Fred Cohen, Shearson Loeb Rhoades, Inc.
- 4 p.m. Advantages of Distributed Processing and Multi-Processing, John Steefel, Q1 Corp.
- 4 p.m. To be assigned.

SATURDAY, NOVEMBER 1

- Noon Educational Software: The Good, the Bad, the Ugly, Jo Ann Comito, S.U.N.Y. at Stony Brook

- Noon Introduction to Personal Computing, RCA—Solid State
- 1 p.m. Computer-Assisted Mathematics Courses, Dr. Frank Scalzo, Queensborough Community College
- 2 p.m. Artificial Intelligence Update, Prof. Peter Kugel, Boston College
- 2 p.m. Compiling and Retrieving Personal Medical Data, Dr. Derek Enlander, St. Luke's Hospital
- 2 p.m. The Present State of CP/M Compatible Software, Tony Gold, Lifeboat Associates
- 3 p.m. Introduction to File Processing, Prof. Peter Kugel, Boston College
- 3 p.m. Connecting the Computer to the Outside World, Prof. James Gips, Boston College
- 4 p.m. Educational Applications in the Home, David Ahl, "Creative Computing Magazine"
- 4 p.m. Household Applications—Same New, Dr. Dennis J. McGuire

SPECIAL SESSION: EXECUTIVE EDUCATION CONFERENCE FOR BUSY PEOPLE

This year, NSCS will present a special five-hour conference formulated as an intensive fast education for administrators and executives. The aim is to show the conferee how to cope with computers in business. No prior knowledge of computers is needed. The session will proceed on a step-by-step basis, covering computers, computer jargon, software systems, and peripherals. It will indicate how to assess computer requirements, how to talk to vendors, and how to make a system work efficiently, after you've bought it wisely.

An executive education session will be given daily for four days, Oct. 29 through Nov. 1, in the New York Coliseum. Each session is limited in attendance, and reservation must be made. Registration is on a first-come, first-served basis. Fee is \$200, and includes three-day admission to the National Small Computer Show, coffee break, and workbook materials. Please write or call the show office for session outline and registration form. (Do not use registration form in this ad for special session.)

NATIONAL SMALL COMPUTER SHOW

110 Charlotte Place
Englewood Cliffs, N.J. 07632 (201) 569-8542

REGISTRATION FOR AMERICA'S BIGGEST SMALL COMPUTER SHOW

Please register me for the 4th Annual National Small Computer Show, Oct. 30 - Nov. 1, 1980 New York Coliseum.

NAME _____

BUSINESS TITLE (If Any) _____

COMPANY (If Any) _____

TELEPHONE _____

ADDRESS _____

ZIP _____

Your company's primary business. Check one.

- | | | |
|--|---|--|
| <input type="checkbox"/> 1 Accounting Firm | <input type="checkbox"/> 9 Engineering | <input type="checkbox"/> 18 Personnel Agency |
| <input type="checkbox"/> 2 Advertising/Marketing | <input type="checkbox"/> 10 Entertainment/News | <input type="checkbox"/> 19 Professional Services |
| <input type="checkbox"/> 3 Banking/Insurance/
Real Estate/Credit/Securities | <input type="checkbox"/> 11 Government/Military | <input type="checkbox"/> 20 Research/Development |
| <input type="checkbox"/> 4 Communications | <input type="checkbox"/> 12 Hospital | <input type="checkbox"/> 21 Transportation (All) |
| <input type="checkbox"/> 5 Computer Consultant | <input type="checkbox"/> 13 Hotel | <input type="checkbox"/> 22 Utility |
| <input type="checkbox"/> 6 Computer Dealer/Dist. | <input type="checkbox"/> 14 Industrial Design | <input type="checkbox"/> 23 Wholesale/Retail Sales |
| <input type="checkbox"/> 7 Construction/Architecture | <input type="checkbox"/> 15 Law Office | <input type="checkbox"/> 24 Other (Please Specify) |
| <input type="checkbox"/> 8 Education | <input type="checkbox"/> 16 Management Consultant | |
| | <input type="checkbox"/> 17 Manufacturing | |

Check your primary job function.

- | | | |
|--|--|--|
| <input type="checkbox"/> 1 Account Executive | <input type="checkbox"/> 9 Designer (All) | <input type="checkbox"/> 17 Salesperson (All) |
| <input type="checkbox"/> 2 Administrator | <input type="checkbox"/> 10 DP/VP Manager/Operator | <input type="checkbox"/> 18 Scientist |
| <input type="checkbox"/> 3 Bookkeeper | <input type="checkbox"/> 11 Doctor | <input type="checkbox"/> 19 Skilled Laborer |
| <input type="checkbox"/> 4 Chemist/Pharm | <input type="checkbox"/> 12 Engineer (All) | <input type="checkbox"/> 20 Student |
| <input type="checkbox"/> 5 Consultant | <input type="checkbox"/> 13 Lawyer | <input type="checkbox"/> 21 Teacher |
| <input type="checkbox"/> 6 Corporate Officer | <input type="checkbox"/> 14 Office Manager | <input type="checkbox"/> 22 Technician |
| <input type="checkbox"/> 7 CPA | <input type="checkbox"/> 15 Programmer | <input type="checkbox"/> 23 Other (Please Specify) |
| <input type="checkbox"/> 8 Creative Arts (All) | <input type="checkbox"/> 16 Purchasing | |

Your primary interest in computers (check only one) 1 Business, 2 Personal, 3 Both

- ONE DAY \$10 TWO DAYS \$20
 THREE DAYS \$30

Mail with payment of \$10 for each day you wish to attend. Use one form per person. Registration badge will be sent by mail in early October. Check or money order only.



Mail prior to October 10, 1980.
Foreign orders: October 1, 1980.
National Small Computer Show
110 Charlotte Place
Englewood Cliffs, NJ 07632
201-569-8542

REGION 1	DATE OF CREATION		DATE OF LAST UPDATE		FIRST FREE REGION		NUMBER OF TAGS		RECORD LENGTH	
REGION 2	TAG 1	TYPE	LENGTH	STARTING POSITION	---	TAG N	TYPE	LENGTH	STARTING POSITION	
REGION 3	FIELD 1		FIELD 2		---				FIELD N	

(a) GENERAL FILE ORGANIZATION

TYPE	D	A	A	A	A	D	A	A	A	A	D	D
	DATE	SURNAME	NAME	INITIAL	ADDRESS	PHONE	DEGREE	MAJOR	WORK INTEREST 1	WORK INTEREST 2	EXPERIENCE 1	EXPERIENCE 2
FIELD LENGTHS	8	10	10	2	28	8	4	16	20	20	2	2
	RECORD LENGTH 130											

- 1) DATE: DATE ON WHICH APPLICATION WAS SUBMITTED
- 2) SURNAME:
- 3) FIRST NAME: } 3 FIELDS COMPRISING THE APPLICANT'S NAME
- 4) INITIAL:
- 5) ADDRESS: ADDRESS OF APPLICANT
- 6) PHONE: TELEPHONE NUMBER OF APPLICANT
- 7) DEGREE: HIGHEST DEGREE EARNED (E.G. B.S.)
- 8) MAJOR: MAJOR FIELD OF STUDY (E.G. MATHEMATICS)
- 9) WORK INTEREST 1: PRIMARY AREA OF INTEREST (E.G. SALES)
- 10) WORK INTEREST 2: SECONDARY AREA OF INTEREST (E.G. PURCHASING)
- 11) EXPERIENCE 1: YEARS OF EXPERIENCE IN PRIMARY AREA OF INTEREST
- 12) EXPERIENCE 2: YEARS OF EXPERIENCE IN SECONDARY AREA OF INTEREST

(b) RECORD DESCRIPTION FOR A PERSONNEL DATA BASE

Figure 1: Organization and example of a self-defining file. Figure 1a illustrates the data organization of a self-defining file. Figure 1b presents the layout of a file record used in examples throughout this article.

New- POWER MODEM

T.M.

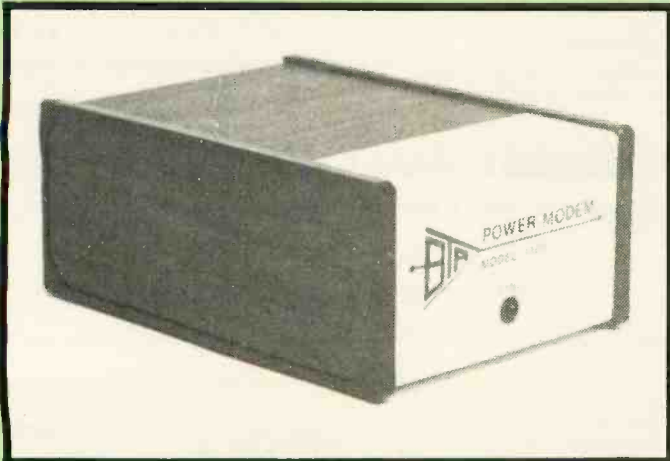

- RS 232 Communications over existing AC power lines.
- Easy installation - plug into AC receptacle.
- 110 or 300 BAUD rate - switch selectable.
- Full duplex operation.
- Multipoint network capability.
- Standard DB 25 I/O connector.

Order one per each communication point • \$139.00 each including shipping • C.O.D., check or money order.

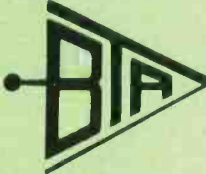

BAY TECHNICAL ASSOCIATES, inc.

Highway 603 • Bay St. Louis, MS. 39520
P.O. Box 387 (601) 467-8231

Now! North Star Application Software!

North Star now offers application software for use on the HORIZON! Now you have one reliable source for both hardware and software needs! The first packages available are:

NorthWord—

NorthWord is a simple-to-operate word processing system designed for use with the popular North Star HORIZON. NorthWord enables you to increase office efficiency and cut document typing time and cost. NorthWord incorporates the most sought-after word processing features: easy editing, on-screen text formatting, simultaneous document printing, and much more. NorthWord can be integrated with other North Star software packages to produce customized letters, labels and reports quickly and efficiently.

MailManager—

MailManager enables you to compile and maintain complete organized mailing lists. Lists are easily accessible and can be compiled with a great deal of flexibility. Entries, corrections and deletions are easily made. The North Star MailManager can print your list on individual envelopes, on mailing labels, or in compact summary form.

InfoManager—

InfoManager is a powerful list-oriented, data management system. It will accept up to 50 categories of information for each record and has the ability to select and sort before printing. The North Star InfoManager has power and flexibility for many applications: product inquiry, inventory, customer/client records, calendar reminders, and as an easy way to fill in often-used forms.

GeneralLedger—

General Ledger and Financial Reporting, two programs in one, maintains general ledger accounts based on such input as checks, bank deposits and journal entries, and uses the information in the general ledger to produce customized financial statements and financial reports.

NorthWord is the central building block for all the North Star application software to follow. Packages now being tested include other accounting and professional application packages. For more information or a demonstration, contact your local North Star dealer.

NorthStar 

North Star Computers, Inc.
1440 Fourth Street
Berkeley, CA 94710
(415) 527-6950
TWX/Telex 910-366-7001



While they were thinking hardware and software, we were thinking

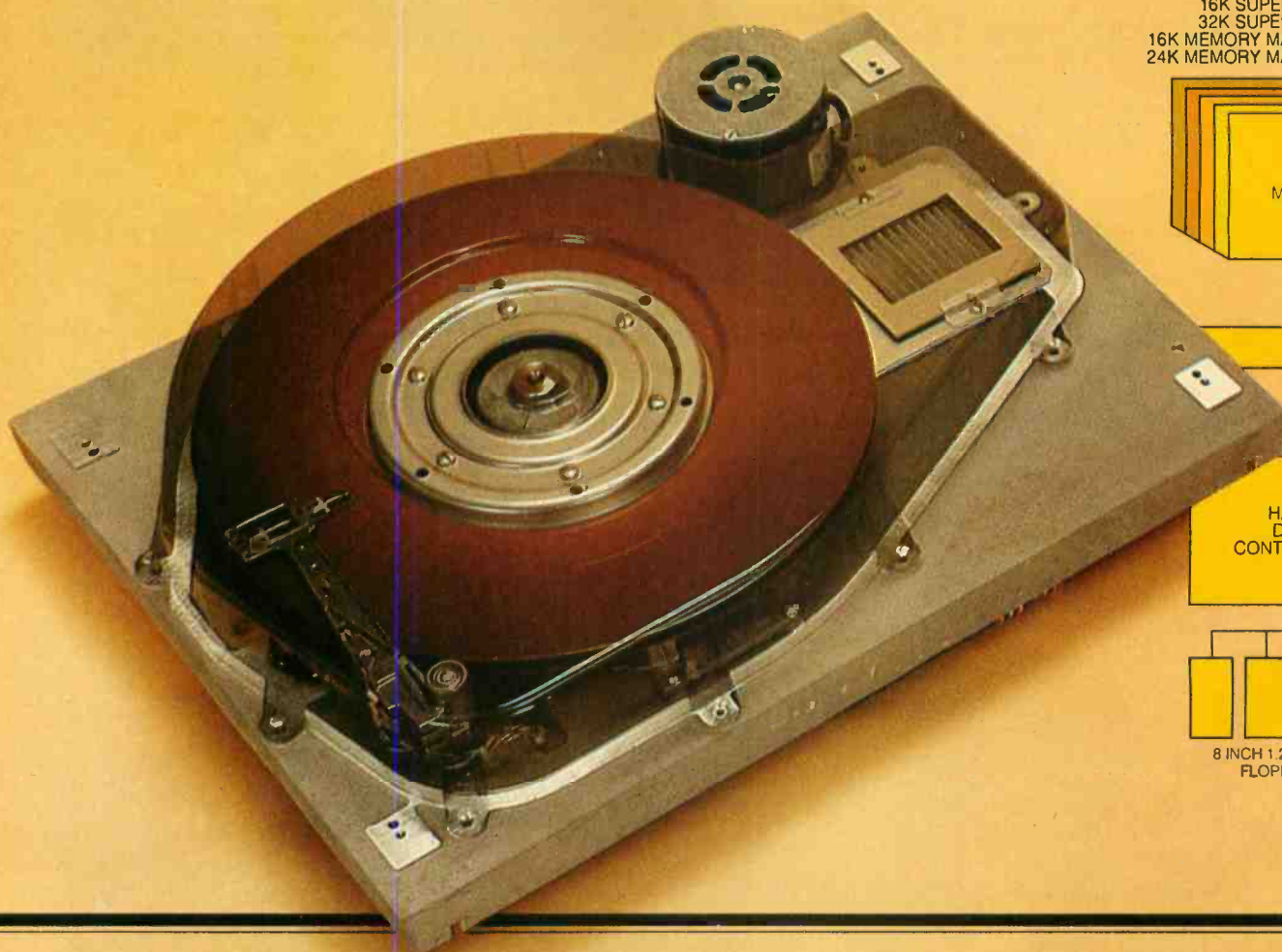

16K SUPER RAM
32K SUPER RAM
16K MEMORY MASTER
24K MEMORY MASTER

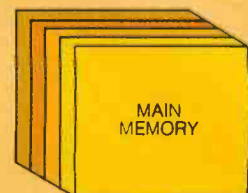

8 INCH 1.2 MEGABYTE
FLOPPY DISKS

S-100 SYSTEMS. From add-in memory boards to add-on hard disk. High performance S-100 busboards. Single, dual and quad-density disk systems with up to 1.2 megabytes on a single floppy disk drive. I/O boards. All, with the Morrow Designs systems approach to hardware and software.

COST EFFECTIVE SYSTEMS.

Morrow Designs Discus M26 offers 26 usable megabytes of memory for just \$4,995. About \$192 per megabyte. And, it's a complete system, including a Shugart SA4008 Winchester-type sealed-media hard disk, power supply, cables, and cabinet with fan. The single board controller supervises all data transfers, communicating

with the CPU through 3 I/O ports (command, status, data). The controller can generate interrupts at the completion of each command. A 512-byte sector buffer is on-board. And the system is available for S-100 mainframes.

SYSTEMS FOR SYSTEMS. Whether you're building systems or trying to expand your present system at reasonable costs, Morrow Designs offers complete, cost-effective subsystems. Modular systems that allow you to build your system your way.

SOFTWARE FOR SYSTEMS.

Morrow Designs backs each subsystem with high-quality, fully-tested software. **INSTALL** software allows you to attach

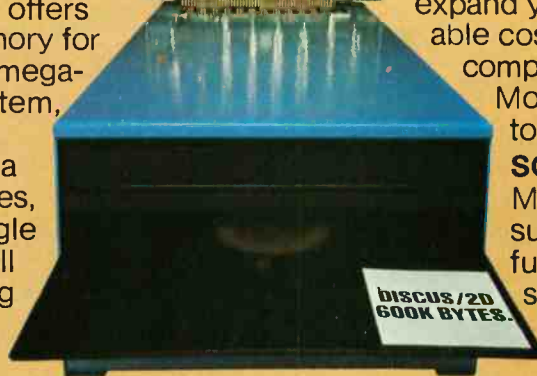

systems.

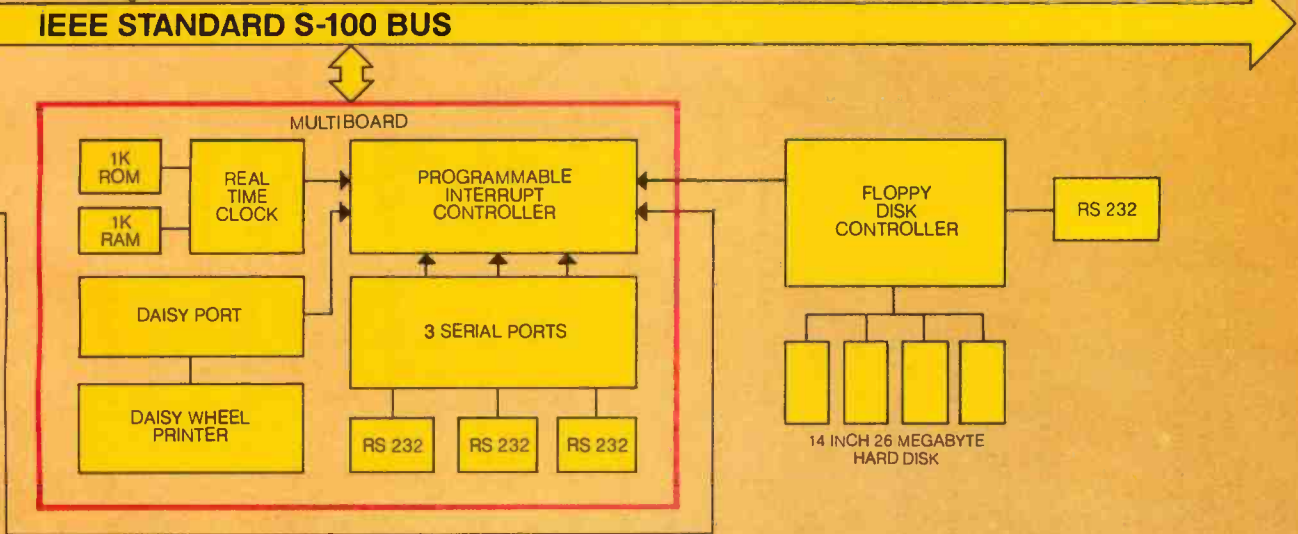
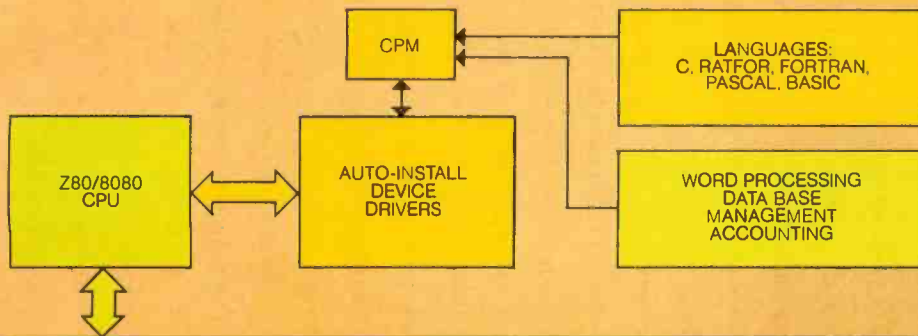

any Morrow disk system to any CP/M system operating under CP/M. Morrow CPM/CDOS software allows you to attach any Morrow disk drive to Cromemco Systems. In fact, if software runs under CP/M, it will run on any Morrow Designs hardware.

COMPARE PERFORMANCE.

Hardware performance. Software performance. System performance. Any Morrow Designs disk drive, hard or floppy, can be mixed and matched through Morrow Designs standard software. And all necessary hardware, software and firmware is included with each system.

NOW, COMPARE PRICE. Morrow Designs products offer maximum efficiency at minimum cost. But we don't cut corners. What that means



to you is reliable system efficiency at cost effective prices.

Better systems for less. See Morrow Designs full line of memory and I/O, plus floppy disk/and the M26 hard disk system at your computer supplier. Or, send in the coupon for our full line catalog. Can't wait: Call us at (415) 524-2101.

MORROW DESIGNS

5221 Central Ave. Richmond, CA 94804

Gentlemen, Please send me your complete OEM hardware and software specifications. Plus the name of my nearest distributor.

Name _____

Company _____

Address _____

City _____

State _____

Zip _____

Listing 1a: A complete self-defining file. The first line, which begins "2-3-79", is region 1 of the file. The second and third lines, which begin with "DATED" and "10", are region 2 of the file. The rest of the file is region 3, that contains data beginning with one line per record on this listing.

```

2- 3-79 2- 3-79 24 12 65
DATED 4 1LNAMA 5 SFHAMA 5 10INITA 1 15ADDR 14 16TEL#D 4 30DEG A 2 34MJR A 8 36INITIA 10 44INT2A
10 54EXP10 1 64EXP20 1 65
78/11/08BLACKWELL LARRY W 8180 PALLISTER DETROIT MI 871-9167RA GENERAL BUSINESS SALES/MARKETING PURCHASING 4 2
78/11/12KRAFT PATRICK A 26044 VILLAGE PLYMOUTH MI 445-6176MS MATHEMATICS PRODUCT ENGRG MANUFACTURING ENRG 2 0
78/11/02HACKMAN GERALD R 292 CARDWELL TOLEDO OH 222-57328A GENERAL BUSINESS SALES/MARKETING QUALITY CONTROL 7 0
78/09/28MERCHANT HAROLD R 9670 TRELAME DEARBURN MI 581-25538S MECHANICAL ENGRG PRODUCT ENGRG MANUFACTURING ENRG 1 0
78/09/29MALST DENNIS R 1025 CHEFNE TOLEDO OH 333-4714MS MECHANICAL ENGRG PRODUCT ENGRG TECHNICAL RESEARCH 8 2
78/10/19DUNNING ALLAN G 1021 THIRD WYANDOTTE MI 868-73268S EDUCATION COMPUTER PROGRAMMING QUALITY CONTROL 0 2
78/10/05KEDFORD KEVIN D 17504 RANIER ALLEN PARK MI 277-45458A ECONOMICS QUALITY CONTROL SALES/MARKETING 3 4
78/09/15STANLEY SUSAN A 29213 GREENLAWN DETROIT MI 555-8002HS+ GENERAL BUSINESS ACCOUNTING SALES/MARKETING 7 0
78/10/10MAYNARD STEPHEN L 36500 RUSHMORE FRANKLIN MI 815-4202MS PSYCHOLOGY INDUSTRIAL RELATIONS SALES/MARKETING 1 0
78/12/10PALINKOMEANTHONY J 43441 DARTMOUTH NOVI MI 447-39024S ELECTRICAL ENGRG TECHNICAL RESEARCH PRODUCT ENGRG 15 2
78/10/04DAYTON THOMAS F 2125 TULANE WESTLAND MI 666-3920HS+ DRAFTING DESIGN/DRAFTING PRODUCT ENGRG 6 0
78/09/30HAYDEN MARY E 24042 PIPEER TAYLOR MI 755-9550A MATHEMATICS ACCOUNTING SALES/MARKETING 10 2
78/09/25VAN HORN BERNARD G 1741 SUNSET LIVONIA MI 227-4021HA PSYCHOLOGY INDUSTRIAL RELATIONS PURCHASING 2 4
78/09/16TIBBY MARTIN W 1401 LAKELAND CHICAGO IL 656-3704RS ELECTRICAL ENGRG TECHNICAL RESEARCH PRODUCT ENGRG 0 0
78/09/13SUNICK PAUL W 5419 HILL OAKPARK MI 599-3497A DRAFTING DESIGN/DRAFTING PRODUCT ENGRG 3 0
78/09/15KOHN ROBERT C 6565 ABERN SOUTHFIELD MI 533-8452RS COMPUTER SCIENCE COMPUTER PROGRAMMING NONE 1 0
78/08/22HAYES JAMES K 1521 SHOOTREFF TROY MI 551-9874RS PHYSICS TECHNICAL RESEARCH PRODUCT ENGRG 5 1
78/11/20SMITH HENRY M 130 BARD DEARBURN MI 469-7412MS MECHANICAL ENGRG PRODUCT ENGRG NONE 3 0
78/07/06KYSER CYNTHIA A 5820 MULHERRY WAYNE MI 666-9287HS COMPUTER SCIENCE COMPUTER PROGRAMMING TECHNICAL RESEARCH 1 0
78/08/02HOSSMAN MARVIN T 3355 ACADEMY DETROIT MI 638-7663HS+ GENERAL BUSINESS ACCOUNTING INDUSTRIAL RELATIONS 5 2
78/09/25MARSHALL PETER K 7914 HADLEY BRIGHTON MI 383-2737HS+ DRAFTING DESIGN/DRAFTING PRODUCT ENGRG 13 6

```

Now Graphics for your computer

\$680

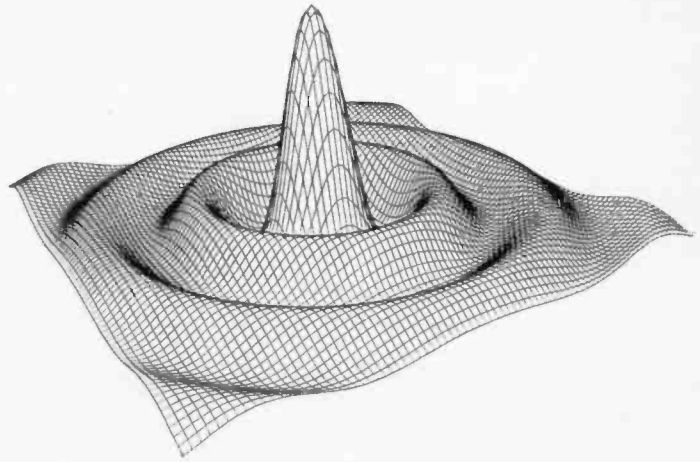

Expand your computer's capabilities with this easy-to-use drum plotter. The Strobe Model 100 interfaces to any computer to generate professional quality graphics.

OFFERING High Resolution Graphics Output * Outstanding Performance * Assembler Coded Drivers for High Speed Plotting * Precise Operator Controls * Interactive Coordinate Input

ALSO AVAILABLE Hardware Interfaces for — TRS-80 * APPLE II * PET * S-100. Applications Software Package providing vector plotting and variable size alphanumerics for: TRS-80 Level II BASIC, Applesoft BASIC, Northstar BASIC, CBASIC, Microsoft BASIC & FORTRAN.

*TRS-80, APPLE II, and PET are trademarks of Tandy Corp., Apple Computer Co. and Commodore Business Machines, respectively

Circle 82 on inquiry card.

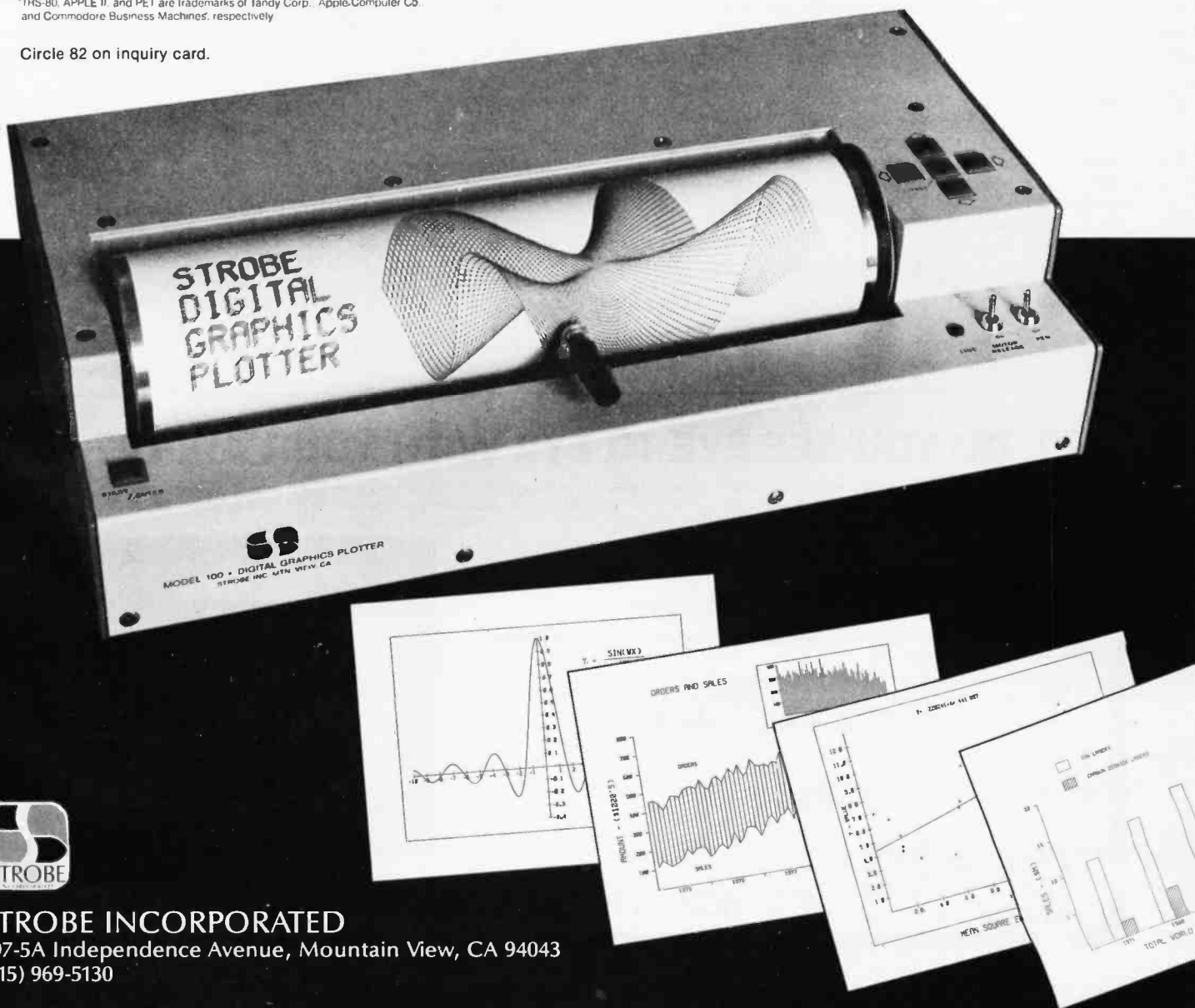

STROBE INCORPORATED

897-5A Independence Avenue, Mountain View, CA 94043
(415) 969-5130

Listing 1b: File records from the self-defining file of listing 1a, printed in formatted form.

REC# 3
 DATE = 78/11/08
 LNAM = BLACKWELL
 FNAM = LARRY
 INIT = W
 ADDR = 8180 PALLISTER DETROIT MI
 TEL# = 871-9167
 DEG = BA
 MJR = GENERAL BUSINESS
 INT1 = SALES/MARKETING
 INT2 = PURCHASING
 EXP1 = 4
 EXP2 = 2

REC# 6
 DATE = 78/09/28
 LNAM = MARCHANT
 FNAM = HAROLD
 INIT = R
 ADDR = 9670 TREELANE DEARBORN MI
 TEL# = 581-2553
 DEG = BS
 MJR = MECHANICAL ENGRG
 INT1 = PRODUCT ENGRG
 INT2 = MANUFACTURING ENGRG
 EXP1 = 1
 EXP2 = 0

REC# 4
 DATE = 78/11/12
 LNAM = KRAFT
 FNAM = PATRICK
 INIT = A
 ADDR = 26044 VILLAGE PLYMOUTH MI
 TEL# = 445-6176
 DEG = MS
 MJR = MATHEMATICS
 INT1 = PRODUCT ENGRG
 INT2 = MANUFACTURING ENGRG
 EXP1 = 2
 EXP2 = 0

REC# 7
 DATE = 78/09/29
 LNAM = MALST
 FNAM = DENNIS
 INIT = R
 ADDR = 1025 CHENE TOLEDO OH
 TEL# = 333-4714
 DEG = MS
 MJR = MECHANICAL ENGRG
 INT1 = PRODUCT ENGRG
 INT2 = TECHNICAL RESEARCH
 EXP1 = 8
 EXP2 = 2

REC# 5
 DATE = 78/11/02
 LNAM = HACKMAN
 FNAM = GERALD
 INIT = R
 ADDR = 292 CARDWELL TOLEDO OH
 TEL# = 222-5752
 DEG = BA
 MJR = GENERAL BUSINESS
 INT1 = SALES MARKETING
 INT2 = QUALITY CONTROL
 EXP1 = 7
 EXP2 = 0

REC# 8
 DATE = 78/10/19
 LNAM = DUNNING
 FNAM = ALLAN
 INIT = G
 ADDR = 1021 THIRD WYANDOTTE MI
 TEL# = 888-7326
 DEG = BS
 MJR = EDUCATION
 INT1 = COMPUTER PROGRAMMING
 INT2 = QUALITY CONTROL
 EXP1 = 0
 EXP2 = 2

DO YOU SEE EYE TO EYE WITH YOUR APPLE?

The DS-65 Digisector® opens up a whole new world for your Apple II. Your computer can now be a part of the action, taking pictures to amuse your friends, watching your house while you're away, taking computer portraits . . . the applications abound! The DS-65 is a random access video digitizer. It converts a TV camera's output into digital information that your computer can process. The DS-65 features:

- **High resolution:** 256 X 256 picture element scan
- **Precision:** 64 levels of grey scale
- **Versatility:** Accepts either interlaced (NTSC) or industrial video input
- **Economy:** A professional tool priced for the hobbyist

The DS-65 is an intelligent peripheral card with on-board software in 2708 EPROM. Check these software features:

- Full screen scans directly to Apple Hi-Res screen
- Easy random access digitizing by Basic programs
- Line-scan digitizing for reading charts or tracking objects
- Utility functions for clearing and copying the Hi-Res screen

Let your Apple see the world!

DS-65 Price: \$349.95
 Advanced Video FSII Camera Price \$299.00
 SPECIAL COMBINATION PRICE: \$599.00



APPLE SELF-PORTRAIT

THE **MICRO**
WORKS

P.O. BOX 1110 DEL MAR, CA 92014 714-942-2400



THE NATIONAL COMPUTER SHOWS

HAVE WE GOT A PROGRAM FOR YOU!

The new computers are showing off. Over \$50 million worth of equipment in over 100,000 square feet of space, including the latest software and hardware for business, government, home and personal use. Everything the NCC show has and more will be on display, and you can buy it all right on the spot.

Computers costing \$150 to \$250,000, mini and micro computers, data- and word-processing equipment, telecommunications, office machines, peripheral equipment and services from leading names in the industry like IBM, Xerox, Radio Shack and Apple will all be there.

There'll be conferences on business uses of small to medium sized computers, and how to make purchasing evaluations.

There'll be robots, computerized video games, computer art and computer music.

Everyone from kids to people who earn their living with computers will have a great time at the largest computer show ever organized in each region.

Admission for adults is \$5. The public is invited, and no pre-registration is necessary.

Don't miss the computer show that mixes business with pleasure. Show up for the show.

THE MID-ATLANTIC COMPUTER SHOW

WASHINGTON, D.C.
D.C. ARMORY/STARPLEX
THURSDAY-SUNDAY
SEPTEMBER 18-21
11 A.M. TO 9 P.M. THURS.-SAT.
11 A.M. TO 5 P.M. SUN.

THE MID-WEST COMPUTER SHOW

CHICAGO
McCORMICK PLACE
THURSDAY-SUNDAY
OCTOBER 16-19
11 A.M. TO 9 P.M. THURS.-SAT.
11 A.M. TO 5 P.M. SUN.

THE NORTHEAST COMPUTER SHOW

BOSTON
HYNES AUDITORIUM
PRUDENTIAL CENTER
THURSDAY-SUNDAY
NOVEMBER 20-23
11 A.M. TO 9 P.M. THURS.-SAT.
11 A.M. TO 5 P.M. SUN.

Produced by National Computer Shows,
824 Boylston Street, Chestnut Hill, MA 02167.
Telephone (617) 739-2000.

Please send me:

- _____ adult tickets at \$5 each. I have enclosed the proper amount of \$ _____
 Information on the show's conference program.
 Hotel registration information Exhibitor rental information

Please print: Name _____
 Address _____
 City _____ State _____ Zip _____

Text continued from page 116:

The overall organization of the information-retrieval system is illustrated in the block diagram of figure 2a. The main program serves only to call segment 1 into memory from the disk, and is never returned to. More will be said of this later when the use of memory overlays in this implementation is discussed.

A Nassi-Schneiderman flowchart of segment 1 is presented in figure 2b. (Such flowcharts are given for all routines.) It is quite straightforward and serves only to parse commands entered by the user. These are:

- CREATE: this command causes segment 2 to be called into memory, which will prompt the

user for the information necessary to create a file.

- INPUT: this command causes segment 3 to be called in, which will prompt the user for information necessary to insert new records into a file.
- QUERY: this command causes segment 4 to be called in to prompt the user for and answer queries pertaining to a file.
- STOP: terminates program execution.

Whenever creation, input, or query operations are terminated, the respective segment (2, 3, or 4) calls in segment 1 once again to parse additional commands. This structure (segments 1 thru 4) is completely analogous to a main program and three subroutines, and will be treated as such in the discussion of the three major file operations.

As previously indicated, some planning is required prior to the creation of a file. The user must first determine the information to be stored, the number of required fields per record, appropriate tags for the fields, field lengths and types (alphanumeric or digital) and the maximum number of records required. This last requirement might not be necessary in implementations where extendable files are used. However, our implementation made use of nonextendable files with fixed record lengths.

An example of the interaction which takes place when creating the personnel file is shown in listing 2. Segment 1 prints the prompts "ENTER A COMMAND" and "#". The reply to the prompt "#" is the command "CREATE". Segment 2 then prompts for the name the user wishes to give the file, the number of records the file is to contain, the record length, and the number of tags. This dialogue corresponds to steps 1 thru 12 of the create-routine algorithm shown in figure 3. The test at step 8 determines whether or not the user's logical record will fit within 128-word (256-character), fixed-length physical records. (The Hewlett-Packard computer uses 16-bit words.) The test at step 13 is necessary because there is only enough room in one record (region 2) for eighteen field-description aggregates. Two words (four characters) are needed for the tag,

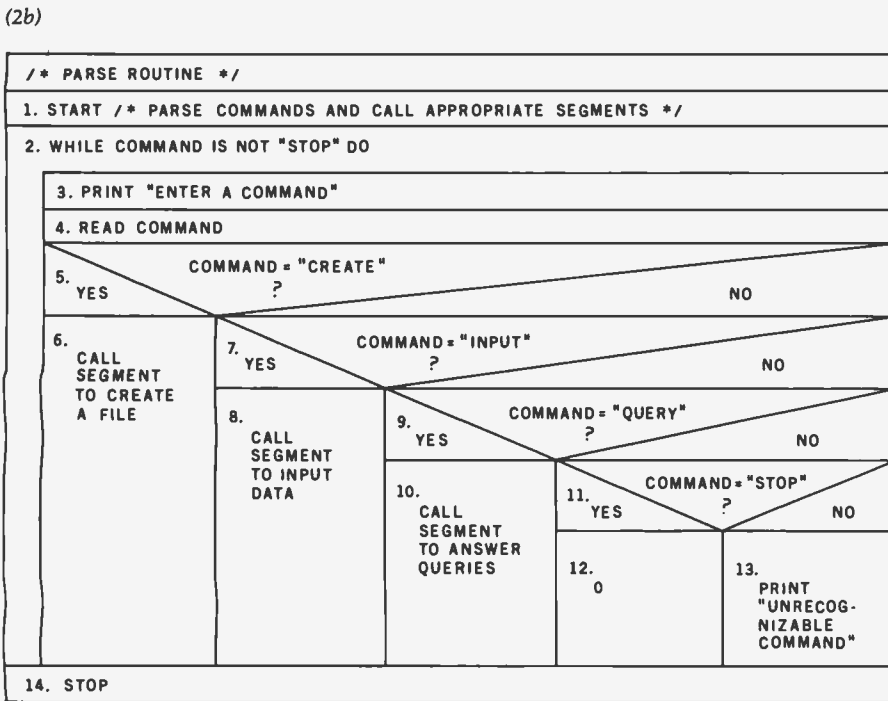
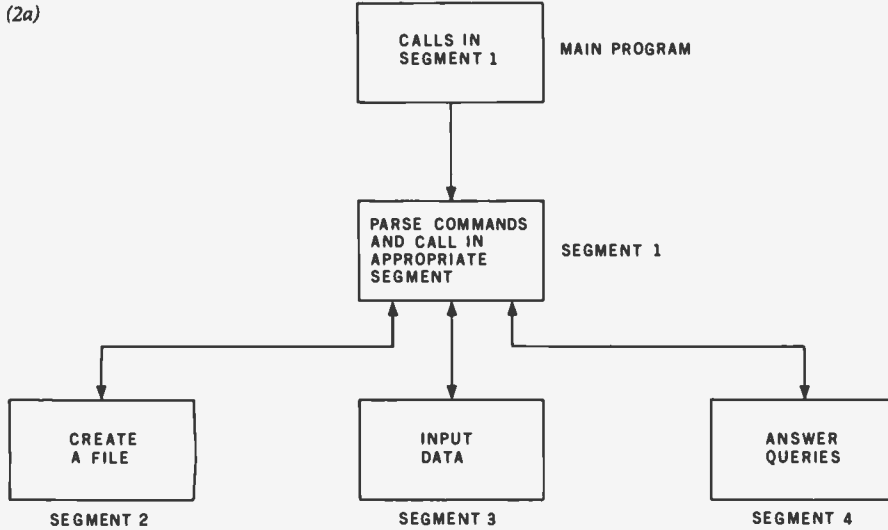

Figure 2: Block diagram of program design and Nassi-Schneiderman chart for parsing routine. Figure 2a illustrates the overall design of the information-retrieval system program. It is designed in such a way that only one of the four program segments needs to be in computer memory at any one time. Figure 2b is a Nassi-Schneiderman chart of the routine in segment 1 that decides what segment is to be loaded into memory next. The L-shaped bracket labeled step 2 performs steps 3 thru 13 under the control of a "while" loop statement. Any step labeled 0 means to do nothing for that step. (See reference 5 for more information on this type of structured flowchart).



Time & Money. Commodore®, Atari® & Apple® users get more with VisiCalc™ software.

A financial VP in Massachusetts is cutting the time it takes to prepare month-end reports from three days to three hours.

A California company is replacing most of its time-share computer service with a personal computer and VisiCalc, saving at least \$30,000 the first year.

Thousands of other personal computer users are also sold on how VisiCalc is increasing their productivity. Besides saving time and money, they're simplifying their work and getting more information that helps them make better decisions. A typical user reaction comes from a New York dentist:

"VisiCalc has become an integral part of my business"

VisiCalc displays an "electronic worksheet" that automatically calculates nearly any number problem in finance, business management, marketing, sales, engineering and other areas. The huge worksheet is like a blank ledger sheet or matrix. You input problems by typing in titles, headings and your numbers. Where you need calculations, type in simple formulas (+, -, X, ÷) or insert built-in functions such as net present value and averaging. As quickly as you type it in, VisiCalc calculates and displays the results.

"I am extremely impressed with VisiCalc's capability, flexibility and orderly presentation of instructions."

So writes the director of a New York corporation. He appreciates VisiCalc's powerful recalculation feature. Change any number in your model and instantly all numbers affected by that change are recalculated and new results are displayed. You can ask "What if . . .?," analyzing

more alternatives and forecasting more outcomes. It really increases your decision-making batting average!

When you finish, you can print a copy of the worksheet just as it appears on the screen and/or save it on diskette.

"I like VisiCalc's ease of use!"

That response comes from a Utah businessman using VisiCalc for production forecasts, financial report ratio analysis and job cost estimating. Ease of use is VisiCalc's best-liked feature. It's designed for a non-programmer, and has an extensive, easy-to-understand instruction manual.

Users also like solving a wide variety of problems with VisiCalc . . . and solving them their way. VisiCalc can even justify the cost of a personal computer, according to a New Hampshire financial analyst:

"VisiCalc is paying for itself over and over."

VisiCalc is available for 32k Commodore PET/CBM, Atari 800 and Apple disk systems. VisiCalc is written by Software Arts, Inc.

See VisiCalc at your Personal Software dealer. For your dealer's name, call Personal Software Inc. at 408-745-7841, or write 1330 Bordeaux Drive, Sunnyvale, CA 94086.

While there, see our other Productivity Series software: Desktop Plan and CCA Data Management System. They're like time on your hands and money in the bank.

Commodore is a registered trademark of Commodore Business Machines Inc., Atari is a registered trademark of Atari Inc., Apple is a registered trademark of Apple Computer Inc.

**PERSONAL
SOFTWARE**

Buy By Mail and Save!

COMPUTERS

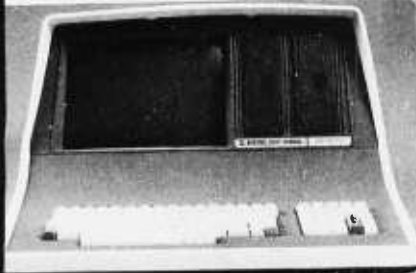

- INTERTEC SuperBrain® 32K . \$2495
- 64K RAM, List \$3345 \$2695
- 64K Quad, List \$3995 \$3395
- NORTH STAR Horizon I®
- 16K D.D. Kit \$1259
- 32K D.D. Kit \$1579
- 32K Assembled, List \$2695 \$2149
- Horizon 2 32K DD, Assm., \$3095 \$2439
- 32K QD, Assm., List \$3595 \$2859



- CROMEMCO Z-2, List \$995 . . . \$ 829
- System 2, 64K, List \$3990 . . . \$3179
- System 3, 64K, List \$6990 . . . \$5479
- ATARI® 400, List \$630 \$ 489
- 800, List \$1080 \$ 839
- TI-99/4, List \$1150 \$ 985

DISK SYSTEMS

- THINKER TOYS® Discus 2D . \$ 939
- Dual Discus 2D \$1559
- Discus 2+2, List \$1549 \$1288

PRINTERS & TERMINALS

- PAPER TIGER IDS-440 \$ 849
- with Graphics Option \$ 949
- CENTRONICS 730-1, List \$995 . \$ 639
- 737, List \$995 \$ 849
- T.I. 810 \$1575
- INTERTUBE II, List \$995 \$ 729
- PERKIN-ELMER Bantam 550 . . \$ 789
- TELEVIDEO 912C \$779
- 920C \$ 839
- HAZELTINE 1420 \$ 839
- 1500 \$ 879
- SOROC 120 \$ 745

FLOPPY DISKS SPECIAL

5 1/4" Box of 10 ONLY \$29.95

(specify TRS-80, North Star, SuperBrain, etc.)

Most items in stock for immediate delivery. Factory sealed cartons, w/full factory warranty. NYS residents add appropriate sales tax. Prices do not include shipping. VISA and Master Charge add 3%. C.O.D. orders require 25% deposit. Prices subject to change without notice.

Computers Wholesale

P.O. Box 144 Camillus, NY 13031

VISA (315) 472-2582

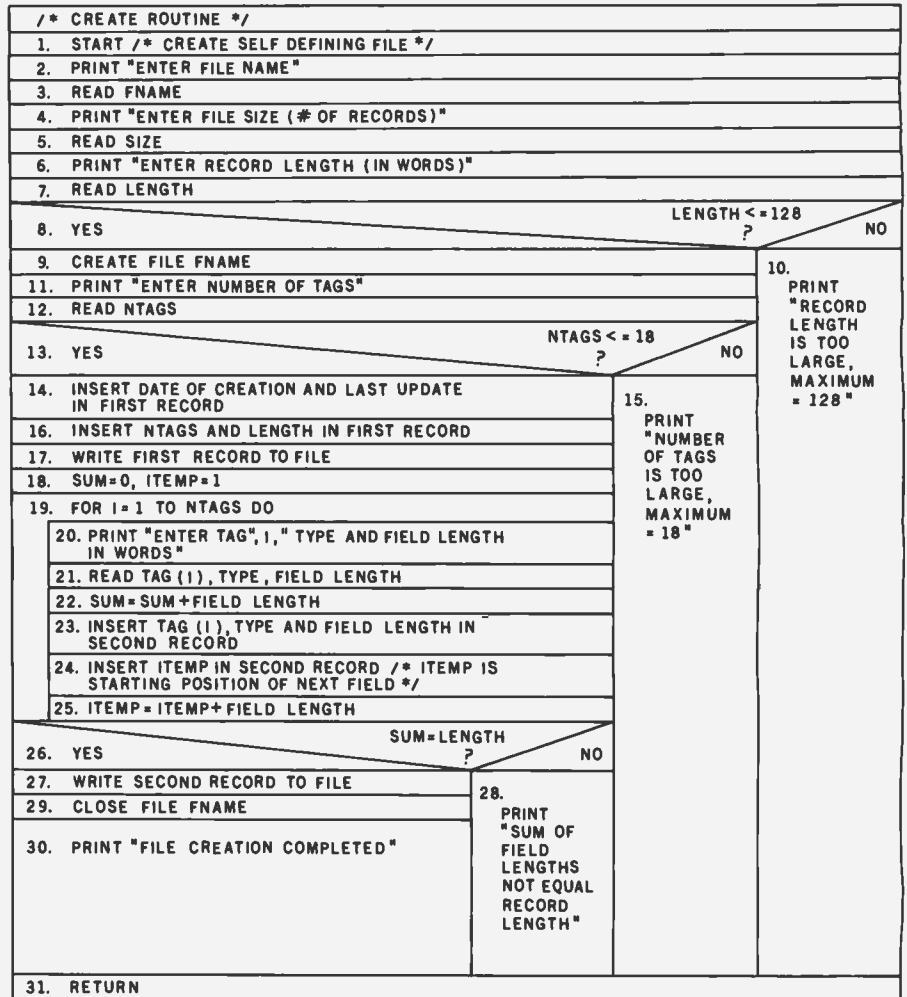

Figure 3: Nassi-Schneiderman chart for the file-creating routine in segment 2. This routine prompts the user for the overall characteristics of the file and the characteristics of each field within the file.

one for the field type (the letter D for digital or A for alphanumeric) and 2 words each for the ASCII representation of the field length and the starting position. At step 14, a call to an operating-system function retrieves the current time, which is inserted into region 1. The number of tags and the logical record lengths are inserted at step 16, and then the region is written to the file.

Steps 19 thru 25 prompt the user for the tags, types, and field lengths as shown in listing 2. The only syntactic restrictions on tags, other than a maximum length of four characters, is that they not begin with a digit and do not contain a colon. The reasons for these restrictions will become clear when the query routine is discussed. These values are placed in region 2 as the aggregates that were previously described. Step 26 is a check to insure that the sum of the

field lengths given equals the specified record length. Region 2 is then written, the file closed, a message indicating successful file creation given to the user, and control is returned to segment 1.

Entering Data

Putting data into a file previously created is the most straightforward of all operations in this information-retrieval system. In preparation, all that is required is that the user have on hand the values to be inserted in each of the fields that make up a record in that file.

Listing 3 is a listing of the dialogue that took place during the insertion of three records in the personnel data base. Once the command "INPUT" is given, the user is prompted for the name of the file to be modified. This corresponds to steps 1 thru 3 in the Nassi-Schneiderman chart for the in-

After you've broken the pole vault record, see if you can outsmart the killer dwarves.

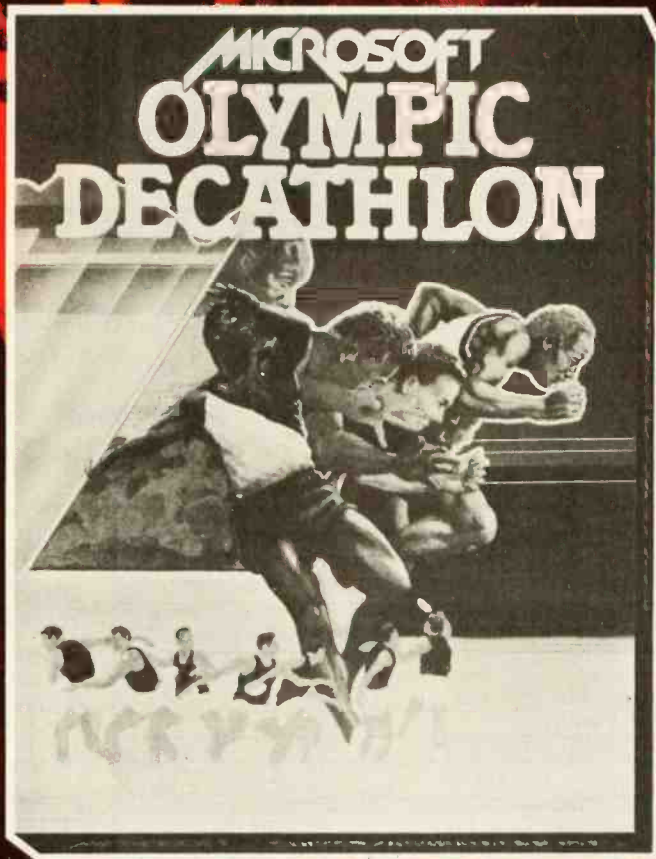

Two incredible games from Microsoft.

There are plenty of computer games around. But most of them probably won't hold your interest for more than a few hours.

That's what makes these two releases from Microsoft so remarkable. They'll keep challenging you in new ways every time you play.

Olympic Decathlon—a real workout!

There's never been a program that tests your reflexes and coordination like Olympic Decathlon. Just like the real one, Microsoft's has 10 events, including shot put, pole vault, long jump, javelin throw, and six more. Winning takes a combination of strategy, timing, coordination, and physical endurance (really!).

When you jump or throw, the program calculates the actual trajectory, and shows you what's happening with exciting animated graphics. After each event, the scores of all competitors (up to 8) are displayed. It's the ultimate party game to show off your computer!

Disk-based Decathlon runs on a 32k TRS-80. The cassette version requires a 16k Level I or Level II system.



Versions for the Apple II available soon.

Adventure—the classic mind game.

If you've ever been lucky enough to play Adventure on a big computer, you know how addictive it is. Fantasy, deduction, and magic all come into play as you explore the chambers of Colossal Cave, collecting treasure while avoiding pitfalls and hostile creatures. There are surprises around every corner, and

even veteran players keep discovering new things and improving their scores.

Microsoft has the complete microcomputer version of the original FORTRAN Adventure that runs on large timesharing systems. It runs on TRS-80 and Apple II systems with at least 32k memory and one disk.

Microsoft—a name worth trusting.

As the world's most experienced producer of microcomputer software, Microsoft's policy is to offer only the best, most rewarding programs in existence.

After playing Adventure and Olympic Decathlon, we think you'll agree.

Visit your computer retailer soon for a real challenge. Or ten.

MICROSOFT

CONSUMER PRODUCTS

400 108th Ave. N.E., Suite 200
Bellevue, WA 98004
(206) 454-1315

Listing 2: The file-creation process. This listing details the questions and answers necessary to create the employee file EMPFL1 of listing 1. It follows the structured flowchart of figure 3. This computer uses a 16-bit word length.

```

ENTER A COMMAND
#CREATE
ENTER FILENAME
#EMPFL1
ENTER FILE SIZE (#OF RECORDS)
#30
ENTER RECORD LENGTH (IN WORDS)
# 65
ENTER NUMBER OF TAGS
#12
ENTER TAG 1, TYPE, AND FIELD LENGTH IN WORDS
#DATE
#D
# 4
ENTER TAG 2, TYPE, AND FIELD LENGTH IN WORDS
#LNAM
#A
# 5
ENTER TAG 3, TYPE, AND FIELD LENGTH IN WORDS
#FNAM
#A
# 5
ENTER TAG 4, TYPE, AND FIELD LENGTH IN WORDS
#INIT
#A
# 1
ENTER TAG 5, TYPE, AND FIELD LENGTH IN WORDS
#ADDR
#A
#14

ENTER TAG 6, TYPE, AND FIELD LENGTH IN WORDS
#TEL#
#D
# 4
ENTER TAG 7, TYPE, AND FIELD LENGTH IN WORDS
#DEG
#A
# 2
ENTER TAG 8, TYPE, AND FIELD LENGTH IN WORDS
#MJR
#A
# 8
ENTER TAG 9, TYPE, AND FIELD LENGTH IN WORDS
#INT1
#A
#10
ENTER TAG 10, TYPE, AND FIELD LENGTH IN WORDS
#INT2
#A
#10
ENTER TAG 11, TYPE, AND FIELD LENGTH IN WORDS
#EXP1
#D
# 1
ENTER TAG 12, TYPE, AND FIELD LENGTH IN WORDS
#EXP2
#D
# 1
FILE CREATION COMPLETED

```

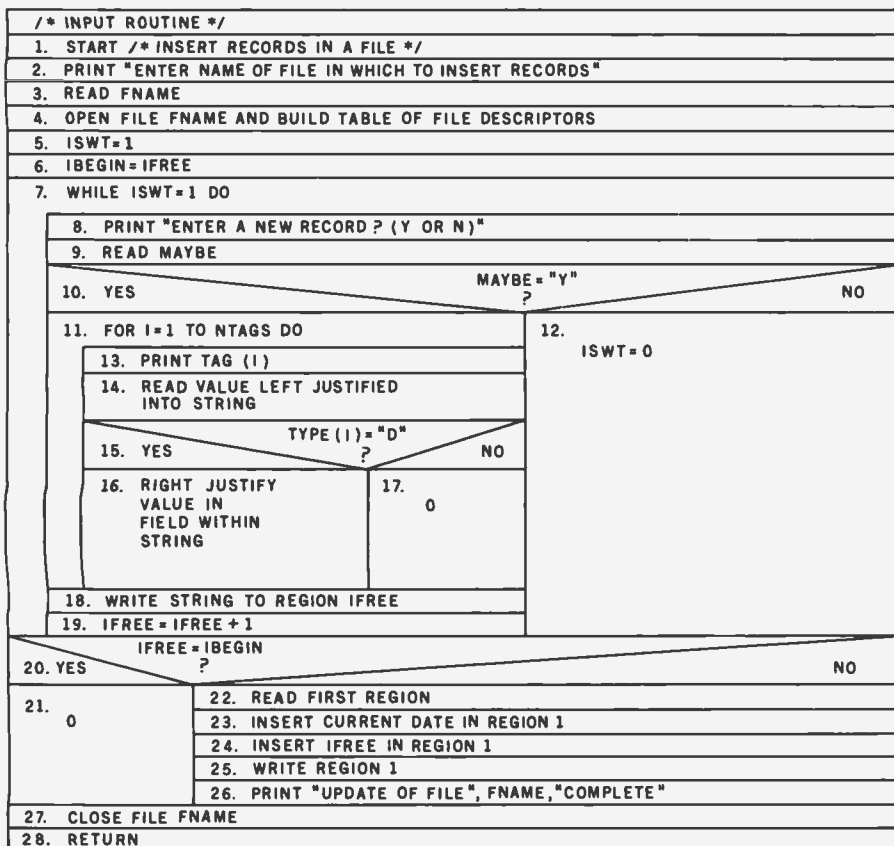

put routine given in figure 4. Step 4 of the flowchart accesses the first two regions of the file specified and retrieves the information necessary to allow the proper formatting of new records and their insertion in the file. This information is as follows:

- first free region, number of tags, and record length
- four arrays, the dimension of which is determined by the number of tags (Remember that the maximum number is eighteen.) The information in these arrays corresponds to the values stored in region 2. That is, one array contains the tags, another the associated types, and the other two contain the field lengths and starting positions. Thus, by referencing the *i*th element of each array, all of the descriptive information regarding the *i*th field may be obtained.

Referring once again to listing 3, it may be seen that if the user responds with "YES" (or simply "Y") to the prompt "ENTER A NEW RECORD", he will be prompted for values to insert in each of the fields which define a record. The form of the

A Few Extraordinary Products for Your 6800/6809 Computer

SS-50 Bus LFD-400™ and LFD-800™ Systems

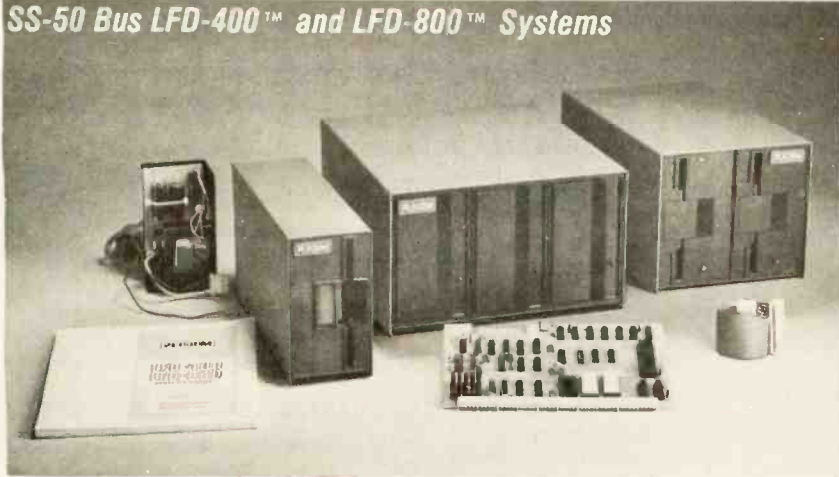

Percom mini-disk systems start as low as \$599.95, ready to plug in and run. You can't get better quality or a broader selection of disk software from any other microcomputer disk system manufacturer — at any price!

Features: 1-, 2- and 3-drive systems in 40- and 77-track versions store 102K- to 591K-bytes of random access data on-line • controllers include explicit clock/data separation circuit, motor inactivity time-out cir-

cuit, buffered control lines and other mature design concepts • ROM DOS included with SS-50 bus version — optional DOSs for EXORciser* bus • extra PROM sockets on-board • EXORciser* bus version has 1K-byte RAM • supported by extended disk operating systems; assemblers and other program development/debugging aids; BASIC, FORTRAN, Pascal and SPL/M languages; and, business application programs.

From Percom . . .

Low Cost Mini-Disk Storage in the Size You Want

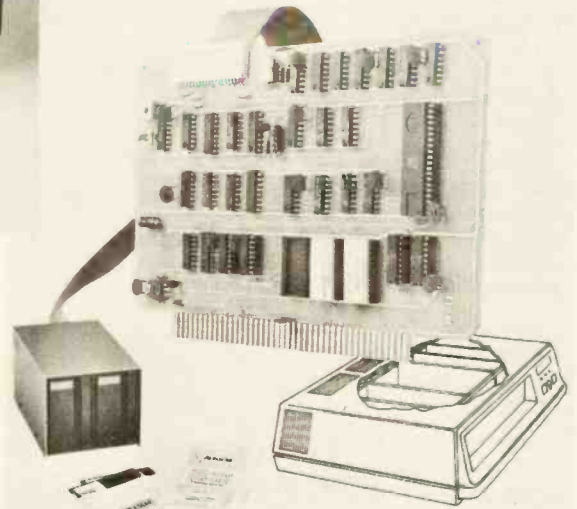

EXORciser* Bus LFD-400EX™ -800EX™ Systems

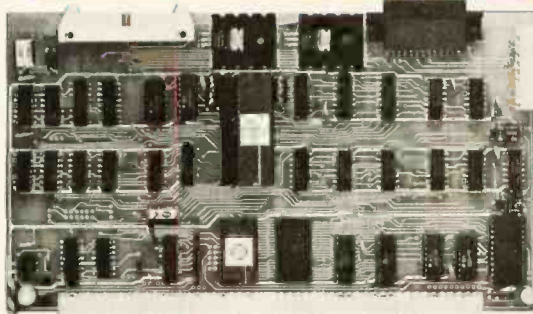

The SBC/9™: A "10" By Any Measure.

The Percom SBC/9™ is an SS-50 bus compatible, stand-alone Single-Board Computer. Configured for the 6809 microprocessor, the SBC/9™ also accommodates a 6802 without any modification. You can have state-of-the-art capability of the '09. Or put to work the enormous selection of 6800-coded programs that run on the '02.

The SBC/9™ includes PSYMON™, an easily extended 1-Kbyte ROM OS. Other features include:

- Total compatibility with the SS-50 bus. Requires no changes to the motherboard, memory or I/O.
- Serial port includes bit-rate generator. RS-232-C compatible with optional subminiature 'D' connector installed. 10-pin Molex connector provided.
- Eight-bit, non-latched, bidirectional parallel port is multi-address extension of system bus. Spans a 30-address field; accommodates an exceptional variety of peripheral devices. Connector is optional.
- Includes 1-Kbyte of static RAM.
- Costs only \$199.95 with PSYMON™ and comprehensive users manual that includes source listing of PSYMON™.

™ trademark of Percom Data Company, Inc.

* trademark of the Motorola Corporation.

Prices and specifications subject to change without notice.

Versatile Mother Board, Full-Feature Prototyping Boards

Printed wiring is easily soldered tin-lead plating. Substrates are glass-epoxy. Prototyping cards provide for power regulators and distributed capacitor bypassing, accommodate 14-, 16-, 24- and 40-pin DIP sockets. Prototyping boards include bus connectors, other connectors and sockets are optional.

MOTHERBOARD — accommodates five SS-50 bus cards, and may itself be

plugged into an SS-50 bus. Features wide-trace conductors. Price: \$21.95

SS-50 BUS CARD — accommodates 34- and 50-pin ribbon connectors on top edge, 10-pin Molex connector on side edge. Price: \$24.95.

SS-30 BUS CARD — 1¼-inch higher than SWTP I/O card, accommodates 34-pin ribbon connector and 12-pin Molex connector on top edge. Price: \$14.95.

The Electric Window™: Instant, Real-Time Video Display Control

Memory residency and outstanding software control of display format and characters make this SS-50 bus VDC card an exceptional value at only \$249.95. Other features:

- Generates 128 characters including all ASCII displayable characters plus selected Greek letters and other special symbols.
- Well-formed, easy-to-read 7x12-dot characters. True baseline descenders.
- Character-store (display) memory included on card.
- Provision for optional character generator EPROM for user defined symbols.
- Comprehensive users manual includes source listing of Driver software. Driver — called WINDEX™ — is also available on mini-diskette through the Percom Users Group.

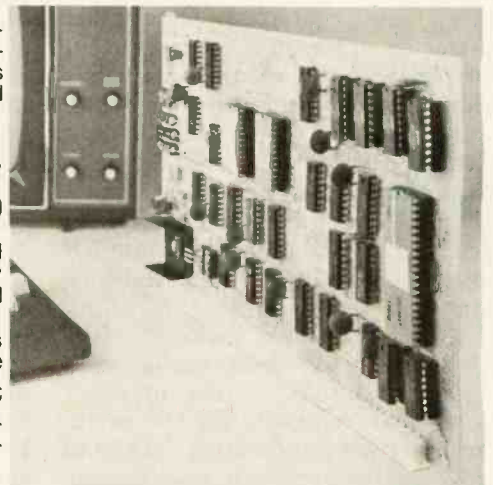

Products are available at Percom dealers nationwide. Call toll-free, 1-800-527-1592, at the address of your nearest dealer, or to order direct.

Circle 354 on inquiry card.

PERCOM

PERCOM DATA COMPANY, INC.
211 N. KIRBY GARLAND, TEXAS 75042
(214) 272-3421

Listing 3: The record-input process. This listing details the questions and answers necessary to add three records to the EMPFL1 file. It follows the structured flowchart of figure 4.

```

ENTER A COMMAND
#INPUT
ENTER NAME OF FILE IN WHICH TO INSERT RECORDS
+ EMPFL1
ENTER A NEW RECORD?(Y OR N)
+ Y
DATE = 78/10/05
LNAME = REDFORD
FNAME = KEVIN
INIT = D
ADDR = 17504 RANIER ALLEN PARK MI
TEL# = 277-4545
DEG = BA
MJR = ECONOMICS
INT1 = QUALITY CONTROL
INT2 = SALES/MARKETING
EXP1 = 3
EXP2 = 4
ENTER A NEW RECORD?(Y OR N)
+ Y
DATE = 78/09/15
LNAM = STANLEY
FNAM = SUSAN
INIT = A

ADDR = 29213 GREENLAWN DETROIT MI
TEL# = 555-8002
DEG = HS +
MJR = GENERAL BUSINESS
INT1 = ACCOUNTING
INT2 = SALES/MARKETING
EXP1 = 7
EXP2 = 0
ENTER A NEW RECORD?(Y OR N)
+ Y
DATE = 78/10/10
LNAM = MAYNARD
FNAM = STEPHEN
INIT = L
ADDR = 36500 RUSHMORE FRANKLIN MI
TEL# = 895-4202
DEG = MS
MJR = PSYCHOLOGY
INT1 = INDUSTRIAL RELATIONS
INT2 = SALES/MARKETING
EXP1 = 1
EXP2 = 0
ENTER A NEW RECORD?(Y OR N)
+ N
UPDATE OF FILE EMPFL1 COMPLETE

```

prompt is "TAGN=". Once all of the values for a record have been obtained, the record is written to the file in the first free region, the free region *pointer* is incremented, and the prompt for entry of a new record is given once again. This sequence of operations corresponds to the iteration of steps 7 thru 19 in figure 4. Once all records have been formatted and written to the file, the current date is inserted in region 1 along with the new value for the pointer to the first free region.

Steps 14 thru 16 accomplish the formatting of values within a record. Although a field may contain any ASCII characters, if we wish to compare these characters to another character string, it is necessary that we know whether the characters represent an alphanumeric or a digital value, and that they be left or right justified accordingly within the field. For example, the string "ABC" compared to the string "ABb" will yield predictable results since they are left justified. (A lowercase, italic *b* represents a significant blank character.) However, the comparison of "ABC" to "bAB" will yield misleading results. Correspondingly, fields that represent digital values must be *right* justified (eg: "123" and "b12"). This approach also permits the comparison of fixed-point digital values (eg: "57.23" and "b1.12").

It may also be necessary to change the order of information within a field to obtain a meaningful compari-

son. For example, the date field in the personnel data base is input as year/month/day, as well as being right justified. This was necessary to maintain the values in a decreasing order of magnitude. Another approach would have been to assign separate tags to each of the three date components.

Answering Queries

Now that records have been created and inserted into the personnel data base, the answering of queries related to it may be discussed.

At the user level, the vehicle used to accomplish this is the query-answering language that was mentioned earlier. The elementary form of a query, which shall be referred to as a *simple* query, is constructed of the three components [tag_i], [relational operator], [value], where [tag_i] is one of the tags defined in region 2 of the file, [relational operator] is either less than (<), greater than (>), or equal (=), and [value] is a character string. The meaning of this construct is that the string given in [value] is to be tested against the field indicated by [tag_i], in the manner determined by [relational operator] for each record contained in the data base. Figure 5a illustrates two valid simple queries. The first is a request for all records such that the field LNAM equals "JONES". The second is a request for all records such that the DATE field is greater than "78/00/00", in other words, all

records dated after the beginning of 1978.

These simple queries may be combined to form more complex queries by using the logical operators AND and OR, the general form of which is [level number] [logical operator], where [level number] is an integer from 1 to 99, and [logical operator] is either the string "AND:" or "OR:". When simple queries are combined by using logical operators, they must also be preceded by a level number which must be higher than that of the logical operator of which they are operands.

Figure 5b is an example of the logical AND of two simple queries. It is a request for all records such that the first area of interest is technical research and the experience in this area is more than 1 year.

Figure 5c is somewhat more complex and serves to point out two important features. First, a logical operation may apply to two or more operands; and second, the operands of a logical operation may actually be logical operations themselves. This query is a request for all records such that the applicant is primarily interested in computer science, has more than 1 year experience in that area, and has a Bachelor of Science degree in the field, or that the applicant is primarily interested in computer science and has more than 3 years experience in that area.

As one final point of interest, it should be noted that blanks are



Please send your free software catalog.

(Check which software is of particular interest)

C COMPILER. Optimized native code for VAX 11/780, PDP-11, LSI-11, Z80, 8085, 8080. Full C language as defined in Kernighan and Ritchie, with comprehensive portable library. Cross compilers available. Runs under VMS, IAS, RSX-11D, RSX-11M, RSTS/E, RT-11, UNIX, Idris, CDOS, CP/M. From \$600

IDRIS OPERATING SYSTEM. System calls and file system identical to UNIX V6, including pipelines. Utilities include shell, editor, assembler, loader, archiver, compare, copy, grep, etc., plus system utilities for file system maintenance. Runs on LSI-11, PDP-11. From \$1000.

PASCAL COMPILER. Optimized native code for VAX 11/780, PDP-11, LSI-11, Z80, 8085, 8080. Full Pascal language as defined in Jensen and Wirth, with standard library. Includes C compiler and portable library, permitting intermixed C and Pascal. Cross compilers available. Runs under VMS, IAS, RSX-11D, RSX-11M, RSTS/E, RT-11, UNIX, Idris, CDOS, CP/M. From \$750.

Idris is a trademark of Whitesmiths Ltd.
UNIX is a trademark of Bell Laboratories.
CP/M is a trademark of Digital Research Co.

VMS, RSX-11, RT-11, RSTS/E, VAX,
PDP-11, LSI-11 are trademarks of Digital
Equipment Corporation.

Name _____

Company _____

Street _____

City _____ State _____ Zip _____

Whitesmiths, Ltd.
Software for grownups.
(212) 799-1200
P.O.B. 1132 Ansonia Station, New York, N.Y. 10023

generally ignored within a query. The only restriction is that at least one blank must separate a level number from a logical operator or a simple query.

Listings 4 thru 10 show the interaction that took place in answering seven queries pertaining to the personnel data base.

In all cases, just prior to the entry of the query, the user specifies what have been called *print/delete options*. These are represented by the characters P and D. Their meaning is as follows:

- P Print the records satisfying this query.
- PD Print the records satisfying this query and delete them from the data base.
- D Delete the records satisfying this query from the data base but do not print them.

Although none of the examples of listings 4 thru 10 specifies the delete option, it will be discussed more fully later.

The query of listing 4 is a request for all applications dated since No-

ember 1, 1978. Five records satisfy this condition, and examination of the contents of the entire file (listing 1a) reveals that these are indeed the only records that satisfy the query.

The remaining examples are interpreted as follows:

- Listing 5 prints all records such that the applicant has either a Bachelor or Master of Arts or Science and his major was computer science or mathematics.
- Listing 6 prints all records satisfying two conditions. The first condition is that the applicant has either a Bachelor or Master of Science degree with a major in mechanical engineering or his primary area of interest is product engineering and he has more than 1 year of experience in that area. The second condition is that the application is dated September, 1978, or later.
- Listing 7 prints all records such that the application is dated during October, 1978.
- Listing 8 prints all records such that the applicant's primary area of interest is technical research and he

Text continued on page 144

```
LNAME = JONES
DATE > 78 /00 /00
```

(a)

```
1 AND:
  2 INT1 = TECHNICAL RESEARCH
  2 EXP2 > 1
```

(b)

```
1 OR:
  2 AND:
    3 DEG = BS
    3 MJR = COMPUTER SCIENCE
    3 INT1 = COMPUTER SCIENCE
    3 EXP1 > 1
  2 AND:
    3 INT1 = COMPUTER SCIENCE
    3 EXP1 > 3
```

(c)

Figure 5: Examples of valid data queries. Figure 5a presents two examples of simple (one condition) queries; note the absence of numbers at the beginning of the line. Figures 5b and 5c are compound (multiple condition) queries. Refer to the text for an English interpretation of these queries.

THE NATIONS LEADER IN AFFORDABLE PRINTERS

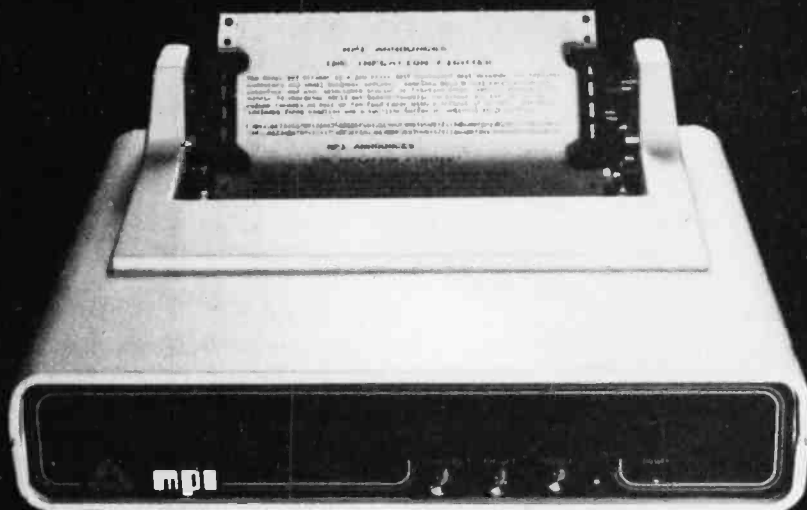

\$749

*Suggested retail price, substantial OEM and dealer discounts available.

The first in a series of new printers designed specifically for the general use computer market, the MODEL 88T DOT MATRIX PRINTER combines quality construction and attractive styling with capabilities generally associated only with more expensive printers. The Model 88T comes standard with a dual tractor pressure-roll paper feed system and a serial/parallel interface. The tractor paper feed system provides the precision required to handle multi copy fanfold forms, ranging in width from 1 inch to 9.5 inches. The pressure-roll paper feed can be used with 8.5 inch roll paper. An optional sheet feeder is available for feeding single sheets. A long life ribbon cartridge gives crisp, clean print without messy ribbon changing. The microprocessor based controller has 80, 96, 120 or 132 column formatting capability while printing upper and lower case characters bi-directionally at 100 characters per second. Write specifications, pricing for complete and distributor list.



MICRO PERIPHERALS, INC.

2099 WEST 2200 SOUTH / SALT LAKE CITY, UTAH 84119 (801) 973-6053

Circle 88 on inquiry card.

Make your micro

MIIGHTY!



Get the most out of your microcomputer with Graham-Dorian Business software.

At any given time, your hardware is only as useful as the software you insert in it.

So it pays to rely on Graham-Dorian, the software that gets your micro performing to its fullest — almost like a mini.

Graham-Dorian, the industry leader, offers highly detailed and well-documented programs. All pretested on the job. Each so comprehensive that it takes little time to learn to run a program — even for someone who's never operated a computer before.

Programs are compatible with most major computers using CP/M disk operating systems, and come in standard 8" or on various mini-floppy disks. Each package contains the software program in INT and BAS file form plus a user's manual and hard copy source listing. Graham-Dorian stands behind dealers with technical advice.

Yes, there's a world of difference in business software. Graham-Dorian has more per-package capabilities and more packages. (With new ones added every few months.)

The Graham-Dorian line now includes these packages:

- Medical
- Dental
- Surveying
- Inventory
- Payroll
- Apartment Management
- Construction Job Costing
- Accounts Receivable
- Accounts Payable
- General Ledger
- Cash Register
- CBASIC-2

Ask your dealer for a demonstration soon.



**Graham-Dorian
Software Systems, Inc.**

211 North Broadway / Wichita, KS 67202 / (316) 265-8633

Listing 4: A simple file query. In this dialogue, the user asks the computer for all records with an application date of November 1978 or later. The five records printed satisfy this criterion.

```

ENTER A COMMAND
#QUERY
ENTER NAME OF FILE TO QUERY
> EMPFL1
ENTER PRINT/DELETE OPTIONS, AND QUERY (RETURN=CR)
> P
> DATE> 78/11/00

REC# 3
DATE      = 78/11/08
LNAM      = BLACKWELL
FNAM      = LARRY
INIT      = W
ADDR      = 8180 PALLISTER DETROIT MI
TEL#      = 871-9167
DEG       = BA
MJR       = GENERAL BUSINESS
INT1      = SALES/MARKETING
INT2      = PURCHASING
EXP1      = 4
EXP2      = 2

REC# 4
DATE      = 78/11/12
LNAM      = KRAFT
FNAM      = PATRICK
INIT      = A
ADDR      = 26044 VILLAGE PLYMOUTH MI
TEL#      = 445-6176
DEG       = MS
MJR       = MATHEMATICS
INT1      = PRODUCT ENGRG
INT2      = MANUFACTURING ENGRG
EXP1      = 2
EXP2      = 0

REC# 5
DATE      = 78/11/02
LNAM      = HACKMAN
FNAM      = GERALD
INIT      = R

ADDR      = 292 CARDWELL TOLEDO OH
TEL#      = 222-5752
DEG       = BA
MJR       = GENERAL BUSINESS
INT1      = SALES/MARKETING
INT2      = QUALITY CONTROL
EXP1      = 7
EXP2      = 0

REC# 12
DATE      = 78/12/10
LNAM      = PALINDROME
FNAM      = ANTHONY
INIT      = J
ADDR      = 43441 DARTMOUTH NOVI MI
TEL#      = 447-3902
DEG       = BS
MJR       = ELECTRICAL ENGRG
INT1      = TECHNICAL RESEARCH
INT2      = PRODUCT ENGRG
EXP1      = 15
EXP2      = 2

REC# 20
DATE      = 78/11/20
LNAM      = SMITH
FNAM      = HENRY
INIT      = M
ADDR      = 130 BARD DEARBORN MI
TEL#      = 469-7412
DEG       = MS
MJR       = MECHANICAL ENGRG
INT1      = PRODUCT ENGRG
INT2      = NONE
EXP1      = 3
EXP2      = 0

ENTER PRINT/DELETE OPTIONS, AND QUERY (RETURN=CR)
>
ENTER A COMMAND

```

Listing 5: A compound file query. The logical operators on a given level (the line number at the beginning of a line) link all entries of the next lowest level (the next higher line number). The query is for all applicants who have any degree (BA, BS, MA, or MS) in either mathematics or computer science. Three records satisfy this query.

```

ENTER A COMMAND
#QUERY
ENTER NAME OF FILE TO QUERY
> EMPFL1
ENTER PRINT/DELETE OPTIONS, AND QUERY (RETURN=CR)
> P
> 1 AND:
>   2 OR:
>     3 DEG = BS
>     3 DEG = BA
>     3 DEG = MA
>     3 DEG = MS
>   2 OR:
>     3 MJR = COMPUTER SCIENCE
>     3 MJR = MATHEMATICS
>

REC# 4
DATE      = 78/11/12
LNAM      = KRAFT
FNAM      = PATRICK
INIT      = A
ADDR      = 26044 VILLAGE PLYMOUTH MI

TEL#      = 445-6176
DEG       = MS
MJR       = MATHEMATICS
INT1      = PRODUCT ENGRG
INT2      = MANUFACTURING ENGRG
EXP1      = 2
EXP2      = 0

REC# 18
DATE      = 78/09/15
LNAM      = KOHN
FNAM      = ROBERT
INIT      = C
ADDR      = 6565 ABNER SOUTHFIELD MI
TEL#      = 533-8452
DEG       = BS
MJR       = COMPUTER SCIENCE
INT1      = COMPUTER PROGRAMMING
INT2      = NONE
EXP1      = 1
EXP2      = 0

```

Listing 5 continued on page 138

WORD PROCESSING SOFTWARE

National Microsoftware Producers ANNOUNCES

VTS/80TM

Video Typing System for 8080, 8085 and Z80's
**PROFESSIONAL QUALITY
WORD PROCESSING PACKAGE FOR
CP/M* COMPATIBLE MICROCOMPUTERS**

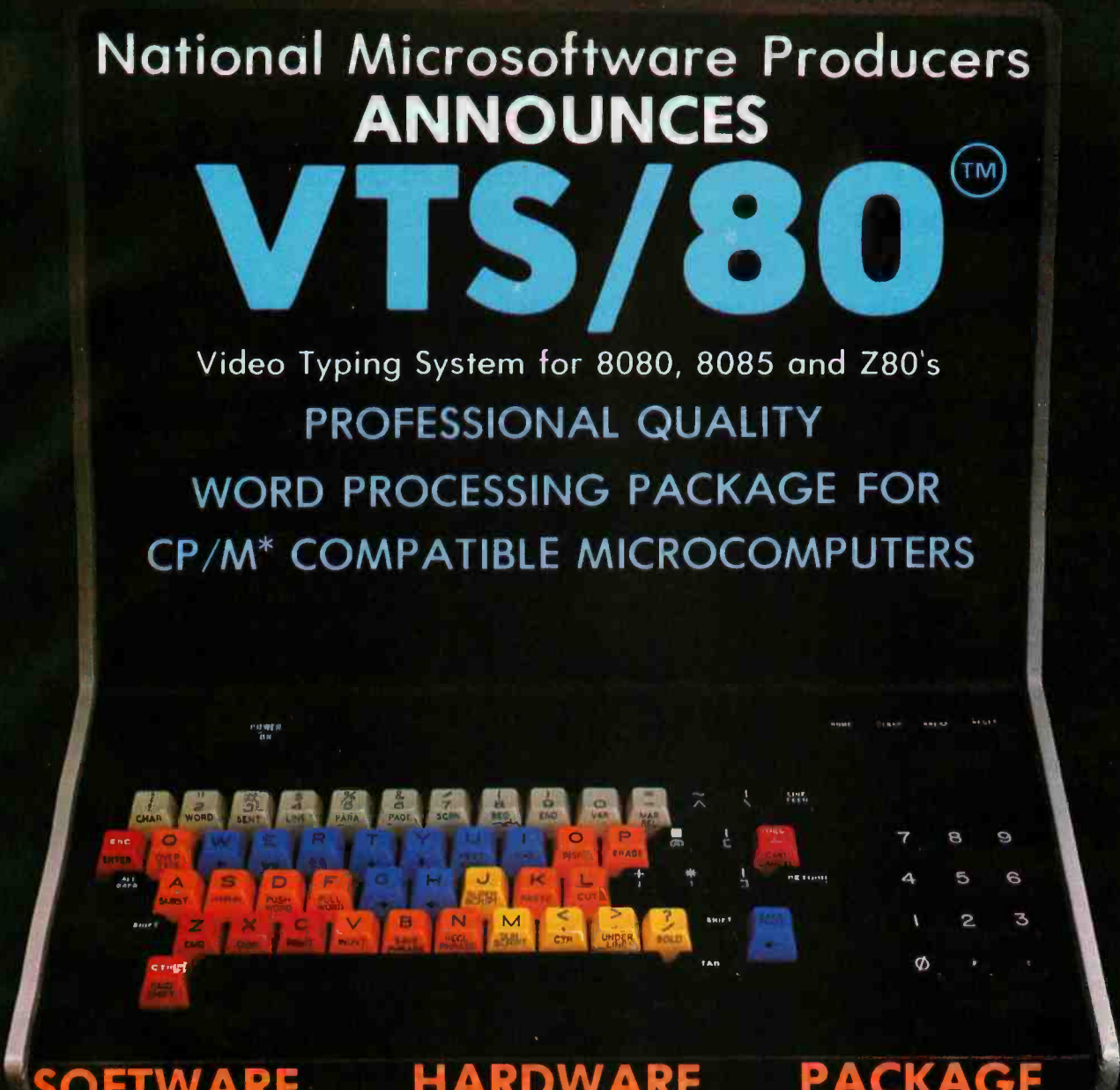

SOFTWARE

- CP/M COMPATIBLE
- EASILY OPERATED BY OFFICE PERSONNEL
- CONTAINS ALL PROFESSIONAL WORD PROCESSING FEATURES
- PROMPTS ON SCREEN GUIDE USER THROUGH FUNCTIONS
- COMPARABLE TO DEC, NBI, Q Y X, WANG . . .

HARDWARE

- OPERATES ON 8080, 8085 AND Z80 MICRO-COMPUTERS WITH 48K MEMORY
- CHOICE OF 5" OR 8" FLOPPY DISKETTES
- REPLACEMENT KEYTOPS PROVIDED FOR MOST CRT's
- SUPPORTS SERIAL AND WORD QUALITY PRINTERS (DIABLO, NEC, QUME)

PACKAGE

- REPLACEMENT KEYTOPS COLOR CODED BY FUNCTION
- MANUAL WITH EXTENSIVE GRAPHICS DESIGNED FOR THE FIRST-TIME USER
- SELF STANDING MANUAL IN EASEL BINDER
- SPANISH, FRENCH, GERMAN, DUTCH VERSIONS AVAILABLE

SOLD THROUGH AUTHORIZED DEALERS AND DISTRIBUTORS ONLY

O.E.M. INQUIRY INVITED

SUGGESTED RETAIL PRICE \$549.00



NATIONAL MICROSOFTWARE PRODUCERS, INC.
3169 FILLMORE STREET
SAN FRANCISCO CA 94123 USA
415-346-7025 TELEX 171790

* CP/M is a registered trademark of Digital Research

Listing 5 continued:

```

REC# 21
DATE = 78/07/06
LNAM = KYSER
FNAM = CYNTHIA
INIT = A
ADDR = 5820 MULBERRY WAYNE MI
TEL# = 666-9287
DEG = BS
MJR = COMPUTER SCIENCE
  
```

```

INT1 = COMPUTER PROGRAMMING
INT2 = TECHNICAL RESEARCH
EXP1 = 1
EXP2 = 0
  
```

```

ENTER PRINT/DELETE OPTIONS, AND QUERY (RETURN=CR)
>
ENTER A COMMAND
  
```

Listing 6: A compound file query. The query being made is explained in the text. Four records satisfy this query.

```

ENTER A COMMAND
#QUERY
ENTER NAME OF FILE TO QUERY
> EMPFL1
ENTER PRINT/DELETE OPTIONS, AND QUERY (RETURN=CR)
> P
> 1 AND:
> 2 OR:
> 3 AND:
> 4 OR:
> 5 DEG=BS
> 5 DEG=MS
> 4 MJR=MECHANICAL ENGRG
> 3 AND:
> 4 INT1=PRODUCT ENGRG
> 4 EXP1>1
> 2 DATE>78/09/00
>
  
```

```

TEL# = 581-2553
DEG = BS
MJR = MECHANICAL ENGRG
INT1 = PRODUCT ENGRG
INT2 = MANUFACTURING ENGRG
EXP1 = 1
EXP2 = 0
  
```

```

REC# 7
DATE = 78/09/29
LNAM = MALST
FNAM = DENNIS
INIT = R
ADDR = 1025 CHENE TOLEDO OH
TEL# = 333-4714
DEG = MS
MJR = MECHANICAL ENGRG
INT1 = PRODUCT ENGRG
INT2 = TECHNICAL RESEARCH
EXP1 = 8
EXP2 = 2
  
```

```

REC# 4
DATE = 78/11/12
LNAM = KRAFT
FNAM = PATRICK
INIT = A
ADDR = 26044 VILLAGE PLYMOUTH MI
TEL# = 445-6176
DEG = MS
MJR = MATHEMATICS
INT1 = PRODUCT ENGRG
INT2 = MANUFACTURING ENGRG
EXP1 = 2
EXP2 = 0
  
```

```

REC# 20
DATE = 78/11/20
LNAM = SMITH
FNAM = HENRY
INIT = M
ADDR = 130 BARD DEARBORN MI
TEL# = 469-7412
DEG = MS
MJR = MECHANICAL ENGRG
INT1 = PRODUCT ENGRG
INT2 = NONE
EXP1 = 3
EXP2 = 0
  
```

```

REC# 6
DATE = 78/09/28
LNAM = MARCHANT
FNAM = HAROLD
INIT = R
ADDR = 9670 TREELANE DEARBORN MI
  
```

```

ENTER PRINT/DELETE OPTIONS, AND QUERY (RETURN=CR)
>
ENTER A COMMAND
  
```

\$ GOLD DISK \$

CP/M® Compatible Z-80 Disassembler

- RECREATES Z-80 ASSEMBLY LANGUAGE SOURCE FILES FROM ABSOLUTE CODE (.COM FILES) FOR ALTERATION.
- FEATURES MNEMONIC LABELS FOR EASY PROGRAM TRACING.
- INCLUDES COMPLETE DOCUMENTATION AND FREE UTILITY FOR SPECIFYING AND DECODING ASCII SECTIONS OF CODE.
- OPERATES UNDER MINIMUM CP/M CONFIGURATION (16K RAM).
- DOCUMENTATION ONLY: \$12 (MAY BE APPLIED TO DISK ORDER).

\$62⁰⁰

POSTPAID

ONE DAY SERVICE FOR CREDIT CARD CUSTOMERS: ORDER DISK BY PHONE FREE! (WE WILL PAY YOU BACK FOR THE PHONE CALL) CALIF. RESIDENTS ADD 6% SALES TAX.



BOWER-STEWART & ASSOCIATES
P.O. BOX 1389
HAWTHORNE, CA. 90250
(213) 676-5055

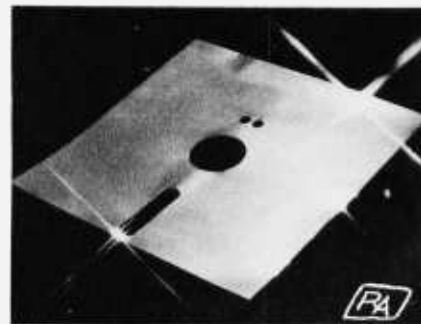

"WORTH ITS WEIGHT IN GOLD"

SPECIFY DRIVE AND SYSTEM
AVAILABLE ON 5 1/4" OR 8" IBM SS/SD DISK
CP/M IS A TRADEMARK OF DIGITAL RESEARCH

For those special people who've stepped ahead with a mini-computer.



Maxell offers a way to stay ahead.

A Maxell 5 1/4" Mini-Disk will consistently let you maximize the capability of your system today. And as your involvement with it grows, tomorrow as well. Maxell Mini-Disks are all made with the same exacting 100% certification and critical dependability of the Maxell 8" Floppy Disk. So you know your 5 1/4" Maxell Mini-Disks meet or exceed the same ISO and Shugart specifications industry requires.

There are double density Maxell single and double-sided 5 1/4" Mini-Disks for soft and hard sector systems. And 8" Maxell Floppy Disks for every disk drive configuration. See your computer supply dealer or write to us for more information. If you are a computer products dealer, write for the growing opportunities Maxell Business Products Division offers you with our 8" Floppy and 5 1/4" Mini-Disks.

maxell 
BUSINESS PRODUCTS DIVISION

Maxell Corporation of America, Business Products Division, 60 Oxford Drive, Moonachie, N.J. 07074 Tel: 201-440-8020

Circle 92 on inquiry card.

**You can talk to more
computers, faster and easier,
with the
VET/2 from SCOTT**



The Scott VET/2 is a compact, highly versatile Voice Entry Terminal developed for TRS-80 users — and available soon for the PET and APPLE computers. Key features of the VET/2 include:

- Easy to use — all programs may be written in Level II BASIC. One USRN statement is all that's needed to allow your program to be voice controlled.
- Performance comparable to systems costing \$10,000 or more.
- High accuracy (98+%) and fast recognition.
- Supplied with demo programs and software tools.
- Connects directly to screen printer I/O port.
- Simplified training mode with automatic prompting.
- Overlay features make vocabulary size virtually unlimited.

The user manual fully describes the operation and training procedures for the VET/2 and includes complete instructions on interfacing the VET with BASIC programs.

All hardware covered by 90-day warranty. Software guaranteed for replacement only. Prices subject to change without notice.

Send coupon or telephone today for more information!

SCOTT 815 North Elm
INSTRUMENTS Denton, Texas 76201 817/387-1054

Please place my order for:
 VET/2 (includes manual and shipping) \$898.50
 VET/2 Operator's Manual \$7.20
 Texas residents add 5% tax
 California residents add 6% tax

Payment Enclosed
 Master Charge
 VISA
 C.O.D.
 Exp. Date _____

Card No. _____

Ship to: _____

Address _____

City _____ State _____ Zip _____

Sig. _____ All orders must be signed.

Listing 7: A compound file query. The query is for all applications dated October, 1978. Four records satisfy this query.

```
ENTER A COMMAND
#QUERY
ENTER NAME OF FILE TO QUERY
> EMPFL1
ENTER PRINT/DELETE OPTIONS, AND QUERY (RETURN = CR)
> P
> 1 AND:
> 2 DATE > 78/10/00
> 2 DATE < 78/11/00
>
```

```
REC# 8
DATE = 78/10/19
LNAM = DUNNING
FNAM = ALLAN
INIT = G
ADDR = 1021 THIRD WYANDOTTE MI
TEL# = 888-7326
DEG = BS
MJR = EDUCATION
INT1 = COMPUTER PROGRAMMING
INT2 = QUALITY CONTROL
EXP1 = 0
EXP2 = 2
```

```
REC# 9
DATE = 78/10/05
LNAM = REDFORD
FNAM = KEVIN
INIT = D
ADDR = 17504 RANIER ALLEN PARK MI
TEL# = 277-4545
DEG = BA
MJR = ECONOMICS
INT1 = QUALITY CONTROL
INT2 = SALES/MARKETING
EXP1 = 3
EXP2 = 4
```

```
REC# 11
DATE = 78/10/10
LNAM = MAYNARD
FNAM = STEPHEN
INIT = L
ADDR = 36500 RUSHMORE FRANKLIN MI
TEL# = 835-4202
DEG = MS
MJR = PSYCHOLOGY
INT1 = INDUSTRIAL RELATIONS
INT2 = SALES/MARKETING
EXP1 = 1
EXP2 = 0
```

```
REC# 13
DATE = 78/10/04
LNAM = DAYTON
FNAM = THOMAS
INIT = F
ADDR = 2125 TULANE WESTLAND MI
TEL# = 666-3820
DEG = HS+
MJR = DRAFTING
INT1 = DESIGN/DRAFTING
INT2 = PRODUCT ENGRG
EXP1 = 6
EXP2 = 0
```

```
ENTER PRINT/DELETE OPTIONS, AND QUERY (RETURN = CR)
>
ENTER A COMMAND
```

CHRISLIN YEARS AHEAD IN MEMORY DESIGN

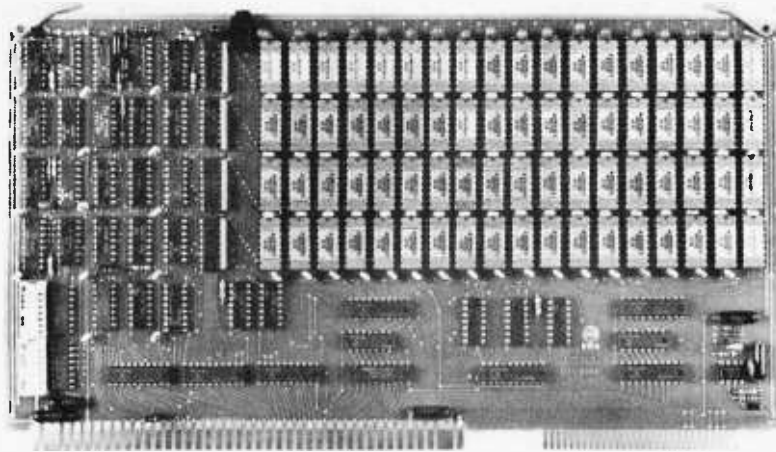

WE'VE DONE IT AGAIN — State of the Art Multibus® Memory Design. First to offer up to 512K on one board, and CHRISLIN again brings pricing sanity to the memory market. Why pay over \$2000 for our competitor's 64K x 8 memory board when we will give you the CI-8086 128K x 9 memory for just \$1500 or better yet, the CI-8086 512K x 9 memory module for \$4700.

Up to 512K bytes in a single option slot. Available in 64K, 96K, 128K, 256K, or 512K configurations. On board parity generator checker, for both 8 bit or 16 bit systems. Off shelf deliveries.

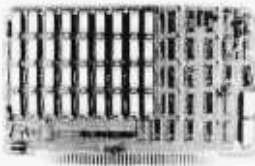

CI-6800-2 — 16KB to 64KB. Plugs directly into Motorola's EXORciser I or II. Hidden refresh up to 1.5 Mhz. Cycle stealing at 2 Mhz. Addressable in 4K increments with respect to VXA or VUA. On board parity. **64K x 9 \$995.00.**

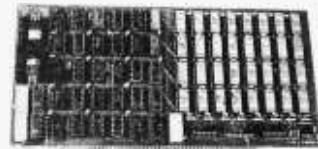

CI-S100 — 16KB to 64KB. Transparent hidden refresh. No wait states at 4 Mhz. Compatible with Alpha Micro and all Major 8080, 8085 and Z80 Based S100 Systems. Expandable to 512K bytes thru Bank Selections. **64K x 8 \$750.00.**

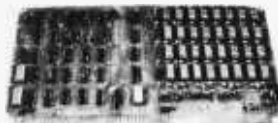

CI-8080 — 16KB to 64KB on a single board. Plugs directly into MDS 800 and SBC 80/10. Addressable in 4K increments up to 64K. **16KB \$390.00. 64KB \$750.00.**

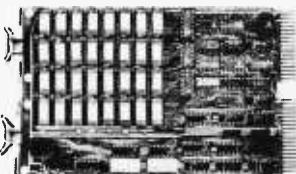

CI-1103 — 16KB to 256KB on a single dual height board. Plugs directly into LSI 11/2, H11 or LSI 11/23. Addressable in 2K word increments up to 256KB. **8K x 16 \$390.00. 32K x 16 \$750.00. 128K x 18 \$2880.00.**

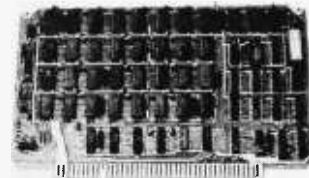

CI-6800 — 16KB to 64KB on a single board. On board hidden refresh. Plugs directly into EXORciser I and compatible with Rockwell's System 65. Addressable in 4K increments up to 64K. **16K x 8 \$390.00. 64K x 8 \$750.00.**

Tested and burned in. Full year warranty.

DON'T ASK WHY WE CHARGE SO LITTLE, ASK WHY THEY CHARGE SO MUCH.



Chrislin Industries, Inc.

Computer Products Division

31352 Via Colinas • Westlake Village, CA 91362 • 213-991-2254

Multibus is a trademark of the Intel Corp.

LSI II is a trademark of Digital Equipment Corp.

EXORciser is a trademark of Motorola

Listing 8: A compound file query. Here, the query is for an applicant who lists an MS in physics and a primary interest in technical research. No records satisfy this query.

```

ENTER A COMMAND
#QUERY
ENTER NAME OF FILE TO QUERY
> EMPFL1
ENTER PRINT/DELETE OPTIONS, AND QUERY (RETURN=CR)
> P
> 1 AND:
> 2 INT1 = TECHNICAL RESEARCH
> 2 DEG = MS
> 2 MJR = PHYSICS
>
***NO RECORDS SATISFY THIS QUERY***
ENTER PRINT/DELETE OPTIONS, AND QUERY (RETURN=CR)
>
ENTER A COMMAND

```

Listing 9: A compound file query. The query is for any application put in by Anthony J Palindrome. Since this query has a unique response, one record satisfies the query.

```

ENTER A COMMAND
#QUERY
ENTER NAME OF FILE TO QUERY
> EMPFL1
ENTER PRINT/DELETE OPTIONS, AND QUERY (RETURN=CR)
> P
> 1 AND:
> 2 LNAM = PALINDROME
> 2 FNAM = ANTHONY
> 2 INIT = J
>

```

```

REC# 12
DATE = 78/12/10
LNAM = PALINDROME
FNAM = ANTHONY
INIT = J
ADDR = 43441 DARTMOUTH NOVI MI
TEL# = 447-3902
DEG = BS
MJR = ELECTRICAL ENGRG
INT1 = TECHNICAL RESEARCH
INT2 = PRODUCT ENGRG
EXP1 = 15
EXP2 = 2

```

```

ENTER PRINT/DELETE OPTIONS, AND QUERY (RETURN=CR)
>
ENTER A COMMAND

```

Listing 10: A compound file query. The query here is for the applications of all applicants whose last name begins with K. Three records satisfy this query.

```

ENTER A COMMAND
#QUERY
ENTER NAME OF FILE TO QUERY
> EMPFL1
ENTER PRINT/DELETE OPTIONS, AND QUERY (RETURN=CR)
> P
> 1 AND:
> 2 LNAM < L
> 2 LNAM > J
>

```

```

REC# 4
DATE = 78/11/12
LNAM = KRAFT
FNAM = PATRICK
INIT = A
ADDR = 26044 VILLAGE PLYMOUTH MI
TEL# = 445-6176
DEG = MS
MJR = MATHEMATICS
INT1 = PRODUCT ENGRG
INT2 = MANUFACTURING ENGRG
EXP1 = 2
EXP2 = 0

```

```

REC# 18
DATE = 78/09/15
LNAM = KOHN
FNAM = ROBERT
INIT = C
ADDR = 6565 ABNER SOUTHFIELD MI
TEL# = 533-8452
DEG = BS
MJR = COMPUTER SCIENCE
INT1 = COMPUTER PROGRAMMING
INT2 = NONE
EXP1 = 1
EXP2 = 0

```

```

REC# 21
DATE = 78/07/06
LNAM = KYSER
FNAM = CYNTHIA
INIT = A
ADDR = 5820 MULBERRY WAYNE MI
TEL# = 666-9287
DEG = BS
MJR = COMPUTER SCIENCE
INT1 = COMPUTER PROGRAMMING
INT2 = TECHNICAL RESEARCH
EXP1 = 1
EXP2 = 0

```

```

ENTER PRINT/DELETE OPTIONS, AND QUERY (RETURN=CR)
>
ENTER A COMMAND

```

DEC LSI-11 Components

Dependable service
at discount prices

Domestic
and Export

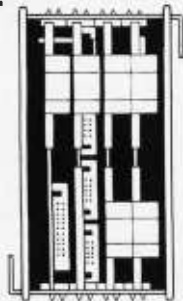

Mini
Computer Suppliers, Inc.

25 Chatham Rd., Summit, N.J. 07901
Since 1973

(201) 277-6150 Telex 13-6476

©Mini Computer Suppliers, Inc.
1979

UniFLEX™



Multi-User

UniFLEX is the first full capability multi-user operating system available for microprocessors. Designed for the 6809 and 68000, it offers its users a very friendly computing environment. After a user 'logs-in' with his user name and password, any of the system programs may be run at will. One user may run the text editor while another runs BASIC and still another runs the C compiler. Each user operates in his own system environment, unaware of other user activity. The total number of users is only restricted by the resources and efficiency of the hardware in use.



Multi-Tasking

UniFLEX is a true multi-tasking operating system. Not only may several users run different programs, but one user may run several programs at a time. For example, a compilation of one file could be initiated while simultaneously making changes to another file using the text editor. New tasks are generated in the system by the 'fork' operation. Tasks may be run in the background or 'locked' in main memory to assist critical response times. Inter-task communication is also supported through the 'pipe' mechanism.



Support

The design of UniFLEX, with its hierarchical file system and device independent I/O, allows the creation of a variety of complex support programs. There is currently a wide variety of software available and under development. Included in this list is a Text Processing System for word processing functions, BASIC interpreter and precompiler for general programming and educational use, native C and Pascal compilers for more advanced programming, sort/merge for business applications, and a variety of debug packages. The standard system includes a text editor, assembler, and about forty utility programs. UniFLEX for 6809 is sold with a single CPU license and one years maintenance for \$450.00. Additional yearly maintenance is available for \$100.00. OEM licenses are also available.

FLEX™

UniFLEX is offered for the advanced microprocessor systems. FLEX, the industry standard for 6800 and 6809 systems, is offered for smaller, single user systems. A full line of FLEX support software and OEM licenses are also available.



Box 2570, West Lafayette, IN 47906
(317) 463-2502 Telex 276143

™UniFLEX and FLEX are trademarks of Technical Systems Consultants, Inc.

Text continued from page 134:

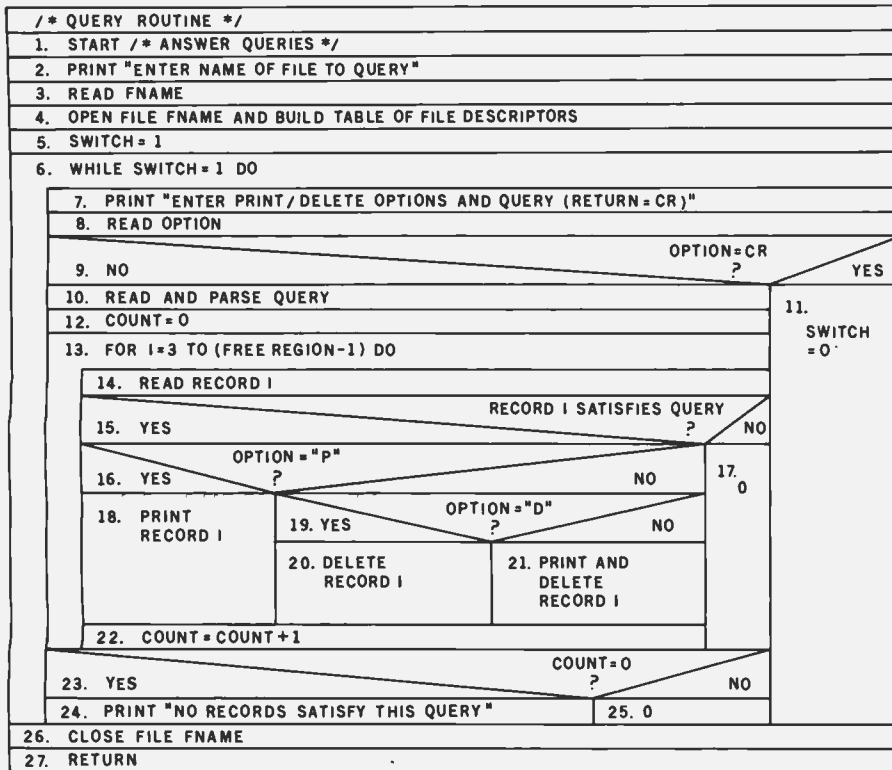

Figure 6: Nassi-Schneiderman chart for the query-answering routine in segment 4. This routine prompts the user for the selection criteria of records to be listed and possibly deleted.

- has a Master of Science degree with a major in physics. (As can be seen, no records satisfy these conditions.)
- Listing 9 is a request for the record containing information about the applicant Anthony J Palindrome.
- Listing 10 is simply a request for all records such that the applicant's surname begins with a K.

Now that we have examined the query language and the operation of the query routine from the user's viewpoint, we will look at the algorithms that parse queries and determine whether or not records satisfy them.

The flowchart for the query routine is given in figure 6. It is self-explanatory with two major exceptions, steps 10 and 15. (Note that step 4 performs the same operations that were discussed with respect to the input routine.) To illustrate the parsing and answering of queries, follow an example through these operations. The query that will be parsed is that of listing 6 on page 138, and a trace of how it is answered for record number 4 will be followed.

The query is read in line by line as the user enters it. Once a line is read, it is broken down into components that are stored in one or more arrays as shown in figure 7a. After each line is read, it is left justified, and the first two characters are taken to be a level number, which is converted to integer form. Thus, the first line is found to have a level number of 1. The line is then shifted left, throwing away the level number and any succeeding blanks. Because the level number is expected first, tags may not use a number as the first character. If a level number is not found, it is assumed that the query is a simple one. The first four characters of the line are then examined to determine whether or not it is a logical operation. This is accomplished simply by checking for one of the character strings "AND:" or "OR:". The presence of a colon in the string is actually what identifies it as a logical operation, and this is the reason why tags may not use this character.

At this point, it is known that line 1 is an AND operation. The type of operation and its level number are then put in array 1 as shown in figure 7a. No further processing of this line is

MULTI-TERMINAL COMPUTERS

Attention COMPUTER DEALERS!

THE NEW IBC SYSTEM 40 OFFERS MULTI-USER PERFORMANCE AT SINGLE-USER PRICES.

- Up to 6 CRT/printers can operate independently and simultaneously.
- 64K to 128K BYTE memory.
- 2-24 M BYTE disk storage.
- Multi-user wordprocessing concurrent with data processing.

The IBC System 40 was designed from the ground up to be a true multi-user, multi-tasking computer, and at prices below those of single-user systems. For pricing and complete information on IBC dealerships contact

IBC / Integrated Business Computers

22010 S. Wilmington Ave., Suite 306, Carson, CA 90745 (213) 518-4245

What's the difference between BASIC and Pascal?

COMPARE THESE APPROACHES TO DRAWING A CIRCLE

in BASIC

"This is easy..."

```
100 MOVE R,0
110 FOR T=0 TO 360 STEP 25
120 DRAW R*COS(T), R*SIN(T)
130 NEXT T
```

"Oops, didn't quite meet ..."

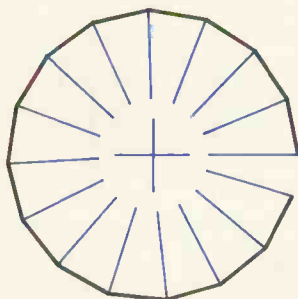

... but that's easy to fix."

```
100 MOVE R,0
110 FOR T=0 TO 360 STEP 25
120 DRAW R*COS(T), R*SIN(T)
130 NEXT T
```

"Oh, now it closes ...
in fact, it overlaps."

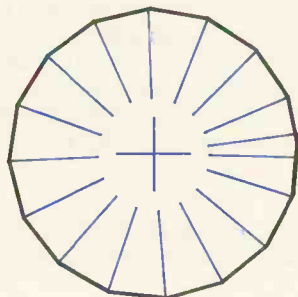

Programming by trial and error

in Pascal

"The simplest circle drawn with line segments is a regular polygon..."

```
procedure Circle (X, Y, Radius: real);
const Sides = 16; Pi = 3.14159265;
var N: integer; Theta: real;
begin
  Move (X+Radius,Y);
  for N := 1 to Sides do begin
    Theta := 2 * Pi * (N/Sides);
    Draw (Radius * cos (Theta) + X,
          Radius * sin (Theta) + Y);
  end;
end;
```

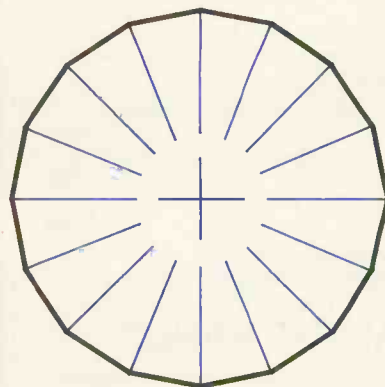

Programming by design

GET IT RIGHT THE FIRST TIME

INTERNATIONAL DISTRIBUTORS

Australia: Sydney Network Computer Services 211-2322	Japan: Tokyo Rikei Corporation 03-345-1411
Canada: Vancouver Valley Software (804) 291-0651	W. Germany: Aachen AC Copy 241/50-60-96
England: London Real Time Products 01-588-0667	W. Germany: Munich PCS 089/68-10-21

If you like the feel of precision tools, give us a call or return this coupon.

BY10

Oregon Software

2340 SW Canyon Road
Portland, Oregon 97201
(503) 226-7760 • TWX 910-464-4779

Name _____

Firm _____

Address _____

City _____

State _____ Zip _____

SOFTWARE
SOFTWARE
DIGITAL MARKETING
DIGITAL MARKETING™

PASCAL/M™

CP/M™ compatible language for 8" 8080/Z80 CPU's, NorthStar 2D, Cromemco CDOS & Micropolis MOD II.

- Random access files
- Runtime debug support
- Over 45 extensions to Standard Pascal

\$175. Manual alone - \$10.
NOW AVAILABLE:
MP/M™ VERSION - \$225.

ACT™

CP/M compatible macro assembler for Z80, 8080/85, 6502, & 6800.

FINALLY, one assembler that supports all major 8 bit micros and runs under CP/M. ACT is available NOW in 8" soft sector, NorthStar CP/M & Micropolis MOD II CP/M formats.

\$125. Manual alone - \$15.
NOW AVAILABLE:
ACT II - INCLUDES ALL OF THE ABOVE PLUS 8086/88 SUPPORT - \$150.

PEARL™

The application software generator.

Pearl asks questions that a programmer would have to answer to code the system. You answer the questions & Pearl uses built-in logic to construct both subroutines & mainline programs. The system then compiles & executes your program code.

- Level 1: For Personal Computing - \$130.
- Level 2: The Business Assistant - \$350.
- Level 3: Advanced Software Development - \$650.

CBASIC2™ required.
Manuals alone - \$25. each

MAGIC WAND™

CP/M-based word processing system for 8" soft-sectored & 5 1/4" NorthStar or Micropolis.

- Full screen text editing
- Full text formatting commands
- Merging with external data files
- Variables
- Conditional commands
- True proportional printing

\$350.

2670 Cherry Lane
Walnut Creek, CA 94596
(415) 938-2880

Pascal/M & ACT are trademarks of Sorcim
CP/M & MP/M are trademarks of
Digital Research
Pearl is a trademark of Computer Pathways
CBASIC is a trademark of Compiler Systems
Magic Wand is a trademark of
Small Business Applications
Add \$4 for shipping USA
Outside USA add \$10 for postage & handling

ARRAY 1:	ARRAY 2:	ARRAY 3:	ARRAY 4:
LEVEL AND LOGICAL OPERATOR (IF ANY)	TAG NUMBER	RELATIONAL OPERATOR	VALUE
AND, 1			
OR, 2			
AND, 3			
OR, 4			
5	7	=	BS
5	7	=	MS
4	8	=	MECHANICAL ENGRG
AND, 3			
4	9	=	PRODUCT ENGRG
4	11	>	1
2	1	>	78/09/00

(a)

WORKING ARRAY	ARRAY												
	1	2	3	4	5	6	7	8	9	10	11	12	13
5	AND,1	AND,1	1	1	1	1	1	1	1	1	1	1	1
4	OR,2	OR,2	0	0	0	0	0	0	0	0	0	0	0
3	AND,3	AND,3	1	1	1	1	1	1	1	1	1	1	1
2	OR,4	OR,4	0	0	0	0	0	0	0	0	0	0	0
5	>		0	0	0	-1	-1	-1	-1	-1	-1	-1	-1
5	=		1	1	1	1	-1	-1	-1	-1	-1	-1	-1
4	<		0	0	0	0	0	0	0	0	0	0	0
1	AND,3	AND,3	1	1	1	1	1	1	1	1	1	1	1
4	=		1	-1	-1	-1	-1	-1	-1	-1	-1	-1	-1
4	>		1	1	-1	-1	-1	-1	-1	-1	-1	-1	-1
2	>		1	1	1	1	1	1	1	1	1	1	1

ANSWER SIMPLE
QUERIES AND SET
ANDS TO 1-
ORS TO 0

(b)

Figure 7: Classification of records according to the query criteria. Figure 7a demonstrates the breakdown of a set of query criteria (the query shown in listing 6) as the first step in determining whether or not a given record matches the query criteria. Figure 7b presents the process by which a record (record number 4) is compared against the query criteria. The algorithm for this process is given in table 3. The circled areas in steps 4 thru 13 show the amount of the array that has been or is being processed to evaluate the compound query line (one using a logical operation) with the number at the left-hand and bottom sides of figure 7b. The result of the comparison is in the upper right-hand number in the circled area.

done. Lines 2 thru 4 are treated in a similar fashion and are also entered in array 1.

Line 5 is found to have a level number of 5. However, the check for a logical operator fails, and it must be parsed further. First, the line is scanned to find the relational operator. This having been found, the characters preceding it are isolated and compared to the table of tags until a match is made. In this case, it is tag number 7. A "7" is entered in array 2. The previously found relational operator is entered in array 3. The first nonblank character following the relational operator is then found and the remainder of the

line is taken to be the value. This value is justified within a field according to the type associated with the tag found and is stored in array 4. The remainder of the lines in the query are further examples of the two cases that have just been detailed, and will result in the arrays shown in figure 7a.

Now that the query has been parsed, a trace will be followed (figure 7b) of how it is determined whether or not a record satisfies the query.

Since this process involves modifying array 1, a copy of it is made (we will refer to this copy as the *working array*). Obviously, this is necessary because the answering algorithm will

Suddenly, RCA makes talking to your computer a lot cheaper.

New interactive data terminal with color graphics—only \$369.*



RCA's new VP-3301 is a professional quality, ASCII encoded, interactive data terminal, suitable for a wide variety of industrial, educational, business and individual applications requiring interactive communication between computer and user. Connects directly to your computer or to a standard modem for over the phone access to time sharing networks and data bases. And it's compatible with networks such as those provided by CompuServe Information Services and Source Telecomputing Corp. Microprocessor intelligence and LSI video control integrated circuits bring performance, features and flexibility at a low price. Operates from 5 volt power supply (included).

Unique color locking circuitry creates sharp, jitter free, true color graphics and rainbow free characters.

You can display the entire field of characters in any of 8 colors against any of 8 background colors (8 gray scales with monochrome monitors). Or to add special emphasis, you can display individual letters, words or lines in different colors or in reverse video.

The VP-3301 offers you a choice of two software-selectable display formats: Either 40 characters by 24 lines. Or 20 characters by 12 lines.

The terminal's resident character set consists of 52 upper and lower case alphabets, 10 numerals, 32 punctuation/math symbols and 31 control characters.

You can also define a total of 125 of your own characters. Including: Greek letters and other foreign alphabets, graphic symbols, large graphics building blocks, playing card suits, unique character fonts and "little green men."

The keyboard section features flexible-membrane key switches with contact life rated at greater than five million operations. A finger positioning overlay and positive keypress action give good operator "feel".

An on-board sound generator and speaker provides aural feedback for key presses and may also be activated with escape sequences to provide an audio output.

The sealed keyboard surface is spill proof and dust proof. This, combined with high noise immunity CMOS circuitry, makes the VP-3301 ideal for hostile environments.

Output is industry standard asynchronous RS232C or 20 mA current loop with 6 switch-selectable baud rates and 8 selectable data formats.

You can connect the terminal directly to a 525 line color or monochrome monitor. Or to a standard TV set using your RF modulator.

For more information, contact RCA MicroComputer Marketing, New Holland Avenue, Lancaster, PA.

Or call our toll-free number: 800-233-0094.

*Suggested user price.

RCA

be repeated for every record in the data base.

The first step is to answer all of the simple queries. In this case, there are six of them. They may be identified within array 1 by an entry consisting only of a level number. Thus, as array 1 is scanned from beginning to end, the first simple query encountered corresponds to line 5

("DEC=BS"). The value to be used in the comparison is in the corresponding element of array 4, and the tag number, which will allow us to find the field in record 4 to compare this value to, is in the first element of array 2. Making the comparison, we find that the value in record 4 ("MS") is greater than the value in array 4 ("BS"). The results of this comparison

replace the level number in the working array. The results of the tests indicated by the other five simple queries are entered in the working array in a completely analogous fashion. The results of this step are shown in column 2 of figure 7b.

Next, the results of the comparisons just made are compared with the corresponding relation stored in array 3. If they are the same, the entry in the working array is replaced by a 1 (true), otherwise with a 0 (false). For example, the first simple query (line 5) is false (the degree field does not equal "BS"). This is indicated by a 0 in the working array. Finally, ANDs are replaced by 1s and ORs by 0s. This completes the transformation from column 2 to column 3.

At this point, we are ready to perform the logical operations indicated. The algorithm which does this is given in table 3. Applying this algorithm to array 1 and the working array will yield the final result in the first element of the working array. In this case, that element is a 1 and, therefore, record 4 satisfies the query. The transformations that the working array goes through are shown in columns 4 thru 13 of figure 7b.

One last point should be made with respect to the flowchart of figure 6. This concerns steps 20 and 21 where records are deleted from the data base. A count n is kept of the number of records that satisfy a query, and when a record is encountered that does not, it is written to a new position within the file n records prior to its present position.

For example, if the file consists of six records, where record 3 satisfies the criteria for deletion, the process proceeds as follows. Record 1 is scanned; the value of n remains 0. Record 2 is then scanned; n remains 0. Because n is zero, no records are rewritten. Record 3 is next scanned and is found to be suitable for deletion. The value of n is increased to 1. Record 4 is scanned in turn and is found to be not suitable for deletion. The value of n stays at 1, but now record 4 is rewritten into position $4-n$ (ie: 3) within the file, thereby destroying record 3. When records 5 and 6 are examined, the value of n remains at 1, and record 5 is written into position 4 (ie: $5-n$) in the file, while record 6 goes into position 5 (ie: $6-n$). Once all records in the file have been checked, the file will be properly compacted and the pointer

```

1) I = INDEX OF LAST ELEMENT OF ARRAY 1
2) IF ARRAY 1 (I) ≠ LOGICAL OPERATION, GO TO 11
3) LEVEL = LEVEL NUMBER IN ARRAY 1 (I)
4) J = I
5) IF LEVEL NUMBER IN ARRAY 1 (J + 1) ≤ LEVEL, GO TO 11
6) IF WORKING ARRAY (J + 1) = - 1, GO TO 9
7) IF ARRAY 1 (I) = 'AND', THEN WORKING ARRAY (I) = LOGICAL AND OF WORKING
   ARRAY (I) WITH WORKING ARRAY (J + 1)
   ELSE WORKING ARRAY (I) = LOGICAL OR OF WORKING ARRAY (I) WITH WORKING
   ARRAY (J + 1)
8) WORKING ARRAY (J + 1) = - 1
9) J = J + 1
10) IF J < INDEX OF LAST ELEMENT OF ARRAY 1, GO TO 5
11) I = I - 1
12) IF I ≥ 1, GO TO 2
    ELSE STOP

```

Table 3: Algorithm for determining record status in relation to a compound query. This algorithm requires the record to be tested and the given query to be in the form of columns 1 thru 3 of figure 7b. It scans the table from bottom to top for the line with the highest-value level and a logical operator. It then calculates the result of that operation with all values below it having a higher-value level; then these lines just operated on are flagged as such with a -1. This operation is repeated until the entire query has been evaluated, giving a 1 if the record matches and a 0 otherwise.

4½ TIMES MORE STORAGE AT UNDER HALF THE COST!



**MS-80/160
Disk Drive
\$749.00**

Also available:
MS-80/80
\$549.00

Compatible with TRS-80, S-100 and Heath H-89

- Includes 5¼" disk drive, case, power supply, regulator board and EXTENDER CABLE. Extender Cable allows drives to be placed in any order easily — no more disassembly required!
- 80 Tracks per side.
- Can be used with or without Radio Shack drives.
- MS-80/160: (160 tracks)
4½ times more storage than Radio Shack.
- MS-80/80: (80 tracks)
2½ times more storage than Radio Shack.
- Shipped ready to run.
Also available Apparatus NEWDOS-80 \$149.00

Ask about our Disk Data Separator & Software

**MATCHLESS
SYSTEMS**

18444 S. Broadway
Gardena, CA 90248
(213) 327-1010

© 1980 Matchless Systems & MarketPlan



ΩMEGA
SALES
CO.

**"WHOLESALE COMPUTER PRICES"
DIRECT TO THE PUBLIC**

12 Meeting St., Cumberland, R.I. 02864

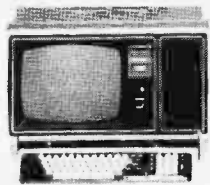

TRS-80
Model II - \$3,500



Apple II
16K - \$999



INTERTEC SUPERBRAIN
32K RAM - \$2449.00
64K RAM - \$2649.00

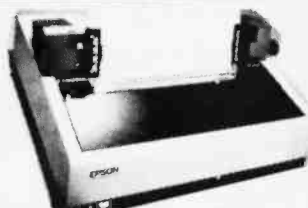

Epson TX-80 - \$699

PRODUCT SPECIAL OF THE MONTH!!

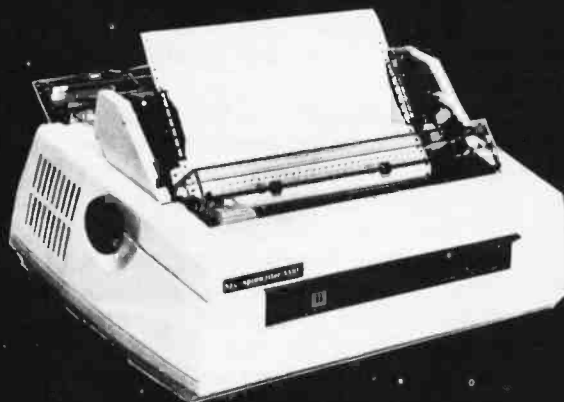

NEC 5510 Printer
\$2395
Tractor Feed Option
\$180



Atari 800
\$749



Soroc 120 - \$699

Products are
NOW
IN
STOCK
AT
ΩMEGA
Sales
Co.

CALL TOLL FREE FOR ΩMEGA'S PRICE!

ΩMEGA OFFERS THE BEST DELIVERY AND PRICE ON:

APPLE • ATARI • TRS-80 MODEL II • INTERTEC •
T.I. 810 • HEWLETT-PACKARD-85 • SOROC •
COMMODORE • NEC • QUME • CENTRONICS

ΩMEGA sells only factory fresh, top quality merchandise to our customers.
ΩMEGA will try to match any current advertised price with similar purchase conditions.
Before you buy anywhere else - be sure to call ΩMEGA Sales Co.
1-401-722-1027 or

ΩMEGA TOLL FREE: 1-800-556-7587

Overseas Inquiries Invited TELEX: 952106
ΩMEGA ships via UPS, truck, or air. COD's, VISA, Mastercharge accepted.

to the first free region is updated by subtracting from it the number of records satisfying the query (ie: n).

General Observations

The information-retrieval system that has been described is quite flexible in several respects. It allows the user to define and organize his data in ways which are meaningful to him and to interrogate that data in a manner that imposes few restrictions. Further, it should be possible to implement this system on virtually any disk-based machine that supports FORTRAN IV. The problems encountered should be fairly minor.

The greatest difficulty encountered with the Hewlett-Packard System 1000 was the fact that the configuration of the operating system did not allow for memory partition sizes sufficient to contain all of the information retrieval system in a single object-code module. Because of this, it was necessary to use overlays. Fortunately, the code was easily segmented since the processes of file creation, data entry, and query answering are mutually exclusive.

Other difficulties were encountered because of the use of FORTRAN IV. Since the language does not allow character-string variables, and Hewlett-Packard's version does not include a byte-length data type of any description, the necessary character manipulation became a bit troublesome.

A previous implementation used PL/I (on an IBM System/360) and employed an alternate query language. The syntax of a simple query was the same (ie: [tag,] [relational operator] [value]), with the exception of the use of enclosing parentheses. For example, the simple query of listing 4 becomes (DATE > 78/11/00). These simple queries were combined using logical operators "&" (AND) and "|" (OR), and enclosing parentheses. Using this notation, the example of listing 7 becomes ((DATE > 78/10/00) & (DATE < 78/11/00)), and the example in listing 6 becomes (((((DEG = BS) | (DEG = MS)) & (MJR = MECHANICAL ENGRG)) | ((INT1 = PRODUCT ENGRG) & (EXP1 > 1))) & (DATE > 78/09/00)). This parenthesized form is obviously somewhat cumbersome when more complex queries are formed; the meaning is obscured by the notation.

This provided the major motivation for the development of the query language present.

Having demonstrated the power of this system, it is also appropriate to mention some of its shortcomings and possible extensions to it. Although it is designed to handle most types of ASCII data, the representation of signed numbers poses a problem. For example, comparing the ASCII representation of the integers +123 and -123 will show that +123 is the smaller of the two, since "+" precedes "-" in the collating sequence.

Another limitation is that relations are not allowed between records. For example, if the personnel data base was to be extended to include a field for the name of the applicant's spouse, there would be no way to specify a query for a list of all applicants whose spouse had also filed an application. The only way to extract this information would be to manually check each application.

A final problem that should be mentioned concerns response time. For small data bases (perhaps a few hundred records or so) the response time should be quite tolerable. However, if the data base consists of several thousand records or more, the user could wait many minutes (or hours) for his reply. In this case, we prefer to be somewhat pragmatic by suggesting that this long response time is still better than searching all records manually.

If faster response times are necessary, the addition of secondary indices to the system should make a dramatic improvement. These indices would consist of small files (one for each field in a record) and would contain all unique values for a field along with pointers to the records containing the value. Thus, a query could be answered by examining a set of smaller files that normally would not need to be searched from beginning to end.

Another extension that would enhance the capabilities of the system is the inclusion of the logical operator NOT. This, along with AND and OR, would allow the synthesis of all Boolean operators (eg: NAND, NOR, XOR).

A final point concerns checking the syntax of queries. Although queries are checked for proper syntax on a line by line basis, there is no provi-

sion for checking the syntax of the entire query (eg: making sure that a logical operator is followed by at least two operands). In the present system, this responsibility is left to the user and it should be understood that errors will yield results that may be misleading.

In closing, it is important to emphasize that what has been presented is not intended to be a cookbook for the implementation of an information-retrieval system. However, we do feel that we have satisfied the goals stated at the outset and that the material presented is sufficiently comprehensive to allow other interested persons to implement similar systems and, perhaps, to expand upon ours. ■

The authors have developed a functionally-equivalent data-base package for the Radio Shack TRS-80 Model I microcomputer; the TRS-80 package uses the same query language and file structure as the FORTRAN system. Some additional features have been included, as well.

The TRS-80 package is coded partially in Disk BASIC and partially in Z80 assembly language, and it runs under version 2.2 of the TRSDOS operating system. For efficiency, the sort routine is coded entirely in assembly language.

The package is supplied on a single 5-inch floppy disk with a user's manual containing over one hundred pages. It may be obtained for \$99.95 from:

Microcosm Inc
POB 2034
Dearborn MI 48123

References

1. IBM System/360 Operating System PL/I (F) Language Reference Manual. Form GC28-8201-4 IBM Corporation, 1972.
2. Hewlett-Packard Real-Time Executive III Software System, Programming and Operating Manual. Library index number 2RTE.320.92060-90004.
3. Hewlett-Packard FORTRAN IV Reference Manual. Library index number 2FORTN.320.5951-1321.
4. Martin, James, Computer Data-base Organization. Prentice-Hall, Inc, 1970.
5. Nassi, I, and Schneiderman, B, Structured Flowcharts, Technical Report, State University of New York, Stony Brook.

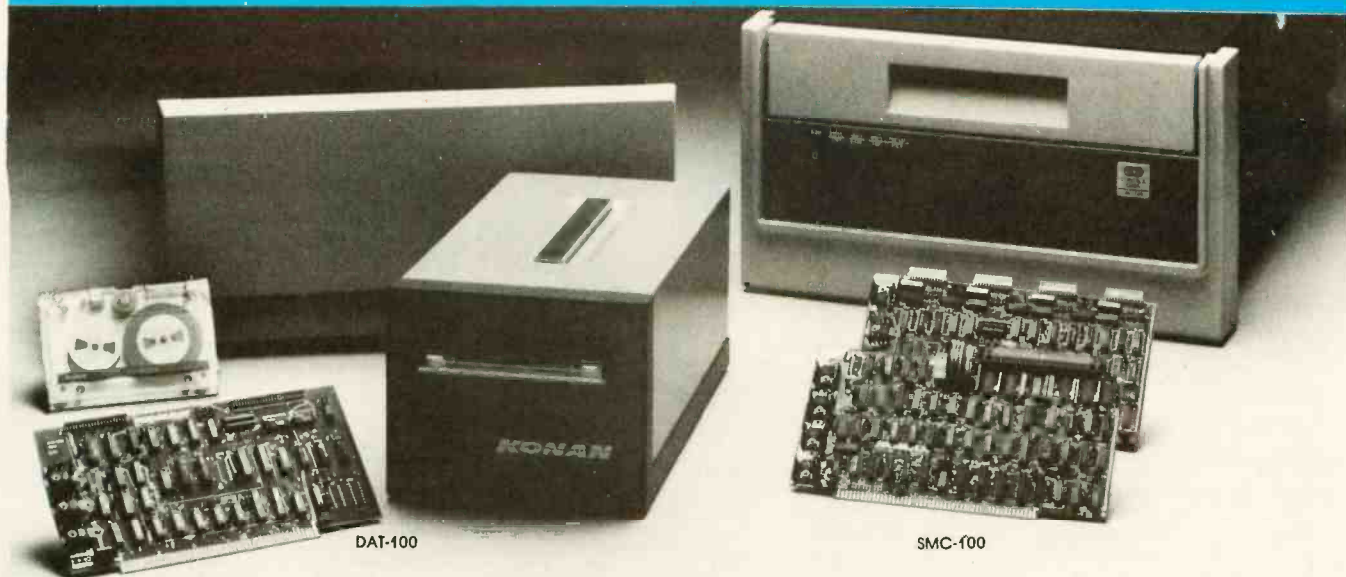

DAT-100

SMC-100

Hard disk and hardtape™ control

Up to 2400 Megabytes of hard disk control for the S-100 bus.

Konan's SMC-100 interfaces S-100 bus micro computers with all hard disk drives having the Industry Standard SMD Interface. It is available with software drivers for most popular operating systems. Each SMC-100 controls up to 4 drives ranging from 8 to 600 megabytes per drive, including most "Winchester" drives -- such as Kennedy, Control Data, Fujitsu, Calcomp, Microdata, Memorex, Ampex, and others.

SMC-100 is a sophisticated, reliable system for transferring data at fast 6 to 10 megahertz rates with onboard sector buffering, sector interleaving, and DMA.

SMC-100's low cost-per-megabyte advanced technology keeps your micro computer system micro-priced. Excellent quantity discounts are available.

Konan's HARDTAPE™ subsystem... very low cost tape and/or hard disk Winchester backup and more.

Konan's new DAT-100 Single Board Controller interfaces with a 17½ megabyte (unformatted) cartridge tape drive as well as the Marksman Winchester disk drive by Century Data.

The DAT-100 "hardtape" system is the only logical way to provide backup for "Winchester" type hard disk systems. (Yields complete hard disk backup with data verification in 20-25 minutes.)

Konan's HARDTAPE™ subsystem is available off the shelf as a complete tape and disk mass storage system or an inexpensive tape and/or disk subsystem.

Konan controllers and subsystems support most popular software packages including FAMOS™, CP/M® version 2.X, and MP/M.

Konan, first (and still the leader) in high-reliability tape and disk mass storage devices, offers OEM's, dealers and other users continuing diagnostic support and strong warranties. Usual delivery is off the shelf to 30 days with complete subsystems on hand for immediate delivery.

Call Konan's TOLL FREE ORDER LINE today:

800-528-4563

Or write to Bob L. Gramley
Konan Corporation, 1448 N. 27th Avenue
Phoenix, AZ 85009. TWX/TELEX 9109511552

CP/M® is a registered trade name of Digital Research,
FAMOS™ is a trade name of MVT Micro Computer Systems.
HARDTAPE™ is a trade name of Konan Corporation.

KONAN

Prices reflect distribution on 8" single density diskettes. If a format is requested which requires additional diskettes, a surcharge of \$8.00 per additional diskette will be added. A surcharge of \$25 will be added for software on CS50 format DC-30001 cartridges. Media charge for 5440 disk is \$100.

Software with Manual / Manual Alone

Software with Manual / Manual Alone

No.16: Take a byte.



Genuine CPM for Apple II Available now!

All Lifeboat programs require CP/M, unless otherwise stated. Software for most popular 8080/Z80 computer disk systems

Software with Manual / Manual Alone

Software with Manual / Manual Alone

CP/M™ FLOPPY DISK OPERATING SYSTEM—Digital Research's operating system configured for many popular micro-computers and disk systems.

System	Version	Price
Apple II	2.x	\$350/250
SoftCard™ with Z80		
Microsoft BASIC version 5		
with high resolution graphics		
North Star Single Density	1.4	\$145/25
North Star Double Density	1.4	\$145/25
North Star Single Density	2.x	\$170/25
North Star Double/Quad	2.x	\$170/25
Durango F-85	2.x	\$170/25
iCOM Micro-Disk 2411	1.4	\$145/25
iCOM 3712	1.4	\$170/25
iCOM 3812	1.4	\$170/25*
Mis 3202/Altair 8800	1.4	\$145/25
Health H8 + H17	1.4	\$145/25
Health H89	1.4	\$145/25
Health H89 by Magnolia	1.4	\$250/25
Health H89 by Magnolia	2.x	\$300/25
Onyx C8001	2.x	\$300/25
Ohio Scientific C3	2.x	\$200/25
TRS-80 Model I	1.4	\$145/25
TRS-80 Model II	2.x	\$170/25
TRS-80 Model II + Corvus	2.x	\$250/25
Processor Technology		
Helios II	1.4	\$145/25
Cromemco System 3	1.4	\$145/25
Intel MDS Single Density	1.4	\$145/25
Intel MDS Single Density	2.x	\$170/25
Microspolis Mod I	1.4	\$145/25
Microspolis Mod II	1.4	\$145/25

The following configurations are scheduled for release soon:

North Star Double/Quad + Corvus	2.x	\$250/25
North Star Horizon HD-1	2.x	\$250/25
Ohio Scientific C3-C	2.x	\$250/25
Microspolis Mod II	2.x	\$200/25
Mostek MDX STD		
Bus System	2.x	\$350/25**
iCOM 3812	2.x	\$225/25*
iCOM 4511/Pentec D3000	2.x	\$375/25*

Software consists of the operating system, text editor, assembler, debugger and other utilities for life management and system maintenance. Complete set of Digital Research's documentation and additional implementation notes included. Systems marked * and ** include firmware on 2708 and 2716. Systems marked + include 5440 media charge. Systems marked @ require the special @ versions of software in this catalog. Systems marked @ have minor variants available to suit console interface of system. Call or write for full list of options. @ includes hardware addition to allow our standard versions of software to run under it.

Z80 DEVELOPMENT PACKAGE—Consists of: (1) disk file editor, with global inter- and intra-line facilities; (2) Z80 relocating assembler, Zilog/Mostek mnemonics, conditional assembly and cross reference table capabilities; (3) linking loader producing absolute Intel hex disk file. \$95/\$20

ZDT—Z80 Monitor/Debugger to break and examine registers with standard Zilog/Mostek mnemonic disassembly displays. \$35 when ordered with Z80 Development Package. \$50/\$10

AVOCET SYSTEMS

XASM-68—Non-macro cross-assembler with nested conditionals and full range of pseudo operations. Assembles from standard Motorola MC6800 mnemonics to Intel hex. \$200/\$25

XASM-65—As XASM-68 for MOS Technology MCS-6500 series mnemonics. \$200/\$25

XASM-48—As XASM-68 for Intel MCS-48 and UPI-41 families. \$200/\$25

XASM-18—As XASM-68 for RCA 1802. \$200/\$25

DISTEL—Disk based disassembler to Intel 8080 or TDL/Xitan Z80 source code. Listing and cross reference files. Intel or TDL/Xitan pseudo ops optional. Runs on 8080. \$65/\$10

DISILOG—As DISTEL to Zilog/Mostek @ mnemonic files. \$65/\$10

SMAL/80 Structured Macro Assembler—Package of powerful general purpose text macro processor and SMAL structured language compiler. SMAL is an assembler language with IF-THEN-ELSE, LOOP-REPEAT-WHILE, DO-END, BEGIN-END constructs. \$75/\$15

PHOENIX SOFTWARE ASSOCIATES

PASM*—Z80 macro assembler, Intel/TDL mnemonics. Generates Intel hex format or relocatable code in either TDL Object Module format or PSA Relocatable Binary Module format. Supports text insertion, conditional branching within macros, recursive macro calls and parameter passing. \$129/\$25

EDIT—Character oriented text file editor. Includes macro definition capabilities. Handles insertion, deletion, searching, block move, etc. for files of any length. Does not require a CRT. \$129/\$25

PLINK*—Two pass disk-to-disk linkage editor/loader which can produce re-entrant, ROMable code. Can link programs that are larger than available memory for execution targeted on another machine. Full library capabilities. Input can be PSA Relocatable Binary Module, TDL Object Module or Microsoft REL files. Output can be a COM file, Intel hex file, TDL Object Module or PSA Relocatable file. \$129/\$25

BUG* and **μBUG***—Z80 interactive machine level debugging tools for program development. BUG has full symbolic trace and interactive assembly (mnemonics compatible with PASM). Dynamic breakpoints and conditional traps while tracing (even through ROM). μBUG is a subset of BUG and is used in memory limited situations. \$129/\$25

DIGITAL RESEARCH

MP/M—Installed for single density MDS-800. Multi-processing derivative of the CP/M operating system. Manual includes CP/M2 documentation. \$300/\$50

MAC-8080—Macro assembler. Full Intel macro definitions. Pseudo Ops include RPC, IRR, REPT, TITLE, PAGE, and MACLIB. Produces absolute hex output plus symbol table file for use by SID and ZSID (see below) \$120/\$15

SID-8080—Symbolic debugger. Full trace, pass count and breakpoint program testing. Has backtrace and histogram utilities. When used with MAC, provides full symbolic display of memory labels and equated values. \$105/\$15

ZSID-Z80—Symbolic debugger with all features of SID. \$130/\$15

TEX—Text output formatter to create paginated, page-numbered and justified copy. Output can be directed to printer or disk. \$105/\$15

DESPOOL—Utility program to permit simultaneous printing from text files while executing other programs. \$80/\$10

tiny C—Interactive interpretive system for teaching structured programming techniques. Manual includes full source listings. \$105/\$50

BDS C COMPILER—Supports most features of language, including Structures, Arrays, Pointers, recursive function evaluation, overlays. Includes linking loader, library manager, and library containing general purpose, file I/O, and floating point functions. Lacks initializers, statics, floats and longs. Documentation includes "The C PROGRAMMING LANGUAGE" by Kernighan and Ritchie. \$145/\$25

WHITESMITHS C COMPILER—The ultimate in systems software tools. Produces faster code than a pseudo-code Pascal with more extensive facilities. Conforms to the full UNIX Version 7 C language, described by Kernighan and Ritchie, and makes available over 75 functions for performing I/O, string manipulation and storage allocation. Linkable to Microsoft REL files. Requires 60K CP/M. \$630/\$30

MICROSOFT

BASIC-80—Disk Extended BASIC, ANSI compatible with long variable names, WHILE/WEND, chaining, variable length file records. \$325/\$25

BASIC COMPILER—Language compatible with BASIC-80 and 3-10 times faster execution. Produces standard Microsoft relocatable binary output. Includes MACRO-80. Also linkable to FORTRAN-80 or COBOL-80 code modules. \$350/\$25

FORTRAN-80—ANSI 66 (except for COM-@ PLEX) plus many extensions. Includes relocatable object compiler, linking loader, library with manager. Also includes MACRO-80 (see below). \$425/\$25

COBOL-80—Level 1 ANSI '74 standard COBOL plus most of Level 2. Full sequential, relative, and indexed file support with variable file names. STRING, UNSTRING, COMPUTE, VARYING/UNTIL, EXTEND, CALL, COPY, SEARCH, 3-dimensional arrays, compound and abbreviated conditions, nested IF. Powerful interactive screen-handling extensions. Includes compatible assembler, linking loader, and relocatable library manager as described under MACRO-80. \$700/\$25

MACRO-80—8080/Z80 Macro Assembler. Intel and Zilog mnemonics supported. Relocatable linkable output. Loader, Library Manager and Cross Reference List utilities included. \$149/\$15

muSIMP/muMATH—muSIMP is a high level programming language suitable for symbolic and semi-numerical processing. Implemented using a fast and efficient interpreter requiring only 7K bytes of machine code. muMATH is a package of programs written in muSIMP. The package performs sophisticated mathematical functions. Keeps track of up to 611 digits. Performs matrix operations on arrays: transpose, multiply, divide, inverse and other integer powers. Logarithmic, exponential, trigonometric simplification and transformation, symbolic differentiation with partial derivatives, symbolic integration of definite and indefinite integrals. Requires 40K CP/M. \$250/\$20

muLISP-79—Microcomputer implementation of LISP. The interpreter resides in only 7K bytes of memory yet includes 83 LISP functions. Has infinite precision Integer arithmetic expressed in any radix from 2 to 36. muLISP-79 includes complete trace facility and a library of useful functions and entertaining sample programs. \$200/\$15

XMACRO-86—8086 cross assembler. All Macro and utility features of MACRO-80 package. Mnemonics slightly modified from Intel ASM86. Compatibility data sheet available. \$275/\$25

EDIT-80—Very fast random access text editor for text with or without line numbers. Global and intra-line commands supported. File compare utility included. \$89/\$15

PASCAL/M*—Compiles enhanced Standard Pascal to compressed efficient Pcode. Totally CP/M compatible. Random access files. Both 16 and 32-bit integers. Runtime error recovery. Convariant STRINGS. OTHERWISE clause on CASE. Comprehensive manual (90 pp index). SEGMENT provides overlay structure. IMPORT/EXPORT and untyped files for arbitrary I/O. Requires 56K CP/M. Specific 8080 CP/M. 2) Z80 CP/M. or 3) Cromemco CDOs. \$175/\$20

PASCAL/Z—Z80 native code PASCAL compiler. Produces optimized, ROMable re-entrant code. All interfacing to CP/M is through the support library. The package includes compiler, relocating assembler and linker, and source for all library modules. Variant records, strings and direct I/O are supported. Requires 56K CP/M. \$395/\$25

PASCAL/MT—Subset of standard PASCAL. Generates ROMable 8080 machine code. Symbolic debugger included. Supports interrupt procedures, CP/M file I/O and assembly language interface. Real variables can be BCD, software floating point, or AMD 9511 hardware floating point. Includes strings enumerations and record data types. Manual explains BASIC to PASCAL conversion. Requires 32K. \$250/\$30

APL/V80—Concise and powerful language for application software development. Complex programming problems are reduced to simple expressions in APL. Features include up to 27K active workspace, shared variables, arrays of up to 8 dimensions, disk workspace and copy object library. The system also supports auxiliary processors for Interfacing I/O ports. Requires 48K CP/M and serial APL printing terminal or CRT. \$500/\$30

ALGOL-80—Powerful block-structured language compiler featuring economical run-time dynamic allocation of memory. Very compact (24K total RAM) system implementing almost all Algol 60 report features plus many powerful extensions including string handling direct disk address I/O etc. \$199/\$20

CBASIC-2 Disk Extended BASIC—Non-@ Interactive BASIC with pseudo-code compiler and run-time interpreter. Supports full file control, chaining, integer and extended precision variables, etc. \$120/\$15

MICRO FOCUS

STANDARD CIS COBOL—ANSI '74 COBOL standard compiler fully validated by U.S. Navy tests to ANSI level 1. Supports many features to level 2 including dynamic loading of COBOL modules and a full ISAM file facility. Also, program segmentation, interactive debug and powerful interactive extensions to support protected and unprotected CRT screen formatting from COBOL programs used with any dumb terminal. \$850/\$50

FORMS 2—CRT screen editor. Output is COBOL data descriptions for copying into CIS COBOL programs. Automatically creates a query and update program of indexed files using CRT protected and unprotected screen formats. No programming experience needed. Output program directly compiled by STANDARD CIS COBOL. \$200/\$20

EIDOS SYSTEMS

KISS—Keyed Index Sequential Search. Offers complete Multi-Keyed Index Sequential and Direct Access file management. Includes built-in utility functions for 16 or 32 bit arithmetic, string/integer conversion and string compare. Delivered as a relocatable linkable module in Microsoft format for use with FORTRAN-80 or COBOL-80, etc. \$335/\$23

KBASIC—Microsoft Disk Extended BASIC version 4.51 integrated by implementation of nine additional commands in language. Package includes KISS, REL as described above, and a sample mail list program. \$585/\$45 To licensed users of Microsoft BASIC-80 (MBASIC). \$435/\$45

XYBASIC Interactive Process Control BASIC—Full disk BASIC features plus unique commands to handle byte rotate and shift and to test and set bits. Available in several versions:

Integer ROM squared	\$350/\$25
Integer CP/M squared	\$350/\$25
Extended ROM squared	\$450/\$25
Extended CP/M	\$450/\$25
Extended Disk CP/M	\$550/\$25
Integer CP/M Run Time Compiler	\$350/\$25
Extended CP/M Run Time Compiler	\$450/\$25

RECLAIM—A utility to validate media under CP/M. Program tests a diskette or hard disk surface for errors, reserving the imperfections in invisible files, and permitting continued usage of the remainder. Essential for any hard disk. Requires CP/M version 2. \$80/\$5

BASIC UTILITY DISK—Consists of: (1) CRUNCH-14—Compacting utility to reduce the size and increase the speed of programs in Microsoft BASIC 4.51, BASIC-80 and TRS-80 BASIC. (2) DPFUN—Double precision subroutines for computing nineteen transcendental functions including square root, natural log, log base 10, sine, arc sine, hyperbolic sine, hyperbolic arc sine, etc. Furnished in source on diskette and documentation. \$50/\$35

STRING/80—Character string handling plus routines for direct CP/M BDOS calls from FORTRAN and other compatible Microsoft languages. The utility library contains routines that enable programs to chain to a COM file, retrieve command line parameters and search file directories with full wild card facilities. Supplied as linkable modules in Microsoft format. \$95/\$20

STRING/80 source code available separately. \$295/NA

THE STRING BIT—FORTRAN character string handling. Routines to find, fill, pack, move, separate, concatenate and compare character strings. This package completely eliminates the problems associated with character string handling in FORTRAN. Supplied with source. \$65/\$15

VSORT—Versatile sort/merge system for fixed length records with fixed or variable length fields. VSORT can be used as a stand-alone package or loaded and called as a subroutine from CBASIC-2. When used as a subroutine, VSORT maximizes the use of buffer space by saving the TPA on disk and restoring it on completion of sorting. Records may be up to 255 bytes long with a maximum of 5 fields. Upper/lower case translation and numeric fields supported. \$175/\$20

CPM/374X—Has full range of functions to create or re-name an IBM 3741 volume, display directory information and edit the data set contents. Provides full file transfer facilities between 3741 volume data sets and CP/M files. \$195/\$10

Coming Soon

CPAids*

MASTER TAX—Professional tax preparation program. Prepares schedules A, B, C, D, E, F, G, H, R/P, SE, TC, ES and forms 2106, 2119, 2210, 3468, 3903, 2441, 4625, 4726, 4797, 4972, 5695 and 6521. Printing can be on readily available, pre-printed continuous forms, on overlays, or on computer generated, IRS approved forms. Maintains client history files and is interactive with CPAids GENERAL LEDGER II (see below). \$995/\$30

STANDARD TAX—As above for schedules A, B, C, D, E, G, H, R/P, SE, TC and forms 2106 and 2441. Also, does not maintain client history files. \$495/\$30

GENERAL LEDGER II—Designed for CPAs. Stores complete 12 month detailed history of transactions. Generates financial statements, depreciation, loan amortizations, journals, trial balances, statements of changes in financial position, and compilation letters. Includes payroll system with automatic posting to general ledger. Prints payroll register, W2's and payroll checks. \$450/\$30

- T/MAKER**—Powerful new tool for preparing management reports with tabular data. Makes financial modeling projects easy. Do you want a weekly profitability report? Set up the table and compute. Just change the sales figures for next week and compute. You have a new report! T/MAKER includes a full screen editor for setting up tables which pages left, right, up and down. Compute includes standard arithmetic, percents, exponents, common transcendental functions, averages, maxima, minima, projections, etc. Requires 48K CP/M and CBASIC-2. **\$275/\$225**

- BSTAM**—Utility to link one computer to another also equipped with BSTAM. Allows file transfers at full data speed (no conversion to hex), with CRC block control check for very reliable error detection and automatic retry. We use it! It's great! Full wildcard expansion to send *.COM, *.EXE, *.OBJ and *.BAT with wildcards. Supports 6000 baud with wire, 300 baud with phone connection. Both ends need one. Standard and versions can talk to one another. **\$150/\$110**

- WHATSI??**—Interactive data-base system using associative tags to retrieve information by subject. Hashing and random access used for fast response. Requires CBASIC-2. **\$175/\$225**
- SELECTOR III-C2**—Data Base Processor to create and maintain multi-key data bases. Prints formatted sorted reports with numerical summaries or mailing labels. Comes with sample applications, including Sales Activity, Inventory, Payables, Receivables, Check Register, and Client/Patient Appointments, etc. Requires CBASIC-2. Supplied in source. **\$295/\$220**

- GLECTOR**—General Ledger option to SELECTOR III-C2. Interactive system provides for customized COA. Unique chart of transaction types insure proper double entry bookkeeping. Generates balance sheets, P&L statements and journals. Two year recording allows for statement of changes in financial position report. Supplied in source. Requires SELECTOR III-C2, CBASIC-2 and 56K system. **\$350/\$225**
- CBS**—Configurable Business System is a comprehensive set of programs for defining custom data files and application systems without using a programming language such as BASIC, FORTRAN, etc. Multiple key fields for each data file are supported. Set-up program customizes system to user's CRT and printer. Provides fast and easy interactive data entry and retrieval with transaction processing. Report generator program does complex calculations with stored and derived data, record selection with multiple criteria, and custom formats. Sample inventory and mailing list systems included. No support language required. **\$295/\$240**

MICRO DATA BASE SYSTEMS

- HDBS**—Hierarchical Data Base System. CODASYL oriented with FILES, SETS, RECORDS and ITEMS which are all user defined. ADD, DELETE, UPDATE, SEARCH, and TRAVERSE commands supported. SET ordering is sorted, FIFO, LIFO, next or prior. One to many set relationship supported. Read/write protection at the FILE level. Supports FILES which extend over multiple floppy or hard disk devices.
- MDBS**—Micro Data Base System. Full network data base with all features of HDBS plus multi-level read/write protection for FILE, SET, RECORD and ITEM. Explicit representation of one to one, one to many, many to many, and many to one SET relationships. Supports multiple one to one and multiple record types within SETs. HDBS files are fully compatible.
- HDBS-Z80 version** **\$250/\$40****
- MDBS-Z80 version** **\$750/\$40****
 8080 version available at \$75 extra.

When ordering, specify one of the language interfaces listed below. Additional language interfaces available at time of purchase for \$100 or \$125 if purchased later.

**The single manual covering HDBS and MDBS when purchased alone comes without specific language interface manual. Manuals are available for the following Microsoft languages:

1) MBASIC 4.51, 2) BASIC-80, 4.3) Compiled BASIC or FORTRAN-80, 4) COBOL-80, 5) MACRO-80. **\$NA/\$110**

MICROPRO

- SUPER-SORT I**—Sort, merge, extract utility as absolute executable program or linkable module in Microsoft format. Sorts fixed or variable records with data in binary, BCD, Packed Decimal, EBCDIC, ASCII, floating & fixed point, exponential, field justified, etc. Even variable number of fields per record! **\$225/\$225**
- SUPER-SORT II**—Above available as absolute lute program only **\$175/\$225**
- SUPER-SORT III**—As II without SELECT/EXCLUDE **\$125/\$225**
- DATASTAR**—Professional forms control entry and display system for key-to-disk data capture. Menu driven with built-in learning aids. Input field verification by length, mask, attribute (i.e. upper case, lower case, numeric, auto-dup, etc.). Built-in arithmetic capabilities using keypad data, constant and derived values. Visual feedback for ease of forms design. Files compatible with CP/M-MP/M supported languages. Requires 32K CP/M **\$350/\$325**

- WORD-STAR**—Menu driven visual word processing system for use with standard terminals. Text formatting performed on screen. Facilities for text pagination, page number, justify, center and underscore. User can print one document while simultaneously editing a second. Edit facilities include global search and replace, Read/Write to other text files, block move, etc. Requires CRT terminal with addressable cursor positioning. **\$445/\$40**
- WORD-STAR-MAIL-MERGE**—As above with option for production mailing of personalized documents with mail lists from DATASTAR or NAD **\$575/\$40**
- WORD-STAR Customization Notes**—For sophisticated users who do not have one of the many standard terminal or printer configurations in the distribution version of WORD-STAR **\$NA/\$95**
- WORD-MASTER Text Editor**—In one mode it has supersets of CP/M's ED commands including global searching and replacing, forwards and backwards in file in video mode, provides full screen editor for users with serial addressable-cursor terminal **\$145/\$225**

- TEXTWRITER III**—Text formatter to justify and paginate letters and other documents. Special features include insertion of text during execution from other disk files or console, permitting recipe documents to be created from linked fragments on other files. Has facilities for sorted index, table of contents and footnote insertions. Ideal for contracts, manuals, etc. Now compatible with Electric Pencil and Word-Star prepared files **\$125/\$20**

New Lower prices for application Software

PEACHTREE SOFTWARE

- General accounting software for small businesses.** Each product can be used alone or with automatic posting to the general ledger. Supplied in source for Microsoft BASIC 4.51.
- GENERAL LEDGER** **\$530/\$40**
- ACCOUNTS PAYABLE** **\$530/\$40**
- ACCOUNTS RECEIVABLE** **\$530/\$40**
- PAYROLL** **\$530/\$40**
- INVENTORY** **\$660/\$40**
- ALSO:**
- MAILING ADDRESS** **\$530/\$40**
- PROPERTY MANAGEMENT** **\$530/\$40**

GRAHAM-DORIAN SOFTWARE SYSTEMS

- Comprehensive accounting software written in CBASIC-2 and supplied in source code.** Each software package can be used as a stand-alone system or integrated with the General Ledger for automatic posting to ledger accounts. Requires CBASIC-2.
- GENERAL LEDGER** **\$805/\$40**
- ACCOUNTS PAYABLE** **\$805/\$40**
- ACCOUNTS RECEIVABLE** **\$805/\$40**
- INVENTORY SYSTEM** **\$555/\$40**
- JOB COSTING** **\$805/\$40**
- APARTMENT MANAGEMENT** **\$805/\$40**
- CASH REGISTER** **\$805/\$40**

- POSTMASTER**—A comprehensive package for mail list maintenance that is completely menu driven. Features include keyed record extraction and label production. A form letter program is included which provides neat letters on single sheet or continuous forms. Includes NAD file translator. Requires CBASIC-2 **\$150/\$20**

STRUCTURED SYSTEMS GROUP

- Complete interactive accounting software for business.** Each product can be used stand-alone or with automatic posting to the general ledger. Each product is thoroughly tested and very well documented. Each product requires CBASIC-2.
- GENERAL LEDGER** **\$820/\$40**
- ACCOUNTS RECEIVABLE** **\$820/\$40**
- ACCOUNTS PAYABLE** **\$820/\$40**
- PAYROLL** **\$820/\$40**
- INVENTORY CONTROL** **\$820/\$40**

NEW! NEWSLETTER FROM LIFEBOAT

- Latest Version Numbers List of Software**
 - Update on CP/M Users Group**
 - The Great ZOSO Speaks Out from Behind the Scenes**
- \$18 ppp. for 12 issues (U.S., Canada, Mexico). Elsewhere \$40.
 Send Check to "Lifelines," 1651 Third Avenue, New York, N.Y. 10028 or use your VISA or MasterCard—call (212) 722-1700

Copyright © 1980 Lifeboat Associates. No portion of this advertisement may be reproduced without prior permission.

- ANALYST**—Customized data entry and reporting system. User specifies up to 75 data items per record. Interactive data entry, retrieval, and update facility makes information management easy. Sophisticated report generator provides customized reports using selected records with multiple level breakpoints for summarization. Requires a disk sort utility such as QSORT, SUPER-SORT or VSORT and CBASIC-2 **\$250/\$15**
- LETTERRIGHT**—Program to create, edit and type letters or other documents. Has facilities to enter, display, delete and move text, with good video screen presentation. Designed to integrate with NAD for form letter mailings. Requires CBASIC-2 **\$200/\$25**
- NAD Name and Address selection system**—Interactive mail list creation and maintenance program with output as full reports with reference data or restricted information for mail labels. Transfer system for extraction and transfer of selected records to create new files. Requires CBASIC-2 **\$100/\$20**
- QSORT**—Fast sort/merge program for files with fixed record length, variable field length information. Up to five ascending or descending keys. Full back-up of input files created **\$100/\$20**

CONDIMENTS

- HEAD CLEANING DISKETTE**—Cleans the drive Read/Write head in 30 seconds. Diskette absorbs loose oxide particles, fingerprints, and other foreign particles that might hinder the performance of the drive head. Lasts at least 3 months with daily use. Specify 5" or 8". Single sided **\$20 each/\$55 for 3**
 Double sided **\$25 each/\$65 for 3**
- FLIPPY DISK KIT**—Template and instructions to modify single sided 5 1/4" diskettes for use of second side in single sided drives **\$12.50**
- FLOPPY SAVER**—Protection for center holes for 5" and 8" floppy disks. Only 1 needed per diskette. Kit contains centering post, pressure tool and tough 7 mil mylar reinforcing rings for 25 diskettes.
- 5", Kit **\$14.95**
 5", Rings only **\$7.95**
 8", Kit **\$16.95**
 8", Rings only **\$8.95**
- PASCAL USER MANUAL AND REPORT**—By Jensen and Wirth. The standard textbook on the language. Recommended for use by Pascal/Z, Pascal/M and Pascal/MT users **\$12**

- THE C PROGRAMMING LANGUAGE**—By Kernighan and Ritchie. The standard textbook on the language. Recommended for use by BDS C, Icy C, and Whitesmiths C users. **\$12**
- STRUCTURED MICROPROCESSOR PROGRAMMING**—By the authors of SMAL/80. Covers structured programming, the 8080/8085 instruction set and the SMAL/80 language **\$20**
- ACCOUNTS PAYABLE & ACCOUNTS RECEIVABLE—CBASIC**—By Osborne/McGraw-Hill **\$20**
- GENERAL LEDGER—CBASIC**—By Osborne/McGraw-Hill **\$20**
- PAYROLL WITH COST ACCOUNTING—CBASIC**—by Osborne/McGraw-Hill **\$20**
- LIFEBOAT DISK COPYING SERVICE**—Transfer data or programs from one media format to another at a moderate cost from \$25

Hearty Appetite.

*CP/M and MP/M are trademarks of Digital Research. Z80 is a trademark of Zilog, Inc. UNIX is a trademark of Bell Laboratories. WHATSI?? is a trademark of Computer Headware. Electric Pencil is a trademark of Michael Shryver Software. TRS-80 is a trademark of Tandy Corp. Pascal/M is a trademark of Scorigm. SoftCard is a trademark of Microsoft. Apple is a trademark of Apple Computer. PASM, PLINK, BUG and BUG are trademarks of Phoenix Software Associates Ltd. CPAids is a trademark of Computer Tax Service, Inc.

Recommended system configuration consists of 48K CP/M, 2 full size disk drives, 24 x 80 CRT and 132 column printer.

- Modified version available for use with CP/M as implemented on Heath and TRS-80 Model I computers.
- User license agreement for this product must be signed and returned to Lifeboat Associates before shipment may be made.
- This product includes/excludes the language manual recommended in Condiments.
- Serial number of CP/M system must be supplied with orders.
- Requires Z80 CPU.

Ordering Information

MEDIA FORMAT ORDERING CODES
 When ordering, please specify format code.

LIFEBOAT ASSOCIATES MEDIA FORMATS LIST

Diskette, cartridge disk and cartridge tape format codes to be specified when ordering software for listed computer or disk systems. All software products have specific requirements in terms of hardware or software support, such as MPU type, memory size, support operating system or language.

Computer system	Format Code	Computer system	Format Code	Computer system	Format Code
Altair 8800 Disk	See MITS 3200	IMS 5000	RA	Research Machines 8	A1
Altos	IMS 8000	IMS 8000	A1*	Research Machines 5 1/4"	RH
Apple SoftCard 13 Sector	RG	IMSAI VDP-40	R4*	REX	03
Apple SoftCard 16 Sector	RR	IMSAI VDP-42	R4**	Sanco 7000 5 1/4"	RO
BASF System 7100	RD	IMSAI VDP-44	R5**	SD Systems 8"	A1*
Blackhawk Single Density	Q3	IMSAI VDP-80	A1**	SD Systems 5 1/4"	R3
Blackhawk Microplus Mod II	Q2	Intecolor	See ISC Intecolor	Sorcereer	See Exidy Sorcerer
CDS Versatile 3B	Q1	Intel MDS Single Density	A1	Spacebyte	A1
CDS Versatile 4	Q2	Interlec Super/Brain DOS 0.1	R7	SuperBrain	See Interlec
COMPAL-80	Q2	Interlec Super/Brain DOS 0.5-2-X	FJ	Tarbelle	A1*
Cromemco System 3	A1*	Interlec Super/Brain DOS 3.X	RK	TEI 5 1/4"	R3
Cromemco Z2D	R6	ISC Intecolor 8063/8360/8963	A1	TEI 8"	A1*
CSSA BACKUP (tape)	T1 #	Kontron PSI-80	RF	Thinkertoyz	See Morrow Discus
Delta	A1*	Meca 5 1/4"	PF	TRS-80 Model I 5 1/4"	R2
Digi-Log Microterm II	RD	Micromation	A1*	TRS-80 Model I - FEC Freedom RN	A1
Digital Microsystems	A1*	(except TRS-80 below)	A1*	TRS-80 Model I - Micromation	RM
Discus	See Morrow Discus	Microplus Mod I	Q1	TRS-80 Model I - Omikron 5 1/4"	A4*
Durango F-85	RL	Microplus Mod II	Q2	TRS-80 Model I - Omikron 8"	A1*
Dynabyte DB8/2	R1	MITS 3200/3202	B1	TRS-80 Model I - Shuttleboard 8"	A1*
Dynabyte DB8/4	A1*	Morrow Discus	A1*	TRS-80 Model II	A1*
Exidy Sorcerer - Lifeboat CP/M	Q2	Moslak	A1*	VDP-40/42/44/80	See IMSAI
Exidy Sorcerer - Exidy CP/M	Q4	MSD 5 1/4"	RC	Vector MZ	Q2
Heath H8 - H17/H27	P4	North Star Single Density	P1	Versatile	See CDS Versatile
Heath H89 - Lifeboat CP/M	P4	North Star Double/Quad	P2	Vista V80 5 1/4" Single Density	P5
Heath H89 - Magnoka CP/M	P7	Nylac Single Density	Q3	Vista V200 5 1/4" Double Density	P6
Helios II - See Processor Technology	A1*	Nylac Microplus Mod. II	Q2	Zenith Z89 - Lifeboat CP/M	P4
Helios III - See North Star	A1*	Onyx Scientific C3	A3	Zenith Z89 - Magnoka CP/M	P7
ICOM 241 - Micro Floppy	R3	Onyx C8001	T2*		
ICOM 3712	A1*	Pentec PCC 2000	A1*		
ICOM 3812	A1*	Processor Technology Helios II	B2		
ICOM 4511 5440 Cartridge	D1*	Quay 500	RO		
CP/M 1.4	D1*	Quay 520	RP		
ICOM 4511 5440 Cartridge	D2#	RAIR Single Density	R9		
CP/M 2.2	D2#	RAIR Double Density	RE		

Prices F.O.B. New York. Shipping, handling and C.O.D. charges extra.
 Manual cost applicable against price of subsequent software purchase.
 The sale of each proprietary software package conveys a license for use on one system only.

* Single-Side Single-Density disks are supplied for use with Double-Density and Double-Side 8 soft sector format systems.
 ** IMSAI formats are single density with directory offset of zero.
 # A media surcharge of \$25 for orders on tape formats T1 and T2 and of \$100 for orders on disk formats D1 and D2 will be added.
 The list of available formats is subject to change without notice in case of uncertainty, call to confirm the format code for any particular equipment.



Add Macro Expansion to Your Microcomputer, Part 1

David C Brown
1704 Manor Rd
Havertown PA 19083

Assembly language is *the* most powerful language available to a given processor. Within the limitations of time and human patience, it allows the most intricate manipulation of data, the smallest program size, and the fastest execution time possible. The drawback is that writing programs in assembly language is very tedious, often involving repeated writing of either identical code or code that is similar to previously written code.

One software tool that can help to decrease the tedium of assembly-language programming is the *macro assembler*. A macro assembler allows you to write one line of assembly-language code (called a *macro instruction* or just *macro*) that is *expanded* to (or replaced by) a predefined sequence of assembly-language statements; this saves you from entering the same code a second time. The original assembly-language file containing the macro statements generates the new expanded assembly-language file; this second file, which contains only valid assembly-language statements, can then be assembled, modified, or stored by the user.

The flowcharts in this article detail *the* process of defining and using macro instructions. The flowcharts can be used either to incorporate a macro facility into an assembler that you are designing or to write a macro-preprocessing program, the output of which is an expanded assembly-language source listing that can be assembled by your existing assembler.

How a Macro Instruction Works

Your first question might well be, "What on earth is a macro instruction, anyway?" To answer this question, consider the following simple example: you are writing a program that manipulates character strings and you have a series of instructions for moving a string of characters from one location to another. You need this routine in many places in your coding. You can store the sending and receiving field addresses, and the length, then call a common subroutine to perform the move.

One software tool that can help to decrease the tedium of assembly-language programming is the *macro assembler*.

However, suppose you need this routine in several different programs; or maybe memory is not a concern and you have decided to code the statements in-line whenever needed in order to speed up your execution. After writing that move routine over and over, your hand is aching and you are looking for a better way. That better way is called a *macro assembler*. The macro assembler lets you define a new operation code, called MOVE in this example. This new operation code will generate the required sequence of instructions every time it is encountered in your programs by the macro assembler.

There are several advantages to using macro instructions. One advantage, as pointed out in the previous example, is that you need to write the macro definition only once; you can then enter one line of source code to generate the sequence of instructions that you have previously defined. This makes it easier for you, as a programmer, to write your program. It can also reduce program errors, since you know that the generated instructions will work after you test them the first time.

Macro instructions make possible a greater standardization of code, ensuring that a set sequence of source statements is used to perform a desired operation. Almost all highly developed assembly languages have macro expansion facilities. My article is based primarily upon the macro language used in the IBM System/360 and 370 assemblers.

Basically, a macro processor takes the place of an assembler's text input routine. It is a preprocessor of text statements, replacing a macro statement with its defined sequence of instructions. This generation of source text may also include substitution of operands within the macro statement. In addition to text generation and substitution, a macro facility might handle *conditional assembly*. This is the ability to vary the sequence of statements generated at assembly time, either within a macro definition or in the normal source code of the program.

Before using a macro instruction in a source program, you must first provide the assembler with a definition

Listing 1: Example of a macro-instruction definition for an 8080 macro assembler. A macro definition is delineated by the first statement, *MACRO*, and the last statement, *MEND* (macro end). *MACRO* and *MEND* are pseudo-operation codes, which provide instructions to the assembler rather than generate machine code. The second line is called a prototype statement because it gives the name of the macro definition (here, *MOVE*) and the names of the variable symbols that will be used within the macro definition (denoted by an ampersand, *&*).

1.	MACRO		
2.	&JUMP	MOVE	&TO,&FROM,&LENGTH
3.	LXI		B,&TO
4.	LXI		D,&FROM
5.	MVI		H,&LENGTH
6.	&JUMP	LDAX	D
7.	STAX		B
8.	INX		B
9.	INX		D
10.	DCR		H
11.	JNZ		&JUMP
12.	MEND		

POINT TO FROM AND TO FIELDS
SET MOVE LENGTH
PICK UP "FROM" BYTE
STORE IN "TO" FIELD
INCR FROM AND TO ADDRESSES
DECREMENT COUNT
LOOP BACK IF MORE

of the macro instruction. This definition includes the macro name (the new operation code you have assigned), the label entry (if used), and the possible operands that can be used. The definition also includes the statements to be generated. The macro definition, then, consists of four parts: the macro header, the macro prototype, a sequence of model statements, and a macro trailer. The header and trailer define the beginning and the end of the macro definition. The macro prototype specifies the label entry, operation code, and operands permitted in the macro statement. The model statements are the assembler statements to be generated by the macro statement; the model statements eventually replace each occurrence of the macro statement.

Listing 1 shows a macro definition for the *MOVE* macro instruction discussed earlier. The numbers to the left of each statement are not a part of the definition, but are there solely for ease in discussing the definition itself. Also, the code shown is not necessarily the best way to perform a move operation, but serves only as an ex-

ample. In this definition, statements 1 and 12 are the macro header and trailer, respectively. Statement 2 is the prototype, which defines the operation code (*MOVE*), the label entry (*&JUMP*), and the allowable operands (*&TO*, *&FROM*, *&LENGTH*). Statements 3 thru 11 are the model statements that will be generated.

Defining and Using Variable Symbols

As you can see, a macro definition is quite easy to write. The only thing that may seem new or unusual at this point are those four names that begin with an *"&"*, known as *variable symbols*. While they may look strange, variable symbols are the single most important part of a macro definition, because they allow you to change the generated code. Without them, the uses of a macro assembler would be severely limited.

A variable symbol is a symbol that can take on many values. These values may be assigned by the assembler, or the programmer may assign them when he or she codes a macro instruction (or *macro call*) in

the source program. When the macro processor expands a macro statement into its generated code, all variable symbols found in the model statements are replaced with the current values assigned to them. Referring to listing 1, when you code the *MOVE* macro instruction in your program, the first variable symbol, *&TO*, is given the value that you coded for your first operand, and so on.

To illustrate this operation, listing 2a shows a *MOVE* macro definition you might have coded in your program. Listing 2b shows the code generated by the *MOVE* macro definition of listing 1. Notice that in the generated code, *&JUMP*, *&TO*, *&FROM*, and *&LENGTH* in the model statements have been replaced by *LOOP*, *FIELDA*, *FIELDDB*, and *14*, respectively, from the macro-call statement.

Some variable symbols are assigned values by the assembler itself. Referring to listing 3a, use of the *INCR* macro definition in several places in your coding will result in the label *LABEL* being defined more than once, a condition that your assembler is likely to interpret as an error. One way to prevent this is to have a special variable symbol, called *&SYSNDX*, for *system index*. This variable symbol has a numeric value that is incremented by one every time a macro instruction is used. By combining this with a letter (known as *concatenating*), as in listing 3b, we can create unique labels. Listings 3c and 3d show the generated code from this macro instruction the first two times it is used. Notice that the two labels are different.

This brings up one more point concerning variable symbols. In listing 3b is the concatenation *L&SYSNDX*,

Listing 2: Example of macro-instruction expansion. When the one-line macro call of the macro definition *MOVE* (listing 2a) is processed within a larger assembly-language program, it is replaced with the expanded macro code, as in listing 2b. Compare this with the macro definition in listing 1.

(a)	LOOP	MOVE	FIELDA,FIELDDB,14
(b)		LXI	B,FIELDA
		LXI	D,FIELDDB
		MVI	H,14
LOOP		LDAX	D
		STAX	B
		INX	B
		INX	D
		DCR	H
		JNZ	LOOP

POINT TO FROM AND TO FIELDS
SET MOVE LENGTH
PICK UP "FROM" BYTE
STORE IN "TO" FIELD
INCR FROM AND TO ADDRESSES
DECREMENT COUNT
LOOP LOOP BACK IF MORE

DP/NET: Redefined

INDIVIDUAL/NET

WORD PROCESSOR



S-100, 7 Slot, 360K Double Density

DUAL/NET

SMALL BUSINESS APPLICATIONS



Up To 4 Terminals
Can Be Slaved Off Master

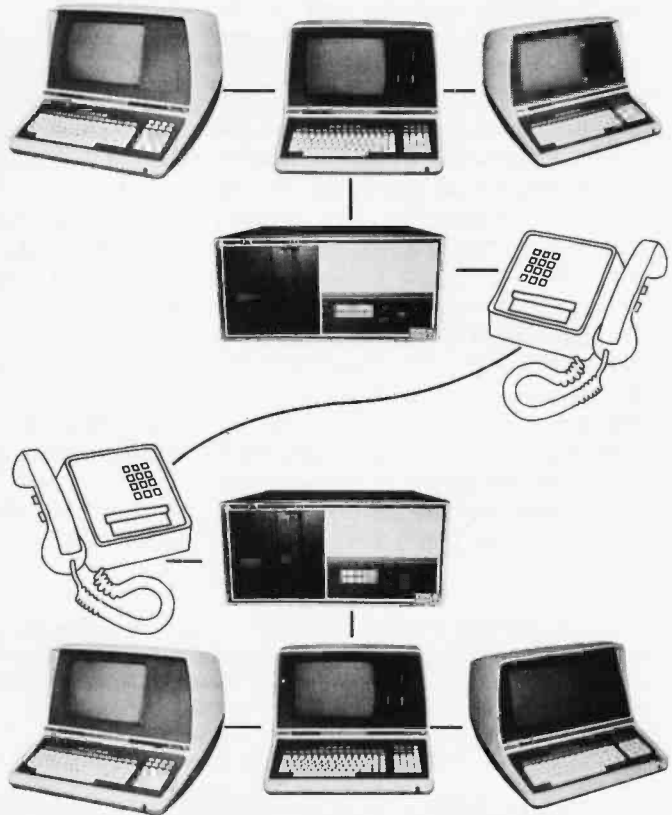
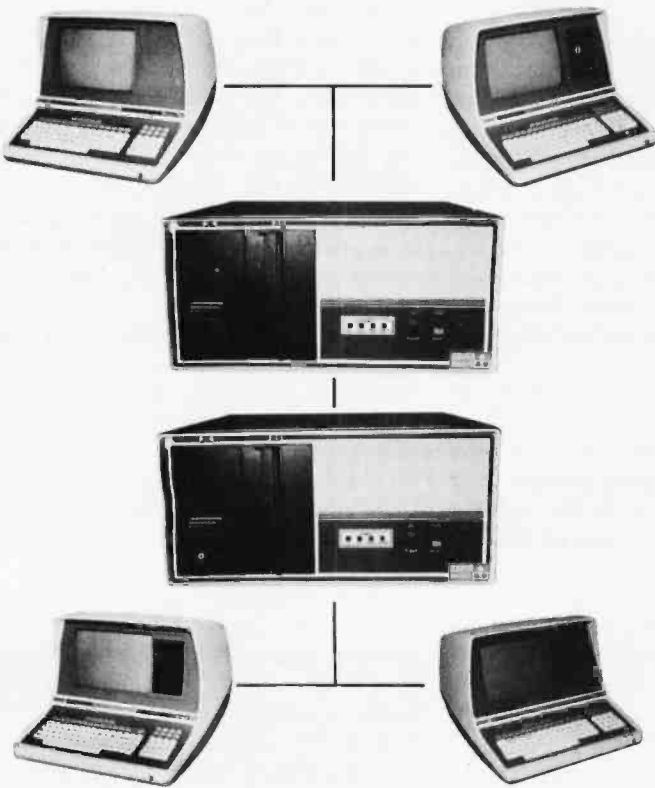

LOCAL/NET

TELEPHONE/NET

OVERSEAS

AUSTRALIA
ASP MICROCOMPUTERS
799 Dandenong Road
East Malvern 3145
Victoria, AUSTRALIA
TEL: 2118855-2118344

UNITED KINGDOM
TERODEC (MICRO SYSTEMS) LTD.
17 The Gallop, Yateley,
Camberley, Surrey
GU17 7SG ENGLAND
TEL: 0252 874790

CENTRAL EUROPE
HANNES KELLER AG
Computer-Zentrum
Eldmattstrasse 36
CH-8032, Zurich
SWITZERLAND
TEL: 01 69 36 33

SOUTH AMERICA
INVERSIONES URIMAN c.o.
P.O. Box 1041
Maracaibo 4001A,
VENEZUELA
TEL: 33015

FAR EAST
MICROBOARDS
1-7-1-1003 Salwal-Cho
Chiba City, Chiba 260 JAPAN
TEL: 0472(47)3081

Configurability

SYSTEM/NET

LARGE SYSTEM NUCLEUS



Hard Disc and 8" Floppy
Any Combination of Master or Slave



MASTER/NET

CANADA
CESCO ELECTRONICS LTD.
4050 Jean Talon Street WEST
Montreal, CANADA H4P 1W1
TEL: (514) 735-5511

BENELUX
MICROSPOT
Postbus 564-3700 AN Zelst
Verheulalaan 3-3971 RD Driebergen
HOLLAND
TEL: 03438-(1) 8899

"BUY" WORD FOR THE 1980's

NETWORKING is the newest 'buzzword' in microprocessors. Delta Products has produced a superior hardware system that cannot be matched in either cost or performance.

Don't buy a system that has "designed-in" limitations; check the following:

PERFORMANCE

This is where DP/NET® beats them all. Delta does multiuser and multitasking operations by using distributed processors. DIGITAL RESEARCH has provided a new operating system (CP/NET®) which combines MP/M® and CP/M 2.2® into the world's most powerful microcomputer system.

The system cannot be bogged down by adding more users. High-speed DMA transfers from Host to Slave, allow many processors to share workloads. (There can be 3 processors at EACH user terminal; a Z-80 for screen function, and a pair of 8085/8088 for main processing.)

FLEXIBILITY

One of the most important advantages of DP/NET® is that you never have to purchase more system than you currently need. Your system can start with a 5" minifloppy 32K terminal for under \$3000.00. Adding a second terminal and additional mass storage is as simple as the original purchase. Networking up to 16 OR MORE intelligent and semi-intelligent work stations can follow in perfect step with the growth of your Company and requirements.

COST

Since you never buy more computer power than you need, the system cost is matched to the demand to be placed upon it. DELTA PRODUCTS has a lot of experience in building micros, with over 2000 DELTA systems now in the field. DELTA component cost has always been extremely competitive. DELTA's new "networking system" is a natural and simple combination of the competitive "good deals" we have been offering for some time.

SOFTWARE

A computer system to the end user IS THE SOFTWARE. All CP/M® compatible programs run perfectly on the DP/NET®. DELTA PRODUCTS is currently writing its' own high-performance custom data base, screen editor, order entry/inventory, and accounting packages in PL/1®. Target release date for the complete package is November, 1980.

**SOLD ONLY THROUGH DEALERSHIPS
CALL FOR YOUR NEAREST REPRESENTATIVE**

DELTA PRODUCTS

15392 Assembly Lane
Huntington Beach, CA 92649
TELEPHONE: (714) 898-1492



TELEX: 681-367 DELTMAR HTBH

MP/M, CP/M2.2, PL/1 & CP/NET ARE REG. TM OF DIGITAL RESEARCH INC.

Circle 104 on Inquiry card.

The macro processor is itself a smaller assembler within the main assembler.

which generated L0001. Suppose we wanted to generate L0001A. Our first thought might be to code it as L&SYSNDXA. However, this presents a problem to the macro processor; it has no way of knowing that you wanted the variable symbol &SYSNDX with an A concatenated behind it. The macro processor thinks you want a variable symbol called &SYSNDXA.

To circumvent this problem, we will set a rule that a variable symbol must be followed by a blank, a special character other than a letter or

number, or a period to mark its end. If the variable symbol is followed by a period, both the variable symbol and the period will be replaced in the generated code. Thus, we would now code L&SYSNDX.A in order to generate L0001A, or L&SYSNDX(1) to generate L0001(1).

Details of the Macro Assembler

Now that we have defined a macro call and discussed how it is used, we should look at the process of implementing macro-expansion facilities in an assembler. First, however, it would be useful to compare a macro processor to an assembler, for the macro processor is itself a smaller assembler within the main assembler. Both the assembler and the macro processor need a symbol table. In the assembler, this symbol table stores names associated with specific memory locations. Defining a name

more than once is usually an error, so the symbol table need store only one entry for each name. For best storage usage, the assembler normally uses a hashing function to store names randomly but evenly distributed in the symbol table, and the symbol table is usually a constant length.

In a macro processor, the symbol table is handled quite differently. The macro processor stores variable symbols and pointers to their current values as entries in the symbol table. If we allow inner macro capability (where a macro definition contains a call to another macro definition), it is possible to have the same variable symbol defined more than once, each definition pointing to a different value.

As an example of this, listing 4a shows a macro definition, SAVE, which stores a specified register at the address in the HL register pair. Line 4 contains a call of the INCR macro definition, listing 4b, to increment the HL pair and count the number of calls to it in the specified register. Both macro definitions refer to ®, but there are actually two different ®s, each with a different value. If the macro call is coded as shown in listing 4c, ® gets replaced with a D in line 1 of the generated code in listing 4d, and with a B in line 3 of listing 4d.

To allow this capability, we will use a *stack*, or pushdown list, for the macro processor's symbol table. The pushdown list is a last-in, first-out list; when a macro expansion needs to find the value associated with a given variable symbol, it will start with the last (or most recent) entry, looking backwards for the most recent definition of the symbol. In this way, ® can be put on the symbol table with a value of D, and later put on the symbol table again with a value of B. When the inner INCR macro statement has completed its expansion, it will delete its entries from the end of the symbol table. This uncovers the old ® and resets it back to a value of D, as shown in line 4 of listing 4d.

One major difficulty encountered by an assembler is in resolving forward references. These occur when a symbol being used has not yet been defined. The assembler cannot get the memory location of the symbol from its symbol table since the definition has not yet been processed. The nor-

Listing 3: Fixed and assembler-assigned labels. In the macro definition of INCR in listing 3a, each macro call results in a line generated with the label LABEL. This would give the same label to two statements if INCR were called twice within the same program. To bypass this program error, we can use the variable symbol &SYSNDX in the creation of label names, as in listing 3b. Since the value of &SYSNDX is incremented after each macro call, successive calls of INCR will result in different labels being generated, as in listings 3c and 3d.

(a)	MACRO INCR LABEL INX B INX D MEND	(b)	MACRO INCR L&SYSNDX INX B INX D MEND
(c)	L0001 INX B INX D	(d)	L0002 INX B IND D

Listing 4: Variable symbols and nested macros. Given the two macro definitions of SAVE and INCR in listings 4a and 4b, the macro call of SAVE in listing 4c, and the resulting expansion in listing 4d, it is obvious that variable symbol ® has the value "D" during the expansion of SAVE and has the value "B" during the expansion of INCR. When macro calls are allowed to be nested, this situation must be allowed for.

(a)	1. MACRO 2. &LAB SAVE ® 3. MOV M,® MOVE REG TO ADDRESS IN HL 4. INCR B CALL INCR TO INCR HL AND COUNT IN B 5. MOV A,® MOVE REG TO A 6. MEND
(b)	1. MACRO 2. INCR ® 3. INX H INCREMENT HL PAIR 4. INR ® ADD 1 TO REGISTER 5. MEND
(c)	SAVE D
(d)	1. MOV M,D MOV REG TO ADDRESS IN HL 2. INX H INCREMENT HL PAIR 3. INR B ADD 1 TO REGISTER 4. MOV A,D MOVE REG TO A

When you pick a Daisy... Pick Vista's V300 Printer.

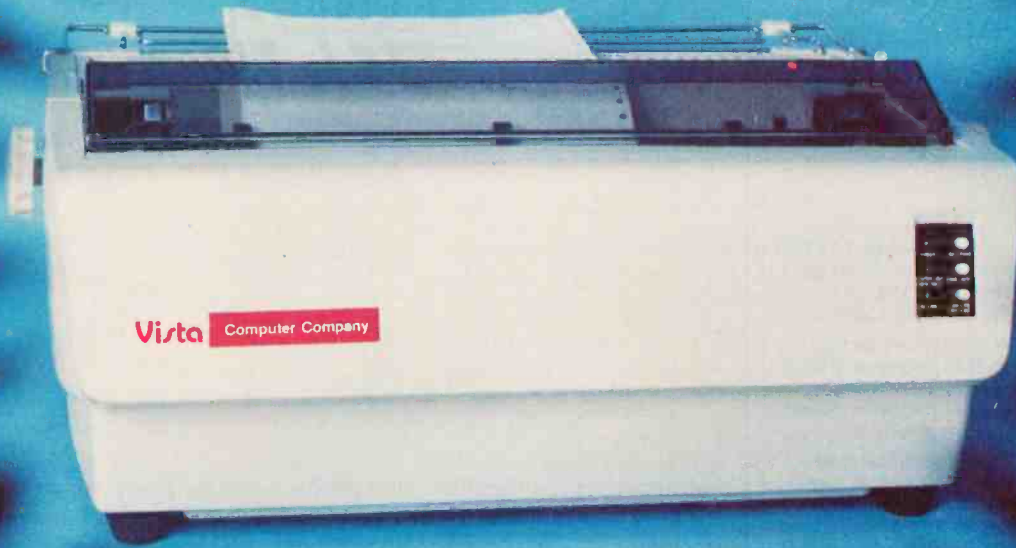

\$1895.

There are Daisies! . . . And, There are Daisies! . . . But Vista has a Peach!

The Vista V300 is exactly that, a "peach" of a daisy wheel printer both from the standpoint of price and performance.

Think of it, a printer at nearly half the price (when compared to models even remotely competitive in quality) combined with the ultimate in reliability, print quality, and flexibility.

Typical Comments: "Superb print quality!", "Highly reliable.", "Definitely letter quality. . . I can't believe the price tag.", "Best use I've seen yet of LSI Technology."

But judge for yourself — look at the V300 features and keep in mind this is a letter quality printer at dot matrix prices.

- Tractor option available
- Print Speed — 25 CPS (Optional 45 CPS for \$2,195)
- Print Wheel — Industry standard 96-character Daisy Wheel (including the extended-life dual plastic wheels)
- Service — Prompt maintenance/service agreements available nationwide through 417 Western Union locations
- Interface — Industry standard parallel (RS232-C optional)
- Printable Columns — 136
- Warranty — 90 days parts and labor, one year parts only
- Proportional, bi-directional printing • Programmable VFU
- Extensive self-test functions • Hardware and software compatible

Vista does it again! Quality, Price and Performance with a peach of a daisy wheel printer.



IMMEDIATE DELIVERY
For Further Information
Call Toll Free (800) 854-8017

The Vista Computer Company 1401 Borchard Street • Santa Ana, California 92705 • 714/953-0523

AND, Vista Has a Complete V100 Word Processing System for Only \$4995!

The Vista V100 is a complete word processing system that includes:

- Exidy Sorcerer Computer, 48K
- V200E20 Disc Drive System, Double Density
- Sanyo Data Display Monitor
- Vista V300 Printer Full Character Daisy Wheel
- Wordstar, CPM 1.4 (Includes E Basic)
- Can also be used for Data Processing



WHAT IF

Muldoon hits 450 for August and Whitey's pitching has an ERA of 2.5? Will the TV ratings improve enough to get back the Big Advertisers? Will the testimonial money come through?

T/MAKER gives me the totals fast on my CRT screen. I can trade players, switch player positions, and play with many variables and see what happens before the front office gets involved.

T/MAKER integrates numerical and text data and makes it easy to analyze and present a player's contract with all edited text. All figures and calculations can be reviewed on our CRT and finally printed out in hard copy form.

T/MAKER is a wonderful tool for data analysis. It is easy to set up calculations for rows and columns of tabular data, automatically perform the computations, review the results and then modify some of the data to see the impact on the over all results. Several days of manual work can be accomplished in minutes.

T/MAKER is a full screen editor for word processing which handles text up to 255 characters wide. It includes features like text formatting and justification, text buffer for block moves and repeated inserts, global search and replace and commands for printing your letters, reports and documents.

T/MAKER can perform an unlimited number of analysis and reporting tasks which integrate numerical and text processing. For example:

- Financial Statements • Balance Sheets
- Statistics • Growth & Projections • Profitability Reports • Revenues & Expenditures • Portfolio Analysis • Price Lists • Rate Structures • Inventory Valuation, and much, much more.

T/MAKER requires a 48K CP/M system, a total of 240K bytes of disk storage, CBASIC-2, and a CRT computer terminal with cursor addressing and clear screen.

T/MAKER system is \$275.00 complete with documentation and quick-reference card. Documentation alone is \$25.00.

LIFEBOAT ASSOCIATES

1651 Third Ave. NY, NY 10028
(212) 860-0300
International Telex 220501
T/MAKER is a trademark of P. Roizen
CP/M is a trademark of Digital Research



Listing 5: An example of conditional assembly. Given the macro definition of MOVE in listing 5a and the macro call in listing 5b, the expanded code is given in listing 5c. Because the `&LENGTH` variable equals 1 in the macro call, the AIF (assemble-if) statement is executed in line 8 of the macro definition, causing lines 9 thru 12 to be omitted in the macro expansion of 5c.

```
(a)  1.          MACRO
      2. &JUMP  MOVE    &TO,&FROM,&LENGTH
      3.          LXI    B,&TO
      4.          LXI    D,&FROM
      5.          MVI    H,&LENGTH
      6. &JUMP  LDAX    D
      7.          STAX   B
      8.          AIF   (&LENGTH EQ '1').END
      9.          INX    B
     10.          INX    D
     11.          DCR    H
     12.          JNZ   &JUMP
     13. .END      MEND

(b)          MOVE    A1,B1,1

(c)  1.          LXI    B,A1
      2.          LXI    D,B1
      3.          MVI    H,1
      4.          LDAX   D
      5.          STAX   B
```

mal approach to handling this problem in an assembler is to use two-pass processing. This means that the source program is read twice. The first time, all definitions are placed in the symbol table. The second time, the assembler generates the actual code, with the definitions of all symbols known as a result of pass one.

A macro processor does not really have this problem. All variable symbols are defined in the prototype statement, which comes *before* the model statements that reference these variables. Values are assigned to the variable symbols when the macro call is encountered, which is also prior to using the symbols for generation of code. All symbols other than variable symbols are left untouched by the macro processor and remain the problem of the main assembler, which will handle them in its two-pass processing, as mentioned earlier.

The only exception to this is if we try to implement conditional-assembly facilities. *Conditional assembly* allows us to alter the sequence of a macro definition's generated code. For example, we might not want to generate a group of instructions depending upon the value of a certain variable symbol.

As an example, listing 5a is a modification of the MOVE macro definition of listing 1. Statement 8 shows how conditional assembly can be used; if `&LENGTH` is a 1 at the point of expansion of line 8, the

macro processor resumes expansion with the model statement which has `.END` as a label, in this case the MEND statement of line 13. Therefore, as in listing 5c, a length of 1 will not generate instruction lines 9 thru 12.

At first glance, this situation might look like a forward-reference problem, but it really is not. Since all model statements are stored in the internal macro definition, the macro processor needs only to point to the first model statement and loop through all model statements to find the one that starts with `.END`. In conditional assembly, the sequence code (`.END` in this example) would not appear on the generated code, thus allowing a sequence symbol to be placed on an instruction without worrying about the main assembler rejecting a label beginning with a period.

Earlier, I mentioned that an assembler is normally a two-pass system. In reality, so is a macro processor. The first pass occurs when reading in and storing the macro definition. The second pass occurs when a macro call is made, resulting in an expansion of the code defined for the macro statement being replaced.

The last major point of difference between the assembler and the macro processor is the method used for storing and scanning the source text. The assembler is interested in statement

If you
just bought
another
printer,
boy are
you gonna
be sorry.



Epson.

The Epson MX-80. It's not just another worked-over rehash of last year's model. It's our top-of-the-line 80-column printer. It's new. From the ground up. And it's the most revolutionary printer to hit the market since Epson invented small printers for the 1964 Olympics in Tokyo. Don't take our word for it, though. Compare. There simply isn't a better value in an 80-column printer. Period.

But here's the fact that's going to stand the printer world on its ear. The MX-80 sports the world's first *disposable* print head. After it's printed about 50 million characters, you can throw it away. Because a new one costs less than \$30, and the only tool you need to change it is attached to the end of your arm.

Now that's revolutionary, but that's only the beginning. The MX-80 also prints bidirectionally at 80 CPS with a logical seeking function to minimize print head travel time

The world's first disposable print head. It has a life expectancy of over 50 million characters, yet it's so simple, you can change it with one hand. And it costs less than—repeat less than—\$30.



and maximize throughput. It prints 96 ASCII, 64 graphic and eight international characters in a tack-sharp 9x9 matrix. And it provides a user-defined choice of 40, 80, 66 or 132 columns and multiple type fonts.

We spent three long years developing the MX-80 as the first of a revolutionary series of Epson MX Printers. We employed the most advanced automatic assembly and machining techniques in existence to produce a printer that is incredibly versatile, remarkably reliable and extraordinarily inexpensive. It's a printer that could only come from the world's largest manufacturer of print mechanisms: Epson.

If it sounds like we're proud of the MX-80, we are. Not only does it do things some of the world's most expensive printers can't do, it'll do them for you for less than \$650. That's right. Under \$650.

And if that isn't revolutionary, we don't know what is.

EPSON
EPSON AMERICA, INC.

23844 Hawthorne Boulevard, Torrance, California 90505, Telephone (213) 378-2220

labels, operation codes, operands, and variables. It is not interested in blanks, comments, punctuation, and so on. The assembler normally has a scanning routine to search each statement for the parts it needs. The scanner usually builds a list of descriptors, which are pointers to the beginning of each piece of the statement. The descriptor also contains the length of the label, variable, etc, and a code that identifies what is pointed at. In this manner, a typical statement to the assembler consists of a list of four descriptors, pointing to the label, the operation code, and the two operands.

While the descriptor system is advantageous to the assembler, which processes only one statement at a time, it is both cumbersome and inefficient for use in a macro processor. In the first place, the macro processor must store all statements of the macro definition, not just the current statement. Secondly, the macro processor need only search for the character "&" to locate the data in which it is interested. A complex scanner is unnecessary, as is a descriptor system, especially when we consider that the macro processor's output will be a series of complete assembler statements.

Instead of descriptors, we will take the approach of text compression. In most assembler languages, the programmers typically start labels in column one, operation code in column ten, operands in column sixteen, and comments separated from operands by one or more blanks. With this in mind, we can compress the model statements of the macro definition by eliminating all blanks but the ones between labels, operation codes, operands, and comments. The end of each statement in the compressed macro definition will be marked by a special character, such as a carriage return. To save even more space, we can eliminate the storing of comments in a macro definition, although this will also eliminate the comments on the generated source statements as well.

Implementing the Macro Assembler

So much for the more theoretical aspects of macro processors. Now let us look at the practical implementation of this facility, starting with the macro definition itself. Macro defini-

tions can be either in-line or referred to from a library. An in-line macro definition is a macro definition coded at the beginning of the file containing the source statements for your program. It contains the macro header, macro prototype, model statements, and macro trailer. Obviously, it must be defined before it can be used in the program. All in-line macro defini-

tions are stored in compressed format by the macro processor.

If certain macro definitions are used frequently, having a macro library is useful. This library will contain the macro definition, preferably with the model statements already in compressed format. When a macro call is encountered in the source program, the in-line macro definitions

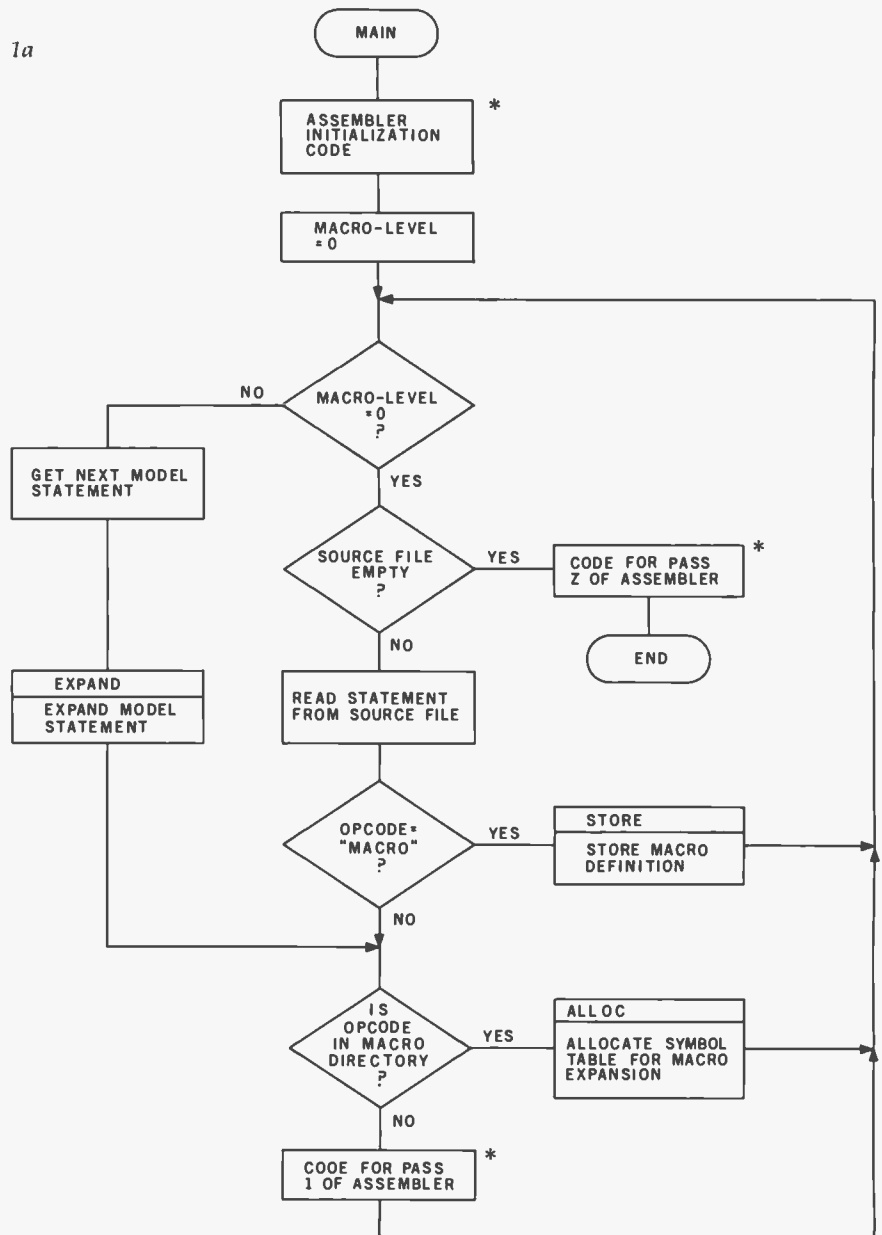

Figure 1: High-level flowcharts of macro use. Figure 1a shows a high-level flowchart for the entire assembler program, which includes the functions of a macro facility. The boxes marked with an asterisk represent the code that performs the assembler functions; the remaining boxes represent the code that is added (through modification of the assembler's "read source" routine) to implement the macro facility. Figure 1b gives the STORE routine, used to store the statements defining a new macro instruction (all those statements between a MACRO statement and the next MEND—macro end—statement). Figure 1c, the ALLOC routine, stores variable-name information about the macro instruction that is currently being expanded. Figure 1d on page 164, the EXPAND routine, shows how a macro instruction is expanded.

will first be searched. If the macro definition is not found, the macro library will then be searched. If found in the library, the definition will be read into memory and treated in the same fashion as an in-line definition. By searching the in-line macro definitions first, we allow the ability to enter an in-line macro definition for a macro already defined in the library and have the in-line macro definition take precedence over or override the library temporarily.

The flowchart of figure 1a shows an overview of macro definition and use. When the macro processor encounters a source statement that contains the pseudo-operation code MACRO, it knows that a macro definition is to follow. The first step to be performed is to add an entry to the macro directory identifying the new macro. The format of the directory entry is shown in figure 2a. The directory entry is of variable length. It will always be at least 12 bytes long, containing the macro name, the model address, the label indicator,

and the parameter count. This fixed portion will be followed by as many 8-byte variable symbols as are defined in the prototype statement. The length of the directory entry is therefore $8P+12$, where P is the number of parameters.

The prototype statement in the macro definition contains most of the information necessary to build a new directory entry. The macro name is taken from the operation code of the prototype statement. The parameter count is the number of variable symbols in the prototype; the variable symbols themselves are stored in variable symbols 1 thru N of the directory entry. The model address is a pointer or address of where the first model statement is to be stored. The label indicator will be a 0 if the prototype statement has no label, or a 1 if the prototype has a variable symbol for a label.

The size of the model-storage area determines the number of macro definitions your macro processor can handle. Since the model statements

are compressed, this will vary somewhat with the lengths of the macro definitions themselves. If you retain comments on the models in order to have them appear in the generated code, this will noticeably reduce the number of macro definitions that can be handled. The model statements are moved one character at a time to the storage area. When a blank is moved, all consecutive blanks after it are bypassed.

If desired, comments can be dropped to reduce storage space, as was mentioned previously. After each statement, a special character is put in the model-storage area so that the macro processor knows when the end of a statement has been reached. A good choice might be a carriage return.

When a MEND (macro end) statement is encountered, the end of the macro definition has been reached. A form feed or other special character is placed in the model-storage area to mark the end of the model statements. The pointer to the model-storage area is set to the position following the special character; its value is stored in the next available directory entry for use by the next macro definition. Figure 2b shows the format of the model-storage area.

Expanding the Macro Instruction

Now that we have the macro definition stored, we can consider the process of macro expansion. However, we still need a few more

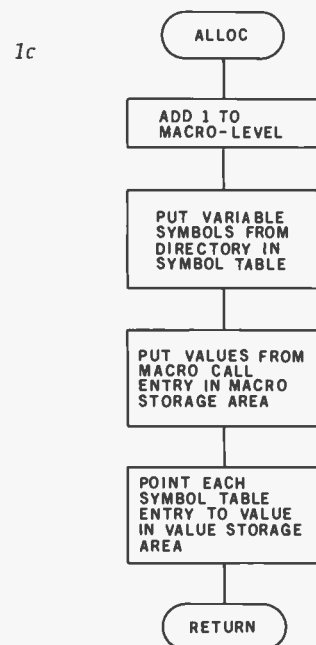
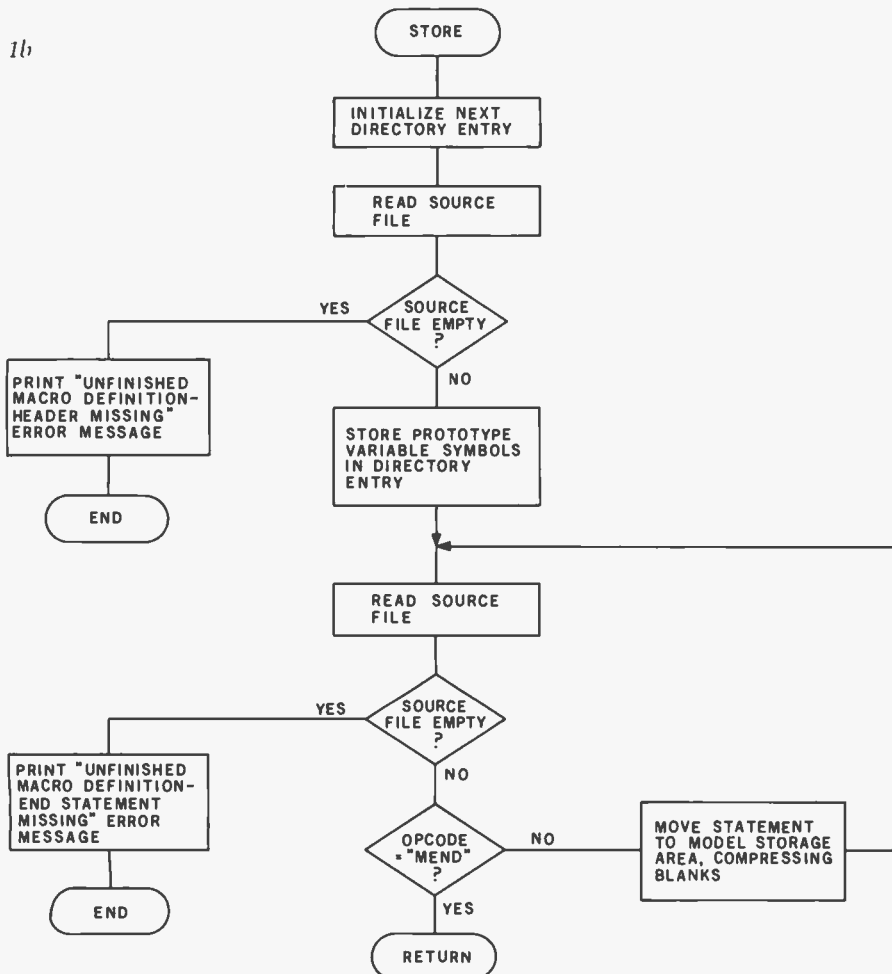

COMPUTER CENTER, INC. BERKELEY

formerly
Byte Shop of Berkeley

FAST, COURTEOUS SERVICE
SINCE 1976

Your Software Source

Specializing in complete systems

Microsoft		
BASIC—80		325
BASIC Compiler		350
COBOL—80 Compiler		700
EDIT—80 Text Editor		90
FORTTRAN—80 Compiler		425
MACRO—80 Assembler		150

Micro—Pro		
Word Star		400
Data Star		350
Super Sort I		225

Small Business Applications		
Magic Wand (w/form letter feature)		395

Structured Systems Group *		
General Ledger		995
Accounts Receivable		995
Accounts Payable		995
Payroll		995
Inventory		995
Analyst		245
Leteright		195
NAD		95
QSORT		95

North Star Software		call
----------------------------	--	------

PASCAL/M		175
CBASIC 2		95
PEARL		call
SELECTOR III C2		325
FMS80		695

Peachtree **		
General Ledger		495
Accounts Receivable		495
Accounts Payable		495
Payroll		495
Inventory		495
Mailing Address		395

Micro B + Index File Subsystem from FairCom		
MBASIC or CBASIC vers.		195
Machine Language vers.		260

TCS Accounting Software **		
General Ledger		95
Accounts Receivable		95
Accounts Payable		95
Payroll		95

* Requires MBASIC
** Requires CBASIC2

VISA...MASTERCHARGE...UPS COD
Prices subject to change
Delivery subject to availability
We pay shipping on prepaid orders

COMPUTER CENTER, INC.
1514 UNIVERSITY AVE.
BERKELEY, CA 94703
415-845-6366

items. So far, we have directory entries and a model-storage area. To this we must add a symbol table, a macro stack, and a storage area for variable-symbol values, as shown in figure 3. As mentioned earlier, the symbol table will be a last-in, first-out stack. It will contain the variable-symbol name, the length of its current value, an indicator for the data format, and a pointer to the value.

The values of variable symbols will be stored in the value-storage area much as the model statements were

stored, with the symbol-table entry pointing to it. When a variable symbol is found in a model statement, we will start at the end (most recent entry) of the symbol-table stack and search backwards for the proper entry. This will in turn point to the current value. As previously discussed, this allows inner macro calls and allows the same variable symbol to be used by different macro definitions to refer to different values. The entries are placed in the symbol table when the macro expansion begins and are

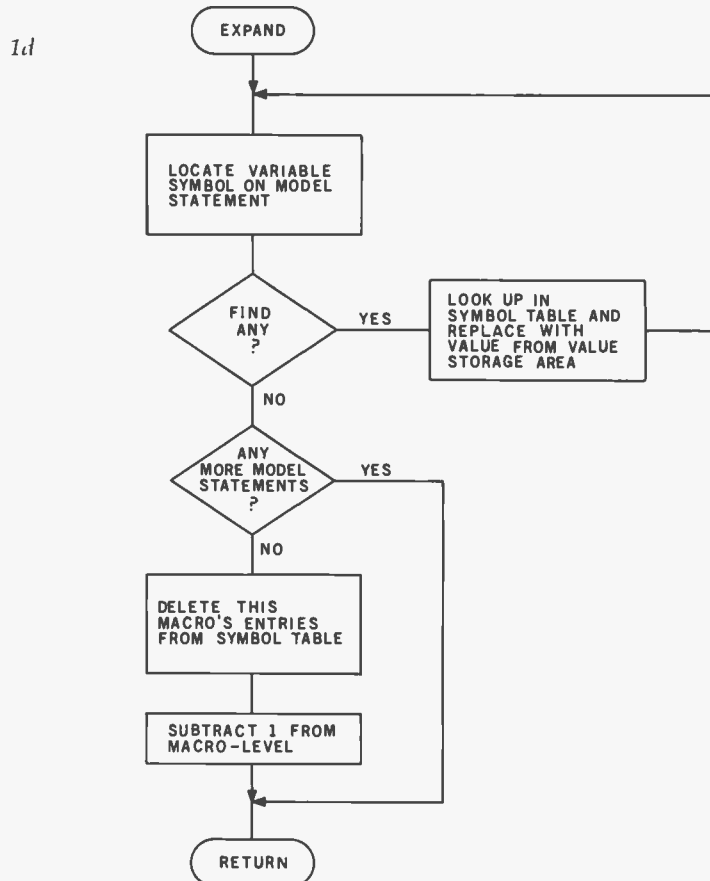

Figure 1d: The macro-instruction EXPAND routine.

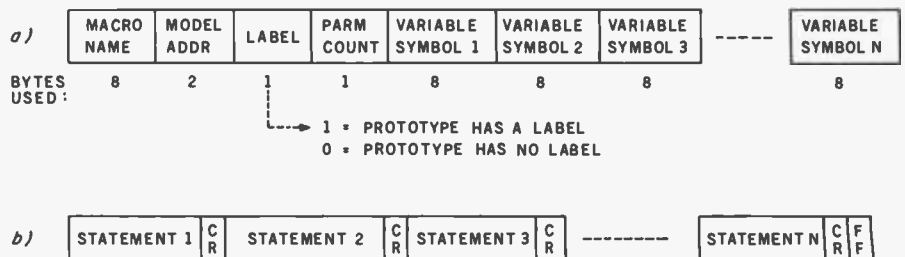

Figure 2: Data areas associated with macro definition. When a MACRO statement, indicating the beginning of a macro definition, is encountered, the first line (which defines the macro name and the names of its variable symbols) is stored as in figure 2a. Once this is done, all successive statements up to but not including the MEND macro-end statement are stored sequentially as in figure 2b.



Cromemco

incorporated
Tomorrow's Computers Today

Now..

Discover Savings and Service with

EBS

MAIL ORDER DIVISION

ORDER TOLL FREE

- WE ARE PROUD to be an AUTHORIZED CROMEMCO DEALER
- CROMEMCO stands for quality, reliability and obsolescence insurance
- CROMEMCO is widely recognized as a microcomputer industry leader
- CROMEMCO provides strong support for their dealers and end-users
- THE BOTTOM LINE - it's what you buy AND where you buy it . . . WE CARE!

New..

CROMEX IS HERE!

The exciting new multi-user, multi-tasking operating system with many added capabilities.

New..

RPG II

Exclusive offering of this important business language by a microcomputer manufacturer

LISP

The language for Artificial Intelligence research

New..

BUSINESS SYSTEMS SOFTWARE!

General Ledger
Accounts Payable
Accounts Receivable
Inventory

New..

SYSTEM ZERO!

The S-100 personal computer with Cromemco reliability.

16 FDC

Double density disk controller

New..

QUADART!

4 port serial I/O
INTELLIGENT I/O CONTROLLER!
On board Z-80

Use these together for results you won't believe!

An integrated turnkey system that requires no computer programming knowledge. Produced and supported by Cromemco, and designed to make full use of the advanced features found in Cromemco hardware.

SYSTEMS: List Our Price

SYSTEM 2 3990 3190.

Now double density!

Dual double-sided mini floppy disk drives; 64K RAM

SYSTEM 3 7395. CALL

Now double density!

2 Mbyte of dual double-sided 8" floppy disk; 64K RAM

Z-2H 9995. CALL

Now double density!

11 Mbyte integral hard disk; 2 double-sided 5" floppy disks; 64K RAM

All Cromemco systems feature the S-100 industry standard bus, 4 MHZ Z-80 CPU, 64K RAM, and can be easily upgraded to multi-user, multi-tasking capability.

PERIPHERALS:

3102 "SMART" TERMINAL
40 function keys; detachable keyboard with 14-key numeric pad

3703 DOT-MATRIX PRINTER
180 CPS; 18-inch platen; 132 columns; bi-directional with double buffering

3355A FULL LETTER PRINTER
55 CPS; 15-inch platen; quality impression suited to camera copy

BOARDS: List Our Price

SGL. CARD COMP. 450. 380.

8K BYTESAVERII 245. 210.

32K BYTESAVER 295. CALL

ZPU 395. 335.

4FDC 495. 420.

64KZ 1785. 1510.

TU-ART 295. 250.

SDI 595. CALL

High resolution color graphics interface

LANGUAGES: List Our Price

COBOL, now updated 95. 90.

FORTRAN IV 95. 90.

MACRO ASSEMBLER 95. 90.

16K BASIC 95. 90.

32K BASIC 295. 275.

DATA BASE MGMT. 95. 90.

WORD PROCESSING 95. 90.

RATFOR 195. 180.

TRACE 95. 90.

EBS BUSINESS SOFTWARE:

GENERAL LEDGER; ACCOUNTS PAYABLE; ACCOUNTS RECEIVABLE; PAYROLL (Calif.); INVENTORY; ORDER ENTRY

List Price \$995. each

Customization available

Call or write for our low mail orders prices on all CROMEMCO products . . . or on PERSCI disk drives, MEASUREMENT SYSTEMS boards, BASE 2, QUME, SOROC, ADDS, TVI, NEC SPINWRITER or other quality products.

EXECUTIVE BUSINESS SYSTEMS

20457 E. Valley Blvd., Walnut, CA 91789
(714) 594-5736

WE ALSO OFFER:

- Complete analysis of your system needs
- Installation, training, support & maintenance
- Custom applications software

AT OUR REGULAR CONSULTING RATES
Phone inquiries welcome



Prices shown are for "Cash with Order"

COLLECT PHONE ORDERS WELCOME or Send check or M.O. (Personal or Co. checks require 2 wks. to clear) Please include phone number. Shipping charges will be added, Within Calif. add applicable sales tax. Factory warranty included. All prices subject to revision.

CDOS® Cromemco, Inc.

CP/M® Digital Research

CBASIC™ Compiler Systems

GET IT OFF THE FLOOR

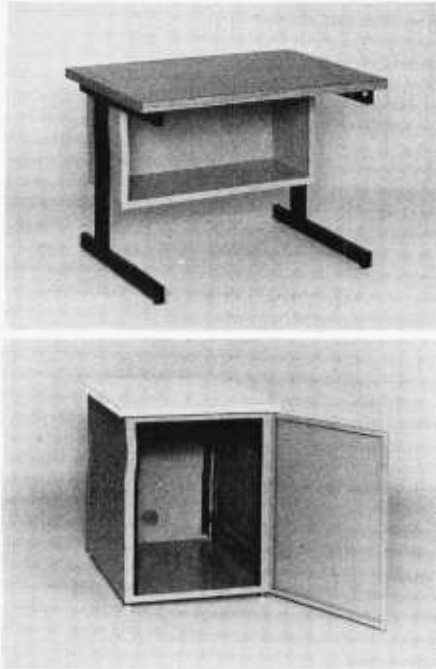

Now that you have a shiny new computer terminal, what are you going to put it on? Computer Furniture and Accessories makes a variety of furniture for a wide range of computer applications. In combinations of six widths, three depths, and three heights. With "L" shaped returns, Micro shelves, data shelves, RETMA mounting, and printer stands. With optional drawers, doors, CRT turntables, and casters. Sizes, shapes and colors designed to fit your office or computer room environment. Reasonably priced and shipped from stock.

Call CF&A. We'll get your system up where you can really put it to use.

CF&A

Computer Furniture and Accessories, Inc.
 1441 West 132nd Street
 Gardena, CA 90249
 (213) 327-7710

deleted at the end of the macro expansion.

The macro stack is used to control the inner macro definition and symbol-table process. It contains a pointer to the directory entry of the macro statement currently being expanded, a pointer to the next model statement to be expanded, a pointer

to the next available byte in the value-storage area, a pointer to the next available symbol-table entry, and a variable holding the depth of macro nesting. If this variable, called the *macro level*, is zero, the next statement in the source file is read. If the macro level is not zero, then a macro expansion is in progress and

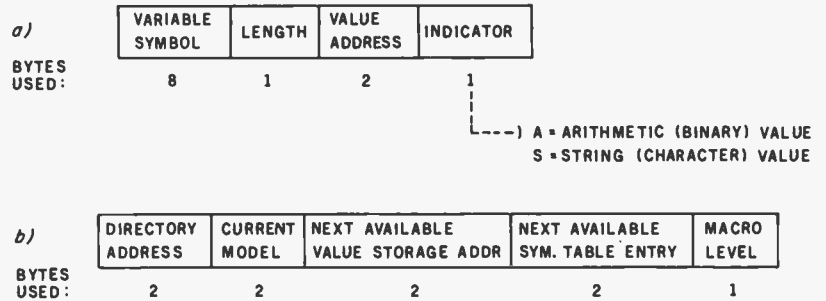

Figure 3: Data areas associated with macro expansion. When a macro statement is encountered in the assembly-language program, one entry with a layout as in figure 3a is pressed onto the symbol-table stack for each variable symbol in the macro-definition header line (directory entry). Also, the calling macro statement pushes one entry (with a layout as in figure 3b) onto the macro stack to represent the current macro instruction being expanded. Refer to figure 4 for a graphic representation of the interrelationships of these fields.

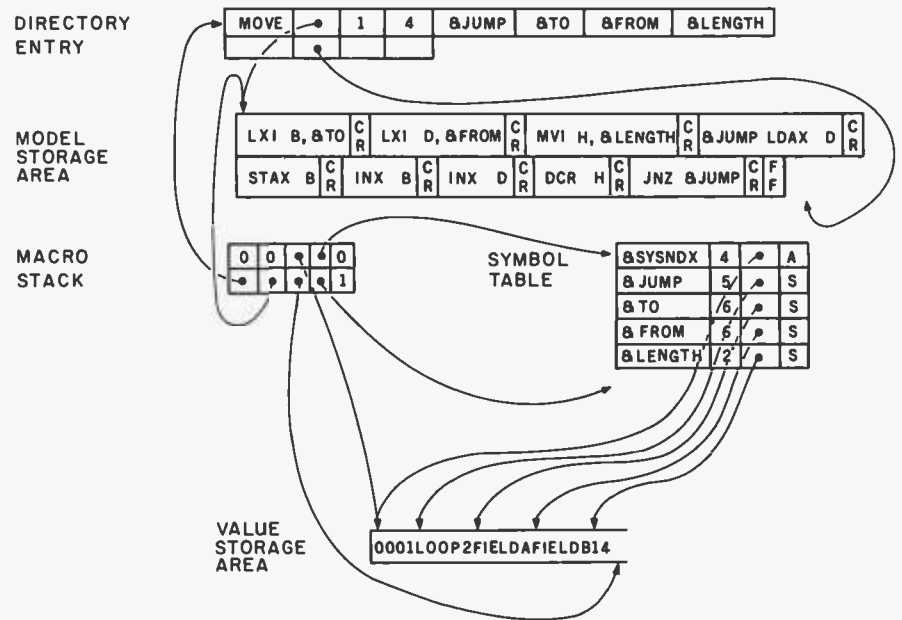
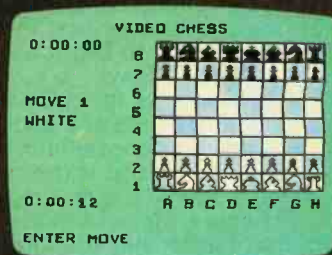
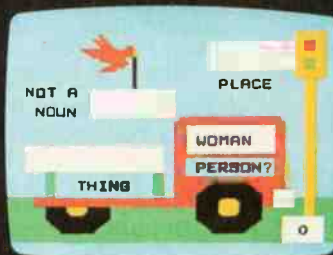
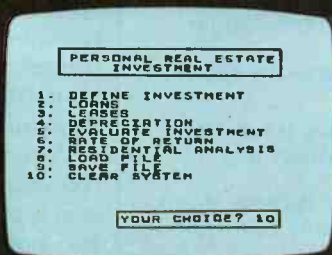
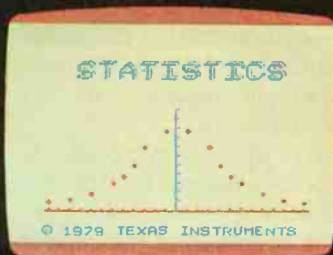
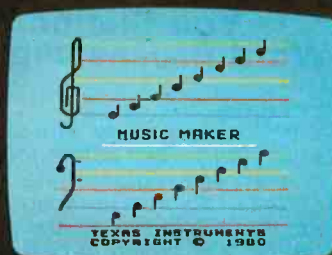
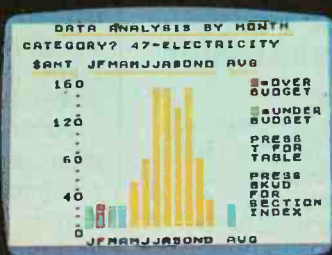
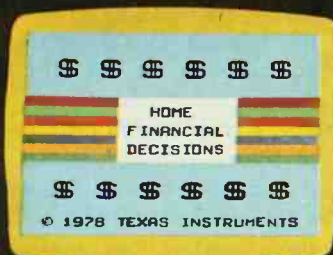

Figure 4: Interrelationship of data areas during macro expansion. Processing of the macro definition results in the directory entry and the entries shown in the model-storage area. When a macro instruction is encountered in the assembly-language program, the second entry in the macro stack is made, along with the entries shown in the symbol table. The first entry in the macro stack, the line with the zeros, is used to denote that the macro stack is empty and that there are no macros currently being expanded. The entries belonging to the current macro are pointed to by the pointer originating in the second row, fourth column of the macro stack. Variable symbols found in the model-storage statements are searched for in the symbol table starting with the last entry in the table and going backwards. The third field in each symbol-table entry points to the first character (or byte) of the variable symbol's value as stored in the value-storage area. The macro statement being expanded is "LOOP2 MOVE FIELD A, FIELD B, 14".

Announcing Texas Instruments Author Incentive Program... win up to \$3,000.



Texas Instruments is looking for unique home computer programs. If you have some, we can help you turn them into profit makers. To begin with--you could win up to \$3,000. You'll still own the programs...we may help you sell them.

One of the most exciting things about the home computer revolution is discovering the many ways a computer can be used.

If you've been working with small computers for a while, chances are you've developed some innovative application programs. This is your chance to put them to work — for a profit.

Texas Instruments is looking for quality programs. We've created an Author Incentive Program to make it worth your while. The award for the top program will be \$3,000. And there are five \$1,000 awards, plus twenty \$500 awards. All winners will be recognized with national publicity. Even if you don't receive one of these monetary awards, we may see enough market potential for your pro-

gram to help you develop it and sell it.

We want programs that offer real utility and lasting value. Programs that are self-teaching, that communicate on human terms. After all, the TI Home Computer was designed to be the first home computer the whole family can use.

TI is interested in education, personal finance and technical or managerial programs for professionals. Home management programs, hobby and simulation programs. We prefer that your submissions exclude entertainment packages.

Your entry can be a program you've created for use on the TI-99/4 or other microcomputers — in any high-level language, from Pascal and BASIC to FORTRAN or COBOL — or even assembly

language. All the way up to 48K RAM.

Keep in mind that programs for the TI Home Computer can incorporate high-quality color graphics, music and sound effects, and TI's remarkably-human synthesized speech.

To submit an entry, call the toll-free number below or use the reader service card in this magazine. We'll send you an entry submission form plus full details. *Please don't send anything until you receive and fill out this entry form.*

Programs must be in by November 15, 1980 — so get your entry form soon.



For an entry form, call 1-800-858-4565.

Call between 8 a.m.-4:30 p.m. CDT, Mon-Fri. In Texas call 1-800-692-4279.

**TEXAS INSTRUMENTS
INCORPORATED**

© 1980 Texas Instruments Incorporated
Offer void where prohibited by law.
Author Incentive Program not open to TI employees,
TI consultants and contractors or their families.

Circle 110 on inquiry card.

221085

The Changes You Make on the Screen
Become the Changes to the File.

A Proven Screen-Oriented Editor

- Easy to Use Features
- Totally Customizable

You Customize The Fastest Editor For
Word Processing, C-Basic, Fortran, Assembler.

Features:

Full screen editor with status line. *The screen continuously displays the region of the file being edited. Changes are made by moving the cursor to any place in the file and typing in new text or hitting a function key.* Full array of cursor movements with single key movement to begin and end of lines, tab positions.

Function keys for character delete, line delete and allowing line splitting and concatenating.

Very easy to use text move in visual mode with a text register.

Flexible command mode allows global search and substitute, repetitive editing operations, text move.

Blocks of text are readily copied from one file to another. Files may be merged on input, split on output and other extensive file handling.

Keeps up with the fastest typists!
Extensive manual with sections for both the beginning and experienced user. (Our users say it is the clearest, best manual available).

Special Features:

Disk buffering can automatically perform Read/Write for files larger than available main memory.

Tabs settable to any positions. Tab key inserts tab character or spaces to next tab position.

Display of clearly marked continuation lines for text lines longer than the screen.

Optional 1 year software support.

You Customize It:

To Your screen size (even 40 or 70 lines), screen address and keyboard layout.

Cursor - blinking, reverse video. Default Tab positions and various parameters.

Scrolling methods. It is ideal for diverse hardware, keyboards and applications.

For OEMs too.

Compatible: Memory mapped displays, including VDM, POLY, SSM, VIO. Most popular CRT terminals. Also for Sorcerer, H8/H89, Cromemco and others.

Also for TRS-80 I & II

Compare with the other screen oriented editors. Some have most of VEDIT's features, fewer have the special features, but none are customizable like VEDIT. And don't be misled by our lower price! Write or call for more information and discover why VEDIT allows you to edit faster and easier than any other editor. (Even users with other screen oriented editors and word processors tell us they prefer VEDIT.)

Ordering: Specify your video board, CRT terminal type or microcomputer, the 8080/Z80 or Z80 code version and disk format desired.

Standard Package: For CRTs, Sorcerer, Model II, PIICEON \$110
Memory Mapped Package: For Memory mapped displays \$100
Manual: Price refunded with software purchase \$ 15
PIICEON V-100: 24 X 80 Video display board, 1 Year Warranty \$445
PICKLES & TROUT CP/M: Super CP/M 2.2 for the TRS-80 MOD II . . \$185

VISA and MASTER CHARGE Welcome. Dealer Inquires Invited.

VEDIT CP/M

Visual Editor from
Compuview Products, Inc.

1531 JONES DRIVE ANN ARBOR, MICHIGAN 48105
CALL ANYTIME: (313) 996-1299

the model statement pointed to by the current model address is processed.

The macro stack will always contain one entry at the bottom with everything set to zero to allow initial and non-macro-definition statements to be read under control of the macro level indicator. The only other areas of memory that we need are an area in which to accumulate the value of &SYSNDX (which is incremented every time a macro definition is expanded) and an 80-byte area in which to expand the current model statement before passing it to the assembler.

At this point, it might be helpful to refer back to figure 1. The STORE routine was discussed earlier. Now that we have defined the symbol table and macro stack, we can look at the ALLOC (figure 1c) and EXPAND (1d) routines. Bear in mind that the actual process is considerably more complex than the simple diagram of the flowchart in figure 1a.

When an operation code is recognized to be a macro call, the first step is to build a new macro-stack entry. Both the addresses of the current macro model and its directory entry are stored. We also store the address of the next available value-storage area and symbol-table entry, and finally add 1 to the old macro level and store it as the macro level of the current macro-stack entry. At this time we also want to increment to &SYSNDX.

Next, we must put the current values for the variable symbols in the symbol table. To do this, we take the first variable symbol from the current macro-directory entry and enter it in the symbol table. We take the first operand (or the label if the LABEL indicator is a 1, indicating that a label is present) from the macro instruction and put it in the value-storage area, also pointing the symbol-table entry to it; this is repeated for every variable symbol in the directory entry. We also put the current value of &SYSNDX into the symbol table. Figure 4 shows how all of the tables, stacks, and storage areas are interconnected for the MOVE macro definition of listing 1. Note that the comments have not been stored in the model-storage area.

One additional complexity should be mentioned concerning the filling of the symbol table from the directory entry and macro call. The SAVE

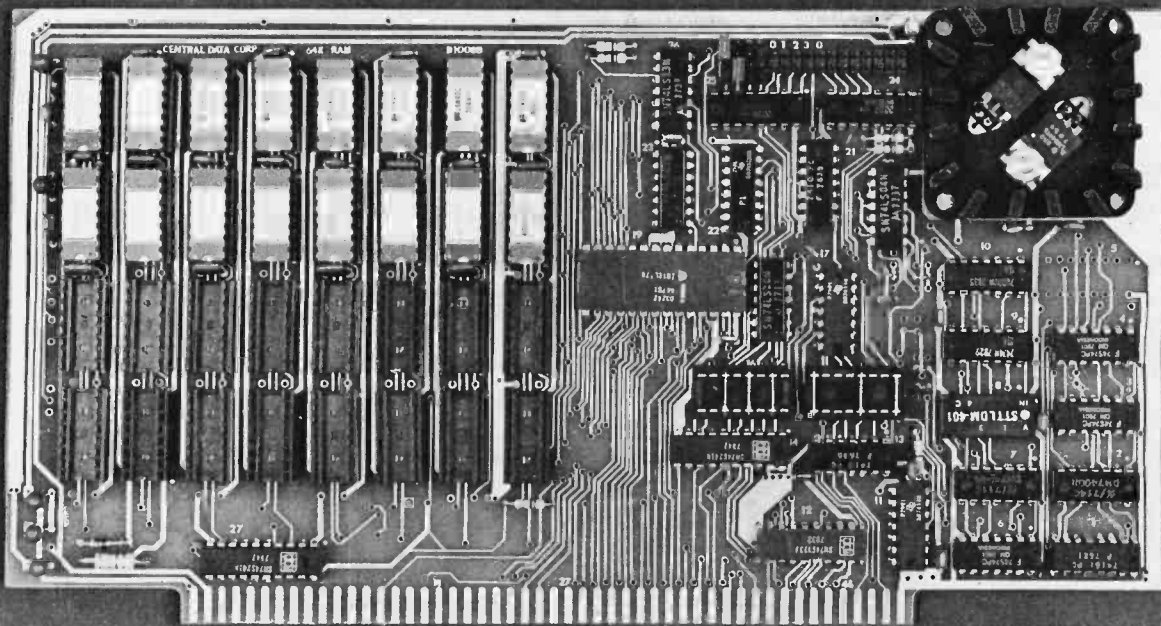

32K Board Pictured Above

Why Not the Best?

From The Dynamic RAM Company.

2MHz	4MHz
16K—\$249	\$259
32K—\$375	\$395
48K—\$500	\$530
64K—\$625	\$665

We have now been shipping our 2MHz dynamic RAM boards for over two years. Hundreds of 4MHz boards have been going out every month since early 1979. Our reliability is proven in the thousands of systems which contain our board. Many quality-minded systems houses across the country and overseas are using our boards for their equipment.

Our prices still beat all. Despite rising 16K memory chip prices (at least from reputable suppliers), Central Data continues to give you the best buy in memory today. Nobody offers a board with a capacity of 64K, assembled, tested, and guaranteed for a full year at the price we do.

Deselect around PROMs. Our boards have the important deselect feature which lets you overlap any fixed memory in your system with no interference.

Our features make the board easily used and expanded. You address our boards on 16K boundaries with mini-jumps (small shorting plugs that slide over wire-wrap pins) near the top of the board for easy access. If you want to expand your board after you have purchased it, all that you need to do is add memory. We can supply you with expansion packages (\$150-2MHz, \$160-4MHz) which include eight RAMs that you can depend on as well as two mini-jumps for addressing. And of course, our board **never** generates wait states.

Low power consumption keeps your computer running cool and reliable. The total power consumption of our 16K board is typically less than 4 watts (+8V @ 300ma, +16V @ 150ma and

—16V @ 20ma). Boards with additional memory typically increase power consumption only 1 watt per 16K!

Standard S-100 Interface. Our board is designed to interface with any standard S-100 CPU. All of the timing of the board is independent of the processor chip, and the board is set up for different processors by changing two plugs on the board.

Call or write us today. That will guarantee a fast response with more information on the board. Or make an order — you'll probably have the board in two weeks! **If you're interested, also ask for a catalog on our Z8000 16-bit processor board designed for the MULTIBUS.** All of these products are available to your local dealer, also.

Central Data Corporation, 713 Edgebrook Drive, PO Box 2530, Station A, Champaign, IL 61820. (217) 359-8010

Central Data

Listing 6: Passing macro parameters to an inner macro call. Some additional code must be added to the macro-evaluation routine in order to enable a macro call within a macro definition to pass the value of one of the parameters of the outer macro. Given the two macro definitions of SAVE and INCR in listings 6a and 6b, the macro call of SAVE in listing 6c, and the resulting expansion in listing 6d, the intent of this code is for the SAVE macro definition to pass its parameter into INCR. Note that the parameter names for the two macro definitions must be different to accomplish this. In line 3 of listing 4d, the operand of the INR instruction (here, D) will always be the same as the argument of the SAVE macro call in listing 6c.

```
(a) 1.          MACRO
    2.   &LAB    SAVE  &REG
    3.          MOV   M,&REG           MOVE REG TO ADDRESS IN HL
    4.          INCR  &REG           CALL INCR TO INCR HL AND COUNT
    5.          MOV   A,&REG           MOVE REG TO A
    6.          MEND

(b) 1.          MACRO
    2.          INCR  &REGISTR
    3.          INX   H               INCREMENT HL PAIR
    4.          INR   &REGISTR       ADD 1 TO REGISTER
    5.          MEND

(c) LABEL1    SAVE  D

(d) 1. LABEL1    MOV   M,D MOVE REG TO ADDRESS IN HL
    2.          INX   H INCREMENT HL PAIR
    3.          INR   D ADD 1 TO REGISTER
    4.          MOV   A,D MOVE REG TO A
```

macro definition given in listing 4a contains, on line 4, a call of the INCR macro definition with a constant operand of B. What if we wanted to use whatever value was coded for ® on the SAVE macro call?

Listing 6a shows the SAVE macro definition again, but this time it calls INCR on line 4, passing a value of ®. In listing 6b, we have the INCR macro definition again, but ®ISTR is used as its variable symbol instead of ®. Now that the INCR macro definition has its own variable symbol, the expansion of line 4 of the SAVE macro instruction can be accomplished as if the value of ® were in line 4 (instead of the characters "®").

When entering the variable symbols and their values in the symbol table during a macro expansion, we must now check the value for an "&". If found, we search back through the symbol table until we find the variable symbol. We use the length and value-storage pointer from that previous definition. In the new symbol-table entry that we are building. Therefore, when the macro call of listing 6c is expanded and gets to the INCR macro call within the SAVE macro definition, the symbol table is searched for ®, and the value-storage pointer and length in the ® entry are used in the ®ISTR entry of the symbol table. Now both ® and ®ISTR are pointing to the value

of D, and the generated code of listing 6d is produced.

By now the worst is over. All that remains is to expand each model statement in turn, replacing variable symbols with their values and putting back compressed blanks. When a variable symbol is encountered, we look it up on the symbol table, get the pointer to the value-storage area, and replace the variable symbol with the data from the value-storage area. Each model statement is scanned, expanded, and passed to the assembler until there are no more model statements to be processed. The final operation is to delete the most recent entry in the macro stack. This effectively deletes from the symbol table all of the symbols associated with the macro instruction just expanded; it also does the same for the value-storage area and macro-level variable.

As always, there are a few complications you should consider. For example, suppose you want to use an ampersand (&) character in your source, but not to denote a variable symbol. The normal solution to this problem is to require you to use two ampersands in this situation, much like the use of two quote symbols within a character string to represent a single quote character. Two ampersands then tell the macro processor that this is not really a variable symbol and that one of the ampersands should be deleted.

Also, before scanning a model statement for variable symbols, you should check to see if its operation code is itself a macro call. If it is, you want to do the entire expansion routine again, setting up another macro-stack entry, putting more variable symbols in the symbol table, and expanding the new macro call (which could contain yet another macro call within it). Once the inner macro instruction is expanded, you should return to the outer macro definition and resume its expansion. If a macro definition calls itself, this situation is referred to as *recursion*.

(Next month, part 2 of this article will present some fairly detailed flowcharts of the macro definition and expansion processes and discuss interfacing the macro processor with the rest of an existing assembler. In addition, I will discuss some enhanced facilities that you might want to add to your macro assembler.)■

For millions of children,
childhood is not a time of
joy, but a time of hurt.
They're abused. And they need
all the help you can give.
Find out what you can do.

 **prevent child abuse.**
write: Box 2844, Ch., IL 60690
National Committee for Prevention of Child Abuse

New

S-100 A/D & TIMER

New

Tecmar's new A/D and Timer Board is designed to meet sophisticated data acquisition needs. The board can accommodate various A/D modules providing options such as 12, 14, 16 bit accuracy; 100 MHz throughput; variable ranges and gains. It contains a powerful timer circuit (AMD 9513) which can start A/D conversion and can also be used independently for time of day, event counting, frequency shift keying and many other applications.

TM-AD200 FEATURES

- Complies with IEEE S-100 specifications
- Transfers data in 8 or 16 bit words
- 30 KHz throughput standard
- 12 bit accuracy standard
- Jumper-selectable for 16 single-ended or 8 true differential channels
- External trigger of A/D
- Provision for synchronizing A/Ds
- Data overrun detection
- Data is latched providing pipelining for higher throughput
- Input ranges: $\pm 10V$, $\pm 5V$, 0 to $+10V$, 0 to $+5V$
- Output formats: Two's complement, binary, offset binary
- Auto channel incrementing

- I/O or memory mapped
- Utilizes vectored interrupt or status test of A/D
- Provision for expansion to 256 channels

TIMER FEATURES

- 5 independent 16 bit counters (cascadable)
- 15 lines available for external use
- Time of day
- Event counter
- Alarm comparators on 2 counters
- One shot or continuous frequency outputs
- Complex duty cycle and frequency shift keying outputs
- Programmable gating and count source selection
- Utilizes vectored interrupt

TM-AD200 OPTIONS

- Programmable gain up to 500
- 14 bit accuracy
- 16 bit accuracy
- Screw terminal and signal conditioning panel with optional thermocouple cold junction compensation

- 100 KHz throughput with 12 bit accuracy
- Low level, wide range (10mV to 10V FSR) permitting low level sensors such as thermocouples, pressure sensors and strain gauges to be directly connected to the module input

Circle 113 on inquiry card.



TECMAR, INC.
(216) 382-7599

23414 Greenlawn • Cleveland, OH 44122

If your data acquisition needs are simple, the original Tecmar S-100 A/D Board will meet your needs.

TM-AD100 FEATURES \$495

- Complies with IEEE S-100 specifications
- 16 single-ended or 8 true differential channels
- 12 bit accuracy
- 25 KHz throughput
- I/O or memory mapped
- Input ranges: $\pm 10V$, $\pm 5V$, 0 to $+10V$, 0 to $+5V$
- Minimal software required.

For digital to analog conversion, Tecmar's D/A Board provides four independent 12 bit high speed D/A channels. \$395

TM-DA100 FEATURES

- Complies with IEEE S-100 specifications
- 4 independent digital to analog converters
- 12 bit accuracy
- 3 μ sec settling time
- I/O or memory mapped
- Output ranges: $\pm 2.5V$, $\pm 5V$, $\pm 10V$, 0 to $+5V$, 0 to $+10V$

S-100 BOARDS

8086 CPU W/vectored interrupts	\$450
RAM 8Kx16/16Kx8	\$395
8086 PROM-I/O	\$495
Serial and Parallel I/O	\$350
Parallel I/O & Timer	\$350

TRS-80¹

PET²

KIM²

APPLE
(available soon)

- ▶ 12 Bit High Speed
- ▶ 8 Ch. Differential
- ▶ 16 Ch. Single-ended
- ▶ Each A/D Module \$495

A/D **D/A**
12 Bit High Speed 4 Channel

Each D/A Module \$395

TRS-80 or PET expansion board, power supply, and enclosure \$200.
Kim expansion board and power supply \$150.

S-100 Real Time Video Digitizer

- Digitizes and Displays in 1/60 sec, flicker-free
- 16 Gray Levels
- Switch Selectable to display Black and White Graphics (8 pixels/byte)
- Maximum Resolution: 512 pixels/line x 240 lines
- Minimal software requirements \$850

Data Acquisition Systems and Video Microcomputer Systems Available

¹Reg. Trademark of Tandy Corp.
²Reg. Trademark of Commodore

Product Description

Three New Computers from Radio Shack

Stan Miastkowski, Editor

Ever since the TRS-80 was introduced, there has been repeated speculation about its successor. Rumors have flown about the imminent demise of the Model I and the introduction of a "TRS-90" (or something of that sort). Last year the TRS-80 Model II was introduced. Even though its capabilities are much greater than the Model I, its price was aimed squarely at the small-business market.

The TRS-80 Model III

All the speculation, or at least most of it, can now come to an end. The TRS-80 Model III has arrived, and along with it come the TRS-80 Color Computer and the TRS-80 Pocket Computer. Even though the Radio Shack people say the Model III is *not* designed to replace the Model I, it is the successor and it seems likely to eventually push aside the Model I.

Several Radio Shack development people told me that the Model III was introduced because they saw a need for

what was termed a "powerful" desk-top computer that would be smaller and less expensive than the Model II (which starts at \$3450).

Cosmetically, the TRS-80 Model III bears a more-than-vague resemblance to the Model II. The entire unit is housed in a one-piece molded case sporting the familiar battleship-gray motif. One big change is that the keyboard (65 keys including keypad) is nondetachable. The high-resolution monitor measures 30.48 cm (12 inches) diagonally, and space has been left next to the monitor to mount one or two (optional) disk drives. The obvious reason for the one-piece design is to provide increased RF (radio frequency) shielding to comply with FCC (Federal Communications Commission) rules and regulations. This was confirmed by several Radio Shack people.

As for the internal design of the TRS-80 Model III, the only thing I was able to uncover is that the Z80 continues to be Radio Shack's microprocessor of choice. At a recent press conference introducing the products, none of the new products was shown with the cover removed. Requests to "take a look inside" were firmly, but politely, denied. Despite the myriad hobbyists waiting with hot soldering irons to get inside, the official policy of the Tandy Corporation is that its computers should be opened only by authorized service personnel.

The TRS-80 Model III is being marketed in three basic configurations ranging in price from \$699 to \$2495. Radio Shack says that all Model I software will run on the Model III without modification. You can purchase 4 K bytes of programmable memory, uppercase-only alphanumeric character set, and Level I BASIC for \$699. An important addition to Level I BASIC is the inclusion of LPRINT and LLIST (since a printer interface is included).

Significantly, none of the Model III configurations include the familiar cassette recorder. Radio Shack is selling the optional CTR-80A for \$59.95. Another new feature is that the cassette data-transfer speed is now a respectable 1500 bps (bits per second) even with Level I BASIC. No more time to go get a sandwich and coffee while a program is loading.

The next step up in the Model III progression is \$999. Inasmuch as this buys you a *lot* of capability, it seems destined to be the most popular version of the new computer. Included are 16 K bytes of programmable memory, uppercase and lowercase alphanumeric, a real-time clock, and something called "Model III BASIC" (not to be confused with Level III BASIC which is marketed for the TRS-80 by an independent supplier). At press time, no details were available on how Model III BASIC differs from Level II BASIC. I did learn that a TIME\$ function and several new statements are included.

The top of the TRS-80 Model III line is what Tandy is calling its "Desktop Business Computer." The price for this configuration jumps to \$2495, but it adds two double-density 5¼-inch (12.7 cm) floppy-disk drives and an RS-232C interface. The drives give the Model III a

SURPLUS
"SELECTRIC" SPECIAL!

"SELECTRIC" TYPEWRITER TERMINAL

Just imagine; an IBM Model 725 "SELECTRIC" typewriter built into a complete table-top RS-232 terminal! These surplus terminals were formerly on lease and appear to be in good condition (we test 'em to make sure the printer is functional!) These fantastic BCD-Coded terminals feature:

- 15" CARRIAGE
- 725 "SELECTRIC"
- RS-232 I/O
- 132 COLUMNS
- Sim. to IBM 2741
- Std. Typewriter Kbd.
- MAX: 15 CPS RATE
- 10 Chars./Inch
- Removeable Type Sphere
- 134.5 BAUD I/O
- 88 Character Set
- 6 Bit BCD CODE
- Attractive Case
- Upper/Lower SHIFT

ONLY \$469⁰⁰!
Ea.



While we will check out each unit, we MUST offer these unique bargains "AS-IS": Meaning they may need some service but are basically operational. Add \$20.00 for packing crate, you pay shipping on delivery.

ALSO INCLUDES: Type ball, I/O circuit boards, power supply & some data. Sorry, no power cord included

—SPECIAL OFFER!—
Buy 2, take 20% Off the Full Price—
You Pay Only **2 for \$750⁰⁰**

"SELECTRIC" PRINTER MAINTAINANCE MANUAL
JUST IN!! We now have available some excellent printer maintenance manuals. These are the most thorough manuals we've seen. Well worth the price! ONLY \$25.00 ea.
"SELECTRIC" is an IBM Trademark

CFR Associates, Inc.
MAIL ADDRESS: P.O. Box 144, NEWTON, N.H. 03058
WAREHOUSE: 18 GRANITE STREET, HAVERHILL, MASS. 01830
(617)372-8536
Phone Orders Are Welcome

Finally...Serious Expansion for the AIM-65



Introducing **Memory-Mate***, the AIM-65 expansion board that lets you spend your time on application solutions, not hardware hassles. Add Memory-Mate to your AIM-65 and make quick work of development and process control projects.

In its primary function, the Memory-Mate board provides 16-48K of RAM expansion assignable in 4K blocks anywhere in the system. Memory-Mate's parity check circuitry insures system RAM integrity (including AIM's 4K on-board RAM) for high reliability applications. The programmable write protect feature eases software development chores. This compact board, which fits directly **beneath** the AIM, also includes four programmable I/O ports, a tone generator for audible warnings, and sockets for 4K of PROM.

I/O intensive applications are accommodated with Memory-Mate's STD BUS interface option. Use off-the-shelf STD BUS cards to solve your biggest I/O problems.

The Memory-Mate with 16K RAM is priced at \$475, with 16K expansion chip sets (including parity chip) costing \$100 each. With 48-hour active burn-in and warranty for a full year, you won't have to worry about reliability either.

First of the complete AIM-Mate* series, Memory-Mate will be joined shortly by the Video-Mate*, Floppy-Mate* and the AIM-Mate case. For further information on the entire AIM-Mate series, write 'Attn: AIM-Mate Series' at the address below.

*TM Forethought Products

Forethought Products

87070 Dukhobar Rd., Eugene, OR 97402
(503) 485-8575

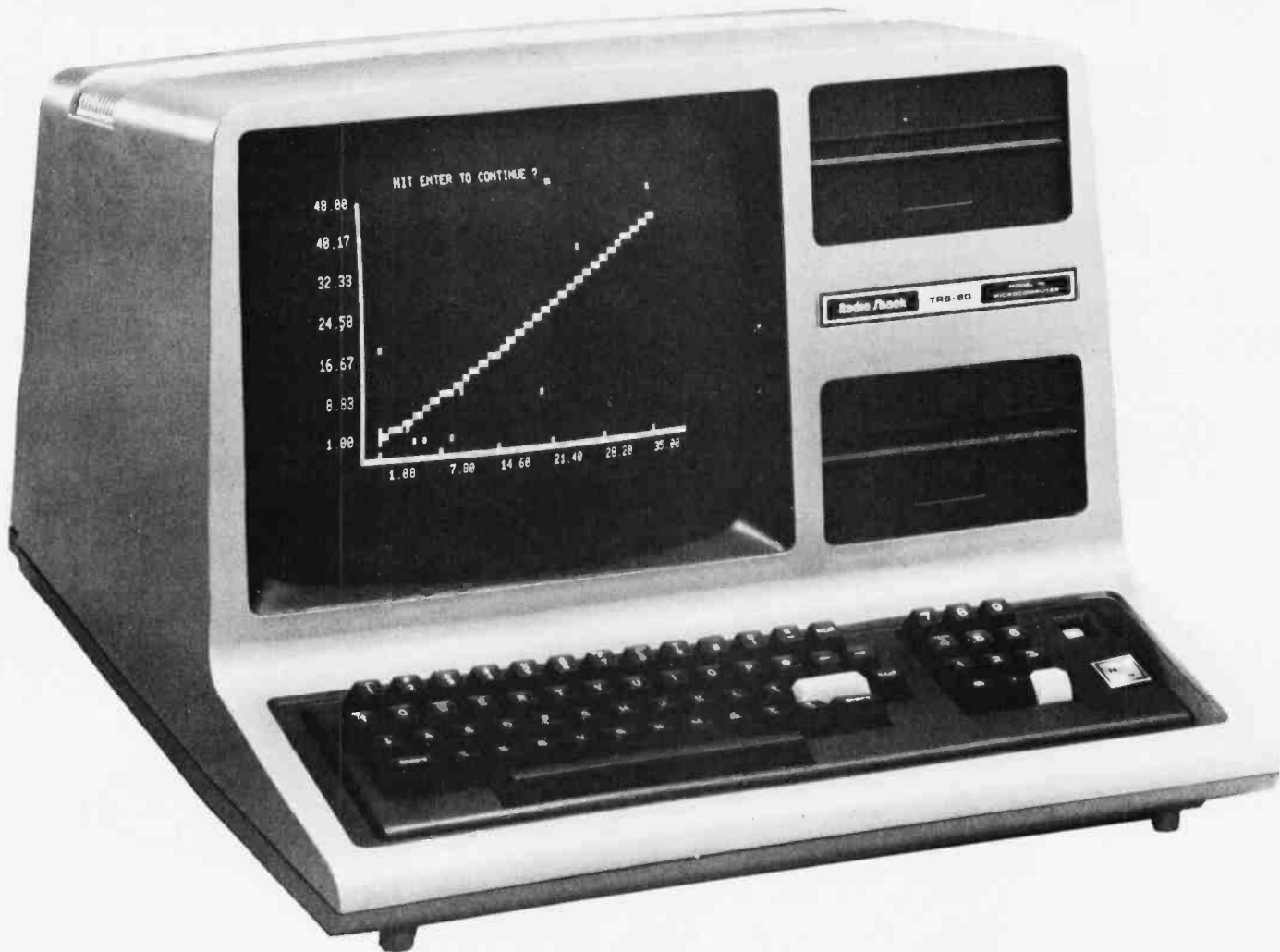

Photo 1: The TRS-80 Model III is available in three configurations ranging in price from \$699 to \$2495. The Model III is housed in a one-piece case with a nondetachable keyboard. Utilizing a Z80 microprocessor, the Model III is available with uppercase and lowercase alphanumeric, real-time clock, RS-232C serial interface, and "Model III BASIC"—an expanded version of the familiar Level II BASIC.

total storage capacity of 315 K bytes. Radio Shack has also introduced a new daisy-wheel printer for \$1960 (more about the printer later). It's a natural to go with the Desktop Business Computer Model III configuration, and it brings the price of the Desktop Business System to \$4455.

Although these are what Radio Shack calls its three basic configurations, you are not limited to them. As with the TRS-80 Model I, you can pick and choose. For example, adding 16 K bytes of programmable memory costs \$199. Sixteen K bytes and the Model III BASIC are \$299. The RS-232C serial interface can be installed in any of the Model III configurations for \$99. If for some reason you want a single floppy-disk drive, it's available for \$849, including a new TRSDOS (disk operating system). The second drive is \$399.

The TRS-80 Color Computer

Of the three new computers that Radio Shack announced, the TRS-80 Color Computer will probably create the most interest in consumer markets. It's sure to create quite a few sales along the way. Radio Shack's copywriters call it "high-technology at low cost." For \$399, you receive a full-fledged computer with color and

sound, and it is programmable in BASIC. Included are 4 K bytes of programmable memory, a built-in television modulator, and a 53-key standard keyboard.

The TRS-80 Color Computer utilizes a Motorola 6899E microprocessor and supports several levels of color graphics, each using increasing amounts of memory. Eight colors are available—any one of which the user can select for the background color. The character format is 16 lines by 32 characters. The "standard" graphics format is 64 by 32. The highest-resolution graphics are 128 by 192 (using four colors) and 256 by 192 (one color only).

A unique built-in feature of the TRS-80 business computer is an RS-232C serial interface for modem or printer connection. Because of this, the Level I BASIC of the Color Computer includes LPRINT and LLIST. With the addition of a modem (\$199) and a special software package (\$29.95), the Color Computer becomes a Videotex terminal (Radio Shack's name for its connection to the CompuServe Information Services Network).

At present, seven games and a personal finance program (all full-color) are available in ROM (read-only memory) "Program Paks" that plug into the side of the unit. Several of the games require optional joysticks (\$24.95).

SAVE

on
add-ons
for

APPLE® and TRS-80®

"APEX" NEW DISK OPERATING SYSTEM FOR THE APPLE®

Fully Professional DOS for the Apple II. The result of two years of extensive development, APEX provides a complete program development and file management system, both powerful and useable. A comprehensive command set allows the user to perform almost any imaginable disk operation. Here are some of APEX features:

- Command structure similar to CPM and main frame systems. Contains 20 command words, with ability to treat external programs as transient commands to the operating system.
- Easy program interface. Simple communications between the DOS and user program.
- Capable of handling 5 inch, 8 inch, and hard disks.
- Safety features to protect against accidental data loss. Features include backup files, directory, read-after-write & limit checks.
- 4 times faster than CPM.
- Auto default structure eliminates tedious typing by automatically setting up command strings, file names, etc.
- Functional on both single and multi-drive systems. Includes utilities for file copy.
- Device handler structure for interfacing peripherals.

The APEX package includes all of the tools for a complete assembly language development system, high speed two pass resident assembler and a powerful macro editor.

The complete APEX package with operating system, assembler, editor and manuals, also includes utilities to maintain files on single or multiple drive systems.

\$99 RELATED SOFTWARE

XPLO	\$79
FOCAL™	\$59

SAVE ON APPLE II 16K



FREE MEMORY UPGRADE KIT TO 48K WITH PURCHASE OF APPLE II 16K **\$1195** (MTI ONLY)

INTRODUCTORY OFFER

SAVE \$300 TRS-80 Graphics List \$1099

INTRODUCTORY OFFER

MTI MINI FLOPPY FOR APPLE

Second Disk Drive By Lobo

OKIDATA MICROLINE 80 OUR PRICE **\$699**

ONLY **\$399**

MTI APPLE 8" DISK SYSTEM

- *One SA800R Floppy
- *2 Drive Chassis & Power Supply
- *Controller, Cable and DOS

\$1439

Drives for any Microcomputer

Does not include power supply & cabinet.

Perrec FD200	\$282	FD250	\$399
Shugart SA400	\$279	SA800/801	\$479
MPI B51	\$279	B52	\$349

Printers

Centronic 779	\$1,069
Base 2	\$599
Centronic 737	\$899
Centronics 702-9	\$1,895
Anadex 9501	\$1,595
Malibu	\$2,395

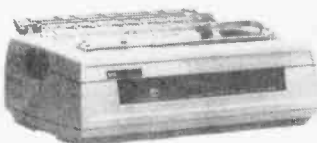

Spinwriter **\$2,549**

NEWDOS 80

A new enhanced NEWDOS for the TRS-80.

The most powerful Disk Operating System for the TRS-80, designed for the sophisticated user and professional programmer who demands the ultimate.

NEWDOS/80 is the planned upgrade from NEWDOS 2.1. Some of the features are:

- New BASIC commands for files with variable record lengths up to 4095.
- Mix or match drives. Use 35, 40 or 80 track 5" disk drives or 8" disk drives, or combo.
- Security boot-up for BASIC or machine code application programs.
- New editing commands.
- Enhanced RENUMBER that allows relocation.
- Command chaining.
- Device handling for routing to display and printer simultaneously.
- DFG function; striking of D, F and G keys allows user to enter a mini-DOS without disturbing program.
- Comparable with NEWDOS & TRSDOS.
- Machine language Superzap/80 2.1 utilities and enhanced debug and copy.

\$149

Disk Drive Sale!

Complete with power supply and chassis.

TF-3 Shugart SA400	\$359
Perrec FD200, 40 track	\$389
*TF 5 MPI B51, 40 track	\$379
*TF 7 Micropolis 77 track	\$595
TDH-1 Dual Sided drive 35 track	\$499
TF-3M Drive Sys 2 Shugart	\$699

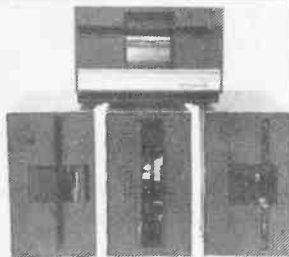

Disk Expansion System

*2 Shugart SA400 TF-3	\$718
*1 Two-Drive Cable	\$ 25
*1 Expansion Interface 32K	\$489
*1 35-track DOS+	\$ 99
TOTAL LIST PRICE	\$1331
SPECIAL PRICE ONLY	\$1,199

NEWDOS+ 40 track	\$110
NEWDOS+ 35 track	\$ 99
Microconductor, Data Base Mgr. Mod I	\$249
Mod II	\$399
AJA Business Pkg.	\$289
Disk Head Cleaner	\$16.95
Disk Alignment Pgm.	\$109

Some as above but includes TRS-80® Level II

\$1984

NEW

TF-8 80 TRACK DISK DRIVE **\$639**
Double Your Capacity

TF-9 DUAL 80 TRACK DISK DRIVE **\$799**
Quadruple Your Capacity

8" Floppy Disk Drive System

for Model I

- One SA801 Floppy
- NEWDOS 80
- Cable & Adapter

\$1095



MICROCOMPUTER TECHNOLOGY INCORPORATED



Apparat, Inc.

TELEX 678-401 TAB IRIN

3304 West MacArthur
Santa Ana, CA 92704
(714) 979-9923

ALL PRICES CASH DISCOUNTED
FREIGHT FOB/FACTORY
ASK FOR OUR FREE CATALOGUE

4401 South Tamarac Parkway
Denver, CO 90237
(303) 741-1778



Photo 2: The TRS-80 Color Computer sells for \$399 with BASIC, 4 K bytes of user memory, and a built-in television RF modulator. It supports eight colors and several levels of graphics resolution. Eight game programs are currently available on ROM-based "Program Paks" that plug into the right side of the unit. Expansion is available with 16 K of programmable memory and Extended Color BASIC, which allows the creation of high-resolution graphics from within a BASIC program. The monitor shown receives standard television signals and sells for \$399.

The TRS-80 Color Computer can be expanded to 16 K bytes with a set of programmable memory processors that sell for \$99 plus installation. Another option is the Extended Color BASIC package (in 8 K of ROM). It gives you the ability to create high-resolution graphics from within a BASIC program. The Color Computer with both the expanded memory and Extended Color BASIC can be purchased for \$599, which is a reasonable

price for its capabilities and should give some other personal-computer manufacturers a few sleepless nights.

One interesting point: the TRS-80 Color Computer can be programmed in machine language (for those so inclined).

For storing and loading programs, you will still need a cassette recorder, which is not included. As I previously mentioned, the CTR-80A sells for \$59.95. If you want

Now NRI takes you inside the world's most popular microcomputer to train you at home as the new breed of computer specialist!

NRI teams up with Radio Shack to teach you how to use, program and service microcomputers... make you the complete technician.

It's no longer enough to be just a programmer or a technician. With microcomputers moving into the fabric of our lives (over 200,000 of the TRS-80™ alone have been sold), interdisciplinary skills are demanded. And NRI can prepare you with the first course of its kind, covering the complete world of the microcomputer.

Learn At Home in Your Spare Time

With NRI training, the programmer gains practical knowledge of hardware, enabling him to design simpler, more effective programs. And, with advanced programming skills, the technician can test and debug systems quickly and easily.



Training includes TRS-80 computer, transistORIZED volt-ohm meter, digital frequency counter, and the NRI Discovery Lab with hundreds of tests and experiments.

(TRS-80 is a trademark of the Radio Shack division of Tandy Corp.)



Only NRI gives you both kinds of training with the convenience of home study. No classroom pressures, no night school, no gasoline wasted. You learn at your convenience, at your own pace. Yet you're always backed by the NRI staff and your instructor, answering questions, giving you guidance, and helping you over the tough spots.

Explore the TRS-80 Inside and Out

NRI training is hands-on training, with practical experiments and demonstrations as the very foundation of your knowledge. You don't just program your computer, you introduce and correct faults... watch how circuits interact... interface with other systems... gain a real insight into its nature.

You also build test instruments and the NRI Discovery Lab, performing over 60 separate experiments in the process. You learn how your trouble-shooting tools work, and gain greater understanding of the information they give you. Both micro-

computer and equipment come as part of your training for you to use and keep.

Send for Free Catalog... No Salesman Will Call

Get all the details on this exciting course in NRI's free, 100-page catalog. It shows all equipment, lesson outlines, and facts on other electronics courses such as Complete Communications with CB, TV and Audio, Digital Electronics, and more. Send today, no salesman will ever bother you. Keep up with the latest technology as you learn on the world's most popular computer. If card has been used, write to:



NRI Schools

McGraw-Hill Continuing
Education Center
3939 Wisconsin Avenue
Washington, D.C. 20016.



FREE COMPUTER FORMS KIT

EACH KIT CONTAINS:

Samples, Prices, Order Form,
4 Checks, 2 Statements, 2 Invoices,
Programming Guides.

We specialize in small quantities, low prices.
500 CHECKS ONLY \$29.95

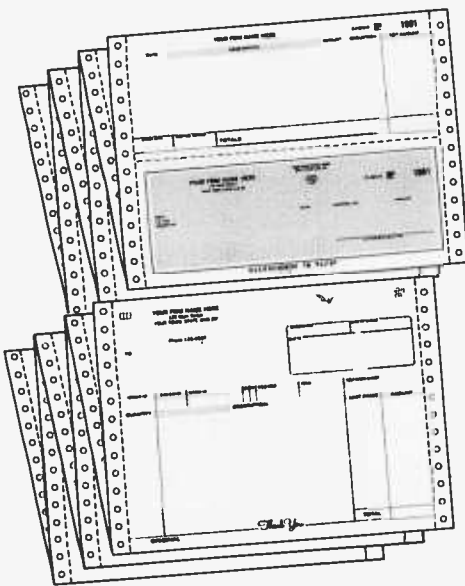

**SEND COUPON, CIRCLE BINGO or
PHONE TOLL FREE
1 + 800-225-9540**

FAST SERVICE — It is our policy to ship within 6 working days following our receipt of your order. **CODE 459**

Name _____

Address _____

City _____

State, Zip _____

**NEW ENGLAND BUSINESS SERVICE, INC.
GROTON, MASS. 01450**

still more storage, Radio Shack says a floppy-disk drive will be available for the Color Computer in early 1981.

You will also need a color monitor for the TRS-80 Color Computer. Since it has a built-in television RF modulator, you can use the family television. But if that draws complaints from the family, an option is available. Radio Shack is now selling its first-ever standard color television. The TRS-80 33 cm (13-inch) Color Video Receiver (made by RCA) sells for \$399 and has full American-standard reception capabilities. It has digital channel display and push-button tuning. At the recent introduction of the Color Computer, it did an excellent job of displaying the high-resolution graphics.

The TRS-80 Pocket Computer

Radio Shack spent a great deal of time stressing the "breakthrough" of the TRS-80 Pocket Computer at this press conference. I have to admit that it is a very interesting product. If you sit back and think a minute, you'll realize that only a couple of years ago genuine pocket computers (not calculators) were something found only in the realm of science fiction.

The TRS-80 Pocket Computer (\$249) is *not* a glorified calculator. It's a compact unit 17.78 by 7 by 1.27 cm (7 by 2¾ by ½ inches), that is programmed in Level I BASIC (without the graphics capability). The keyboard has 57 keys (many of them double function) with the standard "QWERTY" alphanumeric keys. Although the keys are placed very close together, even a high-speed touch-typist can get used to their spacing and feel in a very short time.

The Pocket Computer utilizes a liquid-crystal 24-character alphanumeric display (5-by-7 dot matrix). Lines longer than twenty-four characters can be entered and displayed, and program lines are scrolled automatically. There are 1.9 K bytes of user memory included. For obvious reasons, it is not expandable. An interesting feature is that, since CMOS (complementary metal-oxide semiconductor) programmable memory is used, programs are retained when the power is turned off. Also, automatic BASIC abbreviation eliminates spaces in the stored program to conserve memory space. For off-line program storage, a cassette interface (\$49) is available. Although any cassette recorder is usable, Radio Shack has introduced the Minisetite-9 as a logical companion to the Pocket Computer. It's compact (18.25 by 11.6 by 3.33 cm) and uses standard cassettes.

The TRS-80 Pocket Computer is, interestingly enough, Radio Shack's only computer that is not company-made in Fort Worth, Texas. It's a Japanese product with Radio Shack packaging. (Observant BYTE readers will notice that it bears a distinct resemblance to several other pocket computers which were recently introduced.)

Although I didn't get a look inside, I was able to learn that the Pocket Computer uses *two* 4-bit CMOS microprocessors (one for arithmetic calculations and the other for the BASIC interpreter). There is an 80-character input buffer and the built-in ROM uses 7 K bytes for the BASIC interpreter and 4 K bytes for the monitor.

Not unlike a sophisticated calculator, fifteen mathematical functions are available, including trigonometric and inverse trigonometric with readout in degrees, radians, and gradians, plus logarithms, exponents, angular conversion, integer, and absolute value. The Pocket

THE NEXT GENERATION OF MICROCOMPUTERS IS HERE AT QUASAR DATA PRODUCTS



**16 BIT POWER
Z-8000³**

AND STILL RUN YOUR 8 BIT SOFTWARE

**8 BIT POWER
Z-80**



IF YOU see it our way then we think we have the products for you:

- The S-100 bus is here to stay. It is not the greatest but with proper termination it works reliably at high speeds, and since it is now an IEEE standard, it is well defined.
- The 8 BIT systems are useful but they are the limiting factor for many applications.
- The 16 BIT systems are the way future systems will go. Why not? There is very little price difference and an order of magnitude performance difference.
- The real usefulness of the 16 BIT microprocessors will be determined by the software.
- The systems using 5 1/4 inch disk drives really do not have adequate memory storage or computer power for many business or scientific applications.
- Sixty-four kilobytes of addressable RAM, the maximum for 8 BIT systems, is not adequate for many business or scientific applications.
- It is not worth buying 8 BIT systems or boards now if you can get the same software with 16 BIT systems at about the same price.

- The new 16 BIT microprocessors have power comparable to minicomputers but do not require the same overhead in terms of downtime, maintenance, or initial investment. They are more versatile in many applications such as real time applications.

THIS IS WHAT QDP HAS AVAILABLE:

- A Z-8000 Board that can plug into your existing S-100 Bus System (see below for description)
- A complete Z-8000 System (see below for description).
- A Z-8000 System configured for your exact needs.
- Software to allow you to run all the available Z-80/8080 software including CP/M.
- Software that includes a Monitor, Debugger, Disassembler, and Basic.
- Software options: a) Extended Monitor, b) Pascal, c) Simulators for 8080, Z-80, 6800, 6502, 1802.
- A Z-80 System (QDP-100) that is upward compatible with the Z-8000.

THIS IS WHAT IS COMING FROM QDP:

- A 256 kilobyte RAM card
- UNIX² operating system.

Z-8000 SERIES 16 BIT CPU S-100 BOARD — CAN BE PLUGGED INTO YOUR EXISTING SYSTEM \$695.00

- Fully S-100 IEEE compatible.
- Supports existing 8 BIT memory and 8 BIT peripheral boards.
- Capable of reading and/or writing 8 BIT, 16 BIT, or mixes 8 BIT and 16 Bit memories automatically.
- 8 BIT and/or 16 BIT peripheral modules can simultaneously co-exist in the same bus without any modifications.
- Capable of operating as a slave processor to enable your existing CPU to control the Z-8000.

**Industrial
Quality**

- Supports either segmented CPU or non-segmented CPU.
- Power-on and reset jump dip switch selectable.
- Jumper selectable 2 or 4 MHz. operation.
- Dip switch selectable number and type of wait states.

SOFTWARE

- Z-80 emulator enables you to execute your existing 8 BIT software without any modifications and allows you to run CP/M immediately.
- Extended Monitor, Debugger, Disassembler.

QDP-8100 WITH 2 MEGABYTES STORAGE STANDARD (OPTIONAL 4 MEGABYTES)

- Z-8000 series 16 BIT CPU S-100 Board - see above

SOFTWARE (Provided with system)

- CP/M 2.2¹ operating system
- Basic
- Z-80/8080 Emulator
- Monitor, Debugger, Disassembler software
- Optional software: Pascal
- UNIX² operating system coming

\$6,395.

SYSTEMS



QDP-100 WITH 2 MEGABYTES STORAGE STANDARD (OPTIONAL 4 MEGABYTES)

- Z-80 series 8 BIT CPU S-100 Board (4 MHz. Z-80, Double density disk Controller, 2716 Prom Burner 2 Parallel & 2 Serial Ports, real time clock)

SOFTWARE (Provided with system)

- CP/M 2.2¹ operating system
- Basic
- Accounts Receivable, General Ledger, Accounts Payable, Payroll with Cost Accounting
- Optional software: Fortran, Pascal, Cobol, C

\$4,995.

EACH SYSTEM CONTAINS:

- Intelligent CRT terminal (80 characters X 24 lines)
- 64 kilobytes RAM
- Two 8 inch, double sided, double density floppy disk drives with controller
- 2 serial and 1 parallel (2 parallel for QDP-100) ports
- Attractive woodgrain cabinet with power supplies and cabling

FULL TECHNICAL SUPPORT FROM THE STAFF AT QUASAR DATA PRODUCTS

4 Mhz 64K Dynamic RAM

16K - '250** 32K - '350** 48K - '450** 64K - '549**

QUASAR FLOPPY SYSTEM

- Two MFE DBL sided drives • Cable • Case & Power Supply assembled and tested Wood cabinet '1895**

QUASAR 2 MEG FLOPPY

- 2 MFE double sided drives
- Teletek disk controller board
- Power supply & cable
- Wood cabinet
- CP/M version 2.2 & bios
- Assembled & tested '2295**

Dealer Inquiries Invited, Hours: 9-5:30 M-F

Specifications Subject To Change

'CP/M' Digital Research 'UNIX' Bell Lab 'Z-8000' Zilog

TELETEK DBL. DENSITY, DBL. SIDED

Disk Controller Board..... '395**



PAPER TIGER

Includes Graphics '949**

Cable for TRS-80 '39**

Call for Apple

MFE Double Sided - Double Density 8" Floppy Disk Drives. (the best) '650**
Using the Teletek Controller under CP/M, THIS DRIVE WILL GIVE YOU ALMOST ONE MEGABYTE PER DISK DRIVE.
Power supply for above '110**

TI - 820

Serial Printer -

Full package options... '1995**

30 Day ARO

Checks, money orders accepted

Add \$2.50 freight charges on orders under 10 lbs. Over 10 lbs. F.O.B. Cleveland

QUASAR DATA PRODUCTS

25151 Mitchell Dr., No. Olmsted, Ohio 44070 (216)779-9387





Photo 3: The TRS-80 Pocket Computer. Measuring 17.78 by 7 by 1.27 cm (7 by 2¾ by ½ inches), the hand-held unit sells for \$249 and can be programmed in Level I BASIC. The display is 24-character liquid-crystal type utilizing a 5-by-7 dot matrix. There are 1.9 K bytes of programmable memory included, and a cassette interface (list price \$49) is available for off-line storage. Eight software packages are currently available, including Aviation, Real Estate, Engineering, Finance, Games, and Math.

Computer has 10-digit accuracy. It uses four 67S mercury batteries for a total life of about 300 hours. The Pocket Computer automatically shuts off after seven minutes of inactivity to conserve the batteries.

The Pocket Computer is fun to use, even for hardcore computer enthusiasts. There is something very different about banging in a quick BASIC program on a hand-held unit. If you're used to the pseudo-assembly language of programmable calculators, you'll find using the TRS-80 Pocket Computer an exhilarating experience. Single-step, debug, and edit modes are available to make things easier. It's also useful as a "pocket notebook"—since strings of up to seven characters can be stored as data and then sorted and searched.

Radio Shack has put a good deal of thought and work into eight software tapes that are currently available for the Pocket Computer. They've promised many more to come. Those available now are: Real Estate, Civil Engineering, Aviation, Math Drill, Games I, Business Statistics, Business Financial, and Personal Financial. All of the software has been especially designed for the capabilities of the Pocket Computer. More information fits into that 1.9 K than you might expect. For instance, the Business Statistics software contains eight programs, including forecasting, seasonal variations, moving average, multiple regression, and more. The Management Decisions package also contains eight programs including break-even analysis, optimum order quantity, profit margin, and random sample.

Although there has already been criticism of the TRS-80 Pocket Computer as a "toy," it is a very sophisticated computer for its size and price. Radio Shack is counting on this computer to be a best seller that will

help further Radio Shack's hold on the personal-computer market.

The Printers

Complementing its three new computers, Radio Shack has introduced four new printers, bringing its printer line to seven units at prices ranging from \$219 to \$1960.

The most interesting new arrival is the Daisy Wheel Printer II. Selling for \$1960, it's specifically designed for word-processing applications. It features 10- or 12-pitch as well as proportional spacing and operates at 43 cps (characters per second). A pinchfeed roller takes paper widths from 10.16 to 37.8 cm (4 to 14¾ inches) and a tractor feed will also be available. At present, one character wheel is available, but, because they are easily interchangeable, more can probably be expected in the future.

Another new and different arrival is the Plotter/Printer (\$1460). As the name implies, it can be used as either a normal line printer (uppercase only) or a plotter. It takes 20.3 cm (8-inch) tractor-feed paper and prints at an average speed of 10 cps.

The Line Printer IV sells for \$999, and it is Radio Shack's lowest-cost "letter-quality" printer. It prints both uppercase and lowercase alphanumeric characters in 80- or 132-character columns and handles roll paper, fanfold, or single sheets.

Rounding out the line of new printers is the Line Printer VI. It is a medium-cost business printer designed for reports, checks, invoices, etc. It sells for \$1160. It utilizes a bidirectional printhead (7-by-9 matrix) that operates at 100 cps. It takes 10.16 to 38.1 cm (4- to 15-inch) fanfold, roll, or single sheet paper, and comes with a removable tractor mechanism. ■

MODEL II



26-4002
64K 1 Drive
\$3499.00

MODEL III



26-1061 4K I.....\$630.00
26-1062 16K III.....900.00
26-1063 32K III
2-Drives, RS232.....2246.00



CENTRONICS

Fast 100 CPS Centronics
730 Printer.....\$675.00
Text Quality Centronics
737 Printer.....\$850.00

Model II Cobol Compiler
\$360.00
Cobol Run Time Package
\$36.00

AUTHORIZED TRS-80[®] DEALER A301

COMPUTER SPECIALISTS

26-1056 16K Level II System with Keypad.	\$670.00
26-1145 RS-232 Board.....	84.00
26-1140 "O" K Interface.....	249.00
26-1141 "16" K Interface.....	365.00
26-1142 "32" K Interface.....	476.00
26-1160 Mini Disk - Drive O.....	424.00
26-1161 Mini Disk - Additional.....	424.00
26-1154 Lineprinter II.....	720.00
26-1156 Lineprinter III.....	1799.00
26-1180 Voice Synthesiser.....	339.00
26-1181 VOXBOX.....	145.00
26-1104 Factory Upper/Lower Case Modification Installed.....	70.00
26-1506 Scripsit - Tape.....	60.00
26-1563 Scripsit - Disk.....	85.00

NOTE: Call for availability of VIDEO TEX, Madel III, Color,
and other new products.

ALL OTHER R.S. SOFTWARE
FURNITURE, STANDS, CABLES
AND ACCESSORIES DEDUCT
10% FROM CATALOG PRICE

Novation Cat Modem..\$149.00
CCA Data Management
System.....72.00
Adventure Games
Games 1-9 each.....14.00

Pocket Computer

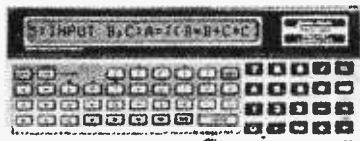

26-3501 1.9K P.C.....\$225.00
26-3503 Cassette I/F.....45.00
14-812 Recorder.....72.00

MODEL I



26-1054
4K Level II
\$552.00

COLOR



26-3001 4K.....\$360.00
26-3002 16K.....540.00
26-3010 Color Video.....360.00
26-1206 Recorder.....54.00
26-3008 Joysticks.....22.50



GAMES:
Alien Invasion.....\$9.00
Stack Market.....9.00
Star Trek.....9.00
Black 'Em.....9.00
Ting-Tang.....9.00
UTILITIES:
System Savers.....14.00
EDUCATION:
Language Teacher.....18.00

FREE: PRICE LIST
UPON REQUEST

1-800-841-0860 Toll Free Order Entry

MICRO MANAGEMENT SYSTEMS, INC.

No Taxes on Out Of
State Shipments

Immediate Shipment
From Stock on Most Items

DOWNTOWN PLAZA SHOPPING CENTER
115 C SECOND AVE. S.W.
CAIRO, GEORGIA 31728
(912) 377-7120 Ga. Phone No.

Full Factory Warranty
on All Items Sold.

Largest Inventory
In the S.E. U.S.A.

*TRS-80 is a registered trademark of the Tandy Corp.

Radio Shack's Modifications to the TRS-80

Terry Li, POB 481, Peterborough NH 03458

Contrary to the opinion of many TRS-80 Model I owners, Radio Shack is constantly improving and upgrading its computers. Two recent improvements are an uppercase-and-lowercase capability, achieved by replacing the character-generator ROM (read-only memory device), and a new set of Level II BASIC ROMs.

Unfortunately, both of these alterations result in changes that require modifications to much of the currently available TRS-80 software. Here's what to expect.

Uppercase and Lowercase

A number of users have expressed disappointment with the TRS-80 uppercase-and-lowercase modification because it does not include the addition of a Control key

to the keyboard. Remember, though, there are always two solutions to a computer problem: change the hardware or change the software.

Hardware modifications that require soldering and cutting have a higher element of risk than simply replacing ROMs. Since the character-generating software is contained in ROM, the obvious means of modifying it is to replace the ROMs. This is what the Radio Shack people have done.

The actual software modification for uppercase and lowercase is relatively simple. Whenever an alphabetic key is pressed, the sixth bit of the character is set high. If an alpha key and the shift key are pressed at the same time, the sixth bit is set low.

There are two distinct disadvantages to the technique that Radio Shack has used:

- **INKEY\$ malfunction:** The INKEY\$ function receives all letters directly from the keyboard, noting whether the key pressed is uppercase (bit 6 low) or lowercase (bit 6 high). When a program uses the INKEY\$ function for one-letter input (eg: Y for *yes*, N for *no*) and that program was written for an unmodified (nonlowercase) TRS-80, the program is looking for an uppercase letter, and the keyboard returns a lowercase letter (unless the user remembers to give a shifted letter as input). The program will then behave unexpectedly because no match was made.

The only way around this problem is to either rewrite the program to look for lowercase letters from INKEY\$ input or to tell the user to always use shifted letters.

- **LPRINT malfunction:** In most cases, the LPRINT command will operate correctly. However, if you're attempting to use the PEEK command to read the video memory, then when LPRINTING the results (which some programmers do), your printer will go berserk, printing carriage returns, form feeds, and garbage. There appears to be no rhyme or reason to this alteration. You cannot PEEK and LPRINT one character, and you cannot PEEK characters, store them in a string variable, and LPRINT the variable without getting this result.

Radio Shack does warn you that not all software will run correctly after the uppercase-and-lowercase modification. This includes some of their own. [However, Radio Shack will exchange old versions of its software for new versions that will work with the modified TRS-80s at no cost; see your local Radio Shack dealer....GW] Some non-Radio Shack word-processing systems (such as Electric Pencil) will not work correctly because of the lack of a Control key on the TRS-80. If some ambitious soul could figure out how to fix Electric Pencil to accept @ as a control character, the problem would be solved.

The New Level II BASIC ROMs

It's not generally known that Radio Shack has come out with a new set of Level II BASIC ROMs. The new ROMs do not include any new features, however, they do fix a few bugs and make the computer a little more reliable. The TRS-80 was originally intended to be a Level I machine, with a small number of users moving up to Level II. Because of this, the TRS-80 circuit board was designed to use only two sockets for the ROMs. For those

8088 PROCESSOR

Add new processing power to your S100 bus system. Add the LDP88 processor to your system and realize performance only available with minicomputers previously. The LDP88 utilizes the Intel™ 8088 processor which is fully compatible with software written for the 8086.

LDP72 FLOPPY DISK CONTROLLER

The LDP72 offers the following advanced features:

- Software selectable single or double density
- Software selectable mini or standard floppy disk
- Onboard data separation for data reliability
- Controls up to 4 double density, double sided floppy disks for up to 4M bytes of storage

86-DOS™

86-DOS, Seattle Computer Products 8086 operating system, is now available for the LDP88 with a BIOS for the LDP88, LDP72 combination.

86-DOS	\$195	Partial Kit	Full Kit	Assembled & Tested
LDP88	\$199.95		\$349.99	\$399.99
LDP72	129.95		219.95	274.95

SPECIAL OFFER (OFFER EXPIRES NOV. 30, 1980)

LDP88 + LDP72 + 86-DOS = \$775

MasterCharge and Visa accepted (Visa add 4%)
(Mass. residents add 5% sales tax)

LOMAS DATA PRODUCTS

11 Cross Street
Westborough, MA 01581
Telephone: (617) 366-4335

86-DOS is a trademark of Seattle Computer Products
Intel is a trademark of Intel Corporation

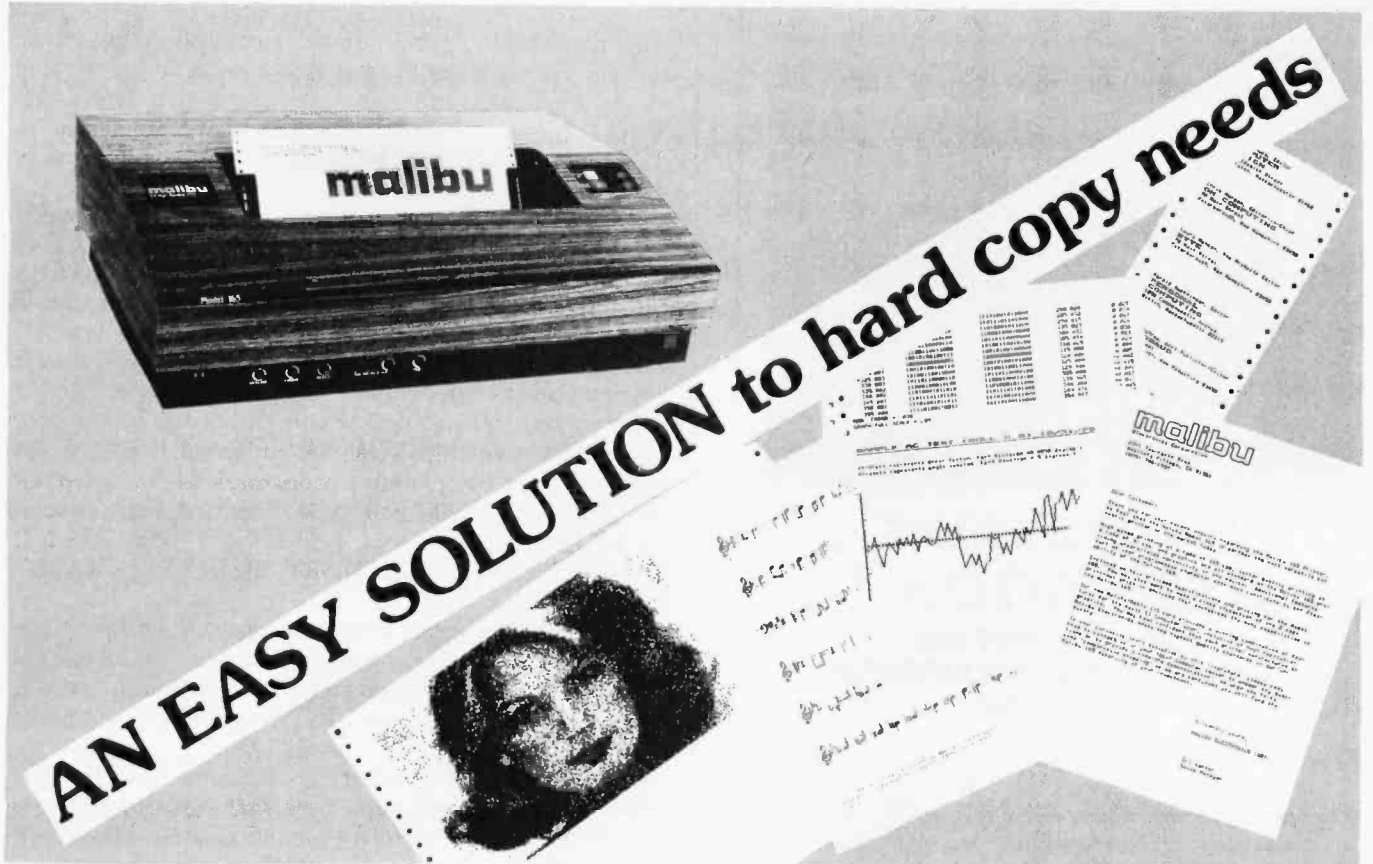

What do you need?

Program listings . . . inventory listings . . . custom logos and letters . . . mailing labels in a multitude of sizes . . . custom forms and the data to complete them . . . curve plotting or bar graphs . . . digitized images from video or bit pads . . . multi-part forms . . . preprinted forms . . . tickets . . . and the list goes on . . .

How do we do it?

High speed bi-directional full logic printing; two standard character sets, upper/lower case with descenders; high speed font at 165 cps; letter quality font at 90 cps; expanded characters, solid underlining; programmable character sets; complete dot control graphics; adjustable tractor feed 3"-16"; user adjustable platen; programmable tabs, forms length and line spacing; out of paper signal; self-test; interface options — RS-232C, Centronics parallel, Apple, S-100; and the list goes on . . .

The Malibu Model 165

Find out if it's the easy solution to your hard copy needs — contact your local computer dealer or you can write or call us today for complete specifications and print samples — you won't be disappointed.

Versatility, Quality and Reliability: We build it in.

malibu
Electronics Corporation

Dealers and OEM'S, call us about our new purchase programs with prices, terms and delivery to meet your needs too.

2301 Townsgate Road, Westlake Village, CA 91361 (805) 496-1990

a subsidiary of Datameetrics Corporation

DATEBOOK for Tue Jan 1 - Not printed since the last change

	First one	Second one	Third one
8:00	John Smith/restoral		Ed Jones/check up and x-rays
10:00		Dennis Johnson/wisdom tooth extraction	
9:00	Kathy Nelson/check up		Judith Washington/restoration
10:00	Mike Silva/restoration		
10:00	George Kennedy/restoration	Thelma Carter/check up	

Schedule: C=cancel, M=modify, L=look for openings, H=hold in, R=reschedule list
 Today, Next day, Future, P=print day's appts, D=display person's appts
 Key is an option letter, number or space for a new display, or 0 to quit

INTRODUCING DATEBOOK™ THE NEW OFFICE APPOINTMENT CALENDAR PROGRAM

DATEBOOK™ helps manage time just like a common office appointment book, but with the speed and accuracy of a computer. DATEBOOK™ eliminates the scribbles, erasures, and frustration of searching through the book for a specific opening.

DATEBOOK™ is ideal for Doctors, Dentists, Lawyers, Salesmen, Repairmen, or in any situation where time management is critical to office efficiency. Its menu display and one-key options make DATEBOOK™ one of the easiest programs to learn and use.

DATEBOOK™ features include:

- Appointment scheduling, cancelling, modifying and rescheduling.
- Automatically searches for openings according to time of day, day of week, and week of year.
- Displays all scheduled appointments for a specified person.
- Lists day's schedule (Screen or hard copy).
- Can be customized to accommodate any workday/hours schedule.

DATEBOOK™ is written in PASCAL and is available to run on CP/M as well as UCSD PASCAL systems.

(415) 455-4034

only **\$295**
Dealer discounts available.

Organic Software
naturally
bug free

1492 Windsor Way, Livermore, CA 94550

who upgraded to Level II, a small circuit board with three sockets (for the three Level II ROMs) was on the left side of the keyboard unit under the panel that has Radio Shack's name stamped in it; this board connected to ROM socket number 1 on the main printed-circuit board, through a long ribbon cable.

As everyone knows, Tandy Corporation drastically underestimated the consumer interest in computers. Level II became the vastly more popular model. Since the long cable is a source of electrical noise to the computer, this is an awkward position for machines using the Level II ROMs, especially if the keyboard has the numeric keypad added to it.

To correct this problem, Radio Shack has been working upon a two-chip ROM set for Level II BASIC. In order for there to be enough room on these devices for all the code, some things had to be shortened. For example, on powerup the user sees "MEM SIZE?" and "R/S L II BASIC" instead of "MEMORY SIZE?" and "RADIO SHACK LEVEL II BASIC."

One disadvantage of these new two-chip ROMs is that some of the machine-language routines in the BASIC interpreter have been moved from their previous locations. This could make some ROM-dependent programs malfunction.

[In fact, TRS-80 owners with machines that give the abbreviated messages should be suspicious of all commercially available software for the TRS-80. Many software packages make use of machine-language routines within the TRS-80 Level II ROMs. If the entry points of these routines have been changed or if the routines have been eliminated, the software will not work and may not be modifiable....GW]

One nice feature of the new ROMs is the elimination of key bounce (the delay loop used in the original ROM was incorrectly calculated).

Another difference is in the keyboard memory map. Tandy has decided to redefine the *shift-down-arrow* key to be a null instead of its former value of decimal 26. This was done to fix an error in the original ROM. Any programs (I know of several) that use the *shift-down-arrow* to emulate a Control key will no longer work correctly. There is no response at all to this key input.

Radio Shack made this change to allow the user to enter control characters from the keyboard. Hitting *shift-down-arrow* and then hitting the A key will return the standard ASCII Control-A character (decimal 01), hitting *shift-down-arrow* and then the B key will return the Control-B character, with a value of 02, and so forth through the alpha keys. For those programs that need the value that *used* to be returned by the *shift-down-arrow* in the old ROM, you should be able to simulate that input by hitting a *shift-down-arrow* followed by the Z key (which will return a value of 26). If this feature had been implemented correctly in the old ROM, then the Electric Pencil word processor would not have needed a separate Control key added to the keyboard in order to function.

The regular unshifted down-arrow still returns its normal value in the new ROM. Since I work with several TRS-80s for a living, I think I have discovered all the unpleasant surprises that result from using the uppercase and lowercase TRS-80 and the improved Level II BASIC. I hope this information will alleviate most frustration that may otherwise result when using these machines. ■

The Empire has expanded!

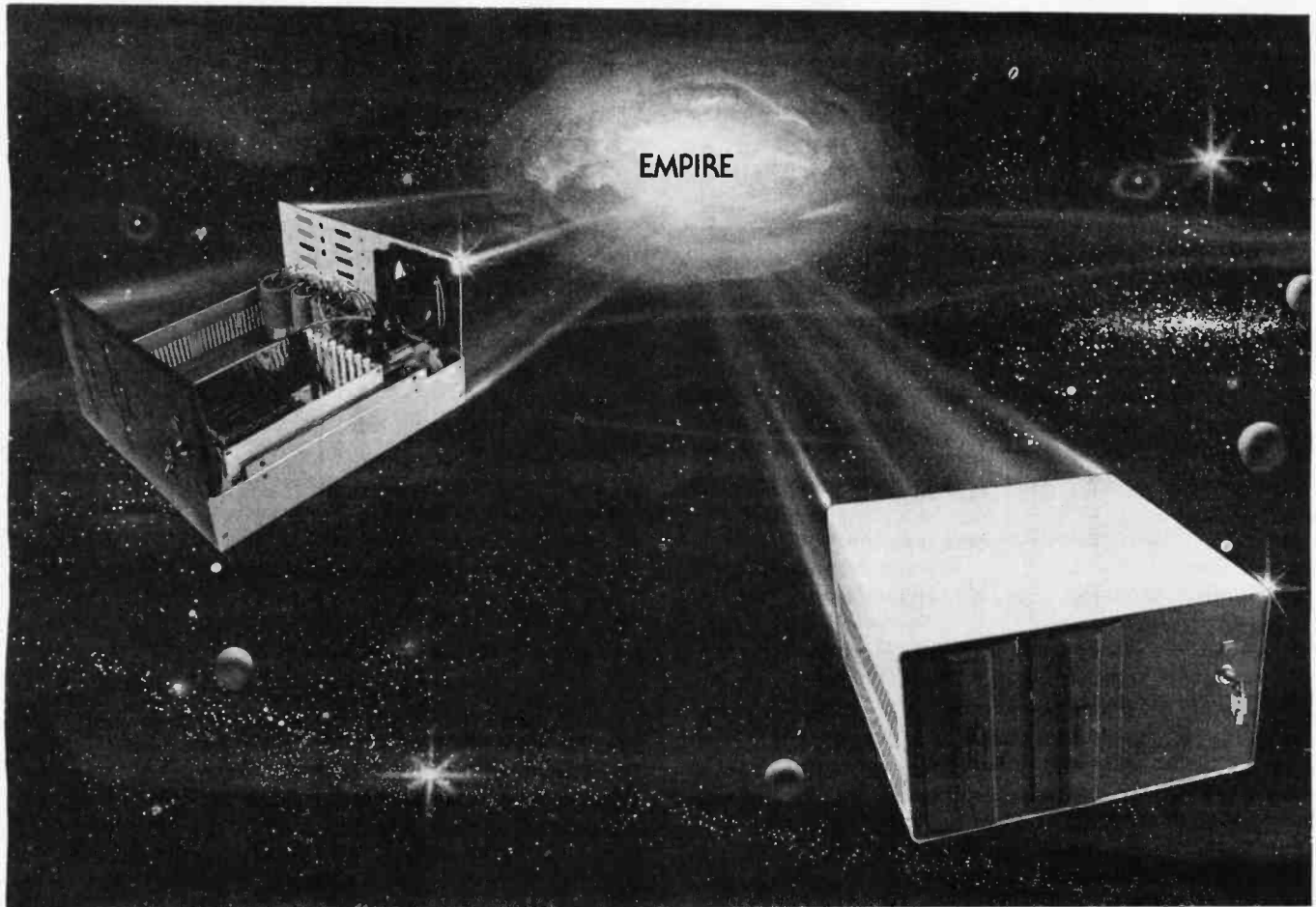

New Mainframe opens more areas for development

In one quantum leap Tarbell has expanded its popular Empire (the vertical disk subsystem) into a full line. This entire series now encompasses 5 variations. Each one contains different components so the S-100 system designer, hobbyist, or serious business user can arrive at the exact custom state he wants and needs.

The basic Empire still includes two Shugart or Siemens 8" disk drives; the compact cabinet with fan and power supply; a Tarbell floppy disk interface; CP/M*; Tarbell BASIC; the necessary cables, connectors and complete documentation. Naturally, it's fully assembled and Tarbell tested.

The new, top of the line Empire contains the basic model's components with the Tarbell design-approved Mainframe. Beside the 8-slot S-100 motherboard with an active terminated bus, there's a cardcage with card guides and a double-density interface.

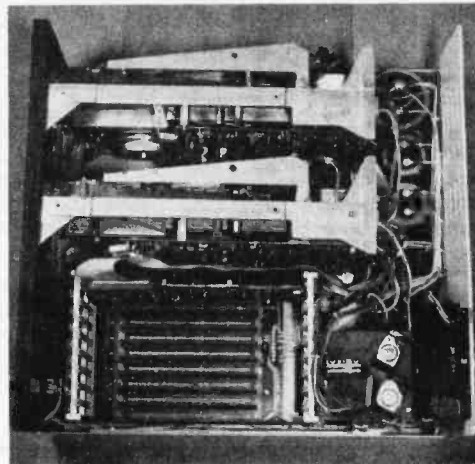

You're the master of your Empire

You can call the shots in the Empire. Tarbell's made sure of that by offering them as complete subsystem packages . . . or, as separate units. For example, the mainframe may be ordered with 1, 2 or no drives. Whichever way you go, however, you always get the reliability of Tarbell tested components and leadership-engineering.

To get control of your own Empire, see your quality computer store for quick delivery. Or, contact us for dealer locations or further information.

CP/M is a trademark of Digital Research.

Tarbell
Electronics

950 Dohlen Place - Suite B
Carson, California, 90746
(213) 538-4251 / 538-2254

BYTE LINES

NEWS AND SPECULATION ABOUT PERSONAL COMPUTING

Conducted by Sol Libes

Floating-Point Standard Released: The IEEE floating-point standard has finally come out of committee. Basically, it is the Intel standard. Integrated-circuit manufacturers will now start producing mathematical-processing integrated circuits to follow this standard. It should come as no surprise to learn that Intel has already announced the 8087 Numeric Processor, the first to meet the standard. It will perform mathematical operations on signed and unsigned integers, real, binary-coded decimal, and floating-point numbers in 80-bit wide registers at a speed one hundred times faster than modern software. Intel expects to have samples of the device in early 1981.

Microprocessor-Controlled House Built: In Phoenix, Arizona, Motorola has created a microcomputer-controlled demonstration house. The computer manages interior climate, electrical consumption, security, and provides data-base functions. The computer automatically opens and closes doors and windows, and it controls an electrical and solar heating and cooling system to achieve optimum comfort with minimum electrical consumption. It also manages a fire/smoke detection system and motion detectors. There are no door keys; keypads, with a code assigned to each entrant, are used. Power consumption is tracked and

reported regularly. A keyboard control console is provided. The display is a standard television. A calendar of events (appointments, birthdays, etc) can be maintained with a time/date function.

The system uses a Motorola 68000 (16-bit) microprocessor in the host computer. Five Motorola 6800 (8-bit) microprocessor-based computers communicate with the host in a five-node network. Each node controls a different part of the house, minimizing the effects of hardware failure.

Toy Robots Gaining Intelligence: Although toy robots have been around for many years, toy manufacturers are beginning to place microprocessors in them and provide keyboards for programmed control. Toy robots due to be introduced next year will include sensors and voice I/O (input/output).

Milton-Bradley (MB), one of the largest toy manufacturers in the US, currently sells a programmable toy tank called "Big Trak." It includes a Texas Instruments TMS1000 4-bit microprocessor, a twenty-key keyboard, 1 K-byte read-only memory (ROM) program, and a sixteen-instruction command set. The microprocessor controls the motor-driven wheels, lights, and produces sound effects. Over one million Big Traks were sold during the past year.

MB is spending \$600,000 this year to develop new

robotic toys. (Incidentally, that figure is comparable to the entire NASA robot research budget.) MB is adding a voice-synthesis integrated circuit that will generate twenty-two different words (costing a little over \$3) with an additional twenty-two-word read-only memory (ROM) to be added (costing \$1.65 per ROM). MB later plans to add sonic and contact sensing and possibly a manipulator.

Amateur robot builders should look into these toys as an inexpensive source of parts.

Slot Machines To Be Computerized: It was bound to happen! The State of Nevada's Gaming Commission has approved microprocessor-based slot machines. They will require less maintenance, and users will find it hard to cheat on them. Further, computerized slot machines will provide cost-accounting functions. Most of a slot machine's components are for security and anti-cheating. Next they may be plugged into a time-sharing network.

Is An Operating System Standard Possible? There are currently a number of problems caused by the lack of microcomputer operating-systems standards. People who use several different types of computers have the most problems. Standardization would help. However, according to Dr Robert

Stewart, Chairman of the IEEE Computer Standards Committees, there doesn't appear to be much interest in developing such a standard. Dr Stewart is currently pursuing an alternative: a possible standard for interfacing software to operating systems. He is currently trying to set up a working group for the standard. Those interested in participating or learning more about the effort should call or write: Dr Robert G Stewart, Stewart Research Enterprises, 1658 Belvoir Dr, Los Altos CA 94022, (415) 941-6699.

Controller Applications At IECI-80: Every year since 1975, the IEEE's Industrial Electronic and Control Society has held a conference on computer applications for process control, automation, and data acquisition. Over the years the computers used have changed from mini-computers to microcomputers. Over eighty papers were presented at the most recent conference, with 50% written by persons from outside the US (a growing trend).

Some of the more interesting applications included the control of an experimental lumber kiln using a TRS-80 (University of New Hampshire); control of a natural-gas converter using a 6800-based processor (Hungary); automation of a sugar crystallization process using an 8085A microprocessor (Japan); a modular temperature controller

COMPUTIQUE

YOUR COMPUTER PROFESSIONALS

SIX STORES
IN SOUTHERN
CALIFORNIA

(714) 549-7373
INFORMATION LINE



TOLL FREE ORDER LINES
(800) 854-0523 (800) 432-7066
(Outside California) (Within California)

hp HEWLETT PACKARD THE HP-85!

The HP-85 is a powerful BASIC language computer complete with keyboard, CRT display, printer, and tape drive - all in one compact unit.



HP-7225A GRAPHICS PLATTER
The compact HP-7225 Graphic Platter is designed to supply cost effective, professional hard-copy graphics. The platter produces publication-quality graphics with clean, continuous ink lines.

HP-2631B IMPACT PRINTER
The HP-2631B Impact Printer provides fast, reliable, full-width printing with up to 132 characters per line. This easy to use printer offers eight print modes, a 7 x 9 dot matrix, the use of multicopy forms, a full ASCII character set, plus a built-in self test verification of the system.

MORE HP VALUES

HP-67	299.95	HP-38C NEW	134.95	HP-38E	104.95
HP-92	399.95	HP-31E	44.95	HP-41C NEW	CALL
HP-97	584.95	HP-32E	54.95	HP-85 NEW	CALL
HP-33C NEW	99.95	HP-33	73.95	HP-7225A NEW	CALL
HP-34C NEW	134.95	HP-37E	59.95	HP-85 ROMS NEW	CALL

Now-the Texas Instruments TI-99/4 Home Computer

A limited time offer when you buy the remarkable Texas Instruments TI-99/4 Home Computer.



\$200⁰⁰
VALUE
\$100 CASH REBATE
PLUS OVER \$100* WORTH
OF FREE SOFTWARE

\$799⁹⁵



MONITOR
NOT
INCLUDED

You can begin using the TI home computer in minutes. Without any previous computer experience. You simply snap in one of TI's Solid State Software Command Modules. Step-by-step instructions are displayed right on the screen.

TEXAS INSTRUMENTS

INCORPORATED			
TI-30SP	17.95	TI-5135 NEW	79.95
TI-35SP NEW	24.95	TI-5142 NEW	124.95
Bus. Anal. I	21.95	TI-808-41 NEW	62.95
BA II Exec. NEW	44.95	TI-58C	109.95
Bus. Card	39.95	TI-59	209.95
Invest. Anal. NEW	49.95	PC-100C	169.95
TI-55	34.95	TI-58/59 Libraries	35.00
TI-57	54.95	Speak & Spell	59.95
TI-5100	39.95	Speak & Read NEW	CALL
TI-5015	64.95	Speak & Math NEW	CALL
TI-5040	89.95	Lang. Tutor NEW	169.95



Apple III is a highly integrated computer system, evolved from the Apple II design and optimized to best serve the professional user. The new computer will be offered in packaged configurations for personal use in professional applications.

Look at these special Apple III features:

- an 80-character upper/lower case display
- disc drive and integrated peripheral interfaces
- enhanced graphics capability
- an emulator mode allowing Apple II software to be run on the Apple III



APPLE III PLUS
\$999⁹⁵
16K MEMORY

COMPLETE BUSINESS, EDUCATIONAL AND GAME SOFTWARE AVAILABLE

ATARI® 800 PERSONAL COMPUTER SYSTEM **\$899⁹⁵**



Plot your investment strategy with confidence. Take the guesswork out of business decisions. Organize your household finances. Control your tax options. Come in and find out why some very shrewd people now own the versatile ATARI PERSONAL COMPUTER SYSTEM.

MORE ATARI

ATARI 810 Disc Drive	559.95
ATARI 820 40-Column Printer	479.95
PLUS Complete Entertainment & Educational	



BSA SYSTEM X-10™ Timer NEW	59.95
Controller Command	33.95
MATTEL ELECTRONICS' Intellivision	299.95
CHESS CHALLENGER ..7"	99.95

SHARP 6200 NEW EXECUTIVE	99.95
5813 NEW PROGRAMMABLE	34.95
5100 NEW LCD Alphanumeric	89.95
5102 NEW	79.95
7000 NEW Memo Writer	99.95
ML-81	49.95
FX-68	27.95

CODE-A-PHONE

1750	109.95
1000	299.95

ALSO CANON, TOSHIBA, NSC, SEIKO, MATTEL, PEARLCORDER, ITT, GTE, AND MANY OTHERS. ALL AT GREAT PRICES!!

WE WILL MEET OR BEAT ANY COMPETITOR'S ADVERTISED PRICE ON MOST ITEMS IF HE HAS THE MERCHANDISE IN STOCK. All units shipped in original factory cartons with accessories according to manufacturer's specification. Visa, Mastercard, \$ Order, Pers. Ck. (14 wrkg. days to clear), COD accepted. Min. \$4.95 for shipping in U.S.A. Air on Request. CA res. add 6% sales tx. All Mdse. subj. to avail.; prices subj. to change. Send orders to Dept. BY-OCT. WRITE OR CALL FOR FREE CATALOG.



NEWPORT BEACH/COSTA MESA 3211 So. Harbor Blvd. Santa Ana, CA 92704 (714) 549-7373	FULLERTON 2514 E. Chapman Ave. Fullerton (714) 738-7775	TORRANCE/LAWDALE 16611 Hawthorne Blvd. Lawndale (213) 370-5795	LOS ANGELES 11986 Wilshire Blvd. Los Angeles (213) 820-0423	TARZANA 18665 Ventura Blvd. Tarzana (213) 705-7507	PASADENA 260 So. Lake Ave. Pasadena (213) 795-3007
---	---	--	---	--	--

using an Intel 8048 (Georgia Tech); a machine controller using an Intel SDK-80 microcomputer; an industrial robot using a 16-bit Texas Instruments SP-990/16 microcomputer (Italy); an amusement ride controller using an Intel MCS-85 microcomputer; a diesel-engine generator controller using a Motorola 6800; and an automobile highway-type cruise control using an RCA 1802. Copies of the proceedings are available for \$25 from the IEEE, 445 Hoes Ln, Piscataway NJ 08854.

32-Bit Personal Computer? Now that Intel is about to start shipping samples of its new 32-bit microprocessor, when can we expect to see a 32-bit personal computer? This is very far off, if it ever becomes a reality. The 32-bit machine would be "overkill" for a personal computer. Intel has defined the following applications for the device: as a front-end processor for large systems, controller for large PABX (private automated branch exchange) systems, sophisticated scientific processor, computer-aided design processor, data-base computer, large multi-user data processing, and graphics.

Intel has released only sketchy details on the device. It will have 4-giga-byte addressing, virtual-memory support, 32-bit integer and 64-bit floating-point mathematics processing, multi-operand instructions with vector and record addressing modes, memory-protection facilities, and high-level language compilation and execution. It will contain approximately 450,000 transistors.

Intel also has other interesting integrated circuits in development due for introduction next year. There are 8 K by 8, 16 K by 8 and 32 K by 8 EPROMs (erasable programmable read-only memories), and a

2 K by 8 electrically reprogrammable EPROM. Memory-error-correction and data-encryption integrated circuits and a system for networking up to thirty-two users are also in development.

The IBM "Gotcha": IBM has introduced a new word-processor system, called "Displaywriter," with an advertised \$7895 price tag. This puts IBM in a strong competitive position. Competitors are charging \$12-15,000 for stand-alone word-processing systems. In fact, IBM has a very good price compared to most personal-computer-based word-processing systems, which generally sell in the \$5-8000 range. But there are some hidden "gotchas."

The IBM system does not include training or installation. If you need help, there is a thirty-day toll-free help number to call. If you need on-site help, it costs \$56 per hour.

The biggest "gotcha" is that the purchase price does not include software. In fact, the software is not for sale. It must be rented at \$15 to \$50 per month. In other words, if you keep the word processor five years, the system will cost another \$900 to \$3000. The likelihood is that all word-processor makers will follow suit with a similar unbundled pricing policy.

A Buyer's Market In Personal Computers: In southern California, Texas Instruments (TI) has increased the rebate on its Model 99/4 personal-computer from \$100 to \$200. There are rumors that the rebate may go higher. Apparently TI is having some problems marketing the 99/4. Some dealers are discounting the 99/4 as much as 27%. Thus the 99/4, with a \$950 list price (less monitor), can be bought for \$695, and you still get the \$200 rebate.

Texas Instruments is not alone. The California area has a proliferation of computer stores, and competition is keen. Apple IIs are being discounted as much as \$250 below list price (\$1195), the Atari 800 is selling for a low of \$699 (list price \$1080), and the Atari 400 as low as \$449 (list price \$630). The HP-85 is also being discounted and is selling for \$2875 or less (list price \$3250).

Radio Shack is also discounting. The TRS-80 Model I with 16 K bytes of programmable memory is being sold for \$100 off the list price, and one Radio Shack dealer, TSE/Hardside of Milford, New Hampshire, is offering a 21% discount off the \$849 list price (ie: \$699).

16-Bit Microcomputer Hardware and Software Now Available: The new Intel 8086 and Zilog/AMD Z8000 16-bit microprocessors are now available for S-100-based microcomputers. So far, only Texas Instruments has introduced an integrated 16-bit personal computer. The new Apple III continues to use the 6502A 8-bit microprocessor, and it appears that the new systems from Radio Shack and Commodore will also continue to use 8-bit microprocessors. Microcomputer users who wish to step up to 16-bit systems will be limited to S-100 systems. There are several 16-bit processors currently available including the Intel 8086, Zilog Z8002, Texas Instruments TMS9900, Digital Equipment Corporation LSI-11, and the Western Digital Micro-Engine. Also available are the Intel 8088 and Motorola 6809, which are really 16-bit microprocessors with 8-bit I/O. Samples of the Motorola 68000 are currently being sent to original-equipment manufacturers. Limited production is slated to begin soon.

Some 16-bit microcom-

puter software is already available. Single-user 8086 BASIC and disk operating systems are available from Microsoft, and 8086 CP/M will soon be released by Digital Research. Pascal is available for both the 8086 and Z8000. A limited implementation of the UNIX operating system for both 8086 and Z8000 will shortly be available from Microsoft. The suppliers of these software packages developed them on large computers with sophisticated cross-assemblers and simulators, permitting the introduction of this software at the same time that the hardware became available. As yet, no personal-computer software supplier has available resident 8086 or Z8000 assemblers and software development programs. Microsoft does have an 8086 assembler that runs on an 8080 system, and Quasar is selling an 8080 emulator to run on its Z8000 system.

Commodore Introduces \$199 Computer: A new low price in personal computers has been reached by Commodore Business Machines (CBM). CBM is about to market the "Video Interface Computer" (VIC) with a list price of \$199. The VIC will use the old PET keyboard, an external television monitor, have limited PET BASIC, a light pen, a joystick, a 32-character by 25-line display, 184-by-200 point graphics, and a sound synthesizer. It will be sold as a "hobbyist" computer with no software support. A color unit will be available for \$299.95. A unit with more memory and a better keyboard will sell for \$399.95.

Backing Up Winchester: Although Winchester hard-disk systems have provided the advantage of megabyte data storage, they have created a new problem of

OSBORNE/McGraw-Hill

WAKES UP YOUR COMPUTER AND PUTS IT TO WORK

**Doing
Something
Useful**



Also available in special NEW PET/CBM edition



All too often, computer users who've cut their eye teeth on entertainment programs, have trouble coming up with ideas for practical computing. Your computer plays space games well enough, but when you have a down-to-earth practical problem like a lease/buy decision, income averaging or statistical estimation, can it perform?

It can now!

In **PRACTICAL BASIC PROGRAMS** you will find 40 useful and easy-to-use programs that solve common problems in finance, management, statistics, math and science. The book includes complete write-ups and real-life situations to help you see a wealth of useful computer applications.

SOME COMMON BASIC PROGRAMS contains no fewer than 76 brilliantly documented programs you can use even if you don't know BASIC. You'll get a lot of math power including personal finance, taxes, and statistics. Other programs include recipe cost and check writer. The cost? — 16¢ per program!

This book is available in a new PET edition, and on ready-to-run cassette or disk for PET/CBM. It's also on cassette for TRS-80 users. All cassettes and disks are fully guaranteed. Use the book for documentation and operating instructions.

So if you have purchased a very expensive plaything, now you can get it busy doing what a computer was meant to do. **WORK!**

Name _____
 Street _____
 City _____
 State _____ Zip _____

	Price	Quantity	Amount
* SCBP Book	\$12.50		
* SCBP PET Book	\$12.50		
SCBP PET Cassette	\$15.00		
SCBP PET Diskette	\$22.50		
SCBP TRS-80 Cassette	\$15.00		
** Practical Basic Programs	\$15.00		

Effective January 1, 1981 prices will be
 * \$14.99 ** \$15.99

Check or Money orders only:
 Add: 75¢/item — 4th class
 \$1.25/item — UPS
 \$2.50/item — Air Mail
 \$4.00/item — Foreign Orders

California residents add local sales tax Phone orders call (415) 548-2805

Tax	
Shipping	
Total	

OSBORNE/McGraw-Hill
 630 Bancroft Way, Dept. B9
 Berkeley, California 94710



1113

backup storage. With the floppy disk, backup was easy: just make a copy on another floppy disk in the same drive. However, the Winchester disks, with few exceptions, are fixed-disk-type drives, and the disks are not removable.

Manufacturers are turning back to magnetic tape for economical backup systems. Currently the quarter-inch tape cartridge is proving the most popular for under 30 megabytes of backup. The newer systems use a "streaming" technique of nonstop recording and playback. Data is transferred in a continuous stream with no starts and stops until all the data has been transferred to or from the disk. This allows for a low-cost system since searching for and transferring single records is eliminated. However, the trend will no doubt be to include the tape-cartridge controller as part of the

disk controller. For example, Shugart Associates is incorporating a tape-cartridge backup controller into its new SA1400 hard-disk drive controller.

Pixel Corporation of Belmont, Massachusetts, expects to introduce a 270-megabyte backup tape system that uses an inexpensive consumer-grade videotape transport. Several copies of the disk data will be made on one videotape reel to ensure data integrity against bit dropouts. Also rumored to be in development is a 1-gigabyte tape drive integrated with an 8-inch Winchester disk system.

Ada May Be Available **Next Year:** Ada is a new language which is a super-extension of Pascal. The US Defense Department has funded development of Ada as a standardized language. Next year will likely

see the availability of the first Ada compilers. SofTech Inc, Waltham, Massachusetts, has undertaken the development of what promises to be the first Ada compiler. SofTech is presently defining environmental requirements and developing sets of tests and tools for validating Ada compilers. Its first implementation will be hosted on a Digital Equipment Corporation VAX-11 and will generate code for the VAX-11, PDP-11, and AN/GYK-12 machines.

Meanwhile, Dr Ken Bowles, the "father" of UCSD Pascal, has disclosed that he plans to implement Ada on a micro-computer using the same p-code approach used in UCSD Pascal.

Intel has announced that its new 32-bit microprocessor will execute Ada code directly. Samples of the microprocessor should be available early next

year. However, no company has yet disclosed plans for a compatible Ada compiler.

Mail: I receive a large number of letters each month, as a result of this column. If you write to me and wish a response, please enclose a self-addressed, stamped envelope.

Sol Libes
Amateur Computer Group
of New Jersey
(ACG-NJ)
1776 Raritan Rd
Scotch Plains NJ 07076

Cancer is often curable.

The fear of cancer is often fatal.

American Cancer Society

DG/H8 — THE TOTAL SYSTEMS CONCEPT

THE DG-80 ZILOG Z80 BASED CPU — \$249.00 (Documentation Only \$25.00)

FEATURES:

- Compatible with Heath® H8 hardware and software
- Z80 CPU — Enhanced instruction set
- Provisions for up to 8K ROM/EPROM and/or 4K RAM
- Jump-On-Reset to any 1K boundary
- DIP switch selectable wait

- states for any or all 8K blocks of memory
- All Z80 interrupt response modes available
- Interrupt Acknowledge and Dynamic Memory Refresh signals available on bus
- Frequently selected options by DIP switch or solderless jumper
- Machined contact gold sockets for

- ROM/EPROM, RAM
- Includes many advanced features for future expansion
- Assembled, tested and guaranteed
- Extensive operations manual and Z80 PROGRAMMING MANUAL
- 90 DAY WARRANTY

DG-64D 64K — \$529.00 48K — \$480.00 32K — \$431.00 16K — \$382.00 8K — \$333.00

BEST RAM EVER AVAILABLE FOR THE H8.

FEATURES:

- Up to 64K bytes capacity Dynamic RAM
- Hardware bank selectable in 8K increments
- Software bank selectable in 16K increments through I/O port
- On-board bank select/CPU ROM disable port, ad-

- dressable to any of 256 I/O addresses
- Up to 8 boards controllable through one I/O port (allows page mode operation)
- On-board transparent refresh for 8080 or Z80 microprocessor backed up by asynchronous refresh upon loss of normal program execu-

- tion
- 4 MHz operation with no wait states required
- Low power consumption — less than 8 watts
- Assembled, tested, & burned-in
- 90 DAY WARRANTY

DG-FP8 — \$69.95

Monitor/Utility package for DG-80 CPU provides functions of PAM-8 as well as the following:

- Split Octal or Hexidecimal Entry and Display
- Z80 monitor features such as display alternate register sets, display index registers
- "Shorthand" display of memory contents pointed to by general purpose registers
- Supports STANDARD CP/M provided by D-G as well as HDOS
- Provides firmware support for DG-ADP4, 4 MHz hardware
- Includes single step features

16K CHIP SETS

(8-4116 Type Dynamic RAMS) for DG-32D, DG-64D, Apple®, TRS-80®, H88/89®, and Pet®

— \$49.00 —

DG-ADP4 — \$19.95

Plug-in hardware modification to allow operation of the Heath® H17 disk system with the DG-80 at 4 MHz. Requires the use of the DG-FP8 firmware package.

DG-FP8/DG-ADP4 — TOGETHER — \$79.95

Save on Combination Purchase
 Purchased Separately — \$89.90

STANDARD CP/M Ver 2.2 \$130.00

DG-32D — 32K — \$339.00 — 16K — \$287.00 — 8K — \$235.00 — DOCUMENTATION \$12.00

CP/M is a registered trademark of Digital Research of Pacific Grove, California. Heath, HDOS, H8, H88/89 & PAM8 are registered trademarks of the Heath Company. Z80 is a registered trademark of Zilog Corp. PET is a registered trademark of Commodore. Apple is a registered trademark of Apple Computer. TRS-80 is a registered trademark of TANDY Corp.

D·G ELECTRONIC DEVELOPMENTS CO.

Ordering Information: Products listed available from DG Electronic Developments Co., P.O. Box 1124, 1827 South Armstrong, Denison, Tx. 75020. Check, Money Order, VISA or Master Charge accepted. Phone orders (charge only) call (214) 465-7805. No COD's. Freight prepaid. Allow 3 weeks for personal checks to clear. Texas residents add 5%. Foreign orders add 30%.

Start learning and computing for only **\$129.95** with a Netronics 8085-based computer kit. Then expand it in low-cost steps to a business/development system with 64k or more RAM, 8" floppy disk drives, hard disks and multi-terminal I/O.

THE NEW EXPLORER/85 SYSTEM

Special! Full 8" floppy, 64k system for less than the price of a mini! Only **\$1499.95!**

(Also available wired & tested. \$1799.95)

Imagine — for only \$129.95 you can own the starting level of Explorer/85, a computer that's expandable into full business/development capabilities — a computer that can be your beginner system, an OEM controller, or an IBM-formatted 8" disk small business system. From the first day you own Explorer/85, you begin computing on a significant level, and applying principles discussed in leading computer magazines. Explorer/85 features the advanced Intel 8085 cpu, which is 100% compatible with the older 8080A. It offers on-board S-100 bus expansion, Microsoft BASIC in ROM, plus instant conversion to mass storage disk memory with standard IBM-formatted 8" disks. All for only \$129.95, plus the cost of power supply, keyboard/terminal and RF modulator if you don't have them (see our remarkable prices below for these and other accessories). With a Hex Keypad/display front panel, Level "A" can be programmed with no need for a terminal, ideal for a controller, OEM, or a real low-cost start.



Level "A" is a complete operating system, perfect for beginners, hobbyists, industrial controller use. \$129.95



Full 8" disk system for less than the price of a mini (shown with Netronics Explorer/85 computer and new terminal). System features floppy drive from Control Data Corp., world's largest maker of memory storage systems (not a hobby brand!)



Level "A" With Hex Keypad/Display.

LEVEL "A" SPECIFICATIONS

Explorer/85's Level "A" system features the advanced Intel 8085 cpu, an 8355 ROM with 2k deluxe monitor/operating system, and an advanced 8155 RAM I/O ... all on a single motherboard with room for RAM/ROM/PROM/EPROM and S-100 expansion, plus generous prototyping space.

PC Board: Glass epoxy, plated through holes with solder mask. • I/O: Provisions for 25-pin (DB25) connector for terminal serial I/O, which can also support a paper tape reader ... cassette tape recorder input and output ... cassette tape control output ... LED output indicator on SOD (serial output) line ... printer interface (less drivers) ... total of four 8-bit plus one 8-bit I/O ports. • Crystal Frequency: 8.144 MHz. • Control Switches: Reset and user (RST 7.5) interrupt ... additional provisions for RST 5.5, 6.5 and TRAP interrupts on-board. • Counter/Timer: Programmable, 14-bit binary. • System RAM: 256 bytes located at F800, ideal for smaller systems and for use as an isolated stack area in expanded systems. • RAM expandable to 64K via S-100 bus or 4k on motherboard.

System Monitor (Terminal Version): 2k bytes of deluxe system monitor ROM located at F800, leaving 6000 free for user RAM/ROM. Features include tape load with labeling ... examine/change contents of memory ... insert data ... warm start ... examine and change all registers ... single step with register display at each break point, a debugging/training feature ... go to execution address ... move blocks of memory from one location to another ... fill blocks of memory with a constant ... display blocks of memory ... automatic baud rate selection to 9600 baud ... variable display line length control (1-255 characters/line) ... channelized I/O monitor routine with 8-bit parallel output for high-speed printer ... serial console in and console out channel so that monitor can communicate with I/O ports.

System Monitor (Hex Keypad/Display Version): Tape load with labeling ... tape dump with labeling ... examine/change contents of memory ... insert data ... warm start ... examine and change all registers ...

single step with register display at each break point ... go to execution address. Level "A" in this version makes a perfect controller for industrial applications, and is programmed using the Netronics Hex Keypad/Display. It is low cost, perfect for beginners.

HEX KEYPAD/DISPLAY SPECIFICATIONS

Calculator type keypad with 24 system-defined and 16 user-defined keys. Six digit calculator-type display, that displays full address plus data as well as register and status information.

LEVEL "B" SPECIFICATIONS

Level "B" provides the S-100 signals plus buffers/drivers to support up to six S-100 bus boards, and includes: address decoding for on-board 4k RAM expansion selectable in 4k blocks ... address decoding for on-board 8k EPROM expansion selectable in 8k blocks ... address and data bus drivers for on-board expansion ... wait state generator (jumper selectable), to allow the use of slower memories ... two separate 5 volt regulators.

LEVEL "C" SPECIFICATIONS

Level "C" expands Explorer/85's motherboard with a card cage, allowing you to plug up to six S-100 cards directly into the motherboard. Both cage and card are neatly contained inside Explorer's deluxe steel cabinet. Level "C" includes a sheet metal superstructure, a 5-card, gold plated S-100 extension PC board that plugs into the motherboard. Just add required number of S-100 connectors.



Explorer/85 With Level "C" Card Cage.

LEVEL "D" SPECIFICATIONS

Level "D" provides 4k of RAM, power supply regulation, filtering decoupling components and sockets to expand your Explorer/85 memory to 4k (plus the origi-

nal 256 bytes located in the 8155A). The static RAM can be located anywhere from 8000 to EFFF in 4k blocks.

LEVEL "E" SPECIFICATIONS

Level "E" adds sockets for 8k of EPROM to use the popular Intel 2718 or the TI 2518. It includes all sockets, power supply regulator, heat sink, filtering and decoupling components. Sockets may also be used for 2k x 8 RAM IC's (allowing for up to 12k of on-board RAM).

DISK DRIVE SPECIFICATIONS

- 8" CONTROL DATA CORP. professional drive.
- LSI controller.
- Write protect.
- Single or double density.
- Data capacity: 401,016 bytes (SD), 802,032 bytes (DD), unformatted.
- Access time: 25ms (one track).

DISK CONTROLLER/ I/O BOARD SPECIFICATIONS

- Control up to four 8" drives.
- 1771A LSI (SD) floppy disk controller.
- Onboard data separator (IBM compatible).
- 2 Serial I/O ports
- Autoboot to disk system when system reset.
- 2716 PROM socket included for use in custom applications.
- Onboard crystal controlled.
- Onboard I/O baud rate generators to 9600 baud.
- Double-sided PC board (glass epoxy).

DISK DRIVE CABINET/POWER SUPPLY

- Deluxe steel cabinet with individual power supply for maximum reliability and stability.

ORDER A COORDINATED EXPLORER/85 APPLICATIONS PAK!

Beginner's Pak (Save \$26.00!) — Buy Level "A" (Terminal Version) with Monitor Source Listing and AP-1 5-amp Power Supply; (regular price \$199.95), now at SPECIAL PRICE: \$169.95 plus post. & insur.

Experimenter's Pak II (Save \$53.40!) — Buy Level "A" (Hex Keypad/Display Version) with Hex Keypad/Display, Intel 8085 User Manual, Level "A" Hex Monitor Source Listing, and AP-1 5-amp Power Supply; (regular price \$279.35), all at SPECIAL PRICE: \$218.95 plus post. & insur.

Special Microsoft BASIC Pak (Save \$103.00!) — Includes Level "A" (Terminal Version), Level "B", Level "D" (4k RAM), Level "E", 8k Microsoft in ROM, Intel 8085 User Manual, Level "A" Monitor Source Listing, and AP-1 5-amp Power Supply; (regular price \$439.70), now yours at SPECIAL PRICE: \$329.95 plus post. & insur.

ADD A TERMINAL WITH CABINET. GET A FREE RF MODULATOR. Save over \$114 at this SPECIAL PRICE: \$499.95 plus post. & insur.

Special 8" Disk Edition Explorer/85 (Save over \$104!) — Includes disk-version Level "A", Level "B", two S-100 connectors and brackets, disk controller, 64k RAM, AP-1 5-amp power supply, Explorer/85 deluxe steel cabinet, cabinet fan, 8" SD/DD disk drive from famous CONTROL DATA CORP. (not a hobby brand!), drive cabinet with power supply, and drive cable set-up for two drives. This package includes everything but terminal and printers (see coupon for them). Regular price \$1630.30, all yours in kit at SPECIAL PRICE: \$1499.95 plus post. & insur. Wired and tested, only \$1799.95.

Special! Complete Business Software Pak (Save \$625.00!) — Includes CP/M 2.0, Microsoft BASIC, General Ledger, Accounts Receivable, Accounts Payable, Payroll Package; (regular price \$1325), yours now at SPECIAL PRICE: \$699.95.

Please send the items checked below:

- Explorer/85 Level "A" kit (Terminal Version) ... \$129.95 plus \$3 post. & insur.
- Explorer/85 Level "A" kit (Hex Keypad/Display Version) ... \$129.95 plus \$3 post. & insur.
- 8k Microsoft BASIC on cassette tape. \$64.95 postpaid.
- 8k Microsoft BASIC in ROM kit (requires Levels "B", "D" and "E") ... \$99.95 plus \$2 post. & insur.
- Level "B" (S-100) kit ... \$49.95 plus \$2 post. & insur.
- Level "C" (S-100 6-card expander) kit ... \$39.95 plus \$2 post. & insur.
- Level "D" (4k RAM) kit ... \$69.95 plus \$2 post. & insur.
- Level "E" (EPROM/ROM) kit ... \$5.95 plus \$06 pch.
- Deluxe Steel Cabinet for Explorer/85 ... \$49.95 plus \$3 post. & insur.
- Fun For Cabinet ... \$13.00 plus \$1.50 post. & insur.
- ASCII Keyboard/Computer Terminal kit: features a full 128 character set, u&l case; full cursor control; 75 ohm video output; convertible to baudout output; selectable baud rate, RS232-C or 20 ma. I/O, 32 or 64 character by 16 line formats, and can be used with either a CRT monitor or a TV set (if you have an RF modulator) ... \$149.95 plus \$3.00 post. & insur.
- Deluxe Steel Cabinet for ASCII keyboard/terminal ... \$18.95 plus \$2.50 post. & insur.
- New Terminal/Monitor: (See photo) Same features as above, except 12" monitor with keyboard and terminal is in deluxe single cabinet; kit ... \$399.95 plus \$7 post. & insur.
- Hazeltine terminals: Our prices too low to quote — CALL US
- Lear-Sigler terminals/printers: Our prices too low to quote; CALL US
- Hex Keypad/Display kit ... \$69.95 plus \$2 post. & insur.

- AP-1 Power Supply Kit ±8V @ 5 amps in deluxe steel cabinet ... \$39.95 plus \$2 post. & insur.
- Gold Plated S-100 Bus Connectors ... \$4.85 each, postpaid.
- RF Modulator kit (allows you to use your TV set as a monitor) ... \$8.95 postpaid.
- 16k RAM kit (S-100 board expands to 64k) ... \$199.95 plus \$2 post. & insur.
- 32k RAM kit ... \$299.95 plus \$2 post. & insur.
- 48k RAM kit ... \$399.95 plus \$2 post. & insur.
- 64k RAM kit ... \$499.95 plus \$2 post. & insur.
- 16k RAM Expansion kit (to expand any of the above in 16k blocks up to 64k) ... \$99.95 plus \$2 post. & insur. each.
- Intel 8085 cpu Users' Manual ... \$7.50 postpaid.
- 12" Video Monitor (10MHz bandwidth) ... \$139.95 plus \$5 post. & insur.
- Beginner's Pak (see above) \$169.95 plus \$4 post. & insur.
- Experimenter's Pak (see above) ... \$218.95 plus \$6 post. & insur.
- Special Microsoft BASIC Pak Without Terminal (see above) ... \$329.95 plus \$7 post. & insur.
- Same as above, plus ASCII Keyboard Terminal With Cabinet, Get Free RF Modulator (see above) ... \$499.95 plus \$10 post. & insur.
- Special 8" Disk Edition Explorer/85 (see above) ... \$1499.95 plus \$26 post. & insur.
- Wired & Tested ... \$1799.95 plus \$26 post. & insur.
- Extra 8" CMC Floppy Drives ... \$499.95 plus \$12 post. & insur.
- Cabinet & Power Supply For Drive ... \$69.95 plus \$3 post. & insur.
- Drive Cable Set-up For Two Drives ... \$25 plus \$1.50 post. & insur.

- Disk Controller Board With I/O Ports ... \$109.95 plus \$2 post. & insur.
 - Special! Complete Business Software Pak (see above) ... \$699.95 postpaid.
- SOLD SEPARATELY:**
- CP/M 1.4 ... \$100 postpaid.
 - CP/M 2.0 ... \$150 postpaid.
 - Microsoft BASIC ... \$325 postpaid.
 - Intel 8085 cpu User Manual ... \$7.50 postpaid.
 - Level "A" Monitor Source Listing ... \$25 postpaid.

Continental U.S. Credit Card Buyers Outside Connecticut

CALL TOLL FREE: 800-243-7428

To Order From Connecticut (Or For Technical Assistance, call (203) 354-9375)

Total Enclosed (Conn res. add sales tax) \$ _____
 Paid By: _____
 Personal Check Cashier's Check/Money Order
 VISA Master Charge (Bank No. _____)
 Acct. No. _____ Exp. Date _____
 Signature: _____
 Print Name: _____
 Address: _____
 City: _____
 State: _____ Zip: _____

NETRONICS Research & Development Ltd.
 333 Litchfield Road, New Milford, CT 06776

APL Makes Life Easy (and Vice Versa)

Selby Evans, PhD, Texas Christian University, Forth Worth TX 76129

With the APL language becoming available on Z80 systems, staunch players of John Horton Conway's game of Life won't be left out and neither will any new or prospective players. Here's a new APL version of the game you can use to discover *blinkers*, *spaceships*, *glider guns*, *puffer trains*, *burloaferimeters*, and many of this favorite pastime's other inherent beasts. (See the December 1978 BYTE theme articles about Life, a game derived from the field of automata theory.) This APL version is much easier to follow than the one-line program presented by Mark Niemiec in his article "Life Algorithms" (January 1979 BYTE, page 90). It is written not to show the language's suitability for compact expression, but to illustrate the ease of programming in APL.

Listing 1 presents the functions. GEN takes one generation and maps it into the next. Lines 1 thru 3 count the

neighbors of each cell by rotating the matrix to bring each neighbor over the cell. Assuming that live cells are represented by 1s and dead cells represented by 0s, the sum of these rotated matrices counts the live neighbors for each cell. The rotations wrap around at the borders, so that the Life space (or universe) has no borders. (The surface is a donut or torus.) Line 4 of GEN specifies a new set of live cells according to the following rules of Life:

A dead cell becomes live in the new generation if it has three neighbors in the current generation. A live cell stays live if it has exactly two or three neighbors in the current generation. All other cells will be dead.

The LIFE function iterates over generations, provides a display of the result, and puts the generation number in the upper-left corner. It requires as right argument X a matrix of 1s and 0s giving the starting state. An array of any size may be used as long as it will fit in the workspace. Because the life space is a closed surface, the size of the matrix influences what happens. A glider crossing the left edge, for example, will reappear at the right edge. With a matrix of appropriate size, a glider gun might promptly shoot itself in the back.

Listing 2 illustrates the output of the LIFE program and shows what happens to BYTE after a few generations of Life. The BYTE editors will no doubt be pleased to see that a heart is revealed after eleven generations. [Hmm....There's a moral here, but I'm not sure I know what it is....GW]

After displaying one generation, the LIFE program pauses and waits for a carriage return. It is sometimes convenient to skip the output of some generations in order to follow the development through more generations. If you type a number before pressing carriage return, the program will skip ahead that many generations before displaying a new generation. Entering a 0 at that point will end the function.

So have some fun with automata theory and learn something new about APL. ■

Listing 1: APL functions for Life program. See text for details.

```

▽ L←GEN X
[1] R←1⊖X
[2] R←(L+⊖1⊖X)+(1⊖X)+(⊖1⊖X)+R+(1⊖R)+⊖1⊖R
[3] R←R+(1⊖L)+⊖1⊖L
[4] L←(R=3)∨X∧R=2
▽
▽ LIFE X;R;N;C
[1] N←0
[2] ST:R←,(⊖X)⊖' '
[3] R[(1=,X)/;⊖R]+⊖'o'
[4] C←' |',(' '-',[1]((⊖X)⊖R),[1]'-'),' |'
[5] C[1;1+;5]+,1⊖'I5'ΔFMT N
[6] C
[7] +0×10=C+1+ε⊖,' 1'
[8] N←N+C
[9] GN: X←GEN X
[10] +(ST×10≥C+C-1),GN
[11] ⍠THE MONADIC ε IN LINE 7 IS THE EXECUTE FUNCTION.
▽
    
```

NEW INTERACTIVE TERMINAL

WE MEET ANY PRICES IN THE NATION

Model 2621A
(shown here)
\$1495⁰⁰

Our Price
\$1395



HEWLETT
PACKARD

- Enhanced 9X15 dot character cell
- Two full pages (48 lines) • Roll, home-up & home-down
- Embedded numeric pad • Screen-labeled control keys
- 8 pre-programmed function keys

Model 2621P Terminal w / printer also available now

HP 41C Calculator Reg. \$295 NOW \$259⁰⁰

—15% off HP Series E Calculators—



**FARNSWORTH
COMPUTER CENTER**

1891 N. Farnsworth Ave.
(At the E-W Tollway)
Aurora, Il. (312)851-3888

Weekdays 10 to 8 - Sat. 10 to 5

Listing 2: An example of the APL function LIFE at work. The frames shown here are from successive generations of a Life colony that begins as a collection of cells that spell the word BYTE. The generation number of each frame is shown in the upper left-hand corner.

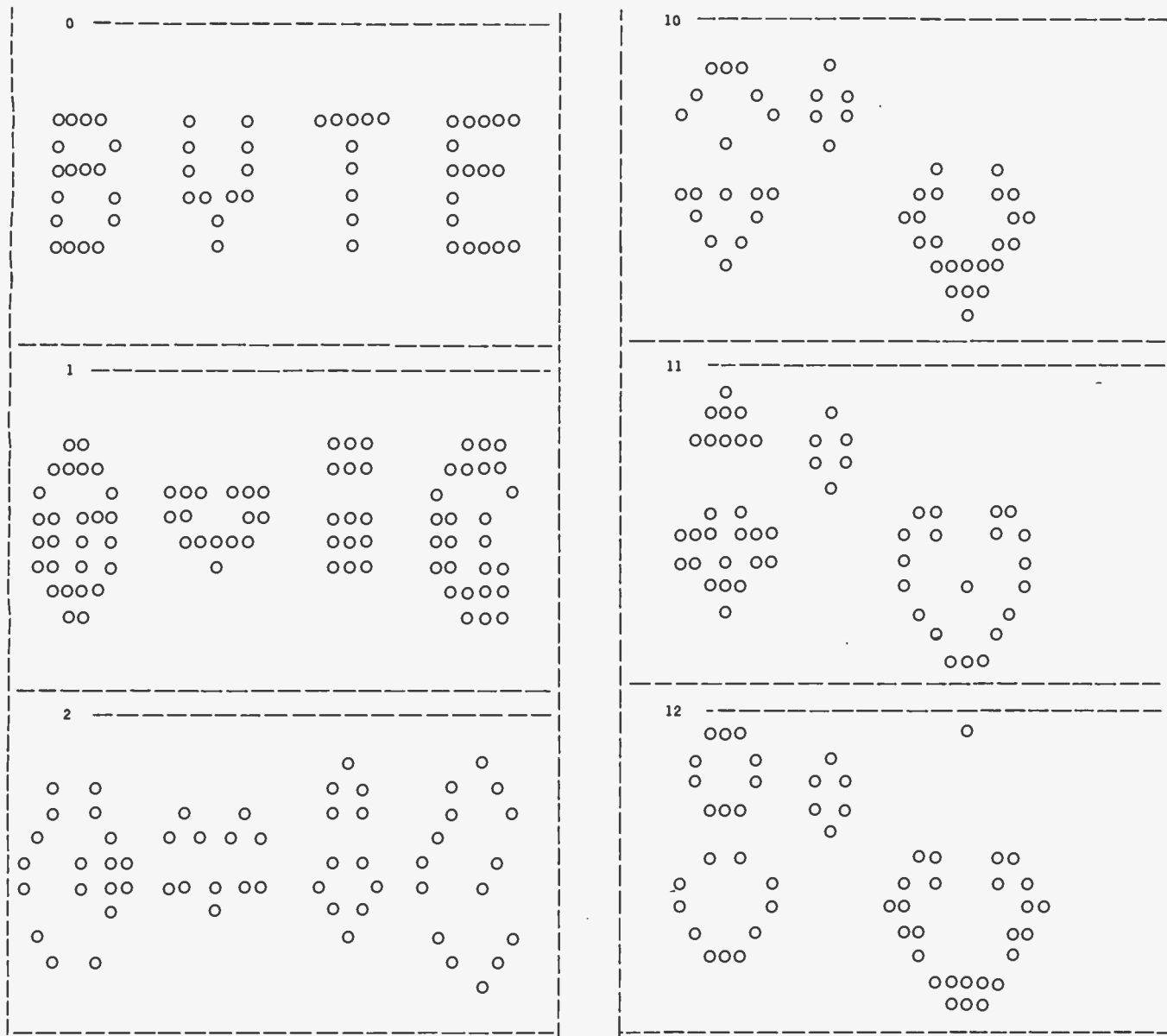

COLOR SOFTWARE

Unless otherwise noted all programs are \$15 each, for Apple II,
Atari 16K, TI 99/4

UNITS: Practice converting yards-feet-inches, pounds-ounces, metric units, etc.

FRACTIONS: Practice adding, subtracting, multiplying and comparing fractions.

NUCLEAR REACTOR: Realistic dynamic model of nuclear power plant in operation.

3-D STARTREK: Discover new planets, fight Klingons in 3-dimensional galaxy.

MAJOR LEAGUE BASEBALL: Manage Major League teams and make all lineup, batting, pitching and running decisions. \$25. Apple II with 48K, Applesoft ROM and one disk.

ROADRACE: Race around 2.25 mile course. 1 or 2 players. Not for TI 99/4.

BLACKJACK: Popular card game for 1 to 3 players. Not for Apple II.

COLOR SOFTWARE, 5410 W. 20th St., Indianapolis, IN 46224



9K RAM (8K user available),
14K BASIC interpreter
operating system ROM.

User-programmable, in
both BASIC and MC6800
machine language.

Built-in RF
modulator.

Built-in sound
synthesizer.

Two built-in
game controllers,
with joysticks and
numeric keypads.

Built-in cassette
deck, with both digital
and audio tracks.

Load in excess of
1500 baud rate.
Saves and loads
programs in
45 seconds
or less.

Keyword shift plate.

Full, standard, 53-key
typewriter keyboard.

Built-in speaker.

Microphone jack
enables you to
add audio to
program tapes.

High resolution picture
on your TV screen, in
8 colors.

256 x 192 graphics mode.

All that computer for \$599.

The Imagination Machine, the personal computer from APF Electronics.

The Imagination Machine is more personal computer than you'd expect at \$599.

The Imagination Machine is a superbly designed, expandable, user-programmable computer system... at \$599.

No other personal computer on the market can touch it, at that price.

Read what it brings you:

First of all, The Imagination Machine has 9K RAM and 14K BASIC-IN-ROM. A full 53-key professional, typewriter keyboard. A high-resolution picture on your TV set, in eight colors. Fast loading (1500+ baud rate), built-in dual-track cassette deck, for APF's digitally recorded tape programs. Built-in sound synthesizer. And, even a built-in RF modulator, which is a \$40 option on other computer systems.

All that, plus user-programmability.

We know sophisticated users aren't going to be satisfied forever using preprogrammed software. (Even though we offer a large library of educational, entertainment, home and business management programs.) So, we made The Imagination Machine user programmable, in both BASIC and MC6800 machine language. To simplify matters, we've just developed the first and only BASIC TUTOR course on cassette. With it, you can learn to program The Imagination Machine in BASIC, with hands-on training, right at the computer.

Some exceptional features.

The Imagination Machine has several unique features that can help you use your time at the computer more effectively.

For example, it stores programs and data on the same cassette tape. (With other computers, you have to read programs from one tape into the computer, remove the tape, put in another tape and store your data on the new tape.)

Another special feature is The Imagination Machine's unique keyword system, which simplifies

BASIC programming. The machine has 24 different programs statements and commands printed at the top of the keyboard. You can enter these 24 into your program without retyping them every time you use them. Instead of typing out "PRINT," for example, you just press two keys and the word appears on the screen. The system helps prevent typing errors and can speed up entering programs.

A third feature is Timed Response Monitoring, which automatically adjusts the computer's pace and level to your own. It makes "tutoring programs," for instance, easier and more interesting to follow.

And then there are The Imagination Machine's three graphic display modes: 1. Alpha numerics, mixed with low-resolution graphics in as many as eight colors. 2. High resolution — up to eight colors — 128 x 192 display. 3. High resolution graphics — up to four colors — with 256 x 192 display.

And expandability.

A personal computer that can't grow along with your growing requirements soon becomes obsolete. So, we designed The Imagination Machine to be expandable. By adding APF's optional "Expansion Box" and interface cartridges, you can hook up any compatible floppy disk or printer, or an additional 8K RAM memory cartridge.

Full mini-floppy system **\$995.**



For small business and professional use, you may require a full mini-floppy

system. In that case, order APF's System II. It includes The Imagination Machine, the "Expansion Box," floppy disk interface and 72K-byte, mini-floppy disk drive. All for just \$995! No one can come close to that price.

You can't beat our prices or our guarantee.

If you can find a better personal computer system for the money, let us know. In the meantime, we stand by our statement: There is no other personal computer on the market that offers so much for so little. And if you order now, we'll even include our \$49.95 APF Technical Reference Manual, with complete schematics, absolutely free.

Order The Imagination Machine directly from APF Electronics, with the assurance that if you are not completely satisfied, you can return it within 30 days of purchase for a complete refund. To order, or to learn the name of the dealer nearest you, call TOLL FREE 1-800-223-1264. New York residents call 212-869-1960. MasterCard and VISA accepted.

Price list:

System I, The Imagination Machine.	\$599.
System II, Mini-floppy System (Includes The Imagination Machine, BB-2, and Mini- floppy Disk Drive).	\$995.
BB-1. Expansion Box with RS232 cartridge.	\$199.95
BB-2. Expansion Box with floppy disk interface cartridge.	\$199.95
8K RAM memory cartridge.	\$ 99.95
RS232 cartridge.	\$ 99.95
Floppy-disk interface cartridge.	\$149.95
Mini-floppy Disk Drive.	\$399.95

\$599. Manufacturer's suggested retail price.

APF electronics inc.
1501 Broadway New York, NY 10036

FLOPTRAN-IV: A Tiny Compiler

Mark Zimmermann
9410 Woodland Dr
Silver Spring MD 20910

These "programmers' programs" allowed a user to write in a language that is more compact and meaningful for humans than machine language.

In the beginning, computers were programmed in machine language. To execute a simple equation, such as $A=B$, a user had to write dozens of instructions. He had to tell the machine, "load the accumulator with the first byte of the number B," and "store the accumulator in the memory location assigned to the first byte of A," *ad nauseam*. A more complicated equation like $C=\text{LOG}(D)$ required hundreds or even thousands of instructions! It's no wonder, therefore, that among the first programs developed were programs to make it easier to write other programs. These "programmers' programs" allowed a user to give the computer instructions in a higher-level language, one that is more compact and meaningful for humans than machine language.

High-level computer languages are nonsense to a machine until they have been translated into fundamental commands that the system can understand and execute. There are two principal methods used to perform this translation: interpretation and compilation. An *interpreter* is a machine-language program that scans through a higher-level program, line by line. As each statement is encountered, the interpreter figures out which operations are necessary to execute that statement, then goes ahead and performs the operations. The interpreter then moves on to the next statement, translates it, and executes it. This process is repeated, with each statement being interpreted (or reinterpreted) *every* time it is executed.

A compiler acts rather differently. Like an interpreter, it scans through a high-level program and figures out what fundamental operations are necessary to execute each line. But, instead of performing those operations, a compiler just writes out (ie: onto a cassette tape drive) the sequence of machine-language instructions that do the job when executed. An interpreter executes a program statement by statement, as it interprets it, so that the interpreter and the program execute concurrently. But,

when a compiler is finished with a program, the result is a machine-language program that represents the higher-level program; the machine-language program must be loaded back into the computer and executed before the problem being programmed is solved.

The two approaches, compilation and interpretation, have different strengths and weaknesses. An interpreter, interpreting and executing line by line, can stop at the first sign of an error and give a helpful and specific error message. The interpretation can also be interrupted at any point (to be later resumed) allowing the human operator to look at the partial results of the calculation and see whether everything is going as planned. This interactive technique makes program development and debugging relatively easy.

On the other hand, when an interpreter has finished running a job, the machine is no "smarter" than when it began. Executing the program a second time will take just as long as it did the first time. In fact, if there is looping within the program so that some lines are executed more than once, these lines are completely reinterpreted, as if they had never been seen before, each time they are encountered. This redundant interpretation wastes a lot of computer time, making interpreted programs somewhat slower than compiled ones.

However, once a compiler has finished with a program, the result is a pure machine-language series of instructions that can be executed without further translation. Although this results in more vague error messages, the advantage to compilation is speed. Depending on the problem, a compiled program typically executes several times faster than an interpreted one—sometimes, the speed advantage is as large as a factor of 100. Once a program has been compiled, it never needs to be compiled again.

The output of a compiler does tend to be larger than the original source program (which the interpreter uses), so that interpreters may seem to have the advantage in terms of memory usage. But, when one remembers that the interpreter must be continuously resident in the computer's memory while the program is running, whereas the compiler can be removed after the program has been compiled, the apparent memory advantage of interpretation over compilation shrinks and often vanishes.



When you're looking for reliable information, turn to the authorities on data processing...

WILEY-INTERSCIENCE.

APL IN PRACTICE What You Need To Know To Install And Use Successful APL Systems And Major Applications

Edited by
Allen J. Rose & Barbara A. Schick,
both of Scientific Time Sharing Corp.

A report on the current state-of-the-art of APL—a concise, consistent and powerful method of interactive computing. You get an overview of APL's diverse applications to such business functions as financial planning, marketing management, general ledger, budgeting, manufacturing and electronics. In addition, the book is an invaluable handbook for systems management and programmers on formatting and reporting, writing maintainable programs, and managing outside computer services. (1-08275-9)/1980/374 pp./\$25.00

PERSONAL COMPUTING Home, Professional, and Small Business Applications

Daniel R. McGlynn,
Quark Microsystems, Inc.

The authoritative survey of the entire field of personal and small business computing—the features, capabilities, and limitations of the various types of hardware and software commercially available today. Particular attention is given to developing selection criteria for the potential user or purchaser of personal computing equipment. The book also surveys programming languages used on personal computers. (1-05380-5)/1979/263 pp./\$9.95

INTRODUCTION TO COMPUTER MUSIC

Wayne Bateman; University of Utah

Comprehensive yet non-technical, this overview of the field of computer music explains how digital computers can be used to generate new and interesting musical sounds. Also discusses acoustics, signal processing, waveform analysis and synthesis, computer programming, and music theory and composition. (1-05266-3)/1980/314 pp./\$24.95

ADVANCED ANALYSIS WITH THE SHARP 5100 SCIENTIFIC CALCULATOR

Jon M. Smith,
NMSA Systems Research and Analysis

This practical manual, written for all who use a Sharp 5100 or 5101 calculator, shows how to perform quick, accurate calculations for a wide range of applications. The text provides hundreds of step-by-step methods for all forms of analysis, including approximations, tables, graphs, flow charts, and much more. (1-07753-4)/1979/132 pp./\$6.95

Circle 131 on inquiry card.

A MANAGER'S GUIDE TO DATA BASE DESIGN AND PERFORMANCE

Shakuntala Atre, IBM Corporation
(A Volume in Business Data Processing: A Wiley Series)

A complete approach to the design and management of a data base independent of any software package. Written from the viewpoint of real world problems and solutions, this thorough text treats data base administration and staff, the data dictionary, data models, data base design and system performance. Two case studies, in banking and university applications, can be followed parallel to the discussion.

(1-05267-1)/Sept. 1980/approx. 456 pp./\$27.95

AN INTRODUCTION TO SOFTWARE QUALITY CONTROL

Chin-Kuei Cho,
The George Washington University
(A volume in Business Data Processing: A Wiley Series)

A self-contained introduction to the achievement of quality programming through preventive and promotive means, using software development methods and statistical quality control principles. Cho emphasizes the production of high quality software through good requirement specifications, structured design, structured programming and structured module interfacing to prevent errors from entering the software. The book introduces an important new concept called the Symbolic Input Attribute Decomposition (SIAD) tree, which is used to represent the input domain of the software from which input data is constructed. Includes background materials, systematic discussions, and numerical and nonnumerical examples and exercises. (1-04704-X)/Sept. 1980/approx. 464 pp./\$29.95

MODERN MICROPROCESSOR SYSTEM DESIGN Sixteen Bit and Bit-Slice Architecture

Daniel R. McGlynn,
Quark Microsystems, Inc.

The new 16-bit and bit-slice microprocessors are the latest development in the rapidly developing field of microcomputers. This book provides a detailed overview of these products, together with modern peripheral components and devices such as magnetic bubble memories, charged coupled devices (CCD), and CRT interface devices. The 16-bit microprocessors considered include the Intel 8086 and Zilog Z-8000.

(1-06492-0)/August 1980/approx. 304 pp./\$21.95

DIGITAL SYSTEM DESIGN WITH LSI BIT-SLICE LOGIC

Glenford J. Myers,
IBM Systems Research Institute

The first book on bit-slice logic, offering the latest information on LSI logic use in digital systems, particularly where other LSI devices, such as standard microprocessors, are not appropriate. Myers evaluates the new technology of bit-slice logic (and the related concept of microprogrammed control) and provides advice on evaluating and designing systems with bit-slice chips. The many topics covered include:

- a detailed discussion of the 2901, the most widely used bit-slice component
- recent ALU/register bit-slice devices and microprogram sequencing devices
- more advanced points of design of microprogrammed systems, including pipelining, microinstruction encoding, and optimization
- other types of bit-slice devices, including memory interfaces and interrupt controllers

Over 160 illustrations help highlight and develop key ideas.

(1-05376-7)/1980/338 pp./\$28.50

LOGIC DESIGN AND SWITCHING THEORY

Saburo Muroga, University of Illinois

Here's an in-depth look at the real power of switching theory in logic design and computer-aided design packed with discussions of the many new design methods in light of current integrated circuit technology. Muroga details MOS networks, LSI chip size minimization, algebraic design procedures that reduce design time, NAND (NOR) gate networks, two- and multi-level networks, sequential network design, and much more. The relationships between theories and design motivations are examined in detail to give an overview of logic design practice. Extensive bibliographic references are listed for advanced study. (1-04418-0)/1980/617 pp./\$29.50

Order through your bookstore or write to John Storjov, Dept. 7158

TO ORDER BY PHONE call toll free (800) 526-5368. In New Jersey, call collect (201) 797-7809.



WILEY-INTERSCIENCE

a division of John Wiley & Sons, Inc.
605 Third Avenue
New York, N.Y. 10158

In Canada:
22 Worcester Road, Rexdale, Ontario

Prices subject to change without notice. 092 1-7158

Operator	Meaning
+	add
-	subtract
*	multiply
/	divide
↑	exponentiation
ABS	absolute value
ATN	arctangent
COS	cosine
EXP	powers of e
FRE	memory available
INT	integer portion of argument
LOG	base-e logarithm
PEEK	look at contents of memory
POS	position of cursor
RND	random number
SGN	sign of argument
SIN	sine
SQR	square root
TAN	tangent

Table 1: Available operators and functions in FLOPTRAN-IV.

Some languages, such as FORTRAN, are usually compiled and are hardly ever interpreted. Other languages, like BASIC, are generally interpreted. Many small-computer systems come with a built-in or easily-loaded BASIC interpreter, but to get a compiled language, it is necessary to pay hundreds of dollars (or more) for extra memory, disk storage, and a compiler.

But there is no reason why a language like BASIC should not be compiled instead of interpreted. Also, there is no reason to ignore or throw away the wonderful

resource that a typical BASIC in read-only memory represents. In those read-only memories are hidden dozens of useful, thoroughly tested, efficient machine-language subroutines; it would be a shame not to take full advantage of them.

What I've done is to write a tiny compiler for a language I call FLOPTRAN-IV, which stands for *FLOating-Point TRANslator, version 4*. The compiler is written in Microsoft (PET) BASIC and is presented in full in listing 1. As written and debugged, the FLOPTRAN-IV compiler runs on an original-version 8 K-byte Commodore PET. The new PETs, which have a different set of read-only memory chips, have moved many of the subroutine entry points so that, to run FLOPTRAN on such a machine, it will be necessary to find the new addresses and change them as they appear in the program of listing 1.

Other 6502-microprocessor machines using Microsoft BASIC, such as the Apple and Ohio Scientific systems, will require more extensive changes in the FLOPTRAN compiler in order to make it operational, although the overall structure of the compiler should still be applicable. In fact, the idea of a tiny compiler that uses the resident BASIC subroutines to do the bulk of its work is extremely general and applicable to systems using any microprocessor. Once I had thought of the concept, it took me only a couple of days to get the compiler up and running; anyone with an intimate knowledge of his personal system should be able to do as well.

Introduction to FLOPTRAN-IV

FLOPTRAN, the floating-point translator, is so named because it is heavily oriented toward floating-point mathematical operations. For compatibility with the PET's read-only memory routines, it uses the standard Microsoft format for storing numbers: five 8-bit bytes, with 1 byte for the exponent (power of 2) and 4 bytes for the fractional part (or mantissa) of the number and its sign. Built into FLOPTRAN are the functions given in table 1; the ability to call a user-defined machine-language function USR is also included, although it may be used infrequently. [Several articles on computer representation of floating-point numbers may be found in the book *Numbers in Theory and Practice*, which is edited by Blaise W Liffick and is available from BYTE Books....RSS]

A FLOPTRAN program looks like a BASIC program and, with one particular exception, it is a legal BASIC program. That exception is the use of the RETURN statement to end the program, as well as to signal a return-from-subroutine. This is done so that the compiled FLOPTRAN program ends with the 6502 instruction RTS (return-from-subroutine); thus, after the compiled program is run using the SYS command, control will return to the PET operating system.

Because FLOPTRAN is essentially BASIC, it is easy to test and debug a FLOPTRAN program by using the BASIC interpreter built into the PET. When the program has been fully debugged, the compiler program need only be executed once; thereafter, the compiled machine-language program can be executed directly.

Note that the PET's Microsoft BASIC interpreter stores the reserved words (ie: keywords) of the BASIC language as single bytes in memory: GOTO is stored as the single-

Text continued on page 212

LEAPAC SERVICES

MAURO PROAC MP-250 PLOTTER - \$695
 with L2D Plot package - \$795
 with L2D & L3P packages - \$950

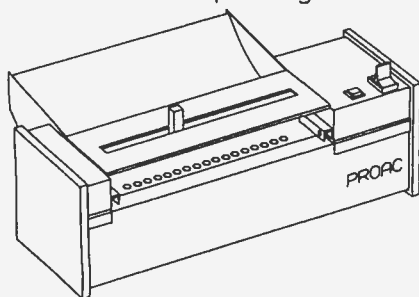

MAURO PLOTTER - Uses 11" by 8-1/2" or any length paper. Resolution is 200 steps per inch. 0.005" tracking error. Mauro X-Y vector software with pen control is available for 8080/Z80, 6502, & 6800 micro-processors. Requires 3 bits of a parallel output port. APPLE, TRS-80, and RS232 Interfaces are available as I/O Options.

LEAPAC SOFTWARE - Supports complete 2D & perspective plotting, including ASCII and curve generation. Available as relative linking libraries (L80) for MICROSOFT compatible software products, FORTRAN-80, COBOL-80, COMPILER BASIC, and MACRO-80 in CP/M compatible files on 8" IBM-3740 disks or 5-1/4" MORTSTAR formatted disks.

L2D - X-Y plot package. Contains over 20 entries, including CALCOMP compatible calls such as PLOT and WHERE.

L3P - Perspective plot package. Contains over 20 entries. Capable of ZOOMING, FLY-INS, ANIMATION and much more. (See self portrait above).

LEAPAC SERVICES (916) 381-1717
 8245 MEDITERRANEAN WAY SACRAMENTO CA 95826
 DEALER INQUIRIES ARE INVITED

CP/M is a registered trade mark of Digital Research, Inc.
 MICROSOFT is a trade mark of MICROSOFT, Inc. CA
 CALCOMP is a trade mark of California Computer Products, Inc.

The COMPUTER FACTORY

TO ORDER CALL (212) 687-5000

SUPERBRAIN™

INTERTEC
DATA
SYSTEMS
**64K
ONLY
\$2995**



32K \$2795

More than an Intelligent terminal, the SuperBrain outperforms many other systems costing three to five times as much. Endowed with a hefty amount of available software (BASIC, FORTRAN, COBOL), the SuperBrain is ready to take on your toughest assignment. You name it! General Ledger, Accounts Receivable, Payroll, Inventory or Word Processing... the SuperBrain handles all of them with ease.

FEATURES INCLUDE:

- 2 dual-density mini-floppies with 360K bytes of disk storage • A CP/M Disk Operating System with a high-powered text editor, assembler and debugger.

Model QD

720K Bytes disk storage
and 64K RAM
\$3895

SUPER BRAIN HARD DISKS

10 Megabyte
\$3995

16 Fixed-16
Removable
\$9995

NEW 80 COLUMN



CBM
Basic 4.0
Operating
System

- 80 column by 25 line display
- 12" CRT
- New screen editor
- Split screen processing
- Super fast string handling
- 15 additional basic commands
- Supports relative record processing

Model 8016
16K memory
\$1495

Model 8032
32K memory
\$1795

AND

NEW 8050 DUAL DISK

1 million bytes on-line storage
and DOS 2.0 operating system

- Supports relative record (Random Access)
- Faster more reliable **only \$1695**

CENTRONICS 704



- 180 cps Bi-Directional • Up to 15" Paper Width • 9 x 9 Matrix
- Upper/Lower Case
- Tractor Feed
- RS-232 Serial Interface

\$1895
List \$2500

CENTRONICS 700-9

\$1295 List \$1895

- 60 cps • Up to 15" paper width
- Tractor Feed • Parallel Interface for Apple & TRS-80 • 2 channel vertical forms! • Top of Form!

CENTRONICS (Letter quality)

737 Serial \$995
737 Parallel \$965

CENTRONICS

730 Serial \$775
730 Parallel \$745

Commodore Computer

These low cost Commodore PET Business Computers have virtually unlimited business capabilities. Accounts Receivable, Inventory Records, Payroll, and other accounting functions.

PET 16N & 32N COMPUTERS

- Full size keyboard
- 16 or 32,000 Bytes Memory
- Level III Operating System
- Full Screen Editor
- Upper lower case & 64 graphic characters



\$1295



PET DUAL FLOPPY DISK

- Stores 360,000 Bytes on-line
- Microprocessor controlled
- Uses single or dual sided floppies



HI-SPEED PRINTER

- 150 characters per second • Up to 4 copies 8" wide
- Microprocessor Controlled • Prints All Graphics • Full Formatting Capability

PERIPHERALS

- 24K Memory Expansion \$499
- 16K Memory Expansion 399
- PET to RS232 Serial 179
- 2 Way Serial/Communication 229
- Modem Board for PET 375
- Analog to Digital Board for 16 Devices 275
- Second Cassette Drive 95

DIP-81 BIDIRECTIONAL 100 CPS MATRIX PRINTER

- Centronics Interface
- Serial add \$50
- Ribbon cartridge
- American made
- 80 column

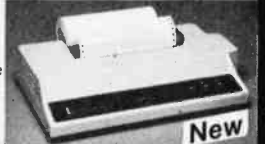

\$495

ANDERSON JACOBSON



841 I/O Terminal Ideal for word processing and small businesses.

- ASCII Code
- 15 CPS Printout
- High Quality Electronic Printing
- Reliable heavy duty mechanism
- Completely Relubricated by A.J.

• Delivered FREE to nearest service center

Parallel **\$1130**
Serial **\$1230**



NEW AMPEX HARD DISK

5 Fixed
5 Removable
Only **\$5995**



APPLE II PLUS \$1195

A complete self-contained computer system with APPLESOFT floating point BASIC in ROM, full ASCII keyboard in a light weight molded carrying case.

Features Include:

- auto-start ROM • Hi-Res graphics and 15 color-video output.
- Expandable to 48K.

Supertalker	\$279	Micromodem	\$379
Disk	595	Superterm (24 x 80)	395
Add-on Disk	495	Spechlab	229
Pascal Card	495	Communication Card	225
Business Software	625	Modem	200
Monitor	159	Graphics Printer	595
Printer Card	180	Graphics Tablet	795



**IS FINALLY HERE
128K RAM!!**



FOR BEST
DELIVERY AND
SUPPORT SEE
IT AT THE
COMPUTER
FACTORY



XEROX 1730

Letter Quality Printer

List \$2755 **Special \$2495**

- 40 Cps
- Uses all 100 metal & plastic daisy wheels
- Automatic bidirectional printing
- Fewer moving parts

90 Day On Site Warranty



XYMEC HQ 1000

with 10, 12, 15 Pitch & Proportional Spacing

- Z-80 controlled
- Up to 198 columns **\$2495**

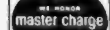

Min. Credit Card Order \$75

N.Y. residents add 8% sales tax
• Same day shipment on prepaid and credit card orders

TO ORDER CALL (212) 687-5000

Open
Mon-Fri. 10-6 Sat. 11-5

The COMPUTER FACTORY

485 Lexington Ave., New York, NY 10017 (46th St. Lobby)

Foreign order desk — Telex 640055

How to Use the FLOPTRAN-IV Compiler

To write and compile a program:

- 1) Load the FLOPTRAN-IV compiler program of listing 1.
- 2) Write the program to be compiled in FLOPTRAN (see summary of syntax in table 2) giving statements line numbers in the range 0 thru 255, and terminating the FLOPTRAN program with a RETURN statement instead of END.
- 3) Optional: you may want to test the uncompiled FLOPTRAN program using the BASIC interpreter; if you change the terminal RETURN to an END or STOP for that purpose, be sure to change it back before compiling.
- 4) To compile, place a blank cassette in the PET tape drive and type RUN 50000. The compiled program will be written to the cassette.

To load and execute a compiled program:

- 1) Type NEW, then load and run the program in listing 3. This loads the compiled program's origin (the first thing FLOPTRAN writes to tape), then loads the program until it hits the "-1" signal that marks the end of the first pass. It then loads the addresses of JMP or JSR targets to be corrected until it hits the final "-1" marking the end of the second pass; this is the end of the data file.
- 2) To run the compiled program now in memory, type SYS(nnnn), where nnnn is the decimal number given in the "BEGIN AT nnnn" message from listing 3.

Note: FLOPTRAN-IV as presently designed is for old PET read-only-memory computers only. Many addresses will have to be changed for this compiler to work with new PETs.

Listing 1: FLOPTRAN-IV compiler program for the original-version PET. This program will convert a FLOPTRAN-IV program (actually a subset of BASIC) to an executable machine-code program, which is written to the PET cassette tape drive to be loaded at a later time. When typing this listing into a PET, all the statements associated with one line number are to be typed on the same line, separated by colons.

```
49000 X=                                     ;;leave at least 60 blanks here
      :RETURN                               ;;to be filled in during a 'LET' operation

49100 TP=TP+1                               ;;subroutine to get next nonblank character
      :CH=PEEK(TP)                          ;;and return it in CH
      :IF CH=32 GOTO 49100

49120 RETURN

49190 IF (CH>64) AND (CH<91) GOTO 49300      ;;64<CH<91 means alphabetic, legal variable name

49200 PRINT                                 ;;abort if unexpected character found
      :PRINT "***ERROR IN LINE";LI;"***"
      :GOTO 61000

49300 Z=5*(CH-65)+0V                         ;;return the address (5 byte location) of the variable
      :ZH=INT(Z/256)                        ;;;'CH'...high and low parts of address in ZH & ZL
      :ZL=Z-256*ZH
      :RETURN

49400 PRINT#1,169                           ;;LDA #ZL
      :PRINT#1,ZL
      :PRINT#1,160                           ;;LDY #ZH
      :PRINT#1,ZH

49420 PRINT#1,32                             ;;JSR $DA74 with A & Y set up as above
      :PRINT#1,116                          ;;transfers the value of the variable being
      :PRINT#1,218                          ;;pointed at to the primary accumulator for floating-
      :PC=PC+7                              ;;-point operations, 'PRI'
      :RETURN                               ;;add 7 bytes to the program-counter & return

49600 DATA 11,219,158,219,42,219,0,0,98,210,133,210 ;;data for floating-point ROM subroutine calls, 2-byte pairs
49640 DATA 36,222,69,223,191,216,160,222,158,223,165,223 ;;SGN,INT,ABS,USR,FRE,POS
49680 DATA 238,223,72,224,230,214,60,215,40,215,253,216,228,217,46,222 ;;SQR,RND,LOG,EXP,COS,SIN
      :;TAN,ATN,PEEK,+,-,*,/,^
```

Listing 1 continued on page 202

COMPUTERS "R" US

MAIL ORDER DISCOUNTS

 **apple computer**
Sales and Service

NEW!
CALL FOR
AVAILABILITY
AND PRICE.

\$949

16K



32K \$999

48K \$1069

APPLE II OR APPLE II PLUS

APPLE COMPUTER PERIPHERALS

DISK II DRIVE & CONTROLLER card	485
DISK II DRIVE ONLY	425
GRAPHICS TABLET	855
SILENTYPE PRINTER w/int. card	515
SSM AIO SERIAL/PARALLEL I/O kit	125
SSM AIO Assembled & Tested	185
SYMTEC LIGHT PEN SYSTEM	215
SYMTEC SUPER SOUND GENERATOR	225
SVA 8 INCH DISK CONTROLLER CARD	335
VERSA WRITER DIGITIZER SYSTEM	215
VIDEX VIDEOTERM 80 COLUMN CARD	315
VIDEX VIDEOTERM w/graphics ROM	335
LOBO DISK DRIVE ONLY	385
LOBO DRIVE w/controller card	465

APPLE COMPUTER INTERFACE CARDS

PARALLEL PRINTER Int. card	145
COMMUNICATIONCARD w/conn. cable	185
HI-SPEED SERIAL Int. card	145
LANGUAGE SYSTEM with PASCAL	425
CENTRONICS PRINTER Int. card	185
APPLESOFT II FIRMWARE card	149
INTEGER BASIC FIRMWARE card	149

MOUNTAIN COMPUTER ACCESSORIES

formerly Mountain Hardware

APPLE CLOCK/CALENDAR card	225
SUPERTALKER SD200 SPEECH SYNTHESIZER SYSTEM	245
ROMPLUS w/keyboard filter	185
INTROL/X-10 BSR REMOTE CONTROL SYSTEM	245
INTROL/X-10 controller card only	165
ROMWRITER SYSTEM	155
MUSIC SYSTEM (16 voices/stereo)	485
A/D-D/A 16 CHANNELS	319
EXPANSION CHASSIS (8 slots)	555

WIN AN APPLE DISK II DRIVE!! GRAND OPENING GIVEAWAY...

HERE'S HOW TO ENTER THE DRAWING: Send your Name, Address, Telephone number, and the name of two friends that own Apple II's or are in the market for one. No purchase is necessary. Drawing will be held on December 1st 1980, all entries must be received before November 15th 1980. Names will be used for our 1981 catalog mailings.

(714) 698-8088

ORDERING INFORMATION: Phone Orders invited using VISA, MASTERCARD, AMERICAN EXPRESS, or bank wire transfers. VISA & MC credit card service charge of 2%, AE credit card service charge of 5%. Mail orders may send charge card number (include expiration date), cashiers check, money order or personal check (allow 14 business days to clear). Please include a telephone number with all orders. Foreign orders (excluding Military PO's) add 10% for shipping and all funds must be in US dollars. Shipping, handling and insurance in U.S. add 3%. California residents add 6% sales tax. Our low margins prohibit us to send COD or on account. All equipment subject to price change and availability. Equipment is new and complete with manufacturer warranty. We ship most orders within 2 days. Order desk hours are Monday thru Saturday 9-5 PST.

SEND ORDERS TO: COMPUTERS "R" US 8907 LA MESA BLVD., LA MESA, CALIF. 92041

 ATARI



16K
\$839

ATARI 800
PERSONAL COMPUTER SYSTEM

ATARI ACCESSORIES

ATARI 400 COMPUTER	439
ATARI 820 PRINTER	489
ATARI 810 DISK DRIVE	575
ATARI 410 Program Recorder	69
ATARI 16K RAM MODULE	145
ASSEMBLER/EDITOR	45
STAR RAIDERS	40



16K

Exidy **\$969**
SORCERER
COMPUTER

S-100 EXPANSION UNIT	375
WORD PROCESSING PAC	179
DEVELOPMENT PAC	89

PRINTERS

ANADEX DP8000	775
ANADEX DP9500	1350
BASE 2	599
CENTRONICS 737	825
MPI 88-T	699
PAPER TIGER IDS-440 w/graphics	875
NEC SPINWRITER	2550
TRENDCOM 200	519
SILENTYPE w/int.	515

OHIO SCIENTIFIC Challenger

OHIO SCIENTIFIC

C1P MOD 2	429
C4P	799
C4PMP (1 disk drive)	1589
AC-16P JOYSTICKS (2)	39
ATV RF TV MODULATOR	35

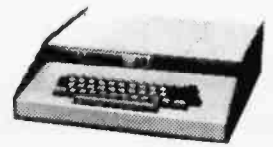

C4P

8K ROM BASIC
8K RAM EXPANDABLE TO 96K
32x64 UPPER & LOWER CASE
256x512 GRAPHICS POINTS
PROGRAMMABLE TONES
ANALOG INPUTS

C1P MOD II

8K ROM BASIC
8K RAM EXPANDABLE TO 32K
COLOR EXPANSION
48 LINE DISPLAY

LEEDEX MONITOR



VIDEO MONITORS

LEEDEX VIDEO 100	129
SANYO 9" B&W	155
SANYO 15" B&W	245
PANACOLOR 10" COLOR	329
ZENITH 13" COLOR	399



CALL OR WRITE FOR OUR FREE 1981 CATALOG!

Listing 1 continued:

```

49720 FOR X=0 TO 19
:READ MLX(X,0),MLX(X,1)          ;;;load addresses into MLX array, low byte, then high
:NEXT X

49740 FOR X=0 TO 255
:LNK(X)=-32767                   ;;;initialize LNK array of line numbers so that nonexistent
:NEXT X                           ;;;lines will be flagged later
:RETURN

50000 DIM X,LNK(255),GOX(127,1),MLX(19,1)
:P=1025                           ;;;RUN 50000 to enter program here & compile code
:GC=0                             ;;;dimension X first so make it easy to find later
                                   ;;;initialize pointer P & GOTO/GOSUB counter GC

50040 L=PEEK(P+2)+256*PEEK(P+3)   ;;;look up line number & scan
:IF L<49000 THEN P=PEEK(P)+256*PEEK(P+1)
:GOTO 50040                       ;;;to locate subroutine 49000 to be used in 'LET'
                                   ;;;assignments during later compilation

50100 XL=P+6                      ;;;store location of first space after '=' in line 49000 in XL
:GOSUB 49600                      ;;;initialize MLX and LNK arrays
:INPUT "COMPILED DATA FILE NAME";C$
:OPEN 1,1,1,C$                   ;;;get file name & open data file for compiled program

50120 INPUT "ORIGIN FOR CODE";OC   ;;;OC stores starting location for compilation
:PRINT#1,OC                      ;;;write it to tape to begin data file
:PC=OC                           ;;;initialize program counter PC

50140 INPUT "VARIABLE TABLE ORIGIN";OV
:TP=1028                          ;;;variables occupy 26*5 contiguous locations beginning at OV
                                   ;;;initialize text pointer to first line number of BASIC program

50200 LI=PEEK(TP-1)+256*PEEK(TP)  ;;;put line number in LI
:IF LI>255 GOTO 60000            ;;;compiling program has lines in range 0-255----exit when finished

50220 LNK(LI)=PC-32767           ;;;store current PC in LNK(LI) to be used in GOTOs or GOSUBs later
:PRINT "COMPILING LINE";LI      ;;;announce to screen what line is being compiled now

50240 GOSUB 49100                ;;;get next nonblank character in CH

50260 IF CH=0 THEN TP=TP+4
:GOTO 50200                      ;;;'0' is end-of-line marker----move text pointer forward and
                                   ;;;loop to get next line number

50280 IF CH=58 GOTO 50240        ;;;'58' is ':'----loop back to allow multiple statements/line

50300 IF CH=136 GOTO 58000       ;;;'136' is 'LET'

50320 IF CH=153 GOTO 59000      ;;;'153' is 'PRINT'

50340 IF CH=133 GOTO 59500      ;;;'133' is 'INPUT'

50360 IF CH=139 GOTO 58500      ;;;'139' is 'IF'

50380 IF (CH=137) OR (CH=141) GOTO 58700
                                   ;;;'137' is 'GOTO' and '141' is 'GOSUB'

50400 IF CH=143 GOTO 56500      ;;;'143' is 'REM'

50420 IF CH=142 THEN PRINT#1,96  ;;;'142' is 'RETURN', the 6502 'RTS' instruction, 96 decimal
:PC=PC+1                         ;;;'RETURN' also ends the compiled program & returns to BASIC after
:GOTO 50240                      ;;;a 'SYS' command starts machine-language

50440 GOSUB 49190                ;;;if none of the above, it better be a variable name----check it

:VL=ZL                           ;;;and store the storage address in VL, VH
:VH=ZH

50460 GOSUB 49100                ;;;get next character
:IF CH<>178 GOTO 49200          ;;;it had better be an '=' sign...abort if not!

50480 GOSUB 49100                ;;;next character
:IF (CH>179) AND (CH<195) GOTO 51000
                                   ;;;179<CH<195 means a monadic function

50500 IF CH=171 GOTO 55600      ;;;'171' is a '-' sign

50520 GOSUB 49190                ;;;otherwise, it better be a variable name....
:UL=ZL                           ;;;store the address of the variable in UL, UH
:UH=ZH

```

Listing 1 continued on page 204

DEC® LSI® 11/23 COMPUTERS \$6750 and we're delivering from stock!



CI-103 DESK TOP COMPUTER. Available with LSI 11/23 or LSI 11/2. Complete computer system enclosed within a VT-103 video terminal, immediate delivery. Only \$4500 with LSI 11/2 and 64K Memory. \$6750 with LSI 11/23 and 96K Bytes Memory.

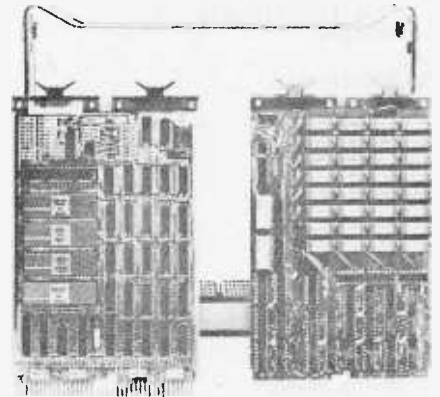
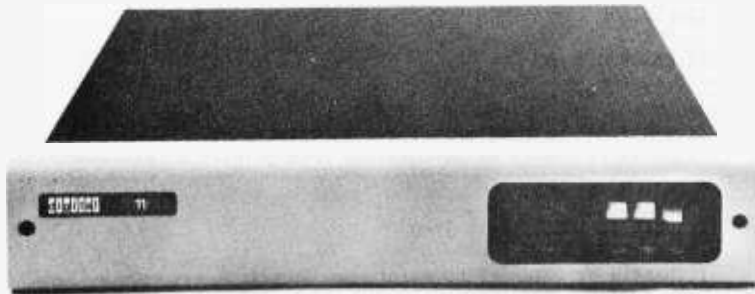

PDP 1103SE — LSI 11/2 CPU, 64KB Memory, power supply, KEV 11 in 8 slot rack mountable chassis. \$2695

CI 1103LK — LSI 11/2 CPU, 64KB Memory, power supply, KEV 11 in 16 slot rack mountable chassis. \$2750

CI-11/23 AC — LSI 11/23 CPU, MMU, 256KB Memory, power supply, in 16 slot rack mountable chassis. \$6895

LSI 11/2 CPU card with 64K Byte Memory. \$1095

1 Megabyte RX02 Floppy Disk System. \$3045

RT11 V4 Operating System. \$1085

RSX11M Operating System. \$3250

VT100AA Video Terminal. \$1795



Chrislin Industries, Inc.

Computer Products Division

31352 Via Colinas • Westlake Village, CA 91362 • 213-991-2254

DEC, LSI, PDP, are Trademarks of Digital Equipment Corp.

Listing 1 continued:

```

50540 GOSUB 49100
      :IF (CH=0) OR (CH=58) GOTO 58300
      ;;if 'end-of-line' or ':', equation is of the form 'V=U'
      ;;otherwise, expect +,-,*,/,^ and abort if not

50560 IF (CH<170) OR (CH>174) GOTO 49200
      ;;FU now records what operator it was
      ;;get next character
      ;;better be variable name...address in ZL, ZH
      ;;write out code to transfer it to primary accumulator

50580 FU=CH-155
      :GOSUB 49100
      :GOSUB 49190
      :GOSUB 49400
      ;;LDA #UL
      ;;LDY #UH
      ;;count the bytes and increment program counter
      ;;take shortcut for '+' or '*' functions

50660 PRINT#1,169
      :PRINT#1,UL
      :PRINT#1,160
      :PRINT#1,UH
      :PC=PC+4
      ;;JSR $D95E transfers 'U' to secondary accumulator
      ;;and sets up for dyadic operation subroutine call
      ;;count the bytes...
      ;;jump down to output code to do the operation & store result

50700 IF (FU=15) OR (FU=17) GOTO 51080
      ;;arrive here to perform a monadic function
      ;;next character better be a '(', else abort!

50720 PRINT#1,32
      :PRINT#1,94
      :PRINT#1,217
      :PC=PC+3
      :GOTO 51080
      ;;get argument of function, address in ZL, ZH
      ;;fetch it to primary floating accumulator

51000 FU=CH-180
      :GOSUB 49100
      :IF CH<>40 GOTO 49200
      ;;expect to see a ')' here!!!

51040 GOSUB 49100
      :GOSUB 49190
      :GOSUB 49400
      ;;JSR to ROM function

51060 GOSUB 49100
      :IF CH<>41 GOTO 49200
      ;;LDA #VL
      ;;LDY #VH

51080 PRINT#1,32
      :PRINT#1,HLX(FU,0)
      :PRINT#1,HLX(FU,1)
      :PC=PC+3
      ;;JSR $DAA6 with target in X & Y registers
      ;;to store result of calculation from primary accumulator

51100 PRINT#1,162
      :PRINT#1,VL
      :PRINT#1,160
      :PRINT#1,VH
      ;;back to top of main loop

51120 PRINT#1,32
      :PRINT#1,166
      :PRINT#1,218
      :PC=PC+7
      :GOTO 50240
      ;;handle monadic '-' operator
      ;;transfer number to be negated to primary floating accumulator
      ;;LDA #$FF
      ;;EOR $B5 (sign storage for primary accumulator)
      ;;STA $B5....now sign is flipped
      ;;go store negated number in target

55600 GOSUB 49100
      :GOSUB 49190
      :GOSUB 49400
      :PRINT#1,169
      :PRINT#1,255
      ;;handle 'REN' statement
      ;;loop until end-of-line encountered

55660 PRINT#1,69
      :PRINT#1,181
      :PRINT#1,133
      :PRINT#1,181
      :PC=PC+6
      :GOTO 51100
      ;;back to top of main loop

56500 GOSUB 49100
      :IF CH>0 GOTO 56500
      ;;handle 'LET' assignment operation
      ;;get address for result to be stored into
      ;;this character better be an '=' sign
      ;;save pointer to first character after '=' in VL
      ;;abort if it wasn't '='

56540 GOTO 50260
      ;;scan until ':' or 'end-of-line' terminates assignment

58000 GOSUB 49100
      :GOSUB 49190
      :GOSUB 49100
      :VL=TP+1
      :IF CH<>178 GOTO 49200

58080 GOSUB 49100
      :IF (CH<>58) AND (CH<>0) GOTO 58080

```

Listing 1 continued on page 206

CP/M* compatible software

SYSTEM MAINTENANCE

DIAGNOSTICS I: Easily the most comprehensive set of CP/M compatible system check-out programs ever assembled. Finds hardware errors in your system, confirms suspicions, or just gives your system a clean bill of health.

Tests:

- Memory
- CPU (8080/8085/Z80)
- Terminal
- Disk
- Printer

To our knowledge the CPU test is the first of its kind anywhere. Diagnostics I can help you find problems before they become serious. A good set of diagnostic routines are a must in any program library.

Minimal requirements: 24K CP/M. Supplied with complete user manual: \$60.00 Manual alone: \$15.00.

ACCOUNTING

ACCOUNTS PAYABLE/RECEIVABLE: A complete, user oriented package which features:

- automatic postings to general ledger (optional)
- accounts payable:
 - check printing with invoice
 - invoice aging
- accounts receivable:
 - progress billing
 - customer statements
 - partial invoice payments
 - invoice aging

The entire package is menu driven and easy to learn and use. It incorporates error checking and excellent user displays. This package can be used stand alone or with the General Ledger below.

Supplied with extensive user manual: \$200.00. Manual alone: \$20.00.

GENERAL LEDGER: A complete, user oriented package which features:

- Accepts postings from external programs (i.e. AP/AR above)
 - Accepts directly entered postings
 - Maintains account balances for current month, quarter, and year and previous three quarters
 - Financial reports: trial balance, income statement balance sheet, and more.
- Completely menu driven and easy to learn and use. Excellent displays and error checking for trouble free operation. Can be used stand alone or with Accounts Payable/Receivable above.

Supplied with extensive user manual: \$200.00. Manual alone: \$20.00.

Both require 48K CP/M, terminal with cursor positioning, home and clear home, one 8" disk or two 5" disks. CBASIC2 required.

TEXT PROCESSING

TFS—Text Formatting System: An extremely powerful formatter. More than 50 commands. Supports all major features including:

- left & right margin justification
- user defined macros
- dynamic insertion from disk file
- underlining and backspace

TFS lets you make multiple copies of any text. For example: Personalized form letters complete with name & address & other insertions from a disk file. Text is not limited to the size of RAM making TFS perfect for reports or any big job.

Text is entered using CP/M standard editor or most any CP/M compatible editor. TFS will link completely with Super-M-List making personalized form letters easy.

Requires: 24K CP/M.

Supplied with extensive user manual: \$85.00. Manual alone: \$20.00.

Source to TFS in 8080 assembler (can be assembled using standard CP/M assembler) plus user manual: \$250.00.

MAILING LIST

SUPER-M-LIST: A complete, easy to use mailing list program package. Allows for two names, two address, city, state, zip and a three digit code field for added flexibility. Super-M-List can sort on any field and produce mailing labels direct to printer or disk file for later printing or use by other programs. Super-M-List is the perfect companion to TFS. Handles 1981 Zip Codes!

Requires: 48K CP/M.

Supplied with complete user manual: \$75.00. Manual alone: \$10.00

UTILITIES

Utility pack #1: A collection of programs that you will find useful and maybe even necessary in your daily work (we did!). Includes:

- CMP:** Compare two files for equality.
- ARCHIVER:** Compacts many files into one, useful when you run out of directory entries.
- SORT:** In core sort of variable length records.
- XDIR:** Extended, alphabetical directory listing with groupings by common extension.
- PRINT:** Formatted listings to printer.
- PG:** Lists files to CRT a page at a time
... plus more ...

Requires: 24K CP/M.

Supplied with instructions on discette: \$50.00.

PROGRAMMING LANGUAGES

FORTH: a full, extended FORTH interpreter/compiler produces COMPACT, ROMABLE code. As fast as compiled FORTRAN, as easy to use as interactive BASIC.

SELF COMPILING: Includes every line of source code necessary to recompile itself.

EXTENSIBLE: Adds functions at will.

Z80 & 8080 ASSEMBLERS included

Single license, OEM licensing available

Please specify CPU type: Z80 or 8080

Supplied with extensive user manual and tutorial: \$150.00

Documentation alone: \$25.00

ENHANCED 'TINY' PASCAL: We still call it 'Tiny' but it's bigger and better than ever! This is the Famous Chung/Yuen 'Tiny' Pascal with more features added. Features include:

- recursive procedures/functions
- integer arithmetic
- CASE
- FOR (loop)
- sequential disk I/O
- one dimensional arrays
- IF ... THEN ... ELSE
- WHILE
- 'PEAK' & 'POKE'
- READ & WRITE
- REPEAT ... UNTIL
- more

'Tiny' Pascal is fast. Programs execute up to ten times faster than similar BASIC programs.

SOURCE TOO! We still distribute source, in 'Tiny' Pascal, on each discette sold. You can even recompile the compiler, add features or just gain insight into compiler construction.

'Tiny' Pascal is perfect for writing text processors, real time control systems, virtually any application which requires high speed. Requires: 36K CP/M. Supplied with complete user manual and source on discette: \$85.00.

Manual alone: \$10.00.

SOFTWARE SECURITY

ENCODE/DECODE: A complete software security system for CP/M. Encode/Decode is a sophisticated coding program package which transforms data stored on disk into coded text which is completely unrecognizable. Encode/Decode supports multiple security levels and passwords. A user defined combination (One billion possible) is used to code and decode a file. Uses are unlimited. Below are a few examples:

- data bases
- general ledger
- inventory
- payroll files
- correspondence
- accounts pay/rec
- programs
- tax records
- mailing lists

Encode/Decode is available in two versions:

Encode/Decode I provides a level of security suitable for normal use.

Encode/Decode II provides enhanced security for the most demanding needs. Both versions come supplied on discette and with a complete user manual.

Encode/Decode I: \$50.00

Encode/Decode II: \$100.00 Manual alone: \$15.00

INTERCOMPUTER COMMUNICATIONS

TERM: a complete intercommunications package for linking your computer to other computers. Link either to other CP/M computers or to large timesharing systems. TERM is comparable to other systems but costs less, delivers more and source is provided on discette!

With TERM you can send and receive ASCII and Hex files (COM too, with included conversion program) with any other CP/M computer which has TERM or compatible package. Allows real time communication between users on separate systems as well as acting as timesharing terminal.

- Engage/disengage printer
- error checking and auto retry
- terminal mode for timesharing between systems
- conversational mode
- send files
- receive files

Requires: 32K CP/M.

Supplied with user manual and 8080 source code: \$110.00

Manual alone: \$15.00.

CP/M Formats: 8" soft sectored, 5" Northstar,
5" Micropolis Mod II, Vector MZ

All Orders and General Information:

SUPERSOFT ASSOCIATES

P.O. BOX 1628

CHAMPAIGN, IL 61820

(217) 359-2112

Technical Hot Line: (217) 359-2691

(answered only when technician is available)

*CP/M REGISTERED TRADEMARK DIGITAL RESEARCH

SuperSoft

First in Software Technology



Listing 1 continued:

```

58100 IF TP-VL>60 THEN PRINT "LINE TOO LONG!"          ;;;subroutine 49000 only has room for 60 characters----sorry!
      :GOTO 49200

58120 FOR L=VL TO TP-1                                  ;;;take the whole expression to be evaluated for the 'LET'
      :UL=PEEK(L)                                       ;;;and POKE it into subroutine 49000
      :POKE XL+L-VL,UL
      :NEXT L

58160 GOSUB 49000                                       ;;;go evaluate the expression!----result returns in variable X

      :FOR L=VL TO TP-1
      :POKE XL+L-VL,32                                  ;;;and clean up (fill with blanks again) subroutine 49000
      :NEXT L

58180 PRINT#1,24                                       ;;;CLC
      :PRINT#1,144                                       ;;;BCC .+5 (a forced branch over the following 5 bytes)
      :PRINT#1,5
      :PC=PC+3
      :VL=256+PEEK(125)+PEEK(124)+2                   ;;;point VL to the place where X is stored now

58220 FOR L=VL TO VL+4
      :PRINT#1,PEEK(L)                                   ;;;fetch all 5 bytes of the current value of X
      :NEXT L                                           ;;;and write them into the compiled file
      :WH=INT(PC/256)
      :WL=PC-256*WH                                     ;;;store their location in the compiled code in WH, WL

58240 VL=ZL
      :VH=ZH
      :PC=PC+5                                         ;;;put the address for the result of the 'LET' to be stored into
                                                         ;;;in VL, VH, and fall into the 'assignment' handling routine

58300 PRINT#1,162                                       ;;;handle simple assignments of the form 'V=W' here
      :PRINT#1,4                                         ;;;LDX #4
      :PRINT#1,189                                       ;;;LDA W,X
      :PRINT#1,WL
      :PRINT#1,WH

58340 PRINT#1,157                                       ;;;STA V,X
      :PRINT#1,VL
      :PRINT#1,VH
      :PRINT#1,202                                       ;;;DEX

58360 PRINT#1,16
      :PRINT#1,247                                       ;;;BPL .-9
      :PC=PC+11
      :GOTO 50260                                       ;;;transfer finished...count bytes & back to main loop top

58500 GOSUB 49100                                       ;;;handle 'IF' statements
      :GOSUB 49190                                       ;;;get variable following the 'IF' ---- address in Z
      :PRINT#1,173                                       ;;;LDA Z
      :PRINT#1,ZL
      :PRINT#1,ZH
      :PRINT#1,240                                       ;;;BEQ .+3 (if variable = 0, skip over following 3 bytes)

58580 PRINT#1,3
      :PC=PC+5
      :GOSUB 49100                                       ;;;get next character
      :IF (CH<>137) AND (CH<>141) GOTO49200             ;;;abort if not 'GOTO' or 'GOSUB'----else, fall into following....

58700 IF CH=141 THEN PRINT#1,32
      :GOTO 58760                                       ;;;handle 'GOSUB' or 'GOTO' statements
                                                         ;;;'GOSUB' becomes 'JSR'

58740 PRINT#1,76                                       ;;;and 'GOTO' becomes 'JMP'

58760 GOX(GC,0)=PC-32766
      :PRINT#1,0
      :PRINT#1,0
      :PC=PC+3
      :TL=0
                                                         ;;;store in GOX array the address of the compiled-code's bytes after
                                                         ;;;the opcode, to be filled in later (second-pass)
                                                         ;;;print zeroes for now, to hold the spaces
                                                         ;;;initialize target line number TL

58800 GOSUB 49100
      :IF (CH<48) OR (CH>57) GOTO 58840                 ;;;read in ASCII target line number

58820 TL=10*TL+CH-48
      :GOTO 58800                                       ;;;and convert it to a number in TL

```

Listing 1 continued on page 210

DYNACOMP

Quality software for:

ATARI
PET
APPLE II Plus

TRS-80 (Level II)
NORTH STAR
CP/M 8" Disk

GAMES

BRIDGE 2.0

Price: \$17.95 Cassette
\$21.95 Diskette

An all-inclusive version of this most popular of card games. This program both BIDS and PLAYS either contract or duplicate bridge. Depending on the contract, your computer opponents will either play the offense OR defense. If you bid too high, the computer will double your contract! BRIDGE 2.0 provides challenging entertainment for advanced players and is an excellent learning tool for the bridge novice.

HEARTS 1.5

Price: \$14.95 Cassette
\$18.95 Diskette

An exciting and entertaining computer version of this popular card game. Hearts is a trick-oriented game in which the purpose is not to take any hearts or the queen of spades. Play against two computer opponents who are armed with hard-to-beat playing strategies.

CRIBBAGE 2.0 (TRS-80 only)

Price: \$14.95 Cassette
\$18.95 Diskette

This is a well-designed and nicely executed two-handed version of the classic card game, cribbage. It is an excellent program for the cribbage player in search of a worthy opponent as well as the beginner wishing to learn the game, in particular the scoring and jargon. The standard cribbage score board is continually shown at the top of the display (utilizing the TRS-80's graphics capabilities), with the cards shown underneath. The computer automatically scores and also announces the points using the traditional phrases.

CHESS MASTER (North Star and TRS-80 only)

Price: \$19.95 Cassette
\$23.95 Diskette

This complete and very powerful program provides five levels of play. It includes castling, en passant captures and the promotion of pawns. Additionally, the board may be preset before the start of play, permitting the examination of "book" plays. To maximize execution speed, the program is written in assembly language (by SOFTWARE SPECIALISTS of California). Full graphics are employed in the TRS-80 version, and two widths of alphanumeric display are provided to accommodate North Star users.

STARTREK 3.2

Price: \$ 9.95 Cassette
\$13.95 Diskette

This is the classic Startrek simulation, but with several new features. For example, the Klingons now shoot at the Enterprise without warning while also attacking starbases in other quadrants. The Klingons also attack with both light and heavy cruisers and move when shot at! The situation is hectic when the Enterprise is besieged by three heavy cruisers and a starbase S.O.S. is received! The Klingons get even!

SPACE TILT (Apple only)

Price: \$10.95 Cassette
\$14.95 Diskette

Use the game paddles to tilt the plane of the TV screen to "roll" a ball into a hole in the screen. Sound simple? Not when the hole gets smaller and smaller! A built-in timer allows you to measure your skill against the time in this habit-forming action game.

GAMES PACK I and GAMES PACK II

Price: \$ 9.95 each, Cassette
\$13.95 each, Diskette

GAMES PACK I contains BLACKJACK, LUNAR LANDER, CRAPS, HORSE RACE, SWITCH and more. GAMES PACK II includes CRAZY EIGHTS, JOTTO, ACEY-DUCEY, LIFE, WUMPUSS and others.

Why pay \$5.95 or more per program when you can buy a DYNACOMP collection for just \$9.95?

STATISTICS and ENGINEERING

DATA SMOOTHER

Price: \$14.95 Cassette
\$18.95 Diskette

This special data smoothing program may be used to rapidly derive useful information from noisy business and engineering data which are equally spaced. The software features choice in degree and range of fit, as well as smoothed first and second derivative calculation. Also included is automatic plotting of the input data and smoothed results.

FOURIER ANALYZER

Price: \$14.95 Cassette
\$18.95 Diskette

Use this program to examine the frequency spectra of limited duration signals. The program features automatic scaling and plotting of the input data and results. Practical applications include the analysis of complicated patterns in such fields as electronics, communications and business.

TFA (Transfer Function Analyzer)

Price: \$19.95 Cassette
\$23.95 Diskette

This is a special software package which may be used to evaluate the transfer functions of systems such as hi-fi amplifiers and filters by examining their response to pulsed inputs. TFA is a major modification of FOURIER ANALYZER and contains an engineering-oriented decibel versus log-frequency plot as well as data editing features. Whereas FOURIER ANALYZER is designed for educational and scientific use, TFA is an engineering tool.

FOURIER ANALYZER and TFA may be purchased together for a combined price of \$29.95 (Cassettes) and \$37.95 (Diskettes).

REGRESSION I

Price: \$19.95 Cassette
\$23.95 Diskette

REGRESSION I is a unique and exceptionally versatile one-dimensional least squares "polynomial" curve fitting program. Features include very high accuracy; an automatic degree determination option; an extensive internal library of fitting functions; data editing; automatic data and curve plotting; a statistical analysis (e.g., standard deviation, correlation coefficient, etc.) and much more. In addition, new fits may be tried without reentering the data. REGRESSION I is certainly the cornerstone program in any data analysis software library.

Availability

DYNACOMP software is supplied with complete documentation containing clear explanations and examples. All programs will run within 16K program memory space (ATARI requires 24K). Except where noted, programs are available on ATARI, PET, TRS-80 (Level II) and Apple (Applesoft) cassette and diskette as well as North Star single density (double density compatible) diskette. Additionally, most programs can be obtained on standard 8" CP/M floppy disks for systems running under MBASIC.

BUSINESS and UTILITIES

MAIL LIST II (North Star only)

Price: \$21.95

This many-featured program now includes full alphabetic and zip code sorting as well as file merging. Entries can be retrieved by user-defined code, client name or Zip Code. The printout format allows the use of standard size address labels. Each diskette can store more than 1100 entries (single density; over 2200 with double density systems)!

TEXT EDITOR I (Letter Writer)

Price: \$14.95 Cassette
\$18.95 Diskette

An easy to use, line-oriented text editor which provides variable line widths and simple paragraph indenting. This text editor is ideally suited for composing letters and is quite capable of handling much larger jobs.

FINDIT (North Star only)

Price: \$19.95

This is a three-in-one program which maintains information accessible by keywords of three types: Personal (e.g., last name), Commercial (eg: plumbers) and Reference (eg: magazine articles, record albums, etc). In addition to keyword searches, there are birthday, anniversary and appointment searches for the personal records and appointment searches for the commercial records. Reference records are accessed by a single keyword or by cross-referencing two or three keywords.

DFILE (North Star only)

Price: \$19.95

This handy program allows North Star users to maintain a specialized data base of all files and programs in the stack of disks which invariably accumulates. OFILE is easy to set up and use. It will organize your disks to provide efficient locating of the desired file or program.

COMPARE (North Star only)

Price: \$12.95

COMPARE is a single disk utility software package which compares two BASIC programs and displays the file sizes of the programs in bytes, the lengths in terms of the number of statement lines, and the line numbers at which various listed differences occur. COMPARE permits the user to examine versions of his software to verify which are the more current, and to clearly identify the changes made during development.

COMPRESS (North Star only)

Price: \$12.95

COMPRESS is a single-disk utility program which removes all unnecessary spaces and (optionally) REMARK statements from North Star BASIC programs. The source file is processed one line at a time, thus permitting very large programs to be compressed using only a small amount of computer memory. File compressions of 20-50% are commonly achieved.

GRAFIX (TRS-80 only)

Price: \$12.95 Cassette
\$16.95 Diskette

This unique program allows you to easily create graphics directly from the keyboard. You "draw" your figure using the program's extensive cursor controls. Once the figure is made, it is automatically appended to your BASIC program as a string variable. Draw a "happy face", call it H3 and then print it from your program using PRINT H3! This is a very easy way to create and save graphics.

TIDY (TRS-80 only)

Price: \$10.95 Cassette
\$14.95 Diskette

TIDY is an assembly language program which allows you to renumber the lines in your BASIC programs. TIDY also removes unnecessary spaces and REMARK statements. The result is a compacted BASIC program which uses much less memory space and executes significantly faster. Once loaded, TIDY remains in memory; you may load any number of BASIC programs without having to reload TIDY!

SIMULATIONS and EDUCATION

BLACK HOLE (Apple only)

Price: \$14.95 Cassette
\$18.95 Diskette

This is an exciting graphical simulation of the problems involved in closely observing a black hole with a space probe. The object is to enter and maintain, for a prescribed time, an orbit close to a small black hole. This is to be achieved without coming so near the anomaly that the tidal stress destroys the probe. Control of the craft is realistically simulated using side jets for rotation and main thrusters for acceleration. This program employs Hi-Res graphics and is educational as well as challenging.

VALDEZ

Price: \$14.95 Cassette
\$18.95 Diskette

A simulation of supertanker navigation in the Prince William Sound and Valdez Narrows. The program uses an extensive 256X256 element radar map and employs physical models of ship response and tidal patterns. Chart your own course through ship and iceberg traffic. Any standard terminal may be used for display.

FLIGHT SIMULATOR

Price: \$17.95 Cassette
\$21.95 Diskette

A realistic and extensive mathematical simulation of take-off, flight and landing. The program utilizes aerodynamic equations and the characteristics of a real airfoil. You can practice instrument approaches and navigation using radials and compass headings. The more advanced flyer can also perform loops, half-rolls and similar aerobatic maneuvers.

TEACHER'S PET: I

Price: \$ 9.95 Cassette
\$13.95 Diskette

This is the first of DYNACOMP's educational packages. Primarily intended for pre-school to grade 3, TEACHER'S PET provides the student with counting practice, various levels of math skill exercises and, depending on your computer system, pattern and color recognition. Correct answers are positively reinforced with graphics and audio where applicable.

Ordering Information

All orders are processed and shipped postpaid within 48 hours. Please enclose payment with order along with computer information. If paying by VISA or Master Card, include all numbers on card. For orders outside North America add 10% for shipping and handling.

Add \$2.50 to diskette price for 8" floppy disk (soft sector, CP/M, Microsoft BASIC)

Deduct 10% when ordering 3 or more programs.

Ask for DYNACOMP programs at your local software dealer. Write for detailed descriptions of these and other programs from DYNACOMP.

DYNACOMP, Inc.
6 Rippingale Road
Pittsford, New York 14534
(716) 586-7579



New York State residents please add 7% NYS sales tax.

BUY ONE of these great professional books when you join the



MINICOMPUTER SYSTEMS, Organization, Programming, and Applications. By Richard H. Eckhouse, Jr. and L. Robert Morris. 2nd Ed., 491 pp., illus. Updated, revised, and expanded, this is a book for every systems programmer, systems designer, computer scientist, and application specialist who wants to know more about microcomputer hardware, software, and design.
787/026 Pub Pr., \$21.95 Club Pr., \$17.75

MICROELECTRONICS: Digital and Analog Circuits and Systems. By Jacob Millman. 801 pp., 700 illus. Exciting news for the thousands of engineers who want a thorough refresher and updating on today's ICs. Will be welcomed by both digital and analog electronics engineers at every level of proficiency.
423/27X Pub. Pr., \$28.95 Club Pr., \$22.50

AUTOMATIC DATA PROCESSING HANDBOOK. Edited by The Diebold Group. 976 pp., 269 illus. Written by a staff of internationally recognized authorities on ADP, this comprehensive handbook explains systems programming and the languages, communications processes, and the design and installation of today's computers.
168/075 Pub Pr., \$44.95 Club Pr., \$31.50

THE Z-80 MICROCOMPUTER HANDBOOK. By William Barden, Jr. 304 pp., illus. paperbound. This book gives you the entire "state of the art" in microcomputer technology today. Arranged in three convenient and logically developed sections, the book discusses architecture and interface signals, then powerful interrupt sequences of Z-80 and interfacing examples of I/O memory devices.
784/914 Pub Pr., \$8.95 Club Pr., \$7.60

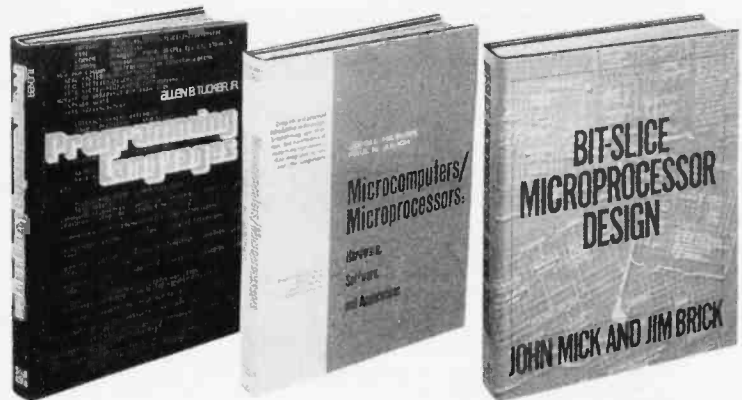

BE SURE TO CONSIDER THESE IMPORTANT TITLES AS WELL—

APPLYING MICROPROCESSORS, New Hardware, Software, and Applications. Edited by L. Altman & S. E. Scrupski
191/603 Pub. Pr., \$23.50 Club Pr., \$18.95

57 PRACTICAL PROGRAMS & GAMES IN BASIC. By K. Tracton
784/957 Pub. Pr., \$10.95 Club Pr., \$9.30

MICROPROCESSOR ARCHITECTURE AND PROGRAMMING. By W. F. Leahy
784/612 Pub. Pr., \$24.50 Club Pr., \$18.50

16 BIT MICROPROCESSOR ARCHITECTURE. By T. Dollhoff
582003-X Pub. Pr., \$24.95 Club Pr., \$19.95

THE BASIC COOKBOOK. By K. Tracton
786/615 Pub. Pr., \$7.95 Club Pr., \$6.75

MICROPROCESSOR PROGRAMMING FOR COMPUTER HOBBYISTS. By N. Graham
783/56X Pub. Pr., \$12.95 Club Pr., \$10.95

DISTRIBUTED MICRO/MINICOMPUTER SYSTEMS. By C. Weitzman
789/622 Pub. Pr., \$22.50 Club Pr., \$18.25

HOME COMPUTER PROGRAMS. By J. W. Trudell, Jr. & M. Landberg
787/042 Pub. Pr., \$8.95 Club Pr., \$7.60

FUNDAMENTALS OF COMPUTER ALGORITHMS. By E. Horowitz & S. Sahni
786/380 Pub. Pr., \$22.95 Club Pr., \$18.25

ELECTRONICS DICTIONARY. By J. Markus
404/313 Pub. Pr., \$24.50 Club Pr., \$19.50

BIT-SLICE MICROPROCESSOR DESIGN. By John Mick and Jim Brick. 398 pp. All in one place—the crucial information you've been needing about the 2900 family of bit-slice microprocessor components. This remarkable "first" designs right before your eyes not just one but two complete 16-bit machines!
417/814 Pub. Pr., \$18.50 Club Pr., \$14.50

PRINTED CIRCUITS HANDBOOK. Edited by C. F. Coombs, Jr. 2nd Ed., 634 pp., 595 illus. Covering the subject of printed circuits from the design's idea to final acceptance, this enormously well-received work includes double-sided plated boards through printed boards and also the major variations such as multilayer and flexible circuits.
126/089 Pub Pr., \$32.50 Club Pr., \$24.50

PRINCIPLES OF INTERACTIVE COMPUTER GRAPHICS. By William M. Newman and Robert Sproull. 2nd Ed., 544 pp., illus. Now in a revised, updated Second Edition, this is a volume that has long been THE standard source of information for designers!
463/387 Pub. Pr., \$24.95 Club Pr., \$19.95

ELECTRONICS ENGINEERS' HANDBOOK. Editor in Chief, D. G. Fink. 2,104 pp., 2026 illus. Brings together in one instant-reference volume the essential principles, data, and design information known today on the components, circuits, equipment, and systems of all the various specialties that make up modern electronics.
209/804 Pub. Pr., \$57.50 Club Pr., \$40.50

THE 8080A BUGBOOK: Microcomputer Interfacing and Programming. By Peter R. Rony, David G. Larsen, and Jonathan A. Titus. 416 pp., with figures, charts, and tables, paperbound. Gives you the basic concepts of microcomputer interfacing and the associated microcomputer I/O programming to develop your own interfaces. For the 8080 user, this book will be invaluable.
783/845 Pub Pr., \$9.95 Club Pr., \$8.45

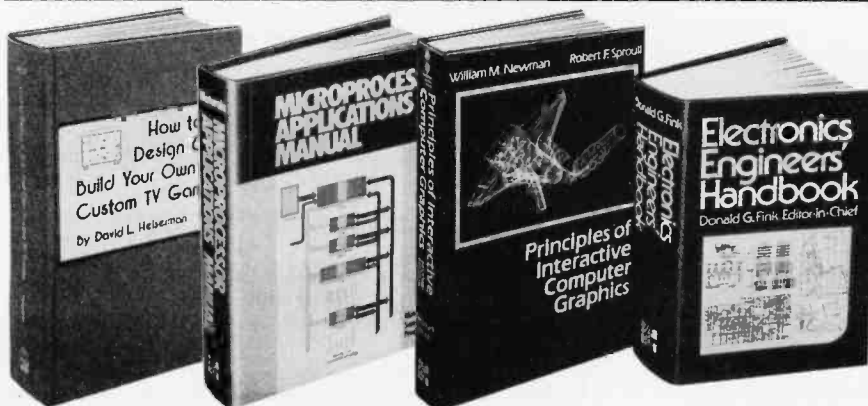

and GET ONE FREE (values up to \$60.00)

COMPUTER PROFESSIONALS' BOOK CLUB



COMPUTER DICTIONARY AND HANDBOOK. By Charles and Robert Sippl. 624 pp., illus. This handy reference/guide defines and explains a wide range of computer procedures, products, problems, and applications. Appendixes provide a "state-of-the-art" guide to essential computer concepts.

82079-X Pub. Pr., \$29.95 Club Pr., \$24.95

ELECTRONIC GAMES, Design, Programming and Troubleshooting. By W. I. Buchsbaum and R. Mauro. 335 pp., 338 illus. Information you need to design, program, and troubleshoot electronic games is right here in this widely popular hands-on guide.

87/210 Pub. Pr., \$21.50 Club Pr., \$16.50

MEMORY DESIGN: Microcomputers to Mainframes Edited by LAURENCE ALTMAN. 192 pp., illus., 8 1/2 x 11 format Keep up with memory chips through this collection of key articles from *Electronics* magazine. Data, diagrams, and discussions put all the technology to work for you in one authoritative book—a volume so up to date it's a pleasure to use.

91/549 Pub. Pr., \$22.50 Club Pr., \$17.95

PROGRAMMING LANGUAGES. By Allen B. Tucker, Jr. 439 pp., illus. Gives you not only the principles of design but the applications of six major programming languages. Shows you their strengths and weaknesses in solving various representative "benchmark" problems.

654/158 Pub. Pr., \$23.95 Club Pr., \$16.95

MICROCOMPUTERS/MICROPROCESSORS Hardware, Software, and Applications. By John L. Hilburn and Paul N. Julich. 372 pp., illus. Expressly created for people involved in the design, use, or maintenance of digital systems using microcomputers. The authors describe the theory and workings behind microprocessor architecture, read-only memory (ROM), random-access memory (RAM), and input/output interfacing methods.

771/449 Pub. Pr., \$22.50 Club Pr., \$16.50

LOGIC DESIGNER'S MANUAL. By John D. Lenk. 504 pp., illus. Written for logic IC users rather than for designers of logic ICs, this book uses time-tested existing commercial logic ICs to solve all design and application problems.

784/671 Pub. Pr., \$18.95 Club Pr., \$15.75

HOW TO DESIGN AND BUILD YOUR OWN CUSTOM TV GAMES. By David L. Heiserman. 544 pp., illus. Shows you how to create and build TV games from scratch and modify the ones you already have.

786/585 Pub. Pr., \$14.95 Club Pr., \$11.95

MICROPROCESSOR APPLICATIONS MANUAL. By Motorola Semiconductor Products, Inc. 720 pp., illus., 8 1/2 x 11 format. With nuts-and-bolts practicality, this manual by the Motorola people (who should know) gives you detailed applications information on microprocessors and assumes no prior knowledge on your part about MPUS.

435/278 Pub. Pr., \$38.00 Club Pr., \$26.50

PERSONAL COMPUTING: Hardware and Software Basics ELECTRONIC BOOK SERIES. 224 pp., 175 illus., outsized 8 1/2 x 11 format Gives you comprehensive guidance to the present state of the art in personal computers—an overall survey of the technology, and methods available to perform various tasks, facts about the work others are doing—and just how they are doing it.

191/514 Pub. Pr., \$19.50 Club Pr., \$15.50



ENCYCLOPEDIA OF COMPUTER SCIENCE. Edited by Anthony Ralston and C. L. Meek. 1,500 pp., 60 illus., 100 charts, 7 x 10 format. This first and only in-depth coverage of the entire field of computer science in a single volume is comprehensive and completely up to date.

769/01X Pub. Pr., \$60.00 Club Pr., \$39.95

ANALOG SYSTEMS FOR MICROPROCESSORS AND MINICOMPUTERS. By Patrick H. Garrett. 248 pp., illus. Explores all possibilities for analog systems in one applications oriented volume—with many specific examples.

786/496 Pub. Pr., \$18.95 Club Pr., \$14.95

Choose any one of these books at the special club discount, and select any other as your gift Free of Charge when you enroll

Why YOU should join now!

► **BEST BOOKS IN YOUR FIELD**—Books are selected from a wide range of publishers by expert editors and consultants to give you continuing access to the latest books in your field.

► **BIG SAVINGS**—Build your library and save money too! We guarantee savings of at least 15% off publishers' list prices on every book. Usually 20%, 25% or even higher!

► **BONUS BOOKS**—You will immediately begin to participate in our Bonus Book Plan that allows you savings between 70-80% off the publisher's price of many books.

► **CONVENIENCE**—14 times a year you receive the Club Bulletin FREE, fully describing the Main Selection and alternate selections, together with a dated reply card. If you want the Main Selection, you simply do nothing—it will be shipped automatically. If you want an alternate selection—or no book at all—you simply indicate it on the regular reply card and return it by the date specified. You will have at least 10 days to decide. If, because of late mail delivery of the Bulletin you should receive a book you do not want, just return it at the Club's expense.

As a Club member, you agree only to the purchase of four books (including your first selection) over a two-year period.

Computer Professionals' Book Club

P.O. Box 582, Hightstown, New Jersey 08520

Please enroll me as a member and send me the two books indicated, billing me for my first selection only at the discounted member's price, plus local tax, postage and handling. If not satisfied, I may return the books within 10 days and my membership will be canceled. I agree to purchase a minimum of 3 additional books during the next 2 years as outlined under the club plan described in this ad. Membership in the club is continuous but cancellable by me any time after the four book purchase requirement has been fulfilled.

Write Code # of
FREE selection here

Write Code # of
FIRST selection here

Orders from outside the U.S. must be prepaid with international money orders in U.S. dollars

Charge my VISA MASTER CHARGE* Exp Date _____

Credit Card # _____ *MC Bank # _____

Signature _____

Name _____

Address _____

City, State, Zip _____

Corporate Affiliation _____

This order subject to acceptance by McGraw-Hill. All prices subject to change without notice. Offer good only to new members. A postage and handling charge is added to all shipments

P39478

Listing I continued:

```

58840 GOX(GC,1)=TL          ;;;record target line number in GOX
      :GC=GC+1              ;;;increment GOTO/GOSUB counter GC
      :GOTO 50260           ;;;back to top of main loop

59000 GOSUB 49100          ;;;handle a 'PRINT' statement
      :IF (CH=0) OR (CH=58) GOTO 59400 ;;;when done with line or statement, print a <CRLF> before quitting

59040 IF (CH=44) OR (CH=59) GOTO 59000 ;;;keep going if ',' or ';' encountered within 'PRINT'

59080 GOSUB 49190          ;;;get address of variable to be printed
      :GOSUB 49400          ;;;transfer it to primary accumulator
      :PRINT#1,32          ;;;JSR $DCAF converts it to ASCII string at top of page 1
      :PRINT#1,175
      :PRINT#1,220

59100 PRINT#1,162         ;;;LDX #0
      :PRINT#1,0           ;;;LDA $100,X
      :PRINT#1,189
      :PRINT#1,0
      :PRINT#1,1

59120 PRINT#1,240        ;;;BEQ .+6 (end of string is marked by a zero)
      :PRINT#1,6           ;;;subroutine outputs code to print accumulator on screen
      :GOSUB 59300         ;;;INX
      :PRINT#1,232        ;;;BNE .-$B (always loop back...number is never longer than 16 bytes)
      :PRINT#1,208
      :PRINT#1,245

59160 PRINT#1,169        ;;;LDA #32 (ASCII blank space)
      :PRINT#1,32         ;;;print accumulator out
      :GOSUB 59300         ;;;count bytes
      :PC=PC+21           ;;;and continue with print statement, looping to above
      :GOTO 59000

59300 PRINT#1,32         ;;;JSR $FFD2 prints out accumulator onto screen
      :PRINT#1,210
      :PRINT#1,255

      :RETURN

59400 PRINT#1,169        ;;;LDA #0D (<CRLF>)
      :PRINT#1,13         ;;;print it
      :GOSUB 59300
      :PC=PC+5
      :GOTO 50260        ;;;back to top of main loop

59500 GOSUB 49100        ;;;handle 'INPUT' statement
      :IF (CH=0) OR (CH=58) GOTO 50260 ;;;finished when 'end-of-line' or ':'

59540 IF (CH=44) OR (CH=59) GOTO 59500 ;;;keep going if ',' or ';'

59560 GOSUB 49190        ;;;LDA #CH
      :PRINT#1,169        ;;;print prompting letter on screen before input request.
      :PRINT#1,CH
      :GOSUB 59300

59580 PRINT#1,169        ;;;LDA #03F (ascii '?')
      :PRINT#1,63
      :GOSUB 59300        ;;;print it

59600 PRINT#1,162        ;;;LDX #0 (to initialize counter for input characters)
      :PRINT#1,0           ;;;JSR $FFCF (inputs, with cursor for user to edit)
      :PRINT#1,32
      :PRINT#1,207
      :PRINT#1,255

59620 PRINT#1,149        ;;;STA $A,X (store input stuff in BASIC input buffer)
      :PRINT#1,10
      :PRINT#1,232        ;;;INX
      :PRINT#1,201        ;;;CMP #0D (check for <CRLF>)
      :PRINT#1,13

59660 PRINT#1,208        ;;;BNE .-$A (loop and keep inputting)
      :PRINT#1,246        ;;;echo <CRLF>
      :GOSUB 59300

```

Listing I continued on page 212

For those who want to test the water before jumping in.



picoFORTH

If you're thinking of getting into polyFORTH and you'd like an introduction through hands-on experience, then picoFORTH is for you. picoFORTH has been designed by FORTH, Inc. to serve as your entry into a complete polyFORTH programming environment.

picoFORTH™ is a disk-based operating system and interactive high-

level language, complete with compiler, editor, and assembler. It's upgradable to full polyFORTH™. And it's priced at only \$495.

So step forth and get your feet wet. The water's fine.

For information, call:

213/372-8493

FORTH, Inc.

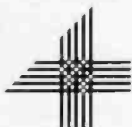

2309 Pacific Coast Highway
Hermosa Beach, California 90254

(213) 372-8493

TWX 910-344-6408 (FORTH INC HMBH)

Listing 1 continued:

```
59680 PRINT#1,169          ;;LDA #0
:PRINT#1,0                ;;STA #72
:PRINT#1,133              ;;LDA #A
:PRINT#1,114
:PRINT#1,169
:PRINT#1,10

59700 PRINT#1,133         ;;STA #71 (set up string pointer to beginning of input)
:PRINT#1,113
:PRINT#1,202              ;;DEX
:PRINT#1,138              ;;TXA (transfer number of characters in string to A)
:PRINT#1,32               ;;JSR #D68D (convert string to floating-point in primary accum.)
:PRINT#1,141

59760 PRINT#1,214
:PRINT#1,162              ;;LDX #ZL
:PRINT#1,ZL               ;;LDY #ZH (point to target location to store result)
:PRINT#1,160
:PRINT#1,ZH

59780 PRINT#1,32         ;;JSR #DAA6 (store primary memory contents in target)
:PRINT#1,166
:PRINT#1,218
:PC=PC+45                 ;;count bytes (a lot!!)
:GOTO 59500               ;;and loop

60000 PRINT "FIRST PASS FINISHED!!!" ;;compiling program finished
:PRINT"PROGRAM OCCUPIES";OC;"THROUGH";PC-1 ;;print statistics

60020 PRINT"VARIABLES OCCUPY";OV;"THROUGH";OV+129

60060 PRINT#1,-1         ;;mark end of first pass on tape file
:IF GC=0 GOTO 61000      ;;skip if no jumps to be corrected

60080 FOR X=0 TO GC-1
:PRINT#1,GOZ(X,0)+32767 ;;print byte to be fixed
:L=GOZ(X,1)              ;;look up desired line number to branch to
:Z=L*Z(L)+32767         ;;find what the program counter was there

60100 IF Z=0 THEN PRINT "TRANSFER TO NONEXISTENT LINE #";L
:GOTO 61000              ;;catch errors

60120 ZH=INT(Z/256)
:ZL=Z-256*ZH
:PRINT#1,ZL              ;;record correct jump (JMP or JSR) target
:PRINT#1,ZH
:NEXT X                  ;;for all that need fixing

61000 PRINT#1,-1         ;;mark end of file
:CLOSE 1                 ;;that's all, folks!!!!
```

Text continued from page 198:

byte value 137, COS is stored as 190, etc. This encoding system saves memory within BASIC programs; when a line is listed to the display, it is decoded so that it can be read in its original form. Encoding also makes the job of the FLOPTRAN compiler easier. Because BASIC encodes reserved words as 1-byte values rather than a sequence of letters, there is, for example, no confusion as to whether the letter G is a variable name or the first letter of a GOTO or GOSUB statement.

Compiler Program Analysis

Because the FLOPTRAN compiler is rather tiny, the language in its present version is a restricted subset of BASIC. The following paragraphs will describe each type of statement that FLOPTRAN understands and explain how it works. The line numbers refer to the statements in the BASIC program of listing 1 that process a given type of statement.

The LET Statement

Lines 58000 thru 58360: To assign a value to a variable during compilation, most BASIC systems allow us to use a statement like:

$$X = 1.234E - 5$$

In most BASICs, however, it is also legal to say:

$$\text{LET } X = 1.234E - 5$$

In fact, in the original BASIC language, the use of the word LET was compulsory.

FLOPTRAN demands the presence of the reserved word LET. When the compiler sees LET, it notes the immediately following variable name, which will receive the assigned value on the right side of the equals sign. The compiler then literally copies the right-hand side of the equation into the blank space available in the subroutine

THE OASIS RECIPE FOR QUALITY APPLICATION SOFTWARE.

Happy customers are fast making Single & Multi-User OASIS recognized as the super system software. BUT, system software is only as good as the applications it runs. And that's where OASIS really cooks.

Application software developers particularly like OASIS because it lets them blend unique performance features with their own products—in other words, build better software. Security features like User Accounting with Logon, Password and Privilege Level; File and Automatic Record Locking; Private, Shared and Public Files. Speed and convenience of Keyed Index (ISAM) Files. Economy from Compiled Re-Entrant BASIC that makes multi-user systems practical on as little as 64K memory. And lots more.

Because OASIS has better development tools—and more of them—creating very sophisticated software is possible, practical, easier, faster. Just one example: BASIC that is an Interpreter and Compiler with Debugger and Editor. If you do your own development, you'll really appreciate these kinds of features. For software

professionals, they make providing superior products much more cost attractive.

Add all the ingredients together and, whether you do it yourself or buy it off the shelf, the pay-off is a wide selection of top-performing, top-quality application software that does more so you do less.

OASIS; Single or Multi-User with a sizzling array of features and tools; almost unlimited software possibilities (*and application software for Single-User OASIS is Multi-User compatible*); the most extensive documentation in the industry—indeed, you get a lot to like. And *that's* put OASIS System Software* among the hottest products on the market.

Drop us a line today for a complete, free Application Software Directory. And see your OASIS Distributor, or send the coupon direct, to get the products you want. Try us. We believe you'll savor the OASIS recipe.

* For Z80 based computers.

OASIS IS AVAILABLE FOR SYSTEMS: Altos; CompuCorp; Cromemco; Delta Products; Digital Group; Digital Microsystems; Dynabyte; Godbout; IBC; Index; Intersystems; North Star; Onyx; SD Systems; TRS 80 Mod II; Vector Graphic; Vorimec.

CONTROLLERS: Bell Controls; Cameo; Corvus; Konan; Micromation; Micropolis; Tarbell; Teletek; Thinkertoys; X Comp.

APPLICATION SOFTWARE AVAILABLE FOR OASIS:

Accounts Payable; Accounts Receivable; General Ledger; Mail List Pak; Order Entry; Inventory Control; Inventory Tracking Pak; Word Processors.

Architects & Pro Designers Timekeeping & Job Cost Analysis; Cable TV Subscriber Billing Sys; Construction Mgt Pak; Construction Pak; Contractors Tracking Pak; Distributors Pak; Dental Office Mgt Pak; Medical Billing Sys; Pharmacy Prescription Processing with A/R; Management Analysis Pak; Real Estate Office Mgt; Restaurant Pak; Sewer & Water Utility Info Pak.

Bisynchronous Communication Pak; 2780/3780/3270 Emulators; File & Screen Mgr with Report Generator; Full Network Data Base Mgt Sys; Game Pak; Hierarchical Data Base Mgt Sys; Radiogs (Radio Station Logs/Schedules/Programming/Billing with A/R, A/P, G/L.

THESE ITEMS ARE NOT AVAILABLE DIRECT FROM PHASE ONE SYSTEMS, INC.—please write for ordering instructions and complete, free Application Software Directory. If you have items you would like listed in the Directory, send us complete information.)



**MAKES MICROS
RUN LIKE MINIS**

PLEASE SEND ME:

Product	Price with Manual	Manual Only
OPERATING SYSTEM (Includes: EXEC Language; File Management; User Accounting; Device Drivers; Print Spooler; General Text Editor; etc.) SINGLE-USER MULTI-USER	\$150 350	\$17.50 17.50
BASIC COMPILER/ INTERPRETER/DEBUGGER	100	15.00
RE-ENTRANT BASIC COMPILER/INTERPRETER/ DEBUGGER	150	15.00
DEVELOPMENT PACKAGE (Macro Assembler; Linkage Editor; Debugger)	150	25.00
TEXT EDITOR & SCRIPT PROCESSOR	150	15.00
DIAGNOSTIC & CONVERSION UTILITIES (Memory Test; Assembly Language; Converters; File Recovery; Disk Test; File Copy from other OS; etc.)	100	15.00
COMMUNICATIONS PACKAGE (Terminal Emulator; File Send & Receive)	100	15.00
PACKAGE PRICE (All of Above) SINGLE-USER MULTI-USER	500 850	60.00 60.00
FILE SORT	100	15.00
COBOL-ANSI '74	750	35.00

Order OASIS from:

Phase One Systems, Inc.
7700 Edgewater Drive, Suite 830
Oakland, CA 94621

Telephone (415) 562-8085
TWX 910-366-7139

NAME _____
STREET (NO BOX #) _____
CITY _____
STATE _____ ZIP _____

AMOUNT \$ _____
(Attach system description;
add \$3 for shipping;
California residents add sales tax)
 Check enclosed VISA
 UPS C.O.D. Mastercharge
Card Number _____
Expiration Date _____
Signature _____

Why Your Next CRT Should Come From MICROMAIL:



SOROC IQ 120

- Displays 80 x 24, upper/lower case.
- Separate numeric keypad and cursor keys.
- Protected fields displayed at reduced intensity.

\$689.00



SOROC IQ 140

- 117-key detachable keyboard with numeric cluster and cursor control.
- Insert/delete line, insert/delete character.
- Underline, blink, reverse, 1/2 intensity, protected and blank fields.
- Printer port with independent baud rate — prints line, partial or full screen.

\$1099.00



TELEVIDEO 912/920

- Insert/delete line, insert/delete character, line/page erase.
- Reverse video, blinking, underline, 1/2 intensity, protected field, blank security field.
- Uses 7 x 10 dot matrix for a high quality w/l case display with descenders.
- Standard typewriter or teletype keyboard; numeric keypad.
- Model 920 includes 17 dedicated keys for function and editing.
- Block or character transmission, auxiliary printer port.
- Cursor up, down, left, right, return, home, load, read, tab and back tab.

Call for Low Price



TEC 510

- Reverse video, blinking, underline, 1/2 intensity, protected fields, blank security field.
- Transmit character, line, partial page, page, or unprotected data.
- Cursor up, down, left, right, return, home, plus load and read.

\$699.00

We Also Represent the Following Manufacturers:

**DIABLO DEC TEXAS INSTRUMENTS
ANADEX GTC TELETYPE**

Write or Call In for Our Free Catalogue!



TO ORDER: Send check or money order to: MICROMAIL, P.O. Box 3297, Santa Ana, CA 92703. Personal or company checks require two weeks to clear. Terminals in stock are shipped the business day after receipt of certified funds. All equipment includes factory warranty.

SHIPPING: We ship freight collect by UPS when possible. Larger terminals are shipped by motor freight. Air and express delivery is available on all products.

HANDLING: All orders are subject to MICROMAIL's handling charges. Less than \$750.00, add 3%. \$750.00 to \$2,000.00, add 2%. Over \$2,000.00 add 1%.

at line 49000, and calls that subroutine to evaluate the expression. Thus, statements such as:

$LET P=17*LOG(\pi/137E8)+ATN(-2)$

are perfectly legal ways to initialize a variable, as long as the right-hand side will fit into line 49000.

A LET assignment cannot, however, use variable names in its equation unless those variables have been defined at compilation time; it would *not* be legal to say:

$LET A = -44:LET B = A$

since A will take on its value of -44 only when the program is executed. (In this case, unless A were defined before running the compiler, B would be assigned the value 0.) The use of variables on the right-hand side of the assignment is covered later, under arithmetic operations.

After evaluating the expression that is to be assigned to some variable, the compiler writes out code (to device 1, the PET's cassette tape drive) which, in 6502 machine language, instructs the microprocessor to skip 5 bytes. Those 5 bytes are filled with the floating-point number to be assigned to the variable; then the compiler executes lines 58300 thru 58360, which takes the stored number and transfers it to the proper target location.

FLOPTRAN allows only single-letter variable names, A thru Z, and reserves storage for each variable, whether it is used or not. This simplifies storage of variables considerably and allows easy and instant access to any variable. The typical BASIC interpreter must scan through a table of variables to find the one it wants to access; the interpreter necessarily wastes a lot of time doing so.

The PRINT Statement

Lines 59000 thru 59400: To get numeric values to the display, statements of the form:

PRINT A

or

PRINT X,Y,Z

are used in FLOPTRAN. When multiple variables are printed by a single statement, they may be separated by either commas or semicolons. In both instances, the numbers that have been requested are translated from floating-point binary radix to ASCII-encoded decimal radix and are printed with a space between them. After the final variable is printed (or if no variables are to be printed) a carriage return and line feed (CR,LF) are printed to the screen.

The PET read-only-memory subroutine at location hexadecimal DCAF does the hard work of converting from binary to ASCII (American Standard Code for Information Interchange) decimal once the value to be converted is placed in the "floating-point accumulator" on memory page 0 (hexadecimal addresses 00B0 thru 00B5); the ASCII string to be displayed is left at the top of page one and ends with a byte of 00. The 6502 code that the compiler generates to take this string and print it out (using the subroutine at hexadecimal address FFD2) is documented in the comments with the FLOPTRAN compiler listing (listing 1).

Circle 138 on inquiry card.

TERRIFIC TRIO: Z80, OASIS, MAROT.

A superior operating system and top application software bring out the best in a microcomputer. That's why Marot offers the OASIS* Operating System and compatible software for owners of Z80 based micros. They make a terrific trio.

1 Z80 MICROS —great machines. Tandy's TRS-80 MOD II* with DMA, bank select possibilities and nationwide service. Altos. Cromemco. Horizon. And many others. Great machines—but it takes a great operating system to tap their full potential.

2 ENTER OASIS —available from Marot. OASIS is fast emerging as *the* operating system for Z80 commercial applications and serious programmers. Why?...rapid formatting and back-up of diskettes; efficient disk utilization; excellent line editor and document processor for file management and textwriting; user accounting with logon, password, privilege level and use accounting; machine independence of programs, data and text files; sequential, direct and keyed index (ISAM) files; interpreted and compiled BASIC; COBOL-ANSI '74; single and multi-user versions; and more. No wonder pros say 'OASIS makes micros run like minis!'

3 APPLICATION SOFTWARE —available from Marot. OASIS is your active, invisible partner supporting these excellent, ready-to-run products:

*Magic Wand.** The wordprocessor combining the ease of screen editing with micro power.

*HDBS.*** For data management needs restricted to hierarchical tree structure and fixed length records.

*MDBS.*** Handles full network CODASYL oriented data structures and variable length records.

*ABS.**** Quality office management systems—accounts receivable and payable, general ledger, etc.—the total interacting, user-oriented business package. Written in COBOL; available with source code.

A *Law* package. And ready soon: complete medical management, real estate, restaurant, pharmacy, management analysis packages, and others.

Marot and its Dealers offer OASIS and many professional software products to individuals, OEMs and dealers. Licensing arrangements are also available. Just call or write and start your own terrific trio.

PLEASE SEND ME: -----

(Circle what you would like and send order with payment to the address shown below.)

SEND COMPLETE INFORMATION

Product	Price
MAGIC WAND*	\$400

ABS ACCOUNTING (call or write)

MDBS, full network	\$900
HDBS	300
Report Generator, Query System	300
Primer (Other options available)	10

Magic Wand, MDBS and HDBS are available for several operating systems.

*OASIS is the trademark of Phase One Systems, Inc

**HDBS and MDBS are produced by Micro Data Base Systems, Inc

***American Business Systems, Inc

TRS-80 is the registered trademark of the Tandy Corporation

Magic Wand is the registered trademark of Small Business Systems, Inc

Product	Price	
	with Manual	Manual Only
OASIS		
OPERATING SYSTEM (Includes: EXEC Language; File Management; User Accounting; Device Drivers; Print Spooler; General Text Editor; etc.)		
SINGLE-USER	\$150	\$17.50
MULTI-USER	350	17.50
BASIC COMPILER/INTERPRETER/DEBUGGER	100	15.00
RE-ENTRANT BASIC COMPILER/INTERPRETER/DEBUGGER	150	15.00
DEVELOPMENT PACKAGE (Macro Assembler; Linkage Editor; Debugger)	150	25.00
TEXT EDITOR & SCRIPT PROCESSOR	150	15.00
DIAGNOSTIC & CONVERSION UTILITIES (Memory Test; Assembly Language; Converter; File Recovery; Disk Test; File Copy from other OS; etc.)	100	15.00
COMMUNICATIONS PACKAGE (Terminal Emulator; File Send & Receive)	100	15.00
PACKAGE PRICE (All of Above)		
SINGLE-USER	500	60.00
MULTI-USER	850	60.00
FILE SORT	100	15.00
COBOL-ANSI '74	750	35.00



**MAROT SOFTWARE SYSTEMS
YOUR EASTERN SOURCE**

Send order to:
Marot Software Systems, Inc.
35 East 85th Street
New York City, NY 10028
Telephone (212) 534-5499

NAME _____
STREET (NO BOX #) _____

CITY _____
STATE _____ ZIP _____

AMOUNT \$ _____

(Attach system description; add \$3 for shipping; New York residents add sales tax.)

Check enclosed VISA
 UPS C.O.D. Mastercharge
Card Number _____
Expiration Date _____
Signature _____

More Printing Terminals From MICROMAIL



DIABLO 1650

- Prints at 40 cps, using 88, 92, or 96 char. metalized printwheels.
- Vertical resolution 1/48"; Horizontal 1/120". Capable of proportional spacing, bidirectional printing, and graphics under software control.
- Bidirectional normal and direct tabs. Left, right, top and bottom margins.

R.O. \$2890.00
KSR \$3285.00

DIABLO 1640

- Uses plastic printwheel and prints at 45 cps. Otherwise, shares identical features with 1650 including:
 - Friction or tractor feed, up to 15" wide.
 - Cartridge ribbon, fabric or carbon.

R.O. \$2745.00
KSR \$3140.00

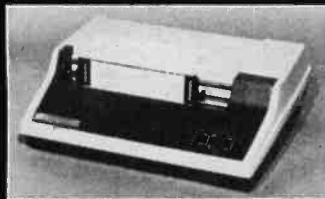

T.I. 810

- Includes upper/lower case option.
- Bidirectional printing at 150 cps.
- Tractor-feed forms, 3" to 15" wide.

\$1599.00

Options:

- Forms length control — \$100.00
- Vertical Format Control with Compressed Print — \$125.00

Call for Low Price

We Also Represent the Following Manufacturers:

TELETYPE GTC TeleVideo TEC SOROC

Write or Call In for Our Free Catalogue!



TO ORDER: Send check or money order to: MICROMAIL, P.O. Box 3297, Santa Ana, CA 92703. Personal or company checks require two weeks to clear. Terminals in stock are shipped the business day after receipt of certified funds. All equipment includes factory warranty.

SHIPPING: We ship freight collect by UPS when possible. Larger terminals are shipped by motor freight. Air and express delivery is available on all products.

HANDLING: All orders are subject to MICROMAIL's handling charges. Less than \$750.00, add 3%. \$750.00 to \$2,000.00, add 2%. Over \$2,000.00 add 1%.



DEC LA 34

(Shown with optional forms tractor and numeric keypad).

- Prints 10, 12, 13.2, or 16.5 characters per inch, upper/lower case.
- 2, 3, 4, 6, 8, or 12 lines per inch.
- Friction feed, paper width to 15 inches.

\$969.00

Options:

- Numeric keypad — \$80.00
- Adjustable forms tractor — \$130.00



ANADIX DP-9500/9501

- High Density Graphics
- Parallel, RS-232C, and Current Loop interfaces standard.
- Double width printing
- 132/175 or 132/220 columns.
- 50 to 200+ lines/min., 150/200 CPS 9 x 7/7 x 9 font or 120/200 CPS with 11 x 9/7 x 9 font.
- 9-wire print head, 650 million character life.
- Bi-Directional printing with shortest distance sensing logic.
- Adjustable width tractor paper feed.
- Complete forms control.

The INPUT Statement

Lines 59500 thru 59780: To read in numbers from the keyboard during program execution, statements of the form:

INPUT P

or

INPUT Q;R,S

are used. As with the PRINT statement, either commas or semicolons are valid delimiters to separate several variable names. (In fact, you can leave out the commas or semicolons and FLOPTRAN will not mind; but then BASIC will misunderstand you.)

The compiler generates code that prompts the user by printing out the variable name awaiting input, followed by a question mark. It then accepts input via the standard subroutine (hexadecimal location FFCF) and puts the input string into the BASIC input buffer on page 0. The read-only-memory subroutine at hexadecimal location D68D converts this string to a floating-point number, which is then stored in its proper location.

The IF Statement

Lines 58500 thru 58840: The only allowed forms of IF statement in FLOPTRAN-IV are the simplest ones:

IF W GOTO 252

and

IF J GOSUB 30

These statements test the variable whose name follows the IF; if that variable's value is nonzero, the statement is considered to be true, and the GOTO or GOSUB is executed. If the value of the variable is exactly 0, the statement is false, and the GOTO or GOSUB is skipped. Program execution proceeds with the next *statement*; note that, in the event of multiple statements per line, FLOPTRAN does *not* skip the rest of the line—unlike Microsoft BASIC, which executes the rest of the line only when the IF statement is true. (It is wise, therefore, to avoid using statements following an IF on the same line, to avoid incompatibility with BASIC.)

After testing for zero versus nonzero, this routine can do one of two things: if the expression is true (nonzero), control transfers to the appropriate GOTO or GOSUB routine; otherwise, control transfers to the next *statement*.

GOTO or GOSUB Statements

Lines 58700 thru 58840: Both of these statements are handled in identical ways; the only difference is whether a 6502 JMP (jump) instruction or a JSR (jump-to-subroutine) instruction is compiled to the tape file. Since the compiler, during its first scan through the FLOPTRAN source program, cannot know the correct absolute address to go to, it temporarily fills the 2 bytes following the JMP or JSR with 0s. It also records, in column 0 of array GO%, the location of those temporary filler 0s, so that the missing addresses can be added later. Since integer arrays use much less space than do floating-

Circle 140 on inquiry card.

SUPERBRAIN[®] HARDWARE, SOFTWARE,

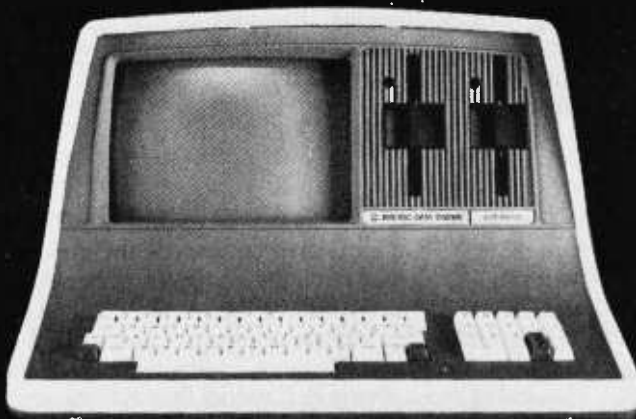

As the Western United States' largest distributor of SuperBrain[®] hardware and software,

**WE WILL NOT BE UNDERSOLD
BY ANY ADVERTISED PRICE!**

Huge volume purchases for national and international marketing gives us the chance to get you rock bottom prices from the factory.

Our SuperBrain[®] prices are the lowest in the country, and our assistance in hardware and software information will be pleasant and helpful at all times.

SOFTWARE.

	CBasic	MBasic	
Accounts Receivable	X	X	\$250.00
Accounts Payable	X	X	250.00
General Ledger	X	X	250.00
Payroll	X	X	250.00
Inventory	X	X	250.00
Restaurant Payroll	X		250.00
Job Costing	X		250.00
Mailing List	X	X	150.00
Word Processing	X		195.00
"Magic Wand"	X		325.00

PROGRAM LANGUAGES.

C Basic	125.00
M Basic	300.00
Fortran	450.00
Cobol	650.00

AND MORE.

Model 88T Impact Matrix Printer 595.00!

•Other Printers Available:

- T-I 810
- Anadex
- Diablo
- NEC
- Qune



Dealer Inquiries Invited.

**COMPUTER
MARKETING
CORPORATION**

Computer Marketing Corporation
116 South Mission
Wenatchee, WA 98801
(509) 663-1626

point arrays in PET BASIC, GO% is an integer-type two-dimensional array. Inasmuch as integers must be within the range -32,767 to +32,767, FLOPTRAN subtracts 32,767 from the actual address before storing it and adds the same value when reading the address out (in line 60080).

Column 1 of GO% stores the target line number for the GOTO or GOSUB. After the compilation is finished, the target line numbers will be looked up in table LN% (lines 60000 thru 61000), which contains the actual address of the compiled code corresponding to the desired line number. Then, the address of the first of the pair of bytes to be replaced is written to tape, followed by the 2 correct bytes for the branch. When the contents of the tape are loaded to memory, these bytes have the effect of correctly filling in the previously incomplete addresses in the body of the compiled program.

Because the original PET read-only-memory routines limit arrays to 256 elements, FLOPTRAN-IV is set up to handle programs with line numbers in the range 0 thru 255 only. This restriction, however, can be removed with additional programming if more lines are needed.

The REM Statement

Lines 56500 thru 56540: Remarks, preceded by the reserved word REM, are not compiled; the compiler skips over them to the beginning of the next line of the program, just as is done in interpreted BASIC.

The RETURN Statement

Line 50420: This statement simply causes a 6502 RTS (return-from-subroutine) instruction to be written to tape.

Arithmetic Operations

Arithmetic operations with variables comprise the remainder of the FLOPTRAN-IV compiler's repertoire. Because this is such a tiny compiler, it does *not* handle multiple arithmetic operations per assignment. The program to be compiled, therefore, must have its arithmetic broken up into elementary operations. For example, a statement like:

$$D = (A - B) / \text{LOG}(C)$$

must be written out as:

$$D = A - B : E = \text{LOG}(C) : D = D / E$$

(assuming that E is not being used otherwise).

Because of this restriction on the permissible forms of arithmetic statements, the part of the compiler which handles them is simple and consists only of lines 50440 thru 51120. One special type of equation, which is of the form:

$$V = W$$

is so simple that it is handled separately in lines 55600 thru 55660. The extensive comments included with the listing make this part of the compiler rather straightforward.

This completes our description of the FLOPTRAN-IV compiler program as given in listing 1. The compiler checks for most errors as it works through the source pro-

A REFURBISHED "SELECTRIC" ASCII TERMINAL
FOR THE SMALL BUSINESSMAN OR SERIOUS HOBBYIST.

The AJ 841 I/O terminal. Now available from dealers nationwide.

Demand for our AJ 841 I/O computer terminal has been great. And now it's getting even greater. So call your local computer shop dealer right away. Supply is limited! You may never have another opportunity like this one to buy your own professional terminal.



The AJ 841 features:

- Choice of serial RS 232 or parallel interface
- ASCII code
- 14.9 cps printout
- High quality Selectric printing
- Heavy-duty Selectric mechanism
- Off-line use as typewriter
- Documentation included
- 30-day warranty on parts and labor (details available on request)

Call toll-free now

For location of your nearest AJ dealer, call toll-free:

800/538-9721

California residents call 408/263-8520.

 **ANDERSON
JACOBSON**

Microcomputer Networking From Digital Research

CP/NET™ brings CP/M® based networking to the microcomputer world.

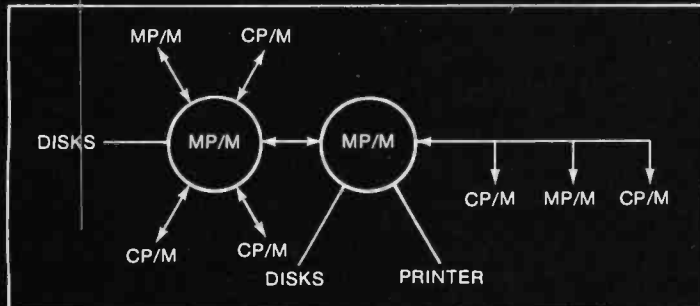

Now you can use CP/M, Digital Research's "industry standard" operating system, in a network environment. In conjunction with MP/M™, our high-powered multi-user system, a variety of CP/NET configurations allow you to share your valuable resources among a number of masters running MP/M, and slaves running CP/M or MP/M.

- **Share and transfer disk files**
- **Share printers and consoles**
- **Share programs and data bases**

As with all Digital Research products, CP/NET is compatible with a large variety of computer hardware, allowing a network to be constructed with any combination of shared memory, parallel I/O or serial links with any protocol.

For the office or the classroom, as well as the application development environment, contact Digital Research or your hardware supplier to find out how CP/NET can enhance your system's flexibility and convenience.

 **DIGITAL RESEARCH®**

U. S. A.
DIGITAL RESEARCH
P.O. Box 579
801 Lighthouse Avenue
Pacific Grove, CA 93950.
408-649-3896 TWX 910 360 5001

EUROPE
VECTOR INTERNATIONAL
Research Park
B-3030 Leuven
Belgium
32 (16) 20-24-96 Telex 26202 VECTOR

FAR EAST
MICROSOFTWARE ASSOCIATES
102 Plasada
3-16-14 Minami Aoyama
Minato-ku
Tokyo 107, Japan
03-403-2120 Telex 2426875 MSA

BUSINESS - PROFESSIONAL - GAME SOFTWARE FOR APPLE AND TRS-80

HOME FINANCE PAK I: Complete package \$49.95 Apple, TRS-80

- BUDGET:** The heart of a comprehensive home finance system. Allows user to define up to 20 budget items. Actual expense input can be by keyboard or by automatic reading of CHECKBOOK II files. Costs are automatically sorted and compared with budget. BUDGET produces both monthly actual/budget/variance report and a year-to-date by month summary of actual costs. Color graphics display of expenses. . . \$24.95
- CHECKBOOK II:** This extensive program keeps complete records of each check/deposit. Unique check entry system allows user to set up common check purpose and recipient categories. Upon entry you select from this pre-defined menu to minimize keying in a lot of data. Unique names can also be stored for completeness. Rapid access to check files. Check register display scrolls for ease of review. 40 column print-out. Up to 100 checks per month storage. Files accessible by BUDGET program. . . \$19.95
- SAVINGS:** Allows user to keep track of deposits/withdrawals for up to 10 savings accounts. Complete records shown via screen or 40 column printer. . . \$14.95
- CREDIT CARD:** Keep control of your cards with this program. Organizes, stores and displays purchases, payments and service charges. Screen or 40 column printer display. Up to 10 separate cards. . . \$14.95

THE UNIVERSAL COMPUTING MACHINE: \$39.95 Apple, TRS-80

A user programmable computing system structured around a 20 row x 20 column table. User defines row and column names and equations forming a unique computing machine. Table elements can be multiplied, divided, subtracted or added to any other element. User can define repeated functions common to a row or column greatly simplifying table setup. Hundreds of unique computing machines can be defined, used, stored and recalled, with or without old data, for later use. Excellent for sales forecasts, engineering design analysis, budgets, inventory lists, income statements, production planning, project cost estimates-in short for any planning, analysis or reporting problem that can be solved with a table. Unique cursor commands allow you to move to any element, change its value and immediately see the effect on other table values. Entire table can be printed by machine pages (user-defined 3-5 columns) on a 40 column printer. Transform your computer into a UNIVERSAL COMPUTING MACHINE.

COLOR CALENDAR: HI-RES color graphics display of your personal calendar. Automatic multiple entry of repetitive events. Review at a glance important dates, appointments, anniversaries, birthdays, action dates, etc. over a 5 year period. Graphic calendar marks dates. Printer and screen display a summary report by month of your full text describing each day's action item or event. Ideal for anyone with a busy calendar. . . (Apple Only) . . . \$19.95

BUSINESS SOFTWARE SERIES: Entire package \$199.95 Apple, TRS-80

- MICROACCOUNTANT:** The ideal system for the small cash business. Based on classic T-accounts and double-entry bookkeeping, this efficient program records and produces reports on account balances, general ledger journals, revenue and expenses. Screen or 40 column printer reports. Handles up to 500 journal entries per period, up to 100 accounts. Instructions include a short primer in Financial Accounting. \$49.95
- UNIVERSAL BUSINESS MACHINE:** This program is designed to SIMPLIFY and SAVE TIME for the serious businessman who must periodically Analyze, Plan and Estimate. The program was created using our Universal Computing Machine and it is programmed to provide the following planning and forecasting tools:
CASH FLOW ANALYSIS PROFORMA BALANCE SHEET SOURCE AND USE OF FUNDS
PROFORMA PROFIT & LOSS SALES FORECASTER JOB COST ESTIMATOR
Price, including documentation and a copy of the base program. Universal Computing Machine. . . \$89.95
- INVOICE:** Throw away your pens. Use the ELECTRONIC INVOICE facsimile displayed on your CRT. The program prompts and you fill in the data. Includes 3 address fields (your, Bill to and Ship to), Invoice No., Account No., Order No., Salesman, Terms, Ship Code, FOB Pt. and Date. Up to 10 items per sheet with these descriptions: Item No., No. of units, Unit Price, Product Code, Product Description, Total Dollar amount per item and invoice total dollar amount. Generates, at your option, hard copy invoices, shipping memos, mailing labels, audit copies and disc updates to master A/R files. (48K) . . . \$49.95

BUSINESS CHECK REGISTER: Expanded version of the Checkbook II program. Handles up to 500 checks per month with complete record keeping. (48K) . . . \$29.95

BUSINESS BUDGET: As described above and companion program to Business Check Register. Handles 500 transactions per month, up to 20 cost categories. Accesses BCR files for actual costs. (48K) . . . \$29.95

ELECTRICAL ENGINEERING SERIES: Both programs \$159.95 Apple

- LOGIC SIMULATOR: SAVE TIME AND MONEY.** Simulate your digital logic circuits before you build them. CMOS, TTL, or whatever, if it's digital logic, this program can handle it. The program is an interactive, menu driven, full-fledged logic simulator capable of simulating the bit-time by bit-time response of a logic network to user specified input patterns. It will handle up to 1000 gates, including NANDs, NORs, INverters, FLIP-FLOPS, SHIFT REGISTERS, COUNTERS and user defined MACROS. Up to 40 user-defined, random, or binary input patterns. Simulation results displayed on CRT or printer. Accepts network descriptions from keyboard or from LOGIC DESIGNER for simulation. Specify 1000 gate version (48K required) or 500 gate version (32K required) . . . \$89.95
- LOGIC DESIGNER:** Interactive HI-RES Graphics program for designing digital logic systems. A menu driven series of keyboard commands allows you to draw directly on the screen up to 15 different gate types, including 10 gate shape patterns supplied with the program and 5 reserved for user specification. Standard patterns supplied are NAND, NOR, INVERTER, EX-OR, T-FLOP, JK-FLOP, D-FLOP, RS-FLOP, 4 Bit COUNTER and N-BIT SHIFT REGISTER. User interconnects gates just as you would normally draw using line graphics commands. Network descriptions for LOGIC SIMULATOR generated simultaneously with the CRT diagram being drawn. Drawing is done in pages of up to 20 gates. Up to 50 pages (10 per disc) can be drawn, saved and recalled. Specify 1000 gate (48K) or 500 gate (32K) system . . . \$89.95

MATHEMATICS SERIES: Complete Package \$49.95 Apple only

- NUMERICAL ANALYSIS:** HI-RES 2-Dimensional plot of any function. Automatic scaling. At your option, the program will plot the function, plot the INTEGRAL, plot the DERIVATIVE, determine the ROOTS, find the MAXIMA and MINIMA and list the INTEGRAL VALUE. For 16K . . . \$19.95
- MATRIX:** A general purpose, menu driven program for determining the INVERSE and DETERMINANT of any matrix, as well as the SOLUTION to any set of SIMULTANEOUS LINEAR EQUATIONS. Disk I/O for data save. Specify 55 eqn. set (48K) or 35 eqn. (32K) . . . \$19.95
- 3-D SURFACE PLOTTER:** Explore the ELEGANCE and BEAUTY of MATHEMATICS by creating HI-RES PLOTS of 3-dimensional surfaces from any 3-variable equation. Disc save and recall routines for plots. Menu driven to vary surface parameters. Demos include BLACK HOLE gravitational curvature equations. . . \$19.95

ACTION ADVENTURE GAMES SERIES: Entire series \$29.95 Apple only

- RED BARON:** Can you outfly the RED BARON? This fast action game simulates a machine-gun DOG-FIGHT between your WORLD WAR I BI-PLANE and the baron's. You can LOOP, DIVE, BANK or CLIMB in any one of 8 directions - and so can the BARON. In HI-RES graphics. . . \$14.95
- BATTLE OF MIDWAY:** You are in command of the U.S.S. HORNETS' DIVE-BOMBER squadron. Your targets are the Aircraft carriers, Akagi, Soryu and Kaga. You must fly your way through ZEROs and AA FIRE to make your DIVE-BOMB run. In HI-RES graphics. . . \$14.95
- SUB ATTACK:** It's April, 1943. The enemy convoy is headed for the CORAL SEA. Your sub, the MORAY, has just sighted the CARRIERS and BATTLESHIPS. Easy pickings. But watch out for the DESTROYERS - they're fast and deadly. In HI-RES graphics. . . \$14.95
- FREE CATALOG-**All programs are supplied in disc and run on Apple II w/Disc & Applesoft ROM Card & TRS-80 Level II and require 32K RAM unless otherwise noted. Detailed instructions included. Orders shipped within 3 days. Card users include card number. Add \$1.50 postage and handling with each order. California residents add 6% sales tax. Make checks payable to:

SPECTRUM SOFTWARE

DEALER INQUIRIES P.O. BOX 2084 - 142 CARLOW, SUNNYVALE, CA 94087
INVITED FOR PHONE ORDERS - 408-738-4387

FLOPTRAN does not allow the appearance of uncompiled constants in an arithmetic statement.

gram; when it finds an unrecognizable statement or a branch to a nonexistent line number, it closes the output file and displays the line number containing the erroneous statement number. This makes one part of the debugging task easy. FLOPTRAN's compatibility with BASIC makes preliminary program testing possible (though perhaps slow) using the PET's BASIC interpreter; this debugging option helps in the discovery and elimination of many other types of errors.

In abbreviated form, table 2 gives a summary of FLOPTRAN-IV syntax. Table 3 presents a very compact summary of the critical read-only-memory subroutine addresses in the original-style PET. (It is probably too compact to be useful to a novice user, but for the experienced assembly-language enthusiast, table 3 should make sense and be a valuable guide to the important entry points. The table is entirely in hexadecimal; P refers to the primary floating-point accumulator, where a 6-byte floating-point binary number is stored in hexadecimal locations 00B0 thru 00B5. S refers to the secondary accumulator, located at hexadecimal locations 00B8 thru 00BF; and A, X, and Y are internal registers of the 6502 microprocessor.) It is unnecessary, however, to understand table 3 or, indeed, to understand *anything* about 6502 machine-language programming to successfully use FLOPTRAN-IV. The compiler as given does all the necessary translation.

Sample FLOPTRAN-IV Program

Listing 2 is a sample program written entirely in the FLOPTRAN-IV language. It solves a simple problem from the Parker Brothers game *Risk*: if an attacker rolls three dice and a defender rolls two, what are the odds of each of the possible outcomes? This puzzle was analyzed and discussed in detail recently by Bruce D Barnett (see reference 1). If you don't play *Risk*, however, don't be concerned—the important thing for our purposes here is that this problem provides a good sample task to exercise the capabilities of the FLOPTRAN-IV compiler.

There are a few significant items to note in the FLOPTRAN-IV program of listing 2. First, since FLOPTRAN does not allow the appearance of uncompiled constants in an arithmetic statement, the first statement in line 3 could not be written as "A=A-1". Instead, it was necessary to define a variable name with the letter O (for "One") to be equal to one, as in the assignment "LET O=1" in line 1. Then the arithmetic statement to decrement A can be correctly written as "A=A-O" (line 3).

While the necessity to define constants in arithmetic statements is an occasional inconvenience, it gives the compiler a great speed advantage. In fact, one of the slowest and most wasteful operations in an interpreted BASIC program is the conversion of every written-out ASCII numeric constant into binary each time it is encountered. Because of this, it is a recommended practice in BASIC to define a variable for any constant that is repeatedly used, in order to avoid repeatedly converting the constant from ASCII-encoded decimal to binary. FLOPTRAN forces the user to follow this efficient procedure.

“GET A HEAD START ON TOMORROW WITH THE SOFTWARE THAT’S GOING PLACES. THE UCSD p-SYSTEM.*”

JULIE ERWIN, Director of Marketing, SofTech Microsystems



Our microcomputer software system's going places for good reasons: We're constantly expanding and developing it. We started with UCSD Pascal* added FORTRAN, and we'll be introducing more in the months ahead.

We offer a total development and execution environment, from operating system and cross assemblers to screen editor.

We run on most major microprocessors today: Z80, 8080, 8085, 6502, 6800, 6809, 9900 and LSI-11™. And because the UCSD p-System's portable, you can be sure that what you invest in software today is a good investment in tomorrow.

We're going places and gaining in popularity with microcomputer manufacturers, applications developers, and demanding end users. Get a head start on tomorrow by working with a company that knows how to develop professional quality software, and that's committed to delivering it.

Our system's available for distribution licensing or for single-copy sales. With Pascal, it costs \$350... with FORTRAN, \$400... and with both languages, \$550. Documentation sets are \$50. Phone orders are welcome, and Visa and Master Card orders are accepted. Write or call for more details.

SOFTech
MICROSYSTEMS
A SUBSIDIARY OF SOFTECH

9494 Black Mountain Road, San Diego, CA 92126. (714) 578-6105

* UCSD p-System and UCSD Pascal are trademarks of the Regents of the University of California.
™ LSI-11 is a trademark of Digital Equipment Corp.

Statement Type	Description	Examples
LET	initialize a variable during compilation; must be 60 characters or less, cannot use variables	LET A = 1 LET B = EXP(2)/2
PRINT	output a variable's value to screen; gives 1 space between values printed and a "return" at end	PRINT X PRINT P,Q;R PRINT
INPUT	read in a number from keyboard (prompts with variable name)	INPUT Z INPUT J;K,L
IF	conditional branch: the GOTO or GOSUB following will be executed if the variable after the IF is nonzero; skipped otherwise	IF S GOTO 0 IF T GOSUB 255
GOTO	unconditional transfer to line number	GOTO 89
GOSUB	subroutine call; returns to statement following GOSUB when done	GOSUB 176
REM	remarks; skip to next line number	REM THIS IS A TEST
RETURN	return from subroutine, and return to BASIC control at program end	RETURN
arithmetic	perform the specified floating-point arithmetic operation, statements can have only one operation to right of equals sign	C = D E = F + G H = -I J = ATN(K)

Notes:

1. All variables must have single-letter alphabetic names.
2. All lines must be numbered 0 thru 255.
3. Variables must be initialized before use; failure to do this results in a random initial value.

Table 2: Summary of FLOPTRAN-IV syntax. Due to the nature of the compiler, the LET statement can be an expression of up to sixty characters but can use only arithmetic operators, functions, and constants. The arithmetic statement (which must not use the word LET) can use variables only and can contain, at most, one operator or function.

A second item to note is the method used (in lines 25, 29, 33, 39, 43, 45, and 51) to compare the relative magnitudes of two variables. In line 25, for example, the real question being asked is: "Is X less than W?" Since FLOPTRAN-IV can only test for zero versus nonzero in its IF statement, the programmer must set up a test variable, Q in this case, that will answer the desired question by being either nonzero for *true* or zero for *false*. For example, after the assignment "Q=X-W" in line 25, the statement "Q=SGN(Q)" returns the value +1 if Q is positive, 0 if Q is zero, and -1 if Q is negative. By adding one in the statement "Q=Q+0", the ultimate result is that Q equals zero if and only if X is less than W. Within the framework of statements 25 and 27, this means that line 27 will be executed only when X is less than W.

Finally, note the "extra" RETURN statement at the end of the program (line 120). In BASIC, this statement is wrong and gives a RETURN WITHOUT GOSUB error message when the interpreter executes it; however, in FLOPTRAN-IV, the RETURN is necessary. It tells the microprocessor that the machine-language routine, which was called by either SYS or USR, is finished and that control now returns to the BASIC operating system. I neglected to include the RETURN in my first compilation of this sample program and was rather embarrassed when, after executing perfectly and printing out the correct answers, the machine "crashed" and had to be reset for further use.

Comparison of FLOPTRAN-IV and PET BASIC

A sophisticated optimizing compiler can usually generate extremely efficient machine-language programs; a common result is a program that runs ten to a hundred times faster than an equivalent interpreted version. FLOPTRAN doesn't do quite that well, although its performance is significantly better than that of PET BASIC in all my tests.

For the *Risk-odds-calculation* program of listing 2, for example, the program took 890 seconds (almost 15 minutes) to reach the answer using the BASIC interpreter. The FLOPTRAN-IV compiled version finished in only 97 seconds, which gives a speed advantage of better than 9 to 1! (Although it is possible that some speed could be gained by rewriting the BASIC program to use FOR-NEXT loops and other structures unavailable in FLOPTRAN-IV, I estimate it would be a small improvement, probably less than a factor of 2.)

The original BASIC program used as the FLOPTRAN source code occupies 627 bytes plus 126 bytes for variables, for a total of 753 bytes. The compiled FLOPTRAN program is bigger, taking 1437 bytes plus its standard 130-byte table of twenty-six variables (not all of which are used in this program), for a total of 1567 bytes. The compilation time for this program is about 4.5 minutes, most of which is spent writing to tape.

Another simple test program, one that doesn't show such a great speed advantage for the FLOPTRAN compiler, is a program to factor a large odd number by trying

WE CAN TAKE YOU FROM WATERLOO TO THE SUPER BOWL. (By way of the North Atlantic.)

In the few short months since we introduced Computer Bismarck™, we've transported over 2500 adventurous minds to the North Atlantic — there to recreate the historic battle between the awesome German warship and the British Home Fleet. The startling realism and excitement of that experience have prompted many well-seasoned travelers to proclaim it "...unique among computer games and board games alike.*" One enthusiast had this to say: "The wealth of detail...is hardly short of fantastic. Only real war rooms...in the Pentagon have ever before been able to simulate a battle in this manner.**" Now we offer two more strategy games to embark you on new flights of the imagination.

COMPUTER NAPOLEONICS™

takes you to the battlefields of Waterloo on the fateful day of June 18, 1815. Here, the greatest battle ever fought is about to begin, awaiting only your commands to set the amassed armies in motion.

You and your friend choose your role — either as the military genius, Napoleon, or as the Duke of Wellington, the iron-willed leader of the Anglo-Allied forces. The video screen displays the map of the Belgian countryside with the artillery, infantry, and cavalry units under your respective commands.

AS NAPOLEON, you must utilize your superior combat strength and numbers to deal Wellington a quick and decisive defeat before his Prussian ally can supply reinforcements. Speed is of the essence. But any tactical blunders in military deployment will result in a repeat of history — Napoleon's ignominious defeat.

AS THE DUKE OF WELLINGTON, you must not only survive the onslaught of the French artillery, cuirassiers, and the dreaded Imperial Guard, you must also inflict sufficient damage to Napoleon's forces to prevent his relentless northward march of conquest.

THE COMPUTER, in our solitaire scenario, plays Wellington while you play Napoleon. Two levels of play are provided by making the entry of Prussian reinforcements variable. This makes the need for French military decisiveness and devastating execution even more critical.

FOR THE NOVICE AND THE ADVANCED.

Computer Napoleonics has all the advantages of your basic, traditional wargame — meticulous detail, realism, and playability. Plus one. Because the computer keeps track of all the rules, neither player can make an illegal move. This makes learning it a cinch (mastery is quite another matter), and it will convert the novice wargamer into a fanatic in no time.

The advanced wargamer will find the computer a worthy opponent indeed, and the two levels of play in the solitaire version will challenge the most experienced of strategists.



COMPUTER QUARTERBACK™

propels you onto the playing field of the Super Bowl. From its multiple offensive and defensive plays and its real-time playing conditions to the animated video display of the grid-iron and the halftime statistics, no strategy football game has ever been more complete in detail or as exciting in realism. Three versions are offered: Semi-Pro, Pro, and Computer-as-Opponent.

SEMI-PRO presents you with a choice of 18 offenses and 14 defenses. Here, you will begin to learn the intricacies of football; the thrill of the perfectly executed two-minute drill; the agony of the fumble, interception, and penalty. On offense, you will learn to read the defense and call audibles as needed.

After you have mastered the Semi-Pro version, it's time to move on to the Big Time...the Pro version!

THE PRO VERSION not only gives you every offense (36) and defense (24 plus double-teaming capabilities and special alignments) you could ever want, it also gives you the team you want! With 2.7 million computer dollars, you get to draft a team to your style and specifications. Spend more on your quarterback and receivers and your passing game may very well be unstoppable...but your running game may suffer for lack of funds.

THE COMPUTER eliminates all the organizational drudgery of conventional board games. It plays scorekeeper, referee, umpire, and linesman. As timekeeper, it makes you play in real-time. Take longer than 30 seconds to hike the ball and five yards will be marched off against you for delay-of-game.

"**THE ROBOTS**" is the team most ably coached by your friendly computer. It's ready to play any time you are. It even "learns" your tendencies and patterns through time, and it will make the necessary tactical adjustments. It plays so well you must be in top form to stand a chance against it.

All you need to start on these mind journeys is an Apple II with Applesoft ROM card, 48K memory, and a mini-floppy disc drive. For \$59.95, Computer Napoleonics comes with the game program mini-disc, two mapboard cards, a rule book, and two player-aid charts. Computer Quarterback, for \$39.95, gives you the game disc, a rule book, and four play diagram charts.

Credit card holders, call 800-648-5600 (toll free) and charge your order to your VISA or MASTERCHARGE. In Nevada, call 800-992-5710. For Computer Quarterback, ask for Operator 178; for Computer Napoleonics, Operator 179.

While you're at it, you can also get our other games:

- Computer Bismarck for your Apple: \$59.95 (Operator 180)
- Computer Bismarck, TRS-80 48K Disc: \$59.95;
- 32K Cassette: \$49.95

- Computer Ambush (a tactical simulation of man-to-man combat in World War II) for your Apple: \$59.95 (Operator 181)

To order by mail, send your check to Strategic Simulations Inc., Dept. B, 450 San Antonio Road, Suite 62, Palo Alto, CA 94306. Our 14-day money back guarantee assures your satisfaction.



STRATEGIC SIMULATIONS INC.

*Creative Computing, Aug. 1980.
**Popular Mechanics, Aug. 1980.

Apple is a registered trademark of Apple Computer Inc.
TRS-80 is a registered trademark of Tandy Corporation.

3a	Hexadecimal Address	Function of Routine	Hexadecimal Address	Function of Routine
	0000	USR(P)	D95E	[(A) + 100(Y)]-S, separating sign, set sign comparison, return with (B0) in A
	CED6	S OR P	D9E4*	S / P
	CED9	S AND P	DA74	[(A) + 100(Y)]-P, separating sign
	D264	FRE(P)	DAA6	roundoff(P)-[(X) + 100(Y)], merging sign
	D285	POS(P)	DACE	S-P
	D349	STR\$	DADE	P-S, with rounding
	D5C4	CHR\$	DAE1	P-S, without rounding
	D5D8	LEFT\$	DAED	roundoff(P)
	D604	RIGHT\$	DAFD	SGN(P)-A
	D60F	MID\$	DB0B	SGN(P)
	D654	LEN	DB2A	ABS(P)
	D663	ASC	DB9E	INT(P)
	D685	VAL	DE24	SQR(P)
	D6E6	PEEK	DE2E*	S I P
	D728*	S - P	DEA0	EXP(P)
	D73C	JSR D95E, then S + P	DF45	RND(P)
	D73F*	S + P	DF9E	COS(P)
	D7AC	normalize P	DFA5	SIN(P)
	D8BF	LOG(P)	DFEE	TAN(P)
	D8FD	JSR D95E, then S * P	E048	ATN(P)
	D900*	S * P		

3b	Hexadecimal Address		Contents	Examples: Hexadecimal Values of Bytes for	
	S pseudoregister	P pseudoregister		S = e = 2.71828...	P = $\pi/2$
	B8	B0		exponent + 80	82
B9	B1	fraction, most significant byte	AD	C9	
BA	B2	fraction, byte 2	F8	0F	
BB	B3	fraction, byte 3	54	DA	
BC	B4	fraction, least significant byte	59	A2	
BD	B5	sign	00	FF	
BE	—	sign comparison	FF	—	
BF	—	roundoff byte	00	—	

3c	Hexadecimal Address	Value stored in floating (merged sign) notation
	CDBC	π
	DDE3	1/2
	E01A	$\pi/2$
	E01F	2 π
	E024	1/4

Table 3: Overview of useful addresses and constants used by the original-version PET. Table 3a is a list of entry points to subroutines within the PET's read-only-memory firmware. Table 3b explains the makeup of the two floating-point pseudoregisters P and S. Table 3c gives the locations of five constants stored in the read-only-memory area of the PET. In table 3a, the routines marked with an asterisk (ie: all arithmetic operations) must be set up before execution as follows: hexadecimal location 00BE must contain the exclusive-OR of the contents of hexadecimal locations 00B5 and 00BD. Also, the contents of hexadecimal location 00B0 must be placed in the 6502 accumulator.

all odd numbers as potential divisors, from 3 up to the square root of the number. The compiled FLOPTRAN code takes 60 seconds to factor the number 567,890,123; the same program run in PET BASIC requires 201 seconds, a speed advantage of better than 3 to 1 for the FLOPTRAN compiler. But, after the BASIC program has been rewritten for speed, the revised program executes in 101 seconds, giving a speed advantage of 1.7 to 1 for compiled FLOPTRAN.

One of the reasons that the BASIC interpreter does not have much of a disadvantage in this factorization problem is that the BASIC program needs to use only a few variables, so that little time is wasted scanning through a variable table. Also, this program performs very little decimal-to-binary conversion and a small amount of branching from one line number to another (which requires more BASIC scanning to find the target line). These three factors contribute to this problem's lower

JUST A "BIT" OF INFORMATION IN SIX COMPLETE GUIDES

Handbook of Microprocessors, Microcomputers and Minicomputers

John Lenk
This invaluable guide describes and identifies the capabilities of the most popular lines of microprocessors available today.
1979, 404 pp. \$18.95 Cloth

Microcomputer Interfacing, 1980

Bruce Artwick
Covering everything from input/output methods to interface devices, this book integrates all the "how to" information necessary to assemble a microcomputer system.
1980, 352 pp. \$18.95 Cloth

Minicomputer Systems: Organization, Programming and Applications (PDP-11) 2nd Ed.

Richard Eckhouse and L. Robert Morris
Using examples for the PDP-11 and FORTRAN, this book illustrates principles and techniques applicable to a wide variety of languages and machines.
1979, 512 pp. \$24.00 Cloth



Microcomputer Experimentation with the INTEL SDK-85, 1980

Lance Leventhal and William Walsh
This reference provides a collection of laboratory experiments, emphasizing practical control applications in engineering design.
1980, 384 pp. \$13.95 Paper

Interactive Computer Graphics: Data Structures, Algorithms, Languages

Wolfgang Cilo
This comprehensive overview of all aspects of interactive computer graphics emphasizes interdependence of data structures, graphic algorithms, and programming languages.
1978, 352 pp. \$22.95 Cloth

Programming Standard PASCAL

J.N.P. Hume and R.C. Holt
Here the authors present the language and methodology of structured programming systematically, and step-by-step, with sample programs illustrating each point of PASCAL.
1980, 400 pp. \$16.95 Cloth

SEE THESE AND OTHER PRENTICE-HALL COMPUTER BOOKS AT:

ARIZONA

Archdale's Bookmark
12 Fashion Square
Scottsdale, AZ 85251
(602) 945-8246

CALIFORNIA

Scholars Book Store
327 Richmond Street
El Segundo, CA 90245
(213) 322-3161

Asucla Students' Store
308 Westwood Place
Los Angeles, CA 90024
(213) 825-7711 X239

Keplers Books
825 El Camino Real
Menlo Park, CA 94025
(415) 324-4321

The Computer Store
820 Broadway
Santa Monica, CA 90401
(213) 395-6956

CONNECTICUT

Huntington's Bookstore
65 Asylum Street
Hartford, CT 66103
(203) 527-1835

DELAWARE

McMahon Books, Inc.
101 Christiana Mall
Newark, DE 19702
(302) 366-7575

FLORIDA

The Bookery, Inc.
2107 S. Babcock
Melbourne, FL 32901
(305) 727-8608

GEORGIA

Engineer's Bookstore
128 North Avenue
Atlanta, GA 30313
(404) 892-1669

ILLINOIS

Byte Shop
1602 S. Neil
Champaign, IL 61820
(217) 352-2323

Kroch's & Brentano's

2950 Wabash Avenue
Chicago, IL 60603
(312) 332-7500
(312) 579-0920

INDIANA

Byte 5hop
5 S. La Grange Road
La Grange, IL 60525
(312) 277-5700

Book World
192 University Park Mall
Mishawaka, IN 46544
(219) 277-5700

MASSACHUSETTS

The Coop
1400 Massachusetts Avenue
Cambridge, MA 02238
1 (800) 343-5570

MICHIGAN

Wayne State University
Book Store
Detroit, MI 48202
(313) 577-2442

MINNESOTA

Minnesota Book Center
231 Pillsbury Drive SE
Minneapolis, MN 55455
(612) 373-3688

MISSOURI

UMKC Bookstore
5100 Rock Hill Road
Kansas City, MO 64110
(816) 276-1401

Washington Univ. Bookstore
Box 1074 Lindell & Skinker
St. Louis, MO 63130
(314) 889-5508

NEW HAMPSHIRE

The Dartmouth Bookstore
33 South Main Street
Hanover, NH 03755
(603) 643-3616

NEW JERSEY

McGraw-Hill Bookstore
Princeton Road
Heightsstown, NJ 08540
(609) 448-1700

NEW MEXICO

White Oak Bookstore
29 First Plaza Galeria
Albuquerque, NM 87102
(505) 243-0312

NEW YORK

Triangle Book Shop, Inc.
403 College Avenue
Ithaca, NY 14850
(607) 272-7111

Downtown Book Store

172 Fulton Street
New York, NY 10007
(212) 267-5817

Harcourt, Brace & Javonovich
757 3rd Avenue
New York, NY 10017
(212) 888-3333

McGraw-Hill Bookstore
1221 Avenue of the Americas
New York, NY 10020
(212) 997-4100

Pace University Bookstore
2 Spruce Street
New York, NY 10038
(212) 349-8580

NORTH CAROLINA

Byte Shop of Charlotte
6341 Albermarle Road
Charlotte, NC 28212
(704) 568-8100

OHIO

Barnes & Noble Bookstore
2400 Euclid Avenue
Cleveland, OH 44115
(216) 861-6464

Wilke News
123 South Ludlow
Dayton, OH 45402
(513) 223-2841

OKLAHOMA

Microlithics, Inc.
304 N. Meridian #15
Oklahoma City, OK 73107
(405) 947-5646

PENNSYLVANIA

Penn State Bookstore
McAllister Building
University Park, PA 16802
(814) 863-0205

TENNESSEE

Burke's Book Store, Inc.
634 Poplar Avenue
Memphis, TN 38105
(901) 527-7484

TEXAS

Varsity Book Store, Inc.
6413 Hillcrest Avenue
Dallas, TX 75205
(214) 528-9266

Brown Book Shop
1219 Fannin Street
Houston, TX 77002
(713) 652-3937

Micro Store
634 S. Central Expressway
Richardson, TX 75080
(214) 231-1096

WASHINGTON

Heritage Books
Renton Shopping Center
Renton, WA 98055
(206) 271-1776

The Elliot Bay Book Co.
First & S. Main Streets
Seattle, WA 98104
(206) 624-6600

WASHINGTON, D.C.
Students Book Company
2120 Pennsylvania Avenue
Washington, D.C. 20037
(202) 223-3334

WISCONSIN

University Book Store
711 State Street
Madison, WI 53703
(608) 257-3784
Schwartz Book Shop
440 W. Wisconsin Avenue
Milwaukee, WI 53203
(414) 272-2700

TO ORDER BY MAIL

Mail this order form to (or stop by)
the bookstore of your choice

PLEASE SEND ME:

- ___ copies of Handbook of Microprocessors, Microcomputers and Minicomputers @ \$18.95 each.
- ___ copies of Microcomputer Interfacing, 1980 @ \$18.95 each.
- ___ copies of Minicomputer Systems @ \$24.00 each.
- ___ copies of Microcomputer Experimentation with the INTEL SDK-85 @ \$13.95 each.
- ___ copies of Interactive Computer Graphics @ \$22.95 each.
- ___ copies of Programming Standard PASCAL @ \$16.95 each.

Total Price for Books _____
State & Sales Tax (if applicable) _____

Postage & Handling (\$1.25 per book) _____

Total Enclosed (Check or Money Order) _____

NAME _____

ORGANIZATION _____

ADDRESS _____

CITY _____

STATE/ZIP _____

All prices subject to change without notice.

Listing 2: Sample FLOPTRAN-IV program. This program calculates the possible outcomes of a dice roll in the game Risk, with the attacker rolling three dice and the defender rolling two dice. See text for details.

```

LIST -120
1 LET F=0
:LET G=0
:LET H=0
:LET J=0
:LET A=7
:LET B=6
:LET C=6
:LET O=1

3 A=A-0
:IF A GOTO 9

4 GOTO 100

5 LET B=6

7 LET A=6

9 LET D=7
:LET E=6

11 D=D-0
:IF D GOTO 21

13 E=E-0
:IF E GOTO 17

15 GOTO 3

17 LET D=6

21 I=I+0

23 V=A
:W=B
:X=C
:Y=D
:Z=E

25 Q=X-W
:Q=SGN(Q)
:Q=Q+0
:IF Q GOTO 29

27 T=X
:X=W
:W=T

29 Q=W-V
:Q=SGN(Q)
:Q=Q+0
:IF Q GOTO 39

31 T=W
:W=V
:V=T

33 Q=X-W
:Q=SGN(Q)
:Q=Q+0
:IF Q GOTO 39

35 T=X
:X=W
:W=T

39 Q=Z-Y
:Q=SGN(Q)
:Q=Q+0
:IF Q GOTO 43

41 T=Z
:Z=Y
:Y=T

43 Q=Z-X
:Q=SGN(Q)
:Q=Q+0
:IF Q GOTO 51

45 Q=V-W
:Q=SGN(Q)
:Q=Q+0
:IF Q GOTO 53

47 GOTO 61

51 Q=Y-W
:Q=SGN(Q)
:Q=Q+0
:IF Q GOTO 71

53 G=6+0
:GOTO 11

61 F=F+0
:GOTO 11

71 H=H+0
:GOTO 11

100 B=B-0
:IF B GOTO 7

110 C=C-0
:IF C GOTO 5

120 PRINT F,G,H
:F=F/I
:G=G/I
:H=H/I
:PRINT F,G,H
:RETURN

```

Notes on CHEEP PRINT

CHEEP PRINT is a software/hardware combination invented by Charles A McCarthy (1359 W Idaho Ave, St Paul MN 55708) to print the listings given in this article; it allows a user with a printer and modem to interface the two to a personal computer. Functionally, CHEEP PRINT produces a rapid sequence of 2025 and 2225 Hz tones (via a short machine-language program) that are converted into RS-232C ASCII character data by a standard Bell-103a-type modem. When storing programs, a simple low-pass filter is inserted between the computer and the cassette recorder to smooth the output waveform for the cassette recorder. A BASIC driver program formats the program listing and passes characters, one at a time, to the machine-language subroutine that generates the tones.

In this implementation, a Commodore PET micro-computer and a Teletype Model 43 are used. The machine-language subroutine for the PET is shortened by the use of the internal clock and programmable shift register of a 6522 VIA (Versatile Interface Adapter) chip within the PET; these are used to generate the required square-wave tones, which are made available on the CB2 pin of the PET's user port.

execution time. On the other hand, the Risk program uses many variables and branches, giving the FLOPTRAN compiled program more of an edge there.

Final Remarks

When the FLOPTRAN-IV compiler program is run, the result is a set of numbers that have been written to the PET's cassette tape drive. This tape, which contains the location and contents of the machine-language program that is the compiled equivalent of the given FLOPTRAN-IV source program, must be loaded into memory before

the compiled program can be run. This is done by running the FLOPTRAN-IV loader program in listing 3.

This short BASIC program reads in the starting address for the compiled code (in the variable PC, which serves as a program counter), POKEs the following numbers into consecutive memory locations until it encounters a -1 end-of-program marker (written to the tape by line 60060 of listing 1), then reads in the addresses and correction-bytes to put into those GOTO and GOSUB instructions that need them. A final -1, written to tape by line 61000 of listing 1, ends the loading process.

The loader program prints out the starting and ending addresses of the compiled code so that the user can check that no data blocks were dropped by the PET's tape recorder. I did not include a subroutine in the FLOPTRAN compiler to force the PET's tape-recorder motor to leave extra gaps between data blocks (if necessary, this can be done with a POKE 59411,53 instruction). Instead, I have added a 5000 to 10,000 μ F capacitor which is connected across the motor terminals during recording; this automatically causes the recorder to leave enough space. The discharging capacitor makes the motor run on for some time after it would normally stop. If your machine needs longer gaps, you may add the above POKE statement, perhaps between lines 49100 and 49120 (this is within the frequently called subroutine which fetches the next nonblank character).

By choosing the starting address for the compiled program appropriately, you can load the compiled program into memory and then load a monitor program that will allow you to save the compiled code as a binary machine-language file. Generally these binary files are much more reliable than ASCII data files, and of course, they load much faster.

You can also locate a compiled program in the video-display area of memory, locations decimal 32,768 thru 33,791, provided that the program is small enough to fit. Running such a program gives very interesting visual effects.

OS-9™ LEVEL TWO MULTIUSER OPERATING SYSTEM

T rue multitasking, multiuser OS for timesharing or real-time control applications.

- Sophisticated memory management permits use of over one megabyte.
 - Versatile, easy-to-use input/output supports multiple devices.
 - UNIX™-like file structure including hierarchical directories, pipes, filters, and byte-addressable random access files.
 - Provides log-on password protection and user file security.
 - Can run on small, inexpensive systems with floppy disks and as little as 32K memory.
- \$495.00*

OS-9™ LEVEL ONE OPERATING SYSTEM

A multitasking real-time operating system for software development, process control and smaller multi-user applications.

- Versatile input/output system can support multiple devices using interrupt-driven, DMA, or program-controlled data transfer. Users can easily add additional I/O devices.
 - Tape or disk-based versions available.
 - Disk versions support UNIX™-like hierarchical directory structure and byte-addressable random-access files.
 - Memory management for single address-space (up to 64K).
- Disk version \$150.00*
 Tape version \$95.00

BASIC09™ PROGRAMMING LANGUAGE SYSTEM

E xtended BASIC language compiler/interpreter with integrated text editor and debug package. Runs standard BASIC programs or minimally-modified PASCAL programs.

- Permits multiple named program modules having local variables and identifiers. Modules are reentrant, position independent and ROMable.
- Additional control statements for structured programming: IF ... THEN ... ELSE, FOR ... NEXT, REPEAT ... UNTIL, WHILE ... DO, LOOP ...

INTRODUCING

6809 SOFTWARE POWER TOOLS

BY MICROWARE®

ENDLOOP, EXITIF ... ENDEXIT.

- Allows user-defined data types and complex data structures. Five built-in data types: byte, integer, 9 digit floating-point, string and boolean.
 - Outperforms any other BASIC on any 8-bit MPU.
 - Available on ROM, disk or cassette tape. Runs under OS-9™ Level One or Level Two.
- Disk or tape \$195.00*

MICROSOFT 6809 BASIC

S tandard Microsoft BASIC optimized for the 6809 and OS-9™.

- Four data types: integer, string, single precision and double precision floating point.
 - Program trace and edit capabilities.
 - Automatic line numbering and renumbering.
 - Supports random and sequential file I/O. Full PRINT USING for formatted output.
- Disk or tape \$250.00

OS-9™ TEXT EDITOR

M inimum-keystroke macro text editor useful for text preparation or interactive word processing.

- User-defined macros with parameters permit virtually unlimited command expansion. Macros can be saved, loaded

and edited.

- Buffer, line and character oriented commands.
 - Search, change and extend operations.
 - Permits multiple input/output files.
- Disk or tape \$75.00
 ROM set (2716) \$90.00

OS-9™ INTERACTIVE ASSEMBLER

Compact Motorola compatible assembler for machine language program development.

- Operates in "batch" mode or interactive line-by-line mode.
 - Facilities for generation of OS-9™ memory modules and system calls.
 - Formatted listings include syntax and context error checking.
 - Runs on OS-9™ Level One or Level Two.
- Disk or tape \$75.00
 ROM set (2716) \$90.00

OS-9™ INTERACTIVE DEBUGGER

F acilitates testing and debugging of machine- language programs.

- Includes common "monitor" functions: memory examine/change, breakpoints, display/change registers, etc.
 - Calculator mode evaluates arithmetic expressions in hex, decimal or binary.
 - Access to system commands.
 - Available on ROM, disk or cassette tape.
- Disk or tape \$35.00
 ROM (2716) \$50.00

BASIC 09 is a trademark of Motorola. OS-9 is a trademark of Motorola and Microware®. UNIX is a trademark of Bell Telephone Laboratories.

Most software is available on ROM, diskette and tape in versions for many popular 6809 computers. Source listings and yearly maintenance/update service are sold separately for most programs.

*Specify manufacturer and type of CPU and I/O controllers. Contact Microware® for specific availability.



MICROWARE®

Microware Systems Corp., Dept. B1
5835 Grand Avenue
Des Moines, Iowa 50304
(515) 279-8844

SORCERER* SOFTWARE!

Unless otherwise noted, all programs are on cassette and require only 8K of memory.

FORTH

new! Now Sorcerer owners can enjoy the convenience and speed of the fascinating FORTH programming language. Based on FIGFORTH and written by James Albanese, this version was designed especially for the Sorcerer and includes the capability to read and write data (screens) to cassette tape and a complete on-screen editor. Requires at least 16K of RAM. **\$49.95**

new! GRAPHICS ANIMATION by Lee Anders. This package provides the BASIC programmer with a powerful set of commands for graphics and animation. The program is written in machine language but is loaded together with your BASIC program and graphics definitions with a CLOAD command. Any image from a character to a large graphic shape may be plotted, moved, or erased with simple BASIC commands. Encounters of plotted character sets with background characters are detected and background images are preserved. Contains a medium resolution plotting routine. A keyboard routine detects key presses without carriage returns. Includes a separate program for constructing images. **\$29.95**

new! STARBASE HYPERION™ by Don Ursem. At last, a true strategic space game for the Sorcerer! Defend a front-line Star Fortress against invasion forces of an alien empire. You create, deploy, and command entire ship squadrons as well as ground defenses in this complex tactical simulation of war in the far future. Written in BASIC and Z-80 code. Full graphics and realtime combat status display. Includes full instructions and STARCOM battle manual. Requires at least 16K of RAM. **\$17.95**

new! HEAD-ON COLLISION™ by Lee Anders. You are driving clockwise and a computer-controlled car is driving counter clockwise. The computer's car is trying to hit you head on, but you can avoid a collision by changing lanes and adjusting your speed. At the same time you try to drive over dots and diamonds to score points. Three levels of play, machine language programming, and excellent graphics make this game challenging and exciting for all. At least 16K of RAM is required. **\$14.95**

new! LUNAR MISSION by Lee Anders. Land your spacecraft softly on the moon by controlling your craft's three propulsion engines. Avoid lunar craters and use your limited fuel sparingly. You can see both a profile view of the spacecraft coming down and a plan view of the landing area. Land successfully and you get to view an animated walk on the moon. Nine levels of play provide a stiff challenge to the most skillful astronaut. Requires at least 16K of RAM. **\$14.95**

new! HANGMAN/MASTERMIND by Charles Finch. Two traditional games are brought to life by Sorcerer graphics. HANGMAN has three different vocabulary levels for you to choose from. In MASTERMIND, the computer selects a four-character code and you have to uncover it. These two games provide an enjoyable way for young people to develop their vocabulary and their logical reasoning ability. Written in BASIC. **\$11.95**

QS SMART TERMINAL by Bob Pierce. Convert your Sorcerer to a smart terminal. Used with a modem, this program provides the capability for you to communicate efficiently and save connect time with larger computers and other microcomputers. The program formats incoming data from time-sharing systems such as The Source for the Sorcerer video. Incoming data can be stored (downloaded) into a file in RAM. Files, including programs, may be saved to or loaded from cassette, listed on the video, transmitted out through your modem, or edited with an on-board text editor. Interfaces with BASIC and the Word Processor Pac. **\$49.95**

DPX™ (Development Pac Extension) by Don Ursem. Serious Z80 program developers will find this utility program to be invaluable. Move the line pointer upward. Locate a word or symbol. Change a character string wherever it occurs. Simple commands allow you to jump directly from EDIT to MONITOR or DDT80 modes and automatically set up the I/O you want for listings. Built-in serial driver. Stop and restart listings. Abort assembly with the ESC key. Save backup files on tape at 1200 baud. Load and merge files from tape by file name. Versions for 8K, 16K, 32K, and 48K Sorcerer all on one cassette. Requires the Sorcerer's Development Pac. **\$29.95**

Other utility programs:

PLOT by Vic Tolomei. High res and low res modes **\$14.95**
SHAPE MAKER™ by Don Ursem. An on-screen character maker **\$14.95**
DEBUG by Bob Pierce. Debug machine language programs **\$14.95**
SOFTWARE INTERNALS MANUAL by Vic Tolomei. A 64-page book **\$14.95**

Other game programs:

MARTIAN INVADERS™ by James Albanese **\$14.95**
NIKE II™ by Charles Finch and Bob Broffiel **\$11.95**
TANK TRAP by Don Ursem **\$11.95**
MAGIC MAZE™ by Vic Tolomei **\$11.95**
FASTGAMMON™ by Bob Christiansen **\$19.95**

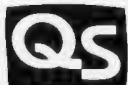

QUALITY SOFTWARE

6660 Reseda Blvd., Suite 105, Reseda, CA 91335
Telephone 24 hours, seven days a week: (213) 344-6599

WHERE TO GET IT: Ask your nearest Sorcerer dealer to see Quality Software's Sorcerer programs. Or, if you prefer, you may order directly from us. MasterCard and Visa cardholders may telephone their orders and we will deduct \$1 from orders over \$19 to compensate for phone charges. Or mail your order to the address above. California residents add 6% sales tax. **Shipping Charges:** Within North America orders must include \$1.50 for first class shipping and handling. Outside North America the charge for airmail shipping and handling is \$5.00 — payable in U.S. currency.

*The name "SORCERER" has been trademarked by Exidy, Inc.

Listing 3: FLOPTRAN-IV loader program. This program is executed to transfer the compiled FLOPTRAN-IV program from the PET cassette tape drive into memory. See the "How to Use the FLOPTRAN-IV Compiler" text box for details.

```
10 OPEN 1: INPUT #1, PC: PRINT "BEGIN AT"; PC
20 INPUT #1, A: IF A = > 0 THEN POKE PC, A:
   PC = PC + 1: GOTO 20
30 PRINT "END AT"; PC - 1
40 INPUT #1, PC: IF PC < 0 THEN CLOSE 1: END
50 INPUT #1, A: POKE PC, A: INPUT #1, A:
   POKE PC + 1, A: GOTO 40
```

What other logical improvements can be made to make FLOPTRAN faster and more useful? String-handling capabilities sometimes come in handy; it would not be hard to allow the compiled program to recognize string variables and print them when requested, though I'm not sure how you would go about manipulating strings.

Perhaps the compiler should not allocate a fixed amount of space to a table of only twenty-six variables; instead, it might define variables when needed by the program. Arrays of variables, which are also valuable to have, should not be hard to implement.

FLOPTRAN suffers from the simplicity of its conditional-branching structure; an IF statement that could test for conditions other than zero/nonzero would be a profitable addition. It also would be good to have a looping structure available, similar to BASIC's FOR...NEXT, or perhaps like FORTRAN's DO-loop. Even a simple decrement-and-skip-on-zero calculator-type instruction would save time and space in many programming situations. Simple integer variables and integer arithmetic might also be worth having for many tasks.

I've resisted pursuing some of the above modifications to FLOPTRAN-IV in order to retain the language's compatibility with BASIC; perhaps that compatibility should be given up in exchange for more power and efficiency.

I would be interested to hear from readers who have used or improved upon FLOPTRAN or who have adapted it to other machines. The idea of a tiny compiler that uses an existing BASIC interpreter (especially one that permanently resides in read-only memory) is a simple idea, but I haven't seen it discussed in print. It is possible that if a manufacturer were to have a few hundred to a couple of thousand bytes of read-only memory available beyond the BASIC interpreter, he could put a better version of a FLOPTRAN-like compiler in that space so that it would always be available. Interpreted BASIC is wonderful, but there are some programming jobs that need more speed and efficiency — jobs only a compiled language can fill. ■

Reference

Barnett, Bruce D, "How to Program a Complex Problem," *Personal Computing*, September 1979, pages 26 to 30.

Acknowledgments

I would like to thank Jim Butterfield and Charles A McCarthy for helpful ideas and programming tools, without which FLOPTRAN would have taken far longer to develop.

NEW!

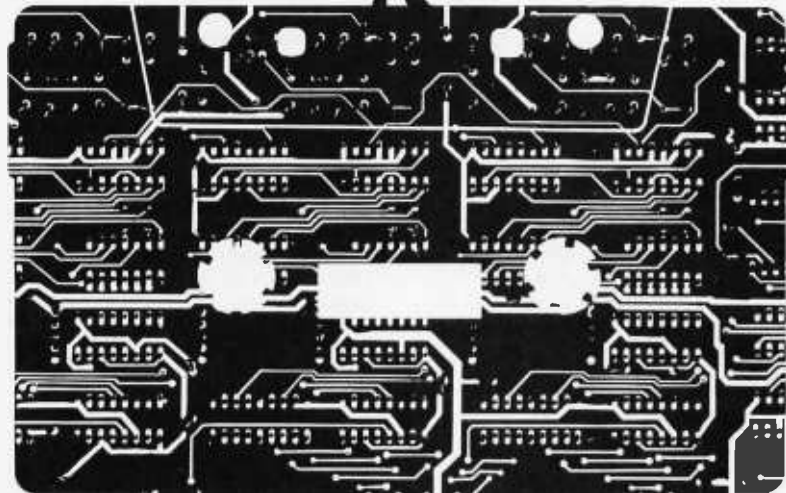

SAMS CIRCUIT DESIGN SOFTWARE.

37 TECHNICAL PROGRAMS TO LET YOU SPEND LESS TIME ON ROUTINE CALCULATIONS, STATISTICS, AND ANALYSES...MORE TIME ON CREATIVE DESIGN AND ENGINEERING.

Sams—the leader in technical publishing—now offers the most advanced engineering software systems available. These tested, documented, debugged programs can be used as stand-alone programs or as subroutines for more complex programs.

■ **FASTER INFORMATION**—Solve simultaneous equations with real and complex coefficients and polynomial roots. Quickly determine the effects of an infinitely variable set of design parameters. Plot graphs for various functions while varying scales to fit data.

■ **EASY TO RUN**—7 cassettes include 37 debugged programs.

- PLOTTING GRAPHS FOR VIDEO DISPLAY (5 Programs)**
Histograms. Cartesian Plots. Semi-Logarithmic Plots. Log-Log Plots. Polar Plots. #26006. \$16.95.
- PLOTTING GRAPHS FOR LINE PRINTER (3 Programs)**
Cartesian Plots. Semi-Logarithmic Plots. Polar Plots. #26000. \$16.95.
- ACTIVE FILTER DESIGN (6 Programs)**
Low and High-Pass (Bessel, Butterworth, 1, 2, and 3-dB Chebyshev). State-Variable Filter. Bandpass Filters with Q's less than 10 and 50. Staggered-Tuned Butterworth Bandpass Filters (2, 3, or 5 states). Notch Filter. #26001. \$21.95.
- DESCRIPTIVE STATISTICS & REGRESSION ANALYSIS (3 Programs)**
Descriptive Statistics (mean, standard deviation, variance, kurtosis, z-scores). Curvilinear Regression (linear, inverse, polynomial, exponential, logarithmic). Multivariable Linear Regression. #26002. \$21.95.
- ELECTRONICS I (5 Programs)**
Zener Diode Voltage Regulator Design. 555 Timer Design (monostable and astable circuits). Transistor Bias Parameters. Single-Stage Transistor Amplifier Design. Heat Sink Selection and Design. #26003. \$16.95.
- ELECTRONICS II (7 Programs)**
4-Quadrant Arctangent Function. Rectangular/Polar Conversion and Complex Number Mathematics. Minimum and Maximum Values of an Array. Roots of Polynomials with Real Coefficients. Inverse Laplace Transforms of a Transfer Function. Solution of Simultaneous Equations with Real and Complex Coefficients. #26004. \$16.95.
- ELECTRONICS III (8 programs)**
Average and RMS Values of a Periodic Function. Fourier Series Expansion of a Period Function. Fourier Transform and Spectrum Plot. Analysis of Damped Oscillations. Impedance Matching Pads. PI-TEE (delta-wye) Transforms. #26005. \$16.95.
- CIRCUIT DESIGN PROGRAMMING BOOK FOR THE TRS-80.**
Circuit Design Programs for the TRS-80 by Howard M. Berlin features all of the programs listed above... and more. #21741. \$10.95

■ **FULLY DOCUMENTED**—Easy-to-read and follow instructions.

■ **DESIGNED FOR POPULAR MICROCOMPUTERS**—Designed for use on TRS-80* systems having Level II BASIC and at least 16K RAM; many of the routines can be adapted to run on other popular computers. Programs will be available soon for Apple and Ohio Scientific.

■ **PROGRAMMED, TESTED, AND DEBUGGED BY HOWARD M. BERLIN**—Howard M. Berlin—an author in the Blacksburg Series—is an electrical engineer with the Chemical Systems Laboratory at Aberdeen Proving Ground, Maryland, and has been adjunct instructor in the Department of Electrical Engineering at the University of Delaware.

Indicate quantities in the boxes above and return entire ad with order.

Mail to: Howard W. Sams & Co., Inc. • 4300 West 62nd Street
Indianapolis, IN 46206. (317) 298-5400.

AMOUNT OF ORDER: \$ _____
(add local tax where applicable)

PAYMENT ENCLOSED A0034
 CHECK MONEY ORDER
 VISA MASTER CHARGE Interbank No. _____

Expiration Date: _____

Account No.: _____

Name (print): _____

Signature: _____

Address: _____

City _____ State _____ Zip _____

SEND INFORMATION ABOUT PRICE AND AVAILABILITY FOR SAMS SOFTWARE
FOR: APPLE OHIO SCIENTIFIC.

Sams Software Systems are available from major Sams Distributors and Computer Stores. Prices good in U.S.A. only. In Canada, contact Lenbrook Industries, Ltd., Scarborough, Ontario, M1H 1H5, Canada. Offer expires 12/31/80.

*TRS-80 is a registered trademark of Radio Shack, a division of Tandy Corp.

Sams Books

NEECO

"Your complete source for all CBM Hardware and Software Products"

PROUDLY ANNOUNCES OUR NEW ONE YEAR WARRANTY ON ALL CBM COMPUTERS!

"All CBM Computers purchased between June 15th and Sept. 15th will automatically carry a full one year NEECO warranty"

The 8032 CBM Computer is now available!

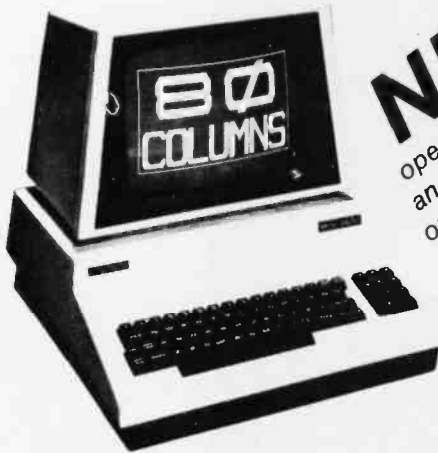

NEW!
operating system
and new disk
operating system
with direct
access!



CBM™ 8000 SERIES BUSINESS COMPUTERS

The new Commodore 8000 series computers offer a wide screen display to show you up to 80-character lines of information. Text editing and report formatting are faster and easier with the new wide-screen display. The 8000 series also provides a resident Operating System with expanded functional capabilities. You can use BASIC on the 8000 computers in both interactive and program modes, with expanded commands and functions for arithmetic, editing, and disk file management. The CBM 8000 series computers are ideally suited for the computing needs of the business marketplace.

CBM™ 8050 DUAL DRIVE FLOPPY DISK

The CBM 8050 Dual Drive Floppy Disk is an enhanced version of the intelligent CBM 2040 Disk Drive. The CBM 8050 has all of the features of the CBM 2040, and provides more powerful software capabilities, as well as nearly one megabyte of online storage capacity. The CBM 8050 supplies relative record files and automatic diskette initialization. It can copy all the files from one diskette to another without copying unused space. The CBM 8050 also offers improved error recovery and the ability to append to sequential files.

HARDWARE SPECIFICATIONS

- Dual Drives
- Two microprocessors
- 974K Bytes storage on two 5.25" diskettes (single sided)
- Tracks 70
- Sectors 17-21
- Soft sector format
- IEEE-488 interface
- Combination power (green) and error (red) indicator lights
- Drive Activity indicator lights
- Disk Operating System Firmware (12K ROM)
- Disk Buffer (4K RAM)

FIRMWARE

- DOS version 2.1
- Sequential file manipulation
- Sequential user files
- Relative record files
- Append to sequential files
- Improved error recovery
- Automatic diskette initialization
- Automatic directory search
- Command parser for syntax validation
- Program load and save

CBM	PRODUCT DESCRIPTION	PRICE
4008N	8K RAM-Graphics Keyboard-40 col.	\$ 795.00
4016N	16KN RAM-Graphics Keyboard-40 col.	\$ 995.00
4016B	16K RAM-Business Keyboard-40 col.	\$ 995.00
4032N	32K RAM-Graphics Keyboard-40 col.	\$1295.00
4032B	32K RAM-Business Keyboard-40 col.	\$1295.00
8016	15K RAM-80 Col.-4.1 O/S	\$1495.00 *
8032	32K RAM-80 Col.-4.1 O/S	\$1795.00
2023	Friction Feed Printer	\$ 695.00
2022	Tractor Feed Printer	\$ 795.00

NOTE:
All current CBM production computers/disks now contain operating system 4.1/DOS 2.1

CBM	PRODUCT DESCRIPTION	PRICE
2040	Dual Floppy-343K-DOS 1.0	\$1295.00
4040	Dual Floppy-343K-DOS 2.0	\$1295.00
8050	Dual Floppy-974K-DOS 2.0	\$1695.00 *
C2N Cassette	External Cassette Drive	\$ 95.00
CBM to IEEE	CBM to 1st IEEE Peripheral	\$ 39.95
IEEE to IEEE	CBM to 2nd IEEE Peripheral	\$ 49.95
8010	IEEE 300 Baud Modem	\$ 395.00 *
2.0 DOS	DOS Upgrade for 2040	\$ 50.00
4.0 O/S	O/S Upgrade for 40 Column	\$ 100.00

*Asterisks indicate fall delivery—all others are immediately available.

SPECIAL OFFER ON CBM COMPATIBLE BUSINESS SOFTWARE!

Purchasing software has always been difficult due to the "you buy it - you own it" attitude of most vendors. We at NEECO, recognize this problem and can now, on all of the Software Packages listed, offer a full 30 day refund policy to NEECO's customers. Now you can purchase with confidence. Buy it - try it; if the program package is not suitable for any reason, send it back to us within 30 days and we will refund the full purchase price—less shipping charges!

SOFTWARE	APPLICATION	REQUIRES	AUTHOR	AVAILABILITY	PRICE
Word Pro I	Word Processing	8K + cassette	Pro Micro	Immediate	\$ 29.95
Word Pro II	"	10K + 2040	"	"	99.95
Word Pro III	"	32K + 2040	"	"	199.95
Word Pro IV	"	8032 + 2040/8050	"	"	299.95
BPI Integrated G/L	Business	32K/8032 + 2040	BPI	"	360.00
BPI Inventory	"	"	"	"	T.B.A.
BPI Payroll	"	"	"	"	"
BPI Enhanced A/R	"	"	"	"	"
CMS G/L	"	"	CMS Software	"	295.00
CMS A/R	"	"	"	"	195.00
CMS A/P	"	"	"	"	195.00
CMS Customer Mail List	"	"	"	"	195.00
CMS Payroll	"	"	"	"	350.00
BMB Database	All Business	32K/8032 + 2050/8050	BMB	August/Sept.	295.00

*Wordprocessing Software requires output printer. We recommend the NEC Spinwriter (\$2995) for letter quality.

*PET is a registered trademark of Commodore Business Machines. Small Keyboard PETS require a ROM Retrofit Kit.

Multi-Cluster is available in Canada from BMB Compu Science, P.O. BOX 121, Milton, Ontario, L9T2Y3

All prices and specifications are subject to change without notice.

NEECO

679 HIGHLAND AVE.
NEEDHAM, MA 02194

NEW ENGLAND ELECTRONICS CO., INC.

"NEW ENGLAND's Largest
Computer Showroom"

(617) 449-1760

MASTERCHARGE OR VISA ACCEPTED
TELEX NUMBER 951021, NEECO
MON-FRI, 9:00-5:30

**NEECO
PROUDLY
INTRODUCES**

ALLOS COMPUTERS



ALLOS ACS 8000-5

- Dual 8" floppy disks
- Megabyte storage
- 64K RAM
- Totally expandable to Hard Disk (29MB) and Multi-User

ALLOS OFFERS OUR USERS TOTAL SYSTEM CAPABILITIES AND FLEXIBILITY . . .

- Z80 based • CP/M • Multi-User
- Hard Disk • Seven languages
- MP/M • NEECO system support
- Full Word Processing

\$5990

"ALLOS Computers offer you System Flexibility and Reliability"

CONTACT NEECO FOR ADDITIONAL INFORMATION ON HOW ALLOS CAN BECOME YOUR COMPUTER SOLUTION.

Altos computers range in price from less than \$3000 to over \$14,000. Altos Computer Systems' capabilities range from single disk-single user to 29 Megabytes-Multi-User.

ALLOS computers are distributed to Dealers/OEMs in the N.E. Region by MICROAMERICA

SUPERBRAIN SOFTWARE

(Business Packages written in MicrosoftBASIC)

Trial Tested Osborne Business Packages on the Superbrain

- | | | |
|-----------------------|----------|---|
| • Accounts Receivable | \$250.00 | Complete 4 Module Package \$795
MicrosoftBASIC \$325 |
| • General Ledger | \$250.00 | |
| • Accounts Payable | \$250.00 | |
| • Payroll Package | \$250.00 | |

SUPERBRAIN

32K RAM \$2795
64K RAM \$2995
FORTAN \$ 450

SPECIAL OFFER!

Purchase a 64K Superbrain at \$2995 and will include MBASIC5 for only \$250! (regularly \$350)

SPECIAL OFFER! - Purchase

a Centronics 704-9 (RS232, 180 CPS, retail \$2380) printer and a 64K Superbrain together for only \$4595 - cash price only.

"The Superbrain is ideal for use as an intelligent terminal or stand alone microcomputer system for OEM's, commercial customers, and other sophisticated computer users."



- Two 5.25" Shugart Minifloppies with over 300 K (CP/M Version 2.2 or later) Disk Storage.
- Integrated in a single compact housing.
- CP/M operating System with MBASIC5 and other interpreters/compiler available.
- 32K or 64K RAM models available.
- 2 I/O Ports - one fully enabled RS232 port for communications. Other port for RS232 serial printer output.
- Too many software packages are now available to list them here.

OEM/DEALER INQUIRIES

All pricing and specifications are subject to change. CP/M is a registered trademark of Digital Research

SUPERBRAIN™

\$2995 The Honor Graduate

NEECO

679 Highland Ave.
Needham, MA
02194

Mon-Fri 9:30-5:30
MasterCharge &
Visa Accepted

(617) 449-1760
Telex: 951021

MICROAMERICA DISTRIBUTING

"Nationwide distributors of Computer Equipment"
21 Putnam Street
Needham, MA
02194

(617) 449-4310

Symbolic Math Using BASIC

David R Stoutemyer
The Soft Warehouse
POB 11174
Honolulu HI 96828

This article describes a simple BASIC program that expands polynomials. For example, when given an expression such as:

$$(5x+7)(2x+3)^3$$

the program produces as output the corresponding fully expanded polynomial:

$$40x^4 + 236x^3 + 522x^2 + 513x + 189$$

Written in ANSI (American National Standards Institute) minimal BASIC, this program requires only a single small one-dimensional numeric array, integer arithmetic, and room for 110 simple BASIC statements. In fact, the program can be adapted to the HP-41C and TI-59 programmable pocket calculators.

Symbolic-mathematics systems have long been available for large computers. The muMATH-79 software developed by The Soft Warehouse and distributed by Microsoft, 10800 NE 8th, Suite 819, Bellevue WA, 98004, brought sophisticated symbolic math to microcomputers based on the Intel 8080, 8085 and Zilog Z80 microprocessors. However, symbolic-math systems are currently unavailable for microcomputers and minicomputers based on other processors, and many 8080-, 8085-, or Z80-based installations lack the requisite minimum of 32 K bytes of programmable memory, a floppy-disk drive, and the TRSDOS, CP/M, CDOS, or IMDOS operating system currently necessary to run muMATH. Consequently, to make some symbolic math available on those computers for which a full-fledged

system is not yet available, this article presents a compact polynomial expansion program written in BASIC. Though nowhere near as flexible, general, or robust as muMATH, this program is useful, nonetheless, and it provides an educational exposure to the idea of computer symbolic math.

Program Outline

Many BASIC programs include mathematical expressions intended for numerical evaluation, but for a symbolic-math program we also want the ability to input and print *data* consisting of mathematical expressions. One way to accomplish this is to input and print expressions as character strings. For example, letting the variable named A\$ store a string representing an unexpanded expression and letting the variable named B\$ store the corresponding expanded polynomial derived by the program, a symbolic-math program could have the following outline:

```
100 INPUT A$
...   derive B$ from A$
900 PRINT B$
910 GO TO 100
920 END
```

The interactive input would be a sequence of string expressions (written in BASIC style) such as:

$$X * (2 * X + 1) \uparrow 2$$

The program could use substring extraction to dismantle A\$ for analysis, while using insertion or catenation to construct the corresponding B\$. Equivalently, A\$ and B\$ could be arrays of one-character strings, using subscripts to dismantle the input and assemble the output.

However, many of the most prevalent small BASIC implementations do not provide substring extraction, insertion, catenation, or arrays of characters. For example, TRS-80 Level I BASIC lacks these facilities.

About the Author,

David Stoutemyer, a partner of The Soft Warehouse, is a professor of electrical engineering at the University of Hawaii. The author of over twenty technical articles, he received bachelor's and master's degrees in engineering from the California Institute of Technology and MIT, followed by a doctorate in computer science from Stanford.

The Cashier*
The Order Scheduler™

Information Master™
Data Master™
Data Base Management System

Disk-O-Check™
Mail List Package
Client Billing System

Chem Lab Simulations #1
Chem Lab Simulations #2

Some Common Basic Programs*

**HIGH TECH SOFTWARE IS SOPHISTICATED —
YET FRIENDLY.**

Novices use it with ease and self-assurance,
professionals with confidence...

Distributed worldwide, HIGH TECHNOLOGY SOFTWARE is recognized as the finest software available for the *APPLE II** computer. Now some of our products are available for the *ATARI-800**. We design our software with two goals in mind . . . flawless performance and user-ease. Computer dealers and their customers tell us . . . it's the best.

See your local computer dealer today
for a demonstration of the best.



High Technology, Inc.™

OKLAHOMA CITY

ST. LOUIS

COLUMBUS

8001 N. Classen • Box 14665 • Oklahoma City, OK 73113 • (405) 840-9900

*ATARI-800 is a trademark of Atari, Inc. Some Common Basic Programs is taken from the book of the same name by Osborne & Assoc. APPLE II and THE CASHIER are trademarks of Apple Computer, Inc.

x	$y = (2x - 1)(x + 1)^2$
-2	$(-4 - 1)(-2 + 1)^2 = -5$
-1	$(-2 - 1)(-1 + 1)^2 = 0$
0	$(0 - 1)(0 + 1)^2 = -1$
1	$(2 - 1)(1 + 1)^2 = 4$
2	$(4 - 1)(2 + 1)^2 = 27$

Table 1: Sample evaluations of a factored polynomial. As part of the expansion process of the factored equation $y = (2x - 1)(x + 1)^2$, the right-hand side is evaluated for each of five sampled values of x . These results are used in table 2.

K	x_k	y_k	Values of d			
1	-2	-5				
2	-1	0	5			
3	0	-1	-1	-6		
4	1	4	5	6	12	
5	2	27	23	18	12	0

Table 2: Difference table of evaluated polynomial. In this example, the right-hand side of $y = (2x - 1)(x + 1)^2$ is evaluated at each of five points x_k , giving the resulting y_k values. A given number in the d section is calculated as the difference of the number to the immediate left of the given number and the number immediately above the given number; for example, the number 23 equals 27 minus 4. For each row, d_1 is the rightmost number in the d section, d_2 is the number (if any) to its left, and so on.

This interpolation algorithm allows us to determine the coefficients for the expanded polynomial.

Actually, insertion or catenation is not really necessary. As they are derived, we can print the pieces that would otherwise successively be catenated onto the right side of B\$, using semicolons to suppress line feeds and carriage returns between these pieces.

The need for substring extraction or an array of characters cannot be eliminated as conveniently for expression input. However, the program in this article uses an indirect *evaluation-interpolation* technique to circumvent the need for string variables. This makes the program suitable for virtually every version of BASIC. The technique is applicable to more general expressions, but to keep the program small and educational, let us consider only polynomials in a variable named x of a degree less than some specified positive integer constant, n .

Given a set of n distinct values of x , together with the corresponding values of a function $y(x)$:

$$(x_1, y_1), (x_2, y_2), \dots, (x_n, y_n),$$

there is a unique polynomial of a degree less than n that passes through these points:

$$p = a_m x^{m-1} + a_{m-1} x^{m-2} + \dots + a_2 x + a_1, \text{ with } m \leq n$$

Moreover, there is a relatively simple and fast algorithm for determining m and the coefficients of the expanded form, a_1, a_2, \dots, a_m , from the pairs $(x_1, y_1), (x_2, y_2), \dots, (x_n, y_n)$. Thus, no matter how $y(x)$ is written, if $y(x)$ is equivalent to a polynomial of a degree less than n , then evaluation of the expression at n points followed by application of this interpolation algorithm allows us to determine the coefficients for the expanded form of this polynomial.

For example, suppose we specify $n=5$ and $y = (2x - 1)(x + 1)^2$. We are free to choose any distinct values of x . Let us make them small-magnitude integers centered around zero, in order to simplify calculating the corresponding values of y . The results of these calculations are given in table 1.

The interpolation algorithm determines that the unique polynomial of a degree less than 5 applied to these five pairs is described as:

$$p = 2x^3 + 3x^2 - 1.$$

Since y is also a polynomial of a degree less than 5, p and y must be different forms of the same polynomial. Note that:

- We never formally expanded the expression for y . Although such an expansion is trivial for this example, manual expansion is increasingly laborious and fraught with opportunities for blunders with increasing degree and size of coefficients.
- The algorithm works even when n exceeds the degree

The world's most popular microcomputer, with 16K of memory and Level II basic for only \$685. complete with full 90 day Radio Shack warranty. We accept check, money order or phone orders with Visa or MasterCard. (Shipping costs added to charge orders).

Disk drives, printers, peripherals, software and games . . . you name it, we've got it (Both Radio Shack & other brands). Write or call for our complete price list.



Shown is Level I. Level II includes Alphanumeric keypad.

C&S ELECTRONICS MART Ltd.

AUTHORIZED DEALERSHIP **Radio Shack**

32 E. Main Street • Milan Michigan 48160 • (313) 439-1400

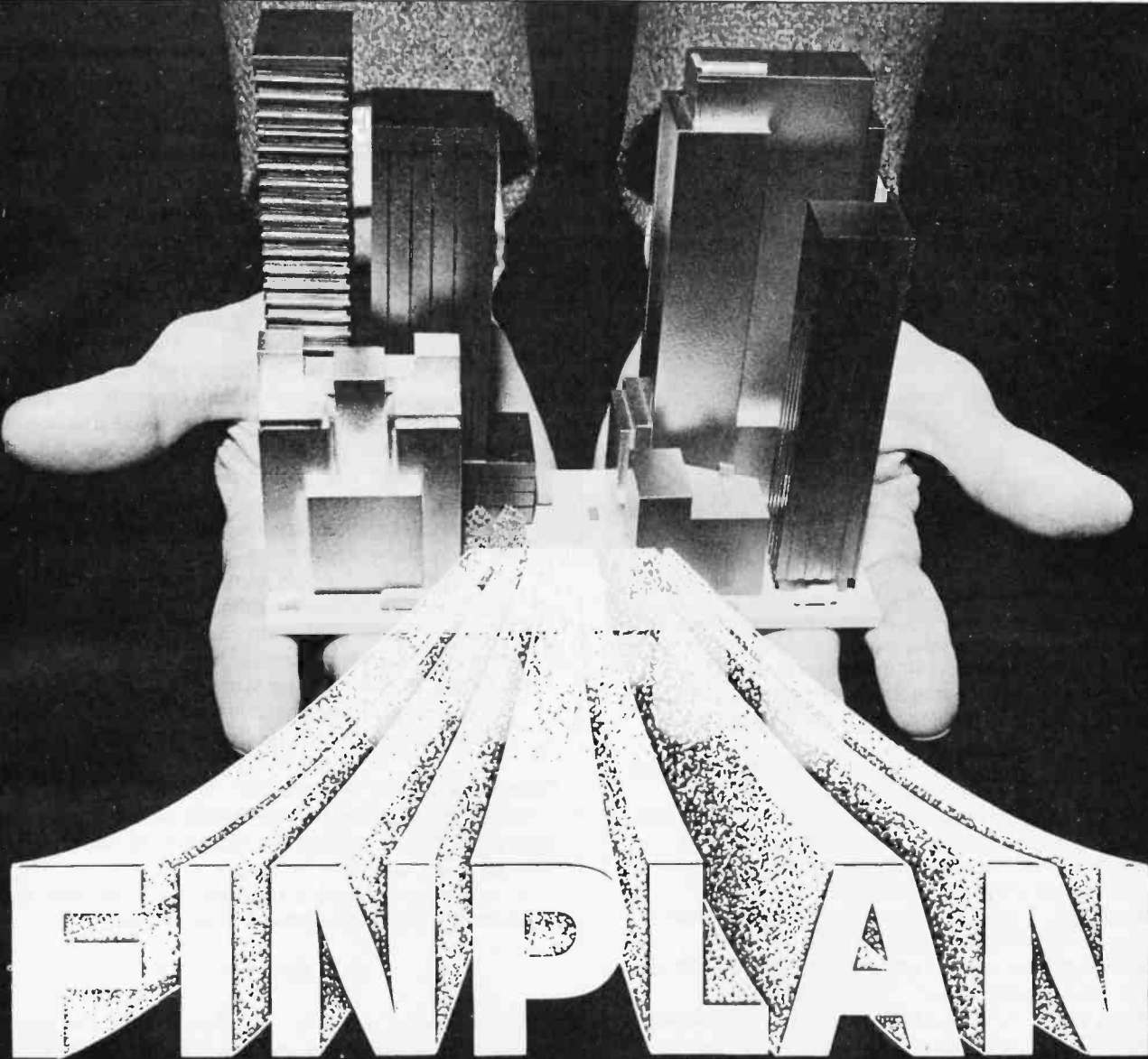

Puts sophisticated business strategies at the fingertips of all TRS-80 Level II owners! **FINPLAN: A Financial Planning Program for Small Businesses** is the most complete financial planning program available.

Here's why . . . **Developed by an expert:** The author, Robert Montgomery, is president of a management consulting firm and a recognized authority on new product planning. **Easy to use:** Data can be entered from normal balance sheet statements. Within seconds, **FINPLAN** will provide financial projections for up to 5 years. **Versatility:** Are you thinking about modernizing equipment, expanding into a new product line, or starting a new business from scratch? Will your plans run you out of business, out of cash, or on to the Fortune 500 list? **FINPLAN** will answer these and other financial questions before you invest a dime. **Extensive documentation:** *You don't have to be a financial wizard to use **FINPLAN** because it comes with 80 pages of documentation.*

Presented in a step-by-step format, the documentation is a great learning tool for those who need it or a dynamic applications tool for getting the most out of **FINPLAN**. And, **FINPLAN** is reasonably priced. #05103, TRS-80 Level II cassette, \$69.95; #05108, TRS-80 Level II Disk, \$74.95.

**Available at your
local computer store!**

or **Call Toll Free**, 24 hours a day,
(1-800-827-3777, ext. 302)* TO CHARGE
YOUR ORDER TO Master-Charge or Visa!
Minimum order is \$10.00; Customer pays
postage and handling.

*From Missouri, call 1-800-892-7655, ext. 302

Hayden Book Company, Inc.

50 Essex Street
Rochelle Park NJ 07662

Diagnostics I

for CP/M* & TRSDOS*



Someday your computer is going to break; even the most reliable computer systems "go down". Often, finding exactly what is wrong can account for the most time consuming part of repairing the system, and the longer the system is down, the more money you lose.

DIAGNOSTICS I is a complete program package designed to check every major area of your computer, detect errors, and find the cause of most common computer malfunctions, often before they become serious. For years, large installations have run daily or weekly diagnostic routines as a part of normal system maintenance and check-out procedures.

DIAGNOSTICS I is designed to provide that kind of performance testing for 8080/Z80 micro computers.

DIAGNOSTICS I will really put your system through its paces. Each test is exhaustive and thorough. The tests include:

- Memory Test
- CPU Test (8080/8085/Z80)
- Printer Test
- Disk Test
- CRT Test

To our knowledge, this is the first CPU test available for 8080/Z80 CPU's. Many times transient problems, usually blamed on bad memory, are really CPU errors.

A good set of diagnostics is an indispensable addition to your program library even if your system is working fine. Hours have been wasted trying to track down a "program bug" when actually hardware was to blame!

DIAGNOSTICS I also allows you to be confident of your system. This can be critical when file merges or sorts and backups are involved. You want to be as sure of your computer as possible during these critical times. Running DIAGNOSTICS I prior to these and other important functions helps to insure that your system is operating at peak performance.

DIAGNOSTICS I is supplied on discette with a complete users manual.

DIAGNOSTICS I: \$60.00 Manual only: \$15.00

**Requires: 24K CP/M; 16K disc for TRS-80
formats: CP/M 8" SOFT SECTORED, NORTHSTAR CP/M
AND TRS-80 DOS**



All Orders and General Information:
SUPERSOFT ASSOCIATES
P.O. BOX 1628
CHAMPAIGN, IL 61820
(217) 359-2112

**Technical Hot Line: (217) 359-2691
(answered only when technician is available)**

*CP/M REGISTERED TRADEMARK DIGITAL RESEARCH
*TRSDOS TRS-80 TRADEMARKS TANDY CORP.

The algorithm is adapted so that only integer arithmetic is involved.

of the result by more than 1, albeit at the expense of computing space and time. The space requirements grow only linearly with n , and the time requirements grow quadratically with n , so even the slowest BASIC interpreters on the slowest microcomputers can generally treat values of n of at least 10 in a few seconds. As will be demonstrated, a more serious consequence of having n much larger than necessary is the possibility of overflow or excessive roundoff error due to the limited range and precision of typical BASIC integer or floating-point arithmetic. A simple strategy for minimizing such evils is to choose successive integers centered around zero for x values, as we have done.

- When $y(x)$ is not a polynomial of a degree less than n , then p is merely a polynomial approximation of $y(x)$. However, even such approximations are often of interest. Moreover, it should usually be clear to a user whether or not an expression can be expanded into a polynomial. If so, there is also usually an obvious reasonable bound on its degree to use for n .

Overview of the Algorithm

Before proceeding to the details of the interpolation algorithm, let us outline the program to summarize the discussion so far. (See listing 1.)

In order to expand an expression, the user merely replaces the line in the program containing:

$$y = (2x-1)(x+1)^2$$

with the desired example. The line setting n in step 1 of listing 1 may also require adjustment. Then the user simply types the BASIC command RUN. To expand a sequence of polynomials, the user repeatedly modifies these one or two lines of the program between runs.

This technique is not as interactive as our original string-based outline because the unexpanded expression must occur as a line of the program rather than as a response to an INPUT request. The line containing the unexpanded expression could be made into a subroutine to divorce it from the rest of the program, but the line would still be part of the program rather than data. Nevertheless, given the semi-interactive nature of BASIC interpreters, and the fact that only one or two lines need to be changed between runs, the interpolation technique is tolerably interactive.

Interpolation Details

The interpolation step is relatively simple in comparison with most scientific computations, but those who are intimidated by detail may prefer to postpone reading this section until after reading the subsequent ones and trying the program. The program can be typed in and used without understanding how it works.

First, we construct a *difference table* for the values of y . (See table 2.)

In table 2, k represents the consecutive integers 1 thru

Text continued on page 242

TRS-80 owners Explore new worlds with CHATTERBOX.™

The MICROMINT INC. introduces its latest data communications product, the "CHATTERBOX." The CHATTERBOX is a unique packaging combination of the presently available COMM-80 I/O interface for the TRS-80* and an acoustic modem. This one box is all that is required to turn even a barebones 4K TRS-80 into a full timesharing terminal.

The CHATTERBOX includes a built-in programmable 50-19200 baud serial port, a Centronics compatible parallel printer port, a 300 baud acoustic originate modem, and a spare TRS-BUS expansion connector. It comes complete with power supply, ribbon cable and connector, user's manual, and smart terminal software for immediate operation. When the modem is in use, the complete data conversation is automatically routed to the serial output port and parallel port where it can be logged on a printer.



The CHATTERBOX is the only peripheral needed to allow a TRS-80 to communicate with timesharing systems such as Micronet and the SOURCE. In addition, CHATTERBOX can be used simply to provide an address selectable serial and parallel port.

It is completely hardware and software compatible with existing TRS-80 products and connects either to the keyboard connector or screen printer port on the RS Expansion interface. It does not require the RS Expansion interface for operation.

CHATTERBOX.™
\$259.95

- Full 8-bit parallel port.
- RS-232-C serial port (up to 19,200 baud).
- Acoustic modem.
- TRS-BUS connector for future expansion.
- Connects to Keyboard or E.I.
- Includes terminal software.
- Users manual.
- Power supply.

MAIL ORDER OR INFORMATION
WRITE OR CALL:

The MicroMint Inc.
917 Midway
Woodmere, NY 11598
Dealer inquiries invited.



THE INTERFACE CONNECTION

**CALL OUR
HOTLINE:
(516) 374-6793**

TRS-80 is a trademark of Tandy Corporation

MARK GORDON COMPUTERS

DIVISION OF MARK GORDON ASSOCIATES, INC.
 15 KENWOOD ST., CAMBRIDGE, MASSACHUSETTS 02139
 (617) 242-2749 (617) 491-7505

SD SYSTEMS COMPUTER KITS

- ★ EXPANDORAM I (No RAMS) 169.00
- ★ VERSAFLOPPY CONTROLLER I . . 189.00
- ★ SBC-100 Single Board Kit 239.00
- ★ Z80 Starter 269.00

OTHER SPECIALS

- ★ 16K Memory Kit 59.00
- ★ CAT Modem 159.00
- ★ Leedex Monitor 109.00
- ★ Atari 400 499.00
- ★ Atari 800 779.00
- ★ Hazeltine 1410 699.00

CALL COLLECT TO ORDER

ORDERING INFORMATION

We accept Visa and Mastercharge. We will ship C.O.D. certified check or money order only. All orders must include 4 percent for shipping and handling. Massachusetts residents add 5 percent sales tax.

The Company cannot be liable for pictorial or typographical inaccuracies.

Buy By Mail and Save!

COMPUTERS

- INTERTEC SuperBrain®
 32K RAM \$2995 \$2495
 64K RAM \$3345 \$2695
 64K Quad, \$3995 \$3395
- NORTH STAR Horizon® 1
 32K Kit, List \$1999 \$1579
 32K Assembled \$2695 \$2149
- Horizon 2
 32K DD, Assm. \$3095 \$2439
 32K QD, Assm. \$3595 \$2859
- CROMEMCO
 System 3, 64K, \$6990 \$5479
 System 2, 64K, \$3990 \$3179
 Z-2, List \$995 \$ 829
- COMMODORE PET 16K \$ 849
 APPLE 16K, List \$1195 \$ 979
 TI-99/4, List \$1150 \$ 985
 ATARI® 400, List \$630 \$ 489
 800 List \$1080 \$ 839
- FLOPPY DISKS, 5 1/4"
 box of 10 SPECIAL \$ 29.95

DISK SYSTEMS

- THINKER TOYS®
 Discus 2D, \$1149 \$ 939
 Dual Discus 2D \$1559
 Discus 2 + 2, \$1549 \$1288
- NORTH STAR MDS-A \$699
 Kit Version \$639

PRINTERS/TERMINALS

- ANADEX DP-8000 \$ 799
- T.I. 810 \$1575
- CENTRONICS 730-1 \$ 639
 737, List \$995 \$ 849
- PAPER TIGER IDS-440 \$ 849
 with Graphics Option \$ 949
- INTERTUBE II, \$995 \$ 729
- P-E Bantam 550 \$ 789
- SOROC 120 \$ 745
- TELEVIDEO 912B \$ 739
 912C \$ 779
 920B \$ 789
 920C \$ 839

Most items in stock for immediate delivery, factory-sealed cartons, with full factory warranty. N.Y.S. residents add appropriate sales tax. Prices do not include shipping. VISA and Master Charge add 3%. COD orders require 25% deposit. Prices subject to change and offers subject to withdrawal without notice.

Computers Wholesale

P.O. Box 144
 Camillus, NY 13031
 (315) 472-2582



Listing 1: Outline of an evaluation-interpolation algorithm for expanding a factored polynomial.

1. Set n to a sufficiently large but not extravagant positive integer.
2. Initialize x to -INT(n/2).
3. For k = 1 to n
 Evaluate y from an unexpanded formula such as
 $y = (2x - 1)(x + 1)^2$
 Increment x by 1
 Next k.
4. Construct the coefficients of the interpolated polynomial having degree less than n.
5. Print the polynomial in algebraic form.
6. End program.

Listing 2: Algorithm for computing the coefficients of an expanded polynomial, given its forward differences.

```

for k = 1 to m - 1
  for j = m - 1 to k step - 1
    dj = dj - dj+1 * xj-k+1
  next j
next k
    
```

Listing 3: Listing for polynomial-expansion routine. Many of the most prevalent versions of BASIC are incompatible with even ANSI minimal BASIC, so minor changes may be necessary to run this program on some installations. However, this program uses such elementary features that any necessary changes will almost certainly be merely syntactic. For example, the DIM statement and the word THEN in IF statements must be deleted for TRS-80 Level I BASIC. The program can even be adapted to a BASIC that supports no arrays by expanding the loops for a particular N, using M = N, and using a scalar named A1 for A(1), A2 for A(2), etc, or using any other unemployed names.

- ```

10 REM, Simple polynomial expansion program.
20 REM,
30 REM, Copyright © 1980 by The Soft Warehouse,
40 REM, Box 11174, Honolulu, Hawaii 96828.
50 REM,
60 REM, Permission hereby granted to freely modify, duplicate,
 and
70 REM, use, provided all remarks with leading commas are retained,
80 REM, and provided all deletions, insertions and modifications
90 REM, are indicated by remarks without leading commas.
100 REM,
110 REM, Write for info about more powerful symbolic math programs.
120 REM,
130 REM, Reference, BYTE magazine, October 1980.
140 REM,
150 REM, To use, replace the right side of the assignment
160 REM, "LET Y = ..." near the beginning of the program with
170 REM, the desired unexpanded polynomial in X, then RUN.
180 REM,
190 REM, Declare X, Y, C, and array A to be maximum allowable
 precision.
200 REM,
210 REM, Set N to 1 more than maximum allowable degree of
 result:
220 REM, (increase if insufficient; decrease if overflow, excessive
230 REM, roundoff, or excessive time). N must be at least 2.
240 REM,
250 REM, -----
260 LET N = 5
270 REM, -----
280 REM,
290 REM, Dimension array A to have at least N elements:
300 REM,
310 DIM A(15)
320 REM,
330 REM, Sample polynomial at N points:

```

Listing 3 continued on page 240



# Anatomy of a Threaded Language

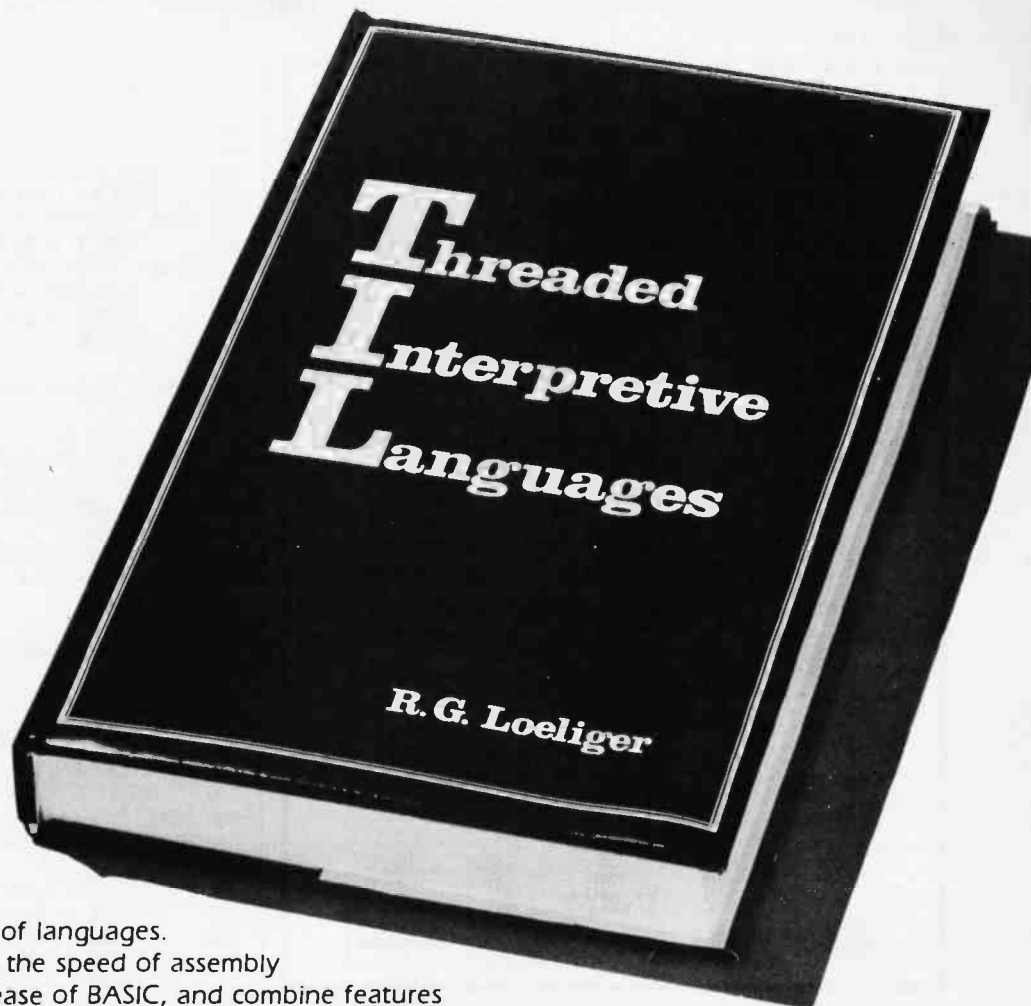

Threaded languages (such as FORTH) are an exciting new class of languages. They are compact and fast, giving the speed of assembly language with the programming ease of BASIC, and combine features found in no other programming languages. An increasing number of people are using them, but few know much about how they work. Is a threaded language interpreted or compiled? How much memory overhead does it require? Just what is an "inner interpreter"? **Threaded Interpretive Languages**, by R. G. Loeliger, concentrates on the development of an interactive, extensible language with specific routines for the ZILOG Z80 microprocessor. With the core interpreter, assembler, and data type defining words covered in the text, it is possible to design and implement programs for almost any application imaginable. Since the language itself is highly segmented into very short routines, it is easy to design equivalent routines for different processors and produce an equivalent threaded interpretive language for other development systems. If you are interested in learning how to write better FORTH programs or you want to design your own powerful, but low-cost, threaded language specific to your needs, this book is for you.



This and other BYTE/McGraw-Hill books are available from BYTE Books or your local computer store.

ISBN 0-07-038360-X  
Price \$18.95

Please send  \_\_\_\_\_ copies of **Threaded Interpretive Languages**

|              |            |                      |               |  |
|--------------|------------|----------------------|---------------|--|
| Name _____   |            | Title _____          | Company _____ |  |
| Street _____ | City _____ | State/Province _____ | Code _____    |  |

Check enclosed in the amount of \$ \_\_\_\_\_  
 Bill Visa       Bill Master Charge  
 Card No. \_\_\_\_\_

Exp. Date. \_\_\_\_\_

Add 75¢ per book to cover postage and handling.  
 Please remit in U.S. funds or draw on a U.S. Bank.

**Available In Nov. 1980**



70 Main St.  
 Peterborough, NH 03458

B10

Marymac Industries Inc

# Radio Shack®

AUTHORIZED SALES CENTER

**Save 10% 15%  
OR MORE**

DELIVERED TO YOUR DOOR

Owned and operated by Marymac Industries Inc. Warranties will be honored by all company owned Radio Shack® Stores and participating franchises and dealer authorized sales centers. Store open Mon.-Sat. 10-7. We pay freight and insurance. Save sales tax. Texas residents add only 5% sales tax. Brand new in factory sealed cartons. Reference: Katy National Bank. Call us for a customer reference in or near your city. Radio Shack® Authorized Sales Center, 21969 Katy Fwy, Katy, Houston Texas 77450.

Texts and information 1-713-392-0747  
Order entry 1-800-231-3680  
or 1-800-231-3681

## TRS-80™ FOR BUSINESS, LEARNING AND ENTERTAINMENT

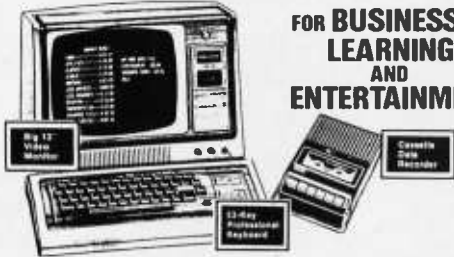

### Meet TRS-80's Big Brother! The New TRS-80 Model II



We are located just 5 hours from the giant Tandy Computerware House in Ft. Worth, Texas.

Call Joe McManus Today

We've added a bigger, more powerful "brother" to the TRS-80 family it's TRS-80 Model II - a completely new microcomputer for business applications.



CHARGE IT



## PUT TIME AND BSR CONTROL IN YOUR APPLE II

### THUNDERCLOCK PLUS™

#### AN INTERFACE FOR THE BSR X-10

- Control AC outlets with your BSR Command Console and APPLE II
- All 22 BSR commands at your program's fingertips
- Up to 128 separate dim/bright levels
- THUNDERWARE'S Scheduler software will control AC outlets in the background, while you run another program in the foreground

#### A REAL-TIME CLOCK/CALENDAR

- Provides month, date, day-of-week, hour, minute, and second
- Software selectable time formats: 24 hour or AM/PM ASCII string, or as numeric values
- Provides interrupts which can be enabled or disabled under software control
- On board battery allows accurate time-keeping for up to 2 years even with your APPLE turned off

#### BOTH FEATURES ON ONE CARD

- On-board firmware makes the THUNDERCLOCK PLUS™ exceptionally easy to use
- Read or set time, control interrupts, and send BSR commands with simple BASIC "INPUT" and "PRINT" statements
- Completely APPLE II compatible: INT and FP BASIC or PASCAL with Unit support
- At an affordable introductory price for both!

THUNDERCLOCK PLUS.....\$119.00

Clock, BSR interface, and User's manual

THUNDERWARE SCHEDULER.....\$24.95

Diskette with Scheduler, examples, demos, and Scheduler manual

PASCAL SOFTWARE.....\$19.95

Diskette with PASCAL Unit for clock and BSR interface



TO ORDER TOLL FREE (VISA/MC) CALL:  
800-227-6204 Ext. 307 (Outside California)  
800-632-2131 Ext. 307 (California Only)

OR WRITE FOR INFORMATION:  
THUNDERWARE INCORPORATED  
P.O. Box 13322, Oakland, CA, 94661

California residents add 6% sales tax  
BSR X-10 is a trademark of BSR (USA) LTD. APPLE II is a trademark of APPLE COMPUTER, INC

Listing 3 continued:

```

340 REM,
350 LET L = -INT(N/2)
360 LET X = L
370 FOR K=1 TO N
380 REM,
390 LET Y = (2*X - 1) * (X + 1) + 2
400 REM,
410 LET A(K) = Y
420 LET X = X + 1
430 NEXT K
440 REM,
450 REM, Compute forward differences:
460 REM,
470 LET M = 1
480 FOR K = 2 TO N
490 FOR J = N TO K STEP - 1
500 LET A(J) = A(J) - A(J-1)
510 NEXT J
520 IF A(K) = 0 THEN 540
530 LET M = K
540 NEXT K
550 REM,
560 REM, Scale coefficients:
570 REM,
580 LET C = 1
590 FOR K = M - 1 TO 1 STEP - 1
600 LET C = C * K
610 LET A(K) = C * A(K)
620 NEXT K
630 REM,
640 REM, Compute coefficients of expanded polynomial:
650 REM,
660 LET U = L + M - 1
670 FOR K = 1 TO M - 1
680 LET U = U - 1
690 LET X = U
700 FOR J = M - 1 TO K STEP - 1
710 LET A(J) = A(J) - X * A(J + 1)
720 LET X = X - 1
730 NEXT J
740 LET A(K) = A(K) / C
750 NEXT K
760 LET A(M) = A(M) / C
770 REM,
780 REM, Print polynomial:
790 REM,
800 LET Z = 1
810 IF M = 1 THEN 1040
820 FOR K = M TO 2 STEP - 1
830 IF A(K) = 0 THEN 1000
840 IF Z = 0 THEN 920
850 IF A(K) < > - 1 THEN 870
860 PRINT " - ";
870 IF ABS(A(K)) = 1 THEN 960
880 GOTO 940
890 PRINT " - ";
900 A(K) = -A(K)
910 GOTO 940
920 IF A(K) < 0 THEN 890
930 PRINT " + ";
940 IF A(K) = 1 THEN 960
950 PRINT A(K); "****";
960 PRINT " X ";
970 IF K = 2 THEN 990
980 PRINT " + "; K - 1;
990 Z = 0
1000 NEXT K
1010 IF A(1) < 0 THEN 1070
1020 IF A(1) = 0 THEN 1050
1030 PRINT " + ";
1040 PRINT A(K);
1050 PRINT
1060 STOP
1070 PRINT " - ";
1080 A(1) = -A(1)
1090 GOTO 1040
1100 END

```

50 N. PASCACK ROAD  
SPRING VALLEY, NEW YORK 10977

\* APPLE IS A TRADEMARK OF THE APPLE CORP.

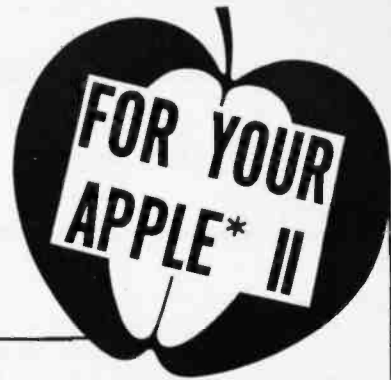

- \* All orders processed within 24-Hours
- \* 30-Day money back guarantee on all Software (less a \$3 penalty for handling)

**FROM COMPUMAX BUSINESS SYSTEMS**

The COMPUMAX business applications programs are written with the novice computer user in mind. They are easy to use, yet powerful in their capabilities. Further, COMPUMAX supplies the BASIC source code. Thus the programs are easy to modify.

**MICROLEDGER**

This General Ledger system performs the essential functions of dual entry bookkeeping and matches revenues and expenses:

- MICROLEDGER Includes the following programs:
- LEDGER 1 - builds and maintains the CHART OF ACCOUNTS file. This file contains both current and accumulated totals for each account.
- LEDGER 2 - builds and updates the JOURNAL TRANSACTION file.
- LEDGER 3 - lists both the JOURNAL file and the CHART OF ACCOUNTS.
- LEDGER 4 - computes the TRIAL BALANCE and executes POSTING of journal transactions into the CHART OF ACCOUNTS. An AUDIT TRIAL of all transaction is output.
- LEDGER 5 - produces the PROFIT AND LOSS STATEMENT.
- LEDGER 6 - produces the BALANCE SHEET. Assets, liabilities and owners' equities are shown by account and by totals. .... **\$140.00**

**MICROPAY**

- An Accounts Payable system, MICROPAY includes the following program & functions:
- PAY 1 - initializes both Transaction and Master files, then begins the Accounts Payable process by inputting and adding records in the Transaction file.
- PAY 2 - allows for changes and deletions of Transaction and Master records.
- PAY 3 - reports outstanding Accounts Payables in four categories; under 30 days, 31-60 days, 61-90 days, and over 90 days.
- PAY 4 - reports all outstanding Accounts Payables for a single customer or for all customers, and computes Cash Requirements.
- PAY 5 - reports all outstanding Accounts Payables for a single date or for a range of dates and computes the Cash Requirements.
- PAY 6 - lists both the Transactions and Master files.
- PAY 7 - prints checks and accumulates and journalizes Accounts Payables. This program simultaneously creates entries for the MICROLEDGER file. .... **\$140.00**

**MICROREC**

- An Accounts Receivable system, MICROREC includes the following programs and functions:
- REC 1 - initializes Accounts Receivable files, adds A/R record and prints invoices.
- REC 2 - accepts receipt of customer payments and changes or deletions of A/R Transaction or Master file records.
- REC 3 - reports outstanding Accounts Receivables in four categories; under 30 days, 31-60 days, 61-90days, and over 90 days.
- REC 4 - reports all outstanding Accounts Receivables for a single customer, or for all customers and computes Cash Projections.
- REC 5 - produces reports for all outstanding Accounts Receivables for a single date or for a range of dates and computes Cash projections.
- REC 7 - lists Transaction and Master files and accumulates and journalizes Accounts Receivables, creating JOURNAL entries which communicate with the MICROLEDGER JOURNAL file. .... **\$140.00**

**MICROINV**

- This Inventory Control system presents a general method of Inventory Control and produces several important reports. Its program includes:
- INV 1 - Initializes Transaction and Master files and adds and updates Transaction and Master records.
- INV 2 - handles inventory issued or received, creating inventory records. This program also accumulates and journalizes transactions, producing JOURNAL entries which communicate with the MICROLEDGER file.
- INV 3 - lists both Transaction and Master files.
- INV 4 - produces the STOCK STATUS REPORT, showing the standard inventory stock data and stock valuation, and the ABC ANALYSIS breaking down the inventory into groups by frequency of usage.
- INV 5 - gives a JOB COST REPORT/MATERIALS, showing allocation of materials used year-to-date by each job or work code. (This is complemented by the Job Cost Report/Personnel in the MICROPERS program.)
- INV 6 - computes and provides the E.O.Q. (Economic Order Quantities) .... **\$140.00**

**MICROPERS**

- This is a Payroll/Personnel program whose functions include:
- PERS 1 - initializes the Master file and allows for entry and updates of Master records.
- PERS 2 - initializes the Payroll file and allows for entry and updates of payroll records.
- PERS 3 - lists an Employee Master Record or the entire Employee Master file; lists a single Payroll Record or the entire Payroll file.
- PERS 4 - computes Payroll and prints the PAYROLL REGISTER. Prints PAYCHECKS and creates JOURNAL entries to be fed into the MICROLEDGER JOURNAL file.
- PERS 5 - produces the JOB COST REPORT/PERSONNEL, computes the quarterly 941 bank deposit, and the Annual W-2 run. .... **\$140.00**

All COMPUMAX programs available in machine readable format (diskette form) for the following machines:

|                 |                      |
|-----------------|----------------------|
| TRS-80™ Model I | Micropolis 1053/11   |
| APPLE II        | Microsoft under CP/M |
| PET             | CBASIC under CP/M    |
|                 | Cromemco             |

**FROM ADVENTURE INTERNATIONAL (By Scott Adams)**

- † 1. **ADVENTURELAND** - You wander through an enchanted world trying to recover the 13 lost treasures. You'll encounter wild animals, magical beings, and many other perils and puzzles. Can you rescue the Blue Ox from the quicksand? Or find your way out of the maze of pits? Happy Adventuring . . . . .
- † 2. **PIRATE'S ADVENTURE** - "Yo ho ho and a bottle of rum" You'll meet up with the pirate and his daffy bird along with many strange sights as you attempt to go from your London flat to Treasure Island. Can you recover Long John Silver's lost treasures? Happy Sailing, matey . . . . .
- 3. **MISSION IMPOSSIBLE ADVENTURE** - Good morning, your mission is to...and so it starts. Will you be able to complete your mission in time? Or is the world's first automated nuclear reactor doomed? This one's well named. It's hard, there is no magic, but plenty of suspense. Good luck . . . . .
- 4. **VOODOO CASTLE** - Count Cristo has had a fiendish curse put on him by his enemies. There he lies, with you his only hope. Will you be able to rescue him or is he forever doomed? Beware the Voodoo Man . . . . .

- 5. **THE COUNT** - You wake up in a large brass bed in a castle somewhere in Transylvania. Who are you, what are you doing here, and WHY did the postman deliver a bottle of blood? You'll love this Adventure, in fact, you might say it's Love at First Byte . . . . .
  - 6. **STRANGE ODYSSEY** - Marooned at the edge of the galaxy, you've stumbled on the ruins of an ancient alien civilization complete with fabulous treasures and unearthly technologies. Can you collect the treasures and return or will you end up marooned forever? . . . . .
  - 7. **MYSTERY FUN HOUSE** - Can you find your way completely through the strangest Fun House in existence, or will you always be kicked out when the park closes? . . . . .
  - 8. **PYRAMID OF DOOM** - An Egyptian Treasure Hunt leads you into the dark recesses of a recently uncovered Pyramid. Will you recover all the treasures or more likely will you join its denizens for that long eternal sleep? . . . . .
  - 9. **GHOST TOWN** - Explore a deserted western mining town in search of 13 treasures. From rattlesnakes to runaway horses, this Adventure's got them all! Just remember, Pardner, they don't call them Ghost Towns for nothin'. (Also includes new bonus scoring system!) . . . . . **\$14.95 Per Adventure**
- \* Note: Apple requires 24K and has no lower case.  
† Recommended for the novice adventurer, with many built-in HELPS!

**FROM PERSONAL SOFTWARE INC.**

- VISICALC** . . . . . **\$150.00**
- Take virtually any problem you would explore using calculator, pen, and paper, working in rows and columns. Apply VisiCalc and you'll see why every reviewer of this product has said the same thing: VisiCalc is the most useful, most important program yet developed for personal computing.
- With VisiCalc, you work with an electronic worksheet of up to 63 columns and 254 rows. At the juncture of any column and row you can type in words and numbers. VisiCalc automatically performs all arithmetic functions, net present value, and transcendental functions - instantly!

**CCA DATA MANAGEMENT SYSTEM . . . . . \$74.95**

- DMS Features:**
- File Creation and Maintenance:
  - Fields may be alphanumeric, numeric, integer, floating point, or fixed decimal with commas.
  - Fields may be COMPUTED FIELDS. DMS will compute any field within a record, using constants or other fields in the same record. Functions include add, subtract, multiply, divide, and raise exponential powers.
  - Records are easily located, using the SCAN feature. SCAN for records with a field over, below, or between a range of values.
  - Records are easily added and updated. DMS "prompts" you with questions.
  - Multi-diskette capabilities for larger files - up to 85,000 characters per file!
  - Sort the records into almost any order, using up to 10 fields as "keys". So you can sort for customer numbers; within zip code, for instance.
  - Delete records, "compact" files, and backup files on data diskettes easily.
- Report Features:**
  - Print reports with records in any order.
  - Select fields to be printed.
  - Print mailing labels.
  - Numeric totals and subtotals can be specified when a value in an unrelated field in the same record changes. For example, sort, subtotal, and print according to department, or month, or customer number, or model number.

**GUARANTEED PROFIT 91% WINS PLACES SHOWS 32% AVERAGE PROFIT AT ALL TRACKS-1978**

**THE HORSE SELECTOR II (FLATS) (By Dr. Hal Davis) . . . . . \$50.00**

- New simplified version of the original Horse Selector. The first Horse Selection System to actually calculate the estimated odds of each horse.
- HIGHER PROFITS (OVER 100%) POSSIBLE THROUGH SELECTIVE BETTING ON:
  - Rates each horse in 10 seconds.
  - Easy to follow rules.
  - Can be used with any Apple II Computer.
  - 100% money back guarantee (returned for any reason).
  - Uses 4 factors (speed rating, track variant, distance of the present race, distance of the last race)
  - Using the above factors, the Horse Selector calculates the estimated odds. BET on horses whose actual payoff (from the Tote Board or Morning Lines) is higher than payoff based on estimated odds.
  - Using the above factors, the Horse Selector calculates the estimated odds. BET on any selected horse with an estimated payoff (based on Tote Board or Morning Lines) higher than calculated payoff (based on Horse Selector II).
  - Source listing for the TRS-80™, TI-59, HP-67, HP-41, Apple and BASIC Computers.
  - No computer or calculator necessary (although a calculator would be helpful for the simple division used to calculate estimated odds)

FREE Dutching Tables allows betting on 2 or more horses with a guaranteed profit.

**24 HOUR ORDER LINE**

**(914) 425-1535**

ADD \$2.00 FOR SHIPPING UPS AREAS  
ADD \$3.00 FOR C.O.D. OR NON-UPS AREAS  
ADD \$4.00 OUTSIDE U.S.A. CANADA & MEXICO

**NEW TOLL-FREE ORDER LINE (OUTSIDE OF N.Y. STATE)**

**(800) 431-2818**

## My first exposure to a symbolic mathematics system was a delightful surprise.

Text continued from page 236:

$n$ . Each entry in the four  $d$  columns is equal to the entry to its left minus the one above that. If we designate the rightmost entry in each row by  $d_1, d_2, \dots, d_n$ , beginning with  $d_1 = y_2 - y_1$ , then the interpolated polynomial can be expressed as:

$$d_1 + \frac{d_2(x-x_1)}{1} + \frac{d_3(x-x_1)(x-x_2)}{1 \times 2} \\ + \dots + \frac{d_n(x-x_1)(x-x_2)\dots(x-x_{n-1})}{1 \times 2 \times 3 \times \dots \times n}$$

Thus, for our example,

$$p = -5 + 5(x+2) - \frac{6(x+2)(x+1)}{2} \\ + \frac{12(x+2)(x+1)x}{6} + \frac{0(x+2)(x+1)x(x-1)}{24}$$

Note that, since we are only interested in the rightmost element in each row, we can avoid wasting space on a two-dimensional array by letting  $d_k$  generally represent the current rightmost computer entry in row  $k$ , provided we compute the entries one column at a time, from the

bottom up. (See listing 3, lines 450 thru 550.)

The above so-called *Newton-forward-difference* form of the interpolated polynomial is fine for numerical evaluation of  $p$  for any specific value of  $x$ , which is the usual purpose of interpolation. However, we seek the coefficients of the fully-expanded form, so a further processing phase is necessary.

Using appropriate multipliers to avoid divisions and possible fractions at this point (see listing 3, lines 560 thru 630), we then apply the algorithm given in listing 2. (See listing 3, lines 640 thru 770.) This gives us the desired expanded polynomial coefficients, which can be expressed by:

$$a_k = \frac{d_k}{(m-1)!}, \text{ for } k = 1, 2, \dots, m.$$

As a practical matter, we can use the same array to store  $y_k, d_k$  and  $a_k$  for  $k = 1$  to  $n$ .

Most numerical-analysis texts outline the theory behind the Newton-forward-difference formula. *Elementary Numerical Analysis*, by Conte and de Boor (McGraw-Hill, 1972), is one of the few texts that also presents an algorithm for transforming the polynomial to its fully expanded form. The above algorithm is adapted from theirs so that only integer arithmetic is involved if the coefficients of the original unexpanded polynomial are all integers. This permits the program to work even on integer-arithmic versions of BASIC. Moreover, it often reduces or eliminates round-off error on BASIC implementations that use floating-point arithmetic.

### Limitations

The finite-precision arithmetic of most BASIC implementations imposes some important limitations on this program. For example, on a version of BASIC offering about eight decimal digits of precision, using  $n=10$ ,

$$(2x + 6)^8$$

yields the exact result:

$$256x^8 + 6144x^7 + 64512x^6 + 387072x^5 + 1451520x^4 \\ + 3483648x^3 + 5225472x^2 + 4478976x + 1679616$$

but both of the "slightly larger" polynomials  $(3x + 6)^8$  and  $(2x + 6)^9$  yield expanded results having absolute coefficient errors as large as 22. The sample values of  $x$  are all exactly representable integers of small magnitude, and the same is true of the unexpanded coefficients for these examples.

The problem is that the sample values of  $y$ , their differences, the product of these differences with the appropriate multipliers, and the final expanded coefficients can be too large to be exactly representable. Moreover, relatively small, consequent roundoff errors committed at intermediate stages can easily propagate into relatively large roundoff errors only one step later.

Unexpanded expressions having fractional coefficients are liable to behave worse in this regard, particularly if any of the fractions are not exactly representable in the number base employed by the interpreter. For example, expanding the expression:

$$(x + 1/3)^2$$

### 779 UPPER CASE/lower case "Conversion Kit I"

Expand the capabilities of your 779 line printer to include word processing!! Available to all Centronics 779 and TRS 80 Printer I owners is the option of lower case and changing slash 0 Zero to standard O. No etch cuts or soldering needed. Installs in minutes with a screwdriver. No program modification or additional interface is required. **Price \$125.00**

UPPER/LOWER CASE NOW AVAILABLE FOR THE FOLLOWING CENTRONICS PRINTERS:

101AL, 102BL, 306, 500, 501, 503, 700, 701, 702, 703, 780, 781.

### Motor Control "CONVERSION KIT II" FOR ALL CENTRONICS 779 & TRS 80 PRINTER I LINE PRINTERS!!

Our "Conversion Kit II" Motor Controller gives your 779 the ability to turn the motor on and off automatically. Removes the annoying noise of constant run, increasing the life span of your 779 and TRS 80 line printer motor! No soldering, software or hardware changes needed. Installs easily. **Price \$95.00**

**SAVE!** Buy Service Technologies "Conversion Kit I" and "Conversion Kit II" together for the single price of **\$199.00**

To order, please send check or money order in the proper amount to:



*Service Technologies, Inc.*  
32 Nightingale Rd.  
Nashua, N.H. 03062  
(603) 883-5369

Visa and Master Charge accepted (please include signature, expiration date and phone number).

THE 6502 BOOK YOU'VE WAITED FOR...

PRACTICAL MICROCOMPUTER PROGRAMMING: THE 6502™

A complete assembly language course for the 6502 consisting of:

THE TEXT...

In 20 chapters and more than 100 formal program examples PRACTICAL MICROCOMPUTER PROGRAMMING: THE 6502 covers fundamental assembly language techniques as applied to the 6502 with the same thoroughness and attention to detail as its predecessors did for the 8080, 6800 and Z80. The "difficult" topics such as interrupts aren't skipped or glossed over but treated in full detail. The example programs address real world programming problems and in many cases can be taken whole from the book for use in application programs. There is no nonsense, no games, just chapter after chapter of solid, accurate programming information. There is nothing else like it available anywhere at any price. If you intend to program the 6502 at assembly level you need PRACTICAL MICROCOMPUTER PROGRAMMING: THE 6502.

THE PROGRAMMING SYSTEM...

A complete editor/assembler system which runs directly on the Apple II computer but will run with user supplied I/O on any 6502 based computer with 10K RAM beginning at \$2000. This is an entirely new programming system written specially for this book. It frees the programmer from having to define page zero references at the beginning of the program and contains many pseudo-ops and compound instructions to solve the problems which have made the 6502 difficult to program in the past. Nothing like this system has ever existed for the 6502 before. The full source listing of this system is given in an appendix.

AND MORE SOFTWARE...

A debugging monitor with self restoring breakpoints, filling and searching of memory, direct viewing of stack contents, memory "windowing" and many other features. This debugging monitor runs specifically on the Apple II but can be modified to run on other 6502 configurations. If you're tired of inserting and removing BRK instructions by hand this program is for you. The source of the debugging monitor is also included in the book.

AND THE OBJECT IS FREE...

The object of both the editor/assembler and the debugging monitor are sent to book purchasers without charge on either Apple II compatible cassette or paper tape when the licensing agreement at the back of the book is returned. The object code is also available on disk for the Apple II for a nominal charge.

IF YOU NEED TO PROGRAM THE 6502 AT ASSEMBLY LEVEL AND YOU'RE TIRED OF THE "QUICKIES" AND REHASHES OF THE MANUAL, THEN PRACTICAL MICROCOMPUTER PROGRAMMING: THE 6502 IS FOR YOU. AT \$32.95 YOU WILL NEVER SEE MORE VALUE FOR THE MONEY.

Available now. Please allow 30 days for delivery.

Apple and Apple II are trademarks of Apple Computer Inc., Cupertino, CA

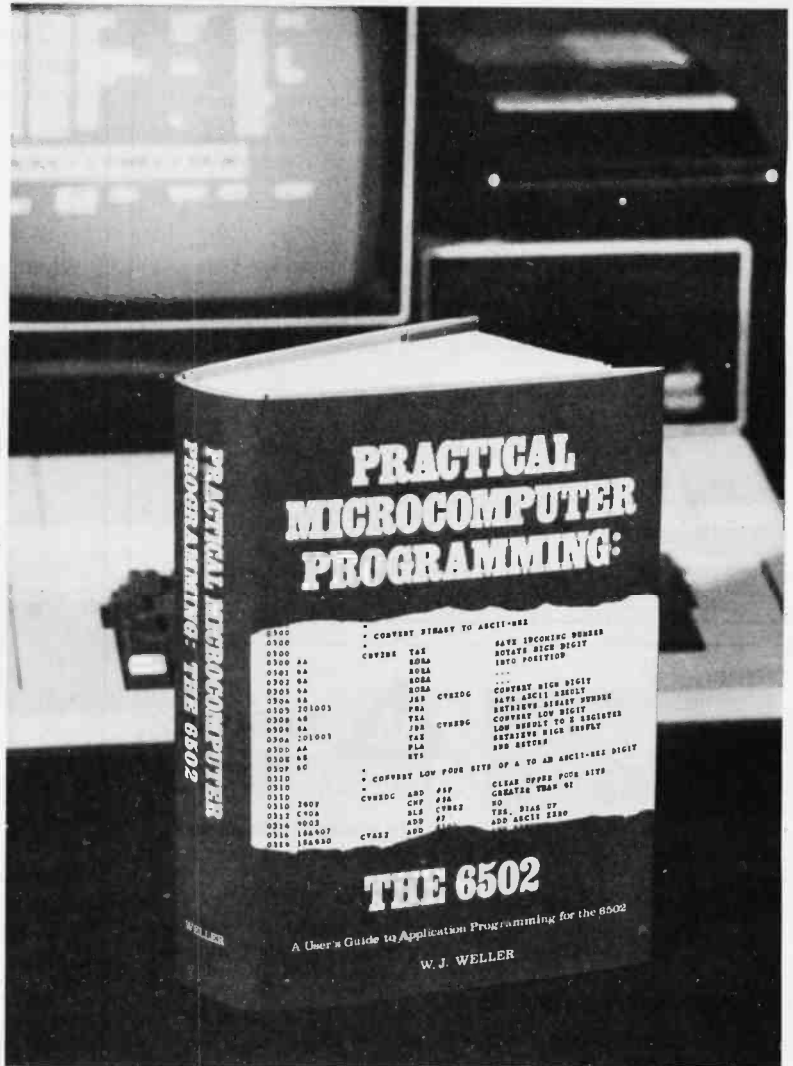

Please send my copy of PRACTICAL MICROCOMPUTER PROGRAMMING: THE 6502 US Funds only. No COD please.
[ ] Check enclosed [ ] Money Order enclosed

NAME \_\_\_\_\_

ADDRESS \_\_\_\_\_

CITY \_\_\_\_\_ STATE \_\_\_\_\_ ZIP \_\_\_\_\_

Send to: Northern Technology Books
Box 62
Evanston, IL 60204

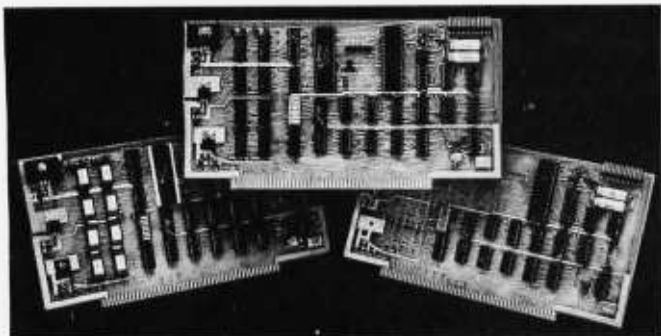

**COLOR VIDEO PROCESSOR**

- Text, Graphics, Animation • 16 Colors • 256 x 192 Resolution
- NTSC Composite Video Output • Uses TMS 9918 • Includes I/O Mapped 16K Video Memory • 3D Simulation with 32 Video Sprites • 2 Byte X-Y Positioning • Real Time Clock • 8 Level Interrupt Selection • Inexpensive RF Modulator allows easy connection to any color TV •

**PROGRAMMABLE SOUND GENERATOR**

- Music, Sound Effects, Tone Signaling, Ultrasonics • 27 Hz to 111 KHz Range • 3 Programmable Analog Channels with Separate Frequency, Volume and White Noise Control • 10 Selectable Envelope Wave Shapes under Software Control • Two 8-Bit Programmable I/O Ports for use as External Keyboard/Display Interface • Power Amplifier for driving External Speaker •



- SINGLE BOARD COLOR VIDEO AND SOUND GENERATOR KIT . . \$350
- COLOR VIDEO KIT . . . . . \$295
- SOUND GENERATOR KIT . . . . . \$195

Texas residents add 5% sales tax. Prices include complete documentation, manuals and programming examples. PC board is solder-masked with gold contacts. Add \$100 for assembled and tested units. Send \$9.50 for documentation only, refundable with order. Compatible with Z80, 8085 and 8080 at 2 or 4 MHz on S-100 buss.



**ELECTRONIC DESIGN ASSOCIATES**  
P.O. Box 94055 Houston, Texas 77018 (713) 999-2255



- **Quantity Discounts Available**
- **90-day Warranty**
- **Ask about our unique "Guaranteed Custom Programming"**

**ZENITH DATA SYSTEMS**

|                                               | LIST    | OUR PRICE |
|-----------------------------------------------|---------|-----------|
| Z89 MICROCOMPUTER SYSTEM . . . . .            | \$2,895 | \$2,495   |
| 48KB Memory                                   |         |           |
| Z19 Video Terminal (24 x 80)                  |         |           |
| 2 Serial EIA ports                            |         |           |
| Single 5" Diskette Drive                      |         |           |
| Z19 Smart Video Terminal . . . .SPECIAL . .   | \$ 950  | \$ 795    |
| 24 lines x 80 col                             |         |           |
| Reverse Video                                 |         |           |
| Numeric keypad                                |         |           |
| HDOS Operating System (with BASIC) . . . .    | \$ 150  | \$ 145    |
| Microsoft Basic . . . . .                     | \$ 150  | \$ 145    |
| Word Processing for Z89 System . . . . .      | \$ 395  | \$ 375    |
| Dual 5" Diskette Drive for Z89 System . . . . | \$1,195 | \$ 1,095  |

**To Order:** Send Check or Money Order to: PK Systems, Inc., 113 North Center, Bloomington, IL 61701. Allow two weeks for personal checks to clear. For COD Orders, add 5% for handling and service charge. Rush orders, add \$50.00

**Shipping:** Freight collect, FOB Bloomington. We ship UPS, air freight, or motor freight.

PK Systems is an Authorized Zenith Data Systems Dealer and Zenith Service Center.

when  $n = 5$ , on a binary implementation of BASIC having about eight decimal digits of accuracy, gives us:

$$2.48353 \times 10^{-9}x^4 + 4.96705 \times 10^{-9}x^3 + x^2 + 0.666667x + 0.111111$$

Although their coefficients are admittedly small, the appearance of apparent terms where none should occur is somehow far more annoying than a modest, relative error in the coefficient of a truly nonzero term.

Unexpanded coefficients that are fractions exactly representable in the underlying number base are less likely to wreak havoc. For example:

$$(x + 1/2)^2$$

yields

$$x^2 + x + 0.25$$

when  $n = 5$ , on the same version of BASIC. These difficulties can be minimized by:

- declaring the relevant program variables to have the maximum allowable precision offered by the BASIC being used;
- avoiding setting  $n$  much larger than necessary;
- phrasing problems to have small magnitude, integer coefficients insofar as possible (For example, perhaps a common denominator can be removed along with a common divisor of the resulting coefficients);
- phrasing the problem to have the smallest possible degree (For example, perhaps there is an obvious common factor  $x^3$ , which can be removed, or perhaps the polynomial can be regarded as a polynomial in  $x^2$ ).

However, even practicing all of these frugalities, the limitations are substantial. For example, it is optimistic to set  $n$  larger than a value found by dividing the underlying number of significant digits in the arithmetic by the largest number of digits in any coefficient of the unexpanded expression. Thus, the program is usable only for relatively modest problems on a typical seven-digit BASIC, and the program is primarily an educational curiosity on a typical four-digit integer BASIC.

It gives one pause to realize that even traditional applications of floating-point arithmetic can entail similar sensitivity to roundoff error and, worse yet, it is more likely to go unnoticed. Indefinite-precision arithmetic, such as that provided by muMATH, overcomes this limitation. However, most symbolic-math systems, including muMATH, are based entirely or predominantly upon techniques other than evaluation and interpolation.

**PICOMATH-80**

After writing this article and the simple polynomial expansion program given in listing 3, I decided to determine how much further the evaluation-interpolation technique could be explored within the confines of a 4 K BASIC program. The results were:

- It was trivial to extend the polynomial-expansion program to also optionally perform symbolic differentiation or integration. It was also possible to

# A Microcomputer for everyone at a Micro Price

The **MicroAce** - a new generation of miniature computers  
**A COMPLETE COMPUTER for \$149.00 for 1K Kit**

Post and Packing FREE

(Add 6% Tax for Shipments inside California)

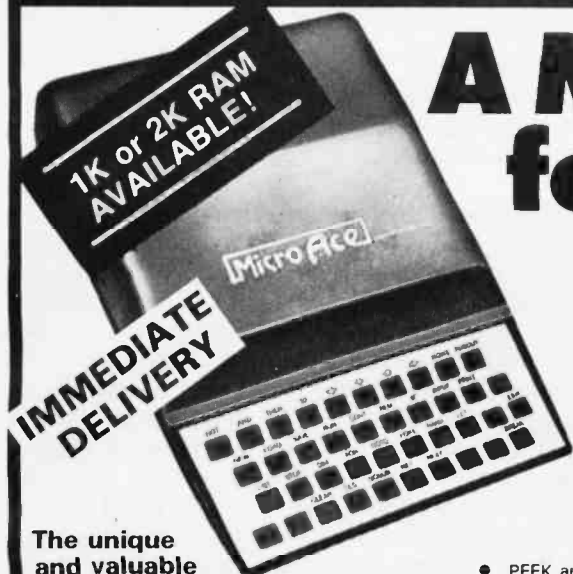

## The unique and valuable components of the MicroAce

The MicroAce is not just another personal computer. Quite apart from its exceptionally low price, the MicroAce has two uniquely advanced components: the powerful BASIC interpreter, and the simple teach yourself BASIC manual.

The unique versatile BASIC interpreter offers remarkable programming advantages:

- Unique 'one-touch' key word entry: the MicroAce eliminates a great deal of tiresome typing. Key words (RUN, PRINT, LIST, etc.) have their own single-key entry.
- Unique syntax check. Only lines with correct syntax are accepted into programs. A cursor identifies errors immediately. This prevents entry of long and complicated programs with faults only discovered when you try to run them.
- Excellent string-handling capability — takes up to 26 string variables of any length. All strings can undergo all relational tests (e.g. comparison). The MicroAce also has string input — to request a line of text when necessary. Strings do not need to be dimensioned.
- Up to 26 single dimension arrays.
- FOR/NEXT loops nested up 26.
- Variable names of any length.
- BASIC language also handles full Boolean arithmetic, conditional expressions, etc.
- Exceptionally powerful edit facilities, allows modification of existing program lines.
- Randomise function, useful for games and secret codes, as well as more serious applications
- Timer under program control.

- PEEK and POKE enable entry of machine code instructions, USR causes jump to a user's machine language sub-routine.
- High-resolution graphics with 22 standard graphic symbols.
- All characters printable in reverse under program control.
- Lines of unlimited length.

## 'Excellent value' indeed!

For just \$149.00 (excluding handling charge) you get everything you need to build a personal computer at home... PCB, with IC sockets for all ICs; case; leads for direct connection to a cassette recorder and television (black and white or color); everything!

Yet the MicroAce really is a complete, powerful, full-facility computer, matching or surpassing other personal computers at several times the price.

The MicroAce is programmed in BASIC, and you can use it to do quite literally anything, from playing chess to managing a business.

The MicroAce is pleasantly straightforward to assemble, using a fine-tipped soldering iron. It immediately proves what a good job you've done: connect it to your TV ... link it to the mains adaptor ... and you're ready to go.

## Fewer chips, compact design, volume production-more power per Dollar!

The MicroAce owes its remarkable low price to its remarkable design: the whole system is packed on to fewer, newer, more powerful and advanced LSI chips. A single SUPER ROM, for instance, contains the BASIC interpreter, the character set, operating system, and monitor. And the MicroAce 1K byte

RAM (expandable to 2K on board) is roughly equivalent to 4K bytes in a conventional computer — typically storing 100 lines of BASIC. (Key words occupy only a single byte.)

The display shows 32 characters by 24 lines.

And Benchmark tests show that the MicroAce is faster than all other personal computers.

No other personal computer offers this unique combination of high capability and low price.

## The MicroAce teach-yourself BASIC manual.

If the features of the BASIC interpreter mean little to you—don't worry. They're all explained in the specially-written book *free* with every kit! The book makes learning easy, exciting and enjoyable, and represents a complete course in BASIC programming—from first principles to complex programs. (Available separately—purchase price refunded if you buy a MicroAce later.)

A hardware manual is also included with every kit.

**The MicroAce Kit:**  
**\$149.00 with 1K COMPLETE**  
**\$169.00 with 2K**

Demand for the MicroAce is very high: use the coupon to order today for the earliest possible delivery. All orders will be despatched in strict rotation. If you are unsuccessful in constructing your kit, we will repair it for a fee of \$20.00, post and packing FREE. Of course, you may return your MicroAce as received within 14 days for a full refund. We want you to be satisfied beyond all doubt — and we have no doubt that you will be.

280 A microprocessor chip, widely recognised as the best ever made.

Sockets for TV, cassette recorder, power supply.

### Your MicroAce kit contains...

- Printed circuit board, with IC sockets for all ICs.
- Complete components set, including all ICs—all manufactured by selected world-leading suppliers.
- New rugged keyboard, touch-sensitive, wipe-clean.
- Ready-moulded case.
- Leads and plugs for connection to domestic TV and cassette recorder. (Programs can be **SAVED** and **LOADED** on to a portable cassette recorder.)
- Mains adaptor of 600 mA at 9VDC nominal unregulated.
- **FREE** course in BASIC programming and user manual.

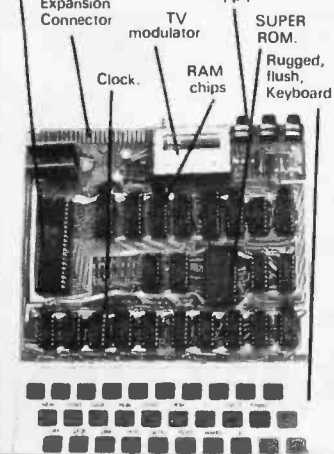

## JOIN THE REVOLUTION - DON'T GET LEFT BEHIND - ORDER YOUR MICRO ACE NOW!!

Send Check, Money Order or quote your Credit Card No. to:  
**MicroAce 1348 East Edinger, Santa Ana, California, Zip Code 92705.**  
**or phone (714) 547 2526 quoting your Credit Card Number.**

| Quantity                               | Description     | Unit Price | TOTAL        |
|----------------------------------------|-----------------|------------|--------------|
|                                        | MicroAce Kit 1K | \$149.00   |              |
|                                        | MicroAce Kit 2K | \$169.00   |              |
|                                        | Manual          | \$10.00    |              |
|                                        | 1K Upgrade Kit  | \$29.00    |              |
| Shipments inside California add 6% TAX |                 |            | <b>TOTAL</b> |

- Amex.
- Diners
- Check
- Money Order
- Master Charge
- Visa

Card No. \_\_\_\_\_

Exp. Date \_\_\_\_\_

Name \_\_\_\_\_

Address \_\_\_\_\_

City \_\_\_\_\_ State \_\_\_\_\_ Zip \_\_\_\_\_

- extend the program to work with three variables.
- Some less trivial techniques reduced the sensitivity to roundoff error somewhat.
- Rational interpolation yields an analogous program that simplifies single-variable rational expressions over a common denominator, reduced to lowest terms. For example:

$$1 + \frac{1}{x-1} - \frac{1}{x+1} + \frac{2x}{x^2-1}$$

simplifies to

$$\frac{x+1}{x-1}$$

Although rational interpolation expands polynomials as a special case, polynomial interpolation is generally more accurate when applicable.

- Two trigonometric interpolation formulas yield a pair of analogous programs that perform many trigonometric simplifications. For example:

$$\frac{\sec x - \tan x - 1}{\tan x + \sec x - 1}$$

can be transformed into the equivalent

$$\tan x$$

and

$$\sin(3x) + 4 \cos(x - \pi/2) - 4 \sin x \cos^2 x$$

simplifies to:

$$3 \sin x$$

These programs are useful for Fourier analysis and

proof of trigonometric identities. Here too it was trivial to optionally perform symbolic differentiation or integration.

Although limited by the underlying finite-precision arithmetic of BASIC, the similar but independent polynomial, rational, and trigonometric programs collectively span a large enough sample of problem classes to constitute a demonstration symbolic-math package. Accordingly, we have collected them together for distribution under the name PICOMATH-80. By the time this article appears, PICOMATH on tape cassettes with documentation should be available for at least the Apple, Atari 800, Exidy Sorcerer, Commodore PET, Texas Instruments 99/4, and Radio Shack TRS-80 Level II computers at most computer stores or from Programma International, 3400 Wilshire Blvd, Los Angeles CA 90010, for \$19.95. The sixty-page manual contains usage directions, explanations of how the programs work, BASIC program listings, and an adaptation guide for various dialects of BASIC or other programming languages. The manual is available separately for \$15.95 from Programma International. Thus, PICOMATH is easily installed on virtually any computer.

### Conclusion

I still recall my disappointment when I first realized that the first programming language I learned, FORTRAN, was essentially arithmetic. The same was true of my second and third programming languages, so the first exposure to a symbolic-mathematics system was a delightful surprise. Though much of the world's scientific computation is (and probably always will be) numerical, it seems likely that many of those who experience symbolic mathematics will want their programming languages to fully support both types of computation. Therefore, beware of trying the symbolic-math program in listing 3. Though it is almost certainly the most trivial and least powerful program of its type, symbolic computer math can be addictive! ■

| Printers                                                                                                                            | <b>WHOLESALE</b>                                              |                | Printers                                                                                                                                                                       |
|-------------------------------------------------------------------------------------------------------------------------------------|---------------------------------------------------------------|----------------|--------------------------------------------------------------------------------------------------------------------------------------------------------------------------------|
| <b>IDS PAPER TIGER</b> with graphics & 2K buffer Parallel & RS232C                                                                  | \$ 950.00                                                     |                |                                                                                                                                                                                |
| <b>OLIVETTI PR 240</b> Thermal 240 LINES per min. serial                                                                            | 950.00                                                        |                |                                                                                                                                                                                |
| <b>CENTRONICS 704</b> 180 CPS Serial                                                                                                | 1900.00                                                       | 28.50/6        |                                                                                                                                                                                |
| <b>NEC SPINWRITER</b> (RO) Serial                                                                                                   | 2900.00                                                       | Fabric 35.90/6 | <br> |
| Tractor Add                                                                                                                         | 150.00                                                        | Carbon 36.90/6 |                                                                                                                                                                                |
| <b>SIEMENS INK JET</b> 270 CPS SERIAL (KSR)                                                                                         | 3700.00                                                       |                |                                                                                                                                                                                |
| (Call for Parallel prices) (RO)                                                                                                     | 3500.00                                                       |                |                                                                                                                                                                                |
| <b>SPECIALS:</b>                                                                                                                    |                                                               |                |                                                                                                                                                                                |
| <b>CENTRONICS 779 Uppercase/Lowercase mod</b> (no soldering)                                                                        | \$150.00                                                      |                |                                                                                                                                                                                |
| <b>CAT MODEM</b> Orig & Answer RS232C                                                                                               | \$185.00                                                      |                |                                                                                                                                                                                |
| <b>MEMOREX</b> Soft Sector                                                                                                          | 5" \$27.50/10                                                 | 8" \$28.50/10  |                                                                                                                                                                                |
| <b>DISK HEAD CLEANING KIT</b> 5" or 8"                                                                                              | \$24.00                                                       |                |                                                                                                                                                                                |
| We also carry <b>DISK DRIVES, TERMINALS, COMPUTERS.</b> and a complete line of <b>SUPPLIES.</b> Call for latest catalog and prices. |                                                               |                |                                                                                                                                                                                |
| <b>BOX 426</b><br><b>WESTFORD, MA 01886</b>                                                                                         | <b>THE WAREHOUSE</b><br>A subsidiary of <b>TEELABCO, Inc.</b> |                | <b>617-692-8408</b><br>TWX 710-342-6467                                                                                                                                        |



## DIGITAL DATA RECORDER MODEL CC-9B

For five years now, the CC series recorders have been the industry NRZ Asynchronous recorder standard. Now the B model sets a new standard in stability and reliability with its tachometer feedback LC stabilized motor circuit.



CC-9B Model  
Price \$275.00  
CC-9 Model  
Price \$225.00

- 4800 or 9600 Baud (3" or 6" per second)
- 10<sup>-8</sup> Error Rate RS232 or TTL In and Out
- RTS motor start
- CTS Data start
- DB 25 or special connector optional
- 110/220 · 50/60 Hz
- Wow & Flutter ± .3%
- Speed Stability (long term) ± .1%

## NATIONAL MULTIPLEX CORPORATION

260 Lackland Drive East  
Middlesex, New Jersey 08846  
Tel. (201) 356-9200 TWX 710-997-9530

## At last...the Typewriter Interface!

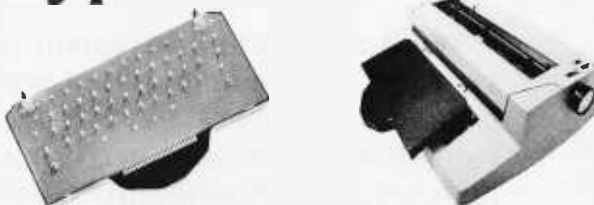

Turn your electric typewriter into a low cost, high quality hard copy printer. 1 Year Warranty

Dynatyper—the patented\* RDI—I/O Pak is fast becoming the industry standard for typewriter output. Why? Because:

1. It takes 2 minutes to initially install and 5 seconds to remove or replace.
2. You do not have to modify your typewriter. All factory warranties and maintenance agreements on your typewriter will be honored.
3. You can use it with all powered carriage return typewriters that have U.S. keyboard. Our Model I works with all non Selectrics and our Model II works with Selectrics. Conversion between models takes 2 minutes and the kit (26 plungers) is available for a nominal charge.
4. You don't have to lug around a bulky printer when you travel. If there is a typewriter at your destination, you can install the light (3 lbs.) I/O Pak in just 2 minutes.
5. Same interface for TRS-80, Apple and GPIB. Centronics and Pet compatible interfaces are available in third quarter 1980. Electric pencil available.
6. Delivery: Stock to two weeks. Price: \$499. for the complete system, FOB Rochester, Domestic.

Over 1000 in operation today. VISA and MasterCard accepted. Call Ken Yanicky at 716-385-4336.

\*Patent Pending

### ROCHESTER DATA

3100 Monroe Avenue, Rochester, New York 14618 incorporated

## New Produced and widely used in England and U.S.A. COMPLETE BUSINESS PACKAGE

INCLUDES EVERYTHING FROM INVENTORY TO SALES SUMMARY  
PROMPTS USER, VALIDATES EACH ENTRY, MENU DRIVEN

Approximately 60-100 entries/inputs require only 2-4 hours weekly and your entire business is under control.

#### PROGRAMS ARE INTEGRATED-

- 01 = ENTER NAMES/ADDRESS, ETC
- 02 = ENTER/PRINT INVOICES
- 03 = ENTER PURCHASES
- 04 = ENTER A/C RECEIVABLES
- 05 = ENTER A/C PAYABLES
- 06 = ENTER/UPDATE INVENTORY
- 07 = ENTER/UPDATE ORDERS
- 08 = ENTER/UPDATE BANKS
- 09 = EXAMINE/MONITOR SALES LEDGER
- 10 = EXAMINE/MONITOR PURCHASE LEDGER
- 11 = EXAMINE/MONITOR (INCOMPLETE RECORDS)
- 12 = EXAMINE PRODUCT SALES

#### SELECT FUNCTION BY NUMBER-

- 13 = PRINT CUSTOMER STATEMENTS
- 14 = PRINT SUPPLIER STATEMENTS
- 15 = PRINT AGENT STATEMENTS
- 16 = PRINT TAX STATEMENTS
- 17 = PRINT WEEK/MONTH SALES
- 18 = PRINT WEEK/MONTH PURCHASES
- 19 = PRINT YEAR AUDIT
- 20 = PRINT PROFIT/LOSS ACCOUNT
- 21 = UPDATE END MONTH FILES MAINTENANCE
- 22 = PRINT CASH FLOW FORECAST
- 23 = ENTER/UPDATE PAYROLL (NOT YET AVAILABLE)
- 24 = RETURN TO BASIC

#### WHICH ONE? (ENTER 1-24)

01 SUB. MENU EXAMPLE: 01 = EXAMINE: 02 = INSERT: 03 = AMEND: 04 = DELETE  
05 = PRINT (1,2,3): 06 = NUMERIC COMBINATIONS: 07 = SORT  
VERY FLEXIBLE. ADD YOUR OWN FUNCTIONS. EASY TO INTEGRATE.

All programs in BASIC for CP/M. PET. 6800

G. W. COMPUTERS LTD, the producers of this beautiful package in U.K.

WE EXPORT TO ALL COUNTRIES:  
BARCLAYCARD ACCEPTED  
CBM APPROVED

CALLERS BY APPOINTMENT ONLY  
89 Bedford Court Mansions  
Bedford Avenue  
London WC1, U.K.

CONTACT TONY WINTER 01-636-8210  
BARCLAYCARD ACCEPTED  
CBM APPROVED

CP/M Ver. 9.00 is one 16 K core program using random access releasing both drives for data storage, and 250 word vocabulary is translatable in any foreign language.

PRICES: Programs 1-23 EXC (19,20,22,23) £475

CP/M Ver. 9.00 is one 16 K core program using random access releasing both drives for data storage, and 250 word vocabulary is translatable in any foreign language.

£575 Stock Integrated Option + £100 Bank Integrated Option + £100

# Throughput is the Only True Measure of Computer Performance.

Want a 300% improvement in throughput compared to 2 MHz systems? IEEE-compatible CompuPro boards are designed *from the ground up* to operate at 6 MHz and beyond, dramatically increasing computing power and performance. Don't settle for less . . . select high speed, high reliability S-100 products from CompuPro.

**16 BITS**

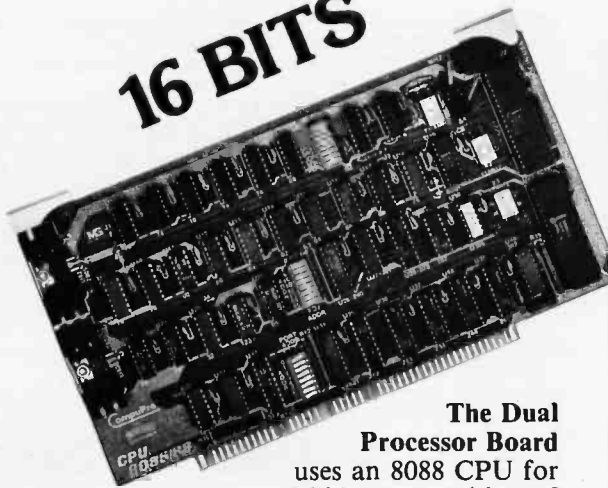

### The Dual Processor Board

uses an 8088 CPU for true 16 bit power with an 8 bit bus, and an 8085 for compatibility with CP/M and 8080 software.

**SPECIAL LOW PRICES:** \$295 unkit, \$425 assm (both operate at 5 MHz); \$525 qualified under the high-reliability Certified System Component program (with 5 MHz 8085, 6 MHz 8088).

**8 BITS**

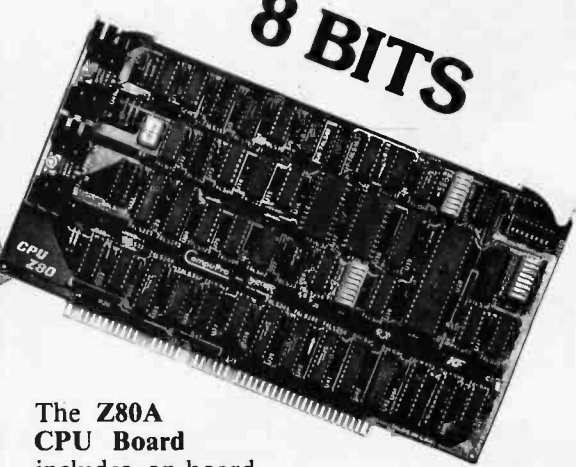

### The Z80A CPU Board

includes on-board fully maskable interrupts for interrupt-driven systems, provision for adding up to 8K of on-board EPROM, IEEE compatible 16/24 bit extended addressing, and much more. 4 MHz standard operation, but also works with 6 MHz Z80s. \$225 unkit, \$295 assm \$395 CSC.

## HIGH SPEED S-100 MEMORY and MOTHERBOARDS

RAM XX (with bank select AND extended addressing) is the perfect match for either CPU board — thanks to fully static operation, extremely low power consumption, and complete IEEE spec compatibility. All unkit and assembled memories work up to 5 MHz, while Certified System Component boards run up to 8 MHz and are guaranteed to work with 6 MHz Z80s. All CompuPro motherboards work up to 10 MHz.

|                                               | unkit | assm  | CSC   |
|-----------------------------------------------|-------|-------|-------|
| 16K RAM XX-16.....                            | \$349 | \$419 | \$519 |
| 24K RAM XX-24.....                            | \$479 | \$539 | \$649 |
| 32K RAM XX-32.....                            | \$649 | \$699 | \$799 |
| 20 slot motherboard with edge connectors..... | \$174 | \$214 | n/a   |
| 12 slot motherboard with edge connectors..... | \$129 | \$169 | n/a   |
| 6 slot motherboard with edge connectors.....  | \$89  | \$129 | n/a   |

**SEE COMPUPRO PRODUCTS IN PERSON AT COMPUTER STORES WORLD-WIDE, OR WRITE US DIRECT IF THERE'S NO STORE IN YOUR AREA.**

TERMS: Cal res add tax. Allow 5% for shipping, excess refunded. VISA®/Mastercard® orders call (415) 562-0636, 24 hours. Please include street address for UPS delivery. Sale prices good through cover month of magazine, other prices subject to change without notice.

**CompuPro**™

from

**GODBOUT**  
ELECTRONICS

Bldg. 725, Oakland Airport, CA 94614

# Fully STATIC Memory

Our memories feature fully static design to eliminate dynamic timing problems, IEEE spec compatibility, 4/5 MHz operation, low power, extensive bypassing, and careful thermal design. Choose from **unkit**, **assembled**, or boards qualified under the Certified System Component high-reliability program.

If you're looking for specs — if you're looking for performance — if you're looking for exceptional value, then look no further than the RAM series from **CompuPro**.

## STANDARD S-100 MEMORY

|                  | unkit | asmm  | CSC   |
|------------------|-------|-------|-------|
| 8K RAM II.....   | \$169 | \$189 | \$239 |
| 16K RAM XIV..... | \$299 | \$349 | \$429 |

(Includes IEEE compatible extended addressing.)

## SBC/BLC MEMORY

|                 |     |     |        |
|-----------------|-----|-----|--------|
| 32K RAM XI..... | n/a | n/a | \$1050 |
|-----------------|-----|-----|--------|

## 8085 CPU BOARD

This board is similar to the Dual Processor Board described on the facing page, but does not include the 8088 16 bit processor. **\$235 unkit, \$325 asmm, \$425 CSC.**

## SPECTRUM S-100 COLOR GRAPHICS BOARD

Includes 8K of IEEE-compatible static RAM; full duplex bidirectional parallel I/O port for keyboard, joystick, etc. interface; and 6847-based graphics generator that can display all 64 ASCII characters. 10 modes of operation, from alphanumeric/semi-graphics in 8 colors to ultra-dense 256 x 192 full graphics. 75 Ohm RS-170 line output and video output for use with FCC approved modulators. **\$339 unkit, \$399 asmm, \$449 CSC.** You don't have to settle for black and white graphics or stripped-down color boards: specify the **CompuPro Spectrum**.

Want graphics software? **Sublogic's 2D Universal Graphics Interpreter** (normally \$35) is yours for \$25 with any Spectrum board purchase.

## PASCAL/M™ + MEMORY SPECIAL

**PASCAL** — easy to learn, easy to apply — can give a microcomputer with CP/M more power than many minis. We supply a totally standard Wirth **PASCAL/M™** diskette by **Sorcim**, with manual and Wirth's definitive book on **PASCAL**, for **\$150 with the purchase of any memory board.** Specify Z80 or 8080/8085 version. **PASCAL/M™** available separately for \$175.

## GODBOUT COMPUTER ENCLOSURE

**\$289 desktop, \$329 rack mount**

This handsome enclosure does justice to the finest computer systems. Includes dual AC outlets and fuseholder on rear, heavy-duty line filter, and black anodized front panel (with textured vinyl painted cover for desktop version). Pre-drilled base accepts our high-performance S-100 motherboards or types by Vector, California Digital, and others. Rack mount version includes slides for easy pull-out from rack for maintenance of board changing.

## 2S "Interfacer I" S-100 I/O BOARD

**\$199 unkit, \$249 asmm, \$324 CSC**

Dual RS-232 ports with full handshake; EIA232C line drivers and receivers along with current loop (20 mA) and TTL signals on both ports. On-board crystal controlled timebase with independently selectable Baud rate generators for each port (up to 19.2 KBaud). Hardware UARTs.

## 3P PLUS S "Interfacer II" S-100 I/O

**BOARD \$199 unkit, \$249 asmm, \$324 CSC**

Incorporates 1 channel of serial I/O (with all the features of a port from the 2S "Interfacer I"), along with 3 full duplex parallel ports plus a separate status port. Attention/enable/strobe bits for each parallel port (with selectable polarity), interrupts for each input port, and separate connectors (with power) for each channel.

## 2708 S-100 EPROM BOARD \$85 unkit

4 independently addressable 4K blocks, with dipswitch selectable jump start right into the board. Includes all support chips and manual, but does not include EPROMs.

## NEW LOW PRICE!

### 16K DYNAMIC RAMS — 8/\$39!!

Lowest price ever on one of our most popular items. Expands memory in TRS-80\* -I and -II, as well as machines made by Apple, Exidy, Heath H89, new Pets, etc. Low power, high speed (4 MHz). Add \$3 for dipshunts plus TRS-80\* conversion instructions. **Limited quantity — first come, first served.**

\*TRS-80 is a trademark of the Tandy Corporation.

## OTHER S-100 BUS PRODUCTS

|                                               |                                  |
|-----------------------------------------------|----------------------------------|
| Active Terminator Board.....                  | \$34.50 kit                      |
| Memory Manager Board.....                     | \$59 unkit, \$85 asmm, \$100 CSC |
| Mullen Extender Board.....                    | \$59 kit                         |
| Mullen Relay/Opto-Isolator Control Board..... | \$129 kit, \$179 asmm            |
| Vector 8800V S-100 Prototyping Board.....     | \$19.95                          |

**COMING SOON:** The Multifunction Board is just about ready to go. Includes a real time day/day/month clock with battery backup capability, interrupt controller, interval timer, and LSI math processor. **Watch for it at your local computer store . . .**

TERMS: Cal res add tax. Allow 5% for shipping, excess refunded. VISA®/Mastercard® orders call (415) 582-0636, 24 hrs. COD OK with street address for UPS. Prices good through cover month of magazine.

**CompuPro™**

from

**GODBOUT**  
ELECTRONICS

Bldg. 725, Oakland Airport, CA 94614

By Netronics

ASCII/BAUDOT,  
STAND ALONE



Computer Terminal  
COMPLETE FOR ONLY \$149<sup>95</sup>

The Netronics ASCII/BAUDOT Computer Terminal Kit is a microprocessor-controlled, stand alone keyboard/terminal requiring no computer memory or software. It allows the use of either a 64 or 32 character by 16 line professional display format with selectable baud rate, RS232-C or 20 ma. output, full cursor control and 75 ohm composite video output.

The keyboard follows the standard typewriter configuration and generates the entire 128 character ASCII upper/lower case set with 96 printable characters. Features include onboard regulators, selectable parity, shift lock key, alpha lock jumper, a drive capability of one TTY load, and the ability to mate directly with almost any computer, including the new Explorer/85 and ELF products by Netronics.

The Computer Terminal requires no I/O mapping and includes 1k of memory, character generator, 2 key rollover, processor controlled cursor control, parallel ASCII/BAUDOT to serial conversion and serial to video processing—fully crystal controlled for superb accuracy. PC boards are the highest quality glass epoxy for the ultimate in reliability and long life.

**VIDEO DISPLAY SPECIFICATIONS**

The heart of the Netronics Computer Terminal is the microprocessor-controlled Netronics Video Display Board (VID) which allows the terminal to utilize either a parallel ASCII or BAUDOT signal source. The VID converts the parallel data to serial data which is then formatted to either RS232-C or 20 ma. current loop output, which can be connected to the serial I/O on your computer or other interface, i.e., Modem.

When connected to a computer, the computer must echo the character received. This data is received by the VID which processes the information, converting to data to video suitable to be displayed on a TV set (using an RF modulator) or on a video monitor. The VID generates the cursor, horizontal and vertical sync pulses and performs the housekeeping relative to which character and where it is to be displayed on the screen.

Video Output: 1.5 P/P into 75 ohm (EIA RS-170) • Baud Rate: 110 and 300 ASCII • Outputs: RS232-C or 20 ma. current loop • ASCII Character Set: 128 printable characters—

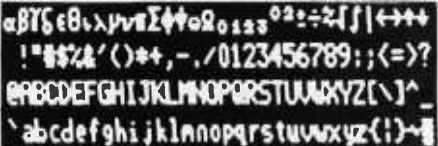

BAUDOT Character Set: A B C D E F G H I J K L M N O P Q R S T U V W X Y Z . ? : \* 3 \$ # ( ) . , 9 0 1 4 1 5 7 ; 2 / 6 8 \*  
Cursor Modes: Home, Backspace, Horizontal Tab, Line Feed, Vertical Tab, Carriage Return. Two special cursor sequences are provided for absolute and relative X-Y cursor addressing • Cursor Control: Erase, End of Line, Erase of Screen, Form Feed, Delete • Monitor Operation: 50 or 60Hz (jumper selectable).

Continental U.S.A. Credit Card Buyers Outside Connecticut

**CALL TOLL FREE 800-243-7428**

To Order From Connecticut Or For Technical Assistance, Etc. Call (203) 354-9375

Netronics R&D Ltd., Dept. B10  
333 Litchfield Road, New Milford, CT 06776

Please send the items checked below—

- Netronics Stand Alone ASCII Keyboard/Computer Terminal Kit, \$149.95 plus \$3.00 postage & handling.
- Deluxe Steel Cabinet for Netronics Keyboard/Terminal In Blue/Black Finish, \$19.95 plus \$2.50 postage and handling.
- Video Display Board Kit alone (less keyboard), \$89.95 plus \$3 postage & handling.
- 12" Video Monitor (10 MHz bandwidth) fully assembled and tested, \$139.95 plus \$5 postage and handling.
- RF Modulator Kit (to use your TV set for a monitor), \$8.95 postpaid.
- 5 amp Power Supply Kit In Deluxe Steel Cabinet (±8VDC @ 5 amps, plus 6-8 VAC), \$39.95 plus \$2 postage & handling.

Total Enclosed (Conn. res. add sales tax) \$ \_\_\_\_\_

By—

- Personal Check     Cashiers Check/Money Order
- Visa                     Master Charge (Bank # \_\_\_\_\_)

Acct. # \_\_\_\_\_

Signature \_\_\_\_\_ Exp. Date \_\_\_\_\_

Print Name \_\_\_\_\_

Address \_\_\_\_\_

City \_\_\_\_\_

State \_\_\_\_\_ Zip \_\_\_\_\_

Send Me More Information

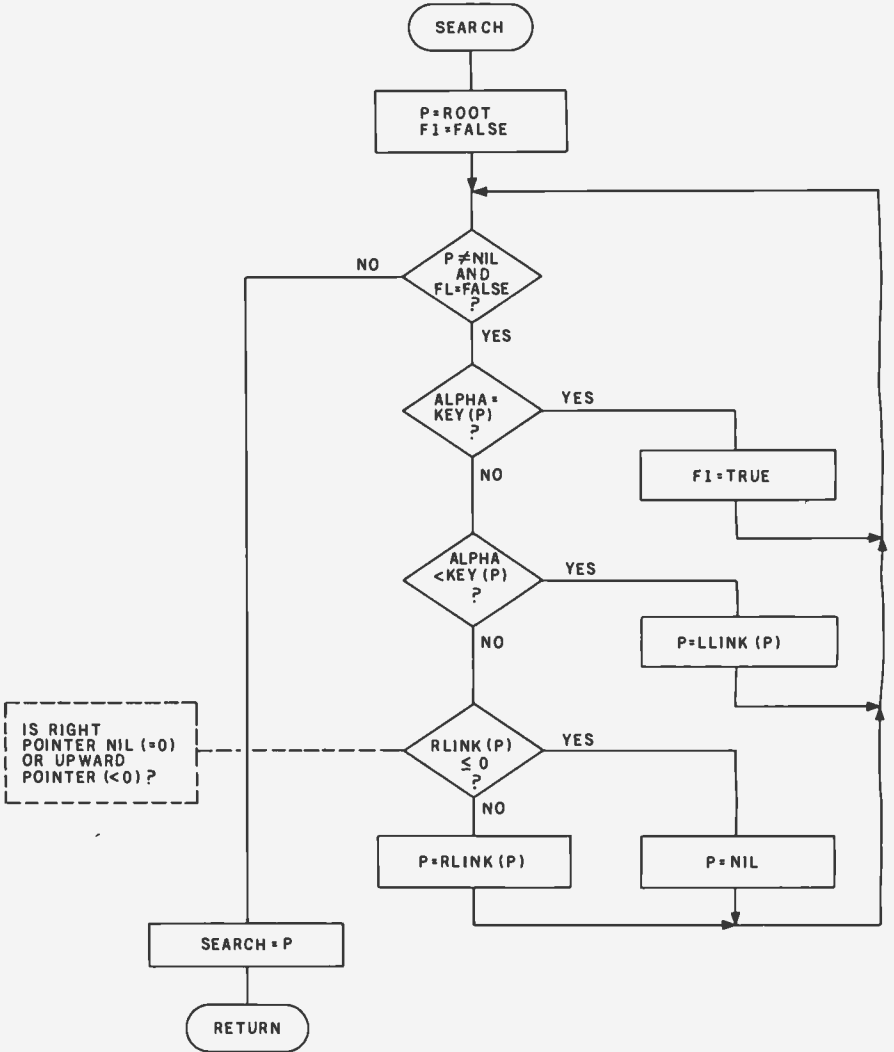

Figure 11: Flowchart for subroutine SEARCH. This subroutine searches the binary tree for a node with a key value of ALPHA.

Text continued from page 110:

will also refer to as NIL). This is node number 7, the one that contains 10 as its key. We print the value 10 and follow the right pointer back up the tree to node 2, which contains a 12. We print the 12 and follow the right pointer of this node to node 4.

Node 4 has no left child, therefore we print 14 and follow the right pointer back up the tree to node 1. At node 1, we print 15 and follow the right pointer to node 3. Node 3 has a left child, so we move from node 3 along the left pointer to node 6. Node 6 has no left child, so we print the contents of node 6, which is 20.

Following the right pointer of node 6 back to node 3, we print its value, 25. Following the right pointer of node 3 to node 5, we find the 26, which has no left child. So we print 26 and look at the right pointer of this

node. Since the right pointer is NIL, the rightmost node must have no successor. This means it is the last node in the tree, so we end the sort.

This is certainly a lot of trouble—unless you want to do more than just sort your numbers once. And it is here that the binary tree shows its greatest advantage. In most sort procedures, if you add a number to the list to be sorted, you have to completely re-sort the new list. But with a binary tree, all you have to do is add one node and list the tree (both of which take much less time than a complete re-sort).

Figure 8 shows the addition of one node, a 13, to be added to the tree of figure 7. The 13, being the eighth number in our list, becomes node 8. It is added to the tree at the bottom of the appropriate branch, necessitating the change of only one pointer in the

# Clipper™

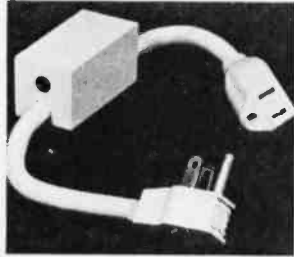
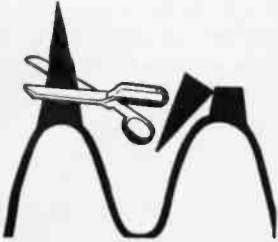

## LINE VOLTAGE TRANSIENT CLIPPING

Features Parallel Operation 5000 Hits/Second

### PROTECTS:

- Computers
- Micro-Computer Systems
- Word Processors
- Cash Registers
- Power Supplies

### PROTECTS AGAINST:

- High Energy Voltage Transients
- On-Off Switching
- Lightning Induced Transients
- Inrush of On/Off Power

MFD. by Energy Electronic Systems, Inc.

Exclusively for:



7133 RUTHERFORD ROAD  
BALTIMORE, MARYLAND 21207  
(301) 298-3130



\*\* S-100 USERS \*\*

## Is LIFE too Slow?

Specialty Video Systems celebrates the tenth anniversary of the game of *Life* with the introduction of a complete *Life* processor on a single S-100 card.

Under full software control, create dazzling video animation effects as this card displays 60 generations per second! See glider guns come to life, see spaceships zoom across the screen!

And, when you are not running *Life*, this card doubles as a 128 x 128 graphics display.

- S-100 compatible
- 128 x 128 *Life* array
- 60 generations per second
- Doubles as a graphics display
- Operates under full software control

For more information, write:

Specialty Video Systems  
P. O. Box 2662  
Van Nuys, CA 91404  
(213) 782-5137

# Omikron's Mapper + NEWDOS/80 8" Drives for the TRS-80

**NEWDOS/80** is Apparat's latest upgrade to NEWDOS. Features include variable length records, chaining, and drivers specifically configured for Omikron's MAPPER II. \$150.

**MAPPER II** adapts the TRS-80 to run both 5" and 8" drives. With NEWDOS/80, storage is increased to 300K per 8" drive. \$99 plus \$10 per cable connector.

**MAPPER I** adapts the TRS-80 to run the vast library of CP/M software as well as the TRS-80 software. All Lifeboat Software may be ordered for the MAPPER I. All MAPPER I CP/M software is compatible with the CP/M for the Model II. With MAPPER II and 8" drives, the Model I becomes disk compatible with the Model II.

Standard features include lower case support, serial and parallel printer drivers, and an addressable cursor. MAPPER I is supplied with complete utilities including a memory test, a disk test, a copy program, and a proprietary program for converting TRS-DOS files to CP/M files. \$199.

**WORD PROCESSING**—MAPPER I supports professional word processors like the Magic Wand and Word Star (see reviews in June 80 Kilobaud). Omikron's implementation includes a blinking cursor, auto repeat, shift lock, debouncing, and an input buffer that eliminates missed characters. Magic Wand super discount price \$299.

**FIELD PROVEN DESIGNS**—After one year of MAPPER production, Omikron has established an impeccable reputation for reliability, integrity, and user support. Omikron's customers include the US Government, major corporations, universities, medical doctors, and professionals in all fields.

**SYSTEMS**—Omikron sells complete systems featuring Model II compatible Shugart disk drives. Call for prices and delivery.

**FOREIGN ORDERS** must include full payment in US funds plus \$25 for air shipping and handling.

See review in July 80 BYTE By Jerry Pournelle.



**OMIKRON**

Products that set Precedents.  
1127 Hearst St Berkeley, CA 94702 (415) 845-8013

The days of complicated, unreliable, dynamic RAM are gone:

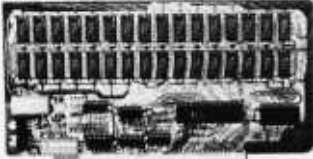

# INTRODUCING JAWS

the ultrabyte memory board

**\$199.95** (complete kit with 16K memory)

Netronics consistently offers innovative products at unbeatable prices. And here we go again — with JAWS, the ultrabyte 64K S100 memory board.

### ONE CHIP DOES IT ALL

JAWS solves the problems of dynamic RAM with a state-of-the-art chip from Intel that does it all. Intel's single chip 64K dynamic RAM controller eliminates high-current logic parts . . . delay lines . . . massive heat sinks . . . unreliable trick circuits.

### REMARKABLE FEATURES OF JAWS

Look what JAWS offers you: Hidden refresh . . . fast performance . . . low power consumption . . . latched data outputs . . . 200 NS 4116 RAMs . . . on-board crystal . . . 8K bank selectable . . . fully socketed . . . solder mask on both sides of board . . . designed for 8080, 8085, and Z80 bus signals . . . works in Explorer, Sol, Horizon, as well as all other well-designed S100 computers.

**GIVE YOUR COMPUTER A BIG BYTE OF MEMORY POWER WITH JAWS — SAVE UP TO \$90 ON INTRODUCTORY LIMITED-OFFER SPECIAL PRICES!**

UNDECIDED? TRY A WIRED 16K JAWS IN YOUR COMPUTER ON OUR 10-DAY MONEY-BACK OFFER (SPECIFY YOUR COMPUTER).

CONTINENTAL U.S.A. CREDIT CARD BUYERS OUTSIDE CONNECTICUT CALL

**CALL TOLL FREE 800-243-7428**

From Connecticut Or For Assistance, (203) 354-9375

**NETRONICS RESEARCH & DEVELOPMENT LTD.** Dept. B10  
333 Litchfield Road, New Milford, CT 06776

Please send the items checked below:

- JAWS 16K RAM kit, No. 6416, \$199.95.\*
- JAWS 16K RAM fully assembled, tested, burned in, No. 6416W, \$229.95.\*
- JAWS 32K RAM kit, No. 6432, (reg. price \$329.95), SPECIAL PRICE \$299.95.\*
- JAWS 32K RAM fully assembled, tested, burned in, No. 6432W, (reg. price \$369.95), SPECIAL PRICE \$339.95.\*
- JAWS 48K RAM kit, No. 6448, (reg. price \$459.95), SPECIAL PRICE \$399.95.\*
- JAWS 48K fully assembled, tested, burned in, No. 6448W, (reg. price \$509.95), SPECIAL PRICE \$449.95.\*
- JAWS 64K RAM kit, No. 6464, (reg. price \$589.95), SPECIAL PRICE \$499.95.\*
- JAWS 64K RAM fully assembled, tested, burned in, No. 6464W, (reg. price \$649.95), SPECIAL PRICE \$559.95.\*
- Expansion kit, JAWS 16K RAM module, to expand any of the above in 16K blocks up to 64K, No. 16EXP, \$129.95.\*

\*All prices plus \$2 postage and handling. Connecticut residents add sales tax.

Total enclosed: \$

Personal Check  Money order or Cashiers Check

VISA  MASTER CHARGE (Bank No. ....)

Acct. No. \_\_\_\_\_ Exp. Date \_\_\_\_\_

Signature \_\_\_\_\_

Print Name \_\_\_\_\_

Address \_\_\_\_\_

City \_\_\_\_\_

State \_\_\_\_\_ Zip \_\_\_\_\_

Send me more information

Deletion of nodes from the tree is not as obvious a procedure as one might suppose.

old tree: the left pointer of node 4 now points to node 8. All the other pointers remain intact, thus keeping computer time to a minimum. Best of all, no key values of nodes have been altered in the least.

It is not hard to write a subroutine that will traverse a binary tree in the proper order. Nor is it difficult to write a subroutine to add a node to a

tree—or, equivalently to add a number to a sorted list. Deletion of nodes from the tree, however, is not as obvious a procedure as one might suppose.

Detaching the node to be deleted is simply a matter of destroying the pointers from other nodes to the undesired node. But repair of the tree diagram—connecting nodes below the deleted node to the body of the tree—is not quite so easy. There are several cases to be considered, all of which are handled by the subroutine DEL.

The binary-tree-sort program in listing 1 was designed as a main routine and a collection of subroutines. A brief description of

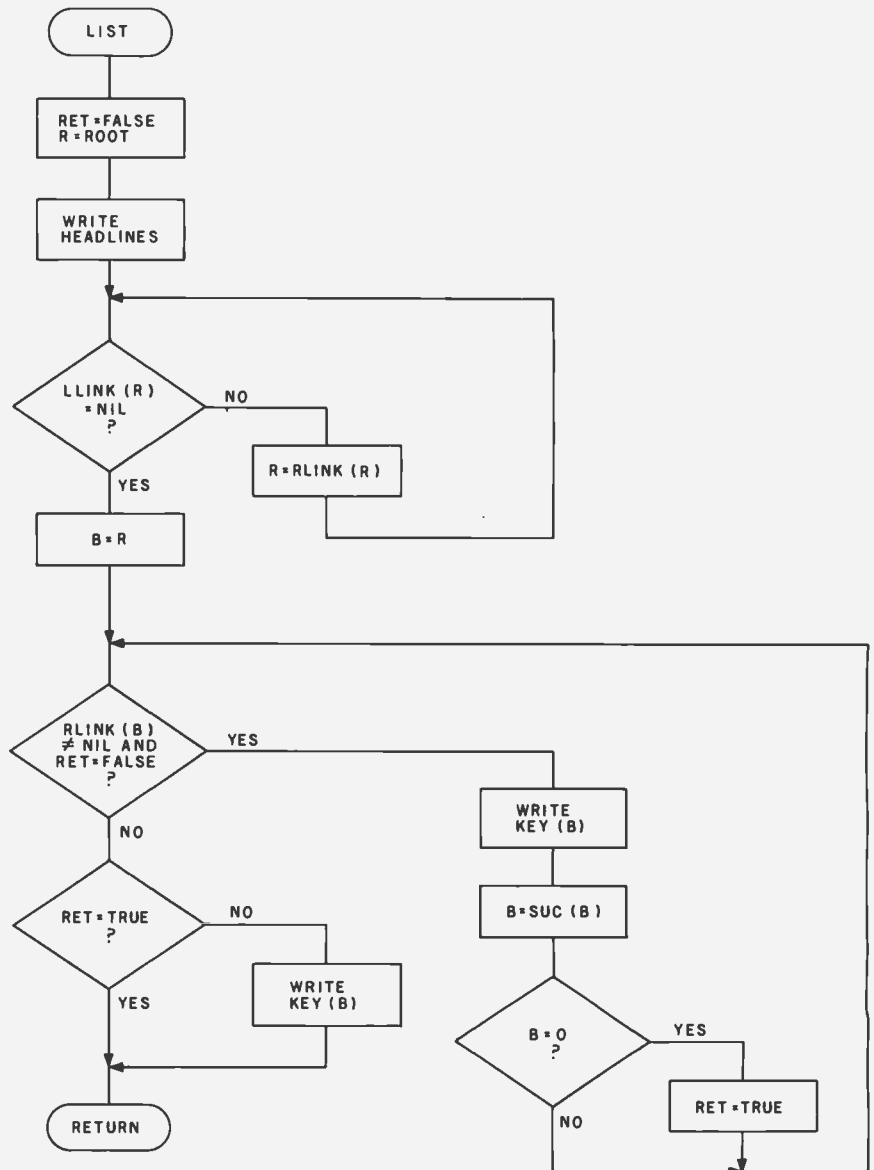

Figure 12: Flowchart for subroutine LIST. This subroutine traverses the binary tree in sorted key order and prints the nodes as they are encountered.

Circle 177 on inquiry card.

# A.25 BISYNC SDLC/SNA

IBM 2770 IBM 2780  
IBM 3270 IBM 3741  
IBM 3780  
IBM 3767

**Software for Your Microcomputer**  
8080 Z80 8086 Z8000

**WINTERHALTER & ASSOCIATES, INC.**  
3825 N. Zeeb Road Dexter, Michigan 48130  
313-426-3029 or 313-665-5582  
SPECIALISTS IN DATA COMMUNICATIONS

## SUPER SAVINGS

| CROMEMCO                                      |         | ZS-800                                                            |        |
|-----------------------------------------------|---------|-------------------------------------------------------------------|--------|
| System Three .....                            | 6195.00 | 64K Dynamic                                                       |        |
| System Two .....                              | 3195.00 | Ram Card for Z80                                                  |        |
| System Two                                    |         | Based Systems .....                                               | 695.00 |
| W/11 MB Hard Disk .....                       | 8995.00 | ZS-FDC                                                            |        |
| 3102 CRT Terminal .....                       | 1695.00 | Single Density                                                    |        |
| similar discounts on<br>all Cromemco products |         | Floppy Disk                                                       |        |
| ZOBEX/ZS SYSTEMS                              |         | Controller .....                                                  | 245.00 |
| S-100 System                                  |         | ZOBEX Z80 CPU                                                     |        |
| W/Z80 CPU                                     |         | 2 SER/2PL Ports .....                                             | 395.00 |
| ZMS-100 (32 KRAM)                             |         | ZOBEX Z80 CPU                                                     |        |
| ZS-800-FDC                                    |         | 4 SER/2PL Ports .....                                             | 475.00 |
| 6 Slot Cage .....                             | 1395.00 | SOFTWARE                                                          |        |
| ZMS-100                                       |         | Cromemco Cromix .....                                             | 265.50 |
| 64K Dynamic                                   |         | Cromemco RPG-11 .....                                             | 535.50 |
| Ram Card .....                                | 795.00  | Cromemco Lisp .....                                               | 265.50 |
|                                               |         | Professional business software<br>available at similar discounts. |        |

California Residents Add Appropriate Sales Tax.  
Call or write for information.

## TORREY PINES BUSINESS SYSTEMS, INC.

14260 GARDEN ROAD SUITE 1B POWAY, CALIFORNIA • 92064  
**(714) 486-3460**  
AUTHORIZED CROMEMCO DEALER





**Televideo**  
912 B . \$698 920 B . \$748  
912 C . \$698 920 C . \$748



**Texas Instruments**  
810 . . . . \$1,498



**Zenith**  
Z-19 . . . . \$787  
Z-89(48K) . . \$2,437



**Okidata**  
Microline 80 . . \$547



**Atari**  
800 . \$748 400 . \$445

|                                 |              |
|---------------------------------|--------------|
| Scotch - 5 1/4" Qty. 10 .....   | <b>\$29</b>  |
| Verbatim - 5 1/4" Qty. 10 ..... | <b>\$26</b>  |
| Novation - Cat .....            | <b>\$148</b> |
| Soroc - IQ 120 .....            | <b>\$696</b> |
| Kurta Digitizer .....           | <b>call</b>  |
| Mattel - Intellivision .....    | <b>\$238</b> |



**Texas Instruments**  
99/4 Console . . . . \$656  
99/4 Color Monitor . \$400  
(when purchased w/ console . \$200)

**We Also Buy and Sell Used Micro Computers & Peripherals.**

Prices reflect 3% cash discount. Add 3% for credit card orders.  
Product shipped in factory cartons with manufactures warranty.  
Add 2%, a minimum of \$5, for shipping and handling.



# 602-954-6109

2222 E. Indian School Rd. • Phoenix, Arizona 85016

We will try to beat any advertised prices!

# OUR PRICES ARE TOO LOW TO ADVERTISE!

CHECK THEM—CALL TOLL FREE!

## 800-243-7428

LOOK WHAT WE OFFER!

- HAZELTINE  
Terminals
- CENTRONICS  
Printers
- LEAR-SIEGLER  
Terminals/ Printers
- DATAPRODUCTS  
Printers
- ANNADEX  
Printers

# BE SMART- DON'T BUY UNTIL YOU CHECK OUR PRICES!

- \_\_\_ MASTERCHARGE
- \_\_\_ VISA    \_\_\_ COD
- \_\_\_ PERSONAL CHECK
- \_\_\_ MONEY ORDER

## NETRONICS

RESEARCH & DEVELOPMENT, LTD.  
333 Litchfield Rd., New Milford, CT 06776

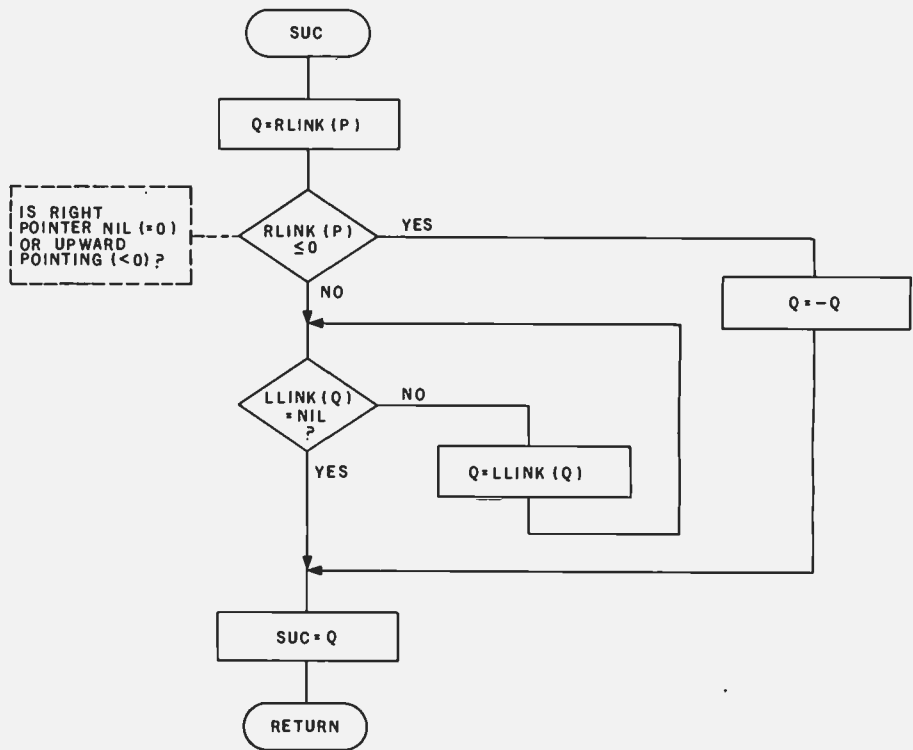

Figure 13: Flowchart for subroutine SUC. This subroutine, given for a node P, finds the number of the node that is the successor of node P in the sorted-key sequence.

each subroutine (given below) and a flowchart describe the operation of each of the subroutine modules. Each of the subroutines was written in structured fashion. Although the main routine is also structured, the current listing reflects a certain amount of modification and experimentation; in other words, it has not been rewritten for optimal structure.

The main routine of listing 1 contains the following sequence: an array of 100 random integers is created and used to create a sorted binary tree; the binary tree is listed; then the user is given the options of adding to the tree, listing the tree, or deleting from the tree. All the necessary subroutines are included in this listing.

This program was originally written in FORTRAN and was later translated to BASIC, running first on a PET, then on an Apple II. The program contains some redundancies so that the program will run as written on both machines; the only restriction is that line 5 must be deleted before running the program on the PET. The structured programming techniques used in writing the

original FORTRAN version proved to be quite necessary when translating and debugging the BASIC version. I feel that structured programming techniques are essential to a program of any size.

### Subroutine Descriptions

**FIX:** The purpose of the subroutine FIX (see flowchart in figure 9) is to initialize all the space to be used for tree nodes before the binary tree is built. The FIX subroutine must be presented with N, the maximum number of nodes to be available to the tree. Once the tree has N nodes, there are no provisions in this program to make additional space available.

**BILDER:** Subroutine BILDER adds a new data entry to the binary tree, placing it in correct relation to the other nodes in the tree. Within the BILDER routine, the node to be added is numbered Q and has a value of KEY(Q). The algorithm (see flowchart in figure 10) compares the node to be added, Q, with other nodes (starting with the root node and moving down the tree) until it can be placed in proper relation to a



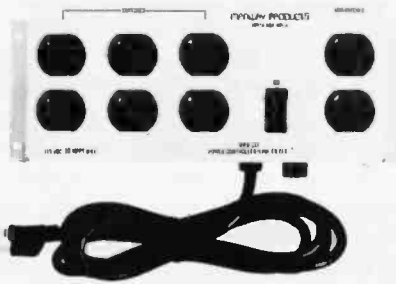

MPD 117

## NO "GLITCHES", SURGES OR INTERFERENCE

Clean power distribution for your:

- Microcomputer system
- Audio Visual system
- Lab instrumentation

Marway Products' new MPD 117 AC Power Controller upgrades a standard AC utility outlet into a convenient noise-free source of AC power. The MPD 117 features:

- High energy EMI filter
- Transient voltage suppressor
- 10 amp circuit breaker
- 6 switched outlets
- 2 direct (unswitched) outlets
- Illuminated "on/off" switch
- UL recognized components

At \$89.00 (plus tax and shipping) the MPD is the low-cost solution to your power distribution needs, and the best dollar value available in AC power distribution and noise suppression products.

Marway can solve your power distribution problems and save you money.

### MARWAY PRODUCTS INC.

2421 S. Birch St., Santa Ana, CA 92707 (714) 549-0623

## INVENTORY CONTROL

### MATERIAL REQUIREMENTS PLANNING FOR THE MICRO-COMPUTER

| TIME PERIOD   | PAST DUE | 01/01/80 | 02/01/80 | 12/01/80 |
|---------------|----------|----------|----------|----------|
| GROSS REQ     |          | 5        | 10       | 30       |
| SCHED RECPTS  |          | 0        | 0        | 0        |
| PROJ. ON HAND | 10       | 5        | 0        | 0        |
| PLAN RECEIPTS | 0        | 0        | 5        | 30       |
| PLAN RELEASES | 5        | 10       | 10       | 0        |

#### FEATURES INCLUDE

- FAST KEY RANDOM ACCESS
- MULTIPLE LOCATION INVENTORY
- INVOICE PRINTING
- SECURITY
- JOB COSTING
- DISPLAY OF ANY RECORD

#### REPORTS INCLUDE

- MRP FOR 12 TIME PERIODS
- ITEM MASTER
- OPEN ORDER
- BILL OF MATERIAL
- WHERE USED
- INVENTORY VALUE
- MASTER SCHEDULE

For more information on MRP-1 or any of our other inventory control systems, call or write:

## MM MICRO MANUFACTURING SYSTEMS

INVENTORY SYSTEMS CONSULTANTS

1670 Norma Rd. • Columbus, Ohio 43229

Phone: (614) 885-0738

## 32 K BYTE MEMORY RELIABLE AND COST EFFECTIVE RAM FOR 6502 & 6800 BASED MICROCOMPUTERS

AIM 65-\*KIM\*SYM  
PET\*S44-BUS

- PLUG COMPATIBLE WITH THE AIM-65/SYM EXPANSION CONNECTOR BY USING A RIGHT ANGLE CONNECTOR (SUPPLIED) MOUNTED ON THE BACK OF THE MEMORY BOARD.
- MEMORY BOARD EDGE CONNECTOR PLUGS INTO THE 6800 S 44 BUS.
- CONNECTS TO PET OR KIM USING AN ADAPTOR CABLE.
- RELIABLE—DYNAMIC RAM WITH ON BOARD INVISIBLE REFRESH—LOOKS LIKE STATIC MEMORY BUT AT LOWER COST AND A FRACTION OF THE POWER REQUIRED FOR STATIC BOARDS.
- USES +5V ONLY. SUPPLIED FROM HOST COMPUTER.
- FULL DOCUMENTATION. ASSEMBLED AND TESTED BOARDS ARE GUARANTEED FOR ONE YEAR AND PURCHASE PRICE IS FULLY REFUNDABLE IF BOARD IS RETURNED UNDAMAGED WITHIN 14 DAYS.

|                                  |          |
|----------------------------------|----------|
| ASSEMBLED WITH 32K RAM           | \$419.00 |
| & WITH 16K RAM                   | \$349.00 |
| TESTED WITHOUT RAM CHIPS         | \$279.00 |
| HARD TO GET PARTS (NO RAM CHIPS) |          |
| WITH BOARD AND MANUAL            | \$109.00 |
| BARE BOARD & MANUAL              | \$49.00  |

PET INTERFACE KIT—CONNECTS THE 32K RAM BOARD TO A 4K OR 8K PET. CONTAINS: INTERFACE CABLE, BOARD STANDOFFS, POWER SUPPLY MODIFICATION KIT AND COMPLETE INSTRUCTIONS. \$49.00

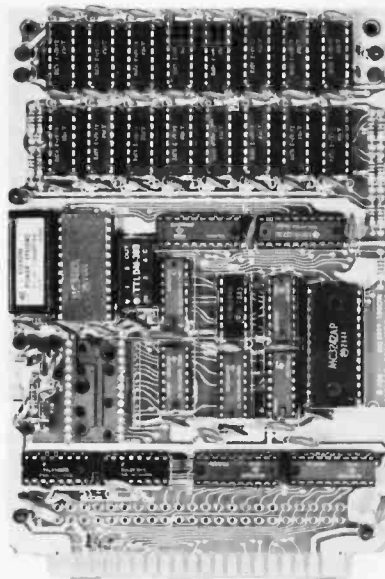

U.S. PRICES ONLY

## 16K MEMORY EXPANSION KIT ONLY \$58

FOR APPLE, TRS-80 KEYBOARD, EXIDY, AND ALL OTHER 16K DYNAMIC SYSTEMS USING MK4116-3 OR EQUIVALENT DEVICES.

- ★ 200 NSEC ACCESS, 375 NSEC CYCLE
- ★ BURNED-IN AND FULLY TESTED
- ★ 1 YR. PARTS REPLACEMENT GUARANTEE
- ★ QTY. DISCOUNTS AVAILABLE

ALL ASSEMBLED BOARDS AND MEMORY CHIPS CARRY A FULL ONE YEAR REPLACEMENT WARRANTY

## BETA

COMPUTER DEVICES

1230 W. COLLINS AVE.  
ORANGE, CA 92668  
(714) 633-7280

Call. residents please add 6% sales tax. Mastercharge & Visa accepted. Please allow 14 days for checks to clear bank. Phone orders welcome. Shipping charges will be added to all shipments.

Now-Break Through The 64K  
Micro-Memory Limit!

# SWEET SIXTEEN

Bank Selectable 16K Static RAM

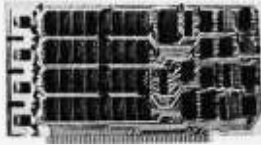

**SAVE \$50.00**  
**LIMITED TIME OFFER**

Don't buy any more antique RAMs (RAM without bank select) — now there's Netronic's new SWEET SIXTEEN board featuring a universal software bank select system. SWEET SIXTEEN is capable of addressing 2,048 different banks. With SWEET SIXTEEN boards you can add memory beyond the 64K limit, or expand to a multi-terminal system.

### LOOK AT THESE FEATURES:

- 300 NS, low power 2114's.
- **Software Bank Selector** — Universal decoder works with Cromenco, Alpha Micro, Netronics, most other systems, or your design. Onboard dip switches: Bank Select Enable; Reset Enable; Reset Disable; Port Address; Port Data.
- **All Inputs And Outputs** meet the proposed IEEE standards for the S-100 bus.
- 4.0 MHz Operation.
- Schmitt Trigger Buffer on all signals for maximum noise immunity.
- **Addressable On 16k Boundaries**, 0-64k, dip switch selectable.
- **Phantom Option**, dip switch selectable.
- **PWR/MWRITE Option**, dip switch selectable.
- **LED Indicator** to display status.
- **Glass Epoxy PC Board** with gold-plated contacts and double-sided solder mask.
- **Fully Socketed**.
- **Four Separate Regulators** for maximum stability.

**10-Day Money-Back Policy For Wired & Tested Unit:** Try a fully wired board — then either keep it, return it for kit, or simply return it in working condition.

Continental U.S.A. Credit Card Buyers  
Outside Connecticut:

**CALL TOLL FREE:**  
**800-243-7428**

From Connecticut Or For Assistance:  
(203) 354-9375

Please send the items checked below:

- SWEET SIXTEEN kit; No. S-16 ... (reg. price \$249.95) now \$199.95\*
- SWEET SIXTEEN, fully assembled, tested, burned in; No. S-16W ... (reg. price \$289.95) now \$239.95\*

\*Plus \$2 postage & insurance. Connecticut residents add sales tax.

Total Enclosed: \$ \_\_\_\_\_

- Personal Check    Money Order/Cashier's Check
- VISA    Master Charge (Bank No. \_\_\_\_\_)

Acct. No. \_\_\_\_\_ Exp. Date \_\_\_\_\_

Signature \_\_\_\_\_

Print \_\_\_\_\_

Name \_\_\_\_\_

Address \_\_\_\_\_

City \_\_\_\_\_

State \_\_\_\_\_ Zip \_\_\_\_\_

## NETRONICS

RESEARCH & DEVELOPMENT, LTD.  
333 Litchfield Rd., New Milford, CT 06776

parent node (a node that has a NIL pointer pointing to where node Q should go).

**SEARCH:** The SEARCH subroutine (see figure 11) returns the node number of a key with value ALPHA. The node number (or zero if the node is not found) is returned in the variable SEARCH. The search done is not a linear search but rather a *binary search* like the one used in BILDER. A binary search is named such because each decision halves the area to be searched.

**LIST:** The LIST subroutine (see figure 12) lists the nodes of the tree in ascending key sequence by traversing

the tree from its leftmost to its rightmost node. LIST follows an optimal path down the leftmost branch of the tree until it encounters a node the left pointer of which has value NIL; this node contains the smallest key value. Having found the smallest key value, LIST then calls SUC (the successor subroutine) repeatedly to find successor nodes; key values are printed in the order they are encountered. When a node is found that has a right pointer of value NIL, the node with the highest key value has been found, and the LIST subroutine has finished.

Text continued on page 260

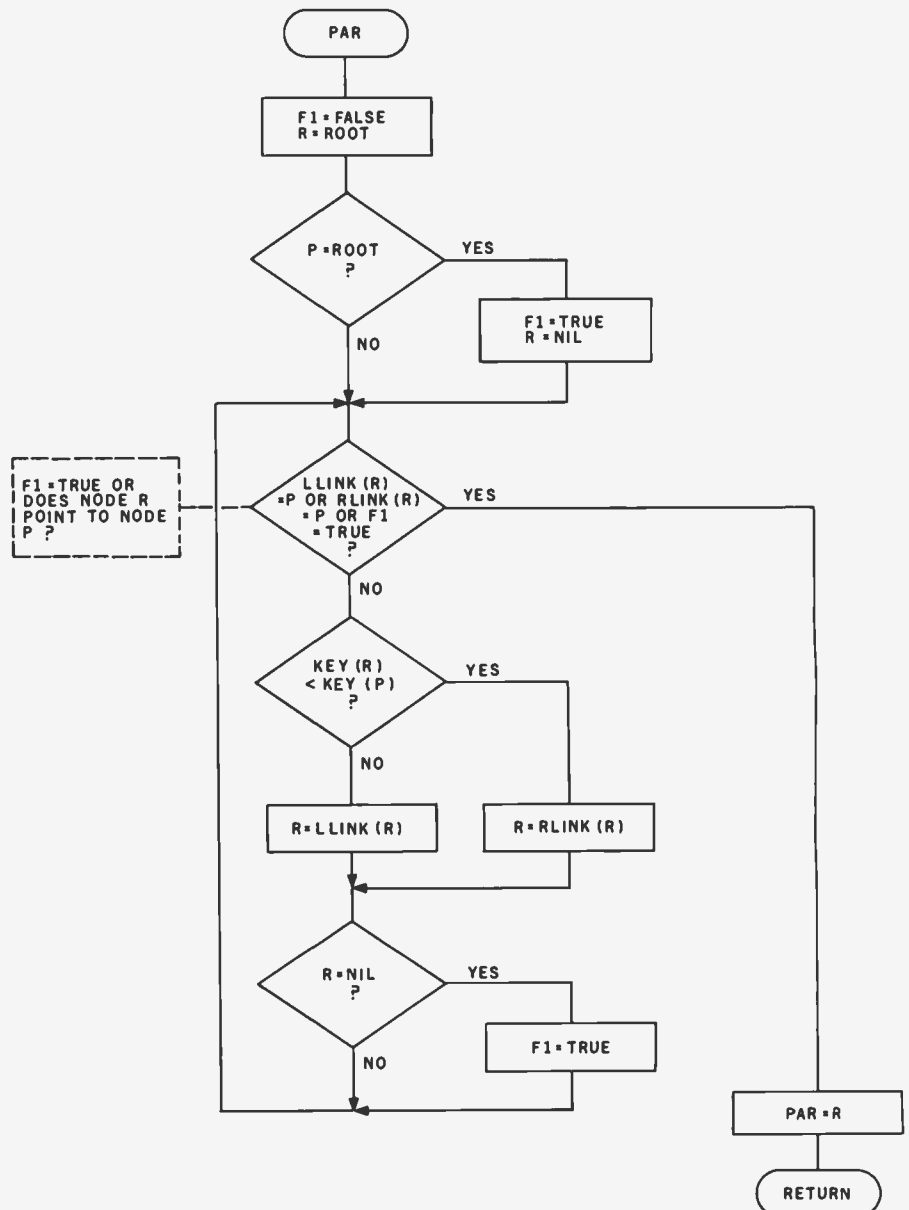

Figure 14: Flowchart for subroutine PAR. This subroutine finds the parent node of a given node P.

A MCGRAW-HILL PUBLICATION

# onComputing™

GUIDE TO PERSONAL COMPUTING

**GETTING STARTED**  
What You Need And What It Will Cost

**EQUIPMENT REVIEWS**  
TRS-80, Apple, Sorcerer and PET

Best-Selling Author  
**JERRY POURNELLE**  
"Writing With A Microcomputer"  
**THE BINARY WORLD**

Also...  
**A PERSONAL  
COMPUTER DIRECTORY**  
**COMPUTER CLUBS:  
WHO NEEDS THEM?**

Plus much much more  
for the new computer user



## When will the Personal Computer Explosion touch YOU?

Are you prepared for the explosive transformation? Right in your own home? Electronic mail. Personalized investment analysis. Foreign language tutorial. Home energy management. Robots. Computer music. Secretarial service. Diet and menu planning. And more, more, more.

**onComputing™**, the new McGraw-Hill quarterly, prepares you for the enormous changes coming during the

1980's (Some are already here). **onComputing™** explains in nontechnical language what personal computers are, how they work, and how you can use them at home, for fun and profit.

Don't let the personal computer explosion catch you off guard. Know what's happening and help make it happen! Prepare now for the exciting future with a subscription to **onComputing™!**

**Call Toll-Free  
800-258-5485**

**Start your  
subscription today.**

**onComputing™** Subscription Dept. P.O. Box 307, Martinsville, NJ 08836

DOMESTIC subscription rate:

U.S. 1 yr. (4 issues) @ \$8.50  Canada & Mexico, 1 yr. (4 issues) @ \$10.00

FOREIGN (to expedite service, please remit in U.S. funds drawn on a U.S. bank.)

Europe (and all other countries, except above), 1 yr. @ \$12.00 — surface delivery.

Bill Visa  Bill Master Charge  Bill me (North America only)

Card Number

Expiration

Signature

Name (please print)

Street/Apartment Number

City

State/Province/Country Code

7BA0

Please allow 6-8 weeks for processing.

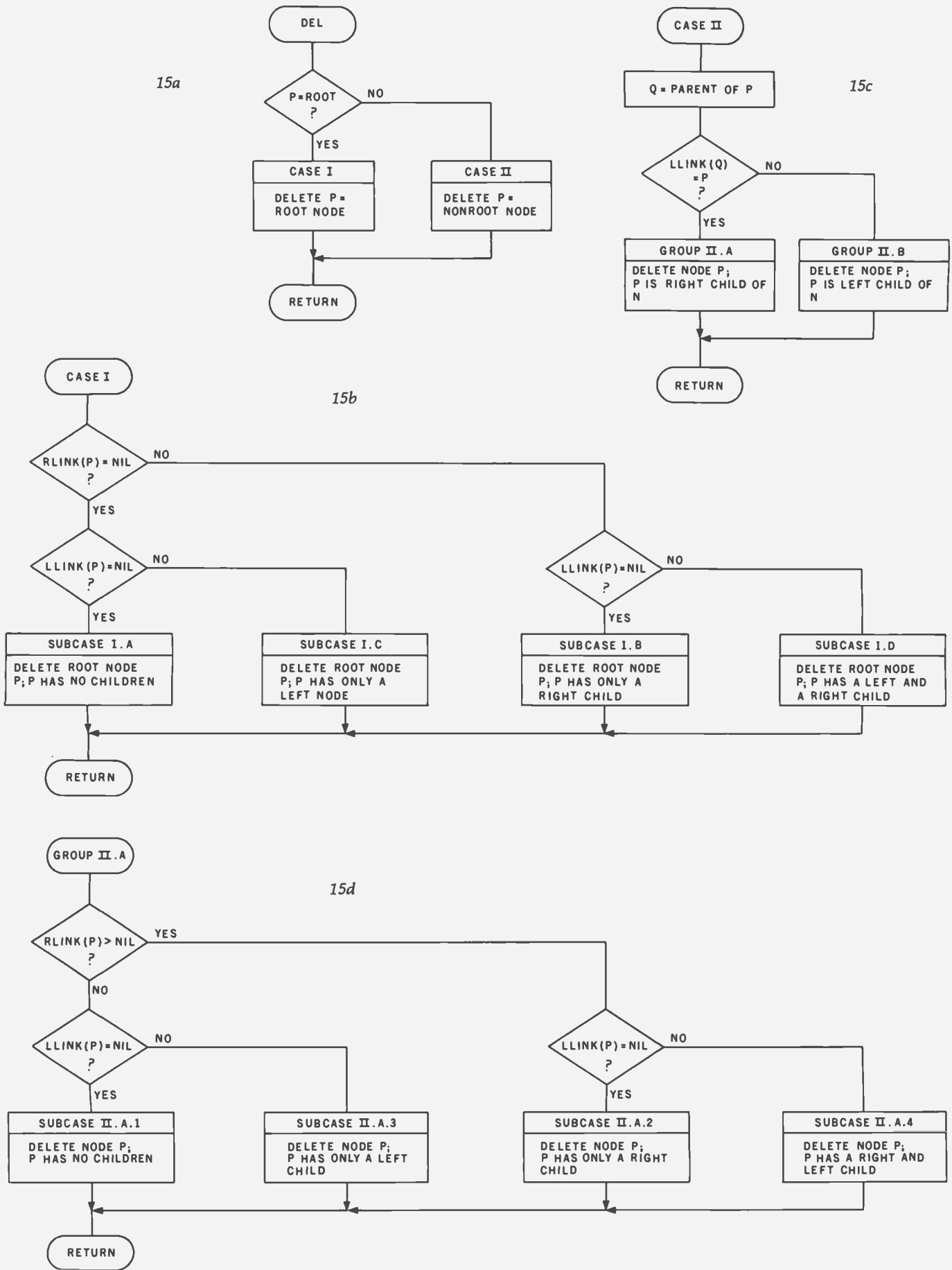
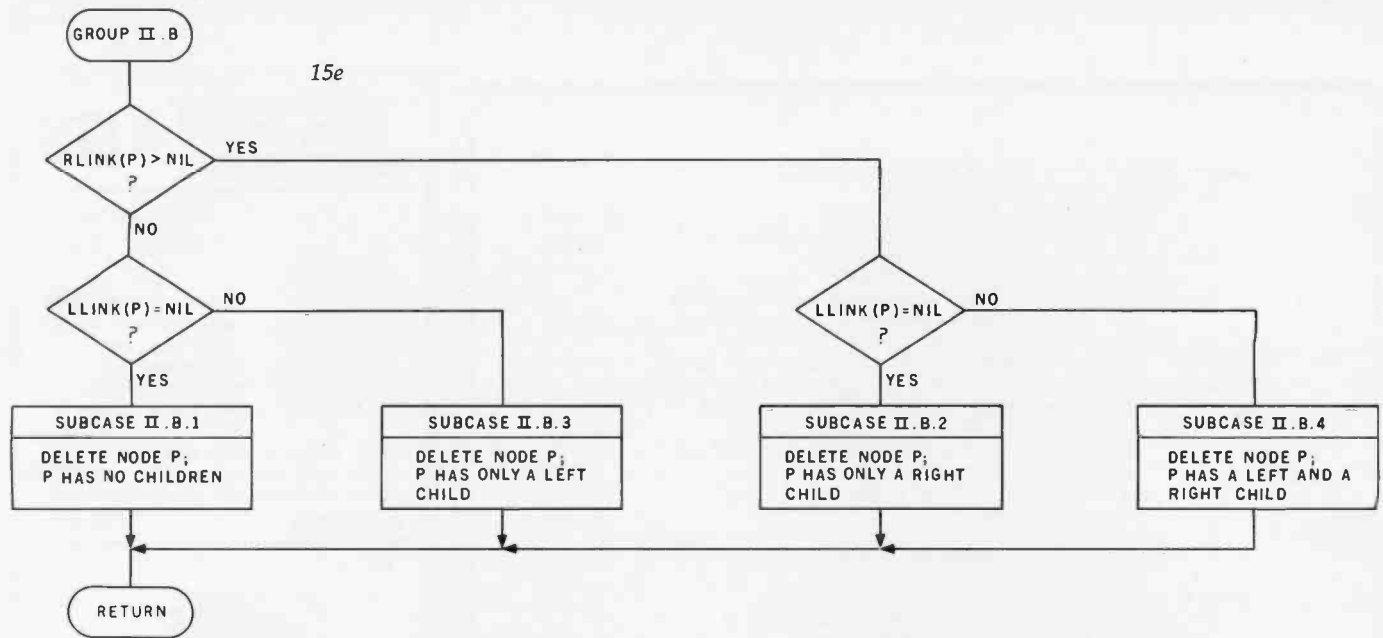

Figure 15: Flowchart for subroutine DEL. Figures 15a thru 15e describe the algorithm, with further description given in table 1. Case I is executed when the node to be deleted, P, is the root node. Case II, group A is executed when the node to be deleted, P, is the left child of a parent node. Case II, group B is executed when the node to be deleted, P, is the right child of a parent node.



SciTronics introduces the first small computer based power monitor . . .

# NEW! ENERGY WATTCHER™

Now have your computer continuously measure, calculate and record your power consumption and cost. Receive energy reports every minute, 15 minute, hour, day and month period.

- Available for TRS-80-I, Apple II & S-100 computers.
- Easy installation clip-on probes supplied.
- Qualify for a 15% energy tax credit.
- Compatible with Remote Controller & Real Time Clock for complete Energy Management System.
- Inexpensive—only \$295.

## Remote Controller & Real Time Clock Available

Have full computer control of up to 256 lights, appliances and even wall switches **without special wiring**. The SciTronics REMOTE CONTROLLER permits direct control of the inexpensive BSR remote line-carrier switches sold by Sears, Radio Shack and many others.

- Controls all 256 BSR remote switches—not just 16
- Hardware driven—requires minimal software
- No ultrasonic link—prevents erratic operation
- No BSR command module necessary
- Real time, crystal controlled clock available

The controller comes complete with full documentation, sample software and is designed to work with most of the popular computers including any S-100 based system, TRS-80-1, Apple II, Heath H8 and others.

Real time clocks are available for all of the above computer systems. When used with the controller, true time scheduling is realized. All clocks are crystal controlled and have battery backup for accurate and reliable operation. Interrupts allow Foreground/Background operation of two programs simultaneously. Clock data includes year, month, date, day of week, hour, minute, and second.

### Applications:

- Make your entire home or apartment computer controlled
- Save energy by controlling lights & appliances
- Control security systems & alarms

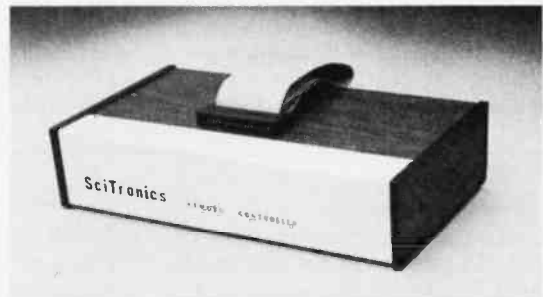

Remote switches not included

|                                                              |               |
|--------------------------------------------------------------|---------------|
| ENERGY WATTCHER                                              | <b>\$295.</b> |
| S-100 CONTROLLER BOARD                                       | <b>\$159.</b> |
| S-100 REAL TIME CLOCK BOARD                                  | <b>\$139.</b> |
| ENCASED CONTROLLER (TRS-80, Apple II etc.)                   | <b>\$184.</b> |
| ENCASED CONTROLLER & REAL TIME CLOCK (TRS-80, Apple II etc.) | <b>\$269.</b> |
| APPLE II CLOCK BOARD                                         | <b>\$109.</b> |

Send check or money order to: **SciTronics Inc.**  
523 S. Clewell St., P.O. Box 5344  
Bethlehem, PA 18015  
(215) 868-7220

Please list system with which you plan to use peripheral. Master Charge and Visa accepted. PA residents add sales tax. COD's accepted.

Dealer Inquiries Invited

- Case I: Node P to be deleted is the root node.
- Subcase A: Node P has no children.
    1. Set EMPTY = TRUE.
    2. Set N (the number of nodes in the tree) to zero.
  - Subcase B: Node P has only a right child.
    1. Set new root equal to right link of old root.
  - Subcase C: Node P has only a left child (see figure 16a).
    1. Set new root equal to the left link of the old root.
    2. Search right branch of left child of P for its rightmost node R. Set the right pointer of R to NIL.
  - Subcase D: Node P has a left and a right child (see figure 16b).
    1. Set new root equal to the right link of old root.
    2. Search left branch of right child of P for its leftmost node S. (S will have a left pointer of NIL.) Set left pointer of S to the left child of the old root (that is, to point to the left subtree of the old graph).
    3. Search right branch of left child of P for its rightmost node R. Set right pointer of R to point to S.
- Case II: Node P to be deleted is not the root node.
- Group A: Node P is the left child of parent node Q.
    - Subcase 1: Node P has no children.
      - a. Set LEFT link of parent Q to NIL.
    - Subcase 2: Node P has only a right child.
      - a. Set LEFT pointer of parent node Q to right child of P.
    - Subcase 3: Node P has only a left child (see figure 16c).
      - a. Set LEFT pointer of parent node Q to left child of P.
      - b. Search right branch of left child of P for its rightmost node R; this node will have an upward right pointer to P. Assign the right pointer of R the value of the right pointer of P.
    - Subcase 4: Node P has a left and a right child (see figure 16d).
      - a. Set LEFT pointer of parent node Q to right child of P.
      - b. Search left branch of right child of P for its leftmost node S. (S will have a left pointer of NIL.) Assign the left pointer of S the value of the left pointer of P.
      - c. Search right branch of left child of P for its rightmost node R. Assign the right pointer of R the value -S.
  - Group B: Node P is the right child of parent node Q. (Subcases 1 thru 4 are the same if the word RIGHT is substituted for the capitalized word LEFT in each subcase.)

**Table 1:** Analysis of node deletion in a threaded binary tree. This table details the operations necessary to delete a node, labeled P, from a threaded binary tree. This table is associated with figure 15, figure 16, and listing 1.

Text continued from page 256:

**SUC:** The SUC subroutine, shown in figure 13, when given the node numbered P, returns the value SUC, which is the number of the node that follows node P in the ascending key sequence. If the right pointer of P, named Q, is an upward pointer (value less than zero), the absolute value of the pointer is the successor node. If Q is a downward pointer, the leftmost child of Q is the successor node. A SUC value of NIL is returned if node P is the rightmost node in the tree.

**PAR:** The PAR subroutine, shown in figure 14, returns in variable PAR the number of the parent node of node P. (Remember that every node in a binary tree except the root node has exactly one parent node.) As in

**BILDER** and **LIST**, a binary search starting at the root uses the values of the current node key and the key of node P to guide the search down the tree until the parent of P is found. This method is much faster than linearly traversing the tree using the SUC subroutine.

**DEL:** The DEL subroutine to delete a node from the tree is the most complicated of the subroutines presented. This is due largely to the necessity of reestablishing the thread that runs through the tree. The algorithm for node deletion is given in figure 15 and table 1; the examples in figure 16 are referred to by table 1.

### A Pascal Implementation

A second and somewhat different

SWITCHES CRYSTALS CONNECTORS HEAT SINKS FUSEHOLDERS TEST CLIPS BOOKS KITS DIP JUMPERS CABLE ASSEMBLIES INTEGRATED CIRCUITS MICROPROCESSOR LEADS



---



### FUNCTION GENERATOR KIT

Provides three basic waveforms: sine, triangle & square wave. Freq. range from 1Hz to 100K Hz. Output amplitude from 0-volts to over 6 volts (peak to peak). Uses a 12V supply or a ±6V split supply. Includes chip, PC board, components and instructions.

**JE2206B . . . . . \$19.95**

---



### VARIABLE POWER SUPPLY KIT

Full 1.5 amp @ 5-10V output. Up to .5 amp @ 15V output. Heavy duty transformer. 3-terminal I.C. voltage regulator. Heat sink provided for cooling efficiency. PC board construction. 120VAC input. Size: 3½" x 5" x 2" H

**JE210 . . . . . \$19.95**

---



### 4-DIGIT CLOCK KIT

Bright .357" h. red display. Sequential flashing colon. 12 or 24 hr. operation. Extruded aluminum case (black). Pressure switches for hrs., min. and hold functions. Incl. all components, case and wall transformer. Size: 3¼" x 1¼" x 1¼"

**JE730 . . . . . \$14.95**

---



### Digital Thermometer Kit

Dual sensors, control switch for indoor/outdoor or dual monitoring — can be extended to 500 ft. Continuous LED .8" ht. display. Range: -40°F to 199° F. -40° C to 100° C. Accuracy: ± 1° nominal. Calibrate for Fahrenheit or Celsius. Simulated walnut case. AC wall adapter included. Size: 3¼" h x 5-5/8" w x 1-3/8" d.

**JE300 . . . . . \$39.95**

Available Today At Your  
Local JIM-PAK® Distributor!  
JIM-PAK® Belmont, Calif. 94002

|                                                                                                                                                                                                                                                                                                                                                                                                                                                                                                                                                                                                                                                                                                                                                                                                                                                                                                                                                                                                                                                                                                                                                                                                                                                                                                                                                                                                                                                                |                                                                                                                                                                                                                                                                                                                                                                                                                                                                                                                                                                                                                                                                                                                                                                                                                                                                                                                                                                                                                                                                                                                                                                                                                                                                                                                                                                                                                                                                                                                                                                                                                                                                                                                                                                                                                                                                                                                                                                                                                                                                                                                                                                                                                                                                                                                                                                                        |                                                                                                                                                                                                                                                                                                                                                                                                                                                                                                                                                                                                                                                                                                                                                                                                                                                                                                                                                                                                                                                                                                                                                                                                                                                                                                                                                                                                                                                               |                                                                                                                                                                                                                                                                                                                                                                                                                                                                                                                                                                                                                                                                                                                                                                                                                                                                                                                                                                                                                                                                                                                                                                                                                                                                                                                                                                                                                                                                                                                                                                                                                                                                                                                                                                                                                                                                                                                                                                                                                                                                                                                                                                                                                                                                                                                                                                                                                                                                                                          |                                                                                                                                                                                                                                                                                                                                                                                                                                                                                                                                                                                                                                                                                                                                                                                                                                                                                                                                                                                                                                                                                                                                                                                                                                                                                                                                                                                                                                                             |                                                                                                                                                                                                                                                                                                                                                                                                                                                                                                                                                                                                                                                                                                                                                                                                                                                                                                                                                                                                                                                                                                                                                                                                                                                                                                                                                                                                                                                                                                                                                                                                                                                                                                                                                                                                                                                                                                                                                                                                                                                                                                                                                                                                                                                                                                                                                             |                                                                                                                                                                                                                                                                                                                                                                                                                                                                                                                                                                                                                                                                                                                                                                                                                                                                                                                                                                                                                                                                                                                                                                                                                                                                                                                                                                                                                                                                                                                                                                                                                                                                                                                                                                                                                                                                                                                                                                                                                                                                                                                                                                                                                                                                                                                                                                                                                                                                                                                                                                                                                                                                                                                                                                                                                                                                                                                                                                                                                                                                                                                                                                                                                                                                                                                                                                                                                                                                                                                                                                                                                                                                                                                                                              |
|----------------------------------------------------------------------------------------------------------------------------------------------------------------------------------------------------------------------------------------------------------------------------------------------------------------------------------------------------------------------------------------------------------------------------------------------------------------------------------------------------------------------------------------------------------------------------------------------------------------------------------------------------------------------------------------------------------------------------------------------------------------------------------------------------------------------------------------------------------------------------------------------------------------------------------------------------------------------------------------------------------------------------------------------------------------------------------------------------------------------------------------------------------------------------------------------------------------------------------------------------------------------------------------------------------------------------------------------------------------------------------------------------------------------------------------------------------------|----------------------------------------------------------------------------------------------------------------------------------------------------------------------------------------------------------------------------------------------------------------------------------------------------------------------------------------------------------------------------------------------------------------------------------------------------------------------------------------------------------------------------------------------------------------------------------------------------------------------------------------------------------------------------------------------------------------------------------------------------------------------------------------------------------------------------------------------------------------------------------------------------------------------------------------------------------------------------------------------------------------------------------------------------------------------------------------------------------------------------------------------------------------------------------------------------------------------------------------------------------------------------------------------------------------------------------------------------------------------------------------------------------------------------------------------------------------------------------------------------------------------------------------------------------------------------------------------------------------------------------------------------------------------------------------------------------------------------------------------------------------------------------------------------------------------------------------------------------------------------------------------------------------------------------------------------------------------------------------------------------------------------------------------------------------------------------------------------------------------------------------------------------------------------------------------------------------------------------------------------------------------------------------------------------------------------------------------------------------------------------------|---------------------------------------------------------------------------------------------------------------------------------------------------------------------------------------------------------------------------------------------------------------------------------------------------------------------------------------------------------------------------------------------------------------------------------------------------------------------------------------------------------------------------------------------------------------------------------------------------------------------------------------------------------------------------------------------------------------------------------------------------------------------------------------------------------------------------------------------------------------------------------------------------------------------------------------------------------------------------------------------------------------------------------------------------------------------------------------------------------------------------------------------------------------------------------------------------------------------------------------------------------------------------------------------------------------------------------------------------------------------------------------------------------------------------------------------------------------|----------------------------------------------------------------------------------------------------------------------------------------------------------------------------------------------------------------------------------------------------------------------------------------------------------------------------------------------------------------------------------------------------------------------------------------------------------------------------------------------------------------------------------------------------------------------------------------------------------------------------------------------------------------------------------------------------------------------------------------------------------------------------------------------------------------------------------------------------------------------------------------------------------------------------------------------------------------------------------------------------------------------------------------------------------------------------------------------------------------------------------------------------------------------------------------------------------------------------------------------------------------------------------------------------------------------------------------------------------------------------------------------------------------------------------------------------------------------------------------------------------------------------------------------------------------------------------------------------------------------------------------------------------------------------------------------------------------------------------------------------------------------------------------------------------------------------------------------------------------------------------------------------------------------------------------------------------------------------------------------------------------------------------------------------------------------------------------------------------------------------------------------------------------------------------------------------------------------------------------------------------------------------------------------------------------------------------------------------------------------------------------------------------------------------------------------------------------------------------------------------------|-------------------------------------------------------------------------------------------------------------------------------------------------------------------------------------------------------------------------------------------------------------------------------------------------------------------------------------------------------------------------------------------------------------------------------------------------------------------------------------------------------------------------------------------------------------------------------------------------------------------------------------------------------------------------------------------------------------------------------------------------------------------------------------------------------------------------------------------------------------------------------------------------------------------------------------------------------------------------------------------------------------------------------------------------------------------------------------------------------------------------------------------------------------------------------------------------------------------------------------------------------------------------------------------------------------------------------------------------------------------------------------------------------------------------------------------------------------|-------------------------------------------------------------------------------------------------------------------------------------------------------------------------------------------------------------------------------------------------------------------------------------------------------------------------------------------------------------------------------------------------------------------------------------------------------------------------------------------------------------------------------------------------------------------------------------------------------------------------------------------------------------------------------------------------------------------------------------------------------------------------------------------------------------------------------------------------------------------------------------------------------------------------------------------------------------------------------------------------------------------------------------------------------------------------------------------------------------------------------------------------------------------------------------------------------------------------------------------------------------------------------------------------------------------------------------------------------------------------------------------------------------------------------------------------------------------------------------------------------------------------------------------------------------------------------------------------------------------------------------------------------------------------------------------------------------------------------------------------------------------------------------------------------------------------------------------------------------------------------------------------------------------------------------------------------------------------------------------------------------------------------------------------------------------------------------------------------------------------------------------------------------------------------------------------------------------------------------------------------------------------------------------------------------------------------------------------------------|--------------------------------------------------------------------------------------------------------------------------------------------------------------------------------------------------------------------------------------------------------------------------------------------------------------------------------------------------------------------------------------------------------------------------------------------------------------------------------------------------------------------------------------------------------------------------------------------------------------------------------------------------------------------------------------------------------------------------------------------------------------------------------------------------------------------------------------------------------------------------------------------------------------------------------------------------------------------------------------------------------------------------------------------------------------------------------------------------------------------------------------------------------------------------------------------------------------------------------------------------------------------------------------------------------------------------------------------------------------------------------------------------------------------------------------------------------------------------------------------------------------------------------------------------------------------------------------------------------------------------------------------------------------------------------------------------------------------------------------------------------------------------------------------------------------------------------------------------------------------------------------------------------------------------------------------------------------------------------------------------------------------------------------------------------------------------------------------------------------------------------------------------------------------------------------------------------------------------------------------------------------------------------------------------------------------------------------------------------------------------------------------------------------------------------------------------------------------------------------------------------------------------------------------------------------------------------------------------------------------------------------------------------------------------------------------------------------------------------------------------------------------------------------------------------------------------------------------------------------------------------------------------------------------------------------------------------------------------------------------------------------------------------------------------------------------------------------------------------------------------------------------------------------------------------------------------------------------------------------------------------------------------------------------------------------------------------------------------------------------------------------------------------------------------------------------------------------------------------------------------------------------------------------------------------------------------------------------------------------------------------------------------------------------------------------------------------------------------------------------------------------|
| ALABAMA<br>Birmingham<br>Birmingham<br>Huntsville<br>Huntsville<br>Mobile<br>Tuscaloosa<br>ALASKA<br>Anchorage<br>Anchorage<br>ARIZONA<br>Flagstaff<br>Green Valley<br>Sierra Vista<br>Tucson<br>Yuma<br>ARKANSAS<br>Little Rock<br>CALIFORNIA<br>Anaheim<br>Atascadero<br>Azusa<br>Bakersfield<br>Berkeley<br>Buena Park<br>Buena Park<br>Chula Vista<br>Cypress<br>Davis<br>Fontana<br>Fresno<br>Fresno<br>Glendale<br>Half Moon Bay<br>Harbor City<br>Hawaiian Gardens<br>Hollywood<br>Inglewood<br>La Habra<br>La Mesa<br>Lancaster<br>Modesto<br>Modesto<br>Monterey<br>Morro Bay<br>National City<br>Northridge<br>Oceanside<br>Oxnard<br>Palmdale<br>Palo Alto<br>Palo Alto<br>Pasadena<br>Paso Robles<br>Pomona<br>Redding<br>Sacramento<br>Salinas<br>San Carlos<br>San Diego<br>San Fernando<br>San Francisco<br>San Jose<br>San Jose<br>San Luis Obispo<br>San Rafael<br>Santa Barbara<br>Santa Cruz<br>Santa Fe Springs<br>Santa Maria<br>Santa Rosa<br>South Lake Tahoe<br>Sunnyvale<br>Torrance<br>Torrance<br>Tustin<br>Vallejo<br>Van Nuys<br>Westminster<br>Whittier<br>Woodland Hills<br>COLORADO<br>Aurora<br>Colorado Springs<br>Denver<br>Denver<br>CONNECTICUT<br>Avon<br>New Haven<br>Westport<br>DELAWARE<br>New Castle<br>Newark<br>Wilmington<br>Wilmington<br>FLORIDA<br>Clearwater<br>Ft. Lauderdale<br>Ft. Lauderdale<br>Gainesville<br>Hialeah<br>Jacksonville<br>Lakeland<br>Lakeland<br>Miami<br>Miami<br>Orlando<br>Pensacola | J.L.S. Electronic Inc.<br>Micrologic Inc.<br>Industrial Electronic Supply<br>W&W Electronics<br>Lafayette Radio Electronics<br>Radio Parts Inc.<br>The Electronic Company<br>TV Mart<br>Jim's Audio & Stereo Repair<br>Radio Shack<br>B&S Electronics<br>Electronic City<br>Yuma Electronics<br>Southern Electronics Co.<br>Heathkit Electronic Center<br>R.F. Electronics<br>Coast Electronics<br>Amco Electronics<br>Jay-Kern Electronics<br>Al Lasher Electronics<br>Ford Electronics<br>S.J. Electronics<br>Lion Electronics<br>SCR Electronics<br>Paradyne Consumer Electronics<br>Fontana Electronics<br>Fontana Electronics<br>Sparky Electronics<br>Eagle Electronics<br>Radio Shack<br>Buff's Electronics<br>Carson Electronics<br>Pacific Radio Exchange<br>Radioland/Inglewood Electronics<br>A.B.C. Electronics<br>Heathkit Electronic Center<br>Consumer Electronics<br>Computer Megic<br>Pacific Radio<br>Zackit<br>Coast Electronics<br>Pacific Radio Electronics<br>Electronic Center<br>Dow Radio<br>Radio Shack A.S.C. Palmdale<br>U.S. Electronics<br>Zack Electronics<br>Dow Radio Inc.<br>Mission Electronics<br>Heathkit Electronic Center<br>Radio Mart<br>Zackit<br>Salinas Radio<br>J&H Outlet Store<br>Radio Shack A.S.C. Mira Mesa<br>San Fernando Electronics<br>Zack Electronics<br>Peninsula Electronic Supply Inc.<br>United Radio & TV Supply<br>Mid-State Electronic Supply<br>Electronic Plus<br>Lombard Electronics<br>Sante Cruz Electronics<br>Industrial Electronics<br>Cap's Communications<br>Electronics Inc.<br>CallPine Electronics<br>Sunnyvale Electronics<br>SE Electronics<br>Torrance Electronics<br>A-B&B Electronics<br>Zackit<br>Thrifty Electronics Supply Inc.<br>JK Electronics<br>Whittier Electronics Co.<br>Heathkit Electronic Center<br>Aurora Electronics<br>Centennial Electronics Inc.<br>Mt. Coin Distributing Co.<br>Micro World Electronics<br>Heathkit Electronic Center<br>Customized Computer Systems<br>Computerworks<br>Delaware Amateur Supply<br>Computerland<br>Laraco<br>Wholesale Electronics Inc.<br>AGL Electronics<br>Computers For You<br>Lafayette Radio Electronics<br>Lafayette Radio<br>Heathkit Electronic Center<br>Laraco of Florida Inc.<br>Lakeland Specialty Electronics<br>Herman Electronics<br>N&G Distributors<br>Lafayette Radio<br>Southeast Micro Data Corp.<br>Grice Electronics Inc. | FLORIDA (Continued)<br>Tampa<br>Tampa<br>Tampa<br>GEOORGIA<br>Atlanta<br>Atlanta<br>Atlanta<br>Columbus<br>Stone Mountain<br>HAWAII<br>Honolulu<br>Honolulu<br>IDAHOO<br>Boise<br>Caldwell<br>ILLINOIS<br>Carbondale<br>Chicago<br>Chicago<br>Evanston<br>Geneva<br>Grovefield<br>Mount Prospect<br>Niles<br>Peoria<br>Peoria<br>Rockford<br>Schaumburg<br>Skokie<br>Village Park<br>INDIANA<br>Bloomington<br>Chesterton<br>East Chicago<br>Evanville<br>Gary<br>Indianapolis<br>Muncie<br>South Bend<br>IOWA<br>Ames<br>Devenport<br>Des Moines<br>Des Moines<br>KANSAS<br>Hutchinson<br>Kansas City<br>Mission<br>Salina<br>Wichita<br>KENTUCKY<br>Lexington<br>Louisville<br>Louisville<br>LOUISIANA<br>Baton Rouge<br>Baton Rouge<br>Baton Rouge<br>Kenner<br>Lake Charles<br>Lake Charles<br>New Orleans<br>Shreveport<br>MARYLAND<br>Annapolis<br>Baltimore<br>Baltimore<br>Baltimore<br>Baltimore<br>Charmville<br>Dumfries<br>Glen Burnie<br>La Vale<br>Rockville<br>Silver Spring<br>Towson<br>Towson<br>Towson<br>Towson<br>Wharton<br>MASSACHUSETTS<br>Littleton<br>Peabody<br>Pittsfield<br>Waltham<br>Wellesley<br>West Springfield<br>Worcester<br>MICHIGAN<br>Adrian<br>Allen Park<br>Ann Arbor<br>Ann Arbor<br>Battle Creek<br>Bay City<br>Canton<br>Canton<br>Crawford<br>Detroit<br>Detroit<br>Detroit<br>Oxford<br>Oxford<br>East Detroit<br>Flint<br>Garden City<br>Grand Rapids<br>Grand Rapids<br>Grand Rapids<br>Jackson<br>Kalamazoo | AMF Microcomputer Center Inc.<br>Heathkit Electronic Center<br>Microcomputer Systems<br>Atlanta Computer Mart<br>Lombard Shop<br>Heathkit Electronic Center<br>Radio Wholesale<br>Cohman's Electronics<br>Industrial Electronic Inc.<br>Inspired Circuit Supply<br>Custom Electronics<br>A-Gem Supply Inc.<br>Picks Electronics<br>Howard Electronic Sales<br>Olson Electronics<br>Tri-State Electronic Corp.<br>Melvin Electronics<br>Melvin Electronics<br>Tri-State Electronic Corp.<br>Computer Land<br>Warren Radio Co.<br>Computer Store of Rockford<br>Date Darnell of Schaumburg<br>Lilgute Computer<br>Melvin Electronics<br>Sponster Radio Co. Inc.<br>Chesterman Electronics<br>Aero Electronics Corp.<br>Hutch & Son Inc.<br>Calumet Electronic Supply<br>Heathkit Electronic Center<br>Pierce Electronics<br>Radio Distributing Inc.<br>Electronic Supply Inc.<br>Memory Bank<br>Gifford Brown Incorporated<br>Radio Trade Supply Co.<br>Hutchinson Electronics<br>Electronic Surplus Sales<br>Heathkit Electronic Center<br>Electronics Inc.<br>Amateur Radio Equipment Co.<br>Radio Electronic Equipment Co.<br>Peebles Electronic Equipment Co.<br>Madison County Electronics<br>Doris Electronics Supply Co.<br>Monard Electronics Inc.<br>Pelican Electronics<br>Heathkit Electronic Center<br>Gulf Power & Controls<br>Wholesale Radio & Equipment<br>Wm. B. Allen Supply Co.<br>Industrial Electronic Supply<br>J&M Electronics Inc.<br>American Distributing Co.<br>Everything Electronic<br>Margo Electronics<br>Trinix, Inc.<br>Churchville Electronics<br>Damascus CB<br>Glen Burnie<br>Revico<br>J&M Electronics<br>Heathkit Electronic Center<br>Baynesville Electronic Etc.<br>Computers Etc.<br>Computers Unlimited<br>Heathkit Electronic Center<br>Computer Crafters<br>Tel. Con. Inc.<br>Heathkit Electronic Center<br>Pittsfield Radio Co. Inc.<br>Computer Mart Inc.<br>Heathkit Electronic Center<br>Norbill's Electronics Inc.<br>R.M. Electronics Inc.<br>E.B.B. Electronics Inc.<br>Electronic Parts Co.<br>Wedemeyer Electronic Supply<br>Warren Radio Co.<br>Kinda Distributing Co.<br>The Electronic Connection<br>Radio Supply & Engineering Co.<br>B&M Electronics<br>Heathkit Electronic Center<br>Radio Supply & Engineering Co.<br>S&S Electronics<br>Oxford Software Co.<br>Heathkit Electronic Center<br>Shand Electronics Inc.<br>Computer Center<br>Micro Computer World<br>Radio Parts Inc.<br>Warren Radio Co.<br>Fulton Radio Supply<br>Warren Radio | MICHIGAN (Continued)<br>Lansing<br>Livonia<br>Livonia<br>Madison Heights<br>Midland<br>Milan<br>Mt. Pleasant<br>Muskegon<br>Niles<br>Rochester<br>Port Huron<br>Saginaw<br>St. Clair Shores<br>St. Joseph<br>Taylor<br>Traverse City<br>MINNESOTA<br>Duluth<br>Mpls.<br>Mpls.<br>St. Paul<br>Wynona<br>MISSISSIPPI<br>Jackson<br>MISSOURI<br>Brignton<br>El Dorado Springs<br>Florissant<br>Florissant<br>St. Louis<br>MONTANA<br>Billings<br>Bozeman<br>Great Falls<br>NEBRASKA<br>Lincoln<br>Lincoln<br>North Platte<br>Omaha<br>Omaha<br>NEVADA<br>Las Vegas<br>NEW JERSEY<br>Cherry Hill<br>Englishtown<br>Fair Lawn<br>Ocean<br>Pennsauken<br>Pompton Lakes<br>Ramsey<br>Trenton<br>Westland<br>NEW YORK<br>Albany<br>Albany<br>Albany<br>Amherst<br>Buffalo<br>Buffalo<br>Cortland<br>Endwell<br>Ithaca<br>Ithaca<br>Jonestown<br>Kingston<br>Kingston<br>Kingston<br>Madison<br>Newburgh<br>New York City<br>New York City<br>New York City<br>Orchard Park<br>Rochester<br>Rochester<br>North White Plains<br>Rochester<br>Troy<br>Utica<br>Utica<br>Wappingers Falls<br>White Plains<br>NORTH CAROLINA<br>Raleigh<br>NORTH DAKOTA<br>Fargo<br>OHIO<br>Cincinnati<br>Cincinnati<br>Cleveland<br>Columbus<br>Dayton<br>Toledo<br>Toledo<br>Toledo<br>Wickliffe<br>Youngstown<br>OKLAHOMA<br>Oklahoma City<br>Oklahoma City<br>OREGON<br>Albany<br>Beaverton<br>Clatskanie<br>Eugene<br>Portland<br>Salem<br>PENNSYLVANIA<br>Bradford<br>Chambersburg | Fulton Radio Supply Inc.<br>Lafayette Radio<br>Radio Supply & Engineering Co. Inc.<br>Warren Radio Co.<br>Computronix Corporation<br>C&S Electronics Mart Ltd.<br>Barr's<br>H.R. Electronics<br>Niles Radio Supply<br>Electronic Supply<br>Main T V Radio Electronics Inc.<br>Electronic Mart<br>Bell Electronics<br>Heath Customer Center<br>Electronic World<br>Traverse City Electronic Supply<br>Northway Radio of Duluth Inc.<br>Heathkit Electronic Center<br>Pal Electronics<br>Heathkit Electronic Center<br>Howatha Electronics Inc.<br>Ellington Electronic Supply<br>Forsythe Computers<br>Beckman Electronics<br>Computer County<br>Computer County (Downtown)<br>Canley Radio Supply<br>Electronic Service & Dist. Inc.<br>Arts Electronics<br>Computer Systems<br>Scott Electronic Supply Inc.<br>Scott Electronic Supply Corp.<br>Midwest Computer<br>Scott Electronic Supply Corp.<br>Heathkit Electronic Center<br>Century 23<br>The Computer Emporium<br>Radionetters<br>Heathkit Electronic Center<br>Heathkit Electronic Center<br>Lafayette Radio<br>Computer Corner<br>Type-tronic Computer Store<br>Lafayette Radio Electronics<br>Lafayette Radio Electronics<br>Action Audio Inc.<br>Fort Orange Electronics<br>Greylock Electronics<br>Heathkit Electronic Center<br>Radio Equipment Corp.<br>Action Audio Inc.<br>Computer Tree Inc.<br>Action Audio Inc.<br>Rad-Tronics<br>Warren Radio<br>Heathkit Electronic Center<br>Action Audio Inc.<br>Greylock Electronics<br>Action Audio Inc.<br>Action Audio Inc.<br>Anita Craft<br>Dipbyte Systems Corp.<br>Tate Electronics 45 Corp.<br>Radio Equipment Co.-P.<br>Action Audio Inc.<br>Greylock Electronics<br>Heathkit Electronic Center<br>Trojan Electronics<br>Am-Com Electronics<br>Central Electronics<br>Action Audio Inc.<br>The Computer Corner<br>Byte Shop of Raleigh<br>S&S Electronics<br>Heathkit Electronic Center<br>Micro-Solution<br>Heathkit Electronic Center<br>Universal Amateur Radio<br>Heathkit Electronic Center<br>Warren Radio<br>Amateur Electronic Supply<br>Ross Radio Company<br>Bits, Bytes & Micros<br>Heathkit Electronic Center<br>Trish Wholesale Electronics<br>Oregon Ham Sales<br>Norvac Electronics<br>Zero-Gee<br>Eugene Amateur Radio Supply<br>Portland Radio Supply<br>Comm-Shack<br>Laff Electronics<br>Sunrise Electronic Dist. Co. | PENNSYLVANIA (Continued)<br>Drexel Hill<br>Drums<br>Erie<br>Frazer<br>Horseshoe<br>Paoli<br>Philadelphia<br>Philadelphia<br>Phoenixville<br>Pittsburgh<br>Pittsburgh<br>Wilkes Barre<br>York<br>RHODE ISLAND<br>Cranston<br>Providence<br>Tearuck<br>Tearuck<br>TENNESSEE<br>Cookeville<br>Knoxville<br>Memphis<br>Memphis<br>Memphis<br>Nashville<br>Nashville<br>Oakridge<br>Tullahoma<br>Tullahoma<br>TEXAS<br>Beaumont<br>Brownsville<br>Dallas<br>Dallas<br>Dallas<br>Fort Worth<br>Houston<br>Houston<br>Lubbock<br>McAllen<br>San Antonio<br>San Antonio<br>San Antonio<br>Waco<br>UTAH<br>Midvale<br>Provo<br>Salt Lake City<br>Salt Lake City<br>VERMONT<br>Essex Junction<br>VIRGINIA<br>Alexandria<br>Alexandria<br>Arlington<br>Blacksburg<br>Charlottesville<br>Falls Church<br>Hampton<br>McLean<br>Norfolk<br>Norfolk<br>Portsmouth<br>Richmond<br>Roanoke<br>Vienna<br>Virginia Beach<br>Warrenton<br>WASHINGTON<br>Bellevue<br>Everett<br>Kennewick<br>Longview<br>Moses Lake<br>Pasco<br>Pasco<br>Richland<br>Seattle<br>Seattle<br>Seattle<br>Spokane<br>Spokane<br>Tacoma<br>Tacoma<br>WEST VIRGINIA<br>Fairmont<br>Morgantown<br>Morgantown<br>Wheeling<br>WYOMING<br>Cheyenne<br>CANADA<br>Alberta:<br>Calgary<br>Ontario:<br>Toronto<br>GUAM<br>ENGLAND<br>Berkshire<br>GUATEMALA<br>PANAMA<br>SINGAPORE<br>SINGAPORE<br>SWEDEN<br>Stockholm<br>WEST INDIES<br>Port of Spain, Trinidad<br>Kass Electronics Distributors<br>Mr. D's Digital Electronics<br>Warren Radio<br>Heathkit Electronic Center<br>Mighty Byte Computer Centers<br>Personal Computer Corporation<br>Heathkit Electronic Center<br>Resco Electronics<br>Stevens Electronics<br>Heathkit Electronic Center<br>South Hills Electronics<br>Hemline Electronics<br>G.Y.C. Company<br>Jabbour Electronics City<br>Jabbour Electronics City<br>Heathkit Electronic Center<br>Wagon's Stereo Center<br>Shields Electronics Supply Inc.<br>Bluff City Electronics<br>Sara-Rose & Spencer Electronics<br>Warren Radio Company<br>Eddie Werner's Parts Company<br>Electra Distributing Co.<br>National Electronics<br>H&H Electronics Co. Inc.<br>Electro-Hut<br>George's Electronics Mart<br>CompuShop<br>Heathkit Electronic Center<br>Rem Micro Systems<br>The Ingenuity Concept<br>Heathkit Electronic Center<br>Interactive Computers<br>Trice Wholesale Electronics<br>Carlos Franco Electronics<br>Appliance & Equipment Co. Inc.<br>C&K Electronics Inc.<br>Heathkit Electronic Center<br>L&M Wholesale Electronics<br>Heathkit Electronic Center<br>Alpine Electronic Supply Co.<br>Best Distributing<br>Computerland of Salt Lake<br>Lafayette Radio<br>Computers Plus Inc.<br>Heathkit Electronic Center<br>Arcade Electronics<br>Arlington Electronic Wholesalers<br>Scotty's Radio & TV Inc.<br>Graves Electronics<br>Crossroad Electronics<br>Electronic Sales Inc.<br>Tyson's Computer Emporium<br>Avec Electronics Corp.<br>Priest Electronics<br>Electronics Unlimited<br>Avec Electronics Corp.<br>Avec Electronics Corp.<br>Electronic Equipment Bank<br>Heathkit Electronic Center<br>Radio Shack<br>ABC Communications<br>ABC Communications<br>C&J Electronics Inc.<br>Progress Electronics<br>Ron's Electronics<br>Riverview Electronics<br>C&J Electronics<br>ABC Communications<br>Amateur Radio Supply<br>Empire Electronics<br>Don's Stereo Center<br>Personal Computers<br>C&G Electronics<br>Northwest Radio Supply<br>TPS Electronics Inc.<br>The Computer Corner<br>Electro Distributing Co. Inc.<br>Lafayette Radio Associate Store<br>Computer Concepts<br>House of Computers<br>Marianas Electronics<br>NewBear Computing Store<br>Electronics Pen-Amexco<br>Applied Digital System<br>Sys-Tech<br>LSI Electronics HB<br>The Hobby Centre |
|----------------------------------------------------------------------------------------------------------------------------------------------------------------------------------------------------------------------------------------------------------------------------------------------------------------------------------------------------------------------------------------------------------------------------------------------------------------------------------------------------------------------------------------------------------------------------------------------------------------------------------------------------------------------------------------------------------------------------------------------------------------------------------------------------------------------------------------------------------------------------------------------------------------------------------------------------------------------------------------------------------------------------------------------------------------------------------------------------------------------------------------------------------------------------------------------------------------------------------------------------------------------------------------------------------------------------------------------------------------------------------------------------------------------------------------------------------------|----------------------------------------------------------------------------------------------------------------------------------------------------------------------------------------------------------------------------------------------------------------------------------------------------------------------------------------------------------------------------------------------------------------------------------------------------------------------------------------------------------------------------------------------------------------------------------------------------------------------------------------------------------------------------------------------------------------------------------------------------------------------------------------------------------------------------------------------------------------------------------------------------------------------------------------------------------------------------------------------------------------------------------------------------------------------------------------------------------------------------------------------------------------------------------------------------------------------------------------------------------------------------------------------------------------------------------------------------------------------------------------------------------------------------------------------------------------------------------------------------------------------------------------------------------------------------------------------------------------------------------------------------------------------------------------------------------------------------------------------------------------------------------------------------------------------------------------------------------------------------------------------------------------------------------------------------------------------------------------------------------------------------------------------------------------------------------------------------------------------------------------------------------------------------------------------------------------------------------------------------------------------------------------------------------------------------------------------------------------------------------------|---------------------------------------------------------------------------------------------------------------------------------------------------------------------------------------------------------------------------------------------------------------------------------------------------------------------------------------------------------------------------------------------------------------------------------------------------------------------------------------------------------------------------------------------------------------------------------------------------------------------------------------------------------------------------------------------------------------------------------------------------------------------------------------------------------------------------------------------------------------------------------------------------------------------------------------------------------------------------------------------------------------------------------------------------------------------------------------------------------------------------------------------------------------------------------------------------------------------------------------------------------------------------------------------------------------------------------------------------------------------------------------------------------------------------------------------------------------|----------------------------------------------------------------------------------------------------------------------------------------------------------------------------------------------------------------------------------------------------------------------------------------------------------------------------------------------------------------------------------------------------------------------------------------------------------------------------------------------------------------------------------------------------------------------------------------------------------------------------------------------------------------------------------------------------------------------------------------------------------------------------------------------------------------------------------------------------------------------------------------------------------------------------------------------------------------------------------------------------------------------------------------------------------------------------------------------------------------------------------------------------------------------------------------------------------------------------------------------------------------------------------------------------------------------------------------------------------------------------------------------------------------------------------------------------------------------------------------------------------------------------------------------------------------------------------------------------------------------------------------------------------------------------------------------------------------------------------------------------------------------------------------------------------------------------------------------------------------------------------------------------------------------------------------------------------------------------------------------------------------------------------------------------------------------------------------------------------------------------------------------------------------------------------------------------------------------------------------------------------------------------------------------------------------------------------------------------------------------------------------------------------------------------------------------------------------------------------------------------------|-------------------------------------------------------------------------------------------------------------------------------------------------------------------------------------------------------------------------------------------------------------------------------------------------------------------------------------------------------------------------------------------------------------------------------------------------------------------------------------------------------------------------------------------------------------------------------------------------------------------------------------------------------------------------------------------------------------------------------------------------------------------------------------------------------------------------------------------------------------------------------------------------------------------------------------------------------------------------------------------------------------------------------------------------------------------------------------------------------------------------------------------------------------------------------------------------------------------------------------------------------------------------------------------------------------------------------------------------------------------------------------------------------------------------------------------------------------|-------------------------------------------------------------------------------------------------------------------------------------------------------------------------------------------------------------------------------------------------------------------------------------------------------------------------------------------------------------------------------------------------------------------------------------------------------------------------------------------------------------------------------------------------------------------------------------------------------------------------------------------------------------------------------------------------------------------------------------------------------------------------------------------------------------------------------------------------------------------------------------------------------------------------------------------------------------------------------------------------------------------------------------------------------------------------------------------------------------------------------------------------------------------------------------------------------------------------------------------------------------------------------------------------------------------------------------------------------------------------------------------------------------------------------------------------------------------------------------------------------------------------------------------------------------------------------------------------------------------------------------------------------------------------------------------------------------------------------------------------------------------------------------------------------------------------------------------------------------------------------------------------------------------------------------------------------------------------------------------------------------------------------------------------------------------------------------------------------------------------------------------------------------------------------------------------------------------------------------------------------------------------------------------------------------------------------------------------------------|--------------------------------------------------------------------------------------------------------------------------------------------------------------------------------------------------------------------------------------------------------------------------------------------------------------------------------------------------------------------------------------------------------------------------------------------------------------------------------------------------------------------------------------------------------------------------------------------------------------------------------------------------------------------------------------------------------------------------------------------------------------------------------------------------------------------------------------------------------------------------------------------------------------------------------------------------------------------------------------------------------------------------------------------------------------------------------------------------------------------------------------------------------------------------------------------------------------------------------------------------------------------------------------------------------------------------------------------------------------------------------------------------------------------------------------------------------------------------------------------------------------------------------------------------------------------------------------------------------------------------------------------------------------------------------------------------------------------------------------------------------------------------------------------------------------------------------------------------------------------------------------------------------------------------------------------------------------------------------------------------------------------------------------------------------------------------------------------------------------------------------------------------------------------------------------------------------------------------------------------------------------------------------------------------------------------------------------------------------------------------------------------------------------------------------------------------------------------------------------------------------------------------------------------------------------------------------------------------------------------------------------------------------------------------------------------------------------------------------------------------------------------------------------------------------------------------------------------------------------------------------------------------------------------------------------------------------------------------------------------------------------------------------------------------------------------------------------------------------------------------------------------------------------------------------------------------------------------------------------------------------------------------------------------------------------------------------------------------------------------------------------------------------------------------------------------------------------------------------------------------------------------------------------------------------------------------------------------------------------------------------------------------------------------------------------------------------------------------------------------------------------|

For Distributor Information, write or phone JIM-PAK<sup>®</sup> 1355 Shoreway Road, Belmont, CA 94002 (415) 595-5936

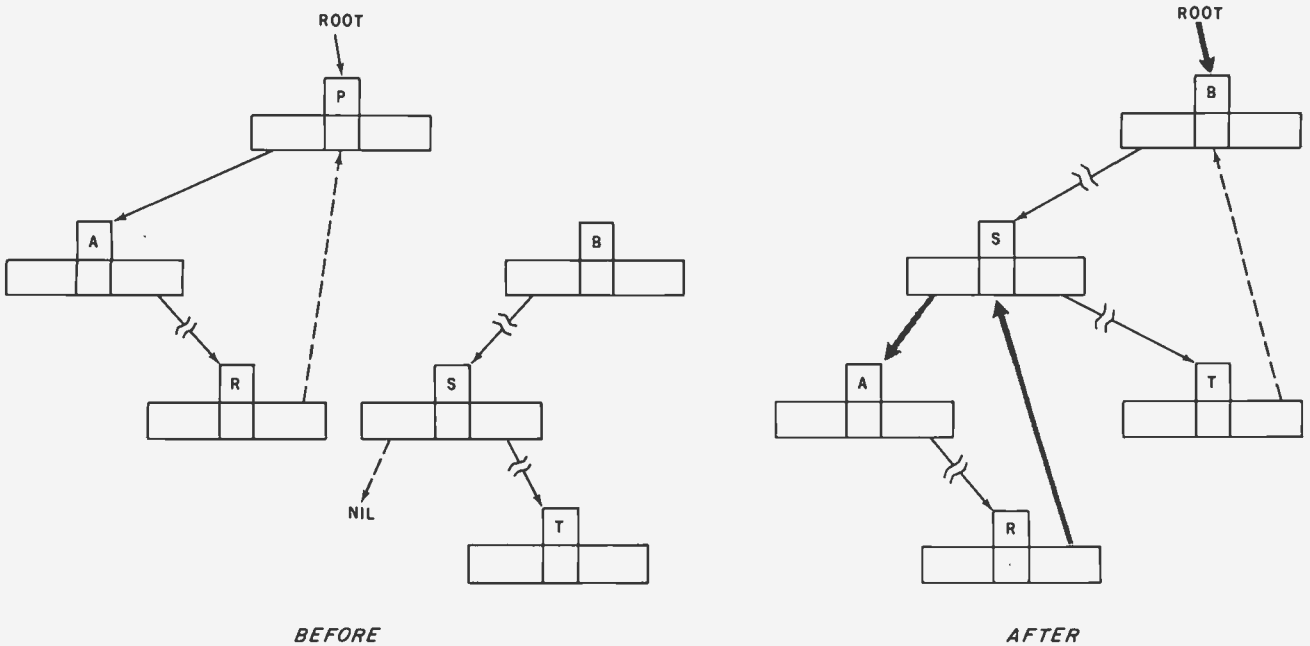
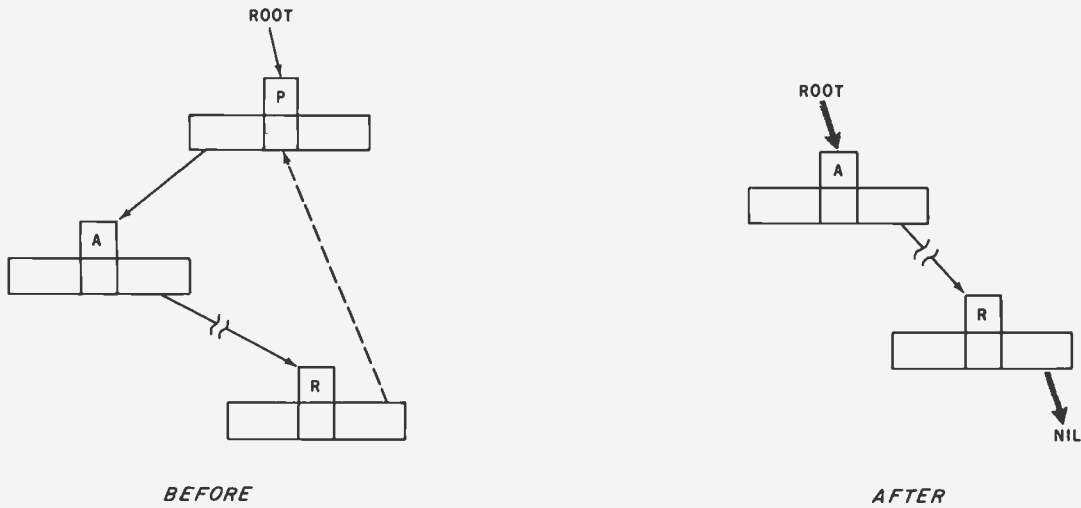

Figure 16: Examples of node deletion. Figures 16a thru 16d are used to illustrate the structure of a binary tree before and after the deletion of node P; they are referred to by table 1. A broken arrow (for example, A to R) denotes an eventual connection through zero or more intermediate children. A dashed arrow denotes an upward right pointer to the next node in the sorted key sequence. A gray arrow in the "after" drawing denotes a pointer that has been changed by the deletion.

version of the binary tree program is given in listing 3. This version does not use a threaded tree (ie: there are no upward right pointers). Because of this, the subroutine to add a node is almost trivial, and the delete routine is greatly simplified. This implementation is, in general, altogether nicer. The main change in this listing (compared to the BASIC program of

listing 1) is the use of the scan procedure to traverse and list the tree. The scan procedure uses a stack, which is maintained by the *initstack* and *push* procedures, along with the *pop* function. The scan algorithm is as follows:

- 1) Move left along the branches of the tree, placing each node

traversed onto the stack.

- 2) When a left pointer of NIL is reached, pop the stack and print what was just popped.
- 3) If you can, move right one node and go to step 1; otherwise, pop the stack, print the node popped, and repeat step 3.
- 4) Underflow of the stack represents the end of the algorithm.



16c SUBCASE II. A. 3

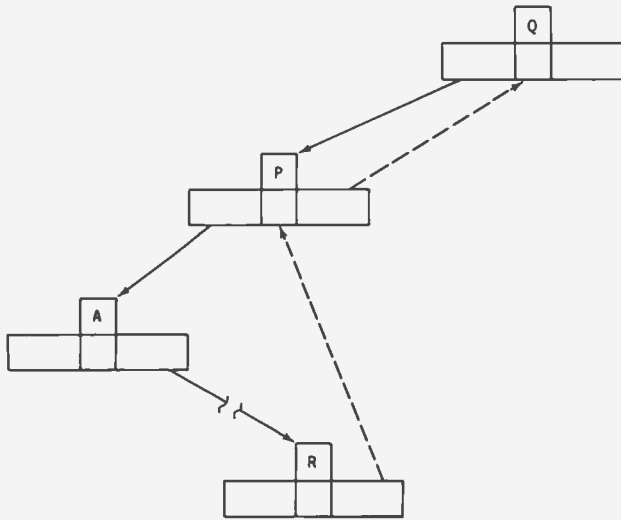

BEFORE

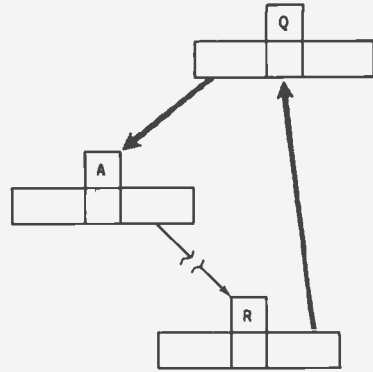

AFTER

16d SUBCASE II. A. 4

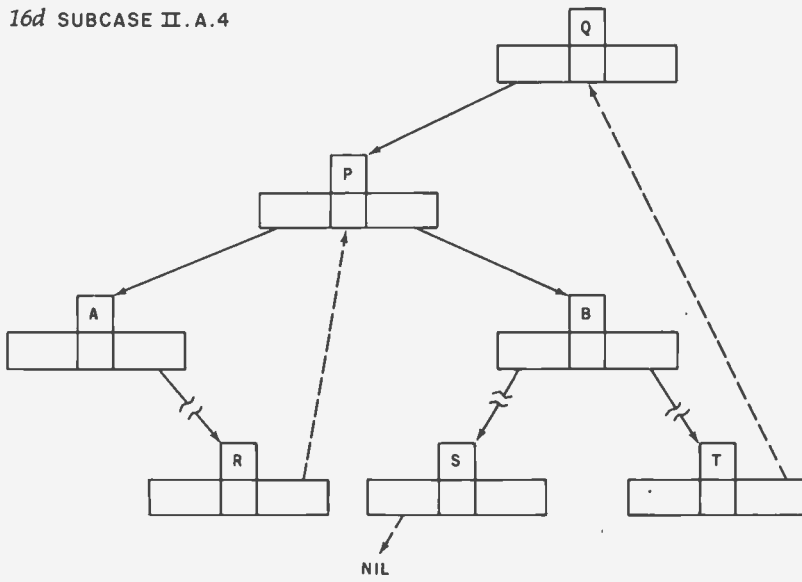

BEFORE

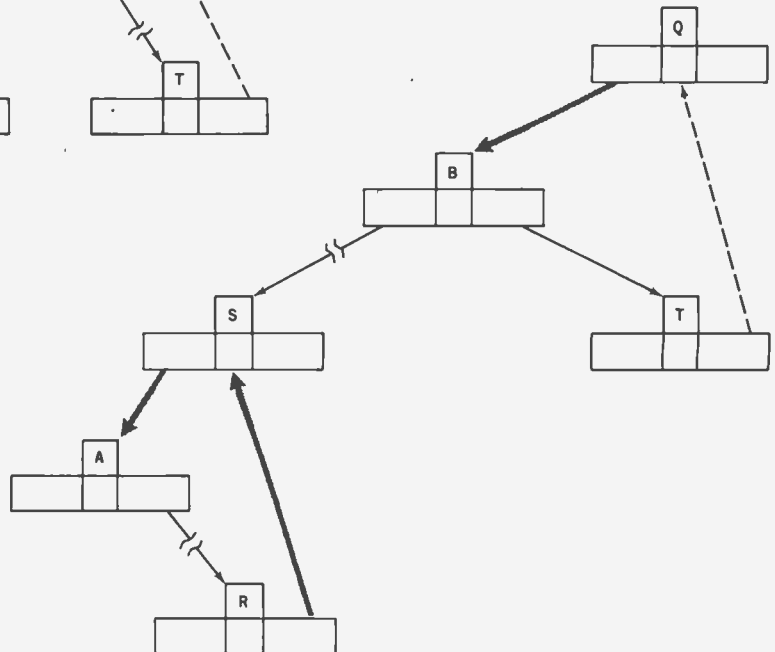

AFTER

Due to the nature of the Pascal language, the listing itself serves to document the algorithm. In all fairness to BASIC, it must be stated that the Pascal program of listing 3 is simpler partially due to the absence of the thread running through the binary tree. ■

Acknowledgements

I would like to thank the Computer Corner of Amarillo, Texas, for the use of their printer to produce listings 1 and 2.

# When You Have To Face A Deadline



Communication Arts, Huntington Beach, CA

## Arm Yourself With Pascal/MT+<sup>®</sup>

From

**MT Micro SYSTEMS**



1562 Kings Cross Drive  
Cardiff, California 92007 (714) 753-4856

We ship on 8" single density and 5-1/4" North Star single density.  
Other formats available. Ask us.

CP/M is a registered trademark of Digital Research

MP/M is a trademark of Digital Research

Pascal/MT+ is a registered trademark of MT Micro Systems

Circle 185 on Inquiry card.

# MT MicroSYSTEMS SOFTWARE ARSENAL:

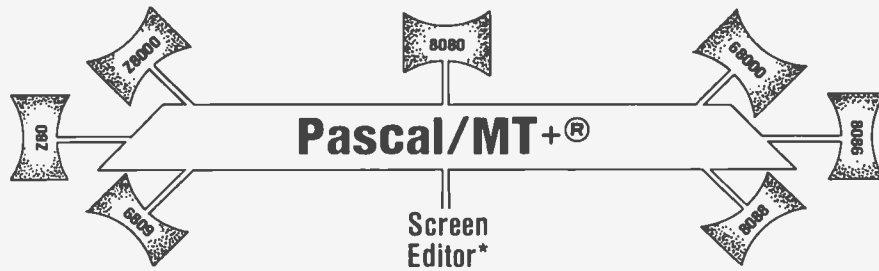

\*Contact us for the exciting news about this leap forward in state of the art technology.

Pascal/MT+® provides you with the power to meet your deadlines head-on! Compiling directly to native code without slowing down to generate P-code or assembly language, Pascal/MT+® generates ROMable, optimized native code and gives you the flexibility of modular compilation; and it does so at speeds up to 2000 lines per minute while the *others* are, at best, *one third* as fast! Even when you're *not* facing a deadline, Pascal/MT+® never wastes your time! Nobody likes to wait for a computer. The Pascal/MT+® won't keep you waiting! Your software written in Pascal/MT+® is totally portable to most 8 and 16 bit processors. The Pascal/MT+® system provides you with a powerful debugging tool. With Pascal/MT+® you *do* have an effective weapon against monstrous deadlines.

Pascal is the most popular programming language in use today. You can use Pascal/MT+® to replace assembly language in your ROM based applications, BASIC and COBOL in your business applications, FORTRAN in your scientific applications, or interpreted Pascal in all of your applications. Because Pascal programs are easy to write, read, and maintain; and because the Pascal/MT+® system contains all of the features you need for your applications, you can get your job done *on time!* In fact, you may never need assembly language or any other high level language again. Pascal/MT+® has the speed, extensions, and portability to stock your software arsenal for years to come!!!

## ISO STANDARD Pascal

Pascal/MT+® supports the ISO Standard. We send the results of our compiler's performance on the Validation Suite. Also, for portability the MT+ compiler can warn you when you are using non-standard extensions.

## Modular Compilation

Pascal/MT+® generates the same industry standard relocatable code used in FORTRAN and PL/I. Both Pascal and assembly language modules may be separately compiled and then combined to produce a final program. With modular compilation available, the run time overhead is as small as 256 bytes and is typically 1200 bytes.

## Native Code Generation

Pascal/MT+® native code is faster than interpreted Pascal and other native code Pascals in benchmark test programs. Optimization steps taken during compilation perform such enhancements as removing redundant PUSH/POP sequences and using single increment and decrement instructions when adding or subtracting small literal numbers. In addition, our disassembler interleaves your Pascal source code and symbolic assembly code to help you write more efficient programs.

## Extras

- Predeclared arrays INP and OUT directly access I/O ports.
- INLINE instruction for inserting assembly language between the Pascal statements. A built-in mini assembler translates the instructions at compile time. Constant tables may be generated using the inline facility.
- ABSOLUTE assembly language procedure declarations for using pre-assembled routines.
- INTERRUPT procedures.
- CHAINING for transferring control from one program to another.
- ELSE clause on the case statement.
- REDIRECTED I/O facilities allow user written character level I/O drivers to be called via READ and WRITE statements.
- HEX literal numbers are supported.
- Built in procedures/functions:
  - bit test, clear, set.
  - byte swap.
  - return hi or lo byte.
  - Shift left and right.
  - Return the address of a data item or routine.
  - Return the size of a data item.
  - Enable, disable interrupts.
  - All standard file I/O plus random read and write to files.
- Include files supported.
- Source code for run-time package included.
- Business (18 digit) arithmetic.
- Scientific (6.5 digit) arithmetic.
- AMD 9511 hardware support.
- Transcendental functions.
- Full string capability (UCSD compatible).

## Symbolic Debugger

Our symbolic debugger is optionally linked into the final program. If you're tired of feeling like you're in the dark when using a higher level language, the Pascal/MT+® debugger lights up the darkness. The debugger traces one or more lines of Pascal code or executes the program until a line number or symbolic breakpoint is reached. To follow program flow the name of each procedure and function entered is displayed by the debugger. The contents of simple and complex variables may be displayed by name. The debugger may be used in a ROM environment so that program flow and variable contents are visible.

## Distribution disk contains

- BCD compiler configured for your target machine.
- Floating point compiler configured for your target machine.
- Linker.
- Interactive Symbolic Debugger.
- Run time package in source and object form.
- Pascal library and utility routines.
- Manual containing an Applications Guide and a Language Guide.
- Sample programs.
- Librarian program to manage libraries of modules.

## System Requirements

- Operating System: CP/M® (or equivalent such as CDOS, IMDOS, etc.) MP/M™, Intel iSIS II, Heath HDOS, and PDP-11 systems to be available soon.
- Memory requirements: 48K minimum.
- Host Machines: 8080 or Z80.
- Target Machines: 8080/Z80, 68000, Z8000, 8086/8088, 6809.
- Resident compilers for all processors will be forthcoming as operating systems become available.

MT MicroSYSTEMS has a very reasonable, graduated, one time royalty arrangement for free standing software generated by Pascal/MT+®.

## Ordering

8 bit processor target machines:  
8080/Z80, 6809 ..... \$250.00 each  
16 bit processor target machines:  
68000, Z8000, 8086/8088 ..... \$500.00 each  
User's guide alone  
(refundable with system purchase): ..... \$30.00

Contact us for information about our automatic update service.

Note: Not all 16-bit CPU code generators are available at this time; contact us for information before ordering.

OEM and Dealer inquiries invited.

Circle 185 on Inquiry card.

# Machine Problem Solving, Part 2: Directed Search Using Cryptarithmic

---

Professor Peter W Frey  
Northwestern University  
Cresap Neuroscience Laboratory  
2021 Sheridan Rd  
Evanston IL 60201

---

## Insight into Problems

Those of us who teach courses on thinking and problem solving are always delighted to find an intellectual puzzle that is stated clearly and concisely, and yet still provides a real challenge for an intelligent problem solver. A number of years ago, Allen Newell discovered the fascination of cryptarithmic and many of his pioneering ideas on human information processing were based on his research with these puzzles.

A *cryptarithmic* puzzle consists of a group of letters arranged in the form of an arithmetic problem. Each letter is a code for a digit (0, 1, 2, ..., 9) and only one letter may represent each digit. The problem solver must determine how to assign digits to letters in such a way that the mathematical constraints are satisfied. For example, a popular cryptarithmic puzzle is:

$$\begin{array}{r} \text{S E N D} \\ + \text{M O R E} \\ \hline \text{M O N E Y} \end{array}$$

If the appropriate digit is assigned to each letter, the numbers will add up to give the correct sum. This type of puzzle can be very challenging. If you doubt this, take a moment and try to solve the example given above.

## Direct Logical Analysis

When humans attempt to solve these problems, they use a combination of logical inference and directed search. The values for some of the letters can be determined, or at least restricted to a subset of values, by *direct logical analysis*. The value of the remaining letters is then determined by a "generate and test" approach in which plausible values are examined until a suitable one is found. As more information is acquired, logical deduction can narrow the search to a limited number of potential solutions.

As an example, let us consider the SEND + MORE = MONEY puzzle. The first insight that most individuals have after considering the problem for a few moments is that the letter M can be easily deciphered. MONEY has five letters and SEND and MORE have only four. Therefore, one can deduce that S + M + the carry from the previous column = MO. The maximum possible values

for S and M are 8 and 9 and the carry is at most 1, so therefore MO is 18 or less. It follows that M can be only 0 or 1. If it were 0, however, it would not be written as the first digit of a number since leading zeroes are not printed. Therefore, the letter M must represent the digit 1.

Armed with this knowledge, it is possible to make additional deductions. For example, if we substitute the digit 1 for the letter M in the equation given in the previous paragraph (ie: S + 1 + carry = O + 10) we can quickly deduce that S must represent a large digit and the letter O has to represent a small digit. In fact, since the maximum value for S is 9, the sum of the column can be no more than 11 if there is a carry and 10 if there is no carry. Therefore, the letter O must be 1 or 0. It is already known, however, that M represents 1 so the letter O represents 0. Given that the sum of the column is 10, then the letter S has to be either 8 (if there is no carry) or 9 (if there is a carry).

## Searching Technique

Our detective work has determined that M is 1, O is 0, and S is 8 or 9. In addition, we can infer that the values of 1 and 0 cannot be assigned to any of the other letters. This narrows the search task considerably. A blind *trial-and-error* search process is not very efficient for this problem. There are eight letters in this cryptarithmic puzzle and ten digits to draw upon. The number of possible assignments is  $10 \times 9 \times 8 \times 7 \times 6 \times 5 \times 4 \times 3$  which equals 1,814,400. The trial-and-error search approach we employed last month for the missionaries-and-cannibals problem is not well-suited for this job. It would work, but it would take a very long time, especially if implemented in BASIC on a microcomputer.

By using logical deduction, however, we can reduce the size of the search space considerably. Since we discovered that M is 1, O is 0, and S is 8 or 9, the number of possible assignments is reduced to  $8 \times 7 \times 6 \times 5 \times 4 \times 2$  which equals 13,440. This is a substantial improvement.

In addition, the nature of the cryptarithmic problem permits the use of a specialized *directed search* instead of a nondirected trial-and-error search. The plan for this specific case is to assign digits to the numbers in the right-hand column of the problem, make the addition, and then see if the two top numbers add to give the value

assigned to the letter at the bottom of that column.

A check is also made to see that these assignments do not contradict information we already know (ie:  $M=1$ ,  $O=0$ ,  $S=8$  or  $9$ ), or produce the assignment of the same digit to more than one letter. If no contradictions exist, we then move one column to the left and repeat the process. If we are successful in repeating this generate-and-test approach all the way to the left-most column, we have successfully found a set of digit assignments which solve the problem. This approach avoids the necessity of assigning digits to all the letters before checking for arithmetic correctness.

### Using Human Deduction

When humans grapple with cryptarithmic problems, there is usually a dynamic interplay between deduction and search. As information is deduced concerning which assignments are feasible, the problem solver discards many of his previous working hypotheses and concentrates on specific possibilities which appear to be most promising. It is difficult to accurately simulate this complex process on a machine, but it is possible to emulate some of the key elements in a way that is sufficient to produce a reasonably efficient computer program for solving cryptarithmic problems. In what follows, we will consider the details of such a program written in Level II BASIC for the Radio Shack TRS-80 microcomputer.

Our technique for solving these challenging puzzles can be considered in three parts: the *representation* for the specific problem, the *deduction of some of the values* on the basis of pattern analysis, and the *development of a complete solution* by directed search. As is often the case, the programming steps required to set up the problem and develop a representation constitute almost half of our effort.

The first steps are strictly preparatory. The video display is cleared, all variables are declared as integers, space is set aside for string storage, and a title is placed on the video display:

```
100 CLS: DEFINT A-Z:
CLEAR 200: PRINT@150, "CRYPTARITHMETIC"
```

Next we have the machine ask for the specific puzzle for which a solution is desired:

```
110 PRINT@272, "CODE FOR FIRST NUMBER";:
INPUT X$(1)
120 PRINT@336, "CODE FOR SECOND NUMBER";:
INPUT X$(2)
130 PRINT@400, "CODE FOR SUM OF ABOVE";:
INPUT X$(3)
```

We will need several arrays to store pertinent information. The C array will record whether a carry is present for each of the columns, given the letter values that are being tested at a given point in time. The D array will keep track of which digit assignments are feasible for each letter after the restrictions we discover from our initial detective work (ie: pattern recognition).

We will identify each letter by a number code and identify these codes by letter in the D\$ array and by position in the puzzle with the S\$ array. The digit that is being tested for each letter will be indexed by the K array

## GOODIES \* GOODIES \* GOODIES \* GOODIES

DISCOUNT PRICES—DELIVERY FROM STOCK

| Teletype Terminals                  | list  | SALE  | list                      | SALE          |
|-------------------------------------|-------|-------|---------------------------|---------------|
| Without function keys               |       |       | With function keys        |               |
| 912B (Teletype keyboard)            | \$875 | \$780 | 920B (Teletype keyboard)  | \$ 945 \$ 855 |
| 912C (Selectric keyboard)           | \$950 | \$785 | 920C (Selectric keyboard) | \$1030 \$ 860 |
| ANADEX DP-9500 and DP-9501 Printers |       |       | \$1695                    | \$1350        |
| Option R (2K Buffer)                |       |       | \$75                      | \$50          |

| DYSAN 10 Sector Minidisks | list | SALE   |
|---------------------------|------|--------|
| 107/1D (Dbl Dens)         | \$7  | \$4.75 |
| 107/2D (Quad)             | \$8  | \$5.40 |

### Word Processing on Northstar

LetterGo is the most sophisticated word processing package available for Northstar DOS. Runs in 32K with one drive. Supports any 24 x 80 terminal with cursor addressing, and any standard serial printer, with micropitch justification on Diablo or NEC.

Documentation only, \$25 Software and documentation, \$400

East Coast Technical Hotline for Northstar Equipment (703/243-6956)  
Complete factory trained service and technical support — Hotline hours: Noon to 6PM EST  
Service Contracts Available

| Northstar Discounts                                         | list   | SALE   |
|-------------------------------------------------------------|--------|--------|
| Quad Drives for Horizon (Orig. Mir.)                        | \$ 739 | \$ 550 |
| Double Density Drive for Horizon (Orig. Mir.)               | \$ 500 | \$ 325 |
| Horizon 2 dbl dens drives, 32K (asmb & burned in)           | \$3095 | \$2550 |
| Horizon 2 dbl dens drives, 64K (asmb & burned in)           | \$3830 | \$3150 |
| Horizon 2 quad drives, 32K (asmb & burned in)               | \$3595 | \$2975 |
| Horizon 2 quad drives, 64K (asmb & burned in)               | \$4330 | \$3575 |
| Horizon 1 dbl dens drive, 32K (asmb & burned in)            | \$2695 | \$2250 |
| Horizon 1 quad drive, 32K (asmb & burned in)                | \$2995 | \$2475 |
| Northstar Soft-Doc (Basic, DOS, Monitor, Reference Manuals) | \$12   | \$ 9   |
| Northstar PAS-DOC (PASCAL documentation)                    | \$40   | \$25   |

Northstar T-Shirts — Orange, Blue, S, M, L, XL \$ 7 \$ 5  
Northstar Users Group Newsletter — send for information

Items delivered from stock subject to manufacturer availability. All hardware burned in for at least 72 hours before shipment.

### MAIL ORDER ONLY

Professional Hardware Distributors, a division of DATEK Systems, Inc.

Box 4146, Arlington, Virginia 22204

Phone orders and information: (703) 243-3770

Please add 1% of the total order for shipping.

We will adjust any difference. VISA and MASTERCARD accepted.

## 6502 MICRO MICROCOMPUTER

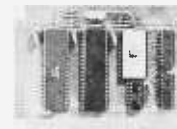

This JBE micro-microcomputer has the following:

- 1024 bytes of RAM (two 2114s)
- 2048 bytes of EPROM (2716)
- Uses one 6522 via (documentation incl.)
- 2 8-bit bidirectional I/O ports
- 2 16-bit programmable timer/counter
- Serial data port
- Latched output and input with handshaking logic
- TTL and CMOS compatible

The 6502 microprocessor is particularly suited for control functions such as temperature control burglar alarm, electrical wheel chair, lights, etc. This micro-micro interfaces with the JBE Solid State Switch and A-D and D-A converter and uses JBE 5V power supply. 2716 EPROM is available separately. A 50 pin connector is included.

80-153 ASSM. \$110.95 Kit \$89.95 Bare Board \$24.95

### DIMMER CONTROL



The JBE Dimmer Control has 4 channels, 256 brightness levels on-board power supply and four 8-bit parallel input ports (not latched). This board interfaces with JBE Solid State Switch and Apple II Parallel Interface Card (documentation included).

80-146 ASSM. \$89.95  
KIT \$79.95  
BARE BOARD \$25.95

### APPLE II DISPLAY BOARD



This handy little board is ideal for teaching and troubleshooting. It has a run-stop single step switch which makes identification of shorted lines between address or data-bits easy & shows single step for teaching computer logic. The display board has 16 address LEDs, 8 data LEDs and 1 RDY LED. All lines are buffered.

80-144 ASSM. \$49.95  
KIT \$42.95  
BARE BOARD \$25.95

## JOHN BELL ENGINEERING

ALL PRODUCTS ARE AVAILABLE FROM: JOHN BELL ENGINEERING  
P.O. BOX 338 • REDWOOD CITY, CA 94064 • (415) 367-1137  
ADD 6% SALES TAX IN CALIFORNIA. FOR ORDERS OUTSIDE THE U.S.A.,  
ADD 5% FOR SHIPPING AND HANDLING.

\*For complete product line, see John Bell Engineering full page ad in *Kilobaud*  
\*Write for our new catalog

# ZOBEX Z<sub>S</sub>-SYSTEMS

Complete computer on 3 S-100 boards with 32K RAM for \$1395.00  
Runs M/PM and C/PM

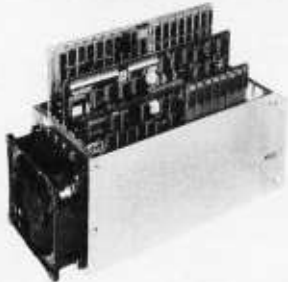

### 64K RAM

4 MHz No WAIT States  
DMA operation,  
Bank select in 16K sections

### DISK CONTROLLER

8" and 5" DRIVES  
All digital design for stable and  
reliable performance. No one-  
shots or analog circuitry. BIOS  
for C/PM available.

### Z80 CPU

2 or 4 serial ports, 3 parallel,  
one 4K EPROM, Vectored inter-  
rupts, real time clock, Software  
controlled baud rates, Drives  
daisy wheel printer directly

### CARD CAGE and Fan

6 slot shielded motherboard for  
good cooling and low noise.

### 2-4 MHZ

SEND FOR FREE INFORMATIONS  
6 months warranty on our boards with normal use

## Z<sub>S</sub>-SYSTEMS ZOBEX

5333 Mission Center Rd., San Diego, CA. 92108  
P.O. Box 1847, San Diego, Ca. 92112  
(714) 447-3997, (714) 296-9182

(parallel to D\$) and the S array (parallel to S\$). The length of each of the code words is stored in the L array.

140 DIM C(8), D(10,10), D\$(10), K(11), L(3), S(3,10), S\$(3,10)

The processing task begins by determining the length of each code word and by breaking up each word into its individual letters:

```
160 FOR J=1 TO 3: L(J)=LEN(X$(J)):
FOR I=1 TO L(J)
170 N=L(J)-I+1: S$(J,I)=MID$(X$(J),N,1):
NEXT I: NEXT J
```

The index J is used to represent the first word (J=1), second word (J=2), and third word (J=3), and the index I is used to represent the right-hand column (I=1), the column one over from the right (I=2), etc.

Our next objective is to assign an identifying number to each letter (the index of array D\$) and associate each of these identifying numbers with a position in the cryptarithmic puzzle by setting up the S array. The variable NL records the number of different letters in the puzzle:

```
200 NL=0: I=0
210 I=I+1: IF I>L(3) THEN 300 ELSE J=0
220 J=J+1: IF J>3 THEN 210
230 IF I > L(J) THEN 220 ELSE N=0
240 N=N+1: IF S$(J,I)=D$(N) THEN S(J,I)=N:
GOTO 220
250 IF N<NL THEN 240
260 NL=NL+1: D$(NL)=S$(J,I): S(J,I)=NL:
GOTO 220
```

It is also necessary to prepare the machine with the knowledge that blank spaces which precede letters in the first two rows should be treated as zeroes.

```
270 IF L(2)>L(1) THEN S(1,L(2)) = 11
280 IF L(1)>L(2) THEN S(2,L(1)) = 11
```

Now the machine is almost ready to begin processing. Before it gets started, however, a neatly arranged graphical display of the puzzle is needed as well as a list of the letters in the order that digits will be assigned:

```
300 CLS: PRINT CHR$(23):
PRINT@226-4*L(2),"+";
310 FOR J=1 TO 3: FOR I=1 TO L(J):
K=104+64*2*(J-1)-4*I
320 PRINT@K, S$(J,I);: NEXT I: NEXT J
330 FOR I=1 TO L(3): PRINT@294-4*I,"---";:
NEXT I
350 FOR I=1 TO NL: PRINT@636+6*I, D$(I);:
NEXT I
```

### Restricting Values

The first step in searching for a solution is to determine what values, if any, cannot be reasonably assigned to particular letters. In our present effort, we will not attempt anything as complex as trying to directly deduce this information. Instead we will use pattern analysis to identify certain obvious cases.

In order to use this information in our search, we will

# NEVADA COBOL

## For CP/M

Powerful subset of ANSI-74

Order now!  
All the elegant simplicity  
of COBOL is now affordable!

DISKETTE  
& MANUAL  
**\$99<sup>95</sup>**

REQUIRES only 16K RAM.  
Available on 8" CP/M  
standard single density or  
5 1/4" diskettes for North  
Star, TRS-80 Mod I and  
Superbrain. Other formats  
too! Manual alone \$24.95.

These powerful, easy to use  
COBOL APPLICATION PACKAGES  
are also available:

- BUDGET PLAN REPORT GENERATOR**  
Fantastic time saver and planning aid for beginning or established businesses.
- PERSONAL FINANCIAL REPORTING**  
Eye-opening insights of personal spending.
- LABELS** for mailing lists.
- PRECOBOL** (a preprocessor).

ALL 4 in one BOOK!  
73 pages with complete COBOL  
source code listings and super  
documentation.

**\$24<sup>95</sup>**

WE ACCEPT



Ellis Computing  
1480 17th Avenue  
San Francisco, CA 94122  
(415) 664-1534



GO FOR IT!

In CA add sales tax. CP/M trade mark of Digital Research. TRS-80 trade mark of Tandy Corp.

set up a special array, D(J,I), in which the first index, J, will represent each of the letters we are working with and the second index, I, will represent each of the digits (0 to 9) which might potentially be assigned to each of the letters:

```
380 FOR J=1 TO NL:
 FOR I=0 TO 9: D(J,I)=I: NEXT I:
 NEXT J
```

To indicate that a particular digit cannot be assigned to one of the letters, the machine will set the appropriate member of the D array to the value of 99. Two subroutines will be used for this purpose. When the machine has determined that a particular letter can be assigned only one digit, it will record this information by calling these subroutines. The first subroutine sets all the values for that letter to 99:

```
2000 FOR I=0 TO 9: D(Z,I)=99: NEXT I: RETURN
```

The second subroutine sets this digit in the arrays for the other letters to 99 and sets the digit value for the correct letter back to the proper value:

```
3000 FOR I=1 TO NL: D(I,X)=99: NEXT I:
 D(Z,X)=X: RETURN
```

With these subroutines in hand, the machine is ready to analyze letter patterns to determine if certain letters can only take on a restricted set of values.

### Patterns

The first pattern the program looks for is the one we described at the beginning of this article when discussing the SEND + MORE = MONEY cryptarithmic puzzle:

```
400 F=0: IF L(3)=L(1) OR L(3)=L(2) THEN 500
410 J=S(3,L(3)): Z=J: GOSUB 2000: X=1:
 GOSUB 3000
420 Z=0: IF J=S(1,L(1)) THEN Z=S(2,L(2))
430 IF J=S(2,L(2)) THEN Z=S(1,L(1))
440 IF Z=0 THEN 500
450 GOSUB 2000: D(Z,8)=8: D(Z,9)=9
460 Z=S(3,L(3)-1): IF J=Z THEN 500
470 GOSUB 2000: X=0: GOSUB 3000: F=1
```

This block of code checks to see if the bottom line of the puzzle is longer than both the first and second lines. If so, the first letter of the bottom line has to be 1, and the D array is altered accordingly. The machine then checks to see if one of the first two lines starts with the same letter as the bottom line. If so, it can further restrict the values which are allowed for the remaining letters in this column.

The next pattern the machine looks for is the case of a column where one of the letters in the first two lines is identical to the letter at the bottom of the column. In this case, the odd letter in the column must be either 0 or 9. If the digit 0 was assigned previously (ie: line 470), then the odd letter has to be 9. If this pattern is discovered, the D array is modified appropriately.

```
500 FOR P=1 TO L(1): Z=0
510 IF S(1,P)=S(3,P) THEN Z=S(2,P)
```

```
520 IF S(2,P)=S(3,P) THEN Z=S(1,P)
530 IF Z=0 THEN 570 ELSE GOSUB 2000
540 IF P=1 THEN X=0: GOSUB 3000: GOTO 570
550 IF F=1 THEN X=9: GOSUB 3000: GOTO 570
560 D(Z,0)=0: D(Z,9)=9
570 NEXT P
```

Both of the above patterns are easy to detect. Other informative letter arrangements are more complex and involve recursive IF ... THEN reasoning. The structure of the present program is such that these additional analyses can be added to increase the "intelligence" of the program. In each case, the information would be used to modify the D array such that certain letter-digit combinations would be eliminated from the search procedure that follows.

### The Directed Technique

The heart of our cryptarithmic problem solver is the directed-search process. Although this process is highly mechanical, it gives the program the appearance of being intelligent. It would work even if lines 400 thru 570 were eliminated from the program. The solution times, however, would be much slower without these lines.

The search process is somewhat similar to the blind trial-and-error procedure we employed last month for the missionaries-and-cannibals problem. The major enhancement is that digits are first assigned to the letters in the right column of the problem and then the addition is checked for accuracy. If it is incorrect, a new value is

*Text continued on page 271*

## CATCH THE S-100 INC. BUS!



|                                                | LIST PRICE | OUR SPECIAL CASH PRICE |
|------------------------------------------------|------------|------------------------|
| S.D. Systems SBC-100 Single Board Computer Kit | 295.00     | *252.00                |
| Godbout — Z-80A CPU A&T                        | 295.00     | 249.00                 |
| Morrow Designs Discus II D A&T                 | 1199.00    | 979.00                 |
| North Star Z-80A CPU A&T                       | 299.00     | 255.00                 |
| North Star Floating Point Board A&T            | 399.00     | 325.00                 |

\*Included free with every S.D. Systems Board is an additional \$25.00 manufacturers rebate coupon.

Subject to Available Quantities • Prices Quoted Include Cash Discounts. Shipping & Insurance Extra.

We carry all major lines such as  
S.D. Systems, Cromemco, Ithaca Intersystems, North Star,  
Sanyo, ECT, TEI, Godbout, Thinker Toys, SSM.  
For a special cash price, telephone us.

Hours:  
Mon.-Fri.  
10 A.M.-6 P.M.

Bus . . . . . **S-100, inc.**  
Address . . . . . **7 White Place**  
**Clark, N.J. 07066**  
Interface . . . . . **201-382-1318**

# CAT-100 FULL COLOR GRAPHICS

The original 256-color imaging system with high resolution video FRAME GRABBER for the S-100 bus.

Capture and digitize a video frame in 1/60 of a second. Select the best resolution for your application, from 256 to 1280 pixels per TV line. Display your digitized or computer processed image with 256 gray levels or 256 colors on standard B&W, NTSC or RGB TV monitors.

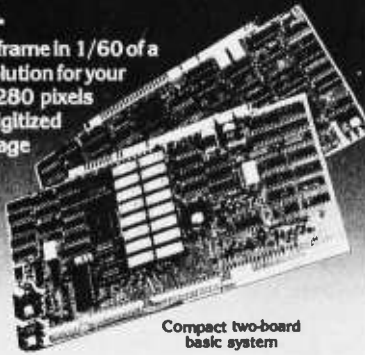

Compact two-board basic system



240x256 Digitized image. 16 levels



480x512 Computer-generated

### Features:

- Highest possible quality 480x512x8 digital video image presently available on the market
- Input capability from TV camera or other sources
- Variety of synchronization choices
- 2 selectable video A/D conversion circuits
- Choice of 1, 2, 4, 8, 16 or 32 bits per pixel
- 32K-byte image memory on the basic system
- 32, 64, 128 & 256K byte system capacity
- Lightpen input
- Photographic trigger control input
- Software selectable system parameters
- Interfaces for TRS-80 and other processors
- Comprehensive line of accessories, monitors and support software

SEND FOR FREE CATALOG



DIGITAL GRAPHIC SYSTEMS

441 California Ave., Palo Alto, CA 94306 415/494-6088

## IEEE-488 BUS SYSTEM BUILDING BLOCKS

For Commodore PET/CBM and other computers...

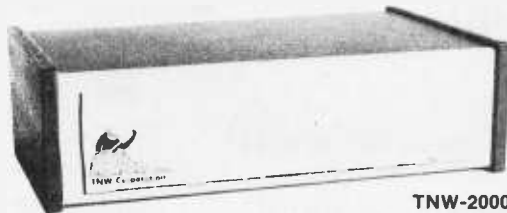

TNW-2000

**TNW-1000** Serial Interface: \$129  
1 channel output only

**TNW-2000** Serial Interface: \$229  
1 channel input and output

**TNW-232D** Dual Serial Interface: \$369  
2 channels input and output plus RS-232 control lines

**TNW-103** Telephone Modem: \$389  
Auto answer/auto dial Use with DAA

**SOFTWARE**  
PTERM: A program that turns your PET into a terminal (Use with TNW-2000, TNW-232D, or TNW 103)  
SWAP: Allows storage of up to 8 programs in PET memory at once. Run them in any order.  
PAN: A sophisticated electronic mail program (use with TNW-103)

Write or call for information today:



TNW Corporation  
3351 Hancock Street  
San Diego CA 92110

(714) 225-1040

Listing 1: A BASIC program to solve cryptarithmic puzzles. This program, written for the Radio Shack TRS-80 computer with Level II BASIC, solves problems similar to SEND + MORE = MONEY, where each letter of each word represents exactly one of the decimal digits 0, 1, 2, ..., 9. This program decreases the solution time by incorporating several human-derived insights that decrease the solution space.

```

100 CLS: DEFINT A-Z: CLEAR 200:
 PRINT@ 150, "CRYPTARITHMETIC"
110 PRINT @272 "CODE FOR FIRST NUMBER"; INPUT X$(1)
120 PRINT@336, "CODE FOR SECOND NUMBER";
 INPUT X$(2)
130 PRINT@400, "CODE FOR SUM OF ABOVE"; INPUT X$(3)
140 DIM C(8), D(10, 10), D$(10), K(11), L(3), S(3, 10), S$(3, 10)
160 FOR J=1 TO 3: L(J)=LEN(X$(J)); FOR I=1 TO L(J)
170 N=L(J)-I+1: S$(J,I)=MID$(X$(J),N,1): NEXT I: NEXT J
200 NL=0: I=0
210 I=I+1: IF I>L(3) THEN 300 ELSE J=0
220 J=J+1: IF J>3 THEN 210
230 IF I > L(J) THEN 220 ELSE N=0
240 N=N+1: IF S$(J,I)=D$(N) THEN S(J,I)=N: GOTO 220
250 IF N<NL THEN 240
260 NL=NL+1: D$(NL)=S$(J,I): S(J,I)=NL: GOTO 220
270 IF L(2)>L(1) THEN S(1,L(2))=11
280 IF L(1)>L(2) THEN S(2,L(1))=11
300 CLS: PRINT CHR$(23): PRINT@226-4*L(2), "+";
310 FOR J=1 TO 3: FOR I=1 TO L(J):
 K=104+64*21*(J-1)-4*I
320 PRINT@K, S$(J,I); NEXT I: NEXT J
330 FOR I=1 TO L(3): PRINT@294-4*I, "---"; NEXT I
350 FOR I=1 TO NL: PRINT@636+6*I, D$(I); NEXT I
380 FOR J=1 TO NL: FOR I=0 TO 9: D(J,I)=I:
 NEXT I: NEXT J
400 F=0: IF L(3)=L(1) OR L(3)=L(2) THEN 500
410 J=S(3,L(3)): Z=J: GOSUB 2000: X=1: GOSUB 3000
420 Z=0: IF J=S(1,L(1)) THEN Z=S(2,L(2))
430 IF J=S(2,L(2)) THEN Z=S(1,L(1))
440 IF Z=0 THEN 500
450 GOSUB 2000: D(Z,8)=8: D(Z,9)=9
460 Z=S(3,L(3)-1): IF J=Z THEN 500
470 GOSUB 2000: X=0: GOSUB 3000: F=1
500 FOR P=1 TO L(1): Z=0
510 IF S(1,P)=S(3,P) THEN Z=S(2,P)
520 IF S(2,P)=S(3,P) THEN Z=S(1,P)
530 IF Z=0 THEN 570 ELSE GOSUB 2000
540 IF P=1 THEN X=0: GOSUB 3000: GOTO 570
550 IF F=1 THEN X=9: GOSUB 3000: GOTO 570
560 D(Z,0)=0: D(Z,9)=9
570 NEXT P
800 FOR I=0 TO NL: K(I)=-1: NEXT I
810 P=1: I=0: C(0)=0: K(11)=0
820 I=I+1: K(I)=-1
830 K(I)=K(I)+1: IF K(I)>9 THEN 1000
840 IF D(I,K(I))=99 THEN 830 ELSE J=0
850 J=J+1: IF J=I THEN 870
860 IF K(J)=K(I) THEN 830 ELSE 850
870 PRINT@762+6*I, K(I);
880 Z=K(S(3,P)): IF Z=-1 THEN 820
890 Y=K(S(2,P)): IF Y=-1 THEN 820
900 X=K(S(1,P)): IF X=-1 THEN 820
910 TS=X+Y+C(P-1)
920 IF TS>9 THEN C(P)=1 ELSE C(P)=0
930 IF TS<>Z+10*C(P) THEN 830
940 IF P<L(1) THEN P=P+1: GOTO 880
950 IF L(3)=L(1) AND C(P)=1 THEN 830
960 IF L(3)>L(1) AND C(P)=0 THEN 830
970 PRINT@960, "SUCCESS"; GOTO 970
1000 K(I)=-1: PRINT@762+6*I, " "; I=I-1: P=1
1010 IF I>0 THEN 830
1020 PRINT@960, "FAILURE"; GOTO 1020
2000 FOR I=0 TO 9: D(Z,I)=99: NEXT I: RETURN
3000 FOR I=1 TO NL: D(I,X)=99:
 NEXT I: D(Z,X)=X: RETURN

```



Text continued from page 269:

assigned to the most recently modified letter. If the addition is correct, values are then assigned to the letters in the second column from the right. The addition for this column, including the carry when present for the right-hand column, is then checked. If incorrect, a new assignment is made. If correct, the machine goes over to the next column. The machine continues this process until it finds a solution or until all letter-digit combinations have been tried without success.

Because there are so many possible combinations, solution time is much shorter if some of the potential assignments can be eliminated during the preliminary analysis of letter patterns. The search occurs much more rapidly with addition checks made column by column rather than through assigning a digit to all letters before checking to see if the digits add up correctly. These preliminary checks provide considerable direction to an otherwise unstructured search.

### Program Operation

The primary actor in the machine's search process is array K. This array keeps track of which digit is currently being tested for each letter. When no assignment has been made to a letter, the value of K will be set at -1. The variable NL, as you recall, represents the number of letters in the puzzle. The index P will represent which column of the puzzle is currently in the spotlight. The array C will keep a record of whether a carry has occurred for each of the columns. The index I keeps track of the letter to which the machine is currently assigning a digit.

The first step is to initialize the key variables:

```
800 FOR I=0 TO NL: K(I)=-1: NEXT I
810 P=1: I=0: C(0)=0: K(11)=0
```

Then we establish the main loop:

```
820 I=I+1: K(I)=-1
830 K(I)=K(I)+1: IF K(I)>9 THEN 1000
```

A branch to line 1000 occurs when all ten digits (0 to 9) have been tried for a letter without success.

The code at line 1000 provides a means to back up and try a new digit for the letter immediately preceding (in the assignment sequence) the current letter:

```
1000 K(I)=-1: PRINT@762+6*I, " "; I=I-1:
P=1
1010 IF I>0 THEN 830
1020 PRINT@960, "FAILURE";: GOTO 1020
```

Each time the machine backs up, the index I is decremented by 1, the column analysis reverts back to the right-hand column, and the last digit appearing on the display is erased. If the value of I decreases to zero, all combinations have been tried and found lacking. The machine then makes its failure public by executing line 1020.

If K(I) is assigned a number at line 830 of 9 or less, the program continues by seeing if the new value is an acceptable one by checking the D array for feasible values (line 840) and then makes sure that this digit has

not already been assigned to another letter (lines 850 and 860):

```
840 IF D(I, K(I))=99 THEN 830 ELSE J=0
850 J=J+1: IF J=1 THEN 870
860 IF K(J)=K(I) THEN 830 ELSE 850
```

If the new assignment passes both of these tests, the machine prints the digit on the display to let the observer know its current "thinking." It then checks to see whether it has assigned a digit to each of the letters in the column that is presently under consideration:

```
870 PRINT@762+6*I, K(I);
880 Z=K(S(3,P)): IF Z=-1 THEN 820
890 Y=K(S(2,P)): IF Y=-1 THEN 820
900 X=K(S(1,P)): IF X=-1 THEN 820
```

If one or more of the letters have not been assigned a digit, the machine branches to line 820 and takes care of this oversight. Otherwise, it calculates the sum of the column (line 910), determines whether or not there is a carry (line 920), and then checks to see if the addition of the two top numbers matches the digit which has been assigned to the bottom letter (line 930):

```
910 TS=X+Y+C(P-1)
920 IF TS>9 THEN C(P)=1 ELSE C(P)=0
930 IF TS<>Z+10*C(P) THEN 830
```

If the numbers do not add up properly, the machine branches to line 830 to try another digit assignment for the letter currently being tested. If the addition is correct,

## TOLL FREE ORDERING



**These Fine Products and More**

|                        |       |                                   |         |
|------------------------|-------|-----------------------------------|---------|
| <b>NORTHSTAR</b>       |       | <b>THINKER TOYS</b>               |         |
| HRZ 1-32K-D .....      | 2100  | DISCUS 2 + 2 1 DRIVE .....        | 1265    |
| HRZ 2-32K-D .....      | 2340  | DISCUS 2D 1 DRIVE .....           | 970     |
| HRZ 2-32K-O .....      | 2690  | DISCUS M26 HARD DISC .....        | 4095    |
| HARD DISC SYSTEM ..... | 3950  | <b>SOLID STATE MUSIC Kit Assm</b> |         |
| <b>DYNA BYTE</b>       |       | SB1 SYNTHESIZER .....             | 161 227 |
| DB 8/1 4 8K .....      | 2395  | VB1B VIDEO .....                  | 125 170 |
| DB 8/2 4 8K .....      | 3900  | CB2 Z80 CPU .....                 | 168 220 |
| DB 8/4 .....           | 3030  | <b>MEASUREMENT SYSTEMS</b>        |         |
| 32M PHOENIX .....      | 11800 | DM 3200 32K 250ns .....           | 500     |
| <b>TERMINALS</b>       |       | DM 6400 64K 250 ns .....          | 640     |
| TELEVIDEO 912 .....    | 745   | DMB 3200 .....                    | 650     |
| TELEVIDEO 920 .....    | 795   | <b>SOFTWARE-DISCS-MISC</b>        |         |
| SOROC IQ-120 .....     | 700   | CPM-2 .....                       | 150     |
| <b>PRINTERS</b>        |       | WORDSTAR .....                    | 350     |
| NEC 5510 .....         | 2700  | GRAHAM-DORIAN .....               | CALL    |
| NEC 5520 .....         | 2975  | STRUCTURED SYSTEMS .....          | CALL    |
| TI-820 .....           | 1650  | VERBATIM 5 (10) .....             | 28      |
| ANADEx .....           | 795   | VERBATIM 8 (10) .....             | 35      |
| BASE 2 .....           | 500   | ATARI .....                       | CALL    |
| EPSON .....            | CALL  | TI 99-4 .....                     | CALL    |

**WE WILL TRY TO BEAT ANY ADVERTISED PRICE**

**Automated Equipment Inc.**

4341 W. Commonwealth Ave Suite D

Fullerton, Calif. 92633

**(714) 739-4701 (800) 854-6003**

# Main/Frames from \$200

# Main/Frames from \$200

- 14 Basic Models Available
- Assembled & Tested
- Power Supply:  
8v@15A, ± 16v@3A
- 15 Slot Motherboard  
(connectors optional)
- Card cage & guides
- Fan, line cord, fuse, power  
& reset switches, EMI filter
- 8v@30A, ± 16v@10A  
option on some models

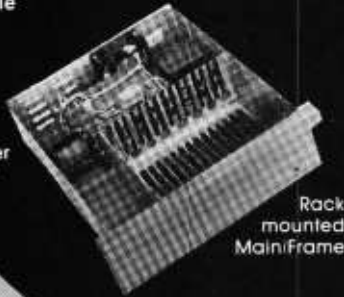

Rack mounted Mainframe

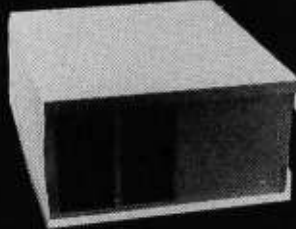

8" Floppy Main/Frame  
(includes power for drives and mainframes)

Write or call for our brochure which includes our application note:  
**'Building Cheap Computers'**  
**INTEGRAND**

8474 Ave. 296 • Visalia, CA 93277 • (209) 733-9288  
We accept BankAmericard/Visa and MasterCharge

## JOE COMPUTER\* Presents Exclusive Software: IT'S FOOTBALL SEASON!

### Pro and College Football from SDL:

A TRS 80† translation of Ken Perry's popular Apple programs. These programs predict point spreads with unbelievable accuracy. They are heuristic and require about 10 minutes a week to record the weekend's results into the data base from your local newspaper. You may predict any game within seconds from the data saved on cassette or disk. Pro Football contains all 28 pro teams. College football contains an unbelievable data base of 78 teams! Each program comes with the entire 1979 season data file on cassette or disk. You can display each team's record of scores or won-loss record. A record of 4-5 weeks is required before predictions are effective so you're just in time! Pro or College Football will be shipped U.P.S. blue label the same day order is received. Order C.O.D. by phone. \$1.00 blue label charge; C.O.D. fees added on.

|                                                       |         |
|-------------------------------------------------------|---------|
| Pro Football Cassette (32K TRS 80 Level II) .....     | \$21.95 |
| Disk .....                                            | \$26.95 |
| College Football Cassette (48K TRS 80 Level II) ..... | \$21.95 |
| Disk .....                                            | \$26.95 |

### Horse Race Handicapping!

Probability Handicapping Device 1 was written by a professional software consultant to TRW Space Systems. This is a complex program carefully human factored for easy use. It is a comprehensive horse racing system for spotting overlays in thoroughbred sprint races. Your computer will accurately predict the win probability and odds line for each horse based on your entries from the racing form. The next day overlay horses can be spotted on the track tote board. The users manual contains a complete explanation of overlay betting plus much more useful information. The appendix contains a detailed tab run of a 100 consecutive race system workout showing an amazing 50% return (\$.50 returned for each \$1.00 flat wager). Includes many features such as error correction, bubble sort, line printer output, archiving, etc. The manual may be ordered separately for perusal for \$7.95 and credit. PHD-1 users manual and cassette for: 8K Apple II Applesoft, 8K Challenger (specify 1P or 4P), TRS-80 16K Level II .....

|                                                                                                                                                                                                                                                                                                                                                                    |         |
|--------------------------------------------------------------------------------------------------------------------------------------------------------------------------------------------------------------------------------------------------------------------------------------------------------------------------------------------------------------------|---------|
| Apple or TRS-80 Disk .....                                                                                                                                                                                                                                                                                                                                         | \$34.95 |
| Brand new from SDL: Win At The Races another Ken Perry spectacular! This algorithm is based on a currently popular book representing the most ambitious multiple regression research on thoroughbred racing to date. The probable odds and win probability for each horse are displayed. Line printer output, error correction, descending sort; all the niceties! |         |
| Win At The Races cassette (32K TRS-80 Level II) .....                                                                                                                                                                                                                                                                                                              | \$34.95 |
| Disk (48K TRS-80 Level II) .....                                                                                                                                                                                                                                                                                                                                   | \$39.95 |

### THE BOOK for the Computerized Handicapper!

WINNING AT THE RACES by William Quirin Ph.D. Computer science has come to the rescue of the racing fan. This is the first major scientific study of handicapping available to the general public, detailing what the computer reveals about class, form, early speed, and more; plus special multiple regression computer systems. A Tom Ainslie — winners circle book.

|                            |               |
|----------------------------|---------------|
| Winning At The Races ..... | \$21.95       |
|                            | + \$.75 P & H |

Order now to get on our list and receive back issues free!

Phone Orders: Mike (213) 992-0514      Systems Design Lab (213) 374-4471

Make Checks payable to: **JOE COMPUTER**  
22713 Ventura Blvd., Suite F, Woodland Hills, CA 91364

\*Get on the Computers & Gambling Products mailing list for \$3.00 & receive available back issues Calif. res. add 6% tax.      TRS-80 is a Registered Trademark of Tandy Corporation

The pattern-analysis portion of the program provides a capability that mirrors human problem-solving skills.

the TRS-80 checks to see if all columns have been tested. If not, it increments P and jumps to line 880. If all columns have been tested, then it makes sure the carry for the left-hand column is correct. If all is in order, the machine announces to the world that it has found a solution:

```
940 IF P < L(1) THEN P = P + 1: GOTO 830
950 IF L(3) = L(1) AND C(P) = 1 THEN 830
960 IF L(3) > L(1) AND C(P) = 0 THEN 830
970 PRINT@960, "SUCCESS";: GOTO 970
```

### A Useful Technique

This program provides an interesting example of problem solving by combining man-like and machine-like techniques. The search process (lines 800 to 1020) is clearly not meant for human use. A systematic, patient search such as this is just not the thing a human would do. On the other hand, it is a highly effective technique for a computer.

The pattern-analysis portion of the program (lines 400 to 520) provides a capability that mirrors human problem-solving skills. Once you have worked with several cryptarithmic problems, you will learn to recognize these patterns immediately and will use the relevant information to speed the solution process. By programming the machine to recognize these same patterns, we provide a useful mechanism for hastening the search.

In many instances, the most effective program for solving a complex problem is one which uses efficient mechanical algorithms in combination with a knowledge base which is triggered by pattern recognition. It is difficult to write a computer program that accurately imitates human problem-solving methods. However, programs that ignore the domain-specific knowledge used by humans in finding a solution are often very inefficient. The best technique often consists of combining useful features from both approaches into a single mechanical strategy.

To test the generality of our procedure, the reader is encouraged to try additional cryptarithmic puzzles on the program. Some common puzzles that are worth considering are:

$$\begin{array}{r} \text{CROSS} \\ + \text{ROADS} \\ \hline \text{DANGER} \end{array} \quad \begin{array}{r} \text{DONALD} \\ + \text{GERALD} \\ \hline \text{ROBERT} \end{array} \quad \begin{array}{r} \text{LETS} \\ + \text{WAVE} \\ \hline \text{LATER} \end{array}$$

As mentioned earlier, the program should be able to solve any puzzle of this type. Try your favorite puzzle and see how long the solution takes. You may wish to add some pattern-recognition information to the program to increase the efficiency of the search.

Next month, we will consider the search process which is commonly employed for two-person, perfect-information, zero-sum games such as chess or checkers. Instead of simply talking about the alpha-beta ( $\alpha - \beta$ ) algorithm, we will present the real thing in its modern form. ■

# Book Reviews

## Microprocessors and Digital Systems

by Douglas V Hall,  
Gregg/McGraw-Hill,  
1980, 426 pages,  
hardcover, \$15.95

*Microprocessors and Digital Systems* by Doug Hall is written for people interested in expanding their practical knowledge of electronics. While ostensibly written for technicians and based on an electronics training program at Herald Engineering College in San Francisco, the book brings together a wide variety of subjects which are of significant value to engineers as well as hobbyists.

This book is based upon the premise that it does little good to know the theory of a design without knowing how to assemble, connect, and test a circuit. It is important to recognize and understand how the choice of components and test equipment can affect the success of any project. In a classic bottom-up approach, the reader first becomes familiar with prototyping techniques, wire wrapping, and typical test equipment. Presuming a knowledge of basic electronics and transistor theory, Mr Hall advances through subjects such as digital logic families, logic gates, interfacing, signal conditioning, analog-to-digital and digital-to-analog conversion, and microcomputers.

In the sections on microprocessors, the 8080, 6800, and 6502 receive considerable exposure. Included are sample schematic diagrams for small systems that incorporate these processors, as well as illustrative programs for each. In keeping with the premise of the entire book, the examples presented are pro-

grams for a microprocessor-controlled weight scale and an EPROM (erasable programmable read-only memory) programmer. Readers interested in larger computers can gain some insights on BASIC, FORTRAN, and Pascal in a chapter on high-level languages.

There are objectives listed at the beginning of each chapter, and review questions and problems at the end of each chapter. Mr Hall makes extensive use of manufacturers' data sheets, application notes, and schematic diagrams. *Microprocessors and Digital Systems* is thoroughly oriented toward people who handle electronic circuits rather than think about them.

Steve Ciarcia  
POB 582  
Glastonbury CT 06033

## Z80 Microprocessor Programming and Interfacing

Volumes 1 and 2  
by Nichols, Nichols, and Rony

Volume 1: 302 pages,  
softcover, \$10.95

Volume 2: 496 pages,  
softcover, \$12.95

Blacksburg Continuing  
Education Series  
Howard W Sams & Com-  
pany Inc, 1979.

*Z80 Microprocessor Programming and Interfacing* is a two-volume series designed to teach the reader how to program and interface the Z80 processor chip. The use of the term *chip* rather than microcomputer is intentional here; this series is very concerned with hard-

ware. Volume one covers how to program the Z80; volume two covers how to use it.

Both volumes are texts intended for use in a laboratory course or for laboratory-based self-study. Each chapter begins with a series of objectives and ends with a series of graduated experiments. The experiments involve both hardware and software development, and stress the trade-offs involved in substituting one for another. Between the experiments and the appendices, much good reference material is included, both hardware and software. Overall, the two volumes make up a very useful text either for class use or for self-study.

There is one glaring problem with both texts, however. All of the experiments assume that the student has one of two single-board computers manufactured by SGS-ATES. This is an Italian company whose products are not widely available in the US, at least from hobbyist sources. Fortunately, almost all of the software experiments can be performed on any Z80-based computer which has either a front panel or a monitor in read-only memory. Many of the hardware experiments can also be performed (with minor changes) on other machines. The exclusive use of this single-board computer along with the consistent use of SGS-ATES data sheets throughout the second volume leads one to believe that the series was sponsored by SGS-ATES. This is all very well, but unfortunately it renders the series useless for self-study by a novice who does not own an SGS-ATES Nanocomputer and who is not knowledgeable enough to make the required changes. On the positive

side, full schematic diagrams and software listings are given for the Nanocomputer, which is an admirable little unit, suitable for use in a number of controller-type applications.

Now for a number of more or less random comments. The interfacing section contains the circuitry for a breadboarding station which could be used with most Z80 systems. This plus the listing of a 2 K-byte monitor and the inclusion of quite a few data sheets are some of the little extras in the book. On the negative side, there is no good index to the data sheets, on page 106 the data sheet for a 74LS138 is mistitled 74LS139, and there is only one blank page at the back for notes.

All in all, this is a useful series to have if you want to learn how to use the Z80 for hardware designs. The series will not teach you about program design, and it assumes a certain amount of sophistication if you do not use the particular computer for which the experiments have been written. But it contains the best discussion that I have seen of machine programming (as opposed to assembler) of the Z80, and the clearest discussion of exactly how the device functions when you make it perform various tasks. The two volumes would be ideal for a class, and belong on the shelf of anyone planning to design systems which contain the Z80. ■

John A Lehman  
716 Hutchins #2  
Ann Arbor MI 48103

# The FORTH Standards Team

---

William Ragsdale  
FORTH Interest Group  
POB 1105  
San Carlos CA 94070

---

How can a standard be created for a computer language when every programmer freely adds his own procedures, data structures, and compilation methods? This dilemma continually faces the FORTH Standards Team as each user creates extensions to the language as the fundamental act of programming!

The recently published FORTH-79 Standard offers a uniform vehicle for interchange of FORTH programs across all computer architectures and models. Additionally, it provides programmers the ability to communicate with other programmers and host computers, as they ply their craft. FORTH was created by Mr Charles Moore from 1960 thru 1970, to meet his real-world programming needs. The standards team has developed the current standard through three generations, to match increasingly broader requirements.

## Why a Standard?

The true cornerstone of standards work is *cost reduction*. This applies to all standards, not just those developed for computer languages. Instead of optimizing the language for each application and computer, we team members accept programs that are a bit slower and a bit bulkier in memory usage. Our reward is less cost for creating and maintaining specific application programs, less cost for personnel training, and less cost for the host operating system itself.

When analyzed in detail, language standards offer five components of cost and efficiency improvement:

- If an application is portable between computers, its cost may be spread over a larger number of installations. Likewise, a standard host system offers a larger potential market.
- A uniform computer language allows programmers to communicate concepts to one another. The concepts may be more efficiently shared if their standard com-

---

## About the Author

*William Ragsdale settled on FORTH in 1977, after a year-long search for high-level software tools to enhance programmer productivity. He is a graduate of the University of California at Berkeley and is president of a communications company. Bill attended the FORTH-78 Standards Team meeting, created the FORTH Interest Group model of the language, and contributes to FORTH Dimensions, the FIG Newsletter. He is currently chairman of the FORTH-79 Team.*

---

ponents are clearly known.

- People move from one job to another. Personnel trained at one site are more quickly productive at another site when standard usage exists. It isn't any quicker to learn a standard language dialect, but naturally, standardized skills have a broader marketplace.
- The evaluation time spent for purchased application or system software is reduced if its components are standardized. Only the new elements need to be analyzed.
- If someone does desire a nonstandard system or application, the standard portion provides a known point of departure for documentation of the differences.

## The Early History of FORTH Standards

FORTH's professional usage began in 1970 with one programmer, Charles Moore, at NRAO (the National Radio Astronomy Observatory). Soon after that, Elizabeth Rather and others joined him. When FORTH came into use at Kitt Peak National Observatory, the number of users grew even larger: finally the users recognized the need for standardization.

Specifically, as FORTH's usage increased in astronomical research, that user community recognized the need for a common dialect. An ad hoc team within the International Astronomical Union, hosted by Kitt Peak National Observatory, and with Jim Brault as chairman, met in May, 1977. This group produced the document AST.1, a glossary of definitions for the minicomputer versions then in use. Extension levels were outlined, but not detailed, for double-length numbers, floating-point numbers, and system extensions.

The work begun as AST.1 was then carried forward with a series of European meetings, again, in the astronomical-research community. The final meeting was held in Utrecht, The Netherlands, in February, 1978. The attendees were Jim Brault, Phil Hill, Robbie Spruit, Paul Bartholdi, Charles Moore, Elizabeth Rather, Hans Nieuwenhuijzen, and Terrel Miedaner. This group's report FST-780314 became the FORTH-77 standard. It is directed toward word-addressing computers, specifically the Data General Nova, the Hewlett-Packard HP-2100, and the Varian 620.

The standards meeting on Catalina Island, Avalon, California, in October, 1978, found the team expanded

to eighteen, and the chairman was Terrel Miedaner of Kitt Peak. A broadened constituency was drawn from the FORTH Users Group based in Europe, FIG (FORTH Interest Group), and FORTH Inc, a company started by Charles Moore.

This meeting was the first that considered byte-addressing computers. Work continuing from FORTH-77 resulted in an increased clarity of word-naming and provided a minimum set of defined words that were collectively more powerful than those of previous standards. However, there were no rules of usage, arithmetic overflow was unspecified, and the byte/word-addressing specification was ambiguous.

### The FIG Model

In March, 1979, the FORTH Interest Group published an implementation model of FORTH written in FORTH. This became a test bed for the current standard and was used to test portability of the language. (See the accompanying "FORTH Connotations" text box.) Applications were transported among computers using the Intel 8080, Digital Equipment LSI-11, Motorola 6800, National Semiconductor PACE, MOS Technology 6502 and Texas Instruments 9900 microprocessors. This public-domain research vehicle was most valuable as preparation for the next standards team meeting.

A team charter was proposed and accepted in October, 1979. Member eligibility, responsibilities, and organizational functions were outlined: new members are observers at their first team meeting; they are eligible to join at the next team meeting. Procedural matters are decided by a simple majority, and standards proposals must be accepted by a two-thirds majority.

### FORTH-79

A FORTH Standards Team of twenty-six people, with me, William Ragsdale, as chairman, met again at Catalina Island in October of 1979. The general goal was to increase the portability of FORTH programs by language specifications in addition to the current glossary definitions.

Each of the four days of meetings was structured by a morning general session lasting until noon, subteam working sessions until 5:00 PM, and a general session concluding at 6:00 PM. Two evenings had informal subteam meetings (until 1:00 AM). Technical proposals were "captured" on work forms; a total of 120 were presented. These were organized and filtered by the subteams, and formally reviewed by the full standards team. Working documents and all team actions were maintained by secretary Jon Spencer.

Proposal decisions, subteam reports, and draft mark-ups were used by four technical referees to prepare the final-draft standard. Referees Charles Moore, Robbie Spruit, Hans Nieuwenhuijzen, and I presented this final draft before the full team for final acceptance in August, 1980.

### Oddities of FORTH

FORTH is an incomplete language—by definition. Each user's program adds new word definitions until all functions demanded by the application exist. (See the "FORTH Connotations" text box.) The programmer specifies the exact procedure for calculating the desired

result rather than simply describing that result.

This means that some of the difficult programming is left to the user. Sixteen-bit integer math is standard; some 32-bit primitives and some mixed-mode primitives are provided. However, a greater burden is placed on the programmer, who must create *application-specific* functions. This characteristic is tolerated, even cherished, by FORTH programmers: but who better understands the demands of the application, the application programmer or a distant compiler writer?

Dr C A R Hoare has said that the most difficult problem of language design is deciding what to leave out. The standards team faces the task of selecting a balance between primitive functions and directly usable functions, enabling the user to complete the software tools to solve his application problem. FORTH allows word definitions to be in higher-level form or in machine code. To maintain portability among computers, the language should be defined so the use of machine-language code can be avoided. Therefore, the provided primitives must be sufficient to solve all problems without use of machine-specific code.

In review, several of the features of FORTH-79 have been pointed out as "novel" for computer-language standards; to those involved in the effort, these features seemed to be natural and necessary. Each of these features was introduced as needed, in response to problems as encountered.

Foremost is the section of *trade-offs*. The FORTH Standards Team members are working FORTH programmers and realize that compromises must be made among their various preferences. The priority of certain language and program characteristics has been formalized for current use and future reference:

1. correctness — most important to a user
2. portability
3. simplicity — most important to FORTH
4. clarity
5. generality
6. execution speed
7. memory compactness
8. compilation speed
9. historical continuity
10. pronounceability
11. teachability

The *pronunciation* of FORTH words must be considered since FORTH allows any ASCII text (without blanks) as definition names. Many of the common words have short names, such as:

! , pronounced "store"  
@ , pronounced "fetch"  
#S , pronounced "sharp-s"  
BLK , pronounced "b-l-k"

and so on.

Each word name that is not directly pronounceable has a standard pronunciation given. There is a commitment from the FORTH Users Group (Europe) that standard words will be spelled in English but that application definitions can be named in any language. Therefore, there will be no need for renaming the standard words

## **FORTH Connotations**

*Some English words have specific connotations when referring to FORTH. Here are some examples.*

*word: Any sequence of ASCII (American Standard Code for Information Interchange) characters (except "return," "rubout," and "blank") terminated with a blank or return. Thus letters, numbers, and punctuation may be used freely to form words. Use of control characters is possible but is frowned upon. The internal representation of "return" is conventionally "null."*

*definition: The execution procedure assigned to a named word. Definitions begin as source text on a mass storage device and are compiled into the dictionary for execution. Programming consists of creating new definitions from the existing definitions, whether resident within the host FORTH system or defined by the user.*

*dictionary: When compiled into memory, FORTH word definitions are usually organized into linked lists and further segmented into smaller lists called vocabularies. Each definition may be located by its word name, for execution or compilation. This dictionary expands as the user adds his own definitions.*

*extensibility: The ability to add operators, functions, and data structures that are indistinguishable from those of the host language, both at the compilation and execution levels.*

*portability: A characteristic that allows a standard FORTH program to run on numerous standard FORTH installations, each having a different host computer.*

with non-English equivalents.

Word definitions controlled by the standard have been given serialized numeric identifiers. Assigned integers between 100 and 999 will be changed when the definition is functionally altered within future standards. (This has been borrowed from the languages M6 by Doug McIlroy and SAM76 by Claude A R Kagan. See "The SAM76 Language" by Ancelme Roichel, *Dr Dobb's Journal*, volume 3, number 1, 1978, page 18.) No other use of these identifiers is required, although they may be of use for calling library functions and archiving evolutionary changes.

Just as FORTH is extensible, so is its standard. (Refer to the "FORTH Connotations" text box.) An experimental-proposals section is a showcase for anticipated change. Inclusion of these proposals allows testing and refinements, leading to future standards consideration.

## **Standard System Versus Standard Program**

Standards for other contemporary languages generally concern the compiler, not the applications. FORTH-79, however, includes requirements for both a standard system (such as address representation, mathematical overflow, mass-storage access, and execution of standard words) as well as a standard program (such as allowed areas of memory access and rules of use of standard words). A standard program must use standard definitions within the rules of usage, but its production is ultimately the programmer's, not the compiler's, responsibility.

The classical compilation process of high-level languages consists of:

- a syntactical and semantic analysis of correctness of the source code text
- the translation of this text into an executable code form.

In FORTH, program correctness is not the responsibility of the compiler but of the programmer. Since the

language and compiler are extensible, new constructs may be introduced at all levels. Therefore, the programmer must work in a responsible manner to decompose his problem into successively smaller components (ie: words). He must define these words as combinations of words from the required-word set; and he must test his new words individually and collectively for program correctness. But as the programmer can extend the compilation process, he may also add to the compile-time and run-time checking. Users are quite grateful that the language gives them the choice of where and when to add execution-time costs.

Much of FORTH's power results from its simplicity and generality. The user may add new compile-time operations as easily as new run-time operations. Traditionally, few resources have been devoted to the detection of compile-time errors. The newer versions tend to increase compile-time checking, and future standards work will reflect this trend.

It is quite correct and compliant with the FORTH-79 standard to offer increased error-checking. The standard expresses a uniform minimum; vendors of standard systems will probably be rated by their customers on compile-time diagnostics, with the higher-quality vendors prospering.

## **Labeling**

*Good Housekeeping Magazine* and Underwriters' Laboratory Inc have established their own labeling for enforcement of product quality. We hope a series of validation programs will be developed for verification against the FORTH-79 standard. The team has reserved the following labels for their use:

- FORTH-79 Standard
- FORTH-79 Standard Subset
- FORTH-79 Standard with xxxxx Standard Extension(s)

where xxxxx names the already-standardized extension(s) included in the package.

## Future Work

Work is still needed to improve compile-time error detection and text string handling, and to broaden support of input/output devices. Note that these functions are all available on some installations but are so new that standardization is still in process. They can be compiled on top of standard systems, and thus are not necessarily required: instead, such capabilities may be implemented as library functions which are loaded as desired.

FORTH derives its speed by operating very close to machine-code level while presenting to the user an abstract and uniform high-level notation. This balance must be preserved, otherwise performance would drop, causing some users to return to more specialized and nonstandard versions of FORTH.

A research group named FORML (FORTH Modification Laboratory) has begun as a clearinghouse for research areas and future standards material. It coordinates the efforts of regional groups and individuals.

## Transportation

We now have the FORTH-79 standard, which is useful and transportable. To the user, the memory space appears as byte-addressed. This imposes some execution-speed reductions on word-addressing computers, but the trade-off was made favoring application portability and simplicity. Except for the usual machine-code definitions, the standard contains all the fundamental elements of FORTH as created by Charles Moore. The quality of the standards team's efforts will be judged by how few disputes are caused by alleged standard programs that do

not execute correctly on a vendor's alleged standard system.

The FORTH Standards Team has requested an interlude of at least eighteen months before the next full-team meeting. This should allow updating of the standard and subsequent evaluation. During this period, regional meetings will be held for user comment.

The FORTH-79 standard-specification document is available from the FORTH Interest Group (POB 1105, San Carlos CA 94070) for \$10 (surface mail to USA or Canada) or \$13 (airmail to all other countries). ■

*The FORTH Standard follows the general outline below:*

0. Forward
1. Purpose
2. Scope
3. Organization
4. Definition of Terms
5. References
6. Standard System Requirements
7. Compliance and Labeling
8. Usage Requirements
9. Glossary Notation
10. Required Word Set (130 definitions)
11. Extension Word Sets
  - a. 32-bit Word Set
  - b. Assembler Word Set
12. Experimental Proposals.



— RACET computes — RACET SORTS — RACET UTILITIES — RACET computes — RACET SORTS — RACET UTILITIES — RACET computes — RACET

## FROM THE LEADER IN UTILITY SOFTWARE

### FOR THE TRS\* COMPUTERS

#### ★ ★ NEW ★ ★ HARD/SOFT DISK SYSTEM (MOD II) \$400

The Hard Disk Software Implementation You Have Been Waiting For!! MOD II TRSDOS compatible — using Cameo controller interface to popular large hard disk fixed/removable combinations (Ampex, CDC, Diablo, Pertec, Wanco, etc.). Compatible with your existing programs — change only 'filename'. All disk BASIC statements identical. Improved dynamic file allocation. A single file can be as large as one disk — 20 megabytes or larger. Alternate mode allows 24-million byte record range. Directory expandable to handle thousands of files! Includes special XCOPY, DCS, and SZAP utilities for use with hard or soft disks. Parameterized FORMAT utility includes options for specifying the number of sectors/track, platters/disk, sectors/granule, sectors/directory, etc.

#### ★ ★ NEW ★ ★ BASIC LINK FACILITY 'BLINK' \$25 Mod I (Mod I Min 32K 1-disk) \$50 Mod II

Link from one BASIC program to another saving all variables! The new program can be smaller or larger than the original program in memory. The chained program may either replace the original program, or can be merged by statement number. The statement number where the chained program execution is to begin may be specified!

#### INFINITE BASIC (Mod I Tape or Disk) \$49.95

Extends Level II BASIC with complete MATRIX functions and 50 more string functions. Includes RACET machine language sorts! Sort 1000 elements in 9 seconds!! Select only functions you want to optimize memory usage.

#### INFINITE BUSINESS (Requires Infinite BASIC) \$29.95

Complete printer pagination controls — auto headers, footers, page numbers. Packed decimal arithmetic — 127 digit accuracy +, -, \*, /. Binary search of sorted and unsorted arrays. Hash codes.

#### BASIC CROSS REFERENCE UTILITY (Mod II 64K) \$50.00

SEEK and FIND functions for Variables, Line Numbers, Strings, Keywords. 'All' options available for line numbers and variables. Load from BASIC — Call with 'CTRL'R. Output to screen or printer!

Circle reader request for free 24-page catalog.

DEALER INQUIRIES INVITED

CHECK, VISA, M/C, C.O.D., PURCHASE ORDER \*TRS 80 is a registered trademark of Tandy Corporation  
Telephone Orders Accepted (714) 837-5016

RACET SORTS — RACET UTILITIES — RACET computes — RACET SORTS — RACET UTILITIES — RACET computes — RACET SORTS — RACET UTILITIES — RACET computes — RACET

# TWICE THE BYTE!



## 8" DISK CONTROLLER NOW—DOUBLE SIDED OPTION!

- DOUBLES APPLE II STORAGE
- APPLE DOS COMPATIBLE
- SHUGART 800 OR 850 COMPATIBLE
- IBM 3740 DATA ENTRY CAPABILITY
- CP/M, UCSD PASCAL CAPABILITY

Available at your local APPLE Dealer: \$400.



**SORRENTO VALLEY ASSOCIATES**  
11722 SORRENTO VALLEY RD.  
SAN DIEGO, CA 92121

# Programming Quickies

## A Quiz on Exclusive-OR

Edmund Lai, 637 Acadia Ct, Roselle IL 60172

Exchanging the content of two memory locations or registers is a very common operation, and every novice programmer learns that the proper way to do it is not:

- A - B
- B - A

Every programming book for the beginner tells us that the proper way is:

- T - A
- A - B
- B - T

This is fine except that an extra register, T, is required. Since a number of 16-bit machines have register-to-register arithmetic and logical operations, can we then make use of these to exchange the content of two registers with three operations and without involving an extra register?

Another related problem concerns the pointers of a doubly-linked list. A number of records are linked together to form a chain. In each record there are two pointers, a forward pointer pointing to the next record, and a backward pointer pointing to the previous record. Therefore, we can scan the chain from record to record in either direction. If there is enough room in the record for only one pointer, can we still have a doubly-linked list?

### Solutions

The first problem is to exchange the contents of two registers without involving a third register. The solution, as the user can guess from the title, involves the exclusive-OR operation. Let us first review some of the properties of the exclusive-OR function,  $\oplus$ :

$$\begin{aligned} A \oplus (A \oplus B) &= B \\ B \oplus (A \oplus B) &= A \\ A \oplus B &= B \oplus A \end{aligned}$$

Now we can make use of the above identities to exchange the content of two registers, A and B:

$$\begin{aligned} A &\leftarrow A \oplus B \\ B &\leftarrow B \oplus A \\ A &\leftarrow A \oplus B \end{aligned}$$

To see how it works, let  $A_0$  and  $B_0$  be the original contents of registers A and B respectively. After the first step the content of A is  $A_0 \oplus B_0$ . After the second step the content of B is  $B_0 \oplus (A_0 \oplus B_0)$ , the  $(A_0 \oplus B_0)$  now being the content of A. Since  $B_0 \oplus (A_0 \oplus B_0) = A_0$ , the original content of A has been transferred to B. After the third step the content of A will become  $(A_0 \oplus B_0) \oplus A_0$ , since the con-

## MR. RAINBOW announces...

our all new 1980 catalog and prompts you to peek at the latest collection of software and hardware products for your APPLE II™



Garden Plaza Shopping Center  
9719 Reseda Boulevard Northridge, California 91324 (213) 349-5560

Write or call today for your free 1980 catalog. Dept 108



tents of A and B after the first two steps are  $A_0 \oplus B_0$  and  $A_0$ . Since  $(A_0 \oplus B_0) \oplus A_0 = B_0$ , the original content of B is transferred to A.

The second problem is to save a pointer in a doubly-linked list. When we access a record in a doubly-linked list, we get the address of the record by scanning the linked list in one direction or the other, therefore we know either its predecessor or its successor, and it can be used as the forward pointer (FP) or the backward pointer

(BP). If we store  $(FP \oplus BP)$  in the record, we can find the other unknown pointer by:

$$\begin{aligned} FP &= BP \oplus (FP \oplus BP) \\ BP &= FP \oplus (FP \oplus BP) \end{aligned}$$

To use this scheme, we need to use the addresses of two successive records as the header, otherwise we can never access more than one record.

## The Towers of Hanoi in BASIC09

Terry Ritter, Mail Stop M2880, Motorola Mos Division, 3501 Ed Bluestein Blvd, Austin TX 78721

Steven Switzer's article "The Towers of Hanoi" (March 1980 BYTE, page 240) brought back fond memories. A Towers of Hanoi game has been available as a plastic toy for a number of years, and I can remember spending hours playing the game as a child. Mr Switzer's analysis of the Towers of Hanoi solution is both elegant and correct, but he is unfortunately hampered in using a nonrecursive BASIC to demonstrate a recursive algorithm. The algorithm is simple (once you know it!), but his BASIC gets in the way.

Listing 1 shows the advantage of expressing the Towers of Hanoi algorithm in a modern, structured, high-level language. The language used in BASIC09, a structured BASIC for the Motorola MC6809 microprocessor. Notice that the solution algorithm is unchanged from the original article; the high-level language allows the programmer to express the algorithm in a more natural manner. The numbers on the left of listing 1 are not line numbers (although line numbers can be used). Instead, they represent the I-code location for the start of each line (relative to the start of the procedure). [BASIC09 compiles into a machine language for an ideal machine, much like the p-code of UCSD Pascal; this allows the language to be more easily transported to other microprocessors....GW] The PARAM statement describes the passage of parameters from the calling routine, while RUN calls a procedure by name.

A number of features of BASIC09 offer advantages to the programmer. The BASIC09 development environment is multiprocedure oriented; procedures are called by name, and the call may include parameters. Procedures are easily modified and debugged: a powerful editor allows global changes; the TRACE mode displays each program line before execution and prints out the result of any expression evaluation. Control structures (IF...THEN...[ELSE...]....ENDIF, FOR...NEXT, REPEAT...UNTIL, WHILE...DO...ENDWHILE, LOOP...ENDLOOP, EXITIF...THEN...ENDEXIT, etc) are fully bracketed and have unique closure elements. All loops are automatically indented in the listing, and all keywords are automatically capitalized. Long identifiers allow the programmer to select names that imply the use of the variable or procedure, making the system easy to understand without constant reference to documentation. And variables are always local to a particular pro-

cedure invocation, allowing the language to directly express a recursive algorithm, such as Towers of Hanoi.

Listing 2 shows the results of executing Towers of Hanoi in BASIC09. By including a parameter in the procedure call which is the number of disks to be moved, the special case of moving one disk is easily identified. (If the

**Listing 1:** *The algorithm for solving the Towers of Hanoi problem expressed recursively in BASIC09.*

```
PROCEDURE hanoi
0000 PARAM n: INTEGER, from, to, other: STRING$(8)
001A
001B IF n=1 THEN
0027 PRINT "move # "; n, " from "; from, " to "; to
004E ELSE
0052 RUN hanoi(n-1, from, other, to)
006D PRINT "move # "; n, " from "; from, " to "; to
0094 RUN hanoi(n-1, other, to, from)
00AF ENDIF
00D1 END
00B2
READY
B
```

**Listing 2:** *A sample run of the Towers of Hanoi algorithm shown in listing 1. The parameters following "run hanoi" are the number of disks to be moved and the position of the spindles.*

```
B: run hanoi(4, "l", "r", "c")
move # 1 from l to c
move # 2 from l to r
move # 1 from c to r
move # 3 from l to c
move # 1 from r to l
move # 2 from r to c
move # 1 from l to c
move # 4 from l to r
move # 1 from c to r
move # 2 from c to l
move # 1 from r to l
move # 3 from c to r
move # 1 from l to c
move # 2 from l to r
move # 1 from c to r
READY
B:
```

task is to move the top four disks from left to right, the solution is to move the top three to the center, move the fourth, then move the three from the center onto the fourth.) Furthermore, that same number can be used to identify the disk to be moved: number 1 is the smallest. The spindle positions are sent to the procedure as string parameters so that letters or names may be used for the spindles.

Most of those who criticize BASIC should understand where programming difficulties arise. Even BASIC is amenable to high-level tasks, as long as the particular BASIC implementation involved includes modern, high-level, programming features. A similar program could, of course, be written in Pascal. When compared to "backward BASIC," the result of using BASIC09 is an easier expression of the algorithm; clearer to the computer, and, most importantly, clearer to people. ■

# The Age of Affordable Pers



In 1978 Ohio Scientific introduced a revolutionary new low cost computer — the Superboard II. This computer provides all important personal computer features on a single board at a cost of under \$300. The Superboard II received rave reviews by microcomputer experts such as:

**"We can heartily recommend the Superboard II computer system for the beginner who wants to get into microcomputers with a minimum of cost. Moreover, this is a 'real' computer with full expandability."**

POPULAR ELECTRONICS MARCH, 1979

**"The Superboard II weighs in at \$279 and provides a remarkable amount of computing for this incredible price."**

KILOBAUD MICROCOMPUTING FEBRUARY, 1979

**"The Superboard II and its fully dressed companion the Challenger 1P series incorporate all the fundamental necessities of a personal computer at a very attractive price. With the expansion capabilities provided, this series becomes a very formidable competitor in the home computer area."**

INTERFACE AGE APRIL, 1979

**"The graphics available permit some really dramatic effects and are relatively simple to program . . . The fact that the system can be easily expanded to include a floppy means that while you are starting out with a low-cost minimal system, you don't have to throw it away when you are ready to go on to more complex computer functions. At \$279, Superboard II is a tough act to follow."**

RADIO ELECTRONICS JUNE, 1979

**"The Superboard is an excellent choice for the personal computer enthusiast on a budget."**

BYTE MAY, 1979

Since the introduction of Superboard II, the cost of personal computers has actually gone up with new models by major manufacturers ranging from \$1000 to well over \$4000 due to the general cost of inflation and the increasing functionality included in these computers. Today Cleveland Consumer Computers is offering you the original Superboard II at its original price of just \$279. In today's economy this is by far the best buy

in personal computing ever!

The Superboard II can entertain your whole family with spectacular video games and cartoons, made possible by its ultra high resolution graphics and super fast BASIC. It can help you with your personal finances and budget planning, made possible by its decimal arithmetic ability and cassette data storage capabilities. It can assist you in school or industry as an ultra

powerful scientific calculator, made possible by its advanced scientific math functions and built-in "immediate" mode which allows complex problem solving without programming! This computer can actually entertain your children while it educates them in topics ranging from naming the Presidents of the United States to tutoring trigonometry — all possible by its fast extended BASIC, graphics and data storage ability.

The machine can be economically expanded to assist in your business, remotely control your home, communicate with other computers and perform many other tasks via the broadest line of expansion accessories in the microcomputer industry.

This machine is super easy to use because it communicates naturally in BASIC, an English-like programming language. So you can easily instruct it or program it to do whatever you want, but you don't have to. You don't because it comes with a complete software library on cassette including programs for each application stated above. Ohio Scientific also offers you hundreds of inexpensive programs on ready-to-run cassettes. Program it yourself or just enjoy it; the choice is yours.

The Superboard II comes fully assembled and tested. It requires +5V at 3 Amps and a video monitor or TV with RF converter to be up and running. **\$279.00**

## Standard Features:

- Uses the ultra powerful 6502 Microprocessor.
- 8K Microsoft BASIC-in-ROM. Full feature BASIC runs faster than currently available personal computers and all 8080 based business computers.
- 4K static RAM on board expandable to 8K.
- Full 53-key keyboard with upper/lower case and user programmability.
- Kansas City standard audio cassette interface for high reliability.
- Full machine code monitor and I/O utilities in ROM.

# Personal Computing is Still Here.



Mini-Floppy Disk Drive

Direct access video display has 1K of dedicated memory (besides 4K user memory), features upper case, lower case, graphics and gaming characters for an effective screen resolution of up to 256 x 256 points. Normal TV's with overscan display about 24 rows of 24 characters without overscan up to 30 x 30 characters.

## Optional Extras:

- Available 610 expander board features up to 24K static RAM (additional), dual mini-floppy interface, and an OSI 48 line expansion interface.
- Assembler/Editor and Extended Machine Code monitor available.
- 630 I/O Expander. RGB color and NTSC composite color outputs with up to 16 colors, Dual 8-axis joystick interface, AC remote control interface which mates with the AC-12P, home security interface which mates with the AC-17P, 16-line parallel I/O interface, 16-pin I/O bus interface which allows the connection of parallel I/O lines or high speed analog I/O module, or a PROM blaster or solderless interface prototyping board, programmable sound generator and program selectable modem and high speed printer ports, and more.

**Freight Policies** All orders of \$100 or more are shipped freight prepaid. Orders of less than \$100 please add \$4.00 to cover shipping costs. Ohio Residents add 5.5% Sales Tax.

**Guaranteed Shipment** Cleveland Consumer Computers & Components guarantees shipment of computer systems within 48 hours upon receipt of your order. Our failure to ship within 48 hours entitles you to \$35 of software. FREE.

**Hours:**  
Call Monday thru Friday  
8:00 AM to 5:00 PM E. D. T.

## Software:

Ohio Scientific and independent suppliers offer hundreds of programs for the Superboard II, in cassette and mini-floppy form. Here is a sampling of popular Ohio Scientific programs for the Superboard II.

| EDUCATIONAL PROGRAMS             | SBII & CIP | Price   |
|----------------------------------|------------|---------|
| BASIC Tutor Series               | SCE-336    | \$35.00 |
| Clock Tutor                      | SCE-353    | 6.50    |
| Continents Quiz                  | SCE-332    | 6.50    |
| Definite Integral                | SCE-326    | 6.50    |
| French Drill & Tutor             | SCE-339    | 6.50    |
| German Tutor & Drill             | SCE-342    | 6.50    |
| Hangman (8K)                     | SCE-324    | 9.00    |
| Log Tutors 1-3                   | SCE-344    | 6.50    |
| Math Blitz                       | SCE-323    | 6.50    |
| Math Intro                       | SCE-319    | 6.50    |
| Mathink                          | SCE-337    | 9.00    |
| Matrix Tutors 1-3                | SCE-345    | 6.50    |
| Metric Tutor & Quiz              | SCE-335    | 6.50    |
| Spanish Drill & Tutor            | SCE-352    | 6.50    |
| Spelling Quiz                    | SCE-333    | 6.50    |
| Trig Tutor (8K) I & II           | SCE-318    | 6.50    |
| BUSINESS PROGRAMS                |            |         |
| Address Book                     | SCB-523    | 9.00    |
| Advertisement Demo               | SCB-520    | 6.50    |
| Inventary Demo                   | SCB-518    | 6.50    |
| Mailing List (8K)                | SCB-524    | 6.50    |
| Straight & Constant Depreciation | SCB-500    | 9.00    |
| Time Calculator                  | SCB-525    | 9.00    |
| PERSONAL PROGRAMS                |            |         |
| Biorhythm                        | SCP-716    | 9.00    |
| Calorie Counter                  | SCP-708    | 6.50    |
| Checking Account                 | SCP-719    | 9.00    |
| Loan Finance                     | SCP-717    | 6.50    |
| Personal Calendar                | SCP-718    | 6.50    |
| Savings Account                  | SCP-720    | 9.00    |
| GAME PROGRAMS                    |            |         |
| Baseball I                       | SCG-975    | 6.50    |
| Black Jack                       | SCG-955    | 6.50    |
| Civil War                        | SCG-977    | 6.50    |
| Destroyer                        | SCG-951    | 6.50    |
| High Noon                        | SCG-960    | 6.50    |
| Hockey                           | SCG-979    | 6.50    |
| Lander                           | SCG-925    | 6.50    |
| New York Taxi                    | SCG-956    | 6.50    |
| Poker                            | SCG-962    | 6.50    |
| Racer                            | SCG-949    | 6.50    |
| Space War                        | SCG-942    | 6.50    |
| Star Trek                        | SCG-946    | 6.50    |
| Star Wars                        | SCG-926    | 6.50    |
| Tic-Tac-Toe                      | SCG-945    | 6.50    |
| Tiger Tank                       | SCG-950    | 14.00   |

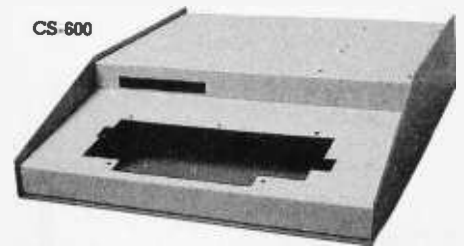

## Hardware:

|                               |                                                                                                                                                                         |       |
|-------------------------------|-------------------------------------------------------------------------------------------------------------------------------------------------------------------------|-------|
| <b>Superboard II</b>          | as specified in the advertisement.                                                                                                                                      | \$279 |
| <b>610 Board</b>              | For use with Superboard II and Challenger I.P. 8K static RAM expandable to 24K or 32K system total. Accepts up to two mini-floppy disk drives. Requires +5V @ 4.5 amps. | 298   |
| <b>Mini-Floppy Disk Drive</b> | Includes Ohio Scientific's PICO DOS software and connector cable. Compatible with 610 expander board. Requires +12V @ 1.5 amps and +5V @ 0.7 amps.                      | 299   |
| <b>630 Board</b>              | As specified in the advertisement.                                                                                                                                      | 229   |
| <b>AC-3P</b>                  | 12" combination black and white TV/video monitor.                                                                                                                       | 159   |
| <b>4KP</b>                    | 4K RAM chip set.                                                                                                                                                        | 79    |
| <b>PS-005</b>                 | 5V 4.5 amp power supply for Superboard II.                                                                                                                              | 35    |
| <b>PS-003</b>                 | Mini-floppy power supply.                                                                                                                                               | 29    |
| <b>C1P Sams</b>               | C1P/Superboard II Manual.                                                                                                                                               | 8     |
| <b>OS-65D</b>                 | V3.2 Disk Operating System with 9-digit extended BASIC, random access and sequential files.                                                                             | 49    |
| <b>CS-600</b>                 | Metal case for Superboard II, 610 and 630 board and two power supplies.                                                                                                 | 49    |
| <b>CS-610</b>                 | Metal case for single floppy disk drive and power supply.                                                                                                               | 49    |
| <b>AC-12P</b>                 | Wireless AC remote control system. Includes control console, two lamp modules and two appliance modules for use with 630 board.                                         | 175   |
| <b>AC-17P</b>                 | Home security system. Includes console, fire detector, window protection devices and door unit for use with 630 board.                                                  | 249   |
| <b>C4P Sams</b>               | C4P Manual.                                                                                                                                                             | 16    |
| <b>C3 Sams</b>                | Challenger III Manual.                                                                                                                                                  | 40    |



610 Board

## To Order:

Or to get our free catalog CALL 1-800-321-5805 TOLL FREE. Charge your order to your VISA or MASTER CHARGE ACCOUNT Ohio Residents Call: (216) 464-8047. Or write, including your check or money order, to the address listed below.

**CLEVELAND CONSUMER COMPUTERS & COMPONENTS**  
P.O. Box 46627  
Cleveland, Ohio 44146

## Order Form:

CLEVELAND CONSUMER COMPUTERS & COMPONENTS P.O. Box 46627 Cleveland, Ohio 44146

- Superboard II \$279.
  630 Board \$229.
  610 Board \$298.
  AC-3P 12" B-W Monitor \$159.
  Mini-Floppy Disk Drive \$299.
  C1P Sams Manual \$8.
- (Attach separate sheet for other items.)

NAME: \_\_\_\_\_

ADDRESS: \_\_\_\_\_

CITY: \_\_\_\_\_ STATE: \_\_\_\_\_ ZIP: \_\_\_\_\_

Payment by: VISA: \_\_\_\_\_ MASTER CHARGE: \_\_\_\_\_ MONEY ORDER: \_\_\_\_\_

Credit Card Account # \_\_\_\_\_

Expires: \_\_\_\_\_ Interbank # (Master Charge) \_\_\_\_\_

TOTAL CHARGED OR ENCLOSED: \$ \_\_\_\_\_ (Ohio Residents add 5.5% Sales Tax)

All orders shipped insured UPS unless otherwise requested. FOB Cleveland, Ohio.

# The 6502 Gets Microprogrammable Instructions

---

Dennette A Harrod  
POB 9475  
Rochester NY 14604

---

"Every programmer is part of a collective mind, and progress demands that he educate and be educated by others." So states H T Gordon in a letter published in the October 1977 issue of *Dr Dobbs Journal of Computer Calisthenics and Orthodontia*.

In this article I shall attempt to educate others by detailing a hardware approach to adding sixty-four user-defined instructions to the MOS Technology 6502 microprocessor. The 6502 device is used in the Apple II, PET, KIM-1, SYM-1, Rockwell, Ohio Scientific, and Atari microcomputers to name a few.

My own research concerning 6502 operation codes (ie: op codes) has closely paralleled the efforts of Dr Gordon (see his Technical Forum article "The XF and X7 Instructions of the MOS Technology 6502" December 1977 BYTE, page 72). Close investigation reveals that sixty-four of the unimplemented op codes can be detected by a simple circuit such as that shown in figure 1. Unimplemented op codes are any of the op codes with the two least significant bits set to 1.

---

#### About the Author

Dennette A Harrod is a systems programmer at Xerox Corp in the Computer Aided Drafting (CAD) Department.

---

A similar circuit, by C W Moser ("Add a Trap Vector for Unimplemented Op Codes" *Dr Dobbs Journal of Computer Calisthenics and Orthodontia* January 1979, volume 4, issue 1, pages 32 thru 34) can be used to detect *all* undefined op codes, but it requires a programmable read-only memory programmer and does not appear to be as cost-effective in its use of components. My circuit uses only three integrated circuits.

#### Simple Hardware Appendage

The circuit in figure 1 is deceptively simple. Its purpose is to cause the 6502 to receive an interrupt signal whenever it attempts to execute one of the sixty-four undefined op codes in which the right nybble (ie: 4-bit segment) has a hexadecimal value of 3, 7, B, or F. (The left nybble can have any value.) These values correspond to the situation where both of the two least significant bits are high.

The software interrupt-service routine then examines the instruction and jumps to a routine to perform the operation specified by that code. This facility enables the user to add instructions not available on the 6502 as supplied. With certain added instructions, 16-bit arithmetic and logical operations can be performed, or string comparison and move operations may be implemented. These

added instructions are called *virtual operation codes*, or *v-codes*.

When the 6502 is in the op-code-fetch phase of the instruction cycle, the normally low SYNC line goes high. When the processor attempts to fetch an op code which has both of the two least significant bits set to 1, the three-input NAND gate (IC2a, 74LS10) output goes low. (Note: one of the NAND gates on the 74LS10 is wired as an inverter.) As a result, the data-bus transceiver (IC4, 74LS245) is disabled, and the 6502 never receives the op code. Instead, a buffer (IC3, 74LS244) is enabled, forcing all 0 values onto the data-bus lines by pulling them to ground potential.

The net effect is that the 6502 thinks it fetched a BRK (break) instruction (hexadecimal 00). The BRK instruction causes the microprocessor to go through an interrupt sequence under program control.

Three things happen when the 6502 executes a BRK instruction.

- The program counter (PC) is incremented by 2 and is pushed onto the stack (thus the processor treats BRK as a two-byte instruction).
- The BREAK bit (B) in the processor status word (PSW) is set to 1, and the PSW is pushed onto the stack.
- The 6502 transfers control to the

| Number | Type    | +5 V | GND |
|--------|---------|------|-----|
| IC1    | 6502    |      |     |
| IC2    | 74LS10  | 14   | 7   |
| IC3    | 74LS244 | 20   | 10  |
| IC4    | 74LS245 | 20   | 10  |

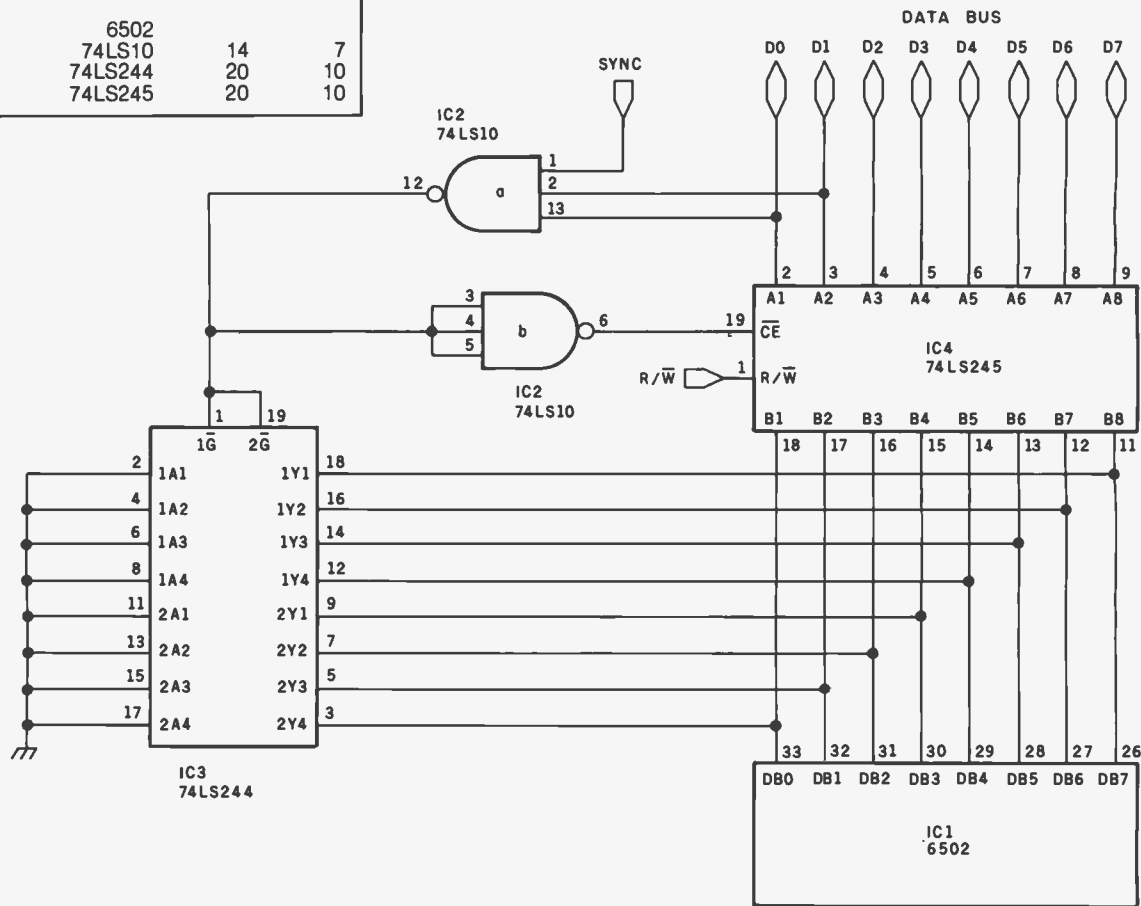

**Figure 1:** Schematic diagram of a circuit that forces all lines on the data bus into a logic 0 (ie: low) condition whenever the 6502 attempts to fetch an operation code with the two least significant bits both set to 1. The low-order hexadecimal digit of such an op code will be 3, 7, B, or F. When all data bus lines are forced low, the 6502 executes the BRK (break) instruction, for which the op code is 00. The BRK instruction causes the processor to go through an interrupt sequence under program control.

address stored in the highest locations in memory (FFFE and FFFF), the IRQ interrupt vector. This address must indicate the starting location of the interrupt-service routine.

### Software Action

The first thing the interrupt-service routine must do is determine whether it was invoked by a hardware or a software interrupt. This is accomplished by examining the B bit in the processor status word. Having determined that it was a software interrupt (B=1), the program uses the stack pointer as an index to get the return address off of the stack. This is accomplished with the help of the TSX instruction to transfer the stack pointer to the X index register. Then it can load the accumulator using the indirect address mode and examine the actual instruction that caused the interrupt. Since the processor is not

fetching the op code for execution, the circuit of figure 1 does not interfere.

Once the interrupt-service routine has established that it was not an actual BRK instruction that caused the interrupt, the v-code can be used as an index into a table of addresses of subroutines. There is one entry in the table for each of the v-codes. The subroutine performs the v-code operation.

By using the byte following the v-code as an additional instruction byte to be decoded by the v-code executing subroutine, each v-code can act as a gateway to 256 more virtual instructions.

Do not be intimidated by the prospect of over 16,000 user-defined instructions. Instead, welcome the ability to microprogram any or all of your favorite machine architectures into the virtual machine now available.

### Instruction Characteristics

At this point I should probably clarify a poorly documented fact about the 6502 BRK instruction. One reason the processor treats BRK as a 2-byte instruction is that the BRK can be followed by a 1-byte code to be interpreted by the interrupt-service routine, much the same way that a supervisor call (SVC) instruction works in the IBM 360/370 computers. Using the circuit of figure 1 enables you to save one byte of code by eliminating the BRK instruction itself. This allows the interrupt-service routine and v-code subroutine to access 2 bytes of user data (the v-code and a data byte) without having to adjust the return address on the stack.

Taking a tip from Steve Wozniak (see "SWEET16: The 6502 Dream Machine" November 1977 BYTE, page 150), you can reserve 16 bytes on page 0 of memory to serve as eight 16-bit registers, each of which may be

used to contain either data or the address of data. The byte following the v-code can then be divided into two 4-bit nybbles to specify *source* and *destination* registers for the virtual operation. The low-order 3 bits of the nybble contain the register number (0 thru 7), while the high bit indicates direct or indirect mode. When the high-order bit has a value of 0, it means the register contains the *data*; a value of 1 means the register contains the *address* of the data.

If you wish, you can use 2 bytes for source and destination information,

in which case 1 nybble of each byte can be used as an index-pointer (meaning it specifies which register to use as an index register). However, this requires the user to assume responsibility for fixing up the return address from the interrupt. On the other hand, if you use a real BRK instruction followed by a v-code and one or more data-bytes, the return address has to be manipulated anyway.

### Hardware Interrupt Vectors

If you are truly ambitious, a circuit

based on one by Yogesh M Gupta ("True Confessions: How I Relate to KIM" August 1976 BYTE, page 44) intended for the vectoring of hardware interrupts, which the 6502 lacks, can be modified and added to the circuit in figure 1 to provide hardware vectoring of the software interrupts. Gupta's circuit generates vectored addresses that are 4 bytes apart. This is a compromise. All you really need is 3 bytes to contain a JMP op code and a 16-bit destination address, but hardware-generated addresses are most conveniently generated in positive powers of 2.

I suggest that the addresses from such a device be 16 bytes apart, so that the service routines can be entered with three assumptions:

- The routine was called by a jump to subroutine (JSR) instruction, which is not strictly true, but this will be clarified in a moment.
- All of the 6502 registers are stored on the stack, directly beneath the return address, so that any register may be used with impunity.
- The routine can exit from anywhere by a return from subroutine (RTS) instruction, and all registers will be restored to the pre-interrupt state before a return from interrupt (RTI) instruction is executed.

**Listing 1:** Example of an interrupt-service routine. It saves the contents of the 6502 registers on the stack, calls a subroutine (by JSR) to operate the interrupting device, restores the registers, and finally returns to the interrupted task. Some instruction mnemonics are from a macro-assembler of the author's own design. For example, the PSH X instruction mnemonic causes the macro-assembler to generate two machine instructions, TXA and PHA.

```

 ABCD SRVRTN EQU $ABCD
XX00
XX00 XX00 ENTRY EQU $XX00
XX00 48 PSH A ;SAVE REGISTERS
XX01 8A 48 PSH X
XX03 98 48 PSH Y
XX05 20 CD AB JSR SRVRTN ;CALL SERVICE ROUTINE
XX08 68 A8 PUL Y ;RESTORE REGISTERS
XX0A 68 AA PUL X
XX0C 68 PUL A
XX0D 40 RTI ;RETURN FROM INTERRUPT
XX0E XX0E END ENTRY

```

**Listing 2:** An interrupt-service routine that uses the soft-coded vector technique of subroutine calling. To call a subroutine, this routine places a return address on the 6502 stack, and then branches to the subroutine by executing a JMP instruction in the indirect addressing mode. The subroutine can return normally to this calling routine by executing an RTS instruction. This procedure compensates for the inability of the 6502 processor to execute the JSR instruction using the indirect addressing mode.

```

YY00
YY00 YY00 SRVADR EQU $YY00
 ABCD SRVRTN EQU $ABCD
YY00 CD AB ADR SRVRTN

XX00
XX00 XX00 ENTRY EQU $XX00
XX00 48 PSH A ;SAVE REGISTERS
XX01 8A 48 PSH X
XX03 98 48 PSH Y
XX05 20 8B XX JRS JMPAT ;SIMULATE JSR @ADDR
XX08 4C 00 ZZ JMP COMRTI ;GOTO REGISTER RESTORE
 XX0B JMPAT EQU .
XX0B 6C 00 YY JMP @SRVADR ;GOTO SERVICE ROUTINE
 XX0E END ENTRY

ZZ00
ZZ00 ZZ00 COMRTI EQU $ZZ00
ZZ00 68 A8 PUL Y ;COMMON RTI ROUTINE
ZZ02 68 AA PUL X ;RESTORE REGISTERS
ZZ04 68 PUL A
ZZ05 40 RTI ;RETURN FROM INTERRUPT
 XX06 END COMRTI

```

### Interrupt Service Routines

The program of listing 1 is an example of how to service an interrupt. It first saves the contents of the 6502 registers on the stack. Next, it calls a subroutine to service the interrupt, restores the registers, and finally returns to the interrupted task. My example is for a 6502, but the instruction mnemonics are for a macro-assembler of my own design; for example, the push X index register on stack (PUSH X) mnemonic generates two instructions: transfer X to register A (TXA) and push A onto stack (PHA).

The program in listing 2 also saves the registers on the stack, but instead of calling a subroutine in the normal fashion, this program places a return address on the stack. It then executes a jump (JMP) instruction in the indirect addressing mode to reach the subroutine. This means that the program in listing 2 will look in a location in memory to find the address of the subroutine to jump to. The impli-

cit assumption is made that the subroutine will exit with an RTS instruction. Thus, the subroutine thinks it was entered by a JSR instruction, when actually, the way there was wormed by a circuitous path.

This method for simulating use of the JSR instruction in indirect mode was developed by Tom Pittman, and I thank him for suggesting this *soft-coded vector* technique.

### Benefits of Indirect-Mode Entry

There are several good reasons for entering an interrupt-service routine (or any monitor-service routine, for that matter) with a JMP indirect rather than by a JSR instruction. The first is that the choice of routine to service a given interrupt can be easily changed. Instead of being forced to use a particular routine in response to a particular interrupt, you need alter only the address value contained in the JMP-indirect vector location, which can be located in program-mable memory. Thus, a string of characters to any of several different peripheral devices can be output using the same microcoded v-code. Simply place the starting address of the desired device-driver routine in the appropriate vector location.

Another reason is that if the locations of service routines are to be changed (perhaps because of additions that make a routine too big for the space it used to occupy), only the entry in the vector address table need be updated. The vector address table can be stored in an inexpensive 256-byte programmable read-only memory. Should the need arise, it is much easier to replace the 256-byte device containing the table than to find all references to a routine in a 2,048-byte programmable read-only memory, change them, and burn a new 2 K-byte device.

The reason for having each routine utilize a common return sequence is that the user may desire to have classes of routines which all need different sets of common operations done before returning to the calling routine. Such an operation could be to transfer the saved register values from the stack into the registers before returning. It may also be used to check if completion of an interrupt service (or v-code instruction) should reset a timer/counter or initiate some

other action before truly returning to the pre-interrupt state.

### Other Ideas

A truly innovative approach, and one that saves software overhead at the cost of more circuitry, is to *latch* the v-code, using the same circuit that detects the v-code, so that when the 6502 attempts to fetch the IRQ vector address from hexadecimal locations FFFE and FFFF, it gets an address that has been stored in a 128 by 8 programmable read-only memory. This approach, while limited in its flexibility, is ideally suited to "black box" or turnkey systems, where it is assumed that the end user has no desire to know (let alone alter) the internal operations of the machine.

I have set forth these ideas to enlighten my fellow computer experimenters. I owe a debt to the authors of the other articles I have mentioned; without their work, I could not have completely developed the ideas discussed here. I assume that many of you will improve on my work. I merely ask that you write to me and keep me informed of your progress. ■

### References

- Gordon, H T, "Decoding 650X Op Codes" *Dr Dobbs Journal of Computer Callisthenics and Orthodontia*, Volume 2, Issue 7, August 1977, pages 20 thru 22.
- Gordon, H T, "Decoding Efficiency and Speed" *Dr Dobbs Journal*, Volume 3, Issue 2, February 1978, pages 5 thru 7.
- Gordon, H T, "Software and Correction" *Dr Dobbs Journal*, Volume 2, Issue 9, October 1977, pages 42 thru 44.
- Gordon, H T, "Use of NOP Codes as Executable Labels" *Dr Dobbs Journal*, Volume 3, Issue 8, September 1978, page 29.
- Gordon, H T, "The XF and X7 Instructions of the MOS Technology 6502", *BYTE*, Volume 2, Number 12, December 1977, page 72.
- Gupta, Yogesh M, "True Confessions: How I Relate to KIM" *BYTE*, Volume 1, Number 12, August 1976, pages 44 thru 48.
- MCS6500 Microcomputer Family Programming Manual*, MOS Technology, Norristown PA, 1976, pages 144 thru 147, pages 87 thru 92.
- Moser, C W, "Add a Trap Vector for Unimplemented Op Codes" *Dr Dobbs Journal*, Volume 4, Issue 1, January 1979, pages 32 thru 34.
- Wozniak, Stephen, "SWEET16: The 6502 Dream Machine" *BYTE*, Volume 2, Number 11, November 1977, pages 150 thru 159.

## NO FRILLS! NO GIMMICKS! JUST GREAT DISCOUNTS MAIL ORDER ONLY

### ATARI 800

Personal Computer System ..... **\$79900**

### NORTHSTAR

Horizon II 32K ..... **234900**  
Horizon II Quad ..... **279900**  
Horizon II 64K ..... **299900**  
Horizon Quad 64K ..... **339900**

### TELEVIDEO

912 ..... **74900**  
920 ..... **79900**

### HAZELTINE

1420 ..... **79500**  
1500 ..... **84900**  
1510 ..... **104900**  
1520 ..... **122900**

### OKIDATA

Microline 80 ..... **69900**

### SOROC Technology

IQ 120 ..... **69900**  
IQ 140 ..... **99900**

### CROMEMCO

System 3 ..... **569500**  
Z2H ..... **799500**

### INTERTEC

Superbrain 32K ..... **249500**  
Superbrain 64K ..... **279500**

### DECwriter IV

LA34 ..... **97900**

### TEXAS INSTRUMENT

810 Multi Copy  
Impact Printer ..... **149900**

**We'll meet or beat any advertised prices!**

Most items in stock for immediate delivery  
Factory sealed cartons. Full manufacturer's guarantee

### DATA DISCOUNT CENTER

Box 100 135-53 Northern Blvd., Flushing, N.Y. 11354  
Visa • Master Charge • N.Y.S. residents add Sales Tax  
Shipping F.O.B. N.Y.

Phone Orders Call 212-465-6609

# Vector Graphics for Raster Displays

John Beetem  
856 Allardice  
Stanford CA 94305

Many personal computers on the market today use raster graphics displays. These consist of devices that display a rectangular matrix of points (actually small rectangles) on a standard raster scan video monitor. The points are stored in a memory, which can be accessed by a computer. Plotting random points is easy, but there is no built-in provision for plotting line segments (vectors). This article describes a method for solving that problem.

In a video monitor, the electron beam moves across the screen in a fixed pat-

tern called a raster. This is different from a true X,Y display (eg: an oscilloscope using horizontal and vertical inputs), where the position of the electron beam is under user control. To keep these types of display separate, I'll call the first a raster display.

Neither X,Y nor raster display has trouble plotting points on the screen, but the X,Y display can plot line segments much more easily than a raster display. All the X,Y display has to do is move the beam position from one endpoint (the origin) to the other endpoint (the endpoint) in a linear path (see figure 1). When a line is to be drawn on the screen, the beam is intensified during this motion, leaving a bright trail on the screen. In contrast, the raster display has no control over the beam's position, so it must intensify the beam at the right points on the raster when the beam gets there (see figure 2). The raster display's data is stored in memory, so it is necessary to set the bits in memory corresponding to the intersections of the desired vector and the raster.

## Plotting Vectors

There are many methods for plotting a vector into a point matrix. The one which most often comes to mind is computing the slope of the line and using a similar triangles method. Trigonometric methods exist. None of these are very good for a small computer, as many slow multiplications and divisions are needed. We would like a method which avoids such operations. Such a method follows.

It is easy to plot a vector when the endpoints are the same point. We simply plot a point. If the endpoints are not the same, divide the line in half (by computing the midpoint), save one half, and work with the other. This new line is half

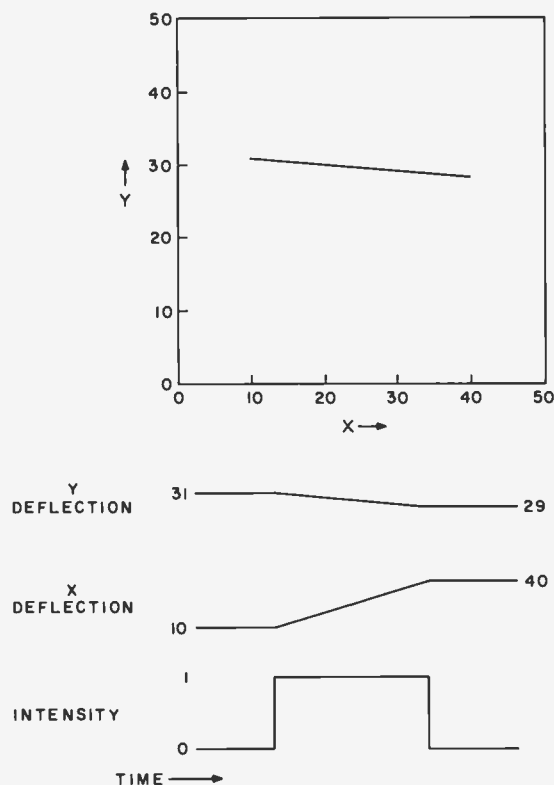

Figure 1: Example of plotting segment from (10,31) to (40,29) on an X, Y display. Note the simple waveforms; we have full control over X and Y deflections.



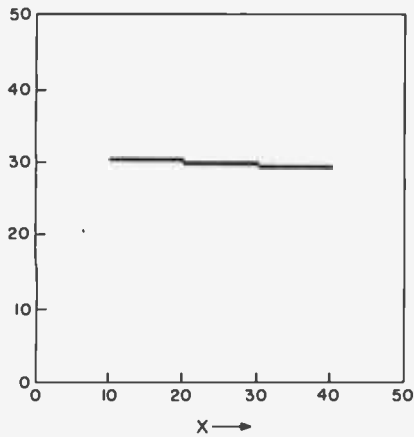
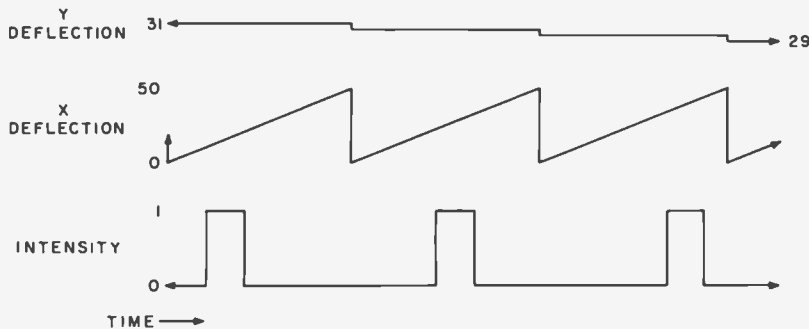

Figure 2: Example of plotting segment from (10,31) to (40,29) on a raster display. Since we have no control over the X and Y deflections, the intensity waveform is complicated. Also note the digitizing on the output display.



as long as the original. Repeat the last step until the vector becomes a point (this will happen because integer arithmetic is used). This point can be plotted. Then get the last segment stored and work with it. Eventually all the segments will be plotted! Figure 3 shows the first few steps of this process.

The only arithmetic done is for computing the midpoints. Storage of segments to be worked on later is done on a stack, so that the most recently stored segment will be worked on next. The flowchart in figure 4 describes the algorithm in more detail.

An example of plotting a one-dimensional line segment is given as table 1 to clarify the procedure. Everything following involves two dimensions, although the method is valid for any number of dimensions.

# FANTASTIC MAIL ORDER DISCOUNTS!!!

October Special! Additional \$10.00 off on most items.

**apple computer**

**16K\*  
\$959**

\*ADD 2% IF USING CREDIT CARD  
ONLY ON APPLE COMPUTERS  
APPLE II OR APPLE II PLUS

APPLE II 32K \$1040\*    APPLE II 48K \$1100\*

## APPLE II ACCESSORIES

|                                            |                                           |
|--------------------------------------------|-------------------------------------------|
| CORVUS 10 MEGABYTE DISK DRIVE . . . \$4850 | SUPER TALKER SPEECH SYNTHESIZER . . . 259 |
| PASCAL LANGUAGE SYSTEM . . . 445           | ROMPLUS CARD w/ KEYBD. FLTR. . . 179      |
| GRAPHICS INPUT TABLET . . . 875            | HEURISTICS SPEECHLINK 2000 . . . 225      |
| DISK II with CONTROLLER CARD . . . 495     | DC HAYES MICROMODEM II . . . 335          |
| DISK II without controller . . . 440       | ALF MUSIC SYNTHESIZER . . . 245           |
| APPLE SOFT II FIRMWARE CARD . . . 155      | SSM A10 CARD (KIT) . . . 129              |
| INTEGER FIRMWARE CARD . . . 155            | SSM A10 CARD (ASSEMBLED) . . . 170        |
| PARALLEL INTERFACE CARD . . . 155          | NOVATION CAT NODE II . . . 159            |
| SERIAL INTERFACE CARD . . . 160            | CCS GPIB IEEE INTERFACE . . . 269         |
| COMMUNICATIONS CARD . . . 190              | MICROSOFT Z-80 SOFT CARD w/CP/M . . . 349 |
| SUP-R-MOD RF TV MODULATOR . . . 25         | MICROWORKS DS-85 DIGISECTOR . . . 349     |
| SUP-R-TERM 80 col. CARD . . . 349          | ROWWRITER . . . 159                       |
| DAN PAYMAR Lower case kit . . . 45         | SYMTEC LIGHT PEN CARD . . . 229           |
| SVA 8" DISK CONTROLLER CARD . . . 349      | CCS PROGRAMMABLE TIMER MODULE . . . 159   |
| CCS ARITHMETIC PROCESSOR CARD . . . 349    | CENTRONICS PRINTER INT. CARD . . . 190    |
| CLOCK/CALENDAR CARD . . . 239              | SLIENTRY PRINTER W/INT. CARD . . . 529    |
| INTROL X-10 SYSTEM . . . 239               |                                           |

## SOFTWARE

|                                           |                                     |
|-------------------------------------------|-------------------------------------|
| PASCAL LANGUAGE SYSTEM . . . \$445        | APPLEWRITER WORD PROCESSOR . . . 69 |
| FORTRAN LANGUAGE PACKAGE . . . 175        | VISI-CALC . . . 125                 |
| THE CONTROLLER GEN. BUS. SYSTEM . . . 529 | SARGON II on Disk . . . 35          |
| THE CASHIER RETAIL MGT. & INV. . . 209    | SUPER INVADER On DISK . . . 25      |
| APPLEPOST MAILING LIST SYSTEM . . . 45    |                                     |

WE WILL GLADLY PERFORM WARRANTY REPAIR ON ALL APPLE COMPUTER PRODUCTS.

**MONITORS**

**LEEDEX VIDEO 100**  
12" BLACK & WHITE MONITOR  
•VIDEO BANDWIDTH 12 MHz±3db  
•COMPOSITE VIDEO INPUT

**\$139** SOROC IQ 120 \$739  
SOROC IQ 140 \$1295

SANYO 9" B/W Monitor \$169 • SANYO 15" B/W Monitor \$259 • ZENITH 13" Color Monitor \$429

**PRINTERS**

|                                             |                           |
|---------------------------------------------|---------------------------|
| PAPER TIGER ITS 440 w/graphics . . . \$1050 | NEC SPINWRITER . . . 2695 |
| TRENDCOM T-200 . . . 559                    | AXIOM EX-801 . . . 495    |
| CENTRONICS 737 . . . 850                    | AXIOM EX-820 . . . 750    |
| CENTRONICS 700-B . . . 1149                 | COMPRINT 912S . . . 599   |
| ANADEX DP-8000 OR AP . . . 850              | COMPRINT 912P . . . 559   |
| MPI 88-T . . . 725                          | TRENDCOM T-100 . . . 349  |

THE AMAZING **SORCERER II 16K** by **\$995**

The SORCERER is a Z80 CPU based micro-computer internally expandable to 48K. 4K ROM resident monitor I/O connector for S-100 expansion. Parallel and serial interface. Dual cassette I/O. Graphic resolution of 240 x 512, 30 lines of 64 characters, 8 x 8 dot matrix. Full ASCII set (upper and lower case), plus standard graphic symbols. User may define up to 128 characters. Keyboard is 63-key data processing type, plus a 16 key numeric input pad.

5-100 EXPANSION UNIT . . . \$399  
WORD PROCESSOR PAC . . . 199  
DEVELOPMENT PAC . . . 99

WE ALSO SELL "QUALITY SOFTWARE" FOR SORCERER AT 10% OFF LIST.

32K 1,145.00 48K 1,295.00

**ATARI 800**

**\$799**

ATARI 800 COMPUTER . . . \$449  
ATARI 820 PRINTER . . . 489  
ATARI 818 DISK DRIVE . . . 579  
ATARI 410 PROGRAM RECORDER . . . 69  
ATARI 16K RAM MODULE . . . 149  
ATARI 8K RAM MODULE . . . 99  
ATARI BASIC ROM . . . 45  
ASSEMBLER EDITOR . . . 45  
+High resolution COLOR Graphics  
+10K Basic in ROM  
+8K user expandable to 48K  
+57 full stroke keyboard

BASKETBALL . . . 39  
VIDEO LASER . . . 39  
SUPER BASKETBALL . . . 39  
MUSIC COMPOSER . . . 49  
COMPUTER CHESS . . . 39  
30 TIC TAC TOE . . . 39  
STAR RAIDERS . . . 45  
PERSONAL FINANCE . . . 45

\*Bulk in RF TV modulator  
\*High speed serial I/O port  
\*Includes ATARI 410 program recorder

**TO ORDER**

Phone orders invited, using credit cards. Or send cashiers check or money order that draws on a U.S. bank. Please add 3% (\$5.00 Minimum) for handling, shipping (air service) and insurance, or equipment will be shipped freight collect. California residents add 6% sales tax. All equipment is in factory cartons with the manufacturers warranty. Equipment is subject to price change and availability without notice.

**CS COMPUTER SPECIALTIES**  
1251 BROADWAY  
EL CAJON, CA. 92021 • (714) 578-0330

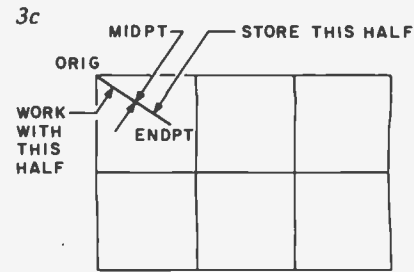
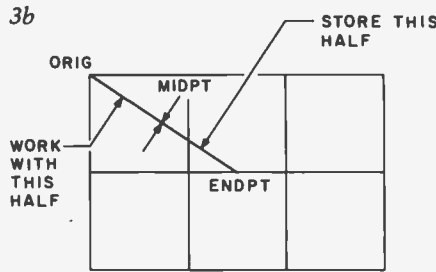
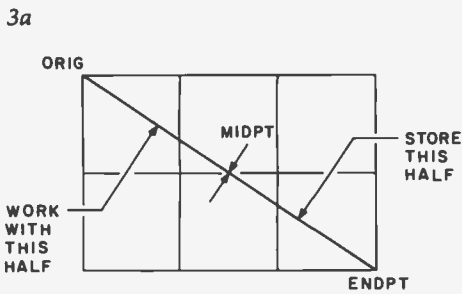

Figure 3: Example of plotting a vector using the method described in text. First the original segment is divided into two parts as in figure 3a. Then a second division is performed as in 3b. The third division (3c) produces a very short segment. Note how quickly a short segment is created. Recursive application of this procedure can be used to plot every point on the line, using a stack oriented algorithm shown in figure 4.

### Midpoints

The midpoint is that point which divides a line segment into two equal segments. It is easy to compute. If a line segment's endpoints are  $(X_1, Y_1)$  and  $(X_2, Y_2)$  in Cartesian coordinates, then the midpoint is  $([X_1 + X_2]/2, [Y_1 + Y_2]/2)$ , that is, each coordinate is the average of each of the endpoints' coordinates. This is easy to do on a computer; division by 2 is simply a shift right, dropping the low bit into the "bit bucket."

There is a subtle problem with computing the midpoint, however. Note that the midpoint is pushed onto the stack and assigned to the endpoint, so that it is plotted twice. We must be careful how we compute the midpoint else the program may enter an infinite loop.

A solution is as follows: we compute two midpoints, one where the average is rounded down (truncated), and one where it is rounded up. For each component (X or Y), the higher average is paired with the greater of the endpoints, the lower with the lesser. Thus, if the origin's X component is less than the endpoint's, then the low average is assigned to the endpoint (see figure 4) while the average plus 1 is pushed onto the stack. Of course, if a component of one endpoint is the same number  $m$  as that component of the other endpoint, then the component of the midpoint is simply  $m$ .

- D = ORIG.X (origin's X coordinate)
- E = ORIG.Y (origin's Y coordinate)
- B = ENDPT.X (endpoint's X coordinate)
- C = ENDPT.Y (endpoint's Y coordinate)
- H = MIDPT.X (midpoint's X coordinate)
- L = MIDPT.Y (midpoint's Y coordinate)

Since each register can hold eight bits, this implementation can handle raster arrays only up to 256 by 256 points. This

### Software Implementation

The problems of storage of coordinates, stack operations, and midpoint handling must be solved to implement the algorithm. These respective problems were solved for the 8080 processor as described below.

- *Storage of coordinates.* I chose to store one coordinate per byte. This allows greater use of registers, which increases speed. The assignment of registers is as follows:

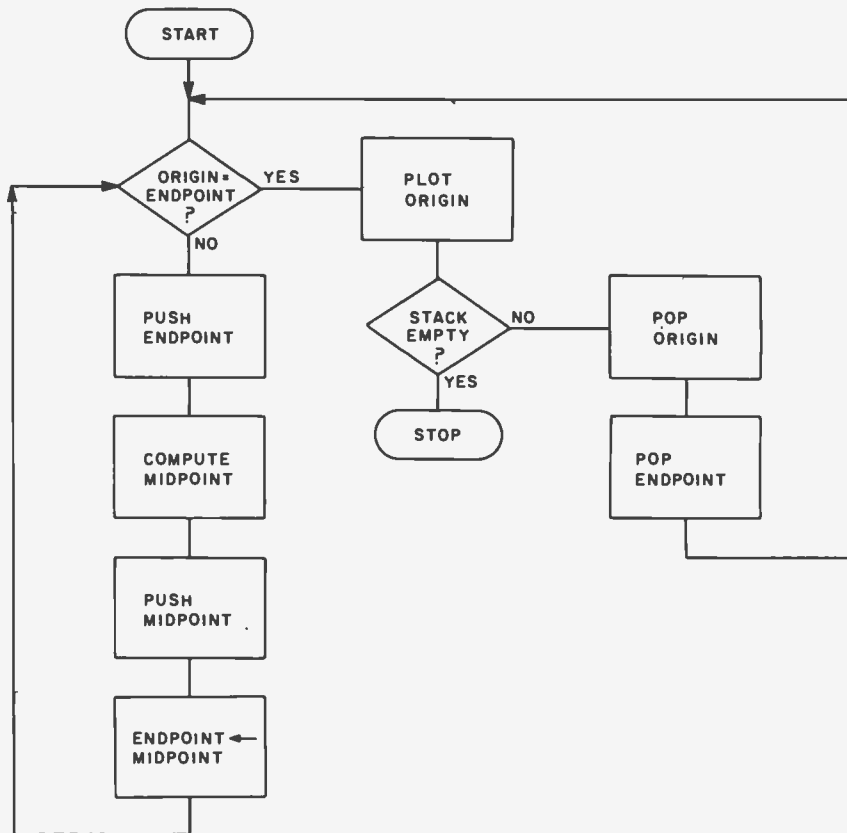

Figure 4: Flowchart for plotting a line segment. This flowchart assumes that integer arithmetic will be used, so that an exact "origin = endpoint" condition will obtain to terminate the algorithm's inner loop.

## CASSETTE PASCAL FOR THE APPLE II®

DYNASOFT PASCAL is a cassette-based PASCAL subset which is ideal for applications like editors, text-processing, controllers, compilers, high-speed graphics, or just plain learning.

DYNASOFT PASCAL includes most of the control structures of standard PASCAL including IF-THEN-ELSE, CASE-OF-OTHERWISE, WHILE-DO, REPEAT-UNTIL, FOR-TO/DOWNTO-DO, and recursive PROCEDURES and FUNCTIONS. It supports the data types INTEGER, CHAR, BOOLEAN, SCALAR, SUBRANGE, POINTER and ARRAY, and both high-resolution (APPLE II PLUS® only) and low-resolution graphics. It is built around a one pass compiler which produces fast, compact p-code and comes complete with compiler, editor, p-code interpreter and a comprehensive user's manual. It requires 16K and is also available for 6800 and 6809 based computers.

Cassette and manual: \$50      Manual only: \$10  
\*registered trademark of Apple Computer Inc.

**Dyna  
soft**  
systems Ltd.

P. O. BOX 51, WINDSOR JCT.  
NOVA SCOTIA, CANADA  
B0N 2V0 (902) 861-2202



# The 2nd Generation is shaping up...

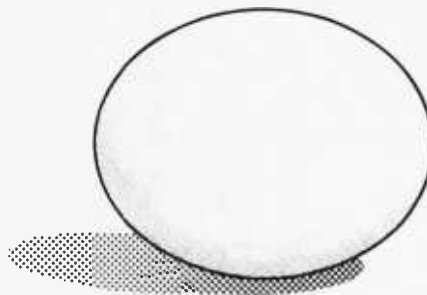

MEASUREMENT  
systems & controls  
incorporated



## MicroByte Software

2415-C Gateway Plaza  
Crabtree Blvd.  
Raleigh, North Carolina 27604 (919) 833-4094

AT LAST! A fully implemented computer based file management system... Only a few minutes of instruction and you are creating and using your own client lists, mailing lists, inventories, bibliographies, vendor lists, and more.

### DBMS80

Files, lists, or records, with user defined formats, can be created, sorted, edited, and printed with ease. Sub-files can be created out of parts of existing files, selecting parts of a record or individual records by a search criterion. ALSO available with DBMS80...

### REPORT80

Build your own custom defined and formatted reports and data summaries. Print tables with user specified formats that will fit your own forms.

DBMS80 and REPORT80 will run under either CP/M or TRSDOS  
 DBMS80 ..... \$250.00  
 REPORT80 ..... \$100.00  
 Manuals each ..... \$25.00

### OTHER PRODUCTS OF MICROBYTE SOFTWARE:

EDIT80 ..... \$100.00  
 Text editor and print formatter which runs under CP/M or TRSDOS  
 DISK80 ..... \$50.00  
 Utility which allows you to examine and patch a disk.  
 UTILS ..... \$50.00  
 Apple PASCAL utilities: extensions to Apple Pascal, together with file control utilities, cross-reference, etc.  
 PAYROLL ..... \$100.00  
 Apple PASCAL payroll for 150 employees, full deduction options, etc.

Write or call today for further details on our products.  
 Source ID#TCF373

APPLE is a trademark of Apple Computer Corp.  
 TRSDOS is a trademark of Lands Corp.  
 CP/M is a trademark of Digital Research

Owing to a printer error a wrong telephone number was run in August. Our apologies for any inconvenience this caused. Our correct telephone number is 919-833-4094.

## What TECO\* does for minis, TED will do for your micro.

Like TECO\*, TED is a character-oriented editor that gives you everything you'd expect. Plus, you get many things you wouldn't expect.

- ▶ 36 command/text buffers
- ▶ 32-entry push-down stack
- ▶ Sophisticated macros
- ▶ Conditional & iterative command execution
- ▶ Conditional & absolute branching
- ▶ Multiple open files

TED and user manual \$90  
 Manual alone \$20  
 Coupon furnished with manuals purchased separately worth \$20 towards purchase of TED.

You'll also find some elegant enhancements among TED's 90-plus commands.

TED's compatible with Z-80\*-based systems supporting standard CP/M\*. We recommend at least 24K bytes RAM. TED's supplied on CP/M\*-compatible 8-inch disks.

SEND FOR FREE COMMAND SUMMARY

**small system design**

P.O. BOX 4546 MANCHESTER, NEW HAMPSHIRE 03108  
 TELEPHONE: 603-432-7929

\*TECO® Digital Equipment Corp., Z-80® Zilog Inc., CP/M® Digital Research Inc

| ORIGIN | ENDPOINT | MIDPOINT | Contents of Stack | Commentary                                    |
|--------|----------|----------|-------------------|-----------------------------------------------|
| 5      | 13       |          |                   | ORIG $\neq$ ENDPT.                            |
| 5      | 13       |          | 13                | Push ENDPT.                                   |
| 5      | 13       | 9        | 13                | Compute MIDPT.                                |
| 5      | 13       | 9        | 13 10             | Push MIDPT + 1.                               |
| 5      | 9        |          | 13 10             | ENDPT: = MIDPT.                               |
| 5      | 9        | 7        | 13 10 9           | ORIG $\neq$ ENDPT; Push ENDPT; Compute MIDPT. |
| 5      | 7        |          | 13 10 9 8         | Push MIDPT + 1; ENDPT: = MIDPT.               |
| 5      | 7        | 6        | 13 10 9 8 7       | ORIG $\neq$ ENDPT; Push ENDPT; Compute MIDPT. |
| 5      | 6        |          | 13 10 9 8 7 7     | Push MIDPT + 1; ENDPT: = MIDPT.               |
| 5      | 6        | 5        | 13 10 9 8 7 7 6   | ORIG $\neq$ ENDPT; Push ENDPT; Compute MIDPT. |
| 5      | 5        |          | 13 10 9 8 7 7 6 6 | Push MIDPT + 1; ENDPT: = MIDPT.               |
| 5      | 5 *      |          | 13 10 9 8 7 7 6 6 | Plot 5.                                       |
| 6      | 6        |          | 13 10 9 8 7 7     | Pop ORIG, ENDPT.                              |
| 6      | 6 *      |          | 13 10 9 8 7 7     | Plot 6.                                       |
| 7      | 7        |          | 13 10 9 8         | Pop DRIG, ENDPT.                              |
| 7      | 7 *      |          | 13 10 9 8         | Plot 7.                                       |
| 8      | 9        |          | 13 10             | Pop ORIG, ENDPT.                              |
| 8      | 9        | 8        | 13 10 9           | ORIG $\neq$ ENDPT; Push ENDPT; Compute MIDPT. |
| 8      | 8        |          | 13 10 9 9         | Push MIDPT + 1; ENDPT: = MIDPT.               |
| 8      | 8 *      |          | 13 10 9 9         | Plot 8.                                       |
| 9      | 9        |          | 13 10             | Pop ORIG, ENDPT.                              |
| 9      | 9 *      |          | 13 10             | Plot 9.                                       |
| 10     | 13       |          |                   | Pop ORIG, ENDPT.                              |
| 10     | 13       | 11       | 13                | ORIG $\neq$ ENDPT; Push ENDPT; Compute MIDPT. |
| 10     | 11       |          | 13 12             | Push MIDPT + 1; ENDPT: = MIDPT.               |
| 10     | 11       | 10       | 13 12 11          | DRIG $\neq$ ENDPT; Push ENDPT; Compute MIDPT. |
| 10     | 10       |          | 13 12 11 11       | Push MIDPT + 1; ENDPT: = MIDPT.               |
| 10     | 10 *     |          | 13 12 11 11       | Plot 10.                                      |
| 11     | 11       |          | 13 12             | Pop ORIG, ENDPT.                              |
| 11     | 11 *     |          | 13 12             | Plot 11.                                      |
| 12     | 13       |          |                   | Pop ORIG, ENDPT.                              |
| 12     | 13       | 12       | 13                | ORIG $\neq$ ENDPT; Push ENDPT; Compute MIDPT. |
| 12     | 12       |          | 13 13             | Push MIDPT + 1; ENDPT: = MIDPT.               |
| 12     | 12 *     |          | 13 13             | Plot 12.                                      |
| 13     | 13       |          |                   | Pop ORIG, ENDPT.                              |
| 13     | 13 *     |          |                   | Plot 13.                                      |
|        |          |          |                   | Stack Empty, end of algorithm.                |

\*ORIG = ENDPT condition is true.

Table 1: An example of plotting a one-dimensional line segment using the algorithm of figure 4. The points are plotted in the order: 5, 6, 7, 8, 9, 10, 11, 12, 13. The maximum depth of the stack is eight.

gives excellent resolution on a small display. The next step up in dimensions complicates this program by an order of magnitude; it would be better to use a 16 bit processor.

● *Stack operations.* On the 8080, only register pairs can be pushed or popped, which is the reason for the HL midpoint register pair. It acts as a buffer to the stack. The hardest part of stack operations is detecting stack empty, as there is no compare stack pointer instruction. The most efficient way is to push a stack empty flag, hexadecimal 0000 or FFFF, and test for it on pop

operations. If such a method is used, the user must be absolutely sure that the flag code is never pushed as an actual datum, or the program will "bomb." (Any program which makes large use of the stack runs the risk of wiping out all writable memory, so be careful!) This implementation uses 0000 as the flag and makes sure there are no problems at the beginning of the program. If the program is used for a smaller matrix, then simplifications can be made by pushing FFFF instead.

● *Midpoint handling:* Choosing the right midpoint to increment involves

comparing the coordinates. This is not something we want to do each time (waste of time), and we don't have to, since the method preserves the order of the endpoints. (IF ORIG.X < ENDPT.X at the beginning, it will stay that way throughout the algorithm.) What we do is as follows:

- (1) Make sure ORIG.X is less than ENDPT.X, switching them if necessary. Then we always increment the MIDPT.X pushed onto the stack.
- (2) If ORIG.X is equal to ENDPT.X, make sure ORIG.Y is not greater than ENDPT.Y (This insures that 0000 is not pushed on the stack as a piece of data.)
- (3) If ORIG.Y is less than ENDPT.Y, then increment the midpoint pushed onto the stack, else increment the midpoint

and L are Y components. The contents of registers A, B, and C are destroyed.

The first two instructions initialize the stack so we can tell when it is empty. Hexadecimal 0000 on the top means the stack is empty. The next eight instructions are used to insure that DE is less than HL, so that it is easy to compute MIDPT.X. Then BC is loaded from HL so as to free HL for the next step.

The next step sets up the midpoint handling for the Y coordinates. Memory location INRAL can have one of two instructions in it: INR A if  $E < C$ , or INR C if  $E > C$ . Again this is to make it easy to compute midpoints. Instruction modification is a poor technique, as programs become nonreentrant, unable to be stored in read only memory, and nondebuggable, but it is used here to save space. It is possible to get rid of this step by duplicating the rest of the subroutine.

The rest of the program plots according to the algorithm. DE is the origin,

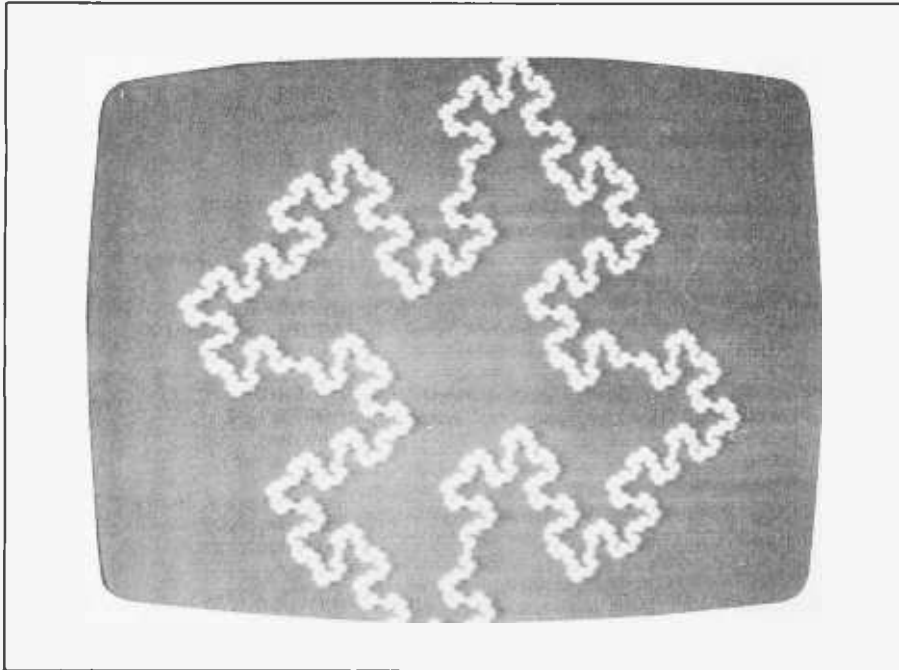

*Photo 1: Example output using the line drawing algorithms presented in listing 1.*

to be assigned to ENDPT.Y. This last operation can be done by modifying one instruction (a bad technique) or by duplicating most of the code (a waste of space).

Listing 1 is 8080 subroutine VECTOR for plotting a line segment between two endpoints. The points are passed through the DE and HL register pairs where D and H are X components and E

BC the endpoint, and HL the midpoint. The code is simply a realization of the flowchart in figure 4. Note the method for detecting 0000 on the top of the stack.

PLOT is a subroutine for plotting a point on your graphics interface. X is passed through B and D, Y through C and E. All registers may be destroyed by your PLOT subroutine (you don't have to save any). PLOT is the only part of VECTOR which is device dependent (within

| Label   | Mnemonic     | Commentary                                     |
|---------|--------------|------------------------------------------------|
| VECTOR: | LXI B,0000H  | ;Push stack empty flag.                        |
|         | PUSH B       |                                                |
|         | MOV A,D      | ;Make DE less than HL.                         |
|         | CMP H        |                                                |
|         | JC NOXG      |                                                |
|         | JNZ XG       |                                                |
|         | MOV A,E      |                                                |
|         | CMP L        |                                                |
|         | JC NOXG      |                                                |
| XG:     | XCHG         | ;Exchange HL with DE if necessary.             |
| NOXG:   | MOV B,H      | ;BC = HL.                                      |
|         | MOV C,L      |                                                |
|         | LXI H,INRAL  | ;point to instruction INRAL.                   |
|         | MVI M,3CH    | ;Make INRAL the instruction "INR A".           |
|         | MOV A,E      | ;If E less than C                              |
|         | CMP C        |                                                |
|         | JC LOOP      | ;Then leave INRAL alone                        |
|         | MVI M,OCH    | ;Else change INRAL to the instruction "INR C". |
|         | ;ORIGIN = DE |                                                |
|         | ;ENDPT = BC  |                                                |
|         | ;MIDPT = HL  |                                                |
| LOOP:   | MOV A,D      | ;If ORIG.X ≠ ENDPT.X.                          |
|         | CMP B        |                                                |
|         | JZ EQX       |                                                |
|         | PUSH B       | ;Then (Push ENDPT                              |
|         | ADD B        | ; compute MIDPT.X                              |
|         | RAR          |                                                |
|         | MOV B,A      | ; ENDPT.X = MIDPT.X                            |
|         | INR A        | ; Adjust midpoint:                             |
|         | MOV H,A      | ; MIDPT.X = MIDPT.X + 1).                      |
|         | MOV A,E      | ;If ORIG.Y ≠ ENDPT.Y                           |
|         | CMP C        |                                                |
|         | JZ EQY       |                                                |
| NEQY:   | ADD C        | ;Then (Compute MIDPT.Y                         |
|         | RAR          |                                                |
|         | MOV C,A      | ; ENDPT.Y = MIDPT.Y                            |
| INRAL:  | INR A        | ; Adjust MIDPT.Y).                             |
| EQY:    | MOV L,A      |                                                |
|         | PUSH H       | ;If ORIGIN ≠ ENDPT in general                  |
|         | JMP LOOP     | ;Then (push MIDPT                              |
|         |              | ; continue loop).                              |
| EQX:    | MOV A,E      | ;If ORIG.X = ENDPT.X                           |
|         | CMP C        | ; and ORIG.Y ≠ ENDPT.Y                         |
|         | JZ EQXY      |                                                |
|         | PUSH B       | ;Then (push ENDPT                              |
|         | MOV H,D      | ; MIDPT.X = ORIG.X                             |
|         | JMP NEQY     | ; treat as above).                             |
| EQXY:   | CALL PLOT    | ;If ORIGIN = ENDPT                             |
|         | POP D        | ;then (plot ORIGIN                             |
|         | MOV A,D      | ; pop new origin                               |
|         | ORA E        | ; stack empty?                                 |
|         | RZ           | ; return if stack empty.                       |
|         | POP B        | ; pop new ENDPT                                |
|         | JMP LOOP     | ; continue loop).                              |

*Listing 1: Subroutine VECTOR plots a line segment between two points. Point number 1 is stored in register pair DE and point number 2 is stored in register pair HL. The contents of registers A, B, and C are destroyed.*

the 256 by 256 limit). PLOT can use any coordinate system: (0, 0) can be in the center, any corner, etc. VECTOR "doesn't care" as long as it is rectangular. A sample subroutine PLOT for the Polymorphics Video Board is included as listing 2.

How much stack space does this program take? Since we are pushing things from all over the place onto the stack, it seems considerable at first glance. However, this is not the case. If your

vector has a length of 256, then it only takes eight midpoint operations to reduce its length to 1, so we only need about that many segments on the stack. Each segment takes four bytes, so we only need about 32 bytes for the stack (give it a little more). This is a small price to pay in storage for a large benefit in program efficiency.

Another use of this program (other than a raster display) might be to drive an X,Y display or a plotter. All you have

| Label                      | Mnemonic     | Commentary                                           |
|----------------------------|--------------|------------------------------------------------------|
| PLOT:                      | XRA A        | ;Clear carry.                                        |
|                            | MOV A,D      | ;Get X.                                              |
|                            | RAR          | ;Divide X by 2 to get horizontal character position. |
|                            | MOV L,A      | ;Store in L.                                         |
|                            | SBB A        | ;Get remainder.(R).                                  |
|                            | MOV D,A      | ;D: = 0 if R=0; D: =FFH if R = 1.                    |
|                            | MVI H,0F8H   | ;H points to video memory offset by X.               |
|                            | LXI B,0040H  | ;Increment = 64.                                     |
|                            | MOV A,E      | ;Get Y.                                              |
| L1:                        | SUI 03H      | ;Divide Y by 3.                                      |
|                            | JM P1        |                                                      |
|                            | DAD B        | ;HL contains quotient times 64.                      |
| P1:                        | JMP L1       |                                                      |
|                            | MOV E,A      | ;Store residue of Y (Res = Remainder - 3).           |
|                            | XRA A        | ;Clear Carry.                                        |
|                            | DCR A        | ;A: = 0FFH.                                          |
| L2:                        | RAL          | ;Rotate zero into A per Residue.                     |
|                            | INR E        |                                                      |
|                            | JM L2        |                                                      |
|                            | INR D        | ;Test remainder of X.                                |
|                            | JZ P2        | ;If it was zero                                      |
|                            | RAL          | ;then rotate zero bit three times.                   |
|                            | RAL          |                                                      |
|                            | RAL          |                                                      |
| P2:                        | ANA M        | ;Set Memory bit.                                     |
|                            | MOV M,A      |                                                      |
|                            | RET          | ;Return.                                             |
| ;Polymorphics Clear Screen |              |                                                      |
| CLEAR:                     | LXI H,0F800H | ;Video Memory.                                       |
| CL1:                       | MVI M,03FH   | ;Clear Character.                                    |
|                            | INX H        | ;Next location.                                      |
|                            | MOV A,H      | ;Last Location?                                      |
|                            | CPI 0FCH     |                                                      |
|                            | JNZ CL1      |                                                      |
|                            | RET          | ;Return.                                             |

Listing 2: A typical PLOT subroutine, this one for the Polymorphics Video Board. The Polymorphics board displays graphics by cutting a character position into six rectangles. The sign bit is 0 for graphics and 1 for characters. There are 16 lines of 64 characters each, or 48 lines of 128 rectangles each. The low 6 bits are used to set the bits as in the following example.

If a byte has its bits numbered: 76543210, the rectangles within a byte correspond to:

|   |   |
|---|---|
| 5 | 2 |
| 4 | 1 |
| 3 | 0 |

The PLOT subroutine plots the rectangle corresponding to  $X=D$ ,  $Y=E$ .

to do is have PLOT send the X,Y data to latching digital-to-analog converters. VECTOR itself is not changed.

### Hardware Implementation

The method is valid for hardware also. A circuit utilizing this method would be an excellent addition to a graphics interface board. As we have seen, the stack need not be deep; some 7489 type memories would be adequate, addressed by an up/down counter. Comparators are no problem, nor is the averaging circuitry. The comparators could control the midpoint manipulation (which would be a pain), eliminating the hardware analog of the instructions before LOOP. Stack empty is trivial. There are lots of integrated circuits in such a dedicated hardware approach, but this

would be fast, great for plots and games. Some simplification might be obtained using LSI (large scale integration) microcontroller chips such as those in the 2900 series or their equivalents. Again, digital-to-analog converters could be used for X,Y display. (It sure gets rid of a lot of analog circuitry needed to generate straight lines on traditional X,Y displays.)

### Summary

This article described a general method for plotting a line segment, given its endpoints, on a raster scan display. The method uses a recursive technique: lines are subdivided until they are short enough to plot as a point. The method can be used in both software and hardware applications. ■

# M7 COMMUNICATOR

**A complete A/D and D/A Control System – Interface your computer to the analog world of process monitoring transducers and controlling actuators.**

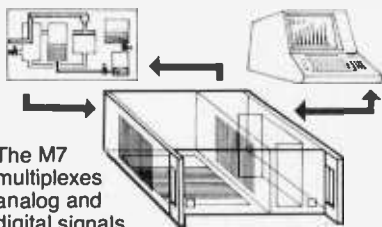

The M7 multiplexes analog and digital signals from your process sensors—temperature, pressure, level, flow, mass, strain, etc.—and continuously down-loads this data in digital form to your computer for display and processing. Simultaneously, command signals are transmitted to the control devices in your process.

Order a complete basic M7 System ready for round-the-clock process control—including a 16/32-Channel A/D Input Module (expandable to 512 channels), a Computer Interface Module, and a 4-Channel (expandable) D/A Output Module. Supplied complete with cabinet, power supply, and all necessary hardware and software for basic control. Bus accommodates eight additional modules. Specify computer make and model when ordering . . . each \$2,990

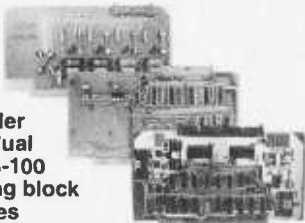

Or, order individual IEEE S-100 building block modules

Supplied complete with fundamental control software:

**A/D Module, AIM-12**—16/32 channel, 12-bit precision/accuracy, 30 kHz data rates, 1-1000 gain amplifier optional • **Thermocouple Compensation Module, THM-8**—16 inputs • **Signal Conditioners, SIG-1**—Long-line drive • **Additional Support Programs, PROG A,B,C**—Signal averaging, control functions, special display, etc. • **D/A Module, AOM-12**—4-channel (expandable), 12-bit precision/accuracy, Output: selectable voltage ranges and oscilloscope • **Control Output-Current Module, VIC 4-20**—4-20 mA standard industrial control output, 12-bit precision/accuracy, 4-channel, Use with AOM-12 • **Programmable Clock/Calendar Module, CLK-24**—Minimum 1 year back-up • **Parallel Output Module, REL-8**—8-channel on-off (bang-bang) control • **Add-On Nonvolatile Memory Modules**—4K and 8K bytes



DUAL SYSTEMS CONTROL CORP.  
1825 Eastshore Hwy. Berkeley, CA 94710  
(415) 549-3854

# Letters

Letters continued from page 22:

## More Significant Digits for Pascal

A reader inquired in the June 1980 BYTE about the significant-digits limitation in UCSD Pascal. (See "Numerical Precision in UCSD Pascal," by Martin Berman, page 17.)

Vejur Software Systems has software packages which allow the precision of 14-, 18-, and 36-decimal digits under the North Star version of UCSD Pascal. Each package has two instructions for converting BCD (binary-coded decimal) numbers to binary form and vice versa, and four instructions for performing binary arithmetic. The 14-digit package stores numbers in 6 bytes; the 18-digit package uses 8 bytes, and the 36-digit package, 15 bytes.

Each package is supplied on a North Star double-density floppy disk for \$20 in object form. Source assembly-language code for the Z80 microprocessor is also available for possible use on other systems.

Arne Paulsen  
Vejur Software Systems  
257 Fifth Ave  
San Francisco CA 94118

## Information Needed

The Psychology Department at the University of North Carolina at Chapel Hill is currently in the planning stages of a computer-based laboratory for undergraduates. We have chosen the Apple II microcomputer and Pascal as the programming language. As such, we would appreciate learning of the availability of any applicable software.

If there are any BYTE readers that know of such products, please let me know.

R F Genovese  
University of North Carolina at Chapel Hill  
Department of Psychology  
Davie Hall 013 A  
Chapel Hill NC 27514

## Shared Files for Education

The special July 1980 BYTE with the Education theme was an excellent overview of the relationship between microcomputers and education, although it leaves readers with some incorrect impressions about the state of the art.

Dr Arthur Luehrmann's Education Forum ("Computer Illiteracy—A National Crisis and a Solution for It," page

CP/M ↔ IBM  
Compatibility  
with

# REFORMATTER™

For \$195 you can now transfer data between large and small systems.

**REFORMATTER™**, a Diskette Utility Program, enables you now to transfer textual data files in either direction between Z-80 or 8080 based micros operating under CP/M and IBM systems using 3741 diskettes.

For detailed information contact

MicroTech Exports  
912 Cowper Street  
Palo Alto, CA 94301  
Tel: 415/324-9114

TWX: 910-370-7457 MUH-ALTOS  
Dealer & OEM discounts available

Circle 245 on inquiry card.

# SURPLUS ELECTRONICS

ASCII



ASCII

IBM SELECTRIC  
BASED I/O TERMINAL  
WITH ASCII CONVERSION  
INSTALLED \$645.00

- Tape Drives • Cable
- Cassette Drives • Wire
- Power Supplies 12V15A, 12V25A, 5V35A Others, • Displays
- Cabinets • XFMRs • Heat Sinks • Printers • Components

Many other items

Send for free catalog.

WORLDWIDE ELECT. INC.

130 Northeastern Blvd.

Nashua, NH 03062

Phone orders accepted using  
VISA or MC

Call Toll Free 1-800-258-1036

In NH 603-889-7861

Circle 246 on inquiry card.

## FIFTY BUS SYSTEMS

32K 6800s from ..... \$1694.99

32K 6809s from ..... \$1844.99

Include: Chassis, CPU, 32K Static Ram, I/Os  
Fully Expandable

2114L 300ns STATIC RAM CHIPS . . \$5.90

FACTORY PRIME From the same shipment we use in our professional quality boards  
Add \$5.00 Handling on Orders Under \$200.00

### 32K STATIC RAM BOARD

FOR THE S550 AND S550C BUS (SWTP etc.)

- S550C Extended Addressing (can be disabled).
- 4 separate 8K blocks • Low power 2114L RAMS
- Sockleted for 32K • Write Protect
- Gold Bus Connectors

16K ..... \$328.12

24K ..... \$438.14

32K ..... \$548.15

Phone, write, or see your dealer for details and prices on our broad range of Boards and Systems for the S550/S550C BUS including our UNIQUE 80 x 24 VIDEO BOARD, and our AC Power Control Products for all computers.

**GIMIX inc.**



1337 W. 37th Place • Chicago, IL 60609  
(312) 927-5510 • TWX 910-221-4055

The Company that delivers.

Quality Electronic products since 1975.

GIMIX® and GHOST® are Registered Trademarks of GIMIX INC

Circle 247 on inquiry card.



# BYTE

Back Issues for sale



The following issues are available:

1976: July and November

1977: March, May thru December

1978: February thru October, December

1979: January thru December except March

1980: January to current issue except February

Cover price for each issue through August 1977 is \$1.75

Domestic; \$2.75 Canada and Mexico; \$3.75 Foreign.

September 1977 through October 1979 issues are \$2.50

Domestic; \$3.25 Canada and Mexico; \$4.00 Foreign.

November 1979 to current is \$3.00 Domestic; \$3.75 Canada and Mexico; \$4.50 Foreign.

Send requests with payment to:

**BYTE Magazine**

70 Main St, Peterborough NH 03458

Attn: Back Issues

## At Last! HIGH RESOLUTION S-100 GRAPHICS

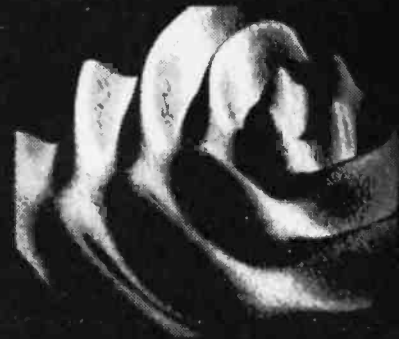

Unretouched photograph

**512 x 640 DOT RESOLUTION  
S-100 PLUG IN  
COMPLETE INTERFACE  
ON-BOARD MEMORY  
ASSEMBLED & TESTED FROM**

**OPTIONS:**

- 16 COLORS
- GREY LEVELS
- LIGHT PEN
- SOFTWARE

**\$1,200**

Send for brochure and data



**CAMBRIDGE DEVELOPMENT LAB**  
36 Pleasant St., Watertown, MA 02172

### PROFESSIONAL

HALF A MILLION TAX RETURNS CAN'T BE WRONG!  
(OR THEY HAD BETTER NOT BE)



## INCOME TAX SYSTEM FOR TRS-80\* MODEL I OR II

Our system, which prepared 500,000 1979 returns, features the following:

1. Full interactive user control, in tax-form language only, line by line.
2. Screen display of full 1040 and all schedules, prior to printout.
3. Change of a single amount item automatically changes and re-computes entire return.
4. All printout formats IRS and state approved.
5. Stores Preparer's Identification for automatic printing at bottom of page 2.
6. Built-in Validation Check tests entire system, hardware and software.
7. Special Printer Adjustment routines, Line Length, etc.
8. Selection of closed or open output formats—for standard Form 1040 or open name-box types.
9. Software control of text position on page. Makes forms-alignment simple. Permits use with non-adjustable printers.
10. Fills in pre-printed Forms or you can use overlays. Your choice.
11. Automatically computes: Tax - SDI Overpayment - Wages Total from W-2's - Earned Income Credit - Income Averaging - Maximum/Minimum Tax - Least Tax Method - All Percentage of Income Limitations - All Fixed Limitations - many, many more.
12. Full support through the tax season—no charge.
13. Inexpensive yearly updates in accordance with tax-law changes.
14. Modular construction—lets you order only the type and size system you need.

PRICING STARTS AT **\$189.95** (1040 & SCHEDULE A)

25-Page Descriptive Manual \$7.50 (Refunded on Order)

Minimum System Required: Model 1, 32K, 1 Disk Drive

\*TRS-80 is a trademark of Tandy Corp.

**CONTRACT SERVICES ASSOCIATES**

706 SOUTH EUCLID • ANAHEIM, CA 92802 • TELEPHONE (714) 635-4055

★ ★ ★ ★ 20 Years of Service ★ ★ ★ ★



## SAVE MORE THAN 20%

**NORTH STAR — INTERTUBE — MICROTEK  
ZENITH — RCA-COSMAC — ITHACA  
THINKER TOYS — GODBOUT — SUPERBRAIN**

*The smartest computers at the smartest price*



| FACTORY ASSEMBLED & TESTED              | LIST ONLY             |              |
|-----------------------------------------|-----------------------|--------------|
| HORIZON-1-32K-DOUBLE DEN                | \$2695                | \$1994       |
| HORIZON-2-32K-DOUBLE DEN                | 3095                  | 2299         |
| HORIZON-2-32K-QUAD DENSITY              | 3695                  | 2699         |
| HORIZON-2-64K-QUAD+HARD DISK            | 8329                  | 7199         |
| HORIZON MEMORY ASSM                     | 18K 389 32K 579       |              |
| HORIZON MEMORY KIT                      | 18K 359 32K 535       |              |
| NORTH STAR HARD DISK 18 Mb              | 4999                  | 3839         |
| PASCAL FOR NORTH STAR ON DISK           | 199                   | 190          |
| Powerful NORTH STAR BASIC...The Best    | .....FREE             |              |
| 2 NORTH STAR SOFTWARE DISKS w/HORIZON   | .....FREE             |              |
| MSSE 1-22 & POI TERRIFIC PROGRAMS       | ONLY 10               |              |
| NORTHWORD 299 MAILMAN 239               | INFOMAN 389           |              |
| RCA-COSMAC VP-111 99                    | RCA-COSMAC VP-711 189 |              |
| COLORI RAINBOW 385                      | CAT-100 1389          | SPECTRUM 289 |
| ITHACA FRONT PANEL COMPUTER 64K         | 3195                  | 2695         |
| Z-8001 CPU CARD 18-bit ITHACA S-100 8Mb |                       | 1179         |
| ITHACA MEMORY 8/16-bit 64K              | 995                   | 845          |
| SEATTLE 8088 CPU 16 bit 10 x faster     |                       | 558          |
| SEATTLE MEMORY 8/16 BIT 16K 4Mhz        |                       | 356          |
| SSM KITS Z-80 CPU 221                   | VIDED BRD VB3 4Mhz    | 412          |
| MEASUREMENT MEMORY 64K A & T 4mhz       |                       | 589          |
| MEASUREMENT MEMORY 64K BANK SELECT      |                       | 789          |
| ECONORAM XIV UNKIT 18K                  | 299                   | 254          |
| CENTRAL DATA 64K RAM                    | 685                   | 599          |
| DISCUS/2D A & T + CP/M                  | 1199                  | 875          |
| THINKER TOYS HARD DISK 28 Mb            | 4995                  | 3995         |
| DISCUS/2+2 1.2 Mbytes A & T             | 1549                  | 1285         |
| TARBELL DISK CONTROLLER DD              | 495                   | 445          |
| TARBELL CASSETTE INTERFACE KIT          | 120                   | 109          |
| SUPERBRAIN                              | 2995                  | 2395         |
| SUPERBRAIN QUAD DENSITY                 | 3995                  | 2995         |



|                                           |                 |      |
|-------------------------------------------|-----------------|------|
| ZENITH-HEATH Z-89 48K                     | 2895            | 2495 |
| INTERTUBE II SMART TERMINAL               | 995             | 725  |
| ZENITH-HEATH SMART TERMINAL               | 995             | 739  |
| ZENITH-HEATH WH-11 18bit COMPUTER         |                 | 2995 |
| CAT INOVATION MODEM                       | 179             | 189  |
| MICROTEK PRINTER                          | 795             | 675  |
| ANADIX PRINTER DP-8000                    | 995             | 865  |
| ANADIX PRINTER DP-9500-1                  | 1650            | 1389 |
| NEC PRINTER Fast Typewriter Quality       | 2915            | 2799 |
| SECRETARY WORD PROCESSOR The Best!        | 85              | 77   |
| TEXTWRITER III Book Writing Program       | 125             | 112  |
| GOFAST NORTH STAR BASIC Spender Upper     | 79              | 71   |
| PDS SUPER Z-80 ASSEMBLER & More           | 99              | 89   |
| SUPER BASIC DEBUGGER 989 COMPILER 135     | HOS             | 40   |
| EZ-80 MACHINE LANGUAGE TUTOR 25           | STATISTICS      | 190  |
| EZ-CODER Translates English to BASIC      | 79              | 71   |
| ECOSOFT FULL ACCOUNTING PKG               | 350             | 315  |
| BOX OF DISKETTES 29                       | IN PLASTIC CASE | 30   |
| Which Computers are BEST? BROCHURE        | .....FREE       |      |
| North Star Documentation refundable w/HRZ |                 | 20   |

ORDER 2 or more COMPUTERS.... BIGGER DISCOUNTS  
YES WE WILL BEAT OUR COMPETITION'S PRICE!  
FACTORY ASSEMBLED & FACTORY WARRANTY

## AMERICAN SQUARE COMPUTERS

KIVETT DR • JAMESTOWN NC 27282  
(919)-889-4577

88) stressed the importance of a personal-computer shared-file system in providing a workable environment for computer education, and indicated this is a problem unsolved by the computer industry.

For several years, Nestar Systems has dedicated itself to providing add-on networks for the popular Apple, Commodore, and Tandy/Radio Shack family of computers. Known as the Cluster/One Model One and Model A, these systems substantially satisfy the features described as needed by Dr Luehrmann in his article. Indeed, one outstanding installation of a Cluster/One Model One system, with twenty-seven microcomputers coupled in a high-speed network, has been running under Dr Luehrmann's guidance at the University of California's Lawrence Hall of Science for over a year.

Readers interested in the details of Nestar's product offerings should contact us at the address below.

Dr Harry J Saal  
President  
Nestar Systems Inc  
430 Sherman Ave  
Palo Alto CA 94306

### Disputes Heath Software Compatibility

I was appalled to read Barry Watzman's (Heath Company's computer product line manager) statement in the July 1980 BYTE that, "...the S-100 bus has nothing at all to do with software, and it is obvious that Mr Libes is referring to 'CP/M' systems, and not to 'S-100' systems." (See "Statement from the Heath Company," page 14.) Does Mr Watzman really believe that, or did he simply miss the point of the statement he was ostensibly refuting? Does this mean that Heath really doesn't understand why their systems are not compatible with the rest of the world?

While it is true that software could not care less about the bus structure of its host processor, the problem is that most of the 8080/Z80 software available in object form requires contiguous user memory starting at location 0. None of the Heath systems can meet this requirement, while virtually all of the S-100 systems can. It would seem that, in practice, the S-100 bus has a great deal to do with software! The difference is purely one of hardware configuration and has nothing to do with whether or not Digital Research Corporation's CP/M is chosen as the operating system, although standard CP/M and all the programs designed to run with it fall into the class of affected programs. No doubt many Heath owners would appreciate a modification (albeit it would not be simple!) that would move their

# ELCOMP Books

**Care and Feeding of the Commodore PET**  
Eight chapters exploring PET hardware. Includes repair and interfacing information. Programming tricks and schematics.  
Order No. 150 \$11.00

**8K Microsoft BASIC Reference Manual**  
Authoritative reference manual for the original Microsoft 4K and 8K BASIC developed for Altair and later computers including PET, TRS-80, and OSI. OSI owners please take note!  
Order No. 151 \$ 9.95

**Expansion Handbook for 6502 and 6802**  
(S-44 Card Manual) Describes all of the 4.5 x 6.5 44 pin S-44 cards incl RAM, ROM, dig. I/O, MUX/A to D, EPROM Prog. etc. With schematics and lunct descriptions. A must for every KIM, SYM and AIM owner.  
Order No. 152 \$ 9.95

**Microcomputer Application Notes**  
New, revised applications manual for the Texas Instruments SN 76477 Reprint of Intel's most important application notes, including 2708, 8085, 8255, 8251 chips. Very necessary for the hardware buff.  
Order No. 153 \$ 9.95

**Complex Sound Generation**  
New, revised applications manual for the Texas Instruments SN 76477 Complex Sound Generator. Circuit board available (\$8.95)  
Order No. 154 \$ 6.95

**Small Business Programs**  
Complete programs for the business user. Mailing List, Inventory, Invoice Writing and much more. Introduction into Business Applications. Many listings.  
Order No. 156 \$14.90

**The First Book of Ohio Scientific, Vol. I**  
Contains an introduction to personal computers and describes the Ohio Scientific Line. Contains explanatory diagrams, block, hook up, expansion, tricks, hints and many interesting listings. Hardware and software information not previously available in one compact source. 192 pages.  
Order No. 157 \$ 7.95

**The First Book of Ohio Scientific, Vol. II**  
Vol. II contains very valuable information about Ohio Scientific microcomputer systems. Introduction to OS-650 and OS65 U, networking and distributed processing, systems specifications, business applications, hard and software hints and tips.  
Order No. 158 \$ 7.95

**Mailing List Program for Challenger C1, C2 8K**  
Order No. 2004 - Personal Version \$ 9.95  
Order No. 2005 - Business Version \$ 9.95

**Ohio Scientific Expansion Information**  
Conversion of C1P (Cassette) to 52x26 display. Detailed step by step instructions for doubling the C1P speed and display size.  
Order No. 1105 \$12.00

**Important Software for CBM 16K/32K**  
Most powerful Editor/Assembler for Commodore CBM 16/32K on cassette. Very fast—Editor divides screen into 3 parts. Scrolling text window. 24 direct commands. 19 serial commands, status and error messages. Assembler can be started directly from the editor or from the 11M monitor. Translates in three passes. If an error is encountered automatic return to the editor. Cassette with DEMO.  
Order No. 3276 \$69.00

**MONJANA I makes Machine Language Programming easy!**  
In every Commodore CBM there is a spare ROM socket waiting for its MONJANA I. The new MONJANA I Machine Language Monitor in ROM offers more user guidance and debugging aids than any other monitor available today. It is indispensable for anyone intending to take full advantage of the computer's features. Trace link disassemble dump, relocate time assemble and much more. Every command function has demand printout option. Price includes extensive manual.  
Order No. 2001 \$98.00

**JANA-Monitor on cassette for the PET**  
Similar to MONJANA I, very powerful.  
Order No. 2002 \$29.00

### ELCOMP PUBLISHING Inc.

3873-L Schaefer Ave., Chino CA 91710 (714) 591-3130

Please send me the books/software indicated below

I enclose \$ \_\_\_\_\_ send postpaid

Send COD (\$5 extra)

Charge my  VISA  Mastercard

Acc't No. \_\_\_\_\_

Expir. date \_\_\_\_\_

Signature \_\_\_\_\_

Book No. \_\_\_\_\_ Book No. \_\_\_\_\_ Software No. \_\_\_\_\_

1 Year subscription to ELCOMP Newsletter \$9.00

Name \_\_\_\_\_ Phone \_\_\_\_\_

Address \_\_\_\_\_

City \_\_\_\_\_ State \_\_\_\_\_ Zip \_\_\_\_\_

CA add 6% sales tax. We also accept Eurocheck. All orders outside USA must add 15% shipping.

# Mark of the Unicorn

presents:

## Amethyst

first of the gemstones



**G**emstones are professionally crafted programs that represent the state of the art in their respective domains. The documentation for each Gemstone includes not just a user's manual but also a design overview and related theoretical material. Each Gemstone also represents an ongoing commitment to user support, in the form of a newsletter, program updates, and a telephone hotline.

**A**methyst is a user-extensible text processing system based on MIT Emacs. Its powerful yet easy-to-learn command set provides convenient screen editing of both programs and documents. The Amethyst command set can be added to or modified to suit personal preferences.

**A** 56k CP/M® with a cursor addressable display is required. Amethyst is written in C, and the BDS C compiler is included to provide for simple reconfiguration of the system. Amethyst is available on 8" soft sector diskettes; other formats soon.

P.O. Box 423  
Arlington, Massachusetts 02174  
617-498-1387

**\$350**

CP/M is a registered trade mark of Digital Research

# NOBODY DOES IT LIKE SYNCHRO-SOUND!



**HAZELTINE  
1420  
VIDEO TERMINAL  
\$775<sup>00</sup>**

**HAZELTINE  
1500  
VIDEO TERMINAL  
\$849<sup>95</sup>**



**SYNCHRO-SOUND ENTERPRISES, INC.**

The Computer People

193-25 Jamaica Avenue  
Jamaica, N.Y. 11423

PHONE ORDERS, CALL:

New York—212/468-7067  
Los Angeles—213/628-1808  
Chicago—312/641-3010  
Dallas—214/742-6090

## MAKE YOUR BASIC BETTER FOR BUSINESS

Developing business applications without keyed file support is like producing a play without the right cast — you can expend needless time and money, and end up giving an inadequate performance.

### Enter MAGSAM™

MAGSAM picks up where your BASIC leaves off by providing it with a powerful Keyed File Management System that's quick and easy to use. The result is applications that do exactly what you want them to — instead of only what BASIC allows you to.

### Supporting Cast

MAGSAM's advanced features and capabilities include:

- Random, sequential, and generic access by key
- Secondary indexing with any number of keys
- Key and record deletes with automatic space reclamation
- Dynamic file allocation and extension
- Complete compatibility with BASIC files
- Interactive tutorial program
- One year update service

The versatile MAGSAM file management is now available in two major versions. MAGSAM IV, the new high performance assembler version, is ideal for business applications in which response time is critical. Complete with an interface for CBASIC, MAGSAM IV is \$295. MAGSAM III is the standard version and is in use world wide. Written in BASIC, it is available for CBASIC, Microsoft BASIC, or Micropolis BASIC for \$145. The MAGSAM manual alone is \$25.

### You're the Star

MAGSAM is available immediately — off the shelf. So you can begin saving time and money now while providing your customers and clients with applications that truly meet their needs. Send for a free brochure telling the full story on MAGSAM, or see a demonstration at your computer dealer today.

Another Business Solution from:

**MAG MICRO APPLICATIONS GROUP**  
7300 Caldus Avenue, Van Nuys, CA 91406

COMING SOON:

# PRISM™

**The Complete  
Information  
Management  
System  
For Business**

Another Business Solution From:



**MICRO APPLICATIONS GROUP**  
7300 CALDUS AVENUE  
VAN NUYS, CA 91406

# New Pascal 1M SUPER-MICRO™

Executes Pascal 13x faster than an LSI-11!

The SUPER-MICRO™ series of X-pert Systems™ designed by Computex, combine high performance with low cost. The X9000 system line features the Pascal MICROENGINE™ 16-bit CPU and is now available for delivery.

Trademarks Western Digital Corp

## SYSTEM X9020 (CPU Manual \$19.95)



**\$4195\*** READY TO RUN

### SYSTEM FEATURES (partial list)

- Pascal MICROENGINE™ X9000
- 16 bit P-code CPU
- 64K bytes RAM/Full DMA
- Floppy disk controller (SS or DS)
- Floating point hardware (IEEE standard)
- System software with enhancements
- 2 serial, 2 parallel ports
- Pascal compiler, text editors, file manager, CPU & memory diagnostics, symbolic Pascal debugger, linker, utilities and more

### Floppy Disk Drives (2)

- 1M combined memory
- Double density, single sided
- Standard 8" diskettes
- 6 ms track to track



## SYSTEM X9023

**\$5095\***

PLUS...

### SYSTEM FEATURES (same as above)



**SUPER-MICRO™ System WORD PROCESSOR... is available!**

## MODEL X-920 DISPLAY/EDIT TERMINAL (Manual \$10)

### X-920 FEATURES (partial list)

- Microprocessor controlled
- Serial RS232C and 20 ma current loop
- 10 baud rates—75 to 19,200
- 24 lines x 80 characters
- 12 x 10 character resolution
- Dual intensity display
- Programmable reverse video & underline
- 14 key numeric pad with decimal
- 16 special function keys
- 8 edit function keys
- 2 block transmission keys
- Block, protect & self-test modes
- 80 storable tabbing
- Insert/delete character and line
- Addressable cursor
- A host of other features, including cursor controls and remote commands such as: clear to nulls, spaces, end of line, end of screen; set hl, low, zero intensity; set blink, etc.

\*LIMITED TIME cash price. 10% DOWN guarantees priority. Master Charge & VISA cards accepted.

Prices: X9000 CPU \$2995, Manual \$19.95, X-920 CRT \$995, Manual \$10, Perkin-Elmer "Bantam" CRT \$799, X-800 disk drive \$495. Hardware F.O.B. Chicago. Manuals postpaid.

Custom systems are also available. We service what we sell. Written hardware warranty. Nationwide service contracts. Custom software. We provide expert technical support.

(312) 684-3183

**COMPUTEX**  
Microcomputer Systems  
"The Computer Experts"  
5710 Drexel, Chicago, IL 60637

user memory to the bottom of the address space and their read-only memory to the top.

Gordon R Smith  
632 University St  
Salt Lake City UT 84102

### Barry Watzman Replies

Thank you BYTE for the opportunity to reply to Mr Smith's letter.

In the July 1980 BYTE, I said "the S-100 bus has nothing at all to do with software, and it is obvious that Mr Libes is referring to 'CP/M' systems, and not to S-100 systems." Mr Libes replied that "although CP/M has now been adapted to run on the H-8, there are still many other operating systems, languages, etc that still run only on S-100-based systems." Mr Smith then says that "while it is true that software could not care less about the bus structure of its host processor, the problem is that most of the 8080/Z80 software available in object form requires contiguous user memory starting at location 0."

Both Mr Libes and Mr Smith have attacked not what I actually said, but rather their own (incorrect) interpretations of what I said. I can readily appreciate that both gentlemen assumed that as product line manager for Heath computers I was defending the H-8, but in fact the machines I had in mind were systems such as the Altos, the Onyx, and other non-S-100 systems which will run any software that an S-100-bus system will run. My point was that the bus structure is independent of the software used, which is true. I neither said nor even implied that the memory map of a computer is independent of the software used, yet that is precisely how both Mr Libes and Mr Smith interpreted my remarks.

Having said that, let me go a step further with regard to Heath computers. Many vendors will maintain vociferously that their products are "perfect," even when they know this is not the case. However, there are very few "perfect" products in this world, and a more mature approach is to recognize, admit, and correct a product's shortcomings. The H-8 and H-89 have admittedly suffered to a degree because the presence of ROM (read-only memory) at address 0 has prevented the use of the standard Digital Research Corporation CP/M operating system and much of the available 8080/Z80 software.

My own background prior to coming to Heath had been with CP/M software and S-100 hardware, so I fully appreciate both the restricted software availability for Heath computers (although there is more Heath software available than most non-Heath users would suspect), and the hesitance of a

## HÄNDLER CONCESSIONAIRES DISTRIBUIDORES O.E.M.

AUSGEZEICHNETE GROSS = HANDELSPREISE stellen nur einen Aspekt unseres Händlerprogrammes dar. Treten Sie noch heute mit uns in Verbindung. (Wir sprechen Deutsch)



UN EXCELLENT PRIX DE GROS ne représente qu'un seul aspect de notre programme de distribution internationale. Mettez-vous en contact avec nous aujourd'hui pour recevoir plus de renseignements. (On parle français!)



EL EXCELENTE PRECIO AL MAYOREO que ofrecemos representa sólo un aspecto de nuestro programa de distribución internacional. Póngase en contacto con nosotros para información más detallada. (Se habla español!)

|            |              |
|------------|--------------|
| A.D.D.S.   | IND. MICRO   |
| ANADIX     | OKIDATA      |
| APPLE      | SOROC        |
| CENTRONICS | SUPERBRAIN   |
| CROMEMCO   | TELEVIDEO    |
| HAZELTINE  | TEXAS INSTR. |



## MICRO-COMPUTER BROKERS INTERNATIONAL

6819-P. North 21st Avenue  
Phoenix, Arizona 85015 U.S.A.

Telephone: (602) 242-9961  
Telex: (0) 668382

# DATADISK SYSTEMS

## CP/M\* FOR NORTH STAR SYSTEMS

**CP/M 2.2** — The industry standard "software bus" specially tailored for the North Star disk systems and 8080, 8085, Z80 microcomputers. Fully supports all standard North Star I/O and single, double or quad capacity disk drives. A minimum of 24K of continuous ram memory starting at location zero is required. The following Digital Research (dr) and Datadisk Systems (dd) programs are included on your CP/M diskette: 19150/\$25

**ED (dr)** — Text Editor. Used to write programs in most languages and modify any ASCII data file. Delete, substitute, search on char/string/line number/relative position, block move, global change, macro commands. ED is your window to CP/M compatible software.

**ASM (dr)** — 8080 Assembler. Uses standard 8080 mnemonics and pseudo-ops. Conditional assembly, HEX file generation, assemble listings, multi-disk file transfer.

**PIP (dr)** — Peripheral Interchange Program. File transfer between disks and logical devices. Software file routing, concatenation, pagination, text extraction, case conversion, line numbering and much more.

**SUBMIT (dr)** — Batch ED, PIP, DDT, ASM and associated parameters into user defined processes.

**DDT (dr)** — Dynamic Debugging Tool. 8080 assembly language run-time monitor. Real time between break points, tracing, full internal register display and alteration at any step, single step, disassembly, assembly, the list goes on and on. If you write device controllers, DDT is an invaluable tool.

**STAT (dr)** — Status/allocation of logical-physical devices, disk drive parameters, storage space, file size.

**LOAD (dr)** — Convert 8080 "HEX" files (output of ASM) into machine executable code. Programs are then executed by typing the program name.

**MOVCPM (dr)** — Reconfigure your system to another memory size.

**SYSGEN (dr)** — Create new system diskette.

**DSTAT (dd)** — Multi-purpose Disk Status routine. Logically assign disk drives to operate with any combination of single density, double density, single side, double side, as well as standard or sequential disk sectoring. An optional selection allows fast stepping and optimal sectoring to significantly reduce disk-intensive program execution time. An additional feature permits system re-configuration to quad capacity. This allows double density owners to upgrade with no additional software expense.

**COPY (dd)** — Diskette duplication and verification.

**XSUB (dr)** — Extends the power of SUBMIT to include automatic line input to programs.

**FORMAT (dd)** — Preload diskette for use with CP/M 2.2.

### FOLLOWING SOFTWARE AVAILABLE IN MOST 5.25 AND 8 INCH FORMATS

|                                                                                                                                                       |                  |
|-------------------------------------------------------------------------------------------------------------------------------------------------------|------------------|
| <b>MAC</b> — 8080 Macro assembler. Z80 instruction library included. Symbol table, an array of output options. . . . .                                | <b>\$85/\$15</b> |
| <b>DESPPOOL</b> — Simultaneous file print and user operation. . . . .                                                                                 | <b>\$45/\$5</b>  |
| <b>TEX</b> — Text formatter. Quality hard copy. . . . .                                                                                               | <b>\$70/\$15</b> |
| <b>SIO</b> — Symbolic instruction debugger. Multiple pass points, back track, histogram, source code labels. . . . .                                  | <b>\$85/\$15</b> |
| <b>ZSIO</b> — Same as SIO for the Z80 instruction set. . . . .                                                                                        | <b>\$95/\$15</b> |
| <b>COMPILER SYSTEMS CBASIC-2</b> ver 2.06. Compiler extended disk BASIC. Self documenting, source code protection, line numbers not required. . . . . | <b>\$95/\$15</b> |

California residents add 6% sales tax. Specify single, double or quad capacity. Additional formats available upon request. Structured Systems Group programs require CP/M and CBASIC-2. \*CP/M is a registered trademark of Digital Research. †Software and documentation/documentation only. Copying for non-Standard Systems Inc. Shipping: \$2.00 C.O.D. \$2.00

|                                                                                                                                                                                      |                   |
|--------------------------------------------------------------------------------------------------------------------------------------------------------------------------------------|-------------------|
| <b>MT microSYSTEMS PASCAL/MT</b> — requires 32K minimum memory. Symbolic debugger, BCD or floating point. Optimized for the CP/M environment. Produces compact machine code. . . . . | <b>\$250/\$25</b> |
| <b>STRUCTURED SYSTEMS (requires CBASIC-2)</b>                                                                                                                                        |                   |
| GENERAL LEDGER . . . . .                                                                                                                                                             | \$895/\$25        |
| INVENTORY . . . . .                                                                                                                                                                  | \$795/\$25        |
| ACCOUNTS PAYABLE . . . . .                                                                                                                                                           | \$695/\$25        |
| ACCOUNTS RECEIVABLE . . . . .                                                                                                                                                        | \$695/\$25        |
| PAYROLL . . . . .                                                                                                                                                                    | \$695/\$25        |
| ANALYST . . . . .                                                                                                                                                                    | \$725/\$20        |
| LETTERRIGHT . . . . .                                                                                                                                                                | \$125/\$20        |
| OSORT . . . . .                                                                                                                                                                      | \$95/\$10         |
| NAD . . . . .                                                                                                                                                                        | \$75/\$10         |
| <b>SHUGART HARD DISK</b> 6 mo. warranty, direct connection to North Star. 13.2 MBYTE. . . . .                                                                                        | <b>\$4995</b>     |
| 26.4 MBYTE. . . . .                                                                                                                                                                  | <b>\$4995</b>     |
| <b>LINE PRINTER</b> — multi-font, multi-language, up to 132 cpl. left left, bold face, 120 cps. much more. . . . .                                                                   | <b>\$795</b>      |
| <b>VERBATIM</b> mini disks (lots of 10). . . . .                                                                                                                                     | <b>\$24.95</b>    |

DATADISK SYSTEMS, P.O. BOX 195, POWAY, CA 92064, (714) 578-3831

IN STOCK FOR IMMEDIATE SHIPMENT

# TRS-80\*

**16K MEMORY KITS \$49.95**  
4116's 6 MONTH WARRANTY INSTRUCTIONS INCLUDED

**DISK DRIVES**  
PERCOM TFD-100 \$325  
PERCOM TFD-200 \$595  
CCI-100 \$305  
CCI-200 \$495

2 DRIVE CABLE \$24.95 4 DRIVE CABLE \$34.95

**PRINTERS \$695**  
MICROTEK MT80P BI-DIRECTIONAL  
125 CPS UPPER & LOWER CASE  
1 YEAR WARRANTY  
CABLE — \$24.95

**DISKETTES**  
MEMOREX OR BASF 10/\$26.50  
YOUR SATISFACTION GUARANTEED OR FULL REFUND

**MICROCOMPUTER SERVICES CORPORATION**  
7314 MATTHEWS-MINT HILL RD. CHARLOTTE, NC 28212

\*TRADEMARK TANDY/RADIO SHACK CORP.  
PERCOM TM PERCOM DATA CCI TM CPU IND.

**704-545-0826**

## BECAUSE WE'RE CPAs OUR NEEDS ARE THE SAME AS YOURS:

And because we use our own software in our practice we were able to see the need for an even more efficient program. Now our General Ledger Program is completely interactive with our Master Tax to generate Schedule C!

### Master Tax Package

- Federal 1040 pages 1 and 2
- Schedules A, B, C, D, E, F, G, R/RP, SE, TC, ES
- Forms 2106, 2210, 2441, 3468, 2119, 3903, 4625, 4726, 4797, 4972, 5695, 6521
- Tax Tables A, B, C, D
- Tax Schedules X, Y, Z
- Sales Tax Tables for Schedule A (state of your choice)
- All clients stored on disks for immediate recall
- Computes alternative minimum tax
- Client instruction letter
- Audit trail available on each client
- Tax return printing capability in batch or individual mode
- 1% and 3% medical limitation incorporated
- Automatically checks for FICA over withholding
- Automatically computes earned income credit
- City/State tax automatically carried over to Schedule A
- Depreciation calculation possible for all rates
- Schedule TC automatically generated when appropriate
- Exemptions are computed automatically
- Dividend exclusions and interest are handled automatically based on the type received

### General Ledger II (Write-up and payroll)

- Flexible Report formatting
- Extensive error trapping and editing features
- Program menu sequenced
- History files maintained - transactions may be recalled from previous months
- Repetitive transactions may be automatically duplicated or incremented
- Incorrect entries can be voided
- Up to 400 accounts and 3000 transactions can be used (8" single density disk)
- Payroll interactive with general ledger so that payroll accounts update general ledger accounts
- Financial statements may be printed before closing to facilitate adjusting entries
- Payroll computations "Before" or "After the fact"
- Ability to examine contents of all data files
- Up to 9 Departments may be used
- Amortization schedule
- Depreciation schedule

### Specifications:

- Requires 48 K of memory
- Screen formatting using cursor positioning
- CRT screen of 80 x 24
- Dual Disks
- Written in Microsoft Basic (compiled)\* CP/M

\*CP/M is a trademark of Digital Research



The sale of each proprietary software package conveys a license for use on one system only.



## WHEN IT COMES FROM US, IT WORKS.

Most Northstar Systems are purchased for business and scientific applications where down-time means money.

That's why Scottsdale Systems pre-tests every Northstar BEFORE we sell it. And package it for SAFE delivery to you.

But we don't stop there. Our Northstar Systems, with a SOROC IQ-120 terminal, and either an NEC Spinwriter or a TI 810, include full integration.

When it comes from Scottsdale Systems, it's ready to work for you.



**Northstar**

|                            |        |
|----------------------------|--------|
| Horizon II 32K DD .....    | \$2399 |
| Horizon II 32 K Quad ..... | \$2799 |
| CCS 16K RAM .....          | \$259  |
| SOROC IQ-120 .....         | \$749  |
| TI-810 Basic .....         | \$1589 |
| NEC-5510 w/tractor .....   | \$2799 |
| NEC-5520 w/tractor .....   | \$3099 |

(NEC's include ribbon, thimble)

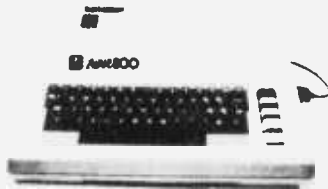

**ATARI**

800 **'798\*** (w/16K RAM) 400 **'449\***

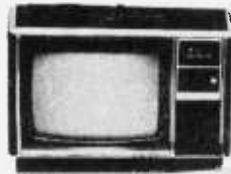

**TI-99/4\***  
w/monitor **'879**  
w/o monitor **'736**



## OCTOBER SPECIALS

|                                   |             |
|-----------------------------------|-------------|
| Dynabyte .....                    | 20% off     |
| Zenith (Heath) Z-89 .....         | 48K! \$2289 |
| Commodore (Pets, CBM's) .....     | 10% off     |
| Mattel Intellivision .....        | \$249       |
| Televideo 912C .....              | \$749       |
| Televideo 920C .....              | \$799       |
| Perkin - Elmer Bantam .....       | \$729       |
| Comprint GP (TRS-80, Apple) ..... | \$489       |
| Comprint S .....                  | \$525       |
| Okidata Microline 80 .....        | \$559       |
| Tractors (w/M80 purchase) .....   | \$100       |
| MPI 88T .....                     | \$659       |

2% cash discount incl./prices subject to change. Product subject to availability. 0-20% fee for returned products. Factory warranties included. Call for add'l products.

## SCOTTSDALE SYSTEMS

6730 E. McDowell Road • Suite 103  
Scottsdale, AZ 85257  
OPEN 6 TO 6 PM • M.-SAT.

**(602) 941-5856**

significant portion of the user community to consider Heath computer systems. One of my goals as product line manager has been to change this. Thus, while Heath will continue to offer, enhance, and fully support its own operating system (HDOS), beginning this fall Heath will also offer and fully support the standard version 2.2 address-zero-based CP/M operating system and a full 64 K-byte all-programmable-memory address space on both the H-8 and the H-89 computers. At the same time, we will also begin offering an 8-inch floppy-disk system (double-sided, double-density, IBM-compatible, and capable of running in an IBM 3740 single-density mode), with the result that Heath systems will become totally software- and media-compatible with most of the other 8080/Z80 computer systems on the market. It is our hope that this will both increase the software available to our current customers (since the new configuration is fully retrofitable), and at the same time encourage those who have previously rejected Heath systems to give us a second look.

### Computers and Telephones: Information Needed

I have been unable to locate a manufacturer or a peripheral device for any readily available personal computer that enables the computer to perform the following telephone-related functions:

1. to answer incoming calls;
2. to receive and decode varying amounts of Touch-Tone (dual-tone, multiple-frequency) data transmitted to the computer over the telephone line;
3. to provide some type of "yay/nay" acknowledgment to the remote caller;
4. to place outgoing calls using Touch-Tone signaling;
5. to initiate other ESS (electronic switching system) custom-calling services.

I would appreciate receiving any information on such a device from any reader of BYTE. Thank you.

Steven Schochet  
POB 14073  
San Francisco CA 94114

### Two Requests for Video Brain Information

I am looking for any information on the programming module, cassette interface, memory expansion module, schematic, or anything to do with the Video Brain computer. Any information

## YOU TOO can become a successful computer ENTREPRENEUR!

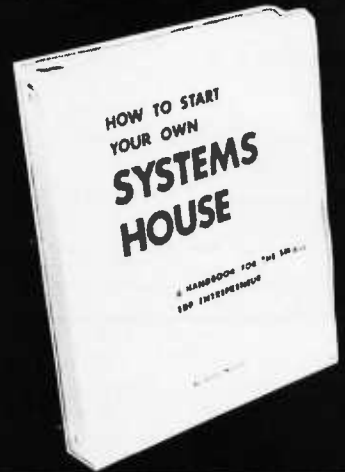

**HOW TO START YOUR OWN SYSTEMS HOUSE** is a practical step-by-step guide for the EDP professional or small businessman who wants to enter the micro-computer systems business.

Written by the founder of a successful systems house, this fact-filled 220-page manual covers virtually all aspects of starting and operating a small systems company. It is abundant with useful, real-life samples: contracts, proposals, agreements and a complete business plan are included in full, and may be used immediately by the reader.

Proven, field-tested solutions to the many problems facing the small systems house are presented.

From the contents:

- New Generation of Systems Houses • The SBC Marketplace • Marketing Strategies • Vertical Markets & IAPs • Competitive Position/Plans of Major Vendors • Market Segment Selection & Evaluation • Selection of Equipment & Manufacturer • Make or Buy Decision • Becoming a Distributor • Getting Your Advertising Dollar's Worth • Your Salesmen: Where to Find Them • Product Pricing • The Selling Cycle • Handling the 12 Most Frequent Objections Raised by Prospects • Financing for the Customer • Leasing • Questions You Will Have to Answer Before the Prospect Buys • Producing the System • Installation, Acceptance, Collection • Documentation • Solutions to the Service Problem • Protecting Your Product • Should You Start Now? • How to Write a Good Business Plan • Raising Capital

6th edition, March 1980 220 pages

**Essex Publishing Co. DEPT. 3**  
285 Bloomfield Avenue Caldwell, N.J. 07006

I would like to order **HOW TO START YOUR OWN SYSTEMS HOUSE** at \$36.00 (New Jersey residents add 5% sales tax)

Check Enclosed  VISA  Mastercharge

Name \_\_\_\_\_

Address \_\_\_\_\_

City \_\_\_\_\_

State \_\_\_\_\_ Zip \_\_\_\_\_

Card # \_\_\_\_\_ exp. \_\_\_\_\_

For immediate shipment on credit card orders call (201) 783-6940

IS THERE A **GAP** IN YOUR LIFE ?

**GAP** General Accounting Package. Fantastic double entry accounting system with user definable accounts. The account numbers are made up of 7 4-digit fields allowing 7 levels of account classifications. With the use of the Operator Report Selector Generator (OSRG), you can generate any type of report you desire, or use report programs in GAP-GL, GAP-AP, and GAP-AR.

**GAP-GL** Includes all basic GAP functions, plus entry of General Ledger transactions, prints General Journal, General Ledger summary and detail, Balance Sheet, Profit and Loss.

Price \$124.95

**GAP-AR** Requires GAP-GL to run, allows adding A/R invoices, printing Sales Journal, detail A/R report, Account Aging, add/update Cash Receipts with register, Cash Receipts Journal, and A/R Billing.

Price \$99.95

**GAP-AP** Requires GAP-GL to run, allows adding of A/P invoices, printing Purchase Journal, detail A/P report, Aging of Accounts, Check Writing, Check Printing, Cash Disbursements Journal.

Price \$99.95

System requirements are 32K CP/M CP/M is registered trademark of Digital Research

**PROFESSIONAL DATA SYSTEMS**



318 E 18 st.  
BAKERSFIELD CA. 93305  
(805) 323-0891

**THE ESSENCE**  
of output quality

- Any IBM SELECTRIC® can be converted to produce high quality output at an affordable price!
- Interfaces directly to S100, Parallel, RS-232 or IEEE-488.
- Compatible with TRS-80, Sorcerer, Pet, Apple, Horizon, etc.
- Why be printer bound? Prices from \$496 to \$675.

Call today.



Backspace and Tab Available NOW!



Escon Products, Inc.  
171 Mayhew Way, Suite 204  
Pleasant Hill, Ca., 94523  
(415) 935-4590

**Getting the Jump Means Winning the Race**

Technical Career Open House is a unique presentation of many productive companies seeking to hire productive professionals in technical job categories. These companies are seeking top-notch engineers, technicians, marketing specialists, computer professionals, and a wide variety of technical support personnel, in the following disciplines:

Biologists, Chemists, Designers, Programmers, Systems Analysts, WP and DP Managers, Customer Trainers, Interface designers, project leaders, researchers; Engineers: Multi-Industry; Automation, Quality Control, Civil, Industrial, Electronic, Power, Nuclear, Energy Control, Instrumentation.

Technical Career Open House is the one place in New York where you can talk to companies both large and small from all parts of the country in just a few short hours. Here are just a few of the many companies waiting to talk to you: Pfizer, SDA, Inc., Blue Cross/Blue Shield, Pitney Bowes, Digital Equipment Corp., Automated Concepts, GTE Systems, Racal-Milgo, Nutech, Chase Manhattan Bank, TRW, Knauer Computer, Eastman Kodak, Power Authority of N.Y.S., Ebasco Services.

Registration for TCOH is free of charge and anonymous if you requested. (Your TCOH badge need only display your job title.) Write or call for registration forms.

**TECHNICAL CAREER OPEN HOUSE/New York**

TCOH HOURS:  
OCT. 29, 31—3 PM to 8 PM

**New York Coliseum Oct. 29 - Nov. 1, 1980**  
110 Charlotte Place, Englewood Cliffs, NJ 07632 / (201) 569-8542

TCOH HOURS:  
NOV. 1—9 AM to 4 PM

# BKG 10.

The improved version of BKG 9.8, the backgammon playing program that defeated the world backgammon champion by a score of 7-1 at Monte Carlo in July, 1979.

**BKG 10.** developed utilizing the expertise of Paul Magriel, former world backgammon champion and author of Backgammon, has emerged as one of the best pieces of artificial intelligence software available on microcomputer.



**BKG 10. features:**

- Version I utilizes direct cursor control for professional display of board, disc, cube, etc.
- Version II adds printer/disc IO of game in progress, enables board set-up at non-standard points and simulation capabilities.
- BKG 10. incorporates advanced SNAC functions (Smooth & Nonlinear Application Coefficients) as described in *Scientific American* June 1980.
- Plays by ABPA Tournament Rules, including doubling, match play and optionally the Crawford Rule. BKG 10. VI will play either side. VII enables machine — machine play for simulation applications.
- BKG 10. responds quickly, making most moves in under 15 seconds (2 MHz), or 7 seconds (4MHz).
- BKG 10. was written entirely in Z-80 Assembler.

**BKG 10.** has the additional capability of suggesting moves and doubling decisions.

• **SYSTEM REQUIREMENTS** •

Z 80 Processor 32K 1PA, CP/M or compatible operating system, cursor addressable video terminal & 8" floppy drive. VII requires printer and additional drive.

**BKG 10. \$79.00 VI \$129.00 VII**

single license fee

PRICE INCLUDES:

Two non-copiable diskettes  
and a complete 30 page manual  
Software Update subscription available  
INTELLIGENCE SYSTEMS LTD., 1245 DELAWARE STREET  
INDIANAPOLIS, IN. 46204 (317) 631-5514

For Mastercard, VISA, or C.O.D. orders only

**Call Now: 800-824-7888** TOLL FREE

Alaska/Hawaii 800-824-7919  
Ask for Operator 105

# BKG 10.

that BYTE readers could send me about where I might find these items would be very helpful. Thanks for your cooperation.

**Brent Dix**  
774 South 1110 W  
Cedar City UT 84720

Since the Video Brain Computer Company went out of business and you can now readily pick up this computer (which has a color display) for around \$88 (from COMB Liquidators in Minneapolis, Minnesota), I would like to suggest that BYTE and BYTE readers develop a few "how to" articles on modifying this computer. Some of these articles could include:

- adding a full-sized keyboard to the Video Brain computer;
- adding language capabilities;
- expanding the programmable and read-only memories in the computer;
- hooking up a cassette tape recorder to store programs.

I know there are certain limitations in the F8 design, but I think the price of the system and the interest to experimenters and other readers would make it an enjoyable and worthwhile project. And if all the above ideas were possible, you could have a pretty good system at a very cheap price. I hope you will consider these suggestions.

**Paul Bazylewicz**  
843 Loomis St  
Jackson MI 49202

*Any readers with information on the Video Brain system or its components are encouraged to write to the above readers. In addition, we at BYTE would be interested in seeing any articles on the Video Brain—either full-length articles or shorter articles that could be placed in our new upcoming column, "System Notes." . . .GW*



## A Financial Problem

In my article "A Financial Analysis Program" (February 1980 BYTE, page 192) several errors appeared in the glossary which, unfortunately, I did not receive with my proofs. On page 198, under the heading Accounts Receivable in Days, both occurrences of *divided by* should have read *divided into*. This correction should also be made for the

# IMAGINE.

A computer game that has drawn the attention of the national news media.

A computer game that has people around the world clamoring for it.

A computer game that turns your love life into a *ménage à trois*... you, your mate, and your computer!

That's Interlude—the hottest new software program for personal computers.

But it's more than just a game. It's an experience that will tantalize you...romanticize you...fantasize you...and often surprise you.

Interlude begins with a unique computer interview of the participants to determine their mood. Then it searches its memory to select the best Interlude for the occasion. You may be referred to the instruction manual which describes most of the 106 Interludes, or your instructions may appear on your screen if you've chanced to hit upon one of the many surprise Interludes buried within the program. (When you discover secret Interlude #99, your love life may never be the same again!)

Interlude...it's fun...it's fanciful... it's fantastic. It's the computer game for adults. Are you ready for it?

# Interlude™

## The Ultimate Experience.

INTERLUDE Dept. B-10 10428 Westpark, Houston, TX 77042. Rush me my copy of Interlude.

Name \_\_\_\_\_ Age \_\_\_\_\_

Address \_\_\_\_\_

City \_\_\_\_\_ State \_\_\_\_\_ Zip \_\_\_\_\_

Apple II\* (16K)  TRS-80\*\* (Level II-16K)  \$14.95 for cassette  \$17.95 for diskette. Add \$1.50 for shipping. Texas residents add 6% sales tax.

My check (payable to Interlude) is enclosed. Charge my  Mastercard  Visa

Account No. \_\_\_\_\_

Expiration Date \_\_\_\_\_

MasterCharge Bank Code \_\_\_\_\_

Signature \_\_\_\_\_

(Charge customers must sign.)

**CHARGE CUSTOMERS:** Order by phone toll-free! 1-800-231-5768 Ext. 306 (TX: 1-800-392-2348 Ext. 306)

\*Registered trademark of Apple Computers, Inc.  
\*\*Registered trademark of Radio Shack, a Tandy Co.

**AVAILABLE FOR IMMEDIATE DELIVERY.**



If you are developing commercial software for a CP/M system, you need a keyed file accessing package to create efficient, on-line, interactive systems.

**Only MICRO B+™ offers all these advantages:**

- **Guaranteed optimal file accessing performance!**
- **Key access to data files with over 10,000 entries in under one second...on floppy disk systems!**
- **No reorganization of index and data files!**

Before you order the most important component of your software development tool kit, compare. MICRO B+™ is unmatched by any other product available anywhere.

Assembly Language Version...\$260.00  
Specify MICROSOFT "REL" Files or CBASIC Compatible

BASIC Source Code Version...\$195.00  
Specify MICROSOFT Basic-5 or CBASIC-2

Shipping \$2.USA/\$5 Foreign

**FAIR COM**

2606 JOHNSON DRIVE  
COLUMBIA, MO 65201  
(314) 445-3304

We accept VISA and MASTERCARD

# The 2nd Generation... It's all that it's Cracked up to be.

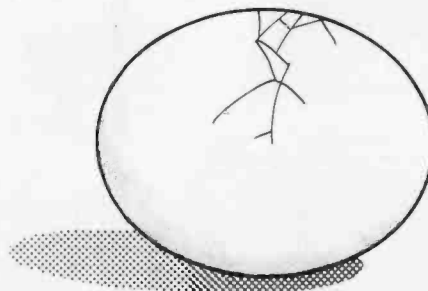

MEASUREMENT  
systems & controls  
incorporated

To further improve service to our customers we have installed a toll-free WATS line in our Peterborough, New Hampshire office.

**BYTE's  
Toll-free  
Subscriber  
W.A.T.S. Line**

If you would like to order a subscription to BYTE, or if you have a question related to a BYTE subscription, you are invited to call\*

(800)258-5485

between 8:00 AM and 4:30 PM Eastern Time.  
(Friday 8 AM - Noon).

\*Calls from continental U.S. only.

**(800) 258-5485**

We thank you and look forward to serving you.

9178

## Payroll General Ledger Accounts Payable Accounts Receivable

Flexible and sophisticated business software that is of the highest quality. Originally developed by Osborne & Associates and rapidly becoming a standard. Accountants are pleased with our balance sheets and income statements. It has been tested and approved by secretaries.

- Complete instructions
- Up and running the same day of delivery.
- 100% guaranteed
- Unlimited free telephone assistance.
- Return within 30 days for complete refund if not satisfied.
- No licensing agreement - use as you want.

|                                  |          |
|----------------------------------|----------|
| Accounts Receivable .....        | \$145.00 |
| Accounts Payable .....           | \$145.00 |
| Payroll-California .....         | \$145.00 |
| Payroll-Non California state     |          |
| Income tax calculations          |          |
| (add to California payroll) .... | \$125.00 |
| General Ledger .....             | \$145.00 |
| Multiple profit center option    |          |
| for general ledger .....         | \$ 50.00 |
| Manuals (each) .....             | \$ 20.00 |

Formats: Any 8" single or double density, TRS-80 Mod II, Northstar DD, Vector Graphics, Super Brain, many others.

Runs on Beehive, Soroc, Hazeltine, ADDS, Televideo, SOL, TRS-80 Mod II, HEATH, ACT V, Interube II, Altos, ADM and many other terminals. All programs in CBASIC under CP/M (includes source).

Synergetic Computer Products

575 Middlefield Avenue Suite J, Palo Alto, CA 94301  
(415) 328-5391

VISA • Master Charge • CDD • Company Check

TRS-80 is a trademark of Radio Shack, Inc. CP/M is a trademark of Digital Research

**UNBEATABLE...**



**APPLE II OR  
APPLE II PLUS**



**Shipped direct to you!**  
**\$899<sup>00</sup>**  
(Plus Shipping)

We have orchard fresh Apple products ready to ship. Immediate delivery. Send certified or cashiers check for quick shipment. Orders with personal checks shipped after bank clearance.

- 16K UNITS..... \$899
- 32K UNITS..... \$999
- 48K UNITS..... \$1099
- Apple Disk Drive \$550
- Pascal Language Card \$450

Above plus \$20 shipping charge. IMPORTANT—No shipments made within the state of Illinois.

**MIGHTY MICROS  
P.O. BOX 11375  
CHICAGO, IL 60611**

**ORDER FORM**

Enclosed \$ \_\_\_\_\_

For \_\_\_\_\_ Via U.P.S.

Ship to: \_\_\_\_\_

Name \_\_\_\_\_

Address \_\_\_\_\_  
(No P.O. Boxes—Street Address Only)

City \_\_\_\_\_

State \_\_\_\_\_ Zip \_\_\_\_\_

definition of *inventory turnover* on page 200.

Also, I had not realized that some of the following abbreviations would be incomprehensible to nonaccountants:

| Abbreviation | Meaning                                      |
|--------------|----------------------------------------------|
| CGS          | cost of goods sold                           |
| SGA          | salaries and general administrative expenses |
| PPD items    | pre-paid items                               |
| Bldg/Equ     | buildings and equipment                      |
| Cur LT       | current portion of long-term liabilities     |
| C-Stk        | common stock                                 |
| APIC         | additional paid-in capital                   |
| RE           | retained earnings                            |
| TOT CR       | total credits                                |

I have received many requests for information on converting the program to run on other systems. Perhaps readers who have adapted this concept to their own machines would like to share their versions by sending a note to BYTE.

John A Lehman  
716 Hutchins #2  
Ann Arbor MI 48103

**BYTE's Bugs**

**An Omission in "Varieties of Threaded Code"**

A paragraph was inadvertently omitted from the first page of "Varieties of Threaded Code for Language Implementation," by Terry Ritter and Gregory Walker (September 1980 BYTE, page 206). The following should be inserted between the first and second full paragraphs on the right-hand column, just before the paragraph that begins, "Any form of interpretation...":

*The run-time overhead of any interpretation technique depends on the relative complexity of the machine-language routines actually invoked. If the functions performed in machine language are similar in complexity to that of a single machine instruction, then the overhead of even a hardware subroutine call and return operation will be quite high. On the other hand, if the machine-language routines are made complex, the overhead of even slow interpretation can be made insignificant.*

This paragraph explains a pivotal point in the article. We apologize for the omission. ■

**Back,  
by popular  
demand.**

Just a few years ago, illegal hunting and encroaching civilization had all but destroyed the alligator population in the south. They were added to the official list of endangered species in the United States.

Now alligators have made a comeback.

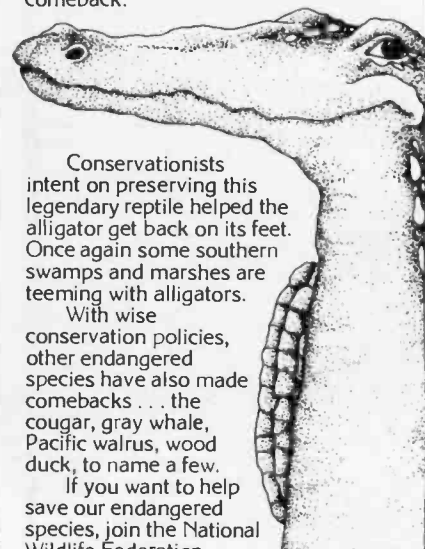

Conservationists intent on preserving this legendary reptile helped the alligator get back on its feet. Once again some southern swamps and marshes are teeming with alligators.

With wise conservation policies, other endangered species have also made comebacks... the cougar, gray whale, Pacific walrus, wood duck, to name a few.

If you want to help save our endangered species, join the National Wildlife Federation, Department 106, 1412 16th Street, NW, Washington, DC 20036.



# Time is precious Why lose it?

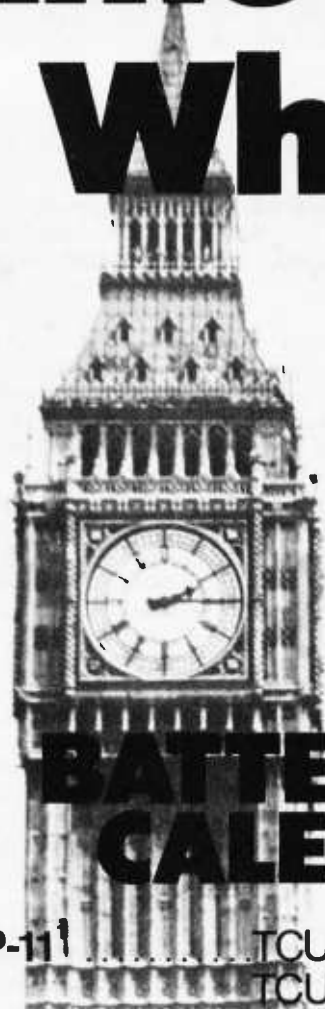

## BATTERY SUPPORTED CALENDAR CLOCKS

|                         |                  |
|-------------------------|------------------|
| PDP-11 <sup>1</sup>     | TCU-100 • \$495  |
|                         | TCU-150 • \$460  |
| LSI-11/2 <sup>1</sup>   | TCU-50D • \$325  |
| Multi-Bus <sup>2</sup>  | TCU-410 • \$325  |
| EXORcisor <sup>3</sup>  | TCU-68 • \$325   |
| HP 2100                 | TCU-2100 • \$395 |
| Lockheed SUE            | TCU-200 • \$550  |
| Naked Mini <sup>4</sup> | TCU-310 • \$385  |



**Serial Line Clock . . . SLC-1 • \$640**  
(RS 232 or 20mA) Microprocessor controlled.  
Auto message intercept and response.  
10 Digit display option \$190.

If automatic and accurate date and time entry is important to your system on power-up — you need a Digital Pathways battery supported calendar clock. All Digital Pathways' TCUs have on board NICAD batteries to maintain date and time during power down (typically up to

three months). Timing is provided by a crystal controlled oscillator. Prices are U.S. domestic single piece. Quantity discounts available.

For more information on these timely products, contact:

Digital Pathways Inc.  
4151 Middlefield Road  
Palo Alto, CA 94306  
Phone: (415) 493-5544

<sup>1</sup> Trademark of Digital Equipment Corp.

<sup>2</sup> Trademark of Intel Corp.

<sup>3</sup> Trademark of Motorola Inc.

<sup>4</sup> Trademark of Computer Automation Inc.



# DIGITAL PATHWAYS

# Ask BYTE

Conducted by Steve Ciarcia

## Terminal Expense

Dear Steve,

Why can't I buy a simple video terminal for less than \$700, when a portable black and white television receiver (including radio- and audio-frequency electronics) costs as little as \$70 and a complete microcomputer system (including video display and keyboard) costs around \$600? I own a KIM-1 and don't use it as much as I would like to because the keypad and LED (light-emitting diode) display are inconvenient. It seems to me that, considering the simplicity and availability of the component parts required for a no-frills "glass Teletype," the price should

be between \$150 and \$200.  
Rob Fullerton

*A high-grade video terminal and a television set are different animals. The terminal has a much wider bandwidth and usually better component tolerances. Granted, this may make it worth \$200 (instead of \$100 for a television), but look at what else you are getting: case, power supply, fan, printed-circuit board with electronics, gold-plated connectors, Hall-effect or reed-switch keyboard, nonglare bezel, etc. These things add up. The reason why the KIM-1 is so inexpensive is that it is just a printed-circuit board with components on it. Most likely*

*the printed-circuit board in a video terminal is as complex as the KIM-1 and worth about the same if sold separately.*

*When a manufacturer produces a television set, he can be satisfied with a 5% or 10% return on investment because he will probably make over a million of each model. An American video-terminal manufacturer runs up for a production run of perhaps 10,000, if he is lucky (there have been a few 100,000 sellers). The effort involved is about the same as designing a television, but all the costs are amortized over 10,000 rather than 1,000,000 units. To stay in business, terminal manufacturers must have a much higher profit margin, and the overall price is therefore higher.*

*As the demand for video terminals grows, you will see the television manufacturers attempt to meet the market needs. With the added volume and competition, I think you can expect to see a \$300 video terminal within a year or two. In the meantime, all you can do is look for a good used terminal for about \$300.*  
Steve

or can you design a hardware keyboard-debounce circuit that can be installed?

I looked at the keyboard data on my oscilloscope. The bounce occurs when the key is released. I tried simple tricks with no luck. I have thought of flip-flops and various timing circuits, but I'm afraid to try them. My technical experience isn't in design. Also, the +5 V series voltage-regulator transistor in the power supply runs hot. I fear that it is being worked to capacity, and I don't want to damage the computer.  
James L Siewert

*Contact bounce is an aggravating situation when it occurs, and not only the TRS-80 suffers from it. Most keyboards with unsealed contacts are susceptible, and the remedies are sometimes no better than the problem.*

*In the case of the TRS-80, it is due to tarnish and oxidation on the key contacts. When you press the key down, you lower an insulator that is situated between the contacts. The contacts then touch together and close the circuit (the process is reversed when the key is released). However, if the contacts are dirty it takes longer for them to make satisfactory contact.*

*This extended time is called bounce because on a scope it appears as if the contacts are opening and closing rapidly or "bouncing." In circuits where there is a high current flowing through the contacts, most of this oxidation would be burned away (or if the contacts were gold they would not tarnish).*

*One solution is to wait longer for the contact bounce to settle. This is accomplished in the older versions of the TRS-80 by loading in the keyboard-fix*

## FOR SERIOUS USERS OF 8080, 8085, OR Z80 COMPUTERS

**PRINTER WIZARD** — Now add powerful capabilities to your printer. Free your computer for use while simultaneously printing backlogged output on a first-in-first-out basis. Transparent operation without noticeable slowing of the computer. Allows continuous computer and printer operation on programs having sporadic output. Will backlog up to 100 pages when used with a disk system. Adds optional automatic paging with numbers, adjustable margins on 4 sides, indented overflow lines. Occupies less than 2½ K.

|                    |           |         |
|--------------------|-----------|---------|
| Documentation only | EX80M103  | \$45.00 |
|                    | EX80M103D | \$ 7.50 |

**DISASSEMBLER** — Disassemble machine code into standard source language. Modify or relocate existing programs such as DOS or BASIC using your existing assembler (not included). Disassembles any 8080, 8085, or Z80 code, including embedded data blocks and "trick" codes. Generates symbol and label tables.

|                    |           |         |
|--------------------|-----------|---------|
| Documentation only | EX80M217  | \$75.00 |
|                    | EX80M217D | \$12.50 |

ALL EXCOM products are fully supported and warranted indefinitely against original defects. Available on single or double density NORTHSTAR 5¼" diskettes, 300 or 1200 baud cassettes (specify). Washington residents add 5.3% tax.

# EXCOM

P.O. Box 1802 Bellevue, Washington 98009 U.S.A.  
Telephone (206) 641-6577

## Radio Shack Bounce

Dear Steve,

No doubt you have heard many cries from frustrated TRS-80 users about keyboard bounce! I took basic programming at a Keene, New Hampshire, high school. There, I heard my complaint multiplied by 15. Our instructor, Charles Tousley, has the software keyboard fix sold by Radio Shack. I don't have to tell you about the complications involved with that and 15 students! Do you know of,

program you mentioned. Entering this tape every time you power up is tedious, and on the first humid day when the contact resistance changes everything goes haywire once again. Rather than only using your TRS-80 in a clean room at NASA, it's easier to attack the problem at the source.

If you have an older version TRS-80 (prints "MEMORY SIZE?" when powered up), you can clean the contacts. Remove the top of the keys one at a time and depress the spring. Using a very light-abrasive paper with a few drops of alcohol on it, run it up and down between the closed contacts a couple times. Repeat it for any keys that continue to bounce.

In the newer TRS-80s (prints "MEM SIZE?" when powered up), there is a patched keyboard routine with a debounce value located at 011C in hexadecimal. Change this byte to increase the delay.

Finally, most experimenters don't appreciate the fact that commercial components very often run hot. Most integrated circuits have a 0°C to 70°C operating range. Transistors usually have an even broader range that may have an upper limit of 125°C to 150°C. The question then is not whether it is hot, but how hot? Series regulators generally run hot because that is the nature of the beast. Switching regulators, such as used on the Apple II, dissipate very little power, but they cost considerably more to manufacture. If the heat still bothers you, add a larger heatsink. Personally, I'd try a little forced air cooling (a fan) first. It's not as messy.

Steve

### Radio Shack Memory Upgrade

Dear Steve,

I recently subscribed to BYTE, and my first copy was the June 1980 issue. I enjoyed reading your fine article on page 40, "I/O Expansion for the TRS-80, Part

2: Serial Ports." I found the article very informative. I am a "new kid in town" when it comes to electronics and all the various equipment available for microcomputers. I have a Radio Shack TRS-80, Level I, with 4 K bytes of memory, and I am just getting used to it. I'm really crazy about computers and plan to become deeply involved with them as a hobby at home.

The reason I am writing is because I am wondering if you could provide me with a reprint of Part 1 of your article which appeared in the May 1980 BYTE, page 22, which dealt with parallel ports. I will be glad to pay you for it if necessary. I am sure the article will be useful to me in the future.

I would like to expand the memory in my TRS-80 to 16 K bytes and would naturally like to do it as cheaply as possible. I have seen all the various advertisements regarding add-on memory for TRS-80s with prices ranging from \$55 to \$80, for expansion kits consisting of "4116-200 ns (8 pcs)." The advertisements say no special skills or tools are required, and if a person can change spark plugs in a car then they can add the memory kit to their system. As I said, I am a novice to any type of electronics and have no idea what "4116-200 ns (8 pcs)" means. I assume "ns" is nanoseconds.

Could you please advise me about these expansion kits? Will my TRS-80 still function the same, are the kits really easy to install, or will I be risking permanent damage to my system? I would greatly appreciate your comments and help.

Michael H Bunt

*There is nothing better than the real thing. If you refer to page 229 of the June 1980 BYTE, you will see that it is easy to obtain the May BYTE (and other back issues) in its entirety.*

*Concerning 16 K-byte memory add-ons for the TRS-80, it isn't too much of a problem to upgrade your system, but it is not as sim-*

## TEXAS COMPUTER SYSTEMS Radio Shack

Authorized Sales Center, OFFERS  
LOWEST PRICES on

# TRS-80 COMPUTERS

Model II 64K  
\$3349

Ask about the discounts/availability of the new Model III, Pocket Computer, Videotex, and other items, and our current price list.

Model I 16K  
Level II \$680

LIMITED TIME ONLY. Model II 64K \$3349. Model I 16K Level II w/keyboard \$680. Model I 4K Level II \$545. Model I 4K Level I \$425. Expansion Interface no memory \$250. We strive to offer the lowest possible price to you. Programs 12% off list. CALL US.

NEW single/DOUBLE DENSITY Modification for the Model I. Using our 40 track anti-crunch disk drives and this kit, 400K is available on the 2-drive system! Max/copy single and DOUBLE DENSITY at the same time for complete compatibility. Can use Flippy disks for greater savings. By Percom \$209. Disk Drives \$349 each. SAVE \$70. Our 16K Memory kit \$79. each with instructions.

Expand your Level I 4K to Level II 16K (when converting to disks) for as low as \$129. CALL FOR DETAILS. FOR 8" CP/M systems—Osborne General Ledger \$49. with multiple profit centers \$99. A/R/A/P \$49. Payroll \$49. All three for \$100. Three w/ multiple profit G/L \$150. Support limited to copies and published errata information. Configured for Soroc and similar terminals. Manuals \$20 each.

- \* No taxes on out-of-state shipments. Texas res. Add 5%
- \* All merchandise is new, checked and guaranteed by manufacturer
- \* Payment: Money Order, Cashier's Check, Certified Check. Personal Checks require 3 weeks to clear. VISA, MASTERCARD—Add 3%
- \* Prices subject to change at any time
- \* Delivery of merchandise is subject to availability
- \* UPS prepaid insured delivery: \$1-\$100. \$5; \$101-\$500. \$7; \$501 up. 1.5% of order. Model II must be shipped by truck. Rate Exception: furniture and some large items.
- \* Texas Residents 915-597-0673

TCS, 106 East 10th, Brady, TX 76825. 800-351-1473

An Authorized RADIO SHACK® Sales Center 22-F-701

## THE PASCAL DATABASE written in UCSD PASCAL™

Software ahead of its time  
available now for the APPLE™ COMPUTER

Create a library of information at your fingertips

Full database power. Unlimited applications for such diverse data as: mailing lists, personal and business accounting, inventory, job estimates, sales analyses and property management.

THE PASCAL DATABASE is easy to use.

Menu driven. Clear screen instructions enable even the inexperienced user to operate THE PASCAL DATABASE.

THE PASCAL DATABASE has advanced features:

- On-line interaction. Update, search and traverse database files... sort on multiple fields... maintain records in several sorted orders.
- Screen formatting...you design the layout of your files.
- Immediate and automatic indexing of information at data entry.
- User definable data description gives you ultimate flexibility... you define file, record and field names
- Generates custom, easy to read reports. Easy storage and retrieval in report library.
- Password protection for individual files
- Up to 1024 bytes per record.

Soon available on 8" IBM 3740 floppies and other UCSD Pascal systems. Source license available. Dealer inquiries invited.

- THE PASCAL DATABASE Special introductory price \$400.00 Shipped on floppy disks. Includes complete documentation and sample datafiles. Arizona residents please add 5% sales tax.
- Manual only \$25.00 Master Charge Bank Americard Check or Money Order (Refundable with system purchase within 90 days)



ARIZONA COMPUTER  
SYSTEMS, INC.

P.O. Box 125 Jerome, Arizona 86331  
(602)-634-7301 9am - 4 pm Mon.-Fri.

™ Apple is a registered trademark of Apple Computer, Inc.

™ UCSD PASCAL is a trademark of the Regents of the University of California

If you're serious about the stock market, you need

# Tickertec™



Watch 48 to 400 of your favorite stocks without a 15 minute delay.

Tickertec™ is a computer program that displays the NYSE or AMEX tickertape on your TRS-80™ Model I or both exchanges as an option on the Model II. You see every trade as it is reported by the exchange and track the last ten trades, tickertape reported volume, and high and low limits on the stocks you are watching. Tickertec prices start at \$1,000.00 with many optional features available including hard copy and portfolio management systems. Programs may be purchased for cash (i.e., hard dollars) or payment can be arranged in the form of discounted brokerage commissions (i.e., Soft Dollar Software™). Exchange fees are extra. Call for FREE brochure TOLL-FREE at (800) 223-6642; in New York call (212) 687-0705; or mail the coupon today.

**Max Ule & Company Inc.** BY1  
6 East 43rd Street, N.Y., N.Y. 10017

Name \_\_\_\_\_  
Address \_\_\_\_\_  
City \_\_\_\_\_ State \_\_\_\_\_ Zip \_\_\_\_\_  
Bus. Phone \_\_\_\_\_  
Pers. Computer?  Y  N Model \_\_\_\_\_  
©1980. Max Ule & Company Inc

## THE BEST OF BOTH WORLDS NORTH STAR BASIC — CP/M

The Fabulous North Star Basic Meets  
The Industry Standard CP/M Operating System

Not all perfect marriages are made in heaven; this one was made in SoHo! The software professionals at the SoHo group present The MATCHMAKER, an easy-to-use conversion kit which enables North Star owners who also own the CP/M operating system to gain the full power of their North Star Basic, running under CP/M.

You'll have dynamic file allocation, automatic file creation and extension, and automatic reuse of deleted files, all under the control of the powerful instruction set of the outstanding North Star Basic interpreter with its byte-access or random files, multiline functions, and extensive library of software. 32K memory is all you need. No relocation or modification of Basic is necessary. And all your existing North Star programs will run without modification!

The installation takes about 30 minutes and involves no disassembly or machine coding. Every powerful feature of both systems is maintained with this professional piece of software. And the instructions are COMPLETE and easy to follow.

**The SoHo Group**  
140 Thompson St.  
Suite 4-B  
New York, NY 10012

**The MATCHMAKER**  
\$89.95 ppd.  
Manual only, \$9.95  
applicable  
against purchase

NY residents include sales tax  
Note: CP/M and North Star are registered trademarks of Digital Research and North Star computers, respectively.

ple as pulling eight 4 K-byte integrated circuits and replacing them with 16 K-byte 4116s. Hardside (6 South St, Milford NH 03055) sells an upgrade kit that includes eight 200 ns 4116s and two DIP shunts. The following is an excerpt from their kit installation instructions:

"Locate Z13 through Z20 on the logic board.... These are the 4 K [programmable memory] chips which you will remove and then replace with the 16 K [memory] chips in your upgrade kit.... Remove the 4 K [memory] chips by gently and gradually prying them loose.... Now, install the 16 K [memory] chips.... Locate the sockets for Z3 and Z71 on the logic board. On "A" Revision boards, note that Z3 is blank. Remove any jumper circuits (DIP shunts) at Z3 and Z71. The numbers Z3 and Z71 should be silk-screened next to the corresponding components on the logic board. Install the DIP shunts which are supplied.... Reassemble the case, place the logic board and the keyboard on the posts of the lower half of the case, with the keyboard face up so that the posts stick through the holes in the logic board and the keyboard rests on these posts. Carefully lift the keyboard about one inch above the posts upon which it rests. FLEX THE CONNECTING RIBBON CABLE AS LITTLE AS POSSIBLE. Replace the spacers on the posts and let the keyboard rest back on the posts.... Turn the computer on. The screen should display 'READY'. Type 'PRINT MEM' and hit 'ENTER'. Your 16 K-byte computer will display '15871' or '15872'."

As you can see, adding

the memory is not a great problem and it will not damage your system.

Steve

### COMM-80

Dear Steve,

I read with great interest your article "I/O Expansion for the TRS-80, Part 2: Serial Ports" (June 1980 BYTE, page 42). However, I have a few questions before I can decide whether or not the COMM-80 is the answer to my problems.

I own a Radio Shack TRS-80, Level II, with 16 K bytes of programmable memory. I want to eventually expand it to include 32 K bytes, a parallel printer, a telephone modem, and an 8-inch floppy-disk system. Since the Radio Shack floppy-disk system is only a 5-inch disk, I knew I'd eventually need to use equipment from another manufacturer.

Could you please tell me if it is possible to use a disk system with the COMM-80? Would that use the RS-232 port? Could I use both the extra 16 K bytes of memory and a disk system at the same time?

Richard L Jamison

The COMM-80 is a serial and parallel port. It can be used with any hardware that will plug into a TRS-80, but it has nothing logically to do with a disk system. However, if you purchase a stand-alone disk controller or memory-expansion module, they would be TRS-BUS driven and could be plugged into the expansion bus connector of the COMM-80.

It is also my understanding that most disk operating systems for the TRS-80 require a 32 K-byte system to run effectively. The question should be whether you can live without the extra 16 K bytes.

Steve

Dear Steve,

My colleagues and I who have worked in computer-controlled laboratories over

the years are intrigued with teaching and research possibilities with modern microcomputers. The Radio Shack TRS-80 is in some senses a bargain, but as you rightly point out, the I/O (input/output) problem is serious. Your May and June 1980 articles in BYTE are suggestive, but questions remain:

- How can the COMM-80 plug into the J2 connector on the Expansion Interface since J2 is the place in the Expansion Interface where it connects itself to the TRS-80? (You must mean the J3 40-pin bus-extension edge connector.)
- How can COMM-80 be used with TRS-80 Expansion Interface? How are sixteen units connected to one another, and to the TRS-80? Your photo 1 shows only 3 connections: one to TRS-80 keyboard, one for serial printer (RS-232), and one for parallel printer interface.

If sixteen units are indeed all "chainable" to the Expansion Interface and one has a 16-unit bus-extension capacity, we would appreciate literature and specs.

J P Rosenfeld PhD

*Sorry about that, but you are correct. The signals on J2 and J3 are the same, but the COMM-80 attaches to J3 when using an Expansion Interface. This is also called the screen-printer port in some of Radio Shack's literature.*

*The COMM-80 is a bus-driven device and can be connected either to the keyboard connector or to J3 as I mentioned. The COMM-80 contains a parallel (Centronics-compatible) and a serial (RS-232C) port. Internally, it has a 4-bit address-selection switch. If you keep the address setting as shipped, the COMM-80 will perform as if it were the serial TRS-232 board installed within the Expansion Interface. However, if you already*

*have a TRS-232 board and want to just add another printer to the system or drive a serial printer in addition to the modem, you would set the COMM-80 to one of the other sixteen addresses. Whether you use two or four COMM-80s, as long as they have different switch settings, they are independent I/O (input/output) channels to the computer.*

*With a 4-bit address code, up to 16 COMM-80s (or 15 and a TRS-232 board) can conceivably be attached to a*

*TRS-80. Each COMM-80 has an auxiliary TRS-BUS connector that is the same as J3. This means that the second COMM-80 is plugged into the auxiliary connector (creating a daisy chain), since J3 on the expansion interface is already occupied. As a practical matter, however, the cable lengths get to be a problem with over ten units connected together. Some extra buffering might be needed at the TRS-80 end to drive thirty or so feet of bus. I believe Radio Shack sold such a*

*device at one time.*

*As far as photo 1 (June 1980 BYTE, page 42) goes, that was my prototype and it did not have the auxiliary expansion-bus connector. The photo on page 62 of the same issue is of a production COMM-80 board. The three connectors you see are (clockwise from bottom left) for the auxiliary TRS-BUS, RS-232, and parallel printer. The connections missing in this photo include the 1.5 feet of ribbon cable and the 40-pin expansion-bus edge connector. They would have*



## Avoid the hassle by upgrading your LA36 for 1200 baud operation with a DS120 Terminal Controller.

The Datasouth DS120 gives your DECwriter® II the high speed printing and versatile performance features of the DECwriter® III at only a fraction of the cost. The DS120 is a plug compatible replacement for your LA36 logic board which can be installed in minutes. Standard features include:

- 165 cps bidirectional printing
- Horizontal & Vertical Tabs
- Page Length Selection
- 110-4800 baud operation
- 1000 character print buffer
- X-on, X-off protocol
- Self Test
- RS232 interface
- 20 mA Current Loop interface
- Top of Form
- Adjustable Margins
- Double wide characters
- Parity selection
- Optional APL character set

Over 4000 DS120 units are now being used by customers ranging from the Fortune 500 to personal computing enthusiasts. In numerous installations, entire networks of terminals have been upgraded to take advantage of today's higher speed data communications services. LSI microprocessor electronics and strict quality control ensure dependable performance for years to come. When service is required, we will respond promptly and effectively. Best of all, we can deliver immediately through our nationwide network of distributors. Just give us a call for all the details.

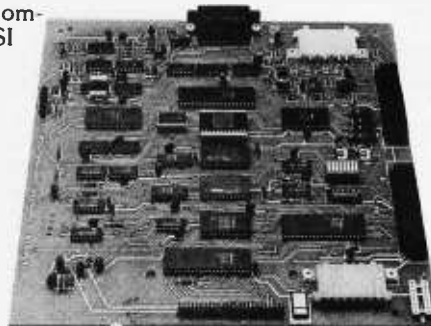

## DATASOUTH COMPUTER CORPORATION

4740 Dwight Evans Road • Charlotte, North Carolina 28210 • 704/523-8500

obscured the picture.  
Steve

WTRS-80

Dear Steve,

I am the manager of a radio station in New Jersey, and I'm contemplating a microcomputer system to perform a variety of tasks at the station. Specifically, I want the computer to do:

- program logs—random selection of public-service

- announcements;
- information retrieval from our record library;
- word processing;
- computations of transmitter output power;
- automatic transmitter control based on plate current, plate voltage, and power output readings.

The last entry in the list above is, perhaps, my main concern. Is there interfacing available to take analog readings and perform correc-

tive action by way of contact closures using a micro-computer such as the Radio Shack TRS-80 Model I or Exidy Sorcerer?

Should I be looking at putting together a process controller, or can I do what I want by using the off-the-shelf computers mentioned above with interfacing hardware?

Ideally, I would like to have a computer doing station functions in real time, and simultaneously use the computer for other func-

tions. I would appreciate your direction in this matter.

P Michael Zeimann

Your question is legitimate, but it is a little like saying, "I want to drive to California next week. What kind of car should I buy?"

The Radio Shack TRS-80 Model I is adaptable to a number of control applications as well as standard bookkeeping; however, unless you are running these functions sequentially rather than concurrently, you will require more than one TRS-80. You could try to write a multiprocessing operating system, but that would put too much dependence on one piece of equipment and the entire radio station could "make like a slow record" when you try to print out your program log.

First of all, let me suggest that you create functional subsystems with common equipment and software. Just program them for the different applications. In the case of the transmitter, you will, in fact, need to configure a closed-loop process-control system. It will probably require an analog and relay interface for reading input sensors and setting output controls. Any computer can be used. How effectively it will perform is a function of the application software and it will require obtaining the necessary peripherals. Of course, you could build everything and write your own software.

You could try another source for information before jumping in. The May 1980 Kilobaud Microcomputing has an article on using a TRS-80 for the programming logs at a radio station; and NAPCO Inc of Terryville, Connecticut, uses a TRS-80 to control a \$250,000 dip-plating line. They manufacture their own front-end equipment (ie: 12-bit A/D [analog-to-digital] and 10-bit D/A [digital-to-analog] converters) and the application may be similar enough for

**FREE\***  
OSBORNE/McGraw-Hill  
Buy 2 get 1 free

Ad #6  
with 25 new items

# DISCOUNT SOFTWARE

"LIGHTNIN" service available! Just call and ask Diana.

CP/M DISK WITH MANUAL / MANUAL ONLY

OSBORNE ¶  
General Ledger #..... \$ 59/\$20  
Acct Rec/Acct Pay #..... \$ 59/\$20  
Payroll w/Cost #..... \$ 59/\$20  
Buy 2 get 1 free..... \$118/\$57  
All 3 & CBASIC2..... \$199/\$71

DIGITAL RESEARCH\*  
CP/M\* 2.2 Northstar..... \$149/\$25  
CP/M\* 2.2 Cromemco..... \$189/\$25  
CP/M\* (other versions). Call  
PL/I-80..... Call  
Mac..... \$ 85/\$15  
Sid..... \$ 85/\$15  
Z-Sid..... \$ 95/\$15  
Tex..... \$ 70/\$15  
Despool..... \$ 50/\$10

MICROSOFT  
Basic-80..... \$284/\$25  
Basic Compiler..... \$324/\$25  
Fortran-80..... \$384/\$25  
Cobol-80..... \$594/\$25

MICRO DATA BASE SYSTEMS  
HDDBS..... \$250/\$40  
MDBS..... \$750/\$40  
Other..... Call

S.O.F.T.W.A.R.E.  
Microtax\* ‡  
Federal individual..... \$749/\$50  
Federal corporate..... \$249/\$25  
State individual..... \$249/\$25  
C.P.A. Plus  
Client Write-up..... \$995/\$95  
Time billing..... \$995/\$95  
Business Plus ‡  
General Ledger..... \$ 79/\$25  
Accounts Receivable..... \$ 79/\$25  
Accounts Payable..... \$ 79/\$25  
Payroll..... \$ 79/\$25  
All 4..... \$269/\$99

SUPERSOFT  
Forth (8080 or Z80) ¶..... \$129/\$25  
Diagnostic I..... \$ 49/\$20  
Other disk software..... less 10%

CP/M users: specify disk systems and formats. Most formats available.

COMPUTER PATHWAYS  
Pearl (level 1) #..... \$ 99/\$25  
Pearl (level 2) #..... \$299/\$25  
Pearl (level 3) #..... \$549/\$25

MICROPRO  
Word-Star (Ver. 2.0)..... \$349/\$40  
Word-Star  
/Mail-Merge..... \$489/\$65  
DataStar..... \$279/\$35  
Word-Master..... \$119/\$25  
SuperSort I..... \$199/\$25  
SuperSort II..... \$169/\$25  
SuperSort III..... \$119/\$25

PEACHTREE\* ¶  
General Ledger ‡..... \$449/\$45  
Accts Receivable ‡..... \$449/\$45  
Accts Payable ‡..... \$449/\$45  
Payroll ‡..... \$449/\$45  
Inventory ‡..... \$499/\$45  
Property Mgt. ‡..... \$899/\$45  
C.P.A. Client Write-up ‡..... \$899/\$45  
Mailing Address ‡..... \$399/\$45

STRUCTURED SYSTEMS  
General Ledger #..... \$747/\$25  
Accts Receivable #..... \$747/\$25  
Accts Payable #..... \$747/\$25  
Payroll #..... \$747/\$25  
Inventory Control #..... \$447/\$25  
Analyst #..... \$197/\$20  
Letterlight #..... \$167/\$20  
NAD #..... \$ 87/\$20  
QSORT..... \$ 87/\$20

GRAHAM-DORIAN ¶ Call

MICRO-AP  
Selector III-C2 #..... \$269/\$20  
Selector IV #..... \$469/\$35  
Glector #..... \$299/\$25  
S-Basic Compiler..... \$229/\$25

WHITESMITHS  
"C" Compiler\*..... \$600/\$30  
Pascal (incl "C")..... \$750/\$45

EIDOS SYSTEMS  
Kiss..... \$299/\$25  
Kbasic..... \$529/\$50

"OTHER GOODIES"  
Tiny "C"..... \$ 69/\$40  
CBASIC (Ver 2.06)..... \$ 89/\$15  
Pascal/Z (Ver 3)..... \$369/\$35  
Pascal/MT (Ver 3)..... \$224/\$30  
Pascal/M..... Call  
Pascal/UCSD..... Call  
FMS-80..... Call  
CBS..... \$279/\$45  
T.I.M. ‡..... \$369/\$45  
Vsort I..... \$159/\$25  
String/80..... \$ 84/\$20  
Whatsit?..... \$149/\$25  
Postmaster..... \$139/\$20  
Textwriter III..... \$111/\$20  
Magic Wand..... \$299/\$45  
Spell Binder..... \$349/\$45  
Electric Pencil II..... less 15%  
CPA ids..... less 12%

APPLE II®  
MICROSOFT  
Softcard (CP/M)..... \$292

PERSONAL SOFTWARE  
Visicalc\*..... \$122  
CCA Data Mgr..... \$ 84  
Desktop/Plan..... \$ 84

PEACHTREE\* ¶  
General Ledger ‡..... \$224/\$45  
Accts Receivable ‡..... \$224/\$45  
Accts Payable ‡..... \$224/\$45  
Payroll ‡..... \$224/\$45  
Inventory ‡..... \$224/\$45

MUSE  
Super-Text..... \$ 84  
Other disk software..... less 10%  
Whatsit?..... \$129  
Apple PIE..... \$ 69

TRS-80® MODEL II  
CP/M 2.2..... \$149  
Electric Pencil II..... less 15%

TRS-80® MODEL I  
CP/M 1.4..... \$129  
CCA Data Mgr..... \$ 68

\*—Special Bonus with order †—Requires microsoft BASIC ¶—Supplied in source code #—Requires CBASIC-2 ®—Mfgs. Trademark

Don't see it—CALL! Other software requirements—Call  
P.S.—We want to be your software source. Give us the opportunity to beat any nationally advertised price!

VISA • MASTERCHARGE

ORDERS ONLY—CALL TOLL FREE

1-800-854-2003 ext. 823 • Calif. 1-800-522-1500 ext. 823

Overseas—add \$10 plus additional postage

Add \$2.50 postage and handling per each item • California residents add 6% sales tax • Allow 2 weeks on checks. C.O.D. ok • Prices subject to change without notice • All items subject to availability •

For information write or call:

THE DISCOUNT SOFTWARE GROUP

1610 Argyle Ave., Bldg. 102 • Los Angeles, CA 90028 • (213) 665-8280



you to use some of their ideas.

Steve

[Software directed toward the needs of radio stations, such as logs, billing, and payroll, is available from The Management, POB 111, Aledo TX 76008. . . .CPF]

### Remote Supplier

Dear Steve,

After reading your article "Handheld Remote Control for Your Computerized Home" (July 1980 BYTE, page 22), I was very impressed with the many ways remote control can be accomplished. I am particularly interested in the CMOS (complementary metal-oxide semiconductor) LSI (large-scale integration) remote-control devices made by Motorola—the MC14422 and the MC6525. After reading your article, I was delighted to find that someone had built a working circuit using these devices.

One problem I have is finding a supplier that carries these integrated circuits; can you tell me your source? Can I use the same type of 40 kHz transducers that you specified in "Computerize a Home" (January 1980 BYTE, page 28)?  
Nicholas Vasil

I usually buy my components through distributors, such as Impact (617) 444-3971, Hamilton-Avnet (800) 952-0851, or Schweber Electronics (800) 952-1075. All three of these distributors carry Motorola products, and, depending upon whether they have any of these devices in stock, they should sell you a pair. Be aware, however, that the current price for the MC14422 is \$8.74 and the MC6525 is \$10.50. You may also find yourself with a \$25 minimum-order requirement.

The 40 kHz transducer I used on the Busy Box home controller may not respond quite as well at 35 kHz, but you shouldn't have any real problems.

Steve

In "Ask BYTE," Steve Ciarcia answers questions on any area of microcomputing. The most representative questions received each month will be answered and published. Do you have a nagging problem? Send your inquiry to:

Ask BYTE  
c/o Steve Ciarcia  
POB 582  
Glastonbury CT 06033

If you are a subscriber to *The Source*, send your questions by electronic mail or chat with Steve (TCE317) directly. Due to the high volume of inquiries, personal replies cannot be given. Be sure to include "Ask BYTE" in the address.

## TEST YOUR E.Q. (Economics Quotient)

For your free copy, write "Economics," Pueblo, Colorado 81009.

### The American Economic System

We should all learn more about it.



A public service message of  
This Magazine & the Advertising Council  
& the US Department of Commerce



## Teach your Cat™ new tricks.

How do you get the best possible performance out of your acoustic modem? It's easy.

First, you start with the best—a Cat acoustic coupler, the largest selling acoustic in the world. It's the finest made, and priced at just \$189.

Second, open up your phone's handset, take out the old carbon mike—and slip in a new Super Mike.

That's it. No more carbon granule packing problem. No more data distorting second harmonics. Now you've got pure, clear data transmission that's up to 5 times better.

Super Mike. At \$9.95, it's a cheap trick.

From Novation. The recognized world leader in personal communications.

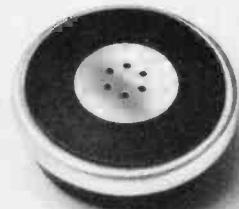

## Super Mike™ by Novation

Call for details:

(800) 423-5410  
In California (213) 996-5060

Available at Avnet Electronics, Hamilton Electro, Hamilton Avnet, Kierulff Electronics, Byte Shops, Computerland, and your local computer store.

Novation, Inc., 18664 Oxnard Street, Tarzana, California 91356

# THE ORIGINAL MAGAZINE FOR OWNERS OF THE TRS-80™\* MICROCOMPUTER

SOFTWARE FOR TRS-80™ OWNERS

# H & E COMPUTRONICS INC.

MONTHLY NEWSMAGAZINE FOR TRS-80™ OWNERS

## MONTHLY NEWSMAGAZINE Practical Support For Model I & II

- PRACTICAL APPLICATIONS
- BUSINESS
- GAMBLING • GAMES
- EDUCATION
- PERSONAL FINANCE
- BEGINNER'S CORNER
- NEW PRODUCTS
- SOFTWARE EXCHANGE
- MARKET PLACE
- QUESTIONS AND ANSWERS
- PROGRAM PRINTOUTS
- .... AND MORE

**PROGRAMS AND ARTICLES PUBLISHED IN OUR FIRST 12 ISSUES INCLUDE THE FOLLOWING:**

- A COMPLETE INCOME TAX PROGRAM (LONG AND SHORT FORM)
- INVENTORY CONTROL
- STOCK MARKET ANALYSIS
- WORD PROCESSING PROGRAM (FOR DISK OR CASSETTE)
- LOWER CASE MODIFICATION FOR YOUR VIDEO MONITOR OR PRINTER
- PAYROLL (FEDERAL TAX WITHHOLDING PROGRAM)
- EXTEND 16-DIGIT ACCURACY TO TRS-80™ FUNCTIONS (SUCH AS SQUARE ROOTS AND TRIGONOMETRIC FUNCTIONS)
- NEW DISK DRIVES FOR YOUR TRS-80™
- PRINTER OPTIONS AVAILABLE FOR YOUR TRS-80™
- A HORSE SELECTION SYSTEM\*\*\*ARITHMETIC TEACHER
- COMPLETE MAILING LIST PROGRAMS (BOTH FOR DISK OR CASSETTE SEQUENTIAL AND RANDOM ACCESS)
- RANDOM SAMPLING\*\*\*BAR GRAPH
- CHECKBOOK MAINTENANCE PROGRAM
- LEVEL II UPDATES\*\*\*LEVEL II INDEX
- CREDIT CARD INFORMATION STORAGE FILE
- BEGINNER'S GUIDE TO MACHINE LANGUAGE AND ASSEMBLY LANGUAGE
- LINE RENUMBERING
- AND CASSETTE TIPS, PROGRAM HINTS, LATEST PRODUCTS COMING SOON (GENERAL LEDGER, ACCOUNTS PAYABLE AND RECEIVABLE, FORTRAN-80, FINANCIAL APPLICATIONS PACKAGE, PROGRAMS FOR HOMEOWNERS, MERGE TWO PROGRAMS, STATISTICAL AND MATHEMATICAL PROGRAMS (BOTH ELEMENTARY AND ADVANCED) . . . AND

**FREE**

WORD PROCESSING PROGRAM (Cassette or Disk) For writing letters, text, mailing lists, etc., with each new subscriptions or renewal



LEVEL II RAM TEST (Cassette or Disk) Checks random access memory to ensure that all memory locations are working properly.

DATA MANAGEMENT SYSTEM (Cassette or Disk) Complete file management for your TRS-80™

CLEANUP (Cassette or Disk) Fast action Maze Game

ADVENTURE (Cassette or Disk) Adventure #0 by Scott Adams (From Adventureland International)

\* TRS-80™ IS A TRADEMARK OF TANDY CORP

**FREE**

SEND FOR OUR NEW 48 PAGE SOFTWARE CATALOG (INCLUDING LISTINGS OF HUNDREDS OF TRS-80™ PROGRAMS AVAILABLE ON CASSETTE AND DISKETTE). \$2.00 OR FREE WITH EACH SUBSCRIPTIONS OR SAMPLE ISSUE.

# COMPUTRONICS

MATHEMATICAL APPLICATIONS SERVICE™

50 N. PASCACK ROAD  
SPRING VALLEY, NEW YORK 10977

ONE YEAR SUBSCRIPTION \$24 .....

TWO YEAR SUBSCRIPTION \$48 .....

SAMPLE OF LATEST ISSUE \$ 4 .....

START MY SUBSCRIPTION WITH ISSUE .....

(#1 - July 1978 • #7 - January 1979 • #12 - June 1979 • #18 - January 1980)

NEW SUBSCRIPTION ..... RENEWAL .....



**24 HOUR ORDER LINE**  
(914) 425-1535



**NEW TOLL-FREE ORDER LINE**  
(OUTSIDE OF N.Y. STATE)  
**(800) 431-2818**

**NEW!!! MOD-II NEWSLETTER \$12/year (or 12 issues)**

CREDIT CARD NUMBER \_\_\_\_\_ EXP. DATE \_\_\_\_\_

SIGNATURE \_\_\_\_\_

NAME \_\_\_\_\_

ADDRESS \_\_\_\_\_ CITY \_\_\_\_\_ STATE \_\_\_\_\_ ZIP \_\_\_\_\_

\*\*\* ADD \$6/YEAR (CANADA, MEXICO) - ADD \$12/YEAR AIR MAIL - OUTSIDE OF U.S.A., CANADA & MEXICO \*\*\*

# H & E COMPUTRONICS INC.

## ••• EVERYTHING FOR YOUR TRS-80™ •••

TRS-80 is a trademark of the Radio Shack Division of Tandy Corporation

★ All Orders processed within 24-Hours

★ 30-Day Money Back Guarantee on all Software (less a \$3 penalty for handling)

★ 10-Day Money Back Guarantee on Disk Drives and Printers PLUS 120-Days Free Service

**LEARNING LEVEL II** By David Lien  
The Original Author Of The Level Manual  
A Step By Step approach to Learning Level II  
especially geared to new TRS-80™ Owners  
**\$15.95**

**TRS-80™ DISK AND OTHER MYSTERIES**  
Over 100 pages of indispensable information for  
disk owners. Learn to recover information from  
bad disks, how to make Basic programs unlistable  
and 12 more chapters of never published tips and  
information. Written by H.C. Pennington.  
(For all Disk Owners).  
**\$22.50**

**NEW SBSG BUSINESS SYSTEM FOR MODEL I  
OR MODEL II - IN STOCK**

- General Ledger
- Accounts Receivable
- Accounts Payable
- Payroll
- Inventory Control with Invoicing

Each module can be operated individually or as a  
coordinated **SYSTEM**. Turn-Key error catching  
operation for beginners.

- Complete manual and documentation  
accompany each program.
- Minimum System requirements 2-Disk Drives  
for Model I...1-Disk Drive for Model II
- Each module can be formatted to span data  
on up to 4-Disk Drives
- Free 30-Day telephone consultation
- Call for complete specifications

• Model I Version **\$125.00** Per Module  
**\$495.00** Per System

• Model II Version **\$225.00** Per Module  
**\$995.00** Per System

**DATA MANAGEMENT SYSTEMS**  
- DMS replace index cards or any data requiring  
long lists of information.

- TBS In-Memory Information System  
(For Cassette Systems) **\$39.95**
- TBS Disk Data Manager (Requires 1 or more disk  
drives)...Set up fast random access, files in  
minutes. Stores up to 320K of information on 4  
Drives. Up to 10 fields and 255 characters per  
record. Supports upper and lower case. RS-232 or  
TRS-232...Features complete editing **\$49.50**
- Personal Software CCA Data Management  
System...Completely user oriented, menu drive,  
130 page Step By Step Manual...Capable of  
inventory control, sorting data, reporting data in  
nearly any form (for reports and mailing labels).  
Sorts data by up to 10 fields for zip code, balance  
due, geographic location or whatever. Prints  
reports with subtotals and totals automatically  
calculated. Fast random access **\$75.00**

**FROM RACET COMPUTES**

- **REMODEL-PROLOAD** - Renumbers program  
lines, combines programs. The only renumber  
program that will renumber the middle of a  
program. Specify 16K, 32K or 48K. Works with  
Cassette or Disk **\$34.95**
- **GSF** - Use in your Basic Programs for Instant  
Sorting (will sort 1000 items in 9 seconds). Other  
commands include Compress and Uncompress  
Data, Duplicate Memory, Display Screen Controls  
and Fast Graphic Controls **\$24.95**  
(For Cassette or Disk, specify 16K, 32K or 48K).
- **DOSORT** - All G.S.F. commands plus special  
Multiple Disk Sorting Routines **\$34.95**  
(Specify 32K or 48K)
- **INFINITE BASIC** - Adds 70 commands to your  
TRS-80™ including Instant Sort, Matrix  
Commands, String Commands, Left and Right  
Justification, String Centering, Simultaneous  
Equations, Upper and Lower Case Reverse and  
more. (For Cassette or Disk) **\$49.95**
- **INFINITE BUSINESS** (Requires Infinite Basic)  
Eliminate Round-off error, 127-Digit Calculation  
Accuracy, Insert New Elements in Sorted Arrays,  
Automatic Page Headings, Footings and  
Pagination, Multiple Precision Arithmetic and  
more. (For Cassette or Disk) **\$29.95**
- **COPYSYS** - Copy Machine Language Programs  
(For Cassette Only) **\$14.95**
- **DSM** (Disk Sort Merge) **\$75.00**

**FROM SMALL SYSTEM SOFTWARE**

- **RSM-2** Machine Language Monitor **\$26.95**
- **RSM-2D** Disk Version of RSM-2 **\$29.95**
- **DCV-1** Converts Machine Language Programs  
from tape to disk **\$9.95**
- **AIR RAID** - The ultimate TRS-80™ game converts  
your TRS-80™ into a real time shooting gallery  
**\$14.95**
- **BARRICADE** - A fast pong style game **\$14.95**
- **CPM** - (For Disk Only) **\$150.00**
- **TRS-232 INTERFACE** - Interface with Software  
driver RS-232 printers to your TRS-80™ **\$49.95**
- **TRS-232 FORMATTER** - Additional (optional)  
Software for TRS-232 owners. Adds many printer  
commands to your TRS-80™ **\$14.95**  
(With purchase of TRS-232) **\$9.95**
- **PENMOD** - Use the Electric Pencil with RS's lower  
case modification **\$19.95**

**FROM GALACTIC SOFTWARE**

- **MAIL PAC** - For Model I Disk Systems  
only **\$99.95**  
Quick-sorting full user control over mailing list  
from Galactic Software.
- **STOCK MARKET PAC** **\$99.95**

**FROM APPARAT NEW DOS +** **\$99.95**  
35, 40 and 77 Track Versions available.

- **NEW DOS/80** (With variable record length files,  
chainings and many other features) **\$149.95**

**FROM THE BOTTOM SHELF**

- **CHECKBOOK II** (For Cassette or Disk) **\$39.95**
- **SYSTEM DOCTOR** (A complete diagnosis of your  
TRS-80™...Checks memory, video, cassette, disk,  
ROM, and all other parts of your system)  
For Cassette or Disk **\$28.50**
- **CHECKBOOK REGISTER ACCOUNTING  
SYSTEM** (Requires 2 disk drives) **\$75.00**
- **LIBRARY 100** - 100 established business, game  
and educational programs plus FREE Tiny Pilot  
all for **\$49.50**
- **BASIC TOOL KIT** - Lists all variables, GOTO's  
and GOSUB's in your program **\$19.80**

- **SOUNDWARE** - Adds sound to your TRS-80™  
Just plus it in **\$29.95**  
Sample programs included.
- **TING TONG** - Can be used with Soundware for a  
Sound version of pong **\$9.95**

- **VIC - The Carta Visual Instructional  
Computer Program** **\$19.95**  
The Level II 16K Cassette is designed to teach  
beginners the Basics of Machine Language and  
Assembly Language Programming. See every  
Machine Language Instruction Display on your  
video. VIC includes Step By Step 55 page manual

**VISTA V80 DISK DRIVE -**  
110K of Storage **\$395.00**  
Add \$29.95 for Cable (Free with purchase of  
2-Disk Drives). 10 day money back guarantee.

**FROM HOWE SOFTWARE**

- **MON-3** - Machine Language Programming for  
beginners. MON-3 is a complete System Monitor  
with Users Manual **\$39.95**
- **MON-4** - Disk Version of MON-3 **\$49.95**

**FROM MICROSOFT**

- **LEVEL III BASIC** **\$49.95**  
Now Cassette owners can add Disk Commands  
to their TRS-80™ without owning a Disk Drive
- **MICROSOFT DISK ADVENTURE** **\$29.95**
- **TRSDOS BASIC COMPILER** **\$195.00**  
Run Basic Programs up to 15 times faster.

- **NEC BUSINESS QUALITY PRINTERS**  
(For MOD-I or MOD-II) **\$2,995.00**

**THE ELECTRIC PENCIL**

- Cassette **\$99.95**
- Disk **\$150.00**
- MOD-II Version **\$325.00**

- **HORSE SELECTOR II** By Dr. Hal Davis  
The TRS-80™ version updated for the TRS-80™  
and originally reviewed in Systems and  
Methods **\$50.00**

### ••• EVERYTHING ••• FOR MOD-II OWNERS

**NEW MOD-II NEWSLETTER**  
MOD-II Catalog Free w/subscription **\$12/year**

**MAIL PAC** **\$199.95**

**MICROSOFT BASIC COMPILER** **\$395.00**

**MICROSOFT BASIC** **\$325.00**

**GSF SORT ROUTINE** **\$50.00**

**CP/M** **\$170.00**

**PEACHTREE BUSINESS SOFTWARE** Call

**WORD STAR** **\$495.00**

# COMPUTRONICS

50 N. PASCACK ROAD  
SPRING VALLEY, NEW YORK 10977

**HOURS: 9-5**  
**Monday thru Saturday**

**8-Page Catalog \$2 FREE With Any Order**  
Order By Phone Or Mail  
Add \$1 Per Order For Shipping Within UPS Areas  
Add \$3 For C.O.D.  
Add \$3 For All Foreign And Non-UPS Shipments  
Add \$3 For UPS Blue Label



**24 HOUR ORDER LINE**  
**(914) 425-1535**

**NEW TOLL-FREE ORDER LINE**  
(OUTSIDE OF N.Y. STATE)  
**(800) 431-2818**

# Book Reviews

## Interfacing and Scientific Data Communications Experiments

by P R Rony, D G Larsen, J A Titus, and C A Titus  
Howard W Sams & Company Inc,  
Indianapolis IN, 1978  
Softcover, 157 pages  
\$5.95

Most communication, whether it is person to person, machine to machine, computer to peripheral, or person to computer, is serial in nature. Words, signals, data, or other basic units of information are sent and received one unit at a time. The opposite type of communication, the parallel format, would require that, for example, all words in a

thought be spoken at the same time. That technique is clearly impractical.

To communicate effectively, the words, signals, data, etc must be in the proper format. The term *format*, as used in serial data communications, covers three areas. First is the method by which the data are transferred. Are they sent asynchronously or synchronously? In other words, does the transmitting device assume that the receiver is always available to receive the data, or must a synchronization method be used to keep data in step? If the latter is used, that method of serial data transfer is synchronous, which is beyond the scope of this book.

Following some introductory comments on the scope and objectives of the

book, and the fact that the reader is assumed to have a basic understanding of TTL (transistor-transistor logic) electronics (some knowledge of transistor theory would be helpful, too), the reader is given illustrations of situations where asynchronous serial data communications would be used. Anyone who has ever priced multiconductor cable for a remote parallel-data format terminal knows that asynchronous serial communication over a twisted pair or twisted triple is much less expensive.

Since TTL integrated circuits can readily be used for asynchronous serial data transfer, shift registers are discussed briefly. The bit format for asynchronous serial data transfer is illustrated and discussed.

Universal Asynchronous Receiver/Transmitters (UARTs) have replaced many TTL building blocks, and their function is discussed at length. Since a device cannot be used effectively until the user understands it thoroughly, the control pins of a generalized UART (ie: the TMS6012, TR1602, or AY-3-1015 are all pin-compatible) are explained in detail. Since the UART is a hardware-programmable device (as opposed to the software-programmable USART discussed later), the function of each pin in the UART transmitter, receiver, and control blocks is explained fully. CMOS (complementary metal-oxide semiconductor) UARTs such as the Intersil IM6403 are touched on because of their use in low-power applications.

The second area covered by the term format is data transfer rate. The UART requires a clock from which to generate the serial bit timing, so various clock generators are discussed next. Two requirements of the clock generator for a UART are given: first, it must be able to provide a square wave of sixteen times the desired serial data rate in bits per second. Secondly, the accuracy of the clock must be 3% or better to ensure accurate transmission and reception of serial data. Motorola's MC4024 oscillator and MC14411 bit rate generator are explained, and circuit diagrams are given. The ubiquitous NE555 is also discussed as a bit-rate generator, and a circuit diagram is given once again.

Presumably the reader now fully understands how a UART works, and, if so, the next logical step is to use it. In the "Microcomputer-UART Interfacing" section, an example is given which shows the TR1863A inter-

## ASCII encoded keyboards: Spillproof. Parallel or serial output, as low as \$69.\*



RCA VP-600 series ASCII keyboards are available in two formats. You can choose either a 58-key typewriter format. Or a 74-key version which includes an additional 16-key calculator-type keypad. Both can be ordered with parallel or serial output.

These keyboards feature modern flexible membrane key switches with contact life rated at greater than 5 million operations. Plus two key rollover circuitry. A finger positioning overlay combined with light positive activation key pressure gives good operator "feel," and an on-board tone generator gives aural key press feedback.

The unitized keyboard surface is spillproof and dustproof. This plus high noise immunity CMOS circuitry makes these boards particularly suited for use in hostile environments.

Parallel output keyboards have 7-bit buffered, TTL compatible output. Serial output keyboards have RS 232C compatible, 20 mA current loop and TTL compatible asynchronous outputs with 6 selectable baud rates. All operate from 5 V DC, excluding implementation of RS 232C.

For more information contact RCA Customer Service, New Holland Avenue, Lancaster, PA 17604

Or call our toll-free number: 800-233-0094.

The RCA logo, consisting of the letters "RCA" in a bold, stylized font.

\*Optional user price for VP-601. Dealer and OEM pricing available

## ATTENTION COMMODORE DISK OWNERS

Never sort another disk file!

With Creative Software's ISAM file handling routine, your files are always maintained in sorted order. 2K bytes of assembly language subroutines allow you to:

- **CREATE** a new ISAM file
- **OPEN** an existing file
- **READ** key and data from file
- **WRITE** key and data to file
- **READNEXT** key and data from file
- **DELETE** key and data from file
- **CLOSE** file
- **SUPPORTS** up to 5 open ISAM files simultaneously

Available for 16K or 32K CBM computers and 2040 disk units

**\$99.95** + \$2.50 shipping

Soon to be available for CBM 8016 and 8032 computers with 8050 disk drive. Manual available separately for \$15.00

# Creative Software

P.O. BOX 4030, MOUNTAIN VIEW, CA 94040

# The 2nd Generation... It's something we've been Pecking away at.

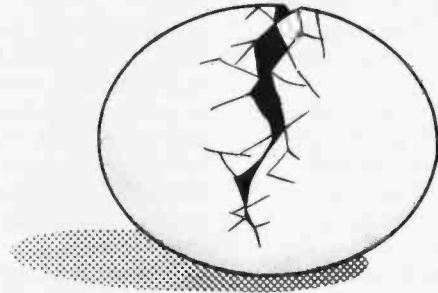

MEASUREMENT  
systems & controls  
incorporated

# SOFTWARE WANTED

If you are an  
inventive programmer  
and could use  
an extra income,  
please call:

**(213) 894-9154**

We are interested in  
Games and Business software.

Royalty or Cash-out basis.

DATASOFT  
16606 Schoenborn St.  
Sepulveda, Ca. 91343

## MICROSTAT NOW AVAILABLE FOR CP/M\*

MICROSTAT, the most powerful statistics package available for microcomputers, is completely file-oriented with a powerful Data Management Subsystem (DMS) that allows you to edit, delete, augment, sort, rank-order, lag and transform (11 transformations, including linear, exponential and log) existing data into new data. After a file is created with DMS, Microstat provides statistical analysis in the following general areas: Descriptive Statistics (mean, sample, and population S.D., variance, etc.), Frequency Distributions (grouped or individual), Hypothesis Testing (mean or proportion), Correlation and Regression Analysis (with support statistics), Non-parametric Tests (Kolmogorov-Smirnov, Wilcoxon, etc.), Probability Distributions (8 of them), Crosstabs and Chi-square, ANOVA (one and two way), Factorials, Combinations and Permutations, plus other unique and useful features.

MICROSTAT requires 48K, Microsoft MBasic with CP/M and is sent on a single-density 8" Disk. It is also available on 5" diskettes for North Star DOS and Basic (32K and two drives recommended), specify which when ordering. The price for Microstat is \$250.00. The user's manual is \$15.00 and includes sample data and printouts. We have other business and educational software, call or write:



## ECOSOFT

P.O. Box 68602  
Indianapolis, IN 46268  
(317) 283-8883

\* CP/M is a registered trade mark of Digital Research.

faced to an 8080-based system. The device-control requirements for the processor have already been explained, so this section is devoted to explaining how to generate the required signals from the 8080's  $\overline{\text{I/O RD}}$  and  $\overline{\text{I/O WR}}$  (input/output read and write) signals. Once the reader has wired the UART into his system, the programs given in the text can be entered into the machine, and the UART is ready to transmit and receive serial data.

In the same section on interfacing, the Intel 8251A Universal Synchronous/Asynchronous Receiver Transmitter (USART) is covered. A block diagram, pinout diagram, and truth table for control inputs are given. Additionally, a circuit diagram is given showing how to interface this device to an 8080 system, along with explanations in tabular form for the mode-control instruction and the com-

mand instruction.

As the terms *mode control* and *command* imply, the 8251A is software programmable. This significantly improves system flexibility because, unlike the UART, no wiring changes are needed to change the number of stop bits, even/odd/no parity, character length, and data rate. Also initialization input and output programs are given.

Now that you have wired your UART or USART on an I/O board, you're ready to connect a teletypewriter and start typing, right? Wrong! A vital link between the UART and the peripheral is missing. The third area covered under the term format is signal level of the serial bit stream. The UART outputs are TTL level signals. An interface is required to convert the TTL level signals to signals capable of being transmitted over longer distances than a foot or so. Both 20 mA current

loops (used by teletypewriters) and RS-232C interface signal levels are discussed.

In contrast to the discussion of RS-232C voltage levels (where no circuit diagrams for voltage level converters are given), the discussion of 20 mA current loops has a number of circuits and optically isolated converter circuits (the latter require a current source). If you do not feel like designing your own 20 mA interface, these circuits alone are well worth the price of the book. A brief discussion of teletypewriter interfacing is the last topic covered in the text.

Following the text are ten experiments, which are based on UARTs. The experiments assume that the reader has available a solderless breadboard (although the experiments may be hardwired), a UART, some 7400 series TTL chips, and a teletypewriter. If the reader chooses,

the experiment modules used may be purchased from E & L Instruments Inc. Their use makes breadboarding easier.

If the reader does not have a teletypewriter, a lot can still be gained from the book since the experiments are tutorial in nature. The authors describe exactly how each experiment is to be performed, then proceed to ask a number of in-depth questions. Following each question is a space to jot down an answer, then the answer is given. Following some of the more involved experiments, a review is given that covers the high points learned.

Simplex, half-duplex, and full-duplex asynchronous serial data communications are discussed in this book. The transmitter in each case is a UART. The receivers range from lamp monitors (to reconvert the serial data back to parallel data for comparison with the transmitted data) to teletypewriters.

Nine appendices follow the experiments. The ASCII (American Standard Code for Information Interchange) code is listed, data rates and clock frequencies are tabulated, a list of UART and USART manufacturers is given, and data sheets for several are included. The last appendix gives an overlay for the LR-21 out-board module, should the reader choose to buy it rather than breadboard his or her own.

In summary, the book fulfills its intended purpose very well. If you have a serial data communication requirement, this book will provide all the information needed to design a UART/USART-based asynchronous serial data communications interface. Even if you do not perform the experiments, a lot of information can be derived from this book.

J C Hassall  
H & H Enterprises  
1201 Highland Cr  
Blacksburg VA 24060

Introducing...

# MINI-FLEX<sup>TM</sup>

Designed Specifically  
to Protect 5" Diskettes



The Newest  
Member of The  
Advance Access  
Diskette  
Protection Family

For Further Information  
**CALL TOLL FREE**  
**800-323-3412**



**ADVANCE ACCESS GROUP**  
2200 S. Main St., Lombard, IL 60148 312-629-5800  
"Manufacturers of Information Processing Supplies"

## An Introduction to Database Systems

by C J Date  
Addison-Wesley, Reading  
MA, 1977  
Hardcover, 536 pages  
\$19.95

This is the second edition of one of the many books in the IBM-sponsored Systems Programming Series. Don't run away because I said IBM. This is not an IBM manual, nor does it say that IBM computers are the answer. Each book in this series is written as a collection of important topics and concepts in a particular area. The books reflect the ideas and opinions of the author, not necessarily those of IBM. This book was written by C J Date of IBM (UK) Laboratories Ltd.

This book, like all the others in the Systems Programming Series, is not for the beginner. It is designed as a text and reference for a systems programmer. I found it to be hard reading. This is not because of its style, but because it contains large amounts of information that were new to me. I found myself continually going back and rereading sections that I had initially read hastily.

This book is divided into six parts, with each part containing several chapters. Part 1 covers the basic concepts of a data base. It addresses the necessity of a data-base management system, and it explores storage structures and data models. Also introduced are the three types of data-base management systems: the relational, the hierarchical, and the network systems. These three types of data-base management systems emerge as the subjects of the next three parts of the book. Each part addresses in detail the capabilities of one type of system and explores it using a current system as an example.

Over three hundred pages later, the book returns from the discussion of these three approaches to discuss data-base security and integrity.

|                                                                                                                                                                                                                                                                                                   |                                                                                                                               |                                                                                                                                                                                                                        |                                                                                                                                                                                                               |
|---------------------------------------------------------------------------------------------------------------------------------------------------------------------------------------------------------------------------------------------------------------------------------------------------|-------------------------------------------------------------------------------------------------------------------------------|------------------------------------------------------------------------------------------------------------------------------------------------------------------------------------------------------------------------|---------------------------------------------------------------------------------------------------------------------------------------------------------------------------------------------------------------|
| <b>MAIL ORDER ONLY</b> (212) 986-7690<br>Micro Computer <small>Your One Stop For... Quality and Huge Savings</small><br><b>DISCOUNT</b> Company<br>QUALITY • DELIVERY • SERVICE<br>60 E. 42nd St. Suite 411 New York, NY 10017                                                                    |                                                                                                                               |                                                                                                                                                                                                                        | <br><b>APPLE</b><br>16K - \$ 959<br>48K - \$1059                                                                           |
| <br><b>ATARI</b><br>400 - \$495<br>800 - \$788                                                                                                                                                                   | <br><b>APF</b><br>IM1 - \$495<br>IM2 - \$988 | <br><b>COMMODORE</b><br>8K - \$729<br>16K - \$888<br>32K - \$1088<br>2022 - \$695<br>2040 - \$1088<br>8050 - \$1435<br>8032 - \$1495 | <br><b>SUPERBRAIN*</b><br>*32K - \$2445<br>64K - \$2645<br>64KQD - \$3395<br>*32K add-in memory<br>only \$10 with purchase |
| <br><b>PAPER TIGER</b><br>440G - \$880                                                                                                                                                                           | <br><b>XYMEC</b><br>HQ 1000 - \$2395         | <br><b>NEC SPINWRITER</b><br>5510 - \$2795<br>5520 - \$2990                                                                          | <br><b>*XEROX</b><br>1740 RO - \$2619<br>1740 SR - \$2995<br>1750 RO - \$2795<br>1750 KSR - \$3170<br>1730 - \$2195        |
| <b>MAIL ORDER ONLY</b><br><small>Send Certified Check (Personal or Company Checks require 2 weeks to clear.)<br/>         We pay all shipping and insurance charges except items marked with asterisk.<br/>         VISA, MasterCharge add 5% N.Y.S. Residents add appropriate sales tax.</small> |                                                                                                                               |                                                                                                                                                                                                                        | <small>*(DENOTES ITEMS SHIPPED F.O.B. NYC)</small> <b>PHONE (212) 986-7690</b><br><b>Micro Computer Discount Co</b><br>60 E. 42nd St., Suite 411, New York N.Y. 10017                                         |

## VISIONS OF PRESENT/FUTURE

### MINDSTORMS

Children, Computers,  
and Powerful Ideas  
SEYMOUR PAPERT



introduced to key concepts in math and physics.

Papert's writing is based on the educational theories of the child psychologist, Jean Piaget. Destined to become a classic!

shipped immediately upon publication

### Mindstorms by Seymour Papert

A book to revolutionize the future of the educational computer. Instead of the computer teaching the child, the child programs the computer, and thereby is

The Aquarian Conspiracy by M. Ferguson speaks to us of a new social force. A force comprised of a minority working at every social and economic level to affect change. These new conspirators look to other power centers for their direction:

Any computerist with a micro is a part of this transforming conspiracy.

- Power of Self-Knowledge
- Power of Letting-Go
- Power of Decentralization

### THE AQUARIAN CONSPIRACY by Marilyn Ferguson



Call 800-528-6050  
Ext. 1227

**BITS inc**



P.O. B. 428  
Peterborough, N.H.

03458

| Book                | Qty                | Price    | Total |
|---------------------|--------------------|----------|-------|
| Aquarian Conspiracy | _____              | \$15.00  | _____ |
| Mindstorms          | _____              | \$12.95  | _____ |
| Postage & Handling  | \$1.50 1st book    |          | _____ |
|                     | \$0.75 each add'l. | shipping | _____ |

Finally, Part 6, using the information previously presented, compares the three types and presents a conclusion. The conclusion, by the way, is a compromise approach, and still does not say to buy an IBM product.

My conclusion: if you are a computer user who wants to know how a data-base system works, don't read this book. However, for anyone seriously interested in developing a data-base management system, this

book is excellent. Until you can understand the concepts presented in this book, you are not ready to develop a data-base system. There is certainly more presented than will be implemented on a microcomputer in the next few years, but it's important to know the concepts so you can select the best approach.

Phil Hughes  
POB 2847  
Olympia WA 98507

## TRS-80 Interfacing

by Jonathan A Titus  
Howard W Sams &  
Company Inc,  
Indianapolis IN, 1979  
Softcover, 190 pages  
\$8.95

TRS-80 Interfacing is one of the new books available on interfacing the Radio Shack TRS-80 to external devices. This book, which is

part of the Blacksburg Continuing Education Series, is written in the same style as the popular *Bugbooks*; ie: the first half covers general interfacing techniques, while the second half deals with hands-on experiments. If you are interested in interfacing your TRS-80 to external devices, this book is a good place to commence.

Chapter 1 begins by describing the pins on the Z80 processor. Level II BASIC is reviewed, and examples are given showing how to move information in and out of the TRS-80 using BASIC commands. The chapter ends by briefly comparing BASIC with assembly language.

Chapter 2 describes various methods of I/O (input/output) address decoding. This is accomplished through diagrams of various integrated circuits and by showing how these circuits are used to select one or more I/O ports. The three decoding methods discussed are gating, decoding, and comparing. After reading Chapter 2, you will know how to decode any I/O address.

While I/O devices are very slow, the TRS-80 is very fast; this problem is discussed in Chapter 3. Latches and three-state bus drivers are shown that can be used with the TRS-80. Although most of the chapter is concerned with standard I/O decoding, memory-mapped I/O is briefly mentioned.

"Flags and Decisions" is the title of Chapter 4. Flags are used for device synchronization and, thus, involve both hardware and software. Hardware circuits that are used for flag detection, along with the necessary Level II software, are discussed.

The construction of a TRS-80 breadboard is covered in Chapter 5. Regardless of whether you plan to actually build the breadboard or not, it is good to review the schematic of the breadboard and make sure you understand how it operates. Included on the breadboard is



## Our Newest Data Base Management System

Introducing CONDOR SERIES 20/DBMS, the relational data base management system for users who want powerful performance at reasonable prices.

For the special introductory offer of \$695, discover how easy it is to develop business or personal information systems with SERIES 20/DBMS.

- Create a Data Base in Minutes
- Full CRT Screen Management
- Use English-like commands. Host language not required.
- Computational, Statistical, and Sorting Capabilities

CONDOR SERIES 20/DBMS is compatible with many Z-80 microcomputers with at least 48K RAM running under CP/M® operating systems.

CP/M is a registered trademark of Digital Research, Inc.

### CONDOR SERIES 20/DBMS

\_\_\_\_ User's Manual (\$35, plus tax) \_\_\_\_ Additional information.  
\_\_\_\_ SERIES 20 package (\$695, plus tax)

Please Send To:

Name \_\_\_\_\_ Position \_\_\_\_\_

Company \_\_\_\_\_ Address \_\_\_\_\_

City \_\_\_\_\_ State \_\_\_\_\_ ZIP \_\_\_\_\_

Phone ( ) \_\_\_\_\_ Computer \_\_\_\_\_ CRT \_\_\_\_\_

#### CONDOR COMPUTER CORPORATION

3989 Research Park Drive, P. O. Box 8318  
Ann Arbor, Michigan 48107 (313) 769-3988

Dealer inquiries welcome.

C 20-2



# FORTH for CP/M\*

An enhanced version of FIG\*\* FORTH is now available on a CP/M\* disk, ready to run. Features include:

- EDITOR, WITH STRING COMMANDS
- Z-80/8080 ASSEMBLER
- RAPID DISK I/O VIA INTERLEAVING
- 8 DISK BUFFERS, 1024 bytes each

The price of \$75 includes documentation suitable for the beginning FORTH programmer, as well as the experienced user.

Available for immediate delivery.

Send \$75 (includes shipping — CA residents add 6% sales tax) & your address to:

**Mitchell E. Timin Engineering Co.**  
 9575 Genesee Ave.  
 San Diego, CA 92121

\*TM Digital Research  
 \*\*FORTH INTEREST GROUP

## Model EP-2A-79 EPROM Programmer



TRS-80  
 PET  
 APPLE  
 AIM-65  
 KIM-1  
 SIM-1  
 OHIO SCIENTIFIC

Software available for F-8, 6800, 8085, 8080, Z-80, 6502, 1802, 2650, 6809, 8086 based systems.

EPROM type is selected by a personality module which plugs into the front of the programmer. Power requirements are 115 VAC 50/60 Hz. at 15 watts. It is supplied with a 36-inch ribbon cable for connecting to microcomputer. Requires 1 1/2 I/O ports. Priced at \$155 with one set of software. (Additional software on disk and cassette for various systems.) Personality modules are shown below.

| Part No. | Programs             | Price   |
|----------|----------------------|---------|
| PM-0     | TMS 2708             | \$15.00 |
| PM-1     | 2704, 2708           | 15.00   |
| PM-2     | 2732                 | 30.00   |
| PM-3     | TMS 2716             | 15.00   |
| PM-4     | TMS 2532             | 30.00   |
| PM-5     | TMS 2516, 2716, 2758 | 15.00   |
| PM-8     | MCM68764             | 33.00   |

**Optimal Technology, Inc.**  
 Blue Wood 127, Earlysville, Virginia 22936  
 Phone (804) 973-5482

Multi-User Capabilities  
 for MicroNOVA™

**Wild Hare Puts Muscle Into Your  
 MicroNOVA™  
 By Adding Multi-User Capabilities  
 To DG's DOS!**

- Supports up to five users simultaneously executing jobs
- All Data General languages for MicroNOVA™ are supported
- User shared code support
- Independent user directories
- Record lockout facility
- Printer spooling package

Now Data General Users  
 Have A Choice!



FORMERLY POLYMORPHIC COMPUTER SYSTEMS, INC.

P.O. Box 3581, Boulder, Colorado 80307  
 (303) 422-1182

# WORD INDEX

- a must for WordStar(tm)\* users

Word-Index commands placed in any document produced by WordStar(tm)\* number chapters, sections and subsections, create tables of contents, figures and tables, and a sorted index register with page references.

The following Word-Index features greatly simplifies the time consuming task of keeping track of large documents:

Automatic numbering of chapters, sections and subsections.

Automatic generation of a table of contents, a list of figures and a list of tables.

Automatic generation of a sorted index register with index words on two levels and master- and sub-references.

Automatic numbering of all page references, chapter, section and subsection numbers, whenever changes are made to your document.

User selectable typeface for headlines: double strike, bold-face, underline, double spaced and elongated in any combination for each three types of headlines.

Word-Index is supplied on 5" or 8" CP/M disk in 8080 or Z80 code at only \$75.00 including manual and shipping. A manual alone is available at only \$10.00. All major credit-cards accepted.

Order Word-Index today and stop spending hours sorting and renumbering. Order today by mail, telex or phone:



**MIDAS**

Modular Intelligent Data Administration Systems

Vandkunsten 4

DK-1467 Copenhagen K.

Phone: + 45 1 12 10 64

Telex: 42531 skibby dk

Dealer inquiries invited.

\*WordStar is a trademark of MicroPro Int. Corp. CP/M is a trademark of Digital Research.

a 5 V power supply, logic probe, device and memory decoders, bus buffers, and control circuitry; a description is given of each.

Chapter 6, which is approximately one-half of the book, contains eighteen experiments. The first eleven experiments provide basic interfacing techniques, while the last seven experiments are more advanced. Topics such as I/O port applications, traffic-light controllers, and A/D (analog-to-digital) conversion are covered in detail.

I recommend *TRS-80 Interfacing* to anyone who is interested in the hardware aspect of the TRS-80. Although the book is not as thorough as I would have liked, it will serve as a good starting place for the beginner. My biggest complaint was that Level II BASIC was the only language used; assembly language and the problems that it can help solve—interrupts, fast I/O, etc—were only briefly mentioned. You may be interested to know that the

major topics discussed in the book are covered in a 3-part article in *Radio-Electronics*, beginning with the November 1979 issue.

**Norman McEntire**  
323 Tram Rd  
Columbia SC 29210

### **Pascal: An Introduction to Methodical Programming**

*by W Findlay and  
D A Watt*  
Computer Science Press,  
Potomac MD, 1979  
Softcover, 306 pages  
\$12.95

Findlay and Watt have organized this book as a text. It presents all of standard Pascal but is arranged so that you can get started, and thereafter learn new concepts and features as you progress. The preface states that the book was written to be used in conjunction with a first course in programming using Pascal. Although initially I was skeptical, after

reading the book, I decided that it does clearly present everything necessary to start from scratch and learn Pascal. Pascal is a complicated language, and any book that promises to be easy will not be able to present all of the language.

I can recommend this book for use in two places; first, in its intended use as a classroom text for teaching Pascal to computer science beginners. Here, the help of an instructor would assist the student in learning the many new concepts. Second, I feel the book makes an excellent text for anyone with some background in another programming language.

In either case, I feel that it is very important to have a Pascal compiler available to try the concepts presented in this book. It would be virtually impossible to learn the details of a language as complex as Pascal without having an opportunity to try ideas on a computer.

For those who feel that this book may be what they

need, here are the details of its contents. The book is divided into six parts plus five appendices. Part 1, entitled "First Steps in Programming," presents the notation used in the book and the concept of data, then explores the data type INTEGER. The basic I/O (input and output) statements are presented and a complete program is developed using only integer data, I/O statements, and the assignment statement.

From this point on, new concepts are presented in such a way that they build on the basic ideas. Part 1 ends by presenting the BOOLEAN data type, WHILE and IF control structures, and some concepts on program refinement, testing, and documentation.

Part 2 introduces the data types CHAR and REAL, enumerated and subrange types, and arrays. Part 3 presents the remaining flow-of-control statements (CASE, FOR, REPEAT, and GOTO). Part 4 introduces the concept of subprograms; this part also presents chapters on functions, procedures, and their uses. Part 5 presents the data structures of Pascal, which include records, packed data and strings, files, sets, and pointers.

Part 6 is entitled "Programming Methodology." It reviews the concept of step-wise refinement presented earlier in the book and does an excellent job of showing its usefulness with two examples. For those of us who can write programs faster than anyone else, but can never quite get them to work or cannot figure out how to add a new feature to the program that we just wrote, this section is required reading. The first example is the development of a simple text formatter. It is developed through four levels of refinement showing why each developmental path was chosen at each level. The second example is a program to tabulate the winner of a transferable vote election. This example is equally well done.

Finally, the appendices

# Industrial marketing problems?

## Call McGraw-Hill Research

Regardless of what marketplace you are staking out, its position or size, we can help you draw a precise circle around it.

Why? Because as the leading business/technical/professional publishing company, we probably already know your market.

Here are just a few of the things we can do for you through our personal interviewing, telephone, mail and focus group capabilities:

- We can tell the size of your market
- Determine where your markets are
- Who the buying influences are
- How well you are known
- The effectiveness of your advertising

- Characteristics most important in product choice
- What market for new products
- Buying habits in your market. Who buys? When? Where? How?

Give us a call. Phone Shep Raskind at 212-997-6401 or write him as Director, Marketing Research, McGraw-Hill Research, 1221 Avenue of the Americas, New York, NY 10020.



If it's a marketing research problem, we probably pioneered the solution.

# THE MISSING LINK<sup>®</sup>

BY MIDNIGHT SOFTWARE

Transfer files between any two CP/M systems with full error checking and auto retry at up to 9600 baud.

- Sends and fetches all file types (including .COM)
- Multiple file transfer by list, indirect file list, and wild card match (eg ABC.HEX \*;.COM @PROGLIST)
- Remote and local directories
- Machine language program requires 16K CP/M
- Conversational mode
- Terminal mode for interacting with timesharing systems (w/download capability)
- Priced at only \$95, manual only is \$5

THIS PROGRAM IS A MUST FOR ALL CP/M SYSTEMS!

CP/M is a trademark of Digital Research  
Software is supplied on 8" single density diskettes.



**COMPUTER CAMP, INC.**  
1235 COAST VILLAGE ROAD, SUITE G,  
SANTA BARBARA, CALIFORNIA 93108  
(805) 965-7777

# The 2nd Generation... It's almost here!

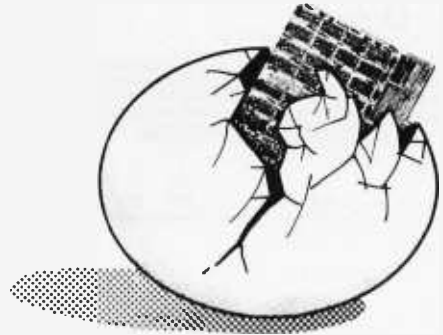

**MEASUREMENT**  
systems & controls  
incorporated

867 North Main Street Orange, Calif. 92668 (714) 633-4460



## A Message to our Subscribers

From time to time we make the BYTE subscriber list available to other companies who wish to send our subscribers promotional material about their products. We take great care to screen these companies, choosing only those who are reputable, and whose products, services, or information we feel would be of interest to you. Direct mail is an efficient medium for presenting the latest personal computer goods and services to our subscribers.

Many BYTE subscribers appreciate this controlled use of our mailing list, and look forward to finding

information of interest to them in the mail. Used are our subscribers' names and addresses only (no other information we may have is ever given).

While we believe the distribution of this information is of benefit to our subscribers, we firmly respect the wishes of any subscriber who does not want to receive such promotional literature. Should you wish to restrict the use of your name, simply send your request to BYTE Publications Inc, Attn: Circulation Department, 70 Main St, Peterborough NH 03458. Thank you.



**COMPUTER INSTANT ADS**

**CAN HELP YOU...**  
BUY OR SELL.  
• LOW COST  
• HOT LINE  
• TWICE A MONTH

Buy or sell **fast** with the Computer Instant Ads. The all ad low cost computer publication for individuals and businesses. It's on convenient 8½" by 11" pages in easy to read type.

**Bargains** — Computers, Components, Peripherals, Software, Positions and Help Wanted, whether you're buying, selling, or swapping you can get fast results at low cost with the CIA.

**Instant Ads** — If you don't want to wait a few days for the next CIA issue—just dial our special computer hot line number (reserved for subscribers) anytime, 24 hours a day, and our computer will tell your computer (with 300 baud modem) all about the ads received by the CIA since our last issue. Call as often as you like. The only additional expense to you is the price of a direct dial phone call. But remember, if you don't want to pay for the phone call, you only have a few days to wait because the CIA is published **TWICE** each month.

**LOW COST ADVERTISING** — Only 10¢ per word for one ad and just 8¢ per word per issue when the same ad is run in two or more consecutive issues.

**FREE ADVERTISING** — Subscribe now for free advertising. Mail an ad (up to 50 words type written or printed, please) to us with your subscription and we will run it free; or phone your subscription using our toll-free number and charge your subscription to your VISA or Master Charge Card. When you telephone your subscription, we will send you a certificate for a free ad.

**LOW SUBSCRIPTION RATES**      One year (24 issues) only \$13.00  
Two years (48 issues) only \$20.00

Subscribe NOW      Call TOLL-FREE 1-800-453-6400  
In Utah phone 268-3000

**CIA COMPUTER INSTANT ADS ASSOCIATION**  
277 East 6100 South • Salt Lake City, Utah 84107



ATARI 800 - \$849.00



ATARI 400 - \$499.00

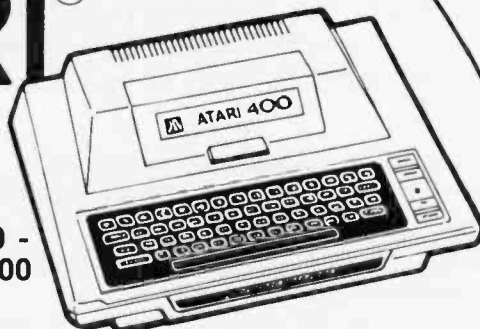

— NO HIDDEN CHARGES —

|                                | LIST PRICE | OUR PRICE |                                    | LIST PRICE | OUR PRICE |
|--------------------------------|------------|-----------|------------------------------------|------------|-----------|
| ATARI 400 Computer System, 8K  | \$629.95   | \$499.00  | MACROTRONICS Parallel Printer Int. | \$69.95    | \$64.95   |
| ATARI 800 Computer System, 16K | \$1079.95  | \$849.00  | MICROMINT Atari Chatterbox Modem   | \$219.95   | \$199.95  |
| ATARI 410 Program Recorder     | \$89.95    | \$79.00   | ATARI Light Pen                    | \$74.95    | \$64.95   |
| ATARI 810 Disk Drive           | \$699.95   | \$599.00  | 16K RAM Memory Module              | \$199.95   | \$169.00  |
| ATARI 815 Dual Density Disks   | \$1499.95  | \$1299.00 | ATARI Joystick Controllers         | \$19.95    | \$18.95   |
| ATARI 820 Printer (40 col.)    | \$599.95   | \$499.00  | ATARI Paddle Controllers           | \$19.95    | \$18.95   |
| ATARI 822 Thermal Printer      | \$449.95   | \$389.00  | ATARI 800 Dust Cover               |            | \$7.95    |
| ATARI 825 80/132 col. Printer  | \$999.95   | \$869.00  | ATARI 400 Dust Cover               |            | \$7.95    |
| ATARI 830 Acoustic Modem       | \$199.95   | \$169.00  |                                    |            |           |
| ATARI 850 Interface Module     | \$219.95   | \$189.00  |                                    |            |           |

PRINTERS

|                             |           |           |                               |          |          |
|-----------------------------|-----------|-----------|-------------------------------|----------|----------|
| Centronics 730              | \$795.00  | \$699.00  | Okidata Microline-80          | \$800.00 |          |
| Centronics 737              | \$995.00  | \$869.00  | Tractor-Feed Option           | \$140.00 | \$129.00 |
| Centronics 779              | \$1559.00 | \$1095.00 | RS-232-C (2K) Option          | \$299.00 | \$279.00 |
| Centronics 779 w/lower case | \$1695.00 | \$1195.00 | LRC to TRS-80 or APPLE        |          | \$20.00  |
| NEC 5510 SpinWriter         | \$3195.00 | \$2595.00 | LRC to PET, IEEE              |          | \$59.00  |
| NEC 5520 SpinWriter         | \$3395.00 | \$2895.00 | LRC to RS232C, male or female |          | \$65.00  |
| NEC 5530 SpinWriter         | \$3195.00 | \$2495.00 | 730 or 737 to TRS-80          |          | \$29.00  |
| NEC Tractor-Feed Option     | \$225.00  | \$195.00  | NEC or 779 to TRS-80          |          | \$35.00  |
| LRC 7000+ (64 col.)         | \$405.00  | \$329.00  |                               |          |          |

GENERAL INTEREST

|                              |          |          |                                |          |         |
|------------------------------|----------|----------|--------------------------------|----------|---------|
| BSR System X-10 5 Pc. System | \$124.95 | \$99.95  | ISO-2/CBS Line Filter-Isolator | \$70.95  | \$59.95 |
| BUSY BOX, TRS-80 or APPLE    | \$114.95 | \$99.95  | ISO-7/CB Super Filter-Isolator | \$146.95 | \$99.95 |
| BUSY BOX, S-100              | \$119.95 | \$114.95 | CASIO C-80 Calculator Watch    | \$49.95  | \$44.95 |
| AC-SFK-31 Line Filter        | \$24.95  | \$19.95  | BONE FONE                      | \$69.95  | \$56.95 |
| ISO-2 Line Filter & Isolator | \$56.95  | \$49.95  |                                |          |         |

Write for complete catalog featuring APPLE, ATARI, COMMODORE and TRS-80.

WE ALSO BUY AND SELL USED PERSONAL COMPUTERS. CALL FOR INFORMATION.



6 SOUTH ST., MILFORD, NH 03055

To order: Call Toll-Free 1-800-258-1790 (in NH call (603) 673-5144)

The Software Exchange & HardSide (Div. of Robitaille & Sons, Enterprises, Inc.), SoftSide Publications



# The Software Exchange has it all!

One phone call

# 1-800-258-1790

gives you access to all these fine companies.

(IN NH CALL 673-5144)

## SOFTWARE

Microsoft  
Apparat  
Racet  
Hayden  
Muse  
Ritam  
Softape  
Lance Micklus  
Image  
Quality Software  
Web Associates  
Small Systems Software  
On-Line Systems  
Creative Computing  
Personal Software  
Scott Adams  
Acorn Software  
Synergistics  
Strategic Simulations  
Automated Simulations  
Avalon Hill  
Micro America  
Edu Ware  
Instant Software  
Interpro  
Micro Auto Systems  
Peripherals Unlimited  
Program Design  
Personal Finance Systems  
Small Business Systems Group  
Syntonic  
Seabrees Computing



## HARDWARE

Square 1  
Computer Resources Company  
Radio Shack  
Commodore Pet  
Atari

Percom  
Centronics  
NEC  
Sun  
Okidata  
Source/TeleComputing  
Computer Case Co.  
MicroMint  
Eaton LRC  
Cover Craft  
BSR  
BASF  
Corvus  
Archbold Electronics  
ESP  
Novation  
AMP Recording Studios  
Dysan

## BOOKS

Hayden  
Wiley  
Scelbi  
Compusoft  
Dilithium  
Sams  
Radio Shack  
SoftSide  
Addison Wesley  
International Jewelers  
Dome Publishing

**The Software Exchange** 6 SOUTH ST., MILFORD, NH 03055

To order: Call Toll-Free 1-800-258-1790 (in NH call (603) 673-5144)

The Software Exchange & HardSide (Div. of Robitaille & Sons, Enterprises, Inc.). SoftSide Publications



present Pascal syntax diagrams, reserved word and special symbol lists, predeclared entities (like arithmetic functions and I/O procedures), and character sets. The final section of the book contains answers to selected exercises.

In conclusion, if you want to learn Pascal, and if you have some knowledge of computing along with access to a Pascal compiler, I feel this book can help you. If you are an instructor, this book would be an excellent choice for the text in a Pascal programming class.

Phil Hughes  
POB 2847  
Olympia WA 98507

### Microcomputer Interfacing

by Bruce A Artwick  
Prentice-Hall Inc,  
Englewood Cliffs NJ  
1980  
Hardcover, 341 pages  
\$18.95

At one time or another, most of us have wanted to use our microcomputer to control items such as lights, appliances, air conditioners, and other things in our "real world." If you are one of these people and have gone through the frustrating chore of trying to put together a suitable interface, this book is for you.

Between the covers of this long-needed book, Bruce A Artwick has compiled a very useful collection of data, technical facts, and advice for the microcomputer user who is interested in interfacing computers to the real world.

The greatest strength of this book is that the author not only covers the advanced topics related to current, technically sound interfacing techniques, but he also takes the time to explain the fundamental theories and information that are generally skipped over in publications geared toward those readers who possess more technical knowledge and skill. Mr

Artwick makes liberal use of drawings, charts, graphs, and schematics to highlight his well-written text.

While this book is easy to read and comprehend, I can assure you that the information contained within it is complete and to the point.

Chapter 1 is an orientation to interfacing. It gets things off to a good start for those readers who are new to this technical area. The chapter details general computer architecture and system design. It also explains how interfaces are used in these systems and gives examples of several types of practical interface applications.

Chapter 2 gives tips on selecting the best microprocessor for the task to be done. The discussion includes most of the popular microprocessors. This chapter lists advantages and disadvantages of each type of microprocessor.

Chapter 3 is devoted to memory. Included is information on several types of memory and the pros and

cons of each. This chapter also discusses medium- and long-term storage devices and techniques. The chapter concludes with tips on selecting the best memory device for the user's particular application.

Chapter 4 covers, in great detail, I/O (input/output) methods and devices. The highlights of this chapter include: I/O standards, buses, DMA (direct memory access), and the transfer of data over long distances.

Chapter 5 is devoted to hardware. The author covers in depth the actual parts that are used to accomplish the interface of a microprocessor to the real world. Conventional items such as transistors, SCRs (silicon-controlled rectifiers), LEDs (light-emitting diodes), and relays are detailed as well as the more recent devices such as UARTs (universal asynchronous receiver/transmitters), modems (modulator/demodulators), and cassette controllers.

Chapter 6 guides the reader in going from theory, learned in the first five chapters, to applications. This chapter gives tips and design rules to help the reader design a workable interface.

Chapter 7 covers interfacing to popular standard buses such as the S-100, SS-50, those used in LSI-11 and TRS-80 computers, and others.

Chapter 8 shows the reader how to take a completed design and actually construct it. This chapter discusses enclosures, connectors, circuit boards, wire-wrap, layout, and assembly. Here, Mr Artwick gives some very good advice on purchasing parts and the pitfalls of some "bargain" buys.

Chapter 9 discusses interface software. This chapter covers software basics in general, but it does not go into any detail on the writing of actual software routines for handling the interface. However, the author does give the reader some tips on obtaining software design information

## FINALLY! ONE ASSEMBLER — A.C.T.<sup>™</sup> BY SORCIM — LETS YOU ASSEMBLE CODE FOR 6502, 6800, 8080, 8085, AND Z80 CPUS . . . FOR ONLY \$125!

In use for two years by Sorcim to facilitate program development, the A.C.T. (Assembly Code Translator) "universal" cross-assembler supports all 5 major processors and is now available to the public. Get out of writing hex and toggling switches; A.C.T. gives you efficient programming as well as the capability to develop code for one processor on a machine using a different processor. Running under CP/M\* 1.4X or 2.X, A.C.T. features:

- Assembly speed greater than 1000 lines/min
- Complete cross reference
- Support for data type hex, octal, or binary (Intel or Motorola format)
- Supports macros
- Comprehensive set of pseudo-ops
- Absolute assemblies, system text file support, local proc definition (8080/5 & Z80 only), code file format (standard Intel hex), and many more special features.

A.C.T. fits in 24K of RAM (including CP/M), comes complete with manual and sample programs, and is shipped on a single-sided, single density, soft-sectored CP/M compatible 8" diskette. Want to know more about A.C.T.'s many talents? The manual is available separately for \$15.

  
PO Box 32505  
SAN JOSE, CA 95152

How to order: We accept UPS COD, Mastercard<sup>®</sup>, VISA<sup>®</sup>, personal checks, and certified checks. Californians add sales tax. Add \$10 outside USA.

ALSO AVAILABLE FROM SORCIM FOR \$175: PASCAL/M<sup>™</sup>, THE LOW-COST/HIGH PERFORMANCE LANGUAGE FOR ALL Z80/8080/8085 COMPUTERS.

\*CP/M is a trademark of Digital Research  
A.C.T. and PASCAL/M are trademarks of Sorcim

from outside sources.

Although the text concludes with Chapter 9, I am compelled to mention the excellent glossary at the end of the book. It contains more than 200 concise, well-written definitions of the technical terms used throughout the book. The glossary is a wealth of information in itself.

In conclusion, I highly recommend this book as a valuable addition to your technical library. It is the best source of interfacing information in one volume that I have yet come across. I am sure that you will be consulting it as often as I do. ■

Clifford R Mosley  
410 Campus  
Jonesboro AR 72401

## BYTE's Bits

### Call for Papers

Papers are being solicited for the 1981 Summer Computer Simulation Conference to be held July 21-23, 1981, in Washington DC. The conference theme is "Simulation: Foundations and the Future." Accepted papers will be published in bound proceedings distributed at the conference. Five hundred word summaries or complete drafts of original papers must be submitted by November 15, 1980, to L G Culhane, The MITRE Corporation, 1820 Dolley Madison Blvd, McLean VA 22102, (703) 827-6000.

### Call for Papers

A November 15, 1980, deadline has been set for submitting papers to the Eighth International Colloquium on Automata Languages and Programming (ICALP 81), The Technion, Haifa, Israel, July 13-17, 1981. Send four copies of an extended abstract to the Chairman of

the Program Committee, Professor S Even, ICALP 81, Computer Science Dept, The Technion, Haifa, Israel. The papers can be on topics concerning automata theory, formal languages, analysis of algorithms, computational complexity, computability theory, mathematical aspects of programming-language definition, and more.

### Microcomputers in Primary Schools Project

The University College, Cardiff Science Mathematics and Technology Centre, in Wales, is working on a project designed to evaluate the use of microcomputers and the currently available software for primary schools. The project has been funded in part by the British Department of Industry, and to obtain the greatest benefit from the project, the college is asking industrial concerns for contributions in cash or support. Doctors Thorne and

Wharry of the computing mathematics and education departments would like to ask any individuals or organizations that have appropriate educational software to forward copies to them. The results of their work will be published and made available to all primary schools in the United Kingdom. For more information, contact Doctors M Thorne and D Wharry, University College, Cardiff Science Mathematics and Technology Centre, Dept of Education, Senghennyd Rd, Cardiff CF2 4AG, Wales.

### Computer War Games Announced

Avalon-Hill, well known in the war-gaming field for its historical simulation games, has announced five games in its new Avalon-Hill Microcomputer Games series. Four of these games, *B-1 Nuclear Bomber*, *Midway Campaign*, *North*

*Atlantic Convoy Raider*, and *Nukewar*, are games for one player against the computer. The fifth game, *Planet Miners*, is a game for one to four players. The games, priced at \$15 each, will run on a Radio Shack TRS-80 with Level II BASIC, an Apple II, or a Commodore PET or CBM, each with 16 K bytes or more of free memory. Avalon-Hill's address is 4517 Harford Rd, Baltimore MD 21214.

In addition, The Software Exchange, 6 South St, POB 68, Milford NH 03055, has three war games on cassette for the TRS-80 running Level II BASIC: *Kriegspiel II*, *Up Periscope*, and *Warpath*; price is \$14.95 each.

Strategic Simulations, 450 San Antonio Rd, Suite 62, Palo Alto CA 94306, offers two games, *Computer Bismarck* (\$49.95 for the TRS-80 and \$59.95 for the Apple II) and *Computer Ambush*, a World War II war game (\$59.95 for the Apple II). ■

## Attention TRS-80 Mod II owners: P&T CP/M<sup>®</sup> 2 has more to offer!

**More Disk Storage** 596K bytes with double density on standard single sided disk drives. If that's not enough, versions are available for double sided expansion drives (1.2M bytes per disk) and the Cameo Hard disk system (10M bytes).

**More CRT Functions** P&T CP/M 2 has the most advanced screen driver available for the Mod II including: erase to end of line/screen, insert/delete line, cursor addressing, non-scrolling area on screen, and much more.

**More Serial I/O Capabilities** The serial drivers in P&T CP/M 2 support ETX/ACK, XON/XOFF, and request to send handshaking. Direct control of the serial ports is also available for special applications.

**More Documentation** We provide the standard CP/M manuals and our own 150 page manual written specifically for P&T CP/M 2.

**More Utilities** We have added 14 of our own utility programs for the Mod II to the standard CP/M utilities.

**More Useful System Functions** P&T CP/M 2 has all sorts of useful features you won't find elsewhere: type-ahead buffer for keyboard input, system time of day clock, automatic program execution, and lots more.

#### Prices

|                                              |       |
|----------------------------------------------|-------|
| Standard P&T CP/M 2                          | \$185 |
| P&T CP/M 2 for Shugart 850<br>2 sided drives | \$220 |
| P&T CP/M 2 for Cameo Hard<br>Disk system     | \$250 |

We also carry these other software packages:

|                                    |       |                                                                                                                                   |       |
|------------------------------------|-------|-----------------------------------------------------------------------------------------------------------------------------------|-------|
| Magic Wand text processor          | \$350 | CBASIC2 (improved performance)                                                                                                    | \$105 |
| VEDIT text editor                  | \$110 | Osborn accounting software<br>(requires CBASIC 2; manuals extra)                                                                  |       |
| LYNC data communication program    | \$95  | each package \$95; all four \$295                                                                                                 |       |
| MCALL intelligent terminal program | \$65  | Also available are single and double sided<br>expansion disk drives and the Cameo Hard<br>Disk System. Call or write for details. |       |
| MAC macro assembler                | \$90  |                                                                                                                                   |       |
| Pascal/M                           | \$175 |                                                                                                                                   |       |
| Microsoft Basic-80 Interpreter     | \$325 |                                                                                                                                   |       |
| Microsoft Basic-80 Compiler        | \$350 |                                                                                                                                   |       |



Prepaid, COD, Mastercharge or Visa orders accepted  
Shipping extra. California residents add 6% sales tax.

## PICKLES & TROUT

P.O. BOX 1206, GOLETA, CA 93017. (805) 967-9563

CP/M is a trademark of Digital Research Inc.

TRS-80 is a trademark of Tandy Corp.

**Today one dollar buys  
 $\frac{1}{3}$  of a business phone call.**





# Today one dollar buys 6¼ readers who actually see your sales message.



**As your selling dollar buys less and less, it pays more and more to advertise in McGraw-Hill magazines.**

As prices keep going up and up, McGraw-Hill magazines help 10.8 million decision-makers keep costs down.

For example, *Chemical Week* told chemical processing managers and professionals how exports credits could lower their debt-servicing costs. And *Engineering News-Record* showed the construction industry how to cope with the destructive effects of the 1981 federal budget.

By helping 10.8 million readers solve their inflation problems, we help you solve yours.

Today, the price of reaching one potential customer in McGraw-Hill magazines is only 16¢.<sup>1</sup> This compares to a cost of \$6.07 for sending a business letter,<sup>2</sup> over \$3.50 for a business phone call<sup>3</sup> and an in-person sales call which, believe it or not, now costs over \$100.<sup>4</sup>

In times like these, when everything costs more, you may be tempted to spend less on your advertising budget. But our Laboratory of Advertising Performance (LAP) Report #5262 demonstrates that "Industrial companies which maintained or increased their advertising expenditure during the 1974-75 recession enjoyed higher sales growth than those which cut advertising." Write 1221 Avenue of the Americas, New York, N.Y. 10020, for LAP Report #5262 today. And let us help you make your advertising more efficient, as the price of all other selling tools becomes more expensive.

<sup>1</sup>One reader-noted impression in the average McGraw-Hill publication.  
<sup>2</sup>The Dartnell Institute of Business Research. <sup>3</sup>"Telephone Marketing" by Murray Roman, P. 87, McGraw-Hill 1976. <sup>4</sup>Laboratory of Advertising Performance Report #8013.4, McGraw-Hill Research.

**McGraw-Hill Magazines**



**With inflation,  
we're an even better buy.**

# Software Received

The following is a list of software packages that have been received by BYTE Publications during the past month. The list is correct to the best of our knowledge, but it is not meant to be a full description of the product or the forms in which the product is available. In particular, some packages may be sold for several machines or in both cassette and floppy-disk format; the product listed here is the version received by BYTE Publications.

This is an all-inclusive list that makes no comment on the quality or usefulness of the software listed. We regret that we cannot review every software package we receive. Instead, this list is meant to be a monthly acknowledgement of these packages and the companies that sent them. Companies sending software packages should be sure to include the list price of the packages and (where appropriate) the alternate forms in which they are available.

Unless otherwise listed, "floppy disk" refers to a 5-inch single-sided, single-density floppy disk; "TRS-80" refers to a Radio Shack TRS-80 Model I; and "Apple II" refers to the Apple II, the Apple II Plus, or the Apple III running in Apple II emulation mode.

**Address Book**, address and mailing label utility for the Apple II, floppy disk, \$49.95, from MUSE Software, 330 N Charles St,

Baltimore MD 21201.

**Adventure**, game for the TRS-80 (other versions exist), floppy disk, \$29.95, from Microsoft Consumer

Products, 10800 NE 8th Ave, Suite 819, Bellevue WA 98004.

**APL80**, subset of APL (programming language) for the TRS-80, floppy disk (available on tape), \$39.95, from Ramware, 6 South St, Milford NH 03055.

**Computer Bismarck**, computer-assisted war game for the Apple II (version for TRS-80 also exists), floppy disk, \$59.95, from Strategic Simulations, 450 San Antonio Rd, Suite 62, Palo Alto CA 94306.

**Death Drednought**, adventure game for the TRS-80, floppy disk, \$14.95, from The Programmer's Guild, POB 66, Peterborough NH 03458.

**EasyWriter**, word-processing system for the Apple II, floppy disk, \$99.95, from Information Unlimited Software, 793 Vincente Ave, Berkeley CA 94707.

**Editor/Assembler-Plus**, Z80 assembler and editor for the TRS-80, cassette, \$29.95, from Microsoft Consumer Products (see above).

**Elementary Math**, arithmetic tutorial for the Apple II, floppy disk, \$39.95, from MUSE Software (see above).

**Higher Text**, character font generator for the Apple II, \$35, from Synergistic Software, 5221 120th Ave SE, Bellevue WA 98006.

**IRV**, keyboard shorthand utility for the TRS-80, cassette, \$25, from The Programmer's Guild (see above).

**Level III BASIC**, utility for the TRS-80, cassette, \$49.95, from Microsoft Consumer Products (see above).

**Lost Dutchman's Gold**, adventure game for the TRS-80, floppy disk, \$14.95, from The Programmer's Guild (see above).

**Odyssey**, adventure game for the Apple II, floppy disk, \$30, from Synergistic Software (see above).

**Sargon II**, chess-playing

program for the TRS-80, floppy disk, \$34.95, from Hayden Book Company, 50 Essex St, Rochelle Park NJ 07662.

**SAT TRAK**, graphic satellite observation program for the Apple II (other versions available), floppy disk, \$45, from SAT TRAK International, Computerland of Colorado Springs, 4543 Templeton Gap Rd, Colorado Springs CO 80909.

**SL5**, version of FORTH (programming language) for selected CP/M machines, 8-inch floppy disk, \$150, from The Stackworks, POB 1596, 321 E Kirkwood Ave, Bloomington IN 47402.

**Softronic APL**, programming language for any CP/M machine, 8-inch floppy disk, \$350, from Softronic, 36 Homestead Ln, Roosevelt NJ 08555.

**Spider Mountain Adventure**, game for the TRS-80, floppy disk, \$14.95, from The Programmer's Guild (see above).

**Stellar Trek**, graphics game for the Apple II, floppy disk, \$24.95, from Rainbow Computing Inc, 9719 Reseda Blvd, Northridge CA 91324.

**Typing Tutor**, educational package for the TRS-80, cassette, \$14.95, from Microsoft Consumer Products (see above).

**Write-On I**, word-processing system for the Apple II, floppy disk, \$99.50, from Rainbow Computing Inc (see above). ■

## Boards for S-100 BUS from S.C. Digital

### "INTERFACE : 1"

Serial Parallel, ROM, RAM,  
Cassette Interface Board  
Assembled & Tested  
\$229 Limited time only

#### Features: MODEL - 3SPC

- 3-Serial with hardware UARTS, RS232-C or 20ma Current loops
- 1-Parallel I/O with full handshakes, polarity is SW selectable
- Built in 4K ROM, 4K RAM Capability with SW disables (for 2708's, 2114's, ROM, RAM not supplied)
- Built in Kansas City cassette interface usable to 1200 BAUD
- Interrupts built in on all 4 inputs
- On board BAUD rate osc generates 19.2K, 9.6K, 4.8K, 1.2K, 300, 110 or 134.5 BAUD
- Switch selectable address, ports and BAUD rates

### "UNISELECT"

#### 16K Static RAM Board

Assembled & Tested \$255 with 200nsec  
Low Power Memory Chips

#### Features: MODEL - 16K US

- Fully static, uses 2114U'S
- 16K Block Addressing & Bank Select
- Universal Bank Select by port and bits, compatible with CROMEMCO, ALPHA MICRO, NORTH STAR, MARINCHIPS, etc.
- Address, Port, Bits, all SW Settable

#### All boards meet IEEE-S100 standards

Fully socketed, solder masks, gold contacts, and guaranteed for one full year.  
Delivery: from stock to 72 hours. Ordering: You may call for M.C., Visa or C.O.D. orders. (Add \$4.00 for C.O.D.) Personal checks o.k., but M.O. speeds shipment. Takes 7 to 15 days to clear personal checks before shipping.  
Undamaged boards can be returned within 10 days for full refunds. Illinois residents add 5 1/4 % sales tax.

D.E.M. PRICING AVAILABLE. DEALER INQUIRY INVITED

**S.C. Digital**

P.O. Box 906 Phone:  
Aurora, IL 60507 (312) 897-7749

## And then there were none.

What happens if civilization continues to slowly choke out wildlife species by species?

Man cannot live on a planet unfit for animals.

Join an organization that's doing something about preserving our endangered species. Get involved. Write the National Wildlife Federation, Department 105, 1412 16th Street, NW, Washington, DC 20036.

It's not too late.



# Clubs and Newsletters

## Software Exchange for PDP-11 Users

A free software exchange service is available to Digital Equipment Corporation PDP-11 users. This service allows the user to submit software for software credits that may be used to obtain other software listed in the *Monthly Software Exchange Bulletin*. Write to the PDP-11 Software Exchange, 1101 Noble Forest Dr, Norcross GA 30092.

## The Maryland Apple Corps

The Maryland Apple Corps now has over fifty members. Hardware and software demonstrations, program exchanges, bugs and fixes, and new uses of the Apple computer are interests of the group. A monthly newsletter, a software library, and membership in Apple International are also features of the group. The annual fee is \$12. For information, contact Maryland Apple Corps, POB 5430, Towson MD 21204, Atten: Art Blumberg.

## North Star Users Group

The North Star Users Group of the Boston Computer Society will hold meetings at 7:30 PM on the second Thursday of odd-numbered months, starting in November. The meetings will be held at the Computer Mart, 1395 Main St, Waltham MA. Contact Gary Saxton at (617) 861-6600, extension 2707.

## REM Interest Group

A REM (Recognition Memory) Interest Group has been formed. The group is soliciting articles, information, and ideas from REM users for its newsletter. In-

itial dues are \$10 payable to REM Interest Group, POB 23317, Honolulu HI 96822.

## VTOS Group

TCUG Inc, a nonprofit computer club, is organizing and chairing a national users group for TRS-80 owners using the Virtual Technology Operating System (VTOS). The purpose of the group is to improve upon the documentation of VTOS by sharing knowledge derived from experience with VTOS. There is a \$15 annual fee to join the VTOS Users Group, which entitles the member to the newsletter. Contact TCUG Inc, VTOS Sub-Group, POB 2235, Reston VA 22090, Attn: Bill Beall. The TCUG Bulletin Board is available at (703) 620-4990.

## National Association of Computer Stores

The National Association of Computer Stores, a trade association representing retail computer stores, has recently been formed with the assistance of IntraCom Inc, an association and organizational management firm. The purposes of the trade association are to ensure prosperity and expansion of stores, to cooperate with applicable government agencies and legislative bodies, and to represent and advance the economic and educational interests of retail computer stores. Information is available from National Association of Computer Stores, 3255 S US 1, Ft Pierce FL 33450, (305) 465-9450.

## Detroit Interact Group

Interact Electronics Corporation went out of

business in early 1980, with over 5000 Interact systems in use and over 1000 on dealers' shelves. In order to see that these owners get support, the Detroit Interact Users Group has gone national. They encourage development of new software and hardware by independent sources. A monitor and a serial port are now available because of this group's efforts. The group also supports a software library. They are trying to locate schematics, documentation, and reliable sources for software, parts, and service for the Interact. The club newsletter, *Interaction*, is bimonthly with information, ideas, and programs. Contact Detroit Interact Group, 15356 Prevost, Detroit MI 48227. ■

And then there were none.

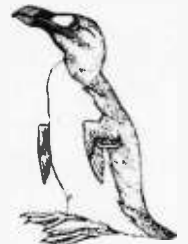

The list of already extinct animals grows... the great auk, the Texas gray wolf, the Badlands bighorn, the sea mink, the passenger pigeon...

What happens if civilization continues to slowly choke out wildlife species by species?

Man cannot live on a planet unfit for animals.

Join an organization that's doing something about preserving our endangered species. Get involved. Write the National Wildlife Federation.



Department 105, 1412 16th Street, N.W. Washington, DC 20036.

It's not too late.

## the electric pencil II™

1981 Michael Shrayer

for the TRS-80 Model II\* Computer



The Electric Pencil is a Character Oriented Word Processing System. This means that text is entered as a continuous string of characters and is manipulated as such. This allows the user enormous freedom and ease in the movement and handling of text. Since lines are not delineated, any number of characters, words, lines or paragraphs may be inserted or deleted anywhere in the text. The entirety of the text shifts and opens up or closes as needed in full view of the user. Carriage returns as well as word hyphenation are not required since each line of text is formatted automatically.

As text is typed and the end of a screen line is reached, a partially completed word is shifted to the beginning of the following line. Whenever text is inserted or deleted, existing text is pushed down or pulled up in a wrap around fashion. Everything appears on the video display screen as it occurs thereby eliminating any guesswork. Text may be reviewed at will by variable speed or page-at-a-time scrolling both in the forward and reverse directions. By using the search or the search and replace function, any string of characters may be located and/or replaced with any other string of characters as desired. Specific sets of characters within encoded strings may also be located.

When text is printed, The Electric Pencil automatically inserts carriage returns where they are needed. Numerous combinations of Line Length, Page Length, Character Spacing, Line Spacing and Page Spacing allow for any form to be handled. Right justification gives right-hand margins that are even. Pages may be numbered as well as titled.

### the electric pencil

- a Proven Word Processing System

The TRSDOS versions of The Electric Pencil II are our best ever! You can now type as fast as you like without losing any characters. New TRSDOS features include word left, word right, word delete, bottom of page numbering as well as extended cursor control for greater user flexibility. BASIC files may also be written and simply edited without additional software.

Our CP/M versions are the same as we have been distributing for several years and allow the CP/M user to edit CP/M files with the addition of our CONVERT utility for an additional \$35.00. CONVERT is not required if only quick and easy word processing is required. A keyboard buffer permits fast typing without character loss.

|                          | CP/M      | TRSDOS    |
|--------------------------|-----------|-----------|
| Serial Diablo, NEC, Qume | \$ 300.00 | \$ 350.00 |
| All other printers       | \$ 275.00 | \$ 325.00 |

The Electric Pencil II is still available for TRS-80 Model I users. Although not as sophisticated as Electric Pencil II, it is still an extremely easy to use and powerful word processing system. The software has been designed to be used with both Level I (iGK system) and Level II models of the TRS-80. Two versions, one for use with cassettes, and one for use with disk, are available on cassette. The TRS-80 disk version is easily transferred to disk and is fully interactive with the READ, WRITE, DIR, and KILL routines of TRSDOS.

|     |          |           |
|-----|----------|-----------|
| TRC | Cassette | \$ 100.00 |
| TRD | Disk     | \$ 150.00 |

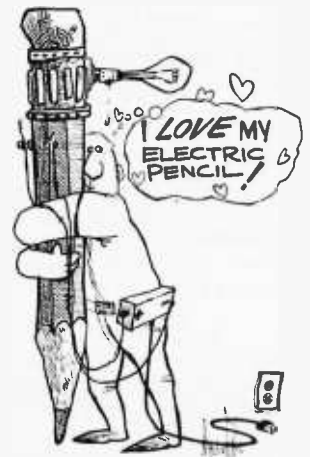

### Features

TRSDOS or CP/M Compatible • Supports Four Disk Drives • Dynamic Print Formatting • Diablo, NEC & Qume Print Packages • Multi-Column Printing • Print Value Chaining • Page-at-a-time Scrolling • Bidirectional Multispeed Scrolling • Subsystem with Print Value Scoreboard • Automatic Word & Record Number Tally • Global Search & Replace • Full Margin Control • End of Page Control • Non-Printing Text Commenting • Line & Paragraph Indentation • Centering • Underlining • Boldface



\* TRS80 is a registered trade mark of Radio Shack, a division of Tandy Corp.

**m ss** MICHAEL SHRAYER SOFTWARE, INC.  
1198 Los Robles Dr.  
Palm Springs, CA 92262  
(714) 323-1400

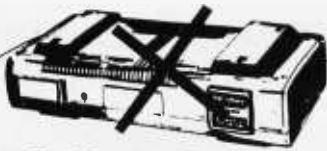

# TRS-80\* interfacing alternatives...

Featuring the Quality Engineering and Manufacturing of THE MICRO MINT



COMM-80

- FULL 8-BIT PARALLEL PORT
- RS-232-C SERIAL PORT (up to 19,200 baud)
- UP TO 16 UNITS CAN BE CHAINED TOGETHER
- TRS-BUS CONNECTOR FOR FUTURE EXPANSION
- CONNECTS TO KEYBOARD OR E I
- INCLUDES TERMINAL SOFTWARE ONLY \$179 95



CHATTER BOX

- FULL 8-BIT PARALLEL PORT
- RS-232-C SERIAL PORT (up to 19,200 baud)
- ACOUSTIC MODEM — 300 BAUD
- TRS-BUS CONNECTOR FOR FUTURE EXPANSION
- CONNECTS TO KEYBOARD OR E I
- CAN BE CHAINED TOGETHER WITH COMM-80
- INCLUDES TERMINAL SOFTWARE ONLY \$259 95



DISK-80

- DISK CONTROLLER (up to 4 drives)
- DATA SEPARATOR INCLUDED
- INCLUDES 16K OF RAM
- PROVISION FOR AN ADDITIONAL 16K RAM
- TRS-BUS CONNECTOR FOR FUTURE EXPANSION ONLY \$299 95



BUSY BOX

- ALLOWS TRS-80 TO CONTROL AC APPLIANCES
- CABLE AND CONNECTOR FOR TRS-80 KEYBOARD OR E.I.
- WORKS WITH THE POPULAR BSR X-10 SYSTEM
- INCLUDES BASIC LISTING FOR CONTROL ROUTINE
- LEVEL II MINIMUM SYSTEM ONLY \$109 95

ALL INTERFACES ARE RADIO SHACK HARDWARE AND SOFTWARE COMPATIBLE

MAIL ORDER OR INFORMATION  
WRITE OR CALL: (510) 374-6193  
The MicroMint Inc.  
317 Midway  
Woodmere, NY 11598  
Dealer inquiries invited.

\*TRS-80 is a trademark of Tandy Corp.

## Books Received

The following is a list of books received at BYTE Publications during this past month. Although the list is not meant to be exhaustive, its purpose is to acquaint BYTE readers with recently published titles in computer science and related fields. We regret that we cannot review or comment on all the books we receive; instead, this list is meant to be a monthly acknowledgement of these books and the publishers who sent them.

**The Architecture of Microcomputers**, S E Greenfield; Winthrop, Cambridge MA, 1980; 18.5 by 24.5 cm, 366 pages, hardcover, ISBN 0-87626-037-7, \$24.95.

**Basic Computer Programs in Science and Engineering**, Jules H Gilder; Hayden Book Company, Rochelle Park NJ, 1980; 18 by 25 cm, 256 pages, softcover, ISBN 0-8104-0761-2, \$8.95.

**Computer Logic, Testing, and Verification**, J Paul Roth; Computer Science Press, Potomac MD, 1980; 16 by 24.5 cm, 176 pages, hardcover, ISBN 0-914894-62-5, \$23.95.

**Digital Computer Simulation**, Fred J Maryanski; Hayden Book Company, Rochelle Park NJ, 1980; 15.5 by 23 cm, 336 pages, softcover, ISBN 0-8104-5118-2, \$15.95.

**Digital Hardware Design**, John B Peatman; McGraw-Hill Book Company, New York NY, 1980; 18 by 25 cm, 438 pages, hardcover, ISBN 0-07-049132-1, price not available at this time.

**Dr Dobb's Journal of Computer Calisthenics & Orthodontia: Running Light Without Overbyte**, The People's Computer Company Series, Hayden Book Company, Rochelle Park NJ, 1980; 21 by 28 cm; volume 1: 368 pages, ISBN 0-8104-5475-0; volume 2: 480 pages, ISBN 0-8104-5484-X; volume 3: 480 pages, ISBN 0-8104-5490-4; softcover, \$18.95 each.

**An Introduction to Microcomputers: Volume 1 Basic Concepts**, Adam Osborne; Osborne/McGraw-Hill, Berkeley CA, 1980; 19 by 23 cm, 480

pages, softcover, ISBN 0-931988-34-9, \$12.50.

**Mathematical Modeling with Computers**, Samuel L S Jacoby, Janusz S Kowalik; Prentice-Hall, Englewood Cliffs NJ, 1980; 16 by 23.5 cm, 292 pages, hardcover, ISBN 0-13-561555-0, \$21.50.

**Microcomputer Management and Programming**, Carol Anne Ogden; Prentice-Hall, Englewood Cliffs NJ, 1980; 18.5 by 24.5 cm, 348 pages, softcover, ISBN 0-13-580936-3, \$16.95.

**Microprocessors and Logic Design**, Ronald L Krutz; Wiley & Sons, New York NY, 1980; 15.5 by 23.5 cm, 467 pages, hardcover, ISBN 0471-02083-4, \$24.95.

**Microprocessor Software Design**, Max Schindler; Hayden Book Company, Rochelle Park NJ, 1980; 22 by 28 cm, 304 pages, softcover, ISBN 0-8104-5190-5, \$11.95.

**The Practical Guide to Structured Systems Design**, Meilir Page-Jones; Yourdon Press, New York NY, 1980; 15.5 by 23 cm, 354 pages, softcover, ISBN 0-917072-17-0, \$19.50.

**Programmable Pocket Calculators**, Mullish, Kochan; Hayden Book Company, Rochelle Park NJ, 1980; 15.5 by 23 cm, 264 pages, softcover, ISBN 0-8104-5175-1, \$8.95.

**TRS-80 BASIC; A Self-Teaching Guide**, Albrecht, Inman, Zamora; Wiley & Sons Inc, New York NY, 1980; 18.5 by 23.5 cm, 351 pages, softcover, ISBN 0-147-06466-1, \$8.95. ■

## THE MASTERS OF FANTASY CRYSTALWARE



You streak into the Vegan System. You are the commander of the terran starfleet. Your cargos are Shisi and Argos crystal. Your shields are low and the aliens are closing in!!... Galactic Quest

Lost in the cellar of a creepy old house. Within these winding corridors, lurk unspeakable horrors; echo with unhuman footsteps. You have almost made it to the stairs... when... House of Usher

Lasar Wars, Time Trek, Sumeria, and many more!

To: Crstal Computer Mfg. & Software  
P.O. Box 206, San Jose, Calif. 95113  
408-292-1897

name: \_\_\_\_\_  
address: \_\_\_\_\_

- |                                       |                                      |                                   |                                           |
|---------------------------------------|--------------------------------------|-----------------------------------|-------------------------------------------|
| <input type="checkbox"/> Please send  | <input type="checkbox"/> Usher       | <input type="checkbox"/> Quest    | <input type="checkbox"/> cassette \$19.95 |
| <input type="checkbox"/> disk \$24.95 | <input type="checkbox"/> Trs-80 16 K | <input type="checkbox"/> Pet 16 K | <input type="checkbox"/> mastercharge     |
| <input type="checkbox"/> Apple 48 K   | <input type="checkbox"/> check       | <input type="checkbox"/> visa     | <input type="checkbox"/> card no _____    |
| <input type="checkbox"/> Catalog      |                                      |                                   |                                           |

# PMC-80

## Level II 16K at \$645



## SOFTWARE COMPATIBLE

- Reads all Level II BASIC tapes
- Reads all SYSTEM tapes
- Full range of peripherals
- Video output for monitor and TV
- Optional FASTLOAD at 8000 baud
- Optional Upper/Lower case

The PMC-80 is a "work-alike" computer to the popular TRS-80\* Model I, Level II by Tandy, Radio Shack. The PMC-80 has 16K bytes of RAM and the complete Level II 12K BASIC ROM by Microsoft that makes it 100% software compatible with programs from Radio Shack and from the hundreds of other independent suppliers. The built-in cassette player reads standard Radio Shack programs for the TRS-80\*.

Sold through computer stores.

The PMC-80 will operate with any of the many peripherals Radio Shack and other independent vendors have invented to plug into the TRS-80\*. Most importantly, the Interface Adapter permits Expansion Interfaces with memory expansion to 48K to be added. An Expansion Interface will also permit the addition of Radio Shack compatible 5 1/4" disks and disk operating systems, RS 232, printers, etc.

\*TRS-80 is a registered trademark of Tandy, Radio Shack.

### Personal Micro Computers, Inc.

475 Ellis Street, Mountain View, CA 94043

(415) 962-0220

# Book Reviews

## Structured Programming

by O J Dahl, E W Dijkstra and C A R Hoare, Academic Press, London, 1972  
Hardcover, 220 pages  
\$18.00

The term "structured programming" is no longer novel. If you were to encounter this slender volume on a bookstore shelf, you might easily pass it by as yet another how-to book, and a not very eye-catching one at that. In reality, this book is a collection of brilliant ideas about program construction, program structure, and data structuring by three internationally renowned computer scientists. *Structured Programming* is already a classic in computer science literature and should be read by everyone seriously interested in programming.

*Structured Programming* is a collection of three essays. The first is Dijkstra's "Notes on Structured Programming." These notes were first circulated in mimeograph form and were the intellectual catalyst for almost the entire structured programming viewpoint. The essay itself is a collection of short notes concerning topics such as program structures, proving the correctness of programs, stepwise program composition, and many more. The concepts are exemplified by many exercises and examples which are themselves quite challenging and thought provoking. One of the more interesting examples is Dijkstra's solution to the *eight-Queens problem*.

Whereas Dijkstra's essay will strike many resonant chords for those already familiar with structured approaches to programming, Hoare's essay will have an air of familiarity for Pascal programmers. Hoare's

"Notes on Data Structuring" is a brilliant analysis of the concept of abstract data types in programming. Hoare advocates the use of high-level data abstractions. He systematically examines unstructured or scalar data types such as enumerated sets and subranges. Next he discusses structured or compound data types (called structures in many languages) such as the Cartesian product, the discriminated union (variant records), the array (in a very generalized form), and the power-set. Finally, he treats more complex data types such as sequences, recursive data structures, and sparse data structures. He introduces the basic concepts for each data type and a notation for syntactic expression. He discusses the general operations that can be performed on each data type and discusses suggestions for achieving workable and efficient data representations and operations.

Hoare's stated objective is not simply to create another programming language that tries to include all data types and operations. Instead, he endeavors to give the reader an understanding of data abstraction. Hoare's suggestion is that the reader adopt and adapt his notation for use as a personal pseudo-language in the initial stages of top-down design. By keeping the data objects in an abstract, conceptually meaningful form and by delaying choice of representation until later in the design several advantages are obtained. A program expressed in a high-level abstract language is more easily read and understood. Details of the algorithm can be worked out at an abstract level which facilitates ensuring the correctness of the algorithm. Finally, alternative representations for the data objects can be explored without the

basic algorithm being changed. In essence, the use of abstract data types represents a stepwise refinement of the algorithmic code.

The final essay, "Hierarchical Program Structures," is coauthored by Dahl and Hoare. This essay represents a synthesis of the ideas from the previous two essays. Although not as clearly written as the other two essays, it discusses the ideas on structured programming presented in the others by showing how they are achieved in the SIMULA language: The most enlightening part of this essay is the description of SIMULA. SIMULA is a powerful general-purpose programming language derived from ALGOL 60 that introduces several novel programming concepts. The

most important of these is the "class" concept. Classes are a means for creating not only abstract data objects but also the operations for manipulating them. This idea of providing a means within a language for creating new data objects and operations has been refined and incorporated into many of the most modern programming languages.

*Structured Programming* will introduce you to a wealth of excellent ideas about programming and program construction. It's a book that not only belongs on every serious programmer's library shelf, but belongs among those volumes that become worn from repeated reading. ■

Glen A Taylor  
19 June 81  
Mattawan NJ 07747

## BYTE's Bugs

### It's Greek to Me!

An error of character substitution took place in a figure in Steve Ciarcia's article "A Build-It-Yourself Modem for Under \$50" (August 1980 BYTE, pages 22 thru 38).

In figure 3 on page 32, two equations should have contained lowercase Greek omega " $\omega$ " characters; lowercase Roman-alphabet "w" characters were substituted.

The proper form of the center-frequency equation is:

$$\omega_0^2 = 1/R_3 C^2 (1/R_1 + 1/R_2)$$

The proper form of the equation under the op amp in the schematic diagram is:

$$\omega_0 = 2\pi f_0$$

The center-of-passband frequency of the "typical bandpass filter response curve" in the graph should have been indicated by  $\omega_0$  not  $w_0$ .

### Data Flub on the Dubber

The price for the Data Dubber in the "What's New?" section of the July 1980 BYTE, page 251, should have read \$49.95, not \$39.95.

### Mix-uprocessors

The August 1980 BYTE "In The Queue" page lists Theron Wierenga's video terminal as based on the Zilog Z80. The project actually uses an Intel 8085. ■



# Let this New Series from **BYTE BOOKS™** answer your programming questions

Programming Techniques is a series of collected articles concerned with the art and science of computer programming. The first volume in the Programming Techniques series is entitled **Program Design**. The purpose of the book is to provide the personal computer user with the techniques needed to design efficient, effective, maintainable programs.

ISBN 0-07-037825-8 Pages: 96  
Price: \$6

Editor: Blaise W. Liffick

**Simulation** is the second volume in the Programming Techniques series. Both theoretical and practical applications are included. Particularly stressed is simulation of motion, including wave motion and flying objects, and the use of simulation for experimentation.

ISBN 0-07-037826-6 Pages: 126  
Price: \$6

Editor: Blaise W. Liffick

**Numbers in Theory and Practice** is the third book in the series. It includes information of value to both the novice and the experienced personal computer user. The mechanics of the binary system are discussed, including software division and multiplication, as well as floating point

numbers, numerical methods, random numbers, and the mathematics of computer graphics.

ISBN 0-07-037827-4 Pages: 192  
Price: \$8.95

Editor: Blaise W. Liffick

The 4th volume of the Programming Techniques series, **Bits and Pieces**, covers various topics of interest to programmers. It

is a collection of the best articles from past issues of BYTE magazine plus new material collected specifically for the series, on subjects such as multiprogramming, stacks, interrupts optimization, and real time processing.

ISBN 0-07-037828-2 Pages: 160  
Price \$8.95

Editor: Blaise W. Liffick



- Please send  \_\_\_\_\_ copies of Program Design  
 \_\_\_\_\_ copies of Simulation  
 \_\_\_\_\_ copies of Numbers in Theory and Practice  
 \_\_\_\_\_ copies of Bits and Pieces

B10

Name \_\_\_\_\_ Title \_\_\_\_\_ Company \_\_\_\_\_

Street \_\_\_\_\_ City \_\_\_\_\_ State/Province \_\_\_\_\_ Code \_\_\_\_\_

Check enclosed in the amount of \$ \_\_\_\_\_

Bill Visa  Bill Master Charge

Card No. \_\_\_\_\_ Exp. Date \_\_\_\_\_

Add 60¢ per book to cover postage and handling.



70 Main St, Peterborough, NH 03458

# Event Queue

October 1980

*October-November*

**Thinking Small—Using Small Computers to Increase Business Productivity.** These conferences will feature leading authorities and small-business computer users in a program designed to explore the opportunities presented by small computers for productivity improvement of the small business. For a schedule of times and places, contact The Information Exchange, 1730 N Lynn St, Suite 400, Arlington VA 22209, (703) 521-6209.

*October-December*

**APL Classes.** STSC Inc has announced its fall schedule of classes and seminars in

APL and related applications. Financial planning, manufacturing and materials management, insurance analysis, and data-base design and management will be covered. Classes will be held in major cities in the US and Europe. Contact Joan Gurgold, STSC seminar manager, 11 Clearbrook Rd, Elmsford NY 10523, (914) 347-5560.

*October-December*

**Hartford Graduate Center Courses,** Hartford CT. Assembly language, mini-computers, Pascal, microprocessors, and computer-aided graphics are courses being offered by the Hartford Graduate Center, 275 Windsor St, Hartford CT 06120, (203) 549-3600, extension 254 or 252.

*October-December*

**Fairchild's Microcomputer Education Center,** San Jose CA. A series of technical training courses are offered for design engineers who must learn to incorporate the microprocessor into a working system. The curriculum includes courses on data communications and the 6856, the 3870 single integrated circuit microcomputer and its family, 6800 microprocessors, bit slice techniques. Contact the Center at MS 42-2120, 101 Bernal Rd, San Jose CA 95119, (408) 224-7096.

*October-January 1981*

**Twenty-nine Seminars from DPMA Education Foundation.** The Data Processing Management Association

(DPMA) is sponsoring a series of two-day computer-oriented seminars. Data processing, software configuration management, computer-aided design and manufacturing, computers and data communications, data base, integrated circuits, and software engineering are some of the topics being covered. For details on site locations and times, contact DPMA Education Foundation Coordinator, 5959 W Century Blvd, Los Angeles CA 90045, (213) 670-2975.

*October 1-2*

**Choosing and Using Microprocessor Development Systems,** London Press Centre, London EC4, England. The seminar will present information and practical experience on which to base the selection and use of microprocessor development systems. It will provide guidelines to answer questions on the definition of microprocessor development systems, what features should be looked for, how to analyze particular requirements, and what systems are commercially available. The program is intended for senior engineers and engineering managers who have some knowledge of microprocessors. Contact the Conference and Course Unit, Sira Institute Ltd, South Hill, Chislehurst, Kent BR7 5EH, England.

*October 1-3*

**The Tenth International Symposium on Fault-Tolerant Computing,** Kyoto, Japan. This meeting is devoted to the theory and practice of reliable computing and will cover design of fault-tolerant circuits and systems; analysis of system performance and reliability; applications of coding techniques; software reliability and testing; and more. For information and traveling arrangements, contact Secretary of FTCS-10,

A 10 Megabyte Winchester  
hard disk based,  
S100 Computer for

**\$7500???**

**YOU BET!!!**

We'll give you 20 to 1  
(storage that is)!



NNC Electronics 15631 Computer Lane  
Huntington Beach CA 92649 (714) 893-4120





systems. The course covers all the elements of data communications systems. Contact American Management Associations, 135 W 50th St, New York NY 10020, (212) 246-0800.

October 27-30

**The Fifth International Conference on Computer Communication**, Peachtree Plaza Hotel, Atlanta GA. The theme for ICCC/80 is "Computer Communications: Increasing Benefits for Society." More than 100 speakers will present papers on applications and

technical developments of computer communication and its worldwide implications for the 1980s. Fees are \$175 for pre-registration and \$200 at the conference. Contact ICCC/80, POB 280, Basking Ridge NJ 07920, (201) 221-8800.

November 1980

November 8-9

**Personal Computer Fair**, Pacific Science Center, Seattle WA. The theme of this year's fair is "Hands On." The booths and ex-

hibits will reflect this idea, and the public will have access to as many computers and terminals as possible. Contact The Northwest Computer Society, POB 4193, Seattle WA 98119, (206) 284-6109.

November 10-14

**The Fourth Annual Data-Entry Management Conference**, Orlando FL. This conference will cover data entry, distributed processing, and word processing with emphasis on data entry, including human-machine interface. Contact

Data Entry Management Association, POB 3231, Stamford CT 06905, (203) 322-1166.

November 11-13

**Canadian Computer Show and Conference**, International Centre, 6900 Airport Rd, Toronto, Ontario, Canada. For information, contact the Show Manager, Industrial Trade Shows of Canada, 36 Butterick Rd, Toronto, Ontario M8W 3Z8, Canada, (416) 252-7791.

November 13-16

**The 1980 International Computer Music Conference**, Queens College, Flushing NY. This conference is for persons interested in computer applications in music. Conference activities include presentation of papers, concerts, workshops, panel discussions, meetings of special interest groups, demonstrations, and an exhibition of computer music equipment. For information, contact Dr Hubert S Howe Jr, Director 1980 International Computer Music Conference, Queens College, Flushing NY 11367, (212) 520-7340.

November 18-20

**The Third Industrial Revolution**, McCormick Place, Chicago IL. This show is an exposition and conference devoted to development by manufacturing companies of systems for information management. Information may be obtained from Banner and Grief Ltd, 110 E 42nd St, New York NY 10017, (212) 687-7730.

November 19-21

**Comdex**, Las Vegas Convention Center, Las Vegas NV. Comdex is a conference and exposition for independent sellers of small-computer and word-processing systems, peripherals, media, and supplies. Address inquiries to The Interface Group, 160 Speen St, Framingham MA 01701, (800) 225-4620.

November 20-21

**Western Educational Computing Conference**, San Diego CA. This conference will feature papers and

**Call on John D. Owens for all Your Computer Needs**

JOHN STARTED PROGRAMMING IN 1959 AND HAS WORKED ON THE IBM 704, UNIVAC I, NCR 304, CDC 6600, IBM 360/370 AND MANY OTHERS. WHEN YOU CALL ON US, JOHN'S EXTENSIVE EXPERIENCE BECOMES AVAILABLE TO YOU.

---

**IMS 5000 and 8000 Systems**  
The new rising stars! Beautifully designed and constructed with the Industrial Micro System reputation for fine quality. These systems feature a Z80 CPU, S-100 bus; double density drives (either single or double sided) CP/M®. 5000 series uses mini floppies, 8000 uses maxi floppies. Hard disk and MP/M now available.

Model 5-00125 with two double density drives, 32K Static RAM ..... \$2,765  
Model 8-00125 as above but with 8" drives ..... \$4,185

---

**AMPEX DFR-900 HARD DISK DRIVES**  
Winchester media; 16MB removable; 32, 64 or 96 MB fixed. These drives are totally integrated with the IMS hardware and CP/M. We can furnish a package consisting of an IMS system, your choice of CRT or printer, optional hard disk and applications software.

---

|                                                                                                                                                                                                                                                                                                                                                                                                                                                                                                                                                      |                                                                                                                                                                                                                                                                                                                                                                                                                                                           |
|------------------------------------------------------------------------------------------------------------------------------------------------------------------------------------------------------------------------------------------------------------------------------------------------------------------------------------------------------------------------------------------------------------------------------------------------------------------------------------------------------------------------------------------------------|-----------------------------------------------------------------------------------------------------------------------------------------------------------------------------------------------------------------------------------------------------------------------------------------------------------------------------------------------------------------------------------------------------------------------------------------------------------|
| <p><b>DRIVES</b></p> <p>Per Sci 299B Now Available!!! ... \$2,200<br/>Cabinet and power supply ..... \$300</p> <p>Per Sci 277 .. \$1,210 Shugart ..... \$525<br/>MPI B51 .... \$265 B52 ..... \$365<br/>Innotronics and QUME also available</p> <hr/> <p><b>HAZELTINE 1500</b> ..... \$885<br/>1510 ..... \$980 1520 ..... \$1,210<br/>1420 (two year warranty) ..... \$775</p> <hr/> <p><b>DEC LA 35/36 Upgrade</b> ..... \$750<br/>Increases baud rate to 1200. Microprocessor controlled. Many features include TOF, tabs and margin control.</p> | <p><b>TELEVIDEO SMART CRTs</b></p> <p>912 B and C ..... \$780<br/>920 B and C ..... \$850</p> <hr/> <p><b>IMS MEMORY</b> 16 K static ..... \$285<br/>                  32 K static ..... \$585<br/>                  64 K Dynamic with parity ..... \$950</p> <hr/> <p><b>TEI MAINFRAMES, S-100</b></p> <p>12 slot ..... \$500<br/>22 slot ..... \$670</p> <hr/> <p><b>TARBELL</b></p> <p>Double density controller ..... \$420<br/>Cables ..... \$40</p> |
|------------------------------------------------------------------------------------------------------------------------------------------------------------------------------------------------------------------------------------------------------------------------------------------------------------------------------------------------------------------------------------------------------------------------------------------------------------------------------------------------------------------------------------------------------|-----------------------------------------------------------------------------------------------------------------------------------------------------------------------------------------------------------------------------------------------------------------------------------------------------------------------------------------------------------------------------------------------------------------------------------------------------------|

---

We have no reader inquiry number.  
Call on us for product sheets.  
Dealer inquiry invited.  
Prices subject to change without notice.

CODs accepted at no extra charge.  
Shipping \$14 for light printers and CRTs.  
Credit cards add 2%.  
NY residents add tax.

---

**WE EXPORT:** Overseas Callers: TWX 710 588 2844  
Phone 212 448-6298 or Cable: OWENSASSOC

---

**We Are Known for Our Prompt and Courteous Service!**

JOHN D. OWENS

Associates, Inc.      212 448-6298

212 448-6283      12 Schubert Street

212 448-2913      Staten Island, New York 10305

seminars on the use of computers in higher education for instruction, administration, and research. Contact Ron Langley, Director, Computer Center, California State University, Long Beach, 1250 Bellflower Blvd, Long Beach CA 90840, (213) 498-5459.

November 20-23

**Northeast Personal and Business Computer Show**, Hynes Auditorium, Boston MA. This is an annual exposition open to the general public. The admission will be \$5. Contact National Computer Shows, POB 678, Brookline Village MA 02147, (617) 739-2000.

November 21-23

**National Home Entertainment Show**, New York Coliseum, New York NY. Exhibits will cover video, photography, audio, games, and home computers. Seminars and demonstrations will be featured in this show. Contact United Business Publications Inc, 475 Park Ave South, New York NY 10016, (212) 725-2300.

December 1980

December 2-5

**The Eleventh International Conference of the Computer Measurement Group**, Sheraton-Boston Hotel, Boston MA. This conference is entitled "Computer Performance Evaluation in the 80s." Contact Judith G Abilock, Price Waterhouse & Company, Office of Government Services, 1801 K St, NW, Washington DC 20006, (202) 296-0800.

December 3-5

**The 1980 Winter Simulation Conference**, Orlando Marriott, Orlando FL. This conference will feature papers, panel discussions, tutorials, and review sessions on discrete and combined simulations. Contact Professor Tuncer I Ören, Chairman, Dept of Computer Science, University of Ottawa, Ottawa, Ontario K1N 9B4, Canada, (613) 231-5420.

December 4

**California Computer Shows**, Hyatt-Palo Alto, Palo Alto CA. Show hours are from 1 to 7 PM. OEM (original equipment manufacturers) and end-user computer and peripheral products will be exhibited and demonstrated by over 60 companies. Contact Norm De Nardi Enterprises, 95 Main St, Los Altos CA 94022, (415) 941-8440.

December 10

**1980 Computer Networking Symposium**, Gaithersburg MD. This symposium is

sponsored by the IEEE Computer Society, Technical Committee on Computer Communications, and the Institute for Computer Sciences and Technology of the National Bureau of Standards. The focus is on office

automation, office system components, and the computer networks required to interconnect them. For information, contact Executive Secretary, POB 639, Silver Spring MD 20901, (301) 439-7007. ■

*In order to gain optimal coverage of your organization's computer conferences, seminars, workshops, courses, etc, notice should reach our office at least three months in advance of the date of the event. Entries should be sent to: Event Queue, BYTE Publications, 70 Main St, Peterborough NH 03458. Each month we publish the current contents of the queue for the month of the cover date and the two following calendar months. Thus a given event may appear as many as three times in this section if it is sent to us far enough in advance.*

## Call on John D. Owens for all Your Computer Needs

COMPUTER CLUBS: discounts for 4 or more on most items.

**TELETYPE Model 43 Inventory Sale!!!**  
 Model 4320 AAK AAL ..... \$1,085  
 Model 4330 punch/reader. 10 or 30 CPS.  
 8 level, 1" tape ..... \$2,595  
 Limited supply of Model 45 available.

**IBM 3101 CRT Model 10** ..... \$1,195  
 Model 20 ..... \$1,395  
 Selectric-like, detached keyboard. 9x16 dot matrix.  
 Maintenance contract from IBM only \$70 per year.

**PET COMPUTERS INVENTORY SALE — LIMITED QUANTITIES**  
 Pet 2001N 32K ..... \$900  
 DUAL DISK SYSTEM ..... \$900

**ATARI SALE:** We are discontinuing this line and selling our stock at below wholesale prices. Hardware & software.

**MARINCHIP SYSTEMS M9900**  
 Elegant 16 bit CPU. S-100 compatible Multi user, multi processor operating system. Extended precision commercial BASIC, FORTH, META, PASCAL, Word Processor and Text Editor. Fast and powerful!  
 Complete kit and software package ..... \$550  
 Assembled ..... \$700  
 We configure complete systems with floppy or hard disk.  
**MARINCHIP USERS: QBASIC for the 9900** ..... \$220  
 16 bit, 32K words, 64K BYTES memory ..... \$1,050

**MICROANGELO** ..... \$2,280  
 High resolution graphics system. Microangelo feature 15", 22MHZ, green phosphor screen, 72 key keyboard; includes complete cabling and software. From SCION.

**GRAPHICS SOFTWARE** On line, real time, for the M9900 to drive the Microangelo. For use in design of PC board masks, IC masks and other applications usually requiring a \$200,000 system.

**COMPUTER TO COMPUTER COMMUNICATIONS**  
 Enables communications from a micro to a terminal or to another micro, mini or maxi computer. Modes of operation: TERMINAL (your system acts like an intelligent terminal), FILE-TO-FILE, LOCAL (Disk commands). Full/Half Duplex on 8" or 5" disks. COM to COM mode does full CRC 16 error check and retransmits block on error.  
 Object Code ..... \$75 Source Code ..... \$150

**CORVUS HARD DISK DRIVES** now being offered.

INDUSTRIAL  
 MICRO  
 SYSTEMS  
 TELETYPE  
 HAZELTINE  
 IBM  
 TELEVIDEO  
 TEI  
 TARBELL  
 CORVUS  
 PER SCI  
 NEC  
 ITHACA  
 INTERSYSTEMS  
 MARINCHIP  
 DATA SOUTH  
 QUME  
 CENTRONICS  
 TEXAS  
 INSTRUMENTS  
 ATARI  
 DEC  
 CALIFORNIA  
 COMPUTER  
 SYSTEMS  
 KONAN  
 EDGE  
 TECHNOLOGY  
 INNOSTRONICS  
 XEROX  
 DIABLO  
 INTEGRAL  
 DATA SYSTEMS  
 CROMEMCO  
 SOROC  
 MICROPRO  
 TELETEK  
 NOVATION  
 AMPEX  
 CDC  
 NORTH STAR  
 COMMODORE  
 SCION  
 MPI  
 POWER ONE  
 MEASUREMENT  
 SYSTEMS  
 AND CONTROL

# JOHN D. OWENS

212 448-6283

Associates, Inc.

212 448-6298

12 Schubert Street,  
 Staten Island, New York 10305

212 448-2913

# What's New?

## MISCELLANEOUS

### High-Speed Cassette for the TRS-80

The TC-8 allows the TRS-80 user to load programs five times faster than the standard cassette recorder allows. It runs at over 3000 bps (bits per second) with an error rate of less than one bad load in a million bytes, with the volume control anywhere between two and eight. The TC-8 cassette recorder supports the saving, loading, and verifying of BASIC programs, system programs, and data files. Features of this system include eight-character names for files and the ability to list the directory of all files on a tape. It is available in kit form for \$90 and fully assembled for \$120 from J P C Products Company, 12021 Paisano Ct, Albuquerque NM 87112, (505) 294-4623.

Circle 609 on inquiry card.

### Microplot 44

The Microplot 44 is a 44-column fixed-head thermal graphic printer for use with microprocessor-based systems. The printer features individual dot addressing, enhanced vector plotting, 256-dot resolution, manual and programmable mode selection, 96-character ASCII double-height and double-density characters, programmable tabs, and IEEE-488 and RS-232 interfaces. The price is under \$1000 from Gulton Industries Inc, Measurement and Control Systems Division, Gulton Industrial Park, East Greenwich RI 02818, (401) 884-6800.

Circle 610 on inquiry card.

### Heavy-Duty Printer from TEI

TEI Inc, 5075 S Loop E, Houston TX 77033, (713) 738-2300, has announced its Model 3431 heavy-duty, 150 cps (characters per second), dot-matrix printer. The printer offers up to 136-column printing using a 9-by-7 dot format to form ninety-four ASCII (American Standard Code for Information Interchange) characters, including lowercase letters with descenders, symbols, double-wide characters, and more. It also offers bidirectional printing. The pin-feed tractor accepts continuous and multipart forms. A parallel interface is standard and RS-232 serial interfaces are available. The unit price is \$1695.

Circle 611 on inquiry card.

### 1 to 1000 MHz Signal Generator



The Wavetek Model 3010 Signal Generator covers the entire frequency spectrum from 1 to 1000 MHz. It features 100 Hz resolution, 0.001% accuracy, complex modulation capabilities, and four internal modulation frequencies. Also featured are standard frequency programmability, Vernier controls for frequency and output level, and four FM (frequency modulation) and two AM (amplitude modulation) modulation scales. RF (radio frequency) power level is +13 to -137 dBm.

Flatness is  $\pm 0.75$  dBm. Frequency is set via seven lever/indicator switches to a resolution of 100 Hz. The Model 3010 is useful for tests of two-way radio, mobile telephones, paging receivers, and other systems that utilize techniques which superimpose subaudible tones or tone-coded signals on voice or other channels. The price is \$4750, from Wavetek Indiana Inc, 66 N First Ave, POB 190, Beech Grove IN 46107, (317) 783-3221.

Circle 612 on inquiry card.

### Computer System from GNAT

The System 10, developed by GNAT Computers Inc, features a Z80 processor, 64 K bytes of programmable memory, 700 K bytes of floppy-disk storage, a hard-disk interface, a DMA (direct memory address) controller, interrupt controller, and three serial I/O (input/output) channels. The system can also be configured with a 9511

arithmetic processor and an IEEE-488 GPIB interface. Software support consists of CP/M 2.0 and a screen editor. BASIC, FORTRAN, C, COBOL, Pascal, and other software are available. Application programs include word processing, accounting, and a mainframe telecommunication package. The price is \$4950 from GNAT Computers Inc, 7895 Convoy Ct, Bldg 6, San Diego CA 92111, (714) 560-0433.

Circle 613 on inquiry card.

### Where Do New Products Items Come From?

The information printed in the new products pages of BYTE is obtained from "new product" or "press release" copy sent by the promoters of new products. If in our judgement the information might be of interest to the personal computing experimenters and homebrewers who read BYTE, we print it in some form. We openly solicit releases and photos from manufacturers and suppliers to this marketplace. The information is printed more or less as a first in first out queue, subject to occasional priority modifications. While we would not knowingly print untrue or inaccurate data, or data from unreliable companies, our capacity to evaluate the products and companies appearing in the "What's New?" feature is necessarily limited. We therefore cannot be responsible for product quality or company performance.

# What's New?

## MISCELLANEOUS

### Ultraviolet EPROM Eraser



The QUV-T8 EPROM (erasable programmable read-only memory) eraser allows hobbyists to erase most industry standard ultraviolet EPROMs such as 2708, 2564, 2716, 2532, and 2704 series EPROMs. The device is capable of erasing up to twenty EPROMs at a time, with an erase time of approximately 25 minutes. The lamp has an estimated life of 7700 hours. It is available from Logical Devices Inc, 1525 N E 26th St, Ft Lauderdale FL 33305, (305) 566-6252.

Circle 619 on inquiry card.

### Speech Circuits Offered by Texas Instruments

The TI TMS5000-series speech-processing integrated circuits provide one hundred words of synthetic speech, and cost approximately \$13 in production quantities. Speech encoding on the TMS5100 speech synthesis circuit is achieved through pitch-excited Linear Predictive Coding (LPC). LPC is based on a linear equation to formulate a mathematical model of the human vocal tract and an ability to predict a speech sample based on previous ones. Codes for twelve synthesis parameters serve as inputs to the synthesizer device. Inputs to the digital filter take two forms: periodic and random. The periodic inputs are used to reproduce voiced sounds that have a definite pitch, such as vowel sounds or voiced fricatives such as Z, B, or D. A random input is used to model fricative sounds such as S, F, T, and SH. Output of the filter drives a converter, which in turn drives a speaker. The circuit can generate up to 10,000 speech samples per second. Contact Texas Instruments Inc, Inquiry Answering Service, POB 1443, M/S 653, Houston TX 77001.

Circle 620 on inquiry card.

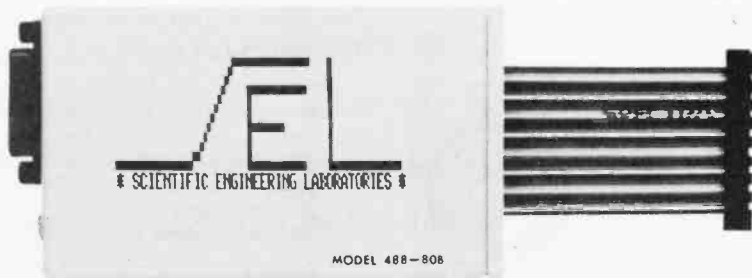

### Interface Adaptor for the TRS-80

Scientific Engineering Laboratories, 11 Neil Dr, Old Bethpage NY 11804, (516) 694-3205, has announced a device for interfacing the GPIB-488 instrument-control bus to the TRS-80 Model I. The Model 488-80B enables a TRS-80 Model

I with a minimum of 16 K bytes of programmable memory and Level II BASIC to be used as a GPIB-488 controller. A machine-level driver program that is provided with the unit interacts with Level II, Level III, or Disk BASIC. The price is \$225.

Circle 621 on inquiry card.

### 8-Bit D/A Converter

The AD558 D/A (digital-to-analog) converter features 1 ms maximum

voltage output settling time and operation from a single +5 to +15 V supply. The monolithic device is guaranteed to operate accurately over its entire temperature range without any user-supplied trimming resistors. Two output ranges of 0 to 2.55 V and 0 to 10 V are pin selectable and require no external components. The AD558 is available in four grades and two package types featuring direct microprocessor interface capability. The prices start from \$5.95 for single units in quantities of 100. Contact Analog Devices, Rt 1 Industrial Park, POB 280, Norwood MA 02062, (617) 329-4700.

Circle 622 on inquiry card.

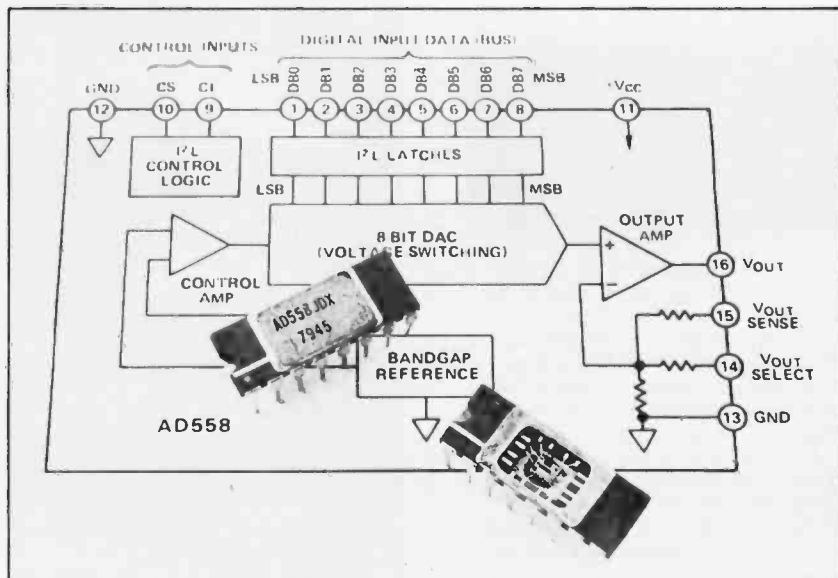
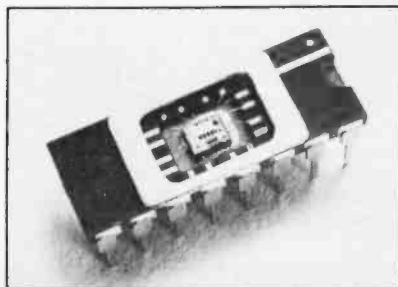

# What's New?

## MISCELLANEOUS

### Instrument Probe from B & K

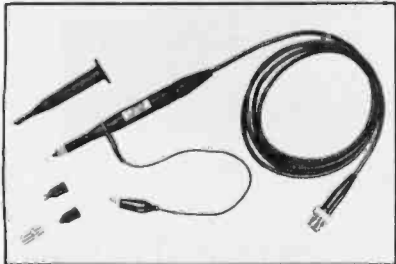

A wideband instrument probe has been announced by B & K-Precision/Dynascan Corporation, 6460 W Cortland St, Chicago IL 60635, (312) 889-9087. The Model PR-40 is designed for use with oscilloscopes and frequency counters in applications through 100 MHz. The PR-40 features a three-position switch which selects either a 10:1, direct mode, or a reference position that grounds the tip through a 9 megohm resistor. Accessories supplied include a spring-loaded retractable tip cover, insulating tip, a snap-on ground clip, BNC tip adapter, and an integrated circuit tip. The BNC adapter converts the probe tip into a push-on BNC connector for interfacing with test points or output jacks. The integrated circuit tip guide eliminates the possibility of shorting the pins of the circuit. The PR-40, with all the accessories, is priced at \$34.

Circle 614 on Inquiry card.

### Two Products from Vector Graphic

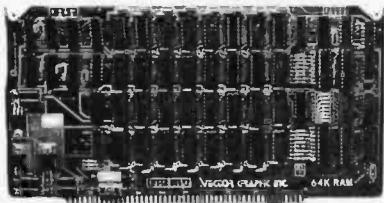

The Vector Graphic MP is a 5-by-7 dot-matrix, software-driven printer that can print at a speed of 150 cps (characters per second). The price of the MP is under \$1000 from Vector Graphic Inc, 31364 Via Colinas, Westlake Village CA 91361, (213) 991-2302. The Vector Graphic 64 K dynamic memory board is an 8-bit memory board which can be used with most Z80-based S-100 systems. The system offers bank selecting capability, allowing up to eight boards to be used in a system at the same time. Circle 615 on Inquiry card.

### Small-C Compiler for CP/M Systems

The Small-C compiler from The Code Works is available to CP/M users on a single-density 8-inch floppy disk. The compiler supports a large subset of the C programming language, and provides an interface to assembly language. The disk includes an executable Small-C

compiler, the complete source code for Small-C, and a demonstration program; the run-time support library and CP/M input/output functions as assembly-language source. The price is \$15 including a manual. Contact The Code Works, POB 550, Goleta CA 93017, (805) 967-0905.

Circle 616 on Inquiry card.

### Switching Power Supply for Diablo Printers

Boschert Inc, 834 Santa Trinita Ave, Sunnyvale CA 94086, (408) 732-2440, has introduced the OL 152, a power module for all Diablo printers. The OL 152 provides up to 170 watts of continuous power. Standard models are available in 110 and 220 V AC. Other

standard features include reverse voltage protection, a series thermistor that reduces line surges at turn-on, and over-voltage and short-circuit protection. The OL 152 for 110 V AC lists for \$179 in 1000-unit quantities, and the OL 152 for 220 V AC is \$186 per unit for 1000 units.

Circle 617 on Inquiry card.

### Standard and Fast Rectifiers from Motorola

The MR2400 series of TO-220 configured packages of standard and fast-recovery power rectifiers has been introduced by Motorola Semiconductor Products Inc, POB 20912, Phoenix AZ 85036, (602) 244-4624. The series ranges from 50 to 600 volts and can handle from 3 to 40 amps. The fast-recovery rectifiers are designed for applications such as switching power supplies, inverters, and converters. The fast-recovery types have a soft-recovery time of 200 ns maximum. The standard rectifiers

are designed for applications requiring a high current surge. Prices range from \$0.82 to \$2 in quantities of 100.

Circle 618 on inquiry card.

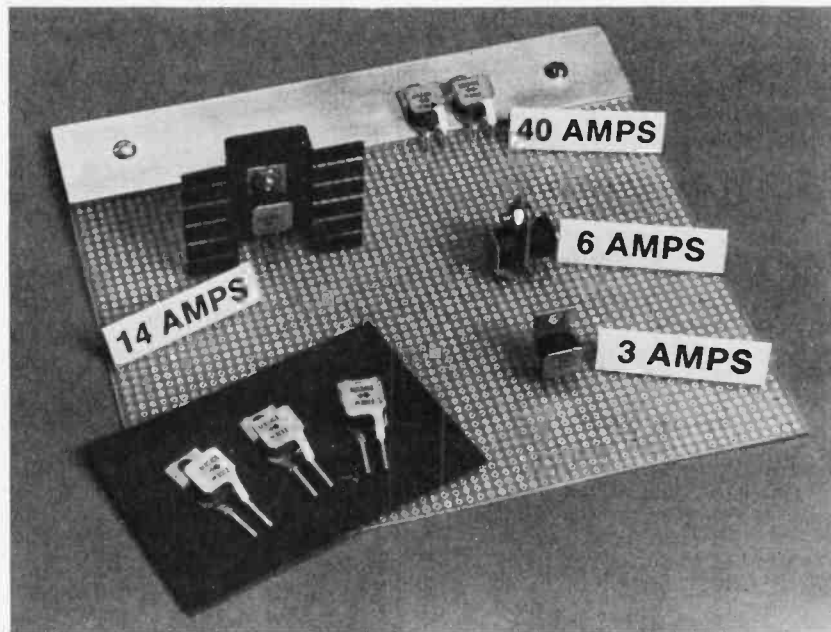
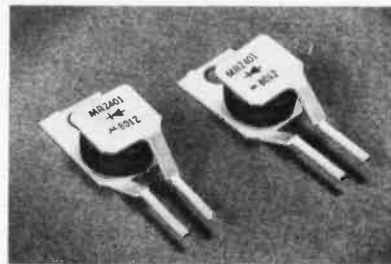

# What's New?

## MISCELLANEOUS

### Z8000 Business Computer

Onyx Systems Inc has introduced the Z8000 processor-based C8002 system. The C8002 supports eight users and both peripheral and communication devices; the computer supports a high-speed local network that allows many C8002s to be linked. The system combines Zilog's Z8000 16-bit microprocessor, a Winchester hard-disk drive, a cartridge tape drive, and up to 512 K bytes of programmable memory.

The Z8000 features 110 distinct instructions, eight addressing modes, and seven data types, including BCD (binary-coded decimal), string, and long word (32 bits). The main processor contains the Z8000 microprocessor, a direct memory address channel, serial and parallel I/O (input and output) ports, memory-management controller, floating-point processor, and support circuitry.

The operating system and all user programs are executed by the main processor. The mass-storage controller uses a Z80 processor and 64 K bytes of programmable memory to handle all disk and tape transactions. Bell Laboratories's UNIX timesharing operating system has been adapted for use on the C8002. This system enables users to share files, process text, and compile or execute programs written in BASIC, COBOL, FORTRAN, C, and Pascal. The C8002 is priced at \$16,000. Write or call Onyx Systems Inc, 37 E Trimble Rd, San Jose CA 95131, (408) 946-6330.

Circle 623 on inquiry card.

### Memory Board for Heathkit/Digital H-11

The CI-1103 memory board is designed for the Heathkit/Digital H-11, LSI-11/2, and PDP-11/03 computers. The new memory features an 8 K by 16 bit (dual width) board using 200 ns 4027 (4 K by 1 bit) dynamic memory devices. The CI-1103 is available with either on-board distributed refresh or external refresh control logic. Data-access time is 300 ns, and cycle time is 525 ns. On-board memory-select is available in 2 K increments up to 128 K words of memory. Power consumption is under seven watts. The 8 K by 16 board is \$390 and the 32 K by 16 board is \$750. Contact Chrislin Industries Inc, 31352 Via Colinas #102, Westlake Village CA 91361, (213) 991-2254.

Circle 624 on inquiry card.

### Prototype Board for the H-8 Bus

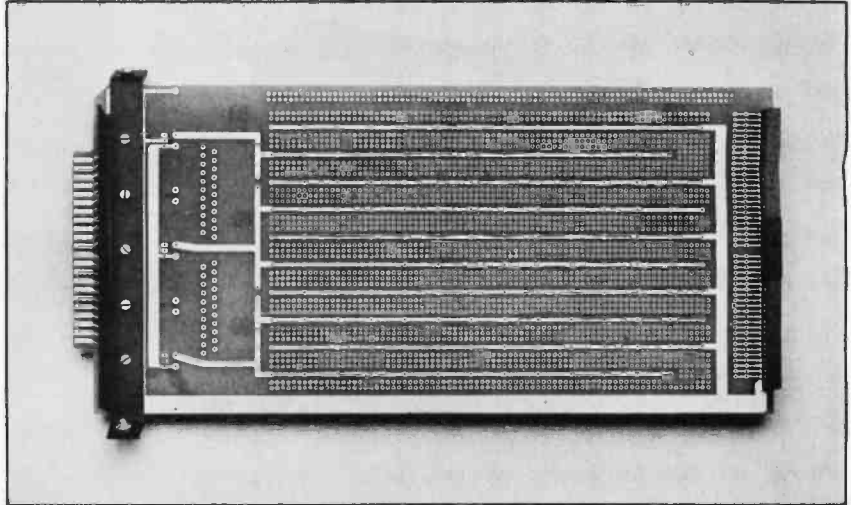

This prototype board will allow personal-computer users to build custom electronic interfaces for their Zenith/Heathkit H-8 personal computers. It is designed for use with a forty-four-pin edge-cable connector opposite the bus connector, or with many different Molex connectors from holes along the board top. There are locations

for 3 V to 5 V regulators, with locations for two filter capacitors, and extra holes for other voltage regulators. The price is \$46 per kit, from Mullen Computer Products, POB 6214, Hayward CA 94545, (415) 783-2866.

Circle 625 on inquiry card.

### Office Computer Under \$5000

The ALPHAsprint system includes 64 K bytes of programmable memory, a 45 K-byte display buffer, high-resolution 12-inch video display, and two double-density 5-inch floppy-disk drives capable of storing 330 K bytes of data. A Selectric II-type keyboard incorporates seventy-two character and function keys and a full numeric keypad. The optional 660-word-per-minute letter quality printer can be shared by up to three ALPHAsprints. Word-processing functions are oriented toward long document preparation. Other standard features include multispeed unlimited

bidirectional scrolling, eight cursor commands, and intercharacter right justification. Printing functions are under program control. Editing can occur in the foreground while other documents are being printed in the background. Automatic centering, boldface, underline, automatic pagination and repagination are standard. Applications software and CP/M, BASIC, FORTRAN, COBOL, and Pascal are available. The single quantity price for the ALPHAsprint is \$4990 from Alpha Professional Systems Inc, 9465 Wilshire Blvd, Suite 518, Beverly Hills CA 90212, (213) 272-3032.

Circle 626 on inquiry card.

### Direct Connect Modem for Multi- or Single-Line Phones

The D-CAT is an Federal Communications Commission (FCC) approved, Bell 103-compatible modem (modulator/demodulator) that can function on either a multi- or single-line phone. It works with a single-line phone

or fifty-pin, six-line business phones. The modem offers full-duplex capability, a voice/data monitor, a hold function, privacy button, and self-test features. The unit has a mode switch to allow the user to monitor whether voice or data is being transmitted. The D-CAT is priced at \$199 from Novation, 18664 Oxnard St, Tarzana CA 91356.

Circle 627 on inquiry card.

# What's New?

## MISCELLANEOUS

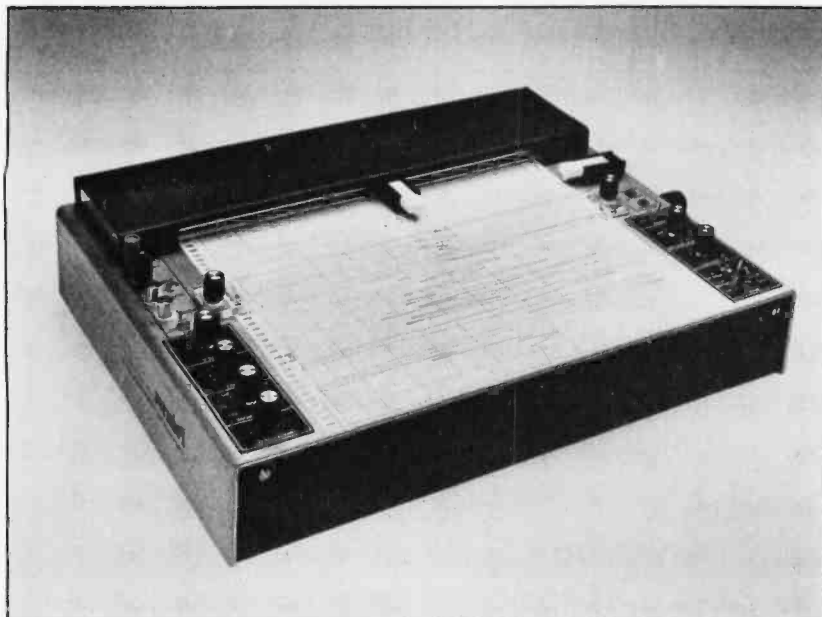

### High-Speed Transient Recorder

The Model 57-TR is a transient recorder that provides hard-copy output of recurring or single-shot transients. With switch-selectable conversion rates from 50 to 200 Hz, the 57-TR will convert analog input data into 10-bit digital words. Upon receiving a preselected trigger signal, the recorder will plot the information which has been stored. The operator can use an oscilloscope to view the analog input signal prior to, during, or after recording. Additional features include plotting rates of 20, 50, or 100 words per second;  $\pm$  trigger level control; variable input off-set of 0 to full scale; and chart speeds of 30 inches per minute when plotting. The list price is \$3300 from Pedersen Instruments, 2772 Camino Diablo, Walnut Creek CA 94596, (415) 937-3630.

Circle 658 on inquiry card.

### Books from Prentice-Hall

The list of computer books from Prentice-Hall includes *Structured System Programming; Software Development: A Rigorous Approach; 16-Bit Microprocessor Architecture; Microprocessors and Programmed Logic; Microcomputer Management and Programming*, and more. For information and a catalog, contact Prentice-Hall Inc, Englewood Cliffs NJ 07632.

Circle 659 on inquiry card.

### Graphics Terminal

A Tektronix Plot-10 software-compatible graphics terminal that provides four operating modes has been introduced by Continental Resources Inc, 175 Middlesex Tpk, Bedford MA 01730, (617) 275-0850. The Continental CPG-4010 graphics terminal provides automatic scaling to allow use of graphics, and compatible status read back that returns alpha cursor position and graphic status information upon receipt of an ESC ENQ. Using a Z80 microprocessor, the CPG-4010 operates in the ADM-3A Alpha, 4010 Alpha, vector, and point modes. Allowing full screen usage, the Plot-10 graphic grid is automatically scaled to the CPG-4010 grid. The terminal is priced at \$1995.

Circle 660 on inquiry card.

### Z80 Board from California Computer Systems

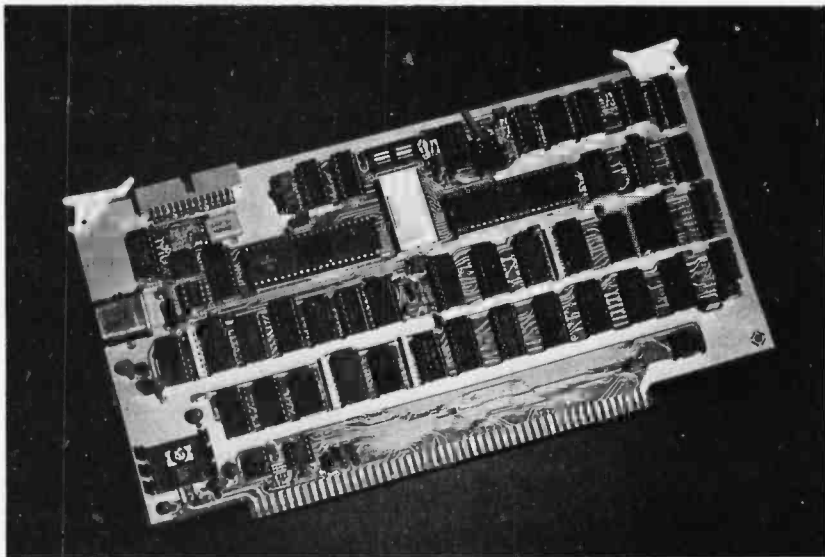

The 2810 Z80 single-board computer is designed for S-100 bus systems. It supports front panel operations and is fully compatible with the Altair and IMSAI computers. The board features easily selectable options including an RS-232 serial port that can be used for a console interface. Other options include I/O (input/output) address mirroring, a power-on jump to any location in memory, and wait states with optional wait state generation. Standard features for the 2810 include a 2 K-byte ROM

(read-only memory) containing monitor firmware. A switch allows the user to select a clock rate of 2 or 4 MHz. The board also features microprocessor and data rate integrated circuits with separate crystal controls, and LEDs (light-emitting diodes) to indicate a Halt state, ROM enabled, and Interrupt enabled. The 2810 is available for \$300 from California Computer Systems, 250 Caribbean Dr, Sunnyvale CA 94086, (408) 734-5811.

Circle 661 on inquiry card.



# What's New?

## SYSTEMS

### Intel's iSBC 80/10B Single-Board Computer

The iSBC 80/10B is fully compatible with the 80/10A board from Intel, and is expandable from 4 K to 16 K bytes of EPROM (erasable programmable read-only memory) and ROM (read-only memory). One K bytes of programmable memory are included and may be extended up to 4 K bytes. The iSBX parallel 350 and serial 351 I/O (input/output) boards provide expansion identical to on-board I/O. Two programmable, 16-bit BCD (binary-coded decimal) and binary timers are available for general use. Another multimodule board is the floating-point math board. This unit is compatible with the IEEE (Institute of Electrical and Electronics Engineers) format and offers single- and double-precision arithmetic functions. The 80/10B system provides a battery backup in the event of a power failure.

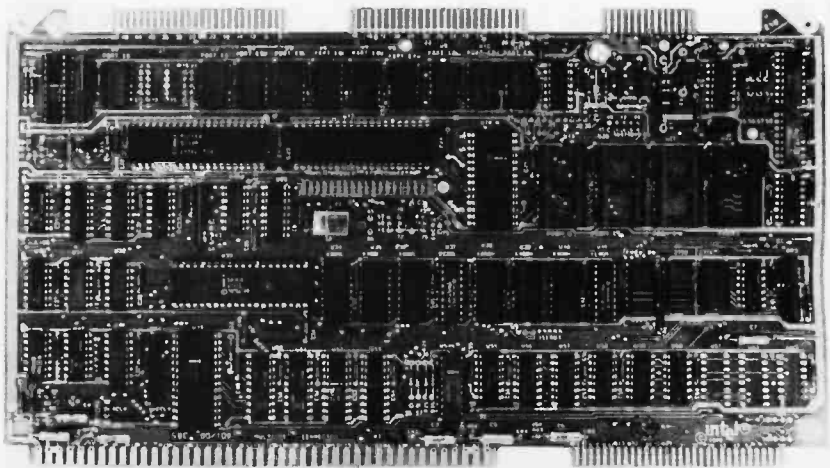

The price for the board is \$560. Prices for the parallel and serial I/O boards and the floating-point board range from \$155 to \$450. Contact Intel Corporation,

5200 NE Elam Young Pky, Hillsboro OR 97123, (503) 640-7147.

Circle 644 on Inquiry card.

### Vector System 2800 Makes Its Debut

The System 2800 consists of a Vector 3 terminal with the ZCB single-board computer, together with 64 K bytes of programmable memory, a floppy-disk controller, and a Flashwriter II video board featuring an 80-character by 24-line display. The second major feature is the Dualstor 8-inch floppy-disk drive unit, which has a total capacity of 2 megabytes. The formatting is

IBM compatible. The drives have an access time of 91 ms and a transfer rate of 500 K bps (bits per second). The standard software on the system is CP/M, Microsoft BASIC-80, RAID debugger, SCOPE editor, and the five Peachtree Software accounting packages are optional. The suggested retail price for the System 2800 is \$7295. Contact Vector Graphic Inc, 31364 Via Colinas, Westlake Village CA 91361, (213) 991-2302.

Circle 645 on Inquiry card.

### System 80-W from NNC

NNC Electronics has recently announced its System 80-W computer, a complete S-100 system built around the newly released 10-megabyte Shugart 8-inch Winchester hard disk. The system includes a floppy-disk controller and one Shugart 801R double-density floppy disk, a two-board hard-disk controller, a Z80A microprocessor running at 4 MHz, 64 K bytes of bank-selectable dynamic memory, eight-level vectored interrupts, a real-time clock, three parallel ports with line drivers for interfacing to all parallel printers, and two RS-232C serial ports with complete handshaking and programmable data-transfer rates. In addition, the computer conforms completely to the IEEE S-100 bus standard. For more information, contact NNC Electronics, 15631 Computer Ln, Huntington Beach CA 92649.

Circle 647 on Inquiry card.

### Zilog Introduces a Z8000 Board

A microcomputer board based on the Z8001 microprocessor is now on the market. The Z8000 board features 32 K bytes of programmable memory with parity protection, 8 K bytes of additional ROM (read-only memory) or PROM (programmable read-only memory) space, two communication channels, and a real-time clock. The Z8001 microprocessor is a segmented

unit characterized by a 414-member instruction set. The Z8001 can address up to 8 megabytes of memory. In addition, the board employs the Z80A serial I/O controller to incorporate two serial channels. Each channel is individually programmable to support synchronous or asynchronous protocols, including IBM Bisync, SDLC, HDLC, and CCITT-X.25. Other features include a parity-error detection circuit, three types of interrupts, and three LEDs (light-emitting diodes) to indicate when the microprocessor is in system mode, WAIT state, and I/O reference. The Z8000 microprocessor board is priced at \$2295. Other members of the family will be introduced later and are to include programmable memory, a single-board terminal, floppy-disk controller, and digital and analog I/O boards. For more information, contact Zilog, 10460 Bubb Rd, Cupertino CA 95014, (408) 466-4666.

Circle 646 on inquiry card.

### Microsette Gets New Name and New Product

Microsette Company has changed its name to Personal Micro Computers Inc. One new product from Personal Micro Computers is Fastload, which is an interface between the Radio Shack CTR-41 cassette recorder and the TRS-80 parallel port. Fastload permits standard cassettes in BASIC or SYSTEM formats to be loaded at 8000 bps (bits per second), sixteen times faster than the usual rate. Personal Micro Computers Inc is located at 475 Ellis St, Mountain View CA 94043, (415) 968-1604.

Circle 648 on Inquiry card.

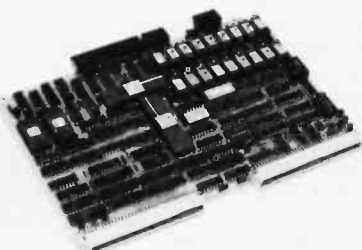

# What's New?

## SOFTWARE

### Real Estate Package for the TRS-80 and CP/M Systems



The Key Realty Management System is for TRS-80- and CP/M-based computers. The system includes listing control, escrow control, sales control, general ledger, and property management subsystems. Accounts payable and payroll are optional. The minimum

system provides for up to 300 listings, 100 sales associates, and 10 offices. The entire package is \$2500. Each subsystem is \$500. Contact Key Systems Inc, 16 Ocean East, Marathon FL 33050, (305) 743-5890.

Circle 639 on inquiry card.

### Pascal and FORTRAN for OSI Systems

Ohio Scientific, 1333 S Chillicothe Rd, Aurora OH 44202, (216) 831-5600, is offering UCSD Pascal and a FORTRAN based on a subset of the ANSI 77 standard. (ANSI is the American National Standards Institute.) The software runs on Ohio Scientific systems with 48 K bytes of memory and two floppy-disk drives. The system includes a screen-oriented text editor and a Pascal com-

piler. An assembler and run-time linker allow machine-code subroutines in either Pascal or FORTRAN. The software package also includes utilities for file maintenance, disk initialization, and disk duplicating. The package was developed and produced by SofTech Microsystems Inc and is sold through Ohio Scientific dealers. The package includes several disks, a Pascal primer, and manuals; price is \$450.

Circle 640 on Inquiry card.

### FMS-80

Systems Plus, 1921 Rock St, Suite 2, Mountain View CA 94043, (415) 969-7047, is distributing FMS-80, a database management system. This system allows users to program applications in less time than it normally takes with higher-level languages. It is completely menu driven and is written in assembly language. It runs on CP/M, MP/M, or Cromemco's CDOS operating systems. FMS-80 features screen formatting, report generation, multiple field handling, and arithmetic manipulation of multiple data records. There is no limit to the size of records or the number of fields.

Circle 641 on Inquiry card.

### HDOS Package for North Star Horizon

Southwest Computer Center has developed a hard-disk operating system for use with the Corvus hard disk and the North Star Horizon computer. HDOS is completely compatible with North Star's DOS 5.0. The hard disk is accessed through two drives that are capable of storing 8.4 and 1.6 megabytes. An incremental backup and recovery system for security (known as IBARS) has also been added. HDOS sells for \$125, and IBARS sells for \$75. The packages can be purchased from Southwest Computer Center, 121 Wyatt Dr, Suite 7, Las Cruces NM 88001, (505) 526-2842.

Circle 642 on inquiry card.

### A Bookkeeping Program

The DTI Bookkeeper I runs under CP/M and the TRSDOS operating systems and is written in Microsoft BASIC. The package includes general ledger, accounts receivable and payable, and payroll. Programs may be used separately, but they share consistent screen formats for user prompting. Maintenance for tax tables, W-2 forms, quarterly tax reports, financial statement headings, and other reports can be generated. One version of the package is for the TRS-80 Model I with 32 K bytes of programmable memory and dual disk drives; and the other version is for CP/M operating systems. The DTI Bookkeeper I is available for \$95 per module or \$335 for the entire package. Contact Data Train Inc, 840 NW 6th St, Suite 3, Grants Pass OR 97526, (503) 476-1467.

Circle 643 on inquiry card.

# What's New?

## SOFTWARE

### VisiCalc Now Runs on PETs and Atari Machines

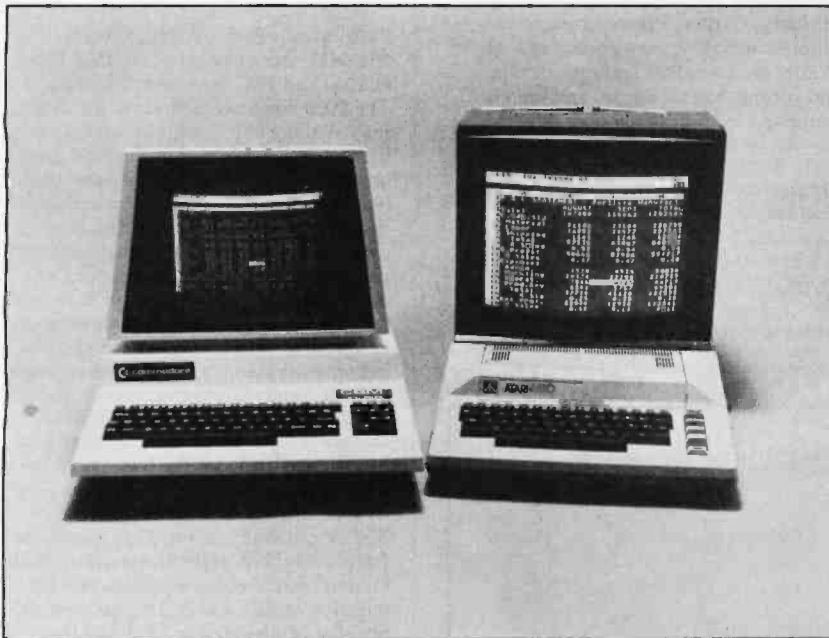

VisiCalc, from Personal Software Inc, 1330 Bordeaux Dr, Sunnyvale CA 94086, (408) 745-7841, is a software package that turns a personal-computer display into an interactive electronic worksheet. It is now available for the Commodore PET and CBM Model 8032 and Atari 800 computers. VisiCalc

creates a 64-column wide, 254-row high matrix on the screen. It is used instead of a calculator in businesses for inventory planning, sales forecasts, financial analyses, and modeling. Prices are available from local computer stores.

Circle 633 on inquiry card.

### Cross Assemblers

These development systems feature a macroassembler, an interactive editor/assembler, and a text editor. They enable CP/M systems to serve as development stations for the Intel 8048 series, RCA COSMAC 1802/1804, National COP400 series, and the Zilog Z8 processors. The development systems share a common operational structure. The assemblers feature instruction mnemonics and syntax as defined by the processor manufacturers. The macro-assembler includes full macroassembly and conditional assembly features, as well as the ability to chain a series of source files together during a single assembly. Programs developed under these systems must be off-loaded to the target processor for testing. Each development system is available for \$150 on CP/M 8-inch floppy disks, 5-inch North Star or Micropolis Mod II disks. Contact Allen Ashley, 395 Sierra Madre Villa, Pasadena CA 91107, (213) 793-5748.

Circle 634 on inquiry card.

### Data Base for the Hewlett-Packard HP-85A

The EDIT Division of Physiologic Corporation, 3800 Woodward Ave, Detroit MI 48201, (313) 831-8800, has introduced EDIT-85 for the HP-85A computer. This data-base management system supports all standard EDIT features such as validity and range checking during data entry, unlimited user viewing of the data, output-format control, data compression, nested data relations within files, and menu-oriented user prompts. EDIT applications include check/request, invoice, mail list, purchase order/request, and quote functions. The EDIT-85 and EDIT-4050 tape cartridge-based systems purchase price is \$1750, and the lease/equity plan is \$110 a month. The introductory applications are \$50 each or \$200 for all five on one tape. All EDIT systems receive 1 year of update privileges and the EDIT newsletter.

Circle 635 on inquiry card.

### Programs for Home Control

The Soft-Sonic programs provide for home control. They run on the Apple microcomputer with a BSR Ultrasonic System X-10 (Sears Home Controller). The package includes the transducer hardware, interface cable, and the programs on a floppy disk. The programs allow for control of lighting, appliances, and more, through user-defined timed sequences or by voice command using Heuristics Speech Lab. The price is \$39.95 from John Blankenship, BACE, POB 52785, Atlanta GA 30355.

Circle 636 on inquiry card.

### The Dow Jones Connection

The Dow Jones Connection is a stock-management system that interfaces the TRS-80 to the Dow Jones computer in Princeton, New Jersey. Interaction with the Dow Jones network is automatic and virtually instantaneous. The first step is to create one or more portfolios of up to twenty-five stocks each. When the portfolio is completed, a second program requests the user password and prepares the data for interrogation of the Dow Jones computer. A telephone call connects the two systems. Hard copy of the data can also be obtained through the user's printer. The Dow Jones Connection requires a TRS-80 Model I or II disk system or a Model I cassette system with a minimum of 32 K bytes of memory, and a Micro Connection modem which has an RS-232 output that can be used to drive a serial printer. For additional information, contact The MicroPeripheral Corporation, POB 529, Mercer Island WA 98040, (206) 454-3303.

Circle 637 on inquiry card.

### Color-Enhanced Business Packages

Peachtree Software has announced a color-enhanced version of its general business packages. The packages have been modified for the CP/M-compatible Intecolor unit at Intelligent Systems Corporation of Norcross, Georgia. Initially offered are the Accounting, Inventory, and Mailing Address systems. For more information, contact the marketing department, Retail Sciences Inc, 3 Corporate Sq, Suite 700, Atlanta GA 30329, (404) 325-8533.

Circle 638 on inquiry card.

# What's New?

## PERIPHERALS

### Floppy-Disk Attachment for Typewriters

The Phrasestore is a floppy-disk storage system that attaches directly to an IBM Model 50, 60, or 75 electronic typewriter. It includes two temporary



working storage memories with edit capabilities. No modifications are made to the typewriter. When power to the Phrasestore is off, the typewriter is electrically isolated. Edit features include add, delete, insert, merge, and search commands. An optional feature provides RS-232 asynchronous communications up to 9600 bps (bits per second). The Phrasestore is priced at \$1810. The communications option is \$350. Contact California Micro Computer, 9323 Warbler Ave, Fountain Valley CA 92708, (714) 968-0890.

Circle 628 on Inquiry card.

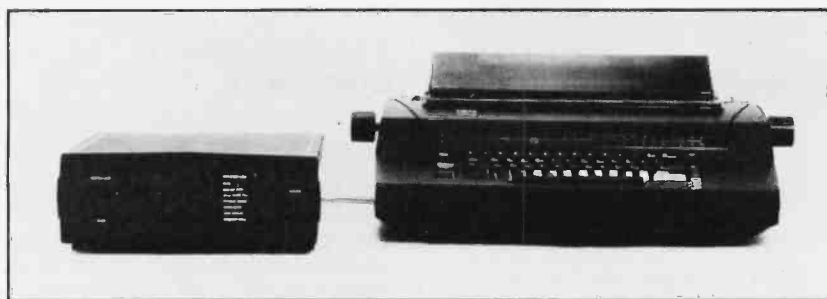

### Intelligent Modems

Business Computer Corporation, POB 7498, Menlo Park CA 94025, (415) 854-5434, has unveiled BIZCOMP Model 1030 and 1031 Intelligent Modems. The 1030 combines a modem, an automatic calling unit, and microcomputer into an FCC-registered unit with auto-answer, auto-dial, and auto-repeat dial features. BIZCOMP's code-multiplexed design allows intelligent modem control using the same terminal as that for data communication. Code-multiplexing enables software to be written in high-level languages. Applications include computer/terminal networking, financial transaction entry, store and forward message routing, remote data-base access, and remote computer diagnostics. RS-232 and current-loop interfaces are standard. Model 1031 includes the features of the 1030 plus command-selectable dial pulse or tone dialing, and self-test. The tone dialing capability of the 1031 is suitable for a CPT-TWX network interface. Both models feature automatic data-rate acquisition at 110, 134.5, 150, 200, or 300 bps. The Model 1030 is \$395 and the 1031 is \$495.

Circle 631 on inquiry card.

### Modules Control AC and DC Circuits

This I/O (input/output) system allows direct microprocessor control of industrial AC and DC circuits. Any mix of AC or DC, input or output solid state plug-in modules can be used in any position on the universal mount. All modules are optically isolated, fused, and have LED (light-emitting diode) indicators. Applications include energy management, machine and process control, and lighting systems. The price is \$10 to \$20 per circuit depending on configuration. Contact Wintek Corporation, 1801 South St, Lafayette IN 47904, (317) 742-8428.

Circle 629 on inquiry card.

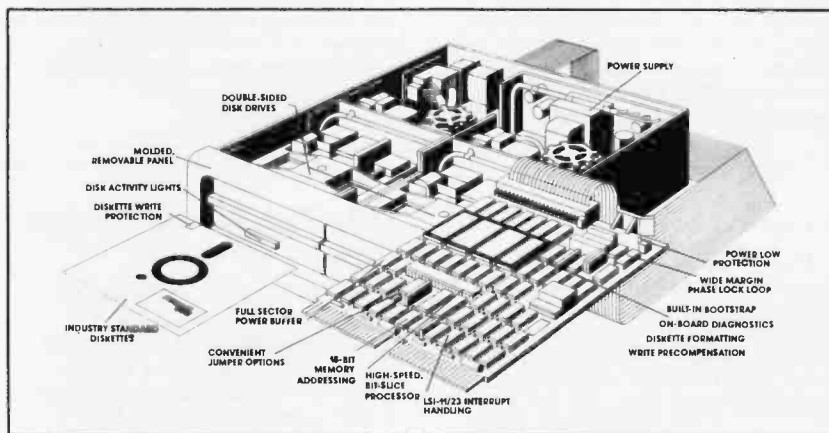

### 6502 Development System

Microproducts has introduced a 6502 development system. This system contains a text editor, assembler, disassembler, and symbolic debugger. It is available for the Apple II on a floppy disk and resides in 8 K bytes of programmable memory. The system is also available on EPROM (erasable programmable read-only memory) with socket adapters to replace Integer BASIC. The text editor supports the entry and maintenance of 6502 assembler text files. The assembler has been designed to process all 6502 op codes designated by MOS Technology, and other pseudo op

codes.

The disassembler will disassemble a specified portion of machine-resident code and produce a text file that is compatible with the assembler. The debugger executes programs step-by-step and displays each instruction along with the microprocessor registers, as well as values contained in up to five hundred user-selected memory locations. The disk version is \$125, a plug-in card of the system on EPROMs is \$395, and socket adapters that plug into the Apple II main board are \$249. Contact Microproducts at 30420 Via Rivera, Rancho Palos Verdes CA 90274, (213) 541-5131. Circle 630 on inquiry card.

### Two-Megabyte Floppy-Disk System

A double-sided double-density Digital Equipment Corporation (DEC) RX02-compatible floppy-disk system has been introduced by Data Systems Design Inc, 3130 Coronado Dr, Santa Clara CA 95051, (408) 727-9353. The DSD 470 is compatible with DEC LSI-11 computers and doubles the capacity of other DEC-compatible floppy-disk systems; it also provides LSI-11/23 multiple-level interrupt support. The DSD 470 is priced at \$4295.

Circle 632 on inquiry card.

# What's New?

## PUBLICATIONS

### Computer Supplies and Accessories

A thirty-six-page issue of the *MISCO Minicomputer Supplies & Accessories Catalog* offers the company's computer products, plus an expanded section of stock, custom and Digital Equipment Corporation-compatible cables; multi-point paper shipping for the lowest shipping costs; and the addition of BASF floppy disks to the selection of products. Catalog merchandise can be ordered by mail, TWX, or by a toll-free telephone number. The free catalog is available from MISCO Inc, POB 399, 963 Holmdel Keyport Rd, Holmdel NJ 07733, (201) 946-3500.

Circle 649 on inquiry card.

### Opto-Electronic Devices Detailed in Catalog

Ferranti Electric Inc has put together a catalog that details its line of solar cells, photodiodes, phototransistors, programmable integrated circuit photoswitches, and infrared detectors. A full product description, table of principal characteristics, and list of applications are provided for each device. Also featured is a section on Ferranti's custom design service. For a free copy, contact Ferranti Electric Inc, Semiconductor Products, 87 Modular Ave, Commack NY 11725, (516) 543-0200.

Circle 650 on inquiry card.

### Design of VMOS Circuits

*Design of VMOS Circuits, With Experiments*, by Robert T Stone and Howard M Berlin, features eleven chapters on the VMOS (vertical metal-oxide semiconductor), and its characteristics. The VMOSFET (vertical metal-oxide semiconductor field-effect transistor) is introduced, and some of its characteristics, such as high input impedances, nanosecond switching times, and low feedback capacitances, are explained. The theory of semiconductor operation and applications and limitations of VMOS devices are also covered. Audio, RF (radio frequency), power supply, and microcomputer applications are illustrated and discussed. The authors set up nine experiments using VMOSFETs. The book lists for \$8.95 from Howard W Sams and Company Inc, 4300 W 62nd St, Indianapolis IN 46268, (317) 298-5400.

Circle 651 on inquiry card.

### Brochure on Speech Technology Products from Texas Instruments



The *Solid State Speech Products and Services Brochure* provides information on voice-synthesis technology available from TI. The brochure describes linear predictive coding technology, vocabulary development for user applications, and solid state speech products. Included are TI's LSI (large-scale integration) voice-synthesis processors and voice synthesis memories, the TM990/306 speech module, and custom speech modules. The brochure is free from Texas Instruments Inc, Inquiry Answering Service, POB 225012, M/S 308, (Attn:CL-501), Dallas TX 75265.

Circle 652 on inquiry card.

### Manual for OSI BASIC Users

*All About OSI Microsoft BASIC in ROM* is a reference manual for Ohio Scientific computers that use Microsoft BASIC Version 1.0, Revision 3.2. Detailed descriptions of BASIC commands, statements, and functions are illustrated with short programs and sample runs. The book explains loops, tapes, and the USR(X) function. Some bugs and their fixes are discussed. Topics on the machine-language level include source code and variable storage, floating-point and two's complement numbers, maps of subroutine locations, and a description of the monitor and support ROMs (read-only memory) at \$FE and FF. The price is \$8.95 from E H Carlson, 3872 Raleigh Dr, Okemos MI 48864.

Circle 653 on inquiry card.

### Catalog from Synertek Systems

A catalog from Synertek Systems Corporation, 150 S Wolfe Rd, Sunnyvale CA 94086, (408) 988-5689, features descriptions and prices of SYM, KIM, and Superjolt products. Single-board computers, video displays, BASIC ROMs (read-only memory), programmable memory kits, and more, are featured.

Circle 654 on inquiry card.

### Catalog of Computer Forms

Moore Business Forms Inc, 1205 N Milwaukee Ave, Glenview IL 60025, (312) 291-8227, has published an eight-page brochure describing its products and services. Products featured are sales books, register forms and registers, snap-apart unit sets, self-mailing systems, print continuous and stock forms. Products for data-processing installations as well as word processing systems are included. Services such as Moore Creative Graphic Centers, Idea Centers, and worldwide sales are also covered.

Circle 655 on inquiry card.

### Nibble for the Apple

*Nibble Magazine* is focused on the Apple II and Apple II Plus computers. Each issue contains a central theme such as home finance, games, simulation, and data-base management. It also features hardware and software reviews, graphics, programming tips, games, and a hardware construction project. *Nibble* is published eight times a year by MicroSPARC Inc, POB 325, Lincoln MA 01773, (617) 259-9710. The subscription rate is \$15.

Circle 656 on inquiry card.

### PET Printout from Europe

*PET Printout* is a magazine from England published every five weeks. It includes news and technical reviews of PET-related products, programming articles and listings, questions and answers, applications stories, and a gossip column about PET personalities on both sides of the Atlantic. *Printout* is published ten times a year and costs \$30. Contact *Printout*, Greenacre, North St, Theale, Berkshire, RG7 5EX, England.

Circle 657 on inquiry card.

**COMPUTERS:**  
the  
INSIDE-*W* STORY  
BY TOM SLOAN

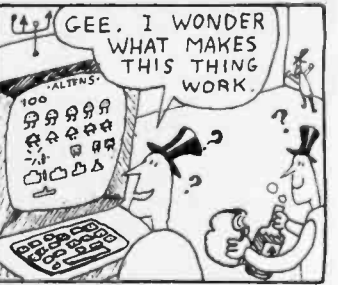
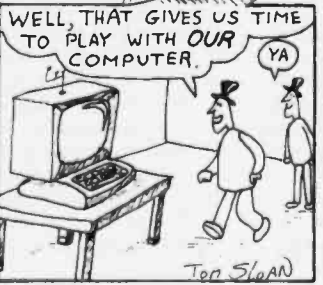
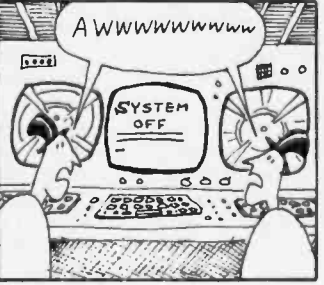
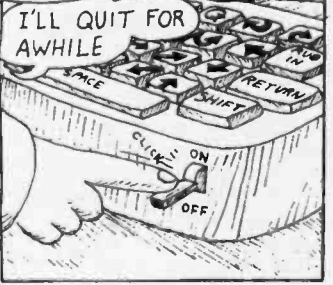
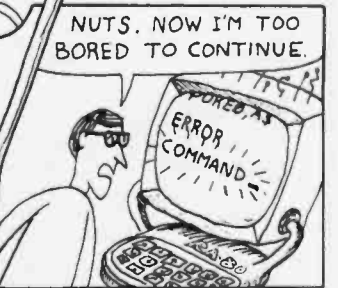
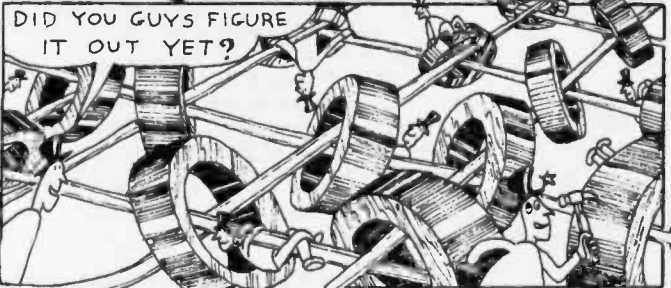
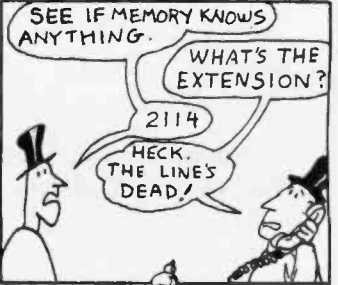
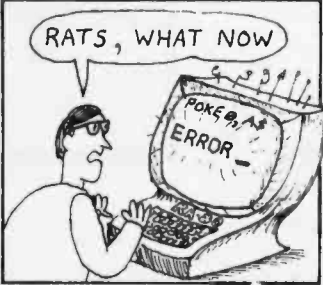
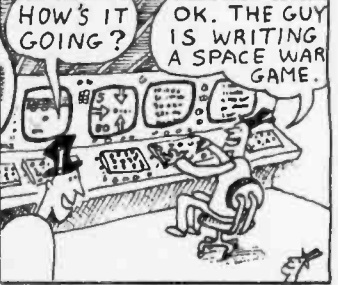
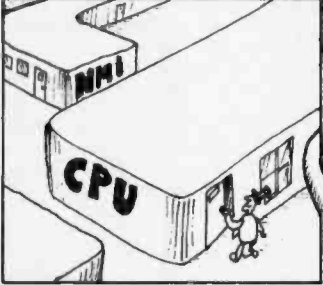
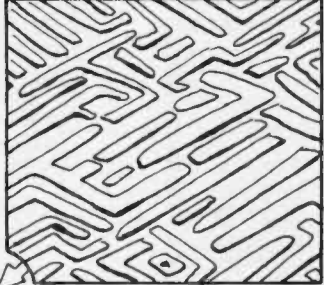
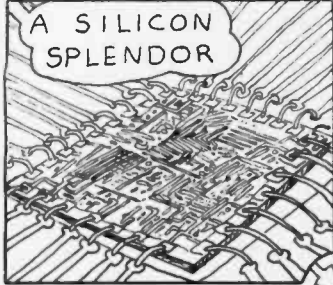
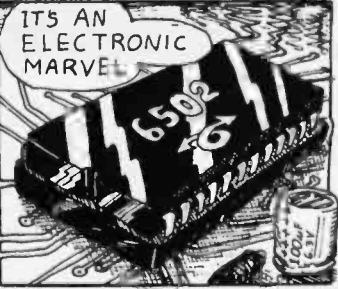
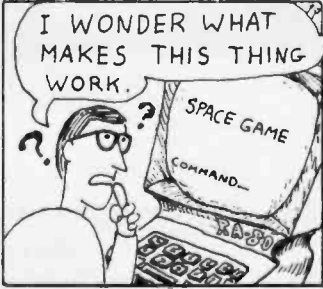
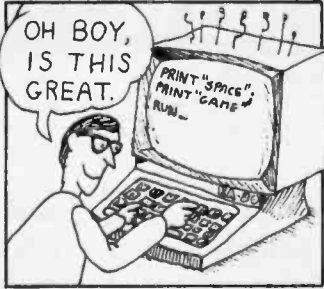

# WORLDS LARGEST MICROPOLIS SALE

## FACTORY CLEARANCE

Tell a Friend

### At Micropolis, complete means complete.

Some suppliers offer only hardware and call that complete. At Micropolis complete means everything: hardware and software and documentation.

The hardware set is complete with S-100/8080/Z-80 compatible controller, drive(s), cable-even a built-in Autoload bootstrap ROM to eliminate tiresome button pushing.

Our full Disk Extended BASIC and DOS, assembler and editor software comes complete, too. On its own diskette, ready to go. Software from Micropolis includes a DOS and Disk Extended Basic designed for 8080/Z80-based microcomputers.

DOS is a complete package, including an assembler, editor, file management functions and utilities, which provides total support for 8080 programming. BASIC is a self-contained package which provides a powerful set of tools for developing, testing, executing, and maintaining BASIC programs.

BASIC is designed for microcomputers with at least 24K bytes of RAM and a Micropolis MetaFloppy disk system. DOS can be used alone in a 16K bytes memory system.

Activating the built-in Auto load ROM brings up the system under control of the DOS executive. BASIC can be accessed by issuing a simple DOS command.

The 1053 MOD II Subsystem is designed for flexible, efficient programming. 8080 programs created under DOS can be loaded and accessed from BASIC. Data files created under BASIC can be processed by user written application programs running under the DOS.

### Imagine getting all the capacity of an 8-inch floppy in a 5 1/4-inch format.

MetaFloppy can give you this higher capacity because it packs more data into every disk. You get the capacity of larger 8-inch drives with the lower price and smaller packaging of 5 1/4-inch drives.

An ordinary 5 1/4-inch floppy provides just 35 tracks/drive and stores only 70K bytes. Not nearly enough for anything useful. So instead, we use 77 tracks—each with 16 sectors of 256 bytes/sector—to yield a capacity of 315K bytes/disk. That's more than four times an ordinary 5 1/4-inch floppy! And why we call this one "quad density."

Combine two of these drives in a compact dual module and you can copy diskettes from one drive to the other, or rearrange data files, or whatever. The dual unit stores 630K bytes. Enough for almost anything. But just in case that isn't enough, our controller can handle two duals (or four singles). That means your micro can have more than a million bytes of formatted disk storage.

If that still isn't enough, on special order you can add a second controller with up to four more drives. That will give you a grand total of over 2,500,000 bytes of storage on-line. This means, if your application keeps growing, we've got you covered in easy steps. And you get all these bytes at surprisingly low cost.

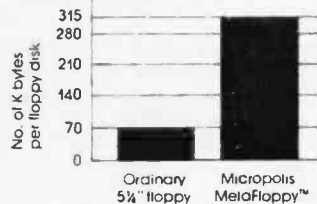
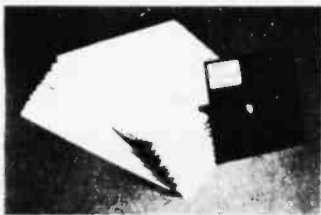

Each one of our floppy disks has a remarkable storage capacity, eliminating the need to keep bothersome stacks of paper.

### Faster than a speeding bullet.

At Micropolis, we don't skimp on performance to deliver maximum capacity. So you can expect professional operating speed and efficiency. Like checks and balances, such as automatic read verification after writing, that you would expect in a sophisticated data processing system.

Like last track-to-track positioning time of only 30 milliseconds. And a data transfer rate of 250,000 bits per second.

Up, Up, and away!

### Metafloppy gets along well with almost everyone.

So choose the microcomputer you want. MetaFloppy's controller is completely compatible with the S-100/8080/Z-80 bus. It just plugs into your MITS 8800, IMSAI 8080, COMPAL-80, SOL-20, Polymorphic 88, CROMEMCO, TDL, or similar micro and it's ready to go. The memory mapped controller/bootstrap may be originated at any 1K byte boundary in the 48K to 64K byte region of memory.

For small businesses, for engineers who want to develop their own software, or for the advanced hobbyist, MetaFloppy is ideal.

# MCP-1053 M2

TWO DISK SYSTEM WITH 630,000 BYTES  
(FORMATTED) OF ON-LINE STORAGE CAPACITY.  
THAT'S  
INCREDIBLE!!

SALE PRICED AT JUST \$995.00

LIST  
PRICE \$1895.00

**PRIORITY ONE ELECTRONICS**  
16723B Roscoe Blvd., Sepulveda, CA 91343

Terms: Visa, MC, BAC, Check, Money Order, U.S. Funds Only. CA residents add 6% sales tax. Just in case — please include your phone no. Prices subject to change without notice. We will do our best to maintain prices thru Oct. 1980.

\*Sale Prices are for prepaid order only. credit card orders will be charged appropriate freight.

ORDER TOLL FREE  
1-800-423-5633  
except CA, AK, HI, CALL  
(213) 894-8171

WE STOCK THE ENTIRE  
MICROPOLIS LINE  
CALL FOR PRICES  
DEALERS WELCOME

PICKED AT THE PEAK OF FRESHNESS

BUYERS GOOF!

BLOW 'EM OUT THE BARE WALLS

SAVE  
\$900.00

WE LOSE OUR LEASE... (\$500 REWARD FOR THE SAFE RETURN HERE OF)

# PRIORITY ONE ELECTRONICS

- Factory Assembled and Tested
- Auto Baud Rate Select
- Z-80 Refresh Option
- Z-80 Non Maskable interrupt Option
- PHANTOM Line Option
- Led's to Indicate: ROM Enable, Halt and Interrupt Enable
- CPU and Baud Rate IC's have separate Cystals
- 2 or 4 MHz Operation (selectable)
- Power On Memory Jump
- S-100 Altair/MSAI Compatible
- Z-80 Monitor Select/Deselect
- Responds to Wait State Generation
- M1 Wait State
- Front Panel Supported
- I/O Address Mirror
- 1-RS232 Serial Port, Selectable I/O Address with 100% Disable Option

## Z-80 SBC CPU

California Computer Systems  
ORDER PART NO  
**CCS-2810 \$300.00**

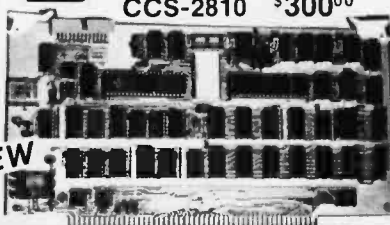

**NEW**

## MULTIMODE FLOPPY DISK CONTROLLER

California Computer Systems  
ORDER PART NO.  
**CCS-2422 \$400.00**

FREE COPY OF CPM 2.2\*



- Factory Assembled & Tested
- Based on Western Digital 1793 - IBM Format Compatible
- ROM Controlled Addressing
- Auto Boot
- Single and Double Density
- 5 1/4" and 8" Drives
- Write Precompensation
- Fast Seek if Voice Coil Type Drives
- Auto Eject (Percsi)
- Read Data Separator
- Data Input Filtering
- Digital Data Separator
- 2K Byte EPROM (2716) for Auto Boot
- Auto Wait Port Select
- Led's to Indicate Boot, Select and Bank
- Four Drive Select Lines

## NEW SPECTRUM S-100 COLOR GRAPHICS BOARD

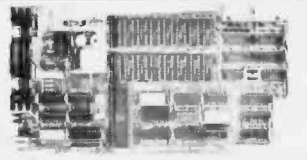

Includes 8K of IEEE-compatible static RAM; full duplex bi-directional parallel I/O port for keyboard, joystick, etc. interface; and 6847-based graphics generator that can display all 64 ASCII characters. 10 modes of operation, from alphanumeric/semi-graphics to 8 colors to ultra-dense 256 x 192 full graphics. 75 Ohm RS-170 line output and video output for use with FCC approved modulators. Introductory prices:

|                       | Reg.     | Sale     |
|-----------------------|----------|----------|
| GBT-144-U (Kit)       | \$339.00 | \$319.00 |
| GBT-144-A (Assembled) | \$399.00 | \$349.00 |

Don't settle for black and white graphics or stripped-down color boards; specify the CompuPro Spectrum.

Want graphics software? Sublogic's 2D Universal Graphics Interpreter (normally \$35) is yours for \$25 with any Spectrum board purchase.

GBT-2D \$25.00

## CK022 S-100 INTERFACER



Our new I/O board gives you unparalleled flexibility and operating convenience. We include such features as:

- 2 independently addressable serial ports (dip switch selectable addresses)
- Real LSI hardware UARTs for minimum CPU housekeeping
- RS232C, current loop (20mA), & TTL signals on both ports
- Precision, crystal-controlled baud rates up to 19.2K baud (individually dip switch selectable)
- Transmitt & receive interrupts on both channels, jumperable to any vectored interrupt line
- Industry standard RS232 level converters with five RS232 handshaking lines per port
- Optically isolated current loop with provisions for both on-board & off-board current sources
- UART parameters, interrupt enables & RS232 handshaking lines are software programmable with power-on hardware default to customer specified hard-wired settings for maximum flexibility
- Port connectors mate directly to ribbon cable & DB25 connectors in standard pinouts
- RS232 lines will conform to either master or slave configurations
- Board gives full feature operation with both 2 & 4 MHz systems
- Low power consumption. +5V @ 450mA, +16V @ 150mA, -16V @ 70mA max.
- No software initialization required for board operation, although board parameters may be altered by software 2 lbs.

|                           | Reg.     | Sale     |
|---------------------------|----------|----------|
| GBT-133U INTERFACER I UKT | \$199.00 | \$189.00 |
| GBT-133A INTERFACER I A&T | \$249.00 | \$219.00 |

## NEW! 32K X 8 ECONORAM XX

Static Storage for the S-100 buss

32K BANK SELECT! S-100 compatible 5 MHz guaranteed operation (0-70 c). Features 1 x 32K block positionable on any 4K boundary. Windows may be positioned every 4K. Bank Select port may be any one of 256 I/O Ports, and any data bit maybe used as a control bit. Perfect for use on Alpha Micro Systems, Marinchip, Cromemco, and others with IEEE 24 bit extended addressing. Uses 4K x 1 low power STATICrams. Current consumption guaranteed 3500 MA max. Shipping Weight 2 lbs.

|                       | Reg.     | Sale     |
|-----------------------|----------|----------|
| GBT-164-U16 16K UNKIT | \$349.00 | \$329.00 |
| GBT-164-A16 16K A&T   | \$419.00 | \$369.00 |
| GBT-164-U24 24K UNKIT | \$479.00 | \$449.00 |
| GBT-164-A24 24K A&T   | \$539.00 | \$479.00 |
| GBT-164-U32 32K UNKIT | \$649.00 | \$598.00 |
| GBT-164-A32 32K A&T   | \$729.00 | \$649.00 |

## SHIELDED/TERMINATED MOTHERBOARDS

A Must for Reliable System Operation!!!

These are third generation micro-motherboards set up to exceed the latest S-100 specs. Designed with operation of the newest 5 to 10 MHz MPUs in mind — with any of these motherboards, you won't have to start from scratch when you want to upgrade your system from 2 or 4 MHz operation.

True active termination — with split termination — half of the termination load at each end of every buss line. Grounded Faraday shield between all buss signal lines to minimize cross-talk. Heavy duty power traces for minimal power loss. Power connectors supplied. All edge connectors & termination resistors supplied soldered to board in "UNKIT" versions. All sizes fit Godbout, Vector, IMSAI, TEI, etc. enclosures.

All boards are double sided fiberglass epoxy, G10/FR4, with plated through holes & solder mask on both sides. A parts legend on the component side makes assembly a snap.

|                       | Reg.     | Sale     |
|-----------------------|----------|----------|
| GBT-155-A 20 SLOT A&T | \$214.00 | \$189.00 |
| GBT-153-A 12 SLOT A&T | \$169.00 | \$149.00 |
| GBT-154-A 6 SLOT A&T  | \$129.00 | \$119.00 |

## INTERFACER II

The new Interfacer II I/O board incorporates one channel of serial I/O with all the features of the INTERFACER dual RS232 serial board, plus 3 full duplex Parallel ports. The serial section includes all the features you've come to expect - a hardware UART, on-board crystal controlled Baud rate generator, hardware/software programmability, RS232 handshaking lines with real RS232 drivers, current loop & TTL drivers, full interrupts and more!!! The parallel selection utilizes LSTTL octal latches for latched input & output data with 24mA drive current, attention, enable & strobe bits for each parallel port (each with selectable polarity), interrupts for each input port, separate 25 pin connectors with power for each channel and a status port for interrupt mask and port status. All in all - an incredibly flexible and easy to use board.

|                            | Reg.     | Sale     |
|----------------------------|----------|----------|
| GBT-150U INTERFACER II UKT | \$199.00 | \$189.00 |
| GBT-150A INTERFACER II A&T | \$249.00 | \$219.00 |

|                                        | Reg.     | Sale     |
|----------------------------------------|----------|----------|
| GBT-143U ECONORAM XIV 16K RAM UNKIT    | \$299.00 | \$279.00 |
| GBT-143A ECONORAM XIV 16K RAM A&T      | \$349.00 | \$298.00 |
| GBT-144U SPECTRUM (Color graphics) KIT | \$339.00 | \$319.00 |
| GBT-144A SPECTRUM (Color graphics) A&T | \$399.00 | \$349.00 |
| GBT-160U CPU-Z80 KIT                   | \$225.00 | \$210.00 |
| GBT-160K CPU-Z80 A&T                   | \$295.00 | \$269.00 |
| GBT-161U CPU-8085 KIT                  | \$235.00 | \$220.00 |
| GBT-161A CPU-8085 A&T                  | \$325.00 | \$259.00 |
| GBT-188U CPU-8085/8088 KIT             | \$385.00 | \$365.00 |
| GBT-188A CPU-8085/8088 A&T             | \$495.00 | \$449.00 |
| GBT-80X-DESK (S-100 Mainframe)         | \$289.00 | \$269.00 |
| GBT-80X-DESK (S-100 Mainframe)         | \$329.00 | \$309.00 |

## ECONOROM 2708

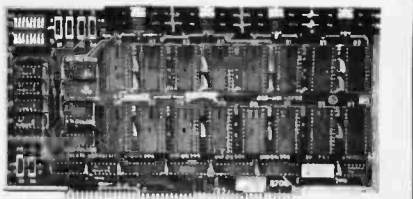

Has provisions for wait states for 4MHz operations. Configured as four 4K blocks - each independently addressable and disableable. Power-on jump. Does NOT include 2708s. Includes all support chips, sockets, regulators, heat sinks, etc. Sold in UNKIT form only. Shipping Weight 2 lbs.

GBT-125U ECONOROM 2708 UKT \$85.00

## ECONORAM XA 32K RAM



- 4 MHz with Z80
- 5 MHz with 8085
- Assembled and Tested
- S-100 Compatible
- Fully Static

Reg. \$689.00  
Sale Priced **\$450.00**

Order No. GBT129A32

# PRIORITY ONE ELECTRONICS

Circle 259 on Inquiry card.

SEND \$1.00 FOR 52 PAGE CATALOG

SEND \$1.00 FOR 52 PAGE CATALOG



# PRIORITY ONE ELECTRONICS

- Features:
- -8V at 8 Amps
  - -16V at 4 Amps
  - 16V at 1 Amps
  - 110V/220V Adjustable Input
  - Industrial Quality
  - Fused Outputs
  - Conservatively Rated
  - Rack Mountable
  - Cut Out for Fan
  - Manufactured by Alpha Power
  - Brand New!
  - Documentation Included

## S-100 POWER SUPPLY SPECIAL PURCHASE

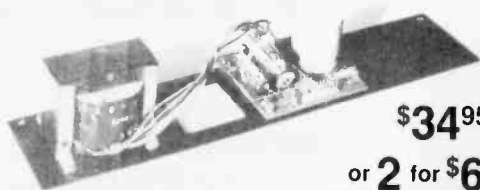

Priority 1 Electronics made this special purchase when a large OEM customer defaulted. Take advantage of the Great Opportunity! HURRY, limited quantity. At these prices they won't last long.

\$34.95

or 2 for \$60.00

## TRS-80/APPLE MEMORY EXPANSION KITS

4116's RAMS

(16Kx1 200/250ns)

8 for \$44.00

100%  
GUARANTEED

1,000's  
SETS SOLD

ADD \$3.00 FOR PROGRAMMING JUMPERS  
FOR TRS-80 KEYBOARD

4116's 100 pcs & UP \$5.20 each

1000 pcs & UP \$4.45 each

## ANACOM 150 DOT MATRIX PRINTER



Order # ANA150S — with Serial Int.  
ANA150P — with Parallel Int.

LIST PRICE \$1350.00  
OUR PRICE \$995.00

### FEATURES:

- 150 Characters per second
- Bidirectional printing, logic seeking
- 9 x 9 Dot matrix
- Upper and lower case with decoders
- Double width characters
- 10 Characters per inch — horizontal
- 6 or 8 Lines per inch — vertical
- Adjustable tractors
- Original and 4 copies
- Parallel or serial interface (you must specify)

The ANACOM-150 is a highly dependable receive only printing terminal. It's modular construction combines rugged quality with convenient serviceability. It is factory warranted for 90 days with an extended service contract available for continued customer protection.

## COMPUTER SYSTEMS INC. IIES S-100 COMPATIBLE

Z80 CPU REV II

- 1K ram on board
- 2 programmable timers
- 2 or 4 MHz selectable
- Jump start to any 1K address
- Programmable baud rate selection (110 to 9600)
- On board Eprom may be disabled
- On board USART for RS-232 serial I/O
- Parallel I/O port

|            |                 |          |
|------------|-----------------|----------|
| QTCZ80R2B8 | (Bare Board)    | \$ 60.00 |
| QTCZ80R2K  | (Kit)           | \$190.00 |
| QTCZ80R2A  | (A&T)           | \$280.00 |
| QTCZ801KM  | (1K Memory Kit) | \$ 12.00 |

### EXPANDABLE + DYNAMIC MEMORY (16K to 64K)

- Works with Cromemco, Northstar, SD Systems & many other CPU boards.
- Uses 3242 Refresh Chip with Delay Line.
- 4 layer board for quiet operation.
- 24 address lines (IEEE spec).
- Optional M1 Wait State allows error-free operation with faster processors.
- Optional Phantom Disable.
- Uses Z80 Refresh Signal.
- Bank select at I/O port 40H per industry standard.
- Bank In use determined by convenient DIP switch selection of data bus bits.
- Low power (5 watts).
- Convenient LED Indication of bank in use.
- Board access time with (4116-200NS)-240NS.

|          |            |          |
|----------|------------|----------|
| QTCXPBB  | Bare Board | \$ 70.00 |
| QTCXP16K | 16K Kit    | \$280.00 |
| QTCXP16A | 16K A&T    | \$325.00 |
| QTCXP32K | 32K Kit    | \$330.00 |
| QTCXP32A | 32K A&T    | \$425.00 |
| QTCXP48K | 48K Kit    | \$380.00 |
| QTCXP48A | 48K A&T    | \$550.00 |
| QTCXP64K | 64K Kit    | \$430.00 |
| QTCXP64A | 64K A&T    | \$625.00 |

### CLOCK CALENDAR +

- Time of day in hours, minutes and seconds
- 24 hour format
- Month and day date functions
- Simple read instruments allow simple interface to basic, CP/M, etc.
- Will run with 4 MHz processors
- Can be located at any group of 4 I/O port addresses

|         |          |
|---------|----------|
| QTCSS8B | \$ 45.00 |
| QTCSSK  | \$ 99.95 |
| QTCSSA  | \$149.95 |



LIST PRICE \$79.95  
SALE PRICE \$59.95  
ORDER GOF-IBAR46

### PROTECT YOUR INVESTMENT PROTECT YOUR DATA WITH

THE ISOBAR ELECTRICAL OUTLET STRIP CONSISTS OF A MASTER POWERSWITCH, INDICATOR, AND 4 INDIVIDUAL 3 WIRE OUTLETS, EACH WITH ITS OWN NOISE FILTER AND SURGE SUPPRESSOR TO PROTECT YOUR EQUIPMENT FROM DANGEROUS TRANSIENTS FROM OTHER EQUIPMENT PLUGGED INTO YOUR ISOBAR OR FROM WHATEVER THE POWER COMPANY IS DOING OUT.

WARNING: "Murphy's Law" predicts that after reading this ad and not acting, your equipment will soon be destroyed by a fatal Glitch.

## ROBINSON RUGENT, INC.

### GOLD 3 LEVEL WIRE WRAP SOCKES



SALE PRICE  
14, 16 & 24 PIN

|          |             |
|----------|-------------|
| RNS-14G3 | 120/\$42.00 |
| RNS-16G3 | 104/\$40.00 |
| RNS-24G3 | 51/\$36.00  |

|                        |           |             |
|------------------------|-----------|-------------|
| TI LOW PROFILE SOCKETS | TIS-16 LP | 100/\$16.00 |
|                        | TIS-14 LP | 100/\$14.00 |

### RS232 and "D" SUB-MINIATURE CONNECTORS



P = Plug, Male Type - S = Socket, Female Type - C = Cover, Hood

| PART NO.    | DESCRIPTION                                                   | 1-9     | 10-24   | 25-99   |
|-------------|---------------------------------------------------------------|---------|---------|---------|
| CNO-0E9P    | 9 PIN MALE                                                    | \$ 2.10 | \$ 1.90 | \$ 1.70 |
| CNO-0E9S    | 9 PIN FEMALE                                                  | \$ 2.70 | \$ 2.40 | \$ 2.10 |
| CNO-0E9C    | 9 PIN COVER                                                   | \$ 1.50 | \$ 1.25 | \$ 1.10 |
| CNO-0A15P   | 15 PIN MALE                                                   | \$ 2.75 | \$ 2.45 | \$ 2.15 |
| CNO-0A15S   | 15 PIN FEMALE                                                 | \$ 3.95 | \$ 3.60 | \$ 3.20 |
| CNO-0A15C   | 15 PIN COVER                                                  | \$ 1.50 | \$ 1.30 | \$ 1.10 |
| CNO-0B25P   | 25 PIN MALE                                                   | \$ 3.50 | \$ 3.25 | \$ 3.00 |
| CNO-0B25S   | 25 PIN FEMALE                                                 | \$ 4.60 | \$ 4.35 | \$ 4.20 |
| CNO-0B51212 | 1 PC. GREY HOOD                                               | \$ 1.60 | \$ 1.45 | \$ 1.30 |
| CNO-P25H    | 2 PC. GREY HOOD                                               | \$ 1.50 | \$ 1.25 | \$ 1.10 |
| CNO-0B51226 | 2 PC. BLACK HOOD                                              | \$ 1.90 | \$ 1.65 | \$ 1.45 |
| CNO-0C37P   | 37 PIN MALE                                                   | \$ 5.80 | \$ 5.10 | \$ 4.45 |
| CNO-0C37S   | 37 PIN FEMALE                                                 | \$ 8.70 | \$ 7.70 | \$ 6.70 |
| CNO-0C37C   | 37 PIN COVER                                                  | \$ 1.80 | \$ 1.55 | \$ 1.30 |
| CNO-0D50P   | 50 PIN MALE                                                   | \$ 8.75 | \$ 7.75 | \$ 6.70 |
| CNO-0D50S   | 50 PIN FEMALE                                                 | \$11.65 | \$10.25 | \$ 8.90 |
| CNO-0D50C   | 50 PIN COVER                                                  | \$ 2.00 | \$ 1.80 | \$ 1.60 |
| CNO-0D0418  | HARDWARE SET 2 PR. RS232, DB25P, EIA                          | \$ 1.00 | \$ 0.80 | \$ 0.70 |
| CNO-RS2328F | CLASS 1 CABLE 8 CON. 8 FT. CENT. 700 SERIES PRINTER CONNECTOR | \$19.95 | \$17.95 | \$15.95 |
| CNO-573036D |                                                               | \$ 9.00 | \$ 7.50 | \$ 6.00 |

### 3 LEVEL GOLD WIRE WRAP SOCKETS PRICE\*

| PART NO.  | PINS | 1-9  | 10-24 | 25-99 | 100-249 | 250-999 |
|-----------|------|------|-------|-------|---------|---------|
| RNS-08WWG | 8    | .50  | .42   | .40   | .37     | .33     |
| RNS-14WWG | 14   | .60  | .49   | .47   | .45     | .42     |
| RNS-16WWG | 16   | .65  | .52   | .50   | .47     | .44     |
| RNS-18WWG | 18   | .85  | .75   | .70   | .65     | .60     |
| RNS-20WWG | 20   | 1.00 | .90   | .80   | .75     | .70     |
| RNS-22WWG | 22   | 1.25 | 1.15  | 1.10  | 1.05    | 1.00    |
| RNS-24WWG | 24   | 1.25 | 1.15  | 1.10  | 1.05    | 1.00    |
| RNS-28WWG | 28   | 1.60 | 1.50  | 1.40  | 1.30    | 1.20    |
| RNS-40WWG | 40   | 1.85 | 1.65  | 1.55  | 1.45    | 1.35    |

\*Price based on gold not exceeding \$400.00 per oz.



Verbatim

| Part No.      | Sectoring      | Application  | Pk. of 2 | Box of 10 |
|---------------|----------------|--------------|----------|-----------|
| VRB-MD 525-01 | Soft Sector    | TRS 80 Apple | \$ 8.95  | \$29.95   |
| VRB-MD 525-10 | Hard 10 Sector | North Star   | \$ 8.95  | \$29.95   |
| VRB-MD 525-16 | Hard 16 Sector | Microplus    | \$ 8.95  | \$29.95   |
| VRB-FD32-1000 | Hard Sector    | Shugart 801R | \$11.95  | \$37.00   |
| VRB-FD34-1000 | Soft Sector    | IBM 3740     | \$11.95  | \$37.00   |

SHIPPING WEIGHT 1 LB

BE SURE TO ORDER YOUR KASSETTE/10 LIBRARY CASE BELOW

## KASSETTE/10 LIBRARY

| Part No.  | GREY BLACK BLUE BEIGE | 8" DISKETTE HOLDER \$4.50 or 3/\$11.00 |
|-----------|-----------------------|----------------------------------------|
| MMM-KS-10 |                       |                                        |
| MMM-KM-10 |                       | 5" DISKETTE HOLDER \$4.25 or 3/\$10.00 |



THE STAR MODEM FROM LIVERMORE

LIST PRICE \$199.00

SALE PRICED \$139.00

0 to 300 baud data rate. Compatible with Bell 103 and 113. Answer/Originate, Full/Half Duplex. Special self test features

## MEMORY HEADQUARTERS

|                              |                  |
|------------------------------|------------------|
| 2716 16K 5 Volt only EPROM   | \$16.00 ea.      |
|                              | 10/\$150.00      |
| 2708 8K 450ns EPROM          | 8/\$55.00        |
|                              | \$8.00 ea.       |
| 2114-3L 1Kx4 300ns Low Power | \$ 45.00         |
|                              | 100 + \$4.00 ea. |
| 5257-3L 4Kx1 300ns Low Power | 8/\$55.00        |
|                              | 100 + \$5.00 ea. |

FOR MORE INFORMATION SEE OUR 52 PAGE AD IN JANUARY BYTE OR SEND \$1.00 FOR CATALOG

• Sale Prices are for prepaid orders only • Quantities are limited, subject to prior sale • CREDIT CARD ORDERS WILL BE CHARGED APPROPRIATE FREIGHT

## PRIORITY ONE ELECTRONICS

16723B Roscoe Blvd. Sepulveda, CA 91343

Terms: Visa, MC, BAC, Check, Money Order, U.S. Funds Only. CA residents add 6% sales tax, Minimum order \$10.00 Prepaid U.S. orders less than \$75.00 include 5% shipping and handling. MINIMUM \$2.50. Excess refunded. Just in case... please include your phone no. Prices subject to change without notice. We will do our best to maintain prices thru October, 1980

\*SOCKET and CONNECTOR prices based on GOLD, not exceeding \$500 per oz.

\*Sale Prices are for prepaid orders only credit card orders will be charged appropriate freight

# PRIORITY ONE ELECTRONICS

Circle 259 on inquiry card.

SEND \$1.00 FOR 52 PAGE CATALOG

SEND \$1.00 FOR 52 PAGE CATALOG

ORDER TOLL FREE  
1-800-423-5633  
except CA, AK, HI, CALL  
(213) 894-8171

**SAVE  
TRS-80's**



# TRS-80's

DISCOUNTS of 10%, 15% and More available.

WE PAY Domestic U.P.S. shipping and insurance on minimum orders.

NO TAXES are collected on out-of-state shipments.

TOLL FREE Order Number 800/531-7466.

OPEN 8:00 a.m. to 6:00 p.m., Central Time, Monday through Friday; 9:00 a.m. to 6:00 p.m., Saturday.

## Pan American Electronics Incorporated

A **Radio Shack**

AUTHORIZED SALES CENTER

1117 CONWAY MISSION, TEXAS 78572

TOLL FREE ORDER NUMBER 800/531-7466

TEXAS AND PRINCIPAL TELEPHONE NUMBER 512/581-2765

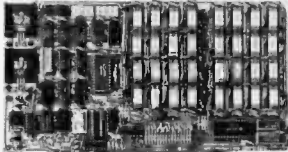

### 64K BYTE EXPANDABLE RAM

DYNAMIC RAM WITH ON BOARD TRANSPARENT REFRESH GUARANTEED TO OPERATE IN NORTHSTAR, CROMEMCO, VECTOR GRAPHICS, SOL, AND OTHER 8080 OR Z-80 BASED S100 SYSTEMS • 4MHZ Z-80 WITH NO WAIT STATES.

- \* SELECTABLE AND DESELECTABLE IN 4K INCREMENTS ON 4K ADDRESS BOUNDARIES.
- \* LOW POWER—8 WATTS MAXIMUM.
- \* 200NSEC 4116 RAMS.
- \* FULL DOCUMENTATION.
- \* ASSEMBLED AND TESTED BOARDS ARE GUARANTEED FOR ONE YEAR AND PURCHASE PRICE IS FULLY REFUNDABLE IF BOARD IS RETURNED UNDAMAGED WITHIN 14 DAYS.

|         | ASSEMBLED / TESTED |
|---------|--------------------|
| 64K RAM | \$595.00           |
| 48K RAM | \$529.00           |
| 32K RAM | \$459.00           |
| 16K RAM | \$389.00           |



S100 MAINFRAME AND CARD CAGE

- \* W/ SOLID FRONT PANEL . . . \$239.00
- \* W/ CUTOUTS FOR 2 MINI-FLOPPIES . . . \$239.00
- \* 30 AMP POWER SUPPLY . . . \$119.00
- \* 8 SLOT MOTHERBOARD . . . \$149.00
- \* 19 SLOT MOTHERBOARD . . . \$199.00

### 16K MEMORY EXPANSION KIT ONLY \$58

FOR APPLE, TRS-80 KEYBOARD, EXIDY, AND ALL OTHER 16K DYNAMIC SYSTEMS USING MK4116-3 OR EQUIVALENT DEVICES.

- \* 200 NSEC ACCESS, 375 NSEC CYCLE
- \* BURNED-IN AND FULLY TESTED
- \* 1 YR. PARTS REPLACEMENT GUARANTEE
- \* QTY. DISCOUNTS AVAILABLE



### VISTA V-200 MINI-FLOPPY SYSTEM

- \* S100 DOUBLE DENSITY CONTROLLER
  - \* 204 KBYTE CAPACITY FLOPPY DISK DRIVE WITH CASE & POWER SUPPLY
  - \* MODIFIED CPM OPERATING SYSTEM WITH EXTENDED BASIC
- \$695.00**

**BETA**  
COMPUTER DEVICES

1230 W. COLLINS AVE.  
ORANGE, CA 92668  
(714) 633-7280

Calif. residents please add 8% sales tax. Mastercharge & Visa accepted. Please allow 14 days for checks to clear bank. Phone orders welcome. Shipping charges will be added to all shipments.

32K BYTE MEMORY  
RELIABLE/COST EFFECTIVE EXPANDABLE RAM FOR 6502 AND 6800 SYSTEM—AIM 65-KIM\*SYM\*PET\*S44-BUS

- \* PLUG COMPATIBLE WITH THE AIM-65/SYM EXPANSION CONNECTOR BY USING A RIGHT ANGLE CONNECTOR (SUPPLIED) MOUNTED ON THE BACK OF THE MEMORY BOARD.
- \* MEMORY BOARD EDGE CONNECTOR PLUGS INTO THE 6800 S 44 BUS.
- \* CONNECTS TO PET OR KIM USING AN ADAPTOR CABLE.
- \* RELIABLE—DYNAMIC RAM WITH ON BOARD INVISIBLE REFRESH—LOOKS LIKE STATIC MEMORY BUT AT LOWER COST AND A FRACTION OF THE POWER REQUIRED FOR STATIC BOARDS.
- \* USES +5V ONLY, SUPPLIED FROM HOST COMPUTER.
- \* FULL DOCUMENTATION, ASSEMBLED AND TESTED BOARDS ARE GUARANTEED FOR ONE YEAR AND PURCHASE PRICE IS FULLY REFUNDABLE IF BOARD IS RETURNED UNDAMAGED WITHIN 14 DAYS.

|                                                        |          |
|--------------------------------------------------------|----------|
| ASSEMBLED WITH 32K RAM & WITH 16K RAM                  | \$419.00 |
| TESTED WITHOUT RAM CHIPS                               | \$279.00 |
| HARD TO GET PARTS (NO RAM CHIPS) WITH BOARD AND MANUAL | \$109.00 |
| BARE BOARD & MANUAL                                    | \$49.00  |

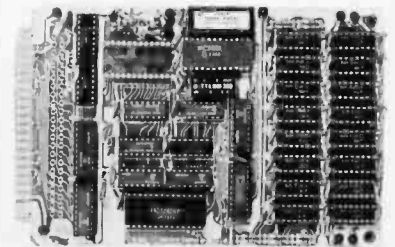

PET INTERFACE KIT—CONNECTS THE 32K RAM BOARD TO A 4K OR 8K PET. CONTAINS: INTERFACE CABLE, BOARD STANDOFFS, POWER SUPPLY MODIFICATION KIT AND COMPLETE INSTRUCTIONS. **\$49.00**

U.S. PRICES ONLY

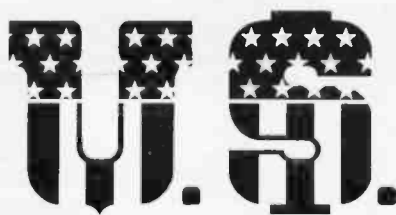

OUR BUYERS ARE IN  
CONTACT WITH EVERY MAJOR  
SUPPLIER AND O.E.M.  
BUY HERE AT 1000 PIECE

**QUANTITY PRICES**

ALL MERCHANDISE 100%  
GUARANTEED! 15 DAY FULL  
CASH REFUND!

CALL TOLL FREE: 1-800-435-9357

TERMS: Prepayment - C.O.D. up to \$100.00 - M/C, Visa  
Please allow personal check to clear before shipment.

**WRITE FOR FULL CATALOG!**

**JUST HOT STUFF SPECIAL OF THE QUARTER SPECIALS OF THE MONTH**

**POWER SUPPLIES**

If you can beat these prices we will be truly amazed. OEM's at 500 lot pay more than this. Call or write for full spec. sheets.



**DISK POWER SUPPLIES**

|                                        |            |             |               |
|----------------------------------------|------------|-------------|---------------|
| PRIAM - SHUGART - SIEMANS - MICROPOLIS |            |             |               |
| +5V @ 9A                               | -5V @ .8A  | +24V @ 7A   | US-384 89.00  |
| SHUGART - SIEMANS - MPI 5 1/4"         |            |             |               |
| +5V @ .5A                              | +12V @ .9A |             | US-340 33.50  |
| +5V @ 2A                               | +12V @ 4A  |             | US-323 56.25  |
| SHUGART - SIEMANS - CDC 8"             |            |             |               |
| +5V @ 1A                               | -5V @ .5A  | +24V @ 1.5A | US-205 52.50  |
| +5V @ 2A                               | -5V @ .5A  | +24V @ 3A   | US-206 69.00  |
| +5V @ 3A                               | -5V @ .6A  | +24V @ 5A   | US-162 89.00  |
| +5V @ 1.7A                             | -5V @ 1.5A | +24V @ 2A   | US-272 69.00  |
| +5V @ 2A                               | +12V @ .4A | -12V @ .4A  | US-HTAA 37.50 |

**TELEVIDEO 912C**

**\$665.00**



Also have 920C, SOROC, HAZELTINE, etc. What we don't have is room on this page. Call Toll Free 800 number for prices.

**C-ITOH PRINTER**

**\$499.00**



Look closely at the photo and see other adds in this rag at \$995.00. Perfect units, warranted. Only 500 pcs. Same story, manufacturer had too many.

**ATARI**

800 - \$899.00  
400 - \$499.00



As long as there is a price war, we will fight your battle. Compare at your local Dept. store and buy US MICRO.

**S-100 POWER**

**\$49.50**



Simple Brute Force. S-100 Power Supply. 6A @ +16V, 6A @ -16V. PC Board design.

**DUAL DRIVE SUBSYSTEM**

**\$995.00**



If this looks like a Lobo Drive System, don't be fooled. Just because it looks like one, works like one, smells like one, and tastes like one (?) doesn't mean it has to cost like one!

2 SHUGART 801R POWER SUPPLY

**S1-MOD (KIT)**

**\$239.00**



Complete S-100 12 Slot Computer. Ample system power with regulated power for drives. Excellent for Subsystem or Hobby use. 4 hours to build.

**EXPANDABLE RAM (KIT)**

This is the best all around 64K board you can buy. If after you see it, you don't agree return (unassembled) for full refund. Bank Select by extended address lines.



32K - \$380.00 64K - \$450.00

**32K STATIC (KIT)**

You have seen this well known board around for years. We bought 500 of them and plan on cornering the market! Bank Select on extended address lines.



\$388.00

**Z-80 CPV (KIT)**

The first time this world popular CPU offered in Kit. 2 serial, 3 parallel, CTC, EProm Z-80 at 4 mhz. Software band rate, etc.



\$212.00

**DMA DISK CONTROLLER (KIT)**

How many DMA Disk Controllers are there on the market? Can't mention the name at this LOW, LOW, LOW, price.



\$265.00

**12 SLOT MOTHER**

We have connectors and power supply too. Start your system with quality components. Terminated.



CONNECTORS \$3.50 ea. \$22.50

**4116s**

**\$4.25**

Expansion 16K Dynamic RAMs for Apple, TRS-80 S-100 systems. T.I., Mostek Intel, Call for manufacturer.

200 NS

**DIP-80**

**\$399.00**

Don't be misled by this LOW price. This is a rugged 100% Duty Cycle 7 by 7 Dot Matrix Printer. Brand new, factory warr.



• RS-232  
• TRACTOR FEED

**2114s**

**\$3.95**

One of the world's two most popular STATIC RAMs. Factory prime tested units. Sold in lots of 8 only. FUJITSU, HITACHI, etc.

200 NS

**TMS-4044**

**\$425.00**

**MM-5257**

**INTEL 2147**

250 NS

The other of the world's most popular STATIC RAMs. This one is 4K by 1 organization. Don't buy Gold, buy these, the price won't last!

**2716s**

**\$13.50**

**2708s**

**\$6.95**

Remember when 2716s were \$50.00 and hard to get? These units are so beautiful it's hard to part with them. But we will, for a small price. Guaranteed!

**SHUGART DRIVE 8" 801R**

**\$385.00**

Manufacturer had too many, buys at 1000 piece rate, sales dropped, so we got'em. Fantastic buy, get them while they last! Full warranty.

**5 1/4" MINI**

**\$265.00**

Now is the time to expand that Trash-80 or Rotton Apple (no offense!) These go so fast. Quantities limited to those on hand. Hurry! No Junkers! Factory warranty.

SHUGART / SIEMANS / MPI

|                   |      |      |       |      |             |       |       |
|-------------------|------|------|-------|------|-------------|-------|-------|
| 6502              | 7.45 | 10 @ | 6.95  | 50 @ | 6.55        | 100 @ | 6.15  |
| 6502A             | 8.40 | 10 @ | 7.95  | 50 @ | 7.35        | 100 @ | 6.90  |
| 6520PIA           | 5.15 | 10 @ | 4.90  | 50 @ | 4.45        | 100 @ | 4.15  |
| 6522VIA           | 6.90 | 10 @ | 6.50  | 50 @ | 6.10        | 100 @ | 5.70  |
| 6532              | 7.90 | 10 @ | 7.40  | 50 @ | 7.00        | 100 @ | 6.60  |
| 2114-L450         |      |      | 4.65  | 20 @ | 4.35        | 100 @ | 4.15  |
| 2114-L300         |      |      | 5.95  | 20 @ | 5.45        | 100 @ | 5.10  |
| 2716 EPROM        |      |      | 21.00 | 5 @  | 19.00       | 10 @  | 17.00 |
| 4116-200 ns RAM   |      |      | 7.00  |      | 8 @         | 6.25  |       |
| 6550 RAM (PET 8K) |      |      |       |      |             |       | 12.70 |
| S-100 Wire Wrap   | 2.65 |      |       |      | Solder Tail |       | 2.15  |

### CASSETTES—AGFA PE-611 PREMIUM

High output, low noise, 5 screw housing, labels.

C-10 10/5.65 50/25.00 100/48.00

C-20 10/6.45 50/29.50 100/57.00

C-30 10/7.30 50/34.00 100/66.00

All other lengths available. Write for price list.



## ATARI 800 SPECIAL \$799

All Atari Modules 20% OFF

## DISKS

(write for quantity prices)

|                        |           |           |             |
|------------------------|-----------|-----------|-------------|
| SCOTCH (3M) 8"         | 10/3.10   | 50/2.85   | 100/2.75    |
| SCOTCH (3M) 5"         | 10/3.15   | 50/2.95   | 100/2.85    |
| Maxell 5"              | 10/3.65   | 50/3.40   | 100/3.15    |
| Maxell 8" Double Dens. | 10/4.10   | 50/3.95   | 100/3.80    |
| Verbatim 5"            | 10/2.40   | 50/2.35   | 100/2.30    |
| BASF 5"                | 10/2.45   | 20/2.35   | 100/2.30    |
| BASF 8"                | 10/2.50   | 20/2.45   | 100/2.35    |
| Diskette Storage Pages |           |           | 10 for 3.95 |
| Disk Library Cases     | 8" - 2.85 | 5" - 2.15 |             |

115 E. Stump Road  
Montgomeryville, PA 18936

## Commodore CBM- PET SPECIALS

**FREE** -Up to \$235 free merchandise with purchase of one of following CBM-PET items:

|                                             |        |      |
|---------------------------------------------|--------|------|
| 8032 32K-60 column CRT                      | \$1795 | 235  |
| 8016 16K-80 column CRT                      | 1495   | 205  |
| 8050 Dual Disk Drive-950,000 bytes          | 1695   | 220  |
| CBM Modem-IEEE Interface                    | 395    | 50   |
| CBM Voice Synthesizer                       | 395    | 50   |
| 8N full size graphics keyboard              | 795    | 100  |
| 16K Full Size Graphics or Business Keyboard | 995    | 145  |
| 32K Full Size Graphics or Business Keyboard | 1295   | 205  |
| 2040 Dual Disk Drive-343,000 bytes          | 1295   | 205  |
| 2022 Tractor Feed Printer                   | 795    | 100  |
| 2023 Pressure Feed Printer                  | 695    | 90   |
| C2N External Cassette Deck                  | 95     | 12   |
| Used PETs (limited quantities)              |        | Call |



### THE STAR MODEM

From Livermore Data Systems

IEEE 488 MODEM

SALE \$288

RS232 MODEM

SALE \$139

|                                         |          |
|-----------------------------------------|----------|
| CBM Full Size Graphics Keyboard         | \$ 74    |
| WordPro II-16 or 32K, 2040, Printer     | 72       |
| WordPro III-32K, 2040, Printer          | 178      |
| WordPro IV for 8032                     | 268      |
| PASCAL Compiler for PET                 | 75       |
| Programmers Toolkit-PET ROM Utilities   | \$ 44.90 |
| PET Spacemaker Switch                   | 22.90    |
| Dust Cover for PET                      | 7.90     |
| IEEE-Parallel Printer Interface for PET | 79.00    |
| IEEE-RS232 Printer Interface for PET    | 149.00   |

## Centronics 737 Proportional Spacing Printer

\$800

NEC Spinwriter-parallel 2450

|                                      |             |        |
|--------------------------------------|-------------|--------|
| SYM-1 \$209                          | with 4K RAM | \$ 238 |
| SYM BAS-1 BASIC in ROM               |             | 85     |
| SYM RAE-1/2 Assembler in ROM         |             | 85     |
| MOT 1000 Syntek Development System   |             | 1345   |
| KTM-2/80 Syntek Video Board          |             | 349    |
| KIM-1 (add \$34 for power supply)    |             | 159    |
| Seawell Motherboard-4K RAM           |             | 195    |
| Seawell 16K Static RAM-KIM, SYM, AIM |             | 320    |
| Leedex Video 100 12" Monitor         |             | 129    |
| Zenith Z19 Terminal (factory asm.)   |             | 770    |

KL-4M Four Voice Music Board for PET \$34.90

Visible Music Monitor (4 Voice) for PET 29.90

SPECIAL—KL-4M with Visible Music Monitor 59.90

MICROTHELLO for PET by Michael Riley \$9.95  
Machine language version—you can't win at Level 5.

VISICAL for PET (CBM/Personal Software) \$128

CBM Assembler/Editor (disk) 89

CBM General Ledger, A/P, A/R NEW! 270

PAPER MATE 60 Command PET Word Processor \$29.95

Full-featured version by Michael Riley



### A P Products 15% OFF

All Book and Software Prices are Discounted

PET Personal Computer Guide (Osborne) \$12.75

PET and the IEEE-488 Bus (Osborne) 12.75

6502 Assembly Language (Osborne) 9.45

Programming the 6502 (Zaks) 10.45

6502 Applications Book (Zaks) 10.45

Programming a Microcomputer: 6502 7.75

6502 Software Bookbook (Scebi) 9.45

215-699-5826

# A B Computers

## WRITE FOR CATALOG

Add \$1.25 per order for shipping. We pay balance of UPS surface charges on all prepaid orders.

| C/MOS (DIODE CLAMPED) |      |      |      |
|-----------------------|------|------|------|
| 4001                  | 35   | 4027 | 45   |
| 4002                  | 35   | 4028 | 45   |
| 4003                  | 1.10 | 4029 | 95   |
| 4007                  | 27   | 4031 | 95   |
| 4009                  | 45   | 4034 | 2.25 |
| 4010                  | 45   | 4035 | 97   |
| 4011                  | 35   | 4040 | 1.00 |
| 4013                  | 35   | 4042 | 1.00 |
| 4014                  | 1.20 | 4044 | 1.00 |
| 4015                  | 1.00 | 4046 | 1.00 |
| 4016                  | 1.05 | 4050 | 1.00 |
| 4018                  | 80   | 4051 | 1.10 |
| 4019                  | 80   | 4052 | 1.10 |
| 4020                  | 1.10 | 4053 | 1.10 |
| 4021                  | 1.10 | 4056 | 1.10 |
| 4022                  | 1.00 | 4080 | 1.00 |
| 4023                  | 35   | 4071 | 35   |
| 4024                  | 75   | 4072 | 35   |
| 4025                  | 35   | 4076 | 1.00 |

## PRINTED CIRCUIT BOARD

4" x 6" DOUBLE SIDED EPOXY BOARD 1/16" thick  
\$.60 ea. 5/82.60

EPOXY glass vector board  
1/16" thick with 1/10" spacing 4 1/2" x 6 1/2" \$1.95

|       |    |        |      |        |      |
|-------|----|--------|------|--------|------|
| 74500 | 30 | 74520  | 40   | 745153 | 1.10 |
| 74502 | 30 | 74530  | 40   | 745151 | 1.25 |
| 74505 | 45 | 74532  | 40   | 745157 | 1.25 |
| 74508 | 40 | 74538  | 1.90 | 745158 | 1.25 |
| 74511 | 35 | 745112 | 85   | 745174 | 1.40 |
| 74515 | 40 | 745140 | 1.00 | 745257 | 1.50 |

## 7 WATT LD-65 LASER DISK IR \$8.95

25 watt Infra Red Pulse (SG 2006 equlv.)  
Laser Diode (Spec sheet included) \$24.95

MINIATURE MULTITURN TRIM POTS  
10K, 5K, 10K, 20K, 250K, 1 Meg, \$.75 each... 3/2.00

|                       |          |
|-----------------------|----------|
| 2N3920 P PET          | \$ .45   |
| 2N5457 N FET          | \$ .45   |
| 2N2646 UJT            | \$ .45   |
| ER 900 TRIGGER DIODES | \$481.00 |
| 2N 6028 PROG. UJT     | \$ .65   |

RP 100 PHOTO TRANS  
RED, YELLOW OR GREEN LARGE LED's. 2" \$1.00  
RED/GREEN BIPOLAR LED's. \$ .55  
MLED3 R LED \$ .75  
MRD 148 PHOTO DIAL. XTOR \$ .75  
TL1-118 OPTO ISOLATOR \$ .75  
IL-5 OPTO ISOLATOR \$ .80  
1 WATT ZENERS: 3.3, 4.7, 5.1, 5.6, 6.8, 8.2, 9.1, 10, 12, 15, 18, or 22V \$1.00

TL RELAY - SPST 6V 20mA \$1.00

## Silicon Power Rectifiers

| PRV  | 1A   | 3A  | 12A  | 50A  | 125A  | 200A  |
|------|------|-----|------|------|-------|-------|
| 100  | .06  | 1.4 | .35  | .90  | 3.70  | 5.00  |
| 200  | .07  | 2.0 | .40  | 1.30 | 4.25  | 6.50  |
| 400  | .09  | 2.5 | .85  | 1.50 | 5.50  | 9.00  |
| 600  | .11  | 3.0 | 8.00 | 2.00 | 8.50  | 12.50 |
| 800  | .15  | 3.5 | 1.00 | 2.50 | 10.00 | 16.50 |
| 1000 | 2.00 | 4.5 | 1.25 | 3.00 | 12.50 | 20.00 |

IN 4148 (IN914) \$15.00  
.1 or .01 uf 25V ceramic disc. caps. 18/101, 100/150.00

## REGULATORS

|                    |        |                      |        |
|--------------------|--------|----------------------|--------|
| LM317T             | \$2.50 | 340K-12, 15 or 24V   | \$1.50 |
| 323K-5V 3A         | .75    | 340T-5, 6, 8, 12, 15 |        |
| 79HGKC-5V at 5A    | \$6.95 | 18 or 24V            | \$1.10 |
| 723                | \$6.50 | 320M5                | \$ .75 |
| 320T-5, 12, or 15V | \$1.10 |                      |        |
| LM305H             | .75    |                      |        |

## TRANSISTOR SPECIALS

|                                 |        |
|---------------------------------|--------|
| 2N1303 PNP GE TO 5              | \$3.10 |
| 2N1307 PNP GE TO 5              | 3.00   |
| 2N1546 PNP GE TO 3              | 5.95   |
| 2N2222 NPN SWITCHING POWER      | \$1.95 |
| MPF-8004 C BR RF TRANSISTOR NPN | .75    |
| 2N2772 NPN SI TO 3              | \$1.00 |
| 2N2908 PNP SI TO 3              | \$1.00 |
| 2N5086 PNP SI TO 92             | 4.00   |
| 2N3137 NPN SI RF                | 5.55   |
| 2N3919 NPN SI TO 3 RF           | 1.95   |
| 2N1420 NPN SI TO 5              | 3.90   |
| 2N2767 NPN SI TO 66             | 8.70   |
| 2N2904 NPN SI TO 18             | \$4.10 |
| 2N3955 NPN SI TO 3              | 6.60   |
| 2N3904 NPN SI TO 92             | 6.61   |
| 2N3066 PNP SI TO 220            | 6.10   |
| 2N5109 PNP SI TO 220            | 5.55   |
| 2N1320 NPN SI TO 18             | 3.90   |
| 1IP 318 NPN SI TO 220           | 6.60   |
| 1IP 328 PNP SI TO 220           | 6.65   |
| 2N5641 NPN LA RF POWER          | \$2.50 |

## TTL IC SERIES

|       |    |       |     |       |      |
|-------|----|-------|-----|-------|------|
| 7400  | 17 | 7448  | 75  | 74157 | 65   |
| 74101 | 17 | 7450  | 17  | 74160 | 85   |
| 7402  | 17 | 7472  | 35  | 74161 | 80   |
| 7403  | 22 | 7473  | 25  | 74165 | 65   |
| 7404  | 24 | 7474  | 42  | 74166 | 85   |
| 7405  | 24 | 7475  | 49  | 74168 | 85   |
| 7406  | 33 | 7476  | 45  | 74169 | 105  |
| 7407  | 35 | 7480  | 45  | 74167 | 135  |
| 7408  | 27 | 7483  | 60  | 74170 | 160  |
| 7409  | 24 | 7485  | 75  | 74171 | 130  |
| 7410  | 17 | 7486  | 42  | 74172 | 85   |
| 7411  | 22 | 7489  | 160 | 74175 | 75   |
| 7412  | 22 | 7490  | 50  | 74176 | 75   |
| 7413  | 42 | 7491  | 55  | 74185 | 75   |
| 7414  | 90 | 7492  | 50  | 74186 | 75   |
| 7415  | 33 | 7493  | 50  | 74187 | 190  |
| 7416  | 37 | 7494  | 60  | 74189 | 120  |
| 7417  | 17 | 7495  | 80  | 74190 | 20   |
| 7418  | 35 | 7496  | 60  | 74192 | 79   |
| 7419  | 33 | 74107 | 35  | 74193 | 79   |
| 7427  | 35 | 74121 | 35  | 74194 | 84   |
| 7430  | 17 | 74122 | 39  | 74196 | 65   |
| 7432  | 27 | 74123 | 42  | 74197 | 87   |
| 7437  | 27 | 74125 | 45  | 74229 | 85   |
| 7438  | 27 | 74126 | 45  | 74325 | 2.25 |
| 7440  | 17 | 74145 | 75  | 74328 | 35   |
| 7441  | 85 | 74150 | 110 | 74307 | 80   |
| 7442  | 50 | 74151 | 65  | 74368 | 65   |
| 7445  | 70 | 74153 | 55  | 74591 | 105  |
| 7446  | 50 | 74154 | 110 | 74592 | 105  |
| 7447  | 75 | 74155 | 75  | 8198  | 1.10 |

14 pin headers 3/81.00

MM5387A AA... CLOCK CHIPS \$5.95

MM5314 \$4.75

MM5316 \$4.95

NO. 30 WIRE WRAP WIRE SINGLE STRAND 100' \$1.40

ALCO MINATURE TOGGLE SWITCHES  
MTA 106 SPDT \$1.05  
MTA 206 DPDT \$1.70  
MTA 206 P-DPDT CENTER OFF \$1.85  
MISD 206 P-DPDT CENTER OFF LEVER SWITCH \$1.85

## Full Wave Bridges

| PRV | 2A   | 6A   | 25A  | 8 PIN  | 17 | 22 PIN | 30 |
|-----|------|------|------|--------|----|--------|----|
| 100 |      |      | 1.40 | 14 PIN | 20 | 24 PIN | 35 |
| 200 | .80  | 1.30 | 2.20 | 16 PIN | 22 | 28 PIN | 40 |
| 400 | 1.00 | 1.65 | 3.30 | 18 PIN | 24 | 30 PIN | 40 |
| 600 | 1.30 | 1.90 | 4.40 | 18 PIN | 25 | 40 PIN | 60 |

## SANKEN AUDIO POWER AMPS

|                    |         |
|--------------------|---------|
| Si 1010 G 10 WATTS | \$ 7.50 |
| Si 1020 G 20 WATTS | \$13.75 |
| Si                 |         |

# DAL - COMP

DAL-COMP gives you the finest lines in electronic hardware, components, computer boards and peripherals.

## \$5.00 CASH COUPON

With Prepaid Order of \$100.00 & over - Expires Sept. 30th

|                                                                                                                               |                                                                                                                           |                                                                        |                                                                                                             |                                                      |                                                                                                        |
|-------------------------------------------------------------------------------------------------------------------------------|---------------------------------------------------------------------------------------------------------------------------|------------------------------------------------------------------------|-------------------------------------------------------------------------------------------------------------|------------------------------------------------------|--------------------------------------------------------------------------------------------------------|
| 4116 8 FOR<br>Buy 4 Sets at 8 For                                                                                             | <b>39.95</b><br><b>37.00</b>                                                                                              | 2114L-3 8 FOR<br>Buy 4 Sets at 8 FOR<br>100 Lot                        | <b>35.95</b><br><b>32.00</b><br><b>3.75 EA</b>                                                              | 2716 5V<br>TMS 2716 +5 -5 +12<br>2708                | <b>16.95</b><br><b>15.00</b><br><b>6.25</b>                                                            |
| 1771<br>1791<br>TR 1602B UART<br>1863/ AY51015 UART<br>\$2350 USRT<br>2513 (3021) CHAR GEN<br>2513 (2140) CHAR GEN<br>MC14411 | <b>26.00</b><br><b>37.00</b><br><b>3.50</b><br><b>5.00</b><br><b>6.50</b><br><b>10.95</b><br><b>10.95</b><br><b>11.00</b> | 3242 Refresh Chip<br>6502 CPU<br>Z80A<br>8080A<br>8035<br>8085<br>8086 | <b>10.15</b><br><b>11.50</b><br><b>12.00</b><br><b>3.50</b><br><b>17.95</b><br><b>19.95</b><br><b>75.00</b> | 8156<br>8212<br>8214<br>8216<br>8224<br>8226<br>8228 | <b>20.00</b><br><b>3.50</b><br><b>4.00</b><br><b>2.95</b><br><b>3.00</b><br><b>3.00</b><br><b>5.95</b> |

### BEFORE YOU BUY

Call Dal-Comp for prices on all your electronic and computing needs. We offer the finest products in the industry at prices you can compare with anyone. Check our fast service and responsive sales people.

**CALL TOLL FREE 800-527-5310 • TEXAS RESIDENTS CALL COLLECT (214) 350-6898**

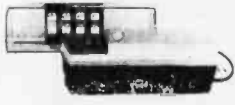
|                                                                                                            |                                                                                                                                                                                                                                                                                                                                                     |                                                                                                          |                                                                                                                                                                              |
|------------------------------------------------------------------------------------------------------------|-----------------------------------------------------------------------------------------------------------------------------------------------------------------------------------------------------------------------------------------------------------------------------------------------------------------------------------------------------|----------------------------------------------------------------------------------------------------------|------------------------------------------------------------------------------------------------------------------------------------------------------------------------------|
| <b>CB2 Z-80 CPU BOARD</b><br>SSM — CB2 — KIT — \$219.95<br>SSM — CB2 — A&T — \$305.00                      | <br><b>EPROM ERASER</b><br>Compact durable quality UV Lamp for erasing EPROMS. Features a special safety lock to prevent accidental exposure. Erases up to four devices (2708, 2716, 2732, 1702A, 52030, 53040, etc.) simultaneously.<br><b>UV S-11E \$68.95</b> | <b>DIP SWITCHES</b><br>3 Pos. \$1.00 6 Pos. \$1.10<br>4 Pos. 1.00 7 Pos. 1.15<br>5 Pos. 1.00 8 Pos. 1.20 | <b>WIREWAP SOCKETS</b><br>8 Pin .39<br>14 Pin .46<br>16 Pin .50<br>18 Pin .68<br>20 Pin .85<br>22 Pin .42<br>24 Pin .94<br>28 Pin 1.23<br>40 Pin 1.60                        |
| <b>I04 2 PARALLEL &amp; 2 SERIAL I/O BOARD</b><br>SSM — I04 — KIT — \$149.95<br>SSM — I04 — A&T — \$215.00 |                                                                                                                                                                                                                                                                                                                                                     | <b>ZIP DIP II SOCKETS</b><br>16 Pin \$5.50<br>24 Pin 7.50<br>40 Pin 9.00                                 | <b>RS-232 CONNECTORS</b><br>DB25P — Male Plug \$2.95<br>DB25S — Female Socket 3.60<br>DB25C — Cover 1.50<br><br><b>RS232 SPECIAL \$6.50</b><br>(1-DB25P — 1-DB25S — 1 Cover) |
| <b>AIO APPLE SERIAL/PARALLEL INTERFACE</b><br>KIT \$124.95<br>ASSEMBLED & TESTED \$164.00                  | <b>MOTHER BOARDS</b><br>6 Slot Bare Board \$19.00<br>6 Slot Kit 36.00<br>8 Slot Bare Board 24.00<br>8 Slot Kit 47.00<br>12 Slot Bare Board 29.00<br>12 Slot Kit 62.00                                                                                                                                                                               |                                                                                                          |                                                                                                                                                                              |

**TERMS OF SALE:** Cash, checks, money orders, VISA, Master Charge. Minimum Order \$10.00. Texas residents add 5% sales tax. Minimum shipping and handling charge \$3.00. COD orders add \$2.00 COD fee. U.S. funds only. PRICES SUBJECT TO CHANGE WITHOUT NOTICE. SOME ITEMS SUBJECT TO PRIOR SALE. WE RESERVE THE RIGHT TO LIMIT QUANTITIES. 90 DAY GUARANTEE. SALE PRICES ARE FOR PREPAID ORDERS ONLY. FOR OPEN ACCOUNT PLEASE CALL FOR PRICING & TERMS.

**DAL-COMP M/O DIV. 2560 ELECTRONIC LANE, SUITE 108, DALLAS, TEXAS 75220 • (214) 350-6895**

**DAL - COMP**  
MAIL ORDER DIV.

# WAMECO

## THE COMPLETE PC BOARD HOUSE

### EVERYTHING FOR THE S-100 BUSS

- \* **FPB-1** FRONT PANEL BOARD FOR 8080A AND Z80 SYSTEMS IMSAI COMPATIBLE.  
PCBD ..... \$56.95      KIT ..... \$175.00
- \* **MEM-2** 16K RAM 2114's. ADDRESSABLE IN 4K BOUNDARIES.  
PCBD .... \$33.95      KIT (LESS RAMS) .... \$80.95
- \* **EPM-2** 16/32K ROM USES 2716 OR 2708. ADDRESSABLE IN 4K BOUNDARIES.  
PCBD .... \$33.95      KIT (LESS ROMS) .... \$74.95
- \* **CPU-1** 8080A PROCESSOR BOARD WITH VECTOR INTERRUPT.  
PCBD ..... \$33.95      KIT ..... \$124.95
- \* **IOB-1** I/O BOARD. ONE SERIAL, TWO PARALLEL WITH CASSETTE.      PCBD ..... \$33.95
- \* **FDC-1** FLOPPY DISC CONTROLLER BOARD USES 1771.      PCBD ..... \$45.95
- \* **QMB-12** 13 SLOT MOTHER BOARD.  
PCBD ..... \$42.95      KIT ..... \$125.95
- \* **QMB-9** 9 SLOT MOTHER BOARD.  
PCBD ..... \$35.95      KIT ..... \$109.95
- \* **PTB-1** POWER SUPPLY AND TERMINATOR BOARD.  
PCBD ..... \$29.95      KIT ..... \$49.95
- \* **RTC-1** REAL TIME CLOCK BOARD WITH TWO INTERRUPTS.  
PCBD ..... \$29.95      KIT ..... \$79.95
- \* **MEM-1** 8K RAM, USES 2102's.  
PCBD .... \$33.95      KIT (LESS RAM) .... \$71.95
- \* **EPM-1** 4K 170Z BOARD.  
PCBD .... \$29.95      KIT (LESS ROM) .... \$59.95

FUTURE PRODUCTS: 80 CHARACTER VIDEO BOARD, Z-80 CPU BOARD WITH ROM, 8 PARALLEL PORT I/O BOARD

**DEALER INQUIRIES INVITED, UNIVERSITY DISCOUNTS AVAILABLE AT YOUR LOCAL DEALER**

MOST PRODUCTS FOR IMMEDIATE SHIPMENT. NO 4-8 WEEK DELAYS REQUIRED FOR OTHERS.



WAMECO, INC., P. O. BOX 877 • 455 PLAZA ALHAMBRA • EL GRANADA, CA 94018 • (415) 726-6378

|                                                                                                                                                                                                                                                                                                                                                                                                                                                                                                                                                                                  |                                                                                                                                                                                                                                                                                                                                                                                                              |                                                                                                                                                                                                                                                                                                                                                                                                                                                                                                                                                                                                                                                                                                                                                                                                                                                                                                                                                                                                                                                                                                                                                                                                                                                                                                                                                                                                                                                                                                        |                                                                                                                                                                                                                                                                                                                                                                                                                                                                                                                                                               |                                                                                         |                                                                                                                                                                                                                                                                                                                       |                                                                                                                                                                                                                                                                                                                                                                                                                                                                                                                                                                                     |                                                                                                  |                                                                                   |                                                                                  |                                                                                            |                                                                                             |
|----------------------------------------------------------------------------------------------------------------------------------------------------------------------------------------------------------------------------------------------------------------------------------------------------------------------------------------------------------------------------------------------------------------------------------------------------------------------------------------------------------------------------------------------------------------------------------|--------------------------------------------------------------------------------------------------------------------------------------------------------------------------------------------------------------------------------------------------------------------------------------------------------------------------------------------------------------------------------------------------------------|--------------------------------------------------------------------------------------------------------------------------------------------------------------------------------------------------------------------------------------------------------------------------------------------------------------------------------------------------------------------------------------------------------------------------------------------------------------------------------------------------------------------------------------------------------------------------------------------------------------------------------------------------------------------------------------------------------------------------------------------------------------------------------------------------------------------------------------------------------------------------------------------------------------------------------------------------------------------------------------------------------------------------------------------------------------------------------------------------------------------------------------------------------------------------------------------------------------------------------------------------------------------------------------------------------------------------------------------------------------------------------------------------------------------------------------------------------------------------------------------------------|---------------------------------------------------------------------------------------------------------------------------------------------------------------------------------------------------------------------------------------------------------------------------------------------------------------------------------------------------------------------------------------------------------------------------------------------------------------------------------------------------------------------------------------------------------------|-----------------------------------------------------------------------------------------|-----------------------------------------------------------------------------------------------------------------------------------------------------------------------------------------------------------------------------------------------------------------------------------------------------------------------|-------------------------------------------------------------------------------------------------------------------------------------------------------------------------------------------------------------------------------------------------------------------------------------------------------------------------------------------------------------------------------------------------------------------------------------------------------------------------------------------------------------------------------------------------------------------------------------|--------------------------------------------------------------------------------------------------|-----------------------------------------------------------------------------------|----------------------------------------------------------------------------------|--------------------------------------------------------------------------------------------|---------------------------------------------------------------------------------------------|
|  <p><b>Dual Trace Oscilloscope</b><br/><b>HITACHI 30 MHz</b></p> <ul style="list-style-type: none"> <li>● TV sync-separator circuit</li> <li>● High-sensitivity 1mV/div (5MHz)</li> <li>● Sweep-time magnifier (10 times)</li> <li>● Z-axis input (Intensity modulation)</li> <li>● Signal delay line</li> <li>● X-Y operation</li> <li>● Trace Rotation</li> </ul> <p style="text-align: center;"><b>\$945.00</b></p> <p style="text-align: center;"><b>More sensitive to your input</b></p> | <p><b>FUNCTION GENERATOR KIT</b><br/>XR2206KB<br/>OPERATES ON EITHER SINGLE 12 V SUPPLY OR 6V SPLIT SUPPLY<br/>Includes all parts to be mounted on PC board</p>  <p style="text-align: center;"><b>\$19.95</b></p> <p style="text-align: center; font-size: small;">Power supply not included</p>                         | <p><b>EPROM</b><br/><b>2708 \$10<sup>50</sup></b></p> <p><b>EPROM</b><br/>(5 Volt) <b>\$16<sup>80</sup></b><br/><b>2716</b></p>                                                                                                                                                                                                                                                                                                                                                                                                                                                                                                                                                                                                                                                                                                                                                                                                                                                                                                                                                                                                                                                                                                                                                                                                                                                                                                                                                                        | <p><b>POWER SUPPLY</b><br/><b>5 Volt 3 Amp</b><br/><b>APS 5-3</b></p>  <table style="width: 100%; border: none;"> <tr> <td style="border: none;">1-9 .....</td> <td style="border: none; text-align: right;">\$42.50</td> </tr> <tr> <td style="border: none;">10 up .....</td> <td style="border: none; text-align: right;">\$40.65</td> </tr> <tr> <td style="border: none;">25 up .....</td> <td style="border: none; text-align: right;">\$38.85</td> </tr> </table> | 1-9 .....                                                                               | \$42.50                                                                                                                                                                                                                                                                                                               | 10 up .....                                                                                                                                                                                                                                                                                                                                                                                                                                                                                                                                                                         | \$40.65                                                                                          | 25 up .....                                                                       | \$38.85                                                                          |                                                                                            |                                                                                             |
| 1-9 .....                                                                                                                                                                                                                                                                                                                                                                                                                                                                                                                                                                        | \$42.50                                                                                                                                                                                                                                                                                                                                                                                                      |                                                                                                                                                                                                                                                                                                                                                                                                                                                                                                                                                                                                                                                                                                                                                                                                                                                                                                                                                                                                                                                                                                                                                                                                                                                                                                                                                                                                                                                                                                        |                                                                                                                                                                                                                                                                                                                                                                                                                                                                                                                                                               |                                                                                         |                                                                                                                                                                                                                                                                                                                       |                                                                                                                                                                                                                                                                                                                                                                                                                                                                                                                                                                                     |                                                                                                  |                                                                                   |                                                                                  |                                                                                            |                                                                                             |
| 10 up .....                                                                                                                                                                                                                                                                                                                                                                                                                                                                                                                                                                      | \$40.65                                                                                                                                                                                                                                                                                                                                                                                                      |                                                                                                                                                                                                                                                                                                                                                                                                                                                                                                                                                                                                                                                                                                                                                                                                                                                                                                                                                                                                                                                                                                                                                                                                                                                                                                                                                                                                                                                                                                        |                                                                                                                                                                                                                                                                                                                                                                                                                                                                                                                                                               |                                                                                         |                                                                                                                                                                                                                                                                                                                       |                                                                                                                                                                                                                                                                                                                                                                                                                                                                                                                                                                                     |                                                                                                  |                                                                                   |                                                                                  |                                                                                            |                                                                                             |
| 25 up .....                                                                                                                                                                                                                                                                                                                                                                                                                                                                                                                                                                      | \$38.85                                                                                                                                                                                                                                                                                                                                                                                                      |                                                                                                                                                                                                                                                                                                                                                                                                                                                                                                                                                                                                                                                                                                                                                                                                                                                                                                                                                                                                                                                                                                                                                                                                                                                                                                                                                                                                                                                                                                        |                                                                                                                                                                                                                                                                                                                                                                                                                                                                                                                                                               |                                                                                         |                                                                                                                                                                                                                                                                                                                       |                                                                                                                                                                                                                                                                                                                                                                                                                                                                                                                                                                                     |                                                                                                  |                                                                                   |                                                                                  |                                                                                            |                                                                                             |
| <p><b>SD SYSTEMS</b></p> <p><b>Z-80 STARTER SYSTEM</b></p> <p>The Z80 Starter Kit by SD Systems uses the powerful Z80 microprocessor as the heart of the complete micro-computer on a single board. Learn a step-by-step introduction to micro-computers with a keyboard and display, audio cassette interface, PROM programmer, wire-wrap expansion area, 4-channel Counter Timer and on Board RAM and PROM. Complete Operation and Instruction Manual Included. ZBUG Monitor in ROM.</p> <p>27004 kit ... \$340    38007 assem/T... \$450</p>                                  | <p><b>8080A MICRO-PROCESSOR \$5<sup>95</sup></b></p> <p><b>AP PRODUCTS</b></p> <table style="width: 100%; border: none;"> <tr> <td style="border: none;">923101 ... \$ 79.95</td> </tr> <tr> <td style="border: none;">923102 ... 124.95</td> </tr> <tr> <td style="border: none;">923103 ... 124.95</td> </tr> </table>  | 923101 ... \$ 79.95                                                                                                                                                                                                                                                                                                                                                                                                                                                                                                                                                                                                                                                                                                                                                                                                                                                                                                                                                                                                                                                                                                                                                                                                                                                                                                                                                                                                                                                                                    | 923102 ... 124.95                                                                                                                                                                                                                                                                                                                                                                                                                                                                                                                                             | 923103 ... 124.95                                                                       | <p><b>NEW HICKOK LX 304</b></p> <p><b>DIGITAL MULTIMETER</b><br/>Compact<br/>Accurate<br/>Dependable</p>  <p style="text-align: center;"><b>\$89<sup>95</sup></b></p> <p>ALSO - STILL AVAILABLE<br/><b>LX303 ..... \$74.95</b></p> | <div style="border: 2px solid black; padding: 10px; text-align: center;"> <p><b>★ 16% ★</b></p> <p><b>DISCOUNT COUPON</b></p> <p>Bring this COUPON into one of our stores or mail to our Mail Order address shown below and receive a <b>16% DISCOUNT</b> on purchases from this Ad of \$100.00 or more.</p> <p><b>Offer EXPIRES on October 31, 1980</b></p> <p>NAME .....</p> <p>ADDRESS .....</p> <p>CITY .....</p> <p>STATE .....</p> <p>ZIP .....</p> <p>PHONE NO. ....</p> <p style="font-size: small;">Coupons accepted only with full name and address filled in.</p> </div> |                                                                                                  |                                                                                   |                                                                                  |                                                                                            |                                                                                             |
| 923101 ... \$ 79.95                                                                                                                                                                                                                                                                                                                                                                                                                                                                                                                                                              |                                                                                                                                                                                                                                                                                                                                                                                                              |                                                                                                                                                                                                                                                                                                                                                                                                                                                                                                                                                                                                                                                                                                                                                                                                                                                                                                                                                                                                                                                                                                                                                                                                                                                                                                                                                                                                                                                                                                        |                                                                                                                                                                                                                                                                                                                                                                                                                                                                                                                                                               |                                                                                         |                                                                                                                                                                                                                                                                                                                       |                                                                                                                                                                                                                                                                                                                                                                                                                                                                                                                                                                                     |                                                                                                  |                                                                                   |                                                                                  |                                                                                            |                                                                                             |
| 923102 ... 124.95                                                                                                                                                                                                                                                                                                                                                                                                                                                                                                                                                                |                                                                                                                                                                                                                                                                                                                                                                                                              |                                                                                                                                                                                                                                                                                                                                                                                                                                                                                                                                                                                                                                                                                                                                                                                                                                                                                                                                                                                                                                                                                                                                                                                                                                                                                                                                                                                                                                                                                                        |                                                                                                                                                                                                                                                                                                                                                                                                                                                                                                                                                               |                                                                                         |                                                                                                                                                                                                                                                                                                                       |                                                                                                                                                                                                                                                                                                                                                                                                                                                                                                                                                                                     |                                                                                                  |                                                                                   |                                                                                  |                                                                                            |                                                                                             |
| 923103 ... 124.95                                                                                                                                                                                                                                                                                                                                                                                                                                                                                                                                                                |                                                                                                                                                                                                                                                                                                                                                                                                              |                                                                                                                                                                                                                                                                                                                                                                                                                                                                                                                                                                                                                                                                                                                                                                                                                                                                                                                                                                                                                                                                                                                                                                                                                                                                                                                                                                                                                                                                                                        |                                                                                                                                                                                                                                                                                                                                                                                                                                                                                                                                                               |                                                                                         |                                                                                                                                                                                                                                                                                                                       |                                                                                                                                                                                                                                                                                                                                                                                                                                                                                                                                                                                     |                                                                                                  |                                                                                   |                                                                                  |                                                                                            |                                                                                             |
| <p><b>SBC-100 SINGLE BOARD COMPUTER KIT</b></p> <p>27003 kit ..... \$295</p>                                                                                                                                                                                                                                                                                                                                                                                                                                                                                                     | <p><b>PROM-100 BOARD KIT PROM Programmer</b></p> <p>27014 kit ..... \$200</p>                                                                                                                                                                                                                                                                                                                                | <p><b>VERSAFLOPPY I FLEXIBLE DISK DRIVE Controller</b></p>  <p>27002 assem/T... \$250<br/>38005 assem/T... \$335</p>                                                                                                                                                                                                                                                                                                                                                                                                                                                                                                                                                                                                                                                                                                                                                                                                                                                                                                                                                                                                                                                                                                                                                                                                                                                                                                | <p><b>VDB-8024 VIDEO DISPLAY BOARD</b></p>  <p>38013 assem/T... \$470</p>                                                                                                                                                                                                                                                                                                                                                                                                  |                                                                                         |                                                                                                                                                                                                                                                                                                                       |                                                                                                                                                                                                                                                                                                                                                                                                                                                                                                                                                                                     |                                                                                                  |                                                                                   |                                                                                  |                                                                                            |                                                                                             |
| <p><b>\$25 FACTORY REBATE</b></p> <p>When you purchase any SD SYSTEMS item you will receive a COUPON FOR A \$25 CASH REBATE direct from the Manufacturer. SD SYSTEMS. Use it with our 16% OFF COUPON for extra savings.</p>                                                                                                                                                                                                                                                                                                                                                      | <p><b>SD Systems EXPANDO RAM</b></p>  <p>27001 kit ..... \$220<br/>38001 assem/T... \$480</p> <p><b>Add-On RAM Kit</b><br/>27010 (16K, 8 devices) \$165</p>                                                                                                                                                               | <p><b>PLESSEY</b></p> <p>Metallized Polyester Capacitors</p> <p>Series 160 MINIBOX SAMPLER \$26.00</p>                                                                                                                                                                                                                                                                                                                                                                                                                                                                                                                                                                                                                                                                                                                                                                                                                                                                                                                                                                                                                                                                                                                                                                                                                                                                                                                                                                                                 | <p><b>SORCERER COMPUTER</b></p> <p>32K Part No. DP1000-2 \$1295</p> <p>FEATURES: 280 - 8K ROM - 32K RAM - Dual Channel I/O - 20 Lines of 64 Characters - 64 On-Screen Characters and 64 User Defined Characters - 512 x 240 Graphic Resolution - Edge Card Connection to S-100 Bus - Serial and Parallel I/O.</p>                                                                                                                                                                                                                                             |                                                                                         |                                                                                                                                                                                                                                                                                                                       |                                                                                                                                                                                                                                                                                                                                                                                                                                                                                                                                                                                     |                                                                                                  |                                                                                   |                                                                                  |                                                                                            |                                                                                             |
| <p><b>ULTRA Low Power Consumption LCD 106</b></p> <p style="text-align: center;"><b>\$13.50</b></p>                                                                                                                                                                                                                                                                                                                                                                                                                                                                              | <p><b>SYM-1 NEW LOW PRICE</b></p>  <p style="text-align: center;"><b>\$239.00</b></p> <p style="text-align: center; font-size: small;">KTM-2 CRT/TV Kybd Term 5349</p>                                                                                                                                                    | <p><b>ANCRONA</b></p> <p>Send check or Money Order to: P.O. Box 2208Y, Culver City CA 90230. California residents add 6% sales tax. Minimum Order: \$10.00. Add \$2.00 to cover postage and handling. Master Charge and Visa welcomed. Please include your charge card number, interbank number and expiration date. <b>PHONE ORDERS: (213) 641-4054</b></p> <table style="width: 100%; border: none;"> <tr> <td style="border: none; width: 25%;"> <p><b>MAIL ORDER</b><br/>P.O. Box 2208Y<br/>Culver City CA 90230<br/>(213) 641-4054</p> </td> <td style="border: none; width: 25%;"> <p><b>PORTLAND</b><br/>1125 N.E. 87th Ave.<br/>Portland, OR 97220<br/>(503) 254-8541</p> </td> <td style="border: none; width: 25%;"> <p><b>SANTA ANA</b><br/>1306 E. Edinger Ave.<br/>Santa Ana, CA 92705<br/>(714) 547-8424</p> </td> <td style="border: none; width: 25%;"> <p><b>CULVER CITY</b><br/>11080 Jefferson Blvd.<br/>Culver City, CA 90230<br/>(213) 390-3595</p> </td> </tr> <tr> <td style="border: none;"> <p><b>TUCSON</b><br/>4518 E. Broadway<br/>Tucson, AZ 85711<br/>(602) 881-2348</p> </td> <td style="border: none;"> <p><b>HOUSTON</b><br/>2648 Richmond<br/>Houston, TX 77008<br/>(713) 529-3489</p> </td> <td style="border: none;"> <p><b>ATLANTA</b><br/>3330 Peachtree Rd. N.E.<br/>Atlanta, GA 30305<br/>(404) 261-7100</p> </td> <td style="border: none;"> <p><b>SUNNYVALE</b><br/>10541 E. Camino Real<br/>Sunnyvale, CA 94087<br/>(408) 263-4121</p> </td> </tr> </table> |                                                                                                                                                                                                                                                                                                                                                                                                                                                                                                                                                               | <p><b>MAIL ORDER</b><br/>P.O. Box 2208Y<br/>Culver City CA 90230<br/>(213) 641-4054</p> | <p><b>PORTLAND</b><br/>1125 N.E. 87th Ave.<br/>Portland, OR 97220<br/>(503) 254-8541</p>                                                                                                                                                                                                                              | <p><b>SANTA ANA</b><br/>1306 E. Edinger Ave.<br/>Santa Ana, CA 92705<br/>(714) 547-8424</p>                                                                                                                                                                                                                                                                                                                                                                                                                                                                                         | <p><b>CULVER CITY</b><br/>11080 Jefferson Blvd.<br/>Culver City, CA 90230<br/>(213) 390-3595</p> | <p><b>TUCSON</b><br/>4518 E. Broadway<br/>Tucson, AZ 85711<br/>(602) 881-2348</p> | <p><b>HOUSTON</b><br/>2648 Richmond<br/>Houston, TX 77008<br/>(713) 529-3489</p> | <p><b>ATLANTA</b><br/>3330 Peachtree Rd. N.E.<br/>Atlanta, GA 30305<br/>(404) 261-7100</p> | <p><b>SUNNYVALE</b><br/>10541 E. Camino Real<br/>Sunnyvale, CA 94087<br/>(408) 263-4121</p> |
| <p><b>MAIL ORDER</b><br/>P.O. Box 2208Y<br/>Culver City CA 90230<br/>(213) 641-4054</p>                                                                                                                                                                                                                                                                                                                                                                                                                                                                                          | <p><b>PORTLAND</b><br/>1125 N.E. 87th Ave.<br/>Portland, OR 97220<br/>(503) 254-8541</p>                                                                                                                                                                                                                                                                                                                     | <p><b>SANTA ANA</b><br/>1306 E. Edinger Ave.<br/>Santa Ana, CA 92705<br/>(714) 547-8424</p>                                                                                                                                                                                                                                                                                                                                                                                                                                                                                                                                                                                                                                                                                                                                                                                                                                                                                                                                                                                                                                                                                                                                                                                                                                                                                                                                                                                                            | <p><b>CULVER CITY</b><br/>11080 Jefferson Blvd.<br/>Culver City, CA 90230<br/>(213) 390-3595</p>                                                                                                                                                                                                                                                                                                                                                                                                                                                              |                                                                                         |                                                                                                                                                                                                                                                                                                                       |                                                                                                                                                                                                                                                                                                                                                                                                                                                                                                                                                                                     |                                                                                                  |                                                                                   |                                                                                  |                                                                                            |                                                                                             |
| <p><b>TUCSON</b><br/>4518 E. Broadway<br/>Tucson, AZ 85711<br/>(602) 881-2348</p>                                                                                                                                                                                                                                                                                                                                                                                                                                                                                                | <p><b>HOUSTON</b><br/>2648 Richmond<br/>Houston, TX 77008<br/>(713) 529-3489</p>                                                                                                                                                                                                                                                                                                                             | <p><b>ATLANTA</b><br/>3330 Peachtree Rd. N.E.<br/>Atlanta, GA 30305<br/>(404) 261-7100</p>                                                                                                                                                                                                                                                                                                                                                                                                                                                                                                                                                                                                                                                                                                                                                                                                                                                                                                                                                                                                                                                                                                                                                                                                                                                                                                                                                                                                             | <p><b>SUNNYVALE</b><br/>10541 E. Camino Real<br/>Sunnyvale, CA 94087<br/>(408) 263-4121</p>                                                                                                                                                                                                                                                                                                                                                                                                                                                                   |                                                                                         |                                                                                                                                                                                                                                                                                                                       |                                                                                                                                                                                                                                                                                                                                                                                                                                                                                                                                                                                     |                                                                                                  |                                                                                   |                                                                                  |                                                                                            |                                                                                             |

# DIGITAL RESEARCH COMPUTERS

(214) 271-3538

## 32K S-100 EPROM CARD

**NEW!**

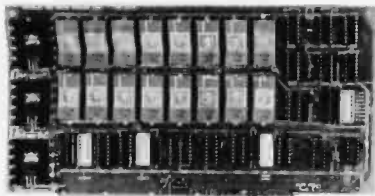

**\$74.95**  
KIT

USES 2716's

Blank PC Board - \$34

ASSEMBLED & TESTED  
ADD \$30

SPECIAL: 2716 EPROM's (450 NS) Are \$19.95 EA. With Above Kit.

**KIT FEATURES:**

1. Uses +5V only 2716 (2Kx8) EPROM's.
2. Allows up to 32K of software on line!
3. IEEE S-100 Compatible.
4. Addressable as two independent 16K blocks.
5. Cromemco extended or Northstar bank select.
6. On board wait state circuitry if needed.
7. Any or all EPROM locations can be disabled.
8. Double sided PC board, solder-masked, silk-screened.
9. Gold plated contact fingers.
10. Unselected EPROM's automatically powered down for low power.
11. Fully buffered and bypassed.
12. Easy and quick to assemble.

## 16K STATIC RAM KIT-S 100 BUSS

PRICE CUT!

**\$225** KIT

FOR 4MHZ  
ADD \$10

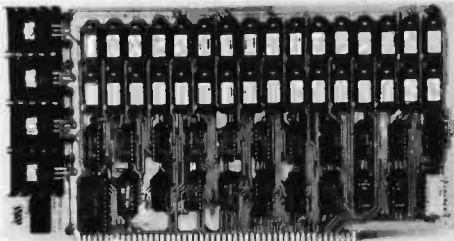

**KIT FEATURES:**

1. Addressable as four separate 4K Blocks.
2. ON BOARD BANK SELECT circuitry. (Cromemco Standard). Allows up to 512K on line!
3. Uses 2114 (450NS) 4K Static Rams.
4. ON BOARD SELECTABLE WAIT STATES.
5. Double sided PC Board, with solder mask and silk screened layout. Gold plated contact fingers.
6. All address and data lines fully buffered.
7. Kit includes ALL parts and sockets.
8. PHANTOM is jumpered to PIN 67.
9. LOW POWER: under 1.5 amps TYPICAL from the +8 Volt Buss.
10. Blank PC Board can be populated as any multiple of 4K.

BLANK PC BOARD W/DATA-\$33

LOW PROFILE SOCKET SET-\$12

SUPPORT IC'S & CAPS-\$19.95

ASSEMBLED & TESTED-ADD \$35

**OUR #1 SELLING  
RAM BOARD!**

## 16K DYNAMIC RAM PARTIALS

LOOK! INTEL 2108 8K X 1 RAMS LOOK!  
8 FOR \$9.95 32 FOR \$35  
FACTORY PRIME!

Huge special purchase of INTEL Dynamic RAM's. These are 2108-4, 300NS, 8K, Ceramic DIP. The 2108 is the INTEL 2116 (16K) tested for either upper or lower 8K only. These are factory prime. Full Spec. See INTEL 1978 Cat. for details or Memory Design Handbook for application data. Both IMSAI and EXTENSYS did mfg. S-100 RAM boards using these devices. — P.S. These devices will not work in the SD EPANDORAM™. Please specify upper or lower 8K. (S1626 or S1627). A super easy RAM to interface to a Z80, 16 PIN DIP.

FOR 4MHZ **SALE!** LOW POWER - 300NS 8 FOR \$44  
**2114 RAM SALE!**  
4K STATIC RAM'S. MAJOR BRAND, NEW PARTS.  
These are the most sought after 2114's, LOW POWER and 300NS FAST.  
8 FOR \$44

## 16K STATIC RAM SS-50 BUSS

PRICE CUT!

**\$229** KIT

FULLY STATIC!

FOR 2MHZ  
ADD \$10

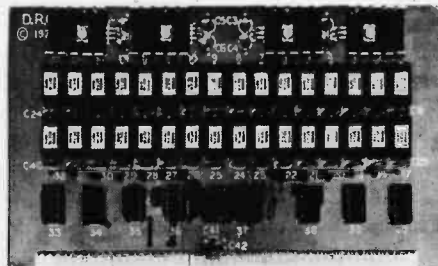

FOR SWTPC  
**6800 BUSS!**

ASSEMBLED AND  
TESTED - \$35

BLANK PC BOARD-\$30 COMPLETE SOCKET SET-\$12  
SUPPORT IC'S AND CAPS-\$19.95

**KIT FEATURES:**

1. Addressable on 16K Boundaries
2. Uses 2114 Static Ram
3. Fully Bypassed
4. Double sided PC Board. Solder mask and silk screened layout.
5. All Parts and Sockets Included
6. Low Power: Under 1.5 Amps Typical

## NEW! STEREO! S-100 SOUND COMPUTER BOARD NEW!

At last, an S-100 Board that unleashes the full power of two unbelievable General Instruments AY3-8910 NMOS computer sound IC's. Allows you under total computer control to generate an infinite number of special sound effects for games or any other program. Sounds can be called in BASIC, ASSEMBLY LANGUAGE, etc.

**KIT FEATURES:**

- \* TWO GI SOUND COMPUTER IC'S.
- \* FOUR PARALLEL I/O PORTS ON BOARD.
- \* USES ON BOARD AUDIO AMPS OR YOUR STEREO.
- \* ON BOARD PROTO TYPING AREA.
- \* ALL SOCKETS, PARTS AND HARDWARE ARE INCLUDED.
- \* PC BOARD IS SOLDERMASKED, SILK SCREENED, WITH GOLD CONTACTS.
- \* EASY, QUICK, AND FUN TO BUILD, WITH FULL INSTRUCTIONS.
- \* USES PROGRAMMED I/O FOR MAXIMUM SYSTEM FLEXIBILITY.

Both Basic and Assembly Language Programming examples are included.

**SOFTWARE:**

SCL™ is now available! Our Sound Command Language makes writing Sound Effects programs a SNAP! SCL™ also includes routines for Register-Examine-Modify, Memory-Examine-Modify, and Play-Memory. SCL™ is available on CP/M™ compatible diskette of 2708 or 2716. Diskette-\$24.95 2708 - \$19.95 2716 - \$29.95 Diskette includes the source. EPROM'S are ORG at E000H

**COMPLETE KIT!**

**\$84.95**

(WITH DATA MANUAL)

BLANK PC  
BOARD W/DATA  
\$31

## RCA CMOS COMPUTER CHIP SET

INCLUDES:

- |                         |                        |
|-------------------------|------------------------|
| 1-CDP1802CD CPU         | 1-CDP1861CD VIDEO IC   |
| 2-CDP1822CE 256 x 4 RAM | 1-CDP1862CE COLOR GEN. |
| 1-CDP1858CE 4 BIT LATCH | 1-CDP1863CE SOUND GEN. |

COMPLETE SET \$45 LIMITED QTY

## 16K EPROM CARD-S 100 BUSS

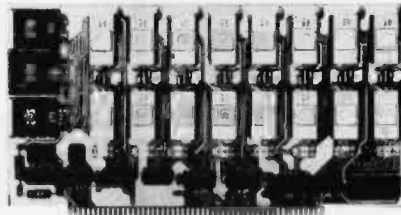

**\$59.95**  
KIT

BLANK PC BOARD - \$28

USES 2708's!

Thousands of personal and business systems around the world use this board with complete satisfaction. Puts 16K of software on line at ALL TIMES! Kit features a top quality soldermasked and silk-screened PC board and first run parts and sockets. Any number of EPROM locations may be disabled to avoid any memory conflicts. Fully buffered and has WAIT STATE capabilities.

ASSEMBLED AND FULLY  
TESTED — ADD \$30

OUR 450 NS 2708'S  
ARE \$8.95 EA. WITH  
PURCHASE OF KIT

## Digital Research Computers

(OF TEXAS)

P.O. BOX 401565 • GARLAND, TEXAS 75040 • (214) 271-3538

## NEW! G.I. COMPUTER SOUND CHIP

AY3-8910. As featured in July, 1979 BYTE! A fantastically powerful Sound & Music Generator. Perfect for use with any 8 Bit Microprocessor. Contains: 3 Tone Channels, Noise Generator, 3 Channels of Amplitude Control, 16 bit Envelope Period Control, 2-8 Bit Parallel I/O, 3 D to A Converters, plus much more! All in one 40 Pin DIP. Super easy interface to the S-100 or other busses.

SPECIAL OFFER: \$14.95 each Add \$3 for 60 page Data Manual.

TERMS: Add \$1.25 postage. We pay balance. Orders under \$15 add 75¢ handling. No. C.O.D. We accept Visa and MasterCard. Tex. Res. add 5% Tax. Foreign orders (except Canada) add 20% P & H. 90 Day Money Back Guarantee on all items. Orders over \$50, add 85¢ for insurance.



**CALIFORNIA COMPUTER SYSTEMS**

- 16K RAM BOARD. Fully buffered addressable in 4K blocks. IEEE standard for bank addressing 2114's. PCBD .....\$28.95 Kit 450 NSEC .....\$249.95
- PT-1 PROTO BOARD. Over 2,600 holes "4" regulators. All S-100 buss functions labeled, gold fingers. PCBD .....\$28.95
- PT-2 PROTO BOARD Similar to PT-1 except set-up to handle solder tail sockets. PCBD .....\$28.95
- CCS MAIN FRAME. Kit (S-100) .....\$339.95
- APPLE EXTENDER. Kit .....\$22.95
- APPLE IEEE INSTRUMENTATION INTERFACE KIT 7490. Kit .....\$275.00
- ARITHMETIC PROCESSOR FOR APPLE 7811A. Kit .....\$350.00
- APPLE ASYNCHRONOUS SERIAL INTERFACE 7710A. Kit .....\$89.95
- APPLE SYNCHRONOUS SERIAL INTERFACE 7712A. Kit .....\$89.95
- ALL OTHER CCS PRODUCTS AVAILABLE



- PB-1 2708 & 2716 Programming Board with provisions for 4K or 8K EPROM. No external supplies required. Textool sockets. Kit .....\$143.00
- CB-1A 8080 Processor Board. 2K of PROM 256 BYTE RAM power on/rest Vector Jump Parallel port with status. Kit .....\$146.00 PCBD .....\$31.95
- VB-3 80x24 VIDEO BOARD. Graphics included. 4MHZ .....\$379.95
- IO-4 Two serial I/O ports with full handshaking 20/60 ma current loop. Two parallel I/O ports. Kit .....\$168.00 PCBD .....\$31.95
- VB-IC 64 x 16 video board, upper lower case Greek composite and parallel video with software, S-100. Kit .....\$143.00
- CB-2 Z80 CPU BOARD. Kit .....\$199.95
- AIO APPLE SERIAL/PARALLEL .....\$144.95
- ALL OTHER SSM PRODUCTS AVAILABLE

**WMC inc. WAMECO INC.**

- FDC-1 FLOPPY CONTROLLER BOARD will drive shugart, pertek, remic 5" & 8" drives up to 8 drives, on board PROM with power boot up, will operate with CPM™ (not included). PCBD .....\$43.95
- FPB-1 Front Panel. IMSAI size, hex displays. Byte, or instruction single step. PCBD .....\$48.50
- MEM-1A 8K x 8 fully buffered, S-100. uses 2102 type rams. PCBD .....\$28.95
- QM-12 MOTHER BOARD, 13 slot, terminated, S-100 board only .....\$39.95
- CPU-1 8080A Processor board S-100 with 8 level vector interrupt. PCBD .....\$28.95
- RTC-1 Realtime clock board. Two independent interrupts. Software programmable. PCBD .....\$25.95
- EPM-1 1702A 4K Eprom card. PCBD .....\$25.95
- EPM-2 2708/2716 16K/32K EPROM CARD. PCBD .....\$28.95
- QM-9 MOTHER BOARD. Short Version of QM-12. 9 Slots. PCBD .....\$33.95
- MEM-2 16K x 8 Fully Buffered 2114 Board. PCBD .....\$28.95
- PTB-1 POWER SUPPLY AND TERMINATOR BOARD. PCBD .....\$28.95
- IOB-1 SERIAL AND PARALLEL INTERFACE. 2 parallel, one serial and cassette. PCBD .....\$28.95
- 2708 .....\$ 9.49 2114L 450 NSEC .....\$5.99
- 2716 .....\$35.95 2114L 200 NSEC .....\$6.99

**OCT. SPECIAL SALE ON PREPAID ORDERS**  
(Charge cards not included on this offer)

- RAM SALE**
  - MEM-2, PCBD .....\$25.95
  - MEM-2 + PARTS LESS RAM .....\$49.95
  - MEM-2 MIKOS #7 450 NSEC. ....\$199.95
- MIKOS PARTS ASSORTMENT WITH WAMECO AND CYBERCOM PCBDS**
- MEM-2 with MIKOS #7 16K ram with L2114 450 NSEC .....\$229.95
  - MEM-2 with MIKOS #13 16K ram with L2114 200 NSEC .....\$249.95
  - CPU-1 with MIKOS #2 8080A CPU .....\$99.95
  - QM-12 with MIKOS #4 13 slot mother board .....\$110.95
  - RTC-1 with MIKOS #5 real time clock .....\$65.95
  - EMP-1 with MIKOS #10 4K 1702 less EPROMS .....\$ 49.95
  - EPM-2 with MIKOS #11 16-32K EPROMS less EPROMS .....\$65.95
  - QM-9 with MIKOS #12 9 slot mother board .....\$99.95
  - FPB-1 with MIKOS #14 all parts for front panel .....\$144.95
- MIKOS PARTS ASSORTMENTS ARE ALL FACTORY MARKED PARTS. KITS INCLUDE ALL PARTS LISTED AS REQUIRED FOR THE COMPLETE KIT LESS PARTS LISTED. ALL SOCKETS INCLUDED.
- LARGE SELECTION OF LS TTL AVAILABLE PURCHASE \$50.00 WORTH OF LS TTL AND GET 10% CREDIT TOWARD ADDITIONAL PURCHASES. PREPAID ORDERS ONLY.**

**MIKOS**

(415) 726-7593  
P. O. Box 955 • El Granada, CA 94018  
Please send for IC, Xistor and Computer parts list

VISA or MASTERCARD. Send account number, interbank number, expiration date and sign your order. Approx. postage will be added. Check or money order will be sent post paid in U.S. If you are not a regular customer, please use charge, cashier's check or postal money order. Otherwise there will be a two-week delay for checks to clear. Calif. residents add 6% tax. Money back 30-day guarantee. We cannot accept returned IC's that have been soldered to. Prices subject to change without notice. \$10 minimum order. \$1.50 service charge on orders less than \$10.00.

**HOME STUDY COURSE ON CASSETTE**

**S1-INTRODUCTION TO MICROPROCESSORS**  
This seminar is intended for persons who wish to acquire a broad understanding of the basic concepts and techniques of microprocessors. It covers the basic operation of microprocessors, their internal structure, and the various methods of data entry and output. It also covers the basic concepts of microprocessor programming. Requires an understanding of the basic concepts of the MICROPROCESSOR SYSTEMS.

**S2-PROGRAMMING MICROPROCESSORS**  
This seminar describes the internal operation of a microprocessor system including how to program and how to use the system. It covers the basic concepts of microprocessor programming. Requires an understanding of the basic concepts of the MICROPROCESSOR SYSTEMS.

**\$2995**  
\*NO TECHNICAL BACKGROUND ASSUMED\*

**Take 20% off 'LS' prices**

|         |     |          |     |
|---------|-----|----------|-----|
| 74LS00  | 38  | 74LS158  | 75  |
| 74LS02  | 34  | 74LS180  | 95  |
| 74LS04  | 34  | 74LS181  | 100 |
| 74LS08  | 35  | 74LS182  | 95  |
| 74LS09  | 38  | 74LS183  | 95  |
| 74LS10  | 28  | 74LS184  | 115 |
| 74LS12  | 28  | 74LS185  | 89  |
| 74LS16  | 28  | 74LS186  | 108 |
| 74LS20  | 38  | 74LS174  | 90  |
| 74LS21  | 38  | 74LS175  | 90  |
| 74LS22  | 39  | 74LS180  | 110 |
| 74LS23  | 36  | 74LS183  | 95  |
| 74LS24  | 36  | 74LS185  | 89  |
| 74LS27  | 39  | 74LS186  | 108 |
| 74LS28  | 39  | 74LS190  | 140 |
| 74LS29  | 39  | 74LS200  | 145 |
| 74LS30  | 39  | 74LS201  | 145 |
| 74LS32  | 39  | 74LS241  | 145 |
| 74LS33  | 39  | 74LS243  | 220 |
| 74LS34  | 39  | 74LS244  | 245 |
| 74LS37  | 52  | 74LS245  | 695 |
| 74LS37A | 52  | 74LS247  | 695 |
| 74LS38  | 95  | 74LS252  | 95  |
| 74LS39  | 95  | 74LS259  | 95  |
| 74LS40  | 45  | 74LS259  | 285 |
| 74LS42  | 78  | 74LS270  | 55  |
| 74LS46  | 78  | 74LS273  | 100 |
| 74LS48  | 75  | 74LS279  | 185 |
| 74LS50  | 75  | 74LS280  | 185 |
| 74LS51  | 75  | 74LS283  | 100 |
| 74LS54  | 35  | 74LS369  | 95  |
| 74LS57  | 52  | 74LS369  | 95  |
| 74LS57A | 52  | 74LS370  | 95  |
| 74LS58  | 95  | 74LS371  | 250 |
| 74LS58A | 95  | 74LS372  | 250 |
| 74LS59  | 110 | 74LS374  | 250 |
| 74LS60  | 110 | 74LS386  | 65  |
| 74LS61  | 110 | 74LS386  | 65  |
| 74LS62  | 110 | SN74393A | 175 |

**SOROC TECHNOLOGY, INC.**

**10120 video 100**

**\$699.00**

**\$139.00**

Leedex Corp.

**12" BLACK & WHITE LOW COST VIDEO MONITOR**

**APPLE II Computer with full 48K of memory!**

**\$1099.00**

**APPLE EXPANSION KIT 16K Memory Add-On**

**\$475.00**

**\$249.50**

**\$100 MEMORY BOARD**

**16K STATIC RAM**

**\$249.00**

California Computer Systems

**2114L**  
1024x4 Static RAM  
450 NS  
**\$450**

**8038C**  
VCO Waveform Generator  
w/Sine  
**\$265**

**80-COLUMN IMPACT PRINTER**  
LOWEST IN PRICE - HIGHEST IN PERFORMANCE  
**\$649.00**

base2, inc.

**VOLTAGE REGULATORS**

|          |          |          |
|----------|----------|----------|
| NEGATIVE | POSITIVE | 7815LS+  |
| 7805/5V  | 7805/5V  | 78181BV/ |
| 7808/8V  | 7808/8V  | 7824/24V |
| 7915/15V | 7812/12V |          |
| 7918/18V |          |          |

**95¢**

**EPROM'S**

|                   |        |
|-------------------|--------|
| 2708              | 56.75  |
| 1K x 8 450NS      |        |
| 8 FOR \$48.50     |        |
| 2716              | 518.95 |
| 16K(2K x 8) 450NS |        |
| 8 FOR \$142.95    |        |
| 2732              |        |
| 32K (4096 x 8)    |        |

**LOGIC PROBE KIT**

**\$17.95**

**555 Timer**

**27¢**

**8212 I/O port**

**\$2.95**

**CONCORD COMPUTER COMPONENTS**

**POWER CONTROLLER**  
8outlet 6 switched  
EMI filtered  
Circuit Breaker  
**\$87.50**

**TRS-80 1980 "IC" Master**

**16K Memory Add-On \$49.95 KIT**  
with jumpers and instructions

**\$47.95**

**1971 SOUTH STATE COLLEGE ANAHEIM, CA. 92806**

VISA MASTERCARD (714) 937-0637 MINIMUM ORDER \$10.00  
CHECK OR M.D. NO COD We stock and sell over 12,000 types of semi-conductors ADD \$1.50 FOR FRT CAL RES ADD 6%

**MSM5832 MICROPROCESSOR REAL-TIME CLOCK/CALENDAR GENERAL DESCRIPTION**

**\$745**



# WE WILL NOT BE UNDERSOLD

**16K MEMORY UPGRADE KITS** 2 for \$85 **\$45**  
for TRS-80\*, Apple II, (specify): **Jumpers \$2.50**

## PRINTERS

### NEC Spinwriter



**Letter Quality High Speed Printer**  
Includes TRS-80\* interface software, quick change print fonts, 55 cps, bidirectional, high resolution plotting, graphing, proportional spacing: R.O. **\$2579**

R.O. with Tractor Feed **\$2679** KSR with Tractor Feed **\$2995**

**779 CENTRONICS TRACTOR FEED PRINTER \$969**

Same as Radio Shack line printer I

**737 CENTRONICS FRICTION & PIN FEED PRINTER \$799**

9 x 7 matrix

**730 CENTRONICS FRICTION & PIN FEED PRINTER \$629**

7 x 7 matrix Same as Radio Shack line printer II

**P1 CENTRONICS PRINTER \$269**

Same as Radio Shack quick printer

**PAPER TIGER (IP440) \$939**

Includes 2K buffer and graphics option

**TI-810 Faster than Radio Shack line printer III**

Parallel and serial w/TRS-80\* interface software

with upper and lower case and paper tray **\$1599**

**OKIDATA Microline 80 Friction and pin feed \$559**

Tractor Feed, friction, and pin feed

**EATON LRC 7000 + 64 columns, plain paper \$299**

**ANADEX DP-9500 \$1359 DP-8000 \$825**

## DISK OPERATING SYSTEMS

**PATCHPAK #4 by Percom Data \$ 8.95**

**CP/M® for Model I, Zenith \$145 • for Model II, Altos \$169.00**

**NEWDOS Plus 40 track \$ 99.00**

**NEWDOS 80 \$135.00**

## ACCESSORIES

**HEAD CLEANING DISKETTE:** Cleans drive Read/Write head in 30 seconds. Diskettes absorb loose oxide particles, fingerprints, and other foreign particles that might hinder the performance of the drive head. Lasts at least 3 months with daily use. Specify 5 1/4" or 8". **\$20 ea/\$45 for 3**

**FLOPPY SAVER:** Protection for center holes of 5 1/4" floppy disks. Only 1 needed per diskette. Kit contains centering post, pressure tool, tough 7-mil mylar reinforcing rings. Installation tools and rings for 25 diskettes. **\$11.95**

**Re-orders of rings only \$ 7.95**

**EXTERNAL DATA SEPARATOR:** Eliminates data separation problems (crc). Improves reliability. This plug in unit comes fully assembled and tested. **\$29.95**

**RS232 \$84.00**

**DISK-DRIVE EXTENDER CABLES:** Fits all mini-disk drives. **\$16.95**

**SIX (6) PRONG ISOLATOR \$54.00**

**AC FILTER/6 PRONG POWER STRIP \$39.00**

**DISK DRIVE CABLES:** 2 drive **\$29.00** 4 drive **\$35.00**

**DUST COVERS: TRS-80/Apple \$ 7.95**

**PLASTIC DISKETTE HOLDER \$ 8.00**

**RF MODULATOR: Adapts video to TV \$35.00**

**TRS-80 & OTHER MYSTERIES \$18.95**

**CAT MODEM Originate and answer same as \$148**

Radio Shack Telephone Interface II

**LEDEX MONITOR Video 100 \$119**

**ZENITH Color Monitor \$379**

**SANYO Model VM 4509 Monitor \$179**



## DISK DRIVES

**\$314**

40 track, 102K Bytes. Fully assembled and tested. Ready to plug-in and run the moment you receive it. Can be intermixed with each other and Radio Shack drive on same cable. TRS-80\* compatible silver enclosure. 90 day warranty. One year on power supply. **External card edge included.**

**FOR TRS-80\***

**CCI-100 5 1/4", 40 Track (102K Bytes) for Model I \$314**

**CCI-280 5 1/4", 80 Track (204K Bytes) for Model I \$549**

**CCI-800 8" Drive for Model II (1/2 Meg Bytes) \$795**

**For Zenith Z89**

**CCI-189 5 1/4", 40 Track (102K Bytes) add-on drive \$394**

**Z-87 Dual 5 1/4" add-on drive system \$995**

**DISKETTES — Box of 10 (5 1/4") — with plastic library case \$24**

**8" double density for Model II (box of 10) \$36**

## COMPLETE SYSTEMS

**ALTOS 64K, DD, SS, 2-Drive, 1MB \$3995**

**TRS-80\* Model II-64K \$3499**

**TRS-80\* LEVEL II-16K with keypad \$689**

**TRS-80\* Expansion Interface \$249**

**APPLE 16K \$989**

**HEWLETT PACKARD HP-85 \$2999**

**ZENITH Z89, 48K all-in-one computer \$2555**

**ZENITH Z19 \$740**

**TELEVIDEO 912B \$745 920B \$769**

**ATARI 400 \$489 ATARI 800 \$769**

**APF M1000 \$99 IM-1 \$499**

**MATTEL INTELLIVISION \$249**

## SOFTWARE FOR THE TRS-80\*

Software w/Manual

**INTELLIGENT TERMINAL SYSTEM ST-80-II BY LANCE MIKLUS:** Enables a TRS-80\* to act as a dial-up terminal on any standard time sharing network. Provides a TRS-80\* with control key, ESC Key, Repeat Key, Rub Out Key, Break Key, full upper and lower case support, selectable printer output and program selectable transmission rates **\$139**

**CCA-DATA MANAGEMENT SYSTEM:** Automate your information processing tasks. You can create a file of customer information; quickly and easily add, delete or update records; search a file; keep a file in order of the value in any field; and print records and labels in any desired sequence or from just a part of a file. Requires 32K TRS-80 and one drive. **\$74.95**

**S & M SYSTEMS INSEQ-80™:** Indexed Sequential Access Method (ISAM) for the TRS-80 Model I. A must for anyone writing business programs. Eliminate wasted disk space from direct record processing. Split second access to any record. Access date records instantly via alpha-numeric "key" eg. Part No, zip code or sequentially in ascending key sequence. Add/modify records in any order. Access up to three files per program — Files

may be spread over multiple disks. Machine language processing from your basic program. Utility program to convert direct files to INSEQ-80 format. **\$48.95**

**FULLY INTERACTIVE ACCOUNTING PACKAGE: ISAM (INSEQ-80) based.** Includes General Ledger, Accounts Payable, Accounts Receivable and Payroll. System runs "stand alone" or "co-ordinated G/L" at users option. Based on Osborne accounting method. Requires 32K, TRS-80, 2 or 3 drives. N/A CA.

General Ledger \$99  
Accounts Receivable \$99  
Accounts Payable \$99  
Payroll \$99  
Osborne books: Req'd as additional documentation \$20 ea

**INVENTORY** Requires 32K, TRS-80, 1 drive **\$125**  
**INSORT-80:** Callable form BASIC via USR. Sorts "Random" Disk Files. "Disk" to "Disk" sort times — 350 records in 35 secs, 1000 records in 8 minutes, 3500 records in 12 minutes. Machine language processing. Up to 35 sort keys ascending/descending. Utility to build BASIC program. Runs under NEWDOS. **\$48.95**

## CP/M BASED SOFTWARE for Zenith, Altos, Radio Shack, Apple

Software w/Manual

**Z-80 SOFTCARD FOR APPLE:** Your key to future software expansion. Get the best of both worlds, Apple's 6502 and CP/M Z-80. Plug in the card and get a Z80. Supports Apple language card and all Apple peripherals. Comes with set of three manuals. **\$339**

**CCI-TELNET VERSION 8:** A communication Package which enables microcomputer users to communicate both with Large Mainframes and other microcomputers. Extensive commands make it useful in many applications where communication between computers is necessary. Powerful terminal mode enabling

user to save all data from a session on disk. Completely CP/M compatible. Multiple communication protocols supported. Able to transfer files in both directions without protocol where the other machine does not support any protocol. Extensive ON-SCREEN help. Source code provided. **\$148**

**MICROPRO-WORD STAR:** Menu driven visual word processing system for use with standard terminals. Text formatting performed on screen. Facilities for text paginate, page number, justify, center and underscore. User can print one document while simultaneously editing a second. Edit facilities include global search and replace, Read/Write to other text files, block move, etc. Requires CRT terminal with addressable cursor positioning. **\$399**

DEALER (NATIONAL/INTERNATIONAL) INQUIRIES INVITED

Send for FREE Catalogue

# The CPU SHOP

TO ORDER CALL TOLL FREE 1-800-343-6522

Massachusetts residents call (617) 242-3361

For detailed technical information, call 617/242-3361

Hours: 10AM-6PM (EST) M-F (Sat. till 5)

\*TRS-80 is a Tandy Corporation Trademark

© Digital Research

5 Dexter Row, Dept. B10M  
Charlestown, Massachusetts 02129

Massachusetts residents add  
5% sales tax

Quantities on some items are limited



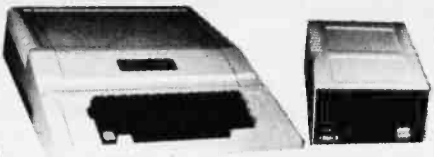

apple computer  
\$975 16K

The APPLE II is a completely assembled and tested computer system. The system includes a rugged molded case, typewriter-style keyboard with N-key rollover, high-efficiency switching power supply, two hand controllers, demonstration programs on tape cassettes, AC power cord, cassette cable, reference manuals.

APPLE II has ROM-resident Integer BASIC interpreter, monitor, mini-assembler and disassembler & BASIC Programming Manual.

October Special! Additional \$10.00 off on most items.

**32K \$1050**

**48K \$1125**

**APPLE II OR APPLE II PLUS**

|                                                                         |                                                  |                                                                      |                                                                      |                                                                                                                     |
|-------------------------------------------------------------------------|--------------------------------------------------|----------------------------------------------------------------------|----------------------------------------------------------------------|---------------------------------------------------------------------------------------------------------------------|
| DISK II-DRIVE ONLY \$429                                                | PROGRAMMABLE TIMER MODULE No. 7440A 145          | M&R SUP-R-TERMINAL 80 COLUMN BOARD 339                               | APPLE II & APPLE II PLUS SOFTWARE                                    | FORTH II by PROGRAMMA SOFTWARE 45                                                                                   |
| DISK II-DRIVE & CONTROLLER CARD 489                                     | 3+ DIGIT BCD ANALOG TO DIGITAL CONVERTER 135     | MICROSOFT Z 80 SOFTCARD SYSTEM W/CP/M 299                            | PASCAL with LANGUAGE SYSTEM FORTRAN for use with LANGUAGE SYSTEM 169 | SINGLE DISK COPY ROUTINES APPLEBUG ASSEMBLER DISASSEMBLER APPLEBUG DEBUGGER APPLEPOST UTILITY PROGRAMS BY HAYDEN 27 |
| MODEM IIB W/INTERFACE 339                                               | GPIB IEEE-488 (1979) INTERFACE No. 7490A 259     | MICROWORKS DS-65 DIGISECURE MOUNTAIN HARDWARE                        | CP/M for use with MICROSOFT Z 80 SOFTCARD 299                        | THE CONTROLLER General Business System 519                                                                          |
| MODEM IIB ONLY (Novation Cat.) 159                                      | ASYNCHRONOUS SERIAL INTERFACE No. 7710A 145      | APPLE CLOCK/CALENDAR CARD SUPER TALKER SPEECH SYNTHESIZER SYSTEM 249 | THE CASHIER Retail Management & Inventory 199                        | PRINTERS, TERMINALS & MONITORS                                                                                      |
| GRAPHICS TABLET 659                                                     | SYNCHRONOUS SERIAL INTERFACE No. 7712A 145       | ROMPLUS - w/KEYBOARD FILTER 169                                      | APPLEWRITER Word Processor 65                                        | PRINTERS, TERMINALS & MONITORS                                                                                      |
| SILENTEYE PRINTER W/Apple Interface 519                                 | PARALLEL INTERFACE No. 7720A 109                 | ROMPLUS - w/o KEYBOARD FILTER 155                                    | APPLEPOST Mailing List System 45                                     | ANADEX OP8000 or DP8000AP \$795                                                                                     |
| APPLE COMPUTER INTERFACE CARDS                                          | ARITHMETIC PROCESSOR CARD NO. 7811B 339          | INTROL X-10 REMOTE CONTROL SYSTEM 249                                | APPLEPOST Graph & Plot System 85                                     | ANADEX DP9500 or OP9501 1395                                                                                        |
| PROTOTYPING/HOBBY CARD \$22                                             | WIRE WRAP BOARD 20                               | INTROL X-10 CONTROLLER ONLY 169                                      | APPLEPOST Portfolio Evaluator 45                                     | BASE 2 w/TRACTOR & BUFFER 599                                                                                       |
| PARALLEL PRINTER INTERFACE CARD 145                                     | SOLDER TAIL BOARD 20                             | ROMWRITER SYSTEM 159                                                 | CONTRIBUTIVE VOLUMES I THRU 5 w/ MANUALS 35                          | CENTRONICS 700-9 1099                                                                                               |
| COMMUNICATION CARD & DB25 Connector Cable 185                           | EXTENDER BOARD 24                                | PROGRAMMA APPLE JOYSTICK SEE-THRU CLEAR PLASTIC TOP FOR APPLE II 23  | VISI-CALC by PERSONAL SOFTWARE DESKTOP/PLAN by DESKTOP COMPUTERS 85  | CENTRONICS 737 849                                                                                                  |
| HIGH SPEED SERIAL INTERFACE CARD 155                                    | PCB ETCH BOARD 20                                | SSM A10 SERIAL/PARALLEL I/O CARD (KIT) 129                           | COA DATA MANAGEMENT By PERSONAL SOFTWARE 85                          | MPI 881 699                                                                                                         |
| LANGUAGE SYSTEM WITH PASCAL CENTRONICS PRINTER INTERFACE CARD 185       | CORVUS                                           | SSM A10 ASSEMBLED & TESTED 169                                       | PIMS Personal Information Management System 23                       | PAPER TIGER IDS 440 895                                                                                             |
| APPLESOFT II FIRMWARE CARD W/Auto-Start ROM 149                         | CORVUS 10 MEGABYTE HARD DISK DRIVE SYSTEM \$4495 | APPLE LIGHT PEN SYSTEM 219                                           | ADVENTURE by MICROSOFT 27                                            | LEOEX VIDEO 100 139                                                                                                 |
| INTEGEX BASIC FIRMWARE CARD W/Mon & Prog. Aid ROMS 149                  | CORVUS MIRROR1 (VTR Required) 695                | SUPER SOUND GENERATOR (MONO) 139                                     | SUB-LOGIC FS-1 Flight Simulator 23                                   | SANYO 9 INCH MONITOR 159                                                                                            |
| ADD-ONS                                                                 | CORVUS MIRROR2 (VTR Required) 795                | SUPER SOUND GENERATOR (STEREO) 229                                   | SARGON II Chess by HAYDEN (Cass.) 27                                 | SANYO 15 INCH MONITOR 249                                                                                           |
| 16K MEMORY UPGRADE (TRS-80, Apple, Sorcerer) \$69                       | CORVUS CONSTELLATION 595                         | SW 8 INCH DISK DRIVE CONTROLLER 339                                  | SARGON II Chess on Diskette 32                                       | TI 13 INCH COLOR MONITOR 429                                                                                        |
| ABT NUMERIC INPUT KEYPAD (Old or New Hybrid) 119                        | DAN PAYMAR LOWER CASE ADAPTER 44                 | VERSA WRITER DIGITIZER DRAWING SYSTEM 219                            | Bill Budge's TRILOGY of GAMES 27                                     | SOROC IQ 120 729                                                                                                    |
| ALF MUSIC SYNTHESIZER 239                                               | DC HAYS MICROMODE II 319                         | VIDEO VIDEOTERM 80 COLUMN CARD 319                                   | Bill Budge's SPACE GAME ALBUM 32                                     | SOROC IQ 140 1199                                                                                                   |
| ALF TIMING MODE INPUT BOARD 19                                          | HUERISTICS                                       | VIDEO VIDEOTERM W/GRAPHICS EPROM 339                                 | SPACE INVADER on cassette 18                                         | HAZELTINE 1500 979                                                                                                  |
| BRIGHTEN LIGHTPEN from SOFTWARE 32                                      | SPEECHLINK 2000 (64 Word Vocabulary) 219         |                                                                      | SPACE INVADER on Diskette 23                                         | HAZELTINE 1510 1079                                                                                                 |
| CALIFORNIA COMPUTER SYSTEMS 12K ROM/PROG ASSEMBLED BOARD NO. 7114A \$69 | SPEECHLAB 20A (Cassette) 169                     |                                                                      | SYBEX APPLE-80 8080 SIMULATOR 17                                     | HAZELTINE 1520 1379                                                                                                 |
|                                                                         | SPEECHLAB 20A (Diskette) 189                     |                                                                      |                                                                      | HAZELTINE 1410 749                                                                                                  |
|                                                                         | MODEL 70 CONTROLLER 75                           |                                                                      |                                                                      | HAZELTINE 1420 829                                                                                                  |
|                                                                         | M&R SUP-R-MOD TV MODULATOR ADAPTER 77            |                                                                      |                                                                      |                                                                                                                     |

**ORDERING INFORMATION:** Phone orders may be placed using Visa, MasterCard or bank wire transfer. Mail orders may send charge card number (include expiration date), cashiers check, money order or personal check (allow 2 weeks to clear). Please include telephone number with all orders. Foreign orders including shipping, PO and 10% for shipping and handling must be in U.S. dollars. Shipping and handling in U.S. is \$10 per lb. surface, \$15.00 per lb. air. No COD or purchase orders. All prices subject to change and availability. Equipment is new and complete with manufacturer warranty.

**GS COMPUTER SPECIALTIES**  
1251 BROADWAY  
EL CAJON, CA. 92021 • (714) 679-0330

**"WE WILL NOT BE UNDER SOLD!"**

**BECKIAN ENTERPRISES**

ALL PRIME QUALITY - NEW PARTS ONLY  
SATISFACTION GUARANTEED.

**EDGE CARD CONNECTORS: GOLD PLATED:**

Abbreviations: S/E Solder Eye . S/T Sold Tail: W/W Wire Wrap.

| PART # DESCRIPTION                         | Row Sp.            | 1-9pc. | 10-24pc.  | 25pc. Up. | .156" CONTACT CENTER CONNECTORS. | Row Sp. | 1-9pc.             | 10-24pc. | 25pc. Up. | 'D' TYPE SUBMINIATURE CONNECTORS.        | PART NUMBER | DESCRIPTION. | 1-9pc.                    | 10-24pc.  | 25-99pc.    |                  |         |         |         |
|--------------------------------------------|--------------------|--------|-----------|-----------|----------------------------------|---------|--------------------|----------|-----------|------------------------------------------|-------------|--------------|---------------------------|-----------|-------------|------------------|---------|---------|---------|
| <b>BRAND: TEXAS INST.</b>                  |                    |        |           |           | <b>PART # DESCRIPTION.</b>       |         |                    |          |           | <b>'D' TYPE SUBMINIATURE CONNECTORS.</b> |             |              |                           |           |             |                  |         |         |         |
| 4070                                       | 50/100 Imaei/Crom. | .250   | \$3.95ea. | \$3.55ea. | \$3.15ea.                        | 15105   | 8/12 S/E PET/INSC  | .140     | \$1.80    | \$1.65                                   | \$1.45      | DE 9P        | Male                      | \$1.80ea. | \$1.40ea.   | \$1.30ea.        |         |         |         |
| 4090                                       | 50/100 Imaei W/W   | .250   | 4.30ea.   | 3.85ea.   | 3.45ea.                          | 15110   | 8/12 S/T PET/INSC  | .140     | 1.85      | 1.65                                     | 1.50        | DE 9S        | Female                    | 2.25ea.   | 2.00ea.     | 1.90ea.          |         |         |         |
| <b>BRAND: SULLINS: U.L. Reg.</b>           |                    |        |           |           | 15137                            |         |                    |          |           | 8/12 S/T PET/INSC                        | .200        | 1.80         | 1.54                      | 1.45      | DE 110983-1 | 2 pc. Grey Hood. | 1.50ea. | 1.35ea. | 1.20ea. |
| 129805                                     | 50/100 Solder Eye  | .140   | 8.00ea.   | 6.10ea.   | 4.50ea.                          | 15175   | 6/- S/E Sgl Row    | -        | 1.70      | 1.50                                     | 1.30        | DA 15P       | Male                      | 2.35ea.   | 2.15ea.     | 2.00ea.          |         |         |         |
| 129870                                     | 50/100 S/T Imaei   | .250   | 4.50ea.   | 4.10ea.   | 3.70                             | 16270   | 10/20 S/E          | .140     | 2.15      | 1.95                                     | 1.70        | DA 15S       | Female                    | 3.25ea.   | 3.10ea.     | 2.90ea.          |         |         |         |
| 129875                                     | 50/100 W/W Imaei   | .250   | 5.25      | 4.75      | 4.20                             | 16435   | 12/24 S/E PET      | .140     | 2.60      | 2.40                                     | 2.10        | DA 51211-1   | 1 pc. Grey Hood           | 1.40ea.   | 1.20ea.     | 1.15ea.          |         |         |         |
| 129885                                     | 50/100 S/T Altair  | .140   | 4.95      | 4.45      | 3.95                             | 15440   | 12/24 S/T PET      | .200     | 2.75      | 2.50                                     | 2.20        | DA 51226-1   | 2 pc. Black Hood          | 2.50ea.   | 2.25ea.     | 2.00ea.          |         |         |         |
| 129990                                     | 50/100 S/T Cromem. | .250   | 4.75      | 4.25      | 3.80                             | 16445   | 12/24 S/T PET      | .140     | 2.40      | 2.15                                     | 1.95        | DA 110983-2  | 2 pc. Grey Hood           | 1.80ea.   | 1.35ea.     | 1.30ea.          |         |         |         |
| <b>OTHER .125" CONTACT CTR CONNECTORS:</b> |                    |        |           |           | <b>PART # DESCRIPTION.</b>       |         |                    |          |           | <b>'D' TYPE SUBMINIATURE CONNECTORS.</b> |             |              |                           |           |             |                  |         |         |         |
| 12305                                      | 22/44 S/E No Ears  | .140   | 4.15      | 3.75      | 3.35                             | 15505   | 15/30 S/E GRI Key  | .140     | 2.50      | 2.25                                     | 2.00        | DB 25P       | Male                      | 2.80ea.   | 2.80ea.     | 2.40ea.          |         |         |         |
| 12759                                      | 38/72 S/T          | .140   | 5.40      | 4.85      | 4.35                             | 15510   | 15/30 S/T GRI Key  | .140     | 2.40      | 2.15                                     | 1.95        | DB 25S       | Female                    | 3.80ea.   | 3.40ea.     | 3.20ea.          |         |         |         |
| 12790                                      | 40/80 W/W          | .250   | 8.30      | 5.85      | 5.00                             | 15515   | 15/30 W/W GRI Key  | .200     | 2.80      | 2.35                                     | 2.10        | DB 51212-1   | 1 pc. Grey Hood           | 1.50ea.   | 1.30ea.     | 1.10ea.          |         |         |         |
| <b>.100" CONTACT CTR CONNECTORS:</b>       |                    |        |           |           | <b>PART # DESCRIPTION.</b>       |         |                    |          |           | <b>'D' TYPE SUBMINIATURE CONNECTORS.</b> |             |              |                           |           |             |                  |         |         |         |
| 10048                                      | 13/28 S/E No Ears  | .140   | 3.40      | 3.05      | 2.15                             | 15600   | 18/38 S/E          | .140     | 3.35      | 3.05                                     | 2.70        | DB 51226-1   | 2 pc. Black Hood          | 1.90ea.   | 1.85ea.     | 1.45ea.          |         |         |         |
| 10280                                      | 25/50 S/E TRS 80   | .140   | 4.50      | 4.05      | 3.80                             | 15610   | 18/38 W/W          | .200     | 3.00      | 2.70                                     | 2.40        | DB 110983-3  | 2 pc. Grey Hood           | 1.75ea.   | 1.50ea.     | 1.35ea.          |         |         |         |
| 10175                                      | 20/40 S/E TRS 80   | .140   | 5.85      | 5.35      | 4.75                             | 15615   | 18/38 S/T          | .140     | 3.00      | 2.70                                     | 2.40        | DC 37P       | Male                      | 4.20ea.   | 4.00ea.     | 3.70ea.          |         |         |         |
| 10180                                      | 20/40 W/W TRS 80   | .200   | 3.30      | 3.00      | 2.15                             | 15615   | 18/38 W/W          | .200     | 3.80      | 3.20                                     | 2.90        | DC 37S       | Female                    | 8.00ea.   | 5.75ea.     | 5.50ea.          |         |         |         |
| 10190                                      | 20/40 S/T TRS 80   | .140   | 3.20      | 2.90      | 2.55                             | 15710   | 22/44 W/W KIM/VEC  | .200     | 3.49      | 3.20                                     | 2.85        | DC 110983-4  | 2 pc. Grey Hood           | 2.25ea.   | 2.00ea.     | 1.75ea.          |         |         |         |
| 10485                                      | 38/72 S/E Vector   | .140   | 5.50      | 4.90      | 4.40                             | 15705   | 22/44 S/T KIM/VEC  | .140     | 3.98      | 3.30                                     | 3.00        | DD 50P       | Male                      | 5.50ea.   | 5.10ea.     | 4.75ea.          |         |         |         |
| 10490                                      | 38/72 W/E Vector   | .200   | 5.80      | 5.25      | 4.85                             | 15705   | 22/44 S/T KIM/VEC  | .140     | 3.98      | 3.30                                     | 3.00        | DD 50S       | Female                    | 9.40ea.   | 8.80ea.     | 8.00ea.          |         |         |         |
| 10500                                      | 38/72 S/T Vector   | .140   | 5.70      | 4.80      | 4.80                             | 15710   | 22/44 W/W KIM/VEC  | .200     | 3.49      | 3.20                                     | 2.85        | DD 51216-1   | 1 pc. Grey Hood           | 2.40ea.   | 2.20ea.     | 2.00ea.          |         |         |         |
| 10535                                      | 40/80 S/E PET      | .140   | 5.85      | 5.35      | 4.75                             | 15805   | 25/50 S/T          | .140     | 4.65      | 4.10                                     | 3.85        | DD 110983-5  | 2 pc. Grey Hood           | 2.80ea.   | 2.40ea.     | 2.10ea.          |         |         |         |
| 10540                                      | 40/80 W/W PET      | .200   | 8.00      | 5.40      | 4.80                             | 15805   | 25/50 S/T          | .200     | 4.85      | 4.35                                     | 3.90        | D 20418-2    | Hardware Set (1 Hood Set) | .90ea.    | .80ea.      | .70ea.           |         |         |         |
| 10550                                      | 40/80 S/T PET      | .140   | 5.80      | 5.25      | 4.85                             | 18115   | 38/72 S/E          | .140     | 6.50      | 6.85                                     | 5.20        |              |                           |           |             |                  |         |         |         |
| 10585                                      | 43/86 S/E COS/ELF  | .140   | 8.95      | 8.25      | 5.65                             | 18120   | 38/72 S/T          | .140     | 6.55      | 5.90                                     | 5.25        |              |                           |           |             |                  |         |         |         |
| 10805                                      | 43/86 S/T COS/ELF  | .140   | 8.60      | 5.95      | 5.30                             | 18125   | 38/72 S/T          | .200     | 6.75      | 6.10                                     | 5.40        |              |                           |           |             |                  |         |         |         |
| 10595                                      | 43/86 W/W COS/ELF  | .200   | 8.90      | 6.20      | 5.95                             | 18145   | 38/72 S/T          | .200     | 6.50      | 5.85                                     | 5.20        |              |                           |           |             |                  |         |         |         |
| 10615                                      | 43/86 S/T COS/ELF  | .200   | 8.80      | 6.10      | 5.40                             | 18235   | 43/88 S/T Mot 8800 | .140     | 8.80      | 5.95                                     | 5.30        |              |                           |           |             |                  |         |         |         |
|                                            |                    |        |           |           |                                  | 18240   | 43/88 W/W Mot 8800 | .200     | 7.80      | 7.05                                     | 6.25        |              |                           |           |             |                  |         |         |         |
|                                            |                    |        |           |           |                                  | 18290   | 43/88 S/T Mot 8800 | .200     | 8.50      | 5.95                                     | 5.20        |              |                           |           |             |                  |         |         |         |
|                                            |                    |        |           |           |                                  | 18725   | 43/88 S/E Mot 8800 | .140     | 7.20      | 6.50                                     | 5.75        |              |                           |           |             |                  |         |         |         |
|                                            |                    |        |           |           |                                  | K-1     | Pol-Keys           |          | .15       | .12                                      | .10         |              |                           |           |             |                  |         |         |         |

|                                                                |                                                                |                                        |                                                                                                                                                                                |
|----------------------------------------------------------------|----------------------------------------------------------------|----------------------------------------|--------------------------------------------------------------------------------------------------------------------------------------------------------------------------------|
| <b>I.C. SOCKETS GOLD. W/WRAP 3 TURN</b>                        | <b>I.C. SOCKETS TIN.</b>                                       | <b>COOLING FANS. Extra Quiet.</b>      | <b>TERMS: MINIMUM ORDER: \$15.00 ADD \$1.35 For Handling &amp; Shipping. Orders over \$30.00 in the U.S.A. We Pay the Shipping. CALIF. RESIDENTS: Please Add 6% Sales Tax.</b> |
| 14 pin \$0.40 ea.<br>18 pin 0.44 ea.                           | 14 pin \$0.15 ea.<br>18 pin 0.17 ea.                           | 1 to 4 \$18.00 ea.<br>5 to 9 17.00 ea. | <b>NOTE: NO C.O.D. OR CREDIT CARD ORDERS WILL BE ACCEPTED.</b>                                                                                                                 |
| <b>8080A PRIME. \$5.00 ea.</b>                                 | <b>CONNECTORS FOR CENTRONICS 700 SERIES. Amphenol 57-30380</b> | <b>PHONE: 213-988-6196</b>             | <b>BECKIAN ENTERPRISES</b>                                                                                                                                                     |
| <b>EIA 8 CONDUCTOR CABLES 8ft. Long. CLASS #1 Type Cables.</b> | 1 to 4 pcs. \$8.00 ea.<br>5 to 9 pcs. 6.00 ea.                 | <b>MAIL ORDERS TO:</b>                 | <b>P.O. BOX #3089</b>                                                                                                                                                          |
| 1. to 4 pcs. \$22.00<br>5 to 9 pcs. 19.00                      |                                                                |                                        | <b>SIMI VALLEY, CA 93063</b>                                                                                                                                                   |

CONTEST ENDS THIS MONTH • DON'T DELAY

# PRE-CHRISTMAS SALE!

ORDER NOW

NOW OPEN • SHOWROOM AND REPAIR CENTER

## STARWRITER DAISY-WHEEL PRINTER

**\$1995.<sup>00</sup>**

REG. \$2195.00

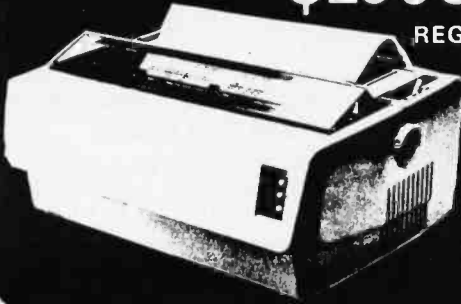

- PARALLEL OR SERIAL INTERFACE
- 96 CHAR FONT WHEEL
- HYTYPE II SUPPLIES
- 45 CPS (OPTIONAL) ADD \$600
- TRACTORS (OPTIONAL) - \$250

## 77-TRACK DISK DRIVES

FOR  
TRS-80™

**\$545.<sup>00</sup>**

REG. \$ 599.00

ORDER NOW TOLL FREE 1 (800) 345-8102 • VISA-MASTER CHARGE ACCEPTED

## 6.3 MEG HARD DISK WINCHESTER

FOR TRS-80, APPLE, S-100

**\$2445.<sup>00</sup>**

## SUPERBRAIN™

BY INTERTEC

**64K**

**\$2995.<sup>00</sup>**

ASK ABOUT OUR SPECIAL PURCHASE GAME SOFTWARE FOR X-MAS.

| SOFTWARE                                           | MOD. I       | MOD. II      | DISK DRIVES \$ 350               | MOD. I TRS-80 COMPATIBLE | 15% + OFF SELECTED TRS-80'S AND PERIPHERALS |
|----------------------------------------------------|--------------|--------------|----------------------------------|--------------------------|---------------------------------------------|
| Medical/Dental Patient Accounting                  |              | \$1500       | Model II Drives                  |                          |                                             |
| Word Processing (Magic Wand)                       |              | 300          | 1 Drive Single Enclosure         | \$ 899.00                |                                             |
| General Ledger                                     | \$149.95     | 249          | 1 Drive Multiple Enclosure       | 1069.50                  | 16K LII w/o Key Pads \$652                  |
| Payroll                                            | 99.95        | 199          | Additional Drives for Mult. Enc. | 540.00                   | 16K Expansion Interface 355                 |
| Data Base                                          | 149.95       | 299          | Disk Head Cleaning Kit - Mod. I  | 14.95                    | 32K Expansion Interface 450                 |
|                                                    |              |              | Disk Head Cleaning Kit - Mod. II | 24.95                    | Centronics 730 Printer 635                  |
|                                                    |              |              | 4K L II TRS-80                   | 575.70                   | Centronics 737 Printer 845                  |
| Upper/Lower Case Modification                      | Tape \$19.95 | Disk \$24.95 | 16K L II                         | 789.60                   | Cable for above Printers 30                 |
|                                                    |              |              | RS-232                           | 92.10                    |                                             |
| Comprehensive Diagnostics                          | 34.95        | 34.95        | OK Expansion Interface           | 278.10                   | <b>PRINTERS</b>                             |
| CP/M                                               |              | \$175.00     | Telephone Modem                  | 179.95                   | NEC 5510, 5530 w/Tractors \$2950.00         |
| New DOS + 40 TK                                    |              | 100.00       | Emulator CRT by Intertec         | 895.00                   | Printer Stands from 119.00                  |
| New DOS/80                                         |              | 145.00       | CRT Stands                       | 139.00                   |                                             |
| Software Documentation Available • CALL FOR PRICES |              |              | Anti-static Mats                 | 160.00                   |                                             |

## V R DATA'S TRS-80™

## SWEEPSTAKES

Celebrating V. R. DATA's 8th Anniversary

OVER \$1700.00 in PRIZES

### SWEEPSTAKES RULES

GRAND PRIZE - 16K LII TRS-80

- 1 ALL ENTRIES MUST BE SUBMITTED ON ORIGINAL ENTRY BLANK
- 2 ONE ENTRY PER PERSON
- 3 WINNERS SELECTED BY RANDOM DRAWING. NOTIFIED BY MAIL
- 4 ENTRIES MUST BE RECEIVED BY 10 31 80
- 5 VOID WHERE PROHIBITED BY LAW. NO PURCHASE NECESSARY

TWO SECOND PRIZES - DISK DRIVES

FOUR THIRD PRIZES - \$50.<sup>00</sup> Gift Certificates

• ABOVE PRICES ARE CASH DISCOUNTED •  
CALL FOR OTHER TERMS • DEALER INQUIRES INVITED

MAIL NOW TO ENTER V. R. DATA'S SWEEPSTAKES

NAME \_\_\_\_\_  
ADDRESS \_\_\_\_\_  
CITY \_\_\_\_\_ STATE \_\_\_\_\_ ZIP \_\_\_\_\_  
TELEPHONE \_\_\_\_\_ OCCUPATION \_\_\_\_\_  
COMPUTER EQUIPMENT OWNED \_\_\_\_\_

INTENDED USE \_\_\_\_\_

SEND FREE CATALOG

**VRData**

ORDER TOLL-FREE

1-800-345-8102

LOCAL CALL

(215) 461-5300

777 HENDERSON BLVD.  
FOLCROFT, PA 19032



LAST MONTH FOR SWEEPSTAKES • OVER \$1700.00 IN PRIZES

ENTER NOW! • GRAND PRIZE 16K LII TRS-80™ • EXPIRES 10-31-80

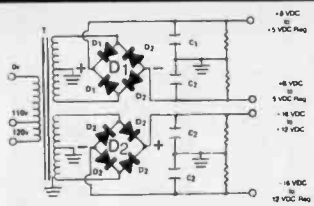

## BUILD YOUR OWN LOW COST MICRO-COMPUTER POWER SUPPLIES FOR S-100 BUS, FLOPPY DISCS, ETC.



### POWER TRANSFORMERS (WITH MOUNTING BRACKETS)

| ITEM NO. | USED IN KIT NO. | PRI. WINDING TAPS | SECONDARY WINDING OUTPUTS |           |               | SIZE W x D x H           | UNIT PRICE |
|----------|-----------------|-------------------|---------------------------|-----------|---------------|--------------------------|------------|
|          |                 |                   | 2x8 Vac                   | 2x14 Vac  | 2x24 Vac      |                          |            |
| T1       | 1               | 0V, 110V, 120V    | 2x7.5A                    | 2x2.5A    | —             | 3 3/4" x 3 5/8" x 3 1/8" | 21.95      |
| T2       | 2               | 0V, 110V, 120V    | 2x12.5A                   | 2x3.5A    | —             | 3 3/4" x 4 3/8" x 3 1/8" | 27.95      |
| T3       | 3               | 0V, 110V, 120V    | 2x9A                      | 2x2.5A    | 2x2.5A        | 3 3/4" x 4 3/8" x 3 1/8" | 29.95      |
| T4       | 4               | 0V, 110V, 120V    | 2x4A                      | (28V, CT) | 48V, CT, @ 3A | 3 3/4" x 3 5/8" x 3 1/8" | 22.95      |

### POWER SUPPLY KITS (OPEN FRAME WITH BASE PLATE, 3 HRS. ASSY. TIME)

| ITEM  | USED FOR        | @+8 Vdc | @-8 Vdc | @+16 Vdc | @-16 Vdc | @+28 Vdc | SIZE WxDxH        | UNIT PRICE |
|-------|-----------------|---------|---------|----------|----------|----------|-------------------|------------|
| KIT 1 | 15 CARDS SOURCE | 15A     | —       | 2.5A     | 2.5A     | —        | 12" x 6" x 4 7/8" | 51.95      |
| KIT 2 | SYSTEM SOURCE   | 25A     | —       | 3A       | 3A       | —        | 12" x 6" x 4 7/8" | 58.95      |
| KIT 3 | DISC SYSTEM     | 15A     | 1A      | 2A       | 2A       | 4A       | 14" x 6" x 4 7/8" | 66.95      |
| KIT 4 | DISC SOURCE     | 6A      | 1A      | 1A       | 1A       | 5A       | 10" x 6" x 4 7/8" | 51.95      |

EACH KIT INCLUDES: TRANSFORMER, CAPACITORS, RESIS., BRIDGE RECTIFIERS, FUSE & HOLDER, TERMINAL BLOCK, BASE PLATE, MOUNTING PARTS AND INSTRUCTIONS. \*OPTION OF KIT 4: REPLACE +28V @ 5A BY +16 @ 6A.

**DISC DRIVE POWER SUPPLY "R3"** ASSY. & TESTED, OPEN FRAME, SIZE: 9"(W) x 6 1/2"(D) x 4 3/8"(H) ..... **66.95**  
 SPECS: +5V @ 5A REGUL, OVP, -5V @ 1A REG., +24V @ 5A REG., SHORTS PROTECT. OPTIONS: 1. REPLACE +24V BY +12V  
 IDEAL FOR 2 SHUGART 801/851 OR SIEMANS FDD 100-8/200-8 DISK DRIVES & ROCKWELL AIM-65. 2. ADD ±12V @ 1A, \$10.00 MORE.

SHIPPING FOR EACH TRANSFORMER: \$4.75. FOR EACH POWER SUPPLY: \$5.00 IN CALIF. \$7.00 IN OTHER STATES. CALIF. RESIDENTS ADD 6% SALES TAX. OEM WELCOME



MAILING ADDRESS:  
P.O. BOX 4296  
TORRANCE, CA 90510

**SUNNY INTERNATIONAL**  
(TRANSFORMERS MANUFACTURER)  
(213) 633-8327 MON-SAT 9-6

SHIPPING ADDRESS:  
22134 S. VERMONT AVE  
UNIT "E"  
TORRANCE, CA 90502



SAVE TIME AND MONEY AT THE APPLE COMPUTER SUPER MARKET....



# COMPUTERS "R" US



**apple computer**  
Sales and Service



- DISK II DRIVE with controller..... **485**
- INTEGER or APPLESOFT II firmware card..... **149**
- PASCAL LANGUAGE SYSTEM.. **425**
- SILENTYPE PRINTER w/int.... **515**
- DC HAYES MICROMODEM II.. **315**
- MICROSOFT Z-80 CARD..... **319**

**APPLE ][ OR  
APPLE ][ PLUS  
16K ONLY**

**\$949**

**32K 999  
48K 1069**

### SOFTWARE

- CCA DATA MANAGEMENT.... **85** VISICALC... **12**
- APPLE FORTRAN..... **165** DOS 3.3.... **4**
- APPLE WRITER 65 DOS TOOLKIT... **6**
- APPLEPOST 45 APPLEPLOT... **6**

### VIDEO MONITORS

- LEEDEX VIDEO 100 12" B&W... **129**
- PANACOLOR 12" COLOR..... **329**
- SANYO 9" B&W..... **155**
- SANYO 15" B&W..... **245**
- ZENITH 13" COLOR..... **399**

### PRINTERS

- EPSON w/GRAPHICS. **729** CENTRONICS 737... **8**
- MPI 88T..... **699** NEC SPINWRITER... **25**
- PAPER TIGER QUME PRINTER... **249**
- w/GRAPHICS..... **975**

**(714) 698-8088**

**NOTE: FOR OTHER DISCOUNT PRODUCTS AND ORDER INFORMATION, PLEASE SEE OUR FULL PAGE AD ON PG. 3**  
 8907 LA MESA BLVD. LA MESA, CALIFORNIA 92041  
 Apple Computer is a trademark of Apple Computer Inc.

# The Supermarket for TRS-80\* Add-on Components (and other computers, too) In stock now. Immediate delivery.

## The Vista V-80/800/8000 Family Disk Drive System

- Fully compatible with TRS-80, Heath/Zenith
- 120 Day Warranty
- 40 Track Patch at NO CHARGE



|                                         |       |           |
|-----------------------------------------|-------|-----------|
| V-80 Single drive system (102K)         | ..... | \$ 395.00 |
| V-80 Two drive system (204K)            | ..... | \$ 770.00 |
| V-800 Single drive, B52 Drive (204K)    | ..... | \$ 595.00 |
| V-800-2 Double drive, B52 Drives (408K) | ..... | \$1175.00 |
| V-8000 Single drive, B92 Drive (408K)   | ..... | \$ 775.00 |
| V-8000-2 Double drive B92 Drives (816K) | ..... | \$1450.00 |

## The VISTA Model II

- Provides one, two or three drives.
- Adds up to 1.5 million bytes of on-line storage.
- 120 day warranty
- Does everything Radio Shack's expansion system will do... for less!

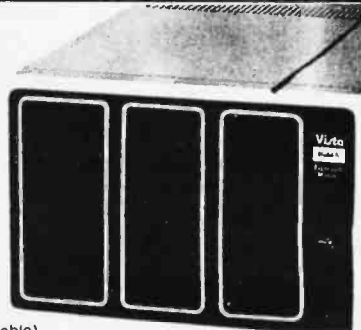

|           |                               |
|-----------|-------------------------------|
| \$ 900.00 | Single drive (non-expandable) |
| \$1000.00 | Single drive Expansion System |
| \$1550.00 | Two drive Expansion System    |
| \$2100.00 | Three drive Expansion System  |
| \$ 525.00 | Additional drives alone       |

## Printers

|                                     |       |                                                                    |
|-------------------------------------|-------|--------------------------------------------------------------------|
| Vista V300                          | ..... | \$1895.00                                                          |
| Daisy wheel                         |       |                                                                    |
| Letter quality                      |       |                                                                    |
| Base 2 Printer                      | ..... | \$575.00 (includes: 2-K Buffer, graphics, high speed tractor feed) |
| Variable line spacing control       |       |                                                                    |
| 0 to 64 dots in half dot increments |       |                                                                    |
| 100 cps — six densities             |       |                                                                    |
| Standard 96 character ASCII         |       |                                                                    |
| Up to 10 character fonts            |       |                                                                    |
| Anadex DP8000                       | ..... | \$895.00                                                           |
| 9 x 7 dot matrix                    |       |                                                                    |
| 80 column (112 cps)                 |       |                                                                    |
| Vista Printer                       | ..... | \$745.00                                                           |
| 5 x 7 dot matrix                    |       |                                                                    |
| 80 column (125cps)                  |       |                                                                    |

## Vista's Add on Drives for Apple™

Speed . Capacity . Price

More for Less

- 30 to 60% cheaper per byte
- From 20 to 400% more capacity
- Twice as fast
- Compatible with Pascal
- Warranty 120 days

|            |          |
|------------|----------|
| 40-Track   | \$365.00 |
| 80-Track   | \$595.00 |
| 160-Track  | \$825.00 |
| Controller | \$100.00 |

## The Vista MUSIC MACHINE 9

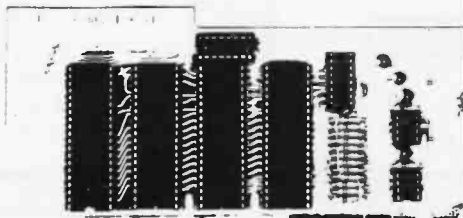

### WITH 9 VOICES!

- NEW! Uses latest State of the Art LSI Technology.
- Requires only one slot for 9 voices!
- Uses three Ay3-8910's to produce nine voices (Other competitive models have only 3 voices).
- Simulates three ALF Boards.
- Plays music generated by the ALF Board.
- APPLE™ II compatible.
- ALF™ software required.

3 Times  
More Powerful  
Than ALF™!

**\$129.95**

## Add On Drives

|         |                                       |       |          |
|---------|---------------------------------------|-------|----------|
| MPI B51 | 40 Track, Double Density-204K         | ..... | \$275.00 |
| MPI B52 | Dual Head, Double Density-408K        | ..... | \$375.00 |
| Siemens | FDD100-5 40 Track Double Density 204K | ..... | \$275.00 |
| Siemens | FDD100-8 8" Single Sided Drive        | ..... | \$448.00 |
| Shugart | 801R Single Sided Drive               | ..... | \$448.00 |

## Other Products

|                                                                      |       |          |
|----------------------------------------------------------------------|-------|----------|
| 1. VISTA Verbatim diskettes (hard or soft sector) Certified 40 track | ..... | \$ 38.95 |
| 2. 16K RPM upgrade kits, guaranteed for 120 days.                    |       |          |
| <b>PRIME PRODUCT</b>                                                 | ..... | \$ 59.95 |
| 3. NEW! DOS +                                                        | ..... | \$110.00 |
| 4. LNW expansion bare board                                          | ..... | \$ 66.95 |
| 5. H.C. Pennington book. TRS-80 Disk and Other Mysteries             | ..... | \$ 18.95 |
| 6. DDT Disco-Tech disk drive timer                                   | ..... | \$ 19.95 |

## The VISTA V-200 for Exidy.

- Completely packaged system, tested and ready to plug in, includes: power supply, two 40 track drives, case, controller, all cabling and total CPM documentation.
- Storage capacity from 400K to 1.2 meg.
- System software-VISTA CP/M Disk Operating System and BASIC-E Compiler recorded on 5-1/4" diskettes.

Price: Starting as low as \$1199.00

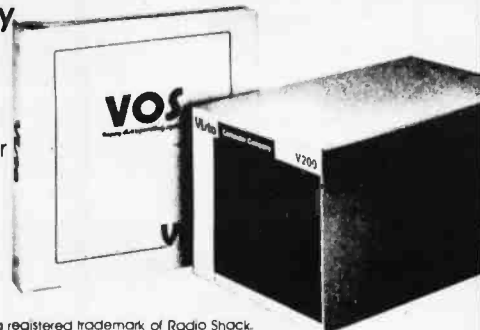

\*TRS-80 is a registered trademark of Radio Shack.



CALL TOLL-FREE 800-854-8017

The Vista Computer Company 1401 Borchard Street • Santa Ana, California 92705 • 714/953-0523

**COMPUTER EQUIPMENT & SOFTWARE BARGAINS**



**EVERY MONTH**

BUY, SELL OR TRADE ALL TYPES OF COMPUTER EQUIPMENT AND SOFTWARE (pre-owned and new) among 20,000 readers nationwide in BIG (11x14") pages. Classified ads are only 10¢ per word and are indexed for easy and fast location. Subscription: \$10 a year/12 issues. Money back guarantee.

**COMPUTER SHOPPER**  
P.O. Box F-14  
Titusville, FL 32780  
(305) 269-3211  
MasterCharge or VISA orders only,  
Call TOLL FREE 800-327-9920

Circle 277 on inquiry card.



**6800 DEVELOPMENT PAC II**

- 6800 MICRO COMPUTER
- 48K RAM
- EPROM PROGRAMMER
- RS-232 INTERFACE
- CASSETTE INTERFACE
- MONITOR DEBUG ROM
- EDITOR/ASSEMBLER
- 4K INDUSTRIAL BASIC
- RACK, BACK PLANE, SUPPLY
- \$1895

**WINTEK** Corp.  
317-742-8428  
801 South St., Lafayette, IN 47904

Circle 278 on inquiry card.

**WE HAVE 8039 MICROCOMPUTERS**

**NEW PRIME PARTS**

- TIMER APPLICATIONS
- CLOCKS
- SYSTEM CONTROLLERS
- KEYBOARD ENCODING
- 5 VOLT SUPPLY 6MHz
- ETC.

**SEND CHECK FOR IMMEDIATE DELIVERY**  
1-5 \$19 6-25 \$15  
**OVER 25 \$10**  
MARSHALL PHILLIPS  
U.S.I., DEPT. 37  
10324 S. DOLFIELD ROAD  
OWINGS MILLS, MD 21117  
(301) 363-3000 TELEX: 8-7675

Circle 279 on inquiry card.



**Solve your disc problems, buy 100% surface tested Dysan diskettes. All orders shipped from stock, within 24 hours. Call toll FREE (800) 235-4137 for prices and information. Visa and Master Card accepted. All orders sent postage paid.**



**PACIFIC EXCHANGES**  
100 Foothill Blvd.  
San Luis Obispo, CA 93401. (In Cal call (805) 543-1037.)

Circle 280 on Inquiry card.

**Disk Based Word Processor**

A COMPLETE WORD PROCESSING SYSTEM FOR YOUR DESKTOP. INCLUDES: EDITING, CORRECTING, INCLUDING, MAILING, COPY, MOVE, FIND, DELETE, INSERTION AND CORRECTION. STORE TO FILE, DISK, PRINT, SCREEN/PERSONAL LETTERS, REPORTS WITH BUNDLING, BULK AND TITLE PAGES.

TEXT IS STORED ON DISK AS BLOCKS AND INSERTED TO FILES AND WILL BE EDITED BY THE AVAILABLE "WORD" COMMANDS AND ONE OF MANY OTHER FEATURES. COMPLETE ON CASSETTE WITH SOFTWARE TO PRODUCE APPROPRIATE LIST OF FEATURES, AND EXTENSIVE MANUAL.

ONLY REQUIRES MINUTE INSTALLATION AND MUCH MORE. SEND CHECK, MONEY ORDER OR ORDER BY PHONE. BY CHECK, VISA, M.C., MASTERCHARGE AND VISA CARD. WEATHER: INCLUDES 50¢ PER COPY FOR FIRST CLASS POST.

Available Now!  
**Mailing List Option**

A COMPLETE MAILING LIST OPTION FOR THE OWNER OF THE PENSA-WRITE WORD PROCESSOR. CAPACITY FOR 100 NAMES PER DISK. SORTS BY ZIP CODE, PRINTS BUSINESS LETTERS (CREATED BY PENSA-WRITE) AGAINST MAILING LIST ON POSITION. INVERSE SORTING TO SEPARABLE ORDER. PRINTS LABELS IN USER DESIGNATED FORMS. MAX NUMBER OF COLUMNS FOR TO 2 ACROSS THE PAGE. ANY THE POSITIONS, AND AN NUMBER OF SPACES DESIGNATED.

INTERFACES SIMILAR TO PENSA-WRITE SOFTWARE TO FORM THE COMPLETE WORD PROCESSING MAILING LIST OPTION. REQUIRES 32- AND ONE DISK DRIVE. PLEASE NOTE: PENSA-WRITE IS NOT A "STAND ALONE" PROGRAM AND IS DESIGNED TO BE USED WITH PENSA-WRITE.

**PENSADYNE**  
4441 West First Ave.  
Vancouver, B.C.  
V6R 4H9  
604-224-3107

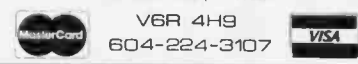

Circle 281 on inquiry card.

**OHIO SCIENTIFIC SYSTEMS**

**CALL FREE FOR OUR PRICES (800) 558-0870**

OR  
**WRITE FOR CATALOG**

**FARAGHER & ASSOCIATES**

7635 BLUEMOUND  
MILWAUKEE, WI 53213  
(414) 258-2588  
In Wisconsin

Circle 282 on inquiry card.

**CONSULTANT'S BILLING SYSTEM**

An automated client/project billing system designed for use by the professional consultant.

- Client/Project Files
- Labor Distribution
- Daily Time & Expenses
- Posts Payments/Adjustments
- Aged Accounts Receivable
- Monthly Invoices
- Project Summary
- Fixed and T&M Projects

Requires CBASIC-2 and 32K CP/M®

Distributed on 8" CP/M compatible diskette. Includes CBASIC-2 Source Code and a 25 page User's Manual including installation procedures.

\$79.00 check with order

**CEDAR HILL SOFTWARE**  
P.O. BOX 652  
STAFFORD, VA 22554  
(703) 659-2890

\* CP/M is a registered trademark of Digital Research

Circle 283 on inquiry card.

**BASEX is . . .**

- More Basic than BASIC!
- More Forthright than FORTH!
- More Tiny than TINY C!
- Runs Fast like FORTRAN!
- Less Pascal than PASCAL!

\*97 page manual (\$8) with complete source listing.  
\*TAPES (\$25) — Meca, SOL, Poly88, TRS80 (16K/II), Paper tape.  
\*DISKS — NStar (\$25); CPM (\$35) 8" SD or 5" (NStar, Meca, MicroII).  
ADD \$.75 shipping (\$1.50 UPS or special handling)



**INTERACTIVE MICROWARE, INC**  
Box 771, State College, PA, 16801  
CALL (814) 238-8294

Circle 283 on inquiry card.

**80X24 VIDEOTERM™**  
7X9 MATRIX DISPLAY FOR  
LOWER CASE W/ DESCENDERS **APPLE II®**



\* REGISTERED TRADE MARK OF APPLE COMPUTER, INC.

80 columns by 24 lines with easy to read 7x9 dot matrix, upper and lower case with descenders using shift lock feature • 1K firmware incorporates PASCAL and BASIC protocols so user is not required to enter machine language programs or change PASCALS. Misc. info. or Gotoxy files • Compatible with all APPLE II peripherals so user won't need new software patches for future software products • Crystal controlled dot clock for excellent character stability • VIDEOTERM is the same size as the Apple language card and power consumption is held to a minimum through the use of CMOS and lower power devices • Character set can be user definable up to a maximum of 128 symbols of 8x16 dot matrix font • Display control character mode and four standard display formats controlled by escape sequences • Built in light pen capability • Inverse display mode • 50/60 HZ operation • Sockets on all IC's.

PRICE: Without graphic EPROM \$345  
OPTIONS: Graphics EPROM line dwg. \$25  
VIDEO SWITCH PLATE, Inserts  
In case riot to choose between  
APPLE II™ and VIDEOTERM \$12  
MANUAL: \$15



VIDEX 3060 N.W. Thistle Pl. Corvallis, OR 97330 Phone (503) 758-0521

Circle 284 on inquiry card.



11542-1 KNOTT ST.  
GARDEN GROVE,  
CA 92641  
OUTSIDE CA (800) 854-6411  
INSIDE CA (714) 891-2663

**ORDERING INFO**

NAME, ADDRESS, PHONE  
SHIP BY: UPS OR MAIL  
ADD \$2.00 FOR  
SHIPPING UP TO  
(5) LBS.

**TERMS**

WE ACCEPT CASH,  
CHECK, MONEY ORDERS  
VISA & MASTER CHARGE  
COD'S ON APPROVAL  
TAX: 6% CALIF. RES.

**CAPACITORS**  
**(.1)**  
@  
12V/CERAMIC  
11¢ ea.  
or  
100/\$10.00

**4116's**

16K X 1 DYNAMIC RAM  
for  
APPLE, TRS-80, HEATH, ETC.  
**8 for \$45.00**  
16/\$85.00 32/\$160.00

**IMSAI**  
**CONNECTORS**  
100 PIN GOLD  
SOLDERTAIL  
**\$2.50 ea.**  
or  
**10/\$2.30 ea.**

**LO-PROFILE SOCKETS**

|        | 1-99 | 100 Up |
|--------|------|--------|
| 14 PIN | .10  | .09    |
| 16 PIN | .12  | .11    |
| 18 PIN | .15  | .13    |
| 20 PIN | .23  | .21    |
| 24 PIN | .26  | .24    |
| 28 PIN | .30  | .28    |
| 40 PIN | .42  | .40    |

**2708**  
(450 NS.)  
**\$7.50**  
EACH  
OR  
8/\$56.00

**CENTRONICS**

MODEL # 737  
•80 CPS PROPORTIONAL SPACED  
•DOT MATRIX (7x9) or (7x8)  
•96 CHARACTER ASCII  
•PARALLEL INTERFACE  
**\$825.00**

**QUME** DATATRAK 8  
DISK DRIVE

•DOUBLE SIDED/SGL. OR DBL. DENSITY  
•154 TRACKS  
•1.2 MEGABYTES/DISK IBM FORMAT  
•3 MS. ACCESS TIME TRACK TO TRACK  
AVAILABLE FROM STOCK **\$625.00**

**SHUGART**  
**SA801**

BARE DRIVES  
SINGLE-SIDED/  
SGL./DBL. DENSITY  
CALL FOR PRICE  
AND  
DELIVERY

**2716**  
5-VOLT ONLY  
450 NS.  
**\$15.00**  
(PRIME)

**SANYO**  
MONITORS

9" BLACK & WHITE  
**\$175.00**  
12" BLACK & WHITE  
**\$240.00**

**ANACOM 150** DOT MATRIX PRINTER

•9x9 DOT MATRIX  
•BI-DIRECTIONAL  
LOGIC SEEKING  
•150 CPS  
•DBL WIDTH CHARACTERS  
•10 CPI-HORIZONTAL  
•6 OR 8 LPI-VERTICAL  
•UPPER & LOWER CASE  
W/DENSCENDERS  
•ADJUSTABLE TRACTORS  
•SERIAL OR PARALLEL  
INTERFACE  
CALL FOR PRICE

**2114L-2**

LO-POWER/200 NS.  
1-16 .....\$4.25  
17-49 .....\$4.00  
50-99 .....\$3.75  
100 Up.....\$3.50

**8080A**  
CPU CHIP  
1 MHZ  
CERAMIC  
**\$2.50**

**SA 800/801 DISK DRIVE**

1 OR 2 DRIVES INSTALLED, SGL. OR  
DBL. DENSITY/SGL.-SIDED, METAL  
CABINET, & POWER SUPPLY  
(1) SA800/\$775.00 (2) SA800/\$1250.00  
(1) SA801/\$795.00 (2) SA801/\$1295.00  
1 YR. WARRANTY PARTS & LABOR

**MICROBYTE 32K**  
STATIC RAM BOARD

•IEEE/S-100 COMPATIBLE  
•4K BANK ADDRESSABLE TO ANY  
4K SLOT WITHIN 64K BOUNDARY  
•ON BOARD 8-BIT OUTPUT PORT  
•NO DMA RESTRICTIONS  
•4 MHZ OPERATION  
ASSEMBLED & TESTED **\$475.00**

COMPONENTS

|         |        |
|---------|--------|
| 74LS240 | \$1.50 |
| 74LS241 | \$1.40 |
| 74LS244 | \$1.50 |
| 74LS373 | \$1.60 |
| 74LS374 | \$1.60 |

**REGULATORS**

|         |     |
|---------|-----|
| 320T-5  | .90 |
| 320T-12 | .80 |
| 340T-5  | .70 |
| 340T-12 | .65 |

**ATARI MODEL #800**  
(NEW 16K VERSION)

•COMPUTER CONSOLE  
•ATARI BASIC 8K ROM  
•57 FULL STROKE ALPHANUMERIC  
KEYS PLUS 4 FUNCTION KEYS  
•INVITATION TO PROGRAMMING  
CASSETTE  
•OPERATORS MANUAL  
•EDUCATION SYSTEMS MASTER  
•JOYSTICKS  
•RF MODULATOR  
•POWER SUPPLY  
CALL FOR PRICE  
(IN STOCK)  
**10% OFF SOFTWARE**  
WITH PURCHASE

**ATARI OPTIONAL ACCESSORIES**

MODEL #810 DISK DRIVE SYSTEM  
MODEL #820 40-COL. DOT MATRIX PRINTER  
MODEL #822 40-COL. THERMAL PRINTER  
MODEL #825 80-COL. DOT MATRIX PRINTER  
MODEL #830 ACOUSTIC MODEM  
MODEL #850 INTERFACE MODULE  
MODEL #CX853 16K RAM MODULE

CALL FOR PRICE & AVAILABILITY

**VERBATIM**

5 1/4" DISKS  
SOFT-SECTOR  
BOX OF (10)  
**\$28.50**

**5257-3L**  
4K STATIC RAM  
1-16 \$5.25  
17 Up \$4.95

**ATARI** SOFTWARE &  
ACCESSORIES

|                        |         |
|------------------------|---------|
| BASKETBALL ROM         | \$30.00 |
| SUPER-BREAKOUT ROM     | \$30.00 |
| STAR RAIDERS ROM       | \$45.00 |
| CHESS ROM              | \$30.00 |
| VIDEO EASEL ROM        | \$30.00 |
| MUSIC COMPOSER ROM     | \$45.00 |
| 3D TIC TAC TOE ROM     | \$30.00 |
| JOYSTICKS              | \$18.00 |
| PADDLE CONTROLS        | \$18.00 |
| #410 CASSETTE RECORDER | \$60.00 |

**SD SYSTEMS**

|                         |          |         |
|-------------------------|----------|---------|
| EXPANDORAM I KIT        | \$180.00 |         |
| EXPANDORAM I KIT W/16K  | \$199.00 |         |
| EXPANDORAM I KIT W/32K  | \$239.00 | (250ns) |
| EXPANDORAM I KIT W/48K  | \$279.00 |         |
| EXPANDORAM I KIT W/64K  | \$319.00 |         |
| EXPANDORAM II KIT       | \$200.00 |         |
| EXPANDORAM II KIT W/16K | \$250.00 |         |
| EXPANDORAM II KIT W/32K | \$300.00 | (200ns) |
| EXPANDORAM II KIT W/48K | \$350.00 |         |
| EXPANDORAM II KIT W/64K | \$400.00 |         |

**FOR SALE:**

Unused Polymorphic System 8813 with 32K Ram Memory with floppy disk drives, printer interface and Abern-Sopher Multiwriter III. System has Canadian import tax paid. Offers for complete system to:

**Bishop Management,**  
#8-825 McBride Blvd.,  
New Westminster, B. C.,  
Canada, V3L 5B5.  
(604) 525-8148.

Circle 287 on inquiry card.

**DISK DRIVE/CRT SALE**

**MPI** (Demos)  
**B51**  
**\$200**  
**B52**  
**\$275**

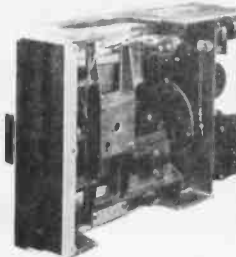

SA 801R for RS MOD II ..... \$468  
Hazeltine 1000 (unused) ..... \$299  
Shugart SA 400 ..... \$279  
Percotec FD 2000...\$279 FD250 .... \$359  
SA 801R w/PS/Cab ..... \$749  
16K Ram Chips (each) ..... \$4.50

**MTI** 3304 W. MacArthur Blvd.  
Santo Ana, CA 92704  
(714) 979-9923

Circle 288 on inquiry card.

Now on Disk

**Learn FORTH**

FORTH is a structured high level language that dramatically cuts program development time. You can expand the FORTH language by defining new operations and data types. FORTH programs are compiled to reduce memory space and speed execution.

tinyFORTH is a complete version of the powerful FORTH language tailored to the TRS-80. The disk tinyFORTH system is a stand-alone operating system with FORTH, a text editor, an assembler, and graphics.

Learn FORTH on your own computer. The tinyFORTH user's manual contains hundreds of examples to teach you FORTH in a hands-on style.

tinyFORTH for 16k level II TRS-80:  
Disk version and full documentation ..... \$49.95  
Cassette version and full documentation ..... \$29.95  
Documentation only (disk version) ..... \$14.95

All orders are fully guaranteed. Add \$1.50 for postage and handling. Order with check, money order, Visa, or MasterCard.

Write for a FREE booklet describing FORTH.

**The Software Farm**

Box 2304 Dept. A32 Reston, VA 22090

Circle 289 on inquiry card.

**JINSAM™ Data Manager**

- ★ CUSTOM DATA FILES
- ★ FAST/EASY/MENU DRIVEN
- ★ HELP COMMANDS
- ★ KEYED RANDOM ACCESS
- ★ MULTIPLE SEARCH KEYS
- ★ PRIVACY ACCESS CODES
- ★ WILD CARD SEARCH

For 16K-32K PET, Dual Disk, and Printer

FREE: LABEL PRINTER MODULE  
FREE: REPORT GENERATOR MODULE  
Specify CBM 2040 or COMPU/THINK

Package \$150 User's Guide only \$25  
Introductory Demo Tape \$5 Disk \$ 8

Check or Money Order plus \$2 Shipping  
(NY residents add 8% Sales Tax)  
- DEALER INQUIRIES WELCOMED -

**JINI MICRO-SYSTEMS, Inc.**  
P.O. Box 274-B • Bronx, NY 10463

Circle 290 on inquiry card.

**CASSETTE DUPLICATION**

TRS-80 (I & II), PET, APPLE, KIM, ATARI

Quality software duplication is more than copying cassettes. Microsette duplication uses a proprietary high speed duplicator designed specifically for computer program duplication. The finished products are of consistent quality, guaranteed to load. Minimum order is 100 with discounts for higher quantities. Call (415) 968-1604 for details.



**MICROSETTE CO.**  
475 Ellis Street  
Mt. View, CA 94043

Circle 291 on inquiry card.

**AD-8/1 ANALOG I/O INTERFACE**

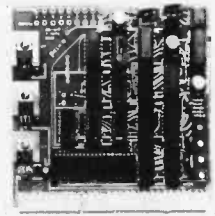

FOR SS-50 BUSS  
6800 SYSTEMS

- 8 A/D input channels
- Very fast A/D over 8500 samples per second
- 1 D/A output channel with sample and hold
- Bipolar input and output
- Full 8 bit resolution
- Upward compatible to 880X
- Complete documentation
- Fully assembled and tested
- Visa and M.C. accepted

\$109.50

**CCM, INC.** P.D. Box 2308  
Reston, VA 22091  
Phone orders call 703-620-3403

Circle 292 on inquiry card.

**OHIO SCIENTIFIC**

..... With This Ad .....

HAZELTINE 1420 ..... \$780  
CENTRONICS 779 W/TRACTOR \$969  
NEC SPINWRITER ..... \$2250

..... Get the Catalog  
&  
Our Low Prices .....

**DATA PRODUCTS MAINTENANCE CORP.**  
**OHIO SCIENTIFIC**

9460 Telstar Avenue (213) 573-5991  
El Monte, CA 91731 (714) 994-4180

Circle 293 on inquiry card.

**WINCHESTER STORAGE FOR THE S100 BUS**

AVAILABLE NOW

|          |                                                                                                                         |         |
|----------|-------------------------------------------------------------------------------------------------------------------------|---------|
| PS100    | S-100 Bus Hard Disc Controller                                                                                          | \$ 795  |
| S33      | 33MB Disc Subsystem<br>ADES PS100 Controller, Primam<br>1350 Winchester Disc, Case,<br>Power Supply & CBIOS for CPM*2.2 | \$4,495 |
| S33CBIOS | BIOS CPM*2.2 and S33 Subsystem                                                                                          | \$ 25   |
|          | PS100 Users Manual                                                                                                      | \$10    |
|          | S33 Users Manual                                                                                                        | \$15    |
|          | S10 Users Manual                                                                                                        | \$15    |

AVAILABLE NOVEMBER 1980

|          |                                                                                                                         |         |
|----------|-------------------------------------------------------------------------------------------------------------------------|---------|
| S10      | 10MB Disc Subsystem<br>ADES PS100 Controller, Primam<br>1070 Winchester Disc, Case,<br>Power Supply & CBIOS for CPM*2.2 | \$3,495 |
| S10CBIOS | BIOS for CPM*2.2 and S10 Subsystem                                                                                      | \$ 25   |

For Product Data Sheets Write:  
Adaptive Data & Energy Systems  
P.O. Box 2087  
Yorba Linda, CA 92688  
Phone (714) 823-9883

\* CPM & HUBBARD TRADEMARK OF DIGITAL RESEARCH • DEALER INQUIRIES WELCOMED 8809103

Circle 294 on inquiry card.

**ATARI OWNERS**

**Parallel Printer Interface for the ATARI 400 / 800**

Connects to controller jacks 3&4 works with BASIC / DOS / ASSEMBLER  
Three printer connectors available:

**ATARI 400 / 800**  
TRENDCOM 100 / 900 A4P-1 A8P-1  
CENTRONICS 730 / 737 A4P-2 A8P-2  
CENTRONICS 36 PIN\* A4P-3 A8P-3

\* Fits all other parallel Centronics plus Anadex, Base 9, Epson, Comprint and Microtek.  
Order by part number, MC / VISA accepted.

**\$69.95** ♦ CA sales add 6% tax



**MACROTRONICS, inc.®**

1185 N. Golden State  
Turlock, CA 95380 (A)  
(209) 667-8888 / 634-8888

Circle 295 on inquiry card.



**ELECTRONICS**

P.O. Box 4430X  
Santa Clara, CA 95054  
Will calls: 2322 Walsh Ave.  
(408) 988-1640

Same day shipment. First line parts only. Factory tested.  
Guaranteed money back. Quality IC's and other components at factory prices.

**INTEGRATED CIRCUITS**

|         |            |      |         |      |             |       |                        |      |  |
|---------|------------|------|---------|------|-------------|-------|------------------------|------|--|
| 7400TTL | LM3236-5   | 5.95 | CD40276 | 2.50 | 4116 200ms  | 7.95  | CONNECTORS             |      |  |
| 7400N   | LM3236-12  | 1.50 | CD40277 | 66   | 84116 200ms | 49.00 | 30 pin edge            | 2.50 |  |
| 7402N   | LM3200-15  | 1.50 | CD40278 | 85   | 25118       | 6.30  | 4 pin edge             | 2.75 |  |
| 7404A   | LM3201-5   | 1.35 | CD40279 | 133  | MM5262      | 4.00  | 100 pin edge           | 5.50 |  |
| 7405N   | LM3201-8   | 1.35 | CD4030  | 40   | MM5260      | 3.00  | 100 pin edge           | 5.25 |  |
| 7410A   | LM3201-12  | 1.35 | CD4035  | 133  | MM5290      | 1.35  | MM5290                 | 1.35 |  |
| 7414A   | LM3201-15  | 1.35 | CD4036  | 133  | MM5330      | 5.94  | IC SOCKETS             |      |  |
| 7420A   | LM3236     | 1.40 | CD4042  | 85   | PD411D      | 4.00  | SOPOP Tin Lead Profile |      |  |
| 7420N   | LM3236     | 1.00 | CD4043  | 45   | PD411D-3    | 4.00  | PIN 1 UP PIN 1 UP      |      |  |
| 7430N   | LM3236-5   | 1.35 | CD4044  | 85   | PS101L      | 8.95  | 8 15 22 30             |      |  |
| 7445A   | LM3236-8   | 1.35 | CD4046  | 167  | 4290A       | 9.95  | 16 16 28 42            |      |  |
| 7447A   | LM3236-15  | 1.35 | CD4049  | 42   | 82325       | 2.90  | 16 16 28 42            |      |  |
| 7448A   | LM3236-12  | 1.35 | CD4051  | 49   | 91L02A      | 1.50  | 16 16 28 36            |      |  |
| 7450N   | LM3236-5   | 1.25 | CD4056  | 142  | HD1615-5    | 6.95  | 20 29 40 37            |      |  |
| 7474N   | LM3401-5   | 1.25 | CD4060  | 71   | MM57100     | 4.50  | 7 w/alt 14 pin w/ 20   |      |  |
| 7475N   | LM3401-12  | 1.25 | CD4066  | 104  | MM566751A   | 5.95  | 32 pin edge            |      |  |
| 7485N   | LM3401-15  | 1.25 | CD4069  | 40   | 9568        | 3.50  | 14 32 32 86            |      |  |
| 7488N   | LM3401-18  | 1.25 | CD4070  | 50   | 4100        | 1.00  | 16 33 28 100           |      |  |
| 7489N   | LM3401-24  | 1.25 | CD4071  | 45   | 4100        | 1.00  | 16 33 28 100           |      |  |
| 7493N   | LM3401-5   | 1.25 | CD4072  | 45   | 4100        | 1.00  | 16 33 28 100           |      |  |
| 7493N   | LM3401-12  | 1.25 | CD4073  | 45   | 4100        | 1.00  | 16 33 28 100           |      |  |
| 7493N   | LM3401-15  | 1.25 | CD4074  | 45   | 4100        | 1.00  | 16 33 28 100           |      |  |
| 7493N   | LM3401-18  | 1.25 | CD4075  | 45   | 4100        | 1.00  | 16 33 28 100           |      |  |
| 7493N   | LM3401-24  | 1.25 | CD4076  | 45   | 4100        | 1.00  | 16 33 28 100           |      |  |
| 7493N   | LM3401-30  | 1.25 | CD4077  | 45   | 4100        | 1.00  | 16 33 28 100           |      |  |
| 7493N   | LM3401-36  | 1.25 | CD4078  | 45   | 4100        | 1.00  | 16 33 28 100           |      |  |
| 7493N   | LM3401-42  | 1.25 | CD4079  | 45   | 4100        | 1.00  | 16 33 28 100           |      |  |
| 7493N   | LM3401-48  | 1.25 | CD4080  | 45   | 4100        | 1.00  | 16 33 28 100           |      |  |
| 7493N   | LM3401-54  | 1.25 | CD4081  | 45   | 4100        | 1.00  | 16 33 28 100           |      |  |
| 7493N   | LM3401-60  | 1.25 | CD4082  | 45   | 4100        | 1.00  | 16 33 28 100           |      |  |
| 7493N   | LM3401-66  | 1.25 | CD4083  | 45   | 4100        | 1.00  | 16 33 28 100           |      |  |
| 7493N   | LM3401-72  | 1.25 | CD4084  | 45   | 4100        | 1.00  | 16 33 28 100           |      |  |
| 7493N   | LM3401-78  | 1.25 | CD4085  | 45   | 4100        | 1.00  | 16 33 28 100           |      |  |
| 7493N   | LM3401-84  | 1.25 | CD4086  | 45   | 4100        | 1.00  | 16 33 28 100           |      |  |
| 7493N   | LM3401-90  | 1.25 | CD4087  | 45   | 4100        | 1.00  | 16 33 28 100           |      |  |
| 7493N   | LM3401-96  | 1.25 | CD4088  | 45   | 4100        | 1.00  | 16 33 28 100           |      |  |
| 7493N   | LM3401-102 | 1.25 | CD4089  | 45   | 4100        | 1.00  | 16 33 28 100           |      |  |
| 7493N   | LM3401-108 | 1.25 | CD4090  | 45   | 4100        | 1.00  | 16 33 28 100           |      |  |
| 7493N   | LM3401-114 | 1.25 | CD4091  | 45   | 4100        | 1.00  | 16 33 28 100           |      |  |
| 7493N   | LM3401-120 | 1.25 | CD4092  | 45   | 4100        | 1.00  | 16 33 28 100           |      |  |
| 7493N   | LM3401-126 | 1.25 | CD4093  | 45   | 4100        | 1.00  | 16 33 28 100           |      |  |
| 7493N   | LM3401-132 | 1.25 | CD4094  | 45   | 4100        | 1.00  | 16 33 28 100           |      |  |
| 7493N   | LM3401-138 | 1.25 | CD4095  | 45   | 4100        | 1.00  | 16 33 28 100           |      |  |
| 7493N   | LM3401-144 | 1.25 | CD4096  | 45   | 4100        | 1.00  | 16 33 28 100           |      |  |
| 7493N   | LM3401-150 | 1.25 | CD4097  | 45   | 4100        | 1.00  | 16 33 28 100           |      |  |
| 7493N   | LM3401-156 | 1.25 | CD4098  | 45   | 4100        | 1.00  | 16 33 28 100           |      |  |
| 7493N   | LM3401-162 | 1.25 | CD4099  | 45   | 4100        | 1.00  | 16 33 28 100           |      |  |
| 7493N   | LM3401-168 | 1.25 | CD4100  | 45   | 4100        | 1.00  | 16 33 28 100           |      |  |
| 7493N   | LM3401-174 | 1.25 | CD4101  | 45   | 4100        | 1.00  | 16 33 28 100           |      |  |
| 7493N   | LM3401-180 | 1.25 | CD4102  | 45   | 4100        | 1.00  | 16 33 28 100           |      |  |
| 7493N   | LM3401-186 | 1.25 | CD4103  | 45   | 4100        | 1.00  | 16 33 28 100           |      |  |
| 7493N   | LM3401-192 | 1.25 | CD4104  | 45   | 4100        | 1.00  | 16 33 28 100           |      |  |
| 7493N   | LM3401-198 | 1.25 | CD4105  | 45   | 4100        | 1.00  | 16 33 28 100           |      |  |
| 7493N   | LM3401-204 | 1.25 | CD4106  | 45   | 4100        | 1.00  | 16 33 28 100           |      |  |
| 7493N   | LM3401-210 | 1.25 | CD4107  | 45   | 4100        | 1.00  | 16 33 28 100           |      |  |
| 7493N   | LM3401-216 | 1.25 | CD4108  | 45   | 4100        | 1.00  | 16 33 28 100           |      |  |
| 7493N   | LM3401-222 | 1.25 | CD4109  | 45   | 4100        | 1.00  | 16 33 28 100           |      |  |
| 7493N   | LM3401-228 | 1.25 | CD4110  | 45   | 4100        | 1.00  | 16 33 28 100           |      |  |
| 7493N   | LM3401-234 | 1.25 | CD4111  | 45   | 4100        | 1.00  | 16 33 28 100           |      |  |
| 7493N   | LM3401-240 | 1.25 | CD4112  | 45   | 4100        | 1.00  | 16 33 28 100           |      |  |
| 7493N   | LM3401-246 | 1.25 | CD4113  | 45   | 4100        | 1.00  | 16 33 28 100           |      |  |
| 7493N   | LM3401-252 | 1.25 | CD4114  | 45   | 4100        | 1.00  | 16 33 28 100           |      |  |
| 7493N   | LM3401-258 | 1.25 | CD4115  | 45   | 4100        | 1.00  | 16 33 28 100           |      |  |
| 7493N   | LM3401-264 | 1.25 | CD4116  | 45   | 4100        | 1.00  | 16 33 28 100           |      |  |
| 7493N   | LM3401-270 | 1.25 | CD4117  | 45   | 4100        | 1.00  | 16 33 28 100           |      |  |
| 7493N   | LM3401-276 | 1.25 | CD4118  | 45   | 4100        | 1.00  | 16 33 28 100           |      |  |
| 7493N   | LM3401-282 | 1.25 | CD4119  | 45   | 4100        | 1.00  | 16 33 28 100           |      |  |
| 7493N   | LM3401-288 | 1.25 | CD4120  | 45   | 4100        | 1.00  | 16 33 28 100           |      |  |
| 7493N   | LM3401-294 | 1.25 | CD4121  | 45   | 4100        | 1.00  | 16 33 28 100           |      |  |
| 7493N   | LM3401-300 | 1.25 | CD4122  | 45   | 4100        | 1.00  | 16 33 28 100           |      |  |
| 7493N   | LM3401-306 | 1.25 | CD4123  | 45   | 4100        | 1.00  | 16 33 28 100           |      |  |
| 7493N   | LM3401-312 | 1.25 | CD4124  | 45   | 4100        | 1.00  | 16 33 28 100           |      |  |
| 7493N   | LM3401-318 | 1.25 | CD4125  | 45   | 4100        | 1.00  | 16 33 28 100           |      |  |
| 7493N   | LM3401-324 | 1.25 | CD4126  | 45   | 4100        | 1.00  | 16 33 28 100           |      |  |
| 7493N   | LM3401-330 | 1.25 | CD4127  | 45   | 4100        | 1.00  | 16 33 28 100           |      |  |
| 7493N   | LM3401-336 | 1.25 | CD4128  | 45   | 4100        | 1.00  | 16 33 28 100           |      |  |
| 7493N   | LM3401-342 | 1.25 | CD4129  | 45   | 4100        | 1.00  | 16 33 28 100           |      |  |
| 7493N   | LM3401-348 | 1.25 | CD4130  | 45   | 4100        | 1.00  | 16 33 28 100           |      |  |
| 7493N   | LM3401-354 | 1.25 | CD4131  | 45   | 4100        | 1.00  | 16 33 28 100           |      |  |
| 7493N   | LM3401-360 | 1.25 | CD4132  | 45   | 4100        | 1.00  | 16 33 28 100           |      |  |
| 7493N   | LM3401-366 | 1.25 | CD4133  | 45   | 4100        | 1.00  | 16 33 28 100           |      |  |
| 7493N   | LM3401-372 | 1.25 | CD4134  | 45   | 4100        | 1.00  | 16 33 28 100           |      |  |
| 7493N   | LM3401-378 | 1.25 | CD4135  | 45   | 4100        | 1.00  | 16 33 28 100           |      |  |
| 7493N   | LM3401-384 | 1.25 | CD4136  | 45   | 4100        | 1.00  | 16 33 28 100           |      |  |
| 7493N   | LM3401-390 | 1.25 | CD4137  | 45   | 4100        | 1.00  | 16 33 28 100           |      |  |
| 7493N   | LM3401-396 | 1.25 | CD4138  | 45   | 4100        | 1.00  | 16 33 28 100           |      |  |
| 7493N   | LM3401-402 | 1.25 | CD4139  | 45   | 4100        | 1.00  | 16 33 28 100           |      |  |
| 7493N   | LM3401-408 | 1.25 | CD4140  | 45   | 4100        | 1.00  | 16 33 28 100           |      |  |
| 7493N   | LM3401-414 | 1.25 | CD4141  | 45   | 4100        | 1.00  | 16 33 28 100           |      |  |
| 7493N   | LM3401-420 | 1.25 | CD4142  | 45   | 4100        | 1.00  | 16 33 28 100           |      |  |
| 7493N   | LM3401-426 | 1.25 | CD4143  | 45   | 4100        | 1.00  | 16 33 28 100           |      |  |
| 7493N   | LM3401-432 | 1.25 | CD4144  | 45   | 4100        | 1.00  | 16 33 28 100           |      |  |
| 7493N   | LM3401-438 | 1.25 | CD4145  | 45   | 4100        | 1.00  | 16 33 28 100           |      |  |
| 7493N   | LM3401-444 | 1.25 | CD4146  | 45   | 4100        | 1.00  | 16 33 28 100           |      |  |
| 7493N   | LM3401-450 | 1.25 | CD4147  | 45   | 4100        | 1.00  | 16 33 28 100           |      |  |
| 7493N   | LM3401-456 | 1.25 | CD4148  | 45   | 4100        | 1.00  | 16 33 28 100           |      |  |
| 7493N   | LM3401-462 | 1.25 | CD4149  | 45   | 4100        | 1.00  | 16 33 28 100           |      |  |
| 7493N   | LM3401-468 | 1.25 | CD4150  | 45   | 4100        | 1.00  | 16 33 28 100           |      |  |
| 7493N   | LM3401-474 | 1.25 | CD4151  | 45   | 4100        | 1.00  | 16 33 28 100           |      |  |
| 7493N   | LM3401-480 | 1.25 | CD4152  | 45   | 4100        | 1.00  | 16 33 28 100           |      |  |
| 7493N   | LM3401-486 | 1.25 | CD4153  | 45   | 4100        | 1.00  | 16 33 28 100           |      |  |
| 7493N   | LM3401-492 | 1.25 | CD4154  | 45   | 4100        | 1.00  | 16 33 28 100           |      |  |
| 7493N   | LM3401-498 | 1.25 | CD4155  | 45   | 4100        | 1.00  | 16 33 28 100           |      |  |
| 7493N   | LM3401-504 | 1.25 | CD4156  | 45   | 4100        | 1.00  | 16 33 28 100           |      |  |
| 7493N   | LM3401-510 | 1.25 | CD4157  | 45   | 4100        | 1.00  | 16 33 28 100           |      |  |
| 7493N   | LM3401-516 | 1.25 | CD4158  | 45   | 4100        | 1.00  | 16 33 28 100           |      |  |
| 7493N   | LM3401-522 | 1.25 | CD4159  | 45   | 4100        | 1.00  | 16 33 28 100           |      |  |
| 7493N   | LM3401-528 | 1.25 | CD4160  | 45   | 4100        | 1.00  | 16 33 28 100           |      |  |
| 7493N   | LM3401-534 | 1.25 | CD4161  | 45   | 4100        | 1.00  | 16 33 28 100           |      |  |
| 7493N   | LM3401-540 | 1.25 | CD4162  | 45   | 4100        | 1.00  | 16 33 28 100           |      |  |
| 7493N   | LM3401-546 | 1.25 | CD4163  | 45   | 4100</      |       |                        |      |  |

# SS-50

## Computing

• THE OTHER ALL 6800  
COMPUTER MAGAZINE

Devoted to the 6800-6809  
enthusiast...Software, fixes,  
hardware, reviews and more!

Charter Subscription  
\$12.00-1 Year \$22.00-2 Years  
VISA MC

FREE SAMPLE ISSUE  
(60¢ in stamps for 1st Class)

SS-50 Computing  
P.O. Box 402B  
Logan, Utah 84321

Circle 297 on Inquiry card.

## DOUBLE YOUR LA36 DECWRITER'S SPEED TO 60 CPS

The ACCELEWRITER converter enables you  
to convert the LA36 Decwriter from 10/15/30  
to 10/30/60 CPS.

Utilizes Decwriter's own built-in 60 CPS  
speed

Plugs into logic board

Compatible with Decwriter option boards  
Decwriter reconverts to "stock" in  
seconds

Thousands sold

In use for over 3 years

Full one-year warranty

\$115 includes shipping



Brochure sent promptly at your request.  
Write or call us.

LARKS ELECTRONICS & DATA

P.O. Box 22, Skokie, IL 60077  
(312) 677-6080

Circle 298 on Inquiry card.

## COMPUTE-A-SCORE™

SOFTWARE FOR  
GYMNASTICS  
SCORING



Now Available in CP/M\* Version

\*CP/M™—Digital Research

Program proven in over three year's use  
at local, district, regional, state,  
national, USGF, high school and college  
competition.

Make your computer earn its keep by  
servicing an expanding field.

Phone or write for complete details.

MC<sub>S</sub>, inc. MICRO COMPUTER  
SERVICE, INC.

"Customized Computer Services"

Salina Star Route  
Boulder, CO 80302  
Phone: (303) 442-2622

Circle 299 on Inquiry card.

NEW

### S-100 A/D

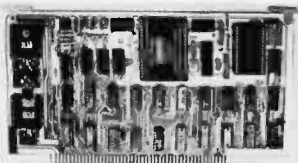

- S-100 Bus Compatible A/D Converter
  - 12 Bit Accuracy
  - 16 Channel Analog Input
  - Programmable Gain Amplifier with Sample-and-Hold
  - High Quality Commercial/Industrial Construction
- 2 and 4 Channel, 12 Bit D/A Boards also available.



CALIFORNIA DATA  
CORPORATION

3475 Old Conejo Road, Suite C10  
Newbury Park, California 91320  
(805) 498-3651

Circle 300 on Inquiry card.

# PET music BOARD

At last! A music maker for your PET. Our  
system consists of a small circuit board  
which plugs into your PET's user port and  
connects either to a speaker or your hi-fi  
system (cable included). Our software (on  
cassette) lets you enter, save, and  
playback music in up to four voices, each  
with its own tone colour. Also included are  
several sample pieces to get you started.  
When ordering, please specify 8k, 16k, or  
32k PET version.

\$49 without amp (plugs into your stereo)  
\$54 with amp (connects to a speaker)  
Please use certified cheque or money order.

Electronic Music Systems  
45 Livingston Rd. Suite 501  
West Hill, Ontario, Canada  
M1E 1K8

a trademark of Commodore B.M.

Circle 301 on Inquiry card.

## BELOW DEALERS COST!

### NorthStar

North Star Horizon

FACTORY DIRECT PRICES!

32 K DD — 2295.00  
32 K QUAD — 2600.00

16K and 32K RAM boards

Application Software

|                                 |                       |                              |
|---------------------------------|-----------------------|------------------------------|
| North Star Pascal<br>\$160.00   | NorthStar<br>\$335.00 | General Ledger<br>\$825.00   |
| Info Manager<br>\$395.00        | North Star<br>BASIC   | Mall Manager<br>\$245.00     |
| Accounts Receivable<br>\$475.00 |                       | Accounts Payable<br>\$475.00 |

COD - CASH IN ADVANCE - VISA / MASTER CHARGE\*

\*ADD 2 PERCENT ON CHARGE ORDERS



CUSTOM BUSINESS COMPUTERS

103 ATLANTIC AVENUE, LYBROOK, NEW YORK 11562 • (516) 887-1500 • 887-3340

Circle 302 on Inquiry card.

## Apple Users!

### NEW 16 CHANNEL VARIABLE A-D BOARD

• Lets you digitally display, store,  
analyze, and print your measure-  
ments. • Allows increased  
measurements from 5 volts up to  
100 volts. • Comes with a complete  
software package including a test  
kit, calibration method, and various  
applications.

Special Introductory Price 179<sup>95</sup>

Visa, Diners Club, Master Card Users  
Call Toll Free 800-854-2003, ext. 815

In CA Call 1-800-522-1500, ext. 815

Or send your check for 179<sup>95</sup>

(Texas res. add 5% sales tax) to:

COMPUTER TECHNOLOGY  
ASSOCIATES

CTA

5812 Cromo Drive, Suite 102  
El Paso, Texas 79912

Circle 303 on Inquiry card.

## THE COMP~ CASE

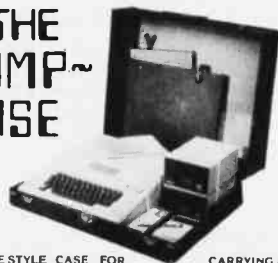

ATTACHESTYLE CASE FOR CARRYING AND  
PROTECTING THE APPLE COMPUTER. CONSTRUCTED  
OF THE HIGHEST QUALITY LUGGAGE MATERIAL.  
WILL ACCOMMODATE COMPUTER, TAPE RECORDER,  
OR DISC DRIVES PLUS TAPES, OR DISCS AND ALL MANU-  
ALS. NEVER A NEED TO REMOVE COMPUTER FROM CASE.  
SIMPLY REMOVE LID, CONNECT POWER AND MONITOR CA-  
BLES, AND OPERATE. LID CAN BE REPLACED AND LOCKED  
FOR SECURITY AND PROTECTION WITHOUT DISCON-  
NECTING CABLES.

DELUXE CASE.....\$109.00

DELUXE CASE/2 DISC DRIVES.....\$119.00

CASES ALSO AVAILABLE FOR THE TRS-80, ATARI,  
CENTRONICS 710 AND PAPER TIGER AS WELL AS  
MATCHING ATTACH CASES.  
OTHERS IN DEVELOPMENT.

COMPUTER CASE COMPANY

5650 INDIAN MOUND CT., COLUMBUS, OHIO  
(614) 866-9464 43213



Circle 304 on Inquiry card.

## MEMOREX Floppy Discs

Lowest prices. WE WILL NOT  
BE UNDERSOLD!! Buy any  
quantity 1-1000. Visa. Mastercharge  
accepted. Call free (800)235-4137  
for prices and information. All  
orders sent postage paid.

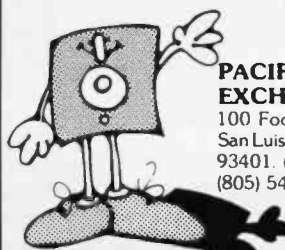

PACIFIC  
EXCHANGES

100 Foothill Blvd.  
San Luis Obispo, CA  
93401. (In Cal. call  
(805) 543-1037.)

Circle 305 on Inquiry card.

# page

## PRE-CUT WIRE WRAP WIRE

| Length | 100/Bag | 500/Bag | 1K/Bag  | Length | 100/Bag | 500/Bag | 1K/Bag  | Kit No. 1                | \$9.95  | Kit No. 3                | \$32.95  |
|--------|---------|---------|---------|--------|---------|---------|---------|--------------------------|---------|--------------------------|----------|
| 2.5"   | \$1.25  | \$3.58  | \$ 6.19 | 6.5"   | \$1.92  | \$6.44  | \$11.81 | 250 3"                   | 100 4½" | 500 2½"                  | 500 4½"  |
| 3.0"   | 1.30    | 3.86    | 6.78    | 7.0"   | 1.99    | 6.76    | 12.44   | 250 3½"                  | 100 5"  | 500 3"                   | 500 5"   |
| 3.5"   | 1.37    | 4.15    | 7.37    | 7.5"   | 2.08    | 7.07    | 13.09   | 100 4"                   | 100 6"  | 500 3½"                  | 500 5½"  |
| 4.0"   | 1.42    | 4.44    | 7.94    | 8.0"   | 2.14    | 7.38    | 13.73   |                          |         | 500 4"                   | 500 6"   |
| 4.5"   | 1.48    | 4.74    | 8.54    | 8.5"   | 2.18    | 7.69    | 14.36   | <b>Kit No. 2 \$24.95</b> |         | <b>Kit No. 4 \$59.95</b> |          |
| 5.0"   | 1.54    | 5.04    | 9.13    | 9.0"   | 2.24    | 8.11    | 15.01   | 250 2½"                  | 250 5"  | 1000 2½"                 | 1000 4½" |
| 5.5"   | 1.58    | 5.38    | 9.72    | 9.5"   | 2.30    | 8.32    | 15.65   | 500 3"                   | 100 5½" | 1000 3"                  | 1000 5"  |
| 6.0"   | 1.65    | 5.66    | 10.31   | 10.0"  | 2.39    | 8.71    | 16.28   | 500 3½"                  | 250 6"  | 1000 3½"                 | 1000 5"  |
|        |         |         |         |        |         |         |         | 500 4"                   | 100 6½" | 1000 4"                  | 1000 6"  |
|        |         |         |         |        |         |         |         | 250 4½"                  | 100 7"  |                          |          |

Kynar precut wire. All lengths are overall, including 1" strip on each end. Colors and lengths cannot be mixed for quantity pricing. Choose from colors Red, Blue, Black, Yellow, White, Green, Orange, and Violet.

## ★ ★ Truckload SALE ★ ★

### FREE WIRE KIT

Kit #1 on orders over \$50  
 Kit #3 on orders over \$150  
 Kit #4 on orders over \$250

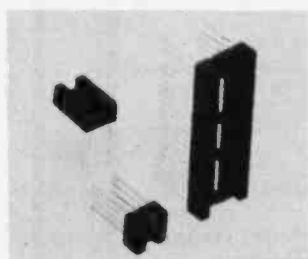

### RN WIRE WRAP IC SOCKETS

3-level Gold  
 Closed Entry  
 Design

\*Sockets sold at these prices by the tube only.

| Size   | Quantity/Tube | Price ea.* | Price/Tube |
|--------|---------------|------------|------------|
| 08 pin | 52            | .39        | \$20.28    |
| 14     | 30            | .46        | \$13.80    |
| 16     | 26            | .50        | \$13.00    |
| 18     | 23            | .68        | \$15.64    |
| 20     | 21            | .85        | \$17.85    |
| 22     | 19            | .92        | \$17.48    |
| 24     | 17            | .94        | \$15.98    |
| 28     | 15            | 1.23       | \$18.45    |
| 40     | 10            | 1.60       | \$16.00    |

Above prices include gold up to \$800/oz.

## IDC CRIMP STYLE CONNECTORS

| Card Edge Connectors | IDC Sockets | Cable Plugs | Right Angle Headers |                        | CABLE  |        |         |       |
|----------------------|-------------|-------------|---------------------|------------------------|--------|--------|---------|-------|
| IDE 10               | \$3.25      | IDS 10      | \$1.25              | IDP 14                 | 1.25   | 10 ft. | 100 ft. |       |
| IDE 20               | \$3.50      | IDS 20      | 2.02                | IDP 16                 | 1.40   | 10     | 2.90    | 17.00 |
| IDE 26               | \$4.05      | IDS 26      | 2.65                | IDP 24                 | 2.25   | 14     | 3.40    | 23.80 |
| IDE 34               | \$4.85      | IDS 34      | 3.50                | IDP 40                 | 3.65   | 16     | 3.70    | 27.20 |
| IDE 40               | \$5.65      | IDS 40      | 4.05                | <b>DB25 Connectors</b> |        | 20     | 4.40    | 34.00 |
| IDE 50               | \$5.90      | IDS 50      | 5.06                | Male                   | \$4.95 | 24     | 5.00    | 40.80 |
|                      |             |             |                     | Female                 | \$5.25 | 26     | 5.40    | 44.20 |
|                      |             |             |                     |                        |        | 34     | 6.80    | 57.80 |
|                      |             |             |                     |                        |        | 40     | 7.80    | 68.00 |
|                      |             |             |                     |                        |        | 50     | 9.50    | 85.00 |

### ORDERING INFORMATION

- Orders under \$25 include \$2 handling.
- All prices good through cover date.
- All prepaid orders shipped UPS Ppd.
- Most orders shipped next day.
- Visa, MC & COD's charged shipping.
- Byte must be mentioned to get sale prices.

### Call or Write for 1980 Catalog:

- ★ IC Sockets
- ★ Vector Boards & Pins
- ★ Bishop Drafting Aids
- ★ OK Tools
- ★ RN IDC Crimp Connectors

## PERTEC FD-200

### Floppy Disk Drives

## 35% OFF LIST

Rebuilt, tested, like-new, with  
90-day Warranty

## \$235<sup>00</sup> ea.

Any quantity, while supply lasts

Also available:  
New and like-new Pertec 24MB, 10MB,  
Cartridge Hard Disk Drives, Magnetic  
Tape Drives and Controllers.

Call, write or TWX for more info.  
**IBEX COMPUTER CORPORATION**  
18730 Oxnard St., Tarzana, CA 91356  
(213) 705-2517  
VISA and MasterCard accepted

Circle 307 on inquiry card.

### INTERTEC SUPERBRAIN SOFTWARE Available Now!

**BUSINESS SOFTWARE**

**INVESTMENT LEDGER** .....\$400  
Takes care of Stocks, Bonds, CD's, A/R,  
Real Estate, others - up to 250 investments

**GENERAL LEDGER** .....\$350  
All general bookkeeping functions, major & sub  
accounts, comparative statements

**EXPENSE LEDGER** .....\$150  
Designed to go-ordinate with the General Ledger  
for applications with multiple cost centers

**CHECK REGISTER/BANK RECONCILIATION** .....\$90  
Relieve the worries of keeping up with  
cash disbursements - balances the checkbook

**FINANCIAL PACKAGE** .....\$65  
Amortization schedule, balloon notes,  
effective interest, present/future value, etc.

**GAMES**.....\$15 \*

- \* Muzup
- \* Escape
- \* Blamark
- \* Adventure
- \* Others

**MISCELLANEOUS**

**REPORT GENERATORS** .....\$25 \*

- \* Rentals, Automobiles, Insurance
- \* Policies, etc.

ALL SOFTWARE EXCLUSIVELY DEVELOPED FOR THE SUPERBRAIN  
All prices include manuals, additional manuals \$40 ea.  
\* Prices do not include media cost



**General Systems Consulting**

(915) 476-9612 2310 S 7th, Suite 118, Abilene Texas 79605

Circle 308 on inquiry card.

## J and S Computers

2247 Shetland Road  
Livermore, Ca. 94550

**Texas Instruments**

99/4 Computer .....\$1090.00  
810 Basic Printer (100) .....\$1600.00  
810 Full ASC II (201) .....\$1695.00

**Evidy**

32K Sorcerer .....\$1074.00  
48K Sorcerer .....\$1205.00

**Lobo Disks**

SA 400 in cabinet w/power supply ....\$410.00  
3101 I SA 400 for Apple w/interface ...\$487.00  
SA 801 in cabinet w/power supply ....\$780.00

**Centronics**

730-1 Parallel .....\$670.00  
730-3 Serial .....\$715.00

and more...send \$1.50 for a catalogue  
California residents add 6% sales tax  
All orders, add 3% shipping and handling

Circle 309 on Inquiry card.



## ATARI®

Atari 800 ..... \$810.00 810 Disk Drive .. \$525.00  
16K RAM Module \$150.00 Controllers ..... \$18/Pr.  
All ROM's, including STAR RAIDERS, 20% OFF!!!

\*\*\*Bit Bucket software for the ATARI\*\*\*

Disassembler/dumper/  
depositer/BASIC renumber ..... \$30.00  
Action Games...\$25.00 Brain Games...\$25.00  
All above Bit Bucket software FREE with  
purchase of ATARI 800.  
Free utilities disk (disasm, renumber, etc.) with  
purchase of 810 Disk.

PET

8K ...\$699.00 16K ...\$876.00 32K ...\$1140.00

**CAT Modems** .....\$156.00!  
Soroc IQ120 Terminals .....\$775.00  
All Centronics Printers 15% OFF!!

**The Bit Bucket**  
168 North Beacon Street  
P.O. Box 365  
Newton Highlands, MA 02161  
Phone: (617) 783-3144

See us at the Northeast Computer Show In Boston  
November 20-23

All prices subject to change without notice.

Circle 310 on inquiry card.

### NORTHSTAR SOFTWARE PROFESSIONAL BUSINESS PROGRAMS

---

**PROPERTY MANAGEMENT** --- \$225  
OFFICE/APARTMENT/CONDO  
200 UNITS/500 EXPENSE ENTRIES

**TIMECLOCK/BILLING** --- \$265  
100 CLIENTS/30 EMPLOYEES  
20 BILLING RATES/ 100 WORK CODES

**ACCOUNTS RECEIVABLE** --- \$225  
350 ACCOUNTS  
800 INVOICES/MONTH

\*\*\*\*\*  
ALL PROGRAMS INTEGRATED  
WITH G/L  
\*\*\*\*\*

**GENERAL LEDGER** --- \$225  
300 LEDGER ACCOUNTS  
1000 CHECKS/MONTH

---

**LADCO DEVELOPMENT CO. INC.**  
P.O. BOX 464  
OLEAN, N.Y. 14760  
(716) 372-0168

Circle 311 on inquiry card.

## CROSS-ASSEMBLERS

WRITTEN IN ANSI FORTRAN IV

| PACKAGE NO. | MACHINE(S)   |
|-------------|--------------|
| XASM6800    | MC6800,02,08 |
| XASM6801    | MC6801       |
| XASM6805    | MC6805       |
| XASM6808    | MC6808       |
| XASM6805    | 8080,8085    |
| XASM1802    | COP1802      |
| XASM6502    | 8500 FAMILY  |

Full instruction set, all addressing modes. Free-format input,  
relocatable listing and object module, many user-selectable  
assembly options. 8-character labels, arithmetic expressions in  
operands, long error messages, high execution speed.

Full-capability assemblers run on almost any system supporting  
ANSI standard FORTRAN IV, 1966 or later, at a fraction of the  
cost of a separate development system.

| FORTRAN SOURCE MEDIA  | PRICE   |
|-----------------------|---------|
| MAGNETIC TAPE PACKAGE | \$75.00 |
| PUNCHED CARD PACKAGE  | \$50.00 |
| MANUAL/LISTING ALONE  | \$20.00 |

Packages include manual/listing, shipping in U.S.A. For cards,  
specify punch code. For tape, specify code, BPI, block size.

## IDM

P.O. Box 14538  
Minneapolis, MN 55414  
(612)-722-1702

Circle 312 on inquiry card.

## OSI's!

OSI DIDN'T FILL YOU IN...  
WE WILL... With the  
Complete,  
New OS-65D  
V3.2  
Disassembly  
Manual.



- 60 pages of listings
- Includes full cross-reference listing

**Order today. Send check for  
\$24.95 to Software Consultants,  
7053 Rose Trail, Memphis, Tenn.  
38134. 901-377-3503. Postpaid.  
Allow 2-3 weeks.**

Circle 313 on Inquiry card.

### !! REAL TIME !!

The TIME MACHINE from ALPHA OMEGA COMPUTER SYSTEMS isn't just another digital clock chip surrounded by interface circuitry. It's an intelligent microcomputer based peripheral device.

The TIME MACHINE communicates with your computer via a serial I/O port at user selectable data rate between 300 and 2400 baud. RS-232, RS-422, or current loop communication may be used.

Battery protection against power loss is included. The TIME MACHINE automatically computes day of the week and leap year. Buffered output pulses at one second, one minute, and one hour intervals are provided.

Dimensions are 2.5 x 4.75 x 7.5 inches. Batteries, power supply, and communication cable are included.

Price is only \$450 single lot and quantity discounts are available. Dealer inquiries invited. Off the shelf delivery.

**ALPHA OMEGA COMPUTER SYSTEMS, INC.**  
P.O. Box 727 / Corvallis, Oregon 97330  
Incorporated in Oregon and General Sales



ES031794-1011

Circle 314 on Inquiry card.

## Close-Out!



### Desk Top Computer

This unit is a computerized Electronic Secretary. It keeps time, date, calendar, message, and meeting files. Originally sold thru a major mail order house for over \$450.00.

Technically, it's a 6507 MICRO, ROM, Ram, Planaplex Alpha Display, Ni-cad Battery, Power Supply, Keyboard, Wood and Aluminum Case with Schematic and Instructions.

Most of these Computers are warranty returns. We are offering refurbished like new units for \$99.95 and as is (most have minor problems) units for \$44.95. Add \$4.95 per unit for shipping and handling per unit ordered. All units are complete as described. All sales are final. California Residents add 6.5% Sales Tax.

*Send Payment and Order to:*  
**Solid State Surplus**  
P.O. Box 32418/San Jose, CA 95152

Circle 315 on inquiry card.

FOR APPLE II AND APPLE II PLUS COMPUTERS

# DoubleVision™

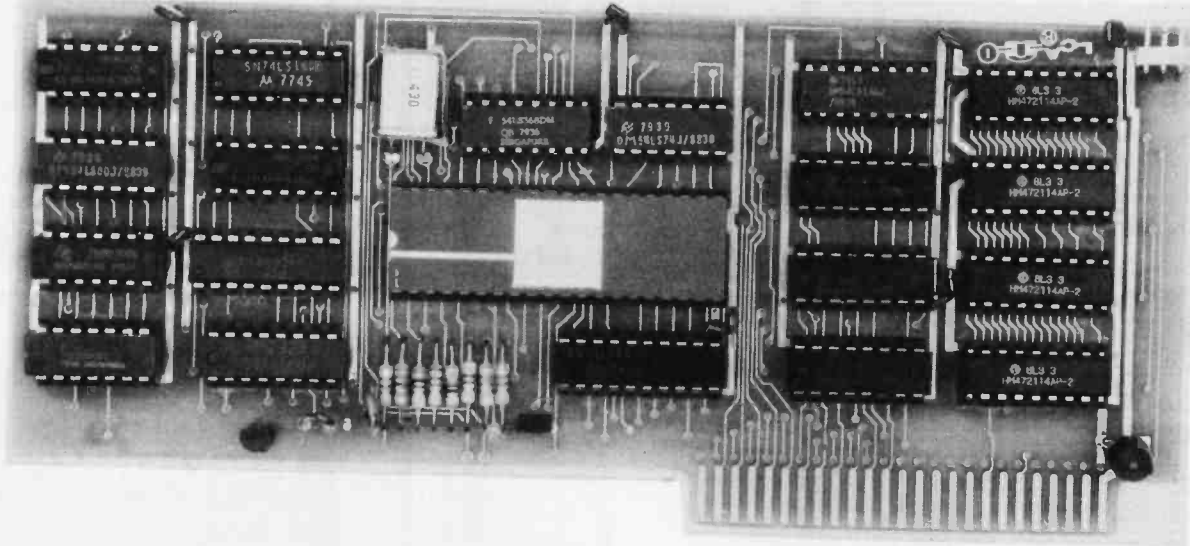

## 80 x 24 Video Display with Upper and Lower Case

COLUMNS LINES

• Is a hardware board that may be plugged into any slot in Apple II or Apple II Plus 32K or 48K Disks • full 128 ASCII character set, including control characters • fully programmable cursor • built in light pen capability • inverse video • full cursor control • works with 50/60Hz • has 2k of its own screen memory • has its own video output jack that must be connected to a monitor (or a high band width black & white TV thru a good RF modulator). Color TV's produce a poor display and are not recommended. • permits you to connect another monitor (or a T.V. set thru RFmod) to the Apple video output jack • displays 24 lines of 80 column text — programmable for different values • permits you to have graphics on Apple video output • video output and Apple video output may be connected to one monitor thru optional video switch • is active only when addressed for reading from or writing to • accepts lower case input from keyboard by use of escape key. (no modification required) or direct use of shift key (1-wire connection from shift key pad to DoubleVision required). • is compatible with the latest version of various word processing software packages. Presently these include Apple-pie 2.0— Programma International, Easywriter Professional system—Informational Unlimited, Text Editor/Formatter—Peripheral's Unltd. (when ordering from these companies, please ask for versions compatible with DoubleVision). All software available from Computer Stop when released. • Peripheral's Unltd. B.I.T.S. and P.I.T.S. and Southeastern Software's "DATA CAPTURE" with Micromodem and communication card. These packages give ability to upload, transfer and download files from remote computers, and all at 80 columns! • Programma Int. latest assembler LISA V:20 will support full 80 column display • is transparent for use with Basic and Pascal • software on disk for easy modification and adaptation for different applications • completely commented source listing of software and hardware schematics available • PASCAL (optional) • becomes the console when installed in Pascal • Permits 80 column text processing with full upper/lower case while using Pascal's editor • must be plugged into slot 3 when operating with Pascal

Available now at your local computer store. . . . . **\$295.00**

Call Computer Stop for Store nearest you

Calif. Residents add 6% Sales Tax

Shipping, Insurance, Handling, extra

\*Apple is a Registered TM of Apple Computers, Inc.

Dealer Inquiries Invited.  
Contact:

**COMPUTER STOP CORP.**  
2545 West 237th St.  
Suite L  
Torrance, CA 90505  
539-7671

**The Computer Stop**  
16919 Hawthorne Blvd.  
Lawndale, CA 90260  
(213) 371-4010

**MON. - SAT.**  
**10-6**

# 3M DISKETTES

For record reliability and quality buy 3M Scotch Diskettes. All Diskettes are in stock for immediate shipment. Call TOLL FREE (800) 235-4137 for prices and information. Visa and Master Card accepted. All orders sent postage paid.



**PACIFIC EXCHANGES**  
100 Foothill Blvd.  
San Luis Obspo. CA  
93401 (In Cal call  
(805) 543-1037.)

Circle 317 on inquiry card.

# GET Paid for using your Computer

FUN! Easy  
RUSH COUPON FOR  
FREE FACTS

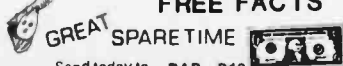

Send today to — DAR - B10  
3110 Fulton Ave, Sacramento CA 95821

**CASH**

NAME \_\_\_\_\_  
STREET \_\_\_\_\_  
CITY \_\_\_\_\_  
STATE \_\_\_\_\_ ZIP \_\_\_\_\_

Circle 318 on inquiry card.



Now you can afford quality!

# Scotch® DISKETTES

SAVE 30% TO 45%!

Possibly the LOWEST prices you'll find on quality SCOTCH Brand Diskettes in sizes to fit all Mini/Micro Computers. One box or by the case, all orders are processed quickly and shipped per your instructions.

Call COLLECT to Order!  
(805) 484-8146

**QUALITY DATA SUPPLY**  
P.O. Box 236, Camarillo, CA 93010

Authorized Distributor  
Information Processing Products



Circle 319 on inquiry card.

## QUARTZ CRYSTALS

|                       |         |         |         |         |         |          |
|-----------------------|---------|---------|---------|---------|---------|----------|
| 3718                  | 5.2420  | 8.8336  | 20.000  | 36.2896 | 42.8518 | 46.8178  |
| 5300                  | 5.6110  | 9.98408 | 20.4968 | 36.3636 | 42.8766 | 47.3768  |
| 1.000A                | 5.7143  | 9.98660 | 22.1184 | 37.0678 | 42.9258 | 47.8838  |
| 1.8432A               | 5.955   | 10.000  | 22.6758 | 38.3768 | 42.9628 | 48.000   |
| 1.8437                | 5.982   | 10.2458 | 26.3556 | 38.4448 | 43.0006 | 48.3006  |
| 7.000A                | 6.030   | 10.4968 | 26.5006 | 38.6258 | 43.0378 | 48.6568  |
| 7.0871A               | 6.144   | 10.7758 | 26.7008 | 38.8258 | 43.0748 | 48.7008  |
| 2.4576A               | 6.15000 | 10.8255 | 27.000  | 39.3178 | 43.1858 | 48.8758  |
| 2.500A                | 6.29780 | 10.8366 | 27.0006 | 39.5038 | 43.2588 | 49.7006  |
| 7.6657                | 6.400   | 11.390  | 27.6506 | 39.6668 | 43.3338 | 49.7338  |
| 7.8650                | 6.5538  | 11.356  | 28.4006 | 39.7538 | 43.3706 | 49.8128  |
| 3.000A                | 6.75300 | 11.2188 | 28.6778 | 39.8768 | 43.4078 | 50.2500  |
| 3.087                 | 6.75840 | 11.2880 | 28.7538 | 39.9628 | 43.4378 | 51.0556  |
| 3.200                 | 6.9003  | 11.4776 | 29.8758 | 40.4448 | 43.4448 | 51.3128  |
| 3.7708A               | 7.0063  | 11.6566 | 29.9378 | 40.5028 | 43.5568 | 51.7778  |
| 3.500                 | 7.0536  | 11.6816 | 30.0648 | 40.8128 | 43.6298 | 51.8506  |
| 3.579A                | 7.8816  | 12.440  | 30.2896 | 40.8338 | 43.5668 | 52.8128  |
| 4.000                 | 7.1836  | 14.3182 | 30.6258 | 40.8758 | 43.7778 | 56.7506  |
| 4.1943                | 7.2586  | 14.4308 | 30.8768 | 40.8888 | 43.8128 | 60.6006  |
| 4.3428                | 8.000   | 15.000  | 31.4378 | 40.9258 | 43.8148 | 60.7508  |
| 4.4803                | 8.0556  | 15.4408 | 31.7538 | 41.0008 | 43.8518 | 66.7506  |
| 4.6103                | 8.1416  | 15.5066 | 31.9008 | 41.1668 | 43.8868 | 70.4008  |
| 4.6503                | 8.1818  | 16.000  | 32.000  | 41.3768 | 43.9248 | 75.0005  |
| 4.8303                | 8.3303  | 16.3848 | 33.2006 | 41.8378 | 44.0008 | 90.8338  |
| 4.9152                | 8.4098  | 17.2448 | 33.6256 | 42.0008 | 44.0378 | 99.9668  |
| 5.000                 | 8.5766  | 17.2427 | 34.5568 | 42.5838 | 44.3768 | 100.6668 |
| 5.0588                | 8.6556  | 18.000  | 34.7538 | 42.6298 | 44.7778 | 101.4668 |
| 5.1203                | 8.9658  | 18.4320 | 34.9778 | 42.7008 | 45.1258 | 102.0668 |
| 5.1850                | 8.9906  | 19.4960 | 35.9256 | 42.7538 | 46.3006 | 103.4568 |
| 5.1856                | 8.47208 | 19.7508 | 36.000  | 42.8148 | 46.7006 | 104.9918 |
| ALL A -- \$2.97       |         |         |         |         |         |          |
| ALL B -- \$1.99       |         |         |         |         |         |          |
| 10 OR MORE-PRODUCT 5% |         |         |         |         |         |          |

ADD \$1.00 SHIPPING  
CAL. RES. ADD 6% SALES TAX  
FREE OSCILLATOR SCHEMATICS  
WITH ANY ORDER  
QUALITY COMPUTER PARTS  
P.O. BOX 743 / CHATSWORTH, CA 91311

Circle 320 on inquiry card.

Sales  
Installation  
Service  
of  
Computers



**JEPSAN, Group K**  
Incorporated

**\* PERCI DISK REPAIR \***  
MINIMIZE DOWN TIME  
BY  
CALLING  
**(616) 698-8700**  
CROMEMCO Dealer  
4180 44th Street S.E.  
Grand Rapids, MI 49508

Circle 321 on inquiry card.

## NEW PRODUCTS

PMC-80 computer ..... \$ 595.  
ADDS 25/120 terminal . \$ 985.  
Diablo 630 printer ..... \$2695.  
IBM 3101 terminal ..... \$1195.  
Atari 400 computer .... \$ 495.  
Soroc IQ 120 ..... \$ 739.  
Novation CAT modem .. \$ 155.

American Express, MasterCard & VISA accepted. Checks require time to clear. CA add 6% tax. All add 3% for shipping. We carry most all brands, micros, terminals, printers, software and accessories.

**SP ELECTRONICS**  
P.O. Box 8265  
Sacramento, CA 95818  
**(916) 442-2323**

Circle 322 on inquiry card.

## DISKETTES 90 DAY WARRANTY

5 1/4 SOFT \$240 ea. in  
10 boxes  
16 of 10

8 SOFT \$260 ea. in  
HARD boxes  
of 10

LIBRARY 5 \$2.50 ea.  
CASE 8 \$2.50 ea.

Use VISA, MC. Add \$2. for C.O.D.  
Ship. & hdg. \$1. + \$.50/lb.

**AMIS, Box 15056**  
Long Beach, CA 90815  
**(213) 597-6839**

Circle 323 on inquiry card.

**dbis** YOUR HEADQUARTERS FOR

## OHIO SCIENTIFIC

SALES · SERVICE · SUPPORT

THE BEST NEW YORK AREA PRICES  
ON ALL OHIO SCIENTIFIC COMPUTERS  
- LOCAL USERS GROUP -  
BUSINESS AND PERSONAL SYSTEMS

PROFESSIONAL BUSINESS SOFTWARE:  
Systems now available:  
Encumbered Budget Accounting  
Inventory/Invoicing Export Management  
Mailing List Payroll  
Accounts Receivable Accounts Payable  
Manuals available separately.....\$35

ALSO AVAILABLE:  
\*Eaton LRC 7000+ Plain Paper Printer...\$356.  
\*Okidata Microline 80 Printer-  
upper/lower case, graphics, any paper,  
software selectable print size.....\$95.

MASTERCHARGE & VISA WELCOME

Designers & Builders of Information Systems, Inc.  
One Mayfair Road - Eastchester, New York 10707

**(914) 779- 5292 (212) 933-4170**

Circle 324 on inquiry card.

## H9 OWNERS!

Upgrade your video terminal with one of these long overdue kits:

**GRAFIX** — Graphical display capabilities assembled and tested \$69.95. Kit \$59.95.

**CURSOR CONTROL** — A total of 8 functions assembled and tested \$34.95. Kit \$29.95.

**FLICKER FREE** — 4800 baud operation assembled and tested \$79.95. Kit \$69.95.

All have a full 6 month warranty.

**NORTHWEST COMPUTER SERVICES, INC.**

**8503 N.E. 30th Avenue**  
Vancouver, WA 98665

Circle 325 on inquiry card.

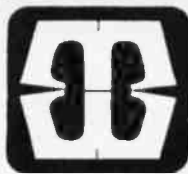

**MICRO**  
BUSINESS WORLD™

**MAIL ORDER**

Immediate response to your orders (verbal or written). toll-free (800) 421-0347



**apple II... Apple II plus  
and the NEW Apple III**

The complete, ready to run computers... Connect to your color TV and start writing programs today. APPLE is faster, smaller, more powerful than it's predecessors. APPLE will change the way you think about computers. **Call for our Price.**

**INVENTORY CONTROL SYSTEM FOR Apple II**

The first truly professional system that can tackle up to 8,100 items • Transaction register/audit trail • Inventory Status report • Re-order report • Keeps track of purchase orders automatically • Will handle multiple departments or divisions

*Fast data retrieval.*

*Minimum hardware requirements: APPLE II Plus with 48K, one disk drive and 80 column printer.*

**Introductory Price: \$99.00** Including comprehensive manual.

**ZENITH DATA SYSTEMS:**  
Smart Video Terminal



**Z-89 Computer System:**

includes: Z19 Display, a built in 5 1/4" Floppy Disk, 2 serial ports, and 16K of memory. **2295.00** 48K Memory **2595.00**  
Also 48K Z-19 has a Z80 Micro -processor, numeric keypad and 8 function key. **895.00**

**ATARI 800** Personal Computer System

Packed with: Computer Console, Basic Language Card, Education System Master Cartridge, Cassette Recorder, TV Modulator, 8K Memory (expandable to 48K), Power Supply & all Books and Manuals **\$799.95**

**ATARI 400** Personal Computer System for less

Packed with: Computer Console, Basic Language Cartridge, Power Supply, TV Modulator, and all Books and Manuals **\$499.95**

**ATARI Program Recorder** **69.99**

**ATARI Software, Roms, Cassettes** 25% off list price

**ATARI Expansion Memory** 8K Module **99.99**

16K Module **169.99**



**commodore** the Great American Solution

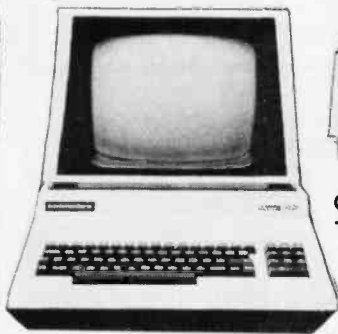

**CBM 8000 SERIES BUSINESS COMPUTER**



**CBM 2022 TRACTOR PRINTER**

**CBM 8050 DUAL DRIVE FLOPPY DISK**

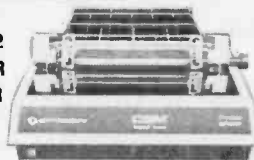

**CBM 2001 SERIES BUSINESS COMPUTER**

**EPSON MX-80 DOT MATRIX PRINTER**

The new Model MX 80 is a high-speed bidirectional, impact printer capable of printing 9x9 dot matrix characters. Prints enlarged, condensed, condensed/enlarged, normal characters with 40,132, 66, 80 columns per line logical seeking function.

**\$645.**

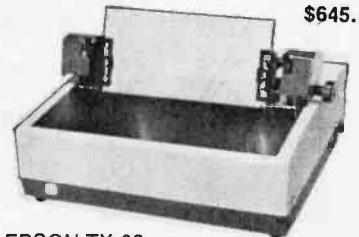

**EPSON TX-80... DOT MATRIX PRINTER**

with graphics **\$795.**



**DYSAN DISKETTES**

THE CADILLAC OF THE FLOPPY DISKS AT LOW LOW PRICES

8" (BOX OF 10) • 3740/1 sgl side/ sgl density..... **4.50 ea**

• 3740/1D sgl side/dbl density..... **6.95 ea**

5" (BOX OF 5) • 104/1 soft sector • 107/1 10 sectors

• 105/1 16 sectors..... **4.50 ea**

Prices subject to change without notice. VISA and MASTER CHARGE WELCOME. Allow 2 weeks for cashiers check to clear, 4 weeks for personal checks. Add 2% for shipping and handling. Calif. residents add 6% sales tax. (Sorry, no C.O.D.)

**U.S. and International dealer inquiries invited.**

Copyright 1980 • MICRO Business WORLD Circle 326 on inquiry card.

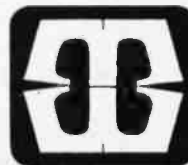

**MICRO**  
BUSINESS WORLD™

15818 Hawthorne Boulevard  
Lawndale, California 90260(213) 371-1660

**16K RAM** set of 8 4116's  
250 ns or better **\$59.00**

## New Program Tracks Your Investments!

... gives your Apple II\* all the capabilities of a Wall Street Brokerage!

- Records Purchases and Sales
  - Maintains Short Sales, Puts and Calls
  - Records Gains and Losses - Both Short & Long Term
  - Prepares Schedule D ... and More!
- Accompanying manual provides complete instructions with examples. (Requires 1 disk drive.)

INVESTOR™ Diskette and Manual Only **\$75.00**

Send check or money order to:  
Sophisticated Microsystems, Inc.  
550 Frontage Road, Northfield, IL 60093  
(312) 441-5802

(\* Apple II is a registered trademark of Apple Computer, Inc.)

Circle 327 on inquiry card.

## MICRO COMPUTERS and CIVIL ENGINEERING

The machine can do it — but you need the application package to make it work for you.

We have brought together the most powerful civil engineering tools available, USA-COGO (Civil Engineering Coordinate Geometry), USA-EARTH (Earthwork Design Quantities), and USA-STRESS (Structural Engineering System Solver). Each system provides a complete data entry and change system in addition to the powerful problem analyzer tied together through a common menu driver.

It's available to you now on your choice of CP/M or TRSDOS in source code BASIC or FORTRAN. For additional information, call us at (314) 878-1277, or write to:

*Universal Software Applications, Inc.*

13001 Cannes Drive  
St. Louis, Missouri 63141  
"Turning Dreams Into Reality"

Circle 329 on inquiry card.

## COGNIVOX



**SPEECH RECOGNITION and VOICE RESPONSE** peripheral for Z-80 based systems. 32 word vocabulary, up to 98% recognition rate. Connects to parallel I/O port, comes complete with microphone, power supply and speaker. Generates music and sound effects too. Beautiful two-tone case, extensive users manual. Breakthrough price, only \$149. Versions available for The Exidy Sorcerer and the TRS-80. Write for more info giving details of your system.

P.O. Box 388  
**VOICETEK** Goleta, Ca 93017

Circle 328 on inquiry card.

## BASF DISKETTES

**BASF Diskettes at competitive price. Call TOLL FREE (800) 235-4137 for prices and information. Visa and Master Card accepted. All orders sent postage paid.**

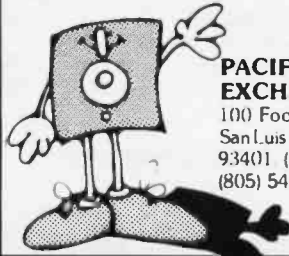

**PACIFIC EXCHANGES**  
100 Foothill Blvd.  
San Luis Obispo, CA  
93401 (In Cal. call  
(805) 543-1037.)

Circle 330 on inquiry card.

## SURPLUS INVENTORY

**\$77**

**22 MHz BANDWIDTH**

**SOLID STATE MONITORS:** Sylvania 12" B&W CRT, 22MHz video bandwidth, 800 line resolution! ASL Model C12ACB OEM tabletop style without case. P4 phosphor, inputs - separate video, horiz & vert. pos. sync pulses at nominal TTL/CMOS levels. Any sweep rate, 10-20 KHz, 115 VAC Simple TRS-80 hookup, add 2 jumpers. With full manual incl. timing, schematics, TRS-80 hookup etc. Slightly used and like new, checked, \$88. Used, checked, no burns ..... \$77

**FLOPPY POWER SUPPLIES (6 OUTPUTS):** North #3678 brand new in orig. foam boxes. 5V/3A, 24V/1.2A, 15V/2.6A full adjustable, w/OV prot. & curr. limiting! 12V/0.1A, -24V/0.3A (both w/OV prot.), -12V/0.1A (adj.). Fully regulated, linear, partially encl. w/sch/s & assy. dwgs. 3.5x5.5x1.4". 115VAC. Will run 1 typical 8" floppy or drop the 15V to 12 and run 2 or 3 minitoppies ..... \$44

**\$100 CORE SALE:** Brand new, tested Ampex core. See article "ITS TIME FOR CORE" (8/79 Kiloquad p. 34) which describes an easily built interface between this core and an S-100 machine. But ignore the prices in the article! Sale priced, including large documentation pkg. Non-volatile, 16K-byte boards ..... \$199. Add \$4 for schematics of core.

**OTHER SURPLUS BARGAINS: LETTER QUALITY ASCII X5R TERMINALS,** Perkin Elmer Carouso 20ma \$1600, RS-232 \$1900, PORTACOM portable terminals - without computer, 110 baud, impact, technician special, AS-IS \$250, checked \$450, FOB.

WRITE OR CALL FOR FULL SPEC SHEETS ON SPECIFIC ITEMS.

**TERMS:** UPS include 48 states except FOB items. UPS COD add \$2.00. VISA & MC add 4%. NJ add sales tax. Everything guaranteed working to specs. immediate shipment or immediate refund. Phone orders and questions are welcome.

**ELECTRAVALUE INDUSTRIAL**

P.O. BOX 157-B  
MORRIS PLAINS, NJ 07950



Phone orders are welcome.  
**201/267-1117**

## MEMORY IC BONANZA

**INTEL 5V ONLY 16K DYNAMIC RAM:** 150ns, ceramic, low power (11mw stby, 150mw oper) version of popular 16Kx1 4116. TTL compatible inputs, tri-state outputs. Equivalent to Motorola 4516. National 5295 etc. OEM list price in quantities of 1000 is \$17, our price, Intel D2118-7s at ..... \$10 ea.

**INTERSIL 4K DYNAMIC RAM:** Equivalent to Mostek 4096, 300ns, 4Kx1, ceramic & gold. TTL compatible inputs, tri-state outputs, low power (24mw stby, 380mw oper), priced at less than 1/2 the usual-hobby price, sold in sleeves of 24, \$30 per sleeve, that's Intersil 7005-12s at ..... \$1.25 ea.

**INTEL 2716 EPROMS - 5V ONLY:** Ceramic, 450ns, the industry standard 2Kx8 EPROM. Sold by others from \$27 to \$59, quantity limited ..... \$20 ea.

**FULL SPEC SHEETS:** Free with order or \$1.00 per set of 3 for evaluation.

**TERMS:** Prices include Insured UPS 48 states. UPS COD add \$2. MC/VISA add 4%. Prime parts, new in original sleeves, guaranteed to mfr's specs. \$20 minimum order. N.J. add sales tax. Immediate shipment or immediate refund.

**ELECTRAVALUE INDUSTRIAL**

P.O. BOX 157-B  
MORRIS PLAINS, NJ 07950



Phone orders are welcome.  
**201/267-1117**

Circle 329 on inquiry card.

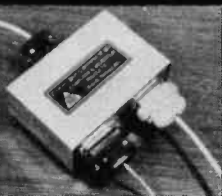

**TERMINAL DATA CORPORATION**

**MODEL 1200 RS-232 DATA SPLITTER**  
available in kit form

Model 1200K gives the terminal or microprocessor user a second interface for a printer, plotter, cassette or tape drive. It operates at any speed & isolates the two output devices from each other, while providing 2 RS-232 interfaces from the terminal or microprocessor.

The kit consists of 3 RS-232 connectors, printed circuit board, all necessary components, enclosure, mounting hardware & assembly instructions ..... \$67.00

write or call

**TERMINAL DATA CORP.**  
11878 Coakley Cir.  
Rockville, MD 20852  
(301) 881-7655

Circle 331 on inquiry card.



**The best choice in mainframes !**

- \$100 CARD FRAME
- 22 MHz 12" CRT MONITOR
- 18 AMP POWER SUPPLY
- UPPER & LOWER CASE ASCII KEY BOARDS
- AXIAL BLOWER
- ASSEMBLED & TESTED
- READY FOR YOUR CARDS
- NEW LOW PRICE **\$885.00**

**INFINITE**

819 E. STRAWBRIDGE, MELBOURNE, FL 32901 - 1305) 724-1588

Circle 332 on inquiry card.

**Dial: 402-987-3771**

**HOT LINE**

YOU NEED CRISP, HIGH CONTRAST BLACK-WHITE and VIVID COLOR ALPHA-NUMERICS/GRAPHICS CAPABILITIES FROM YOUR VIDEO MONITOR IF YOU WANT REALLY SUPER-LOOKING IMAGES FROM YOUR COMPUTER!!

AS SPECIALISTS IN VIDEO IMAGING...we think we have the right monitor or modulator for your system. Our product line includes the popular "Micro-Verter" (OSI and Apple Inc. approved UNF color modulator), a variety of color and B-W monitors, color cameras, B-W cameras, Audio subcarrier life and parts. FREE CATALOG UPON REQUEST. Dealers welcomed. Well established program with over 400 dealers.

Dial: (402) 987-3771

GET FREE DETAILS VIA OUR HOTLINE!!

**ATV Research 13-B BROADWAY DAKOTA CITY, NE. 68731**

Circle 331 on inquiry card.



## TRS-80 SERIAL I/O

- Can input into basic
- Can use LLIST and LPRINT to output, or output continuously
- RS-232 compatible
- Can be used with or without the expansion bus
- On board switch selectable baud rates of 110, 150, 300, 600, 1200, 2400, parity or no parity odd or even, 5 to 8 data bits, and 1 or 2 stop bits. D.T.R. line
- Requires +5, -12 VDC
- Board only \$19.95 Part No. 8010, with parts \$59.95 Part No. 8010A, assembled \$79.95 Part No. 8010 C. No connectors provided, see below.



EIA/RS-232 connector Part No. DB25P \$6.00 with 9' 8 conductor cable \$10.95 Part No. DB25PS.



Ribbon cable with attached connectors to fit TRS-80 and our serial board \$19.95 Part No. 3CAB40

## COMPUCRUISE



\$129.95, with cruise control \$169.95

## PAPER TIGER

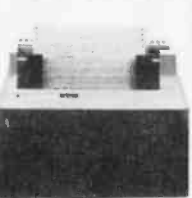

Prints address labels, multicopy invoices and legal-size reports. Adjust the tractor width from 1-3/4 to 9-1/2 inches. 8 switch-selectable forms lengths. Print 6 or 8 lines per inch. Add the software-selectable full dot plotting graphics option to print illustrations, block letters, charts, graphs. Part No. 162172 \$899.95 • with graphics option Part No. 162173 \$1099.95

## GAME PADDLES & SOUND



Includes: 2 game paddles, interface, software, speaker, power supply, full documentation including: schematics, theory of operation, and user guide; plus 2 games on cassette (Pong and Starship War). \$79.95 Complete Part No. 7922C

## DIGICOM DATA PRODUCTS INC. Series 312 Acoustic Coupler



300 BAUD Originate, Part No. AC3122, \$219.95. 300 BAUD Answer, Part No. AC3122, \$219.95. 300 BAUD Answer/Organate, Part No. AC3123, \$229.95.

## IBEX LIGHT PEN



Comes with Backgammon and Tic-Tac-Toe on tape with full documentation and program listing. Requires 9v. battery. Part No. IBEX \$19.95

## SYSTEM EXPANSION from LNW Research

- Serial RS232C/20 mA I/O
- Floppy controller
- 32K bytes memory
- Parallel printer port
- Dual cassette port
- Real-time clock
- Screen printer bus
- Onboard power supply
- Software compatible
- Solder mask, silk screen. PC board and user manual, Part No. LNW80, \$69.95.

## DISKETTES



Box of 10, 5" \$29.95, 8" \$39.95. Plastic box, holds 10 diskettes, 5" - \$4.50, 8" - \$6.50.

## 16K RAMS

For the Apple, TRS-80 or Pet \$8 each Part No. 4116/2117.

## LEEDEX MONITOR



12" Black and White • 12 MHz Bandwidth • Handsome Plastic Case • \$139.00

## S-100 INTERFACE



AN S-100 bus Adapter—Motherboard for the TRS-80. Kit, Part No. HUH81DLXK, \$295.95. Assembled, Part No. HUH81DLXA, \$375.95.

## NOW! A FULL SUPPORT SYSTEM FOR TRS-80

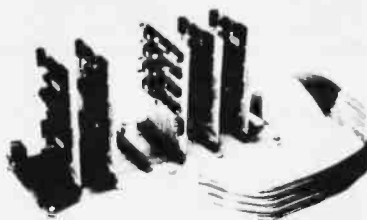

- 32K of RAM
- EPROM firmware
- Disk control
- Data acquisition
- Parallel I/O
- Serial I/O
- Plug into GPA's Motherboard. GPA's quality design includes: 6-44 pin edge connectors • +5V, -5V, +12V, -12V external power supply required
- Active termination. The Motherboard, Part No. GPA80, is only \$149.95.

## TAKE ADVANTAGE OF GPA-EXPANSION CARDS FOR THE GPA80

**Memory cards:** Now with Fortran compilers available for your TRS-80, additional expansion memory is a must! Card with sockets only, Part No. GPA801, \$119.95. Card with 16K of 4116 Dynamic Ram, Part No. GPA802, \$224.95. Card with 32K of 4116 Dynamic Ram, Part No. GPA803, \$329.95. All cards come equipped with sockets to accommodate 32K of Ram.

**EPROM firmware card.** Put those valuable subroutines in firmware. Don't waste time loading and unloading tapes and disks. For 2708 or 2716 EPROMS, Part No. GPA806, \$79.95.

**Serial I/O card.** Here's what you've been asking for, a full serial terminal interface, with RS-232C or 20 mA. Current loop. Input/output capabilities. Part No. GPA807, \$79.95.

**Parallel I/O Card.** Control functions in the outside world, monitor and store real time events. Two parallel output ports. Dip switches select ports (0-254). Part No. GPA808, \$79.95.

## FLOPPY DISK STORAGE BINDERS

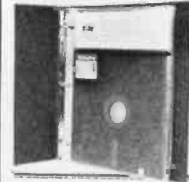

Three ring binder comes with ten transparent plastic sleeves which accommodate either twenty, five-inch or ten, eight-inch floppy disks. Binder & 10 holders, Part No. 810B—\$9.95 • Extra holders, Part No. 810—69¢ each.

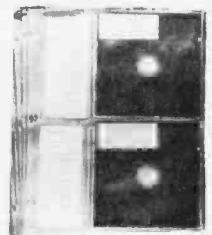

Three-ring binder with ten 5 1/4 inch jackets Part No. 510B—\$9.95 • Jackets only, fits standard 3-ring binders, Part No. 510—69¢ each.

## DIGITAL CASSETTE



5 min. each side. Box of 10 \$9.95. Part No. C-5.

## TRENDCOM PRINTER



TRENDCOM 200, Part No. TRC0200 \$495.95. **Interface** for TRS-80, Part No. T80A \$49.95. For Apple II, Part No. TRCALL, \$75.95. For PET, No. TRCPC2, \$79.95. For Scroccer, TRCSR1 \$45.95.

## SARGON: A Computer Chess Program

Features the complete program that won the 1978 West Coast Computer Faire Tournament. Part No. 00603 — TRS-80 Level II; Part No. 00604 — Apple II (24K) \$19.95

## SPINWRITER MODELS 5510 and 5520



Features—EIA RS-232C/CCITT V.24 Interface Standard • 55 Characters Per Second Maximum Print Rate • Impeccable Print Quality (OCR Quality) • Microprocessor Electronics • High Resolution Plotting/Graphing • Lowest Operating Noise Level • Self-Test Printing • Operator Engineered Control Panel • Prints Original and up to Seven Copies • NEC Information Systems new Model 5510 Receive Only and Model 5520 Keyboard Send/Receive SPINWRITER terminals are microprocessor controlled serial, impact terminals designed for remote printing applications where impeccable print quality is required. Model 5510 AO, Part No. NECA30759 \$2795.95 • Model 5520 KSR, Part No. NECA30762 \$3095.95

Send for FREE Catalog...a big self addressed envelope with 80¢ postage gets it fastest!

## To Order:

Mention part no., description, and price. In USA shipping paid by us for orders accompanied by check or money order. We accept C.O.D. orders (U.S. only) or a VISA or Master Charge no., expiration date, signature and phone no., shipping charges will be added. CA residents add 6.5% for tax. Outside USA add 15% for air mail postage and handling. Payment must be in U.S. dollars. Dealer inquiries invited. Prices subject to change without notice.



Order Line: (408) 448-0800

# ELECTRONIC SYSTEMS

Dept. B, P.O. Box 21638, San Jose, CA USA 95151

### HEX ENCODED KEYBOARD

Four onboard LEDs indicate the HEX code generated for each key depression. The board requires a single +5 volt supply. Board only \$15.00 Part No. HEX-3, with parts \$49.95 Part No. HEX-3A. 44 pin edge connector \$4.00 Part No. 44P.

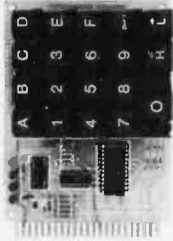

### ASCII TO CORRESPONDENCE CODE CONVERTER

This bidirectional board is a direct replacement for the board inside the Trendata 1000 terminal. The on board connector provides RS-232 serial in and out. Sold only as an assembled and tested unit for \$249.95. Part No. TA 1000C

### ASCII KEYBOARD

53 Keys popular ASR-33 format • Rugged G-10 P.C. Board • Tri-mode MOS encoding • Two-Key Rollover • MOS/DTL/TTL Compatible • Upper Case lockout • Data and Strobe inversion option • Three User Definable Keys • Low contact bounce • Selectable Parity • Custom Keycaps • George Risk Model 753. Requires +5, -12 volts. \$59.95 Kit.

### ASCII KEYBOARD

TTL & DTL compatible • Full 67 key array • Full 128 character ASCII output • Positive logic with outputs resting low • Data Strobe • Five user-definable spare keys • Standard 22 pin dual card edge connector • Requires +5VDC, 325 mA. Assembled & Tested. Cherry Pro Part No. P70-05AB. \$119.95.



### A-to-D D-to-A CONVERTER

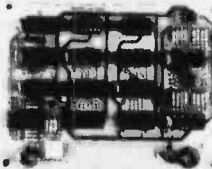

Analog to Digital, Digital to Analog Converter, A-D conversion time 20us. D-A conversion 5us. Uses include speech and music synthesizing and slow scan TV. Single power supply (5V), 8 Bits wide, latched I/O, strobe lines. Part No. 792B7K Complete Kit \$49.95 • Part No. 792B7A Assembled \$69.95

### SOLID STATE SWITCH



Your computer can control power (120VAC) to your printer, lights, and other 120VAC appliances up to 720 watts (6AMPS at 120VAC). Input 3 to 15 VDC, 2-13 MA TTL compatible, isolation 1500V. Part No. 79000K 1 Channel Kit \$9.95 • Assm. \$12.50 • Part No. 79004K 4 Channel Kit \$34.95 • Assm. \$44.95.

### SUPERMODEM



Originate, RS-232 and 20 mA compatible, Full duplex, and half duplex, direct connect or acoustic coupled, on board power supply, carrier detect light, DB25 plug, 300 BAUD, Type 103 compatible frequencies, Bare board Part No. 2000, \$19.95, Kit Part No. 2000A, \$99.95.

### T.V. INTERFACE

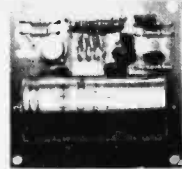

• Converts video to AM modulated RF, Channels 2 or 3. So powerful almost no tuning is required. On board regulated power supply makes this extremely stable. Rated very highly in Doctor Dobbs' Journal. Recommended by Apple • Power required is 12 volts AC C.T., or +5 volts DC • Board only \$7.60 part No. 107, with parts \$13.50 Part No. 107A

### SOROC IQ 120



Upper/lower case display • Numeric keypad & cursor keys • Protected fields, 1/2 intensity display • RS 232 interface & aux. port. IQ 120—\$799.95 • IQ140 Detachable keyboard—\$1199.95

### RS-32/TTL INTERFACE

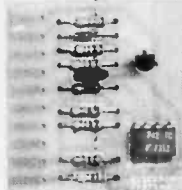

• Converts TTL to RS-232, and converts RS-232 to TTL • Two separate circuits • Requires -12 and +12 volts • All connections go to a 10 pin edge connector, kit \$9.95 Part No. 232A 10Pin edge connector \$3.00 part No. 10P.

### DC POWER SUPPLY

• Board supplies a regulated +5 volts at 3 amps., +12, -12, and -5 volts at 1 amp. • Power required is 8 volts AC at 3 amps., and 24 volts AC C.T. at 1.5 amps. • Board only \$12.50 Part No. 6085, with parts excluding transformers \$42.50 Part No. 6085A



### TAPE INTERFACE



• Converts a low cost tape recorder to a digital recorder • Works up to 1200 baud • Digital in and out are TTL serial • Output of board connects to mic. in of recorder • Earphone of recorder connects to input on board • No coils • Requires +5 volts, low power drain • Board only \$7.60 Part No. 111, with parts \$29.95 Part No. 111A

### MODEM

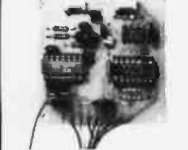

• Type 103 • Full or half duplex • Works up to 300 baud • Originate or Answer • Serial TTL input and output • connect B & speaker and crystal mic. directly to board • Requires +5 volts • Board only \$7.60 Part No. 109, with parts \$29.95 Part No. 109A.

### COMPCOLOR II



With reg. keyboard MOD3 8K \$1449.95 MOD4 16K \$1495.95 MOD5 32K \$1699.95 Without disk drive subtract \$450.00. Add-on drives, \$495.00. With 101 key option add \$134.95. With 117 key option add \$179.95.

### T.V. TYPEWRITER



• Stand alone TVT • 32 char/line, 16 lines, modifications for 64 char/line included • Parallel ASCII (TTL) input • Video output • 1K on board memory • Output for computer controlled cursor • Auto scroll • Non-destructive cursor • Cursor inputs: up, down, left, right, home, EOL, EOS • Scroll up, down • Requires +5 volts at 1.5 amps, and -12 volts at 30 mA • All 7400, TTL chips • Char. gen. 2513 • Upper case only • Board only \$39.00 Part No. 106, with parts \$145.00 Part No. 106A

### UART & BAUD RATE GENERATOR

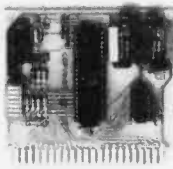

• Converts serial to parallel and parallel to serial • Low cost on board baud rate generator • Baud rates: 110, 150, 300, 600, 1200, and 2400 • Low power drain +5 volts and -12 volts required • TTL compatible • All characters contain a start bit, 5 to 8 data bits, 1 or 2 stop bits, and either odd or even parity. • All connections go to a 44 pin gold plated edge connector • Board only \$12.00 Part No. 101, with parts \$35.00 Part No. 101A, 44 pin edge connector \$4.00 Part No. 44P

### 44 BUS MOTHER BOARD



Has provisions for ten 44 pin (.156) connectors, spaced 3/4 of an inch apart. Pin 20 is connected to X, and 22 is connected to Z for power and ground. All the other pins are connected in parallel. This board also has provisions for bypass capacitors. Board cost \$15.00 Part No. 102. Connectors \$3.00 each Part No. 44WP.

### RS-232/20mA INTERFACE



This board has two passive, opto-isolated circuits. One converts RS-232 to 20mA, the other converts 20mA to RS-232. All connections go to a 10 pin edge connector. Requires +12 and -12 volts. Board only \$9.95, part no. 7901, with parts \$14.95 Part No. 7901A.

Send for FREE Catalog...a big self addressed envelope with 80¢ postage gets it fastest!

### To Order:

Mention part no., description, and price. In USA shipping paid by us for orders accompanied by check or money order. We accept C.O.D. orders (U.S. only) or a VISA or Master Charge no., expiration date, signature and phone no., shipping charges will be added. CA residents add 6.5% for tax. Outside USA add 15% for air mail postage and handling. Payment must be in U.S. dollars. Dealer inquiries invited. Prices subject to change without notice.



Order Line: (408) 448-0800

**ELECTRONIC SYSTEMS** Dept. B, P.O. Box 21638, San Jose, CA USA 95151

## Apple II Or APPLE II PLUS



16K \$975.95, Extra 16K E.S. RAM installed \$74.95, extra 32K E.S. RAM installed \$148.95.

**APPLE II HOBBY/PROTOTYPING CARD**  
Part No. 7907 \$14.95

## APPLE II PARALLEL INTERFACE

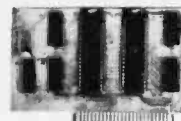

Interfaces printers, synthesizers keyboards, and JBE A-D-D-A Converter & Switches. This interface has 4 I/O ports with handshaking logic, 2-6522 VIA's and a 74LS74 for timing. Inputs and outputs are TTL compatible. Part No. 79295K Complete Kit—\$69.95 • Part No. 79295A Assembled—\$79.95

## REAL TIME 100,000 DAY CLOCK

**MT. HARDWARE** Double the utility of your S-100 bus computer with a real-time clock that keeps time in 100µS increments for over 273 years. Program events for the entire period with real time interrupts...without derailing the system. Maintain a log of computer usage, time and date transaction printouts, call up lists. On-board battery backup. MHPX004—\$349.00

## 16K EPROM

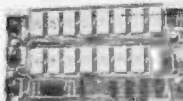

Uses 2708 EPROMs, memory speed selection provided, addressable anywhere in 65K of memory, can be shadowed in 4K increments. Board only \$24.95 part no. 7902, with parts less EPROMs \$49.95 part no. 7902A.

## PET COMPUTER



With 16K & monitor—\$895.00 • Dual Disk Drive—\$1095.00

## OPTO-ISOLATED PARALLEL INPUT BOARD FOR APPLE II

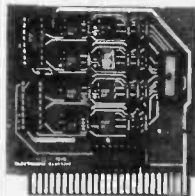

There are 8 inputs that can be driven from TTL logic or any 5 volt source. The circuit board can be plugged into any of the 8 sockets of your Apple II. It has a 16 pin socket for standard dip ribbon cable connection. Board only \$15.00. Part No. 120, with parts \$69.95. Part No. 120A.

## VIDEO TERMINAL

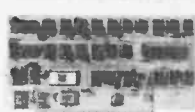

16 lines, 64 columns • Upper and lower case • 5x7 dot matrix • Serial RS-232 in and out with TTL parallel keyboard input • On board baud rate generator 75, 110, 150, 300, 600, & 1200 jumper selectable • Memory 1024 characters (7-21L02) • Video processor chip SFF96364 by Neculonic • Control characters (CR, LF, →, ←, ↑, ↓, non destructive cursor, CS, home, CL) • White characters on black background or vice-versa • With the addition of a keyboard, video monitor or TV set with TV interface (part no. 107A) and power supply this is a complete stand alone terminal • also S-100 compatible • requires +16, & -16 VDC at 100mA, and 8VDC at 1A. Part No. 1000A \$199.95 kit.

## PARALLEL TRIAC OUTPUT BOARD FOR APPLE II



This board has 8 triacs capable of switching 110 volt 6 amp loads (660 watts per channel) or a total of 5280 watts. Board only \$15.00 Part No. 210, with parts \$119.95 Part No. 210A

## APPLE II SERIAL I/O INTERFACE



Baud rate is continuously adjustable from 0 to 30,000 • Plugs into any peripheral connector • Low current drain. RS-232 input and output • On board switch selectable 5 to 8 data bits, 1 or 2 stop bits, and parity or no parity either odd or even • Jumper selectable address • SOFTWARE • Input and Output routine from monitor or BASIC to teletype or other serial printer • Program for using an Apple II for a video or an intelligent terminal. Also can output in correspondence code to interface with some electrics. • Also watches DTR • Board only \$15.00 Part No. 2, with parts \$42.00 Part No. 2A, assembled \$62.00 Part No. 2C

## 8K EPROM PICEON

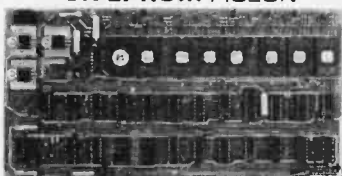

• Programs 2708's address relocation of each 4K of memory to any 4K boundary • Power on jump and reset jump option for "turnkey" systems and computers without a front panel • Program saver software in 1 2708 EPROM \$25. Bare board \$35 including custom coil, board with parts but no EPROMS \$139, with 4 EPROMS \$179, with 8 EPROMS \$219.

## WAMECO PRODUCTS

With ELECTRONIC SYSTEMS parts

- FDC-1 FLOPPY CONTROLLER BOARD** will drive shugart, pertek, remex 5" & 8" drives up to 8 drives, on board PROM with power boot up, will operate with CPM (not included). PCBD ..... \$42.95
- FPB-1 Front Panel.** (Finally) IMSAI size hex displays. Byte or instruction single step. PCBD ..... \$42.95
- MEM-1A 8Kx8 fully buffered, S-100, uses 2102 type RAMS.** PCBD ..... \$24.95, \$168 Kit
- GMB-12 MOTHER BOARD,** 13 slot, terminated. S-100 board only ..... \$34.95 \$89.95 Kit
- CPU-1 8080A Processor board S-100 with 8 level vector interrupt PCBD** .. \$25.95 \$89.95 Kit
- RTC-1 Realtime clock board.** Two independent interrupts. Software programmable. PCBD ..... \$25.95, \$60.95 Kit
- EPM-2 2708/2716 16K/32K EPROM card PCBD** ..... \$24.95 \$49.95 with parts less EPROMS
- GMB-9 MOTHER BOARD.** Short Version of GMB-12. 9 Slots PCBD ..... \$30.95 \$67.95 Kit
- MEM-2 16Kx8 Fully Buffered 2114 Board PCBD** ..... \$25.95, \$269.95 Kit

YOU MUST REFER TO THIS AD TO GET THESE PRICES.

## D.C. HAYES MICROMODEM

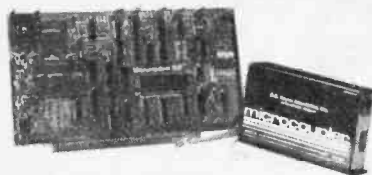

Fully S-100 bus compatible including 16-bit machines and 4 MHz processors. • Two software selectable Baud rates—300 Baud and a jumper selectable speed from 45 to 300 Baud. (110 standard). Supports originate and answer modes. • Direct-connect Microcoupler. This FCC-registered device provides direct access into your local telephone system, with none of the losses or distortions associated with acoustic couplers and without a telephone company supplied data access arrangement. • Auto-Answer/Auto-Call. The MICROMODEM 100 can automatically answer the phone and receive input; it can also dial a number automatically. • Automatic Reset and Disconnect. • Software compatible with the D.C. Hayes Associates 80-103A Data Communications Adapter. Micromodem-DCHA32625—\$379.95

## TIDMA



Tape Interface Direct Memory Access • Record and play programs without bootstrap loader (no prom) has FSK encoder/decoder for direct connections to low cost recorder at 1200 baud rate, and direct connections for inputs and outputs to a digital recorder at any baud rate • S-100 bus compatible • Board only \$35.00 Part No. 112, with parts \$110.00 Part No. 112A.

## SYSTEM MONITOR

8080, 8085, or Z-80 System monitor for use with the TIDMA board. There is no need for the front panel. Complete with documentation \$12.95.

## RS-232/TTY INTERFACE

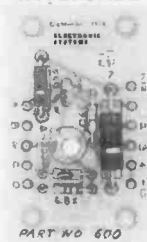

This board has two active circuits, one converts RS-232 to 20 mA, the other converts 20 mA to RS-232. Requires +12 and -12 volts. \$9.95 Part no. 600A Kit.

## SERIAL I/O



Four Serial I/O RS-232 ports. S-100 Bus. Software or jumper selectable baud rate (110, 300, 600, 1200, 2400, 4800, 9600, 192K), on board Xtail baud rate generator. Addressing, switch selectable, Parity or no parity (odd or even) switch selectable. 1 or 2 stop bits, 5 to 8 bits/character. Board only \$29.95, Part No. 7908. With parts (kit) \$199.95. Part No. 7908A.

## S-100 BUS ACTIVE TERMINATOR



Board only \$14.95 Part No. 900, with parts \$24.95 Part No. 900A

Send for FREE Catalog...a big self addressed envelope with 80¢ postage gets it fastest!

## To Order:

Mention part no., description, and price. In USA shipping paid by us for orders accompanied by check or money order. We accept C.O.D. orders (U.S. only) or a VISA or Master Charge no., expiration date, signature and phone no., shipping charges will be added. CA residents add 6.5% for tax. Outside USA add 15% for air mail postage and handling. Payment must be in U.S. dollars. Dealer inquiries invited. Prices subject to change without notice.



Order Line: (408) 448-0800

# ELECTRONIC SYSTEMS

 Dept. B, P.O. Box 21638, San Jose, CA USA 95151



**COMPUTER SYSTEMS INC.**

15335 South Hawthorne Boulevard  
Lawndale, California 90260  
(213) 970-0952

Place Orders **Toll Free** 1-800-421-5150  
(Continental U.S. **Only** — Except Calif.)  
Retail Store Open 10:00 A.M. to 6:00 P.M.  
Daily **Except** Sunday  
**QT CATALOG NOW AVAILABLE**

**THE GREAT Q.T. BOARD SET SALE**  
USER PROVEN BOARD SETS AT NOT MUCH ABOVE OUR  
WHOLESALE COST. 6 SLOT MOTHER BOARD KIT  
FREE WITH EACH BOARD SET PURCHASED.

**Q.T.**  
BOARD SET #1 (KIT)  
Z+80 CPU (Rev 1)  
Expandable + with 32K  
Monitor For Serial Terminal

**FOR STARTERS**  
Our Normal Retail \$525.00  
Q.T. Price \$425.00

**S.D.**  
BOARD SET #1 (KIT)  
SBC-100  
Expandoram I with 32K RAM  
Versafloppy I  
Monitor For Serial Terminal  
BIOS for 8" or 5 1/4" Drives

**FOR SERIOUS HOBBYISTS**  
Our Normal Retail \$950.00  
Q.T. Price \$850.00

**Q.T.**  
BOARD SET #2 (KIT)  
Z+ CPU (Rev 1)  
Expandable + with 64K  
Versafloppy II  
Monitor For Serial Terminal

**FOR HOBBYISTS**  
Our Normal Retail \$1050.00  
Q.T. Price \$850.00

**S.D.**  
BOARD SET #2 (KIT) & SOFTWARE DEVELOPERS  
SBC-200  
Expandoram II with 32K RAM  
Versafloppy II  
Monitor For Serial Terminal  
BIOS for Disk Drives

**FOR SMALL BUSINESSES**  
Our Normal Retail \$1150.00  
Q.T. Price \$1000.00

**PARTICIPATING IN THIS SALE ALSO ENTITLES YOU TO SUCH BONUSES AS:**

- \$36.00 Per set of 4116's — 200ns devices only
- Free second page of memory option in all Televideo 912 & 920 Smart CRT's.

**QT MEMORY EXPANSION KITS**  
for  
**TRS-80 • APPLE • EXIDY**

4116 200 ns  
8 for **\$40.00**  
2716 (5V - 450 ns)  
**\$18.00**  
2716 (5 & 12V - 450 ns)  
**\$14.00**  
2732 (5V)  
**\$55.00**  
2114L 300 ns  
8 for **\$40.00**  
100 - **\$4.25 ea.**  
4118 - **\$24.95**

**TELEVIDEO (CRT)  
SMART TERMINAL**

- Reverse Video • Blinking/blank fields
- Upper/lower case character • Protected fields
- Non-glare screen • Underlining
- 12 x 10 character resolution • Single stroke editing keys
- Function keys • Blinking cursor • TTY keyboard
- Numeric pad • 9 Baud rates (75-9600 Baud) • Self-test • Printer port

912B ..... \$750.00  
920B ..... \$835.00  
920C ..... \$850.00

OPTION:  
2nd Page Memory ..... \$34.95  
Nationwide Field Service available from General Electric Instrumentation and Communication Equipment Service Shops.

**VERBATIM  
MEMOREX  
& WABASH**

| Part No.    | Sectoring      | Pkg. of 2 | Box of 10 |
|-------------|----------------|-----------|-----------|
| QTMO 525 01 | Soft Sector    | \$ 8.95   | \$29.95   |
| QTMO 525 10 | Hard 10 Sector | \$ 8.95   | \$29.95   |
| QTMO 525 16 | Hard 16 Sector | \$ 8.95   | \$29.95   |
| QTFO32 1000 | Hard Sector    | \$11.95   | \$34.95   |
| QTFO34 1000 | Soft Sector    | \$11.95   | \$34.95   |

**KASSETTE LIBRARY**

| Part No. |                       |                          |
|----------|-----------------------|--------------------------|
| CAS-10-8 | Blue/Grey/Beige/Black |                          |
|          | 8" Diskette Holder    | .... \$4.50 or 3/\$10.00 |
| CAS-10-5 | Blue/Grey/Beige/Black |                          |
|          | 5" Diskette Holder    | .... \$4.25 or 3/\$10.00 |

**CONNECTORS**

|                                        |                     |
|----------------------------------------|---------------------|
| RS232 Set                              | ..... \$6.50        |
| .1 Male DB-25, 1 Female DB-25, 1 Cover |                     |
| DB25P                                  | ..... \$2.95        |
| DB25S                                  | ..... \$3.60        |
| Cover                                  | ..... \$1.50        |
| S-100 (IMSAI STYLE)                    | ..... \$2.50 ea.    |
| Gold Solder Tall                       | ..... 10 for \$2.25 |

**SEE QT PRODUCTS AT THE  
NORTHEAST PERSONAL &  
BUSINESS  
COMPUTER SHOW  
IN BOSTON - NOV. 20-23  
ISLAND BOOTH #408**

**PARTS**

**MICROPROCESSORS**

|             |             |
|-------------|-------------|
| Z80 (2MHz)  | ... \$10.95 |
| Z80A (4MHz) | ... \$12.95 |
| 6502        | ... \$11.25 |
| 6800        | ... \$12.50 |
| 6802        | ... \$18.00 |
| 8035        | ... \$20.00 |
| 8080A       | ... \$ 3.50 |
| 8085A       | ... \$20.00 |
| 8086-4      | ... \$60.00 |
| 8088        | ... \$60.00 |
| 8748-8      | ... \$70.00 |

**8080A SUPPORT**

|        |             |
|--------|-------------|
| 8212   | ... \$ 3.50 |
| 8214   | ... \$ 4.50 |
| 8216   | ... \$ 2.95 |
| 8224   | ... \$ 4.00 |
| 8228   | ... \$ 6.00 |
| 8238   | ... \$ 8.00 |
| 8243   | ... \$ 5.00 |
| 8251   | ... \$ 7.00 |
| 8253   | ... \$19.00 |
| 8253-5 | ... \$20.25 |
| 8255   | ... \$ 6.25 |
| 8257   | ... \$17.95 |
| 8257-5 | ... \$19.00 |
| 8259   | ... \$19.95 |
| 8275   | ... \$69.95 |
| 8279   | ... \$17.50 |
| 8279-5 | ... \$18.00 |
| 8295   | ... \$16.50 |

**KEYBOARD CHIPS**

|          |             |
|----------|-------------|
| AYS-2376 | ... \$13.75 |
| AYS-3600 | ... \$13.75 |

**BAUD RATE GENERATORS**

|             |             |
|-------------|-------------|
| MC14411     | ... \$11.00 |
| 1-8432 XTAL | ... \$ 4.95 |
| BR1941L     | ... \$10.00 |

**DISC CONTROLLER**

|         |             |
|---------|-------------|
| 1771B01 | ... \$24.95 |
| 1791B01 | ... \$37.95 |

**EPROMS**

|       |               |
|-------|---------------|
| 1702A | ..... \$ 4.95 |
| 2708  | ..... \$ 6.25 |
| 2516  | ..... \$18.00 |
| 2758  | ..... \$27.00 |
| 2532  | ..... \$55.00 |
| 2732  | ..... \$55.00 |

**USRT**

|       |               |
|-------|---------------|
| S2350 | ..... \$ 7.95 |
|-------|---------------|

**MISCELLANEOUS OTHER COMPONENTS**

|         |               |
|---------|---------------|
| N8T20   | ..... \$ 3.25 |
| N8T26   | ..... \$ 2.50 |
| N8T97   | ..... \$ 2.00 |
| N8T98   | ..... \$ 2.00 |
| 1488    | ..... \$ 1.25 |
| 1489    | ..... \$ 1.25 |
| D3205   | ..... \$ 3.00 |
| D3242   | ..... \$10.15 |
| D3245   | ..... \$ 5.80 |
| P3404   | ..... \$ 6.75 |
| TMS5501 | ..... \$19.00 |
| DM8131  | ..... \$ 3.00 |

**CRT CONTROLLER**

|         |               |
|---------|---------------|
| MC6845P | ..... \$22.00 |
|---------|---------------|

**UARTS**

|         |               |
|---------|---------------|
| TR1602B | ..... \$ 3.75 |
|---------|---------------|

**CHARACTER GENERATORS**

|      |                         |
|------|-------------------------|
| 2513 | (Upper case) .. \$10.95 |
| 2513 | (Lower case) .. \$10.95 |
| 2513 | Upper (5 v) ... \$ 9.75 |
| 2513 | Lower (5 v) ... \$10.95 |

**6800 PRODUCTS**

|       |               |
|-------|---------------|
| 6802P | ..... \$18.00 |
| 6821P | ..... \$ 5.25 |
| 6845P | ..... \$22.00 |
| 6850P | ..... \$10.00 |
| 6860P | ..... \$11.55 |
| 6875P | ..... \$ 7.40 |

# SSM PRODUCTS

## CB2 Z-80 CPU

Kit ..... \$225.00  
 Assembled & Tested ..... \$310.00  
 • 2MHz, 4MHz, Mixed • Type—2716 or 2732 (not incl.) • Dip switch addressing • One wait state added • Dip switch disable • Type—TMS 4016 (not incl.) • 8 additional address lines • Power on/reset firmware jump using first instruction in EPROM

## IO4 2P + 2S I/O Interface

Kit ..... \$150.00  
 Assembled & Tested ..... \$200.00  
 • Two serial ports with status • Two parallel inputs • Two parallel outputs • Current-loop by optical isolators • UART presets by dip switch: —stop bits —word length —parity even and odd • Dip switch addressing of serial I/O to any four port boundary • Dip switch addressing of parallel I/O to any two port boundary

## PB1 2708/2716 EPROM Programmer

Kit with Textool sockets ..... \$140.00  
 Assembled & Tested w/Textool sockets ..... \$190.00  
 • 2708 EPROM (not included) • 2716 EPROM + 5V type (not included) • Any 4K boundary • Separate 2708 and 2716 sockets • Any 4K/8K boundary above 8000 Hex • Optional Textool sockets (for programming only) • Programming software & bit for bit verify routines provided

## VB1C

Kit ..... \$160.00  
 Assembled & Tested ..... \$210.00  
 • 64 or 32 Characters Per Line • 16 Lines • Graphics (128 x 48 matrix) • Separate Video, Horizontal & Vertical Sync • Memory Mapped Board • 1024 Bytes • Dip Switch Addressing in 1K Increments • All Lines Buffered

## VB 3 80 Character Video Interface

80x24 Display, 4 MHz  
 Kit ..... \$369.95  
 Assembled & Tested ..... \$439.00  
 • 80 char. per line, up to 51 lines • Graphics up to 160 x 204 matrix • Upper & lower case characters • Software controlled timing, top & bottom margins, horiz. position • U.S. & European T.V. timing • 4096 Bytes (8192 bytes optional) • Switch addressing, 8K increments • CP/M compatible driver routine

## S-100 BARE BOARDS

|                                     |         |                              |         |
|-------------------------------------|---------|------------------------------|---------|
| CB1A 8080 CPU                       | \$33.00 | MB3 4K 1702 EPROM Board      | \$30.00 |
| VB2 I/O Mapped Video Interface      | \$33.00 | MB6B 8K Static RAM           | \$27.00 |
| IO2 Parallel I/O Interface          | \$33.00 | MB7 Low Power 16K Static RAM | \$30.00 |
| IO4 2P + 2S I/O Interface           | \$33.00 | MB8A 16K 2708 EPROM Board    | \$30.00 |
| SB1 Music Synthesizer               | \$40.00 | T1 Terminator                | \$26.00 |
| OB1 Vector Jump & Prototyping Board | \$29.95 | MT1 15 Slot Motherboard      | \$40.00 |
|                                     |         | XB1 Extender Board           | \$13.50 |

## S-100 KITS & ASSEMBLED BOARDS

|                                        |          |                                                |          |
|----------------------------------------|----------|------------------------------------------------|----------|
| <b>APPLE SERIAL/PARALLEL INTERFACE</b> |          | <b>MB8A 16K 2708 EPROM Board</b>               |          |
| A1/O Kit                               | \$125.00 | Kit - without EPROMS                           | \$ 99.00 |
| A1/O A&T                               | \$165.00 | Assembled & Tested                             | \$159.00 |
| <b>CB1A 8080 CPU</b>                   |          | <b>MT1 15 Slot Motherboard</b>                 |          |
| Kit                                    | \$149.95 | Kit (with Connectors)                          | \$100.00 |
| Assembled & Tested                     | \$199.95 | Assembled & Tested                             | \$150.00 |
| <b>IO2 Parallel I/O Interface</b>      |          | <b>OB1 Vector Jump &amp; Prototyping Board</b> |          |
| Kit                                    | \$ 59.00 | Kit                                            | \$ 55.00 |
| Assembled & Tested                     | \$ 89.00 | Assembled & Tested                             | \$ 85.00 |
| <b>MB3 4K 1702 EPROM Board</b>         |          | <b>SB1 Music Synthesizer (4)</b>               |          |
| Kit - without EPROMS                   | \$ 65.00 | Kit (with Connector)                           | \$199.00 |
| Assembled & Tested                     | \$125.00 | Assembled & Tested                             | \$279.00 |
| <b>MB6B 8K Static RAM</b>              |          | <b>T1 Active Terminator</b>                    |          |
| 450 ns RAM                             |          | Kit                                            | \$ 34.00 |
| Kit                                    | \$139.95 | Assembled & Tested                             | \$ 64.00 |
| Assembled & Tested                     | \$199.95 | <b>VB2 I/O Mapped Video Interface</b>          |          |
| <b>250 ns RAM (MB6B)</b>               |          | Kit                                            | \$160.00 |
| Kit                                    | \$179.95 | Assembled & Tested                             | \$210.00 |
| Assembled & Tested                     | \$245.00 | <b>XB1 Extender Board</b>                      |          |
| <b>MB7 Low Power 16K Static RAM</b>    |          | Kit (with Connector)                           | \$22.00  |
| Kit                                    | \$325.00 | Assembled & Tested                             | \$30.00  |
| Assembled & Tested                     | \$375.00 |                                                |          |

## \$25 REBATE

on any SD Systems microcomputer board

Offer expires 10-31-80

## SD SYSTEMS

## ALL SD A&T PRODUCTS

SOLD BY QT ARE

ASSEMBLED & TESTED BY QT

## VERSAFLOPPY II

### DOUBLE DENSITY DISK CONTROLLER

• For single or double density • 985600 bytes on 8" double sided diskettes • 259840 bytes on double sided 5 1/4" diskettes • S-100 bus • IBM 3740 format in single density • 8" and 5 1/4" drives controlled simultaneously • Operates with Z-80, 8080, and 8085 CPU's • Controls up to 4 drives

VF-2K (KIT) ..... \$300.00  
 VF-2AT (A&T) ..... \$369.00

## SBC-100/200

### 2 OR 4 MHz SINGLE BOARD COMPUTER

• S-100 bus Z-80 CPU BD • 1K of on-board RAM • 4 EPROM sockets accommodates 2708, 2716, or 2732 • One parallel and one serial I/O port • 4-channel counter timer chip (Z-80 CTC) • Software programmable serial baud rates

SBC-100K (2MHz KIT) ..... \$255.00  
 SBC-100AT (2 MHz A & T) ..... \$325.00  
 SBC-200K (4 MHz KIT) ..... \$289.00  
 SBC-200AT (4 MHz A&T) ..... \$369.00

## PROM-100

• For S-100 Bus • Programs the Following EPROMs: 2708, Intel 2758, 2716, 2732 and T1 2516 • Dip Switch Selection of EPROM type • 25 VDC Programming Pulse Generated On Board • Maximum Programming Time: 16.384 Bits In 100 seconds • Software Provides for Reading of Object File from SDOS, CP/M or PROM and Programming into EPROM • Program Verification • Verification of Erasure • Zero Insertion Force Socket

PROM-100K (KIT) ..... \$175.00  
 PROM-100AT (A&T) ..... \$225.00

## Z-80 STARTER KIT

### COMPLETE Z-80 MICROCOMPUTER

• On-board keyboard, display, EPROM Programmer, and cassette interface • On-board S-100 interface • Wire-wrap area and room for 2S-100 connectors • Two 8-bit parallel I/O ports, 4-channel CTC, 5 programmable breakpoints • Examine a 1 change memory, I/O ports, or register

Z-80K (KIT) ..... \$289.00  
 Z-80AT (A&T) ..... \$349.00

## 8" DRIVES

SA-801R ..... \$475.00  
 Single Sided, Sgl/Dbi Density  
 Buy 2 EA 801R & Get One Free Cabinet

REMEX 4000D ..... \$675.00  
 Double Sided, Dbi Density

**5 1/4" DRIVES**  
 MPI B-51 ..... \$275.00  
 Single Sided, Sgl/Dbi Density  
 Exact Replacement for SA-400

MPI B-52 ..... \$395.00  
 Double Sided, Dbi Density

PERTEC FD-200 ..... \$250.00  
 Single Sided, Sgl/Dbi Density

Add \$5.00 for Disk Drive Manuals

## STATIC RAM BOARDS

SR-8K BARE BD (Ithaca Audio) 21L02 ..... \$ 19.00  
 SR-16K BARE BD (Problem Solvers) 2114 ..... \$ 19.00  
 SR-16K A&T 2114L 4MHz ..... \$249.00  
 SR-32K KIT (Uses 2114L) 4MHz ..... \$400.00  
 SR-32K A&T (Uses 2114L) 4MHz ..... \$450.00

## TEXTOL ZIP\* DIP II SOCKETS

16 PIN ZIP\* DIP II ..... \$ 5.50  
 24 PIN ZIP\* DIP II ..... \$ 7.50  
 40 PIN ZIP\* DIP II ..... \$10.25

\*ZERO INSERTION PRESSURE

## PRINTERS

NEC Spinwriter  
 Model 5500 ..... \$2600.00  
 Model 5510 ..... \$2900.00  
 Delivery-Allow 4 Wks

Paper Tiger  
 IDS-440 ..... \$950.00  
 W/GRAPHICS ..... \$1050.00  
 Centronics 737-1 ..... \$995.00

QT TECHNICAL HOTLINE  
 (213) 973-2619



COMPUTER SYSTEMS INC.

15335 South Hawthorne Boulevard  
 Lawndale, California 90260  
 (213) 970-0952

PLACE ORDERS TOLL FREE  
 1-800-421-5150  
 (CONTINENTAL U.S. ONLY)  
 (EXCEPT CALIFORNIA)

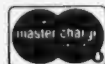

TERMS OF SALE: Cash, checks, money orders, credit cards accepted. Also C.O.D. orders under \$100.00. Minimum order \$10.00. California residents add 6% sales tax. Minimum shipping and handling charge \$2.50. Prices subject to change without notice. International sales in American dollars only.

Contact us for new prices  
**Qume Datatrak 8**

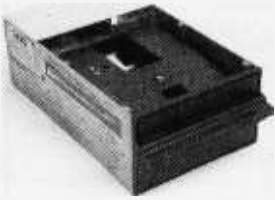

Double sided floppy with NO HEADACHES. Although many think this an impossibility, seeing is believing, and this drive is really something! Shugart compatible, fully optioned, reliable, and rapidly becoming the standard in double-sided diskdom.

\$599. Two/\$549.

**Siemens FDD 100-8D**

Single sided 8" floppy drive, the latest & greatest revision. Features double density plus much more. An extremely reliable drive \$439 2/\$409  
 Hard sector option kit... \$9.95  
 Data separator option kit... \$9.95

The following 5 1/4" mini-floppies share most features with their 8" cousins, so without further ado...

- Siemens FDD 100-5D. .... \$279.
  - Qume Datatrak 5 (double sided)... 399.
  - BASF Mini mini ..... 279.
  - SA 400 ..... 299.
- All the above mini-floppies are fully SA400 compatible.

Manuals for all drives are \$10, refundable against future purchase of drives. Also, all 8" drives can be ordered with 220 v/50 hz for world-wide use.



**Disk controllers**

- Delta Products double density \$349
- Micromation doubler 439
- Tarbell single density, A & T 225
- Tarbell single density, kit 184
- Tarbell double density, DMA 425
- Sorrento Valley 8" single density for Apple 375



**Electrolabs' Monthly Special!!!**

TELEVIDEO 912C ..... \$699  
 TELEVIDEO 920C ..... 799  
 Features typewriter keyboard, microprocessor controls, Upper/lower case, adjustable baud rates (75-9600 baud), special function keys, much much more.  
 Second page memory option \$29.00

**Data Display Monitors**

used 12" Sylvania monitors. Composite video, 12 MHz, 120 VAC. with new P-39 or P-4 tube, \$79, used tube \$59, OEM style (without case), subtract \$12. U-fix model, 10/\$300.

**Accessories**



Cable kits for 8" drives with 10' 50 cond. flat cable, power cable, and all connectors. Assembled if desired. One drive 27.50, two 33.95, three 38.95 for mini floppies (34 cond): one 24.95, two, 29.95

CP-206 Power-one power supply. Powers two drives more than adequately, top quality. 2.8A/24V, 2.5A/5V, 5A/5V. .... \$99.

mini-floppy power supply ..... \$79

**Hard Disk**

CII HB 10 MBY fully REMOVEABLE cartridge drive. Complete with controller, personality card, media, power supply, cabling, connectors and documentation. Highlighted by stylish & modern cabinetry. \$6995.  
 Shugart SA4008 20MBY fixed disk system. S-100, includes controller, power supply, and all that is necessary to run \$6995.

**Electrolabs**

POB 4436, Stanford, CA 94305

415-321-5601      800-227-8266

Telex: 345567 (Electrolab Pla)

Visa    MC    Am. Exp.

**Media**



- 8" ...\$39.99 SS/SD
- 8" ...\$49.00 SS/DD
- 8" ...\$55.00 DS/SD
- 8" ...\$59.00 DS/DD
- 5 1/4" \$34.95 SS
- 5 1/4" \$59.00 DS

Verbatim, Memorex, Scotch, or equivalent name brand  
 Special Introductory Offer!!!  
 Wabash 8" diskettes \$29.00 SS  
 \$39.00 DS

Price is cheap, but they run like champs!!!!

Diskette head cleaning kit for 5 1/4" or 8" \$28.75 includes everything for 1 drive for 1 year. Alignment Diskette for Floppy Drives ..... \$39.00



**ENCLOSURES**

Rackmount Mainframe MT-200. This gorgeous beast is so appealing that it can easily function also as stand-alone mainframe. Very modern styling with fully actively terminated S-100 bus.

With two 8" single-sided disk drives. . . \$1899.  
 With two 8" double sided disk drives in place of single-sided variety. .... \$2499.

Desktop Mainframe MT-100. Contemporary styling, a handsome cabinet coated with durable epoxy finish colors (blue, beige, off-white & silver). Easy to fit into an office environment. The proper way to start your system.

Above plus two 8" single sided disk drives ..... \$1599.  
 Above with two 8" double sided disk drives in place of single-sided variety ..... \$2199.

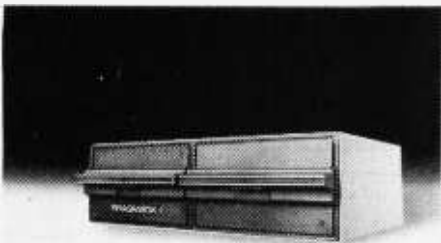
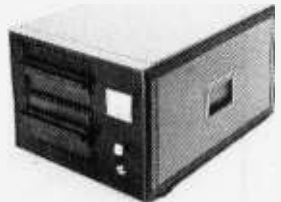

**PRAGMATIX 1**

Incredible!! - Two 8" Shugart compatible single sided floppy disk drives (double density), CP-206 power supply, in handsome color coordinated cabinet, with full cabling, connectors, and documentation, plus one box diskettes!!! All for an unprecedented \$1295. Up to one MBY of storage. with Qume Datatrak 8" double-sided drive \$1695

\$25 min. order. Calif. residents add 6% sales tax. Orders under \$75, add 5% shipping and handling, over \$75 add 2.5%. All pricing subject to change without notice.



### Keyboard Special 2 !!

Keytronics 1660 . . . \$149.00  
Hard Plastic enclosure . . . 49.00  
BOTH only . . . . \$152.00



### ESAT 200B

**BI-LINGUAL 80x24 Communicating Terminal**  
Scrolling, full cursor, bell, 8x8 matrix, 110-19,200 baud, Dual Front Applications. Arabic & Hebrew, Multilingual Data Entry Forms Drawing, Music, & Switchyards. Alone . . . . . \$279.  
with Cherry Pro keyboard & custom metal case . . . . . \$399.

### Disk Subsystem

Matchmaker Technology  
TURNKEY DISK SUBSYSTEMS

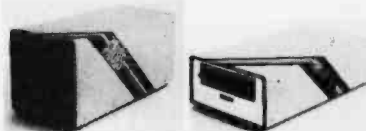

APPLE . . . . . Single density disk controller. Expanded Apple DOS  
TRS-80 . . . . . Single or double density. Expansion interface necessary. Space for 48K dynamic RAM on controller card RS232 port  
SORCERER . . . Full RS-232 Interface. One S-100 slot for memory expansion. Single or double density  
All above units come as follows: Complete, assembled and tested, with two 8" floppy disk drives (Apple available in one drive model). Includes all cabling, connectors and documentation in a stunning color coordinated cabinet with power supply. Ready to go, plug in and run!!!

When ordering specify single or double sided drives

Software available for above disk add-ons

TRS-80 & Sorcerer operate on all CP/M compatible software

### Keyboard Special 1 !!

CHERRY "PRO" Keyboard . . . . . \$119.00  
Streamlined Custom Enclosure . . . . . 34.95  
BOTH only . . . . \$134.95

### Daisy Wheel Printers



NEC Spinwriter 5510/2 \$2899  
NEC Spinwriter 5520/2 call  
NEC Spinwriter 5530/2 for prices

### Qume S/5

Sprint 5/45 RO \$2699  
Sprint 5/55 RO 2829  
Sprint 5/45 KSR 3029  
Sprint 5/55 KSR 3159  
Forms Tractor \$210  
Pinfeed platen 155  
paper guide 30  
paper basket 50

### Qume Sprint 3/45

(requires self assembly)  
printer mechanism \$1499  
power supply 349  
combination special 1699  
cases 200  
S-100 interface card 149

Circle 338 for Electrolabs

## Electrolabs

POB 4436, Stanford, CA 94305

415-321-5601 800-227-8266

Telex: 345567 (Electrolab Pla)

Visa MC Am. Exp.

### Peripheral Sale!!

Hiplot Plotter . . . . . \$875.  
Hipad Digitizer . . . . . 715.  
IDS 440 Paper tiger . . . . . 899.  
SD Expandoram II (A&T, 64K) . . . . . 560.  
Imesai 65K dynamic RAM III 399.  
DC Hayes Micromodem 100 . . 399.  
Super switcher power for hard disk & more . . . . . 349.  
DC Hayes Micromodem 11 (for apple) \$344  
DC Hayes Micromodem 100 \$349

many print wheels, ribbons, & more available

Contact us for new prices

# SOFTWARE LABS

735 LOMA VERDE, PALO ALTO, CA. 94303

PHONE: 415 493-8186

LSI-11 Z-80 8080 8085 6502

### Database Management Systems

**HDBS** A hierarchical Database Management System featuring fixed length records, read/write protection at file level and one to many set relationships.

Z-80 Optimized 250.00  
8080 Optimized 325.00  
6502 Optimized 325.00

**MDBS** A large computer DBMS with hierarchical and full network data structures (CODASYL Oriented). Explicit representation of one to one, one to many, many to one and many to many sets. Routines are callable from BASIC, PASCAL, COBOL or Machine Language.

Z-80 Optimized 750.00  
8080 Optimized 825.00  
6502 Optimized 825.00

### Communications

**BISYNC-80/3780** A full function IBM 2780/3780 emulator that provides one of the most widely used communications protocols. 550.00

**BISYNC-80/HASP** A full function Hasp Multi-leaving Workstation package. 800.00

**BISYNC-80/ASYNC** An asynchronous communications package that uses the full error correcting BISYNC protocol. 95.00

**BISYNC-80/3270** A full function IBM 3275 or 3271/3277 terminal emulator that converts a "dumb" terminal into a very smart one. 550.00

Multiple License Pricing  
- Upon Inquiry -

\* LSI-11, PDP-11 TM DEC, UNIX TM Western Electric, CP/M TM Digital Research

### High Level Languages

8080, 8085, Z-80 (Under OS-1 or CP/M)

**BASIC**  
Microsoft Compiler 395.00  
Microsoft "BASIC 80" 350.00

**FORTRAN**  
Microsoft "FORTRAN 80" (Includes MACRO 80) 500.00

**COBOL**  
Microsoft "COBOL 80" 750.00

**"C"**  
Whitesmith's "C" 600.00

**PL/1**  
Digital Research's PL/1 500.00

**PASCAL**  
M.T. Compiler 250.00

Z-80 Optimized (Under OS-1 or CP/M)

**COBOL**  
R-M Z-80 COBOL ANSI '74 750.00

LSI-11\*/PDP-11\* Under RT-11 or RSTS

**COBOL - ANSI '74 Introducing:**  
**RJ-11 Compiler** 1750.00

### Applications in COBOL '74

Available in R-M COBOL, COBOL 80 and RJ-11. (Source Included)

**General Ledger** 995.00  
**Accounts Receivable** 995.00  
**Accounts Payable** 995.00  
**Inventory Control** 995.00  
**Order Entry/Invoicing** 995.00  
**COMPLETE LEGAL** 4200.00  
**COMPLETE DENTAL** 4200.00

Why COBOL?  
It's portable (ANSI '74) it's universal!

### OPERATING SYSTEMS

#### Z-80 Optimized

**OS-1™** A breakthrough in microcomputer software from Electrolabs! UNIX\*-like OS with virtual I/O, bank-select memory control to 16 MBY and optional memory protection! Totally compatible with all CP/M programs. You will be amazed at the difference! Excellent brochure available. Includes editor, linker-loader, debugger, and one year update. 249.00

#### 8080, 8085 & Z-80

**CP/M** Version 2.2 150.00  
Manuals only 25.00  
**CP/M - MCZ** Version 2.2. Runs on ZILOG MCZ and PDS-8000 systems. Only from Software Labs! 200.00  
Manuals only 35.00

### OUR CATALOGUE

Software  
Supplies  
Media  
Storage Equipment  
Publications  
- Upon Request -

Circle 339 for Software Labs

### TO ORDER

\*Price of manuals applied against software purchase.  
**By Mail:** Send check or money order (or P.O. from rated or institutional customers).  
**By Phone:** Use Master Charge or Visa No.  
**Important Note:** Please specify complete system hardware and software configuration with each order.

# California Digital

Post Office Box 3097 B • Torrance, California 90503



**NEW**  
from  
**INTEGRAL DATA**  
**460**  
**Paper Tiger**

\*\*\*\* All the features of the 440 and more \*\*\*\*  
The 460 uses a dot matrix character formation technique in which the placement of the dots overlap both horizontally and vertically to achieve a correspondence-quality printing.  
The printer's nine-wire print head uses staggered needle rows to create the vertically overlapping dots. The head is driven bidirectionally under microprocessor control by a stepper motor driven mechanism with logic-seeking look ahead capability.  
Standard "Two-K Byte" buffer allows the printer to accept the entire content of a 1,920-character CRT screen. Weight 27 lbs.  
Suggested list price \$1,295. Calif. Digital price **\$1,076**

**S-100 Mother Board**

**Quiet Buss**

The quiet buss from California Digital is quality engineered. No short cuts have been taken to produce this mother board. Active termination circuitry prevents noise and crosstalk, manufactured from extra heavy epoxy glass.

**\$2995**  
8803-18  
18 slot  
MSAI

**TELETYPE MODEL 43**

**4320 KEYBOARD**

TTL ..... AAA \$ 950  
RS232.... AAK 1050 plus shipping  
Friction... AAE 1100  
1033 Modem AAB 1575

**WESTERN UNION ENCLOSURE**

These enclosures were manufactured for Western Union by Universal Technology. The exact purpose of the product is still a mystery but the enclosure is ideally suited for an S-100 mother-board with shielded power supply. Removable hood and plastic front make this enclosure an attractive home for any hobby product. New surplus in factory boxes supplied with three 22/44 edge connectors! DB-25S communications connector six foot grounded power cord and more. Inside dimensions: 19" x 10 1/2" x 8 7/8". Shipping weight 8 lbs.

**\$24.95**

**FREE PLASTIC LIBRARY CASE** with purchase of each box of .... Memorex mini-diskettes. \$5 value.

**\$27** BOX of TEN

10 Boxes \$24.95  
100 Boxes \$22.25  
forty track

**DB25**

each 10+  
male \$2.50 225  
female 325 305  
hood-zip 125 98  
Centronic 895

**Edge Connectors**

**GOLD 100 PIN MSAI/ALTAIR**

Imsal solder .125 x .250 \$2.95 3/4 7.50  
Imsal w/w .125 connectors \$4.95 3/4 13.00  
Altair soldered .140 row \$5.95 3/4 15.00

**SPECIALS**

22/44 Kim eyelet .156" \$1.95 3/4 5.00  
25/50 solder tab .156" \$1.09 3/4 2.00  
36/72 wide post w/w .156" \$1.95 3/4 5.00

**BCD Thumbwheel 195 Switch**

Ten Position  
Mfg. by Digiswitch  
1 7/8" high 1 7/2" wide

**EDGE CONNECTORS**

**GOLD 100 PIN MSAI/ALTAIR**

Imsal solder .125 x .250 \$2.95 3/4 7.50  
Imsal w/w .125 connectors \$4.95 3/4 13.00  
Altair soldered .140 row \$5.95 3/4 15.00

**SPECIALS**

22/44 Kim eyelet .156" \$1.95 3/4 5.00  
25/50 solder tab .156" \$1.09 3/4 2.00  
36/72 wide post w/w .156" \$1.95 3/4 5.00

**SUPER BUY**

**IDS 440G PAPER TIGER**

**\$770**

California Digital has recently purchased these printers from a computer manufacturer who is experiencing a "Cash Flow" problem. All units are first class fresh merchandise shipped in factory sealed cartons. Every Integral Data Systems 440G Paper Tiger includes factory installed "Dot Plot" graphics with 2K buffer. Order now before inventories are exhausted and save \$300 off retail prices. Only 70 available. PRD-440G

**S-100 PRODUCTS**

Godbout Rack Enclosure \$289  
Godbout Desk Top Enclosure 329  
Electronic Controls ECT 1008 250  
Cal-Digital 18 slot mother board 30

**S-100 BOARDS**

Think/Type Switchboard I/O 319  
Chilton TTY-2 Extended. Also code 49  
Artec W1100 Wireless Pro 250  
SD 418. Espandrom. Memory 25  
16 BIT S-100 BOARDS

Cal-Digital CAL-86 650  
Terma 4086 650  
Seale Computer 8088 650  
Godbout 9085 8085 650  
THINK I/ANKODS

Cherry Pro ASCII Keyboard 129  
Ultra-switch II X keyboard 69  
UV Eraser II-E 11-E  
Super Mod II RF Modulator 30

**Authorized Distributor**

**Scotch Data Products**

740-0 IBM soft format. \$39.00 \$3.50  
740/2 Double sided soft 65.00 6.00  
741-0 Double density 53.00 4.90  
743-0 Double/Double 70.00 6.60  
740-32 8" Hard sector 39.00 3.50  
744-(0)(10)(18) 5 1/4" mini 39.00 3.50

Library case for any above: Add \$3.00

834 A Data Cassette 5.50  
DC100 Mini C Cartridge 16.00  
DC300 Data Cartridge 20.00  
920V1 Disk Cartridge 80.00

**Shugart Associates**

**SA800-R Floppy Disk Drive**

**\$449.50**

**XEROX 800 WORD PROCESSING KEYBOARD**

**ASCII ENCODED**

This 77 key word processing keyboard was manufactured by Micro-switch for use in the Xerox 800 word processing system. The keyboard outputs a seven bit ASCII code along with an eighth bit that allows most keys to shift and toggle. Functions as special characters. Extra large "Tab A Return" keys are designed into the layout of the keyboard to emulate the IBM Selectric. 17 illuminated keys serve for special word processing codes. The keyboard is equipped with two thumbwheel switches for defining line width.

Original Xerox acquisition over \$400. California Digital USE1 price only \$49.00. Excellent condition. Documentation included.

**MEMORY**

**TRS-80 \$49**

**APPLE II 49**

**16k memory (8) 4116's**

Installation is simple. Anyone who has ever changed a spark plug should be able to up-grade his microcomputer.  
How can California Digital offer these memory up-grade sets at 25% below our competition? Simple, we buy in volume, wholesale to dealers and sell the balance directly to owners of personal micro-systems. These 16K dynamic memory circuits are factory prime and unconditionally guaranteed for one full year. NOW, before you change your mind, pick up the telephone and order your up-grade memory from California Digital. Add \$3 for TRS80 jumpers.

| STATIC        | 1-31 | 32-99 | 100-5C | 999  | 1K+  |
|---------------|------|-------|--------|------|------|
| 21L02 450ns.  | 1.19 | .99   | .95    | .90  | .85  |
| 21L02 250ns.  | 1.49 | 1.39  | 1.25   | *    | *    |
| 2114 1Kx4 450 | 5.95 | 5.50  | 5.25   | 4.75 | 4.50 |
| 2114 1Kx4 300 | 8.95 | 8.50  | 8.00   | *    | *    |
| 4044 4Kx1 450 | 5.95 | 5.50  | 5.25   | *    | *    |
| 4044 4Kx1 250 | 9.95 | 9.50  | 9.00   | *    | *    |
| 4045 1Kx4 450 | 8.95 | 8.50  | 8.00   | *    | *    |
| 4045 1Kx4 250 | 9.95 | 9.50  | 9.00   | *    | *    |
| 5257 low pow. | 5.95 | 5.50  | 5.00   | 4.80 | 4.60 |

**\$49**

**DATA INPUT TERMINAL**

The Keyboard terminal was recently acquired from the CMC division of the Perceco Corporation. The unit was originally designed for inputting data directly into magnetic tape.

The system is comprised of a pre-man cast aluminum and fiberglass enclosure, along with a Honeywell/Microswitch hall effect keyboard. Thirty display lamps advise the operator of the systems status. Four inch loud speaker acknowledges acceptance of data and alerts the operator of pending problems. But most of all this "USED" terminal, with a little imagination, can be engineered to make the perfect home for an S-100 computer and video display; or with slight modification will accept the Rockwell A18-85 micro-computer.

Five volt regulated power supply is available for an additional \$20. (see June Byte) All units are in excellent condition. Original acquisition over \$700. 22 lbs.

**Scotch DISKETTE HEAD CLEANING KIT**

**\$24.95**

Please specify:  
8" or 5 1/4"

**MINIATURE SWITCHES**

your choice  
**\$ .98**

**SPDT Miniature Toggles**

7101 C&K ON-NONE-ON  
7107 J&T ON-OFF/Int. ON  
7108 CK ON-(moment ON)  
7103 CK ON OFF ON  
Rotary 3P-4-Pos.  
Rotary 3P-6-Pos.  
Push B (N.O.) \$3.95ea 4/\$1

**\$49**

**CONTROL DATA CRT Terminal?**

Frankly we made a mistake and are offering these terminals below our cost just to get them out of our warehouse. As far as we can determine the units are complete. But we are offering them on an "as-is" basis without any return privileges.

The terminals were originally purchased from All State Insurance. At present we have been unable to secure any printed information on the units. If you have any doubts, please do not purchase one of these terminals. Shipped via truck. Freight collect.

**KEYBOARD \$24.95**

This classic typewritten keyboard is similar to the one used in the Hewlett Terminal. 82 non-encoded contacts. three locking. Factory based Altair surplus. Shipping 3 lbs.

**DIP Switch**

\$129 10 25 100 18  
Ca. \$119.00 97 82  
specify 4 for 8 pos.

**2716 EPROM SALE \$13**

\*\*\* THOUSANDS \*\*\*  
We have slashed price in an effort to reduce our over stocked inventory. These are Single Five Volt Eproms, manufactured by one of the Worlds largest producers of semiconductors. Please phone for volume pricing.

**\$139.50**

**PORTABLE DATA ENTRY SYSTEM**

These used data terminals were originally designed for chain store inventory control and order entry systems. The operator enters the inventory control number, merchandise and the unit price. After all pertinent data has been entered into the recorder, the main warehouse is telephoned, the handset is placed in the acoustic coupler and all the recorded information is transmitted back to the master computer. With a little imagination and one of these portable entry systems, you should be able to enhance programs and computer information with associated across the country. All units were removed from service in working condition. Original cost \$2,500. Each system comes complete with:

- Portable Cassette Drive Unit
- Removable Entry Keyboard with LED Display
- Five Gold "D" NiCads
- Acoustical Coupler
- Battery Charger
- DB25 Cable
- Shoulder strap
- Full Documentation

**BSR SYSTEM X-10**

The new BSR timer runs your home like clockwork. Turns on lamps and appliances while you are away from home. Completely compatible with your existing system X-10 devices.

**BSR Timer \$65.00**  
Master Console 34.95  
Ultrasonic Controller 19.95  
Modules: Appliance, Lamp or Wall Switch 13.95

**VISA**

**master charge**

All merchandise sold by California Digital is premium grade. Shipping: First five pounds \$2.00; each additional add \$4.00. Foreign orders 10% shipping. Excess will be refunded. California residents add 6% sales tax. COD's discouraged. Open accounts extended to state supported educational institutions and companies with a "Strong Dun & Bradstreet." Warehouse: 15608 Inglewood Blvd. Visitors by appointment.

**TOLL FREE ORDER LINE**  
**(800) 421-5041**  
**TECHNICAL & CALIFORNIA**  
**(213) 679-9001**



# California Digital

Post Office Box 3097 B • Torrance, California 90503



Introducing the  
**ANACOM 150**  
DOT MATRIX PRINTER  
Mfg. suggested list \$1350  
California Digital Introductory Price  
**\$995**

**Full 136 Characters for the price of 80**

DURABILITY... is the key component of the new Anacom 150. No belts, no whistles, no problems, just consistent high quality output.

This nine wire dot matrix printer features a ballast type print mechanism, guaranteed for three million characters. Low cost (16) integrated circuits add to the reliability of the printer.

Microprocessor controlled logic seeking bidirectional head allows the Anacom to print up to speeds of 150 characters per second... 136 columns wide.

Adjustable tractor and variable head gap permit the Anacom to accept fifteen inch wide multi-part forms.

Switch selectable: skip paper perforation, carriage return/line feed and six or eight lines per inch.

Lean paper shield and enclosure sound proofing add to the overall quality of the printer.

The Anacom 150 is definitely the best value in today's extremely competitive world of micro-printers.

If you are in the market for a "Quality Engineered" dot matrix printer, please consider the Anacom 150 before purchasing a less reliable machine.

Available either RS-232 serial 9600 baud, PRA-150S or Centronics parallel PRA-150P. Field exchange, UPS shipping within 48 hours.

## IBM 3101 DISPLAY TERMINAL

The new 3101 display terminal is the IBM entry into the plug compatible micro computer industry.

This modularly constructed CRT terminal has been engineered with the user in mind. The video display module swivels and tilts to provide the operator with a comfortable viewing posture.

Twelve inch P-39 green phosphor screen boasts a crisp 7 by 14 character matrix.

Standard 80 by 24 line screen format with a 25th line to display machine status and aid in the diagnostics in the event of a system malfunction.

87 key Selectric style keyboard arrangement along with numeric entry pad. Eight user definable function keys.

The 3101 video terminal is RS232 compatible and displays all 128 ASCII characters including control codes.

Accessible customer setup switches aid in choosing such options as line speed, parity, scroll, and reverse video.

But most of all, built into every 3101 terminal is the quality that you have learned to expect from the IBM Corporation. VDT-3101



IBM direct price \$1295  
CALIFORNIA DIGITAL discount price  
**\$1195** immediate delivery

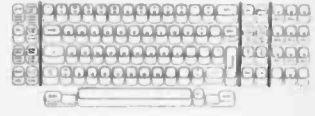

**Local Data \$4,300**  
The Quiet 300 from Local Data incorporates the field proven Teletype Model 40 line printer mechanism. The unit attains print speeds up to 300 lines per minute. Switch selectable between RS-232 serial and Centronics parallel interfacing. 132 column full character belt printer with vertical forms control. PRL-300A, 125 lbs.

**NEC Spinwriter 5510P/S \$2495**  
The word processing quality Spinwriter prints at speeds up to 55 characters per second. The Model 5510P/S is supplied with both parallel and RS-232 serial interfacing. Also included is the tractor feed mechanism, along with print thimble and ribbon. PHS-5510P/S 70 lbs. Keyboard (KSR) Model 5520P/S available \$2995. PHS-5520P/S 75 lbs.

**PRINTRONIX P-300 \$4500**  
Forty-four separate print heads shuttle to provide overlapping dots. This unique feature allows a resolution of 60 dots per inch horizontal and 72 vertical. The Printronix P-300 has the capability of outputting pictures, bar codes and large labels, a feature not provided with band or chain printers. PIP-300 200 lbs.

**Anadex DP-9500 \$1395 PRX 9500**

**TI-810 Basic Printer list 1895 \$1495 save \$400 PRT-810**

**CENTRONICS 730 \$595 737 \$795**  
Both the Centronics 730 and the 737 are capable of accepting standard office letterhead or pin feed continuous forms. For higher resolution the 737 implements a nine wire dot matrix print head. Parallel interfacing. A81 \$65 for RS232. PRC-730P (S), PRC-737P (S) 17 lbs.



**ADDS TELEVIDEO 912B \$739 920B \$795 920C 875**

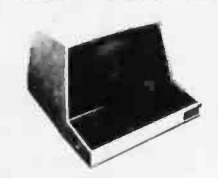

**SOROC 120 \$695 140 \$995**



**BMC VIDEO MONITOR \$259**

Applied Digital Data Systems Inc.  
REGENT 25 \$850 80 character by 24 line twelve inch screen. 18 key numeric-entry cluster. Reverse video. Displayable control characters. VDT-R25 ship, 60 lbs.  
REGENT 30 \$950 Additional features. Special function keys. High resolution graphics. 25th status line. Multi-intensity screen. Superior quality keyboard. VDT-R30  
REGENT 40 \$1195 Insert/delete line feature. Eleven special graphic symbols. VDT-R40  
REGENT 60 \$1495 Buffered display. Block mode transmission. Protected fields. VDT-160



**HAZELTINE VDT-H 1400 \$695 1410 \$725 1420 \$895 1500 \$950 1510 \$1025 1520 \$1295**



**BMC VIDEO MONITOR \$259**

Green phosphor with 18 MHz bandwidth, composite video input make the BMC VG-12C an ideal monitor for anyone requiring a high resolution 12" display. High impact plastic enclosure assures that the BMC monitor is a rugged take anywhere instrument. For added protection the unit is equipped with a removable smoked non-glare protective screen. VDM-BMC 18 lbs.

**HEWLETT PACKARD HP 85 \$2650**  
The Hewlett Packard HP-85 is a complete, low cost portable computer system. This self contained package includes CPU, keyboard, printer, CRT display and cassette tape drive. SYS-HP85 30 lbs.

**APPLE II \$988**

**ATARI 800 \$747 400 \$695**

**LOBO Disk Drives**  
The package includes a durable steel enclosure, Power One brand disk power supply, muffin exhaust fan and all the necessary harnessing cables. The Lobo package with: One Shugart SA801R disk drive...\$795 Two Shugart SA801R disk drives...\$1195

**Measurement Systems DMB 6400 \$850**  
The DMB-6400 is the most reliable dynamic memory board that we have tested. California Digital uses the DMB with our in house 16 bit Alpha-Micro computer. After months of service we have not experienced any errors. Assembled and burned-in. DMB-316400

**direct connect MODEM Universal Data 103 \$169**  
Connects directly to the new modular phone jack. Fully powered from your existing telephone line. No need to locate external AC power. Crystal control prevents frequency drift. Direct connect feature eliminates loss of information due to carbon compression that is associated with acoustic modems. Runs circles around those other "Domesticated" modems.



Circle 340 on Inquiry card.  
All merchandise sold by California Digital is premium grade. Shipping: First five pounds \$2.00; each additional add \$4.00 Foreign orders 10% shipping. Excess will be refunded. California residents add 6% sales tax. COD's discouraged. Open accounts extended to state supported educational institutions and companies with a "Strong Dan & Bradstreet." Warehouse: 15608 Inglewood Blvd. Visitors by appointment.

**TOLL FREE ORDER LINE (800) 421-5041 TECHNICAL & CALIFORNIA (213) 679-9001**

# 7400

|          |      |          |      |
|----------|------|----------|------|
| SN7400N  | 19   | SN74123N | 59   |
| SN7401N  | 22   | SN74125N | 39   |
| SN7402N  | 22   | SN74126N | 44   |
| SN7403N  | 22   | SN74128N | 69   |
| SN7404N  | 22   | SN74132N | 69   |
| SN7405N  | 23   | SN74136N | 95   |
| SN7406N  | 23   | SN74139N | 95   |
| SN7407N  | 23   | SN74141N | 89   |
| SN7408N  | 26   | SN74142N | 29   |
| SN7409N  | 23   | SN74143N | 65   |
| SN7410N  | 22   | SN74144N | 85   |
| SN7411N  | 29   | SN74145N | 62   |
| SN7412N  | 29   | SN74147N | 95   |
| SN7413N  | 29   | SN74148N | 120  |
| SN7414N  | 59   | SN74150N | 99   |
| SN7416N  | 29   | SN74151N | 67   |
| SN7417N  | 29   | SN74152N | 67   |
| SN7420N  | 22   | SN74153N | 67   |
| SN7421N  | 35   | SN74154N | 119  |
| SN7422N  | 29   | SN74155N | 82   |
| SN7423N  | 29   | SN74156N | 89   |
| SN7425N  | 29   | SN74157N | 69   |
| SN7426N  | 29   | SN74158N | 155  |
| SN7427N  | 29   | SN74160N | 95   |
| SN7429N  | 29   | SN74163N | 85   |
| SN7430N  | 29   | SN74162N | 89   |
| SN7432N  | 29   | SN74165N | 87   |
| SN7437N  | 29   | SN74164N | 97   |
| SN7438N  | 29   | SN74165N | 97   |
| SN7439N  | 29   | SN74166N | 120  |
| SN7440N  | 24   | SN74167N | 195  |
| SN7441N  | 79   | SN74170N | 169  |
| SN7442N  | 57   | SN74172N | 59   |
| SN7443N  | 79   | SN74173N | 79   |
| SN7444N  | 79   | SN74174N | 89   |
| SN7445N  | 79   | SN74175N | 89   |
| SN7446N  | 79   | SN74176N | 85   |
| SN7447N  | 59   | SN74177N | 85   |
| SN7448N  | 79   | SN74178N | 180  |
| SN7450N  | 23   | SN74180N | 75   |
| SN7451N  | 23   | SN74181N | 175  |
| SN7453N  | 23   | SN74182N | 75   |
| SN7454N  | 23   | SN74184N | 195  |
| SN7459N  | 29   | SN74185N | 195  |
| SN7460N  | 23   | SN74186N | 95   |
| SN7470N  | 39   | SN74188N | 390  |
| SN7472N  | 34   | SN74190N | 115  |
| SN7473N  | 36   | SN74191N | 115  |
| SN7474N  | 36   | SN74192N | 85   |
| SN7475N  | 38   | SN74193N | 85   |
| SN7476N  | 38   | SN74194N | 85   |
| SN7478N  | 4.60 | SN74195N | 85   |
| SN7480N  | 59   | SN74196N | 85   |
| SN7481N  | 1.10 | SN74197N | 85   |
| SN7482N  | 1.10 | SN74198N | 139  |
| SN7483N  | 1.10 | SN74199N | 139  |
| SN7485N  | 5.5  | SN74221N | 139  |
| SN7486N  | 39   | SN74221N | 139  |
| SN7489N  | 1.75 | SN74273N | 1.05 |
| SN7490N  | 39   | SN74279N | 89   |
| SN7491N  | 65   | SN74283N | 2.15 |
| SN7492N  | 65   | SN74284N | 3.90 |
| SN7493N  | 49   | SN74285N | 3.90 |
| SN7494N  | 72   | SN74290N | 1.25 |
| SN7495N  | 65   | SN74298N | 95   |
| SN7496N  | 72   | SN74298N | 95   |
| SN7497N  | 3.75 | SN74298N | 95   |
| SN74100N | 99   | SN74367N | .79  |
| SN74107N | 32   | SN74368N | .79  |
| SN74109N | 53   | SN74390N | 1.90 |
| SN74116N | 1.95 | SN74393N | 1.90 |
| SN74121N | 39   | SN74490N | 1.90 |
| SN74122N | 39   |          |      |

# 74LS00

|          |      |          |      |
|----------|------|----------|------|
| 74LS00N  | 35   | 74LS164N | 1.19 |
| 74LS01N  | 28   | 74LS165N | 89   |
| 74LS02N  | 28   | 74LS166N | 2.48 |
| 74LS03N  | 27   | 74LS168N | 1.89 |
| 74LS04N  | 28   | 74LS169N | 1.89 |
| 74LS05N  | 28   | 74LS170N | 1.99 |
| 74LS06N  | 39   | 74LS173N | 88   |
| 74LS08N  | 39   | 74LS174N | 99   |
| 74LS09N  | 39   | 74LS175N | 99   |
| 74LS10N  | 39   | 74LS181N | 2.20 |
| 74LS12N  | 39   | 74LS190N | 1.15 |
| 74LS13N  | 47   | 74LS191N | 1.15 |
| 74LS14N  | 1.25 | 74LS192N | 98   |
| 74LS15N  | 39   | 74LS193N | 98   |
| 74LS20N  | 39   | 74LS194N | 1.15 |
| 74LS21N  | 38   | 74LS195N | 95   |
| 74LS22N  | 38   | 74LS196N | 89   |
| 74LS26N  | 39   | 74LS197N | 89   |
| 74LS27N  | 39   | 74LS221N | 1.49 |
| 74LS28N  | 39   | 74LS240N | 1.95 |
| 74LS30N  | 26   | 74LS241N | 1.90 |
| 74LS32N  | 39   | 74LS242N | 1.95 |
| 74LS37N  | 79   | 74LS243N | 1.95 |
| 74LS38N  | 79   | 74LS244N | 1.95 |
| 74LS40N  | 79   | 74LS245N | 4.95 |
| 74LS42N  | 79   | 74LS247N | 1.10 |
| 74LS47N  | 79   | 74LS248N | 1.10 |
| 74LS48N  | 79   | 74LS249N | 1.89 |
| 74LS51N  | 28   | 74LS251N | 1.79 |
| 74LS52N  | 28   | 74LS252N | 1.79 |
| 74LS55N  | 35   | 74LS257N | 98   |
| 74LS73N  | 45   | 74LS258N | 98   |
| 74LS74N  | 59   | 74LS269N | 2.95 |
| 74LS75N  | 68   | 74LS260N | 69   |
| 74LS76N  | 45   | 74LS261N | 2.49 |
| 74LS78N  | 65   | 74LS268N | 59   |
| 74LS83AN | 99   | 74LS273N | 1.75 |
| 74LS85N  | 1.19 | 74LS275N | 4.40 |
| 74LS86N  | 1.19 | 74LS279N | 59   |
| 74LS89N  | 75   | 74LS283N | 1.10 |
| 74LS91N  | 75   | 74LS285N | 1.29 |
| 74LS93N  | 75   | 74LS293N | 1.85 |
| 74LS95N  | 88   | 74LS295N | 1.10 |
| 74LS96N  | 88   | 74LS298N | 1.29 |
| 74LS107N | 45   | 74LS324N | 1.75 |
| 74LS108N | 1.19 | 74LS325N | 1.95 |
| 74LS112N | 49   | 74LS348N | 1.95 |
| 74LS113N | 49   | 74LS352N | 1.85 |
| 74LS114N | 55   | 74LS353N | 1.85 |
| 74LS122N | 55   | 74LS363N | 1.49 |
| 74LS123N | 55   | 74LS364N | 1.99 |
| 74LS124N | 55   | 74LS365N | 99   |
| 74LS125N | 89   | 74LS367N | 73   |
| 74LS126N | 89   | 74LS368N | 73   |
| 74LS132N | 79   | 74LS373N | 2.75 |
| 74LS136N | 59   | 74LS374N | 2.75 |
| 74LS139N | 75   | 74LS375N | 69   |
| 74LS145N | 1.25 | 74LS385N | 1.95 |
| 74LS148N | 1.49 | 74LS386N | 1.95 |
| 74LS151N | 1.79 | 74LS390N | 1.95 |
| 74LS153N | 3.25 | 74LS391N | 3.95 |
| 74LS154N | 2.19 | 74LS395N | 1.70 |
| 74LS155N | 1.49 | 74LS399N | 2.85 |
| 74LS156N | 99   | 74LS424N | 2.95 |
| 74LS157N | 99   | 74LS428N | 1.75 |
| 74LS160N | 88   | 74LS435N | 2.29 |
| 74LS161N | 1.15 | 74LS436N | 1.99 |
| 74LS162N | 98   | 74LS437N | 1.99 |
| 74LS163N | 98   | 74LS438N | 1.99 |

**16K UPGRADE ONLY**  
**\$49.95**  
 SPECIFY COMPUTER

**NEW!**  
 We Now Have The  
**Apple IIe**  
**Silenttype**  
**IN STOCK**

With Apple Intelligent Interface Card. Reg. **\$95.00**

Interface Card Has All Software For Hi-Res. Graphics & Pascal Use. **\$549.00**

**BECKMAN**  
 Digital Multimeters

MODELS TECH 300 AND TECH 310

AS LOW AS \$100.00

Choice of Models - The TECH 310 has all above features, 7 functions, 20 ranges and 0.25% accuracy. The TECH 300 has a 0.5% accuracy and all the above features, but without "Zero-Offset" continuity function or the 10 amp output.

TECH 300 Digital Multimeter... \$100.  
 TECH 310 Digital Multimeter... \$130.  
 VC-201 Vinyl Carrying Case... \$10.  
 DC-202 Deluxe Carrying Case... \$24.  
 HV-211 High Voltage Probe... \$35.  
 BR-221 BR Probe... \$35.  
 CR-231 AC Current Clamp... \$99.  
 DL-241 Deluxe Test Lead Kit... \$10.  
 TL-242 Spare Test Leads... \$10.

**MUSIC MACHINE 90**  
 WITH 9 VOICES!

NEW! Uses latest State of the Art LSI Technology. • Requires only one 5 1/4" disk for 9 voices • Uses new AY-8910's to produce new voices • Plays music generated by the AY's or AY software routines. • APPLE II compatible

RELEASABLE CASSETTE **\$129.95**

**THE BONE FONE**

• SKIERS  
 • JOGGERS  
 • SKATERS  
 • CYCLERS

You must hear it and feel it to believe it!

AM/FM stereo surrounds and fills your body with sound. No earplugs. You wear it!

**\$65.95**

**FLOPPY DISK DRIVES**

MPI B51-55\*, 40 tracks... 278.00  
 Shugart SA400-55\*, 35 tracks... 295.00  
 Shugart 800/801 R\*, 40 tracks... 475.00  
 Siemens Shugart Compatible Model

FDD-120-8D... 429.00  
 PERSCI Model 277 Dual... 1195.00  
 WANGO/SIEMENS 5 1/4" Drive... 290.00  
 MPI B52 5 1/4" Dual... 348.00  
 WANGO/SIEMENS 282 Dual 5 1/4"... 395.00  
 WANGO/SIEMENS B2... 290.00

**CONTINENTAL SPECIALTIES**

Model LM-3 40-channel Logic Monitor... \$85.00  
 Model LM-1 Logic Monitor... 60.00  
 Model LM-2 Logic Monitor... 147.00  
 MAX-100 100 MHz Portable Frequency Counter... 145.00  
 Model LP-1 Digital Logic Probe... 50.00  
 Model LP-2 Economy Logic Probe... 28.00  
 Model LP-3 High Speed Logic Probe... 77.00  
 Model LP-1 Logic Probe Kit... 21.95  
 Model LTP-1 LTC-2 Logical Analysis Kits... 220.250

**Proto Clips**

14-Pin Clip PC-14... 4.25  
 16-Pin Clip PC-16... 4.50  
 24-Pin Clip PC-24... 8.50  
 40-Pin Clip PC-40... 14.95

**Proto Boards**

96... 16.95  
 PB-100... 18.00  
 PB-101... 21.00  
 PB-102... 21.00  
 PB-103... 43.00  
 PB-104... 44.00  
 PB-203... 97.00  
 PB-204... 97.00  
 PB-203A-Kit... 129.00

# ADVANCED COMPUTER PRODUCTS

**Apple II. 16K**  
 or **Apple II. Plus \$990**  
**DISK SYSTEM SPECIAL**

Apple II Plus w/48K Supermod Video Modulator  
 Disk II w/Controller Integer Based ROM Card  
 Reg. \$2,220.00, ACP Price \$1819.00 **SAVE \$401.00**

Hi-Speed Serial VU... \$189.00  
 Centronics Printer VU... 180.00  
 Apposoft II Firmware... 189.00  
 Apple Clock... 269.00  
 Intro X-10 System... 179.95  
 Intro X-10 Controller... 269.95  
 All Music Synthesizer... 259.95  
 16 Ch. Analog Input... 249.95  
 2 Ch. Analog Output... 164.95  
 13-Key Keypad... 119.95  
 VSP-Cat... 125.00

D565 Dsp Sector... \$349.00  
 Apple Graphics Tablet... 180.00  
 D.C. Hayes Modem II... 349.95  
 Disk II w/Controller... 599.00  
 Pascal Lang System... 450.00  
 Parallel Printer Card... 165.00  
 Communications Card... 189.00  
 Business Software Pkg... 625.00  
 Convus 10 Megabyte Drive... 4625.00

Integer ROM Card... 2195  
 Proto Card... 2995  
 M & R Modulator... 2995  
 Sanyo Cassette... 5495  
 16K Upgrade Kit... 5495  
 Desktop Pk... 98.00  
 8 Floppy Controller... 350.00  
 Heuristics Speechlab... 179.00  
 Romplus +... 169.00  
 Superkiller... 279.00  
 Cashier... 250.00

**ATARI 800 & 400**  
 Personal Computer System

**ATARI 800 \$825.00**  
**ATARI 400 \$449.00**

**ATARI 800 Includes:** Computer Console, BASIC Lang. Cartridge, Education System Master Cartridge, BASIC Language Programming Manual, 800 Operator's Manual w/Notebook, Atari 410 Program Recorder, 16K RAM Module, Power Supply, TV Switch Box.

**Education System Cartridge Programs**

|                          |       |                            |        |
|--------------------------|-------|----------------------------|--------|
| U.S. History             | 35.00 | Spelling                   | 35.00  |
| U.S. Government          | 35.00 | Basic Business             | 35.00  |
| Supervisory Skills       | 35.00 | Basic Algebra              | 35.00  |
| Word History/Western     | 35.00 | Basic Game Programs        | 18.00  |
| Basic Science            | 35.00 | Guide to BASIC Programming | 16.00  |
| World History            | 35.00 | BASIC Game Programs        | 18.00  |
| Physics of Accounting    | 35.00 | Math Memory                | 120.00 |
| Great Classics (English) | 35.00 | 16K RAM Memory Module      | 110.00 |
| Business Communications  | 35.00 | Beaulet                    | 25.00  |
| Basic Psychology         | 35.00 | Disk File Manager          | 5.00   |
| French Writing           | 35.00 | Assembly Games             | 18.00  |
| Auto Mechanics           | 35.00 | Driving Controller Pkg.    | 18.00  |
| Principles of Economics  | 35.00 | Basic Controller Pkg.      | 18.00  |
| U.S. History             | 35.00 | Atytek Controller Pkg.     | 18.00  |

**TEXAS INSTRUMENTS**  
 INCORPORATED

**99/4 PERSONAL COMPUTER**

Superior Color, Music, Sound and Graphics - and a Powerful Extended Basic - All Built In!

TI 99/4 Console only available for \$659.00 **\$1099.00**

**Commodore**  
**PET AS \$775.00**

DISCOUNT PRICES

|                          |         |                                 |         |
|--------------------------|---------|---------------------------------|---------|
| 2001-6K                  | 775.00  | 2023 80 Col Print Paper Printer | 695.00  |
| 2001-16K                 | 875.00  | 2040 Dual Mini Disk Drive       | 1250.00 |
| 2001-320K 16mg           | 1075.00 | Per to IEEE Cable               | 39.95   |
| 2001-320K 16mg           | 1250.00 | IEEE to IEEE Cable              | 49.95   |
| 2001-320K 16mg           | 1250.00 | C2M External Cassette Drive     | 95.00   |
| 2023 80 Col Mini Printer | 795.00  |                                 |         |

**CompuCruise**  
 Zenco, Inc.

Model 44 with cruise control **\$174.95**

Model 41 without cruise control **\$154.95**

An onboard navigational computer for automobiles, trucks, and mechanical vehicles. Features cruise control, fuel management system, trip computer, multifunctional quartz crystal time counter, plus many other functions.

**BACK TO SCHOOL SPECIALS ON CALCULATORS**

**TEXAS INSTRUMENTS**

|                             |        |
|-----------------------------|--------|
| TI Programmable             | 52.95  |
| TI-55                       | 35.95  |
| TI-57                       | 54.95  |
| TI-58                       | 112.95 |
| TI-59                       | 219.95 |
| TI-30 SP Student Math Calc. | 18.00  |

**CASIO**

|                      |       |
|----------------------|-------|
| FX60 Super Math Card | 22.95 |
| JL 30                | 48.95 |
| JL 30                | 58.95 |

**NATIONAL BUREAU CONDUCTOR**

|                          |       |
|--------------------------|-------|
| NS 6010 Metric Converter | 17.95 |
|--------------------------|-------|

**SHARP**

|         |       |
|---------|-------|
| EL 8100 | 88.95 |
| EL 506  | 28.95 |
| EL 211  | 12.95 |

**AUDIO DISC**

Transforms a whole room into an Audio System.

Make us retro cool, then or calling come alive with fantastic stereo sound.

SUGG. RET. \$119.00

**\$89.95 PER PAIR**

NOT A SPEAKER

Available to any professional audio/computer compatibility equipment! Expansion pack (optional) for use with your present stereo equipment! Top quality sound! Easy to install!

**TOTAL VEHICLE PROTECTION AUTOLOCK-7**

• SIMPLE HOOD UP  
 • SUPER SENSITIVE DETECTOR  
 • EXIT ENTRY DELAY  
 • SECRET CODE DIGITAL  
 • SOLID STATE CIRCUITRY  
 • 1 YEAR WARRANTY

ACP Price Only **\$99.95**

THE PROFESSIONAL SECURITY SYSTEM  
 DIGITAL VEHICLE SECURITY SYSTEM

**SINGLE BOARD COMPUTER SELECTION GUIDE**

| BOARD      | PROCESSOR | ACP PRICE | ENCLOSURE |
|------------|-----------|-----------|-----------|
| KYM-1      | 6502      | 169.00    | Add 29.95 |
| SYM-1      | 6502      | 239.00    | Add 39.95 |
| Cromemco   | Z80       | 409.00    | N/A       |
| SD-SBC100  | Z80       | 239.00    | N/A       |
| AIM 65     | 6502      | 375.00    | Add 49.95 |
| Cosmac Vip | 1802      | 199.00    | Inc.      |

# CMOS

|        |      |         |       |
|--------|------|---------|-------|
| CD4000 | 35   | CD4093  | 99    |
| CD4001 | 35   | CD4098  | 2.95  |
| CD4002 | 35   | CD4098  | 2.49  |
| CD4006 | 1.39 | CD4098  | 2.49  |
| CD4007 | 29   | MC14408 | 12.95 |
| CD4008 | 1.39 | MC14409 | 12.95 |
| CD4009 | 49   | MC14410 | 12.95 |
| CD4010 | 49   | MC14412 | 12.95 |
| CD4011 | 39   | MC14414 | 8.95  |
| CD4012 | 29   | MC14419 | 9.95  |
| CD4013 | 49   | CD4501  | 39    |
| CD4014 | 1.39 | CD4502  | 1.65  |
| CD4015 | 1.15 | CD4503  | 69    |
| CD4016 | 39   | CD4505  | 8.95  |
| CD4017 | 1.15 | CD4506  | 7.75  |
| CD4018 | 96   | CD4507  | 8.95  |
| CD4019 | 49   | CD4508  | 3.95  |
| CD4020 | 1.15 | CD4510  | 1.39  |
| CD4021 | 1.15 | CD4511  | 1.39  |
| CD4022 | 1.15 | CD4512  | 1.39  |
| CD4023 | 38   | CD4515  | 3.95  |
| CD4024 | 79   | CD4516  | 1.69  |
| CD4025 | 38   | CD4518  | 1.39  |
| CD4027 | 39   | CD4520  | 1.39  |
| CD4028 | 85   | CD4555  | 9.95  |
| CD4029 | 1.2  |         |       |

# ADVANCED COMPUTER PRODUCTS

GET YOUR 1980 CATALOG

FIRST TO OFFER PRIME PRODUCTS TO THE HOBBYIST AT FAIR PRICES!

1. Proven Quality Factory tested products only.
2. Guaranteed Satisfaction
3. Over \$1,000,000 Inventory

**1980 CATALOG NOW AVAILABLE.**  
Send \$2.00 for your copy of the most complete catalog of computer products. A must for the serious computer user.

## STATIC RAM BOARDS

**• S-100 32K** (uses 2114)  
ASSEMBLED Kit *less than 1/2¢ per bit!*  
450ns 499.00 450ns 469.00  
250ns 539.00 250ns 499.00  
Bare Board 49.95  
Bare Board w/all parts less mem. 99.95

## • S-100 16K (S-100 Compatible)

- Low Power
- 2 MHz or 4 MHz
- Assembled & Tested
- 2 MHz ..... \$250.00
- 4 MHz ..... \$265.00



## • LOGOS 16K

ASSEMBLED  
450 ns 149.95 KIT 450ns. 125.95  
250ns 169.95 250ns 149.95  
Vector Graphic 8K Kit \$139.95  
Bare PC Board w/4K \$21.95  
\*Special Offer: Buy 4x 8K 450ns Kits \$117.00

## The Vista V-80 Disk Drive System

• 27% more storage capacity than 8" disks  
• 100 day warranty  
• 40 disc pack! NO CHARGE

**SALE \$299.00**

## THE VISTA V-200 FOR EXIDY

Price: Starting at less than \$199.00

| Model             | Capacity | Drive   | Weight  | Price   |
|-------------------|----------|---------|---------|---------|
| V200 E-20         | 400      | 2 Drive | 25 lbs. | 1199.00 |
| V200 E-22         | 800      | 2 Drive | 25 lbs. | 1549.00 |
| V200 E-30         | 600      | 3 Drive | 32 lbs. | 1524.00 |
| V200 E-12 1/2 MEG | 1200     | 2 Drive | 32 lbs. | 1999.00 |

## ATTENTION VIDEO HOBBYISTS!!!

- BOX BUILDERS
  - USE AS REMOTE TUNER/TIMER
  - FULL SCHEMATICS AVAILABLE
- FOR ONLY \$5.90! - FREE W/PURCHASE
- A Recent Special Purchase Arrives! Use To Present The Following:
- NEW, UNUSED COMPONENTS**  
From The RCA VCR-201 Videocassette Recorder
- 1. UNWIND Toner Subassembly with all tapes and Video Demagnetizer ..... **\$89.00**
  - 2. RF Modulator with Auto & Video controls Channel 1 or 4 Output ..... **\$39.00**
  - 3. Digital Clock Module AMP/RF Fluorescent Reactor (Green) ..... **\$19.00**
  - 4. 3000 Ohm to 15 Ohm Matching ..... **\$2.49**
  - 5. Complete Set of All the Above to Dry ..... **\$74.95**
- Please Call For Volume Discounts

## RAM BOARDS SPECIAL

16K Atari Mite Dynamic RAM Boards  
Assem. & Tested \$110.95 Untested \$95.00

## LOW COST FLOPPY DISK SUBSYSTEM

Simple FDD 120-120 (2) VISTA Floppy Controller (S-100), Clock, Power Supply & Cable, CPU M Disk Operating System Assembled & Tested Within 1 Hour! Parallel I/O Module \$149.00  
\*CHECK OUR FLOPPY DISK PRICES ON THIS PAGE!  
\*SAVE \$300.00 (\$1799.00 VALUE)

## WATANABE MIPLLOT

Max. print speed 50 mm/sec. resolution 10 mm/pixel. 1/2 mm dot character generator size. 4 x 4 inches of usable space. 100% duty cycle. 40% printing done with simple commands.

**\$1195.00**

## IMS STATIC RAM BOARDS

|            | 250 ns.  | 450 ns.  |
|------------|----------|----------|
| 8K Static  | \$209.00 | \$189.00 |
| 16K Static | \$449.00 | \$399.00 |
| 32K Static | \$729.00 | \$629.00 |

## CENTRONICS PRINTER

- Centronics complete printer
- The 137 has everything you need to check and compare the features.
- New low price **\$835.00**

## SALE! SD SYSTEMS BOARDS

**TAKE 10% OFF!**

| Model                                | Kit      | ASSEM    |
|--------------------------------------|----------|----------|
| SBC 100 Single Board Computer (2MHz) | \$265.00 | \$349.00 |
| SBC 200 Single Board Computer (4MHz) | 299.00   | 399.00   |
| Z80 Starter System                   | 335.00   | 459.00   |
| Versa-Floppy II                      | 325.00   | 429.00   |
| Expando PROM                         | 115.00   | 225.00   |
| SD100 Computer System w/84K          |          | 6995.00  |
| SD200 Computer System w/64K          |          | 7995.00  |

## 6800 MICROMODULE PRICE LIST

| MODEL NO. | DESCRIPTION                     | PRICE    |
|-----------|---------------------------------|----------|
| 9000A     | Single Board Microcomputer      | \$495.00 |
| 9609      | Advanced Single Bd Comp (6809)  | 595.00   |
| 9610      | 16 Slot Mother Board            | 175.00   |
| 9602      | 8 Slot Mother Board             | 100.00   |
| 9603      | Power Supply                    | 275.00   |
| 9605      | DC Input Power Supply           | 225.00   |
| 9610      | Utility Proto Board             | 39.00    |
| 9611      | Arith. Proc/Memory Module       | 495.00   |
| 9612      | Buffered Utility Proto Board    | 49.00    |
| 9616      | 32K EPROM/RAM Module            | 250.00   |
| 9620      | EPROM Programming Head          | 250.00   |
| 9620      | 16 Channel Parallel I/O Module  | 255.00   |
| 9622      | Serial-Parallel I/O Module      | 325.00   |
| 9627      | 16K Static RAM Module 470ns     | 395.00   |
| 9628      | 32K Static RAM 450ns            | 695.00   |
| 9629A     | 32K Static RAM 200ns            | 895.00   |
| 9630      | Card Expander                   | 68.00    |
| 9640      | Multiple Programmable Timer     | 495.00   |
| 9650      | 8 Channel Duplex Serial I/O Mod | 395.00   |
| 9655      | Intelligent Tape Controller     | 550.00   |
| 96103     | 32/32 I/O Module                | 275.00   |
| 96702     | Contact Closure Module          | 350.00   |

## UNPOPULATED BOARDS (Also Available)

## APPLE/EXIDY/EXPANDO TRS 80 16K-UPGRADE KIT

**\$49.95 TRS-80/APPLE \$49.95**

MEMORY EXPANSION KITS,  
4116's, 16K (200/250 ns),  
8 pcs for \$49.95  
w/instructions & jumpers  
Call For Volume Pricing

- ★ Special: TRS80 Schematic..... \$ 4.95
- ★ Expansion Interface Schematic..... \$ 4.95
- ★ Expansion Interface Connector..... 7.95

## EXPANDORAM II MEMORY KITS

- ★ Bank Selectable ★ Uses 4116 200 ns.
- ★ Write Protect ★ Power B/VDC. ±16VDC
- ★ Phantom NEW LOW PRICES ★ Up to 4 MHz

Expando 64 Kit (4116) Assem. & Tested Add \$50.  
16K \$269.00 48K \$435.00  
32K \$349.00 64K \$505.00

## SORC TERMINALS SALE

IQ 120 ..... \$ 695.00  
IQ 140 ..... 995.00

## UV "Eprom" Eraser

Model UVs-11E \$69.95  
Holds 4 Eprom's at a time.  
Backed by 45 years experience.  
Model S-52T...\$265.00  
Professional Industrial Model

## EMAKO-20... Reg. \$777.00 \$599.00

UNBELIEVABLE!  
125 Caps, 500pm/Vertical  
Format Unit - 95 Characters  
Users - Upper/Lower Case -  
4's - 9's Adjustable  
- 80 col/40 col double  
width - Full 96 char. ASCII

## EMAKO-22... \$799.00

Prints a 132 column. Available with parallel or serial output at same price.

## VISTA PRINTER

25 CPS, Full Character  
Daisy Wheel, 136 Column  
Model  
No. FP1500 **\$1995.00**

## BASE II PRINTER

80 Column Impact Printer  
• 60 Lines Per Minute  
• 115/230 VAC, 50  
or 60 Hz  
• 72, 80, 96, 120, or  
• 132 Char/Line  
• 3 Self-Test Switch

REG. \$699.00  
**\$575.00**

WITH ALL OPTIONS ACP Price \$575.00  
Option "M" Terminal Select Buffer (1920 Char.) ..... \$500.00  
Option "S" High Speed Paper Advance & Graphics ..... \$500.00  
Option "T" Tractor Feed ..... \$50.00

## Z-80/Z-80A/8080 CPU BOARD

- On board 2706 & 2708 (included 450ns)
- Power on/Off. • Completely socketed.
- 280 Assembled and Tested..... \$185.00
- 280 Kit..... \$129.95
- Z-80 Bare PC Board..... \$ 34.95
- For 4MHz Speed Add \$15.00

8080A Kit ..... \$ 99.95  
8080A Assembled ..... \$149.95

## S-100 MOTHERBOARD SPECIAL

8 slot expandable w/9 conn.  
Reg. \$69.95..... NOW \$52.95

## SIEMENS'S FLOPPY

- Special buy while supply lasts
- 8" Drive with Double-Density
- 30 Day Warranty
- CHECK OUR FLOPPY DISK PRICING ON THIS PAGE

## ACOUSTIC MDEEM

NOVATION CAT™  
0-300 Baud  
Ball 100  
Answer, Original **\$149.95**

## MONITORS

| Model                      | Price    | Model                    | Price  |
|----------------------------|----------|--------------------------|--------|
| Sanyo 17" Data Display     | \$325.00 | Zenith 13" Color Monitor | 499.00 |
| IBM 17" Color TV           | 349.00   | IBM 17" Color Monitor    | 575.00 |
| Mosira 17" High Resolution | 599.00   | VAMP 17" Color Monitor   | 449.00 |
| 22 MHz OEM Model           | \$69.95  | Sanyo 9"                 | 279.00 |
| Mosira 5"                  | 279.00   | Leont 17"                | 199.99 |

## DATA BOOKS • COMPUTER BOOKS

1980 IC Master ..... \$59.95  
INTEL Data Books ..... 7.90  
INTEL MCS 85 Manual ..... 7.90

## SALE • OSBORNE BOOKS • SALE

| Reg. Sale                                                   |
|-------------------------------------------------------------|
| Intro to Micros Vol. I..... \$40 7.75                       |
| 8080A Programming..... \$40 7.75                            |
| 8080 Programming..... \$40 7.75                             |
| 8080 Programming..... \$40 7.75                             |
| 8080 Programming..... \$40 7.75                             |
| Vol. II Some Real Microprocessors w/Binder..... \$60 27.50  |
| Vol. III Some Real Microprocessors w/Binder..... \$60 27.50 |
| Intro to Micros Vol. II..... \$40 18.50                     |

## SALE • SYBEX COMPUTER BOOKS • SALE

| Reg. Sale                                           |
|-----------------------------------------------------|
| 6800 Games..... \$12.95                             |
| Intro to Personal & Business Computing..... \$12.95 |
| Microprocessors: From Chips to Systems..... \$12.95 |
| Microprocessor Interfacing Techniques..... \$12.95  |
| Programming the Z80..... \$12.95                    |
| Programming the 8080..... \$12.95                   |
| Programming the 6502..... \$12.95                   |
| 6502 Applications Book..... \$12.95                 |

## MICROPROCESSORS

| Model                              | Price |
|------------------------------------|-------|
| Z8001 18 bit to 8Bit..... \$189.00 |       |
| Z8002 18 bit to 64K..... 149.00    |       |
| Z8003 18 bit to 64K..... 107.75    |       |
| Z8004 18 bit to 64K..... 149.00    |       |
| Z8005 18 bit to 64K..... 149.00    |       |
| Z8006 18 bit to 64K..... 149.00    |       |
| Z8007 18 bit to 64K..... 149.00    |       |
| Z8008 18 bit to 64K..... 149.00    |       |
| Z8009 18 bit to 64K..... 149.00    |       |
| Z8010 18 bit to 64K..... 149.00    |       |
| Z8011 18 bit to 64K..... 149.00    |       |
| Z8012 18 bit to 64K..... 149.00    |       |
| Z8013 18 bit to 64K..... 149.00    |       |
| Z8014 18 bit to 64K..... 149.00    |       |
| Z8015 18 bit to 64K..... 149.00    |       |
| Z8016 18 bit to 64K..... 149.00    |       |
| Z8017 18 bit to 64K..... 149.00    |       |
| Z8018 18 bit to 64K..... 149.00    |       |
| Z8019 18 bit to 64K..... 149.00    |       |
| Z8020 18 bit to 64K..... 149.00    |       |
| Z8021 18 bit to 64K..... 149.00    |       |
| Z8022 18 bit to 64K..... 149.00    |       |
| Z8023 18 bit to 64K..... 149.00    |       |
| Z8024 18 bit to 64K..... 149.00    |       |
| Z8025 18 bit to 64K..... 149.00    |       |
| Z8026 18 bit to 64K..... 149.00    |       |
| Z8027 18 bit to 64K..... 149.00    |       |
| Z8028 18 bit to 64K..... 149.00    |       |
| Z8029 18 bit to 64K..... 149.00    |       |
| Z8030 18 bit to 64K..... 149.00    |       |
| Z8031 18 bit to 64K..... 149.00    |       |
| Z8032 18 bit to 64K..... 149.00    |       |
| Z8033 18 bit to 64K..... 149.00    |       |
| Z8034 18 bit to 64K..... 149.00    |       |
| Z8035 18 bit to 64K..... 149.00    |       |
| Z8036 18 bit to 64K..... 149.00    |       |
| Z8037 18 bit to 64K..... 149.00    |       |
| Z8038 18 bit to 64K..... 149.00    |       |
| Z8039 18 bit to 64K..... 149.00    |       |
| Z8040 18 bit to 64K..... 149.00    |       |
| Z8041 18 bit to 64K..... 149.00    |       |
| Z8042 18 bit to 64K..... 149.00    |       |
| Z8043 18 bit to 64K..... 149.00    |       |
| Z8044 18 bit to 64K..... 149.00    |       |
| Z8045 18 bit to 64K..... 149.00    |       |
| Z8046 18 bit to 64K..... 149.00    |       |
| Z8047 18 bit to 64K..... 149.00    |       |
| Z8048 18 bit to 64K..... 149.00    |       |
| Z8049 18 bit to 64K..... 149.00    |       |
| Z8050 18 bit to 64K..... 149.00    |       |
| Z8051 18 bit to 64K..... 149.00    |       |
| Z8052 18 bit to 64K..... 149.00    |       |
| Z8053 18 bit to 64K..... 149.00    |       |
| Z8054 18 bit to 64K..... 149.00    |       |
| Z8055 18 bit to 64K..... 149.00    |       |
| Z8056 18 bit to 64K..... 149.00    |       |
| Z8057 18 bit to 64K..... 149.00    |       |
| Z8058 18 bit to 64K..... 149.00    |       |
| Z8059 18 bit to 64K..... 149.00    |       |
| Z8060 18 bit to 64K..... 149.00    |       |
| Z8061 18 bit to 64K..... 149.00    |       |
| Z8062 18 bit to 64K..... 149.00    |       |
| Z8063 18 bit to 64K..... 149.00    |       |
| Z8064 18 bit to 64K..... 149.00    |       |
| Z8065 18 bit to 64K..... 149.00    |       |
| Z8066 18 bit to 64K..... 149.00    |       |
| Z8067 18 bit to 64K..... 149.00    |       |
| Z8068 18 bit to 64K..... 149.00    |       |
| Z8069 18 bit to 64K..... 149.00    |       |
| Z8070 18 bit to 64K..... 149.00    |       |
| Z8071 18 bit to 64K..... 149.00    |       |
| Z8072 18 bit to 64K..... 149.00    |       |
| Z8073 18 bit to 64K..... 149.00    |       |
| Z8074 18 bit to 64K..... 149.00    |       |
| Z8075 18 bit to 64K..... 149.00    |       |
| Z8076 18 bit to 64K..... 149.00    |       |
| Z8077 18 bit to 64K..... 149.00    |       |
| Z8078 18 bit to 64K..... 149.00    |       |
| Z8079 18 bit to 64K..... 149.00    |       |
| Z8080 18 bit to 64K..... 149.00    |       |
| Z8081 18 bit to 64K..... 149.00    |       |
| Z8082 18 bit to 64K..... 149.00    |       |
| Z8083 18 bit to 64K..... 149.00    |       |
| Z8084 18 bit to 64K..... 149.00    |       |
| Z8085 18 bit to 64K..... 149.00    |       |
| Z8086 18 bit to 64K..... 149.00    |       |
| Z8087 18 bit to 64K..... 149.00    |       |
| Z8088 18 bit to 64K..... 149.00    |       |
| Z8089 18 bit to 64K..... 149.00    |       |
| Z8090 18 bit to 64K..... 149.00    |       |
| Z8091 18 bit to 64K..... 149.00    |       |
| Z8092 18 bit to 64K..... 149.00    |       |
| Z8093 18 bit to 64K..... 149.00    |       |
| Z8094 18 bit to 64K..... 149.00    |       |
| Z8095 18 bit to 64K..... 149.00    |       |
| Z8096 18 bit to 64K..... 149.00    |       |
| Z8097 18 bit to 64K..... 149.00    |       |
| Z8098 18 bit to 64K..... 149.00    |       |
| Z8099 18 bit to 64K..... 149.00    |       |
| Z8100 18 bit to 64K..... 149.00    |       |

## ADVANCED SUPPORT

AM9511 Arith. Processor..... 175.00  
8255 8 bit Parallel I/O..... 175.00  
8257 8 bit Parallel I/O..... 175.00  
8259 8 bit Parallel I/O..... 175.00  
82C01 8 bit Parallel I/O..... 175.00  
82C02 8 bit Parallel I/O..... 175.00  
82C03 8 bit Parallel I/O..... 175.00  
82C04 8 bit Parallel I/O..... 175.00  
82C05 8 bit Parallel I/O..... 175.00  
82C06 8 bit Parallel I/O..... 175.00  
82C07 8 bit Parallel I/O..... 175.00  
82C08 8 bit Parallel I/O..... 175.00  
82C09 8 bit Parallel I/O..... 175.00  
82C10 8 bit Parallel I/O..... 175.00  
82C11 8 bit Parallel I/O..... 175.00  
82C12 8 bit Parallel I/O..... 175.00  
82C13 8 bit Parallel I/O..... 175.00  
82C14 8 bit Parallel I/O..... 175.00  
82C15 8 bit Parallel I/O..... 175.00  
82C16 8 bit Parallel I/O..... 175.00  
82C17 8 bit Parallel I/O..... 175.00  
82C18 8 bit Parallel I/O..... 175.00  
82C19 8 bit Parallel I/O..... 175.00  
82C20 8 bit Parallel I/O..... 175.00  
82C21 8 bit Parallel I/O..... 175.00  
82C22 8 bit Parallel I/O..... 175.00  
82C23 8 bit Parallel I/O..... 175.00  
82C24 8 bit Parallel I/O..... 175.00  
82C25 8 bit Parallel I/O..... 175.00  
82C26 8 bit Parallel I/O..... 175.00  
82C27 8 bit Parallel I/O..... 175.00  
82C28 8 bit Parallel I/O..... 175.00  
82C29 8 bit Parallel I/O..... 175.00  
82C30 8 bit Parallel I/O..... 175.00  
82C31 8 bit Parallel I/O..... 175.00  
82C32 8 bit Parallel I/O..... 175.00  
82C33 8 bit Parallel I/O..... 175.00  
82C34 8 bit Parallel I/O..... 175.00  
82C35 8 bit Parallel I/O..... 175.00  
82C36 8 bit Parallel I/O..... 175.00  
82C37 8 bit Parallel I/O..... 175.00  
82C38 8 bit Parallel I/O..... 175.00  
82C39 8 bit Parallel I/O..... 175.00  
82C40 8 bit Parallel I/O..... 175.00  
82C41 8 bit Parallel I/O..... 175.00  
82C42 8 bit Parallel I/O..... 175.00  
82C43 8 bit Parallel I/O..... 175.00  
82C44 8 bit Parallel I/O..... 175.00  
82C45 8 bit Parallel I/O..... 175.00  
82C46 8 bit Parallel I/O..... 175.00  
82C47 8 bit Parallel I/O..... 175.00  
82C48 8 bit Parallel I/O..... 175.00  
82C49 8 bit Parallel I/O..... 175.00  
82C50 8 bit Parallel I/O..... 175.00  
82C51 8 bit Parallel I/O..... 175.00  
82C52 8 bit Parallel I/O..... 175.00  
82C53 8 bit Parallel I/O..... 175.00  
82C54 8 bit Parallel I/O..... 17

### 7400 TTL

|         |     |         |     |          |      |
|---------|-----|---------|-----|----------|------|
| SN7400N | .25 | SN7400N | .25 | SN74160N | .89  |
| SN7401N | .20 | SN7401N | .20 | SN74161N | .89  |
| SN7402N | .25 | SN7402N | .25 | SN74162N | .89  |
| SN7403N | .25 | SN7403N | .25 | SN74163N | .89  |
| SN7404N | .25 | SN7404N | .25 | SN74164N | .89  |
| SN7405N | .25 | SN7405N | .25 | SN74165N | .89  |
| SN7406N | .25 | SN7406N | .25 | SN74166N | .89  |
| SN7407N | .25 | SN7407N | .25 | SN74167N | 1.95 |
| SN7408N | .25 | SN7408N | .25 | SN74168N | 1.95 |
| SN7409N | .25 | SN7409N | .25 | SN74169N | 1.95 |
| SN7410N | .25 | SN7410N | .25 | SN74170N | 6.00 |
| SN7411N | .25 | SN7411N | .25 | SN74171N | 1.25 |
| SN7412N | .25 | SN7412N | .25 | SN74172N | 1.25 |
| SN7413N | .25 | SN7413N | .25 | SN74173N | 1.25 |
| SN7414N | .25 | SN7414N | .25 | SN74174N | 1.25 |
| SN7415N | .25 | SN7415N | .25 | SN74175N | .89  |
| SN7416N | .25 | SN7416N | .25 | SN74176N | .79  |
| SN7417N | .25 | SN7417N | .25 | SN74177N | .79  |
| SN7418N | .25 | SN7418N | .25 | SN74178N | .79  |
| SN7419N | .25 | SN7419N | .25 | SN74179N | 1.95 |
| SN7420N | .25 | SN7420N | .25 | SN74180N | .79  |
| SN7421N | .25 | SN7421N | .25 | SN74181N | 1.95 |
| SN7422N | .25 | SN7422N | .25 | SN74182N | .79  |
| SN7423N | .25 | SN7423N | .25 | SN74183N | 2.25 |
| SN7424N | .25 | SN7424N | .25 | SN74184N | 2.25 |
| SN7425N | .25 | SN7425N | .25 | SN74185N | 3.95 |
| SN7426N | .25 | SN7426N | .25 | SN74186N | 3.95 |
| SN7427N | .25 | SN7427N | .25 | SN74187N | 1.25 |
| SN7428N | .25 | SN7428N | .25 | SN74188N | 1.25 |
| SN7429N | .25 | SN7429N | .25 | SN74189N | 1.25 |
| SN7430N | .25 | SN7430N | .25 | SN74190N | 1.25 |
| SN7431N | .25 | SN7431N | .25 | SN74191N | 1.25 |
| SN7432N | .25 | SN7432N | .25 | SN74192N | .89  |
| SN7433N | .25 | SN7433N | .25 | SN74193N | .89  |
| SN7434N | .25 | SN7434N | .25 | SN74194N | .89  |
| SN7435N | .25 | SN7435N | .25 | SN74195N | .89  |
| SN7436N | .25 | SN7436N | .25 | SN74196N | .89  |
| SN7437N | .25 | SN7437N | .25 | SN74197N | .89  |
| SN7438N | .25 | SN7438N | .25 | SN74198N | 1.49 |
| SN7439N | .25 | SN7439N | .25 | SN74199N | 1.49 |
| SN7440N | .25 | SN7440N | .25 | SN74200N | 4.95 |
| SN7441N | .25 | SN7441N | .25 | SN74201N | .89  |
| SN7442N | .25 | SN7442N | .25 | SN74202N | .89  |
| SN7443N | .25 | SN7443N | .25 | SN74203N | .89  |
| SN7444N | .25 | SN7444N | .25 | SN74204N | .89  |
| SN7445N | .25 | SN7445N | .25 | SN74205N | .89  |
| SN7446N | .25 | SN7446N | .25 | SN74206N | .89  |
| SN7447N | .25 | SN7447N | .25 | SN74207N | .89  |
| SN7448N | .25 | SN7448N | .25 | SN74208N | .89  |
| SN7449N | .25 | SN7449N | .25 | SN74209N | .89  |
| SN7450N | .25 | SN7450N | .25 | SN74210N | .89  |
| SN7451N | .25 | SN7451N | .25 | SN74211N | .89  |
| SN7452N | .25 | SN7452N | .25 | SN74212N | .89  |
| SN7453N | .25 | SN7453N | .25 | SN74213N | .89  |
| SN7454N | .25 | SN7454N | .25 | SN74214N | .89  |
| SN7455N | .25 | SN7455N | .25 | SN74215N | .89  |
| SN7456N | .25 | SN7456N | .25 | SN74216N | .89  |
| SN7457N | .25 | SN7457N | .25 | SN74217N | .89  |
| SN7458N | .25 | SN7458N | .25 | SN74218N | .89  |
| SN7459N | .25 | SN7459N | .25 | SN74219N | .89  |
| SN7460N | .25 | SN7460N | .25 | SN74220N | .89  |

## JE608 PROGRAMMER

### 2704/2708 EPROM PROGRAMMER



3 separate Display Registers: A, B, & C for Hex Key entries, 16 LED's (2" x 2") for Address Register and 16 LED's for Data Memory Register. Data Memory Register displays the contents of the RAM and the EPROM Data.

Development of microprocessor systems by means of a ribbon cable from the programmer panel lead to the EPROM socket on the microprocessor board.

Rapid checking verification of programmed data changes.

On-line status display from a cursor to RAM's or write into RAM's with keyboard entries.

Address manual stepping manipulation (up and down) via address location.

Reads and writes EPROM Programmer operating at:

16-bit Hexadecimal Keyboard assembly, Programmer Board assembly with 4-bit keypad and a LED/16-bit Switch Panel Board assembly. The Hexadecimal Keyboard and a LED/16-bit Switch Panel Board assembly. The Programmer Board assembly with 4-bit keypad and a LED/16-bit Switch Panel Board assembly.

Compact desk-top enclosure. Case-coordinated design. Power requirements: 115VAC, 50Hz, 0.5A. Components and parts in color. Dimensions: 20" x 11" x 11". Weight: 5 lbs.

The JE608 EPROM Programmer is a completely self-contained unit which is independent of computer control and requires no additional systems for its operation. The EPROM can be programmed from the Hexadecimal Keyboard or from a programmed EPROM. The JE608 Programmer can emulate a programmed EPROM by the use of its internal RAM. This will allow the user to test or protect a program, for a system, prior to programming a chip. Any changes in the program can be entered directly into the memory circuits with the Hexadecimal Keyboard so that reprogramming the entire program will not be necessary. The JE608 Programmer contains a Programmer/Board with 25 1K's and including power supplies of -5V, +5V, +12V and +20V. The Hexadecimal Keyboard and LED/16-bit Switch Panel Board are separate assemblies within the system.

### JE608K KIT

### JE608A Assembled and tested

\$399.95

\$499.95

### DISCRETE LEADS

|                     |      |                     |      |                     |      |
|---------------------|------|---------------------|------|---------------------|------|
| XC566 .200" red     | 5/51 | MV50 .085" red      | 6/51 | XC111R .190" red    | 5/51 |
| XC566G .200" green  | 4/51 | XC209R .125" red    | 4/51 | XC111G .190" green  | 4/51 |
| XC566Y .200" yellow | 4/51 | XC209Y .125" yellow | 4/51 | XC111Y .190" yellow | 4/51 |
| XC566C .200" clear  | 4/51 | XC256R .185" red    | 5/51 | XC111C .190" clear  | 4/51 |
| XC22R .200" red     | 5/51 | XC256Y .185" yellow | 4/51 |                     |      |
| XC22G .200" green   | 4/51 | XC256C .185" clear  | 4/51 |                     |      |
| XC22Y .200" yellow  | 4/51 |                     |      |                     |      |
| MV10B .170" red     | 4/51 |                     |      |                     |      |

### INFRA-RED LED

4x4x1/16" flat  
IRL-5/51

### DISPLAY LEADS

C.A. - Common Anode C.C. - Common Cathode

| Type    | Polarity        | Ht  | Price | Type      | Polarity              | Ht  | Price |
|---------|-----------------|-----|-------|-----------|-----------------------|-----|-------|
| MAN 1   | C.A.-red        | 270 | 2.95  | DL701     | C.C.-red              | 300 | 99    |
| MAN 2   | S.D.D.-red      | 300 | 4.95  | DL702     | C.C.-red              | 500 | 1.49  |
| MAN 3   | C.C.-red        | 125 | 25    | DL703     | C.C.-red              | 600 | 1.25  |
| MAN 4   | C.C.-red        | 187 | 1.95  | DL704     | C.A.-red ± 1          | 630 | 1.49  |
| MAN 7G  | C.A.-green      | 300 | 1.25  | DL707     | C.A.-red              | 600 | 1.49  |
| MAN 7Y  | C.A.-yellow     | 300 | 99    | DL750     | C.C.-red              | 600 | 1.49  |
| MAN 7C  | C.C.-red        | 300 | 75    | DL318     | C.C.-red              | 110 | 35    |
| MAN 74  | C.C.-red        | 300 | 1.25  | FND70     | C.C.-red              | 250 | 69    |
| MAN 82  | C.A.-yellow     | 300 | 49    | FND358    | C.C. ± 1              | 357 | 99    |
| MAN 84  | C.C.-yellow     | 300 | 99    | FND359    | C.C.                  | 357 | 75    |
| MAN 320 | C.A.-orange     | 300 | 99    | FND503    | C.C. (FND500)         | 500 | 99    |
| MAN 360 | C.C.-orange     | 300 | 99    | FND504    | C.A. (FND510)         | 500 | 99    |
| MAN 340 | C.C.-orange     | 300 | 99    | 5082-7730 | C.C.-red              | 300 | 99    |
| MAN 410 | C.A.-orange     | 300 | 99    | HDS-3403  | C.C.-red              | 800 | 1.50  |
| MAN 480 | C.A.-yellow     | 400 | 99    | HSP-3400  | C.C.-red              | 800 | 1.50  |
| MAN 490 | C.C.-yellow     | 400 | 99    | 5082-7513 | C.C., R.H.D.-red      | 300 | 1.25  |
| MAN 660 | C.A.-orange-DO  | 560 | 99    | 5082-7623 | C.A., L.H.D.-yel.     | 300 | 1.25  |
| MAN 630 | C.A.-orange ± 1 | 560 | 99    | 5082-7630 | C.C., R.H.D.-yel.     | 300 | 1.25  |
| MAN 660 | C.C.-orange-DO  | 560 | 99    | 5082-7731 | C.A., R.H.D.-red      | 300 | 1.25  |
| MAN 650 | C.C.-orange     | 560 | 99    | 5082-7750 | C.A., L.H.D.-red      | 430 | 1.25  |
| MAN 670 | C.A.-red        | 560 | 99    | 5082-7751 | C.A., R.H.D.-red      | 430 | 1.25  |
| MAN 670 | C.C.-red ± 1    | 560 | 99    | 5082-7760 | C.C., R.H.D.-red      | 430 | 1.25  |
| MAN 670 | C.C.-red        | 560 | 99    | 5082-7300 | 4x7 sig. dig. L.H.D.P | 600 | 19.95 |
| DL701   | C.C.-red ± 1    | 270 | 3.95  | 5082-7302 | 4x7 sig. dig. L.H.D.P | 600 | 19.95 |
| DL770   | C.C.-red        | 300 | 99    | 5082-7304 | 4x7 sig. dig. hex.    | 600 | 22.50 |

### RCA LINEAR

|         |      |         |      |                   |      |              |      |                |      |
|---------|------|---------|------|-------------------|------|--------------|------|----------------|------|
| CA3013T | 2.15 | CA3028N | 2.00 | MM5725            | 2.95 | MM5309       | 4.95 | MC1408L7       | 4.95 |
| CA2023T | 3.28 | CA3030N | 1.60 | MM5738            | 2.95 | MM5311       | 4.95 | MC1408L8       | 5.75 |
| CA3035T | 2.45 | CA3068N | 1.85 | DM8864            | 2.00 | MM5312       | 4.95 | MC1489L        | 2.95 |
| CA3039T | 1.35 | CA3089N | 1.75 | DM8865            | 2.00 | MM5313       | 4.95 | MC2202         | 2.95 |
| CA3066N | 1.30 | CA3130T | 1.39 | DM8867            | 7.5  | MM5316       | 6.95 | MC3061P        | 3.50 |
| CA3069N | 3.25 | CA3160T | 1.25 | DM8869            | .75  | MM5318       | 9.95 | MC4016 (P4465) | 1.00 |
| CA3080T | 1.25 | CA3401N | .59  | 9374 7-seg.       | .59  | MM5339       | 2.95 | MC4024P        | 3.95 |
| CA3081N | 2.00 | CA3600N | 3.50 | LED driver 1-watt | 5.95 | MM5377       | 4.95 | MC4049P        | 6.95 |
|         |      |         |      | MM5399            | 4.95 | MM5382/1998A | 4.95 | MC4044P        | 6.50 |

### LOW PROFILE (TIN) SOCKETS

|           |      |       |        |
|-----------|------|-------|--------|
| 14 pin LP | 1-24 | 25-49 | 50-100 |
| 16 pin LP | 1-17 | 16    | 15     |
| 18 pin LP | 20   | 19    | 18     |
| 20 pin LP | 22   | 21    | 20     |
| 22 pin LP | 27   | 28    | 27     |
| 24 pin LP | 34   | 32    | 30     |
| 26 pin LP | 39   | 38    | 35     |
| 28 pin LP | 48   | 47    | 43     |
| 30 pin LP | 58   | 59    | 58     |
| 40 pin LP | 63   | 62    | 61     |

### SOLDERTAIL STANDARD (TIN)

|           |      |       |        |
|-----------|------|-------|--------|
| 14 pin ST | 1-24 | 25-49 | 50-100 |
| 16 pin ST | 17   | 16    | 15     |
| 18 pin ST | 20   | 19    | 18     |
| 20 pin ST | 22   | 21    | 20     |
| 22 pin ST | 27   | 28    | 27     |
| 24 pin ST | 34   | 32    | 30     |
| 26 pin ST | 39   | 38    | 35     |
| 28 pin ST | 48   | 47    | 43     |
| 30 pin ST | 58   | 59    | 58     |
| 40 pin ST | 63   | 62    | 61     |

### WIRE WRAP SOCKETS (GOLD) LEVEL #3

|           |      |       |        |
|-----------|------|-------|--------|
| 14 pin WW | 1-24 | 25-49 | 50-100 |
| 16 pin WW | 17   | 16    | 15     |
| 18 pin WW | 20   | 19    | 18     |
| 20 pin WW | 22   | 21    | 20     |
| 22 pin WW | 27   | 28    | 27     |
| 24 pin WW | 34   | 32    | 30     |
| 26 pin WW | 39   | 38    | 35     |
| 28 pin WW | 48   | 47    | 43     |
| 30 pin WW | 58   | 59    | 58     |
| 40 pin WW | 63   | 62    | 61     |

### 1/4 WATT RESISTOR ASSORTMENTS - 5%

|          |       |         |         |         |         |         |        |        |
|----------|-------|---------|---------|---------|---------|---------|--------|--------|
| ASST. 1  | 5 ea. | 10 OHM  | 12 OHM  | 15 OHM  | 18 OHM  | 22 OHM  | 60 PCS | \$1.95 |
| ASST. 2  | 5 ea. | 27 OHM  | 43 OHM  | 39 OHM  | 47 OHM  | 56 OHM  | 60 PCS | \$1.95 |
| ASST. 3  | 5 ea. | 180 OHM | 270 OHM | 270 OHM | 330 OHM | 390 OHM | 60 PCS | \$1.95 |
| ASST. 4  | 5 ea. | 470 OHM | 560 OHM | 680 OHM | 820 OHM | 1K      | 60 PCS | \$1.95 |
| ASST. 5  | 5 ea. | 1.2K    | 1.5K    | 1.8K    | 2.2K    | 2.7K    | 60 PCS | \$1.95 |
| ASST. 6  | 5 ea. | 3.3K    | 3.9K    | 4.7K    | 5.6K    | 6.8K    | 60 PCS | \$1.95 |
| ASST. 7  | 5 ea. | 8.2K    | 10K     | 12K     | 15K     | 18K     | 60 PCS | \$1.95 |
| ASST. 8  | 5 ea. | 27K     | 27K     | 33K     | 39K     | 47K     | 60 PCS | \$1.95 |
| ASST. 9  | 5 ea. | 56K     | 68K     | 82K     | 100K    | 120K    | 60 PCS | \$1.95 |
| ASST. 10 | 5 ea. | 150K    | 180K    | 220K    | 270K    | 330K    | 60 PCS | \$1.95 |
| ASST. 11 | 5 ea. | 390K    | 470K    | 560K    | 680K    | 820K    | 60 PCS | \$1.95 |
| ASST. 12 | 5 ea. | 1M      | 1.2M    | 1.5M    | 1.8M    | 2.2M    | 60 PCS | \$1.95 |
| ASST. 13 | 5 ea. | 2.7M    | 3.3M    | 3.9M    | 4.7M    | 5.6M    | 60 PCS | \$1.95 |

ASST. 8R Includes Resistor Assortments 1-7 (350 PCS.) \$10.95 ea.

\$10.00 Min. Order - U.S. Funds Only  
Calif. Residents Add 6% Sales Tax  
Postage - Add 5% plus 1 Insurance (if desired)

Spec Sheets - 25¢  
1981 Catalog Available - Send 41¢ stamp

## AMECO ELECTRONICS

MAIL ORDER ELECTRONICS - WORLDWIDE  
1355 SHOREWAY ROAD, BELMONT, CA 94002  
PRICES SUBJECT TO CHANGE

PHONE ORDERS WELCOME  
(415) 592-8097

### TELEPHONE/KEYBOARD CHIPS

|         |                              |         |
|---------|------------------------------|---------|
| AY-4100 | Push Button Telephone Dialer | \$14.95 |
| AY-5200 | Rotary Dialer                | 14.95   |
| AY-5800 | CMOS Clock Generator         | 4.95    |
| AY-5276 | Keyboard Encoder (88 keys)   | 11.95   |
| 74C207  | Keyboard Encoder (16 keys)   | 7.50    |
| 74C222  | Keyboard Encoder (16 keys)   | 5.49    |
| 74C223  | Keyboard Encoder (20 keys)   | 5.75    |

### ICM CHIPS

|         |                         |       |
|---------|-------------------------|-------|
| ICM7045 | CMOS Precision Timer    | 24.95 |
| ICM7205 | CMOS LED Stowback/Timer | 19.95 |
| ICM7207 | Oscillator              | 14.95 |
| ICM7208 | Seven Decade Counter    | 19.95 |
| ICM7209 | Clock Generator         | 6.95  |

### NMOS READ ONLY MEMORIES

|         |                                      |       |
|---------|--------------------------------------|-------|
| MCME571 | 128 X 9 X 7 ASCII Shifted with Greek | 13.50 |
| MCME574 | 128 X 9 X 7 Math Symbol & Pictures   | 13.50 |
| MCME575 | 128 X 9 X 7 Alpha Control Char Gen   | 13.50 |

### MISCELLANEOUS

|           |                                         |           |
|-----------|-----------------------------------------|-----------|
| TL074CN   | Quad Low Noise Bi-In Op Amp             | 2.49      |
| TL494CN   | Switching Regulator                     | 4.49      |
| TL496CP   | Single Switching Regulator              | 1.75      |
| 11C80     | Divide 10/11 Prescaler                  | 11.95     |
| ICM7207   | Hi-Speed D/A 10/11 Prescaler            | 14.95     |
| 4N33      | Photo-Darlington Opto-Isolator          | 1.25      |
| MK50240   | Top-Off Freq. Generator                 | 17.50     |
| D50026CH  | 5MHz 2-phase MOS clock driver           | 3.75      |
| TL308     | 277 read mem. display w/ing. logic chip | 10.95     |
| MM500     | TV Game, Gen. Generator                 | 14.95     |
| MM5330    | 4% Digit DPM Logic Block (Special)      | 3.95      |
| LD110/111 | 3% Digit A/D Converter Set              | 25.00/set |
| MC14433P  | 3% Digit A/D Converter                  | 13.95     |

### LITRONIX ISO-LIT 1

Photo Transistor Opto-Isolator  
(Same as MCT 2 or 4N25)

49¢ each

### SN 76477

SOUND GENERATOR  
Generates Complex Sounds  
Low Power - Programmable

\$3.95 each

### TV GAME CHIP AND CRYSTAL

AY-3-8500-1 and 2.01 MHz Crystal (Chip & Crystal includes score display, 6 games and select angles, etc.)

7.95/set

### EXAR

|         |        |          |      |
|---------|--------|----------|------|
| XR205   | \$8.40 | XR2242CP | 1.50 |
| XR210   | 4.40   | XR2264   | 4.25 |
| XR215   | 4.40   | XR2264   | 3.20 |
| XR220   | 1.55   | XR2267   | 2.99 |
| XR-L555 | 1.50   | XR2303   | 1.25 |
| XR      |        |          |      |

## BLAK-RAY Ultraviolet Intensity Meter



TWO MODELS:  
LONG WAVE  
AND  
SHORT WAVE

Meter consists of a sensor cell attached to a compact (3" x 3 1/4" x 3") metering unit. Can be hand-held or placed directly on surface for measuring. Can be used remotely, while connected to a meter housing by a 4-foot extension cord. Two models available — one for long wave and one for short wave ultraviolet. Readings are in microwatts per square centimeter. Weight: 1 lb.

Completely assembled (includes sensor cell, reduction screen, extension cord, contrast filter and certification report.)

**J-221 LONG WAVE**  
(300nm-400nm) ..... **\$242.00**

**J-225 SHORT WAVE**  
(200nm-280nm) ..... **\$260.00**

## EPROM Erasing Lamp



- Erases 2708, 2716, 1702A, 5203Q, 5204Q, etc.
- Erases up to 4 chips within 20 minutes
- Maintains constant exposure distance of one inch
- Special conductive foam liner eliminates static build-up
- Built-in safety lock to prevent UV exposure
- Compact — only 7-5/8" x 2-7/8" x 2"
- Complete with holding tray for 4 chips

**UVS-11E** ..... **\$79.50**

## Jumbo 6-Digit Clock Kit

- Four .630" ht. and two .300" ht. common anode displays
- Uses MM5314 clock chip
- Switches for hours, minutes and hold functions
- Hours easily viewable to 30 feet
- Simulated walnut case
- 115 VAC operation
- 12 or 24 hour operation
- Includes all components, case and wall transformer
- Size: 6 1/4" x 3 1/4" x 1 1/4"

**JE747** ..... **\$29.95**

## JE701

- Bright .300 ht. comm. cathode display
- Uses MM5314 clock chip
- Switches for hours, minutes and hold modes
- Hrs. easily viewable to 20 ft.
- Simulated walnut case
- 115 VAC operation
- 12 or 24 hr. operation
- Incl. all components, case & wall transformer
- Size: 6 1/4" x 3-1/8" x 1 1/4"

**6-Digit Clock Kit** **\$19.95**

## Regulated Power Supply

Uses LM309K. Heat sink provided. PC board construction. Provides a solid 1 amp @ 5 volts. Can supply up to .5V, .9V and .12V with JE205 Adapter. Includes components, hardware and instructions. Size: 3 1/2" x 5" x 2 1/4"

**JE200** ..... **\$14.95**

## ADAPTER BOARD

—Adapts to JE200—  
±5V, ±9V and ±12V

DC/DC converter with +5V input. Toroidal hi-speed switching XMF8. Short circuit protection. PC board construction. Piggy-back to JE-200 board. Size: 3 1/2" x 2" x 9/16"

**JE205** ..... **\$12.95**

## MICROPROCESSOR COMPONENTS

| 8086/8088 SUPPORT DEVICES          |                                   | MICROPROCESSOR MANUALS  |                      |
|------------------------------------|-----------------------------------|-------------------------|----------------------|
| 8080A                              | CPU                               | 5                       | 95                   |
| 8212                               | 8-Bit Input/Output                | 3                       | 25                   |
| 8214                               | Priority Interrupt Control        | 5                       | 95                   |
| 8216                               | Bi-Directional Bus Driver         | 3                       | 49                   |
| 8224                               | Clock Generator/Driver            | 3                       | 95                   |
| 8226                               | Bus Driver                        | 3                       | 49                   |
| 8228                               | System Controller/Bus Driver      | 4                       | 95                   |
| 8238                               | System Controller                 | 5                       | 95                   |
| 8251                               | Prog. Comm. 1/0 (USART)           | 7                       | 95                   |
| 8253                               | Prog. Interval Timer              | 14                      | 95                   |
| 8255                               | Prog. Periph. 1/0 (PPI)           | 9                       | 95                   |
| 8257                               | Prog. DMA Control                 | 19                      | 95                   |
| 8259                               | Prog. Interrupt Control           | 14                      | 95                   |
| 8080/8080 SUPPORT DEVICES          |                                   | MICROPROCESSOR MANUALS  |                      |
| MC6800                             | MPU                               | 1101                    | 256X1                |
| MC6802CP                           | MPU with Clock and Ram            | 1103                    | 1024X1               |
| MC6810AP1                          | 128KB Static Ram                  | 2101(8101)              | 256X4                |
| MC6821                             | Periph. Inter. Adapt (MC6820)     | 4                       | 1024X1               |
| MC6829                             | Priority Interrupt Controller     | 21L02                   | 1024X1               |
| MC6830LB                           | 1024KB Bit ROM (MC6830-B)         | 2111(8111)              | 256X4                |
| MC6850                             | Asynchronous Comm. Adapter        | 2112                    | 256X4                |
| MC6852                             | Synchronous Serial Data Adapt     | 2114                    | 1024X4               |
| MC6880                             | 8-600 bps Digital MODEM           | 2114L                   | 1024X4               |
| MC6882                             | 2400 bps Modem                    | 2114-3                  | 1024X4               |
| MC6880A                            | Quad 3-State Bus. Trans. (MC8126) | 9101                    | 256X4                |
| MICROPROCESSOR CHIPS—MISCELLANEOUS |                                   | RAM'S                   |                      |
| 280(780C)                          | CPU                               | 7489                    | 16K4                 |
| Z80A(780-1)                        | CPU                               | UPD414                  | 4K                   |
| CDP1802                            | CPU                               | (MK4027)                | Dynamic 16 pin 150NS |
| 2650                               | MPU                               | MM5290-2                | (UPD416/MK4116)      |
| 6502                               | CPU                               | 45H                     | Static               |
| 8035N6                             | 8-Bit MPU w/clock, RAM, 1/0 lines | TMS4044                 | 4K                   |
| P8085                              | CPU                               | 45H                     | Static               |
| TMS9901JL                          | 16-Bit MPU                        | 4995                    | 15,384X1             |
| SHIFT REGISTERS                    |                                   | PR0M'S                  |                      |
| MM500H                             | Dual 25 Bit Dynamic               | 5                       | 50                   |
| MM503H                             | Dual 50 Bit Dynamic               | 5                       | 50                   |
| MM505H                             | Dual 100 Bit Static               | 1702A                   | 2048                 |
| MM510H                             | Dual 64 Bit Accumulator           | 50                      | 2716                 |
| MM510H4                            | 500x512 Bit Dynamic               | 88                      | TMS2516              |
| 2504(1404A)                        | 1024 Dynamic                      | 3                       | 95                   |
| 2518                               | Hex 32 Bit Static                 | 4                       | 95                   |
| 2522                               | Dual 132 Bit Static               | 2                       | 95                   |
| 2524                               | 512 Bit Dynamic                   | 2                       | 95                   |
| 2525                               | 1024 Dynamic                      | 2                       | 95                   |
| 2527                               | Dual 256 Bit Static               | 2                       | 95                   |
| 2528                               | Dual 250 Static                   | 4                       | 00                   |
| 2529                               | Dual 240 Bit Static               | 2                       | 95                   |
| 2532                               | Quad 80 Bit Static                | 2                       | 95                   |
| 3341                               | File                              | 6                       | 95                   |
| 74LS870                            | 4X4 Register File (TriState)      | 2                       | 49                   |
| UART'S                             |                                   | DIGITAL THERMOMETER KIT |                      |
| A-Y-5-1013                         | 30K BAUD                          | 5                       | 95                   |

## Function Generator Kit

Provides 3 basic waveforms: sine, triangle and square wave. Freq. range from 1 Hz to 100K Hz. Output amplitude from 0 volts to over 6 volts (peak to peak). Uses a 12V supply or a ±5V split supply. Includes chip, P.C. Board, components & instructions.



**JE2206B** ... **\$19.95**

## DIGITAL THERMOMETER KIT

- Dual sensors—control switch for indoor/outdoor or dual monitoring—extension up to 500 feet
- Continuous LED .8" ht. display
- Range: -40°F to 199°F / -40°C to 100°C
- Accuracy: ±1°
- Calibrate for Fahrenheit/Celsius reading
- Sim. walnut case—AC wall adapter incl.
- Size: 3 1/4" H x 6-5/8" W x 1-3/8" D

**JE300** ..... **\$39.95**

## DESIGNERS' SERIES

### Blank Desk-Top Electronic Enclosures



- High strength epoxy molded end pieces in mocha brown finish
- Sliding rear/bottom panel for service and component accessibility.
- Top / bottom panels .080 thk alum. Anodize type 1200 finish (gold tint color) for best paint adhesion after modification
- Vented top and bottom panels for cooling efficiency.
- Rigid construction provides unlimited applications.

#### CONSTRUCTION:

The "DTE" Blank Desk Top Electronic Enclosures are designed to blend and complement today's modern computer equipment and can be used in both industrial and home. The end panels are precision molded with an internal slot (all around) to accept both top and bottom panels. The panels are then fastened to 1/4" thick tabs inside the end pieces to provide maximum rigidity to the enclosure. For ease of equipment servicing, the rear/bottom panel slides back on slotted tracks while the rest of the enclosure remains intact. Different panel widths may be used while maintaining a common profile outline. The molded end pieces can also be painted to match any panel color scheme.



| Enclosure Model No. | Panel Width | PRICE   |
|---------------------|-------------|---------|
| DTE-8               | 8.00"       | \$29.95 |
| DTE-11              | 10.65"      | \$32.95 |
| DTE-14              | 14.00"      | \$34.95 |

\$10.00 Min. Order — U.S. Funds Only  
Calif. Residents Add 6% Sales Tax  
Postage—Add 5% plus \$1 Insurance (if desired)

Spec Sheets — 25¢  
1981 Catalog Available — Send 41¢ stamp



**Jameco ELECTRONICS**

PHONE ORDERS WELCOME  
(415) 592-8097

MAIL ORDER ELECTRONICS — WORLDWIDE

1355 SHOREWAY ROAD, BELMONT, CA 94002

PRICES SUBJECT TO CHANGE

10/80



National Semiconductor

## RAM SALE

**MM5290J-2** (MK4116/UP0416) . . . **\$6.95 each**  
16K DYNAMIC RAM (150NS)  
(8 EACH \$49.95) (100 EACH \$550.00/lot)

**MM5298J-3A** . . . **\$3.25 each**  
8K DYNAMIC RAM (LOW HALF OF MM5290J) 200NS  
(8 EACH \$23.95) (100 EACH \$250.00/lot)

**MM2114-3** . . . **\$5.95 each**  
8K STATIC RAM (300NS)  
(8 EACH \$49.95) (100 EACH \$450.00/lot)

**MM2114L-3** . . . **\$6.25 each**  
8K STATIC RAM (LOW POWER 300NS)  
(8 EACH \$44.95) (100 EACH \$475.00/lot)

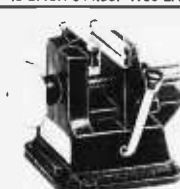

**Vacuum Vise**

Vacuum-based light-duty vise for small components and assemblies. ABS construction. 1 1/2" jaws, 1 1/2" travel. Can be permanently installed.

**VV-1** ..... **\$3.49**

## TRS-80

### 16K Conversion Kit

Expand your 4K TRS-80 System to 16K.  
Kit comes complete with:  
• 8 JE610/MM5290-2 (UP0416) (16K Dynamic Rams) 150NS  
• Documentation for conversion

**TRS-16K** ..... **\$49.95**

## JE610 ASCII

### Encoded Keyboard Kit



The JE610 ASCII Keyboard Kit can be interfaced into most any computer system. The kit comes complete with an industrial grade keyboard switch assembly (62-keys), IC's, sockets, connector, electronic components and a double-sided printed wiring board. The keyboard assembly requires +5V @ 150mA and -12V @ 10mA for operation. Features: 60 keys generate the 126 characters, upper and lower case ASCII set. Fully buffered. Two user-define keys provided for custom applications. Caps lock for upper-case-only alpha characters. Utilizes a 2376 (40-pin) encoder read-only memory chip. Outputs directly compatible with TTL/DTL or MOS logic arrays. Easy interfacing with a 16-pin dip or 18-pin edge connector.

**JE610** (Case not included) **\$79.95**

**Desk-Top Enclosure for JE610 ASCII Encoded Keyboard Kit**  
Compact desk-top enclosure. Color-coordinated designer's case with light tan aluminum panels and molded end pieces in mocha brown. Includes mounting hardware. Size: 3 1/4" H x 14 1/2" W x 8 3/4" D.  
**DTE-AK** ..... **\$49.95**  
**SPECIAL: JE610/DTE-AK PURCHASED TOGETHER**  
(Value \$129.90) ..... **\$124.95**

## JE600 Hexadecimal Encoder Kit



The JE600 Encoder Keyboard Kit provides two separate hexadecimal digits produced from sequential key entries to allow direct programming for 8-bit microprocessor or 8-bit memory circuits. Three additional keys are provided for user operations with one having a bistable output available. The outputs are latched and monitored with 9 LED readouts. Also included is a key entry strobe. Features: Full 8-bit latched output for microprocessor use. Three user-define keys with one being bistable operation. Debounce circuit provided for all 19 keys. 9 LED readouts to verify entries. Easy interfacing with standard 16-pin IC connector. Only +5VOC required for operation.

**JE600** (Case not included) **\$59.95**

**Desk-Top Enclosure for JE600 Hexadecimal Keyboard Kit**  
Compact desk-top enclosure. Color-coordinated designer's case with light tan aluminum panels and molded end pieces in mocha brown. Includes mounting hardware. Size: 3 1/4" H x 8 1/2" W x 8 3/4" D.  
**DTE-HK** ..... **\$44.95**  
**SPECIAL: JE600/DTE-HK PURCHASED TOGETHER**  
(Value \$104.90) ..... **\$99.95**

New Summer 1980  
**SEND FOR OUR FREE CATALOG**



**CompuMart  
lets you  
put 'em on trial**

CompuMart has been selling computers by mail since 1971. Our thousands of satisfied customers rely on CompuMart for services not generally available from the others. Namely:

- Product Selection/Each product advertised by CompuMart has been evaluated by our in-house staff for best price, performance, and supplier reliability
- Return Privilege/After receipt of our products, you are protected by CompuMart's exclusive, 10-day return privi-

ledge-good for all products except software.

- Support/Our Customer Service Dept. and expert technicians are always there to assist you by phone or at CompuMart's outlets. Our knowledgeable phone sales force can provide you with detailed information and complete product specifications.

- Phone Ordering/For added convenience, CompuMart maintains a toll-free ordering number. 1-800-343-5504.

with  
**10 day free return**

## Printers

### The Paper Tiger Printer From Integral Data

Uses standard 1/4 inch roll paper and ribbon  
40 characters per line  
Speed: 40 characters per second  
UL approved

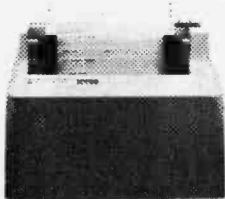

High resolution dot matrix impact printer

IDS Paper Tiger Printer ..... \$995  
IDS Graphics Paper Tiger Printer ..... \$1,094

### NEW! From Integral Data. The IDS 460.

We saw this new desktop printer at the NCC 80 and when we saw its features: Correspondence quality printing, High-resolution graphics capability, programmable print control functions, and automatic text justification—we knew that we had to offer this printer to our cost/features conscious customers \$1,295

### The Omni 810 Printer from Texas Instruments

TI Omni 820 Receive-Only (RO) Package. Includes machine-mounted paper tray and cable. A compressed print option and device forms control are standard features ..... \$2,155

### CENTRONICS PRINTERS

New! The incredible Model 737. Correspondence and Draft Quality Printing for Under \$1,000. This is the first printer in its class to offer print quality suitable for text processing, plus the performance and application flexibility required for data processing. ..... \$995

737-3 (Serial Interface) ..... \$1,045  
Tractor Feed Printer. Centronics' Most Popular Model. Perfect for the needs of a small business system. Recommended by Apple and Radio Shack. ..... \$1,079

### NEC The First Name in Letter Quality Printers.

CompuMart offers beautiful print quality with NEC Spinwriter terminals. The Spinwriters, both KSR and RO versions, give unsurpassed hard copy output. CompuMart offers a complete range of NEC Spinwriters—Call our expert salesforce

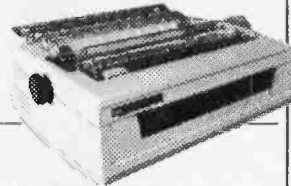

## Monitors

### EXCLUSIVE from CompuMart! Special Offer. Zenith Color Video Monitor for \$379!

The perfect monitor for Apple, Atari and Texas Instruments owners.

### NEW FROM SANYO — Four Great Monitors at Low CompuMart Prices.

Sanyo's new line of CRT data display monitors are specifically designed for the display of alpha-numeric or graphic data.

9" Sanyo Monitor ..... \$169  
12" Sanyo Monitor ..... \$289  
12" Sanyo Monitor with green screen ..... \$299  
13" Sanyo Color Display Monitor ..... \$495

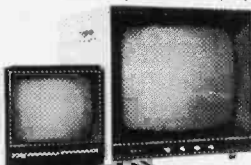

## Terminals

### Televideo 912C

820 x 24—Lower case descenders. Teletype or telewriter keyboard. 110/220 VAC. 50 to 19.2K Baud Item entry pad. Great looking and no fan noise.

### Televideo 920C

Similar to the TV 912 but has programmable function keys across top. Excellent for text editing.



**Call for Introductory Sale Prices**

We've got the following Lear Siegler Terminals In Stock at prices too low to print—**Call for quotes.**

ADM-3A Industries favorite dumb terminal for some very smart reasons.

ADM-3A. + New from Lear Siegler. CALL!

ADM-31. The terminal that's too smart to be considered dumb.

ADM-42. Available with keyboard semi-intelligent terminal offering tremendous user flexibility. The optional configurations are amazing.



Call for details. ★

### HAZELTINE TERMINALS AT SPECTACULAR SAVINGS!

|                 |             |                  |
|-----------------|-------------|------------------|
| Hazeltine 1410. | List \$850  | CompuMart \$749  |
| Hazeltine 1420. | List \$995  | CompuMart \$895  |
| Hazeltine 1500. | List \$1095 | CompuMart \$995  |
| Hazeltine 1510. | List \$1395 | CompuMart \$1325 |
| Hazeltine 1520. | List \$1585 | CompuMart \$1485 |
| Hazeltine 1552. | List \$1395 | CompuMart \$1295 |

Call CompuMart for complete specs and quantity discounts.

## Calculators

### A CALCULATOR, A SYSTEM, A WHOLE NEW STANDARD.

### HEWLETT-PACKARD'S HP-41C

HP-41C Calculator ..... \$288.00

The System  
Memory Modules. For storing programs or up to 2,000 lines of program memory ..... \$45.00  
"Extra Smart" Card Reader. Records programs and data back onto blank mag-cards ..... \$199.00  
The Printer. Upper and Lower case, High resolution plotting, Portable Thermal operation ..... \$355.00  
Application Modules ..... \$45.00 EACH

Standard pac:  
Statistics,  
Math,  
Financial &  
Surveying



### TI CALCULATORS -

The TI Programable Calculator —  
**Super Sale \$229.00**

### NOVATION CAT™ ACOUSTIC MODEM

- Answer Originate
- 300 Baud
- Bell 108
- Low Profile Design

Looks good, works great! ..... \$179.00



### Texas Instruments TI-99/4 Home Computer

Save \$300 on this 16-Bit computer with monitor

TI-99/4 w/Monitor ..... \$889  
TI-99/4 w/o Monitor ..... \$725

Circle 343 on inquiry card.

★ **COMPU MART NOW OFFERS THE ENTIRE DEC LSI-11 PRODUCT LINE CALL FOR PRICES & DELIVERY.**

# Computers

## BUY-OF-THE-MONTH Apple III is Here

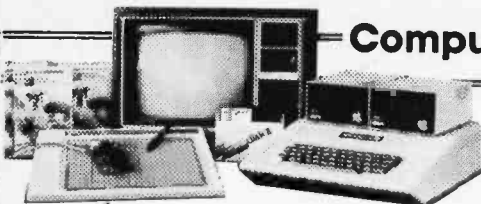

**apple computer**

- Brand New From Apple for the Apple II**
- DOS 3.3 Convert disks to 16 sector format for 23% more storage and faster access **\$60**
  - Apple Plot. The perfect graphic complement for Visicalc. **\$70**
  - Dow Jones News & Quotes **\$95**
  - Adventure **\$35**
  - DOS Tool Kit **\$75**
  - Apple Fortan **\$200**

### New From Videx! — Video Term.

- 80 column by 24 line 7 x 9 matrix — plug in compatible board for the Apple II. Price: \$325 w/o graphics EPROM
- Options: Graphics EPROM **\$25**
  - Video Switch Plate, inserts between Apple II Video and vidoterm board **\$12**

### NEW FROM MUSE FOR YOUR APPLE II

- The Voice **\$39.95**
- Super Text **\$99.00**
- Address Book **\$49.95**
- S.S.M. Serial & Parallel Apple Interface **\$225**
- NEW! ABT's Numeric Key pad **\$110**
- C.C.A. Data Management Program for Apple II **\$ 99**

- New from Mountain Hardware — Expansion Accessories for Your Apple.**
- Introl/X-10 System **\$289**
  - Super Talker **\$299**
  - The Music System **\$545**
  - ROM plus board w/ Keyboard filter **\$199**
- New from Microsoft — The Z-80 Softcard \$349**

- Apple III Accessories**
- Silentye Thermal Printer **\$525**
  - Disk III **\$545**
  - 12" B&W Monitor **\$320**
  - Vinyl Carry Case **\$ 75**

We have a complete inventory of Apple computers, peripherals and software

### Introducing the HP-85 \$3,145



Hewlett-Packard's Personal Computer for Industry. This extremely portable computer features extended BASIC to solve your problems quickly and efficiently along with an advanced graphics system to enhance communication.

**NEW from Hewlett-Packard**  
HP 82900-Series Flexible Disk Drives for the HP-85

- These 4 new Flexible Disk Drives provide fast on-line storage using flexible disks
- \* HP 82901M. Supplies approx. 540K bytes of on-line storage. **\$2,500**
  - \* HP 82902M. Approx. 270K bytes of on-line storage. **\$1,500**
  - \* HP 82901S. Supplies an additional 540K bytes when connected to an HP 82901M or an HP 82902M. **\$2,200**
  - \* HP 82902S. Supplies an additional 270K bytes when connected to an HP 82901M or an HP 82902M. **\$1,300**

The Hewlett-Packard 7225A. High Quality/Low Cost Graphics Plotter. **\$2,050**

Call our expert sales force for complete product specifications.



and We've Got It!

**Apple III System Packages**

Apple III Information Analyst Option A. Includes: Apple III System with 96K RAM memory, Information analyst configuration package, 12" B&W monitor for Apple III **\$4,340**

Apple III Information Analyst Option B. Same as Option A plus: Disk 11 for Apple III **\$4,885**

Apple III Information Analyst Option C. Same as Option A plus: Disk 11 for Apple III, Silentye Thermal Printer for Apple III **\$5,410**

**Apple III Software**

- Visicalc III **\$250**
- Mail List Manager **\$250**
- Business Basic **\$250**
- PASCAL **\$250**
- FORTRAN **\$250**
- System Software & Manuals **\$250**

### Super Sale on Exidy Sorcerer

|                      | List Price | Sale! |
|----------------------|------------|-------|
| 16K Sorcerer         | \$1,295    | \$999 |
| Parallel Data Cable  | \$35       | \$20  |
| Development PAC      | \$99       | \$85  |
| Word Processing PAC  | \$199      | \$169 |
| S-100 Expansion Unit | \$419      | \$389 |

Lots of other Sorcerer accessories in stock at low prices — CALL!

### ROCKWELL AIM 65

The single board development system that's perfect in the classroom or lab.

Our AIM System includes: 4K AIM with BASIC Interpreter assembler, Power Supply, Cassette recorder & Enclosure **\$799.**

- 4K AIM — 65 **\$499**
- PL65 High Level Language **\$125**
- Paper for the AIM (roll) **\$ 2.50**
- Rockwell's 4-slot Motherboard (SALE) **\$175**

CompuMart's Microflex 65 System for your AIM Includes: Adapter Buffer Module w/ 4-slot module stack, 8K RAM module, 16K PROM/ROM module, Asynchronous communications Interface, & Power Supply **\$1,299**

Call or write for our complete Microflex 65 brochure

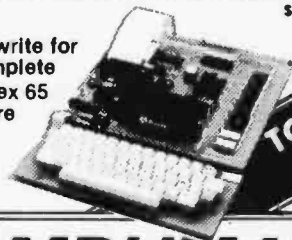

★ **CompuMart stocks the complete line of MATROX PRO. PRODUCTS. CALL FOR SPECS.**



### Zenith Z-89

The All-In-One-Computer  
This is the famous computer system which takes up no more space than a terminal alone. The 12" screen is beautiful and lends itself perfectly to professional applications thanks to its 25 lines of 80 characters. We know of no other computer which gives you this many features at such a low price.

- Zenith 48K Z-89 Dual Port **List \$2,895**  
**CompuMart \$2,695**
- Z-19 Smart Video Terminal **List \$995**  
**CompuMart \$895**



### COMMODORE

Buy Direct from the largest Commodore dealer in the country, and the very first Commodore distributor in the U.S. Buy from the experts. Buy from CompuMart.

Commodore — We have everything that Commodore manufactures. In stock for Immediate Delivery!

Call CompuMart now for low prices and special deals.

### ATARI 800 Personal Computer System.

Comes with 800 Operators Manual, 16K RAM Memory module, 10K ROM Operating System, power supply, TV Switch Box. **\$1080**

### PERIPHERALS

- Atari 410 Program Recorder (FREE w/ purchase of Atari 800) **\$89.95**
  - Atari 810 Disk Drive **\$899.95**
  - New Dual Disk double density **\$1499.95**
  - 825 Printer (Centronics 737) **\$995.00**
  - RS232 interface w/ Cable **\$249.95**
  - NEW! Light Pens **\$74.95**
- Call for New Software



### IMPORTANT ORDERING INFORMATION

All orders must include 4% shipping and handling. Mass residents add 5% sales tax. Mich. residents 4% for sales tax.

Phones open from 8:30 a.m. to 5:30 p.m. EST, Mon.-Fri. • P.O.'s accepted from D&B rated companies — shipment contingent upon receipt of signed purchase order • All prices are subject to change without notice • Most items in stock for immediate shipment — call for delivery quotation • In the Arin Arbor area? Our retail store is open 11:00 a.m. to 7:00 p.m. Tues.-Fri., 10:00 a.m. to 5:00 p.m. Saturdays (closed Sun. and Mon.)

**TO ORDER CALL: 800-343-5504**  
In Mass. call 1-617-491-2700

Circle 343 on inquiry card.

# COMPUMART

270 THIRD STREET, DEPT 110 CAMBRIDGE, MA. 02142



**Notice  
The  
Difference**



**At HOBBYWORLD the difference is service.**

Our proud tradition is built on serving our customer's needs. Starting with honest and friendly customer relations, HOBBYWORLD is also dedicated to maintaining an in-stock availability of state-of-the-art products, at competitive prices. Our service continues with careful attention to shipping and handling your orders in compliance with all the FTC mail-order regulations.

**HOBBYWORLD is your electronics "shopping-center".**

We bring to you the largest selection of electronics equipment that can be found anywhere, and all under one roof. Our vast inventory includes: computer systems & peripherals, computerized toys & games, disks & diskettes, application boards, integrated circuits & electronics parts... almost anything you need, HobbyWorld has it! We also stock an extensive library of comprehensive software & books.

**Two convenient showrooms.**

Whether you live in southern California, or are visiting the Los Angeles area, we encourage you to come in and experience this progressive field of business, entertainment and technology. We also offer

non-technical "mini-course" seminars for business people, professionals and prospective home users who may be considering their first computers.

**Notice the difference!**

Call us toll-free and ask for your free product catalog, or circle the readers service inquiry number in this magazine... or fill out the information below and send to:

**HOBBYWORLD ELECTRONICS, INC.  
19511 Business Ctr. Dr. Dept. B10  
Northridge, California 91324**

**FREE HOBBYWORLD CATALOG**

Name \_\_\_\_\_  
Company \_\_\_\_\_  
Address \_\_\_\_\_  
City \_\_\_\_\_ State \_\_\_\_\_  
Zip \_\_\_\_\_

*Service makes the difference.*

**HOBBYWORLD  
ELECTRONICS, INC.**

Toll-Free: USA (800) 423-5387  
Toll-Free: Calif. (800) 382-3651  
Local & Outside USA: (213) 886-9200

# Get the inside copy of CP/M\*

Just purchase a Jade Double-D or CCS double density disk controller this month and CP/M\* 2.2 is yours for free.

## S-100 Boards

### DOUBLE-D - Jade

Double density disk controller with the inside track  
 IOD-1300K Kit & CP/M 2.2 ..... \$395.00  
 IOD-1300A 8" A & T & CP/M 2.2 .. \$469.00  
 IOD-1305A 5 1/4" A & T & CP/M 2.2 \$469.00  
 IOD-1200B Bare board ..... \$55.00

### DOUBLE DENSITY - Cal Comp Sys

5 1/4" or 8" disk controller with free CP/M 2.2  
 IOD-1400A A & T ..... \$374.95

### THE BIG Z - Jade

2 or 4 MHz switchable Z-80 CPU with serial I/O  
 CPU-30201K Kit ..... \$145.00  
 CPU-30201A A & T ..... \$199.00  
 CPU-30200B Bare board ..... \$35.00

### SBC-100 - SD Systems

2.5 MHz Z-80 CPU with serial & parallel I/O ports  
 CPC-30100K Kit ..... \$269.95  
 CPC-30100A Jade A & T ..... \$339.95

### SBC-200 - SD Systems

4 MHz Z-80 CPU with serial & parallel I/O ports  
 CPC-30200K Kit ..... \$299.95  
 CPC-30200A Jade A & T ..... \$375.00

### CB2 - S.S.M.

2 or 4 MHz switchable Z-80 CPU with RAM, ROM, & I/O  
 CPU-30300K Kit ..... \$239.95  
 CPC-30300A A & T ..... \$299.95

### 2810 Z-80 CPU - Cal Comp Sys

2 1/4 MHz Z-80A CPU w/serial I/O port  
 CPU-30400A A & T ..... \$275.00

### ExpandoRAM I - SD Systems

2.5 MHz RAM board expandable from 16K to 64K  
 MEM-16130K 16K kit ..... \$245.00  
 MEM-16130A 16K Jade A & T ..... \$295.00  
 MEM-32131K 32K kit ..... \$275.00  
 MEM-32131A 32K Jade A & T ..... \$325.00  
 MEM-48132K 48K kit ..... \$305.00  
 MEM-48132A 48K Jade A & T ..... \$355.00  
 MEM-64133K 64K kit ..... \$335.00  
 MEM-64133A 64K Jade A & T ..... \$385.00

### 64K RAM BOARD \$359.95

### ExpandoRAM II - SD Systems

4 MHz RAM board expandable from 16K to 256K  
 MEM-16630A 16K kit ..... \$249.95  
 MEM-16630A 16K Jade A & T ..... \$299.95  
 MEM-32631K 32K kit ..... \$289.95  
 MEM-32631A 32K Jade A & T ..... \$339.95  
 MEM-48632K 48K kit ..... \$324.95  
 MEM-48631A 48K Jade A & T ..... \$374.95  
 MEM-64633K 64K kit ..... \$359.95  
 MEM-64633A 64K Jade A & T ..... \$409.95

### 32K STATIC RAM BOARD \$249.95

### 16K STATIC RAM BOARD \$149.95

### 32K STATIC RAM - Jade

2 or 4 MHz expandable static RAM board uses 2114L's  
 MEM-16151K 16K 4 MHz kit ..... \$149.95  
 MEM-16151A 16K 4 MHz A & T ..... \$199.95  
 MEM-32151K 32K 4 MHz kit ..... \$249.95  
 MEM-32151A 32K 4 MHz A & T ..... \$299.95

16K STATIC RAM - Cal Comp Sys  
 2 or 4 MHz 16K static RAM - a real memory bargain  
 MEM-16160K 16K 2 MHz kit ..... \$249.95  
 MEM-16160A 16K 2 MHz A & T ... \$279.00  
 MEM-16162K 16K 4 MHz kit ..... \$279.95  
 MEM-16162A 16K 4 MHz A & T ... \$309.00  
 MEM-16160B Bare board ..... \$29.95

### PB-1 - S.S.M.

2708, 2716 EPROM board with built-in programmer  
 MEM-99510K Kit ..... \$159.95  
 MEM-99510A A & T ..... \$239.95

### PROM-100 - SD Systems

2708, 2716, 2732, 2758, & 2516 EPROM programmer  
 MEM-99520K Kit ..... \$175.00  
 MEM-99520A Jade A & T ..... \$225.00

### 32K BYTESAVER - Cromemco

32K EPROM board with on-board 2716 programmer  
 MEM-32550A A & T ..... \$295.00

### I/O-4 - S.S.M.

2 serial I/O ports plus 2 parallel I/O ports  
 IOI-1010K Kit ..... \$179.95  
 IOI-1010A A & T ..... \$259.95  
 IOI-1010B Bare board ..... \$35.00

### BIT STREAMER II - Vector Graphic

3 serial I/O ports plus 2 parallel I/O ports  
 IOI-1025A A & T ..... \$259.00

### CB-1 - Mullen

S-100 controller for up to 8 external devices  
 IOC-1100K Kit ..... \$119.95  
 IOC-1100A A & T ..... \$169.95

### 100K DAY CLOCK - Mtn Hardware

Crystal controlled S-100 clock with NiCad backup  
 IOK-1400A A & T ..... \$329.95

### SB1 - S.S.M.

15 Hz to 25K Hz music synthesizer for S-100  
 IOS-1005K Kit ..... \$239.95  
 IOS-1005A A & T ..... \$299.95

### TB-4 - Mullen

Extremely versatile extender board with logic probe  
 TSX-180K Kit ..... \$55.00  
 TSX-180A A & T ..... \$75.00

### TERMINATOR & EXTENDER - C.C.S.

Can be used as both an S-100 extender and terminator  
 TSX-150K Kit ..... \$39.95

### S-100 EXTENDER - Cal Comp Sys

Puts problem boards within easy reach  
 TSX-160A A & T ..... \$24.95

### VERSAFLOPPY I - SD Systems

Versatile floppy disk controller for 8" or 5 1/4"  
 IOD-1150K Kit ..... \$219.95  
 IOD-1150A Jade A & T ..... \$269.95

### VERSAFLOPPY II - SD Systems

New double density controller for both 8" & 5 1/4"  
 IOD-1160K Kit ..... \$309.95  
 IOD-1160A Jade A & T ..... \$369.95

### S-100 PROTO BOARD - Jade

Universal design, plated thru holes, gold fingers  
 TSX-140B Bare board ..... \$24.95

### 2708/2716 EPROM BOARD - Jade

Holds up to 16 EPROMs, addressable on 1K banks  
 MEM-16230K Kit ..... \$69.95  
 MEM-16230A A & T, no PROMs ..... \$99.95  
 MEM-16230B Bare board ..... \$30.00

### 8K RAM BOARDS - Special Sale

Uses 21L02 RAM chips  
 2 boards & manual for ..... \$30.00

### VDB-8024 - SD Systems

80 x 24 I/O mapped video board with keyboard I/O  
 IOV-1020K Kit ..... \$339.95  
 IOV-1020A Jade A & T ..... \$399.95

### VB3 - S.S.M.

80 x 24 or 80 x 48 memory mapped with graphics  
 IOV-1095K Kit, 4 MHz ..... \$399.95  
 IOV-1095A A & T, 4 MHz ..... \$464.95  
 IOV-1096K 80 x 48 upgrade, 4 MHz ..... \$89.00

### VIDEO BOARD - Jade

64 x 16 assembled & tested S-100 video board  
 IOV-1050B Bare board ..... \$29.95  
 IOV-1050A A & T sale price ..... \$99.95

## Single Board Computers

### AIM-65 - Rockwell

6502 computer with printer, display, & keyboard  
 CPK-50165 1K AIM ..... \$374.95  
 CPK-50465 4K AIM ..... \$449.95  
 SFK-74600008E 8K BASIC ROM ... \$99.95  
 SFK-64600004E 4K assembler ROM \$84.95  
 PSX-030A Power supply ..... \$59.95  
 ENX-000002 Enclosure ..... \$49.95  
 4K AIM, 8K BASIC, power supply, & enclosure  
 Special package price ..... \$599.00

### Z-80 STARTER KIT - SD Systems

Z-80 computer with RAM, ROM, I/O, & keyboard  
 CPS-30010K Kit ..... \$319.95  
 CPS-30010A Jade A & T ..... \$399.95

## Video Monitors

### VIDEO 100 - Leedex

12" B & W video monitor with 12 MHz bandwidth  
 VDM-801210 ..... \$139.95

### VIDEO 100-80 - Leedex

81 x 24" version of Video 100 with metal cabinet  
 VDM-801230 ..... \$179.95

### 9" B & W MONITOR - A.P.F.

High quality, high resolution video monitor  
 VDM-750900 9" monitor ..... \$149.95

### 13" COLOR MONITOR - Zenith

The hi res color you've been promising yourself  
 VDC-201301 ..... \$449.00

### 12" GREEN SCREEN - NEC

20 MHz, P31 phosphor video monitor with audio  
 VDM-651200 12" monitor ..... \$249.95

## Software

### SDOS - SD Systems

DOS, CBASIC2, Z-80 assembler/editor/linker  
 SFX-55001000D Manual set ..... \$24.95  
 SFX-55001002M 5 1/4" disks & man \$149.95  
 SFX-55001006F 8" disk & manual \$149.95

### CP/M 2.2 - Digital Research

Latest & most powerful release of CP/M  
 SFC-52506000D Manual set ..... \$24.95  
 SFC-52506000M 5 1/4" disk & manual \$149.95  
 SFC-52506000F 8" disk & manual \$149.95

\*CP/M is a registered trademark of Digital Research Corp.

All royalties paid by Jade Computer Products and California Computer Systems.

# track and a free 2.2 to boot !!!

## Accessories for Apple

### 16K MEMORY UPGRADE

Add 16K of RAM to your TRS-80, Apple, or Exidy  
**MEX-16100K TRS-80 kit** ..... \$39.95  
**MEX-16101K Apple kit** ..... \$39.95  
**MEX-16102K Exidy kit** ..... \$39.95

### DISK DRIVE for APPLE

5 1/4" disk drive with controller for your Apple  
**MSM-12310C with controller** ..... \$575.00  
**MSM-123101 w/out controller** ..... \$475.00

### 8" DRIVES for APPLE

Controller, DOS, two 8" drives, cabinet, & cable  
**Special package price** ..... \$1475.00

### AIO - S.S.M.

Parallel & serial interface for your Apple  
**IOI-2050K Kit** ..... \$159.00  
**IOI-2050A A & T** ..... \$199.00

### APPLE CLOCK - Cal Comp Sys

Real time clock w/battery back-up  
**IOK-2100A A & T** ..... \$125.00

### SUPERTALKER - Mtn Hardware

Speech recognition/synthesizer w/speaker & mike  
**IOS-2015A A & T** ..... \$275.00

### Z-80 CARD for APPLE

Z-80 CPU card with CP/M for your Apple  
**CPX-30800A A & T** ..... \$298.00

### MICROMODEM - D.C. Hayes

Auto answer/dial modem card for Apple or S-100  
**IOM-2010A Apple modem** ..... \$349.95  
**IOM-1100A S-100 modem** ..... \$375.00

## Printers

### BASE 2 - Impact Printer

132 cps, bi-directional, tractor feed, & graphics  
**PRM-13100** ..... \$675.00

### DP-9501 - Anadex

9 x 11 dot matrix, 220 column, 200 cps, & graphics  
**PRM-10501 Standard DP-9501** ..... \$1495.00  
**PRM-10511 with graphics & 2K** .. \$1595.00

### LP-80 - Matchless

9 x 7 matrix, 132 column, 125 cps, bi-directional  
**PRM-37204** ..... \$775.00

### PAPER TIGER - Integral Data

132 column, parallel & serial, 150 cps, graphics  
**PRM-33440 IDS-440** ..... \$950.00  
**PRM-33441 IDS-440 w/graphics** .. \$1050.00

### MILOT - Watanabe Instruments

Intelligent graphics plotter uses 7 bit ASCII code  
**PRP-10800** ..... \$1075.00

### SPINWRITER - NEC

65 cps, bi-directional, letter quality with tractor  
**PRD-55510 with 2K buffer** ..... \$2695.00

### NOVATION CAT

300 baud, auto answer/originate acoustic modem  
**IOI-5200A Special sale price** ..... \$149.00

### EPROM ERASER - L.S.Engineering

UV eraser for up to 48 EPROMs  
**XME-3200 A & T** ..... \$39.95

### TV-1 - Best Buy

The inexpensive alternative to video monitors  
**IOR-5040K Kit** ..... \$8.95

**Call for your free 1980 catalog**

## Disk Drives

### JADE DISK PACKAGE

Double-D controller kit, two 8" double density drives  
 CP/M 2.2, cabinet, power supply, & cables  
**Special package price** ..... \$1395.00

### DUAL 8" DRIVES - Jade

A pair of double density Shugarts in a cabinet  
**MSF-12800R 2 single sided** ..... \$995.00  
**MSF-125202 2 double sided** ..... \$1425.00

### 8" DISK DRIVES

Highly reliable double density floppy disk drives  
 Shugart 801R single sided, double density  
**MSF-10801R SA-801R** ..... \$425.00  
**Special Sale Price** ..... 2 for \$800.00  
 Qume Datatrak 8 double sided, double density  
**MSF-750080 851R compatible** ..... \$625.00

### DISKETTES - Jade

Bargain prices on magnificent magnetic media  
 5 1/4" single sided, single density, box of 10  
**MMD-5110103 Soft sector** ..... \$27.95  
**MMD-5111003 10 sector** ..... \$27.95  
**MMD-5111603 16 sector** ..... \$27.95  
 5 1/4" double sided, double density, box of 10  
**MMD-5220103 Soft sector** ..... \$39.95  
 8" single sided, single density, box of 10  
**MMD-8110103 Soft sector** ..... \$33.95  
 8" single sided, double density, box of 10  
**MMD-8120103 Soft sector** ..... \$55.95  
 8" double sided, double density, box of 10  
**MMD-8220103 Soft sector** ..... \$57.95

### FLOPPY SAVERS - Tri-Star

Protect your valuable software from spindle damage  
**MMA-205 5 1/4" kit** ..... \$13.95  
**MMA-208 8" kit** ..... \$15.95

## Motherboards

### ISO-BUS - Jade

Silent, simple, and on sale - a better motherboard  
 6 Slot (5 1/4" x 8 3/4")  
**MBS-061B Bare board** ..... \$19.95  
**MBS-061K Kit** ..... \$39.95  
**MBS-061A A & T** ..... \$49.95  
 12 Slot (9 1/4" x 8 3/4")  
**MBS-121B Bare board** ..... \$29.95  
**MBS-121K Kit** ..... \$69.95  
**MBS-121A A & T** ..... \$89.95  
 18 Slot (14 1/2" x 8 3/4")  
**MBS-181B Bare board** ..... \$49.95  
**MBS-181K Kit** ..... \$99.95  
**MBS-181A A & T** ..... \$139.95

## Mainframes

### MAINFRAME - Cal Comp Sys

12 slot S-100 mainframe with 20 amp power supply  
**ENC-112105 Kit** ..... \$309.95  
**ENC-112106 A & T** ..... \$349.95

### DISK MAINFRAME - NNC

Dual 8" drive cutouts with 8 slot motherboard  
**ENS-112320 with 30 amp p.s.** ..... \$699.95

### KIM-1 - Commodore

6502 computer with RAM, ROM, I/O, & keyboard  
**CPK-50010A A & T** ..... \$175.00

### SYM-1 - Synertek

6502 computer with RAM, ROM, I/O, & keyboard  
**CPK-5002A A & T** ..... \$249.95

### MICROPROCESSORS

|           |       |         |
|-----------|-------|---------|
| Z-80      | ..... | \$10.95 |
| Z-80A     | ..... | \$12.95 |
| 6502      | ..... | \$11.50 |
| 6800      | ..... | \$11.95 |
| 6802      | ..... | \$17.95 |
| 6809      | ..... | \$39.95 |
| 8035      | ..... | \$24.00 |
| 8035-8    | ..... | \$24.00 |
| 8080A     | ..... | \$ 6.50 |
| 8085      | ..... | \$15.95 |
| TMS990011 | ..... | \$39.95 |

### PROMS

|              |         |
|--------------|---------|
| 2708 (450ns) | \$ 8.95 |
| 2716 (450ns) | \$19.95 |
| 2716 (5v)    | \$19.95 |
| 2732 (5v)    | \$95.00 |
| 2758 (5v)    | \$19.95 |

### RAMS

|                |       |          |
|----------------|-------|----------|
| 211.02 (2 MHz) | ..... | \$ 1.25  |
| 211.02 (4 MHz) | ..... | \$ 1.50  |
| 211.4L (2 MHz) | ..... | \$ 3.75  |
| 211.4L (4 MHz) | ..... | \$ 3.95  |
| 4116           | ..... | \$ 4.95  |
| 4127 (70ns)    | ..... | \$ 39.95 |
| 4164 (64K x 1) | ..... | \$175.00 |
| 5257 (2 MHz)   | ..... | \$ 6.75  |
| 5257 (4 MHz)   | ..... | \$ 7.25  |

### SUPPORT DEVICES

|      |       |         |
|------|-------|---------|
| 8212 | ..... | \$ 4.95 |
| 8214 | ..... | \$ 4.65 |
| 8216 | ..... | \$ 2.95 |
| 8224 | ..... | \$ 3.25 |

### UARTS

|        |         |           |           |
|--------|---------|-----------|-----------|
| 8224-4 | \$10.95 | AY5-1013A | .. \$8.25 |
| 8226   | \$ 3.85 | AY3-1014A | .. \$8.25 |
| 8228   | \$ 4.95 | TR1602B   | .. \$5.25 |
| 8238   | \$ 4.95 | TMS6011   | .. \$5.95 |
| 8243   | \$ 8.00 | IM6403    | .. \$9.00 |

### BAUD RATE GENERATORS

|         |       |         |
|---------|-------|---------|
| MC14411 | ..... | \$10.00 |
| CRYSTAL | ..... | \$ 4.95 |

### Z80 SUPPORT

|             |       |         |
|-------------|-------|---------|
| 3881 (PIO)  | ..... | \$ 9.50 |
| 3881-4      | ..... | \$11.95 |
| (PIO-4 MHz) | ..... | \$14.50 |
| 3882 (CTC)  | ..... | \$ 9.50 |
| 3882-4      | ..... | \$14.95 |
| (CTC-4 MHz) | ..... | \$14.95 |
| 3883 (SIO)  | ..... | \$29.50 |
| 3884 (SIO)  | ..... | \$49.50 |

### 6800 SUPPORT

|        |       |         |
|--------|-------|---------|
| 6821P  | ..... | \$ 5.95 |
| 6828P  | ..... | \$11.95 |
| 6834P  | ..... | \$12.95 |
| 6840P  | ..... | \$18.75 |
| 6850P  | ..... | \$ 4.80 |
| 6852P  | ..... | \$ 5.79 |
| 6875L  | ..... | \$ 7.40 |
| 68488P | ..... | \$25.00 |

## PLACE ORDERS

### TOLL FREE

Inside California Continental U.S.  
 800-262-1710 800-421-5500

For customer service  
 or technical inquiries call 213-973-7707

Write for our FREE 1980 catalog

## JADE COMPUTER PRODUCTS

4901 W. Rosecrans, Hawthorne, CA 90250

**TERMS OF SALE:** Cash, checks, credit cards money orders or from recognized institutions. Purchase orders accepted. Minimum order \$10.00. California residents add 6% sales tax. Minimum shipping and handling charge \$2.50. Prices are for U.S. and Canadian delivery only and are subject to change without notice. For export prices and information send for a **JADE INTERNATIONAL CATALOG.**



# Computers, Disk Systems

## SUPERBRAIN<sup>™</sup> By INTERTEC



32K or 64K (Double or Quad Density units available). Uses two Z-80 CPU's. Commercial-type terminal with 12" monitor. Dual double density minifloppies. Over 350 kilobytes of storage (twice that with quad density drives). Two serial RS232 ports, I/O ports standard. Expandable with optional S-100 S-100 interface. Comes with CP/M<sup>™</sup> 2.2 operating system. MiniMicroMart includes BASIC interpreter and can supply a wide range of CP/M Development and Application software.

w/32K Double Density, List \$2995. **\$2685**  
w/64K Double Density, List \$3345. . . . . **\$2883**  
w/64K Quad Density, List \$3995. . . . . **\$3595**  
W/64K Quad — MiniMicroMart  
Upgrade Special. . . . . **\$3395**

## MICROMATION



A 64K complete computer with dual density 8" floppies (1 megabyte). Rack or vertical mounting. Systems with double-sided drives, hard disks, and multi-user (MP/M).

Z+ 100 64K RAM, Computer, \$2495. . **\$2099**  
Z+ 120 Includes two 8" disks, \$4995. . . **\$4199**  
"Z" system features new distributed processing multi-user concept with one Z-80 per user, with Z-80 for MP/M (Master Satellite concept).

**AS LOW AS \$11,899!**

## SD SYSTEMS

SDS-100, w/32K RAM, \$6995. . . . . **\$5945**  
SDS-200, List \$8995. . . . . **\$7645**

## RADIO SHACK TRS-80<sup>™</sup>

**10% OFF!**



## INTERSYSTEMS formerly ITHACA AUDIO



DPS-1, List \$1795

**Call for Price!**

The new Series II CPU Board features a 4 MHz Z-80A CPU and a full-feature front panel. 20-slot actively terminated motherboard, with 25 amp power supply (50/60 Hz operation, incl. 68 cfm fan).

**COMPLETE SYSTEM** with InterSystem 64K RAM, I/O Board w/priority interrupt and double density disk controller board. Full 1-year warranty, List \$3595

**Call for Price!**

## HEWLETT-PACKARD HP-85A

Desk-Top  
Computer

**Call  
for  
Price**



## MORROW THINKER TOYS<sup>®</sup> DISCUS M26<sup>™</sup>

26 megabytes of  
formatted storage  
List \$4,995

**\$4,199**



## THINKER TOYS<sup>®</sup> DISK SYSTEMS

Now includes CP/M<sup>®</sup> 2.2

Discus 2D, List \$1199. . . . . **\$1019**

Discus 2D, dual-drive, List \$1994. . . . . **\$1694**

Discus 2+2, Assem., List \$1549. . . . . **\$1319**

Dual Discus 2+2, Assem., \$2748. . . . . **\$2335**

All Morrow systems now include CP/M<sup>®</sup> 2.2

## NORTH STAR DOUBLE DENSITY CONTROLLER BOARDS

Kit, List \$399

**OUR PRICE \$329**

Assembled and Tested, List \$499. . . . . **\$399**

*In Stock — First Time in 2 Years!*

## FANTASTIC SAVINGS on a "QUAD" DENSITY HORIZON UPGRADE

North Star Double Density Controller Board (see above) and a quad density MPI-52 (features superior disk handling and door mechanism).

MDS-H-MQ/K Kit form  
List \$999

**OUR PRICE \$699**

MDS-H-MQ/A Assembled form, List \$1099

**\$759**

Shipping and insurance: Add \$6.

## NORTH STAR MDS-A Double Density Mini Floppy Disk System

Double Density, Kit  
List \$799

**OUR PRICE \$669**

Assembled and Tested. . . . . **\$719**

Quad Version, Kit, List. . . . . **\$836**

Assembled, List \$1099. . . . . **\$896**

Above MDS-A units do not include cabinet or power supply.

Shipping and Insurance: Add \$7.50.

## Super Special!

## North Star Controller Board, Drive, Cabinet, and Power Supply **\$709**

Complete system similar to above but also includes a cabinet and an assembled/tested power supply for the drive (silver finish). Your choice of Shugart SA-400 or MPI-51 Double Density Drive or MPI-52 quad density drive (MPI drives feature improved door and disk handling mechanism).

w/Controller Bd. kit, SA-400. . . . . **\$709**

w/Controller Bd. kit, MPI-51. . . . . **\$709**

w/Controller Bd. kit, MPI-52. . . . . **\$809**

w/Assembled Bd. and SA-400. . . . . **\$765**

w/Assembled Bd. and MPI-51. . . . . **\$765**

w/Assembled Bd. and MPI-52. . . . . **\$869**

Shipping and Insurance: Add \$6.

For converting existing Horizon 2 to quad, order additional MPI-52

MPI-52 Quad Density Drive. . . . . **\$379**

Circle 346 on inquiry card.

# Terminals and Printers!

## ELEVIDEO TVI-912C



Upper and lower case, 15 baud rates: 75 to 1,000 baud, dual intensity, 24 x 80 character display, 12 x 10 resolution. Numeric pad. Programmable reversible video, auxiliary port, self-test mode, protect mode, block mode, scrolling, addressable cursor. Microprocessor controlled, programmable underline, line and character insert/delete. "C" version features typewriter-style keyboard. List \$950

**OUR PRICE \$789**

Model 912C (with 11 function keys, 6 edit keys and transmission mode keys, List \$1030

**ONLY \$849**

## SOROC



**IQ-120**

List \$995

**SPECIAL \$729**

IQ-140 List \$1495  
**SPECIAL \$1149**

## TI-810

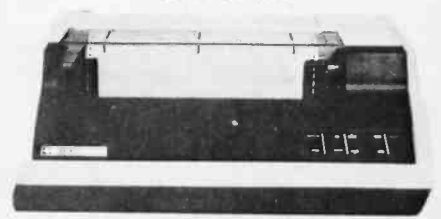

TI-810 Basic Unit, \$1895 . **ONLY \$1695**

TI-810 w/full ASCII (Lower case), vertical forms control, and compressed print . \$1895

TI-745 Complete printing terminal with acoustic coupler, List \$1695 . . . \$1399

## HAZELTINE

1500  
**ONLY \$879**



1410 w/numeric keypad, List \$900 . . . . \$749  
1420 w/lower case and numeric pad . . . . 849  
1510, List \$1395 . . . . . 1089  
1520, List \$1650 . . . . . 1389

## PAPER TIGER®

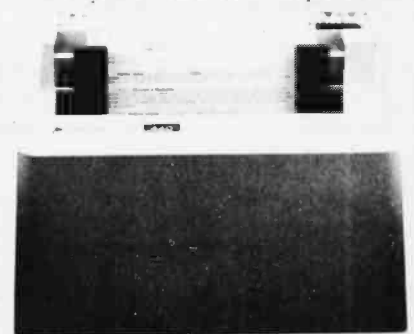

IDS-440 Paper Tiger, List \$995 . **\$895**

w/graphics option, incl. buffer, \$1194 . . \$989

TRS-80 cable . . . . . 45

## Intertec EMULATOR

Software compatible with a Soroc IQ-120, Hazeltine 1500, ADM-3A or DEC VT-52. Features block mode transmission and printer port; "anti-glare screen; 18-key numeric keypad; full cursor control. List \$895

**OUR PRICE \$729**



## Intertec INTERTUBE II

List \$995 **ONLY \$799**

15" display, 24 x 80 format, 18-key numeric keypad, 128 upper/lower case ASCII characters. Reverse video, blinking, complete cursor addressing and control. Special user-defined control function keys, protected and unprotected fields. Line insert/delete and character insert/delete editing, eleven special line drawing symbols.

## BANTAM 550 From Perkin-Elmer



**ONLY \$799**  
with anti-glare CRT  
**ONLY \$829**

## NEC SPINWRITER™



Terminal/Keyboard as well as PRO Printer Only models available.

**CALL FOR PRICES!**

## CENTRONICS PRINTERS

NEW 730, parallel, friction, tractor . . . **\$679**  
NEW 737 parallel, friction, tractor . . . **\$849**  
779-2 w/tractor (same as TRS-80 Line Printer I), List \$1350 . . . . . 1049  
702 120 cps, bi-direct., tractor, VFU . . . 1995  
703 185 cps, bi-direct., tractor, VFU . . . 2395  
704 RS232 serial version of 703, \$2350 . . \$1995

## OKIDATA Microline 80 **ONLY \$649**

Tractor Feed Option . . . . . \$99  
Serial interface . . . . . \$89

**AXIOM IMP I . . . . . \$699**

**COMPRINT 912 w/parallel interf. \$559**  
912 w/serial interface, List \$699 . . . . \$589

**MICROTEK, List \$750 . . . . . \$675**

**ANADEX 80-Col. Dot Matrix. . . . \$849**

Above prices reflect a 2% cash discount (order prepaid prior to shipment). Add 2% to prices for credit card orders, C.O.D.'s, etc. Prices are f.o.b. shipping point. Prices are subject to change and offers subject to withdrawal without notice. **WRITE FOR FREE CATALOG.** Circle 347 on inquiry card.

# MiniMicroMart, Inc.

1618 James Street, Syracuse NY 13203 (315) 422-4467 TWX 710-541-0431



**If North Star or Cromemco offer it . .**

**WE HAVE IT!!**

**Immediate Delivery at Discount Price**



**NORTH STAR  
Horizon® 2**

32K Double Density  
Assembled and Tested  
List \$3095

**ONLY \$2619**

North Star KIT products have been discontinued. MiniMicroMart HAS INVENTORY of most items!

**KITS**

- HORIZON 1 16K, DD . . \$1474
- 32K, DD, List \$1999 . . . . 1684
- 32K, QD, List \$2199 . . . . 1869
- HORIZON 2, 16K, DD . \$1824
- 32K, DD, List \$2399 . . . . 2034
- 32K, QD, List \$2779 . . . . 2359

**ASSEMBLED**

- HORIZON 1, DD . . . . . \$2279
- 32K, QD, List \$2995 . . . . 2539
- HORIZON 2, 32K, DD . \$2619
- 32K, QD, List \$3595 . . . . 3049
- 48K, DD, List \$3590 . . . . 3039
- 48K, QD, List \$4090 . . . . 3469
- 64K, DD, List \$3830 . . . . 3239
- 64K, QD, List \$4330 . . . . 3669

**NORTH STAR APPLICATIONS SOFTWARE**

(Exclusive for use with North Star Disk Systems — specify Double or Quad Density)

- NORTHWORD, List \$399 . . . . . \$339
- MAILMANAGER, List \$299 . . . . . 249
- INFOMANAGER, List \$499 . . . . . 419
- GENERALLEDGER, List \$999 . . . . . 799
- ACCOUNTSRECEIVABLE, List \$599 . . . . . 499
- ACCOUNTSPAYABLE, List \$599 . . . . . 499

**NORTH STAR HARD DISK HD-18**

18 megabytes, plugs into parallel port of North Star Horizon. Utilizes tried-and-proven 14" Century Data Marksman. List \$4999.

**OUR PRICE \$4199**

**NORTH STAR MDS-A — Double (or Quad)**

Density Disk System, Kit, List \$799 . **OUR PRICE \$669**  
Assembled and Tested, List \$899 **SPECIAL \$719**

**NORTH STAR MEMORY BOARDS**

- 16K Dynamic RAM (RAM-16-A/A), Assembled, List \$499 . . . . \$420
- Kit, List \$449 . . . . . **SPECIAL \$299**
- 32K (RAM-32/A), Assembled, List \$739 . . . . . \$620
- Kit, List \$669 . . . . . **ONLY \$499**

SHIPPING AND INSURANCE: Add \$15 or Horizons, \$2.50 for Boards and Software. Hard Disk Systems and Cromemco systems shipped freight collect. Advertised prices are for prepaid orders. Credit card and C.O.D. 2% higher. Deposit may be required on C.O.D. All prices subject to change and are subject to withdrawal without notice.

— WRITE FOR FREE CATALOG —

**MiniMicroMart, Inc.**

1618 James Street, Syracuse, NY 13203 (315) 422-4467

TWX 710-541-0431

**NEW System**

by CROMEMCO

Now with Double Sided Double Density drives (over 2 megabytes of Storage) 64K of RAM List \$739

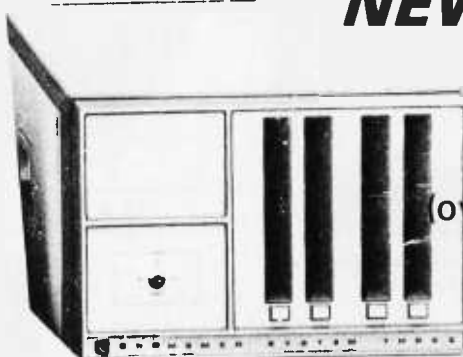

**LIMITED TIME INTRODUCTORY SPECIAL \$6199**

**CROMEMCO SYSTEM 2** — Now features dual sided drives — double the capacity. Similar to System 1 except features dual, double-sided mini floppy drives. List \$3990 . . . . . **ONLY \$3399**

**Z-2 COMPUTER SYSTEM** (can be rack mounted), List \$995 . . . . . \$899

**SINGLE CARD COMPUTER — SCC-W** 4 MHz. List \$450 . . . . . \$399

**NEW COLOR GRAPHICS INTERFACE — SDI** List \$595 . . . . . **OUR PRICE ONLY \$549**

**CROMEMCO HDD** — 11/22-megabyte Hard Disk for use with existing systems. DMA controller. Transfer rate of 5.6 megabytes/second.

HDD-11, List \$6995 . . . . . **OUR PRICE ONLY \$5995**

HDD-22, List \$11,995 . . . . . \$10,995

**CROMEMCO Z-2H**

Full 11-megabyte Hard Disk

system. Fast Z-80

4 MHz processor

two floppy drives,

64K RAM, RS

special interface

printer interface

and extensions

software available

List \$999

**OUR PRICE \$849**



# Try to beat our prices!

## UPERBRAIN<sup>®</sup> by Intertec

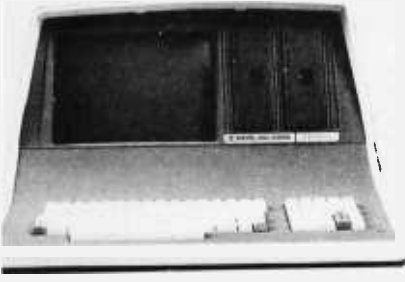

Self-contained computer with dual disks and two RS232C ports. Complete with CP/M<sup>®</sup> 2.2 and BASIC.

16K Double Density, List \$2995 **\$2685**  
 32K Double Density, List \$3345 **\$2883**  
 K MiniMicroMart-upgraded  
 32K Quad Density **SPECIAL \$3395**

## VIDEO TERMINALS

TELETYPE EMULATOR (Intertec), List \$895 **\$ 729**  
 VERTUBE II, List \$995 **ONLY \$ 799**  
 PROLOG 120, List \$995 **SPECIAL \$ 729**  
 Q140, List \$1495 **SPECIAL \$1149**  
 PERKIN-ELMER 550, List \$997 **\$ 799**  
 with anti-glare screen, \$1027 **\$ 829**  
 AZELTINE 1410, List \$900 **\$ 749**  
 420 **\$ 849**  
 500, List \$1225 **\$ 879**  
 510, List \$1395 **\$1089**  
 520, List \$1650 **\$1389**  
 DDS R-20, List \$995 **\$ 945**  
 STAR SIEGLER ADM3A, Assembled **\$ 849**  
 TELEVIDEO 912C, List \$950 **\$ 789**  
 20C, List \$1030 **\$ 849**

## PRINTERS

NADEX DP-8000 **\$ 849**  
 DP-9500, List \$1650 **\$1399**  
 INTEGRAL DATA IP-125 w/1210 **\$ 724**  
 P-225 w/1210 & 1250 op., List \$988 **\$ 834**  
 P-225 w/tractor, 1210, 1250, 1221  
 (2K Buffer), 1241 (graphics) **NOW \$ 899**  
 PAPER TIGER IDS-440, List \$995 **\$ 895**  
 w/graphics op., incl. buffer, \$1195 **\$ 989**  
 EC Spinwriters **Call for Price**  
 TELETYPE 43 KSR **\$1087**  
**CENTRONICS**  
 30-1 parallel interface **NEW LOW \$679**  
 37 parallel interface **SUPER VALUE \$849**  
 79 w/Tractor, List \$1350 **\$1049**  
 102 w/Tractor, VFU, List \$2480 **\$1995**  
 103 w/Tractor, VFU, List \$2975 **\$2395**  
 104 w/Tractor, VFU, List \$2350 **\$1995**  
 810 Basic, List \$1895 **\$1695**  
 10/serial & Centronics-style  
 parallel interface, List \$1940 **\$1735**  
 10 w/full ASCII (U/LC), Vertical  
 Forms Control, Compressed Print **\$1895**  
 820 KSR, List \$2165 **\$1895**  
 745 w/full ASCII, List \$1695 **\$1399**  
 COMPRINT 912 w/parallel interface **\$ 559**  
 12 w/serial interface, List \$699 **\$ 589**  
 MIOM IMP I **\$ 699**  
 CROTEK, List \$750 **\$ 675**  
 KIDATA Microline 80, List \$949 **\$ 649**  
 tractor Feed Option **\$ 99**  
 S232 Serial Interface **\$ 89**

SHIPPING AND INSURANCE: Add \$2.50 for boards, \$6 for Selectric Converter or Floppy Disk Drives, \$7.50 for Floppy Disk Systems, \$15 for Horizon. SHIPPED FREIGHT COLLECT: SuperBrain, Centronics  
 T.I. printers. Contact us for shipping information on other terminals and printers.

Our prices reflect a 2% cash discount (order prepaid prior to shipment). Add 2% to prices for credit card orders, C.O.D.'s, etc. Prices are subject to change and offers subject to withdrawal without notice.

— WRITE FOR FREE CATALOG —

## NORTH STAR HORIZON<sup>®</sup> (Call for North Star Specials)

**HORIZON 1 KITS**  
 16K, Double Density, List \$1749 **\$1474**  
 32K, Double Density, List \$1999 **\$1684**  
 32K, Quad Density, List \$2199 **\$1869**  
**HORIZON 1 ASSEMBLED & TESTED**  
 32K, Double Density, List \$2695 **\$2279**  
 32K, Quad Density, List \$2995 **\$2539**  
**HORIZON 2 KITS**  
 16K, Double Density, List \$2149 **\$1824**  
 32K, Double Density, List \$2399 **\$2034**  
 32K, Quad Density, List \$2779 **\$2359**  
**HORIZON 2 ASSEMBLED & TESTED**  
 32K, Double Density, List \$3095 **\$2619**  
 32K, Quad Density, List \$3595 **\$3049**  
 48K, Double Density, List \$3590 **\$3039**  
 48K, Quad Density, List \$4090 **\$3469**  
 64K, Double Density, List \$3830 **\$3239**  
 64K, Quad Density, List \$4330 **\$3669**

## FLOPPY DISK SYSTEMS

**NORTH STAR MDS-A**  
 Assembled, List \$899 **SPECIAL \$ 719**  
 Kit Version, List \$799 **\$ 669**  
**MORROW THINKER TOYS<sup>®</sup> Discus 2D,**  
 List \$1199 **OUR PRICE \$1019\***  
 Discus 2D, dual-drive, List \$1994 **\$1694\***  
 Discus 2+2, A&T, List \$1549 **\$1319\***  
 Dual Discus 2+2, A&T, List \$2748 **\$2335\***  
 \*Now includes CP/M<sup>®</sup> 2.2  
**MICROMATION Megabox, DD w/**  
 8" drives, 1-megabyte, List \$2295 **\$1949**  
 2-megabyte, List \$3095 **\$2629**  
**MICROPOLIS 1041 MacroFloppy<sup>™</sup>**  
 w/enclosure (no P.S.), List \$695 **\$ 625**  
 1042 MacroFloppy w/case & AC P.S. **\$ 709**  
 1053 Dual MetaFloppy<sup>™</sup>, List \$1895 **\$1695**

## VIDEO BOARDS

I/O Mapped  
**SD COMPUTER VDB-8024, kit, List \$370 \$319 †**  
 Assembled, List \$470 **\$ 399 †**  
**XITEX SCT-100K, Kit **ONLY \$154.95****  
 SCT-100A Assembled **\$174.95**  
**SSM VB2 I/O, Kit, List \$169 **\$ 144****  
 Assembled & Tested, List \$234 **\$ 199**  
 Memory Mapped  
**SSM VB1C, 16x64, Kit, List \$179 **\$145****  
 Assembled & Tested, List \$242 **\$196**  
**SSM VB3, 80-Char., 4MHz, Kit, List \$399 **\$ 339****  
 4 MHz, A&T, List \$464 **\$ 394**  
**INTERSYSTEMS, 16x64, A&T, List \$165 \$149**

## ESCON CONVERSION FOR IBM SELECTRIC

Complete w/microprocessor controller and power supply. Factory built. User installs solenoid assembly or it can be done at Esccon factory at nominal cost.

Parallel (TRS-80, Sorcerer, etc.), \$575 **\$514**  
 RS232 Standard Serial, List \$599 **\$534**  
 IEEE-488 (for PET), List \$660 **\$584**  
 TRS-80 Cable **\$ 25**

## CPU BOARDS

(assembled unless noted)

**NORTH STAR Z80A (ZPB-A/A), \$299 \$254**  
**CROMEMCO 4 MHz (ZPU-W), List \$395 \$335**  
 4 MHz (SCC-W), List \$450 **\$382**  
**INTERSYSTEMS (formerly Ithaca Audio)**  
 new Series II Z-80, 4 MHz, List \$395 **\$349**  
**SSM CB1 8080 A&T, List \$219 **\$186****  
 CB1A Kit, List \$159 **\$135**  
 CB2 Z-80, A&T, List \$275 **\$234**  
 CB2 Kit, List \$210 **\$179**  
**DELTA Z-80, with I/O **\$289****  
**SD SBC-100, List \$350 **\$298 †****  
 SBC-100 Kit, List \$295 **\$250 †**  
 SBC-200, List \$400 **\$332 †**  
 SBC-200 Kit, List \$320 **\$272 †**

## MEMORY BOARDS

**32K SD ExpandoRAM Kit  
 ONLY \$249<sup>†</sup>**

ONLY \$159 without RAM chips

† Get \$25 rebate from SD Computer when you buy any of their products prior to October 31, 1980.

**NORTH STAR 16K Dynamic RAM Board,**  
 A&T (RAM-16-A/A), List \$499 **\$420**  
 16K Kit Version, List \$449 **SPECIAL \$299**  
 32K A&T (RAM-32/A), List \$739 **\$620**  
 32K Kit, List \$669 **SPECIAL \$499**  
**CROMEMCO 16KZ-W, List \$495 **\$419****  
 64KZ-W, List \$1795 **\$1485**  
**MEASUREMENT SYSTEMS & CONTROLS**  
 (Guaranteed performance, incl. labor/parts 1 yr)  
 DM6400 64K Board w/all 64K, \$795 **\$659**  
 DM4800 with 48K, List \$695 **\$589**  
 DM3200 with 32K, List \$595 **\$509**  
 DMB6400 64K Board w/all 64K **\$859**  
 DMB4800 with 48K **\$789**  
**MORROW SuperRAM — all static, all A&T**  
 16K, 4 MHz or 2 MHz, List \$349 **\$299**  
 32K, 4 MHz, List \$699 **\$629**  
 16K Memory Master, List \$399 **\$339**  
 24K Memory Master, List \$549 **\$465**  
**INTERSYSTEMS (formerly Ithaca Audio)**  
 8K Static 2 MHz, A&T, List \$165 **\$149**  
 8K Static 4 MHz, A&T, List \$195 **\$176**  
 16K Static 2 MHz, A&T, List \$475 **\$427**  
 16K Static 4 MHz, A&T, List \$495 **\$445**  
 64K Dynamic, List \$995 **\$895**  
**CALIFORNIA COMPUTER**  
 16K Static, A&T, List \$349.95 **\$259**

## FLOPPY DISK CONTROLLER BOARDS

**NORTH STAR, DD, Kit, List \$399 **\$329****  
 Assembled, List \$499 **\$399**  
**MORROW Disk Jockey 1, A&T (\$213) **\$189****  
 Disk Jockey 2D, A&T, List \$479 **\$429**  
**SD Versafloppy 1, Kit, List \$250 **\$212 †****  
 Versafloppy II, DD Kit, List \$350 **\$297 †**  
 Versafloppy II, DD, A&T, List \$430 **\$365 †**  
**DELTA double density A&T (\$385) **\$345****  
**CONDUCTOR, double density A&T **\$269****  
**INTERSYSTEMS FDC-2, A&T, \$495 **\$439****  
**MICROMATION Doubler, DD, A&T **\$399****  
**TARBELL Floppy Disk Interface Kit **\$199****  
 double density, A&T, List \$495 **\$444**

# MiniMicroMart, Inc.

1618 James Street, Syracuse NY 13203 (315) 422-4467 TWX 710-541-0431

# Unclassified Ads

**UNCLASSIFIED POLICY:** Readers who are soliciting or giving advice, or who have equipment to buy, sell or swap should send in a clearly typed notice to that effect. To be considered for publication, an advertisement must be clearly noncommercial, typed double spaced on plain white paper, contain 75 words or less, and include complete name and address information.

These notices are free of charge and will be printed one time only on a space available basis. Notices can be accepted from individuals or bona fide computer users clubs only. We can engage in no correspondence on these and your confirmation of placement is appearance in an issue of BYTE.

Please note that it may take three or four months for an ad to appear in the magazine.

**FOR SALE OR TRADE:** PET monitor with schematic for monitor and interface to Commodore PET computer. Requires horizontal and vertical drive and composite video, all are TTL levels. Has built-in power supply. Trade for composite video only monitor or sell for \$70. Works great. Lynn SIm, 113B Tyndall Ave, Colorado Springs CO 80916, (303) 574-5810.

**FOR SALE:** Heathkit H8 computer, H9 video terminal, 20 K static memory, H8-5 serial I/O and cassette interface, Benton Harbor Extended BASIC software, and all manuals. Assembled, tested, and running. Original cost \$1370, best offer over \$850. Louis F Latilla, 61 Turf Rd, Staten Island NY 10314.

**FOR SALE:** Two S-100 16 K static-memory boards. Both use TMS 4044-25 chips. These are fast boards and have logged over 1000 hours on a 4 MHz Z80 system with zero faults. Will sell either board alone for \$225, or both for \$400. Shipping paid within continental USA. Call after 5 CT weekdays. Richard Kruse, (316) 744-1548.

**FORTRAN:** I want to do FORTRAN on an Apple II Plus. Who could help? Oen Sek Hong, 13939 Carnell St, Whittier CA 90605.

**HELP:** Need back issue magazines desperately. These include BYTE, *Creative Computing*, *Personal Computing*, *Recreational Computing*, etc. Paying up to \$10 each. John J Liska, POB 98, Brandywine MD 20613.

**FOR SALE:** IMSAI 8080 with 4 K board; \$700, Processor Tech VDMI; \$100, Godbout 8 K board; \$100, Morrow Speakeasy board with ATE; \$120, IMSAI MIO board; \$150, TV monitor; \$125. I will pack; you pay the freight. Dwight Hebert, 2053 Willowick St, Lake Charles LA 70605, (318) 436-7563.

**FOR SALE:** Brand-new TRS-80 16 K/Level II. Has not been taken out of original carton. \$700 plus shipping. Fariborz Hamzel, 26911 Fond du Lac Rd, Palos Verdes CA 90274.

**FOR SALE:** Model 15 Teletype with built-in loop supply and RS-232 interface; \$50 local pickup. SwTPC CT-1024 terminal in metal cabinet with built-in keyboard and cassette interface. Modified for 64 characters, scrolling, and two pages of display; \$175. SwTPC 4 K programmable-memory boards; \$40 each or 3/\$105. 2102 memory chips; 8/\$3.00. Joe Dubner, 865 S Hasket St, Mountain Home ID 83647, (208) 587-9383.

**FOR SALE:** Datapoint 3300P thermal printer, 80-column, RS-232 serial input at 300 bps. Uses TI 745 paper. Case is 15 by 14 by 5 and color matches Apple. Quiet, reliable, and attractive printer. 30-day guarantee. \$500 freight collect, \$550 with Apple serial interface. Also, have some S-100 equipment for sale. Dave Vallere, 207 Edgewood Dr, Wilmington DE 19809, (302) 764-7210.

**FOR SALE:** Xitan Alpha II computer with complete TDL cassette software (Z80 Macroassembler, Editor, and 12 K BASIC). Hardware includes Z80 processor board, 16 K programmable memory, and System Monitor Board II (SMB). SMB board contains two serial and one parallel ports. Monitor software in read-only memory. Asking \$1200 or best reasonable offer, cost \$1700 new. John E Parsons, 3118-A Avent Ferry Rd, Raleigh NC 27606, (919) 851-0411.

**FOR SALE:** Altair dual-disk drives with controller and eprom boot boards. Drives just back from factory overhaul. All for \$1500. Original cost over \$3000. Dick Whipple, 305 Clemson Dr, Tyler TX 75703, (214) 561-1648.

**FOR SALE:** Printer-terminal: GTE Novar 5560, IBM 72 Selectric, and tape drive. TI Silent 700 printer and H9 video terminal. In excellent condition with documentation. Best offer. R A Ackerman, 2 Hillside St, Red Bank NJ 07701, (201) 291-0680, 741-0923.

**FOR SALE:** One Wameco EPM-2, 2708/2716, eprom S-100 card. Assembled but never used. \$45 or best offer. D Snyder, c/o Buell Div Envirotech, 200 N 7th St, Lebanon PA 17042, (717) 272-2001 ext 527 days, (412) 287-1625 evenings.

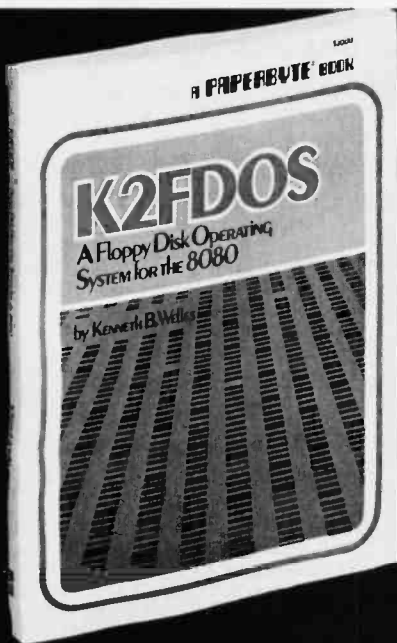

## A New Floppy Disk System for the 8080. Small (4K), but powerful!



This and other Byte/McGraw-Hill books are available from Byte Books or your local computer store.

ISBN #0-07-069206-8  
Price \$20.00

Please send  \_\_\_\_\_ copies of  
**K2FDOS A Floppy Disk Operating System for the 8080**

| Name   | Title | Company        |
|--------|-------|----------------|
| Street | City  | State/Province |
|        |       | Code           |

Check enclosed in the amount of \$ \_\_\_\_\_  
 Bill Visa  Bill Master Charge  
Card No. \_\_\_\_\_ Exp. Date \_\_\_\_\_

Add 75¢ per book to cover postage and handling.

Please remit in U.S. funds or draw on a U.S. Bank

Available in October

70 Main Street, Peterborough, N.H. 03458



K2FDOS is a complete software package. It includes all the specific routines necessary to bootstrap and run a powerful floppy disk operating system on an 8080 based microcomputer. K2FDOS features assembly language source code listings and object code in hexadecimal listings and machine-readable (PAPERBYTE®) bar code format.



**FOR SALE OR TRADE:** SwTPC 6800 computer with 12 K memory, CT-64 terminal, and AC-30 cassette interface. Sold separately or as a unit to first reasonable offer. Will consider trade for Apple hardware, especially Disk II without controller, printer, etc. Art Boice, 14 Beech St, Norwich NY 13815, (607) 334-5746.

**FOR SALE:** TI 99/4 computer, 16 K programmable memory, 26 K read-only memory, 30 K add-on read-only memory (preprogrammed) available. Five months old. Comes with RS-232 interface and modem (300 bps). Interface and modem are one month old, hardly used. Also, comes with GE tape recorder and dual recorder interface. Originally \$2000, now \$1500. Carl Hewitt, 958 Woodthrush Ct, San Jose CA 95120, (408) 268-9761.

**FOR SALE:** Two Hazeltine 1500 video terminals; \$825 apiece. Dust covers included with both, maintenance manual available. Both terminals one-year-old. Will ship UPS for certified check. T Stowe or J Boniakowski, POB 1126, Neptune NJ 07753, (201) 295-9105, (201) 922-3460.

**FOR SALE:** Amphenol 50 pin connectors, male and female with one metal hood per pair. All contacts are gold-plated. \$15 per pair with hood. Also, some 86 pin industrial wire-wrap edge connectors, gold-plated, \$5 each. Marc Samson, 4355 Royal Ave, Montreal Quebec, H4A 2M7 Canada.

**FOR TRADE:** Gas-panel display and power supply by Digivue. 512-by-512 dots, for 51 lines of 85 characters each. Simple to interface and control. Perfect for graphics. Buffered; no regeneration required. Uses X/Y addressing. New cost \$7000. Interested in Apple, TRS-80, and programs/information on ELF II (1802), E W Kilby, 1904 Lewis St, Tarboro NC 27886, (919) 823-3775.

**FOR SALE:** Radio Shack Level II, 32 K expansion interface, two disk drives. Excellent condition. \$1800. Will sell separately. Robert Webster, 3221 Riverside Dr #147, Tulsa OK 74105, (918) 742-2538.

**WANTED:** TRS-80, KIM. Complete unit. Give full details and your lowest price for the unit. John Waskowitz, 35-30 73rd St, Flushing NY 11372.

**FOR SALE:** TI-59 programmable calculator and some software. Must sell. Software includes accurate stopwatch program and *Master Mind* game. Mitch Wyle c/o Taffy's Inc, 701 Beta Dr, Cleveland OH 44143, (216) 461-3360.

**FOR SALE:** 6800 system (MSI) with 32 K programmable memory, two Siemens SSSD floppy-disk drives (300 K bytes each), Centronics 306 impact printer, and Beehive 8-100 terminal. Software Dynamics BASIC compiler and MSI BASIC interpreter included. System can be upgraded to 6809 with FLEX if desired. All offers considered; best offer takes. Will consider selling computer and disk drives separately. Gary Patrick, 4110 Clark #1, Kansas City MO 64111, (816) 753-2293.

**FOR SALE:** SOL-20, 32 K static programmable memory (Dynabyte), and North Star disk. Excellent condition. Sacrifice for \$2250. Yannick Benitah, 2626 Stanford Ct, Indianapolis IN 46268, (317) 299-5202.

**FOR SALE:** ELF II microcomputer, 4 K static programmable memory, Giant Board (tape interface, Monitor/Editor, RS-232C/TTY interface, 8-bit parallel I/O), ASCII keyboard, and Tiny BASIC. All units are assembled. Worth over \$300 in kit form. Only \$250. Power supply for the unit; \$40. Extra ASCII keyboard can be purchased separately for \$55. First reasonable offer with a money order takes it postpaid. Amit Solomon, 7 Yair Stern St, Herzlia, Israel 46425, (011) 972-52-88127.

**WANTED:** Persons interested in cooperative life in Washington DC area directed towards designing, programming, and construction of artificial intelligence beings. AIB, 6504 Democracy Blvd, Bethesda MD 20034.

**FOR SALE:** TRS-80 Scripsit Disk Word Processor. Brand new and unused. Complete with program disks, instructional cassettes, manual, binder, etc. The regular price for this word-processing program is \$99.95, but I will sell mine for \$50, including first class postage. W L Pierce, 703 23rd St S, Arlington VA 22202.

**FOR SALE:** Heath H-11 16-bit computer with 8 K bytes of programmable memory and parallel interface card. Fully assembled. Users manual included. \$2300 value; will sell for \$1600. Craig Altenburg, 328 Taidan Ave, Virginia Beach VA 23462, (804) 499-6254 evenings.

**FOR SALE:** BYTE Issue #1 thru May 1977. Best offer takes the lot. Philip F Curtiss, 2146 Lost Tree Way, Bloomfield Hills MI 48013.

**FOR SALE:** Heath Zenith H-89 microcomputer. Brand new, fully assembled and tested, floppy disk, cassette-tape interface, 16 K programmable memory, software, and full documentation. List over \$2500; sell for \$1700. Robert E Martin, 2505 Cherrywood Ln, Titusville FL 32780, (305) 268-1164.

**FOR SALE:** Texas Instruments TI-59 programmable calculator and PC-100 printer with four library modules, 80 magnetic cards, PPX bulletins, PPX catalog, all documentation, and many programs. \$525 value for \$395. H D Moxness, 14 McGregor Ave, Mt Arlington NJ 07856, (201) 663-2402.

**FOR SALE:** Tutorial on Pattern Recognition Ideas that will make your computer smarter (and which might make its entrepreneurial user wealthier). Send \$0.45 in stamps. G Butler, 475 Selby Ln, Atherton CA 94025.

**FOR SALE:** S-100: Wameco MEM-1A 8 K-by-8 static 450 ns programmable memory, \$120; SSM I/O-4 2 parallel + 2 serial, \$120. All circuits socketed, full documentation. Surplus keyboard, keypunch style, metal case, one 5-by-7 display, thumbwheels, counter, no documentation, \$25. Douglas Zimmerman, 2824 St Paul St, Baltimore MD 21218, (301) 889-1698.

**FOR SALE:** A copy of the first issue of BYTE. In mint condition. Max Guze, 1201 Mill St, Montreal Quebec, H3K 2B2 Canada.

**FOR SALE:** Nearly new Gimix computer, excellent condition. 6800 processor card, 16 K static memory card (Gimix) \$800. Also, Smoke Signal Broadcasting disk-controller card. \$250. Paul Lamar, 123 S Juanita St, Redondo Beach CA 90277, (213) 374-1673 work, (213) 316-8351 home.

**FOR SALE:** Exidy Sorcerer with 32 K programmable memory; \$895. S-100 expansion unit; \$250. Both for \$1100. Larry Shelton, 2470 Hummingbird Rd, Dalzell SC 29040, (803) 499-2763.

**FOR SALE:** North Star Horizon 48 K with two double-density floppies. Built from kit and working perfectly. Includes extra blank diskettes, full assembly manuals, BASIC software and documentation, and Z80 assembler programming manuals. \$2000 firm. John Perez, 1946 Winterport Cluster, Reston VA 22091, (703) 620-5961 evenings.

**FOR TRADE:** Drake 2-A receiver and Q multiplier plus Heath DX 60-B and V.F.O. for best AIM-65 offered. Also, exchanging programs, etc for OSI Challenger. Henry Etchason, Box 147, Sage AR 72573.

**FOR SALE:** 16 K Apple II like brand new. In original carton. Super Mod with extra box. New recorder with counter. Four 6502 books by Zaks and MOS. ADC/DAC and RS-232 interface. The new *Apple II Reference Manual*. Many materials, magazines, and notes (old and new BYTEs). MicroChess 2.0. Big software library. My cost over \$1450 and twelve months. Asking \$1100. Lee Gillie, 1804 Elk #140, Rock Springs WY 82901, (307) 382-5998 after 5 PM MST.

**WANTED:** Graduate student on small budget would like quotes on used Houston Instruments HIPLLOT DMP-2 and/or Apple graphics pad. Arthur B Busby, 1025 E 57, Dept of Anatomy, University of Chicago, Chicago IL 60637, (312) 955-5934.

# BOMB

## BYTE's Ongoing Monitor Box

| Article # | Page | Article                                                              | Author(s)                   |
|-----------|------|----------------------------------------------------------------------|-----------------------------|
| 1         | 24   | Make Liquid-Crystal Displays Work for You                            | Ciarcia                     |
| 2         | 62   | An 8088 Processor for the S-100 Bus, Part 2                          | Cantrell Walker             |
| 3         | 96   | Sorting With Binary Trees                                            | Elmore and Agarwal          |
| 4         | 114  | An Information-Retrieval System                                      | Brown Zimmermann Stoutemyer |
| 5         | 154  | Add Macro Expansion to Your Microcomputer, Part 1                    | Frey Ragsdale               |
| 6         | 196  | FLOPTRAN-IV: A Tiny Compiler                                         | Harrod                      |
| 7         | 232  | Symbolic Math Using BASIC                                            | Beetem                      |
| 8         | 266  | Machine Problem Solving, Part 2: Directed Search Using Cryptarithmic |                             |
| 9         | 274  | The FORTH Standards Team                                             |                             |
| 10        | 282  | The 6502 Gets Microprogrammable Instructions                         |                             |
| 11        | 286  | Vector Graphics for Raster Displays                                  |                             |

### User's Column Towers Over Circuit Cellar in July

Jerry Pournelle's first installment of *The User's Column*, entitled "Omikron TRS-80 Boards, NEWDOS+, and Sunday Other Matters" (page 198), produced a favorable response from readers of the July *BYTE* who voted in the BOMB tally. Dr Pournelle won the first-place prize of \$100.00.

Steve Ciarcia, for his *July Ciarcia's Circuit Cellar* article, "Handheld Remote Control for Your Computerized Home," received second place in the voting. Steve was awarded \$50.00.

# Reader Service

To get further information on the products advertising in BYTE, fill out the reader service card with your name and address. Then circle the appropriate numbers for the advertisers you select from the list. Add a 15-cent stamp to the card, then drop it in the mail. Not only do you gain information, but our advertisers are encouraged to use the marketplace provided by BYTE. This helps us bring you a bigger BYTE. \*Correspond directly with company.

| Inquiry No. | Page No.                                           | Inquiry No. | Page No.                                        | Inquiry No. | Page No.                                   | Inquiry No. | Page No.                                 |
|-------------|----------------------------------------------------|-------------|-------------------------------------------------|-------------|--------------------------------------------|-------------|------------------------------------------|
| 262         | AB Computers 354                                   | 324         | Designers & Builders Information Sys (DBIS) 372 | *           | Meas Sys & Controls 29, 289, 303, 315, 321 | 119         | Quasar Data Products 179                 |
| 45          | Ackerman Digital 74                                | 127         | DG Electronics 190                              | 188         | MicroAce 245                               | 296         | Quest 367                                |
| 193         | AEI 271                                            | 35          | Digicom Research Corp 58                        | 153         | MicroAmerica Distributing 231              | 196         | RACET Computers 277                      |
| 294         | Adaptive Data & Energy Sys 368                     | 99          | Digital Marketing 146                           | 75          | Micro Age Computer Store 113               | 44          | Radio Shack 73                           |
| 238         | Advance Access Group 316                           | 191         | Digital Graphic Systems 270                     | 209         | Micro Appl Group (MAG) 297                 | *           | Rainbow Computing 278                    |
| 341         | Advanced Comp Prod 384, 385                        | 225         | Digital Pathways 305                            | 210         | Micro Appl Group (MAG) 297                 | 100         | RCA Solid State 147                      |
| 314         | Altos Computer 40, 41                              | 267         | Digital Research Comp (TX) 357                  | 326         | Micro Business World 373                   | 235         | RCA Solid State 314                      |
| 24          | Alpha Omega Comp Sys 370                           | 143         | Digital Research Corp (CA) 219                  | 201         | Micro Byte Software 289                    | 59          | RNB Enterprises 92                       |
| 206         | American Square Comp 296                           | 232         | The Discount Software Group 310                 | 212         | Micro Computer Brokers 298                 | 171         | Rochester Data 247                       |
| 323         | AMIS 372                                           | 203         | Dual Systems Control Corp 294                   | 214         | Micro Comp Discount Co 317                 | 190         | S-100 Inc 269                            |
| 36          | Anacom 59                                          | 138         | Dynacomp Inc 207                                | 299         | Micro Computer Serv Corp 299               | 150         | Howard W Sams Co 229                     |
| 266         | Ancrona 356                                        | 200         | Dynasoft Systems Ltd 289                        | 117         | Microcomputer Serv Corp 299                | 258         | SC Digital 328                           |
| 142         | Anderson Jacobson 218                              | *           | Eaton Corp 14                                   | 13          | Microcomputer Serv Corp 299                | 93          | Scott Instruments 140                    |
| 130         | APF Electronics 194, 195                           | 207         | Ecosoft 315                                     | 83          | Micro Data Base Sys 99                     | 2           | Scion Corp 5                             |
| 5           | Apple Computer 12, 13                              | 237         | Elcomp Pub Co 296                               | 138         | Micromail 214                              | 183         | SciTronics Inc 259                       |
| 38          | Applied Digital Data Sys (ADDS) 83                 | 338         | Electravalue Industrial 374                     | 140         | Micromail 216                              | 215         | Scottsdale Systems 300                   |
| 116         | Apparat 175                                        | 72          | Electronic Control Tech 110                     | 120         | Micro Management Sys 181                   | 185         | Service Technologies 242                 |
| 228         | Arizona Comp Systems 307                           | 186         | Electronic Design Assoc 244                     | 181         | Micro Manufacturing Sys 255                | 257         | Michael Shrayer Software 329             |
| 3           | Artec Electronics 6                                | 301         | Electronic Music Systems 368                    | 29          | Micro Mikes 47                             | *           | Shugart 7                                |
| 286         | ASAP 365                                           | 56          | Electronic Specialists 68                       | 291         | Micro Mint 237, 330                        | 48          | Small Business Appl 77                   |
| 16          | Atari Personal Computers 27                        | 336         | Electronic Systems 375, 376, 377                | 60          | Microsette 366                             | 202         | Small Sys Design 289                     |
| 16          | ATV Research 374                                   | 17          | Electronic Sys Furniture Co 28                  | 86          | Microsoft 93                               | 21          | Smoke Signal Broadcasting 37             |
| 193         | Automated Equipment Inc (AEI) 271                  | 189         | Ellis Computer Systems 268                      | 245         | Microsoft (Cons Prod Div) 129              | 22          | Smoke Signal Broadcasting (Dealers) 37   |
| 65          | Automated Simulations 101                          | 106         | Epson 161                                       | 42          | Microtech Exports 294                      | 145         | Softech Microsystems 221                 |
| 61          | base 2 inc 95                                      | 218         | Escon 301                                       | 242         | Microtek Inc 71                            | 46          | SOFTWARE 75                              |
| 79          | Bay Technical Associates Inc 118                   | 216         | Essex Publishers 300                            | 148         | Microware 227                              | 313         | Software Consultants 370                 |
| 272         | Becklan 360                                        | 50          | Exatron Inc 79                                  | 83          | The Micro Works 124                        | 252         | The Software Exchange 323                |
| 187         | John Bell Engineering 267                          | 226         | Excom 308                                       | 76          | Micro World 115                            | 289         | The Software Farm 366                    |
| 182         | Beta Comp Devices 352                              | 108         | Executive Business Sys 165                      | 244         | Midas 319                                  | 58          | The Software Federation 91               |
| 182         | Beta Comp Devices 255                              | 39          | Factory Direct 64                               | 268         | Mighty Micros 304                          | 339         | Software Labs 381                        |
| 287         | Bishop Management Co Ltd 366                       | 222         | Faircom 303                                     | 95          | Mikos 358                                  | 230         | The SoHo Group 308                       |
| 310         | The Bit Bucket 370                                 | 282         | Faragher & Assoc 364                            | 346         | Mini Computer Suppliers 142                | 263         | Solid State Sales 354                    |
| 239         | Bits Inc 317                                       | 128         | Farnsworth Comp Center 192                      | 347         | Mini Micro Mart 394                        | 315         | Solid State Surplus 370                  |
| 91          | Bower-Stewart & Assoc 138                          | 137         | Forth Inc 211                                   | 348         | Mini Micro Mart 395                        | 327         | Sophisticated Micro Sys 374              |
| *           | BYTE Books 60, 239, 333, 398                       | 115         | Forethought Products 173                        | 349         | Mini Micro Mart 396                        | 253         | Sorcim 324                               |
| *           | BYTE Back Issues 295                               | 308         | Frederick Computer Prods 84                     | 81          | Mini Micro Mart 397                        | 197         | Sorrento Valley Assoc 278                |
| *           | BYTE Subscriber 321                                | 247         | General Systems Consulting 370                  | 10          | Morrow/Thinker Toys 120, 121               | 351         | Southwest Tech Prod Corp C II            |
| *           | BYTE WATS 303                                      | 67          | Gimix 294                                       | 77          | Mountain Computer Inc 19                   | *           | Specialty Video Systems 251              |
| 155         | C & S Electronics 234                              | 172         | Global Parameters 104                           | 88          | Mountain Computer Inc 116                  | 144         | Spectrum Software 220                    |
| 11          | Calif Comp Systems 20, 21                          | 63          | Godbout Electronics 248, 249                    | 288         | mpi 134                                    | 322         | SP Electronics 372                       |
| 300         | Calif Data Corp 368                                | 159         | Mark Gordon Computers 238                       | 71          | MTI 366                                    | 297         | SS-50 Computing 368                      |
| 340         | California Digital 382, 383                        | *           | Graham-Dorian Software Sys 135                  | 185         | MTI Inc 108                                | 4           | SSM 11                                   |
| 204         | Cambridge Develop Labs 295                         | 172         | GW Computers 247                                | 69          | Multi Business Comp Sys 106                | 146         | Strategic Simulations 223                |
| 292         | CCM Inc 366                                        | 184         | H & E Computronics 241                          | 90          | The National Comp Shows 125                | 82          | Strobe 123                               |
| *           | Cedar Hill Software 364                            | 234         | H & E Computronics 312, 313                     | 258         | National Microsoftware Prod Inc 137        | 15          | SubLOGIC 26                              |
| 112         | Central Data 169                                   | 12          | Hardhat Software 22                             | 170         | National Multiplex 247                     | 274         | Sunny Int'l 362                          |
| 114         | CFR Assoc Inc 172                                  | 251         | Hardside 322                                    | 78          | National Small Comp Show 117               | 43          | SuperSoft 72                             |
| 94          | Chrislin Industries 141                            | 156         | Hayden Book Co Inc 235                          | 258         | NCC Electronics 334                        | 70          | SuperSoft 107                            |
| 134         | Chrislin Industries 203                            | 86          | Heath Company 103                               | 151         | NEECO 230                                  | 135         | SuperSoft 205                            |
| 107         | Circle Comp Sales 164                              | 51          | Hewlett-Packard 81                              | 152         | NEECO 231                                  | 53          | Sybase 85                                |
| 198         | Cleveland Consumer Computers & Components 280, 281 | 154         | High Technology Inc 233                         | 118         | Netronics 191, 250, 252, 254, 256          | 73          | Symtec 111                               |
| 129         | Color Software 193                                 | 344         | Hobbyworld Electronics 390, 391                 | 118         | New England Business Service (NEBS) 178    | *           | Synchro Sound 53, 297                    |
| 343         | CompuMart 388, 389                                 | 26          | Houston Instruments 45                          | 14          | Nixdorf Computer 25                        | 223         | Synthetic Comp Prod 303                  |
| 249         | Computer Camp Inc 321                              | 97          | IBC 144                                         | 14          | Northern Tech Books 243                    | 124         | Tarbail Electronics 185                  |
| 304         | Computer Case Co 368                               | 307         | IBEX Comp Corp 370                              | 80          | North Star Computers Inc 119               | 96          | Tech Sys Consultants (TSC) 143           |
| 107         | Computer Center Inc 164                            | 312         | IDM 370                                         | 325         | Northwest Comp Services 372                | 219         | Technical Career Open House 301          |
| *           | Computer Factory 199                               | 55          | Image Resource Corp 87                          | 233         | Novation 311                               | 113         | Tec-Mar Inc 171                          |
| 109         | Computer Furniture & Accessories 166               | 18          | Industrial Micro Systems 31                     | 353         | NRI Schools 177                            | 178         | TCOH 301                                 |
| 250         | Computer Instant Ads Assoc 321                     | 23          | Industrial Micro Systems 39                     | 28          | Ohio Scientific Instr C IV                 | 331         | Terminal Data 374                        |
| 141         | Computer Marketing Corp 217                        | 332         | Infinite Inc 374                                | 28          | OK Machine & Tool 46                       | 227         | Texas Comp Sys 307                       |
| *           | Computer Prof Book Club 208, 209                   | 62          | Integral Data Sys 97                            | 176         | Omkron 251                                 | 20          | Texas Instruments 35                     |
| 277         | Computer Shopper 364                               | 194         | Integrand 272                                   | 9           | Omega Research 18                          | 68          | Texas Instruments 105                    |
| 199         | Computer Specialties 287                           | 34          | Intel 56, 57                                    | 102         | Omega Sales Co 149                         | 110         | Texas Instruments 167                    |
| 271         | Computer Specialties 380                           | 220         | Intelligent Systems 302                         | 242         | onComputing 257                            | 25          | 3M Company 43                            |
| 133         | Computers R Us 201                                 | 263         | Interactive Microware 364                       | 54          | Optimal Technology 319                     | 163         | Thunderware 240                          |
| 275         | Computers R Us 382                                 | 221         | Interlude 302                                   | 123         | Orange Micro 86                            | 241         | Mitchell E Timin Engineering Co 319      |
| 49          | The Computer Stop 78                               | 8           | Intertac Data Sys 17                            | 98          | Organic Software 184                       | 192         | TNW Corp 270                             |
| 316         | The Computer Stop 371                              | 30          | Intertec Data Sys 49                            | 126         | Oregon Software 145                        | 178         | Torrey Pines Busn Sys 253                |
| 303         | Computer Technology Assoc 368                      | *           | Ithaca Intersystems 8, 9                        | 280         | Osborne/McGraw-Hill 189                    | 229         | Max Uie & Co 308                         |
| 85          | Computers Wholesale 128                            | 309         | J & S Computers 370                             | 280         | Owens Associates 336, 337                  | 352         | United Business Products CIII            |
| 160         | Computers Wholesale 238                            | 345         | Jade Computer Prod 392, 393                     | 305         | Pacific Exchanges 364                      | 279         | United Software of America 69            |
| 179         | Computer Warehouse 253                             | 342         | Jameco Electronics 386, 387                     | 317         | Pacific Exchanges 372                      | *           | Universal Security Instruments (USI) 364 |
| 211         | Computex 298                                       | 321         | Jepsan Group K Inc 372                          | 330         | Pacific Exchanges 374                      | 329         | Universal Software Appl 374              |
| 125         | Computix 187                                       | 184         | Jim-Pak 260, 261                                | 306         | Page Digital 369                           | 261         | US Micro Sales 353                       |
| 111         | CompuVlaw Products Inc 188                         | 290         | Jini Microsystems 366                           | 260         | Pan American Elec 352                      | 31          | US Robotics 51                           |
| 240         | Condor Computer Corp 318                           | 195         | Joe Computer 272                                | 174         | PDF Corp 251                               | 32          | VANDATA 54                               |
| 269         | Concord Comp Components 358                        | *           | Kemco Ltd 83                                    | 281         | Pansadyne Comp Services 384                | 47          | Vector Electronics 78                    |
| 205         | Contract Services Assoc 295                        | 103         | Konan Corp 151                                  | 6           | Parcom Data 15                             | 57          | Vector Graphics 89                       |
| 74          | Cover Craft 112                                    | 40          | Kurta Corp 65                                   | 87          | Parcom Data 131                            | 284         | Videx 364                                |
| 270         | The CPU Shop 359                                   | 311         | Ladco Develop Co Inc 370                        | 354         | Parcom Data 131                            | 105         | Vista Computers 159                      |
| *           | Creative Software 315                              | 298         | Lark Electronics & Data 368                     | 175         | Personal Micro Comp Inc 331                | 276         | Vista Computers 383                      |
| 1           | Cromemco 1, 2                                      | 132         | Leapac Services 198                             | 84          | Personal Software 127                      | 328         | Voicetek 374                             |
| 285         | Crystal Computer 330                               | 33          | Lifeboat 50, 109, 152, 153, 160, 299            | 254         | Phase One Systems 213                      | 373         | VR Data 361                              |
| 302         | Custom Busn Computers 366                          | 84          | Lomas Data Products 182                         | 167         | Pickles & Trout 325                        | 265         | Wameco 356                               |
| 284         | Dal-Comp 355                                       | 292         | Macrotronics 100                                | 17          | PK Systems Inc 244                         | 169         | The Warehouse 246                        |
| 318         | DAR Sales 372                                      | 295         | Macrotronics 366                                | 147         | Power One Inc 16                           | *           | Whitesmith's Ltd 133                     |
| 213         | Data Discount Center 285                           | 139         | Marol Software Systems Inc 215                  | 259         | Prentice Hall 225                          | 243         | Wild Hare Comp Sys 319                   |
| 293         | Datadisk Systems 299                               | 208         | Mark of the Unicorn 297                         | 217         | Priority One 349, 350, 351                 | 41          | John Wiley & Sons 68                     |
| 236         | Data Products Maintenance 366                      | 180         | Marway Products Inc 255                         | 19          | Professional Data Sys 301                  | 131         | John Wiley & Sons 197                    |
| 231         | Data Soft Inc 315                                  | 162         | Marymac Industries 240                          | 37          | Professional Software Inc 61               | 278         | Wintek Corp 364                          |
| 231         | Datasouth Computer Corp 309                        | 101         | Matchless Systems 148                           | 337         | QT Comp Systems 32, 33                     | 177         | Winterhalter & Assoc 253                 |
| 186         | Datek Systems Inc 267                              | 92          | Maxell Data 139                                 | 320         | QT Comp Systems 378, 379                   | 246         | Worldwide Electronics 294                |
| 104         | Deita Products 156, 157                            | *           | McGraw-Hill Magazines 326, 327                  | 319         | Quality Computer Parts 372                 | 333         | Zilog Inc 335                            |
|             |                                                    |             |                                                 | 149         | Quality Data Supply 372                    | 168         | ZS Systems 268                           |
|             |                                                    |             |                                                 |             | Quality Software 228                       |             |                                          |



# A COMPANY TO RELY ON... UNITED BUSINESS PRODUCTS



**UNITED BUSINESS PRODUCTS**  
20268 E. Carrey Rd.  
WALNUT, CA. 91789



UNITED  
BUSINESS  
PRODUCTS

(213) 448-4850

(714) 594-5966

NAME OF COMPANY \_\_\_\_\_

ADDRESS \_\_\_\_\_

CITY, STATE, ZIP \_\_\_\_\_

ATTENTION OR DEPT. \_\_\_\_\_

**A**  The swingline table top burster will separate single-ply continuous forms into individual sheets up to 15". Length 2 3/4" to 12". Paper weight 10 to 110 lb. bond. Speed is constant at 125 ft. per minute.

**Wt. 95 lbs. Price \$ 899.00**

**B**  Our custom forms have a guarantee that speaks for itself. Our time on forms range from two to five weeks for custom work and before we start a job we now give a guaranteed shipping date and price. depending on art work. from two to five weeks and for every day we're late we give you a 10% discount. To get a quote just mail the detached portion of this ad with sample of form or layout and we will call you the day we get the information with a price and guaranteed day of shipment.

**C**  The swingline table top decollator is a portable unit which separates both carbon and carbonless continuous computer forms into stacks. The separated carbon is easily and neatly removed from carbon pick-up spool. Form size is up to 15" wide. Wt. is 10 to 110 lb. bond paper. and the speed is variable from 75 to 200 feet per minute and takes only 120 volts AC 60 hertz to operate.

**Wt. 40 lbs. Price \$ 419.00**

**D**  The Datatech Intimus 007 shredder works for Scotland Yard, for government authorities, for important corporations, banks and embassies. The cutting capacity is 12 to 14 sheets at one pass. Cross cut is 1/35 x 3/8. It has a 2 H.P. motor and runs off of 220/380 V 3 phase.

**Wt. 320 Lbs. Price \$6799.00**

**E**  The Intimus 306 is designed for trouble free operation and has a switch for forward and reverse rotation. It has 2 motors with terminal overload. Housing consists of coated steel, mounted on rubber cushions for noiseless shredding. The 306 can sit on a table or a stand. Cutting width is 3/4" or 1/2" and has two 150 watt 110 V 60 cycle, 1 phase motors.

**Wt. 66 Lbs. Price \$1199.00**

**F**  The Intimus Simplex is designed for security without problems in the office. One push of the button renders confidential information into five illegible paper strips 1/8" thin. The simplex has a wide opening in the middle for throw away of cans, etc. Even a paper clip is simply cut into pieces. The cutting capacity is 8 to 10 sheets at one time. It has a 1/5 H.P. motor and runs off of 110 volts.

**Wt. 27 Lbs. Price \$ 599.00**

**G**  Our catalog consists of more information on equipment in this ad. Other models are available plus a complete line of calculators and typewriters by Adler, Latham time recorders, several varieties of safes, and our disintegrator that destroys paper, aluminum, film and carbon to a complete loss of identity.

**Price \$2.00**

**H**  Free Brochures and more information:

1.  Business Forms
2.  Calculators
3.  Forms Handling Equipment
4.  Time Recorders
5.  Typewriters

**Terms:** Check or money order U.S. funds only. Prepaid orders add 3% S/H, COD's add 5% S/H (U.S. only). California residents add 6% sales tax.



Prices subject to change without notice.



# Cost Effective Systems for the Microcomputer OEM.

Ohio Scientific has been building small business microcomputers and personal computers since the beginning of the microcomputer revolution. Most Ohio Scientific products incorporate a bus architecture utilizing modular circuit cards mated to a multi-slot backplane. Ohio Scientific's 48 signal line bus is designed to effectively marry the versatility and modularity of bus architecture with the economies of consumer products producing an ultra-low cost yet reliable system. Many industrial users of microcomputers recognize the economy and versatility of Ohio Scientific's modular computer boards and utilize these boards and subsystems as well as customers who purchase complete computer systems on an OEM basis.

## Ohio Scientific's New OEM Program

Ohio Scientific now recognizes the importance of the OEM marketplace and is introducing a complete program for the board level OEM user as well as the system OEM. The program starts with our standard products including three CPU boards, a broad range of static and dynamic memory boards, mini and 8" floppy disk controllers, printer controllers, multiple RS-232 port boards, a hard disk controller, and video interface with optional keyboard. Backplanes with two, four, eight or sixteen slots are available. These standard products are now being supplemented by a broad range of

products specifically for the OEM user including:

- New universal telephone interface board which has auto-dial capability, auto-answer capability, tone encoding and decoding, answer and originate 300 baud modem and voice I/O via tape recorder or optional phonetic voice output system.
- New calendar-clock with several month battery backup capability which can be programmed to automatically restart the computer or shut off the computer at set times. The circuit board also includes automatic power-fail restart capability.
- Instrumentation quality high speed, 12-bit analog A/D - D/A module with a 16-channel input multiplexer and two 12-bit D/A converters.
- A large range of parallel interface options including circuit cards containing 48 parallel I/O lines.
- New solderless prototyping board which connects to the computer system and allows rapid prototyping of new interface ideas.
- System PROM blaster which accepts 8K through 64K bit industry standard EPROMS and a universal EPROM-ROM card.
- A card edge extender, bus analyzer and bus compatible breadboards.

## Documentation

All of Ohio Scientific major circuit boards are now fully documented by Howard Sams (the originator of the Sams Photo-fact series for Consumer Electronics) servicing manuals which include block diagrams, schematics, detailed pictorials, parts placement diagrams and parts lists

providing the designer, systems integrator and serviceman with detailed hardware information. Ohio Scientific is offering qualified OEM users its principal disk operating system (OS-63D V3.2) which supports multiple languages, mini-floppies, 8" floppies, printers, modems and other accessories in documented Source Code and machine readable form which can be reassembled on standard OSI computers. This gives the product developer the ultimate flexibility in integrating these components into his total system design.

## Best of all is the Price

Because of Ohio Scientific's hundreds of thousands of boards per year volume for the consumer and small business market, these products cost a mere fraction of the corresponding LSI-11, SBC or S-100 bus boards. This economy allows you to utilize a floppy subsystem in your product at a total cost typically less than an EPROM based system from other vendors.

Ohio Scientific's reasonably priced universal telephone interface and voice output capabilities allow you to integrate advanced telecommunications, remote control capabilities and/or unlimited vocabulary voice response in your systems at the same price as a "bare bones" implementation with other bus architectures.

## Easy to Start With

Getting started with the OSI bus architecture is now easy with documentation, off the shelf availability, and economical computer systems for in-house software development using Assembler, BASIC FORTRAN or PASCAL. Ohio Scientific's new OEM contract provides easy to start with terms and generous volume discounts.

**For more information and the name and phone number of your local Ohio Scientific OEM representative call 1-800-321-6850 toll free. Please specify your interest as an OEM user.**

Circle 353 on inquiry card.

**OHIO SCIENTIFIC**  
1333 SOUTH CHILLICOTHE ROAD  
AURORA, OH 44202 • (216) 831-5600

