

*The Broadcast  
Engineers'  
Journal*

JANUARY, 1946

VOLUME 13, NO. 1

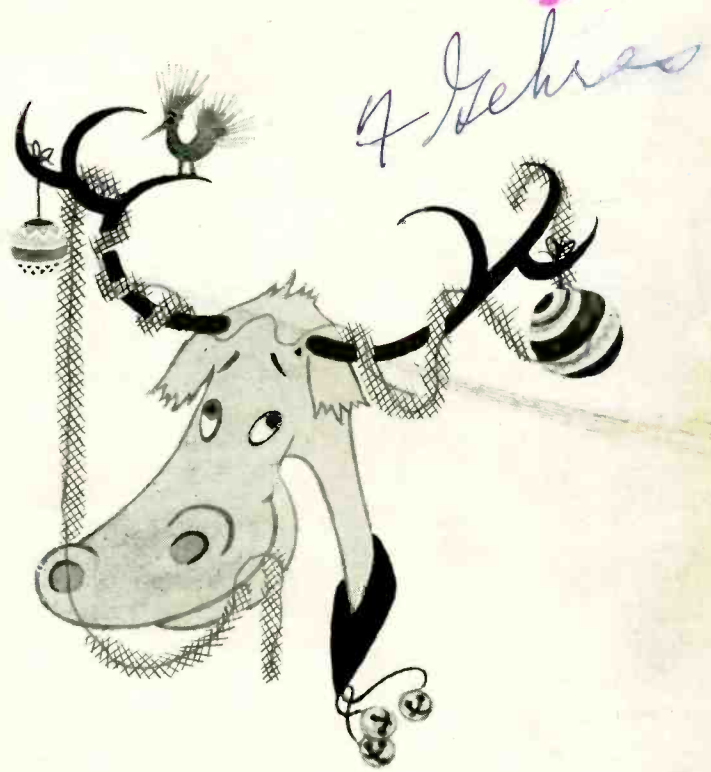

1946

YEARBOOK

*Karil*



*Improved!*

*Now better than ever...*  
**Gould-Moody "Black Seal" Aluminum  
Instantaneous Recording Blanks**

Technological advancements, brought about by our wartime assignments, now provide the critical engineer with "Black Seal" blanks of improved cutting and reproduction qualities, plus more satisfactory playback life.

Gould-Moody "Black Seal" blanks are made of the finest nameplate aluminum, coated with an exclusive compound, and free from all abrasive materials. They are guaranteed not to dry out, age, harden or deteriorate. Continued high fidelity is assured through many months of playbacks. The true tonal qualities, long life and great economy of Gould-Moody "Black Seal" blanks place them head-and-shoulders above competition. The proof of their value is in their performance. Order as a trial a sample case, and see for yourself.

You can get Gould-Moody  
"Black Seal" Aluminum  
Instantaneous Recording  
Blanks without delay.

**Old Aluminum Blanks recoated with the  
famous "Black Seal" formula on short notice**

**BUY AND HOLD MORE WAR BONDS UNTIL VICTORY**

**THE GOULD-MOODY COMPANY**

RECORDING BLANK DIVISION

395 BROADWAY, NEW YORK 13, N. Y.

N A B E T  
**President  
Powley's**  
M E S S A G E



We are beginning our sixth year as a national independent union. During the last five years our membership has doubled, and continues to increase from day to day. This is being accomplished in the face of planned opposition by management and repeated attacks by other national unions. Our independence and success can only be maintained so long as we continue to operate as a union of, by, and for the radio engineer.

To the members of the National Council who have donated their time and efforts to the cause, I express the appreciation of the National Office.

To the Membership I extend the Season's Greetings with the hope that the new year will be a happy one and, with the help of NABET, a prosperous one.

A handwritten signature in cursive script that reads "A. S. Powley". The signature is written in dark ink and is positioned above the typed name.

*President, NABET*

# THE BROADCAST ENGINEERS' JOURNAL

**Ed. Stolzenberger**

Editor

Coordinator

F. R. Rojas

Volume 13, No. 1



January, 1946

Contents Copyright, 1946, by A.T.E. Publications, Inc.

## TABLE OF CONTENTS

	Page
Reflex Oscillators .....	7
Ham Ban Lifted; I.R.E. Elects.....	14
Introducing: H. V. Kramer, KGO.....	16
RCA Demonstrates New Television Tube.....	18
The Dsychopathic Misdemeanor—or "Surgery Calling Dr. Killfidgit".....	29
Hollywood News .....	59
Novel Microphone Designation!.....	71
Return of the Conqueror.....	77
ABC West Coast Engineering Manager.....	83
San Francisco News.....	95
This is WTAM, Cleveland.....	113
This is Baltimore.....	129
Chicago News .....	141
Omaha's Glamour Girl.....	151
President Powley Visits Cleveland.....	161
West Coast NABET Office Opens.....	161
Denver News .....	169
New York NBC - ABC News.....	187
Hudson Chapter News.....	211

## STRIKES

The radio news reports and the newspaper headlines have been keeping us posted on the "strike situation" and the various forms of strikes—the sit-down, slow-down, lock-out, lock-in, wild-cat, unauthorized, the group fishing party, the group illness, etc., etc., and lest we lose sight of it, the old-time "legitimate" strike. There is still another form of strike. You will experience its effect as you turn these pages and notice an abrupt change in the type of paper; this is the effect. The cause: the growing "sellers strike" in the form of refusal to release inventories. As we write this, we have had delivered only enough paper to print half of this Yearbook; enough of another type of paper has been located in Kalamazoo and has started East—we hope!

The printing trades has finally had its wage scales adjusted, but not until Chicago had a twenty-three day strike which crippled about four hundred nationally-circulated magazines. The New York Printing Trades Association took the cue, immediately settled on a new contract, and WE have a 26 per cent increase in printing costs! Since space is curved, given time, the circle will of course complete itself. We don't have a key to the back door of Fort Knox, and the bills have to be paid. Effect: immediate upward revision of advertising and subscription rates.

Philosophy teaches us how to "keep smiling" while briefly visiting this Earth: Keep repeating aloud until you believe it, "I am not hungry, nothing hurts, and I have no problems."

## THE BROADCAST ENGINEERS' JOURNAL

Trustees: R. R. DAVIS, C. L. BENNIS, C. THROPP, R. A. SCHLEGEL, H. E. MEYER

Treasurer.....C. W. PHELAN  
Assistant Treasurer.....D. J. MOLONEY  
Staff Writers.....JORDAN McQUAY; TOM MCKAY

### ASSOCIATE EDITORS

Baltimore.....	WM. HOOS
Chicago.....	K. A. SLOBB
Cleveland.....	BERT PRUITT
Denver.....	GEORGE POGUE
Detroit.....	DAVE STEWART
Dixie.....	REX COSTON
Engineering Chapter.....	JACK IRVING
Hollywood.....	NORMAN DEWES
Hudson Chapter.....	JIM CARTER
KFI-KECA.....	E. F. WILMSHURST
Mohawk.....	"NEWT" BARNES
New York.....	G. F. ANDERSON, JR., GIL McDONALD
Omaha.....	BOB RUDD
Rochester, N. Y.....	ARTHUR KELLY
San Francisco.....	JACK VAN VART
Washington.....	W. VAN BEUREN DE VRIES

The Broadcast Engineers' Journal is a privately printed monthly publication issued by A.T.E. Publications, Inc., a corporation of the State of New Jersey. Address all communications to Editor's office: E. Stolzenberger, 116-03 91st Avenue, Richmond Hill 18, L. I., N. Y. Telephone Virginia 9-5553. **THE BROADCAST ENGINEERS' JOURNAL IS THE OFFICIAL PUBLICATION OF THE N.A.B.E.T.**

Advertising rates and information supplied on request. Subscription, \$2.50 per year; \$4.00 for two years. Single copies, except Christmas Yearbook, 35c; Christmas Yearbook free to subscribers. All remittances in advance. Foreign: Add postage. Back copies 50c, back Yearbooks, \$2.00.

Nothing appearing in The Broadcast Engineers' Journal shall be construed to be an expression of The Broadcast Engineers' Journal or the National Association of Broadcast Engineers and Technicians, but must be construed as an individual expression of the author or authors.

**NATIONAL N.A.B.E.T. OFFICE**  
66 Court Street, Brooklyn 2, N. Y.  
A. T. Powley, President

**P. T. Barnum Is Alleged to Have  
Made This Wise Observation:**

***If You Don't Advertise  
Your Business, the Sheriff Will***

**We Are Confident in the Future, Are You?**

**FOR ADVERTISING RATES AND DATA**

**Write: THE BROADCAST ENGINEERS' JOURNAL**

**ED. STOLZENBERGER, Editor and Business Manager**  
116-03 91st Avenue Richmond Hill 18, N. Y.  
Telephone Virginia 9-5553



*NABET Vice-President La Croix*

NABET members have great cause to be especially joyous in this season of good cheer. Never in our twelve-year history has so much been done to assure our future welfare. In working conditions, in prestige and in union we have made tremendous and satisfying gains. Much hard work lies ahead. Now more than ever those gains must be kept and added to so that our progress shall be ever steady. With new members and the continued enthusiastic support of our older ones, NABET can and must and will rightfully dominate our field. Best wishes to all for a Happy Christmas and a very successful New Year.

*Thor E La Croix*

# National Association of Broadcast Engineers and Technicians

The Only Union  
That Is 100%  
Of, By and For the  
Broadcast Engineer

## Attention, Broadcast Engineers!

- NABET is a dignified union *worthy* of your support.
- NABET is an *effective* union, Of, By, and For the Broadcast Engineer *exclusively*, operated upon and dedicated to the principle that every member has a *right* to know what is going on in the union "front office."
- NABET is controlled by its *members*; they have the right to vote on all matters of union policy. As a NABET member, you would have the *right* to Okay any actions which your President might take.

### Contact any of the following officers for further information

**A. T. Powley, President**  
66 Court Street  
Brooklyn 2, N. Y.

**C. A. Allen**  
National Representative  
1240 N. Utah  
Arlington, Va.

**Harry Boone**  
3804 Penhurst Ave.  
Baltimore 15, Md.

**A. J. Doran**  
13254 Pinehurst Ave.  
Detroit 4, Mich.

**Frank Schnepfer**  
3508 W. 97th Street  
Evergreen Park, Ill.

**George Anderson**  
939 S. Gilpin St.  
Denver 9, Colo.

**Reid R. Davis**  
18 Squirrel Hill Rd.  
Roslyn Heights, N. Y.

**Don Morey, Apt. 26-A**  
3 Circle Lane  
Albany 3, N. Y.

**Dorson A. Ullman, NBC**  
Trans-Lux Building  
Washington 5, D. C.

**Thor C. La Croix**  
Vice-President  
6000 Sunset Boulevard  
Hollywood 28, Calif.

**Harry C. Hiller**  
Nat'l Sec'y-Treasurer  
66 Court Street  
Brooklyn 2, N. Y.

**Harold V. Brandt**  
P. O. Box 68  
Brecksville, Ohio

**Roy Glanton**  
5500 Kansas Ave.  
Omaha 12, Neb.

**Charles Thropp**  
141-41 72nd Avenue  
Flushing, N. Y.

**Mark Dunnigan**  
5920 Laird Ave.  
Oakland 3, Calif.

**J. Willard Dean**  
217 E. North St.  
Raleigh, N. C.

**Charles Snyder**  
106 Pembroke St.  
Rochester 7, N. Y.

**Charles L. Bennis, Apt. DA-2**  
117-14 Union Tpke  
Kew Gardens 15, N. Y.

# Answers to your Questions about the SHURE "556" Super-Cardioid Broadcast Dynamic

Q. *What is meant by Super-Cardioid?*

**Answer:** Super-Cardioid is an improvement on the cardioid (heart-shaped) pickup pattern, which makes it even more unidirectional. "Super-Cardioid" reduces pickup of random noises by 73% as compared to 67% for the Cardioid, and yet has a wide pickup angle across the front.

Q. *To accomplish this, is it necessary to have two Microphones in a single case?*

**Answer:** No. The Shure "556" is designed according to the "Uniphase" principle, a patented Shure development which makes it possible to obtain the "Super-Cardioid" pattern in a single compact, rugged unit.

Q. *Over what range does the Shure "556" give quality reproduction?*

**Answer:** The Shure "556" provides a high degree of directivity, both horizontally and vertically over a wide frequency range from 40 to 10,000 cycles.

Q. *Does the Shure "556" reduce feedback?*

**Answer:** Yes! Reflected sounds and "spill-over" from loud speakers entering from the rear are cancelled out within the Microphone.

Q. *Can the Shure "556" be used outdoors?*

**Answer:** Yes. It is insensitive to wind and will withstand heat and humidity. The low impedance models may be used at practically unlimited distances from the amplifier.

Q. *Can the Shure "556" be used for Studio Broadcasting?*

**Answer:** More than 750 Radio Broadcast Stations in the United States and Canada use the Shure "556" in their studios. Because it can be placed with its back to the wall without picking up reflected sounds or echoes, it facilitates Microphone placement.

*Model 556A for 35-50 Ohm circuits—  
LIST PRICE \$75*

*Model 556B for 200-600 Ohm circuits—  
LIST PRICE \$75*

## SHURE BROTHERS

*Designers and Manufacturers of Microphones  
and Acoustic Devices*

225 West Huron Street, Chicago 10, Illinois

CABLE ADDRESS: SHURE MICRO



**ADVANCE RECORDING BLANKS**  
available in only one  
quality . . . *the finest!*

Hence, in every Advance Blank  
you find these qualities:

- A minimum of surface noise
- Clean cutting
- Non-static threads
- Longer playing life
- And reproduction to delight  
the most severe critic

*Send in your order for ADVANCE RECORDING BLANKS today!*

**Advance**  
Recording Products  
Company

36-12 34th STREET • STILLWELL 4-7837 • LONG ISLAND CITY, N.Y.



# Reflex Oscillators

By J. R. Pierce

Electronic Apparatus Development

(Reprinted from the Bell Laboratories Record, August 1945, by permission of the Bell Telephone Laboratories).

**I**N ELECTRONIC apparatus operating at very high frequencies, the usual negative-grid triodes, tetrodes and pentodes are often replaced by vacuum tubes in which the transit time of electrons plays a basic role. Such devices have rapidly come into extensive use to meet the needs of war for ever higher frequencies. Their general principles of operation have been known for some time; one long-transit-time device, the Barkhausen oscillator, has been described in the RECORD.\* During the war, the Laboratories have made available for military use several types of long-transit-time tubes called reflex oscillators. In certain applications these have a number of electrical and mechanical advantages over other somewhat similar devices.

In its basic principle of operation, the reflex oscillator is simple. Consider first the arrangement shown in Figure 1. The electrodes are assumed to be enclosed in a highly

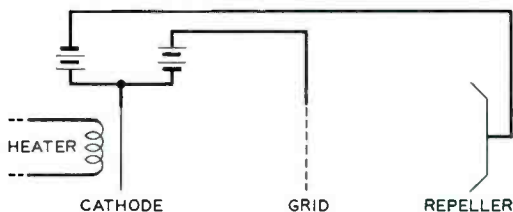

Fig. 1—In an ordinary triode, the plate is positive and attracts electrons that pass through the grid, which is usually negative. If the plate is made negative and the grid positive as above, electrons will be accelerated by the grid but will be repelled by the negative plate, which may thus be called a repeller

evacuated container as with a conventional triode, but the grid is positive with respect to the cathode, and the repeller, which corresponds to the plate, is negative. Electrons leaving the cathode in a steady stream will be accelerated by the grid. Some of them will be stopped by it, but others will continue through its meshes and proceed toward the repeller. Since the repeller is negative with respect to the grid, how-

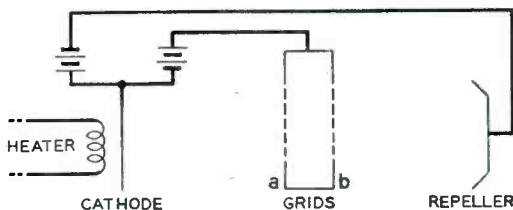

Fig. 2—With two grids arranged as a closed box, the action of the complete double grid is the same as that of the single grid of Figure 1, but between the two grids A and B, the velocity of the electron will be increased or decreased in accordance with the radio frequency field between them, and the electrons will thus pass toward the repeller with varying velocities.

ever, all of the electrons that pass through the grid will be turned back before they reach it, and will stream back steadily and pass through the grid in the opposite direction. In both directions, the flow of electrons will be uniform, and the electrons will continuously take energy from the circuit as they approach the positive grid from either direc-

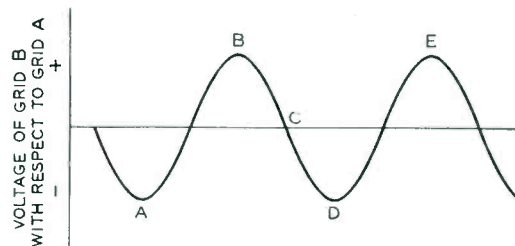

Fig. 3—Radio frequency voltage between grids A and B of Figure 2. During the interval from A to B, the electrons are being increasingly accelerated, and during period B to D, increasingly retarded.

tion and will give energy to the circuit as they depart from it.

Now suppose that this grid is replaced by two grids set into the top and bottom of a metal pillbox, as indicated in Figure 2. Electric current flowing around such a closed "cavity" or "resonator" produces an electric field between the grids, and yet there will be no field whatever outside of the resonator. The principle of such resonators is very simple. The two grids may be thought of as part of the capacitance of a resonant circuit, and the annular connection between them made through the walls of the pillbox, which act as a single turn coil, provides the inductance. When such a resonator is used, the action of the radio frequency field on the electron stream in the tube is confined to the short space between the two grids.

In the structure shown in Figure 2, the accelerating effect between the cathode and grid, a, and the retarding effect between grid, b, and the repeller are the same as in the cathode-grid and grid-repeller regions of the arrangement shown in Figure 1. In the space between the two grids, however, the oscillating electric field affects the electrons. The grids are closely spaced so that the time of passage of an electron from one to the other is a small fraction of a period of oscillation. Depending on its direction at the moment, the field will be accelerating or decelerating, and thus successive groups of electrons will be alternately speeded up and slowed down. As a result of this action of the field between the grids, the electron stream is velocity modulated, and electrons pass into the drift space between grid b and the repeller with different velocities, depending on the time

(Continued on Page Eleven)

\*RECORD, August, 1935, p. 354.



# CLAIM STAKING

## Hallicrafters and Very High Frequency

Based on the facts in the case, Hallicrafters can stake out a very strong claim to leadership in the very high frequency field. The facts include such things as the Model S-37, FM-AM receiver for very high frequency work. The Model S-37 operates from 130 to 210 Mc.—the highest frequency range of any general coverage commercial type receiver.

Hallicrafters further supports its claim to domination in the high frequency field with the Model S-36A, FM-A M-CW receiver. The 36A operates from 27.8 to 143 Mc., covers both old and new FM bands and is the only commercially built receiver covering this range.

*Further developments in this direction can soon be revealed—adding further support to Hallicrafters claim to continued supremacy in the high frequency field.*

HALLICRAFTERS NEW \$600,000 HOME NOW UNDER CONSTRUCTION.



# hallicrafters RADIO



THE HALLICRAFTERS CO., MANUFACTURERS OF RADIO AND ELECTRONIC EQUIPMENT • CHICAGO 16, U. S. A.

©COPYRIGHT 1945 THE HALLICRAFTERS CO.

# PRESTO-1946

A PREVIEW OF THE **NEWEST** PRESTO RECORDER

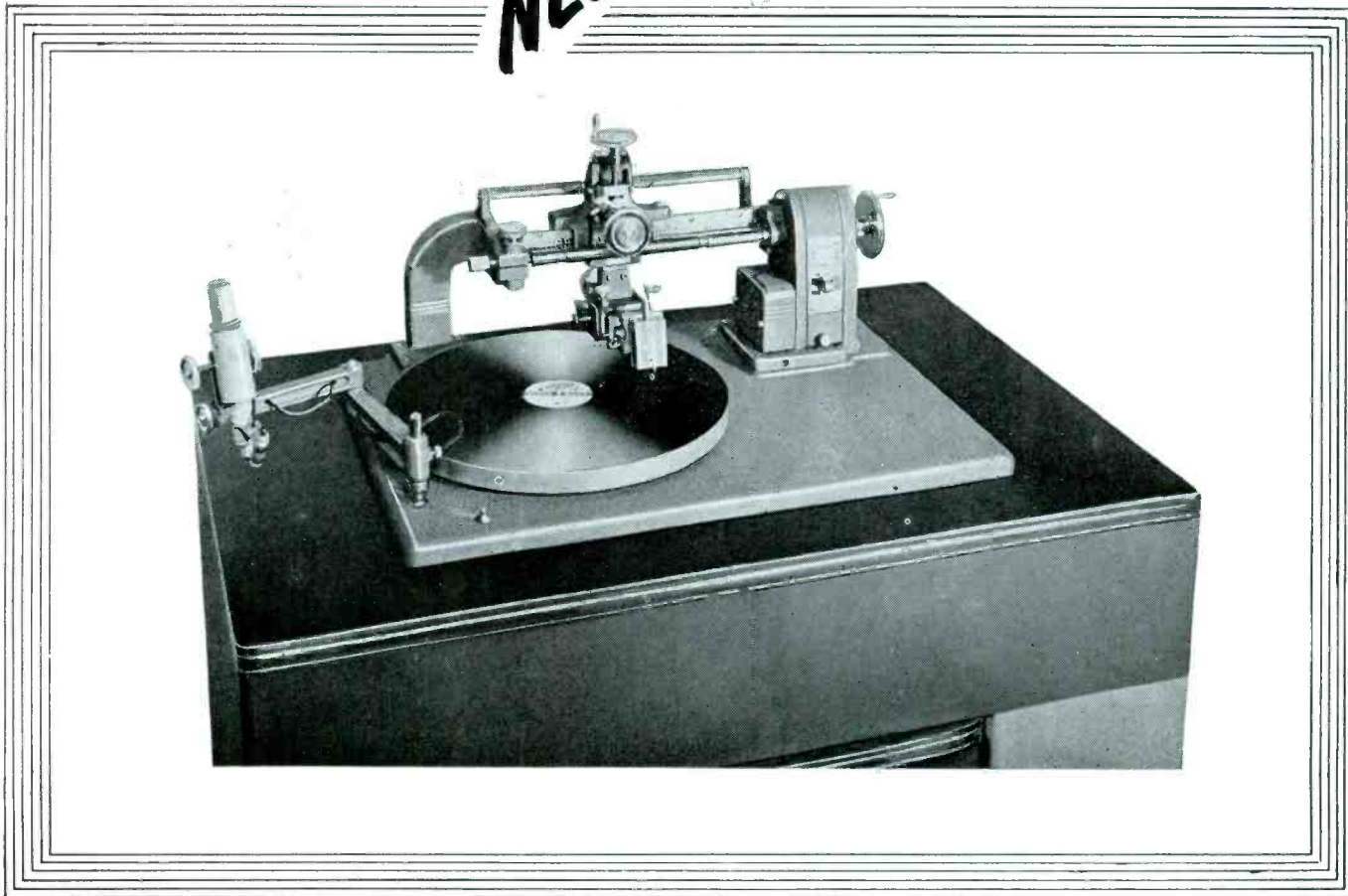

Presto's new 14A Recorder herewith makes its bow to all major radio stations, recording companies and motion picture studios. In presenting this model for the first time, Presto offers many new features that are fully described on Page One of Presto's postwar catalog. Send for Page One today.

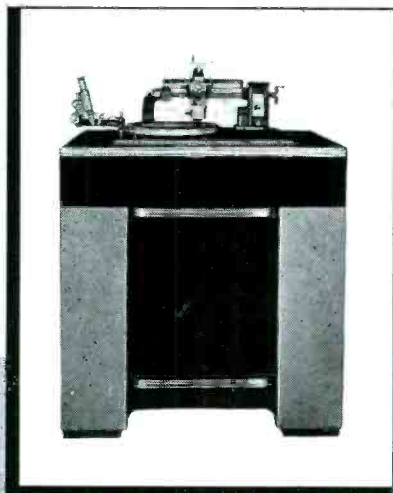

## PRESTO

**RECORDING CORPORATION**

242 West 55th Street, New York 19, N. Y.

*Walter P. Downs, Ltd., in Canada*



**WORLD'S LARGEST MANUFACTURER OF INSTANTANEOUS SOUND RECORDING EQUIPMENT AND DISCS**

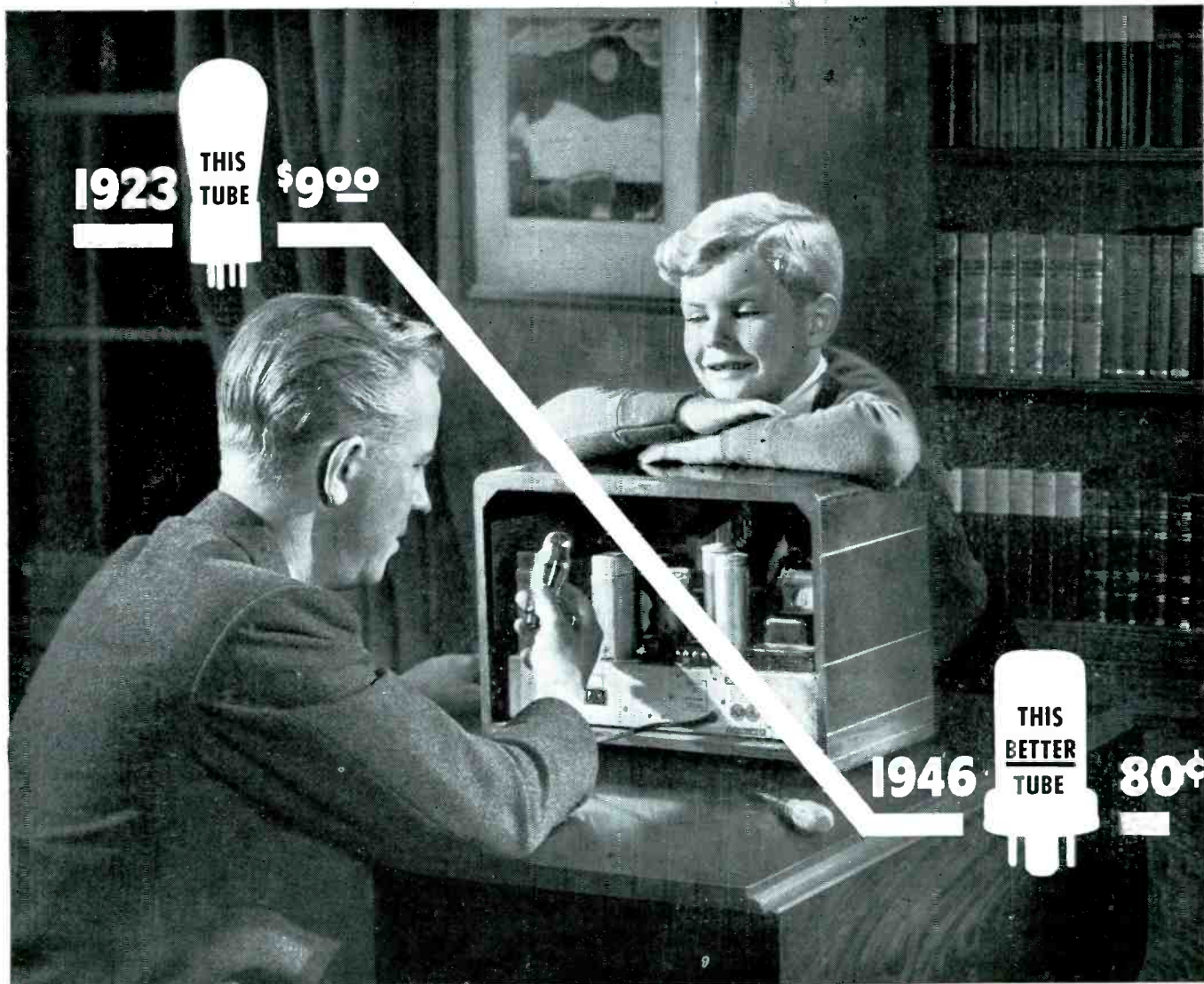

1923

THIS  
TUBE

\$9.00

1946

THIS  
BETTER  
TUBE

80¢

**TODAY—A complete radio set for less than half the cost of the tubes alone in 1923!**

• Today you can buy a six-tube table model radio for about \$25. A little over twenty years ago the six tubes alone cost \$54—*nine dollars apiece*.

Think of it—from \$9 to 80¢. You can buy *eleven* of these more powerful, longer-lasting radio tubes today for what you used to pay for only *one!*

This was brought about through RCA's combination of research, engineering skill, manufacturing efficiency and our American philosophy of making something *better—for less*.

Such progress means far more than simply a saving of \$8.20 on every radio tube. It means that radio has been

brought within the easy reach of practically everyone in this country.

There are now *fifty million* more radios in America than there were twenty years ago. Almost everyone depends upon broadcasting in some measure for entertainment, news, education.

Research and pioneering at RCA Laboratories contributed many of the scientific advances that so greatly improved and extended the services of radio to the American people.

*Radio Corporation of America, RCA Building, Radio City, New York 20, N. Y. . . . Listen to The RCA Victor Show, Sundays, 4:30 P. M., Eastern Time, over the NBC Network.*



The new 1946 RCA Victor Table Model (56X) costing about \$25. With our civilian production increasing, you can again look to RCA for the finest instruments of their kind that science has yet achieved. The principle of making it better—for less—applies to RCA Victor radios, television sets, Victrola radio-phonographs . . . every product bearing the RCA label.



**RADIO CORPORATION of AMERICA**

# OSCILLATORS

(Continued from Page Seven)

in the oscillating cycle at which they pass through the field between the grids. Because of this, the period during which the electrons will remain in the drift space will vary for different electrons.

This action can be likened to that of a man standing on the ground and throwing balls vertically upward. In such a situation, the force of gravity corresponds to the opposing force of the repeller. Balls thrown upward with a high velocity will require a longer time to return to the ground than those thrown with a small velocity. If a series of balls were thrown up at one-second intervals, but with steadily increasing velocities, they would return to the ground more than one second apart, while if the balls were thrown with steadily decreasing velocities, the times of their return to the earth would be closer together than one second. By properly selecting a series of decreasing velocities, a whole series of balls thrown up at regularly spaced intervals could be made all to return to the ground at exactly the same time.

With the oscillating electric field of Figure 2, these two effects alternate. Those electrons passing through the grid space during the interval A to B of Figure 3 will be spaced farther apart when they return to the grid because of the increasing velocities with which they left it, while those passing through the grid space during the interval B to D will be bunched closer together on returning. The electrons returning to the grid of the tube will thus alternately be bunched and dispersed.

As the electrons pass through the grid space on their return journey, they will give energy to the oscillating circuit or absorb energy from it, depending on whether the electric field at that moment opposes or assists the electron stream, and the amount of energy transferred will depend on the density of the electron stream and on the strength of the field. If the circuit conditions are so arranged that during the brief interval while a returning bunch of electrons

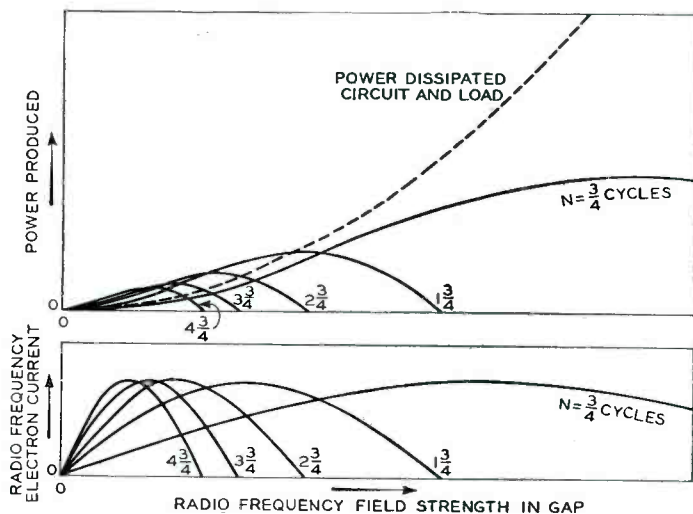

Fig. 4 (below)—Relationship between radio frequency field strength in gap and radio frequency current for repeller voltages giving drift times of  $\frac{1}{4}$ ,  $1\frac{1}{4}$ ,  $2\frac{1}{4}$ ,  $3\frac{1}{4}$ , and  $4\frac{1}{4}$  cycles. Fig. 5 (above)—Relationship between radio frequency field strength and output power for the same repeller voltages as in Figure 4.

is passing through the grid space, the field is a maximum in the opposing direction, a comparatively large amount of energy will be absorbed from the bunched electrons, far more than is transferred to electrons over the scattered section of the returning stream. As a result, pulses of energy are conveyed to the circuit at the oscillating frequency.

To have the bunches pass through the field when the field is maximum opposing, the interval between the instant an electron leaves the grids and that at which it reaches them on its return trip should be  $N + \frac{3}{4}$  cycles of the oscillating frequency, where  $N$  is any integer including zero. This may be seen from Figure 3. Since bunching occurs over the region B to D, the leaving time for the center of the bunch can be taken as point C. Returning electrons will encounter an opposing field whenever grid b is positive

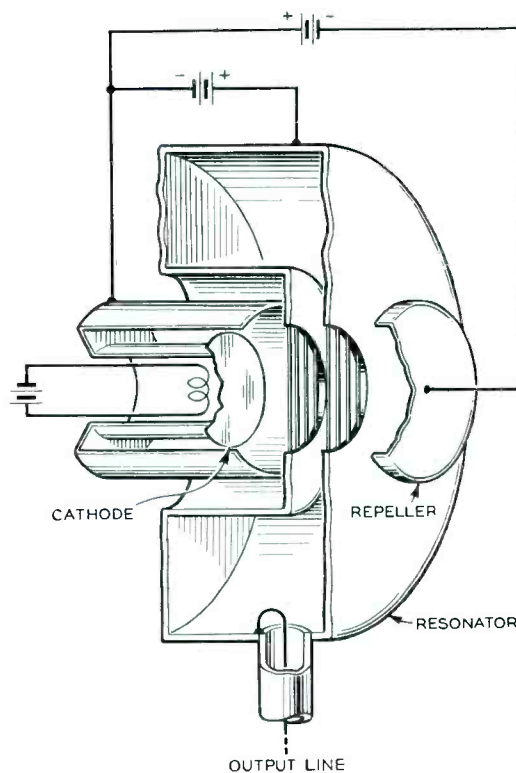
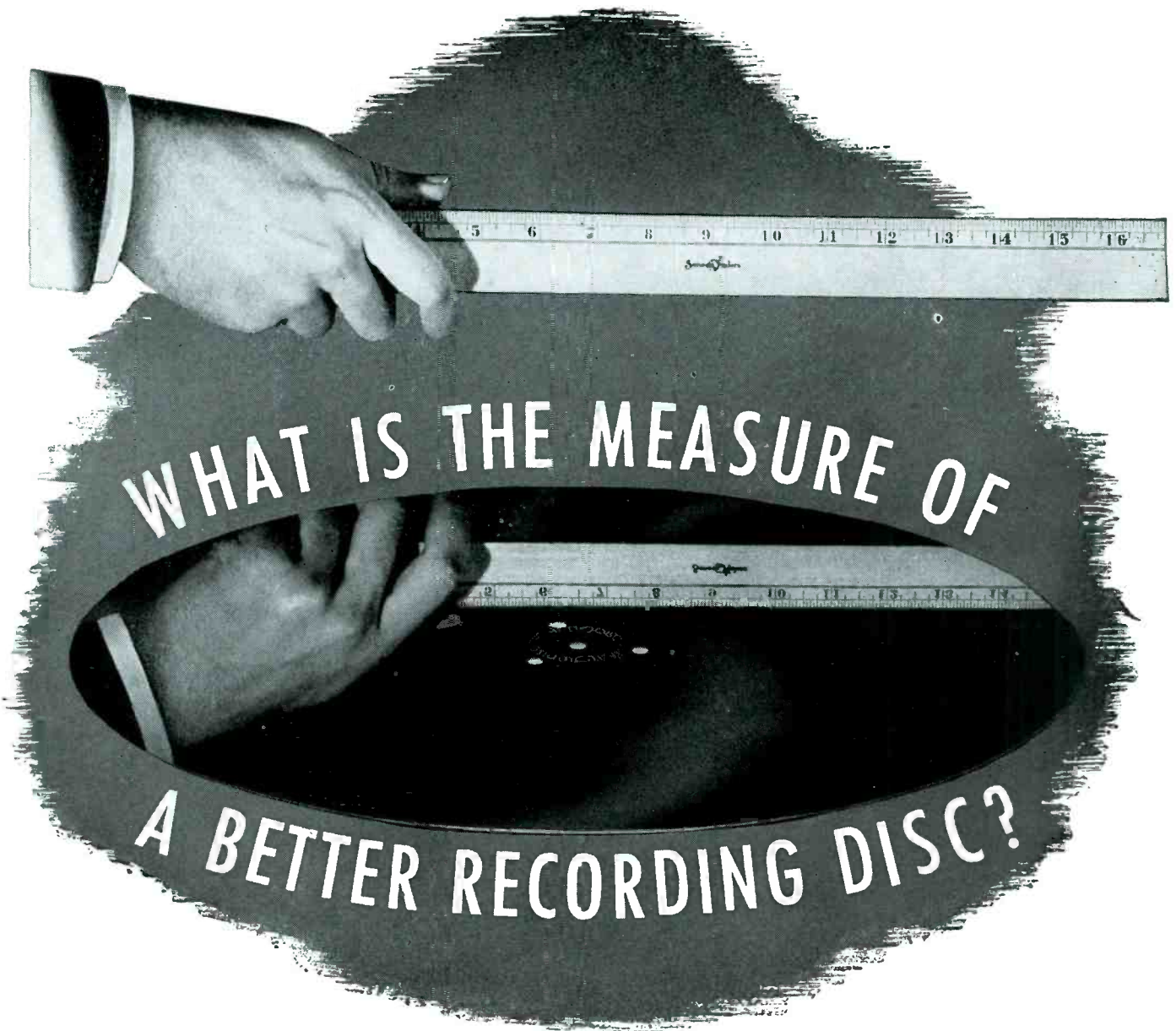

Fig. 6—Cross-section of internal structure.

relative to grid a, and thus during the upper half-cycles of Figure 3, and the maximum opposing field is at the tops of these half-cycles. If the electron bunch repassed through the field at point E, therefore, or at any succeeding positive peak, it would encounter maximum opposing field. The interval from C to E, however, is  $\frac{3}{4}$  cycle; that to the next positive peak is  $1 + \frac{3}{4}$ , and so on. For point E, the  $N$  in the above expression is zero. For the next positive peak, it is 1, and so on. This drift time of the electrons, from grid b toward the repeller and back, depends on the voltage of the repeller, and may be adjusted as desired.

The degree of bunching depends in turn both on the voltage of repeller and on the strength of the accelerating field between the grids. With the repeller voltage set to give a drift time of  $1 + \frac{3}{4}$  cycle, for example, the degree of bunching will first increase as the field strength is increased, will reach a

(Continued on Page Fifteen)



**JUST** by the simple expedient of putting a ruler to a recording disc, you can, in one sense, "measure" recording quality.

The disc must reflect a *true* image. Any imperfection in the reflection means that you can expect corresponding imperfection in recording characteristics. That's just A-B-C.

But a *better* recording disc must possess many other in-built qualities in addition to a flat, smooth, mirror-like surface:

*For recording*, it must have (a) split-hair accuracy in thickness of coating (b) easy cutting characteristics (c) positive thread-throw with no annoying static and (d) these qualities must not change — *regardless of the age of the disc.*

*For playback*, it must have (a) brilliant high frequency response (b) no audible background scratch, even after many playings (c) no increase in surface noise from the time of recording to playback or processing.

— *And finally*, these qualities must last as long as the recording

is needed. *There must be no deterioration with the years.*

\* \* \*

You cannot discover these qualities in a recording disc, by any yardstick we know of — except one:

*Just look for the name Audiodisc* — because it assures you all the qualities named above — a combination you will not find in any other recording disc.

*Audiodiscs* are manufactured by a patented, precision-machine process which is *uniquely* theirs, and the *Audiodisc* recording lacquer is produced from a formula developed by our research engineers. Thus, *Audiodisc* quality is consistently dependable. It is fully controlled—straight through from raw materials to finished disc.

There is an *Audiodisc* designed and priced for every recording need. No matter what the purpose, the name *Audiodisc* is, and will remain, the measure of a *better* recording disc.

**AUDIO DEVICES, INC., 444 Madison Avenue, New York 22, N. Y.**

*Audiodiscs manufactured in U.S.A. under Exclusive License from La Societe Des Vernis Pyrolac — France.*



*they speak for themselves* **audiodiscs**

## CAPPS\*

SAPPHIRE is, and has always been, the only material for making cutting styli for high class recordings.

CAPPS\* Patented Sapphire Styli (2187512) are the original and accepted standard for high class professional acetate recordings.

*Imitated but not equalled*

**FRANK L. CAPPS & CO., Inc.**

244 W. 49th STREET NEW YORK CITY

Telephone CIRCLE 6-5285

\* Reg. U. S. Pat. Off.

# C O P I E S

**BY DIRECT CUTTING  
OF YOUR RECORDINGS**

33 $\frac{1}{3}$  RPM transcriptions  
for broadcast or audition  
use.

**24 HOUR SERVICE**  
—packaged and shipped  
from Chicago.

Aluminum based material  
available for broadcast use.



*Write for  
complete  
details and  
prices.*

**L. S. TOOGOOD**  
RECORDING COMPANY  
221 N. LA SALLE ST. CHICAGO 1



***The War***  
has taught all of us  
the importance of  
**DEPENDABILITY**  
*and*  
**PERMANENCE**  
in all of our equipment

*Today — Write, Phone, or Wire  
your order for*  
**SCULLY MASTER RECORDERS**

**SCULLY  
Machine  
Company**

62 Walter Street

Bridgeport 8, Conn.

Telephone BRIDGEPORT 4-5300

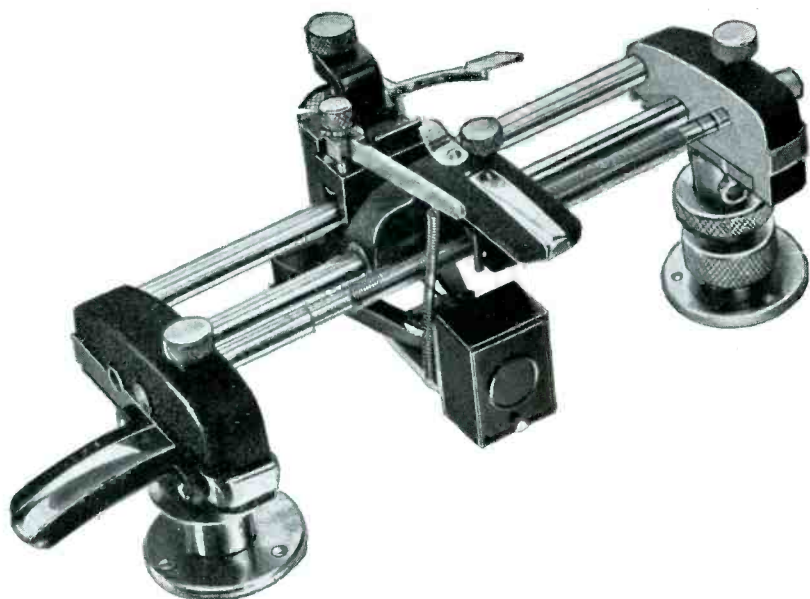

# REK-O-KUT

REK-O-KUT acknowledges with grateful appreciation the helpful aid and sincere effort of you, the Operating, Recording, and Maintenance Engineers of the Broadcast Industry, for your vision and practical suggestions which made possible the NEW, BEAUTIFUL, STREAMLINED REK-O-KUT "MASTER PRO" Overhead Recording Mechanisms.

A PRECISE tool of recording efficiency, it meets your every requirement  
 RUGGEDNESS • FLEXIBILITY  
 SIMPLICITY • APPEARANCE

*You Envisioned It!*  
*We Built It!*  
*Here It Is!*

See your local distributor or write for bulletin today!

## REK-O-KUT COMPANY

146 GRAND STREET

NEW YORK 13, N. Y.

Export Division MORHAN EXPORT Co., 458 Broadway, New York 13, N. Y.

## Amateur Ban Lifted

West Hartford, Conn.—The nation's radio hams sat up late Wednesday night, November 14, to celebrate their return to three bands of frequencies released for their use by the Federal Communications Commission effective at 3 o'clock, EST, the following morning (November 15).

According to Kenneth B. Warner, secretary of the American Radio Relay League, most welcome was the FCC announcement that amateur operators will be permitted again to use their 28,000-kilocycle band, which in prewar days carried many an international conversation.

"With amateurs of numerous other countries in the process of being reactivated and the FCC's withdrawal of its 1940 prohibition of foreign contacts," Warner said, "many of the 60,000 government licensed, experimentally minded private communicators will be looking forward to renewing international friendships."

Also released for amateur use is the 56-60 megacycle band—due to be shifted to 50-54 MC. March 1 when television stations are moved to a new channel—and a 144-148 megacycle band, both of which are useful for distances far beyond line-of-sight when air-wave bending conditions occur in the troposphere.

"In addition," Secretary Warner declared, "four new bands of microwaves are assigned so that hams may sample various portions of the spectrum heretofore used almost exclusively by radar. However, it will not be new territory for many amateurs, who contributed to radar's development in government laboratories during the war, and thousands more who operated equipment while serving in uniform."

"In fact, all traditional amateur ingenuity and know-how will be devoted to making these new microwaves a means of two-way communications instead of solely for detection and ranging apparatus as heretofore."

The League's secretary had high praise for the cooperative attitude of the commission in its relations with the amateur group as well as for the decision of Army and Navy authorities to release amateur frequencies from military communications uses as soon as practicable.

"We hope these policies will be continued," Warner said, "so that all our bands may be restored soon."

## Radio Engineers Elect New Officers

The election of Dr. Frederick B. Llewellyn, of Summit, New Jersey, as President of the Institute of Radio Engineers for the year 1946, was announced today by the Board of Directors of that society. He succeeds Dr. William L. Everitt, head of the Department of Electrical Engineering of the University of Illinois.

Dr. Llewellyn, a consulting engineer on the staff of Bell Telephone Laboratories, is an international authority on the design of vacuum tubes used for communication and electronic control purposes. His theoretical study of the subject resulted in his invention of the ultra-high-frequency oscillator tube which is fundamental to the development carried on during the war in radar and other communication devices. He is also known for his work on stabilized oscillating  
 (Continued on Page Twenty)



# OSCILLATORS

(Continued from  
Page Eleven)

maximum at some particular value, and then will decrease because of an effect that may be called "over-bunching." Returning to the analogy of the ball-thrower, when a sequence of balls is thrown upward with decreasing velocities, the first being thrown at the greatest velocity and the last at the least, it is obvious that if one particular velocity is given to the first ball, it will return to the ground at the same time as the last. If the first ball were thrown at a lower velocity, it would return before the last ball, and full bunching would not have been obtained. If, on the other hand, the first ball were thrown at a greater velocity, it would not return until after the last one, and again bunching would not be a maximum; "over-bunching" would occur.

This situation as applied to the reflex oscillator is illustrated by the curves of Figure 4. Here, distance along the abscissa represents the voltage between grids A and B, that is, the strength of the electric field between the grids times the distance between them, and that along the ordinate represents the degree of bunching, which may also be referred to as the strength of the electron current, since greater bunching, representing a greater concentration of electrons, corresponds to a greater current. Each curve represents the relationship for one repeller voltage selected to give an optimum drift time such as  $\frac{3}{4}$  cycle,  $1 + \frac{3}{4}$  cycle, and so on up to  $4 + \frac{3}{4}$  cycles. All the curves rise to the same maximum value since the maximum bunching is the same for all drift times, but the field or voltage required to produce maximum bunching decreases as the drift time increases. The power transferred from the electron stream to the circuit is proportional to the product of current and voltage. As the current changes slowly with voltage near the current maximum, maximum power will not occur at maximum current but at a voltage a little higher than that giving maximum bunching. Power will be greater for shorter drift times, since the voltage to produce maximum power is greater for shorter drift times and the current is the same. The solid curves of Figure 5 represent power.

Power may be taken from the oscillating circuit by means of a coil coupling the magnetic field of the resonator of Figure 2. Part of the power will be absorbed by the load connected to this coupled coil, and part will be absorbed by the losses in the resonator itself. The total power dissipated in load and resonator is proportional to the square of the voltage between the grids. For any given set of conditions, therefore, the total power could be represented by the dashed curve of Figure 5.

Steady oscillation will take place at points where the dashed curve crosses a solid curve, since at these points the output just equals the input. Maximum power will be obtained when this intersection is at the peak of one of the curves. For the conditions shown, the dashed curve never crosses the curve for  $\frac{3}{4}$ -cycle drift time, which means that with the load and circuit losses represented by the dashed curve, the tube would not oscillate with a repeller voltage giving a drift time of only  $\frac{3}{4}$  cycle.

An important characteristic of the reflex oscillator is the electronic tuning of which it is capable. With a drift time of  $N + \frac{3}{4}$  cycle, the current is in direct opposition

to the electric field between the grids, and thus the effect of the electron stream can be regarded as a negative conductance shunted across the resonator. If now the repeller voltage is changed so that the drift time is no longer exactly  $N + \frac{3}{4}$  cycle, the radio frequency current is no longer in exact phase opposition to the radio frequency voltage. The electron stream no longer produces a pure negative conductance, but rather an admittance, with a susceptance as well as a negative conductance. The susceptance tends to alter the frequency of oscillation just as would a capacitance or inductance connected across the resonator. Thus, if the repeller voltage is changed, the frequency of oscillation is also changed.

Figure 2, used to explain the operation of the reflex oscillator, is in a highly schematized form. The actual oscillators are constructed more as shown in Figure 6. The resonator or resonant circuit, shown as a flat pillbox in Figure 2, is actually a re-entrant metal anulus of the form shown in Figure 6, and the grids are stretched across circular openings in the centers of the opposite faces. At one point on the periphery of the anulus, a copper tube is connected that serves as the outer surface of a concentric conductor. The central conductor is connected to the anulus at the point where the tube is fastened, makes a single loop inside the anulus, which links the magnetic field, and then passes through the tube. It is by coupling to this loop that the output power is obtained. The actual proportioning and arrangements of the various elements, and the type of containers, vary with the particular use to which the tube is to be put.

## Courmettes & Gaul OPTICIANS

55 West 49th Street

R. C. A. Building (Main Floor), New York

EYE EXAMINATIONS

Prescriptions Filled . . . Prompt Repair Work

Invisible Contact Lenses Fitted

## Aaron Lippman & Co.

246 Central Avenue

Newark, N. J.

## Radio and Electronic Equipment

*We Expedite — Ask Anyone*

# Unusual and Vital ELECTRONIC EQUIPMENT

PRODUCED BY

## TECH LAB

SUBCONTRACTING DEPT.



Special Short Wave Transmitter  
Range: 1-16 megacycles on  
one dial.



Development of special  
hearing aid analyzer for  
Western Electric Company.



Production Test Set to test varistors. A sensi-  
tive wheatstone bridge arranged with  
switching means for  
quickly checking a  
number of varistors  
in rapid sequence.

Manufacturers have continually called upon the modern facilities of Tech Lab Subcontracting Department to assist them in the production of unusual and vital electronic equipment. Our Engineering Department is ready to assist you with your production problems.

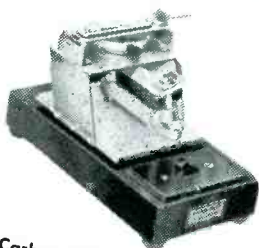

Carbon filling machines for  
precision filling of carbon  
microphones.

**TECH**  
LABORATORIES

MANUFACTURERS OF PRECISION  
ELECTRICAL RESISTANCE INSTRUMENTS

15 LINCOLN STREET, JERSEY CITY 7, N. J.

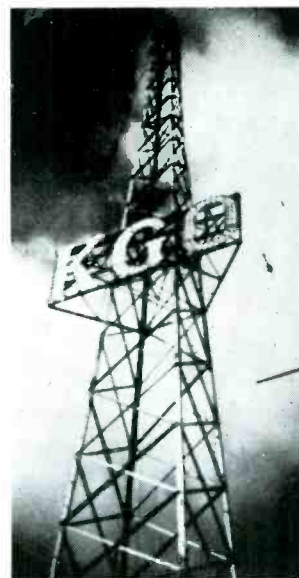

## INTRODUCING

By Ken Martin

**H**ERBERT VINCENT KRAMER, TE, born in Taber, Alberta, Canada, on April 20th, 1909.

It's like this," Herb explains, anxious to have you believe he is really not a foreigner. His parents were American citizens and he was born in Canada, so that makes him almost as good as an American citizen, doesn't it? He came back to Democrats Country at the age of two, anyway. Well, he's good enough for our money, either way.

Papa Kramer at the time was a railroad man; Herbert, therefore, had the unique experience of attending grade schools on a circuit that covered the United States pretty thoroughly but settled long enough in Dos Palos, California, to wangle his way through the local High School, eventually putting in a year at Fresno State College.

There's an awful gap right here, but no amount of arm twisting or eye gouging broke our subject down. It was after the days of Prohibition—so that's out, but he soon saw the error of his ways and put in a grueling stint at Pacific Radio School, San Francisco, where he achieved a Second Telegraph license with First Telephone endorsement. Perceiving his folly in the nick of time, he about faced and went into a saner line of business, thereafter using his hardearned license only for the purpose of "hamming" on W6ECW right up to the opening gun of the recent war.

Thus for ten long years, our Herb hammered diligently at the unyielding bulwarks of the petroleum industry with the Union Oil Company where he learned to be a slippery customer in a white collar and was just beginning to carve up his third desk when, in a weak moment, he backslid into radio again and came to work at KGO Transmitter on August 21st, 1942.

All kidding aside, it was Petroleum's loss and our gain—Herb's a right guy and a fast man with a slide rule. Past NABET Councilman for this Shop, Herb put in some good work, acquitting himself as an able representative and staunch union man. Hereabouts

Broadcast Engineers' Journal 16  
Yearbook :: January, 1946

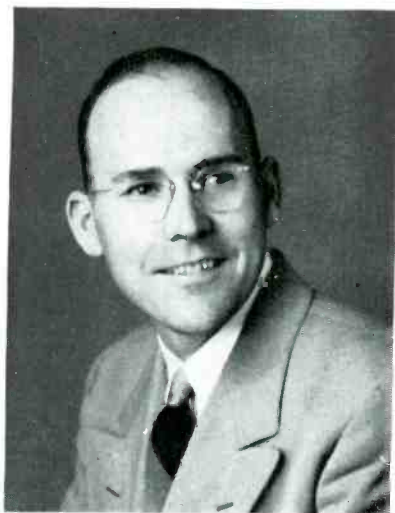

H. V. KRAMER

he is affectionately known as "Dudley" but don't let the appellation fool you—he can really put a mean curve on the ball!

Herbert and Berniece Kramer live in an aerie, reached by a torturous hairpin road—2151 Drake Drive, high in the Piedmont Hills overlooking the Bay Area, where they guard and guide the destiny of shy, blonde Karen Kramer, now 4, and the apple of my eye.

Salud, Herb.

### A Night in September

'Twas a night in September  
 When all through the land  
 Not a fellow was grinding,  
 Not even a hand!  
 Loud speakers were silent  
 And faders and tallies  
 Were silent like pixies  
 In mountains and vallies.  
 Transmitters, once humming  
 With power, shut down  
 And brought a strange silence  
 To city and town.  
 Then all through the land  
 There came such a clatter  
 You couldn't help thinking:  
 "Why, what is the matter?"  
 Mysterious fading  
 And clatters and clicks  
 Caused people to mutter:  
 "Those noisy St. Nicks!"  
 From Tuesday till Wednesday  
 Confusion was there  
 To show that dear Santa  
 Was up in the air.  
 Then all of a sudden  
 On Wednesday at 8  
 Conditions went normal.  
 And there by the grate  
 Were stockings well-filled  
 With lettuce and hay . . .  
 Which proves that dear Santa  
 Is active today!

—X. Ray.

A

A



# ALLIED

*The Name to Remember for  
Quality in Recording Discs*

ORDERS SHIPPED PROMPTLY

## ALLIED RECORDING PRODUCTS COMPANY

21-09 43rd Ave., Long Island City, N. Y.

Phone STillwell 4-2318

Cable: Allrecord, New York

# RCA Demonstrates New Television Camera Tube of Revolutionary Design and Sensitivity

Freed of Wartime Secrecy, New Television 'Eye' Called 'Image Orthicon' Is Shown for First Time at NBC Studio — It Picks Up Scenes in Candlelight and in Darkness — Helps Solve Many Major Problems of Illumination in Television Programming.

A new television camera tube of revolutionary design and sensitivity emerged from wartime secrecy today for exhibition by the Radio Corporation of America in a series of studio and remote pickups in which it not only transmitted scenes illuminated by candle and match light but performed the amazing feat of picking up scenes with infra-red rays in a blacked-out room.

The new tube, known as the RCA Image Orthicon, was demonstrated to newspaper and magazine writers in a studio of the National Broadcasting Company, Radio City, with the cooperation of NBC's engineering and production staff. Ben Grauer, NBC announcer, acted as program commentator. In the exhibition, members of the audience saw themselves televised under lighting conditions that convincingly proved the super sensitivity of the new electronic "eye" which solves many of the major difficulties of illumination in television programming and makes possible 'round-the-clock television coverage of news and special events.

Further evidence of the tube's superiority came in the transmission of scenes from a special rodeo show arranged at Madison Square Garden for the visiting United States Navy Fleet. Exciting cowboy acts were picked up by the Image Orthicon and transmitted to the studio in a comparative demonstration showing its advantage over conventional television pickup tubes in providing greater depth of perception and clearer views under shifting light conditions.

RCA-NBC engineers capped the demonstration by blacking out the studio where the writers were assembled, and providing the unprecedented spectacle of picking up television scenes in apparent darkness. Unseen infra-red (black) lights were turned on, but it was so dark that a member of the audience could not see the person next to him. Then on the screens of television receivers in the studio appeared bright images of a dancer and other persons who were in the room. The Image Orthicon tube, it was explained, achieved the feat through its sensitivity to the infra-red rays.

## Aladdin's Lamp of Television

"This is the Aladdin's Lamp of television," declared John F. Royal, NBC Vice-President in charge of television. "Its revolutionary effect on lighting problems means that many of our major difficulties of illumination will be eliminated.

"This new instrument which is easily portable and suitable for use in every field of television opens new vistas that challenge the imagination. It assures television of twenty-four-hour coverage, in daylight, twilight, or moonlight—in good weather and in bad.

"It is, in a word, revolutionary!"

Declaring the Image Orthicon to be 100 times more sensitive than conventional pick-

up tubes, E. W. Engstrom, Research Director of RCA Laboratories, Princeton, N. J., explained details of the development of the tube. He said that early models were built before the war in efforts of RCA television scientists and engineers to improve the quality of television transmission. When war came, the armed forces found urgent need for television applications, and throughout the conflict RCA research and development continued at an accelerated pace in response to military requirements. Many advances were made.

The Image Orthicon tube, for example, Mr. Engstrom said, emerged in its present form much sooner than would normally have been the case. A military secret until now, it can be revealed that it makes use of the most advanced results of more than twenty years of research not only in television pickup tubes but in electron optics, photo-emission processes, electron multipliers, and special materials.

## Men Who Developed the Image Orthicon

Credit for the tube's development goes to three members of the RCA research staff: Dr. Albert Rose, of Middletown, N. Y.; Dr. Paul K. Weimer, of Wabash, Ind., and Dr. Harold B. Law, of Kent, Ohio. The project is a continuation of RCA Laboratories' work on the pick-up tube over the past 20 years under the direction of Dr. V. K. Zworykin, Associate Director of RCA Laboratories. During part of that period, the work was headed by B. J. Thompson, Associate Director of the Laboratories, who was killed in action overseas in July, 1944, while on a special mission for the Secretary of War.

Engineers of the tube division plants in Lancaster, Penn. and Harrison, N. J., have been engaged in development of the Image Orthicon for military applications and will be responsible for the final commercial design of the tube for television uses.

Announcing incorporation of the Image Orthicon in a new super-sensitive television camera to be manufactured by RCA Victor, Meade Brunet, General Manager of the Company's Engineering Products Division, said that deliveries on the camera are expected to be made to television broadcasters in about six months.

"The new super-sensitive RCA Victor television camera will fill a long-felt need in the television broadcasting field," said Mr. Brunet. "This equipment is especially well suited for televising events remote from the studio and those where brilliant lighting is either impracticable or undesirable. The portable camera is lightweight, simple to operate, and can be quickly set up and placed in operation. It is particularly adaptable for use in televising out-of-door sports and news events and for remote indoor pick-ups such

as in theaters, concert halls, schools, churches, courtrooms, and other public buildings."

## Advantages in Performance

RCA engineers listed these specific advantages in performance of the Image Orthicon:

1. Ability to extend the range of operations to practically all scenes of visual interest, particularly those under low-lighting conditions.
2. Improved sensitivity, permitting greater depth of field and inclusion of background that might otherwise be blurred.
3. Improved stability which protects images from interference due to exploding photo flash bulbs and other sudden bursts of brilliant light.
4. Smaller size of tube, facilitating use of telephoto lens.
5. Type of design that lends itself to use in lightweight, portable television camera equipment.
6. Improved gain control system that provides unvarying transmission, despite wide fluctuations of light and shadow.

## How the Tube Works

Resembling a large tubular flashlight in size and appearance, the advanced development model of the Image Orthicon has an overall length of about 15 inches, with the shank about two inches in diameter and the head about 3 inches in diameter and 3 inches long. It has three main parts: An electron image section, which amplifies the photoelectric current; an improved Orthicon-type scanning section, smaller and simpler than those built before the war; and an electron multiplier section, the function of which is to magnify the relatively weak video signals before transmission.

The principle which makes the new tube super-sensitive to low light levels is similar to that which enables RCA's famous multiplier phototube to measure starlight. This principle, known as secondary electronic emission, involves the use of electrons emitted from a primary source as missiles to bombard a target or a series of targets, known as stages or dynodes, from each of which two or more electrons are emitted for each electron striking it.

Light from the scene being televised is picked up by an optical lens system and focused on the photo-sensitive face of the tube, which emits electrons from each illuminated area in proportion to the intensity of the light striking the area.

Streams of electrons, accelerated by a positive voltage applied to a grid placed directly behind the photo-sensitive face and held on parallel courses by an electromagnetic field, flow from the back of the photo-sensitive face to a target. Secondary emission of electrons from the target, caused by this bombardment, leaves on the target a pattern

(Continued on Page Twenty)

# To Our Friends and Customers

**T**he Langevin Company Inc. believes its customers are entitled to a statement of the company's future plans. The entire life of the company has been spent in the audio frequency field. *It intends to remain in that field.*

Due to its war effort, its facilities, experience and personnel have been increased. It will continue to develop, design and manufacture—to better than FM standards—sound and broadcast speech input equipment.

Its products will continue to include quality transformers and quality amplifiers, ranging from the smallest unit to especially-engineered speech input sys-

tems for the large broadcast stations. Much of this equipment is now in production; some in development—some between development and production.

To our old customers, the above is sufficient. To those who may be interested in becoming customers— we are 23 years old, all our equipment carries the Union Label and is fully licensed under A.T.&T. patents.

*Carl C. Langevin*  
PRESIDENT

## The Langevin Company

INCORPORATED

SOUND REINFORCEMENT AND REPRODUCTION ENGINEERING

NEW YORK

37 W. 65 St., 23

SAN FRANCISCO

1050 Howard St., 3

LOS ANGELES

1000 N. Seward St., 38

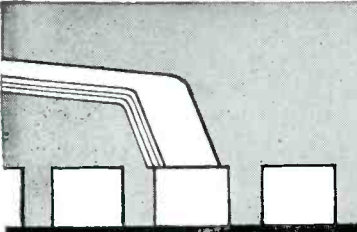

# FLAT Contacts

reduce noise, prolong service life

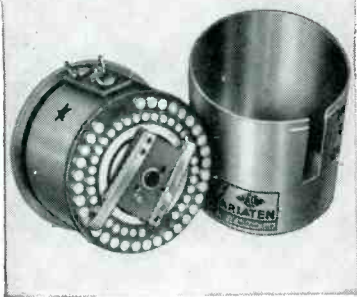

**VARIATEN #1218**  
*"T" Circuit—1½ db per step; 30 to 600 ohms impedance. Price, F.O.B...\$17.50*

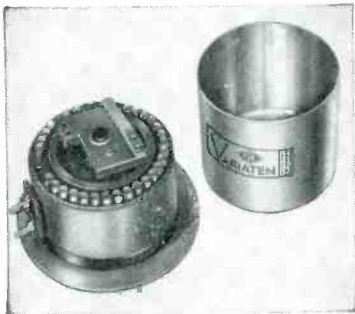

**VARIATEN #1156**  
*Ladder Circuit—1½ db per step; 30 to 600 ohms impedance. Price, F.O.B...\$12.50*



**VARIATEN #1384**  
*Ladder Circuit—2½ db per step; 30 to 600 ohms impedance. Price, F.O.B...\$7.50*

**VARIATEN** contacts and brush surfaces make contact over their entire area because the contacts are ground flat and the brushes stone-lapped, *not* buffed. Buffing produces rounded surfaces and therefore a "point" contact highly susceptible to noise. Variaten brushes move from one contact to the next without rocking motion. The resulting perpendicular spring pressure at all positions allows us to take advantage of the natural resiliency of metals to provide a completely flat contact over the entire brush surface at all times and so reduce noise and lengthen service life.

**No carbon resistors are used in any Variaten Mixer...**

All are of stable, wire-wound construction. Most are step type. Where quiet operation is the major consideration, we recommend ladder type mixers because the circuit requires only one contact brush operation on the input side of the circuit and any possible brush noise is therefore attenuated along with the signal.

By all means compare circuits, construction and features of these mixers. From the hundreds of Variaten attenuators you may select the attenuators best adapted to your specific needs. Write for the Variaten Catalog today.



**CINEMA ENGINEERING CO.**  
 Established 1935 • Burbank • California

## IRE ELECTS

(Continued from Page Fourteen)

circuits used in radio and telephony. A graduate of Stevens Institute of Technology, his early work was in connection with the transatlantic telephone, and he was also one of the engineers who installed radio telephones aboard the steamship Leviathan, the first installation to be used in public service between ship and shore. In 1936 he received the Morris Liebman Memorial prize for his analysis of reactions within the vacuum tube.

As President of the Institute of Radio Engineers, he will direct, on behalf of its 16,000 members, a program of activity which has been enlarged by peacetime utilization of wartime developments in radio and electronics. This program has also been increased by the recent successful conclusion of a building fund providing for further expansion of the Institute's facilities.

Elected with Dr. Llewellyn, as Vice-President, was E. M. Deloraine, President of the International Telecommunication Laboratories, New York, and well known in engineering circles in this country and in Europe. Three directors were also elected: Dr. Walter R. G. Baker, Vice-President of General Electric Company, Syracuse, New York; Dr. Donald B. Sinclair, Assistant Chief Engineer of General Radio Company, Cambridge, Mass.; and Virgil M. Graham, Plant Manager of Sylvania Electric Products, Inc., Williamsport, Pa. Installation will take place in January at the annual meeting, which is to be held the first day of the Winter Technical Meeting at the Hotel Astor.

The election is the thirty-fourth in the history of the Institute, which was established in 1912. It has headquarters in New York City, and embraces Sections in key industrial centers throughout the United States and Canada, and members throughout the world.

## RCA TELEVISION

(Continued from Page Eighteen)

of varying positive charges which corresponds to the pattern of light from the scene being televised.

The back of the target is scanned by a beam of electrons generated by an electron gun in the base of the tube, but the electrons making up this beam are slowed down so that they will stop just short of the target and return to the base of the tube except when they approach a section of the target which carries a positive charge. When this occurs, the beam will deposit on the back of the target through electrons to neutralize the charge, after which it will again fall short of the target and turn back until it again approaches a positively charged section.

The returning beam, with picture information imposed upon it by the varying losses of electrons left behind on the target, is directed at the first of a series of dynodes near the base of the tube; secondary electrons "knocked out" of this electrode by the bombardment strike a second dynode, and this process continues, with the strength of the signal multiplying at each stage until it reaches the signal plate and is carried out of the tube through an external connection.

Broadcast Engineers' Journal  
 Yearbook :: January, 1946 **20**

*Every* **TECHNICIAN**  
**NEEDS THIS**  
**ALL-PURPOSE**  
**SOLDERING**  
**PENCIL**



**No. 536** • Pyramid Tip, made from Tellurium.

**R**ADIO AMATEUR'S HANDBOOK lists soldering equipment as one of the radio technician's indispensable tools. And out of the crucible of war came the Electrical Industry's newest, trimmest, slimmest soldering tool . . . the Ungar light-as-a-feather Soldering Pencil—available in **FOUR INTERCHANGEABLE TIPS** . . . each designed to solve a particular problem, which makes it a "MUST" for the amateur now that peacetime activity is here.

For speedy precision on intricate, hard-to-reach jobs, you can't beat this ruggedly built Ungar Soldering Pencil! Takes plenty of punishment . . . weighs only 3.6 ounces . . . perfectly balanced; length 7 inches . . . heats in 90 seconds . . . draws only 17 watts and handles with fountain pen ease. No. 776 Handle-Cord set with No. 536 tip sells for considerably less than \$2. Please order only from your Electronics Distributor.

**No. 776** • Handle-Cord Set. Plastic, 6 ft. cord. For all tips.

**No. 537** • Pencil Tip made from Elkaloy A, tip 1/8" dia.

**No. 539** • Extra Hot, made from Tellurium.

**No. 538** • Chisel Tip, made from Elkaloy A tip 1/8" dia.

**Ungar Electric Tools, Inc.**  
 Formerly Harry A. Ungar, Inc.  
**LOS ANGELES 54, CALIF.**

*Greetings*

THE HALLMARK





# CHARLOTTE GREENWOOD

## SHOW

HARMON ALEXANDER  
MARTIN BROONES  
RICHARD CARROLL  
and BETTY HOPKINS  
PHIL COLE  
CHARLES DANT  
NORMAN DEWES  
PAULINE DRAKE  
BARBARA EILER  
ANDREWS FRENCH  
CHARLOTTE GREENWOOD  
LOLA HALLOWELL  
NORMA HARRIS

JACK HASTY  
DON JOHNSON  
BOBBY LARSON  
ARNOLD MAGUIRE  
WENDELL NILES  
FRANCES PURCELL  
EDWARD RYAN  
THOMAS FREEBAIRN-SMITH  
MIKE STEWART  
SYLVIA THALBERT  
HOWARD TOLLEFSON  
ISABEL WITHERS  
IAN WOLFE





Season's Greetings

From the Engineers

**HOLLYWOOD CHAPTER**

**N.A.B.E.T**

**NBC**

*Hollywood*

**ABC**

*Hollywood*

**KFI**

*Los Angeles*

**KFSD**

*San Diego*

**KECA**

*Los Angeles*

# B I N G

PUBLIC SERVICE . . . AN OBLIGATION,  
A PRIVILEGE, AN OPPORTUNITY

# COLD NEWS MAKES HOT NEWS *in Southern California*

Several years ago an unexpected frost in Southern California wiped out more than half of the citrus crop . . . cost orchard owners more than *fifty million dollars!* Today, California citrus growers make it their business to stay one jump ahead of Jack Frost.

For five years now, it has been part of KFI's business to help citrus growers do just that.

Nightly at 8 P.M. during the frost season KFI broadcasts detailed frost warnings by remote lines from the Fruit-Frost Station of the U. S. Weather Bureau. By regulating orchard heating operation according to this service, orchard owners now beat Jack Frost to the punch.

Here again is evidence of KFI's policy of adding purposeful local service to its top-ranking program structure. Hence, KFI's undisputed leadership in the rural as well as urban areas of Southern California.

# KFI . . . NBC for LOS ANGELES

50,000 WATTS • CLEAR CHANNEL • 640 KILOCYCLES

*Earle C. Anthony, Inc.*

## *Valuable Weather Chart Developed by KFI*

This unique weather chart, printed in four contrasting colors for quick reference and study, outlines all the temperature and climatic zones of Southern California, as well as frost warning districts. Developed by the Agriculture Department of KFI in collaboration with the United States Weather Bureau and farm industry leaders, this new chart offers valuable factual data never before compiled. The United States Weather Bureau recently adopted it as the official definition of Southern California temperature and climatic zones. Offered at the cost of 10¢ to cover mailing and handling, KFI's Weather Chart has already been requested by thousands of agriculturists throughout California.

EDWARD PETRY AND COMPANY, INC., NATIONAL REPRESENTATIVES

# FIBBER McGEE *and* MOLLY

*(Marion and Jim Jordan)*

# JACK BENNY

# The Psychopathic Misdemeanor Or Surgery Calling Dr. Killfidget!!

By Tom McKaye

PRIVATE AMOS Q. KILLFIDGET, destined to have some sort of confusing association with practically every branch of the U. S. Army, brushed with the Medical Corps in a most peculiar fashion. And it was all due to a blonde WAC, a bicycle, and Pfc. Byron Smears.

"We should oughtta be gettin' back to camp, Doc!" urged a nondescript private (first class), whose height was about four feet, sitting or standing. "Hey, Doc!"

"Um?"

Dr. Killfidget put down his empty hot toddy glass and surveyed his newly found friend and staunch companion. This was rather difficult for the old gentleman, since the good Doctor was well over six-and-a-half feet on the approximate vertical, and Private Smears was, to say the least, brief.

"C'mon, Doc! You had enough hot toddy for one night! We should oughtta be gettin' back!"

Killfidget was reluctant.

"Private Smears," began the Doctor, "I am indeed most ungrateful to return to the confines of our army camp, leaving such a pleasant and sociable establishment as this. It sort of

reminds me of Joe's place, back in —"

"Dis ain' no 'stablishment!" insisted Pfc. Smears, "dis is a saloon." The small soldier finished his short beer, and then said: "You know what the Sarge said to you last night!"

"That I do," winced the Doc, a veil of considerable gloom descending upon his withered and weatherbeaten countenance. "Perhaps we should hie away to our humble retreat."

"Huh?" puzzled Pfc. Smears. He came from Brooklyn, and didn't always understand what Killfidget was talking about. Neither, for that matter, did Killfidget.

Outside in the open air the two soldiers guided each other with mutual uncertainty.

Almost to their destination the trouble started brewing.

"Whoo-oo-oo!" screamed Killfidget, suddenly. "I'm a steam engine! Whoo-oo-oo!" He proceeded to imitate the choo-choo-ing of a locomotive, aided and abetted by Pfc. Byron Smears. The two soldiers chugged along the deserted highway, making quite a spectacular exhibition of a steam

(Continued on Page Thirty-five)



---

*William Morris Agency, Inc.*

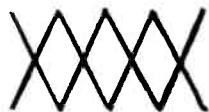

*New York* • *Chicago* • *Hollywood*





**Hi, Fellas . . .**



ZASU PITTS

ME

HEDDA HOPPER

Sure Hope You Like Our Movie—

**"BREAKFAST IN HOLLYWOOD"**

Sincerely,

**TOM BRENEMAN**





Season's Greetings

FROM

# Universal Radio Supply Company

Equipped to Furnish

## *Broadcasting & Recording Components & Equipment*

Both Commercial and Composite—From "Flea" Power to "Any" Power

DISTRIBUTORS OF

"Kluge" Transmitting Equipment • Amperex  
Victor J. Andrew • Cardwell • Corning Glass  
E. F. Johnson • Allen Bradley  
Barker & Williamson • Sprague • UTC  
Allen B. Dumont • Ward-Leonard • Millen

The Brands You Will Eventually Use  
"Why Not Now?"

*Universal Has It! Write, Visit, Phone or Wire*

Prospect 5488

## Universal Radio Supply Company

1404-1406 Venice Blvd., Los Angeles 6, California

## Season's Greetings

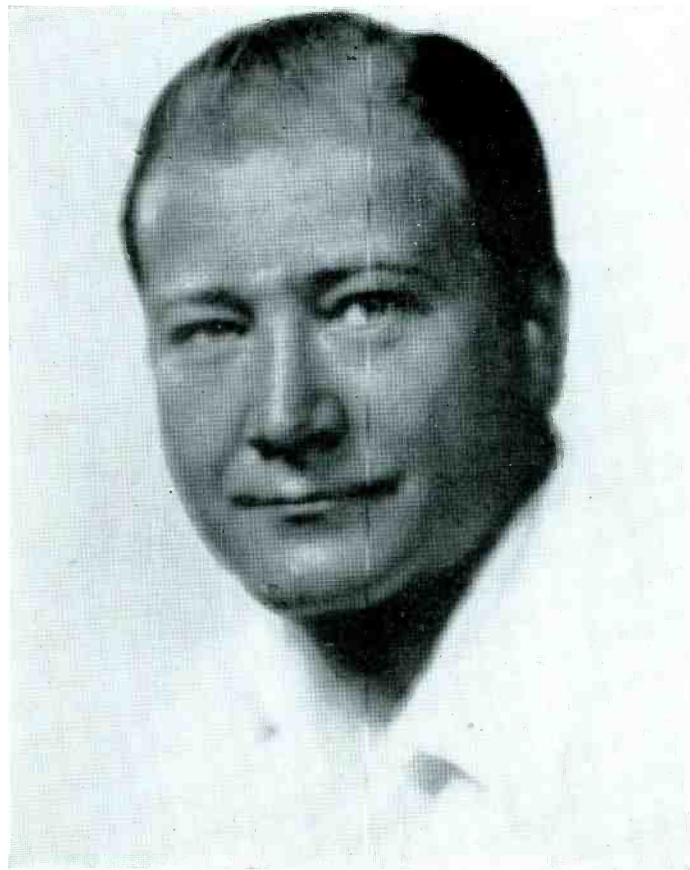

JOHN CHARLES THOMAS

WESTINGHOUSE EVERY SUNDAY

Broadcast Engineers' Journal **33** Yearbook :: January, 1946

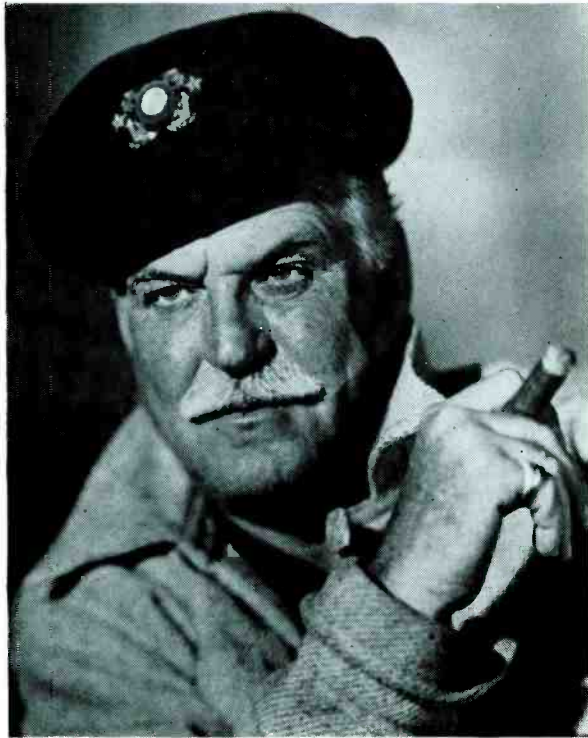

All the Best...

FRANK MORGAN

*Merry Xmas*

WALLY MAHER

*Merry Christmas*

*and*

*A Happy New Year*



JOHN BROBERG

CECIL HIND

LEIGH MATTESON

BILL RATIGAN

FRANCES WAY

JOE ALVIN

NEWS AND SPECIAL EVENTS

NBC

HOLLYWOOD



### The Walsco Staple Driver

An Ideal Tool for Temporary and Permanent  
Installation of Wires and Cables

- Feeds Staples Automatically
- Drives Staples in Hard Walls
- Driving Depth of Staple Positively Controlled
- For Wires and Cables up to 1/4" Diameter

Price Only \$3.70 at all Radio Parts Jobbers

Write for Free Walsco Catalog No. 45 BC

WALTER L. SCHOTT CO.  
Beverly Hills, Calif.

# DR. KILLFIDGIT

(Continued from  
Page Twenty-nine)

engine—replete with much hissing and whistling, taking all turns on two wheels.

"Whoo-oo-oo! Whoo!" whistled the Doctor.

At this unexpected moment a WAC on a bicycle overtook them, and then pedalled on ahead.

"Hey!" yelled Pfc. Smears, above the general roaring and puffing. "Did you see what I seen, Doc?"

"More speed!" screamed Killfidget. "I'm certain she was a blonde!"

Whereupon their railroad antics were exaggerated into a mad roaring dash, as the Killfidget-Smears R.R. sped into the blackness of the night. The noise of choo-choo-ing was stopped to preserve failing wind power on the part of the venerable Doctor, but Pfc. Smears continued to emit occasional ear-splitting whistles. Byron had formerly delivered ice in Flatbush.

"We're gaining," gasped Killfidget. "Faster, faster!"

At about this point the blonde slowed down, to enable the two gentlemen to catch up with her. But Killfidget and Smears were not aware of this point of etiquette. They raced through the darkness, suddenly tumbling into the blonde and the bicycle!

All concerned were evenly distributed about the highway. The blonde WAC registered surprise at such unorthodox commando tactics, and then became indignant. Private Killfidget registered confusion, and wrestled mentally with a reeling brain. Pfc. Smears wasn't registering anything; he was out cold, but cold.

When the fog began to lift—some time later—Privates Killfidget and Smears were jogging along in an army ambulance. The blonde was nowhere in sight, but probably it was just as well.

"What happened?" mumbled Killfidget, mentally groping

But no one answered him.

Except for the prostrate and silent form of Byron Smears, stretched out on a cot just opposite, the ambulance was empty. So when the car stopped briefly just inside the main gate of the camp, Doctor Killfidget quietly slipped out and left his bosom friend to the mercies of the Medical Corps.

"That," muttered the Doctor, as he carefully picked his unsteady way back to the barracks, "is no place for me!" He meant the Medical Corps in general, and the hospital in particular. "Those sawbones are liable to find all sorts of things wrong with me."

Except for some minor bruises, the old gentleman suffered little from his experience with the blonde and the bicycle. But it was different with Pfc. Byron Smears.

Proper x-rays and examinations the following day revealed four broken ribs and a number of minor defects in the diminutive soldier. In addition, it was noted on his chart that the private was obviously delirious, since he kept imagining that he was a train locomotive. He ranted and roared all day long, emitted huge clouds of smoke from his ears, and whistled at all the nurses.

When this unbalanced condition had continued for over five days, Doctor Killfidget decided he should visit his sick and injured companion. It was, he declared, the least he could do—under the circumstances. Besides the good Doctor might run across some good looking nurses to make up for the WAC that got away.

During visiting hours the next afternoon, Private Killfidget stalked boldly into the vast and antiseptic confines of the Station Hospital. And the first person he met was a young Corporal in the Medical Corps, named Pruitt.

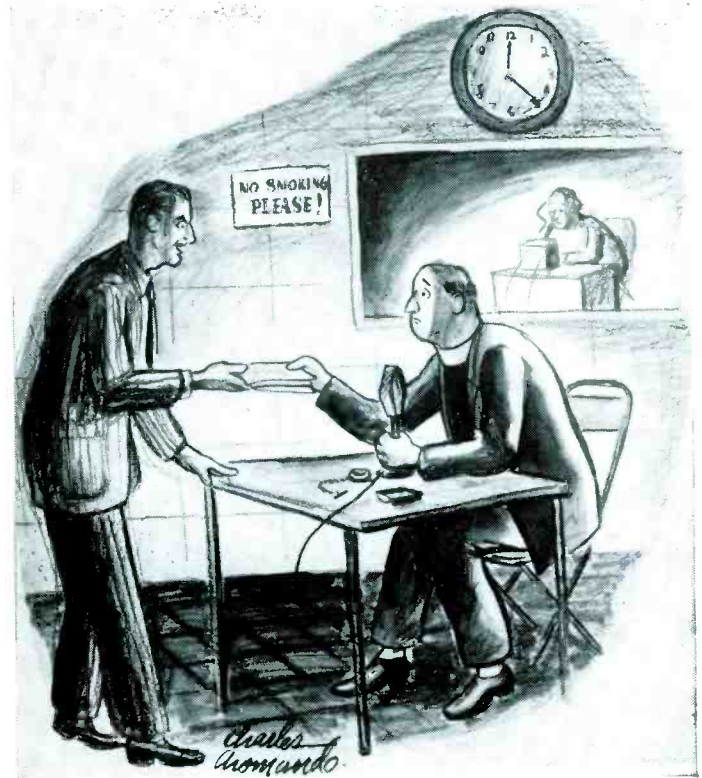

"We go on the air in 5 minutes, Reverend; and by the way, Mr. Dunninger just phoned and said you have a slight error on page 4."

"I have come," said Killfidget, with all the dignity his weary appearance could command, "to see my old and trusted friend and compatriot, my comrade and crony, my colleague and chum, Private First Class Byron Smears!"

Corporal Pruitt laid aside the Breezy Stories Magazine he was reading and looked the Doctor over, from stem to stern.

"Do you always stand at an angle like that?" asked the Corporal, purely out of medical curiosity.

"Of course," said Killfidget.

Corporal Pruitt was amazed. "I don't see how you do it!"

"Never mind that, Corp," said the old man. "How about this lad Smears? Where is he?"

"Who?"

"Smears! Smears!" The Doctor was impatient.

Corporal Pruitt thumbed through a gigantic card index, that also contained some good telephone numbers in the village.

"How did you ever get in the Medical Corps?" asked Killfidget.

"I'm a bone specialist," answered the Corporal.

"Set 'em?" inquired the Doc.

"No. Roll 'em."

At last the medical NCO clutched a card in his unsteady hand.

"This the guy? Smears?"

"The very one!" congratulated Doctor Killfidget. "Now, tell me where I can find him, Corp, before you forget what hospital you're in!"

"Room 333!"

"Thanks," mumbled the Doctor, heading for the nearest stairway.

(Continued on Page Forty-one)



Season's Greetings

# Amos 'n' Andy

*Freeman F. Gosden*

*Charles J. Correll*

With Every Kind Wish  
For a Merry Xmas  
and Happy New Year



Hattie McDaniel	Ernestine Jones Wade	Lou Lubin	James Baskett
<small>as</small> "Sadie Simpson"	<small>as</small> "Sapphire (Battle Axe) Stevens"	<small>as</small> "Shorty, the Barber"	<small>as</small> "Gabby, the Lawyer"

AMOS 'N' ANDY SHOW

DELTA RHYTHM BOYS



GREETINGS

AMOS 'N' ANDY SHOW

*Best Wishes to*

THE ENGINEERS



ROCHESTER



YOUNG ARTISTS SERIES  
 PACKARD YOUTH PARADE  
 THE BULLOCKS' SHOW



"MUSIC  
 BY  
 SWEETEN"

TRANSCRIPTIONS



**CLAUDE SWEETEN**

*Musical Director, KFI*



Here's Activating  
 Your Grids  
 Continually  
 For the Next 52

**TED MEYERS**



*Season's Greetings*



**HAL CURTIS**

*Thanks for Everything*



**Syd Zelinka**

**Howard Harris**



---

**Merry Christmas  
and  
A Happy New Year**

**BUD ABBOTT      LOU COSTELLO**



*Merry Christmas*  
*and*  
*Atomic New Year*

GROUCHO MARX

Greetings

DAVE KLEIN

OVER A DECADE  
OF SERVICE  
to the  
BROADCASTING  
INDUSTRY



As another year rolls around we take this opportunity to extend to our many friends in the Broadcasting Industry our deep appreciation and our sincere wishes for a successful year to come.



RADIO SPECIALTIES  
COMPANY

PHOENIX

LOS ANGELES

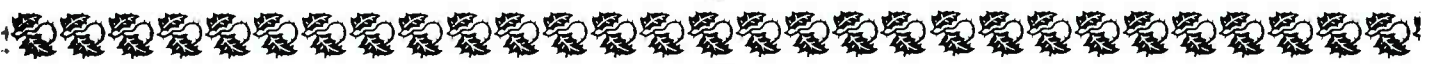

# DR. KILLFIDGET

(Continued from  
Page Thirty-five)

"Hey!" yelled the Corporal. "You gotta have a pass!"

But Killfidget went tearing up the steps three at a time and was soon beyond sound of the Corporal, who went back to his magazine on anatomy.

Somewhere on the way upstairs, however, the old gentleman passed several nurses, and this encounter served to derail his mental train of thought. He forgot the room number of his buddy, Pfc. Smears.

"Ah, well," mused Killfidget, wandering aimlessly down the first hall he came to, "I can find Byron easily enough! After all—the boys at the radio station have been calling me Doctor for years! I should be right at home in a place like this!"

But this wasn't strictly true, of course.

Killfidget barged into the first door he saw open, and was met with cold stares from nurses, doctors and interns huddled around a form on an operating table. Somebody said: "Outside, soldier!" and tossed a wad of cotton at him. The cotton was well soaked with ether. And after getting a good whiff of the anesthetic, Killfidget didn't need an order or an invitation to leave.

"Wow!" mumbled Doctor Killfidget, rolling unsteadily out into the corridor.

His somewhat hazy vision focused slowly and unsteadily upon a large white form that blocked his path. It was a real doctor, a huge man named James Thornbury, complete with white uniform and rubber gloves.

"Um-m-m," said the medic with the rubber gloves. "Bad case! Never seen anything like this before!" Whereupon he summoned several other doctors and nurses who happened to be passing.

Everyone stood and stared at poor old Killfidget, and then nodded their heads collectively. As the effects of the ether began to wear off, Killfidget found himself bodily in the hands of several white-coated orderlies.

"Hey!" protested Killfidget, struggling vainly.

"Take it easy, soldier," said one of the orderlies, a former embalmer named Whitnah. "Just relax, and you'll be all right."

"But—but—"

"Toss him in the psycho room," instructed a thin and

haggard orderly named Rojas, slapping Killfidget over the head with an old racing form. "He may get violent!"

Everyone seemed very business-like. So Killfidget didn't even protest when they dragged him into a small, padded room, stripped him of his G.I. clothing, draped a worn and bedraggled white night-gown over his gaunt frame, and tossed the old gentleman into a bed.

"This," commented Killfidget, when they had gone, "is very undignified, and more than somewhat peculiar." They had even locked the door.

"Just like a radio studio," mumbled the old man, glancing around at the nicely padded floor and walls. "No furniture, or chairs, or anything! Reminds me of the old days at WBZ!"

Set well back into the thick walls were two small windows. Killfidget could see various pairs of eyes looking at him through these windows, but the old man didn't care. He stuck out his tongue at them, and when this had no effect he wiggled his long, bony fingers in the immediate vicinity of his proboscis.

Finally he yawned and lay back on the bed.

"I don't think my C.O. is going to like this," muttered Killfidget. "Captain Gootee won't like this a bit! And I still haven't found my old friend and buddy, Pfc. Smears!"

The old man dozed off into a sound sleep, probably due to having been out most of the previous night—saturating himself with hot toddy. When he awoke some time later, two bearded gentlemen were intently watching him.

"Do you always make funny noises when you sleep?" inquired one of the beavers, an elderly gentleman named Finch, from Denver.

Killfidget rubbed the weariness from his gaunt and hollow eyes.

"What noises?" he inquired.

"Those noises!" explained the other bearded psychiatrist, a horse doctor named Carl Lorenz.

Killfidget concluded that both the bearded ones were nuts! They just kept looking at him—and shaking their heads.

"When am I going to get out of this madhouse?" asked Killfidget.

"Don't worry," said one of the medics.

(Continued on Page Forty-seven)

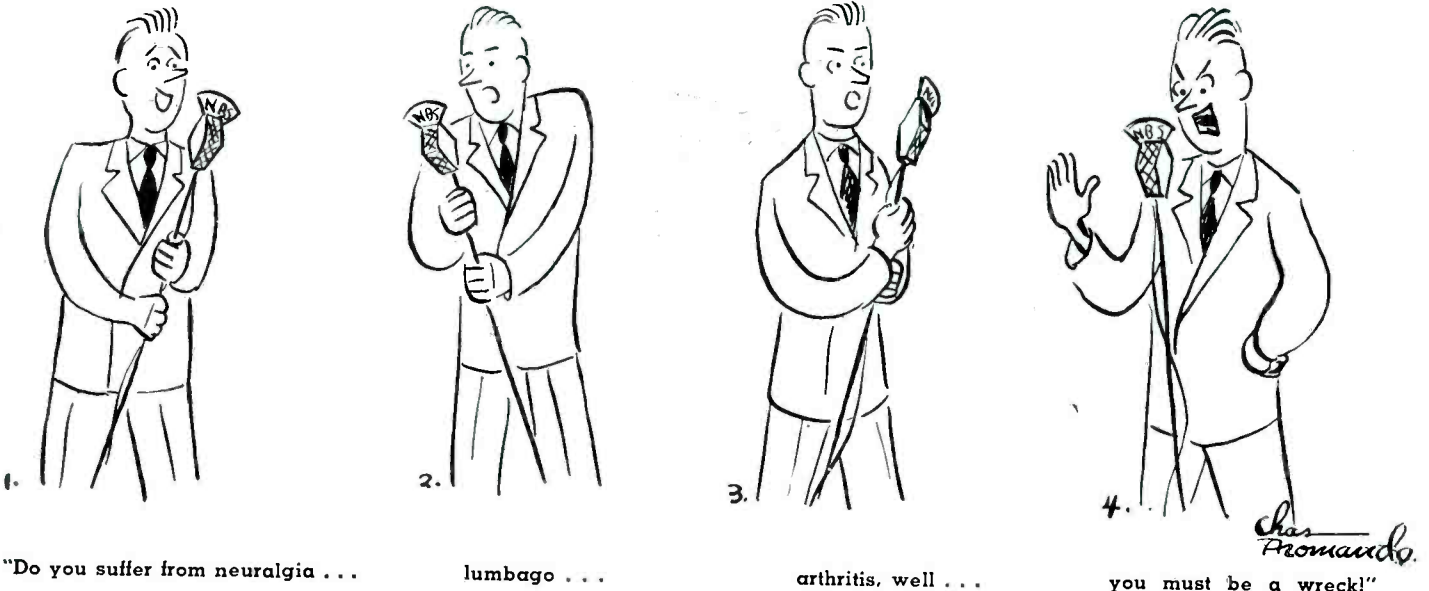

Season's Greetings

JOHN SCOTT TROTTER

KRAFT  
MUSIC  
HALL



Merry Xmas and  
A Happy New Year



WILL OSBORNE

Mirandy's Emporium  
General Merchandise



at the  
Farmers Market  
Third & Fairfax  
Los Angeles



Same "Mirandy" of the American Broadcasting Co.

JOSEPH ENOS

NBC

*Spason's Greetings*

*Borden's Presents*

**GINNY SIMMS**

*with*

FRANK DE VOL

THE BORDEN CHORUS

DON WILSON

Season's Greetings

*From*

IGNACE HILSBURG

NBC

*Thanks for Everything*  
**FRANCES SCULLY**

"STAR GAZING AT HOLLYWOOD"

KECA

Season's Greetings

TO THE

*Engineers*

**RUBY LLOYD**

American Broadcasting Co. Staff Organist  
HOLLYWOOD

5th Year as "The Great Gildersleeve"

**HAROLD PEARY**

NBC — SUNDAY

KRAFT FOODS CO.



SHIRLEY ROSS

## GREETINGS FELLOWS



LEO GORCEY

ORSON WELLES

COME  
A M or F M



THE "CYCLE" OF CHRISTMAS  
Brings the Same Holiday Greeting  
from  
CARLTON K<sub>a</sub> DELL

GREETINGS

Robert Emmett Dolan



# DR. KILLFIDGET

(Continued from  
Page Forty-one)

"Everything is going to be all right!" explained the other.

Then both looked at each other in a resigned manner, and left the good Doctor Killfidget and the leather-padded room. In their haste to report to a higher authority, however, they neglected to bolt securely the door to Killfidget's room.

As soon as the twin-bearded psycho boys had disappeared from view, Killfidget wandered innocently out into the hall, looking for Pfc. Smears. The old man was rather loosely clad in what was laughingly called a nightgown; but it resembled more a flannel sleeping bag of oversize proportions. The sweeping white folds of this garment transformed the old gentleman into an Arab, except for the bony, white, flat feet that protruded from the bottom in a most un-Arabic manner: they were clean.

Two nurses suddenly coming upon this gaunt spectre, threw up their hands in horror and went screaming to from whence they came. The old man, being something of a hunter, had decided to give enthusiastic chase when he was suddenly confronted by an elderly matron. She was used to seeing wild and gaunt spectres, being one herself, and she sternly demanded to know who he was.

Killfidget looked the old tomato squarely in the eye, and said: "I, madam, am Doctor Killfidget!"

This was a most unexpected answer.

"A d-d-doctor?" she stuttered, caught off-balance.

Killfidget nodded, quite pleased with himself.

"But—but—but—," she began, pointing vaguely to his outlandish costume.

"Lost my clothes," explained Killfidget. "Big airplane crash! Got away by the skin of my teeth!" To prove this

point he removed his upper plate and handed it to the nurse for closer examination. He noticed that the false teeth still bore the slogan "World's Fair 1893" across the roof of the plate.

"I—I—I'll see what I can do!" exclaimed the matron nurse, departing hastily for a sedative. Killfidget inserted his teeth in his mouth, clicked them soundly several times, and wandered down the hall.

He found a door marked "X-ray Room. Do Not Enter"—and pushed his way into the camera room, with arrogant curiosity. He was looking for Byron Smears—and the old man was unprepared for what happened.

The door was suddenly slammed shut behind him, he was whisked across the semi-darkened room, strapped against a huge X-ray machine, and a dozen or so pictures were taken of his internal workings before he could summon a cry of protest.

But it was too late. The pictures were taken.

And the results of those pictures will long be remembered by the Medical Corps of the U.S. Army.

Among the various assortments of objects found lodged in the old gentleman's stomach were two dimes, a phoney nickel, three Coca Cola bottle caps, a free ticket to the Steeplechase at Coney Island, two empty beer cans, a defective rheostat, 350 feet of transformer wire, two passes to the Chicago Rialto Burlesque Theater, a broken roller skate, an even dozen champagne corks, and a defective carburetor for a 1927 Chevrolet.

"Well," demanded one of the interns that had taken the amazing x-ray photography, "What do you think of these things?"

Killfidget shook his head.

(Continued on Page Fifty-three)

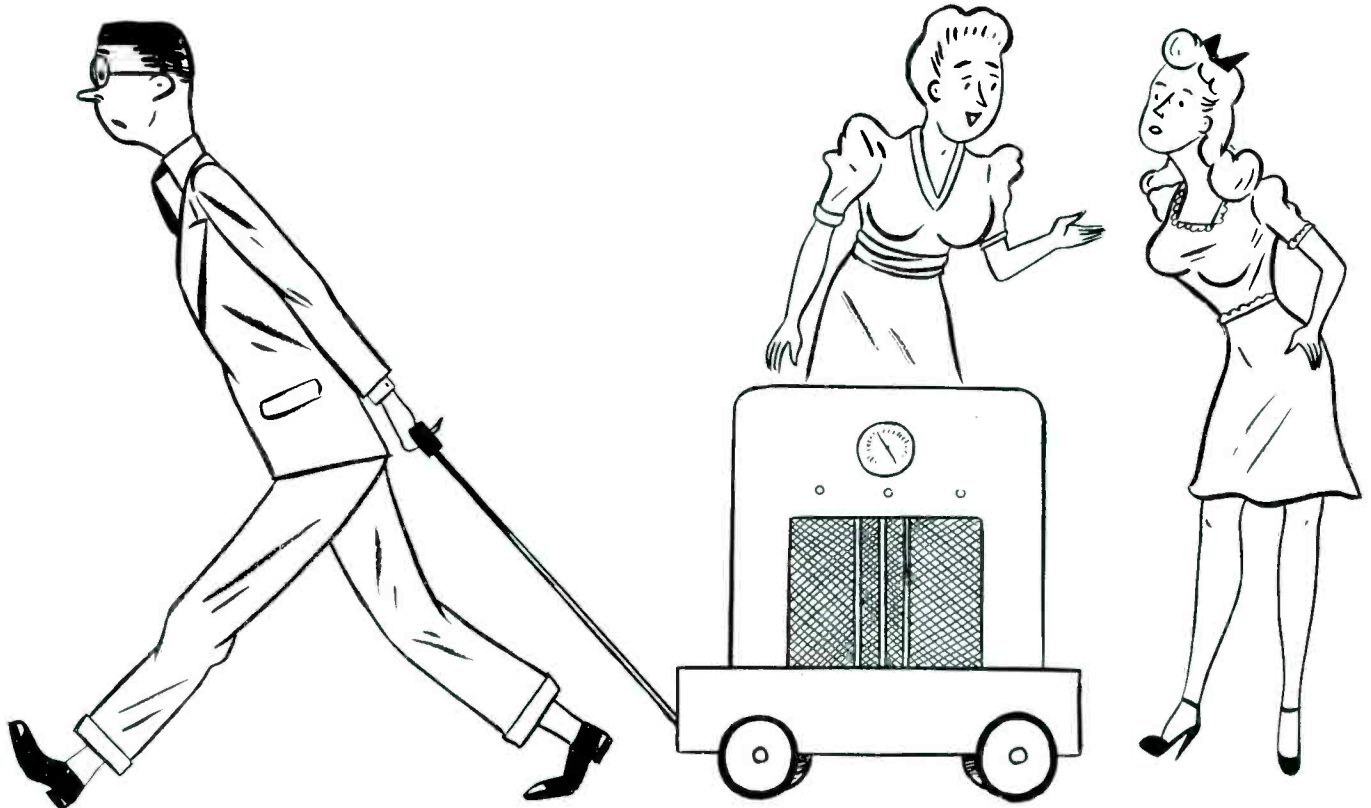

"The salesman told him it was portable!"

---

JUST A SIMPLE STATEMENT

(*Meaning so much*)

MORE STATIONS USE STANDARD  
TRANSCRIPTION SERVICE THAN ANY OTHER

*Standard Radio*

NEW YORK • CHICAGO • HOLLYWOOD • DALLAS

---

*Seam's Greetings*

*from*

ROUNDUP TIME

AMERICAN BROADCASTING Co.

SLIM DUNCAN • MERLE TRAVIS • HANK PENNY

ABIGAIL *and* BUDDY

ART WEST *and* the SUNSET RIDERS

---



Best Wishes from the Cast of

# A Date With Judy

LOUISE ERICKSON

DIX DAVIS

MYRA MARSH

JOHN BROWN

HELEN MACK, Director

*Music by*

PAUL SAWTELL

*Musical Director*

C. BAKALEINIKOFF

*Courtesy R.K.O. Studios*

*Sound Effects*

LEONA SHATAN

*Engineer*

BOB MORRIS

jack meakin



Musical Director . . .

"THE GREAT GILDERSLEEVE" — NBC

## Season's Greetings

To Our Many Friends

The Broadcast Engineers

FROM

"The Boys Around the Corner"

Hollywood Radio Supply, Inc.

5521 Hollywood Blvd.

Hollywood, Calif.

COMPLIMENTS

OF

**GORDON JENKINS**



Greetings and Appreciation

*from*

**CLIFF ARQUETTE**

AND THE CAST OF

**GLAMOUR MANOR**

# CASS DALEY

## *Fitch Bandwagon*

EVERY SUNDAY

N. B. C.

### Season's Greetings



E. Broox Randall & Sons, Inc.

INSURANCE

For Every Purpose

5901 Sunset Boulevard

Hollywood 28, Calif.

### Good Morning, Americans! ART BAKER and His NOTEBOOK



# DR. KILLFIDGET

(Continued from  
Page Forty-seven)

"I don't know *what* to think!" explained the old gentleman. "I don't *ever* remember of drinking any champagne!"

When the nurses and interns were gone, he lost little time in leaving the embarrassing confine of the X-ray room.

"What'll they think of *next*?" he mumbled, slamming the door behind him, and walking directly into the arms of another man-in-white.

"Going somewhere, soldier?" asked the medic, a retired foot doctor named Wilson Knight.

"I would like," explained Killfidget, with quiet and careful emphasis, "to get the hell out of this place before I go nuts!"

"Step into the Chief's office," suggested the medic. "I think *he* can straighten you out!"

"Well—" began Killfidget.

"Right this way," ushered the medic. He had formerly worked at Grauman's Chinese Theater.

In the office there was a very attractive secretary, and Killfidget allowed himself to be led most willingly.

"This is Miss Fishbeinder," said the medic, turning to go. "You wait here, until I locate the Chief Doctor."

"Okay!" laughed Killfidget, sitting on the edge of the desk. "I certainly would like to get out of this over-size laundry bag—and find my pal Byron Smears!"

When the head doctor arrived on the scene he wasn't any too pleased with Killfidget's attitude toward Miss Fishbeinder. He didn't know Killfidget.

Arising from the secretary's lap, the old gentleman assumed a vague position of attention.

"Sir!" announced Killfidget, "as one Doctor to another, I would like to make a very sincere and personal request."

"Oh? You a doctor?" The Chief was surprised.

Killfidget was modest.

"Well, in a small way," explained the old man. "You see, I sort of operate on radio sets. The boys back in—"

"*What?*" exploded the chief doctor. His face turned from crimson to purple and back again to crimson. "Are you the maniac that's been causing our nurses so much trouble? Are you the nut that—"

"I'm no nut!" screamed Killfidget, wildly flapping his white nightshirt, and scaring Miss Fishbeinder so much she had to run out and powder her nose. "I'm an American citizen! I've got my rights! Viva la France!" The doctor-in-charge was speechless with fury—and Killfidget roared on. "I came in here to see my friend Private Smears! That's all! And what happens?"

"Yes!" blared the chief doctor. "What all *has* happened that I don't already know about?"

"I protest!" bleated Killfidget. "I've got my—!"



"The crisis is over . . . It'll work again!"



"For added pep and energy—eat Neaties and Smile, Smile, Smile, Smile, Smile."

His high-pitched, quivering voice stopped in mid-air. The doctor he had encountered earlier in his travels came into the office; he was the big man named James Thornbury, still with white coat and rubber gloves.

"You!" exclaimed the doctor with rubber gloves.

"Recognize him, eh?" said the chief doctor.

"Absolutely!"

"What," asked the chief doctor, following a lengthy period of embarrassing silence, "have you got to say for yourself? How can you explain your actions?"

Killfidget, the Invincible, yawned.

"I'm tired," he said, simply. "Maybe I don't want to see old Smears, after all!"

They led the old man away, examined him more completely, and later discovered that the psychiatrists must have made a mistake. Finally, three days later, they gave him back his GI clothes, and discharged him from the Station Hospital. But they never could account for the variegated collection of articles reposing in Killfidget's breadbasket.

And neither, for that matter, could Killfidget.

Sitting in his cell in back of the Provost Marshall's office several weeks later, the venerable Doctor reflected upon the strange chain of circumstances that had transpired as a result of the accident. Killfidget, it would seem, had many serious moments like this.

"I wonder," he mused, looking through the barred window of his solitary cell, "what that blonde WAC was doing on a bicycle at *that* time of night!"

\* \* E N D \* \*



# *Greetings Through the Glass*



**FLEETWOOD LAWTON**

*News Analyst*

KFI

NBC

## Season's Greetings

To our many Friends in the Radio Industry from

**MUSIC CITY and MAGNAVOX**

We are proud to announce our selection as  
Hollywood's exclusive dealer for the NEW

**Magnavox**  
RADIO PHONOGRAPH



*Hollywood Meets its Music  
where Sunset Meets Vine*

## GREETINGS

*from*

Chief Scissors Man

and Head Paster

*Bob Burns Show*

**VIC McLEOD**



***Microphonically***

***Yours***

***Rudy Vallee***

---

# ***Carlton E. Morse Productions***

**“ONE MAN’S FAMILY”**

**“I LOVE A MYSTERY”**

**\* “ADVENTURES BY MORSE”**

*and now*

**“HIS HONOR THE BARBER”**

*Starring*

**BARRY FITZGERALD**

. . . and more to come

**1500 VINE STREET**

**HOLLYWOOD 28, CALIF.**

\* Transcribed . . . Write or Wire for Information

---

## **Merry Christmas**

. . . from . . .

### **“RADIO TEL”**



Come in and see us. Since last Christmas we have moved to a new location. Here we have greater facilities and a better opportunity to give you good service. New transmitters, receivers, test equipment and sound equipment is now arriving. Won't you come on in and allow us to show it to you?

**RADIO TELEVISION SUPPLY CO., INC.**

**1509 So. Figueroa Street**

**Los Angeles 15, California**

**SPADE COOLEY** and His Western  
Dance Gang



Compliments

*of*

**TWO FRIENDS**

**Greetings**

*to the Boys*



**PHIL and ALICE**

**HARRIS**

*and Family*

---

## The Leo J. Meyberg Co., Inc.

... Complete stock of all major lines of electronic equipment

... RCA Distributors

... For your convenience, branches in San Francisco and Los Angeles

*For prompt, courteous and specialized service*

**"CALL MEYBERG FIRST"**

### THE LEO J. MEYBERG CO., Inc.

2027 So. Figueroa St.  
Los Angeles 7, PR 6011

70 Tenth Street  
San Francisco, Underhill 1212

---

Thanks to you all and

Season's Greetings

from

**FREDDY MARTIN**



By Norman Dewes

**P**IC . . . which heads up Hollywood this Yearbook, and which if Stolzie fancies it, we hope, will be used to identify the Hollywood chips henceforth, is the result of not a few evenings of clicking, dipping and pasting on the part of Mr. Robert Jensen, official photog and Art Producer for the NABET Hollywood Chapter (see p. 54 of last year's Yearbook, "p. 19" of the August issue, etc.) . . . thing started out very quietly to be a simple montage of a few scenes around Radio City, but Jensen and we kept finding more 'n more things to shoot which were reminiscent of Sunset 'n Vine and environs, and it turned into quite a project . . . it should be captioned perhaps, "Through Hollywood with Paste and Shears," for it is what is commonly looked down upon in the trade as a "paste-up," and scorned by all true artists of the Bulb 'n Sheet . . . but we don't care, so long as it is looked down upon . . . and we had fun cutting 'em all out 'n sticking 'em up, on Bob's living room floor, with the Jensen child life climbing around and lovely Jan (the missus) cooking up a lovely steak 'n baked potatoe dinner for us afterward, with pumpkin pie and coffee . . . every shot is a Jensen original and all were taken at nighttime . . . and the entire production was directed by Dewes . . . hmnf, hmnf, hmnf, hmnf, hmnf . . .

Scanning . . . the scene from left to right, you see just about everything you see when standing on the veranda of Radio City in the evening . . . KFI, KECA and KHJ are a few blocks away, and are included to sort of round out the network scene, even

though they can't quite be seen unless you go up on the roof . . . all the others are eye-shot shots . . . Starting with "line one" as the TV boys say, we see a glimpse of KFI's studios over on Vermont Avenue, where KECA used to be also until the Move last year to their own Highland 'n Sunset spot . . . KFI is NBC's 50 KW Los Angeles area outlet and a fine modern radio station, well equipped and operated, with a long past of years of meritorious public service . . . Next is a shot of Vine Street, looking up toward Hollywood Boulevard from the Sea Wall around the front of Radio City, with typical vistas of Vine Street bistros, Bowling Alley and Breneman's . . . we call it the Sea Wall because all the beautiful girls perch there, with the Army, Navy, Marines and Civilians passing in Review beneath . . . but everytime by the time we get close enough to see anything, all the gals have been taken . . . next is a view of Carpenter's Drive-In across the street, where we sometimes eat when we feel lucky, it being quite a feat due to the problem of bucking Sunset Boulevard traffic . . . besides, it's always so crowded your car has to have a reservation or you're out of luck . . . then comes KECA's call letters, above their still new Highland Avenue studios, home of La Croix and Eilers, who can be seen by appointment only . . . although Eilers can usually be seen only with a Stroboscopic Viewer, or else he's just a blur, flashing by from crisit to crisis . . . this KECA joint is a veritable harem, with a steady stream of beautiful things

(Continued on Page Sixty-five)



Season's Greetings

from

GEORGE BURNS and GRACIE ALLEN

*Maxwell House Coffee Time*

THURSDAY NIGHTS NBC



*Holiday Greetings*

from

MEREDITH WILLSON

*Merry Xmas, Fellows!*

DEAN FOSSLER

ORGANIST

SHERLOCK HOLMES — MBS

STAFF — ABC



OLLIE O'TOOLE

VOICES



*Greetings from*  
**NBC HOLLYWOOD PRODUCTIONS**

Homer Canfield (Production Manager)

Howard Wiley

Andrew Love

Bruce Kamman

Charles Buck

Van Urbanski

Richard Tate

Karl Gruener

Harlan Dunning

Robert Dwan

Al Ulrich

Johnny Morris

Jack Lyman



**THOMAS MANCINI**

Concert Master

N. B. C.

HOLLYWOOD

*Season's Greetings*

**V. T. RUPP CO.**

1150 West Olympic Blvd.

Los Angeles

Aldo Bussi — Engineer

Representing . . .

AUDAK

AUDIODISCS

BURGESS BATTERIES

CARDWELL CONDENSERS

MACHLETT TRANSMITTING TUBES

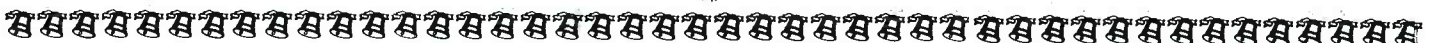

**Season's Greetings**

**Radio Products Sales Co.**

238 W. 15th Street

Los Angeles 15, Calif.

PRospect 7471



*Complete Equipment*

*for*

*Broadcast Station*

*Radio Laboratory*

*Amateur*

**Merry Christmas**

**Happy New Year**

**BOB LATTING**

Announcer

ABC

HOLLYWOOD

**"Thank You for Listening"**

**JUNNIUS PIERCE**

Commentator

KECA

ABC



*Compliments of*

**LUD GLUSKIN**

*Musical Director*

*Amos 'n' Andy*





The fun with words game  
**"NOAH WEBSTER SAYS"**  
WITH HAVEN MacQUARRIE



**COAST TO COAST**

East—7:30 to 8:00 P.M.—E.S.T. Every Saturday Evening  
West—9:30 to 10:00 P.M.—P.S.T. Every Thursday Evening  
Sponsored by Wesson Oil and Snowdrift

**SPERRY'S  
THIS WOMAN'S SECRET**

We thought of being funny,  
We thought of being smart,  
We thought of kinda taking  
The engineers apart.

But when we had another thought  
We threw those in the ditch—  
We thought of how the show would sound  
If no one threw the switch!  
So . . . in all dignity . . . Thanks, gentlemen,  
For your swell cooperation at NBC  
Hollywood

**HELEN MORGAN  
IVAN GREEN**

**Merry Christmas**



*Norman B. Neely Enterprises*



420 Market Street  
San Francisco 11, Calif.

7422 Melrose Avenue  
Los Angeles 46, Calif.



With Sincere Appreciation to the Boys  
Who Kept Me on the Level  
in 1945

And With Equally Sincere Trust That They  
Will Do the Same in 1946

**Edward Jorgenson . . . News Analyst**

KFI - - - - LOS ANGELES

**JOAN SCHAFER**

on

**"What Do You Say?"**

DAILY

KFI



**Best Wishes**

from

**Dustin Rhodes**

while

**"Living in Hollywood"**

for

**STUDIO**

**GIRL**

**SHAMPOO**

KFI

**Season's Greetings**

**Le La Fayette Restaurant**

*Cuisine Francaise*

7165 Beverly Blvd., Hollywood

WAlnut 2828

**Wesley Tourtellotte**

ORGANIST

# HOLLYWOOD

(Continued from  
Page Fifty-nine)

clicking up and down the halls past MCD and the Maintenance Shop . . . both Thor, MCD Super, and Johnny, Maint. Super wear bibs while on duty and Eilers issues you one while you are there . . . All the creatures are gorgeous, but there is one who takes our eyes everytime . . . she is Nadyne, the Program Manager's secretary, and did'ja ever try to solder yer joint without looking at it? . . . you get tinned fingers, but you never notice and anyway, they're worth it . . . Both of 'em . . . next row shows the big Capitol Records sign proclaiming that they are "Where the Hits Begin" . . . a Capital statement, and looking right at us, catty-corner across the street . . . sign tops the Radio City Drug Store where they feature Bromo-Seltzer . . . a nice touch . . . "Settles Stomachs and Soothes Nerves" it says, and they sell it by the case . . . then, of course, are the Three Big Letters which spell NBC down the City's face . . . impressively illuminated, they dominate the Corner day or night . . . and the traffic signal and Street sign out in front, which proclaims our location . . . the Crossroads of the World . . . and a glimpse through one of the Main Entrance doors into the Lobby . . . as mentioned before, there are two addresses for the Building, one on Vine for NBC and 6285 Sunset for the Americans . . . in the background can be seen the Lobby murals and Master Control, through the Looking Glass . . . this was a nite shot, and we had to expose the film for six minutes or so late one evening and Jensen had to go to do a news program and left us standing out there alone with the box and we almost got laid out by a couple of inebriates who assumed we were spies or something and tried to bust us up . . . next is a view of the old Melrose Studios, once NBC and Hollywood's first Radio Village, then when Sunset 'n Vine was built, taken over by Don Lee to house KHJ's expanded facilities and Mutual outlet . . . joint was modernized, and has a very nice Master Control board . . . very easy to make pre-sets, and what is more important, Re-Sets . . . "Melrose" is soon to be vacated once again, when "HJ" moves to their new building . . . in the B.G. can be seen the sign of the Melrose Grotto, a famous and favorite gathering place for NBC engineers and announcers in the "old days" a few years ago . . . now, making the re-trace back across the pic we see the imposing marquee of Columbia Square, where CBS and KNX are, down Sunset a few blocks . . . they have a very beautiful building too, and even the rivals, are friends with us and we drop in as often as time permits . . . the boys on the Desk there are of the busy type, having to switch network feeds and keep KNX running locally too, twenty-four hours a day . . . their MCD board is very fanciful as well as functional, with huge volume meters, panels of colored lights and king-size 'scopes on things . . . we manage to eat pretty often at adjoining Brittinghams, where you can get a Square meal for not too much, and sometimes see some CBS men there . . . the tangent tower 'n shack are those of Don Lee's FM station K45LA, up on the crest of the hills above Hollywood . . . officially, it is Hollywoodland and atop Mt. Lee . . . and the tall tower's flashing red lights and the brilliantly flood-lighted Television studios can be seen from afar, from Town on one side and out in the Valley on the other . . . this was a nite shot too, taken from about half-way up the mountain's twining road . . . portions of which are wonderful parking spots for activities of various sorts, including sightseeing and mobile 2 and 1/2 meter ham radio . . . and cars can be found there in numbers each evening, the occupants engaged in transmissions of one kind or another . . . Keynoting the pic is the sign of Daily Variety, up on Vine above the Boulevard and the innocent source of much information and inspiration . . . below is a close-up of Breneman's Beanery, from which emanate Monday through Friday TC shots of Tom Breneman and the Ladies at "Breakfast in Hollywood" . . . evenings, they serve other things and it's still a place for ladies . . . with an escort . . . you can get a good steak there, too . . . tucked down along the edge is a wee glimpse of the parking lot, where they have a big sign stating that there is "No Bailment Created" . . . this passage puzzles everybody, including the lot attendants and Orsen Welles, who had his lawyers look it up . . . reminds us of that song, "Mama Don't 'Low It" . . . take it, fellows, "Mama Don't 'Low No Bailment Creatin' Here" . . . yes . . . sounds faintly risgay to us, and we wish we knew what it meant . . . next pic is a shot of the huge Palladium down the Boulevard toward CBS, where the famous hands give out with the jive for the 'bugs 'n 'cats . . . you should try to get in there on a Satiddy night, much less try to dance . . . it's an emotional experience, and, as Wendell Niles says, it's crowded to the point where it's fun . . . then, of course, we had to include a view of the Brown Derby, where movie stars gather to be seen and to glare

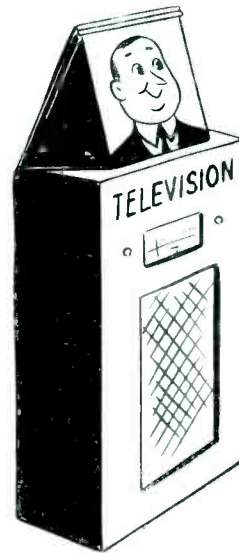

at other movie stars . . . and where we eat, when taken by a producer or agency man who probably wants another mike on the orchestra or two more in the audience . . . the portion of the sign below says in full, "Canadian Club Whisky," which is some sort of appetizer which they serve there a la cart . . . a fellow comes up to yer table with a portion of the potion in a little cart, you partake, and he wheels you away . . . this shot was taken from an alley around in back, after we got pushed off the sidewalk around in front three times by professional snappers . . . and then to complete the pic is Earl Carroll's famous Theater Restaurant, or Resterant, or Restaurant (alright, lessee you spell it . . .), home of Beryl Wallace and through whose doors pass the Most Beautiful Youknowwhats in the World . . . trouble is, the door is a back door and has a cop on it and just try to get in . . . the gals all come out under armed guard, too, so we gave that up long ago . . . but as for Beryl, well, we are still trying . . . wonder if the fellows would be filled with ennuif if we got Stolzie to run another view of her . . . all we got to say is, if Beryl is ennuif or even vice-versa, why Hooray! and watch yer pronunciation, bub . . . Well . . . looks like most of our space is used up and we should make way for the commercial copy, so had better omit the personal persiflage this month, in favor of the ads . . . hook has some extra choice chit hanging, and also some chat, which will make good reading for next issue, providing we don't get it in late too late. It's been a pleasure this last year . . . and we're looking forward to the next . . . we've enjoyed hearing about the other Sections and Chapters of NABET, through the fingers of the other associate editors, and wish we could get to know you all personally . . . we feel that NABET has done much to further the position of the Broadcast Engineer, and will continue to do much more . . . So-o-o-o-o-o, from the Hollywood Chapter, Very Best Wishes for Your continued success and happiness . . . and Mable sez so too . . . BCNU. (See Page 71!—ND).

## NABET HAM NETWORK

All members are requested to send their calls, operating frequencies, names, etc., to W6LN—Thor LaCroix, NABET Vee-Pee, who will co-ordinate this means of closer social contact between the membership.—Ed. S.

**Merry Christmas**

**RICHARD LANE**

*With*

**best wishes to all our friends of**

**N.A.B.E.T.**

**CASTLE'S, INC.  
HOLLYWOOD, CALIF.**

**Merry Xmas**

*and*

**a Happy New Year**

*to the*

**Broadcast Engineers**



*for your Audio Discs*

**Dow Radio Supply**

1759 E. Colorado, Pasadena 4, Calif.

Dial — RYan 1-6683



**Talking • Singing**

**Sound**



**WRIGHT SONOVOX**

**HOLLYWOOD**

**CHICAGO**

**NEW YORK**

Season's Greetings



THE LYTTLE SISTERS

and

ANDY WILLIAMS

"CALIFORNIA MELODIES"

KHJ

HOLLYWOOD

Holiday Greetings to the Engineers  
of Southern California and Arizona

W. BERT KNIGHT CO.

908 Venice Blvd.

Los Angeles 15

Representing

Shure Brothers — Microphones

Cornell - Dubilier Electric Corp. — Capacitors

Ward - Leonard Electric Company — Resistors

Standard Transformer Corp. — Transformers

Season's Greetings

LOUIS ADRIAN

H'ya, Fellows!

FRANK NELSON

Greetings

THOMAS PELUSO

Musical Director

N.B.C. WESTERN DIVISION

John Nesbitt

Season's Greetings  
and THANKS!

The Hollywood  
NBC Announcers



Greetings  
Ken Lane

Frank Barton  
Bob Campbell  
Doug Gourlay  
Archie Presby

John Saar  
Jimmy Powell  
John Storm  
Aubrey Ison

A MERRY CROSSLEY  
*and a*  
HOOPER NEW YEAR!



“THE LIFE OF RILEY”  
*with* WILLIAM BENDIX *as* “RILEY”  
SATURDAY NITE ON NBC

Packaged by IRVING BRECHER  
8732 Sunset Boulevard  
Hollywood, Calif.



A Merry Christmas

*from*

Red Skelton



SEASON'S GREETINGS FROM

“MEET ME AT PARKY’S”

- . . . Is Written by Hal Fimberg and Harry Einstein
- . . . Produced and Directed by Hal Fimberg
- . . . For Lennan & Mitchell, Inc.
- . . . For the Purpose of Selling Old Gold Cigarettes
- . . . Over N.B.C.— Sunday Nights— Coast-to-Coast

*No Other Program Can Make This Claim!*

**NBC**

Station for

San Diego

**KFSD**

600  
K. C.

Season's  
Greetings

AFRA  
Len Lundmark  
George Reed  
Bill Bozarth  
Russ Plummer  
Alys Phreaner

NABET  
Virgil Anderson  
James Kemp  
Ralph Evans  
Richard Gartner  
Charles Glass

**KFSD**

SAN DIEGO, CALIF.  
N. B. C.





## A VERY NOVEL MICROPHONE DESIGNATION!

This pulchritudinous ABC trio took time out from their acting chores at Metro-Goldwyn-Mayer studios in Hollywood to illustrate the American Broadcasting Company's NEW ABC MICROPHONE DESIGNATION. The lovelies who posed for the ABC network shot were JEAN ASHTON, KATHERINE BOOTH, and LINDA CHRISTIAN. Ah—Television!



Happy Noel

SPIKE JONES  
and the  
CITY SLICKERS



PICTURES—

“Tom Breneman’s  
Breakfast in Hollywood”  
and

“Ladies’ Man”

VICTOR RECORDINGS—

“Holiday for Strings”

“Cocktails for Two”

Special Album—

“Nutcracker Suite”



JACK HALEY



# Season's Greetings

Bob Hope



OPIE CATES, HIS CLARINET  
and HIS ORCHESTRA



*Thanks to*

Old Gold's "Meet Me at Parky's"

(Art Brearley, NBC Engineer)



Colgate - Palmolive - Peet's "Judy Canova Show"

(Ed Miller, NBC Engineer)



Ballatine's "His Honor, the Barber"

(Murdo MacKenzie, NBC Engineer)





It can't be my face boys, it must be the  
way you make me sound on the radio

## BOB BURNS





**CONSTANCE BENNETT PRODUCTIONS, INC.**

**CONSTANCE BENNETT COSMETICS**

**CONSTANCE BENNETT FASHION FROCKS**



**Constance Bennett calls on you**

**to wish you**

**A Merry Christmas and Happy 1946**



# Return of the Conqueror

By Ed Stolzenberger

**B**ACK to radio broadcasting, back to New York, back to civilian ranks came Tom Gootee last month—officially and honorably discharged from active duty with the U. S. Army after a period of almost four years.

Readers of pre-war issues of the Journal will remember Tom's insane chronicles of wild life in Chicago, his many technical articles, and other literary endeavors. Tom successfully combined his technical ability with his literary skill for many years before the war.

So it was inevitable that even his Army career would encompass both widely divergent fields of endeavor and occupation.

But his technical work for the Army, it must be admitted, was by far the most adventurous, the most important toward winning the war. And this is the first time the Journal is able to publish word of Tom's war work, because of the secrecy that cloaked radar development from its inception. Ex-Captain Gootee's various exploits closely parallel the history of the early days of the war, when the odds were against our winning and the going was tough.

Early in the spring of 1942, without much fanfare, Tom cashed in a Signal Corps reserve commission and was ordered to active duty as a Second Lieutenant—replete with brass bars, Sam Browne belt, and Tom's usual deadpan, self-effacing attitude toward things in general.

Because of his past radio experience, particularly in design and development, 2nd Lt. Tom Gootee was destined for a long career in radar. He quietly retreated into the obscurity and secrecy that surrounded radar development during those early days. And even some of his closest Chicago and New York friends hadn't the slightest idea of his whereabouts or doings.

Those were grim months—early in 1942—when the Germans played havoc with our Atlantic lifeline to Britain. And those were terrifying months to the people of England, subjected to an almost constant siege of aerial bombardment by Hitler's invincible Luftwaffe: ruler of the European skies. There was no secret made, then, of England's desperate need for help—from the United States, the only ally capable of helping.

Early radar experimentation was in progress in England—as they frantically sought to perfect existing equipment, and devise new sets for new purposes. But they needed technical assistance. In particular, the Royal Air Force and British Navy and Army needed qualified officers to assist their technical staffs. To each of these services the U. S. Government loaned specially picked U. S. Army Signal Corps officers—chosen primarily for their technical ability as scientists, physicists, and engineers—to assist in the design, development, and operation of new radar equipment to be used jointly by Britain and America.

Into that picture stepped Tom Gootee, arriving in England during the last days of the German Blitz on London and other English cities.

"It was a rough war," comments Tom, looking back over the past years. And he should know, having participated in the Spanish War and a half dozen minor revolutions during the past eighteen years. "It was a new experience—working with the RAF as they developed new tactics against the Germans, tactics eventually used by our own 8th Air Force."

The Royal Air Force was responsible for alerting England and Scotland against approaching enemy bombers. They also had to send up planes to attack the mighty air armadas that Goering threw against England.



(Photo by Bachrach)

Ex-Captain Tom Gootee now with NBC.

And radar was used for these purposes, playing a part of such vast importance that it cannot even now be fully realized through practical comparisons. Of course, radar alone could never have won the war alone. Needed were men, the infantry, tanks, planes, rockets, the atomic bomb. But radar turned the tide: radar won the Battle of Britain—at a time when the tactical position was desperately on the defensive.

Working under the strain and stress of time, working often under direct bombardment by enemy aircraft or long-range cross-Channel guns,—American and British officers and men worked hand-in-hand developing a precision system of radar in record time. Tom Gootee was one of these men, devoting his entire time to radar development and field test operations. He participated in the development of ground stations, airborne equipment, and the first successful high-altitude long-range microwave radar interception gear. Much of the design formula for 10 centimeter ground sets were prepared by Tom, then put to practical use in the actual development of the equipment. Not limited to centimeter wave lengths, he also did much work in the improvement of the

existing CHL chain-network of ground warning stations (on 200 megacycles), as well as airborne sets used for the detection of surface vessels and submarines by coastal-patrol airplanes.

On some 35 missions over Germany and Central Europe, Tom saw radar—the result of combined Allied efforts—direct our heavy bombers through impenetrable mist and fog to unseen targets. Radar bomb-release equipment insured almost-perfect precision scores on targets. And with the work done, radar brought the bombers back to their bases in England—despite fog, rain, sleet, snow, or clouds. Tom also worked on 3, 5, and 10 centimeter airborne radar sets—designed for use by our night fighters in tracking down enemy bombers in the dead of night.

But his activities weren't confined to the Air. For England in those days was the "front line" of the war. And Tom saw more than 100 air raids directed at English towns, cities, and RAF ground installations.

"In most southern localities of England in those days," says Tom, "the long, mournful wail of the air-raid siren went on and off continuously during the daytime. And about a dozen times at night."

During one such raid, Tom had a too-close brush with death. The town was Eastbourne—once a famous English summer resort. The day was a Saturday—in May of 1943. Six Focke-Wulf's roared over the rooftops in a low-level raid—to try to escape radar detection—and each plane dumped a pair of 500-pound eggs on the city. One of the "busters" hit an almost-deserted street less than 75 feet from Tom, skidded along the pavement for a hundred yards, and collided with a brick surface shelter as it exploded. The air raid shelter was crowded, unfortunately. Most of them women and children. "We never knew how many," explains Tom. "There were bricks and parts of bodies scattered everywhere." Putting his emergency first aid knowledge to work resulted in at least a few saved lives, since Tom was first on the scene. He earned the double right to wear the Purple Heart for this encounter: for valor and for wounds.

Slowly, as the war progressed in the Allies' favor, radar became more and more automatic. Improvements were still being made. But the early days and weeks of anxiety was at an end by the summer of 1943. American industry carried the ball from there, being directly responsible for the production of most joint British-American equipment. But it should be recorded for posterity that all present-day Army and Navy radar equipment stems basically from the combined efforts of British and American engineers—working in secret laboratories in England.

When Tom Gootee returned to the United States in the summer of 1943, he would certainly have had reason to brag about the job he'd done in England, about his efforts and accomplishments in radar. But, as usual, he was generally reticent and aggravatingly uncommunicative. Radar was still highly classified, particularly certain phases of its

(Continued on Page Eighty-three)



*Greetings Folks . . .*

*How Y'all?*



**Kay Kyser**





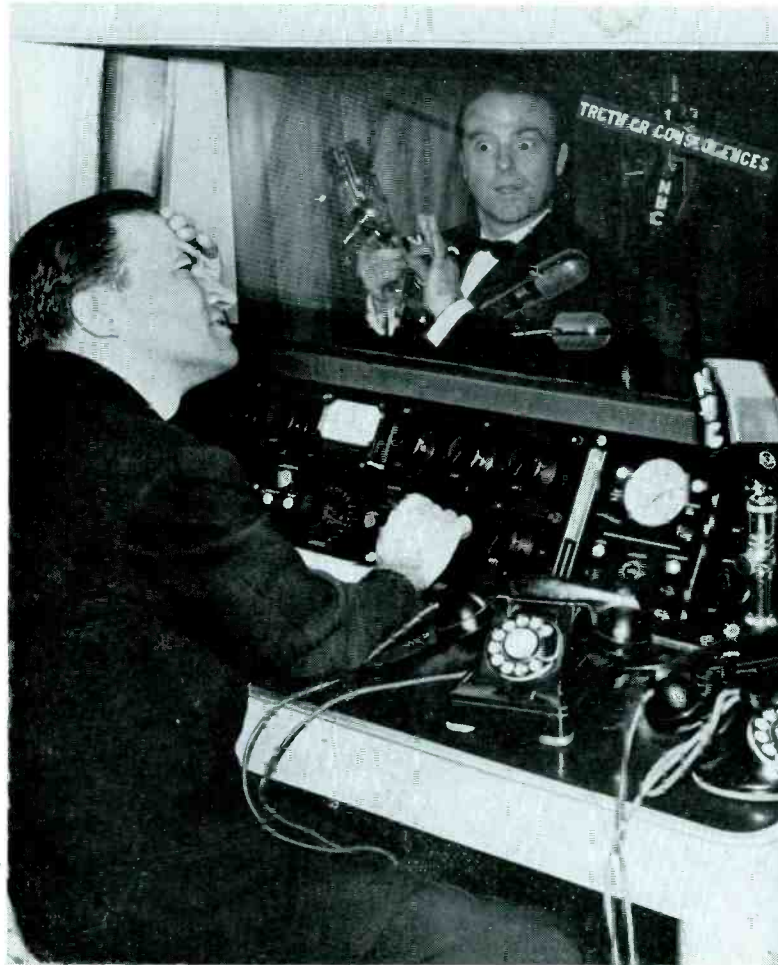

*It Ain't H. V. Kaltenborn!*

=====

# BENTON & BOWLES, INC.

Equitable Building —:— Hollywood, Calif.



## From Hollywood

**Glamour Manor**  
Starring Cliff Arquette

**Maxwell House Coffee Time**  
Starring George Burns and Gracie Allen



All the Best  
For This and  
Every Season

**MARVIN MILLER**





## BEST OF LUCK

To the Boys Who Worked So Hard  
To Make Me Sound Well . . .

JIMMIE FIDLER





*Hats Off to All the Engineers*

# HEDDA HOPPER



## Season's Greetings



**Wendell Niles**



YOUR BLUE-EYED BOY

Rugged  
**MICHAEL ROY**

*Protecting arm and guiding  
light of the working girl*

Good Announcing Done Expensive!



# ABC West Coast Gets New Engineering Boss

**W**ITH the appointment of T. B. Palmer to the position of Manager of Technical Operations, the Western Division of the American Broadcasting Company has a newly-created head office for engineering operations. Mr. Palmer, better known as "Bev," comes to Hollywood from San Francisco where he has been manager of ABC's station KGO for over a year, having succeeded Don Searle in that post when the latter moved to Hollywood in September, 1944, as ABC Vice-President in charge of West Coast Operations.

Palmer is only 42, but is virtually an old-timer in radio, with some 25 years of background in broadcasting. He is a native of British Columbia, born in Victoria in 1902 and attending high school there. Later, he went on to Spratt-Shaw Institute to study radio engineering. He obtained his first operator's license in 1920 when only 18, and served for the following seven years with the Canadian Marconi Company, at sea most of the time as a shipboard operator visiting the faraway ports of the world.

In 1927, he married Cora Lister, also of Victoria, and whom he had met two years before. The new Mrs. Palmer picked San Francisco as the place to live and two weeks after their arrival there, Bev went to work as a temporary engineer at KYA. The job was to last only some ten days, but Bev stayed on, later to become Chief Engineer of the station. Shortly after this event, the National Broadcasting Company purchased KYA, but re-sold it in 1934, at which time

Palmer went over to NBC as a Field Engineer. During the next eight years, Bev moved steadily upward with the organiza-

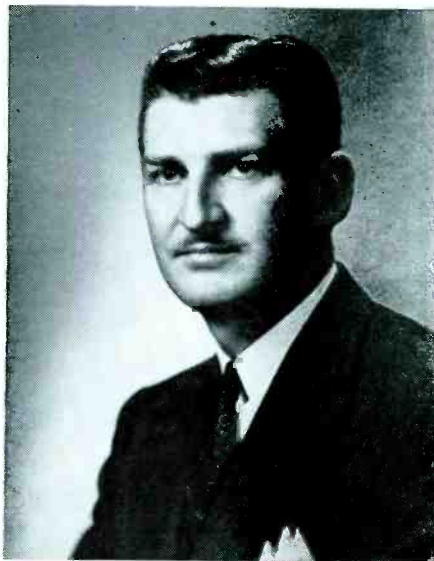

— ABC Network Photo  
**T. B. "BEV" PALMER**  
Manager of Technical Operations for the  
American Broadcasting Company's  
Western Division.

tion, first becoming a relief Control Supervisor, then Junior Control Supervisor and finally in 1942, Field Supervisor for San Francisco.

A year later, Palmer was made Chief Engineer of station KGO, San Francisco, the Northern California outlet for the newly-separated Blue Network Company. He remained in that capacity until he became KGO's Station Manager in 1944. Bev and Cora have one son, Hugh, who is 14.

In announcing the appointment of Palmer to the position of Technical Operations chief for the West Coast, Vice-President Searle stated that although Bev has been doing an outstanding job as station manager at KGO, he was filling a greater need in the new engineering post, in view of ABC's plans for technical expansion into FM and Television, new network studios and increased power of owned and operated stations in their Western Division.

The new appointment places the engineering departments of San Francisco and Hollywood under one head, where formerly they were managed separately, and has the full approval of George Milne, ABC National Director of Technical Operations, who states that "Bev Palmer is just the man for the job."

Palmer will make his headquarters in Hollywood, and will take over the duties of Ralph G. Denechaud, who has held the post of ABC Engineering Manager in Hollywood since the separation of the former Blue Network from NBC in January, 1942.

## GOOTEE

(Continued from  
Page Seventy-seven)

development. And Tom had nothing to say period.

Then followed a long tour of duty at Fort Monmouth, New Jersey, covering nearly three years—and allowing Captain Tom Gootee to pursue his literary endeavors. He prepared engineering reports on British-American radar accomplishments in England, wrote instruction books for new Army radar sets, and prepared technical manuals covering all phases of the training, operating, and maintenance of the Army's many radar sets. The job was a long and tedious one, ending only shortly after Japan threw in the sponge.

All during his residence close to New York, Tom, never the one to pass up an opportunity, took advantage of his closeness to the Big City to write radio scripts for all of the major networks. He also did a great deal of extra-curricular technical, fiction, and non-fiction writing—most of the articles and stories being published under any of several different "pen names." He also did a lot of ghost-writing, and started work on two books, and a play. "The stuff I wrote," says Tom, "wasn't all good. But it was certainly prolific." Readers of the Journal have probably often encountered Tom's work in this and contemporary technical publications.

His working day usually averages about twenty active hours—which explains some of his voluminous literary achievements. But

even those close to him don't see how he does it.

Besides the Purple Heart, Tom collected quite a few other ribbons and decorations during his overseas assignment. Among these are British '39-'42 Star, the British Air Force Cross, service ribbons for the American and European Theater of Operations, the Unit Citation Award, and two more British decorations.

Such exploits naturally netted Captain Gootee a good many "points" toward discharge, and Tom exchanged his be-ribboned Army tunic for civvies just a few weeks ago. "A gesture," he says, "accomplished without remorse."

Mister Gootee has lots of plans for the future—plans that particularly include radio and television development. And, of course, radio script writing.

He's now with NBC's Studio-Field Group in New York. Tom claims his transfer is entirely due to a jurisdictional dispute within the Company. Says Tom: "NBC Chicago wanted me to stay in New York; NBC New York wanted me to stay in Chicago. Chicago had their way by threatening to secede from the Union if I returned to the Windy City. So here I am in New York."

A man of many talents, it's anybody's guess where Tom Gootee will wind up. Or, as he's done in the past, he may continue to hold down two or three full-time jobs simultaneously—a feat unbelievable but true, like many of his other accomplishments.

Of war, Tom has had his fill.

"Count me out of the next one!" he says. "And since we've lost the peace, it looks like we're headed right back into another one."

The shock of Tom's unexpected return now having been somewhat absorbed by NBC New York, life for Mister Gootee settles down to a slow roar.

### FCC News Release No. 86,387

As a result of a conference with representatives of the National Association of Broadcasters, the Federal Communications Commission adopted a new system of numbering FM channels. Under this system, the first channel frequency (88.1 megacycles) will be numbered 201; the second frequency (88.3 megacycles) will be numbered 202; and so on up to and including channel number 300 (107.9 megacycles).

This will give all FM stations in the 88-108 megacycle band and in probable extensions thereof channel numbers with three digits.

Inasmuch as FM receiver production is just starting and in order to provide for possible expansion of the FM band in the future without disturbing channel numbering of stations in the 88-108 megacycle band, it appears desirable to revise the channel numbering plan at this time to provide for such expansion.



**Season's Greetings**  
**DEL PORTER**  
and the  
**Sweet Potato Tooters**

*Thanks to All the Boys*

**KEN CARPENTER**

**YALE RADIO ELECTRIC CO.**

Wholesale Distributor

RADIO and ELECTRONIC  
PARTS and EQUIPMENT

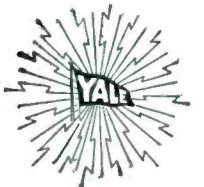

**6616 Sunset Boulevard • Hollywood**

GL adstone 4169

**Season's Greetings**

**With Best Wishes**



**SKINNY ENNIS**

**Bob Hope Show**



# ANDREWS SISTERS

AND

## LOU LEVY

Broadcast Engineers' Journal **85** Yearbook :: January, 1946



*Season's Greetings to Broadcast Engineers*

## Buzz Adlam and ABC Staff Hollywood Orchestra



Greetings to the Broadcast Engineers' Journal

FROM THE CAST OF

### "THE GREAT GILDERSLEEVE"

WALTER TETLEY.....	<i>Leroy</i>	RICHARD LE GRANDE.....	<i>Peavey</i>
LOUISE ERICKSON.....	<i>Marjorie</i>	BEA BENADERET.....	<i>Eve Goodwin</i>
LILLIAN RANDOLPH.....	<i>Birdie</i>	ARTHUR Q. BRYAN.....	<i>Floyd Munson</i>
EARLE ROSS.....	<i>Judge Hooker</i>	KEN CHRISTY.....	<i>Chief Gates</i>
SHIRLEY MITCHELL.....	<i>Leila Ransome</i>	JOHN LAING.....	<i>Announcer</i>
		FRAN VAN HARTESVELDT.....	<i>Director</i>



---

**Season's Greetings**

from  
**PERRY WARD**  
and  
"What's Doin' Ladies?"  
ABC

---

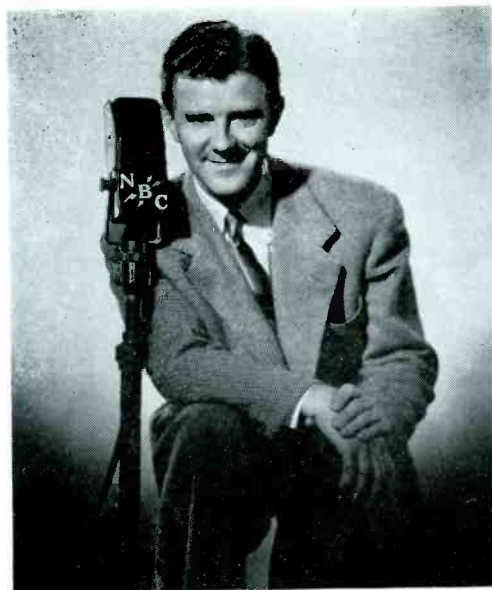

*Here's looking at you . . .*

**CHARLES "BUD" DANT**

---

*Extending*

**Season's Greetings**

To All Our Friends in Radio and the Armed Forces  
from  
**JACK SCURLOCK'S**  
**RADIO CITY BARBER SHOP**  
Sunset and Vine

---

**HURRAY FOR THE ENGINEERS!**

**Keep That Needle Runnin' High**

Like these guys have done so well for us . . .

George Foster, Leon Fry, Art Brearley, Harold Lindquist,  
Joe Kay, Ray Ferguson and Hal Platt



**"People Are Funny"**

**"G. E. House Party"**

*Starring*

**ART LINKLETTER**

**John Guedel Radio Productions**  
Hollywood

---

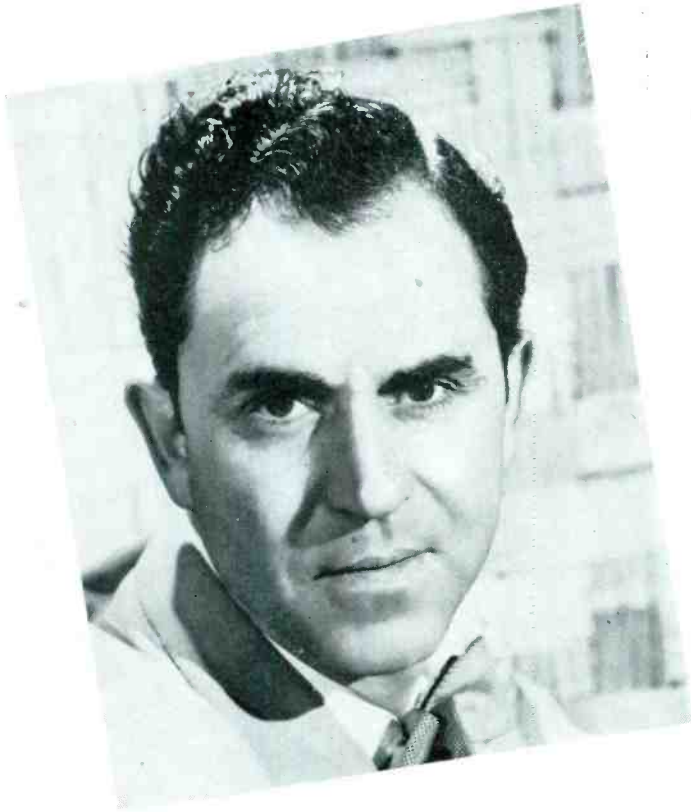

---

HERE'S HOPING IT'S THE  
MERRIEST  
OF  
ALL

*from*

KELLOGG NEWS  
IODENT  
DOAN'S  
THIS MOVING WORLD

**GILBERT MARTYN**

Merry Xmas Also from  
My Associate Writers  
BOB LA SALLE  
KATHLEEN WILSON

---

Sid Fine • Matty Matlock • Marty Seliger



To My Friends the Engineers

DINAH SHORE



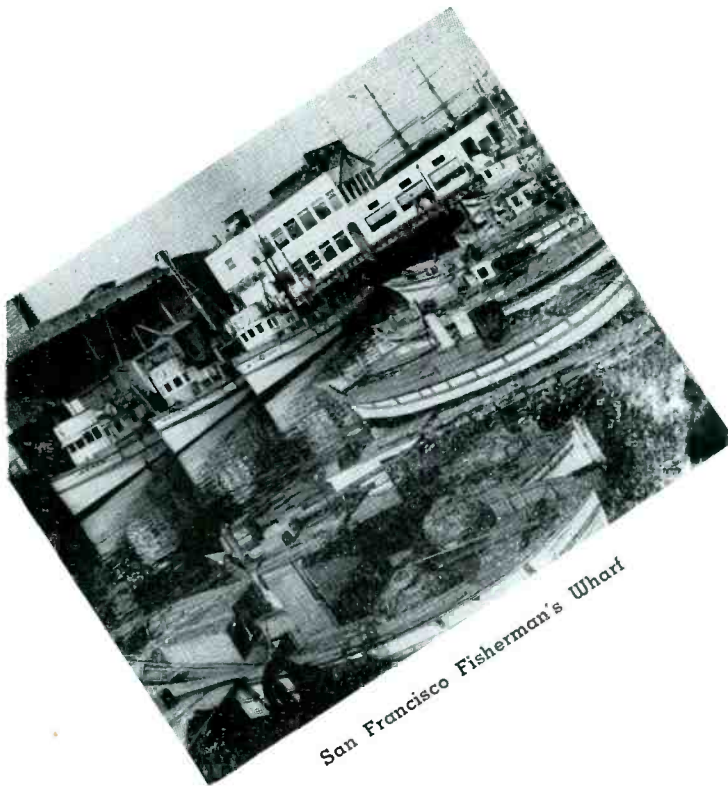

San Francisco Fisherman's Wharf

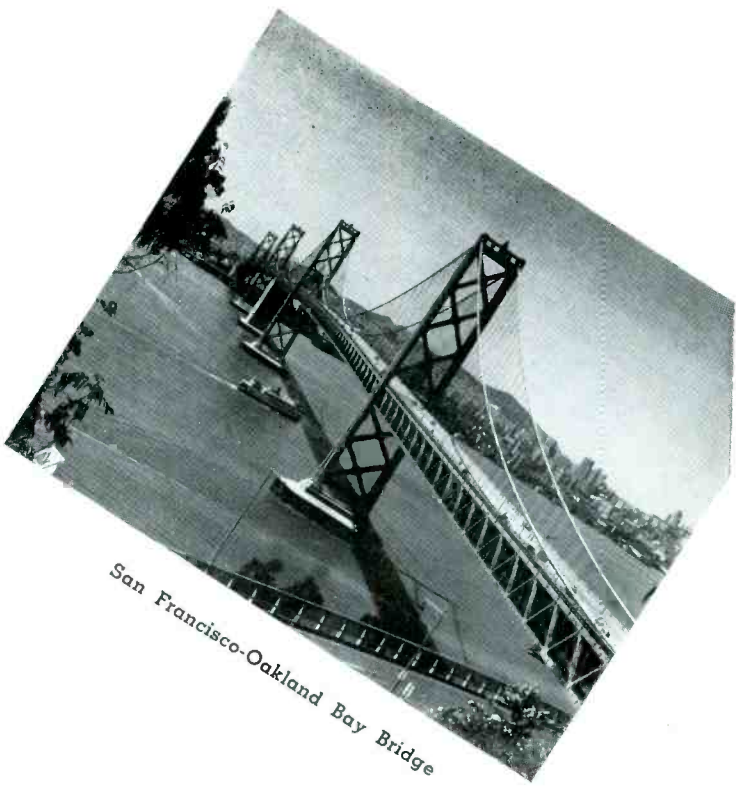

San Francisco-Oakland Bay Bridge

# SEASON'S

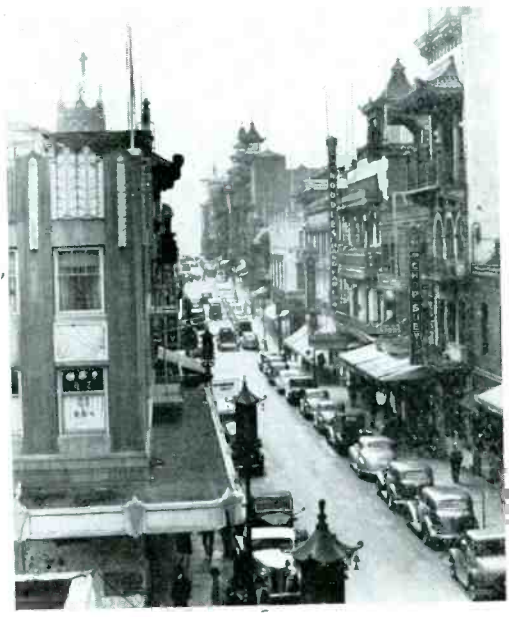

San Francisco Chinatown

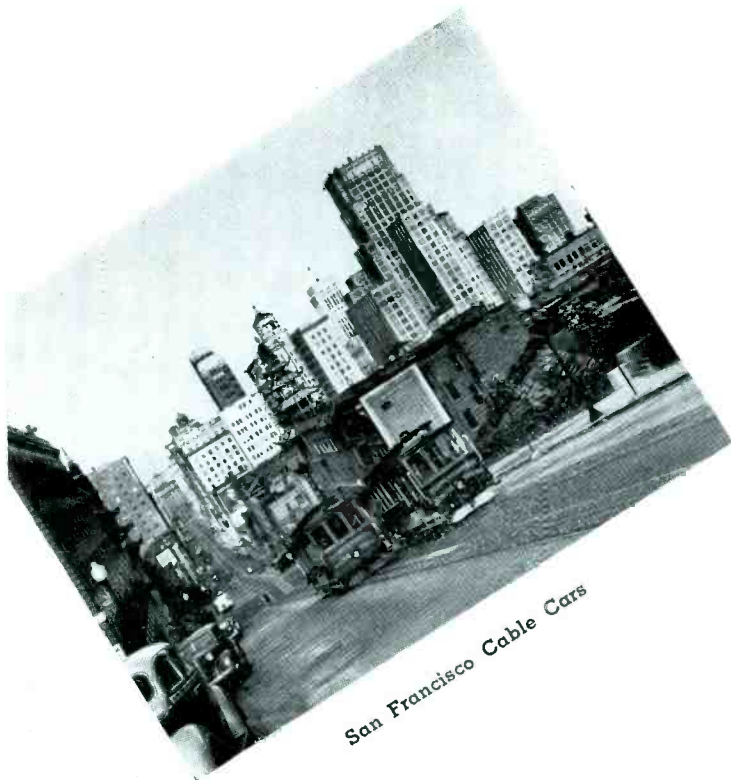

San Francisco Cable Cars



San Francisco

# GREETINGS



San Francisco Ocean Beach

SAN FRANCISCO  
CHAPTER N.A.B.C.T.

Studio Field [San Francisco]  
KPO [Belmont] KGO [Oakland]  
KNBA, KNBI, KNBX [Dixon]

*To Our Engineers and Technicians*

# GREETINGS



The Standard Hour's Opera Series features the San Francisco Opera Orchestra; its General Director, Gaetano Merola; and such famous singers as Rise Stevens, Charles Kullman, Virginia MacWatters, and Francesco Valentino, shown here at NBC's San Francisco Radio City studios.

## THE STANDARD HOUR

*(Affiliated with the Standard School Broadcast course in Music-Enjoyment)*

STANDARD OF CALIFORNIA

Broadcast Engineers' Journal **92** Yearbook :: January, 1946

*Hey Wait a Minute . . . This Is a Rehearsal*



But we don't need any rehearsal to say

**Thanks**

**and**

**Merry Christmas**

*from SAN FRANCISCO and*

**SWINGING on the GOLDEN GATE**

CLANCY HAYES

BETTY BROWNELL

BILL ERIN

MADHATTERS

HAP KAUFMAN PRODUCES

Coast to Coast AMERICAN . . . 6:30 P.M. PST, Monday



**1921**

KPO's original studio from which our first broadcast originated in 1921. The thing that looks like a horn on the piano is an early version of a microphone.



**1945**

KPO's Studio "A" in 1945. Several hundred guests are in the audience for a favorite San Francisco broadcast. Quite a difference in just 24 years.

# SO BIG... SO FAST!

*bet you never dreamed radio would grow so rapidly*

**KPO**  
SAN FRANCISCO 

KPO's the only 50,000 watters west of Salt Lake, north of Los Angeles, south of Seattle and east of Moscow.

THIS IS THE NATIONAL BROADCASTING COMPANY  
A SERVICE OF THE RADIO CORPORATION OF AMERICA  
Represented by NBC SPOT SALES



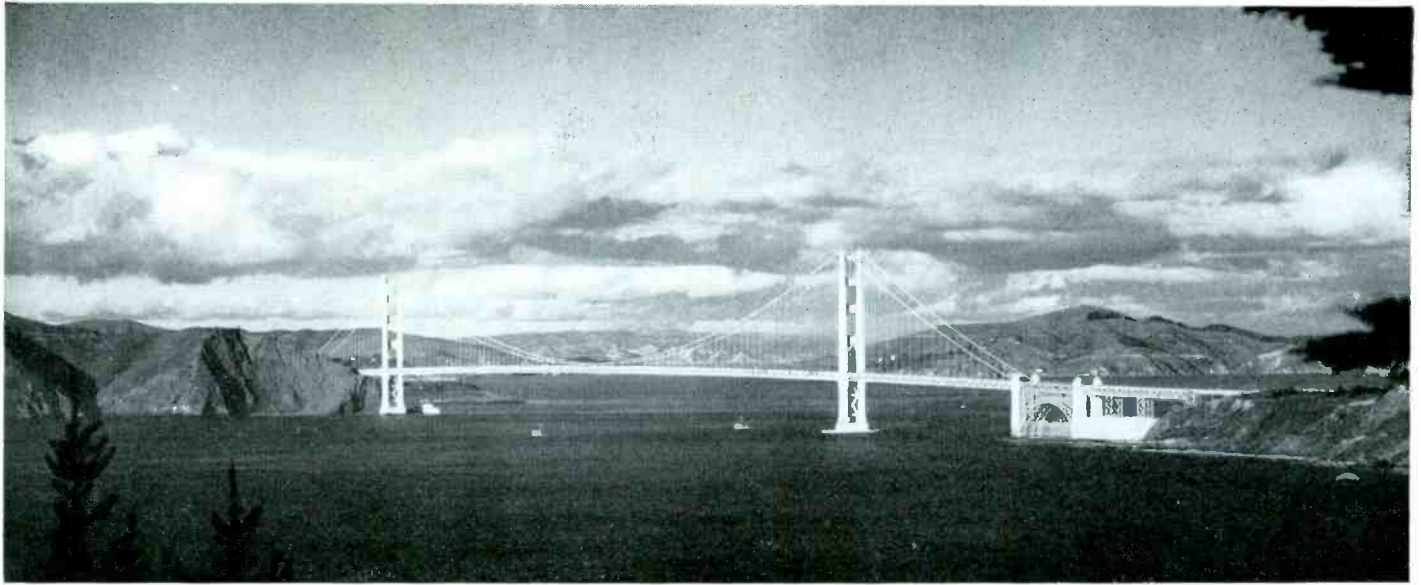

# This Report Comes To You By Way Of **San Francisco**

By Jack Van Wart

**W**ITH the start of the first Post-War year, we in San Francisco are looking forward to great things in San Francisco radio. Among the many planned activities we contemplate is Frequency Modulation. We have reason to believe that Frequency Modulation will become a realization in San Francisco in the very near future, and its inception will undoubtedly mean many more jobs for those interested in the engineering end of broadcast radio. Present plans are said to call for "FM" stations for both companies, presumably atop Mt. Tamalpais in Marin County across the Golden Gate. This site has been receiving more and more interest lately as a locale for most of the proposed UHF and VHF transmitters. In addition to this, the men at the KGO transmitter are eagerly awaiting the final announcement and even more eagerly awaiting the arrival of their new fifty kilowatt. Rumor has it that the new site will be the East end of the San Mateo Bridge and will include a directional antenna beamed North and South. The studio men are speculating on the possibility of NBC taking over the programing of the High-power short wave transmitters at Dixon, California. At the present time they are being programed by a State Department Agency and are shortly to be taken over by The Office of Inter-American Affairs. The Recording Department is also anxiously awaiting the arrival of their new recording equipment. It is understood that they are to have two new Scully machines and four new RCA DeLuxe recorders.

Men with twenty years experience in broadcast radio are a common commodity here in San Francisco, and we are justly proud of them. But with all the increased activity in sight, many are looking to the wide open spaces with an eye to divorcing themselves from the hussel and bussel of everyday big-city life. For example, Stevens, our latest father, sold his home in Berkeley recently and settled down in Walnut Creek where, as Steve puts it, "I can grow enough to feed my family and have a ham rig". T. Dwight Maxwell is another who has his "place in the country". Max has some land in Novato, which is about 30 miles North of San Francisco, where at present his only activity is keeping bees. The honey he gets is excellent and many of us have been fortunate enough to receive some of the product. Max is looking to the time when he can make it his year around address. When he does he says he will have a small skiff which he will keep at Black Point, to use when he goes bass fishing in the

Bay. He also intends to build a kilowatt transmitter on his property. Steve and Max are only two of the many who are looking forward to the time when the ban is lifted on ham radio. For all I know, this may become a reality by the time this is in print. At least there are a great many who hope so. They are all ready to put that famous California Kilowatt on the air once again. Many of our members were "on the air" right up to the time they were ordered off at the start of the war. Since that time many new techniques have been developed and there is every indication that the Bay Area will be "Heard" all over the world. Just now they are looking over the FCC frequency allocations and deciding in what band they will want to operate. Many are considering the Ultra highs below five meters.

Among the other favored extra-curricular activities is sailing. Just returned from work at Columbia University is Harry Jacobs. Before going east, Harry was a wind-boat enthusiast like yours truly. We both agree that there is no place like the San Francisco Bay and its tributaries for sailing and boating in general. Few realize it but there are over three thousand miles of navigable water inside the Golden Gate. It would take a long time to see all of this.

Another of the major hobbies of our members is amateur photography. Many boast excellent dark rooms with the associated equipment where they turn out some fine work. Typical examples is the group of microphotographs in the back of the NBC Recording Handbook. These were done by G. Warren Andressen of the San Francisco Chapter. A group of studio men have an eight millimeter club to which they pay monthly dues to be used for the purchase of films which they add to their library for their home use. The library includes films on such topics as travel, comedy, kid films, etc. All those interested are eagerly awaiting the release of film to the public, as their activities have been definitely limited during the war. Projection equipment is the speciality of Bob Shover. He spent many years in the Hollywood Motion Picture Studios where he was employed as a maintenance man in the projection department. He continues to do a small amount of this work in his off hours when trouble occurs in some of the larger San Francisco theaters.

To conclude, San Francisco can truly boast a versatile group of men and women in the engineering department. They do not limit their talents to their chosen vocation.

*Merry Christmas*  
*Happy New Year*

An aerial photograph of the San Francisco-Oakland area, showing the dense urban landscape of San Francisco in the foreground and Oakland in the background, with the bay between them. The image is in black and white.

**KGO**

**SAN FRANCISCO - OAKLAND**  
**American Broadcasting Company**

Season's Greetings  
*from*  
**TOM GERUN**  
**FRANK MARTINELLI**



**"BAL TABARIN"**  
 Columbus at Chestnut  
 SAN FRANCISCO



Holiday Greetings  
*and*  
 Best Wishes  
**SONIA SHAW**

Best Wishes  
*to the*  
 Engineers



**ELMER W. PETERSON**

Thanks For Your  
 Help in Building  
 "The Farmer's Digest"

**HENRY SCHACHT**  
 Sponsored by  
 Standard of California



*Flash!*

**Happy Holidays, Engineers**

*Unflash!*

INA SHIPPEY  
 BARBARA CARY  
 GRACE FOOTE  
 BERT SILEN

BURT LEIPER  
 NEWELL McMAHON  
 BUD MAYER  
 TOM FLYNN

NBC News and Special Events  
 SAN FRANCISCO

**GREETINGS**

*to the*  
 Boys We Can't Do Without



**THE NBC PRODUCERS**

DON THOMPSON  
 NOEL FRANCIS

SAM DICKSON  
 GEORGE SNELL

DICK BERTRANDIAS

SAN FRANCISCO



Schenoravor Dzenount Yev Pari Geghant

Which Means in Armenian

MERRY CHRISTMAS and HAPPY NEW YEAR

TO ALL THE ENGINEERS

**GEORGE MARDIKIAN**

of Omar Khayams

# Huletide Greetings

to

**N.A.B.E.T.**

from

**SAN FRANCISCO CHAPTER**



AMERICAN

FEDERATION OF

RADIO

ARTISTS

## Season's Greetings

To the Engineers

from

**GREIG and BARBARA McRitchie**

## Holiday Greetings

from

**JANE LEE**

"The Woman's Magazine  
of the Air"

NBC



## Season's Greetings

from

**"Glen Again"**

KPO — NBC  
SAN FRANCISCO

## Holiday Greetings

to

**N.A.B.E.T.**

from

**Phil Bovero**





Season's  
Best Wishes

to all the  
Engineers

**ANN HOLDEN**

San Francisco

ray lewis

Season's Greetings

from

American' **S** Announcers  
Herb H **A** ley  
Dea **N** e Banta

John Ca **F** rey  
Tommy G **R** eenhow  
Hoyt **A** ndres  
Berto **N** Bennett  
Ja **C** k Webb  
Bill Er **I** n  
Tony Mor **S** e  
Os **C** an Baan  
Mark J **O** rdan

ABC NEWS FEATURE  
RUNNING TIME: 14:30  
Writing -- MOSER  
NARRATION -- WEBB

" ONE OUT OF SEVEN "  
ANNCR: (UP) From San Francisco --  
the American Broadcasting Com-  
pany presents --

(ON ECHO)  
WEBB: ONE OUT OF SEVEN  
MUSIC: UP FULL WITH THEME. HIT AND  
FADE FOR

WEBB: ("LIVE") Our story of this  
week -- or any week -- is a  
big "Thank You" to the guar-  
dians of the gain, the  
watchers of the V.U.'s and  
D.B.'s ---

MOSER" (INTERRUPTING) In other words,  
to the engineers, in all  
sincerity---

SOUND: UP FULL WITH TREMENDOUS AP-  
PLAUSE, CHEERS.  
HOLD FULL AND UNDER FOR

WEBB  
AND : (UNISON) Thanx !!!  
MOSER  
MUSIC: UP FULL AND OUT.

BEST WISHES

from

Dwight Newton

"Schoolcast"

"Newton and the News"

NBC — SAN FRANCISCO



GREETINGS

from

**THE GOLDEN GATE**

and

**JAMES ABBE**



HOLIDAY GREETINGS

from

**Vivian Lane**

"VIVIAN LANE'S PARTY"

NBC



THANKS and  
GREETINGS from

NBC's

"Man With the Hoe"

**Norv Gillespie**

Garden Director for  
NBC's Western Division



Season's Greetings

from

**Yvonne Peattie**

"BARBARA TATE"

"HAWTHORNE HOUSE"



SEASON'S  
GREETINGS

**Emil Martin**

ORGANIST

ABC, San Francisco

*Thanks, Fellas*

SINCERE  
GOOD WISHES

**Asher Hayes**



GREETINGS

from your

"Night Editor"

HAL BURDICK

Management  
LARRY ALLEN, Inc.



Thanks to the  
Engineers

Without whom we who babble  
into the mike would be nothing

**IRA BLUE**

KGO Sports Editor



H. C. CAPWELL'S  
BARBARA LEE

Sent me to to bring you  
Greetings and Appreciation  
from

**Ruth Andersen**

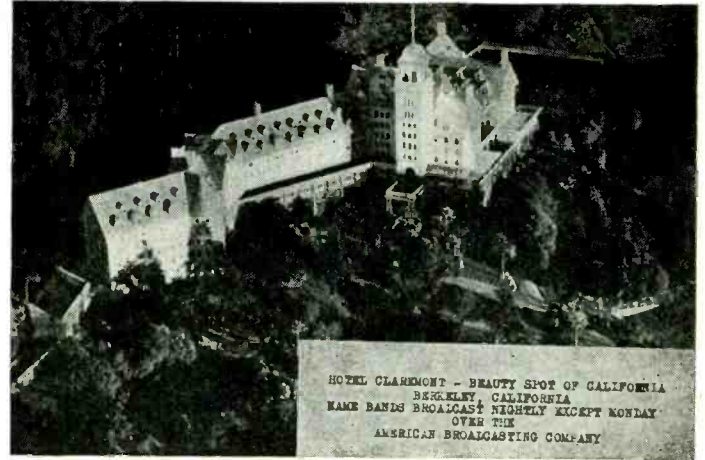
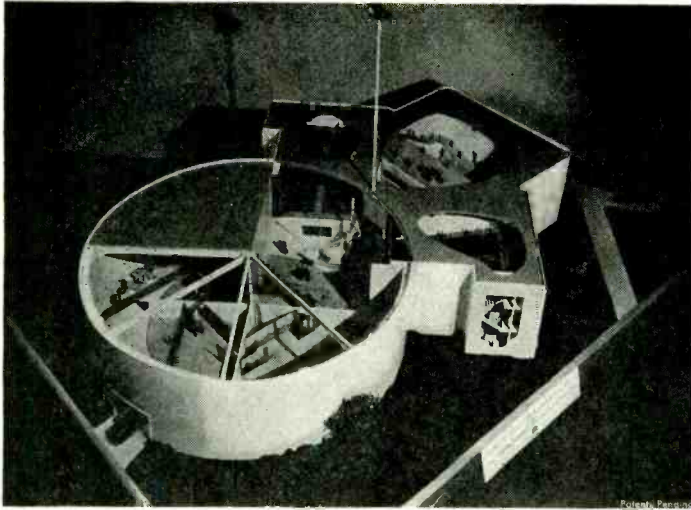

# TELEVISION STUDIOS

DESIGN AND CONSTRUCTION

*including*

**F-M Broadcasting**

**A-M Broadcasting**

**Relay Stations**

**The Austin Company**

ENGINEERS



BUILDERS

Offices in Principal Cities • Coast-to-Coast

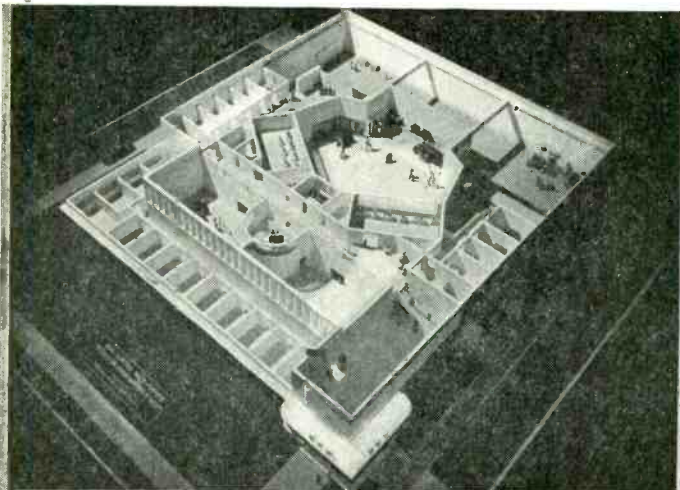

Sincere  
Good Wishes

**Albert White**

San Francisco







*Thanks, for Everything, Fellahs!*

*Sincerely*

HARRY VON ZELL



Season's Greetings



Matty Malneck



Sharon  
Douglas

Merry Christmas

AND

A Happy New Year



LARRY STEVENS

JACK BENNY SHOW



J. Donald Wilson

This Is  
Our Cue  
To Say  
Season's  
Greetings



Ted MacMurray

... So when the engineer  
said my voice should be  
higher, I tried this ...  
thanks, guys ... I duz  
appreciate it ...

**jay stewart**



As Usual,  
Lots of  
Congrats

**PAT McGEEHAN**

---

Hello!



JERRY COLONNA



---

Season's Greetings

from

AL PEARCE



AMERICAN BROADCASTING COMPANY

Monday through Friday — 12 to 12:30 P.M. P.S.T.

"I hope you'll be listening, I hope, I hope, I hope!"



We Blend Over Backwards  
For You Boys . . .

## THE SPORTSMEN

*Bill Days*

*Martin Sperzel*

*Max Smith*

*Gurney Bell*

### *Holiday Greetings*

*from*

Pierre Andre

Jerry Lee

Dresser Dahlstead

Douglas Pledger

George Fenneman

Burleigh Smith

John M. Kennedy

Michael Stokey

Robert Latting

Abbott Tessman

Harry Walstrum

### *Season's Greetings*

## RADIO RECORDERS

7000 Santa Monica Blvd., Hollywood

ABC

HOLLYWOOD ANNOUNCERS

Hollywood 3917



**ED "ARCHIE" GARDNER**

*Radio and Cinema Star Bon Vivant*

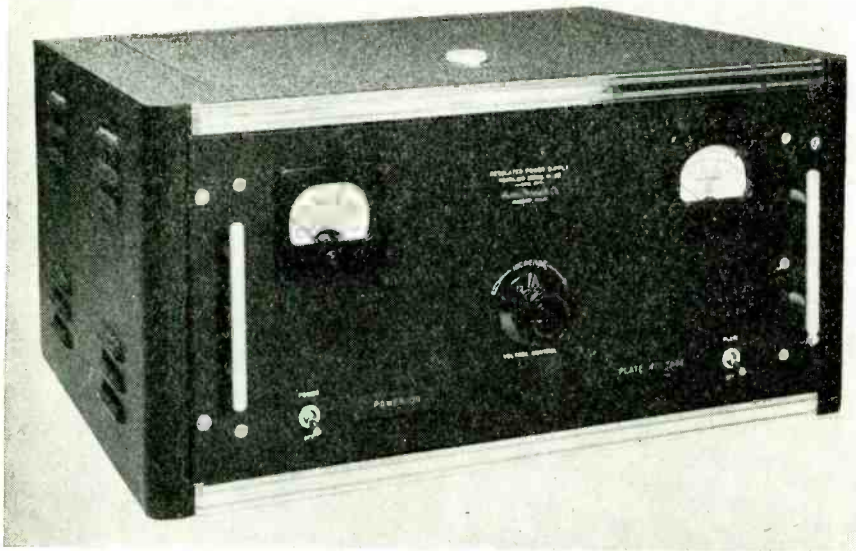

Model  
210

### REGULATED POWER SUPPLY

A new development for use with equipment requiring a constant D.C. voltage source.

Output voltage variable from 230-300 volts with less than one percent variation on loads up to .1 ampere.

Regulation constant within one percent for line voltage fluctuations

90 to 130 volts. Input 115 A.C. 50-60 cycles.

Special networks  
made to your  
specifications.

Manufacturer  
of  
Mixers, Attenuators,  
Master Gain Controls,  
also Standard Relay Rack  
Panels and Chassis.

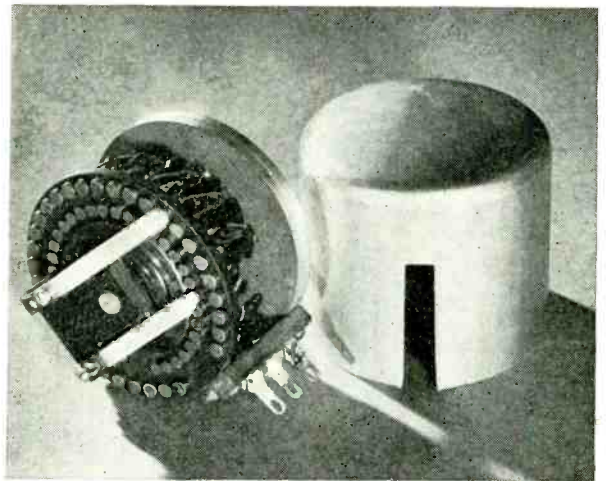

We invite your inquiries.

## AUDIO PRODUCTS COMPANY

Since 1910

MANUFACTURERS OF BROADCAST AND ELECTRONIC EQUIPMENT

2101 West Olive Avenue, Burbank, Calif.

# “Something New” on NBC --- Hoagy Carmichael and The Teenagers



Sponsored by NU MADE MAYONNAISE Produced by ED CASHMAN  
Written by JIM BLOODWORTH

Agency: Foote, Cone & Belding

**Holiday Greetings**

*from*

**KEN NILES**

**On the ABC Newsroom Team  
in Los Angeles**



*Very Best Wishes*

*from*

**Monty Margetts**



**Hugo Carlson**

**Newscaster**

**WIN, PLACE or SHOW**

*“tell ya what I’m gonna do”*

**Season’s Greetings**

**Eddie Marr**

**Archie Hall**

**Newscaster**

**Clete Roberts**

**Newscaster**

**Best Wishes**

**HARRY LANG**

**George Lewin**

**Editor**





**Season's Greetings**

*from*

**LUM and ABNER**

(Arkansas's Revenge for the Civil War)

Thanks for keeping us on the air

*To the Engineers . . .*

God Love 'Em

**Barbara Jo Allen**

**Season's Greetings**

**LOU KOSLOFF**

*Conductor*  
LIFE OF RILEY  
PROGRAM



Sincerely Yours

**Ralph Waldo Emerson**

Musical Director

Lum and Abner

ABC Network



*Greetings from the*

**CLEVELAND CHAPTER**

**WTAM Studios**

John Disbrow  
J. J. Francis  
Alvin McMahon  
W. C. Pruitt  
Harry Caskey  
Tom Cox  
Bert Pruitt  
Frank Whittam  
Cecil Bidlack  
Charley Ames  
John Hyatt  
George Molnar  
John Wilhelm

**Transmitter**

Ross Plaisted  
A. H. Butler  
A. B. Stewart  
Harold Brandt  
W. Jerome  
Earl Holl  
F. H. Anthony  
J. Dietrich  
Wm. Robertson

**WHK Studios**

F. L. Barrett  
F. Y. Best  
D. Irwin  
J. M. Carment  
N. M. Drysdale  
T. F. Hinz  
B. H. Koeblitz  
A. J. Pekkola  
R. B. Sanderson  
L. Shipley  
A. G. Sobbota  
P. C. Tuttle  
J. F. Ulrich

**Transmitter**

M. T. Bennett  
H. B. Okeson  
J. Sturtevant  
P. S. Van Deusen

**WHKK, Akron, Ohio**

B. V. Berg  
Wm. Batchelder

H. Ross  
J. Smith

I. Mintz  
T. Smith

A. Poole  
L. Miller

# This Is WTAM, Cleveland

By Vic Liston

THE only way you can tell the story behind those call letters is to talk about S. E. Leonard, WTAM's engineer-in-charge. Eddie—as he's affectionately called around the National Broadcasting Company's Cleveland station—has been associated with WTAM since that night in September, 1923, when the station's identification call letters were aired for the first time.

The history of WTAM and the dreams and accomplishments of Eddie Leonard are closely allied. After World War One, during which he served as Chief Electrician, Radio, U. S. N., Leonard joined the Radio Corporation of America and was put in charge of station construction in that corporation's Great Lakes Division.

While in this job, Leonard met T. A. Willard, founder of the Willard Storage Battery Company. Taking the young engineer up on his offer to install a radio receiving set in his home, Mr. Willard became more and more interested in the possibilities of radio, and, in 1922, hired Eddie to help him develop radio storage batteries.

Both men were very interested in radio broadcasting which at that time had begun to catch the public's fancy. Those were the days when most amateur wireless men had radio sets and businessmen and schoolboys were trying to construct receivers—and making the night hideous with the howls from the contraptions.

Together Leonard and Willard applied for a license. Then they built an amateur broadcasting set in the basement of the main office of the Willard Company on Taft Avenue near East 131st Street. The call letters for that station, as many Clevelanders recall, were W8XG.

Soon the radio storage battery was perfected, and Eddie Leonard got the idea of operating a commercial broadcasting station entirely with batteries. On the night of September 26, 1923, the first program under the call letters WTAM went on the air.

The station was a fifteen-hundred-watt affair, and was the first station in the United States to be granted so much broadcasting power. The whole staff of the station at that time consisted of three men—an operator, an announcer, and a program director.

Following the gleam which he was

certain would lead into larger pastures, Leonard made up his mind that the little station was going to grow. He turned his hand to the construction of the largest storage battery the world has ever seen. This ten-thousand volt battery, installed on the 20th floor of the Union Commerce Building, consisted of five thousand lead storage battery cells. Power for WTAM's transmitter came from this battery during 1926-1929.

When the station began remote control programs a second studio was constructed in the Euclid Music Store. Another was built in the offices of The Cleveland Plain Dealer for daily broadcasts. These remote programs soon opened the way for regular broadcasts from all of Cleveland's leading hotels, night clubs.

Almost from the start, WTAM had been dividing its time on the air with another Cleveland station, WEAR, operating on the same wave length. But in 1926, the Willard Company bought WEAR and moved both stations into the Union Commerce Building. After the Cleveland Electric Illuminating Company purchased both stations in 1928, WEAR was discontinued while WTAM went on a full-time basis, with a power increase to five thousand watts.

Behind most of these developments was the energetic mind of Eddie Leonard. No sooner had one step been made than he was working out the details of the next. Early in 1929, he supervised the construction of WTAM's first transmitter at Brecksville, Ohio, some seventeen miles south of the present-day studios. This transmitter had two towers, each 200 feet high. They have since been replaced by a 460-foot structure of steel which pin points into the sky from the highest ground level in the state. The modern transmission unit and antenna are built to carry 500,000 watts.

November 6, 1929 The Auditorium Building became WTAM's fourth home. On the building's sixth floor the station for the first time boasted large studios and control rooms.

The last time the station changed hands was in 1930 when WTAM was purchased by the National Broadcasting Company and became one of its key network stations.

It was in 1934 that NBC chose Vernon H. Pribble to guide the des-

tinies of WTAM as general manager of the network's Cleveland division. Mr. Pribble marched to the drums of World World One, from which he emerged with the rank of captain.

A year after that war, he was in Chicago where he busied himself in almost every advertising division of The Chicago Tribune. Later, he was appointed general manager of WGN, Chicago.

In 1931, he took over the radio department of the Stack-Goble Advertising Agency, staying with this position until the call went forth from NBC three years later. And, December 20, 1934, WTAM once more had a chief.

On Saturday, February 19, 1938 WTAM moved into its present location. And when it moved, the man who dreamed of a radio station such as now occupies the first four floors of the NBC Building on Superior Avenue, saw his dream come true. From the very start, Pribble dedicated WTAM's 50,000 watts to the proposition that its call letters would stand for service in the community.

He never missed an opportunity to find out how best the station's facilities could serve Cleveland. From the first day he arrived he has never failed to attend any meeting, civic or otherwise, to which representatives of radio stations had been invited. So thoroughly had he laid the ground work of public relations that on that day in February, seven years ago, 10,000 women accepted invitations to visit WTAM.

The same welcome which was extended to those guests, was extended to every group present throughout the week of celebrations, marking a new era in the life of WTAM. Those visitors to the station saw what is acknowledged to be one of the outstanding radio organizations in the country from every standpoint—large, air conditioned studios, the last word in technical equipment, staff quarters, private elevators, tastefully decorated lobby—all the outward and visible signs of a first class radio unit.

WTAM's manager is responsible for a number of "firsts" in radio broadcasting. Among these was the unusual broadcast ten years ago from a Stinson plane which flew above the city while a priest offered prayers over the Christmas-lit city. A keen sportsman, Mr.

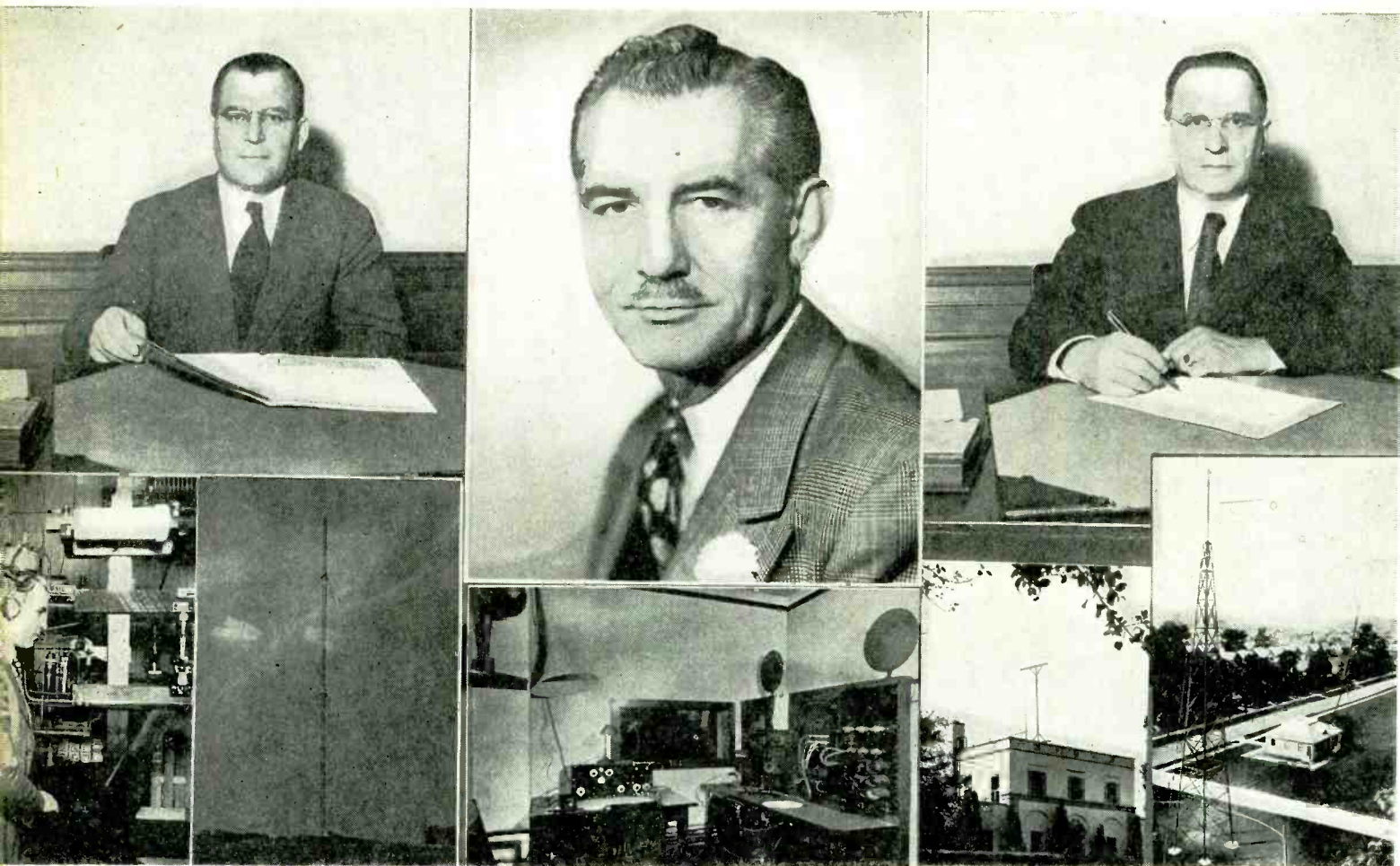

Left to right, top: S. E. Leonard NBC Cleveland Division Engineer; Vernon H. Pribble, Manager Cleveland Division NBC; C. C. Russell, WTAM Transmitter Station Engineer.

Left to right, bottom: That contraption on top of S. E. Leonard's head was called "The Hooligan"—probably in honor of that cartoon character of yesteryear who went through his strips with a tin can on his pate. Anyway, this is a copy of an old photograph made of WTAM's engineer-in-charge, Mr. Leonard. At the time he was monitoring programs with the headpiece in Radio Station WTAM's first studios. That was way back in 1923 when the studios were located at Taft Ave. and boasted an auxiliary studio on East Ninth Street. Mr. Leonard explains that the headpiece has long since been replaced—but he's going strong since 1908! (Commercially since 1917).

From this skylining structure of steel is broadcast one of Cleveland's oldest station calls: "This is WTAM in Cleveland." And from letters received, that station call is heard all over the world. The antenna rises 460 feet into the air, and is a triangular constant cross section of welded steel. Located at Brecksville, Ohio, seventeen miles south of the WTAM studios, the transmission line and antenna tower are designed to carry 500,000 watts and was erected in 1938.

This is another copy of an old photograph of the early type installation of a studio and master control room. This room, with its old-type horns and cones was a vital part of WTAM's operations when the station was in Cleveland Union Commerce Building in 1926.

WTAM's modern transmitter. The building is equipped with living accommodations.

Here is WTAM's original transmitter and studio plant, Taft Avenue and East 131st Street, in Cleveland. The station, which was adjacent to the Willard Storage Battery's plant, was a one thousand watts affair, operated on a frequency of 770 kilocycles and was fully powered by storage batteries—another first in radio history for WTAM. It was opened in September, 1923, and boasted one studio.

Pribble has taken a prominent part in the network broadcasts of the National Air Races.

Apart from his professional duties, he is by nature intensely interested in cultural and civic affairs. On one occasion when the station was still housed

in the Auditorium Building, he threw open the lobby to Cleveland artists, providing them with a chance to show their work. He has long been a supporter of the Cleveland Orchestra, the Playhouse and in the educational field, was responsible for originating the fam-

ous Western Reserve Roundtable of the Air.

Among the many great names which are remembered when the conversation turns back to yesterday, none shines brighter in the affection of thousands

(Continued on Page Two Hundred One)

# MERRY CHRISTMAS



NELL STECK

A  
N  
D  
  
A  
  
H  
A  
P  
P  
Y



DOROTHY CRANDALL

Christmas comes but once a year,  
So with that thought in mind  
We use this journal space to say:  
Good luck of every kind!



DOROTHA BROOKS

N  
E  
W  
  
Y  
E  
A  
R



NINA RUVLOFF



**JOE MULVIHILL**  
Announcer, WTAM — NBC — Cleveland

Merry Christmas and the Best of Everything  
to the Best in the Business  
— THE ENGINEERS —

*Best Wishes*

**BRYON WADE**

"Personalities in the News"

"WTAM"



Greetings to Everybody  
**SALT and PEANUTS**  
WTAM

*Season's Best*



**TOM HALEY**  
WTAM

# Greetings from the Nation's Capital



## Washington Chapter . . . N. A. B. E. T.

### N B C

#### *Studios*

CHEW  
CLARK  
De VRIES  
FUGAZZI  
GODWIN  
HAMILL  
HENRY  
HILDRETH  
HOGAN, USNR  
McCOLLOM

McGINLEY, USMM  
NEWMAN  
ROGERS  
SIMMONS  
STETSON, USNR  
TERRELL  
ULLMAN  
WARD, W. C.  
WEAVER  
WILLIAMS

### W O L

#### *Studios*

ANDRICK  
BELL  
BELOTE  
BALLINGER  
COOPER  
CORNELL  
HALLUM  
HERMAN  
MALPEE  
NEFF  
SAMAH  
STOTTLEMEYER  
WARD, M. E.

### W M A L

#### *Transmitter*

ANSPACH  
BURG, USNR  
HUNTER  
NAGY  
WILLIAMS

#### *Recording*

ACTON  
CLOSE  
EMERSON  
MELINE  
SHENTON

### W R C

#### *Transmitter*

BUTTS  
MEYERS  
STAHL  
YATES

#### *Transmitter*

BOGAR  
MENGLER  
MILLER  
STARK

#### **In Memoriam**

—  
ALFRED

R.

McGONEGAL

USNR



In behalf of students and graduates of the National Radio Institute, and the N. R. I. Staff, I extend most cordial Season's Greetings to the N. A. B. E. T.

*J. E. Smith*  
President

NATIONAL RADIO INSTITUTE, WASHINGTON, D. C.

*We wish to express our best wishes for the holiday season  
to our friends, the engineers of NBC - WRC.*

**BURT'S TRANS-LUX RESTAURANT**

Radio Center, Washington, D. C.

BURT LOPATIN • MARGARET LOPATIN • BETTY CONRAD





**Merry Christmas**  
**and**  
**Sincere Good Wishes**

. . . to the great gang who so efficiently handle all our programs on WMAL, as well as the many Washington origina-  
tions to the American Broadcasting Company, from . . .

*The Evening Star Station*

**W M A L**

**BASIC ABC NETWORK**

---

WMAL — Washington, D. C.

NABET AND AFRA = WMAL

*Never a Better Engineering Team*

---

All Friendly Regards — Announcers

ABC BOYS

JIM GIBBONS

HAROLD STEPLER

LEE DAYTON

NORMAN WESS

JACKSON WEAVER

TONY HOWARD

JACK HALLORAN

---

GREETINGS

*from*

"Eid in Washington"

---

Season's Greetings

*from*

DUTCH BERGMAN

WRC . . . Washington

---

To THE ENGINEERS:

*"Thanks - very much!  
from  
Bankhage*

---

To the Engineers:

Thanks and a Happy New Year

MARTIN AGRONSKY

ABC Network . . . Washington

# Raymond Swing

Management THOMAS L. STIX and J. G. GUDE





## Christmas Greetings

to the

NBC Washington NABET Gang

and special thanks to

JOHNNY ROGERS • KEITH WILLIAMS  
JIMMY WEAVER • JIMMY MELINE  
JOHNNY McCOLLOM

From

BILL HERSON

Thanks, Again . . .



**RICHARD HARKNESS**

NBC, Washington

Greetings from



**MORGAN BEATTY**

—That's all for now and thank you!

*To Our  
Friends  
of CREI*

**HOLIDAY  
GREETINGS**

*from*

**E. H. RIETZKE**

and the  
**CREI STAFF**



**CAPITOL RADIO  
ENGINEERING  
INSTITUTE**

16th Street and Park Road, N. W.  
Washington 10, D. C.

**ROBERT McCORMICK**

The National Hour

WASHINGTON

Thank You for  
Helping Me Get a  
New Contract for 1946

**Merry Christmas**

Sincerely

**KEN EVANS**

**EARL GODWIN**

**MARCELL STUDIO**

**Banquet • Group • Convention**

Publicity and Commercial Photographers

"Cleveland Chapter Photographer"

DAY AND NIGHT SERVICE

M. GOODWIN

314 Superior Avenue, N. E.

Cleveland, Ohio

---

HELLO THERE!

won't you come in?



**DIXIE CHAPTER NABET**



now representing

WBIG CBS  
Greensboro

WPTF NBC  
Raleigh

WDNC CBS  
Durham

WAGA ABC  
Atlanta

---

*Thank You, Sirs . . .*

you paved the way

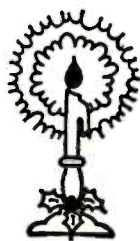

RALEIGH LOCAL A.F.R.A.

---

# Greetings . . .

## From the North Carolina Division of the Southern Federation of Telephone Workers

MRS. NELLIE PICKETT, *Chairman* . . . . . Durham Local  
MR. B. F. COLLINS, *Chairman* . . . . . Goldsboro Local  
MR. O. C. LEE, *Chairman* . . . . . Raleigh Local  
MR. C. L. GARNER, *Chairman* . . . . . Wilmington Local

---

### Supreme Radio Suppliers

*Wholesale*

RADIO and ELECTRONIC

*Parts*



Raleigh, North Carolina

Phone 2-2525

103 W. Hargett St.

---

Merry Christmas and Happy New Year  
to the ENGINEERS

*Thanks for a Job Well Done—*

**WDNC**

Durham  
North Carolina

1490 Kc.  
CBS Network

---

### Southern Radio Supply Co.

*"Serving Broadcast Stations in the Southeast"*

415 Hillsboro St.

Phone 3-1937

Raleigh, North Carolina

## Season's Greetings



And Best of Luck

**BILL MAYER**

## Johannesen Electric Company, Inc.

Wholesale Distributors  
Electrical Supplies — Appliances  
Electronic Equipment

312 - 314 N. Eugene Street  
Phone 6169 Greensboro, N. C.

## Season's Greetings

## Carolina Radio Equipment Company, INC.

Distributors of

*Broadcast Equipment*

105 E. Martin Street Raleigh, North Carolina

## Presenting The Lone Star Quartet

*Five Successful Years at WPTF*

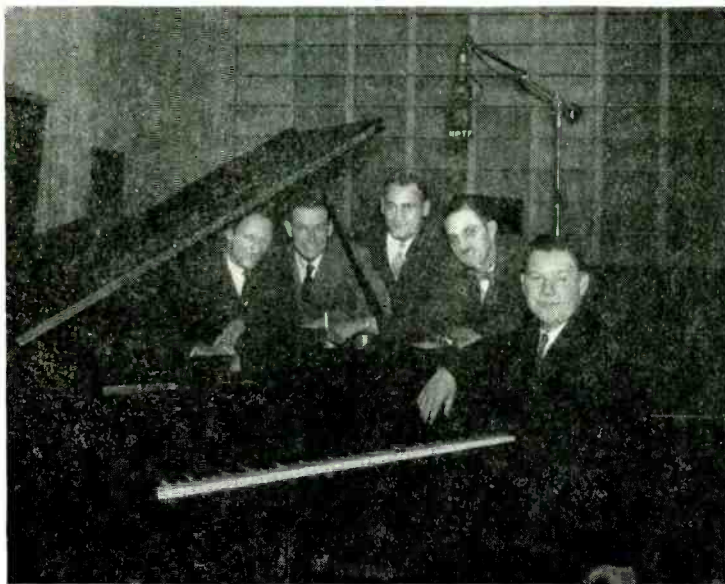

(Left to right) Bert Carroll, Manager and First Tenor; Elmer Johnson, Secretary and Second Tenor; Elmo Fagg, Baritone; Carl Rains, Bass and Emcee; Jack (Tiny) Taylor, Piano.



*Best Wishes from the home of the Star-Spangled Banner*

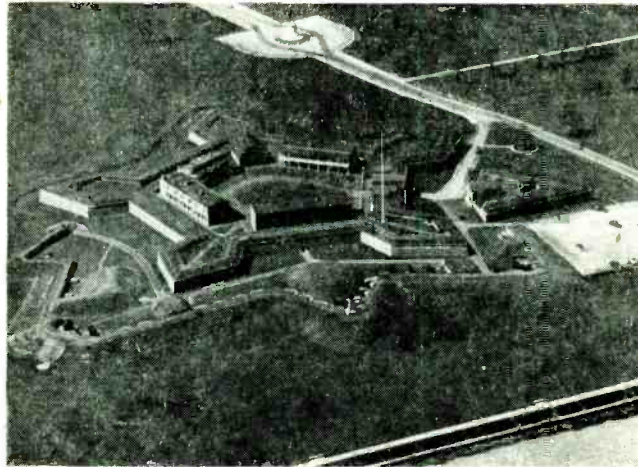

**Fort McHenry**

Otis R. Beauchamp  
 Gilbert G. Boehl  
 Harry M. Boone  
 Robert D. Briele  
 William D. Carrigan  
 Vincent D. Connery  
 Edward V. Stover

William T. Doster  
 Albert C. Goldbach  
 Francis V. Guidice  
 Norman A. Hendrich  
 Frederick M. Hines  
 William R. Hoos

Lawrence H. Taylor

Samuel H. Houston  
 C. Edward Jung  
 Frank R. Jones  
 William D. Kelly  
 Richard A. LaCourse  
 John Lappe

Merwyn K. White

Henry R. McNally, Jr.  
 Howard H. O'Day  
 Oliver A. Oliver  
 Albert W. Rhine, Jr.  
 L. Paul Ruckert  
 C. Robert Sherrer



*My Heartiest  
 To the Guys Who Work the Hardest*  
**Jack Day**

WFBR - Baltimore

Announcing

*Best Wishes from*



*Martha Ross Temple*

WFBR - BALTIMORE

**Season's Greetings**

**Radio Electric Service Co.**

RADIO AND ELECTRONICS DISTRIBUTORS

3. N. Howard St.

Baltimore 1, Maryland



LGxington 3835 - 6

*Happy Holiday*



Many Thanks For Your "Level" Best  
**LONNY STARR**

WFBR

Baltimore

**Season's Greetings**



**GEORGE YEATMAN**  
*and his Music*  
BALTIMORE, MD.



*Compliments of*

**COMMERCIAL RADIO INSTITUTE**

38 West Biddle Street

Baltimore, Maryland



# Here Is Baltimore Chapter

By Wm. Hoos

This issue we're saying it with pictures, inasmuch as no news has developed since the last deadline. We'd like to give credit and thanks to Paul Ruckert for the group shots, and to G. Catanzaro for that of Fred Himes.

All the NABET men from Baltimore, at WFBR, WCBM, and WITH wish to you and yours the best in this holiday season.

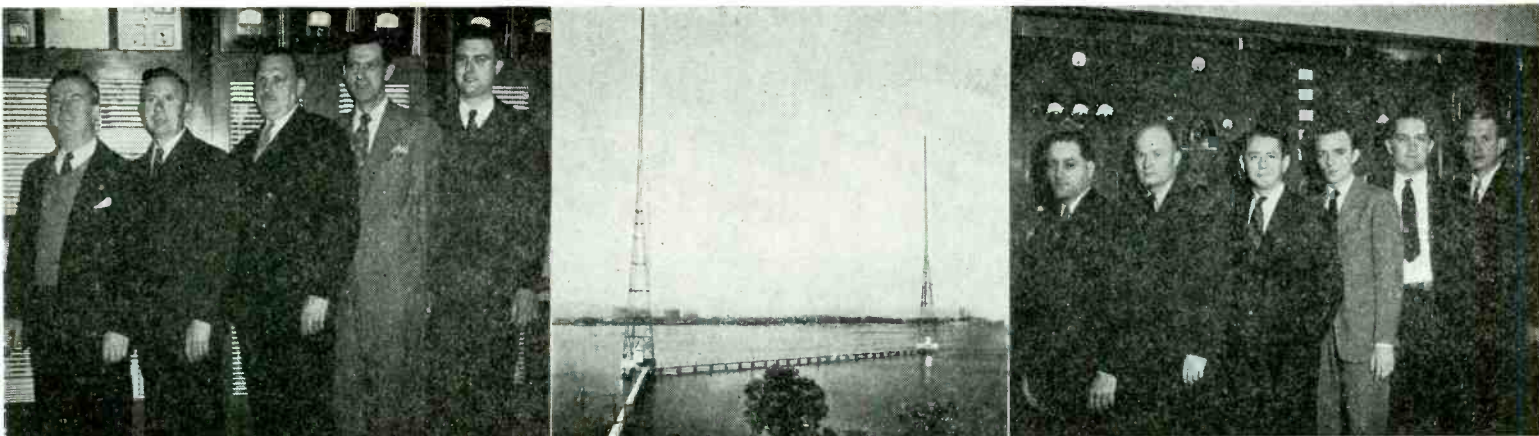

(Left) WFBR TEs, from left to right: Howard O'Day, Transmitter Councilman Ed Jung, Transmitter Supervisor and Chapter Secretary-Treasurer Bill Kelly, Bob Sherrer, and Bill Doster. (Center) WFBR Antenna System. The 300 foot towers that radiate WFBR's signal. They are located at Westport in Baltimore harbor. This was the first broadcast antenna array in the U. S. to be built with the radials laid in salt water. (Right) WFBR SEs, from left to right: Studio Councilman Bob Briele, Studio Supervisor Paul Ruckert, Chapter Chairman Harry Boone, Fred Himes, Bill Hoos, and Ed Stover.

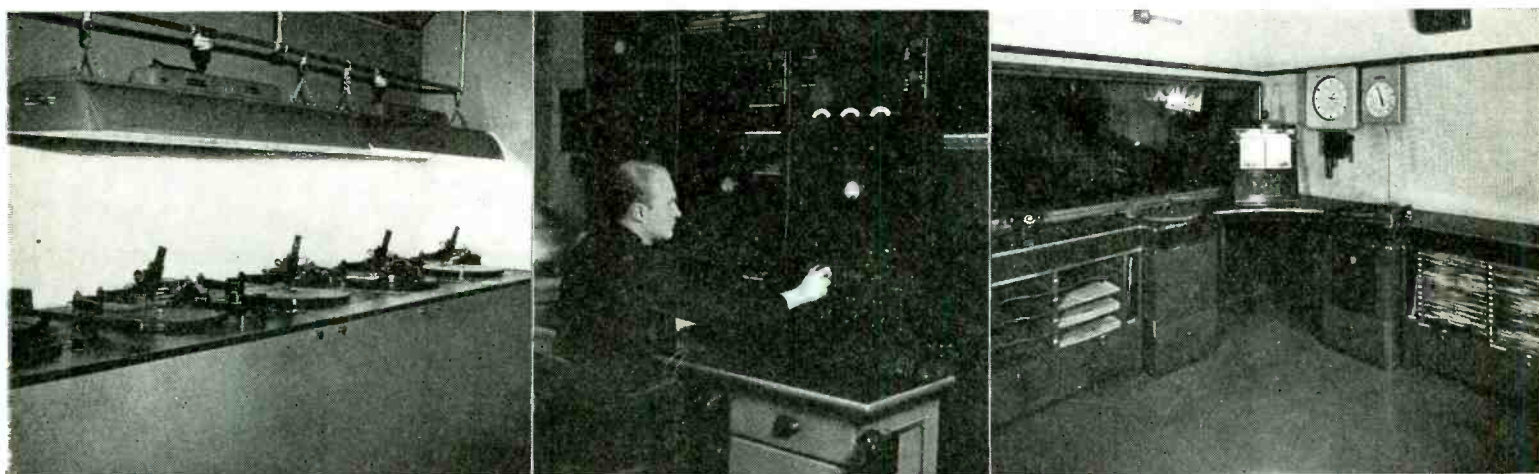

(Left) Recording Setup at WFBR. Four Fairchild Recorders are in use at the studios of WFBR along with an RCA 70-B for dubbing. Cutter amplifiers are located below each machine. This layout was designed and built by the studio gang. (Center) WFBR's former Control Room. This shot hardly belongs in the 1946 Yearbook, but we're using it for nostalgic reasons. This was THE Control Room for WFBR till June, 1939. The gent with his eye glued to the VI is our Studio Supervisor Paul Ruckert, when he wasn't quite so thin on top. (Right) Studio "C". This is the work studio at WFBR, used when we're riding the net or running ETs.

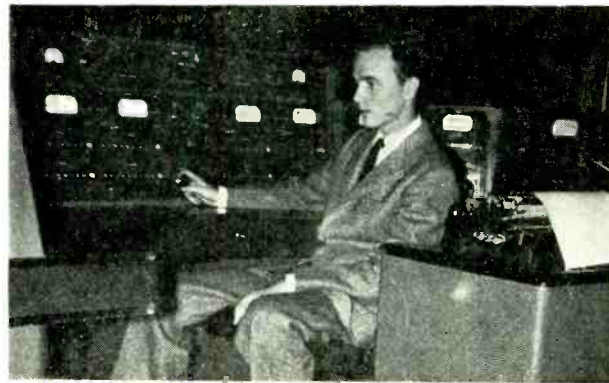

Another pose by the transmitter gang. (Left) Messrs. O'Day, Jung, Kelly, Doster, and Sherrer on the steps of the transmitter building along with Rhett the trusty watchdog. (Center) Freddie Himes at the master desk. (Right) Another view of the master desk showing more of the operating equipment.

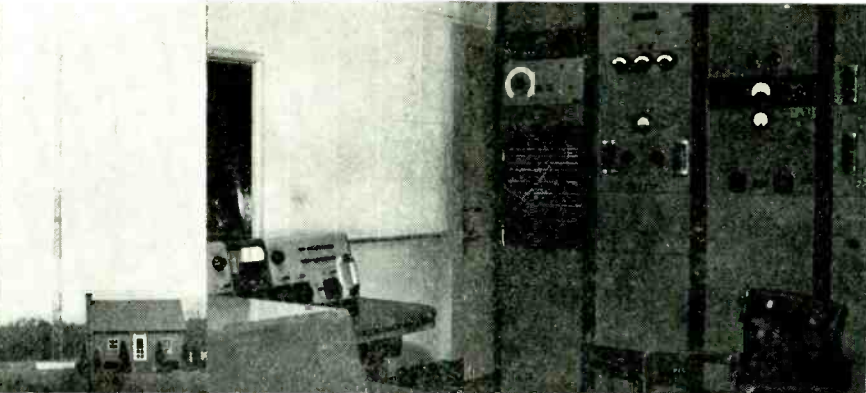
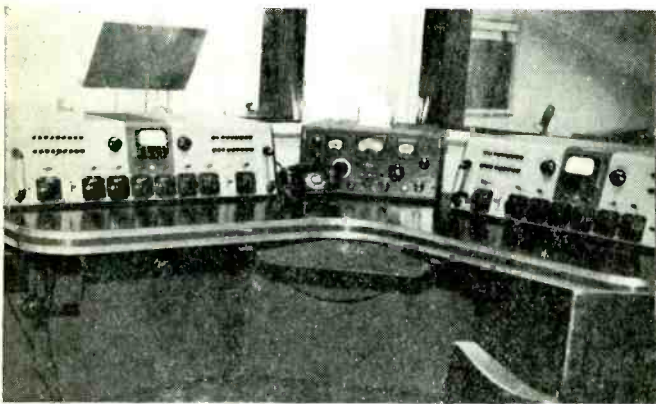

(Left) WCBM Control Room. Here's a view in the Control Room at WCBM, the second Baltimore station to be NABETized. Sam Houston, Frank Jones, and Merwyn White watch the VIs here. (Center) Transmitter Building and Antenna. 1400 KC at 250 watts are radiated from here. The NABET men—Henry McNally, Al Goldbach and Lawrence Taylor. (Right) Another view of WCBM Speech Input Equipment.

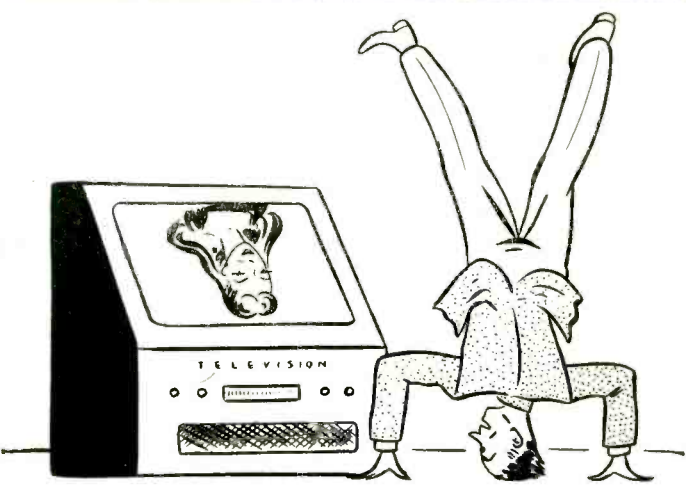

Season's  
Greetings

"I'll be singing for you"

**BETTY WELLS**

with

ELAINE LEE at the piano

WFBR ABC Baltimore, Md.





## Season's Greetings



## JOLLY PICKETT

and His

## Radio Jamboree Gang



### Make Your Customers Your Friends

Assure their complete satisfaction by choosing your replacement parts and test equipment from our comprehensive stock—which includes ONLY products of manufacturers nationally recognized for their high quality standards,

... and, if you're not already on our mailing list, write today for your FREE copy of F. Y. I.—the monthly news letter that keeps you up-to-date on Radio Servicing and Engineering.

### WHOLESALE RADIO PARTS CO., Inc.

WHOLESALE DISTRIBUTORS

### National Advertised Radio Products

311 W. Baltimore Street, Baltimore, Md.

Telephone: LExington 9708

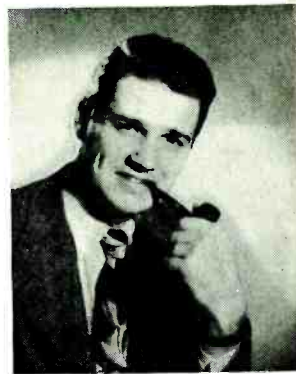

Every Good Wish

### Gene Webster

Vocalist

W F B R

## Season's Greetings

HENRY O. BERMAN CO.

12 E. Lombard Street

Baltimore, Md.

# Greetings

from WFBR'S



Marion Dawn  
*vocalovely*

Marion Dawn  
songs

Phil Crist  
songs

Carroll Warrington  
organist

Russ Andrews  
announcer

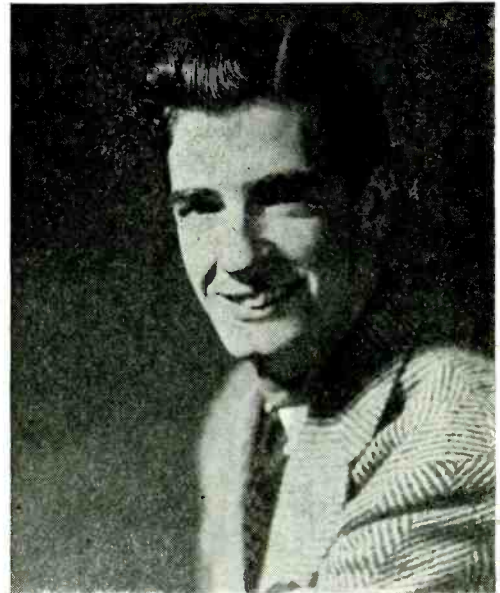

**TOM McKEE**

(WHEC — Rochester)

To the Gain Jockeys from a Disk Jockey  
Merry Merry — Happy Happy and  
Thanks, Guys!

AND

**THE CLUBMEN ORCHESTRA**

“... they SAID they would  
refund our money if we  
didn't like the Product!!

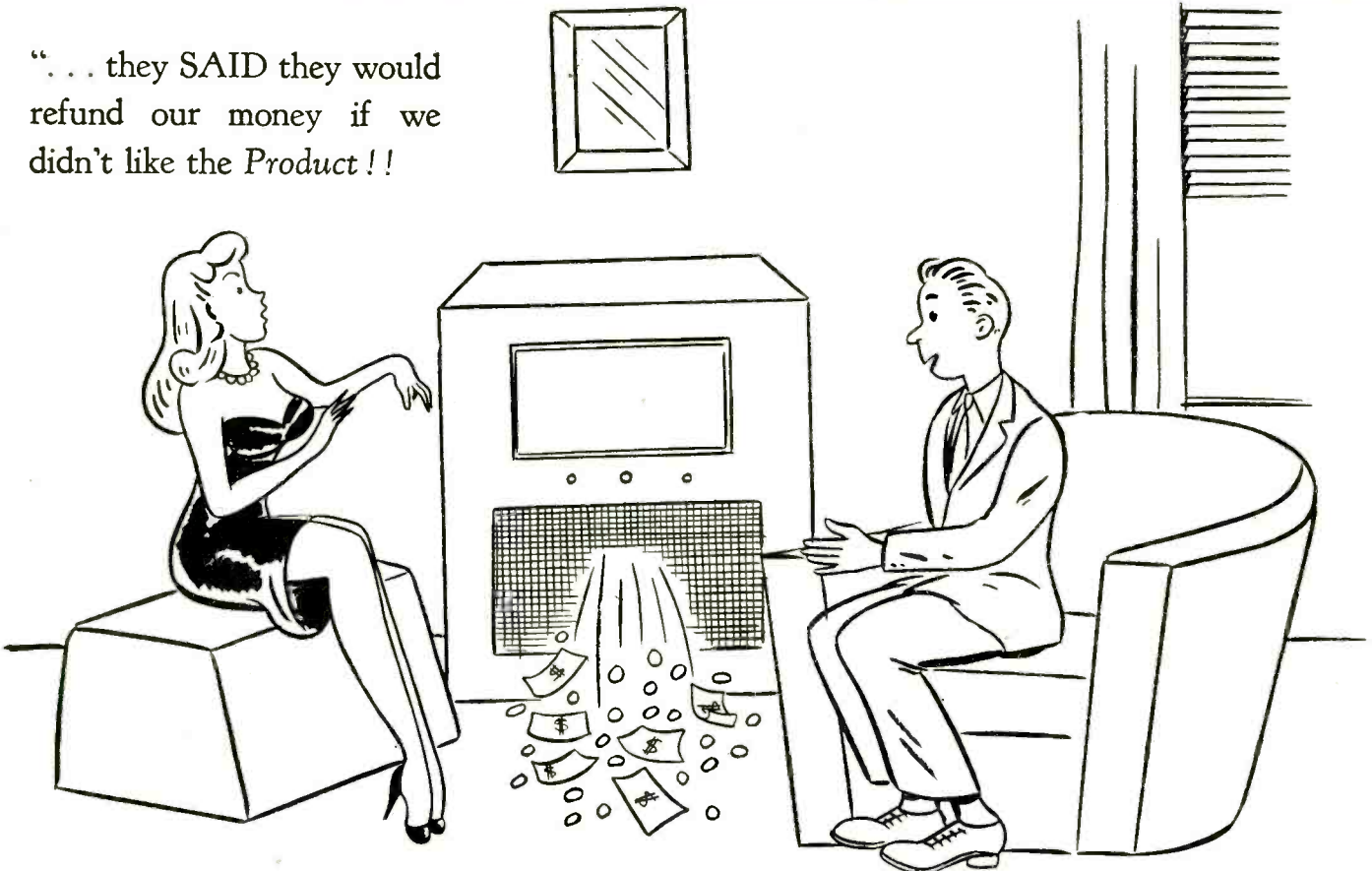

Season's Best from  
**MAX RANEY**

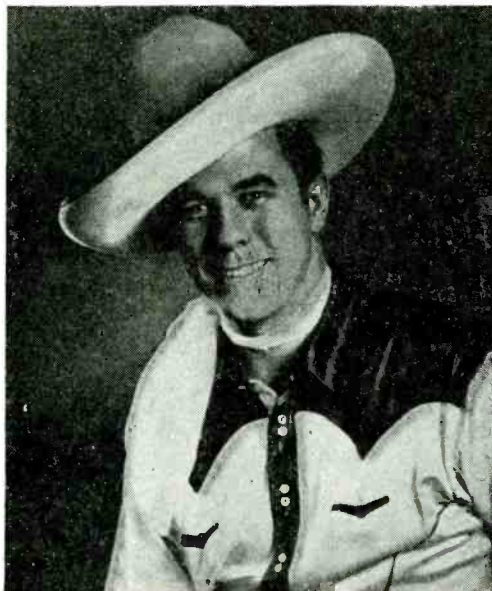

HIS HI BOYS and LITTLE FLOSSIE  
—○—  
STARS OF THE NBC NETWORK  
Still Going Strong at WHAM

## Season's Greetings

To the Rochester Chapter

N.A.B.E.T.

Rochester **RADIO** Supply Co.

*Wholesale Distributors of All  
Leading Lines of "Ham" Equipment*

118 St. Paul Street      Rochester, N. Y.

Phone Main 2290

## Season's Greetings

To the Rochester Chapter

From the Management and Staffs of

**WHAM**

-

**WHFM**

The Stromberg-Carlson Stations

ROCHESTER, N. Y.

# Season's Greetings

## CHICAGO CHAPTER — NABET

FRANK C. SCHNEPPER  
*Chairman*

### Night Studio

J. P. Daugherty  
G. J. Devlieg  
H. C. Eckland  
E. A. Golec  
H. P. Jackson  
A. P. Johnson  
H. C. Johnson  
W. T. Knight  
R. H. Knowles  
J. V. Lato  
R. H. Parker  
T. S. McEwan  
L. M. Mulatz  
K. A. Slobb  
B. H. Speirs  
H. B. Wyers

### Day Studio

D. R. Fitch  
H. L. Cavanah  
E. A. Cunningham  
P. K. Franklin  
L. E. Heiden  
G. F. Kemp  
W. C. Lahman  
E. A. Macornack  
H. L. Reynolds  
A. E. Scarlett  
E. L. Tolleson  
G. W. Smith  
M. E. Trottnner  
D. J. Wilson

### Maintenance

L. N. Balsley  
W. E. Beeson  
R. R. Brooks  
A. H. Elkins  
E. A. Holm  
J. F. Martin  
H. C. Newbouer  
W. W. Schooley  
R. D. Werheim  
H. T. White

### Supervisory

W. K. Cole  
C. V. Corliss  
H. H. Eichorst  
F. E. Golder  
R. S. Davis  
J. R. Miller  
V. D. Mills  
A. H. Otto  
J. H. Platz  
M. W. Rife  
W. F. Lanterman  
H. D. Royston  
M. J. Wilson  
R. B. Sturgis

### Field

C. A. Cabasin  
W. H. Cummings  
H. R. Maule  
F. C. Schnepper  
R. B. Whitnah  
A. W. Hjorth

### WENR-WLS

#### Transmitter

H. R. Rawson  
W. T. Anderson  
A. J. Forgach  
A. R. Johnson  
T. G. Bombaugh  
W. J. McDonnell  
J. F. Hehren  
C. E. Wise  
H. F. Kohnitz

### WMAQ

#### Transmitter

A. D. Aldred  
R. E. Fitzpatrick  
D. E. Howser  
C. P. Lonie  
R. A. Mingle  
A. J. Schroder  
E. G. Squires

### RCA Recording

L. H. Chase  
E. J. Eckhardt  
F. F. Elsasser

### WGRC Louisville

Diana Adams  
J. K. Haberman  
W. T. Hall  
James Jared  
D. A. Millican  
W. J. Morrison  
K. B. Smith

### Inactive

#### Armed Forces

F. C. Ahlgrim  
E. L. Bernheim  
T. E. Gootee  
A. L. Hockin  
D. J. Kempkes  
R. A. Limberg  
P. J. Moore  
C. L. Pierce  
W. C. Prather  
M. F. Royston  
F. C. Shidel  
H. W. Schumacher  
L. L. Washburn

### Inactive

H. F. Abfalter  
W. O. Conrad  
R. W. Cory  
J. W. Eastman  
E. G. Eisenmenger  
V. L. Fulton  
G. E. Webster

### Honorary

B. F. Fredendall



---

# A Christmas Greeting

To the engineers who have helped build the radio industry  
to its present high standard of service.



# A New Year's Wish

For a lasting peace and the continued development of the  
radio industry to new heights.



50,000 WATTS  
AMERICAN AFFILIATE

Represented by  
JOHN BLAIR  
AND  
COMPANY

CHICAGO 7

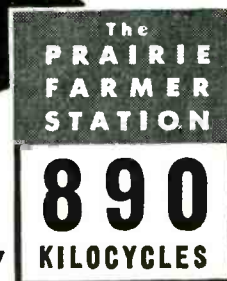

"At Your Service"



**WENR**  
*Chicago*

*A clear channel station*

Owned and Operated by the

AMERICAN BROADCASTING COMPANY, INC.



Thanks and greetings to all the ABC Station engineers throughout the country who for the last 12½ years have managed to wake up between 8 and 9 CST at least every 15 minutes.

**DON McNEILL**

Breakfast Club



I can only repeat what Mr. McNeill has just said, and I thought it was pretty dull. So I'll shut up. (Which is probably the best offer you guys have had in years.)

## SAM COWLING

Same time — same stations



# JACK OWENS



*“Hey, Don! Interview this one—she’s cute!”*

*Cruising Crooner*  
*ABC's Breakfast Club*  
**9 - 10 A.M. E.S.T.**  
*Monday thru Friday*

*Star of*  
*Tin Pan Alley of the Air*  
**NBC Saturdays**  
*5:45 and 6:30 P.M. E.S.T.*



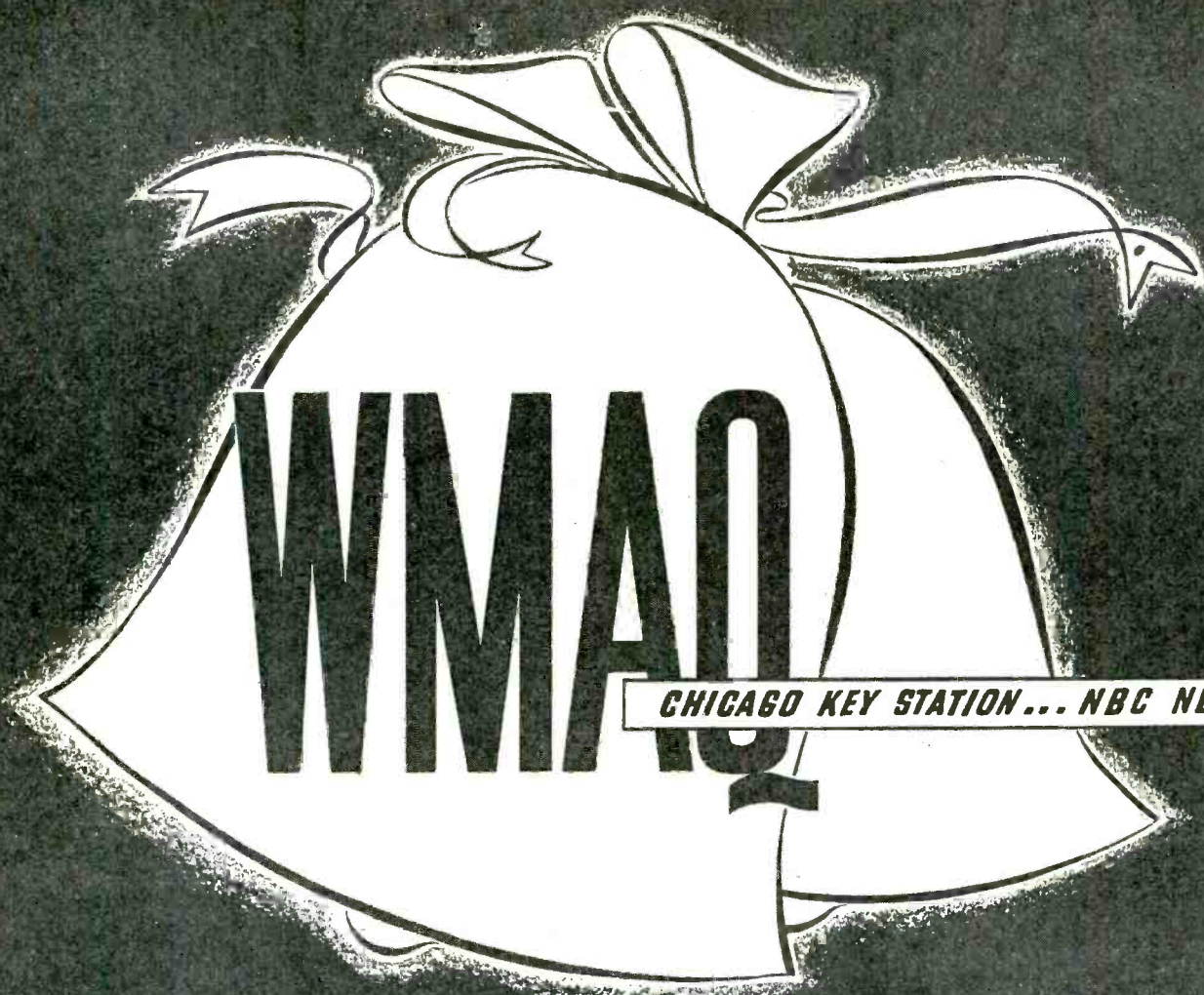

CHICAGO KEY STATION... NBC NETWORK

*Extends  
Cordial Season's Greetings  
to all Members of*

**N.A.B.E.T.**



# CHICAGO CORN FROM A COB REPORTER *By* K. A. SLOBB

**T**HIS has been a momentous year for NABET. You fellows who have been in ATE or NABET since its inception will probably agree with me that we have done more this year than since the time you first formed a Union. There are some who think we are something like "pi" . . . we have reached 3.14 and from there on until infinity our gains will be small. That may be so . . . unless there should be some labor upheaval, a sudden reshuffling because of television, a fee system, or something along that order.

NABET stands now in the position of being the only immovable object which has successfully turned back the irresistible force of the AFM and James C. Petrillo. During 1945 we received a court order showing our jurisdiction over platter-turners everywhere in the country except Chicago, and to this writing the AFM has not seriously threatened to disregard that order.

Strikes are never pleasant, for employer or employee, but the NABET strike during 1945 seems to have served its purpose. A strike was inevitable, if only to show the strength of NABET, and without a doubt 1945 was the best year for it.

NABET negotiated a contract with NBC and ABC with wage scales much higher than any network ever had before, and without a doubt we drew the CBS-WLS-IBEW boys up by their bootstraps so that they could enjoy the fruits of our labors.

Yes, indeed, 1945 was a great year for NABET. Chicago played a large part in this drama . . . may even have been the sparkplug of much of the action.

1946 is upon us now. NABET is still independent, and under our expansion plan we have more full-time representatives to service radio stations throughout the country. There are better things in store for NABET men . . . we should look forward to the time when engineers receive their rightful place in the broadcasting picture. Salary is all-important . . . working conditions must be satisfactory . . . but we want to be able to stand alongside the actor, the announcer, the production man and the musician when it comes to recognition. It must be an individual and a concerted effort.

Here is a picture of what happened during 1945, as gleaned from the columns about Chicago during the year. Minor Wilson bought a new home in Bellwood . . . Paul Franklin joined NBC Studio . . . Herb Wyers and Jim Dougherty joined Blue Studio . . . the television classes and Clarence Radius . . . RCA Recording engineers joined the Chicago Chapter . . . Art Hjorth resigned as Chi editor and yours truly took the reins . . . Herb Wyers buys a home in Broadview . . . the stork visited Carl Cabasin's home . . . Vern Mills new Secretary-Treasurer of Chi Chapter . . . V-E Day . . . Glenn Webster left to join Collins . . . a bouncing baby boy at the Joe Alusic residence . . . the shakeup in Master Control . . . Paul Clark came back and left immediately for RCA . . . Blue changed to ABC . . . WLS Studio gang joined IBEW . . . Bev Fredendall resigned to join private firm . . . Art Cunningham and Al Johnson joined NBC Studio . . . Frank Schnepfer made Chairman of Chi Chapter . . . V-J Day . . . Mills gets Transmission Engineer job . . . NBC Outing . . . Bill Knight buys home at Crystal Lake . . . Everett Janess leaves as stockroom clerk . . . Art Johnson and Thur Bombaugh, WENR-WLS transmitter men, back from Navy . . . ABC Outing . . . contract signed . . . retroactive pay . . . Roy Smith joins NBC as stockroom clerk . . . Pete Cavanah signs contract to build new home . . . "no breaks" edict.

Those are just a few of the things that happened during the year 1945. The columns don't really show a true picture of the doings here in Chicago . . . there were lots of laughs during the year, many unprintable, and of course, lots of gripes.

I would like to thank all those who took ads in the Yearbook. Your cooperation is appreciated not only by myself but by all the engineers in Chicago whom I represent in this magazine.

Right now, I'll wind up this column with two new items. First, welcome back to Russell Sturgis, who has returned to NBC

Master Control. Russ left NBC in March, 1943, as a Lieutenant in the Army Air Corps, and came back as a Major. He spent all his time as Communications Officer for the 440th Troop Carrier Group. As a matter of fact, he joined the cadre when it was activated and remained until it was inactivated. During his time with the 440th Group, Russ was 18 months overseas in the ETO, and took part in seven campaigns, including the invasions of Normandy and Southern France and the push through France and Germany. We'll try to have a picture of Russ in the February issue.

Jim Lato, ABC Studio, is planning on building in Elmhurst next year, and has purchased property there. That's the news till next month. 73.



Harvey Hays

Thanks to you fellows for everything . . .



ALEX DRIER

Merry Christmas



Louis Roen

ANNOUNCERS



Charles Lyon



John Holtman

NBC • CHICAGO



Kleve Kirby

Happy New Year





**GREETINGS**  
and  
**BEST WISHES**  
to **N. A. B. E. T.**  
for 1946



**IRNA PHILLIPS and CARL WESTER**





**Percy Faith**  
*Musical Director*



**Josephine Antoine**  
*Soprano Soloist*

Compliments of

# CARNATION CONTENTED HOUR CAST

Harry K. Gilman, Producer

## CHOIR

Lois Fehr  
Florence Edwards  
Ruth Slater  
Lillian Chookasian  
Richard Paige  
Robert Kessler  
Dean Reed  
Earl Tanner  
Maxwell Wilson  
Allan Davies  
Rex Hogan  
Lewis Warenan  
Leslie Dole  
Hans Alten  
Abwin Schweig  
Robert Childe

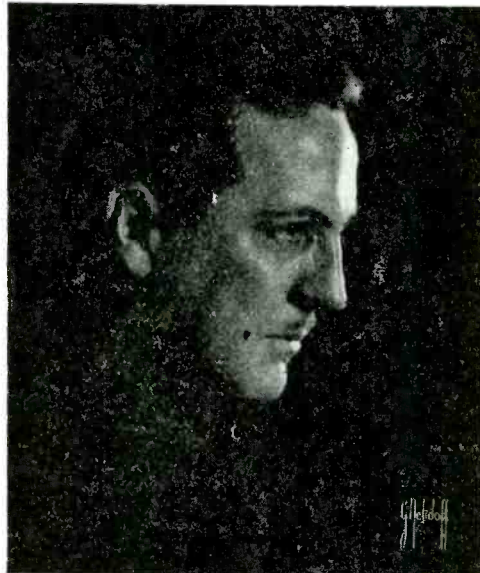

**Reinhold Schmidt**  
*Baritone Soloist and Choral Director*

HOMER (Homer) HECK — HERBERT (Herb) LATEAU — ELLIOT (Ei) ROBERTSON

WILLIAM (Bill) LAWRENCE — ARTHUR (Jake) JACOBSEN — NORMAN (Norm) FELTON

EDWIN (Ed) BAILEY — PARKER (Park) GIBBS — BERT (Bert) WHALEY

*It's that time of year again!*

# SEASON'S GREETINGS

To All You Guys . . .

NBC CHICAGO  
PRODUCTION  
DEPARTMENT



HARRY (Harry) BUBECK — RICHARDSON (Dick). LOUGHRIN



*Greetings and Best Wishes*  
**Tommy Port**



**Fran Allison**

"Aunt Fanny" — Breakfast Club  
"Clara" of "Clara, Lu and Em"

**The Fontaine Sisters**

BEA • MARGIE • GERI



BRACH — SWINGS THE THING  
ROY SHIELDS SHOW  
BOWMAN MUSICAL MILKWAGON



**Marion Mann**

# *Welcome Home!*

**Major Washburn, Lieutenant Bombaugh,  
Major Moore, Lieutenant Johnson  
and Major Sturgis**

*Your return to Chicago and the presence of our old  
friends of NABET makes this a Happier New Year*

## **THE “MA PERKINS FAMILY”**

*Ma Perkins . . . Virginia Payne*

*Shuffle Shober . . . Charles Egelston*

*Willie Fitz . . . Murray Forbes*

*Fay Perkins . . . Cheer Brentson*

*Baby Paulette . . . Nannette Sargent*

*Junior Fitz . . . Bobby Ellis*

*Stella Carlon . . . Marilou Neumayer*

*Burt Carlon . . . Jack Petruzzi*

*Mathilde Pendleton . . . Beverly Younger*

*Augustus Pendleton . . . Maurice Copeland*

*Charlie Warren . . . Tom Moore*

*Director . . . Phil Bowman*



# *The American Broadcasting Co.*

Central Division Production

CHICAGO



JAMES BILLINGS

EARL BRONSON

LEW GREEN

BILL JOYCE

FRED KILLIAN

CLIFF PETERSEN

ED. SKOTCH

J. CLINTON STANLEY

HAROLD STOKES

\*LT. TED TOLL

ISABELLE FAUST

(Secretary)

MARY FRANCES JONES

(Secretary)

MAURICE WETZEL

(Manager)

★ U.S.M.C.





# Wanted



## ENSIGN DICK NOBLE

The Chicago NBC Staff Announcers wish to inform Ensign Dick Noble that the war is over. If anyone sees a fellow in China who looks like this, tell him to come back — there's an audition for the Wilson News Show Tuesday.

Signed

NORM BARRY

HANK COOKE

DON ELDER

JOHN HOLTMAN

BOB BROWN

NED LeFEVRE

GEO. STONE

AND OUR PEACHY

FORT PEARSON

KLEVE KIRBY

CHAS. LYON

SUPERVISOR

DAVE GARROWAY

ED. ALLEN

LOUIE ROEN

MR. KEPHART



The

ENGINEERS  
N.A.B.E.T.

of

**WOW**

N.B.C.

23

YEARS OF  
PUBLIC SERVICE

Extend the Season's Greetings  
To Radio Engineers Everywhere!

**RADIO STATION WOW, Inc.**

590 KC

OMAHA

5000 WATTS

JOHN J. GILLIN, JR., President



This Xmas will be a WOW!

WOW Announcers' Quartette

Thomsen Holtz

Lyle DeMoss

Tom Chase

Ray Olson

Season's Greetings

To Engineers of

NABET

JOE HEROLD

Technical Supervisor WOW, Inc.

Season's Greetings

from

Morton Wells

and the

WOW Orchestra

Omaha, Nebraska





## Season's Greetings



ED. NESTANDER, Prop.

Complete Service for the Radio  
Service Man, Amateur and  
Broadcast Engineer

Presto Recording Equipment and Discs

RADIO EQUIPMENT CO.

Phone: AT.7700

2820-22 Farnam Street, Omaha, Nebr.

The Management and Employees of the

## COLONY CLUB

Extend Season's Greetings to

**N.A.B.E.T.**

IN OMAHA



*"It's Always the Colony Club"*

**FINEST LIQUORS**

**PACKAGE or MIXED DRINKS**

AIR CONDITIONED

ART SMITH, Owner

1912 Farnam Street

Phone: 9484

Omaha, Nebraska



Joe Herold G. Fynn and Bob Rudd collaborated in bringing you this lovely, and they take great pride in introducing to the National NABET the Omaha Chapter's Entry for "Sweetheart of the Broadcast Engineers".

She is Miss Loretta Dundis and is a Stenographer in the Program Dept. of Radio Station WOW. We ask that every one refrain from drooling—**PLEASE.**

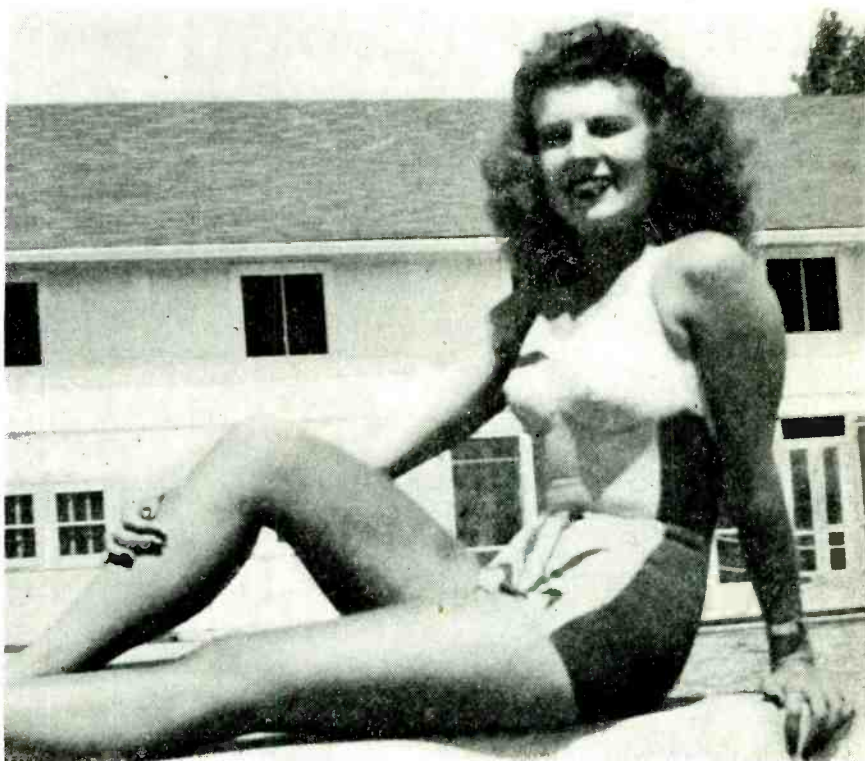

GENERAL MILLS HOUR

# The Guiding Light

*Starring*

**LOU HEIDEN**

*with*

Eloise Kummer

Rita Ascot

Rye Billsbury

Constance Crowder

Maurice Copeland

Jerry Walters

Clare Lawrence

Peggy Lamont

Tim Lawrence

Lucille Marshall

Dwight Lamont

Bill Brown

Producer — Joe Ainley

HOST: ED PRENTISS

# Today's Children

*Starring*

**WOODY LAHMAN**

*with*

Virginia Payne

Murray Forbes

Ruth Rau

Pat Dunlap

Ernie Andrews

Kleve Kirby

Art Hern

Mama Schultz

Papa Schultz

Marilyn Larimore

Bertha Schultz

Otto Schultz

John Murray

Richard Stone

Producer — Harry Bubeck

GENERAL MILLS HOUR

Broadcast Engineers' Journal 152 Yearbook :: January, 1946

Greetings

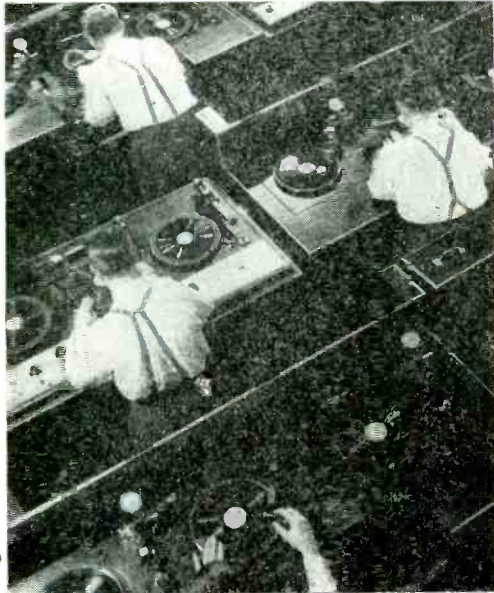

NBC—CHICAGO  
SOUND ARTISTS



B  
R  
A  
D  
L  
E  
  
C  
U  
R  
L  
E  
Y



WILLARD WATERMAN



TOM

DICK

HARRY

*Under Management*

SAM HARRINGTON—NCAC



BEULAH KARNEY



FRANK DANC

# PACKAGE PRODUCTIONS

Bookings now received for:

**Beulah Karney's "MEAL OF THE DAY"**

*(Five minute open-end recordings)*

**"OF HEART AND HOME"**

*(Fifteen minute dramatic program)*

AND OTHER NICELY WRAPPED-UP PACKAGES

Ride that level — watch that gain!

## Season's Greetings

### JACK ARMSTRONG CAST

Jack .....	CHARLES FLYNN
Betty .....	SARAJANE WELLS
Billy .....	JOHN GANNON
Lady Thunder.....	VIRGINIA PAYNE
Announcer .....	FRANKLYN FERGUSON

Writer-Director.....JAMES JEWELL

GENERAL MILLS



**Best Wishes to the Boys**  
**SMILIN' ED McCONNELL**



GENERAL MILLS HOUR

# The Woman in White

Starring

**LEE TOLLESON**

with this supporting cast

Sarajane Wells	Eileen Holmes
Muriel Bremner	Helen Bradley
Ken Griffin	Dr. Paul Burton
Harry Elders	Dr. Jack Landis
Hugh Studebaker	Doc Purdy
Cheer Brentson	Amelia Jamieson
Sidney Breese	Dr. Jonathan Macneill
Charlie Lyons	The Voice of Wheaties

Herb Futran — Asst. Cue Thrower

HOST: ED PRENTISS

# Hymns of All Churches

Starring

**DON FITCH on NBC**  
**JOE ALUSIC on ABC**

The Choir

Louise Weber  
Lillian Chookasian  
Margery Mayer  
William Miller  
John Toms  
Win Stracks  
Paul Nettinga  
Arwin Schweig  
Bruce Foote

FRED JACKY, Director

FRANKLYN MACCORMACK, Narrator

GENERAL MILLS HOUR

Broadcast Engineers' Journal **156** Yearbook :: January, 1946



**DON DOWD**



*Season's Greetings*  
**JOE WILSON**



**PAUL BARNES**  
"Coronet Front Page" Reporter

*The Best to You . . . Always*



*The Four Vagabonds*



Fraternal Greetings from the Chicago Local

# American Federation of RADIO ARTISTS

to our fellow union members



## Order from NEWARK

**for  
Quick  
Service  
on  
Radio  
Parts**

Right NOW we may have exactly what YOU need. Every day we supply transformers, resistors, rheostats, condensers, rectifiers, filters, wire, panels, sockets, tubes, and thousands of other vital electronic items to America's Radio and Communications industries.

When you send us an order for the things you need, we ship every possible item, at once, right from stock, and advise probable delivery date on balance of order. You will like NEWARK service!!

Write for latest catalogue, just out.



## NEWARK ELECTRIC CO.

323 W. Madison Street  
Chicago 6, Illinois

115 W. 45th Street  
New York 19, N. Y.





**Skip Farrell**



**Kay Campbell**

**Best Wishes to Our Friends the Engineers**

BERYL VAUGHAN

HARRY ELDERS

RAY SUBER

CONSTANCE CROWDER

CLIFF SOUBIER

JIM CAMPBELL, *Announcer*

LEW VALENTINE, *Host*

HARRY HOLCOMBE, *Director and Producer*

MYRON GOLDEN, *Script Editor*

PORTER HEAPS, *Musical Director*

BYRON SPEIRS, *Engineer*

*Appearing each Thursday Night at 9 o'clock on ABC in*

**CURTAIN TIME**

*Bloom*

**PHOTOGRAPHERS**  
32 WEST RANDOLPH STREET  
TELEPHONE CENTRAL 5807  
**CHICAGO**

*Betty's Mart*  
JUNIOR MISS APPAREL  
222 NO. BANK DRIVE CHICAGO

**SHAPIRO AND DASKAL**

Merchandise Mart

OFFICIAL FLORISTS FOR THE  
BROADCAST ENGINEERS

**Season's Greetings**

**SHANOFF'S**  
The Merchandise Mart Jewelers  
Main Arcade, Merchandise Mart

**CHICAGO**  
"Jewelers to the Radio Profession"

**Season's Greetings**

Hi Walders :-: Al Lee



**ALLEGRETTI'S GRILL**

359 No. Wells Street

**Season's Greetings**

To Our Many Radio Friends

for

**Haberdashery and Sportswear**

of distinction take your cue from the

**Merchandise Mart Shop for Men**



2nd Floor Arcade

## PRESIDENT POWLEY STOPS IN CLEVELAND

SOMEONE once said you should not take things for granted. We failed to realize the importance of such a statement before President Al Powley stopped in Cleveland while on his way to Detroit. We had always assumed that the truth of our Cleveland publicity would never be questioned. So, imagine our surprise when President Powley alighted from a train over at Cleveland's Terminal Tower Building. His right foot hadn't been on terra firma more than a second when he said: "I've been reading a lot of yarns coming out of Cleveland . . . I get around to a lot of stations and some of the boys are putting the bee on me . . . They question the truth of some of those yarns . . . What about . . ."

"Which yarns?" interrupted Harold Brandt. Brandt, as you no doubt know, is Cleveland's Chapter Chairman.

"They have mentioned several but there's one in particular . . . The one about WTAM having a billiard table in their recreation room . . . I've read a lot of fiction but nothing to compare with or top that one!"

"You haven't seen anything," chimed in Frank Whittam (Sec. Treas.) who had been watching a cute little blonde trying to do the impossible when she attempted to tie a shoe-string with one hand while holding a hat-box with the other. "And that isn't all," continued Frank as the object of attraction

disappeared down a ramp . . . "We've facilities for deuces wild to boot!"

To which President Powley said: "I'll believe it when I see it!"

Harold Brandt called a cab. "Where to," said the cabbie with a pained look showing through a two-days' growth of beard.

"Nbc Bldg.," said Brandt.

"Where's that?" questioned the cabbie.

"Ninth and Superior," said Brandt.

"You've got your nerve," complained the cabbie. "Four men! Two blocks! Two bits! What a way to make a living!"

You have heard the cab drivers complain and you've no doubt seen a lot of people getting out of cabs. The day wasn't windy and there weren't any short-skirted models in our cab . . . so let's change the subject.

We entered the NBC Bldg. and went down to the Technical Floor.

"By George," exclaimed His Nibs in disbelief. "I still can't believe it . . . A pool table in a radio station!"

"That isn't all," said Whittam. "See that ping-pong table?"

"You win," admitted His Nibs. "I'll believe anything Pruitt writes from now on."

"Thanks," said I.

Well, Al wanted to know who gave us the room in the first place. Harold Brandt explained that it all came about through the generosity of Manager Vernon H. Pribble

several years ago when we first moved into the building. Someone then suggested that we play a game of pool. We agreed that this was an excellent idea, so we racked them and rolled out the pills for the break. His Nibs got the lowest numbered pill so he hauls off and pulverizes them with a tremendous jab. What followed was cause for someone other than Al Powley to open his eyes . . . Al ran off 32 balls without a near-miss. Whittam racked his cue and said he'd never really cared much for pool in the first place. Brandt and I didn't bother to rack our cues . . . We just tossed them in a corner and asked His Nibs how about a game of poker.

That question proved to be a sad mistake. We never should have suggested poker . . . not to Al Powley. He's either a good bluffer or has terrific hands . . . Our pocket-books will testify to the truth of that statement. Al took our shirts. He'd have taken our pants except for the fact that Brandt interrupted the robbery to say we had a dinner appointment at the Hickory Grill.

The steak proved to be tender . . . but not tender enough to make us forget the trimming President Powley gave us with the cue and cards.

There'll be no more publicity from Cleveland regarding recreation rooms!—B. P.



Left (left to right): Supervisor Alvin McMahon and Pres. Powley. Center (left to right): Brandt, Whittam, Powley, and Pruitt. Right (left to right): Harold Brandt, Frank Whittam, Al Powley, and Bert Pruitt.

## WEST COAST NABET OFFICE

Effective Jan. 1, 1946, the National Association of Broadcast Engineers and Technicians will open an office in Hollywood, at 6000 Sunset Boulevard, Hollywood 28, Calif., under the personal direction of NABET Vice-President Thor E. LaCroix. Thor is well-known as W6LN. As mentioned elsewhere in this issue, LaCroix is coordinating all NABET ham activities. NABET ham schedules, news, etc., and operating frequencies should be sent directly to his office. W6LN is operating on 10 meters, and will be on the lookout for NABET calls.



**Art Van Damme**  
and His Quintet



**Season's Greetings**  
from  
**Jimmy Blade and His Music**  
WMAQ



*Greetings*  
**Norman Ross**

*Season's Best*  
*To the Best in the West*



*Much Obligated, Boys*  
**TOM MOORE**

**VINCENT  
PELLETIER**

*Best wishes to the boys  
who do the real work*



**Capt. Michael Fielding**



The PAUL HARVEYS wish you guys  
Merry Christmas and "Good News"



**The Cadets**

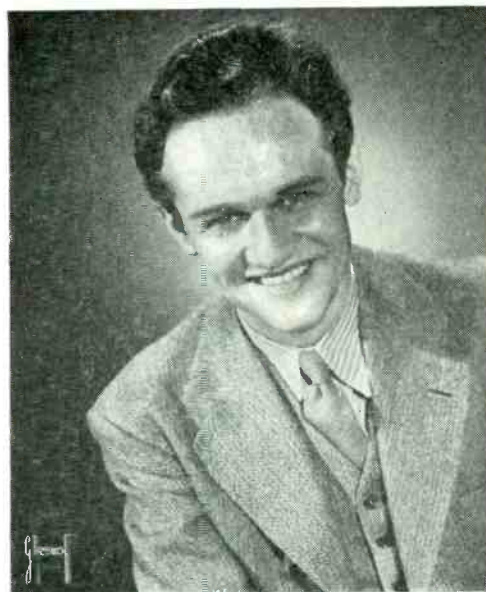

Best Wishes for the  
Holiday Season and the New Year

**Wilms Herbert**

Bob  
Murphy



*Too much is  
always just enough*  
**Thanks!**  
Herb Newcomb

Greetings, Fellows . . .



ED ROBERTS



NANCY MARTIN

Compliments of the Season

EVERETT MITCHELL

*Central Division Director of Agriculture*

NATIONAL BROADCASTING COMPANY

HARRY FROHMAN

DICK PLATT

Piano-Organ Duo



**TOMMY  
BARTLETT**



**Carolyn  
Gilbert**

Greetings  
**Sidney C. Ellstrom**



Greetings  
**ELIZABETH HART**

*LEAF GUM Presents*  
**TIN PAN ALLEY OF THE AIR**  
**HEADLINING ED GOLEC**

with

**Jack Owens**  
**Johnny Neblett**  
**The Four Vagabonds**  
**Jimmy Blade and his Leftans**

**A TIM MORROW PRODUCTION**

**Directed by Harry Bubeck**

**Boyce Smith**



Merry Christmas, Fellers



WALTER  
HERLIHY

Season's Greetings

to the Engineers

from

PAT BARNES

Season's Greetings



Greetings

RALPH  
HOWARD  
PETERSON



from

MOE GALE



GEORGE HAYES  
A.B.C.



---

# Thanks

## TO A BUNCH OF *Great Guys* FOR DOING AN *Excellent Job!*

---



### ALL MUTUAL ENGINEERS

for the splendid cooperation on "QUEEN FOR A DAY"  
Monday through Friday



FRED H. RAGSDALE

NORMAN H. DEWES

BEN M. DOTY

for the LUM and ABNER broadcasts,  
from Los Angeles, 3 times daily



A. J. HORWATH

for New York broadcast of  
ALKA-SELTZER NEWS OF THE WORLD  
Monday thru Friday



HUNTER REYNOLDS

for QUIZ KIDS Program  
every Sunday night



MAURICE DONNELLY

for the ALKA-SELTZER NATIONAL  
BARN DANCE every Saturday



"BY" SPEIRS

for the MAURICE B. SACHS  
Amateur Hour and  
Herbie Mintz Shows



HARRY JOHNSON

for Chicago broadcast of  
ALKA-SELTZER NEWS OF THE WORLD  
Monday thru Friday



CHUCK OSTLER

for the MURPHY JAMBOREE  
from WLS Chicago every Saturday night

---

From

WADE ADVERTISING AGENCY

Chicago

# Season's Greetings

from

# K O A

NBC's station at the foot of the towering  
snowcapped Rockies in Mile-High Denver

# DOINGS IN DENVER . . . By George Pogue

**G**REETINGS! Here we are again after having missed an issue. Since the 10 meter band opened up November 15th the ham bug has been flying around Denver biting engineers round and about so that they are busily getting their rigs ready and getting on the air. Vern (21 MC) Andrews is on the air. There is a vacant place in his living room since he has taken his radio out of the garage where his transmitter is located. Vern has fixed his garage as a combination radio shop, ham shacks, and garage. His present problem is figuring out an alarm system that will protect his valuable equipment, yet that he can turn off so that he wont arouse the neighborhood when he gets home some night after a late shift.

Joe (Super Power) Rohrer has his rig on the air but he is having trouble with his tank coil running warm. His rig is putting out about 350 watts, but when he is done, Joe hopes it will put out 500 watts and have a dialing system to change frequencies when more bands are open.

Francis Nelson is on the air and has been doing quite a bit of hamming since he has had a bit more leisure time. He is on leave of absence from the transmitter at KOA.

Among those who hope to be on the air soon are Garland Dutton, Joe Turre, Carl Nesbitt, and Russel Thompson. Carl is getting his rig ready for some of the lower freaks when they open up. Russ has a breadboard layout but wont go on the air until he gets a receiver. They tell me that helps a lot.

Since last issue there have been a few changes in the status of the engineering personnel at KOA. Clarence Peregrine has been promoted to Operational Supervisor at KOA; Walter Morrissey to Control Supervisor; Joe Rohrer to Assistant Control Supervisor; Stan Neal to Control Room Engineer, and Vernon Andrews to Control Room Engineer. Roy Carrier has returned to his position of Assistant station Engineer since Commander Slusser has returned from the navy to be Station Engineer.

Gene Carpenter and Joe Finch have a new project these days. They are busy going up into the hills, cutting Christmas trees, and bringing them in to sell. Gene says it's mighty cold up in "them thar hills".

Kenneth Cooper is back on maintenance at the transmitter after his vacation which he spent in Greeley, Colorado where his family lives. Kenny is our only real commuter, driving to and from work between Denver and Greeley, a distance of 50 miles. He was one of the lucky ones though; he was able to buy a brand new Studebaker during the war. He hopes the housing shortage in Denver will ease up soon so that he can move his wife and three lovely daughters down to Denver.

Neighbors of Joe Finch are wondering if he is inventing some new kind of atomic bomb as there have been weird lights flashing out of his basement windows at night lately. He has been experimenting with a Precipitron which he hopes to install in his furnace to collect dust. He has it to the high voltage stage so far and says that with a few thousand more volts he thinks it could be used as a Cyclotron. However he says, he is still master of the situation.

Milt Hall was sent by plane to Rapid City, South Dakota for a pick-up of a balloon launching base. The program was a net pick-up for NBC. He said he had a grand trip; every one at Rapid City was grand to him and he thinks all pick-up trips should be made by plane.

Douglas "Pinkie" Kahle has bought a new home out in Westminster, Colorado, and had a house-warming for the studio gang. He must have had some experience with Captain Kidd's treasure as his invitation contained quite a complete map on how to get there. After turning left at the schoolhouse and right at the night club (or was it vice versa?), everybody eventually found his place and a grand time was had by all.

Around the studio we note: Walter Morrissey is on the hoof again since he decided to have that sleek job of his completely overhauled; Stan Neal a bit stiff in the joints from painting the roof of his house these nice warm sunny days; Kenneth Raymond pheasant hunting in his time off; and George Pogue bustling around again with a yearbook in one hand and a contract in the other trying to sell ads for this edition.

Aubrey Blake had an unique experience the other day. Being our chapter secretary-treasurer, he went over to the bank for a draft in the amount of \$35.00. When he got back to the studios, he found that the bank had made the draft for \$35,000.00. The

bank was very grateful to get that draft back and to make out a new one for the correct amount.

Carl Schucknecht got a real write-up in our local papers in an article, complete with pictures, about the Denver Model Railroad Club. Carl is an active member and has done a great deal to build up the club. They have a real set-up in the basement of the Union Station. Carl has built his own locomotive which he uses at the club. In case you are a model railroad fan, Carl has an SP Mikado, "0" gauge.

A familiar face that we are glad to see back at KOA is that of Al McClellan. He was in the Naval Reserve before the war so was called up in summer of 1941 and was at Pearl Harbor on that fateful day of December 7th. Al is back at his old place as studio engineer. Welcome back, Al!

As we draw this edition to a close, we see our chapter chairman, George Anderson busy up to his ears in the problems of NABET, negotiating a contract with KVID, and running up to Greeley on business with KFKA. And this being our first peace time Christmas in four years all the gang at KOA really feel the spirit of "Peace on Earth and Good Will Toward Men" and heartily wish everyone a "A Very Merry Christmas and A Happy New Year".

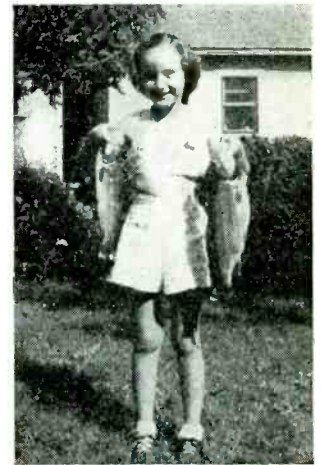

Laura Lee Rothinier, Aubrey Blake's niece holding two fish of that BIG catch that Aubrey caught on his vacation.

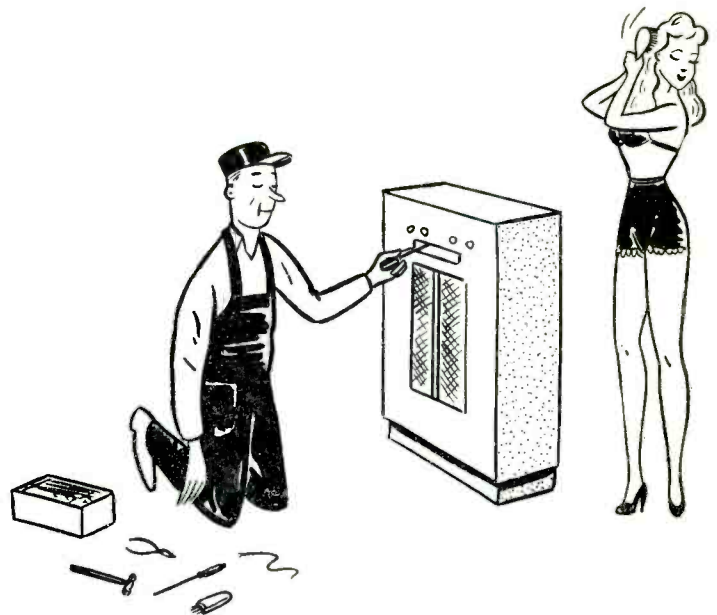

"Am I bothering you, Mr. Phelan?"

## Season's Greetings

### KFKA

R. Harris  
H. W. Johnson  
C. M. Petit  
R. Smith

### KOA

G. H. Anderson  
V. E. Andrews  
A. F. Blake  
J. E. Carpenter  
R. D. Carrier  
K. H. Cooper  
G. S. Dutton  
J. Finch  
\*G. R. Glasscock  
J. M. Hall  
D. D. Kahle  
A. C. McClellan

### KVOD

V. W. Corbett  
C. McElroy  
P. L. Obluda  
F. F. O'Brien  
A. R. Peterson  
J. W. Summers



**N-A-B-E-T**  
**Denver**



*"A Happy  
Good Morning  
to You"*

**HAPPY  
JACK TURNER**

KOA and NBC

**Season's Greetings**

To the Rochester Chapter

Bob — W8ETJ and Gordon — W8ILO

**HUNTER ELECTRONICS**

233 East Avenue

**Season's Greetings**

from the

**PIONEER RADIO  
DISTRIBUTOR**

of the

**Rocky Mountain Region**

Distributors of

**Radio Corp. of America Products  
and Audiodiscs**

**Inter-State  
Radio and Supply Co.**

1639 Tremont Place

Denver, Colo.

Established 1921

Season's Greetings

from

**KFKA Greeley**

910 ON YOUR DIAL

"Northern Colorado's Own Station"

**H. C. GREEN**  
Managing Director

**FRANCIS PRICE**  
General Manager

Merry Christmas

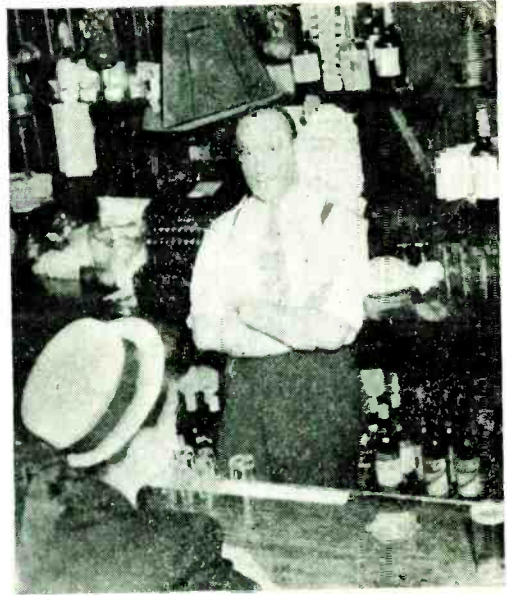

A Happy New Year

*Hy Lavin*

**THE CACTUS GRILL**

**In the Mack Building**

Just Across from NBC

Rhapsody of the Rockies

from

Out of the West

**MILTON SHREDNIK — KOA**

"Music by Shrednik"

Greetings Engineers



from the

**KOA - NEWS ROOM**

LIZ MELLOR

CECIL SCAVEY, Dir.

ED WEBER

VIV FINLEY

Season's Greetings



**K V O D — Denver**



# The Voices of N.B.C.

— *from Radio City in New York* —

Tex Antoine

Robert Denton

Clyde Kittell

Don Pardo

Ken Banghart

Arthur Gary

Bulkely Kozlow

Herb Sheldon

Ray Barrett

John Gorman

Bill Malcolm

Bob Sherry

Roger Bowman

Ben Grauer

Charles F. McCarthy

Bob Stanton

Jack Costello

Ed Herlihy

Tom O'Brien

Lyle Van



... *Join in Wishing You a*

*STENTORIAN*

**MERRY CHRISTMAS**

*and a*

*PEAR-SHAPED*

**HAPPY NEW YEAR!**



I'm no fool . . . you guys could ruin me!

DICK LEIBERT



**N. B. C.**  
**Radio-Recording**  
**Division**

---



**Season's Greetings**

**DON VOORHEES**





No. 1 Daughter



AMZIE STRICKLAND

# The Adventures of Charlie Chan

Charlie Chan



ED BEGLEY

No. 1 Son



LEON JANNEY

# 亲斤斤喜 亲斤斤喜

## HAPPY NEW YEAR

FROM

### *The Charlie Chan Bong*

It Is Written

"One Actor Cannot Make a Play"

Announcer



DORIAN ST. GEORGE

Writer - Director



ALFRED BESTER

Music



GENE PERAZZO

A CHICK VINCENT PRODUCTION

Broadcast Engineers' Journal **175** Yearbook :: January, 1946

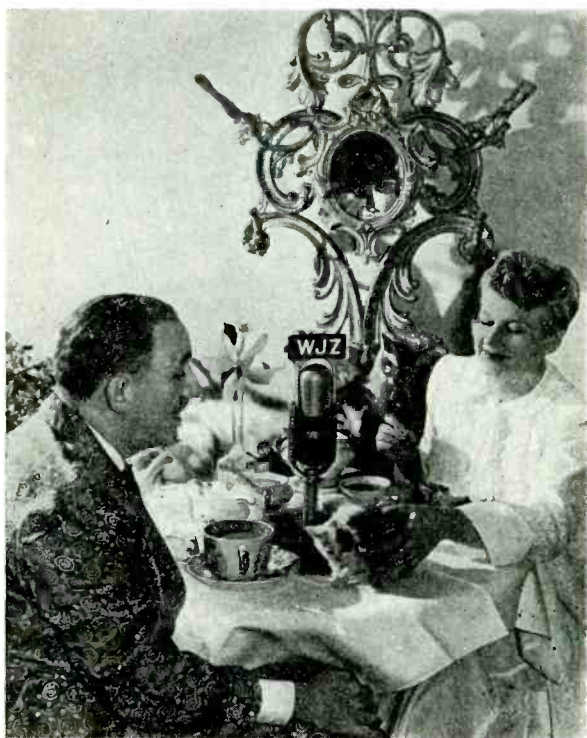

## The Fitzgeralds

WJZ — ABC



After a broadcasting junket around the world, I came back with a higher regard than ever for you fellows on the engineering side here at home! So in wishing you a Happy New Year I do so with more enthusiasm than ever.

**Lowell Thomas**



**meeder**

"HIRES TO YA!"

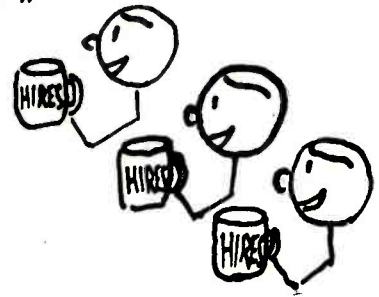

a toast to the engineers — and  
especially to our boy, JOHN KINSEL, who  
comes in mighty handy every Sunday at 6:30 P.M.!

NEMO —  
KENNY —  
AND PHIL —

## PHIL DAVIS and ORCHESTRA



Greetings

FELIX KNIGHT

*Hires' Sunday Evening Party*

A. B. C.

**AIR  
FEATURES  
Inc.**



**247 PARK AVENUE  
NEW YORK, N. Y.**

CHRISTMAS GREETINGS

and

BEST WISHES

Ed Wolf

Wolf Associates — 420 Madison Ave., N. Y. C.



Season's Greetings

and Best Wishes

To a Swell Gang . . .

All the Engineers

from

**THE THREE SUNS**

ARTIE DUNN

MORTY NEVINS

AL NEVINS

Hotel Picadilly



## Season's Greetings

Paul Lavalle

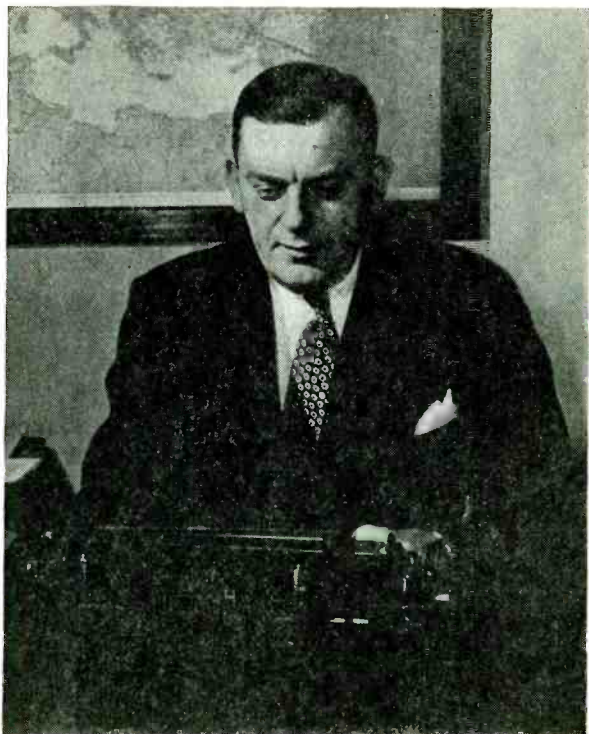

**WALTER KIERNAN**



BEST REGARDS TO  
THE CONTROL CORNER  
FROM  
KIERNAN'S CORNER

*All We Know  
Is . . .  
It Goes in Here*



THANKS For D-Day  
VE-Day  
VJ-Day

And a Couple of Times In Between!

McCall — Ext 737  
Schneider — Ext 586  
Meyers — Ext 587  
Prince — Ext 404  
Wakelee — Ext 405

From the NBC NEWS ROOM in N. Y.



*Greetings*  
**BOB STANTON**





**“Won’t you step into my parlour**

**(Just Outside 6A)**

**Said the spider to the fly.”**

*Thanks, Fellows*

**MARTIN BLOCK**

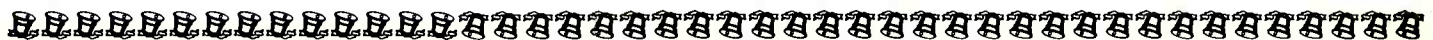



*Season's Greetings*

MARY SMALL

ALL THE BEST  
TO THE BOYS AND GIRLS  
ON THE TECHNICAL SIDE

Kelvin Keech

*Best Wishes from*

TED RAPH

Musical Director  
BLIND DATE

DETECT AND COLLECT  
TRANSCRIPTIONS



Season's  
Greetings

DON PARDO

NBC — WGRF

The Season's BEST

to Every one!

from

Jack (John Patrick)

Costello





# SALUDOS

## N B C Spanish Section

Arturo Despuoey  
Emilio De Torre  
Francisco Forcade  
Ernesto Foregger

Alberto Gandero  
Santiago Garcia  
Francisco Lara  
Alberto Moré

Fernando Nuñez  
Eugenio Soler  
Manuel Trucco  
Armando Zegri

# Season's Greetings

*From:—*

---

**HURLEY BROS. & DALY'S**  
**RADIO CITY BAR & GRILL**

WHERE STAGE,  
SCREEN and  
RADIO STARS  
MEET

*Finest Wines and Liquors*

N. E. CORNER OF 6th AVENUE and 49th STREET

---

*Under Management of:*  
**CONNIE HURLEY**

# New York NBC News

By G. F. Anderson, Jr.



Photo by Joe Conn

# This Is ABC New York

By Gil McDonald

**H**APPY NEW YEARS to yez all, and may all your troubles be light and easy. Seeing as how this is prior to both the Christmas and New Year's celebrations we are not predicting physical conditions on the first day of 1946. However, if as in the past, the celebrations are as usual, "Don't use Southern Comfort."

From the department of megacycles and kilowatts we hear that Michael Pirozek is the latest addition to the staff at Boundbrook. Mike comes from Kearney, N. J., and has been employed by the Federal Telephone and Radio Company, at their Newark Plant as a Senior Supervisor in the test department.

Lester Whitehead has had the second operation performed within the past month (November) to correct an old fracture of his arm. Latest report is that everything is progressing satisfactorily and he expects to be back at Boundbrook by the end of November.

Johnnie Dunn, from the Lone Star State, Texas, has joined the ranks of home owners, having bought a Spanish type bungalow near Somerville. He had been looking for one of those Texas Style Adobe homes but had to settle for a bungalow.

The Hunting season (Wild Life Type) opened November 10th and Joseph Stemple and the protection department spent a busy day keeping the Nimrods off the property. It seems that the boys in the past, due to a scarcity of game, would test their shooting eye by popping insulators off the antennas and transmission lines. Now there are 'No Hunting' signs posted and woe to he who tries to hunt some wild life.

Ten of the NABET members of Boundbrook met at the Colonial Inn, November 1st, for a Steak Dinner and general

**T**HE studio, field, maintenance and transmitter engineers of the New York Chapter join in wishing their brother engineers in all the other chapters the greetings of the season. Let's hope that the coming year sees the return of all those boys still remaining in the service of their country.

The highlight of the month was the surprise visit of Jim Dougherty to New York. Jim was in the studio group here for about a year before he returned to his home town of Chicago to work for ABC out there. He has put on weight and looks great. Says its a real racket working away from New York.

Many of the boys took advantage of the ABC Cocktail party this month. John MacDonald, Fred Moore, Bob Dougherty, Bill Glasscock, Bill Trevarthen and George Milne report the affair a great success and say that this year saw the biggest turnout of engineers yet. Somehow or other I always seem to get the wrong days off.

The lounge hecklers are still razzing one of our members who will have to remain nameless. He got quite friendly with one of the female sirens and after lots of dancing and imbibing finally persuaded her to let him take her home to Jersey City. After her making a short phone call, they started out by train and on arriving at the JC station, were met by a big burly cop. Said he, "Thanks for taking my Sis home, Pal." Said she, "Thanks for a lovely evening." Said our colleague, quote \$%/\*??? unquote.

The opening up of the amateur bands finds many working furiously to get the old gear, which became idle Dec. 7, 1941, back into operation. After developing a four day beard, and plenty of blisters, I got 2CHK back on 10 meters. Sure was a great feeling to have a guy in New Mexico answer that first CQ. Bill Simpson is on CW on 10 also.

Millard Dickerson cops the title of the pop of the biggest baby born to any New York engineer during 1945. He became the father of a 10 lb. 6 oz. girl this month and is he proud. It's his first and we hear both the daughter and Mrs. Dickerson are coming along in good style.

Larry Williams is looking over the 1946 model cars with lots of interest and is just about to drive one of the better ones off.

Deric Leighton who left engineering some time back to take a fling at production, is back in the fold. Welcome back, OM.

That's all for 1945. See you in 1946. Gil.



Journal Mogul Ed Stolzenberger and Millie vacation in Florida. Here you see him sweating out the day's mail, between dips in the Gulf—photo by Millie!

discussion. Everyone went away filled with steak and vowing to meet again for a duplicate affair at least four times a year.

John Gullans has been appointed Station Engineer, and Arthur Lindstrom, Assistant Station Engineer. Johnnie and Art can be classed as old timers, having been at this station, Boundbrook, for seventeen and eighteen years, respectively.

Eddie Costello and Eddie Gundrum have been looking over surplus Government radio equipment with the idea of purchasing

some medium wave low power transmitters and receivers for use on pleasure boats, (Private Yachts).

Art Holub, Transmission Engineer, is also in the market for some of the above mentioned equipment. Art already has a couple of dynamotors—12 V DC input and 750 V 250ma Output. Now, all he needs is a transmitter and a receiver, and he will be all ready to do a little Ham radioing.

Johnnie Pawlek, formerly of New York Studio and now from Hollywood, dropped in the last week of November and paid the boys a visit. Johnnie came East with Truth or Consequences and took a day or two off to see his family and also we here in New York.

James Hackett, FE, recently showed the boys how not to make money while using your car on Company Business. Jimmie was driving out to Kings Point for a little bake and halfway there, his clutch, pardon—the car's clutch, burned out. Before the day was through, Jamie had parted with thirty-seven dollars for a new clutch and ten dollars in taxi fares.

He was reimbursed for the taxi charge, but the seven cents a mile for only 25 miles, did not cover the repair bill!

Back in NBC after an absence of several years are the following members—Charles Grey, Major AUS. Harold Flood, Capt. AUS. James Coleman, Captain USMC. Jack Petrie, USN. Phillip

(Continued on Page Two Hundred Eleven)



# Holiday Greetings

and

# THANKS

*To the NBC Washington Fellows*

*From 1942 — 1945*

and

*To the NBC Guys in New York*

*1945—*



## KEN BANGHART



### Thanks, Fellows

from

## GALEN DRAKE



### BEST WISHES

from

DON LOWE



This Speaks 100 PLUS

### Season's Greetings

To the NABET Boys

### Dorian St. George

ABC Announcer N. Y.

# STAN SHAW



Good Morning  
***IT'S KNIGHT***  
and it's  
***Season's Greetings***

Every Day  
7:15 - 7:45 A. M. WJZ, New York

Packaged by  
Raymond Knight Associates



"Who's Cuckoo Now?"

ABC Television — WRGB Schenectady

Greetings to the Engineers

ROBERT DENTON

Season's Greetings

HUGH JAMES



CHARLES STARK

*Announcing*

SEASON'S  
GREETINGS





**N**ine times out of ten we've got it  
**A**lways, we can get it, and fast  
**B**est stock of phonographs in New York  
**E**xtraordinary Library of Recordings  
**T**ops in radio phonograph combinations

Those Who Know — Always Go — To

37 West 57th Street  
2 Park Avenue

*Dynamic*  
ELECTRONICS—NEW YORK, INC.

Endicott 2-0200

MUSIC • PHONOGRAPHS • RECORDS • RADIOS • RECORDERS  
REFRIGERATORS • ELECTRICAL APPLIANCES • WASHERS



**Merry Christmas**

**Eastern Production Division  
National Broadcasting Company**





*Merry Christmas  
and Best Wishes*

**BUD COLLYER**



**In Appreciation**

**W. W. CHAPLIN**



**GREETINGS**

**To My Many Good**

**— Friends Among**

**Broadcasting**

**— Engineers**

**CLEM McCARTHY**



**To the Men Who Know What Makes It Go  
With the Cordial Regards of**

**John W. Vandercook**



Season's Best to You All



ED. HERLIHY



Masters Mart, Inc.

66 West 48th Street

New York 19, N. Y.

BRyant 9-7725



GEORGE  
UN  
N

THANKS



ANNOUNCER

WJZ - ABC

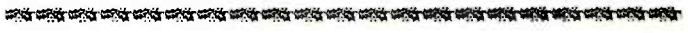

Compliments of

H. Leopold Spitalny





Cordially Yours

**Milton Katims**

To "Soupy" Campbell and His Pals  
Who Are Trying to Make Me Sound  
Like a Pfc (poor frustrated civilian) Again

SINCERE BEST WISHES  
FOR A HAPPY HOLIDAY

**GENE HAMILTON**

Announcer — American — N. Y.



**Fred B. Cole**

A. B. C.

Announcer's Division

"A Toast to the Boys Who Control Our Noise"



**Jonny Olsen**

Says — Thanks Guys  
For Helping Me  
Seat the 'Ladies' and  
Raise the "Rumpus"

**A Merry Christmas**



**DON GARDINER**

NEW YORK

Season's Best to All

**BILL STERN**

“73” — and Thanks



DOUGLAS BROWNING



A. B. C.

Greetings, Gentlemen

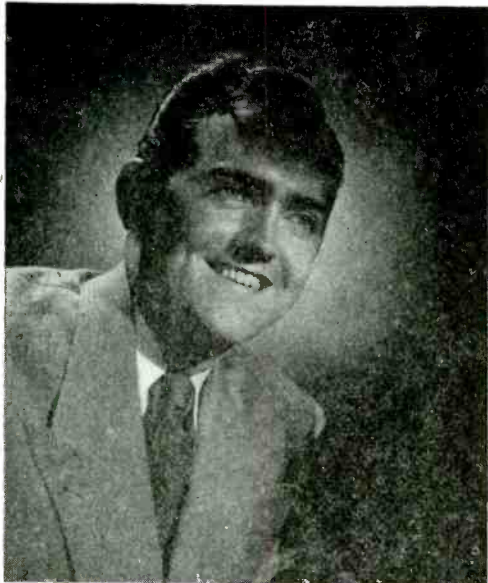

**GEORGE ANSBRO**

A.B.C. - N. Y.

Season's Greetings

To a Great Bunch of Guys

**DAN SEYMOUR**

*Thanks for Everything*

*Season's Greetings*

**Bernard Lenrow**

Geoffrey Barnes of

Mollé Mystery Theatre



**Season's Greetings**  
and  
**SINCERE BEST WISHES**



**BEN GRAUER**

*Best Wishes*

*Alfred W. McCann, Jr.*

GREETINGS TO OUR FRIENDS

FROM

**YORK BAR**

Your Favorite Rendezvous

BROADCASTING STUDIO

EMPLOYEES

**LOCAL 782**

International Alliance of Theatrical Stage Employees



Greetings, Gang

and THANKS

**Roger Krupp**

announcer

American Broadcasting

Company

New York

Season's  
Greetings

**Jack Arthur**



*From  
all of us here . . . from  
all our clients*

**MANY THANKS**

*for your swell cooperation  
in the past*

**BEST WISHES**

*for your continued success  
in the future*



**THE BIOW COMPANY**

INCORPORATED

HOLLYWOOD

NEW YORK

SAN FRANCISCO



**Maggi McNellis**

and Maggi's Private Wire — N.B.C.



*Greetings at Xmastime*

CLYDE KITTELL



Greetings

GLENN  
RIGGS

**Season's Greetings**

from

**Mary Margaret McBride**



In the Spirit of the Yuletide—  
Greetings to the Engineering Staff

**FRANK BLACK**



**I Love to Spend  
Each Wednesday With You**

**Eddie Cantor**  
NBC

---

# CHRISTMAS GREETINGS

Fred Waring *and his* Pennsylvanians

*My Best Wishes Always*  
**LUCILLE WALL**

---

"You've been looking at me for a long time —  
Here's looking at you"



**DON GODDARD**

# WTAM

(Continued from  
Page One Hundred Fourteen)

than Walter Logan's. Dean of music in Cleveland, Walter Logan had been with WTAM 17 years when he died, March 11, 1940. As WTAM's music director, Logan formed the nucleus of Cleveland's Symphony Orchestra and was active in the development of other local musical groups. In his early days of radio, he was one of the first men to adapt operettas for the air. Logan was an intimate friend of such musical celebrities as Victor Herbert and Nora Bayes.

As a young man, Cleveland's first musician was a violin soloist with the Chicago Symphony Orchestra and the St. Paul Symphony Orchestra. He was a composer of some 30 published compositions including the comic opera, "Nearly a Duchess".

The list of early WTAM artists who went on to national fame is impressive. Here are a few: Guy Lombardo and his Orchestra; Gene and Glenn, the comic team that started as a breakfast hour 15-minute program and grew to be Cleveland's most popular; the Landt Trio; Tommy Riggs and Betty Lou; Eddie Peabody, the guitarist; Fred Waring and his Orchestra; and Tom Waring and his voice; Phil Spitalny and his Orchestra; Smiling Ed. McConnell; Singing Sam; Lum and Abner; Pie Plant Pete, and a score of others.

On the executive side, WTAM's graduates include John F. Royal, once its manager, who left in 1931, to become NBC's vice president in charge of programs.

On the music side, Werner Janssen, the composer and conductor. There are those who have become famous and have remained with the Cleveland station. One of these notable is Tom Manning.

Tom Manning graduated from a megaphone at League Park into a radio baseball announcer in 1926 and joined WTAM as its sports announcer in 1927.

His rapid-fire voice has brought the WTAM call letters before the nation in his reporting of big sports events over the NBC networks. Since 1930 he has had a yearly assignment to announce the World Series baseball games for NBC.

He has covered nearly every major sports broadcast the last eight years—golf, football, field events, championship fights and many special events. Mr. Manning is WTAM's special events manager now.

There are many others on the staff closely connected with the station's history. C. C. Russell, one of the first engineers, now has charge of the big Brecksville transmitting plant. John Disbrow, Jesse Francis, and Alvin McMahon, engineers, have been with the station since its earliest years.



"They report that our small boy has been located in Richmond Hill, living under some funny alias like Stolzenberger, and getting fabulously rich in the publishing business!"

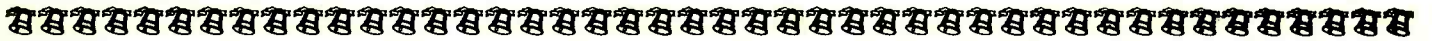

# *Season's Greetings*

FROM THE

## STAFF ORGANISTS

---

---

ARLO

*American Broadcasting Co.*

DOLPH GOBEL

GEORGE CROOK

GEORGE HENNINGER

FELIX McGUIRE

ROSA RIO

*National Broadcasting Co.*

JACK WARD

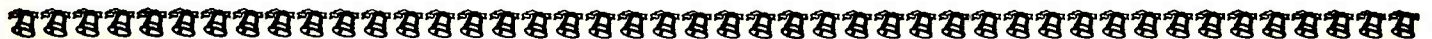



**Hudson Chapter of N. A. B. E. T.  
WOR—Mutual**

**Welcomes back its Members from the  
Armed Forces**

*and extends*

**BEST SEASON'S GREETINGS**

*to the*

**National Association of Broadcast  
Engineers and Technicians**

---

To the Engineers

A MERRY CHRISTMAS

*and*

A HAPPY AND PROSPEROUS NEW YEAR

*from*

THE CAST OF SUPERMAN

CLAYTON COLLYER

JACKSON BECK

JACKIE KELK

JOAN ALEXANDER

JULIAN NOA

---



MERRY XMAS

CHET KINGSBURY

HAPPY NEW YEAR



---

Broadcast Engineers' Journal **204** Yearbook :: January, 1946



*BEST WISHES FOR THE YEAR AHEAD*

**T. C. STREIBERT**  
*President, WOR*

Broadcast Engineers' Journal **205** Yearbook :-: January, 1946

---

RENSIE  
RADIO  
AUCTION

HOBBY  
LOBBY

Merry Christmas



Happy New Year

DAVE ELMAN

---

THANKS, BOYS



Season's Greetings



RAY BLOCK

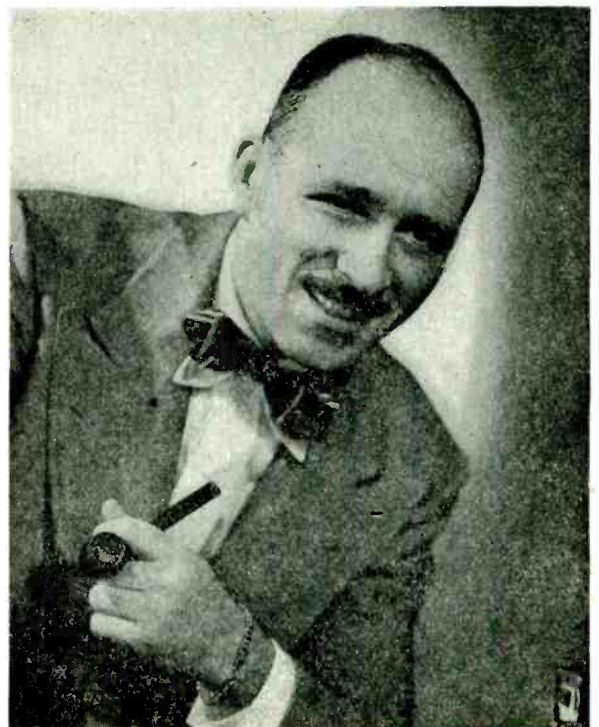



*Compliments of*

**SUPERMAN, INC.**

**Producers of**

**The Adventures of**  
**SUPERMAN**  
MUTUAL

**HOP HARRIGAN**  
AMERICAN



Al Young      Tony Lane      Ralph Prince

**AIR LANE TRIO**

Mutual Network — American Broadcasting Co.

DELUXE  
RECORDS

LANGWORTH  
TRANSCRIPTIONS

FILMCRAFT SOUNDIES  
Currently Hotel Dixie, N. Y. C.

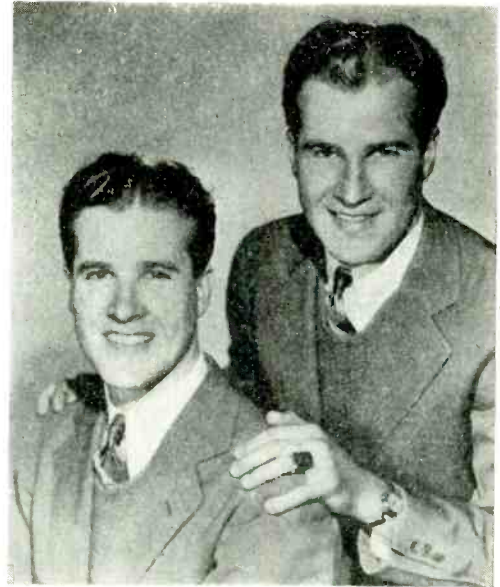

Greetings from the

**MacFarland Twins  
Glee Club and Orchestra**

Currently playing — Plantation Room, Hotel Dixie, N. Y.

Management — CHARLES H. BARBER

## Christmas Greetings



**SYLVAN  
LEVIN**



WOR — Mutual



Greetings, Fellows

**ROBERT STANLEY**

WOR — Mutual



NICK CARTER  
JACK BIRCH SHOW  
REAL LIFE STORIES  
SONORA RECORDS  
NBC THESAURUS LIBRARY

Compliments of  
**GEORGE WRIGHT**  
Organist



Season's Greetings from  
Mr. and Mrs. "Reporters"  
**Margorie and Royal Arch Gunnison**

Mutual Broadcasting System

JANE COWL

**Greetings**

RICHARD WILLIAM

MAXWELL—WIRGES  
INC.

FOR

**Good Food and High Class Liquors**

VISIT

**McCARTHY'S**

147 West 40th Street

New York City

*Compliments of Jack Plunkett*



# Hudson Chapter News

By

**Jim Carter**

**M**ERRY CHRISTMAS—Happy New Year—Season's Greetings to all of our many Friends; if anyone were to doubt it, just scan through this tremendous 1946 Year Book. Boy Oh Boy! What a volume.

As surely as Radio is here to stay, So Is Good Old NABET sure we have our problems, who hasn't, but time is a wonderful help.

Things have certainly been flying around here between Paul Reveal's memos and Herbert Sutcliff's Ad Contracts, a guy just doesn't get time to keep abreast of Superman,—Lucky—Mac Benoit, he has "Up! Up! And Away! across the board.

Howard M/C. Donniez and Louise, have their hands really full with one Richard Lewis Donniez, wrapped in a blue blanket, weighing nine and 3/4 lbs., born Nov. 5th. Good Luck to the above trio.

Bill Hoffman — "Who was it that said, a colt is a great equalizer."

Jackson Beck — "I think it was Bat Masterson."

Mac Benoit — "For the love of Mike don't tell De Covny, he'll try to put one in the Panel." (End of joke)

One show they couldn't schedule in Studio Five, "Queen For A Day." three of WOR's Finest, Mac Reid, Kibby, and none other than Joe Craig, with SRO at Madison Sq. Garden, nice job fellers.

It didn't take Ed. M/C. Scaterday, long to find his way back, if you had a broom you could sweep the floor too, Ed.

What was the final score Stanford? Garuffy tells me you can get a nice fade by just turning the parabola away from the crowd. Hi, Hi.

Can He Do A Dance? Yes Sir: Dick Berner and his "Better Half" really can Step. Thanks for the assist Sam! And if Donniez needs any help with those three cornered things, just call on Charlie Thropp, Herman Berger and Ted Kasna can vouch for Charlie's ability and Technique.

If only we might have more of those little get togethers, Hax M/C. Hadden and Marie, Cookie and Mrs. Jack "Better Half" Byrne and Else, Ted's Mrs., Charlie's Mrs., Sam's Mrs., after that I used Clara's No. 9.

What if some of Ralph Schlegle's (recording) Ham equipment is sent to Bill Schlegle S. E. will Bill go on the "Air"? Listen in next month.

There goes that Guy Walter Payne S.E. F.E. and man with the Smile, rush the "wire recorder" Walter you ain't in the Army now.

Who was it that was going to get me all the new Bosses' Pictures, Reveal—no, Singer—no, Davis—no, Riley—no, Frankie—well maybe Joe Williams had too many meters to read, or perhaps we should have turned it over to Sutcliff.

Has anyone seen Al Abromatis S.E., since he collected all those Dues? Oh, I get it, Bob "Shortie" Albrecht has a new suit and Al was last seen with Bob and two Sweet young things heading up B'way. Be careful or there will be all married men on the Staff.

Saving money Tom? Tom "Breakfast with D & D" Batson, S.E. "630 Pk. Cabbie!"

Eric Herud S.E. F.E. and what have you, the nerve of you to take all of my Remotes, we all miss you on Days.

MacIntee R.E. tells me that Conover W2LUK and Yeomans W2OHC are to be heard on 2 1/2 hope in the near future to be able to have everyone's call letters in this column.

WOR's Recording Department has definitely hit a new high, take a look at who we have here: John Bartles, Cy Getter, Bob Doherty, Robert Lee, Geo. Corey, Jack Carney, Pres. Yeomans,

Frank Ennis, Danny Conover, Ray McEntee, Jim McInerney, Bart Simpson, Doug Hawkins, Ralph Schlegle, every one tops at recordin'. And one of the above told me that they are putting on four more.

Nat Abramson please note, Ed Boquist S.E. has just written music for four pianos, trumpet, Bass, etc., to be played by Gene Clark S.E., Jerry Dreisbach S.E., Mac Benoit S.E., Bill Boher M/C., Al King S.E., Walt Shaver S.M., and any more of the Talented Members of the Engineering Group that you may wish under contract. Hi Hi.

Continually studying you will observe Johnnie Garlinger S.E. and Fred Sperr S.E., never without their books. Keep at it Boys.

Want to know anything about the equipment or shows in the theatres? Just ask Lowel Frank T.E., Bill DaCosta T.E., Pat Miller T.E., Gene Clark T.E., Bob Albrecht T.B.E., etc. Many thanks for a lot of help to Jerry, Harry, Harry and Tom.

The forgotten Men of the "Grave Yard Trick" Ed. Zajac S.E., Bob Stankus S.E., Pete Saveski S.E., Bill Sakal S.E., Robert Bergen S.E.—(Ten percenters)

Dennis Connor M/C., and Jim Chapman M/C., Don Williamson S.E., and Jim Mullins S.E., all have their dues paid up, so why not wish them Season's Best.

Seems like this time we have included everybody from Bert Harkins and Ed Content to Al Nilson R.E., and Rita Jerry Barton F.E., Lou Jurgenson F.E., and Ruth.

Please, once and again, do send in some material, even short notes that we may put in this column.

73. Jim.

P. S. Judy McMahon—Transcription Library, many thanks for being "keeper of the Ad. Pictures."

P. P. S. Gosh! There wouldn't have been any P. A. in the Macy Parade if it hadn't been for Don McLean, Good old Mc, some day you may be an Engineer.

## NEW YORK

(Continued from Page One Hundred Eighty-seven)

Falcone, Lieutenant AUS. Victor Tervola, Captain AUS. Cliff Paul, USN. Edward Bertero, Lieutenant USNR., and Donald Ewart, Commander USNR.

It is with deep regret that we record the passing of Daniel N. Stair, who died Friday, November 2nd, after an illness of several weeks. Mr. Stair had been Station Engineer of Bound Brook since its inception in 1925, and we, who were fortunate enough to know him, gained untold benefits from association with a man of his high character and integrity.

Words cannot express our deep sorrow. His loss will be felt throughout the company, and we extend our sincere and heartfelt sympathy to his family. The Boundbrook Station Flag will fly at half-mast for a period of one month in honor of his memory.



"That's the fourth night in a row she's winked at you!"



**THANKS**  
**Lee Sullivan**



**Hi - Ya, Fellows**  
**Phil Brito**

  
73's . . .

from an ex-engineer

**John B. Gambling**

. . . **WOR**

**" Better Haff "**

Merry Xmas

and

Happy New Year

Fellows

  
**Jack Byrnes - - - Tiny Ruffner**



Thanks to the Boys Behind the Glass Window!

from



FRANK SINGISER



ED PEARSON

## “THE SINCLAIR HEADLINER”

Monday — Wednesday — Friday — 7:30 P. M., E.S.T. —MBS Network

Exclusive Management: National Concert and Artists Corporation, 711 Fifth Avenue, New York City 22

*Daniel S. Tuthill, Vice-President, Director Popular Division*



Greetings and Best Wishes to a  
Helluva Swell Bunch of Fellows!  
The Above Bears Repeating



Gratefully and Sincerely  
TOM SHIRLEY

Season's Greetings and Warmest Wishes  
for the Coming Year



MICHAEL FITZMAURICE



Season's Greetings

LEN STERLING

Best Wishes to the Engineers



LOUISE WILCHER



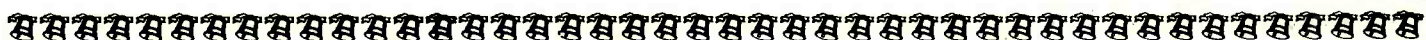

# Season's Greetings

from

**The Eastern Crew—Coca Cola Co.**

## SPOTLIGHT BANDS

Knute Stammer	-	-	-	Director
Ed. Stokes	-	-	-	Announcer
Phil Hewitt	-	-	-	D'Arcy Agency
Jerry Barton	-	-	-	WOR Engineer

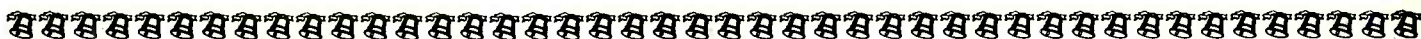

## Season's Greetings

To the Engineering Boys

### EVERGLADES

BAR AND GRILL

218 West 48th St., N. Y. C.



Here's to all the Engineers.  
Without you boys, fellows  
like us couldn't get along.  
Best Always

**Bob Martin**

WOR Staff Announcer

## VINCENT CONNOLLY

*Freelance Announcer*

*Newsreel Narrator*

## SEASON'S GREETINGS

V. I. JOES!

And Many More to Come!

**Bob Dixon**

FREE LANCE ANNOUNCER

HOBBY LOBBY

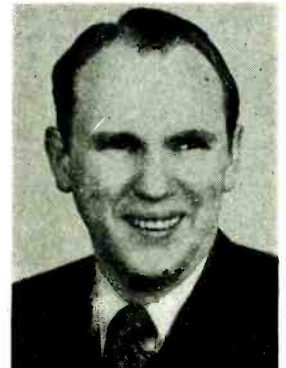

## Masters Mart, Inc.

66 West 48th St.

New York

BRyant 9 - 7725

Merry Christmas

from

ARTHUR HALE

Season's Greetings and Best Wishes



**THE TREASURE HOUR OF SONG**

*5th Consecutive Year*

for

**Conti Castile Shampoo**

*starring* **Licia Albanese • Francesco Valentino**

*Leading Artists of the Metropolitan Opera*

Mutual Broadcasting System, Thursday Evening, 9:30 E.S.T.

Produced by Roger Bower

Monitored by Eugene Clark

*Advertising Agency:*

**Birmingham, Castleman & Pierce, Inc., New York**

Greetings - - - Best Wishes



**JOCK MacGREGOR**

WOR — MUTUAL

The Season's Greetings, boys,  
and the best of luck to you all!

**HUGH CHAMBERS**

WOR Mutual

*Greetings from*

**"THE UNCLE"**

*to Millions*

**"UNCLE DON"**

WOR

**A Big New Year**

**to the Engineers**

**BILL ADAMS**



Thanks for Your Patience  
and Swell Jobs

**ROGER BOWER**

**73's**

**BOB EMERY**

---

# *Radio at Its Best*

# W O R

M U T U A L

## Greetings to the Engineers from the Announcers

### *Announcing Staff:*

Jack Barry  
Joe Bier  
Ted Brown  
Harry Carlson  
Roger Chase  
Don Frederick  
Jack Irish  
Dan McCullough  
Ken Powell  
Hugh Sanders  
Jack Scanlon  
John Scott  
Craig Stewart  
Frank Waldecker  
Carlton Warren  
Dick Willard



### *In the Armed Services*

Bruce Eliot  
George Hogan  
Keyes Perrin



Best Wishes  
For 1946

**Helen Choat**

Oh How I

Love

Those Engineers

*Brrrrr!!*

**Jack Bundy**



Regards to a  
Swell Bunch

**Joe Brattain**

Erwin, Wasey & Company

THE BEST

TO ALL

THE BOYS

**HENRY JEROME**

and Orchestra

MUTUAL

*Season's Greetings*

TO AL KING

and

THE BOYS

Herb Waters

Arranger — Kreml — MBS

*Sincere*

*Greetings!*

"DOC" WHIPPLE



To my friends  
who help to  
make it all possible

Sincerely

**GILBERT MACK**

Merry Christmas

Happy New Year

**HARVEY HARDING**

Organist



# Can You Top This?

*Holiday Greetings*



**N.B.C. Network**

Saturday — 9:30-10:00 P. M. **E.S.T.**

Ed. J. Weber, Gen. Mgr.  
156 W. 44th St.,  
New York 18, N. Y.

**W.O.R.**

Wednesday — 8:00-8:30 P. M. **E.S.T.**



Best Wishes —  
Season's Greetings  
To THE ENGINEERS

Fred  
Vandeventer

WOR — Newscaster

GREETINGS FROM

Melvin Elliott

News Caster

Hello, Everybody!!

Season's Greetings

Frazier Hunt

Paul Schubert

Merry Christmas

and a

Happy "News" Year

LEO EGAN

GREETINGS

STAN LOMAX

WOR — Sport News

Henry Gladstone

GREETINGS,  
FELLOWS

WOR  
Newscaster

Prescott Robinson





STNEMILPMOC

FO

NATURES

VICTOR LINDLAHR      DALE KENNEDY



This one is on me...

Nat Abramson,  
*manager*  
WOR Entertainment  
Department

# Holiday Greetings

From the Staff of

## THE BROADCAST ENGINEERS' JOURNAL



**C. W. PHELAN**  
Treasurer



**DAVE MOLONEY**  
Assistant Treasurer



**ED. STOLZENBERGER**  
Editor and Business Manager

### 1946 Yearbook Sales Co-ordinators

JOHN EILERS .....	Hollywood
KERMIT SLOBB .....	Chicago
A. J. HORWATH .....	New York
JIM CARTER .....	Hudson (N.Y.)
JACK VAN WART .....	San Francisco
W. V. B. DE VRIES .....	Washington
WM. HOOS .....	Baltimore
BERT FRUITT .....	Cleveland
GEORGE POGUE .....	Denver
J. WILLARD DEAN .....	Dixie
F. A. RUDD .....	Omaha
ART KELLY .....	Rochester

★

### Chapter Associate Editors

Baltimore .....	WM. HOOS
Chicago .....	K. A. SLOBB
Cleveland .....	BERT FRUITT
Denver .....	GEORGE POGUE
Detroit .....	DAVE STEWART
Dixie .....	REX COSTON
Engineering .....	JACK IRVING
Hollywood .....	NORMAN DEWES
Hudson .....	JIM CARTER
Mohawk .....	NEWT BARNES
New York .....	G. F. ANDERSON, JR. GIL McDONALD
Omaha .....	F. A. (BOB) RUDD
Rochester .....	ARTHUR KELLY
San Francisco .....	JACK VAN WART
Washington .....	W. V. B. DE VRIES

### Board of Trustees

C. L. BENNIS  
R. R. DAVIS, III  
A. T. POWLEY  
C. THROPP

(plus two pending appointments)

★

### Office Manager and Executive Secretary

MRS. MILDRED STOLZENBERGER

★

### Consultants

F. R. ROJAS.....Business Policy  
THOMAS E. GOOTEE...Art and Editorial

★

### Staff Writers

TOM MCKAY  
JORDAN MCQUAY  
BERT FRUITT  
SERGEI DE SOMOV

## Once Again . . .

- It is with a great deal of personal pleasure that we present this 1946 Yearbook, and Once Again — as usual — the biggest, finest in the Journal's whole career.
- To our many friends across the country, Season's Greetings, and may the New Year give us the opportunity to meet you all once again.
- With cordial good wishes for the future

**MILLIE and  
ED STOLZENBERGER, Editor**

# LOCATE and MEASURE

FROM  
100 MC

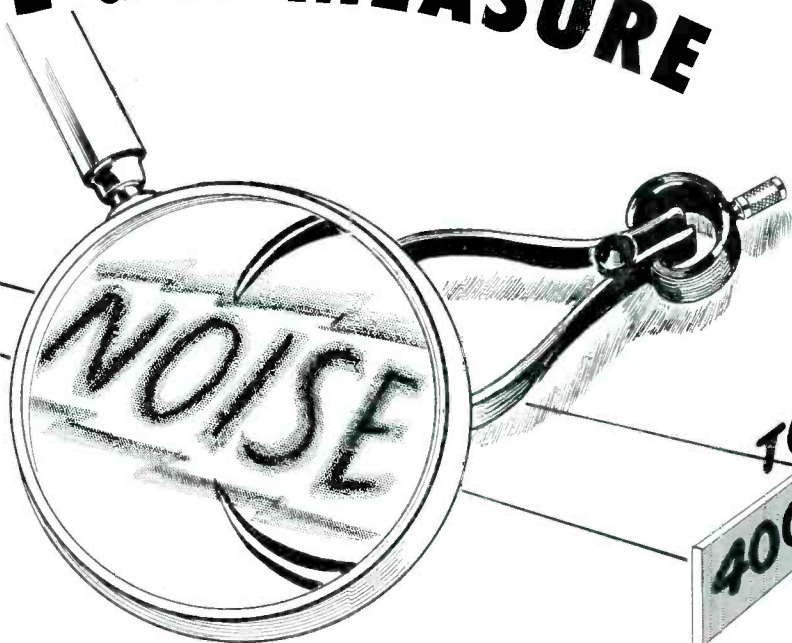

TO  
400 MC

## STODDART NOISE AND FIELD INTENSITY METER

Model NMA-4

- 100 to 400 MC in single band.
- One Microvolt sensitivity.
- Direct reading in Microvolts.
- Measures conducted and radiated noise.
- Provision for External Recording Meter.
- Measures Field Strength of Transmitters in the U.H.F. Range.
- It assists in the production of noise-free products by manufacturers.
- It locates and analyzes existing noises which interfere with radio reception.
- Its stability and accuracy enable transmitter engineers to obtain dependable field strength patterns.

Write for further information and complete technical data.

*Now available*  
FOR NON-MILITARY USE

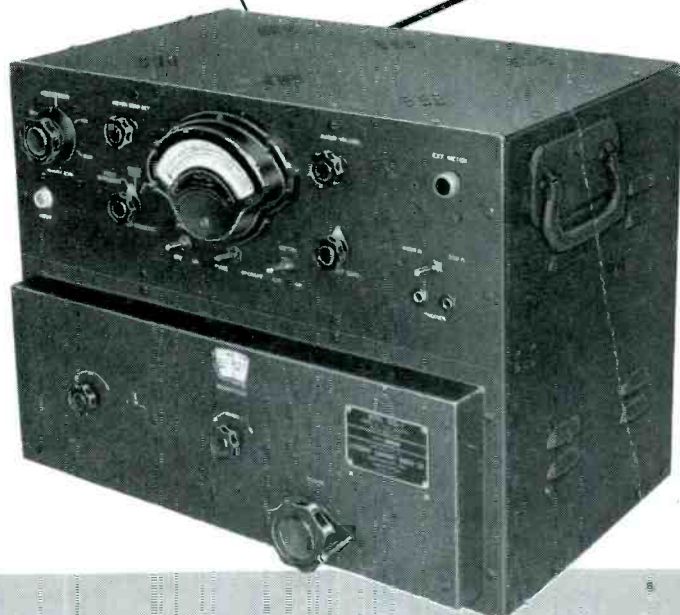

# STODDART AIRCRAFT RADIO CO.

6644 SANTA MONICA BLVD.

• HOLLYWOOD 38, CALIFORNIA

# DAVEN

## ATTENUATION NETWORKS

### Series 690

DAVEN Series 690 Attenuation Networks comprise 20 models, designed for general laboratory and production testing at audio frequency levels. DAVEN plug-in type Fixed Attenuators are employed for matching source and load impedances with the base impedance of the network. A high degree of flexibility is thus achieved with an absence of mis-match, reflection loss and switching noises.

#### MODEL VARIATIONS

- 2 MOUNTINGS: Portable and Rack Type
- 3 BASE IMPEDANCES: 50Ω, 600 and 135 ohms
- 2 CIRCUITS: "T" and Balanced "H"
- 2 RANGES: 0-110DB, steps of 1DB (2 dials)  
0-111DB, steps of 0.1DB (3 dials)

\*Balanced "H" type may be used as an unbalanced network of one-half the base impedance.



#### OTHER SPECIFICATIONS

**ACCURACY:** Resistors calibrated with  $\pm 1\%$

**PLUG-IN PADS:** Octal tube base, panel mounting, in wide range of impedances and losses.

**FREQUENCY RANGE:** 0-17,000 c.p.s.; at higher frequencies, slight reduction in accuracy.

**OPERATION LEVEL:** +20DB (0.5w) maximum input.

**SIZE:** 2 dial portable: 5" x 10" x 5"; 3 dial portable: 6" x 11 1/2" x 5"; rack: 3 1/2" x 19"

Daven Attenuation Standards types 740 and 742 (resistor accuracy  $\pm 1/2\%$ ), are designed for applications requiring greater accuracy. See your DAVEN Catalog or write for details.

#### PORTABLE TYPES

"T"	BAL "H"	DB RANGE	BASE Z
T-690-A	H-690-B	0-110	500
T-690-C	H-690-D	0-110	600
T-692	H-692	0-111	500
T-693	H-693	0-111	600
T-694	H-694	0-111	135

#### RACK TYPES

"T"	BAL "H"	DB RANGE	BASE Z
T-690-AR	H-690-BR	0-110	500
T-690-CR	H-690-DR	0-110	600
T-692-R	H-692-R	0-111	500
T-693-R	H-693-R	0-111	600
T-694-R	H-694-R	0-111	135



THE **DAVEN** COMPANY

191 CENTRAL AVENUE  
NEWARK 4, NEW JERSEY

Daven manufactures the most complete line of precision attenuators in the world, plus more than 80 models of specialized and laboratory test equipment.