

Sec. 562, P. L. and R.

U. S. POSTAGE

PAID

New York, N. Y.

Permit No. 2961

F A GEHRES WGBF-WEOA  
2232 E POWELL  
EVANSVILLE 14 IND  
S148

116-03 91st Ave., Richmond Hill 18, N. Y. If addressee has moved, notify sender on Form 3547, postage for which is guaranteed.

# The Broadcast Engineers' Journal

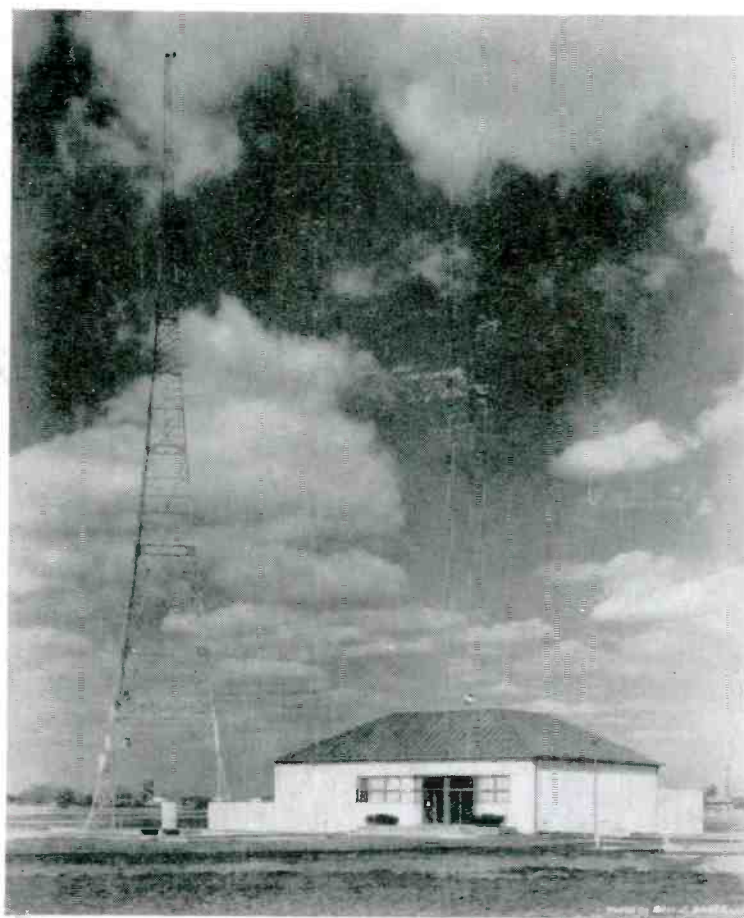

.....  
FEBRUARY  
1944  
.....

**WOR**  
Transmitter  
Carteret, N.J.

1922— $\frac{1}{4}$  kw

1923— $\frac{1}{2}$  kw

1927— 5 kw

1935— 50 kw

***Since 1934 . . . Of, By, and For The Broadcast Engineer***



# GOULD-MOODY "BLACK SEAL" GLASS BASE INSTANTANEOUS RECORDING BLANKS . . .

## RECORDING AMERICA'S POWERFUL VOICE

Transmitter of America's Powerful Voice is Radio . . . awake twenty-four hours a day . . . talking to our friends and our enemies . . . transporting Broadway and Hollywood and the girl next door to the boys over there . . . building morale on the home front.

Recording America's Powerful Voice . . . in leading broadcasting stations from coast-to-coast . . . are Gould-Moody "Black Seal" Glass Base Instantaneous Recording Blanks. Made entirely of glass, "Black Seals" are as thin as aluminum, thereby eliminating the necessity of recorder adjustments. No foreign inserts . . . no metal grommets . . . no ageing, hardening or deterioration. Every disc has four holes . . . center-flow thread action . . . may be played back for months without appreciable loss of fidelity. Enclosure of your preference rating extensions with your order will expedite deliveries.

**SHARE YOUR BLOOD WITH A WOUNDED SOLDIER**  
—donate a pint to the Red Cross today

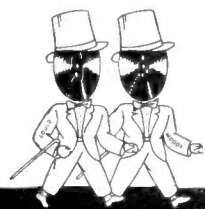

# THE GOULD-MOODY COMPANY

RECORDING BLANK DIVISION

395 BROADWAY, NEW YORK 13, N. Y.

# THE BROADCAST ENGINEERS' JOURNAL

Contents Copyright, 1944, by The Broadcast Engineers' Journal

Volume 11, No. 2

409

February, 1944

## TABLE OF CONTENTS

	Page
Elemental Electronics—Part II.....	3
Washington News .....	7
Cleveland News .....	9
WGAR—Cleveland's Friendly Station.....	10
WOR's 22nd Anniversary—A Pictorial His- tory .....	12
Blue Doings .....	16
WPTF—Raleigh .....	18
Chicago Chapter Chatter.....	19
Hollywood News .....	20
San Francisco News.....	21
Radio Engineers Popular.....	22
New York News.....	23

## THE BROADCAST ENGINEERS' JOURNAL

Trustees: V. J. DUKE, H. E. HILLER, G. B. RILEY, R. A. SCHLEGEL,  
D. A. ULLMAN

**ED. STOLZENBERGER**  
Managing Editor

Coordinator..... F. R. ROJAS  
Contributing Photographer..... SERGEI DE SOMOV  
Treasurer..... C. W. PHELAN  
Assistant Treasurer..... D. J. MOLONEY

### ASSOCIATE EDITORS

Chicago..... A. W. HJORTH  
Cleveland..... BERT PRUITT  
Denver..... KENNETH N. RAYMOND  
Engineering Chapter..... V. J. DUKE  
Hollywood..... BOB JENSEN AND NORMAN DEWES  
KFI-KECA..... H. M. McDONALD  
New York..... G. F. ANDERSON, JR.  
San Francisco..... BOB SHOVER  
Washington..... R. E. SHENTON  
WLW-WSAI-WLVO..... BOB BROCKWAY  
WOR—MUTUAL..... HERMAN G. BERGER  
WPTF, Raleigh..... REX COSTON

The Broadcast Engineers' Journal is a privately printed monthly publication issued by A.T.E. Publications, Inc., a corporation of the State of New Jersey. Address all communications to Editor's office: E. Stolzenberger, 116-03 91st Avenue, Richmond Hill 18, L. I., N. Y. Telephone Virginia 9-5553. **THE BROADCAST ENGINEERS' JOURNAL IS THE OFFICIAL PUBLICATION OF THE N.A.B.E.T.**

Advertising rates and information supplied on request. Subscription, \$1.50 per year; \$3.00 for three years. Single copies, except Christmas Yearbook, 25c; Christmas Yearbook free to subscribers. All remittances in advance. Foreign: Add postage.

Nothing appearing in The Broadcast Engineers' Journal shall be construed to be an expression of The Broadcast Engineers' Journal or the National Association of Broadcast Engineers and Technicians, but must be construed as an individual expression of the author or authors.

**NATIONAL N.A.B.E.T. OFFICE**  
Suite 1009, Investment Bldg., Washington, D. C.  
A. T. Powley, President



*This War . . .*

is daily emphasizing the importance of dependability and permanence in all of our equipment.

**This is especially true of  
Radio Recording  
Equipment**

*The Test of Time has proven*

**SCULLY  
Master Recorders**

to be unsurpassable as precision,  
superb recording machines

**BUY U. S. WAR BONDS NOW  
and plan to install  
SCULLY MASTER RECORDERS  
After the Victory!**

**SCULLY  
Machine Company**

62 Walter Street

Bridgeport, Conn.

Telephone BRidgeport 4-5300



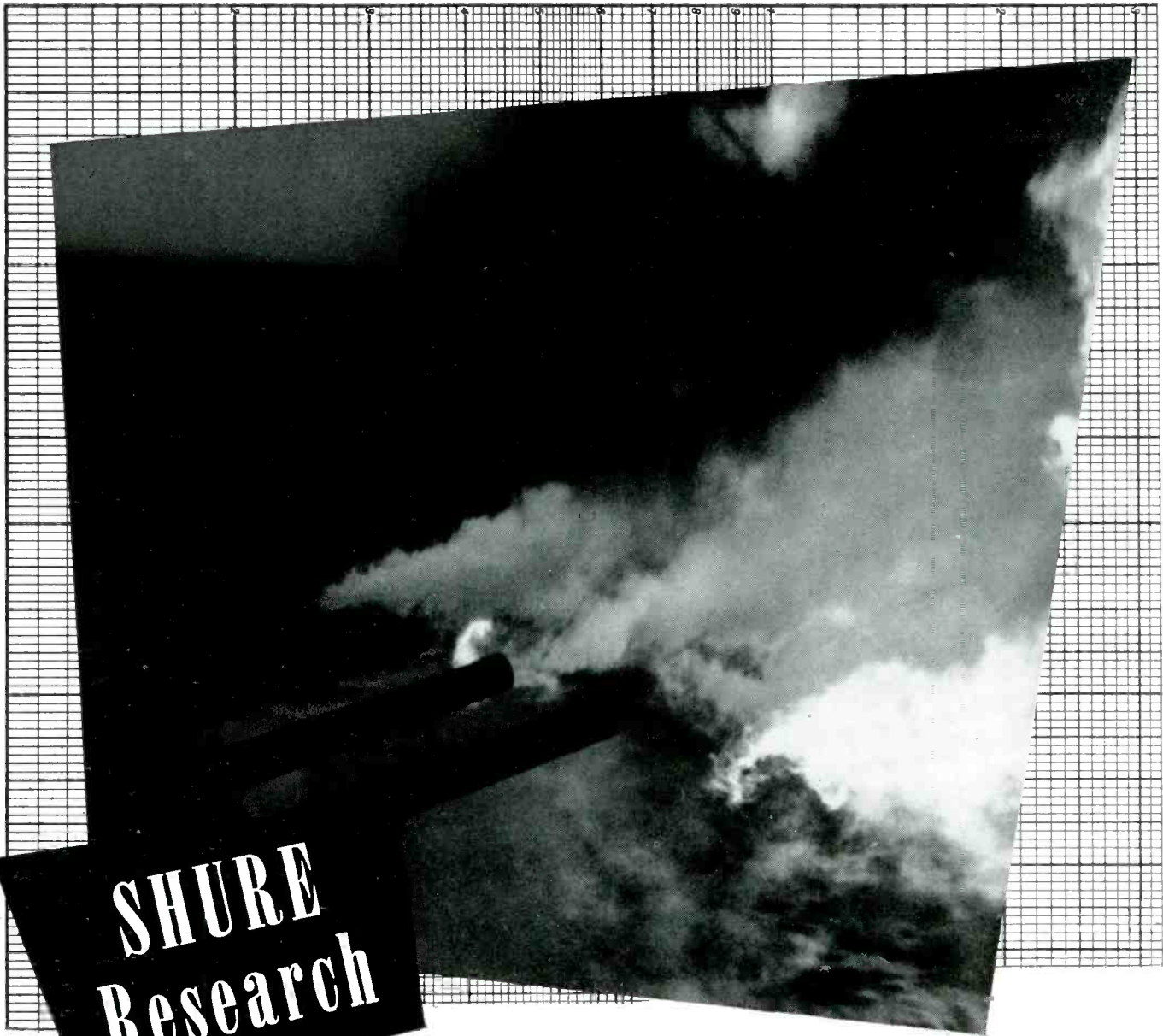

**SHURE  
Research**

***... in Blast Pressures***

In war, a microphone cannot expect to be pampered. It cannot be treated as a delicate instrument operating under carefully controlled conditions. It was a problem of Shure Research Engineers to design a microphone that would efficiently respond to infinitesimal speech pressure, and yet withstand the tremendous pressure of a sixteen-inch salvo—a pressure millions of times as great.

Research such as this assures you of a new standard of microphone performance for postwar.

**SHURE BROTHERS, 225 West Huron Street, Chicago**

*Designers and Manufacturers of Microphones and Acoustic Devices.*



# Elemental Electronics — Part II

## Time Constant : : By Jordan McQuay

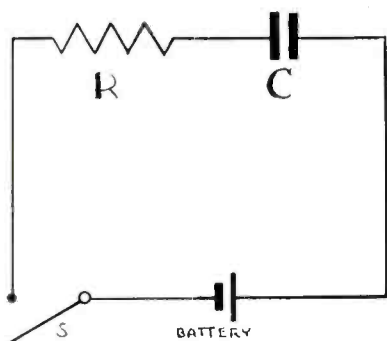

Fig. 1. — A simple R-C circuit

IN MOST ordinary radio and audio circuits, where the signal wave shapes consist of pure sine waves and low-order harmonic or distortions of sine waves, the consideration of *time constant* is of no particular importance. However, with the advent of precision square, rectangular, and pulse wave shapes used in television, radiolocation, and other electronic devices, the *time constant* of a circuit containing either resistance and capacitance (R-C) or resistance and inductance (R-L) assumes an immediate and extreme importance.

The electronic consideration of *time constant* evolves from a basic electrical and radio conception: (1) the building-up of a charge in a condenser in a circuit containing resistance and capacitance in series (known as an R-C circuit), or, (2) the building-up of a current in an inductor in a circuit containing resistance and inductance in series (known as an R-L circuit).

The R-C circuit is more generally used, and will be considered first.

When a source of voltage is applied to a resistor and condenser connected in series, as shown in figure 1, the *initial* flow of current is limited by the amount of resistance. A longer period of time is required to charge the condenser, than would be necessary if the resistance was not present. Then, too, different values of resistance will limit the rate of charge of the condenser.

Curve A of figure 3 illustrates a typical charging curve for such a circuit con-

taining resistance and capacitance. When the condenser is discharged through a resistance, a period of time is taken for the current to reach a very low value. This discharge is shown by curve B of figure 3, and the *time* of this discharge is identical to the time required to charge the condenser. In the cases of either charging or discharging, the time required is proportional to the actual values of the condenser and resistor. And the product of the capacitance and the resistance is known as the *time constant* of the circuit, or,

$$R \times C = \text{Time Constant (RC)}$$

When C is in farads and R is in ohms, the product of the two gives the actual *time in seconds* required for the voltage to rise within 63.2% of its final voltage *when charging*, or to lose 63.2% of its original full voltage *when discharging*. Note that the *time constant* does not represent the time required to fully charge or discharge the condenser.

An accurate graph of the voltage rise and fall across either of the components of such an R-C series circuit is shown in figure 3. The time scale of these curves is calibrated in terms of the RC product, so that the curves may be em-

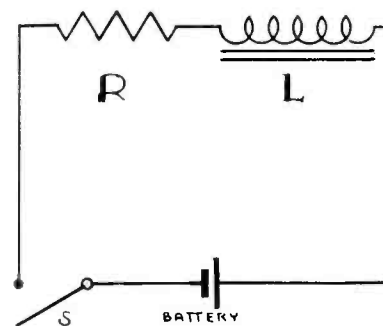

Fig. 2. — A simple R-L circuit

ployed for any RC product. The voltage scale is calibrated in terms of percentage of the full (maximum) voltage, so that the curves may be employed for any voltage. When the *time constant* (RC product) and initial (or end) voltages for the circuit are known, the voltages across either component can be obtained from the curves of figure 3 for any time after the circuit is closed for either charge or discharge.

A circuit containing inductance and resistance, as shown in figure 2, also has a *time constant* and for identical reasons. But this time constant is equal to L/R. When L is expressed in henrys and R is in ohms, the quotient is the *time in seconds* required for the current

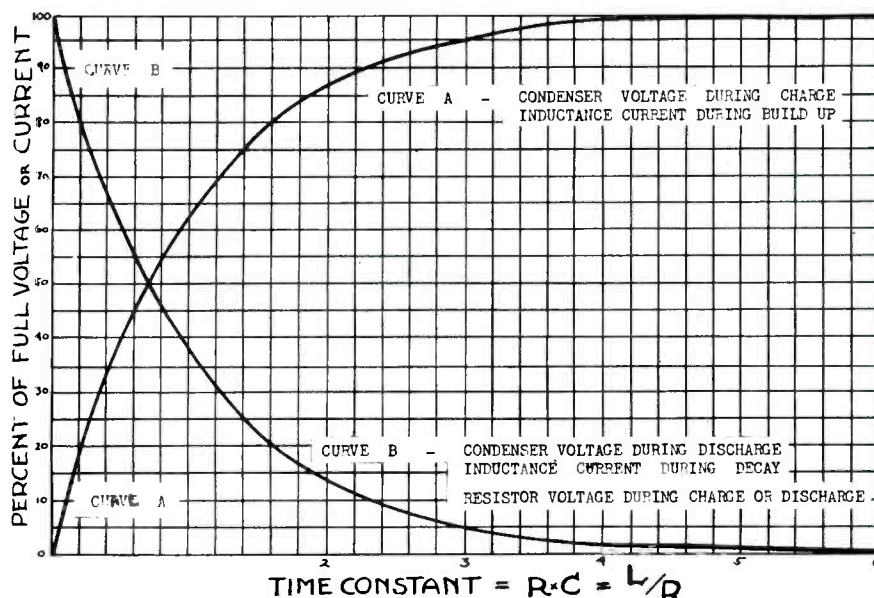

Fig. 3. — Universal time constant chart for R-C and R-L circuits

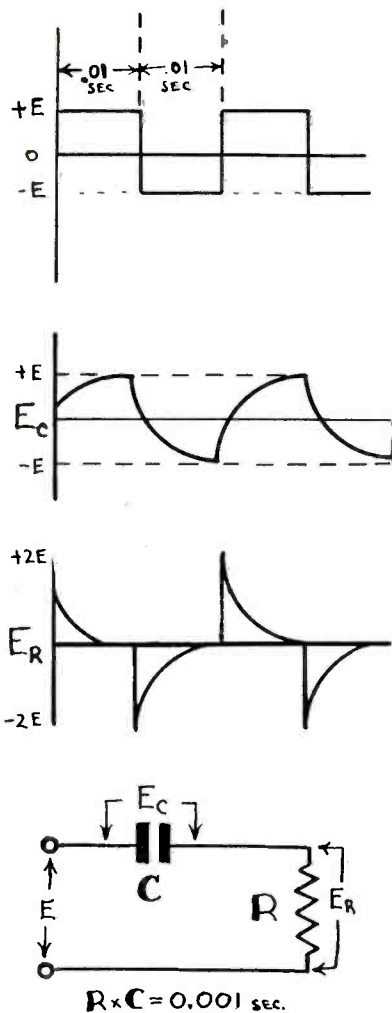

Fig. 4.—Voltage wave forms in an R-C circuit when the time constant is SHORT

to reach 63.2% of its final value when charging, or to lose 63.2% of its original current when discharging. The curves A and B shown in figure 3 may be used similarly for resistance-inductance circuits, as shown in that diagram.

With reference to figure 3, it should be noted that curves A and B are exponential in characteristic and have approximate mirror symmetry. That part of both curves between 0 time constant and 1 time constant is almost linear, and small portions of this part of either curve may be considered as a straight line. This is an important fact to remember. By the use of calculus, any portion of either of the curves can be used to obtain different rates of change.

An interesting and useful property of the curves shown in figure 3 is that in a time equal to 1 time constant the con-

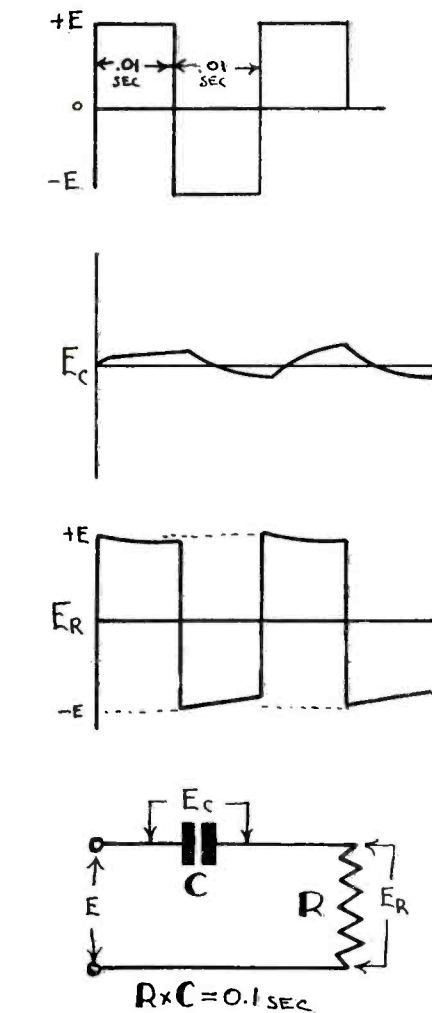

Fig. 5.—Voltage wave forms in an R-C circuit when the time constant is LONG

denser charge reaches 63.2% of its full value. In the next time constant (or RC) the charge will change through 63.2% of the remaining 36.8%, or 23.2%. This continues through successive time constants, and therefore, at least mathematically, the condenser can never be completely charged.

However, when the charge on a condenser has reached a time constant of 5, for almost all purposes the condenser can be considered fully charged. Conversely, when the discharge curve has reached a time constant of 5, the charge on the condenser will have dropped to a negligible value, usually almost zero.

In later Chapters it will be shown that saw-tooth wave shapes may be produced by utilizing merely the charge and discharge curves of a normal condenser, and that such saw-tooth wave shapes may have

different "slants" or rates-of-change depending upon which portions of curve A (figure 3) are employed to produce the saw-tooth voltage wave form.

In any R-C circuit, if the value of either the resistance or the condenser is increased, or both are increased, the condenser will take longer to charge, because it has a larger time constant. Since these components have a directly proportional influence on the charging time of the condenser, they can be varied in value to give almost any charging time required. The same is true for R-L circuits; any value of charging time may be obtained by selecting the proper values of R and L, which when divided L/R will give the time constant.

A consideration of the terms long time constant and short time constant emphasizes the important fact that in electronics, such evaluations are purely relative.

A long time constant means that the time (expressed in R x C seconds) is long compared with the time necessary for the impressed (or signal) voltage to complete a half cycle. For example, assume that the product RC of figure 1 is 5 seconds. That time constant is short when compared with, say, the 15 seconds required for a half wave of 2-cycle-per-minute frequency; but the same time constant of 5 seconds is long when compared with the half second required for a half cycle of 60-cycle-per-minute frequency.

A short time constant, for the same reason, means that the time (expressed in R x C seconds) is short when compared with the time required for the impressed voltage to complete a half cycle.

When non-sinusoidal waves (see Part I, Jan. B.E. Journal) are applied to a circuit having a short time constant (that is, short in comparison with the frequency of the impressed non-sinusoidal voltage) the circuit introduces distortion which has an important utilization in electronics circuits.

When non-sinusoidal waves are applied to a long time constant circuit (that is, long in comparison with the frequency of the impressed non-sinusoidal



voltage) there is little or no distortion. For this reason, R-C or R-L circuits can be used as a means of coupling between stages of a resistance-coupled amplifier.

When pure sine waves are applied to R-C or R-L circuits, no distortion of any kind is introduced, regardless of the brevity or length of the *time constant*.

A typical *short time constant* circuit is shown in figure 4, where the time constant is one-tenth of the time for a half cycle of the square wave. When a succession of square wave voltages (E) are impressed on this circuit, the condenser is charged to E volts with a polarity determined by the polarity of the square wave. The voltage across this condenser (Ec) is shown in graphic form, and it will be noted that the wave shape follows the charge and discharge of the condenser (C). Should such a sloping wave shape ever be desired in an electronic circuit, it would be merely necessary to tap off this voltage (Ec) from across the condenser. The voltage across the resistor (Er) is shown in the last graph, and

this unusual "peaked" effect of the wave shape is known as *peaking*. Peaking is an important form of distortion that is utilized in electronics circuits to create pulse wave shapes, operate switches, and a variety of other circuit functions. Peaking and pulse wave shapes will be considered in greater detail in a later chapter, but it is important to note that a short time constant produces a "peaked" wave when a square wave is impressed on the circuit.

A typical *long time constant* circuit is shown in figure 5, where the time constant is ten times the time for a half cycle of the square wave. When a succession of square wave voltages (E) are impressed on this circuit, the condenser is not permitted to charge to its full value (E). Before the condenser can become fully charged it is discharged by reversal of the square wave. Thus, the voltage across the condenser (Ec) represents this charge, and seldom becomes very large. It can be seen from figure 5 that the voltage across the resistor (Er) is almost a duplicate of the impressed

wave shape voltage (E). The actual time constant of this particular circuit is merely ten times the time of a half cycle of the impressed voltage; if the time constant were forty or fifty (or more) times that of a half cycle of the square wave, the voltage across the resistor (Er) would be *identical* with the input voltage (E), and the voltage across the condenser (Ec) would be hardly perceptible. Since practically the entire voltage drop of the RC circuit of figure 5 is across the resistor, this explains the wide use of long time constant circuits as *coupling devices* between stages of resistance-coupled amplifiers.

Wave shapes *other* than square waves may be applied to long or short time constant circuits with varying effects, as will be treated in later chapters. However, a pure sine wave does not suffer distortion when it is passed through either a short or long time constant, since one of the important mathematical properties of a sine wave is that a sine wave may be differentiated any number of times without changing its shape.

If you have not been using or have not yet tried Allied's New Glass Base Discs, a trial will convince you of their merits and superior quality — at no premium in the cost to you. We invite you to try this disc — that is how we obtain new customers. We feel certain that you will reorder — that is how we build sales volume — from satisfied users. Your telephone call, letter, wire or cable will receive our prompt and courteous attention.

# ALLIED GLASS BASE RECORDING DISCS

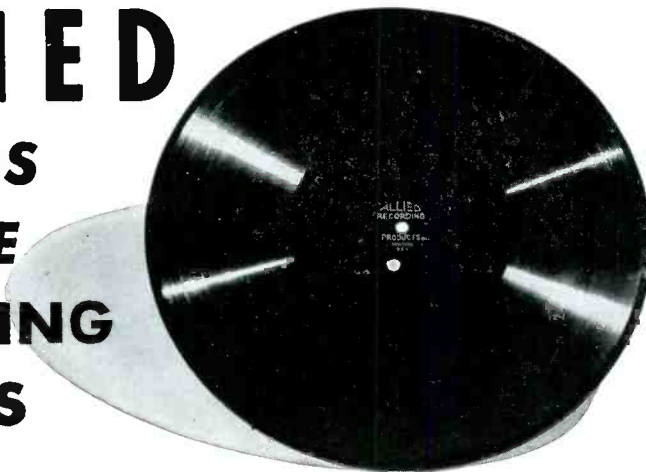

PROMPT DELIVERY direct from the manufacturer to any part of the United States, Canada, South America and to some foreign countries. ALSO AVAILABLE recoating service for your old aluminum discs. Delivery in one week. Details on request.

## ALLIED RECORDING PRODUCTS CO.

21-09 43rd Avenue

Phone STillwell 4-2318  
Cable: Allrecord New York

Long Island City, N. Y.



## One Part Hollywood — One Part New York — Mix Well in Chicago

**O**UT in a California training camp, a couple of thousand soldiers are howling their heads off at a gag . . . the band plays a short fanfare . . . applause . . . the announcer comes in with his commercial.

A neat, smooth operation—yet the comedian and announcer are 3,000 miles apart, and probably have never met each other. They're "mixed" in a studio in Chicago.

When there's to be a pick-up from any out-of-the-studio spot, NBC sends equipment and engineers to the scene two or three days ahead of time. They set up a circuit between that pick-up point and the "mixing" center. If the announcements on the program are to come from New York, they will go over a special NBC circuit direct to the same "mixing" point.

The mixing engineer gets his cues and his timing by telegraph. Then he sits down before an NBC mixer—and with a flick of the wrist performs the miracle of blending together a comedian on the coast with an announcer from the east—so subtly that it sounds as if they were both sitting in the same room!

NBC engineers helped develop this miraculous mixer—which *automatically* fades out a voice from one source and fades in a voice from another source.

Perfecting devices and operations such as this, working out every new means for making broadcasting more effective, increasing the scope and richness of radio through every resource at its disposal—*these are some of the things that make NBC "The Network Most People Listen to Most."*



—The **N**ational **B**roadcasting **C**ompany

America's No. 1 Network—A SERVICE OF RADIO CORPORATION OF AMERICA



# Washington News

## WRC — WMAL

By R. E. Shenton

**I**F ANY Visiting Firemen come to Washington in the next few months, or even further in the future, hunting one A. T. Powley, we suggest that they go to Room 1009 in the Investment Building, or call National 4489 for an appointment. The reason is that Mr. Powley now divides his time between that office and the NBC Washington Studios, where he frequently can be found tending the relays and tally lights at the MCD.

But in his office in the Investment Building, Mr. Powley is known as President A. T. Powley, newly elected leader of the National Association of Broadcast Engineers and Technicians. We might also add that E. W. McGinley, somnambulist, has traded his nightshirt for the quill and purse of the National Secretary-Treasurer, taking on a job equally as important and extensive as Mr. Powley's.

Al's new position climaxes a 27 year career in radio and affiliated industries, which began when he built a mighty transmitter in the year 1917, using a Ford spark coil, four of which were standard equipment in every Model "T"; Al claims the DX was about a mile! After being graduated from Kingston High School, in Kingston, New York, Mr. Powley proceeded into radio with a vengeance, and completed his courses at the Nilson and Hornung Radio School in New York in 1924. A few months later he became "Sparks" aboard ship, working for Federal Telephone and Telegraph, at which job he remained for about two years, leaving late in 1926 to begin his long career as a broadcast engineer.

WOR was the station which first had Al as a studio and field engineer, and two years later, he migrated to NBC in New York, at the old 711 Fifth Avenue location, where he did the same kind of work.

Perhaps the most interesting portion of Al's career was the period between November, 1928, and August, 1936, during which he worked as a newsreel operator for the widely known Fox Movietone organization. Al was assigned to the presidential retinue, and made many trips with Former President Herbert Hoover, as well as President Roosevelt. Also during his stay with Fox Movietone, Powley made a trip on the U. S. S. Arizona to the West Indies. Needless to say, such work was constantly filled with interesting and exciting experiences, as Al himself will nostalgically confirm.

President Powley came to NBC Washington in February, 1937, and, of course, has been here ever since. He has served as President of the Washington Chapter of NABET twice, once in the 1940-1941 term, and is now serving his second term. Prior to his assumption of the duties of National President, Al was National Vice-President, taking over the robes of the Chief upon the resignation of James H. Brown, Former President.

Washington personnel extend hearty congratulations, swelling with just pride at having the head man a member of the Washington Staff.

Just between you and us, the night before Al took over the gavel, he held open house "the-drinks-are-on-me-boys" down at the NBC-Washington Annex, known to the out-



**A. T. POWLEY**  
President, N.A.B.E.T.

side world as Burt's' (Beanery and Brewery) in order to celebrate his last night of freedom. We're sure that our new President is fully aware of the magnitude of the job ahead, and further, we're doubly sure that he is the man to meet and lick that job.

\* \* \*

The boys here in Washington welcomed back Sam Newman, recently First Lieutenant S. E. Newman of the Signal Corps. It seems that the rigorous life of operating portable equipment under simulated battle conditions brought back an old ailment, so Sam left the Army life to return to NBC. For a while at least, Sam will go out to the WRC transmitter, where he worked before becoming a studio engineer prior to his enlistment in the Army. Several other changes and additions have taken place recently as well. Sherman Hildreth comes to the studio group from WJAX, Jacksonville, Florida. Before going to Florida, he worked at WCSC in Charleston, South Carolina, which is also the alma mater of SE's Jim Weaver and "Mac" McGinley. Both of these gentlemen are, consequently, already acquainted with Mr. Hildreth, so in a sense his arrival is really a reunion.

H. A. Walker, 10 year NBCite comes to the WRC transmitter from Cleveland, in exchange for J. W. Dietrich. Cleveland, it seems, is Dietrich's home town, so he will now be able to continue working for the same organization, but closer to home. The welcome mat is out for both Mr. Walker and Mr. Hildreth, as well as for Sam Newman, of course. And our best wishes to Mr. Dietrich.

\* \* \*

The stork double crossed us here in connection with Brother McGinley's imminent offspring last month, but this month he made up for it by arriving just before deadline time. Recipient of his bundle this time was Mrs. R. L. Terrell; the proud papa Operations Supervisor R. L. Terrell, who kept the whole affair a complete secret right up to the last minute. The arrival? Oh yes, a young lady, as yet unnamed, but then, at this writing she is literally only a few hours old. Congratulations to the parents. Just to get even

(Continued on Page Nine)

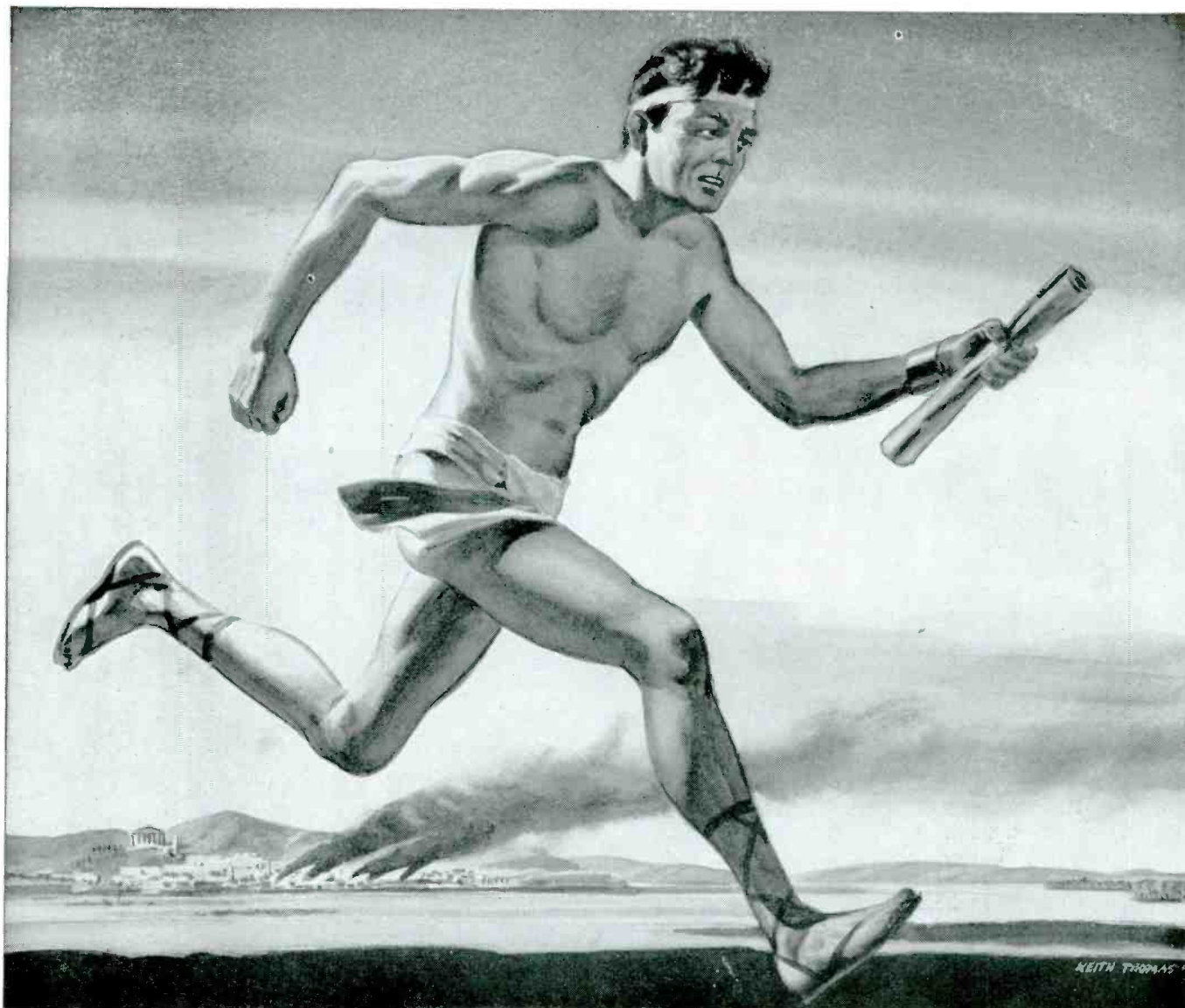

*History of Communications Number One of a Series*

## A FORERUNNER OF MODERN COMMUNICATIONS

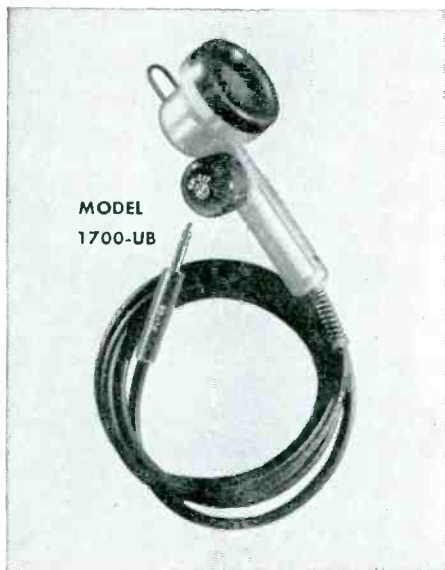

One of the first known channels of message carrying was by runner, and annals of Grecian and Phoenician history describe the nimble lads who firmly grasped rolls of parchment and sped hither and yon. Clad in typical running gear of the period, they covered amazing distances with almost incredible speed. That was the forerunner of today's modern communications where scientific electronic devices are "getting the message through" on every war front. Universal Microphone Co. is proud of the part it plays in manufacturing microphones and voice communication components for all arms of the United States Armed Forces, and for the United Nations as well. Other drawings in the series will portray the development of communications down through civilization and the ages to the modern era of applied electronics.

*< Model 1700-UB, illustrated at left, is but one of several military type microphones now available to priority users through local radio jobbers.*



**UNIVERSAL MICROPHONE CO., LTD.**  
INGLEWOOD, CALIFORNIA

FOREIGN DIVISION: 301 CLAY STREET, SAN FRANCISCO 11, CALIFORNIA • CANADIAN DIVISION: 560 KING STREET WEST, TORONTO 1, ONTARIO, CANADA





# CLEVELAND



By Bert Pruitt

THE present site of Cleveland was a wilderness in 1679 when Rene Robert Cavalier Sieur de La Salle sailed past the shores of the Great Lakes to explore the Mississippi. Radio Broadcasting was a considerable distance down the highway leading to the 20th Century and the land along the shore of Lake Erie, at the mouth of the Cuyahoga River, held by the French; later by the English.

"Has Pruitt," you may logically wonder, "bumped his head against a rafter, or could he have been kicked by a mule? Otherwise, why would he want to take us back to the 17th Century where we must guard against being scalped by Indians?"

"It's like this . . . Step out here on the sidewalk with us in front of the NBC Bldg. and you'll look history smack-dab in the face. You will not need bi-focals to recognize the fact that the Connecticut Land Company purchased three million acres of land in the Western Reserve for thirty cents an acre. That bargain included the land where the NBC Bldg. now stands.

The Connecticut Land Company decided to divide the "Promised Land" into small lots. They sent Moses Cleaveland to do the dividing. Moses Cleaveland, soldier, scholar, surveyor and sage, left Connecticut with an entourage of fifty men. This included a civil engineer, an astronomer, a mathematician, a commissary, and helpers made up the remainder of the group.

Their boat slipped into the Cuyahoga river on the morning of July 22, 1796. They landed on the east side of the river approximately seven city blocks west of the NBC Bldg. That statement may be misleading. We have not been here in the NBC Bldg. since July 1796. We should have said they landed on the east side of the river, seven blocks from the spot where the NBC Bldg. would stand 147 years later.

Cleaveland made a town plan, a central square from which streets extended. He put his official O. K. on the map, called the town Cleaveland then went back east. Years later, a newswriter left out the "a" and the revised spelling was accepted.

That, in a nutshell, is how Cleveland got its name. We now find it necessary to do a little explaining. Our Local Draft Board is not a part of the Cleveland Chamber of Commerce. The Cleveland Chamber of Commerce has never fixed a parking ticket for us and we do not think Cleveland has the most perfect climate in the world. We are not publicizing Cleveland in hopes of encouraging you to pack your duffle bag and move in . . . far from it, there aren't enough houses for the population as it is.

Lorenzo Carter and his good wife left Vermont for the Western Reserve. They built a home near what is now West 2nd St. A good golfer, with a favorable roll, could poke one from the NBC Bldg. to West 2nd St. where the Carters built their log cabin. Carter shot game in the woods up near the vicinity of Euclid Ave. where the Palace Theatre now stands. They roasted venison on a spit before an open fire and it is doubtful if they discussed the possibilities of missing the next station call.

Lorenzo Carter became a leader in the Pioneer settlement of Cleveland. Responsibility goes hand in hand with leadership so Lorenzo (Major) found it necessary to conduct

an execution when an Indian by the unusual name of O'Mic was found guilty of murdering two trappers near Sandusky.

A small group of men armed with flint-lock guns formed a guard about O'Mic. The gallows were erected on Public Square and O'Mic approached the gallows determined to show the white men how a brave Indian could die.

O'Mic lost his bravado when a black cape was drawn over his head. O'Mic decided he had an appointment over there in the woods where WTAM's Transmitter now stands. His attempt to escape failed. He did the next best thing when he agreed to die bravely if they'd give him a pint of whiskey. Major Carter considers this request to be a reasonable one for a warrior preparing to take the long journey back to a reunion with his ancestors.

A pint of courage-inducing liquid was produced. O'Mic upended the bottle, then smiled: He was prepared to go to the Happy Hunting grounds where white-man law was unheard of and game was plentiful. The rope was again adjusted and the cape lowered.

The whiskey hadn't been strong enough. O'Mic was almost paralyzed with fear. He demanded another pint to make his journey more comfortable. The Major acquiesced. O'Mic upended the second pint and the wagon was driven out from under him.

We can stand here in front of the NBC Bldg. and see that history repeats. Those places across the street, with flickering lights and foot-rails, prove that O'Mic was not alone in the belief that a generous use of John Barleycorn is what the doctor orders when it comes to bolstering courage.

## Washington News

(Continued from Page Seven)

with the McGinleys, we won't even mention that the new arrival in their homestead was a nine-pound boy, Edward W. McGinley, III. The event occurred on January 2, which, let it be known, is the very same day that copy must be in the hands of Ed. S. Perhaps our new President can take care of a little legislation to prevent such untimely arrivals of NBC progeny.

\* \* \*

In the miscellany this month two items; first, SE Jim Weaver can be seen about the palatial corridors of the NBC Washington Chateau these days *sans* cheaters. This degogging is the result of reading an apparently influential volume entitled, in a paraphrased form, "You TOO can see without glasses!" or "Why make a spectacle of yourself?" When interviewed on the subject, Jim replied that he failed to see anything illogical in the context of the book, so he guessed there must be something to it. So far no catastrophic results have come from his pince-nezlessness, but rest assured than many index and middle fingers are intertwined in hopes that his luck may hold out.

Second item may be labeled *Errata-pianissimo*: Last month in introducing FSE Metz to our gentle readers, we labeled her Miss Ermadine Metz. Further research on the name reveals that it should be spelled Miss Ermadean Metz. A thousand and one pardons, Ma'm. And so we close. This column came to you from Radio Center. We drink our Hemo and go to Nemo.



John F. Patt  
Gen. Mgr. and V.-P.



Harry Kampt  
Sales Manager



Don MacColleston  
Transmitter Supv.



Lloyd Wingard  
Act'g Chief Eng.



Carl George  
Operations Supv.



R. Morris Pierce  
VP in Charge of  
Engineering

# WGAR — Cleveland's Friendly Station

By Bert Pruitt

**E**LECTION of R. Morris Pierce to the position of Vice President in charge of engineering of Stations WJR, WGAR and KMPC was announced recently by G. A. Richards, President of the company, following the annual Stockholders and Directors meeting of the stations.

Pierce, who has been Chief Engineer of The WGAR Broadcasting Company in Cleveland for thirteen years, served the O.W.I. and the Psychological Warfare Branch of the U. S. Army in North Africa and Sicily for seven months of 1943, and at present is again on leave of absence from his regular duties. He is returning to the European theatre this week to resume his job as chief engineer for the Radio Branch of the Psychological Warfare department of the Army.

"Election of Mr. Pierce to be Vice President of our three stations is recognition of the outstanding contributions which he has made to the interests of these companies and to radio in general," Mr. Richards stated. "We also wish to relieve Mr. Pierce of many of the details of supervising a single station's daily operations so that we may have the benefit of his advice on over-all engineering policy, and for the planning of post-war technical developments."

Pierce is generally regarded as one of the industry's most brilliant and competent young engineers, being conversant with every phase of broadcasting and television engineering. He worked out all of the many technical details of WGAR'S recent application for 1220 kilocycles, Mexican 1-A channel, which the F.C.C. granted September 7th. When Italy surrendered, Pierce was given a large share of the credit for having effected the transfer of the Italian Fleet to Allied ports through his decision to tune a super-power Allied transmitter to the international distress frequency to call in the fleet units.

Mr. Pierce expects to report to his new duties with WJR, WGAR, and KMPC in approximately six months, after having directed the supervision of certain radio transmitters and perfecting technical teams to operate them in the European theatre.

Appointment of Pierce's successor as chief engineer for WGAR will not be made until his return. Lloyd Wingard, control room supervisor, will be acting chief at WGAR during Pierce's absence.

It is now our pleasure to take the Journal readers over to radio Station WGAR. They're located on the 14th floor of the Statler Hotel Building. They have been there since they first went on the air in October 1930. They operate on a frequency of 1480 KC and they have 5000 dignified watts to tickle the ether waves.

They have no use for Hitler and Hirohito over there at WGAR, and who can blame them? If it weren't for such fellows as Adolph the Self-Styled Magnificent and Hiro the Stupendous WGAR could begin construction on their 50,000

watt transmitter immediately. Permission for this increase in power has been granted with an O.K. for a frequency shift to 1220 KC. Construction will begin as soon as the priority situation clears up.

WGAR's transmitter is located at 1000 Harvard Road. Their new 50 KW beauty will be at Broadview Heights and Aiken Road.

WGAR is owned by G. A. Richards who is Chairman of the Board of Directors of stations WGAR, WJR Detroit, and KMPC Los Angeles, California.

We probably shouldn't mention this but our gossipy instinct insists that we advise you that the Employer-Employee relationship at WGAR come as near being a perfect democratic organization as any we've had the pleasure of visiting. **Radio people in Cleveland have heard many surprising stories of the Christmas parties the management throws over there at WGAR.** Employees might just as well go prepared to carry home anything from a thirty pound turkey to a \$25.00 War Bond. And who hasn't heard of the carefree way they toss out bonuses just before the tinkle of St. Nick's sleigh bells are heard approaching Cleveland from the general direction of Detroit, Mich.?

"Yes," said Lloyd Wingard, Acting Chief, "this is a great place to work!"

"Lloyd," we said, "who is that out there grinding again? It looks like Bob Fox."

"It is."

"Thought he was in South America doing work for the Government!"

"He was . . . came back six months ago!"

"What's this we hear about Morrie Pierce being promoted?"

"He's now Vice President in charge of Engineering for stations WGAR, WJR and KMPC!"

"That's quite a jump eh?"

"Yes and Morrie's the fellow who can easily make the jump and retain his equilibrium."

"His what?"

"Balance."

"Oh . . . that was a fine write-up he had in Life Magazine, wasn't it?"

"Sure was," said the Chief answering the phone.

Manager John Patt was calling. Something was stirring up there in the front office and Lloyd had to leave.

We accidentally bumped into Walberg Brown on our way out. Walberg is Musical Director at WGAR. He used to be at WTAM. "Well I'll be darned," he said, "what kind of diet are you on?"

Walberg wanted to know how I had been able to lose 30 pounds since he last saw me. A discussion of diet would be boring to the Journal readers, so we will not repeat that part of our conversation. After we had solved the diet situa-



tion one thing led to another and we were soon talking about the time Tommy Cox, Bob Stephan and myself were out at Walberg's place, fishing from a 75 foot bluff, one night during the good old days of prohibition.

Bob is Radio Editor of the Cleveland Plain Dealer and Tommy Cox is now Captain Cox in the Army Signal Corps somewhere in the South Pacific. We have a great respect for the vast distances out there so we believe we are safe in telling this one about Tommy Cox.

The four of us were sitting there on the bluff tossing our lines into Lake Erie. The toss was 75 feet straight down. The future Captain is allergic to mosquitoes so he always made it a practice to carry a bottle of mosquito equalizing liquid. Well, the mosquitoes were thicker than office seekers on election day and they stabbed with uncanny accuracy. They'd get up about six feet over our heads then power dive for our necks. Cox kept nipping at his equalizing bottle and you know as well as we do that society etiquette demands a spirit of one for all and all for one on a fishing trip where the mosquitoes are thick. "Boys," exclaimed Cox, "aren't they buzzing louder than usual tonight?" We answered in the affirmative so Cox answered by saying he still had confidence in the mosquito toxin so he got up and headed for an old oak tree standing about thirty feet south of us. He hadn't gone more than half that distance when we heard a scream for help!

"Who's that?" said Bob.

"Must be Tom . . . come on!" Walberg jumped to his feet.

The three of us dashed over where we thought the call for help was coming from. Bob scanned the ground with the beam of his flashlight and located Tom lying in a hole about seven feet deep. He was in a vertical position, hanging onto the root of a tree for dear life!

"What's wrong?" we asked.

Tom didn't say a word at first. He slowly opened his eyes and gave us a surprised look. He then looked down at his feet expecting to see the worst. After gazing at his feet a second or two he said, "I'll be darned . . . I thought I was hanging over that 75 foot cliff!"

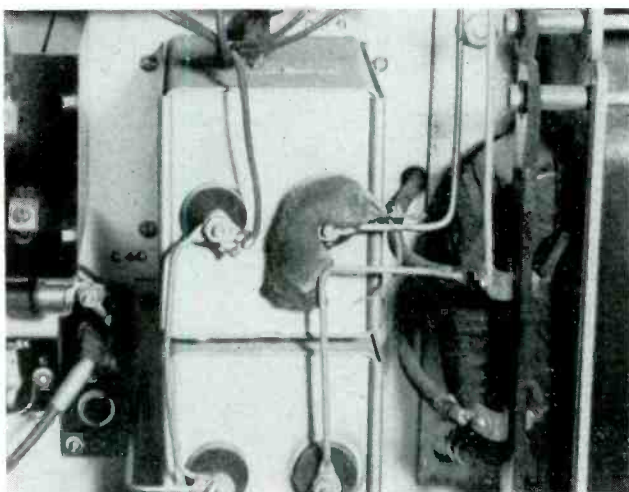

#### BETTER MOUSE TRAPS!

We have heard of ants in the pants, bats in the belfry, frogs in the bogs and a lot of other things in something or other. Bob Morrison, chief engineer of WMRN, Marion, Ohio, gives us a new one; mice, or rather mouse in the xmitter. Bob says the mouse didn't cause any program interruptions but the mouse took the long one-way trip to mouse heaven.—B. P.

## TERMINAL

In a single, comprehensive place—  
aply named **TERMINAL**—you can  
acquire every part, instrument,  
etc., needed in your activities. If  
you can get it anywhere, you can  
get it at

**TERMINAL**  
**Radio Corporation**

85 Cortlandt St., New York 7, N.Y.

Phone: WOrth 2-4415

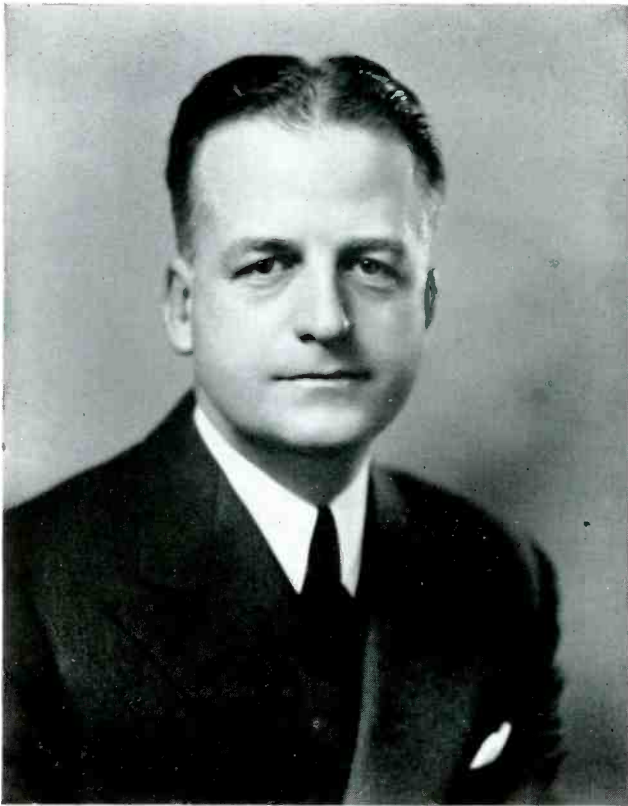

J. R. POPPELE  
Chief Engineer, WOR

**T**HROUGHOUT the entire broadcasting industry there are few personalities who hold a record of service equal to that of J. R. Poppele, WOR's chief engineer and secretary of its board of directors. Today, engineering head of a giant 50,000 watt station, Poppele became affiliated with WOR on February 18, 1922—four days before the first tiny 250-watt broadcaster took to the etherways on the roof of L. Bamberger's store in Newark, N. J.

Since February back in 1922, Poppele has been a guiding figure in the growth and destiny of WOR, following the rise of the station from its modest beginning to the present 50,000 watt status. No American broadcasting station operates today with greater power.

Tall, dark, lean and intense in his work, Poppele is like many of today's radio engineers, having started his career during the World War as a radio operator both on commercial vessels and in the Army transport service. His first encounter with radio, however, took place at the age of 14 when he constructed and operated an amateur station with an early spark coil transmitter.

Poppele was born in Newark, N. J., where he attended local schools, then studied electrical engineering at Newark Tech and Penn State before the War saw him turn to radio as a lifetime career.

Under Poppele's guidance and constant contact with the latest developments and trends of radio, WOR has enjoyed a continued rise in power as well as prestige. Jumping from

1922— **WOR** —1944

*By Herman G. Berger*

## *22nd Anniversary!*

Yes, Sir, I am twenty-two years old this month. And I am proud that I was born on George Washington's Birthday, February 22, 1922. I hope that the pictorial history portrayed in the following pages will give you some idea of how I have grown!

250 to 500 and then to 5,000 watts, WOR threw the master switch on a giant 50,000-watt transmitter in March 4, 1935—assuming at the same time the position of one of the greatest stations east of the Mississippi. Originally the station's only engineer, Jack Poppele now heads a staff of sixty crack technical experts.

He is also known across the nation as one of America's leading engineers, both in vision as well as practice, often being called upon by other radio heads to aid them in solution of modern broadcasting problems. He makes frequent appearances before technical bodies, engineering societies and other groups for addresses on the varied phases of radio, from regular transmitter procedure to facsimile, the transmission of printed matter and pictures—a new art in which WOR was actively engaged. In 1935 he served as technical consultant of the New Jersey Police Radio Commission, also aided in the establishment of the City of Newark Police radio system.

During his stewardship at WOR, Poppele has instituted and maintained a research laboratory in which many devices now in common use have been developed to help the advance of broadcasting. Much of the equipment at the 50,000 watt transmitter in Carteret, N. J., was specially designed under Poppele's guidance. He is a member of the Institute of Radio Engineers as well as several clubs of northern New Jersey. His sole hobby, aside from an omnipresent interest in radio, is amateur photography. Married and the father of three children, he makes his home in South Orange, N. J.

**ELECTRONIC DEVICES ARE WINNING THIS WAR!**

**BUY MORE BONDS**





Joseph M. Barnett, Studio Director, signing on that powerful 250 Watt WOR Station. Yes sir, that's the way it was done in those days.

(Right)—The WOR Reception Room or Grand Foyer as it was called in those days of 1922.



WOR's first microphone ever used on our ether waves, 1922.



This was the last word in Studios installed and operated by WOR in the Globe Indemnity Building, Newark, N. J. 1932.

(Right)—Jack Poppele, a young clerk and radio operator at L. Bamberger & Co., with unceasing determination to get ahead in the field of Radio and would not take "No" for an answer. Finally got his message to Garcia. Said Jack, "At that time it would have been easier to sell my employers a Baldwin Locomotive, than the idea of starting a Radio Station." When L. Bamberger & Co. finally gave in to his request, it was then that Jack had his first foot on the step of that long ladder to success. We hope that the following pictures and facsimiles will give you some idea as to his progress. The Station was started with a Staff of 5 in all, and now that little Staff has grown to approximately 300. Yet only a few of the WOR Staff has any idea of the fact that they owe J. R. Poppele a vote of thanks for their job.



A typical WOR Studio located on Bank Street, Newark, N. J. August 1923.



Gifford C. Campbell, admired by all in his department, was one of the old timers. He came to WOR on August 17, 1931, and left to serve his country in November of 1943. He was not only known for his good nature, but also as an expert in the field of transcriptions.

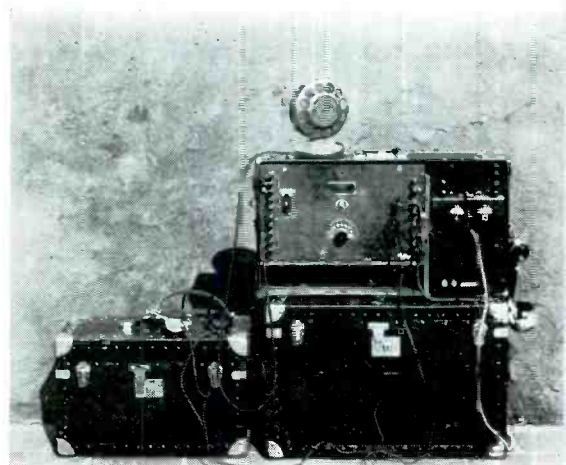

Old Western Electric 24A Remote Equipment. Weight—130 lbs. Only the Old Timers will appreciate the 130 lbs.



# WOR's 22nd ANNIVERSARY



Yes you guessed it, none other than Charlie Chaplin himself, making his Radio Debut. 1923.



First Broadcast of a plane pick-up, August, 1925. Jack Poppele at the Control.



WOR Transmitter and Control Desk



A typical American family spending the evening at home. Dad with the paper and mother with a good book, while Bob and Ann listen to the Radio back in 1923.



The little fellow at the extreme right is none other than Floyd Bowman who sang at WOR 17 years ago, later became the 5th employee of WOR. He later was promoted to Captain of the Page Boys and is now in charge of WOR's Mimeograph Department.



500 Watt Transmitter on the roof of L. Bamberger & Co., Newark, N. J. 1922.





WOR Master Control, 1440 Broadway, New York City, with Jack Byrne, another Old Timer, at the Controls, 1943.



A portion of WOR's Frequency Modulator Transmitter W71NY located on the 44th Floor of 444 Madison Avenue Building, New York City, 1942.



A view of one of WOR's many Transcriber Studios completed in 1943. Herman G. Berger, one of the Old Timers, at the Controls.



Annette Bennett, Movie Star, saying a few words to her public. For your information the hat was acoustically treated for Eddie Content's benefit.

#### THE BOYS OF THE TRANSMITTER AT CARTERET, N. J.

The first gentleman on the left is none other than Mr. Charles Singer, supervisor, now on leave of absence as assistant director of operational research group, associated with the U. S. Army Signal Corps at Washington, D. C.

The second gentleman from the right is Mr. George Robinson, assistant supervisor, now acting supervisor during Mr. Singer's absence. And the gentleman on the extreme right is Mr. Poppele, Chief Engineer of WOR.

Some of the Field Equipment used by WOR when they have to take their transmitter with them on a Remote Hook-up.

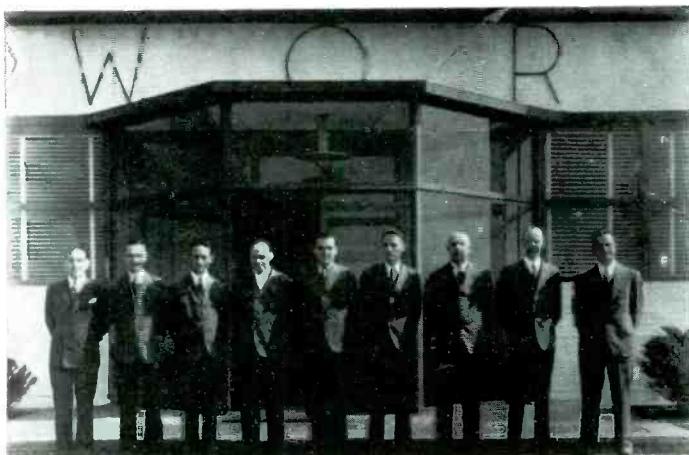



# BLUE DOINGS

By Norman Dewes

**W**EATHER . . . just to carry on the Brooke tradition. **SUN** . . . plenty of it, if you've got a stratosphere plane handy . . . mornings and evenings have definitely progressed to **EAR MUFFS**. (Where can you buy ear muffs?) One engineer was seen on the Boulevard after the early "Sardis" show still wearing his headphones . . . claimed that they kept his **EARS** warm at least. Many raincoats still observed walking around, with engineers peering furtively out at lowering skies. **BEACHES** . . . some are there and some aren't, such as Redondo after severe pounding by unprecedented high waves and tides. One of our beaches is missing . . . **BUT** some really wonderful warm 'n sunny typical California spring days interspersed, at just the right intervals to relieve the monotony, or maybe that should be vice versa . . . **SUMMING** it all up, to quote **Heffernan**, not long from N. Y.,

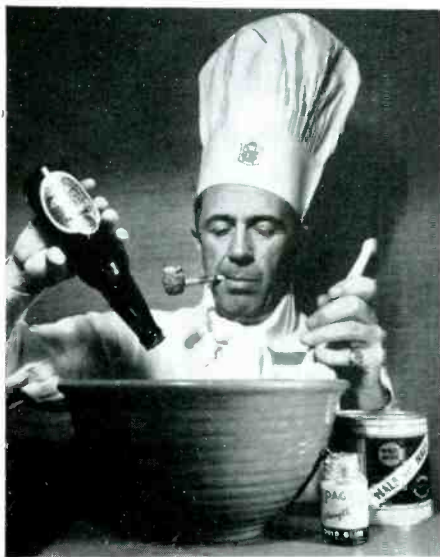

"Denny" Denechaud

"California weather is simply **UNBELIEVABLE** . . ." Yes . . .

**TOP STORY** of the month: **CHIEF Denechaud DROPS AN "I"!** Prominent young Hollywood Engineering Supervisor Ralph G. Denechaud, better known as "**CHIEF**" to his associates **AND** slaves, dropped an "**I**" this month and is now officially "**the CHEF**" . . . by virtue of having been made the recipient of the highly coveted title of "**CHEF OF THE WEST**" by Sunset magazine. (See January, 1944 issue, page 20.) In addition to his many other accomplishments it seems that, **LITTLE KNOWN** to most of us, Denny is **ALSO** a connoisseur, an epicure, a gourmet and perhaps even a **GOURMAND** of strange foods from strange lands. Not only **THAT**, he also **COOKS** 'em . . . to wit, **SHISH KABOBS**, **PILAFFS** and **STUFF**. These delectable delicacies in double-talk proved to be so diverting when served to a friend and prominent member of a highly exclusive association of amateur cooks that the friend saw to it that the dishes were given suitable recognition in his column in Sunset, and the **CHIEF** made a **CHEF**. (See photo, showing **CHEF DENNY** preparing a tempting **NOV SMOZ KA POP**, using simple ingredients to be found in any kitchen.) The highlight of the above mentioned banquet was the **SHISH KABOB**, an Armenian dish also known in certain provinces of Russia as a **SHOSLICK** or **PROSNIKOFF**, where it is served in local **Casbahs** on flaming skewers or swords . . . carried in procession to your table by Russian **Samovars**. Quite the thing for these cool evenings in Hollywood. **SERIOUSLY**, Denny is certainly to be congratulated, as **WE UNDERSTAND** that he is really quite an accomplished cook, amateur standing, and a **VERY** handy man around the kitchen. For a selection of his favorite recipes, address a card or letter to **CHEF Denechaud**, care of Blue Network, Hollywood, and enclose 10 cents to cover cost of.

**IT SEEMS** that more things happen to the guys on the Coke show pickups than **ANYBODY** . . . and small wonder. "**Rags**" Ragsdale, our Blue Hlyd Field, Supervisor-without-portfolio and official photographer, came down with "dat ole debbil flu" while enroute to El Centro, California, and arrived with temperature, a poor golf score, and walking about three feet off the ground.

**ACCURATE**

ARMY NAVY

TYPE 10  
**BLILEY**  
FREQUENCY CONTROL  
SERIAL NUMBER  
**R19655**  
FREQUENCY  
**7115** KC  
MADE IN U.S.A.  
ERIE, PA.

Accuracy and dependability are built into every Bliley Crystal Unit. Specify **BLILEY** for assured performance.

**BLILEY ELECTRIC COMPANY**  
ERIE, PENNSYLVANIA

*Bliley Crystals*



Did the show in a pool of perspiration and immediately collapsed in bed at Hotel Barbera Worth. Struggled out several days later and came down to breakfast to find hostelry overrun with beautiful LADY WACS . . . sleeping all over the lobby in chairs, on floor and in potted plants. That he was still delirious, NATCHERLY, and tried to get back to room, but found that they were real, AND WOW! Four of them were already occupying his bed. RAGS remark, for posterity, "No-o-o-o—you see, I had the wife along . . ."

THINGS HAPPEN to others of us also, howsoever . . . Thor La Croix helping to strike a portable booth and holding up HIS END when the guys on the OTHER end let loose and walked away, intent on something else . . . roof of booth slipped and landed on the La Croix CONK, pushing his neck several inches down into his collar. When it emerged, neck had acquired an ODD TWIST and La Croix went around for several days looking up spiral staircases, only there WEREN'T any. Result, you had to converse with him over his right shoulder . . . a SILLY SITUATION.

WE HEAR from Lieutenant Roger Love, who left to serve in the Signal Corps sometime ago, that he is now stationed at Camp Edison, Sea Girt, N. J. According to the letter, they've got him assigned to a typical ARMY DEAL . . . being a VERY GOOD radioman, he is instructing the kids in the intricacies of DIESEL ENGINES. Quite a switch . . . but then maybe you never know when you're going to be confronted with a Diesel engine and it will be handy to know how to get STEAM up on the thing . . .

WE ENJOYED a visit from Phil Carlin from N. Y., who attended several of our shows, and had much to say regarding BIG THINGS for the Blue . . .

A DELAYED New Year's Cocktail Party was thrown by the "Breakfast at Sardis" people for selected guests and the regular production crew, at the Hollywood Knickerbocker the 14th . . . engineering dep't was well represented by Eilers and Powell. Hours were from four to six and I'LL SAY! At least that many were hoisted and lowered PER HOUR, and a good time was had.

OVERHEARD IN THE BOOTH DEP'T . . . Producer Bill Johnson on "Red Ryder" show, subbing for regular one and his first time with the cliff-hangers, beginning to get restless as "30 for tonight" rapidly approaching

on clock and engineers Lorenz and music. Finally, Bill yells "FADE THE MUSIC!!", but as music was just in particularly thrilling crescendos near the end, Eilers yells back "NO!!" and Eilers still gaily playing closing theme Lorenz co-operates perfectly by not moving a muscle . . . they make the cue, just, and Carl dumps the lights, quietly remarking, "Don't worry kid, we ALWAYS get this show off on time". Johnson sighs, and quietly sneaks out.

#### Program Managers

Oh Potentates of high reknown  
We envy you a lot;  
You listen to some talent and  
Your eyes deceive you not!

#### Patch Cords

Well, boss, the patch cord kinked into  
A twisted figure 8;  
That slowed the program down  
somewhat,  
Therefore it came up late!  
— B. PRUITT.

## BOOK REVIEW

### Electron-Optics

By Dr. Paul Hatschek

Translated from the original German work by Arthur Palme. 6"x9", 156 pages, published by American Photographic Publishing Co., Boston. \$3.00. Material presented in a straightforward, easy-to-understand style through the frequent use of light-optics analogies. Non-mathematical. Recommended especially to those whose work in the near future will require some understanding of the whole subject of electron-optics as it relates to television. Chapters titled "Electric and Magnetic Lenses," "Resolution and Enlargement," "Amplifying Tube Design," and "Electron Multipliers" will be found informative and thought-provoking. The publisher's presentation is to be commended, in that in almost all cases, illustrations referred to in the text appear on the same page. In brief—an excellent \$3.00 investment.—Ed S.

**WE HAVE PARTS Galore — TO SPEED VICTORY!**

**SEND for YOUR COPY of this FREE CATALOG**

**OVER 10,000 ITEMS — IN STOCK!**

**SUN RADIO & ELECTRONICS CO.**  
212 FULTON ST. • NEW YORK 7

**FOR PROMPT SERVICE Telephone BARclay 7-1840**

**Everything in Radio and Electronic Equipment**

*Purchasing Agents Engineers!*  
This massive buying guide is yours simply by writing on station letterhead stating your title. Address Box 31.

# WPTF — Raleigh . . . by REX COSTON

THE most recent addition to the control room staff is **D. Gordon McCrary** of Raleigh. He had a rating as a Seaman 1/C in the Navy until he was given an honorable discharge a few months ago. "Mac" attended radio school at the San Diego Naval Base and was operating as an apprentice aboard ship just before being discharged.

**Hatley and Radford**, guards at the transmitter, were out clearing off the field (they said) but within the next day or so they had a rabbit barbecue. Then last week **Holliman** had some of the boys out for a **pork and chicken** barbecue. Hmm, as soon as I get back my transmitter pass (that I sent with a suit to be cleaned) I think I'll go out and hunt rabbits!

**Alton Tripp** (CS) is now back on the job after being out for several weeks with injuries sustained in the now famous "Kitty Hawk Incident". One thing that Tripp still can't understand about the accident is how **Jack Hill** got from the front seat of the

club coupe into that small back seat, where he was found after the wreck, along with **Henry Hulick** and **Carl Goerch** who had been in the back seat all the time.

Several issues ago I mentioned that CPO **Sam Liles** was in Africa running a transmitter for the Navy. Sam is now a Warrant Officer. Before joining the staff of WPTF I spent a short time in the Army—most of it in a Fort Bragg hospital. Some of the patients who weren't actually tied down were allowed to walk over to the PX or to the Red Cross recreation hall. During some of the hottest weather a few of us would go out on the lawn beside the ward to bask in the sun. We took off as many clothes as was possible in order to get full benefit of old sol. Just as we got settled for the afternoon snooze our nurse, Miss Liles, white and angelic-looking, would bellow out sergeant-like, "It's against the rules and regulations for the patients to be seen without their shirts on." Too sun-weakened to resist we obediently slid arms into sleeves.

A couple of years later when we began to feel like steamed clams complete without the shell, Miss Liles treacherously sneaked up on us again and apparently picking on the least resistant among us said, "It's against the rules and regulations, etc. . . . Coston, your face is showing."

Seriously Miss Liles was a swell nurse and we had a lot of fun kidding her and the other nurses. They are really doing a swell job with their skill and wonderful dispositions that have amazing results on the soldier by keeping his mind off his troubles.

And then a couple of days ago I saw my ex-nurse's picture in the paper and the paper was telling me in six-point type that Miss Judy Liles is serving in England and that she has a brother serving in Africa! To think that while I was in the Army, she had a brother working at WPTF where I didn't even know I was going to work later after he had left to go in the Navy and I had gotten out; and she didn't even mention it to me!

## THE GIANT OF MILITARY RADIO

### *The Army's SCR-299 Communications Unit*

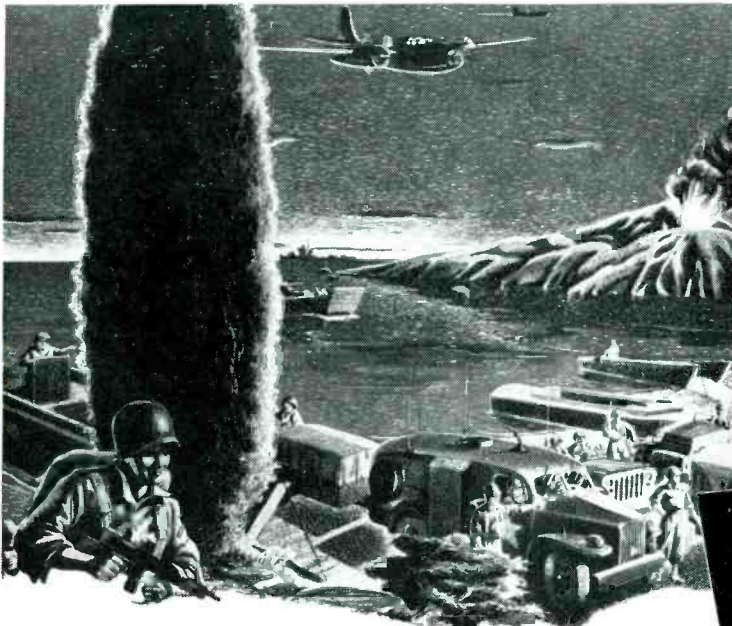

HALLICRAFTERS HAS THE HONOR OF BEING THE 1ST EXCLUSIVE RADIO MANUFACTURER TO RECEIVE THE ARMY-NAVY PRODUCTION AWARD FOR THE 3RD TIME! THE WORLD'S LARGEST EXCLUSIVE MANUFACTURER OF SHORT WAVE RADIO COMMUNICATIONS EQUIPMENT.

As beachheads and command posts are established, the SCR-299 built by Hallicrafters speeds ashore and immediately starts operation in voice and code, while stationary or speeding through woods and along rough roads under enemy fire.

Today these Giants of Military Radio are repeating this tough job, with the Allied Nations, on all the battlefronts of the world. Whether directing the fire of battle wagons lying offshore or the concentration of Allied land forces' fire on a strategic hill, the SCR-299 "gets the information through!"

BUY MORE BONDS!

  
**hallicrafters**



# CHICAGO CHAPTER CHATTER

By Arthur Hjorth

**CAPTAIN ED. BERNHEIM**, NBC engineer-on-leave, stopped for a few short hours in Chicago Jan. 21st going east, destination not revealed. Ed. had a Colonel in tow. Someone who saw Ed. said he hadn't changed at all, in fact Ed. would change the Army before the Army would change him.

Versatile **Ray Bierman**, pianist, vocalist, aviator and BLUE engineer gained a six to nothing decision January 26th to become Chief Engineer for the Permaflux Corporation in Chicago. May his flux never vary and his residual magnetism ever be in our midst.

A certain NBC producer, just before giving birth to a colossal show for network dissemination from studio "A" in Chicago with the organ in "G" as a stabilizer was in the studio giving last minute commands to the cast when the organist's voice boomed o'er the P. A. speakers. To answer the organist's query our confused producer rushed to the center of "A" and cupping his hands looked up to the P. A. speakers near the ceiling and shouted his reply. It took much coaxing to convince him that it would be much simpler if he'd just step up to one of the mikes and answer in a soft voice. The story is true but professional ethics will not allow this column to divulge the name of the characters.

Profuse apologies for misspelling MARGUERITE as Margaurite. Can MR. BROOKS come out of the doghouse now?

Supervisor W. O. "Connie" Conrad, NBC Chicago Supervisor has left us to go with Western Electric as a field engineer and it is understood his duties will eventually take him overseas.

C. M. "Charlie" Butler, senior NBC Chicago studio engineer left us during February to become a production director for the BLUE Network at Chicago. NBC's loss will definitely be BLUE's gain since few men in radio broadcasting are as thoroughly familiar with every phase of this intricate business and all of his NBC friends, which include every one from Mr. H. Luttgens to "Archie," will watch with personal interest and satisfaction his successful progress with the BLUE . . . and now you'll REALLY be able to do business with the BLUE.

E. L. "Lee" Tolleson came from WDBO at Orlando and WTMC at Ocala, Florida, during May 1943 to join NBC as an apprentice. Now we proudly salute our newest "Group Two Man" Studio Engineer LEE TOLLESON.

NBC engineer-on-leave Lieut. **Marvin F. Royston** did a wonderful job of a combat recording made on a baby flat-top somewhere in the Atlantic recently. This recording was used on the MEET YOUR NAVY show, January 28th, with an added plug for Marvin. At least we know where he is now . . . or do we?

A letter from **Wow's Roy "Tex" Glanton** to Editor **Stolzenberger** promises a story with pictures of our new NABET member KODY just as soon as they get some operators and fix up the joint. We'll keep hounding him.

**MAJOR Lester L. Washburn** (ex-Captain), NBC engineer-on-leave, stopped for a short hour Saturday, January 8th, in Chicago returning to Hollywood, racing the stork back from Washington.

According to an official Weekly Production Progress Report, received by **Minor Wilson**, NBC Recording, Major Washburn reports the production of a Female Model on January 19th, weighing six pounds, four ounces, to be known as MISS NANCY JUDITH WASHBURN.

March winds will bring memories of that GREAT day, some years ago, when wedding bells announced the wedding of ETHEL and W. J. "Mac" McDONNELL of WLS-WENR transmitter and CLEO and DON WILSON of NBC studio.

While yet NBC's star engineer **Charlie Butler** proudly announced the arrival of a son, Charles M. Jr., weighing in at eight pounds and fifteen ounces, Thursday, February 3rd. Mr. and Mrs. Butler were relieved that junior arrived before the "Blue" could claim him as their production.

Hollywood challenged the world with the start of a beauty contest. We admit that their contestant, **Rhoda Gardner**, is a glamorous "gal," but . . . we submit as the second contestant, and from Chicago, our engineering secretary (part-time recording) **Mary Kirkbride**. Wouldn't tell her birthday but know she was 21 in January. Plans to marry a Navy man this March and loves chocolate sodas but doesn't like to have her picture taken . . . and now what does New York and Washington and etc. . . . have to offer . . . and incidently who are the judges and what does MISS NABET 1944 win?



MARY KIRKBRIDE

"Don" Howser, "Q" transmitter Councilman, and "Andy" Forgach, WENR-WLS Councilman, both report NO NEWS. If something doesn't happen at these transmitters by next month we're going to have to concoct a story of the trials and tribulations of these "forgotten" men and their families.

M. W. Rife, C. A. Cabasin and H. D. Royston are happy to announce that they are now 1-A.

☆ . . . again, ☆  
☆ and again, ☆  
☆ and again . . . ☆  
☆ BUY MORE BONDS ☆  
☆ ☆

# HOLLYWOOD NEWS

By Bob Jensen

**I**N THE January issue, we made an unkind statement about the lack of proper drainage facilities, or something or other. The weather man must have heard us, for since that statement was made we have been having the most unbelievable warm sunshiny days that possibly could be created. Grass is coming up everywhere, and the hills have changed from brown to green. January 19 was officially pronounced the second hottest day of the winter with the temperature at 84.5. The much talked of "rainy season" has yet to make its appearance, with so far only two light showers this month. Chicago was never like this—O. K., Chamber of Commerce, come and get me!

Main talk around these parts is still the draft situation, with the flu coming in a close second. Our prexy, **Jim Brown**, heads the list of those forced into a couple days' vacation from the flu bugs. **Louis Onofrio** has been down for about five physicals, but his bright smile is still seen dashing back and forth to the Biltmore. He prefers to be called "former civilian" rather than "Mr.," so that the shock of becoming "Sir" won't be too great, or do they call buck privates, "Sir"? **Al Gage** has graduated from 2A to 3A, but **Oscar Wick**, also of maintenance, has taken a couple of physicals but says they don't mean anything because he's sure he has flat feet. **Howard Cooley**, record-

ing, is sporting a 1A which gives him an added worried look as he tramps the path to the Re-recording room. **Raoul Murphy** has joined the maintenance group as an apprentice. He was formerly in charge of the Hollywood NBC Mail Room and has been with NBC since March, 1943—an old timer! Welcome to the fold, Raoul. **Walter McWhinney** has changed his title from Recording Room Clerk to Recording Apprentice. Walt has been serving as clerk for about nine months and previous to that time he was on the page staff. Walt's hobby is photography, and with the aid of a complete darkroom outfit donated by **Jim Thornbury**, he has been producing some very unusual photographs.

**Vic Livoti**, Field apprentice, has acquired the title, "Dare-Devil Livoti," from his recent roller coaster ride on "People Are Funny" insert from Ocean Amusement Park. **Bob McGaughey** and **Leon Fry** went along and their combined efforts turned out a swell show. **Ralph Clements**, senior recording engineer, has been proving himself an able carpenter, plumber and electrician. He has just finished building an extra room onto his North Hollywood estate. **Al Korb**, MCD, is also a member of the local housepainters' guild. He is painting the outside and has the job three-fourths completed. **Pickett** has been in the poison oak again; sez he contacted the enemy but was forced to retreat.

**Blue** opens at 5:15 A. M. now, which explains reason **Wetteland**, MCD, was seen at Ration Board on his knees the other day. The Blue is still on the air, so guess he got the gas coupons. Next problem is to find a station that has any "bang water". Stuff is pretty scarce in these parts; guess the P-38's take it all. Letter came in from Capt. **Miv Adams**, former Field Supervisor. Miv. is in So Pacific with 5th Amphibious Corps Fleet Marine Force. **Sil Caranchini** is number one of the honor roll of New RCA Bowling League which started January 26. He came through with a score of 536.

Major **Washburn**, former Chicago Studio engineer now stationed on the coast, is in the news again. This time it's a 6½ pound baby girl born Jan. 19. When asked what they were going to call it, he said he thought they would call it "quits"! Mother Alvina and daughter doing fine.

**Mrs. Ed. Bertero**, nee Primont, secretary to Mr. O. B. Hanson, was in Hollywood on a vacation with her husband who is now an Ensign in the Navy. They spent a couple of hours touring the plant and meeting familiar New York faces.

NBC looks more like a movie lot lately than a radio studio. **Bob Burns** had the "Screen Snapshots" crew in to do a sequence of his presentation of a lion cub to the Navy. "People Are Funny" show was filmed in Studio B by Columbia Pictures with two cameras on stage. Sound was piped to recording truck outside. Army outdid them all by filming "Mail Call" in full. Studio was filled with special scaffolding, cameras, lights, directors and blondes. Engineer **De Grazzio** was busier than a one armed paper hanger mixing for both the picture and the recording.

## CAPPS\*

SAPPHIRE is, and has always been, the only material for making cutting styli for high class recordings.

CAPPS\* Patented Sapphire Styli (2187512) are the original and accepted standard for high class professional acetate recordings.

*Imitated but not equalled*

**FRANK L. CAPPS & CO.**

244 W. 49th STREET NEW YORK CITY

Telephone Circle 6-5285

\* Reg. U. S. Pat. Off.



# San Francisco By Bob Shover

ONE of the biggest events to start out the year at San Francisco Radio City was the "Eddie Cantor 4th War Loan Bond Drive," a 24-hour variety show from Studio A which was open to the public during the entire day and night and wound up with a total sale of over \$40,000,000. Studio Engineers—Tommy Watson, Sam Melnicoe, Willie Watson, Hal Ashby and C. T. Stevens



EDDIE CANTOR — 6 A. M.

really had their hands full during the 24-hour period and a special mention to Jack Van Wart, who cut 14 of these special programs plus the regular line shows on his watch.

George Mardikian, owner of Ormar Khayyams, who kept the 24-hour vigil with Cantor and supplying the whole crew with hot coffee and food during the series of broadcasts. Along with Cantor, were Cookie Fairchild, Nora Martin, and many night club stars to round out the program. The biggest individual purchase was \$1,250,000 for a Jap bayonet. A Jap helmet was auction off at \$240,000 and many items from \$100,000 and down. "\$1,000 for a glass of beer and a Swiss on rye." Skeets Casidy, take note!

Well, fellas, to follow up on the NBC-KPO Bond Drive. The Blue Special Events or "What's New on the Blue," had a short wave broadcast from a B-24 bomber flying over San Francisco during a noon hour with Bill Baldwin interviewing Mayor Lapham and several high ranking army officers. Clark Sanders riding the gain from the plane.

Saw a new face around the plant the other day, that of G. W. Andresen, who has been away so much of late on Coca Cola pick-ups that I was just about to greet him as a newcomer here.

Mark Dunnigan tells us that he is converting his last year's vegetable garden to all-out fruit tree growing, says the weeding was too much for his back! S'pose we will have to raise more of our own this year.

Cliff Rothery has a new pest playing havoc in his vast garden. He's never seen one, they don't leave any trail, and none of the poisons or traps seem to catch the sabytodgers. Why don't you stay up some night with your

camero and a telephoto lens and see if you can shoot a few of them? On the other hand E. E. Jefferson has pest control par excellence, he lives "High on a Windy Hill" adjoining his eucalyptus grove and he says that the racoons keep his garden free from pests. Hungry neighbors, for instance?

Tech. Sgt. Bobby Woods of the Army Air Corps dropped in the other day to pay us a visit. From his stories he's been there and seen things. Hope when its all over Bobby will be back. He was an ex-NBC page boy who became an apprentice engineer and then decided to go out and see the world with Uncle Sam's Army. He said that his training here at Radio City has helped him a great deal in the Army. So long—see you all next month.

## Radio Club of America Announces Newly-Elected Officers

The Radio Club of America, Inc., founded in 1909, announces its newly elected officers for 1944, as follows:

President, F. L. Klingenschmitt, Amy, Aceves & King, Inc.; Vice President, O. James Morelock, Weston Electrical Instrument Corp.; Treasurer, J. J. Stantley, Continental Sales Company; Corresponding Secretary, M. B. Sleeper, FM Radio-Electronics Magazine; and Recording Secretary, J. H. Bose, Engineer connected with Major E. H. Armstrong at Columbia University.

## CONTROL APPARATUS by AUTOMATIC ELECTRIC

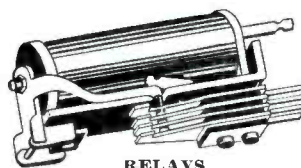

RELAYS

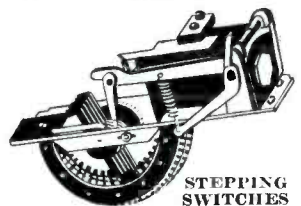

STEPPING SWITCHES

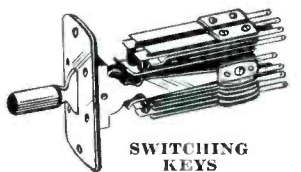

SWITCHING KEYS

IN AMERICA'S leading radio broadcast studios, Automatic Electric remote control devices are used for the dependable operation of such important equipment as master control boards and announcers' cabinets, for program monitoring and switching, and for other electrical control uses.

These devices have a built-in quality that is the direct result of over 50 years experience in the design and manufacture of communication, signaling, and control systems, utilizing the same engineering skill that revolutionized telephony with the automatic dial telephone.

A complete engineering and consultation service is available to broadcasting studios on any electrical control problem. Avail yourself of this service today by writing—

**Automatic Electric  
Sales Corporation**  
1033 West Van Buren Street  
Chicago, Ill.

**AUTOMATIC ELECTRIC**

TELEPHONE, COMMUNICATION, AND SIGNALLING EQUIPMENT

# Radio Engineers Amazingly Popular . . . By Bert Pruitt

**T**HE prolific engineer should be able to turn out a Best Seller every month or so. The war has put him in the Literary driver's seat. He gets a daily squint of human nature in its oddest form, and human nature in that form presents unlimited possibilities to the prolific engineer.

He cannot believe his eyes when a violinist, one he has worked with ten years, comes into the control room and asks his opinion as to the outcome of the war. Up until then the musician hasn't bothered to ask the engineer's opinion as to the outcome of a local charity football game, much less the outcome of a world war.

So who can blame the engineer for being surprised when the musician inquires as to the health of his family. The engineer almost swallows his cigar when the musician says he and his wife have been talking about having he and his wife out for a duck dinner. The engineer immediately changes his idea of violinists. This one could stand a hair cut, but he isn't such a bad fellow after all.

One thing leads to another and the first think you know the musician switches the subject. They discuss the radio-tube shortage. The engineer explains that it is impossible to get new tubes today . . . "Why," sadly says the engineer, "I can't even get new tubes for my set!" The musician's captivating smile begins to fade and there goes the engineer's duck dinner.

Most people are under the impression that all radio drama takes place in the studio. Nothing could be further from the truth. There's more down to earth drama in the control room than there ever will be in the studio. Just take the case of the engineer who slipped-up on a cue one day. The production man was as tough a character as ever bummed a cigarette from a studio engineer. The engineer expected the worst and was greatly surprised when the production man smiled and told him not to worry about such small mistakes . . . "I'll fix it with the boss and sponsor!" he said. The engineer was so flabber-gasted he missed the next cue. The production man's smile stuck to his face like a Boston Bull hanging onto a milkman's coat tail.

The program ended and the production man remained in the control room. This was an unprecedented act. You know as well as we do that they usually high-tail it for the studio where they hope to have their ears soothed with favorable comments. "Joe" began the production man with

the kind of smile he usually reserved for the agency or sponsor, "Joe, what's wrong with a radio set when the tubes fail to light?"

Then there's the husband who has his wife call the local radio station. The call invariably reaches the MCR. The supervisor didn't think it possible for so much sex and charm to come through the nickle-talkie . . . He has been married twenty years and his imagination gets the best of him when she asks him if he is a lady killer. His imagination goes sky-high when she wants to know where he lives. He upsets an ink bottle when she says he has the most romantic voice she has ever heard.

Boy, oh boy, isn't it wonderful to be a control room supervisor? Then she says: "Oh, yes, do you know where I could get someone to come out and look at my radio?"

Next comes the bar-room drama. You've been stopping by at a certain place for several months and never has the bartender offered you one on the house. You and an announcer stop by for a quickie and the announcer says something about never having seen so many radio tubes as you have in your basement.

The bartender becomes as active as a muskrat in a cornfield. His eyes scan his most expensive selection of scotch. Out comes a bottle and two double-sized glasses. "Help yourselves, boys," says the bartender beaming with generosity. This makes you believe in Santa Claus again. "He's a swell fellow you say to the announcer who is pouring himself another one. One thing leads to another and the first thing you know you are out at the bartender's house replacing a burned out condenser.

You can take it for granted that something is brewing when your butcher insists that you should have nothing but the best cuts of meat. And if he doesn't weigh his thumb with your purchase you may as well begin preparing your ears to receive the statement that his set needs retuning. Lodge members likewise show the condition of their sets by the width of their smiles. Church members pray a little louder and act a little more friendly to engineers when their sets begin to squeal. Relations call up a little more often when their sets develop a hum, especially old aunts. You haven't heard from them for at least twenty years and you almost faint when they insist on you coming over for a turkey sandwich. Your voice breaks and you try your best to thank your dear old auntie for remembering you. After all, wasn't she a perfect dear when you were a little shaver about ten years old. You stand there with tears in your eyes while thinking of the times she gave you strawberry jam and butter and bread. Then you realize that Auntie is still talking . . . "And be sure and bring your tool-kit along . . . my radio went dead this afternoon!"

Pages could be filled along this line. Whether these pages would be read is another story. A theory could be presented, showing how the radioman's present popularity is a direct result of Hitler's uncontrolled ambition. But it wouldn't be theory if you went ahead and explained that this popularity will drop quicker than the barometer when the war ends and the tube manufacturers get going again.

I have had a few of the above mentioned experiences. When someone asks me what I think of the eventual outcome of the war, I say: "What war?" That seems to stop them before they can change the subject to radio tubes.

## Courmettes & Gaul

### OPTICIANS

55 West 49th Street  
R. C. A. Building, New York  
Main Floor

### EYE EXAMINATIONS

Prescriptions Filled . . . Prompt Repair Work



# New York News

By George F. Anderson, Jr.

**A**L POWLEY, NABET Prexy, visiting here in New York, was shown around by NBC Harry Hiller. Lt. Harold Flood reports that he is now in England; Ted Kruse, now Pvt. Theodore Kruse, AUS, is now at Camp Crowder, Mo. and Joe Colledge, FE BNCI has become Lt. (jg) Charles H. Colledge, USNR.

Studio 3H, which has been used for International Department programs for the past year, is now in the process of being converted back into a television studio.

NBC and BNCI are sponsoring a television course for NBC and BNCI engineers. The course, consisting of lectures and discussions is given three times a week and the

ducer AND engineer; producer for The Agency and engineer for BNCI.

George Mathes SE BNCI became George Mathes SE NBC on the first of February, and Bob Ward SE BNCI has taken over George's shows for the Blue, notably Counterspy and Gangbusters. Bob will have his hands full now with the addition of these shows to the ones that he already does, and George will be free to spend long hours in Studio 2C for the International department, spinning platters.

Ed Strong, who was with NBC a few years back, is again being seen in the studio control rooms having joined the BNCI staff, as a studio engineer.

Harold Luedeke has now decided to see if the things that a traveling salesman sees are true. Harold transferred to the Radio Recording department last month as a salesman, and is going to sell the shows that Herb Wood produces. Both Herb and Harold are voyagers from the NBC Studio Engineers staff. Watch out for the expense account Harold, and Good Selling.

The ancient art of checker playing has taken the fancy of those SE's who happen to have a few spare minutes, and every game has several kibitzers.

The masters of the Game are Claude Clayton and Sergei DeSomov, who vie with each other as checker champs. When not playing checkers Sergei can be seen discussing ice fishing with Alex Horwath, Harry Hiller, Bob Ward or Pete Narkon.

Lt. Rudy Bauer, USNR, informs us that although he is in the Navy, he is still in the broadcasting business. Along with his regular duties at the Brooklyn Navy Yard he also is Technical Director of the Yard's PA system. The system is not only used for calling purposes, but is also used to furnish news and entertainment. He has an OP 5 amplifier and it is used for nemo pickups around the yards. He is in charge of seeing to it that all in the yard hear all the launchings that take place, and we imagine that when the U. S. S. Missouri was launched, Rudy was on hand with his OP 5.

Vacation discussion is again on the upswing, now that all the '43 vacations are past and, as last year, gasoline is again the major factor.

Well the typewriter ribbon seems to have dried up, or is it the guy who writes this, either way—that's all for now from New York.



"I can't wait to get home to hear 'Information Please!'"

attendance is excellent. The schedule for the lectures has been arranged in a manner that enables practically everyone to attend, no matter what hours he works.

A newcomer to the BNCI SE staff is Fred Moore from WFIL Philadelphia, and out at Boundbrook, where NBC's shortwave transmitters are, is another newcomer, Melvin Stickles. Melvin joins us from WOV, where he was station Engineer.

Among other recent additions to the staff are the following apprentices; Richard Ely, Robert Zweck, John Norton, M. J. Lustgarten, John Butler, and W. H. Chambers.

When you call Studio 3A now and ask to speak to the producers of the Morton Downey show, you get the engineer, if you ask for the engineer, you get the producer, all this is due to the fact that Bill Glasscock is now the pro-

## Aaron Lippman & Co.

246 Central Avenue Newark, N. J.

### Radio and Electronic Equipment

*We Expedite — Ask Anyone*

## Whyland Wistful When Waltzing Mice Waver

By Arthur Hjorth

Diligent search behind the scene of the average radio engineer's workday reveals some strange and interesting hobbies.

WLS engineer, E. B. "Ed. Burr" Whyland, modestly claims fame as the only NABET member raising waltzing mice. Actually they "raise" themselves faster than an erratic soprano on a VI meter. Attaining maturity at three weeks, they produce a litter of "pups" (so Ed calls them) in three more weeks with four to six offspring and then they grow up, and etc. Starting with two, there are now twenty or more, and this in spite of the fact that every friend of Ed's



WLS Engineer Whyland lovingly holds great-grandmother "Minnie" while curious member of family, "Pepper," suspiciously eyes Mama Mouse. Mrs. Whyland was at safe distance.



Engineer Ed Gleason, now Private Ed Gleason, U. S. A., slaving away in WLW's Studio B control room. The rather ill-fitting garment about the "Reverend's" shoulders is Randolph Baer's coat, which is a couple of sizes too large for Edward. We can't say about the pants, but we're certain Ed has on his own shirt and tie.

or friend of a friend to the four and fifth degree has received a pair of the logarithmic lovers.

Except for a little "cheating" now and then, they pair off for their lifetime of about two years. Eating bread, lettuce and bird seed, they continually spin dizzily around any object, including themselves, expending much energy.

Ed's patient and tolerant wife, Vera, isn't too fond of the Lilliputian Lovers, but Ed's fascination for them does keep Ed home at nights, and knowing the vagaries of radio engineers, Mrs. Whyland is content.

A letter to Ed and payment of shipping costs will result in you, too, having a pair of these "whimsical waltzing wonders" in your home. Write today, tomorrow may be too late!!!

## F.C.C. Release No 72397 December 15, 1943

THE Federal Communications Commission has announced the adoption of an amendment to its rules and regulations looking toward the issuance of standard broadcast licenses for a normal license period of three years, the maximum period authorized under the Communications Act of 1934. The present license period is two years.

Initial renewals will be for staggered periods, ranging from one year to two years and nine months. Thereafter, all regular licenses will be for the full

three-year period. In this way the plan will be placed in operation in such manner as to spread the work load incident to examination of applications for renewals over the full three-year period. Stations are grouped in order of the different license expiration dates in such manner as to include in each group a fair cross-section of the entire industry. This will automatically accomplish a fair distribution of the work load on renewal applications.

"This action is in line with the policy of the Federal Communications Commission and its predecessor, the Federal Radio Commission, to extend the length of licenses whenever the advancement of the radio art and the growth of the radio industry seemed to warrant such

extension," Chairman James Lawrence Fly said.

"In deciding the matter of extending the normal term of licenses, the Commission has always had to consider the concept of a license as a public trust and the need of the industry for all the assurance and stability that seemed consistent with the public trust concept."

In 1927, when the Federal Radio Commission was first organized, licenses were issued for sixty days. In 1928, the normal license of a broadcast station was a three-month period. This was increased to six months in 1931. In 1939, the Federal Communications Commission authorized the issuance of licenses for one-year periods, and in October, 1941, increased the period to two years.





## *Beating it out*

In the desolate hills of India, or in the dark regions of South Africa, the rhythmic beat of the marimba sets the tempo for daily life. Hung about the neck of the performer, or resting on the ground, the ten gourd resonators of the marimba are beaten, in the manner of the xylophone, with drumsticks which have heads of native rubber.

The marimba is regarded as the national instrument of Costa Rica. Here, in the United States, it is in popular usage by dance and orchestral bands. Listeners at home, who appreciate harmonicons of this type, demand clear, true recordings. It is good to know that exotic music, as well as all music, may be perfectly recorded on *Advance Glass Base Recording Blanks*. Each deftly struck note can be absolutely lifelike in reproduction . . . Try *Advance Glass Base Recording Blanks*, and be convinced of their superiority.

*The Need Is Great . . .  
Donate a Pint of Blood  
to the Red Cross Today*

38-12 34th Street • Stillwell 4-7837  
Long Island City, N. Y.

**Advance**  
**Recording Products**  
**Company**

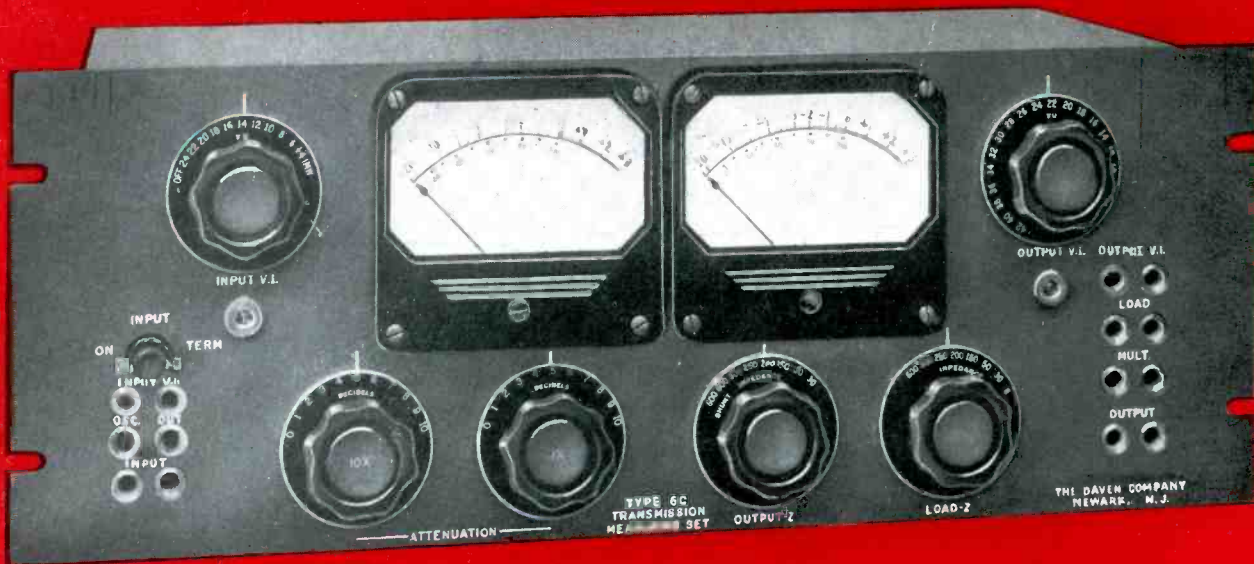

in **WAR** ...  
 performing our greatest peacetime task

Practically any reference to precision control in wartime brings to mind the wide use of DAVEN components in military and industrial applications. And yet, even now, our components are performing their greatest peacetime role. That is, control of radio transmission—not only for the major commercial broadcasting stations in this country, but for the communications transmitters which speed messages to all parts of the earth. DAVEN equipment will assume still greater importance in the postwar world of television, sound picture production and scientific laboratory development.

For many years, DAVEN has maintained a commanding position in a field where the standards for accurate control and measurement are set at the highest levels. Engineers specify DAVEN components where absolute dependability and extreme accuracy are essential. We produce not only the most complete line of precision attenuators in the world, but such specialized equipment as output power meters, transmission measuring sets, decade resistance boxes, volume level indicators and many other types of laboratory test equipment for electrical, broadcast, sound picture and television applications. May we send you a DAVEN catalog?

**THE DAVEN COMPANY**

191 CENTRAL AVENUE

NEWARK 4, NEW JERSEY

**BUY ANOTHER WAR BOND TODAY**