

SEPTEMBER 1984

\$3.00

BME

BROADCAST MANAGEMENT/ENGINEERING

PROGRAMMING &
PRODUCTION
LIVE LOCAL NEWS
VIA SATELLITE!



Also in this issue:

Audio Production Report ■ Editel/Chicago ■
Choosing an Audio Console ■ RCPC Preview

A True Stereo Console from the Leader in Television Consoles

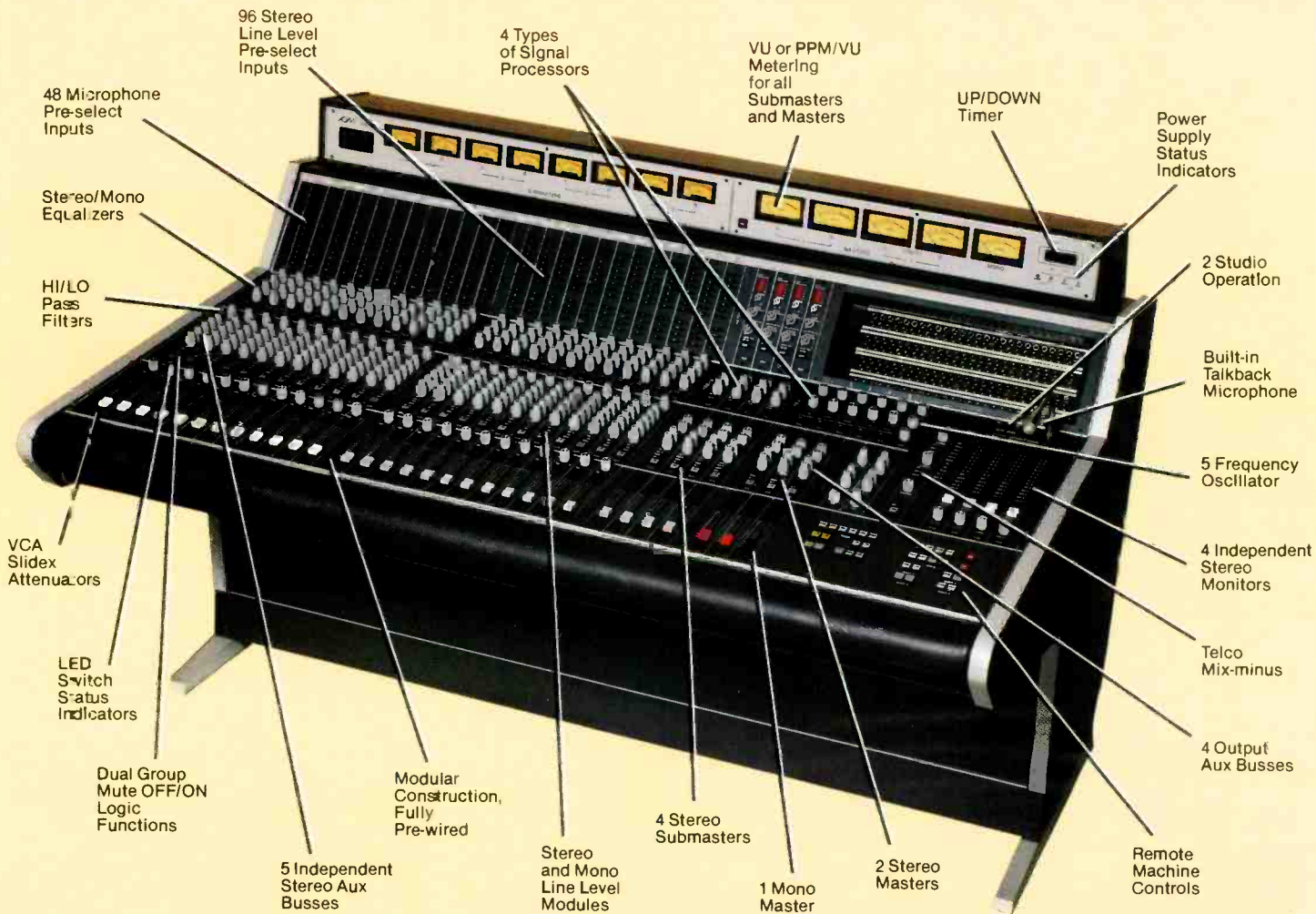

Once again, ADM is ahead of the entire industry with introduction of the new BCS series. Designed specifically for TV, the BCS is entirely new, not merely a rework of a mono console. The result is total stereo capability.

The new BCS series stereo television console is designed to make the transition to stereo television simple and manageable. And, like all ADM consoles, it carries an exclusive full 5-year unconditional warranty on both parts and labor.

For more information, contact ADM Technology, Inc., 1626 E. Big Beaver Road, Troy, Michigan 48084. Phone: (313) 524-2100. TLX 23-1114.

ADM provides more where it counts.
Can you afford anything less?

ADM[®]
The
Audio
Company

WEST CENTRAL SALES
(817) 467-2990

WEST COAST SALES
(415) 931-3082

MAIN OFFICE AND
EAST COAST SALES
(313) 524-2100

BOSCH**FGS 4000**

UPDATE

V I D E O G R A P H I C S Y S T E M

The FGS-4000 Produces Unsurpassed Video Image Quality

Is it presumptuous for us to suggest that the pencil is passé? The brush a bygone? To the traditional graphics designer, perhaps yes. To the video graphics designer, not really. But regardless of tradition, the designer with the most adequate tools can best implement his imagination. And those tools come from Bosch.

“It gives unlimited capability to design, generate, modify and manipulate two- and three-dimensional objects in three-dimensional space.”

Our reason for developing the FGS-4000 was really very simple. We wanted to give the graphics artist more freedom. To give him wings for flights of fancy. To give him a better way to unleash his energy. More than a character generator or electronic paint set, the FGS-4000 is a tool for handling objects in a very real and natural way.

This is not a one-button special effects box. The FGS-4000 is one of many electronic tools that has helped Bosch set or raise industry production standards. But while our products are based on the computer, they are built for the designer. In fact, they do not reach the market

until they are tested and proven by artists for artists.

Since this is a software-based system, the FGS-4000 comes with a future. As new software applications are developed over time, they will find a home in Bosch hardware. To the graphic designer in the video environment, that means the system will grow with *you* as well as with the industry. It means the system provides an unlimited capability to design, generate, modify and manipulate two- and three-dimensional objects in three-dimensional space.

The FGS-4000's image quality is exceptional. It is characterized by apparent resolution in 10 nanoseconds. There are no stair steps, breaking or tearing of edges when scaling, positioning or rotating objects. Images are completely recreated and anti-aliased at each frame, and appear virtually perfect at beginning and ending frames, and at every one in between. In fact, images produced by the FGS-4000 are indistinguishable from camera-entered graphics.

Bosch will help you get your hands on the FGS-4000 picture. We will train you in our new, fully-equipped facility. We will teach you both fundamental and advanced operating skills to help you free the visual images still locked in your imagination. You will work on a video graphics system so limitless that wonders become realities at your command.

How do you get your hands on the FGS-4000? Call (801) 972-8000. Or write to Video Equipment Division, Robert Bosch Corporation, P. O. Box 31816, Salt Lake City, Utah 84131.



The FGS-4000 creates an image quality comparable to that of a high quality TV. camera. Special anti-aliasing hardware continuously smooths out the edges, creating, at all times, clean images regardless of size. Seeing is believing.

Robert Bosch Corporation
Video Equipment Division
P.O. Box 31816, Salt Lake City, Utah 84131
(801) 972-8000



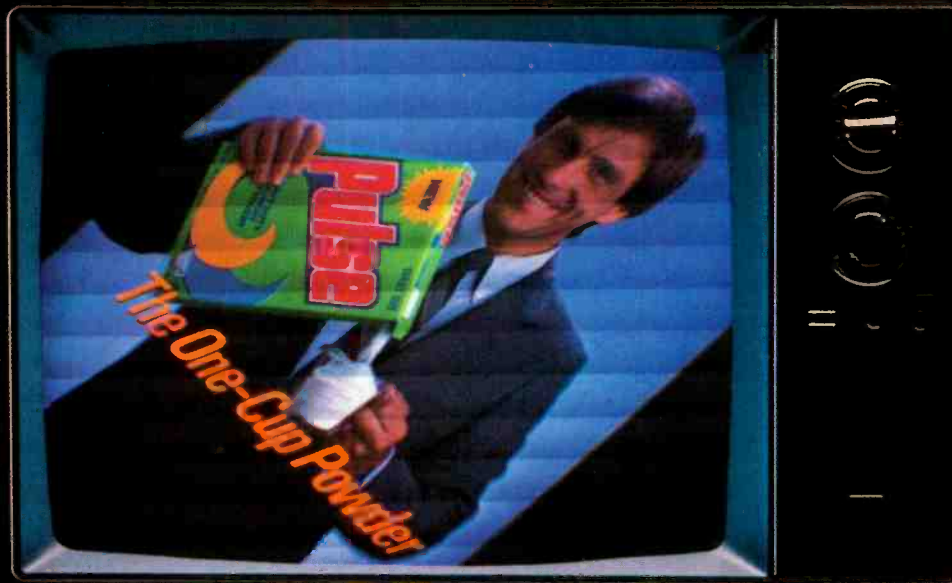

What you see above is yet another installment of TV's longest-running horror series: "The Lost Commercial."

The villain is the antiquated 2-inch cart machine—notorious for making valuable commercial air time vanish into thin air. And its appetite for destruction seems endless. Statistics show it's not unusual for a station to squander upwards of \$15 million yearly on makegoods alone.

But the nightmare is ending. Because Sony announces the first real advance in cart machine technology in over a decade. The new Betacart™ multicassette system.

THE CART MACHINE VS. THE SMART MACHINE.

What the old cart machine tried to do by mechanical means, the Sony Betacart achieves through superior intelligence.

Microprocessors keep constant track of 40 cassettes. They maintain the alignment of the system's four BVW-11 decks and its elevator. They run self-check diagnostic routines.

And, in the belief that an ounce of prevention is worth many times its weight in makegoods, they solve problems before they occur—such as warning a technician that he's about to remove a cassette that's due to air shortly.

The Betacart is communicative in other ways, too. It's smart enough to guide your technicians through its operation, and will even interface directly with your station's main computer.

MAINTAINING MACHINERY VS. MAINTAINING PROFITS.

The end result of all this electronic

THE MACHINE INSPIRED BY BILLIONS OF DOLLARS WORTH OF COMMERCIAL FAILURES.

sophistication is the kind of mechanical simplicity that virtually eliminates breakdowns—not to mention the makegoods, excessive downtime and high maintenance costs that are generally part of the package.

And, as its name implies, the Sony Betacart uses Betacam cassettes—which cost less than a third of what 2-inch cartridges cost. Its format also makes the system ideal for ENG use during newscasts—thanks to its compatibility with the Betacam™ camera/recorder, along with its multiple video and audio outputs and freeze/instant-start capabilities.

All these advantages, plus its low initial cost make the Sony

Betacart multicassette an investment that will pay for itself quickly. And it will keep paying off in new ways. Its stereo capability, for example, will allow you to capitalize on the coming introduction of stereo TV broadcasting.

For more information, call in New York/New Jersey (201) 833-5350; in the Northeast/Mid-Atlantic (201) 833-5375; in the Midwest (312) 773-6045; in the Southeast (404) 451-7671; in the Southwest (214) 659-3600; in the West (213) 841-8711.

After all, to err may be human. But there's nothing divine about having to forgive a machine.

SONY
Broadcast

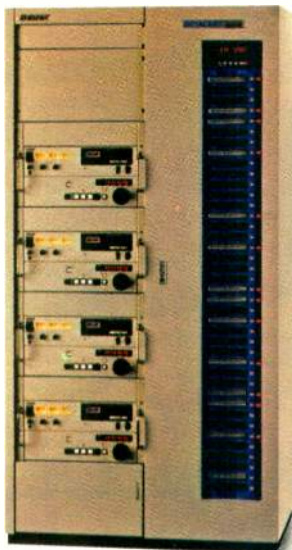

A Station Break on the HCC-55 is Kid Stuff!

BM/E

BROADCAST MANAGEMENT/ENGINEERING

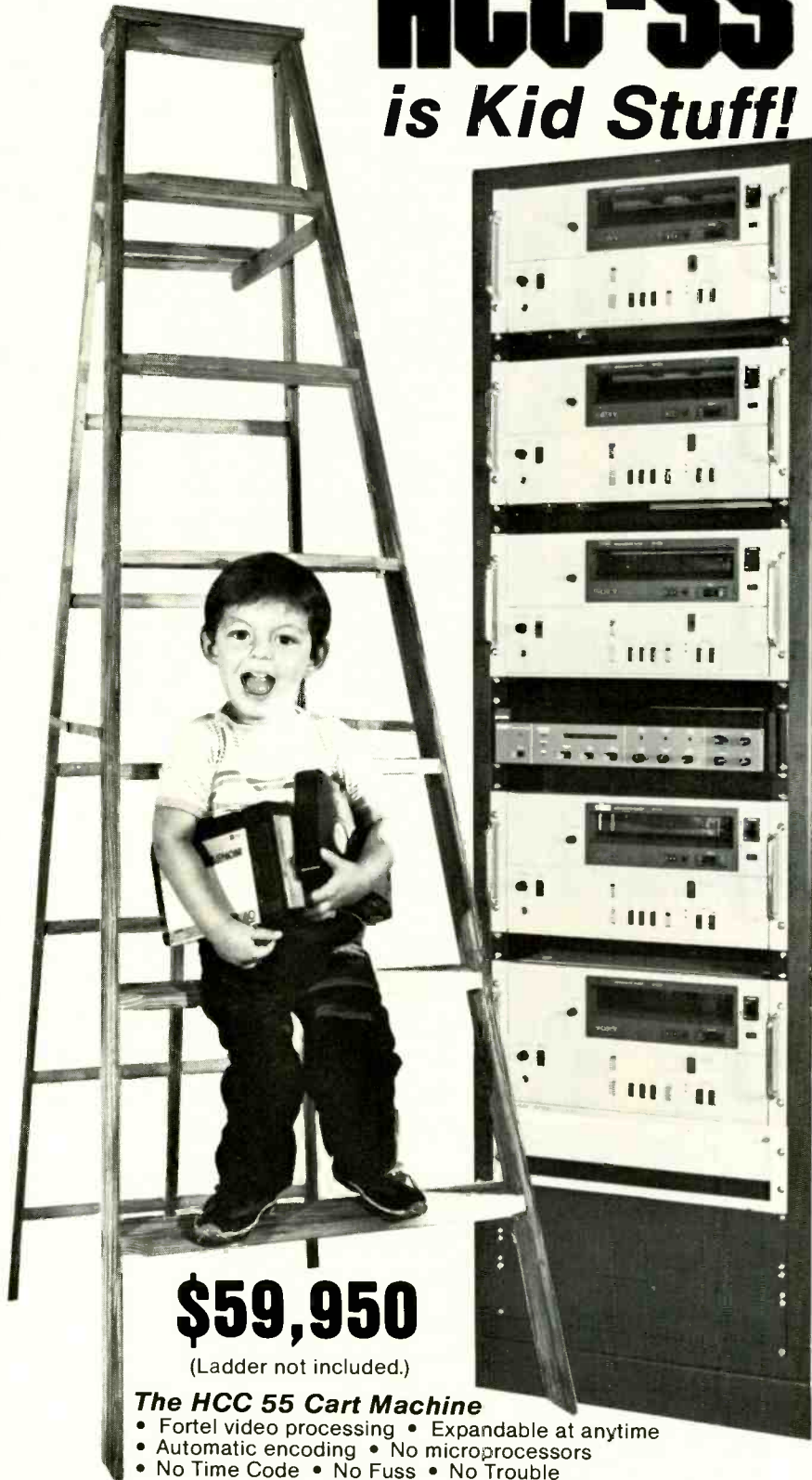

\$59,950

(Ladder not included.)

The HCC 55 Cart Machine

- Fortel video processing
- Automatic encoding
- No Time Code
- No Fuss
- No Trouble
- Expandable at anytime
- No microprocessors

HUBCOM

HUBBARD COMMUNICATIONS, INC.

10383 Oak Street N.E. • St. Petersburg, FL 33702-1894
813/577-7759 • Twx: 810-863-0417

Publishing Director
Charles C. Lenz, Jr.
Editor Emeritus
James A. Lipke

Publisher
William McGorry

Editor
Robert Rivlin
Senior Editor
Eva J. Blinder
Associate Editor
Michael Greenhouse
Assistant Editor
Douglas Damoth
Copy/Research Editor
Michael Starr

FCC Counsel
Bechtel & Cole
Broadcast Financial Consultant
Mark E. Battersby
Special Projects Editor
C. Robert Paulson

Art Director
Edwin Torres
Design Assistant
Annette Fernandez

Production Director
Nick Tartaglia
Advertising Coordinator
Sharon Porges

Associate Publisher
Neal Wilder
Marketing Services Director
Liz Schroeder

Marketing Services
Kathryn Petersen

Controller
Michael J. Lanni
Assistant Controller
Andrea Bettke

BROADBAND INFORMATION SERVICES, INC.

295 Madison Ave., New York, N.Y. 10017
212-685-5320, Telex: 64-4001

Publishers of:

BM/E—Broadcast Management/Engineering
BM/E's World Broadcast News

ABP

BPA

BM/E BROADCAST MANAGEMENT ENGINEERING (ISSN 0005-3201) is published monthly by Broadband Information Services Inc. Postmaster: Send address changes to BM/E—Broadcast Management/Engineering, 295 Madison Ave., New York, NY 10017. BM/E is circulated without charge to those responsible for station operation and for specifying and authorizing the purchase of equipment used in broadcast facilities in the U.S. and Canada. These facilities include AM, FM and TV broadcast stations, CATV systems, ETV stations, networks and studios, audio and video recording studios, telecine facilities, consultants, etc. Subscription prices to others \$24.00 one year, \$36.00 two years. Foreign \$36.00 one year, \$60.00 two years. Air Mail rates on request. Copyright 1984 by Broadband Information Services, Inc., New York City. Second class postage paid N.Y., N.Y. and additional mailing offices.

HOURS AWAY,

GET TOUGH . . .

MRC-1600

Remote control is sometimes more remote than control. Not so with the MRC-1600 Microprocessor Remote Control. It's Moseley tough, Moseley reliable, and Moseley designed to give broadcasters flexibility at a not-so-tough price. Sixteen raise/sixteen lower command channels, coupled with sixteen status and sixteen telemetry channels, assure control and feedback of critical operation parameters to the station. Power-down problems? All setup data is stored in Moseley Memory. Plug-in modules adapt the MRC-1600 to two or four wire telco lines, subaudible, FM subcarrier or any combination thereof.

MRC-1600 operation is tailored to individual station requirements during setup. Status inputs may be set to alarm on rising, falling, rising and falling waveforms, or they may be muted completely. Upper and lower telemetry limits can be set or disabled independently. Each telemetry channel may be calibrated in one of four modes: power, indirect power, linear or millivolt. Should there be a disallowed change in status, or telemetry data exceed pre-set limits, visible and audible alarms are activated. When the operator acknowledges the alarm, the MRC-1600 automatically displays the data needed to correct the situation. The optional CRT gives the operator keyboard control of the transmitter and provides a clear-English display of all status and telemetry data, which is printed on the optional Logger. Tough remote site? Get Moseley tough.

- 16 RAISE/16 LOWER COMMANDS
- 16 CHANNELS, STATUS AND TELEMETRY
- NON-VOLATILE MEMORY STANDARD
- USER-DEFINABLE ALARMS
- CRT AND LOGGER AVAILABLE

Circle 103 on Reader Service Card

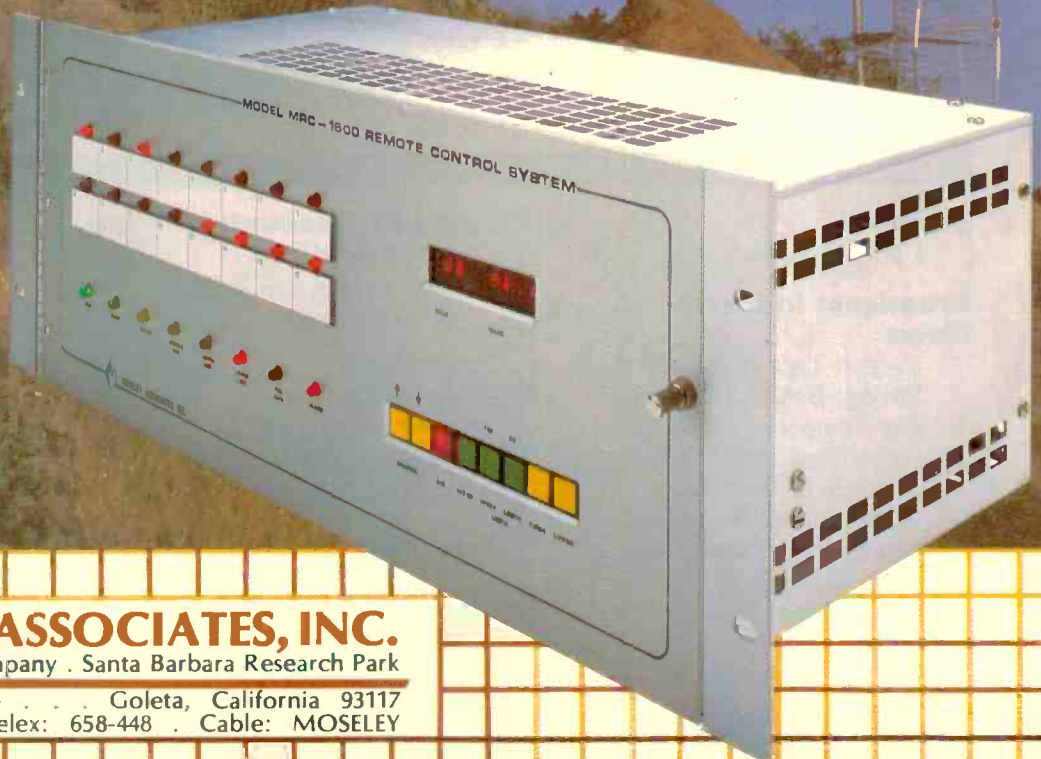

Get Moseley Tough,
Contact Moseley Marketing.

MOSELEY ASSOCIATES, INC.
A Flow General Company . Santa Barbara Research Park
111 Castilian Drive . . . Goleta, California 93117
(805) 968-9621 . Telex: 658-448 . Cable: MOSELEY

BME

BROADCAST MANAGEMENT/ENGINEERING

SEPTEMBER 1984

VOLUME 20/NUMBER 9

FEATURES

ON-AIR GRAPHICS PRODUCTION

42

Should on-air graphics be produced in-house or left to the experts at production companies? No matter what your choice, there are dangers at every turn . . . by *Michael Greenhouse*, Associate Editor.

Cover art prepared by Slide Systems Inc. NYC: Cover images, counter-clockwise: "Channel 7" in house by KATV, Little Rock, AK, with Dubner CBG-2; "Spirit of Texas" by Acme Cartoon, Dallas, TX; "WTBS Theatre" bumper by TV By Design, with Chyron IV/MGM; "Channel 4 London" by Digital Effects, NYC, director George Parker, animators Don Leich, C. Robert Hoffman III; "WNEW-TV 5" by California Film, Los Angeles, creative director Wendy Vanguard; "NBC Be There" promotion produced for Marks Communications by Pacific Data Image, Sunnyvale, CA, animator Glenn Entis; "The Weekend Movie" by Artronix Computer Arc Services, Seattle, WA, with MCI/Quante! Paint Box; "Cityscape" in house by Chyron, With Chyron IV/MGM; "Rock'n'Roll" by Charlex, NYC; "Channel 9" by Pacific Data Image, creative director Lee Minard, animator Don Venhaus; "Channel 3" in house by Aurora Systems, San Francisco, created by Aurora artist Richard Sloss.

PRODUCTION FACILITY REPORT: EDITEL/CHICAGO

61



Despite state-of-the-art technology, this large midwest facility places its emphasis on talent and techniques . . . by *Michael Greenhouse*.

AUDIO PRODUCTION REPORTS

73

Spurred by advances in technology, radio and television stations around the country are creating some unusual audio productions . . . by *Eva Blinder*, Senior Editor.

FACILITIES DESIGN AND ENGINEERING: PART 14

93

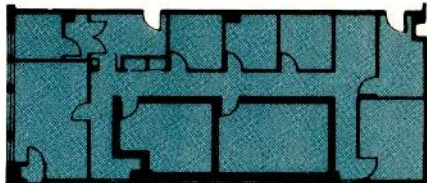

Choosing a Low-Cost Audio Production/Post-Production Console . . . by *Dick Rosmini*.

RCPC PREVIEW

105

A look at the first Radio Convention and Programming Conference being held this month in Los Angeles.

DEPARTMENTS

Editorial

Up With Radio!

10

Broadcast Industry News

¾-Inch Tape Format Still Strong; BMI All-Industry Fee Tempest Brews; TV Advertisers to Log Commercials in Test; RCA CCD Camera Sees Convention Use; Ampex Predicts DVTR Within Year of Standard

12

Radio Programming and Production

New Production Room Caps Changes at WZGO

29

Television Programming and Production

Live Local Remote Via Ku-Band Satellite

37

Advertisers Index

112

FCC Rules and Regulations

117

Renewal Expectancy

in the "Age of Deregulation"

Broadcast Equipment 121

Business Briefs 130

COMING IN
OCTOBER:
SMPTÉ PREVIEW
SATELLITE NETWORK
CENTERS
NEWSROOM COMPUTERS

We couldn't improve the conditions you work under. So we improved the tape you work with.

HGX Pro 1/2" Videocassettes.

Differences you can see, hear. And retain.

At last, tape performance impervious to the whims of weather and the rigors of editing. Harnessing new tape technology, Maxell brings ENG dramatic improvements you can see, hear and retain.

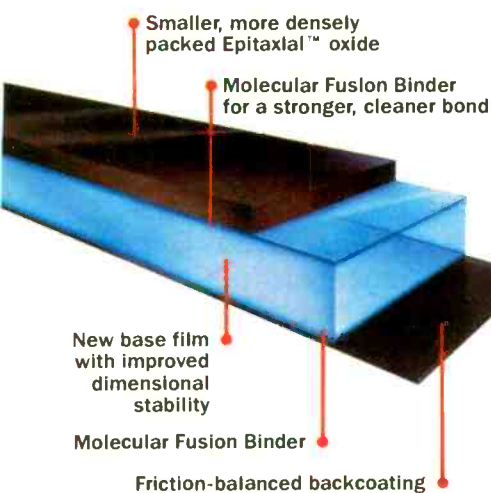

The Epitaxial™ contribution: higher video, brighter chroma.

A new, smaller oxide achieves unprecedented packing density. Expect enhanced signal-to-noise. Better definition. And extended replays without signal loss.

Molecular Fusion Binder: longer life bonding for truer-to-life performance.

A bond immune to time, temperature or mechanical stress. With no need of plasticizers, so none can creep to the surface. Anticipate far fewer dropouts, less clogging and extended tape and head life.

New base, binder, backcoating. Better support for the signal.

No static. No noise. No dust. The molecular-fused backcoating assures diminished mechanical and magnetic noise. And optimum running smoothness, even in high heat.

A shell made to the industry's toughest standards.

Ours. The transport is quiet, jam-proof. The housing immune to temperature extremes.

From open reel tapes to a complete line of KCS/KCA U-Matics, audio and VHS/Beta cassettes, we're getting quality down to a science. And in your hands, our science turns to art.

HGX Pro 1/2" Videocassettes in Beta and VHS.



maxell



GOODYEAR

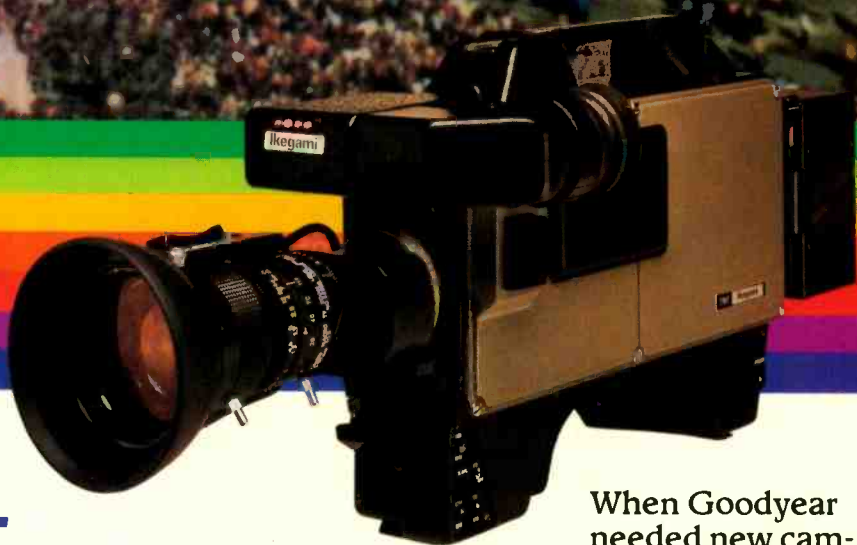

**Midwest
and Ikegami
put Goodyear
on top of
the action**

When Goodyear needed new cameras for their fleet of airships, they contacted the company with over 20 years experience in meeting the needs of the communications industry . . . Midwest Corporation. To keep Goodyear on top of the action, the obvious choice was Ikegami's HL-79.

The HL-79 was designed to meet – and surpass – the most rigorous standards of performance. Although small and light enough to be used as a handheld camera, the HL-79 produces a higher quality image than many other manufacturers' top-of-the-line studio cameras. By using the

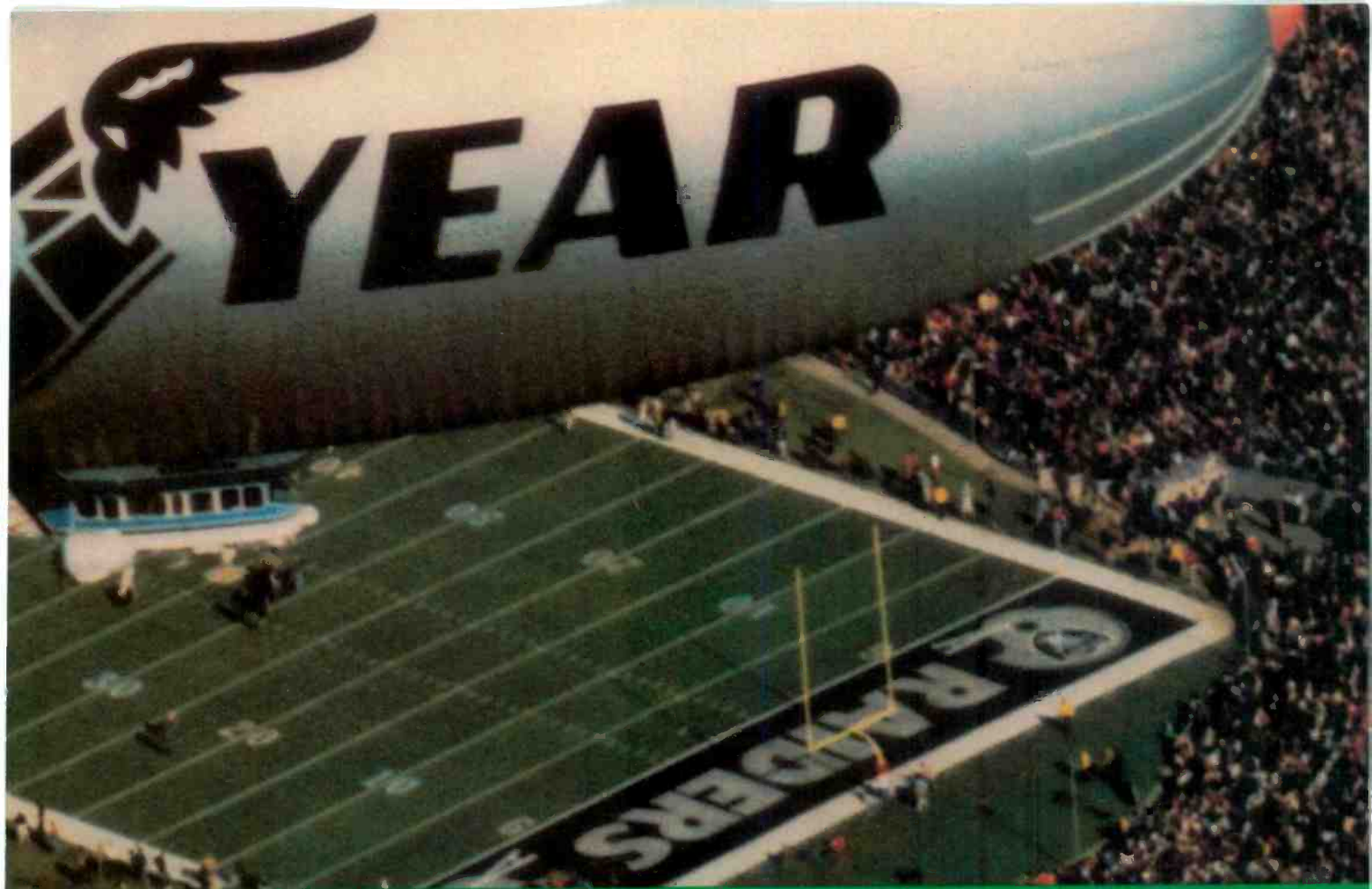

Ikegami HL-79, Midwest ensured that Goodyear would continue to rise to the occasion. The next time you see a sporting event covered by a Goodyear Blimp, chances are that you are seeing Ikegami performance first hand.

With our unique systems approach we at Midwest can custom design and supply anything from mobile units to teleproduction systems with Ikegami cameras as the basic ingredient. And with Ikegami, you can depend on our systems to produce top quality results under the most adverse conditions.

Contact Midwest and we can help keep you on top of the action, like Goodyear Aerospace.



**One Sperti Drive
Edgewood, KY 41017**

Cincinnati, OH
606-331-8990
Columbus, OH
614-476-2800
Dayton, OH
513-298-0421
Cleveland, OH
216-447-9745
Pittsburgh, PA
412-364-6780
Indianapolis, IN
317-251-5750
Detroit, MI
313-689-9730
Grand Rapids, MI
616-796-5238
Louisville, KY
502-491-2888
Lexington, KY
606-277-4994
Charleston, WV
304-722-2921

Clarksburg, WV
304-624-5459
Nashville, TN
615-331-5791
Bristol, TN
615-968-2289
St. Louis, MO
314-225-4655
Atlanta, GA
404-875-3753
Virginia Beach, VA
804-464-6256
Charlotte, NC
704-399-6336
Richmond, VA
804-262-5788
Washington, DC
301-577-4903
Miami, FL
305-592-5355
Tampa, FL
813-885-9308

**Call Toll Free
800-543-1584
(In Kentucky 606-331-8990)**

Circle 105 on Reader Service Card

Up With Radio!

When the gavel comes down at the opening of the Radio Convention and Programming Conference (RCPC) later this month in Anaheim, the entire radio industry should bear witness to the historical event. For despite their traditional political differences, NRBA and NAB are joining forces, combining the NRBA show and NAB Radio Programming Conference into a single, unified event.

Declining interest in both shows recently was certainly part of the motivation for joining forces. But the RCPC also represents a coalition with far more important consequences than simply swelling the coffers of the two trade organizations.

In fact, management, engineering, and programming at radio stations have always been unified, and should never have been split into separate factions in the first place. At smaller stations, the three functions are sometimes combined. And at larger stations, with separate GMs, CEs, and PDs, the spirit of cooperation has never been greater. Gone are the days when management simply handed over a capital budget to engineering and said "do what you want," or when programming acted as if it were part of a separate business unit. It is the team approach which is lifting radio into the ranks of greatness again, and the team which must be supported if radio is to continue to grow.

We at *BM/E* wholeheartedly support the RCPC as the first step towards unification of the radio industry. And we urge forward-thinking radio broadcasters in all disciplines—management, programming, engineering, and production—to give it their wholehearted support as well. "United we stand..." has never had greater economic implications.

Worth Its Wait In Gold.

For Harrison Reliability

Sure, Harrison has waited to enter the U.S. broadcast market. When you're a stickler for precise engineering and a perfectionist when it comes to quality performance – you've got to take your time to get it right. *Get it just right for you.*

No Compromises

It can be tough getting the right console to match your specifications. About as easy as fitting a square peg in a round hole, right? Harrison Systems has anticipated your need for versatility. A good deal of time and research goes into our consoles in order to bring you the smartest, most efficient technology and service. We've got the system that fits the size and scope of your needs, whether it be:

- Teleproduction
- Video Sweetening and Post-Production
- Video Edit Suite
- Film Sound Post-Production
- On-Air Broadcasting
- Broadcast Production
- Live Sound Reinforcement
- Music Recording and Scoring

At Harrison Systems, we give you choices – not excuses or unnecessary fluff. Our systems are designed to bring you long-lasting, clean performance and reliability.

Harrison Puts You In Good Company

Organizations like Swiss Broadcasting and Belgian Radio and Television have believed in the superior quality of Harrison Stereo Broadcast Audio Consoles for years and have chosen Harrison for multiple broadcast installations. Swedish Television has selected 8 TV-3 consoles and has committed to several more. This year's Winter Olympics in Yugoslavia received the main audio feed from a TV-3.

At Last

At Harrison, we take the time to listen to your needs. We design our consoles with the flexibility to fit your operation. And although our standards may be high for our consoles – our prices are very, very reasonable. We think you'll find it's been worth the wait – in golden, Harrison-true performance. Call us for a demonstration and see for yourself.

For Harrison Innovation

Introducing Harrison's TV-3, PRO-7 and TV-4, the broadcast consoles you've been waiting for:

TV-3 For large scale TV audio, remote production, studio production, post-production and sweetening ■ Adapts to wide range of tasks ■ Available in a variety of configurations for customization ■ Plus many options.



PRO-7 Designed for comprehensive use in broadcast, live sound, motion picture teleproduction ■ Two major configurations ■ Simple to operate ■ Cost-effective ■ Independent mix decision capability ■ Long-term performance achieved through thick-film laser-trimmed resistor networks ■ Plus many options.

TV-4 For medium scale on-air production, remote production, studio production, sweetening and post-production ■ Three major, simplified configurations ■ Easy to install ■ High-speed, low noise, low distortion amplifiers allow for best possible electronic performance ■ Plus many options.

Harrison's new VSI Fader Section, which allows for simultaneous interface with automation and video editor/switcher, is available for TV-4 and PRO-7 consoles.



Why wait any longer? Call or write Harrison Systems, Inc., P.O. Box 22964, Nashville, TN 37202; (615) 834-1184, Telex 555133.

**Harrison**

RCA CCD Camera Sees Convention Use



NBC correspondent Connie Chung on floor of Democratic National Convention with RCA CCD camera.

The new RCA CCD-1 solid-state CCD camera saw its first on-air use recently at both the Democratic and the Republican national conventions.

NBC used two cameras at each convention, using them on the floor in the midst of the action, then relaying the signal to the control room by micro-

wave. The cameras' high sensitivity, lack of smearing, and ability to handle a wide contrast ratio in the same frame made them ideal for floor coverage where lighting conditions cannot be controlled.

TV Advertisers to Log Commercials in Test

A remote system for monitoring the presence and quality of aired television commercials will start a six month test this December in Los Angeles, Chicago, and New York. Telescan, Inc. will code line 20 of the vertical interval to watch for commercials run by participating advertisers, which currently include Pepsico and Kinney Shoes Corp. If the test attracts enough attention, Telescan hopes to establish itself as the advertisers' version of station logs, especially for the spot market.

The key to the whole system is encoding a standard commercial number (ISCI) on line 20 of the vertical interval for all frames of commercials put out by participating advertisers. A.C. Neilson currently uses line 20 within programs to monitor individual sets. Telescan plans to set up a receiver in each of the cities it will monitor and scan as many as 10 channels per second, cable as well as broadcast, watching for encoded commercials. The duration will be noted along with the presence of audio, video, color, and noise, and will be stored with the time and channel on a computer. A master computer will poll the remote sites and assemble daily and weekly reports for the advertisers or their agencies.

Telescan cites two statistics to support its belief that advertisers will pay for this information. Estimates of the error rate for television commercials range from half a percent to five percent, according to Jonathan Feller, marketing manager for Telescan, while spending for spot and network TV advertising runs about \$18 billion annually. Telescan says its fees will cost approximately one-tenth of one percent of gross billings, or about \$10,000 on \$10 million worth of airtime.

Feller suggests that errors such as a few seconds of missing audio may not always be noted on invoices and that these mistakes may increase with the FCC's deregulation of logging. The

KSL Finds New Home in Salt Lake's Triad Center

After more than 30 years in a former automobile showroom, KSL-TV and KSL Radio have moved to prestigious quarters in Triad Center, a brand-new complex in downtown Salt Lake City. The 130,000 square-foot facilities, designed by Kansas City architect Jay Ritchie in close consultation with station personnel, even have a helicopter landing pad on the roof.

The move, which also included production arm Video West and parent company Bonneville International Corp., puts the stations at the top of the technological heap, with studios floated within the main structure for full sound isolation. Both the television and radio sides are fully stereo capable; KSL Radio has been broadcasting AM stereo since 1982 and KSL-TV plans stereo operations in the near future.

For the news departments, a keystone of the modernization is the Newstar newsroom computer system from Colorgraphics. KSL has switched entirely to electronic storage, processing, and writing of news with Newstar, which also

gives reporters instant access to wire service material.

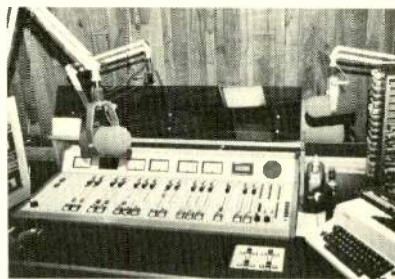

KSL Radio studios are floated and fully isolated for top audio quality.



New KSL-TV editing room-with-a-view is designed for operator comfort and convenience.

THE FIRST 3-CHIP CCD CAMERA IS ON THE STREET.

NEC's 3-chip CCD camera is making news all over America.

In fact, it's making history.

SP-3 is the first ENG camera without pick-up tubes inside. So it's the first to eliminate burn-in, retubing, and the hassle of re-registration.

With SP-3, NEC takes imaging quality out of your hands and puts it in the chips. To be precise, 3 solid state CCD chips.

Chips which give you more than 450 lines of beautiful color resolution. For any VTR: M-format, Beta™, 1/4 and 3/4 inch.

Chips which eliminate comet tails, burn-ins, and sticking.

Chips which make the SP-3 so rugged, you could probably drop it on a sidewalk and still get the picture.

Yet, the SP-3 head weighs only 5.9 lbs. and draws a scant 12 watts of power. So it'll never be a drag on those long city blocks.

And the price? Perhaps the most newsworthy part of our story. \$16,900 for the camera without lens. To find out more, call NEC toll free at 1-800-323-6656.

Just remember. If you want reliability, it's in the chips. And on the streets.

NEC

IMAGINE WHAT WE'LL DO FOR YOU

NEC America, Inc., Broadcast Equipment Division
130 Martin Lane, Elk Grove Village, IL 60007
In Illinois 312-640-3792.

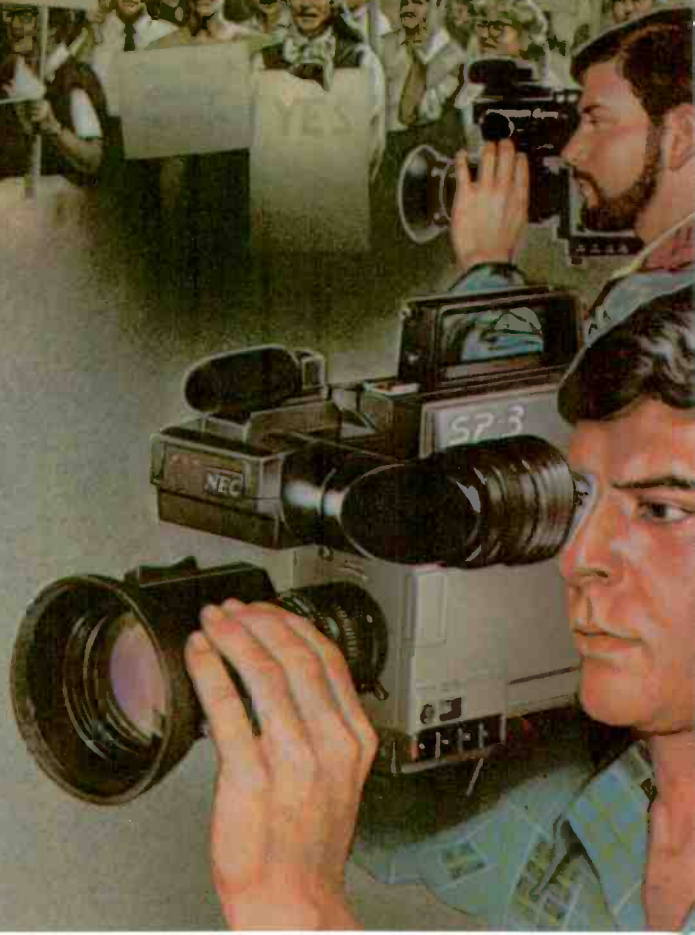

YOUR WORLD

A building collapses. You send your best crew to cover it. Under the worst conditions possible—flying dust, falling debris, crowds and chaos—they've got to get the story. And that means you've got to back them with the best equipment you can get—right down to the tape.

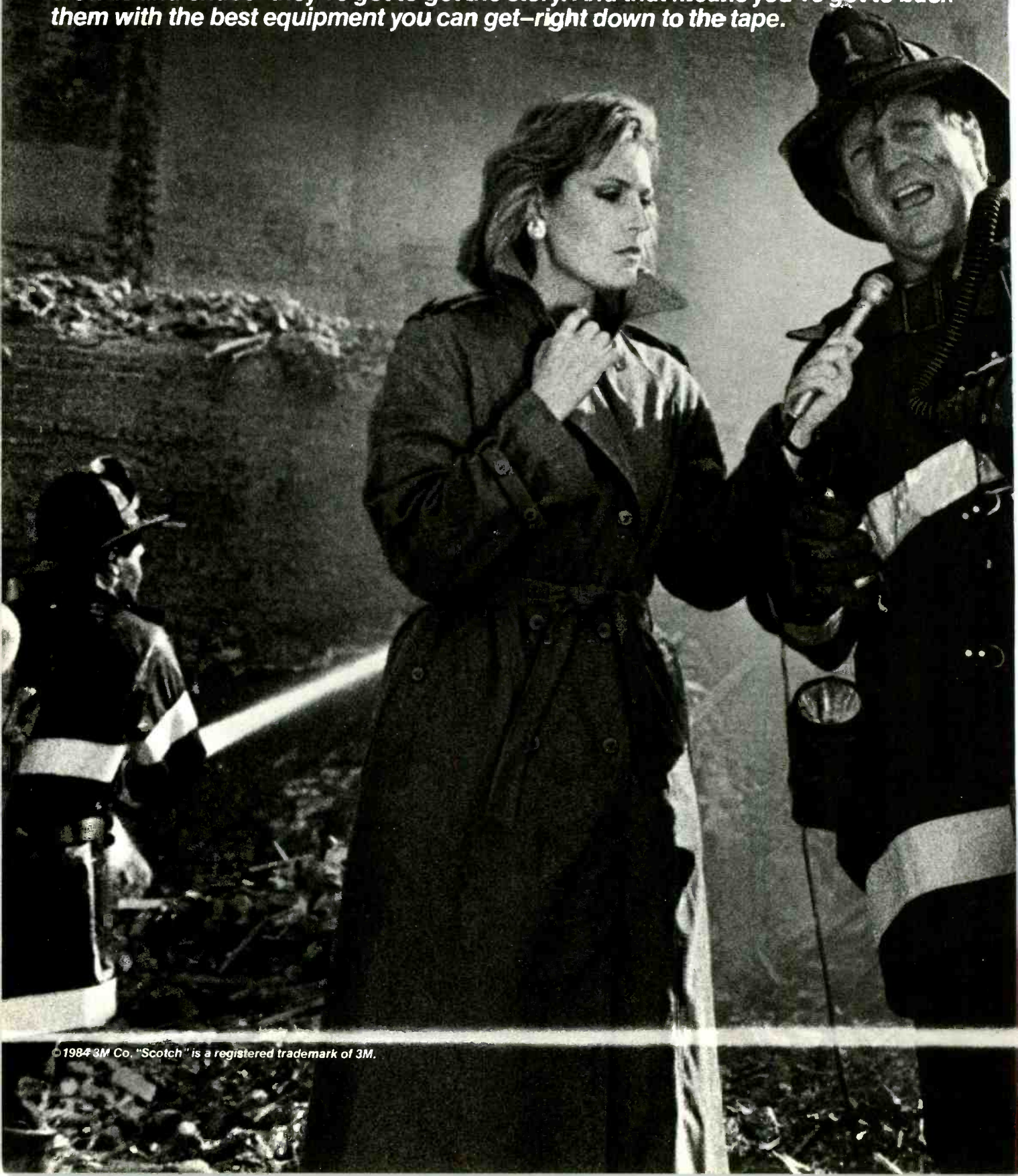

OUR TAPE



dust can be as big a problem as deadlines. Dust that is drawn by the static charge on your videocassette—causing the transient dropouts that destroy a picture. So

INDUSTRY'S LOWEST ELECTROSTATIC CHARGE

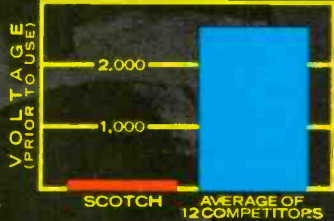

we've created the Scotch® Color Plus Super High Grade 1/2 Inch Videocassette. With our exclusive new Anti-Stat Treatment for the industry's lowest electrostatic charge levels—detering dust better than any other videocassette. And with the durability to withstand the stress of editing and high speed recording. Available in our unique Hanger Case for Professional VHS and Beta (PV and PB) in ten and twenty

minute lengths. All backed by our engineers a call away. Scotch Color Plus Super High Grade 1/2 Inch Videocassettes. One more reason we're...number one in the world of the pro.

We know that in your business,

Scotch®

AUDIO & VIDEO TAPES

NUMBER ONE IN THE WORLD OF THE PRO

3M

company says it will supply functional specs to any broadcaster who wants to examine its setup.

Telescan especially hopes to interest retail advertisers who pay extra for commercial rotations and cut-ins. Companies conducting surveys of a commercial's effectiveness will want both the "quality control" and daily availability of results the system offers, says Feller.

20,000 Attend SIGGRAPH Computer Graphics Show

A record number of attendees — over 20,000—flocked to Minneapolis in late July for the annual SIGGRAPH conference, arranged by the Special Interest Group on Computer Graphics of ACM, the Association for Computing Machinery, the country's largest computer trade organization.



The Bosch FGS-4000 was one of the most popular new items at the SIGGRAPH computer graphics show.

Especially significant were the presence of large numbers of TV and teleproduction/post-production graphics people, and the emergence of hardware developed for the TV industry as "hot" items on the exhibit floor. Last year it was MCI/Quantel's Paint Box, which stole crowds away from products developed especially for the CAD/CAM industry. This year it was Bosch's turn, with every demonstration of the FGS-4000 attracting overflow crowds. In the computer graphics industry, of course, real time manipulation of three-dimensional solids is only a very recent development, and those in the computer graphics business wondered where the Robert Bosch Co. had been all their lives.

Also popular at the show were hard-

ware exhibits put on by other companies which have made their reputations in broadcasting—the Dubner CBG, for example, and the Computer Graphics Lab Images system (although the latter was developed by people within the computer graphics industry itself). Several monitor manufacturers known well to broadcasters—Ikegami, Conrac, Barco, Dynair, and several others—were on hand with their high-resolution RGB models.

For many, the most impressive feature of SIGGRAPH is the film and video show, *The Electronic Theater*, in which researchers, artists, and producers put together their best computer graphic work. This year it was presented to two packed audiences on successive evenings at the Minneapolis Auditorium. Again, the TV and post-production side of the computer graphics business was not without representation. Broadway Video showed its reel, containing the award-winning Paul Simon video "Mr. and Mrs. Magritte." Videograf, a New York City-based production company working with a Via Video system, showed "Seasons," a real-time animation produced for *Sesame Street*. And Dean Winkler of VCA-Teletronics showed a selection from "Wallpaper," an hour-long background visual designed to be used in discos.

There were also numerous demonstration reels from computer graphics production companies which specialize in creating on-air promos and IDs for networks and TV and radio stations, among them Robert Abel and Associates, Digital Effects, Digital Productions, Cranston/Csuri, Bo Ghering, MAGI/Synthavision, Computer Creations, Pacific Data Images, Omnibus, and Acme Image.

Fiberoptics Provides Olympic Communications

While Olympic planners were worrying about moving athletes and spectators along Los Angeles' famous freeways, Pacific Bell faced the even more arduous task of moving voice, video, intercom, and data signals into, out of, between, and beyond the far-flung venues. The solution involved a complex fiber optic network with over 300 miles of cable routed through 19 45-foot mobile

telecommunications trailers.

For example, ABC got its signal out of the venues by feeding the broadcast output from its on-site video trucks to the Pacific Bell trailers. Lyle Bradt, assistant staff manager for Pacific Bell and in charge of the trailers at the Los Angeles Coliseum, explains, "We take the analog video signal from ABC's studio compound at the Coliseum and process it through a digital converter. It's then sent over



Lyle Bradt displays fiber optic cable in Pacific Bell's mobile telecommunications facility at the Los Angeles Coliseum.

the existing facility lightwave network to the receiving end in Hollywood, where it's converted back to an analog signal."

In addition to the broadcast video, the trailer served as a "telephone office on wheels" for the approximately 1200 telephones installed at the Coliseum, with comparable demands at the other venues. "The facility is fully self-contained," Bradt continues. "If there's a power outage, we have about 12 hours of battery backup available. There's also a diesel turbine generator with about 100 hours of fuel."

Journalists covering the Olympics—as well as the athletes themselves—were able to avail themselves of another Pac Bell fiber optic service, the electronic messaging system (EMS). Reminiscent of a super-large-scale newsroom computer system, the EMS system consisted of about 2000 AT&T-supplied Teletype terminals and printers scattered around the 4500 square-mile Olympic area. The system's database, developed by the Los Angeles Olympic Organizing Committee, supplied instant information on the various events, records, teams, and individual athletes. In addition, within 60 seconds after the completion of an event, information on winners and scores was plugged into the EMS system and made available at all venues.



**Seven types of video tape,
one reply card,
and all you have to do is mail it in.**

Please have a salesman contact me. Please send me more information.

My interest is in the following tape formats.

2" 1" 3/4" 3/4" BR 1/2" 1/2" Prof. Bulk Product (Specify _____)

Name _____ Title _____

Company Name _____

Address _____ Telephone _____

City _____ State _____ Zip _____

FUJI. Nobody gives you better performance.

© 1984 Fuji Photo Film U.S.A., Inc., Magnetic Products Div., 350 Fifth Avenue, NY, NY 10118 (212) 736-3335



NO POSTAGE
NECESSARY
IF MAILED
IN THE
UNITED STATES

BUSINESS REPLY CARD

FIRST CLASS PERMIT NO. 5310, NEW YORK, N.Y.

POSTAGE WILL BE PAID BY ADDRESSEE

FUJI PHOTO FILM U.S.A., INC.
Attr: Thomas Daly
Magnetic Products Division
350 Fifth Avenue
New York, N.Y. 10118

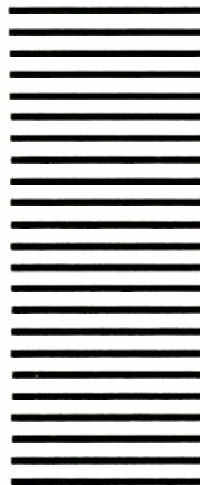



What good is a \$75,000 video recorder when the video tape gives a two-bit performance?

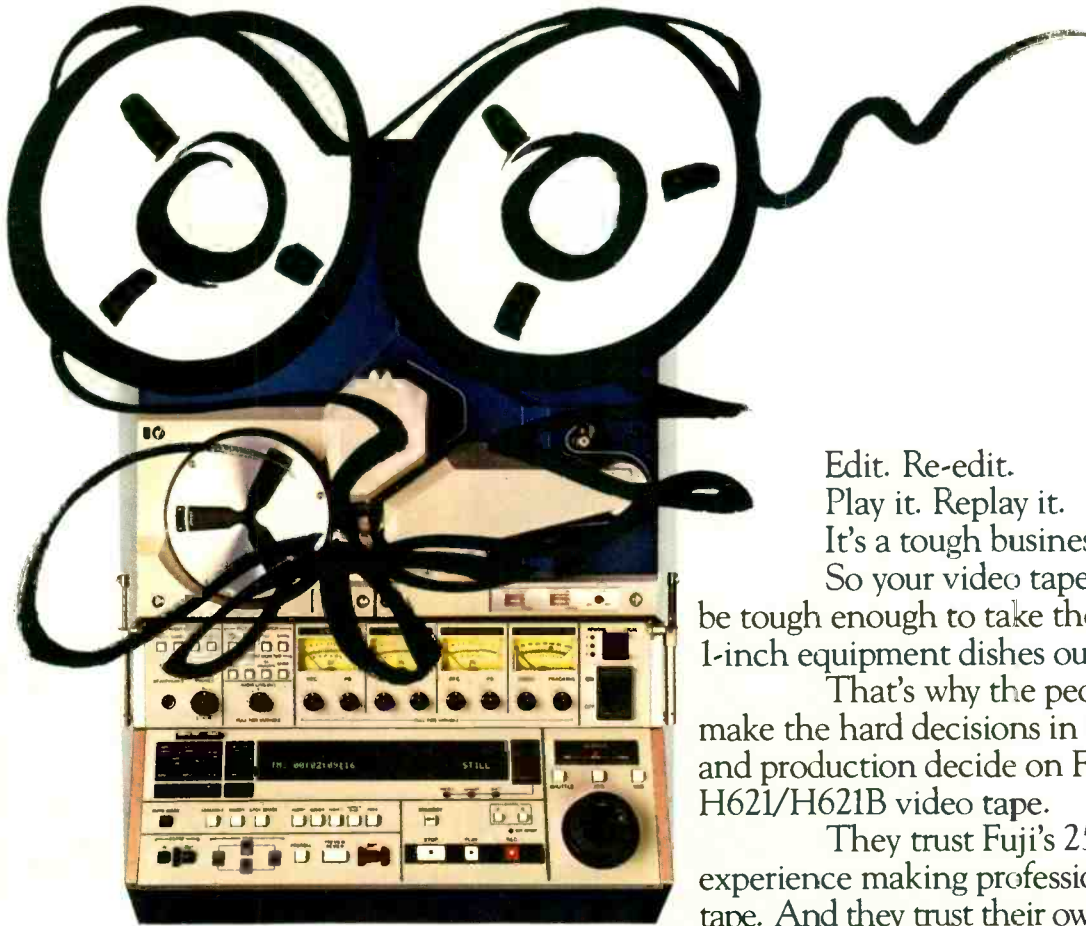

Edit. Re-edit.
Play it. Replay it.
It's a tough business.
So your video tape has got to be tough enough to take the beating your 1-inch equipment dishes out.

That's why the people who make the hard decisions in broadcasting and production decide on Fuji 1-inch H621/H621B video tape.

They trust Fuji's 25 years of experience making professional video tape. And they trust their own experience.

With Fuji, they know that our high-density BERIDOX formula and special back-coating deliver picture quality that's consistently vivid, even after multiple generations. They know that dropouts drop down to a minimum. And that valuable video heads are protected to a maximum.

If you want to know more about what makes Fuji's extraordinary video tape the first choice of professionals, just do a very ordinary thing.

Run to your phone and call Fuji. And we'll show you a tape you can run and run and run and run and run and run.



FUJI.

Nobody gives you better performance.

© 1984 Fuji Photo Film U.S.A., Inc., Magnetic Products Div., 350 Fifth Avenue, NY, NY 10118

Circle 108 on Reader Service Card

Reporters could use the terminals to call up information, write their stories, and even transmit them via the Western Union Telex network.

According to Ron Keller, senior engineer at Pac Bell, "The fiberoptic network will contribute to the growth of the Los Angeles telecommunications network. The only link that will be removed is the one between the trailers and the central office." Because of the compact size of the fiberoptic cables, they can be fed through existing cable

lines without tearing-up the streets, Keller added.

Hitachi SR-3 Sees Convention Service

Part of the massive engineering effort which ABC put into covering the LA Olympics were several systems being evaluated for future use by the network. Among these were the Hitachi SR-3 "Quarter Recorder" recorder/camera combination using quarter-inch tape.

The entire package weighs but 22 pounds, including battery, lens, and tape, making it ideally suited for EFP coverage such as interviews of team members done on location around Los Angeles. Following the Olympics, the camera was shipped off to cover the Republican National Convention.

Besides its light weight, the SR-3 boasts high signal quality, with three 3/4-inch Plumbicon or Saticon tubes and composite or component output. The recorder uses the newly developed metal particle or metal oxide tape, and provides a full 21 minutes of recording time.

3/4-Inch Tape Format Still Strong

Three-quarter inch videotape remains the strong industry standard despite incursions from newer formats and dissatisfaction with 3/4-inch quality, especially among engineers. This was one of the major findings of a recent study commissioned by 3M Corp. and conducted by independent researchers Custom Research, Inc.

"We wanted to know where and when a shift between tape formats might take place," explains Frank Russomano, market development manager for 3M's Magnetic Audio/Video Products Div. "Over the next few years, one of the most critical issues is to determine when the transition will occur from 3/4-inch to other formats like half-inch. Right now, the 3/4-inch format is the industry standard."

A telephone survey, which consisted of 153 interviews with 127 VHF and UHF stations (representing major networks and groups, all network affiliates in the top 50 markets, and a random sample of all other TV stations), found 98 percent using 3/4-inch tape. Five percent of the stations used both 3/4-inch and half-inch tape, while just two percent were exclusively half-inch. (Both Beta and M-format were included in the questions.) Interest in half-inch is rising, however: while half-inch recorders represent only two percent of the portable VTR market, they accounted for six percent of the purchases last year. Similarly, only one percent of editing machines used for ENG are half-inch, but six percent of last year's ENG editor sales were for half-inch units.

The reason for the growing interest in half-inch comes as no surprise: there is widespread dissatisfaction with the

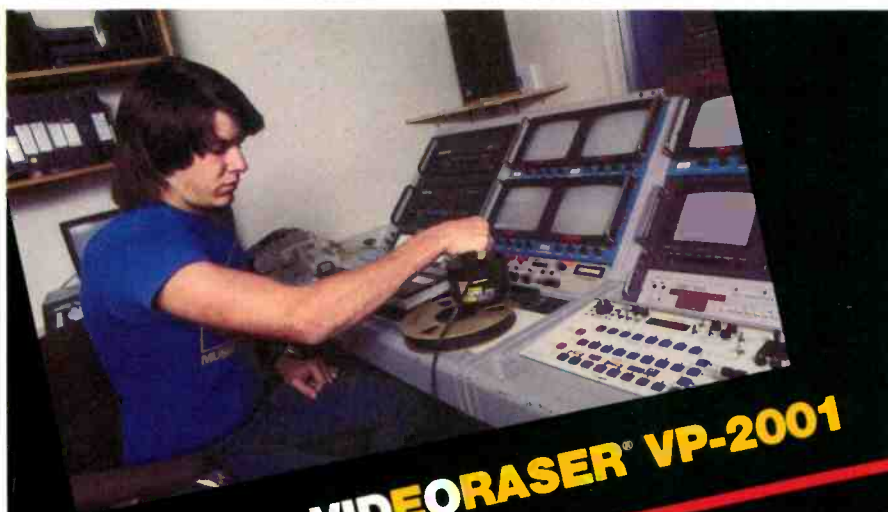

PULSING VIDEOERASER VP-2001

A professional eraser for 3/4" U-Matic, 1" and 2" broadcast quality tape.

"Industrial and Broadcast high-energy tapes are the hardest to erase. The VP-2001's tremendous power not only can be felt, but you can actually hear its pulsing action removing all traces of video and audio signals, and even time codes."

Available for only \$165.00 from professional video dealers. FULL ONE-YEAR WARRANTY. For information on all of Sonar's media erasers, including the name of the dealer nearest you, use the Reader Service Card.



3000 Stirling Road, Hollywood, FL 33021
305-981-8800

Voice, Video and Data
Communications Products and Services

Circle 109 on Reader Service Card

Camera Mart and MilabTM

Whatever your professional needs Milab makes the right microphone at the right price. Each model is engineered with special capabilities to give you top performance and versatility in all your PA, broadcast and recording requirements. And each is the best in its class for the money.

LC-25 Transformerless Cardioid:
For extraordinary purity of sound. Very low inherent noise for the most demanding studio work such as direct-to-disc or digital recording.

DC-63 Variable Pattern:
For general studio and concert hall use, where the ultimate fidelity and ambient sound pick up is required, from close-in vocals to full orchestra and chorus.

DC-21 Cardioid:
Small, rugged, lightweight. For podium, PA use, and as choir/orchestra pick up in close to long range. Good definition for strings and brass.

VM-41 Cardioid:
For acoustic instruments, overhead percussion, cymbals, snare and brass. Close to medium range PA and ENG work.

DC-96B Studio Cardioid:
For all studio and line recording use. Low noise, high output. For instruments, narration or choir. Close or distant work.

XY-82 Coincident Stereo Cardioid:
Top of the line dual cardioid stereo/mono with separate outputs. Two single membrane condenser capsules, smooth on and off-axis frequency response, two separate pre-amps, two separate output signals. Unmatched fidelity and versatility.

BM-73 Cardioid:
For live hand held vocals, drums and amplified instruments. Built-in "pop" filter with LF roll-off. Close to medium range studio or outdoor work.

LC-25

DC-63

DC-21

VM-41

DC-96B

XY-82

BM-73

**SIMPLY THE BEST PERFORMANCE FOR THE MONEY IN
PROFESSIONAL CONDENSER MICROPHONES.**

Exclusive USA Distributor. Dealer Inquiries Invited.

The Camera Mart, Inc.

456 West 55th Street, New York 10019 • (212) 757-6977 / Telex: 1-2078
Sales • Service • Rental

overall performance of 3/4-inch tape and ENG equipment. Engineers were least pleased with 3/4-inch, with 63 percent of respondents not very satisfied. News directors and station managers were more tolerant of the 3/4-inch format, but about a third were not very satisfied. Product performance and size and weight of equipment were the most commonly cited drawbacks.

As for half-inch equipment, more than two-thirds of those surveyed had at least considered the new formats, and

over half had tested and evaluated it. Both engineers and news directors rated the half-inch gear better in portability, quality of successive dubs, and picture quality. However, the lack of an industry standard for half-inch still deters prospective buyers. Of those planning to purchase ENG equipment this year, 24 percent definitely or probably would buy half-inch, 17 percent might or might not, and a full 59 percent definitely or probably would *not* buy it. Over 60 percent of those who

would not buy half-inch gave lack of standards as the reason.



To get live and taped news feeds out of San Francisco during the Democratic convention, Storer, Times-Mirror and several other groups and stations had Microwave Mobile Systems transmit their signals from Moscone Center to this hillside in El Cerrite, 13 miles away. Bonneville Telecommunications orbited the feeds from there with its transportable uplinks. Microwave Mobile, which is located in Huntington Beach, CA, also provided relays at the L.A. Olympics and the Republican convention in Dallas.

When you cover the action from the source...

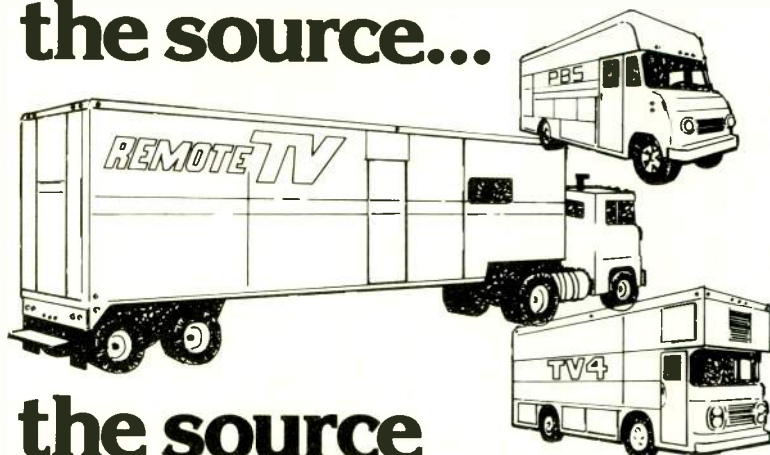

the source for mobile studios should be Gerstenslager.

In a van or trailer, your most modern, best equipped studio could be your Gerstenslager. It all starts when you tell us what you need. The job to be done. Then we'll work with your engineers and principal equipment suppliers. Develop the plans. Detail placement of every piece of equipment, generators, wiring, climate control, consoles. Exactly as you want it. Then, build the unit from the frame up. A studio on wheels that is actually a dependable broadcasting station comparable to conventional studio systems.

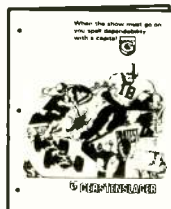

How we do it with examples of work we have done for others is included in this brochure. It's yours for the asking. Write or call: (216) 262-2015.



GERSTENSLAGER

The Gerstenslager Company, Wooster, Ohio 44691

Ampex Predicts DVTR Within Year of Standard

In support of the recent SMPTE and Magnum Group acceptance of a 19 mm (3/4-inch) tape size as the digital videotape recorder standard, Ampex is still strongly pursuing its DVTR development program, according to Carlos Kennedy, Ampex director of long-range planning. There had been speculation that Ampex might fall behind since much of its development has been using one-inch transport technology, whereas Sony, the strongest proponent of the 19 mm standard, already has over 90 percent of worldwide sales of 3/4-inch decks.

In an exclusive interview, Kennedy and Michael D'Amore, business manager for the video recorders group of Ampex AVSD, revealed that though the company would have preferred a one-inch DVTR standard, it will now comply with the 19 mm document. It also revealed that Ampex had prepared for the new standard some time ago by doing research work on both 19 mm and one-inch transports.

"Many things have been tentatively decided so far," said Kennedy, "including the tape width at 19 mm. We've been very careful to distinguish the DVTR format from 3/4-inch U-matic. All they have in common is

LEADER

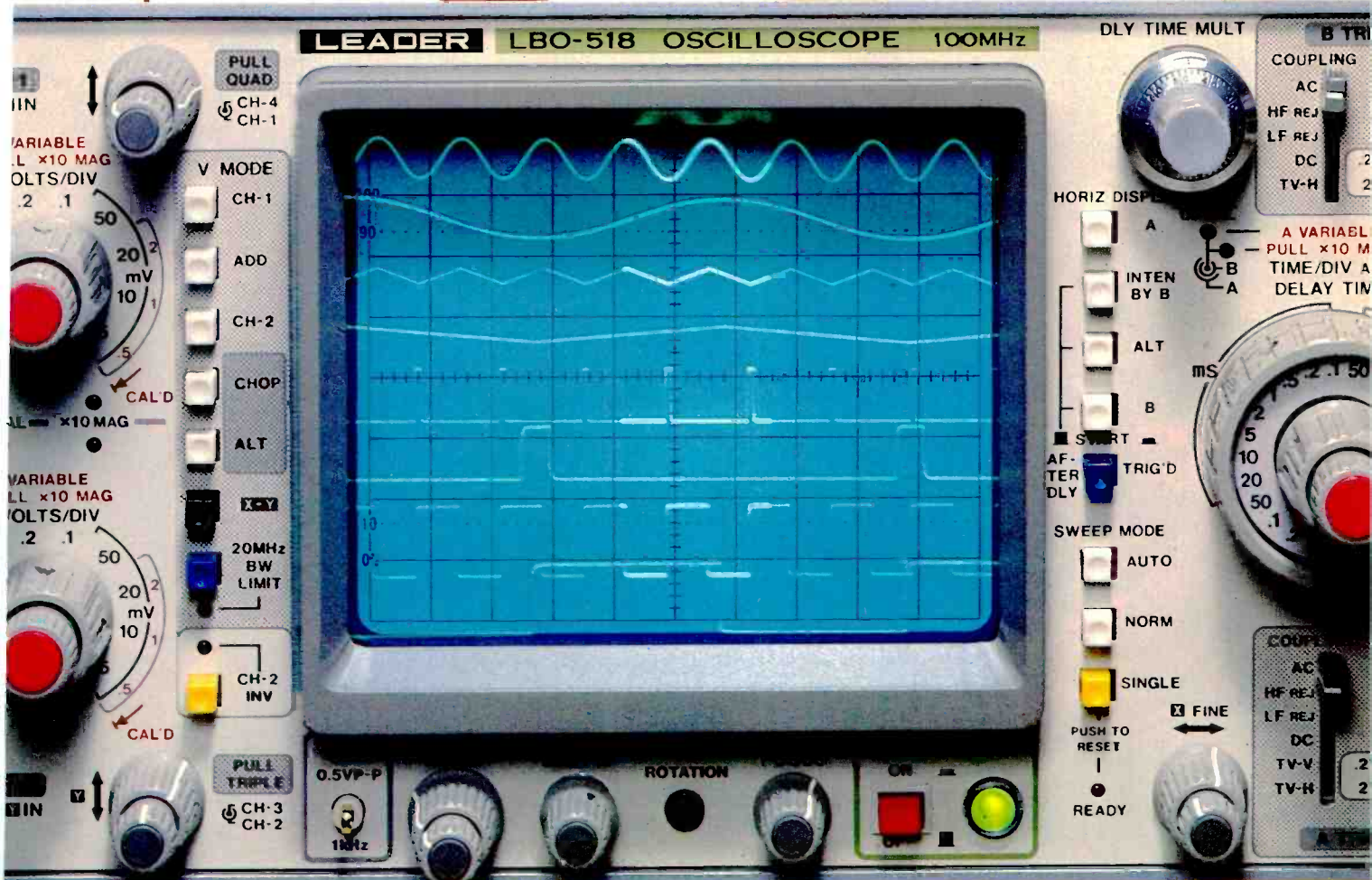

\$2050

MANUFACTURER'S SUGGESTED LIST PRICE

LBO-518 emerges as the proven 100-MHz standard.

Hundreds of companies have proven it.

A year ago, we predicted that the Leader LBO-518 would replace the TEK 465 as the new industry standard. Now, there is no doubt about it. Hundreds of companies have evaluated and purchased the LBO-518, some in very large quantities. And new orders are pouring in.

The LBO-518 beats TEK 465 & 2235.

Although the LBO-518 costs \$1090* less than did the TEK 465, this versatile 4-channel alternate time base scope provides superior performance and features. It has a faster, brighter, higher voltage CRT; ten times greater maximum vertical

sensitivity; an extra calibrated input; and it's compact enough to fit under most airline seats. Of course, the LBO-518 beats the TEK 2235, since that's not even in the same league as the 465.

Your company will love it.

Try one Leader LBO-518. You'll be impressed with its amazing versatility, performance, accuracy and ease-of-use. Compare this cost-effective, feature-packed oscilloscope to any on the market. Once you do, we're sure the LBO-518 will become your company's new 100-MHz standard.

Two-year warranty.

Our two-year warranty, including the CRT, is backed by factory service depots on both coasts.

Call toll-free
(800) 645-5104

In New York State
(516) 231-6900

Ask for an evaluation unit, catalog, and the name of your nearest "Select" Leader distributor.

For professionals

who know the difference.

LEADER
Instruments Corporation

380 Oser Avenue
Hauppauge, New York 11788
Regional Offices:
Chicago, Dallas, Atlanta,
Los Angeles, Boston
In Canada call Omnitronix Ltd.
(514) 337-9500

Circle 112 for Product Demonstration

Circle 113 for Product Information

*Based on price & specs published in 1983 Tektronix catalog. TEK is a registered trademark of Tektronix.

THE SONY 1" T



JOGGING DURABILITY	GUIDE WEAR-OFF	VIDEO S/N
SIGNAL WEAR	STILL TEST	RF OUTPUT

TAPE MEASURE.

THE VIDEOTAPE THAT ACHIEVES THE OPTIMUM BALANCE BETWEEN THESE 16 VITAL ELEMENTS.

What good is a recording tape that gives you a terrific video signal-to-noise ratio but falls short in signal wear? Or one that excels in video sensitivity but is dismal in dropouts? Or, for that matter, one that reduces head wear but sticks and slips in the joggng mode?

The answers bear the simplicity of common sense: no good. Which is why Sony created the yardstick for all 1" videotape: the Sony V-16.

The V-16 is based on the assumption that the only good tape is a perfectly consistent tape. And to achieve this consistency Sony has developed exclusive tape production techniques, created special binding materials, lubricating oils and additives. And then each batch of V-16 is submitted to over 16 quality-control checks where meticulous attention is paid to every detail from dropouts to print-throughs.

Any Sony tape that isn't perfectly balanced in picture quality, runnability, durability and audio will never find its way into your editing suite.

So if you're looking for the best overall performance in a 1" tape, look for the one that's superior **SONY** in 16 points, not just some of them: V-16 from Sony. Industrial Tape Division

© 1984 Sony Tape Sales Company, a division of Sony Corporation of America. Sony Drive, Park Ridge, New Jersey 07656. Sony is a registered trademark of Sony Corporation.

COLOR S/N	DROPOUT	AUDIO SENSITIVITY	AUDIO OUTPUT UNIFORMITY	FREQUENCY RESPONSE	AUDIO S/N	RUBBING NOISE	HEAD WEAR	PRINT-THROUGH	EASE OF ERASURE
-----------	---------	-------------------	-------------------------	--------------------	-----------	---------------	-----------	---------------	-----------------



the width of the tape. The question of cassette design is still up in the air."

Once the decision on the cassette shape and tape format mechanical and electrical parameters have been reached, however, Kennedy and D'Amore predict that it will take only a year to develop a prototype DVTR to handle it, and another year before a commercial product is available. "It will probably appear in the U.S. first as a post-production product," observes D'Amore. "In Europe, however, it may find

widespread use for all recording tasks."

At the same time, Kennedy and D'Amore revealed that Ampex is looking seriously at optical disk recording technology (which it has already demonstrated in conjunction with the ACE editor). "The name of our unit is the Video Recorders Group, not Videotape Recorders," observes D'Amore. "We're not closed to any new recording technology, provided we feel there is a real need for it in the marketplace."

The Correct Way To Match An Antenna

1) Low Pass L Network

$$X_2 = R_2 \left(\frac{R_1}{R_2} - 1 \right)^{1/2}$$

$$X_3 = - \left[\frac{R_1}{\left(\frac{R_1}{R_2} - 1 \right)^{1/2}} \right]$$

2) High Pass L Network

$$X_2 = - \left[R_2 \left(\frac{R_1}{R_2} - 1 \right)^{1/2} \right]$$

$$X_3 = \frac{R_1}{\left(\frac{R_1}{R_2} - 1 \right)^{1/2}}$$

3) T Network

$$X_1 = - \frac{R_1 \cos \beta - (R_1 R_2)^{1/2}}{\sin \beta}$$

$$X_2 = - \frac{R_2 \cos \beta - (R_1 R_2)^{1/2}}{\sin \beta}$$

$$X_3 = - \frac{(R_1 R_2)^{1/2}}{\sin \beta}$$

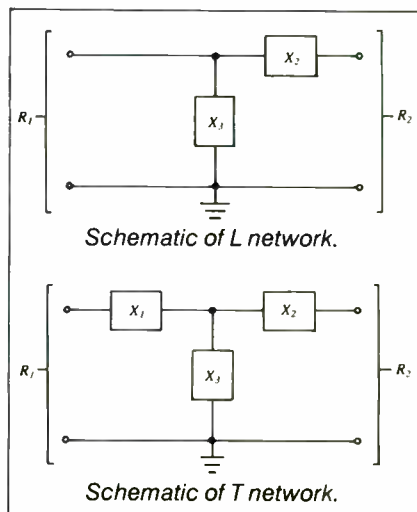

Eliminate

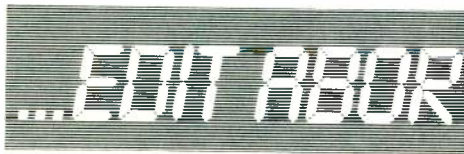

problems

with the flick

of a switch



IT'S SIMPLE. Add the "REGEN" option to Cipher Digital's Model 710A Time-Code Reader/Character Inserter and a majority of editing glitches are gone forever.

WHY? Most computer editing glitches relate to the quality of the Time-Code provided to the system. The Model 710A with the "REGEN" option provides the edit system with perfect, *re-timed* and *re-synced* code, irrespective of the original code quality.

Even non-synchronous, free running code will edit correctly.

Cipher Digital has even solved the "No-Code" problem. Supplied with control-track pulses, the Model 710A will continue to output error-free Time-Code *without* reading incoming data.

Think of the edit time these two features alone could salvage. But the 710A offers much more.

For detailed information or demonstration of this remarkable product, contact our **Sales Department:**



Sales/Marketing Headquarters:
150 Huntington Avenue • Boston, MA 02115
Tel: (617) 267-1148 • Telex: 940536

Superior Time-Code Products

Circle 114 on Reader Service Card

Over 200 broadcasters bought the Harris Medalist audio console in its very first year! Here's why.

Wide input switching flexibility. Transparent audio performance. Choice of attenuators. Adaptability to any application. Excellent cost/benefit ratio. Broadcasters across the country cite these as major reasons for choosing the new Medalist dual stereo audio console over all others.

Switching Flexibility

Input selectors switch *after* the mic preamp, allowing intermix of mic and other types of sources on any channel. The Medalist also gives you six selector positions each for headphone and speaker monitoring.

Superb Audio Quality

Harris engineering makes the Medalist remarkably transparent. The Signal-to-Noise ratio of 95 dB beats the competition by 10 to 20 dB, and is typical of the Medalist's outstanding performance.

Linear Or Rotary: Take Your Pick

Harris gives you a choice—two styles of linear and two styles of rotary attenuators. Intermix rotary with linear if you like, to suit *your* station's particular needs.

Circle 115 on Reader Service Card

Easy To Install...Easy To Maintain

The barrel terminals on the input and output circuits connect quickly and surely. Additional preamps and program amp interconnect with plug-in ribbon cables. Also, you can change attenuator modules—even while you're on the air—in about the time it takes to cue up a record.

Now In 8, 10 and 12 Channels

The Medalist is equally well suited for AM/FM/TV on-air and production applications. Take your choice of three models—8, 10 or 12 channels.

Learn more about the Harris Medalist family of audio consoles. Write Harris Corporation, Studio Division, P.O. Box 4290, Quincy, Illinois 62305-4290. 217-222-8200.



Visit Harris Booth 1004 RC and PC Los Angeles Sept. 16-19

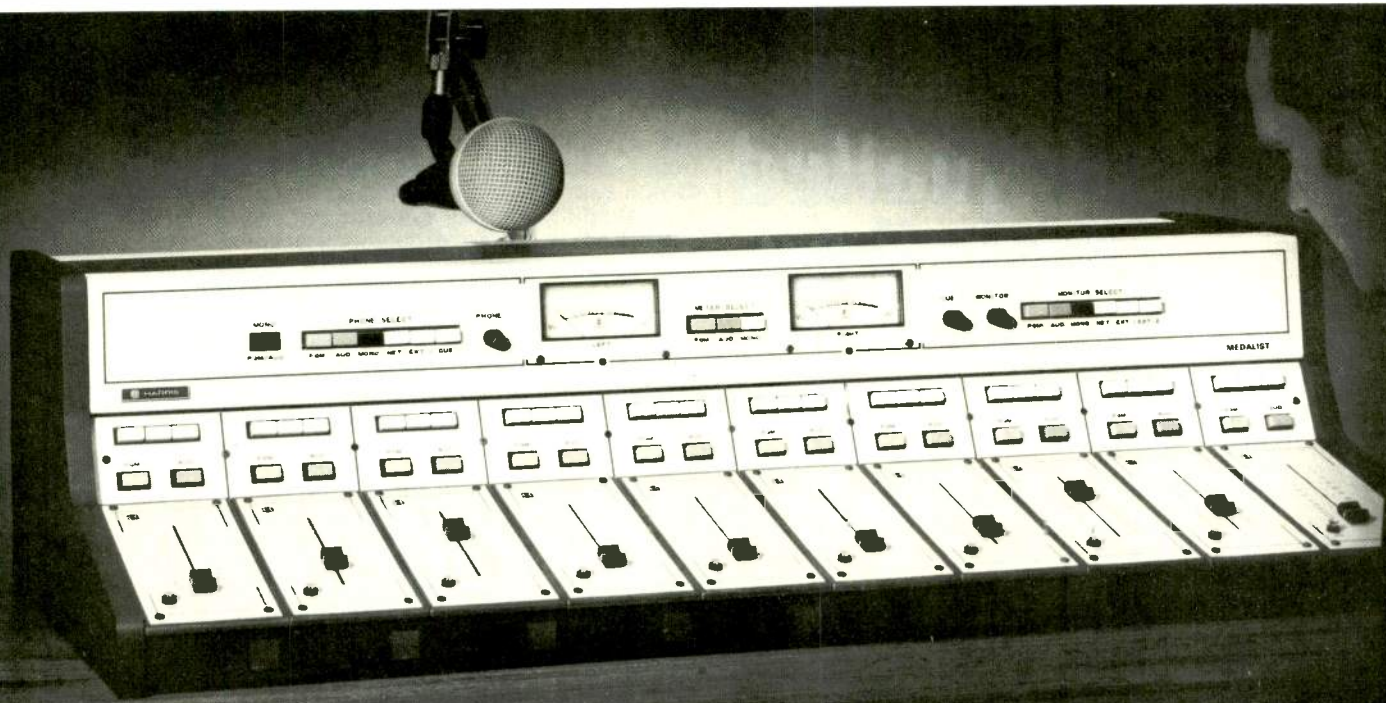

NEWS BRIEFS

Music television stations are springing up around the country—in stereo of course—backed by owners' predictions of a new medium on the UHF dial that will kill Warner's MTV and capture a sizeable fraction of the radio audience. Most stations plan to broadcast with a radio-style format 24 hours a day . . . **Telepictures Corp.** has bought syndication rights to the ABC O&O news material formerly marketed as Newsbank. The extra programming will be available to N.I.W.S. subscribers; ABC is folding Newsbank this month.

The Television Bureau of Advertising in New York City has put out a brief compendium of **advertising statistics**, including the top 40 local ad categories with related figures . . . **NAB regional meetings** for television broadcasters in 100+ markets will be held September 10 and 24 at the Los Angeles and Boston airports. Call (202) 293-5111 for information.

Salaries for radio group managers range from \$42,811 and \$94,744 on average, according to an NRBA survey. Group VPs make about \$94,744

including bonuses, while GMs average \$86,641 in the top 50 markets, \$75,060 in the top 50-100, and \$42,811 in 100+ markets. Eight out of ten GMs have a company car . . . Stations responding to a recent RTNDA survey report **women news directors** now head 11 percent of television and 20 percent of radio news departments, up from eight and 18 percent in 1982 and one and four percent in 1972. 94 percent of television stations and 58 percent of radio stations responding said they employ women in their news departments.

American **sales of television sets** hit a record 20 million over the 12 month period ending last June, a figure almost equalling 25 percent of households. Home VCR sales soared 90 percent to over 5 million . . . Satellite Network Delivery Corp. has signed the first commercial broadcasters for its **Business Teletext Network** service. Four Meredith stations will transmit satellite-distributed material over two VBI lines leased from them . . . The United States Satellite Broadcasting Co. (USSB) has contracted with RCA Astro-Electronics for two **high power**

DBS satellites, each providing six channels of stereo television. Launch is slated for 1988. **WETG** (ch. 61) in Hartford, CT has received FCC approval to sign on this month with 5 MW of visual and 1 MW aural power, stereo. The station says it will be the most powerful television station in the U.S. . . . The FCC has proposed allowing AM stations to **measure operating power** by direct readings of RF meters, and FM and aural TV measurements to be made by calibration of the power meter . . . The Commission has rejected an NAB request to renew **signal coverage requirements** for additional city identification.

NATPE's first **Production Conference** will take place March 14-17, 1985 in New Orleans. Suppliers, manufacturers, and distributors will be there, while seminars will include production for various station departments . . . The **U.S. TV and Radio Commercials Festival** is taking entries with an October 1 cutoff. Contact J.W. Anderson at (312) 834-7773 . . . Applications for the **November SBE certification exams** are due September 14.

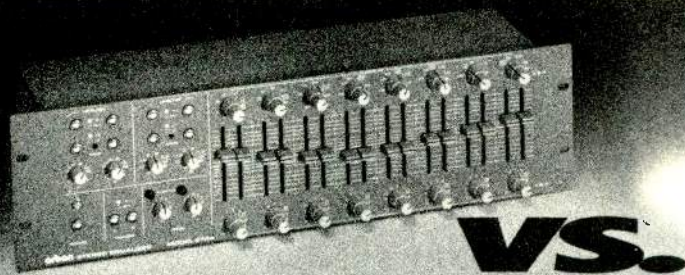

The unequalled equalizer.

Not all equalizers are created equal. You know that from experience. So do we. Our years of parametric design experience let us build so much performance and versatility into our 672A (mono) and 674A (stereo) graphic/parametric equalizers that *Modern Recording & Music* (October, 1981) described the 674A as "... the most powerful equalizing tool for pro audio work that I have yet to come across".

They clearly appreciated the versatility and functionality of eight bands of EQ with fully adjustable center frequency and bandwidth, plus the availability of 12dB/octave highpass and lowpass filters to limit signal bandwidth or to serve as a full electronic crossover.

No matter what your application—production, program shaping, room tuning, reinforcement work, or clean-up chores—you can count on Orban's heavy-duty professional construction and equally professional documentation and service. Find out why the Orban 672A/674A's are truly the "un-equalled equalizers".

orban

Orban Associates Inc. 645 Bryant Street
San Francisco, CA 94107 (415) 957-1067
TLX: 17-1480

Discover a high-performance mixer with a personality all your own.

The Ramsa WR-8616.

Inside every recording engineer is the desire for more creative control at the board.

Now there's a post-production/recording mixer designed to make your sessions sound more like you. And less like everybody else's. The Ramsa WR-8616. And its modular design is as ambitious as your needs.

You can have 16 channels of either full stereo or mono modules. Or a combination of the two.

The WR-8616 will also save you valuable time. By letting you simultaneously monitor as many as 16 channels on a multi-track machine while recording.

What's more, this high-performance mixer gives you two discrete mixes. This allows for full monitoring capability, which can be independent from the control room's mix.

SPECIFICATIONS:

- +4dBm, 600-Ohm Line Input and Output Signal Levels
- Frequency Response: 20-20,000Hz; ± 0.5 dB
- Noise: -128dB (IHF "A" WTD, 150 Ohm)
- THD: 0.05% typical at 1kHz, +20dBm
- CMRR: Greater than 80dB typical

And in the mixdown, you'll have access to all 16 inputs without having to repatch or reset the board.

You'll also find the 3-band continuously variable input EQ will give you more precise control over the highs, midrange and lows. And the six-channel remote start/stop capability lets you program materials using turntables, or tape and cart machines.

To make the WR-8616 even more compatible, we've given it a dual set of meters. Eight LED bar graphs will monitor the 16 input signals. While the six VU meters handle the Master, Group, Send, Echo outputs and Solo level.

And the balanced Mic and Line inputs and Main outputs won't let any unwanted noise come between you and your sound.

The Ramsa WR-8616. A post-production/recording mixer designed to treat you like an individual.

RAMSA



Please send me more information about the Ramsa WR-8616.

Name _____ PLEASE PRINT

Address _____

City _____ State _____ Zip _____

Phone () _____

Return Coupon To: Panasonic Industrial Company, Professional Audio Systems, One Panasonic Way, Secaucus, N.J. 07094.

Panasonic
PROFESSIONAL AUDIO SYSTEMS

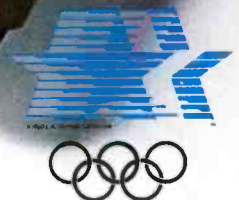

Supplier of Sound Systems
for the 1984 Olympic Games

CHECK OUT MOTOROLA C-QUAM[®] AM STEREO ON THE HOTLINE!

There are solid reasons our C-Quam AM Stereo system has rolled up such tremendous momentum. Technical excellence is just one! Receiver manufacturer acceptance is another! And the C-Quam system is also news in your market... big news that you can merchandise aggressively.

If you're a station owner or manager who's thinking AM Stereo, use our Hotline to get the story of the C-Quam system and its exciting potential. If you already have the C-Quam system, call to find how to build audience, advertiser interest and time sales with creative promotions.

We have ideas to help boost your visibility and your ratings. We can suggest incentive programs to psych up your sales force. We know how to make your co-op money more productive.

Whatever your questions, concerns or problems, Hotline wants to answer them. Call Steve Kravitz, Sales/Marketing Manager, at 312-576-0554 collect.

MOTOROLA AM STEREO. THE WINNING SYSTEM.



RADIO

programming & production

New Production Room Caps Changes at WZGO

By David G. Meyer

A radio station can do many things to improve its listenership. It can change formats. It can upgrade equipment for improved air sound and production capabilities. It can change personnel, hoping that new blood will bring in new ideas and enthusiasm. And if all that doesn't produce the desired results, the station can take the relatively drastic approach of changing call letters.

It would be reasonable to expect a station, at any given moment, to do one of these things, especially in a market as competitive as Philadelphia. WZGO-FM, however, elected to do all four in a relatively short period of time beginning in September 1982. The station's format changes and revamped identity soon created the need for a modern production facility.

WZGO first went on the air as WQAL in 1959, changing its calls to WWSH ("Wish") and its format to beautiful music when United Artists Broadcasting bought the station in 1970. In 1978 it was purchased by Cox Communications, its present owner.

The tide began to turn in the early 1980s, however, as it became clear the market could not support two beautiful music stations. With competitor WEAZ beginning to take the lead, Cox Communications made the bold move of dropping the beautiful music format and switching to a soft adult contemporary sound. Almost immediately, though, competition heated up in the new format. Suddenly no less than five other stations were vying for virtually the same demographic. As Bill Phippen, the station's general manager since January 1983, explains, "By mid-April (1983) we felt that we weren't getting audience moves. We were a very flat radio station in the high ones and low twos (Arbitron figures) and it just became apparent to me that we

David G. Meyer is with the Audio Systems Div. of Peirce-Phelps, Inc.



Air personality Chuck Tyler holds down the fort with a Pacific Records board and Tomcat cart machines.

ought to look at other ways of going."

In July 1983, therefore, the station dramatically introduced a new personality-based, adult-oriented CHR format, with the new WZGO tag debuting a year later.

Focus on production

As the second format change was getting underway, discussions at the station turned away from programming and toward production. WZGO was a new station, creating new business, and therefore needed more realistic and up-to-date production facilities. After lengthy discussion among the general manager, chief engineer, and program director, the station called in the Audio Systems Div. of Peirce-Phelps, Inc., to help in evaluating the station's needs and to make specific recommendations for the equipment.

As a beautiful music station, WZGO had relatively small production needs. Before the upgrade, its production facility consisted of an 8 x 2 LPB Citation console, two Ampex A-440 quarter-

inch two-track ATRs, a Technics turntable with LPB phono preamps, a pair of Pacific Records Tomcat stereo cart recorder/reproducers, and a Kenwood KX-1030 cassette recorder. The studio also had a Crown D75 amp, two Electro-Voice Sentry 1 speakers, a UREI 527 1/3-octave equalizer, a dbx 900 cart NR system, and an E-V RE20 mic.

This equipment inventory had proved quite satisfactory during the station's beautiful music incarnation, not only for in-house promotion needs but for client production as well. The format change, however, brought new needs into focus.

CE Bill Smith sums up, stating that the station needed "an extensive, modern production facility to meet the requirements of our new programming, further improvements in the station layout to better utilize the space and accommodate a larger staff, and upgrading of the control room soundproofing, furniture, and equipment layout to deal with needs we never had before."

Ironically, the room chosen for the

BRILLIANCE

The richness of sounds produced in their fullest natural intensity. Richness captured through outstanding signal-to-noise with minimal distortion characteristics. Richness resulting in a video tape of exceptional brilliance. Ampex 197.

AMPEX

Ampex Corporation • One of The Signal Companies 

AMPEX
197

PROFESSIONAL BROADCAST VIDEOCASSETTE 

RADIO PROGRAMMING

new studio was Smith's engineering office. He explains, "Because of the size of it [10 by 13 feet] and its location we came to the decision that it would be the ideal place to start from scratch and go with a brand-new production facility."

Equipment choices

The first major piece of equipment to be considered was the production console. Smith's first choice was the Pacific Recorders ABX-18, which would have duplicated many of the functions of the PR BMX-14 in the control room, thus easing the transition from air to production for personnel. At about \$30,000, however, the ABX proved too pricey for WZGO—especially since Smith's budget for the total project was \$50,000. Several other strong contenders were also rejected because their price tags were too steep.

Smith found himself in the difficult position of finding a true broadcast production console that would meet all the station's requirements for under \$10,000. His answer was the Ramsa WR-8616B, just introduced during



Parts of the old production studio, shown here, had to be upgraded when WZGO changed formats.

WZGO's shopping expedition. The 16-input, four-output console has stereo line input capability, full modular inputs and outputs, remote start and stop of cart machines and turntables, complete metering of all signal paths, and an impressive array of effects sends—enough features to allow for

anything the station would want in terms of four-track production, with room for future expansion. Although not specifically designed as such, the 8616B can and will be used as an auxiliary air console from time to time; according to Smith, the Ramsa will be on-air while the control room is being remodeled.

Once the console question was settled, the next area of debate was tape machines. It had already been decided to make the main production medium four tracks on half-inch tape, with a quarter-inch two-track machine as the mastering deck. Everyone involved wanted the best possible tape machines, and happily the budget was sufficient. The final choice was MCI ATRs, which the station has found to be sonically outstanding, with excellent tape handling characteristics. Smith is happy not only with the decks' quality, but with the attention and service of Peirce-Phelps. "There were several minor problems when the MCI decks were first put into service," comments Smith, "but they were handled quickly and efficiently by the Peirce-

This new portable UHF Field Strength Meter gives you accurate readings across the entire band.

Someone once said that "Certainty is Security." That is the main idea behind field strength measurements. They verify the signal level and rf environment at the point of reception. You know for certain what's out there.

It is now easy for UHF stations to achieve this certainty. With the new FIM-72 from Potomac Instruments.

Tune the entire UHF band

From 470 to 960 MHz. The received signal strength is shown in volts and dB, with a 140 dB measurement range. Select peak or averaging detection; wide or narrow IF bandwidth. Seven 20dB logarithmic ranges assures precise readings. Internal demodulators (AM and FM) provide audio monitoring of the selected signal.

It is easy to use

Find the desired signal on the spiral dial. Calibrate the meter using the internal generator, then read the signal strength from the mirrored meter. The field strength is easily determined from the supplied calibration data.

Laboratory applications

The FIM-72 includes a precision rf generator that tracks the tuned frequency. Typical measurements include insertion loss, VSWR, and filter response.

Call Potomac Today

Place your order for this new UHF field intensity meter. Put it to work. And then you will know for certain.



POTOMAC INSTRUMENTS

932 PHILADELPHIA AVE. SILVER SPRING, MD 20910
(301) 589-2662

RADIO PROGRAMMING

Phelps service department." Smith describes his relationship with Peirce-Phelps' Audio Systems Div. as much more than simply buyer/seller. "Our work relationship with Peirce-Phelps has been excellent," Smith says. "It's not high-pressure sales—it's good involvement, realistic advice."

With the console and the ATRs in place, the staff began to complete the

equipment roster. Smith's first choice to replace the old speakers were JBL 4313Bs, which, however, had been discontinued; instead he decided on a pair of 4411s. Other equipment chosen included a UREI 535 dual-channel, octave graphic equalizer, Technics SP-15 turntable with AudioMetrics stereo phono preamp, and TASCAM 122 cassette recorder.

On-air Orban

WZGO also purchased an Orban 424A stereo processor for the production room; what eventually happened to that unit is worth noting. Steve Davis, the new program director, saw the processor in Smith's office and asked if it was going on the air chain. The idea intrigued Smith, and he put it on the air for a trial period. That trial ended up as the unit's permanent situation; its primary function is to provide very consistent levels from the console to the Optimod.

The new equipment has greatly enhanced WZGO-FM's production capabilities. Now, instead of two-track production that is at best difficult to work with, the station staff has a complete and modern facility to produce not only high-quality station promotions, but client and agency work as well.

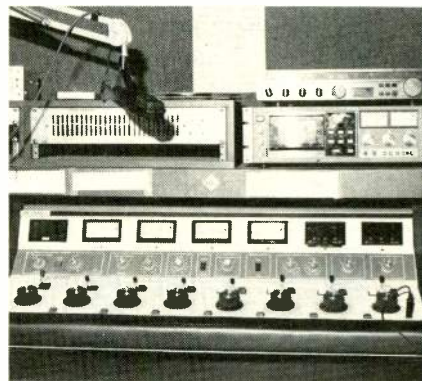

A new MCI JH110B-2-HP waiting to be installed.

And now that the project is complete, what of the future of WZGO? According to Phippen, the key word is consistency: of format, image, and sound.

Phippen is always looking for ways to make the station more competitive and more profitable. While not under immediate consideration, there is talk of selling time in the production room to agencies to defray some of the cost of the equipment. WZGO is also working to expand the morning show into "a little bit more service," a move which everyone hopes will strengthen the station's market position. Says Phippen, "We're doing it in a way that may take a little longer, but hopefully the base will be built solid enough that when our day comes and someone takes a shot at us, we'll be much better protected." Certainly the steps taken during the past 18 months will provide a foundation upon which WZGO can grow and prosper.

BM/E

"Isn't it about time you cleaned up your audio act?! telcom c4 is proven to give the best high fidelity with no looking after, just plug it in. telcom c4 is equipped on more VTRs than any other noise reduction system! That simple? That's something!" 2 channel VTR unit \$2435, 3 channel VTR unit \$3630.

The Battle ... is won

Most of today's 1" type B VTRs are equipped with telcom c4

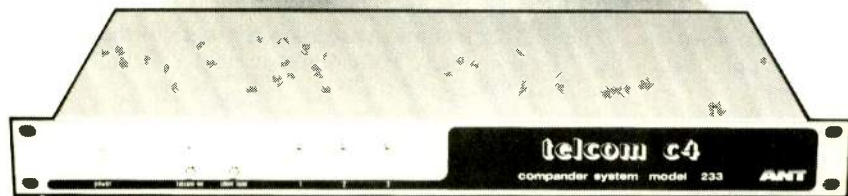

Users already selected telcom c4 as the most suitable NR System for type C VTRs. The new telcom c4 units are now designed to improve the sound of type C VTRs. telcom c4 creates lower distortion from tape, better crosstalk attenuation, improved headroom plus a 25 dB gain in dynamic range. No line-up procedures. telcom c4 units for VTRs

are available for 1, 2 (stereo) and 3 channels, for simultaneous encode/decode and automatic switching.

Furthermore, telcom c4 is used in connection with ATRs, line and satellite transmission. Don't you also need super sound for stereo or copying?

Just contact us for further information.

Contact:

Solway Inc., P.O. Box 7647,
Hollywood, FL 33081
Phone (305) 962-8650, Telex 467257

ANT
Telecommunications

ANT Nachrichtentechnik GmbH
Lindener Str.15 D-3340 Wolfenbüttel
Phone (05331) 83-0 Telex 95651 ant d

Circle 121 on Reader Service Card

ONE LESS ALLIGATOR

The Broadcast Engineer works with time-line responsibilities few of us will ever experience. He knows that equipment problems can wreck production schedules.

That's why the Otari BII is the most widely used audio machine for broadcast mix-down, news editing and production.

Three speed operation, front panel record calibrations, a microprocessor controlled tape counter with LED display, and variable speed control, coupled with "bulletproof" reliability and high level product support all add up to one less alligator snapping at your heels. From Otari: The Technology You Can Trust.

Contact your nearest Otari dealer for a demonstration, or call Otari Corporation, 2 Davis Drive, Belmont, CA 94002 (415) 592-8311 Telex: 910-376-4890



OTARI®



© Otari 1984

Circle 122 on Reader Service Card



"OUR NEWS IMAGE HAS NEVER BEEN BETTER."

-David Choate, News Director WSVN-TV, Miami

"Ranked as a competitive activity, TV news would probably fall somewhere between rugby and wild boar wrestling in terms of fierceness. Which is why we're constantly on the lookout for anything that might give us an edge.

"Our 6 Betacam camera-recorder systems are a good example. Their image quality is spectacular, so we look great on-air.

"But even better, the mobility Betacam offers is a real incentive to our photographers to go for that really dramatic, unusual shot. The kind you won't see on every channel at 6 and 11. Because at least for the time being every station doesn't have Betacam."

"THE ABILITY TO SEND OUT MORE CREWS ON MORE STORIES IS WHAT I CALL GOOD NEWS."

-Tom Kirby, VP/News WTCN-TV, Minneapolis

"Before coming here, I was with Gannett's Denver station, KUSA, which was the



winner of the NPPA's 1983 'Station of the Year' award. And frankly, my goal here is to get to the finals again. A not unrealistic objective when you consider the talent we have, and the fact that we recently purchased 23 Betacams.

"After all, it seems obvious, the more people you have on the street, the better your chances are of coming up with a winner. Providing, of course, you give those people equipment that's as performance-minded as they are."

"WITH SO MUCH LESS EQUIPMENT TO LUG AROUND, WE'RE SEEING A LOT MORE EXCITING TAPE."

-James Delmonico, President/General Manager WRGB-TV, Schenectady

"I don't care how inspired or dedicated a photographer is, eight hours of hauling sixty-plus pounds of camera, recorder, lights,



and cable all over hell and gone is bound to have a stifling effect on someone's creativity.

"That's what initially got us interested in Betacam, and ultimately, why we made the decision to invest in it. The simple fact that you don't have to be a gorilla to use it. The maneuverability of this system is tremendous. So naturally we're seeing shots you just couldn't get before. And, of course, the image quality itself is magnificent.

"In fact, I'd have to say from the looks of things, we'll be adding more Betacam systems

HOW THE PEOPLE WHO LIVE AND DIE BY THE RATINGS RATE THE SONY BETACAM.™

before long. If for no other reason than to stop our crews from fighting over who gets to use the ones we currently have."

"THIS IS CLEARLY A SYSTEM BUILT FOR THE REAL WORLD."

*-Allan Howard, VP/General Manager
KXTV-TV, Sacramento*

"You rarely find news under ideal conditions. More likely you're getting jostled around by a huge crowd, buffeted by gale winds or caught in a very tense, fast-moving situation. All of which tend to play havoc with equipment life spans.

"Betacam, however, seems to have been designed especially for this environment. It's an extremely well-built, exceptionally rugged system, particularly for its weight. And the net result is that in the year we've had them, downtime has been virtually nil.

"Equally important, because Betacam is totally compatible with 3/4" systems, you can



move into this technology at your own pace. Which is another part of adapting to the real world, the world of equipment budgets."

These are just a few examples of the reports we're getting from stations that have made the move to Betacam. To hear more, or, better yet, to get a look at the system behind them, just give us a call. In the New York/New Jersey area (201) 833-5350;

in the Northeast/Mid-Atlantic (201) 833-5375; in the Midwest (312) 773-6045; in the Southeast (404) 451-7671; in the Southwest (214) 659-3600; in the West (213) 841-8711.

SONY
Broadcast

Sony Broadcast Products Company, 1600 Queen Anne Rd., Teaneck, New Jersey 07666. © 1984 Sony Corporation of America. Sony is a registered trademark and Betacam a trademark of Sony Corporation.

"WHY USE FLEXWELL"

Optimum Design

Cablewave Systems offers Flexwell Transmission Lines designed to meet your most stringent electrical and mechanical requirements.

Highly reliable, the unique Flexwell construction provides a combination of strength and flexibility with optimum performance.

Outstanding electrical parameters include extremely low RF loss, smooth impedance coefficient, and conservatively rated power handling capability.

Flexwell utilizes a copper corrugated outer conductor, solid or corrugated inner conductor (depending on size), and a tough, durable corrosion resistant polyethylene jacket suitable for burial and prolonged life. A low loss foam version called Cellflex is also available in 1/2", 7/8" and 1 5/8" sizes.

Air Dielectric Flexwell in smaller diameters (1/2" and 7/8") offer a field proven, fixed helix design called Spirafil II—a single, continuous extrusion which locks the center conductor coaxially within the outer conductor, resulting in a linear impedance coefficient throughout the entire length of line.



Optimum Performance

Larger Diameter Air Dielectric Flexwell Cables, (1 5/8", 3", 3 1/2" and 4 1/2") feature a unique vertebra helix design to achieve optimum crush and tensile strength. Its "pillar effect", using less volume of dielectric, provides lower loss and higher average power handling capability due to the more rapid dissipation of heat from the center conductor.

Flexwell has it all: low loss, low VSWR, higher power handling, smoother impedance coefficient, and rugged, long dependable life.

Cablewave System's Flexwell is type accepted for sampling systems in accordance to FCC Part 73.65.

For complete details contact Cablewave Systems*, 60 Dodge Avenue, North Haven, Connecticut, 06475, Phone (203) 239-3311 or P.O. Box 310 Claremont North Carolina, 28610 Phone (704) 459-9762

* Division of Chester Cablewave Systems Corp.

In Canada: LeBlanc & Roy Communications, Inc. 514 Chartwell Rd., Oakville Ontario, Canada L6J 5C5 Phone (416) 844-1242.

See us at NRBA Booth #1208

Cablewave Systems

Member of Radio Frequency Systems Group



Circle 123 on Reader Service Card

TELEVISION

programming & production

Live Local Remotes Via Ku-band Satellite

by Michael Greenhouse,
Associate Editor

It was the second week of April 1984, and a much publicized murder trial was getting underway in Ivanhoe, MN. A number of Minneapolis-St. Paul TV stations sent crews to Ivanhoe—about 150 miles away—to cover the trial by taping reports and air-shipping them back to the Twin Cities. KSTP-TV, an ABC affiliate in Minneapolis-St. Paul, also sent a crew; but its coverage included a twist none of the other stations could compete with: live reports.

Live remotes, by a local station, from a site 150 miles from the plant? It can't be done with microwave, of course, and uplinking via satellite has previously been impractical for all but the networks. For this shoot, however, KSTP unveiled its Newstar Ku-band remote truck. This vehicle—at the time the only one in existence—enabled KSTP to transmit live segments three times a day, for two of the three weeks of the trial, via Anik C-2, a Canadian Ku-band satellite. For the first time, KSTP was able to go beyond its standard 35-mile coverage area and broadcast, live, a story of local interest.

In a commercial sense, the shoot was a success for the station. As Marvin Mitchell, supervisor of special engineering, recalls, "We wanted to use the truck to go live and kill the competition here, which it succeeded in doing."

But Newstar also worked out from a production point of view. On this shoot, and on one that immediately followed, setting up the truck for transmission proved to be fairly simple and fast; except for cost (which will soon come down for KSTP), the Ku-band system made long-distance live programming manageable where a C-band system could not have been.

The truck

Newstar, which was designed and built by Hubcom, a division of



Supervisor of special engineering Marvin Mitchell, left, and engineer Jeff Nelson examine the generator in the Newstar truck. Newstar can also use shore power.

Hubbard Communications, is a small, relatively uncomplicated mobile earth station. It is 22-feet long, eight feet wide, and about 10 feet high. If it weren't for the 2.4-meter Ku-band dish protruding from the vehicle's rear end, Newstar would look like most mid-sized mobile vans.

Inside the truck are two Sony 5800 3/4-inch machines with an editing controller, a small Panasonic video switcher and Panasonic monitors, a six-input Yamaha stereo audio console, a TBC, lights, extension cord, mics, phone equipment, cable, a generator, and of course, uplink equipment.

The uplinking equipment, which is housed together in one rack, consists of an LNR exciter, two MCL 250 watt travelling-wavetube amplifiers, MCL phase combiners, and power supplies for the MCLs. The amplifiers are phase combined so Newstar can put out 500 watts if it needs to. But, according to Marvin Mitchell, "With less than 200 watts we've been able to reach full saturation." The truck uses about 35 amps of 110 V ac power, usually provided by a generator though the Newstar crew can use shore power if necessary.

The original configuration of the truck was modified somewhat by

KSTP. The editing setup was added, as was the TBC and some additional Panasonic monitors. Also, the rack-mounted Yamaha audio console replaced two small Shure mixers. This gave Newstar stereo capability, though only one of the two available audio subcarriers is used in a Newstar transmission. Mitchell says the other subcarrier is used "for a redundant audio feed, or for one-way communications from the truck back to the plant."

The maiden voyage

Newstar's first shoot, in Ivanhoe, was handled a bit differently than subsequent remotes, according to Mitchell. Three engineers, including senior engineer Tom Hartho, travelled in the truck. Following the truck, caravan-style, was a reporter, technician, photographer, courtroom artist, and editor. Since then, the crew has been pared down to just Hartho, who handles the truck by himself, and a news crew, which consists of one reporter, a photographer, and a technician/grip, Jim Biagi. The news crew always travels separately from the truck—often in advance of it—and it always carries the cameras and some lights. As Mitchell explains, "The crew can often get there faster. They're often sent by helicopter. That way they can get all the background information and raw tape they need before the truck gets there. By the time the truck arrives, they're set to edit, feed tape, and do the live shot."

The actual setup and transmission procedure was established on the Ivanhoe shoot, and it has been the standard procedure ever since. The first task is to locate a telephone and park the truck near it. As Mitchell explains, "The problem you need to overcome on these satellite shoots is to establish phone communications with the satellite control point in order to put your transmitter on the air. You need to get the go-ahead from, in this case, Telesat of Canada—we were using Anik C-2. So a phone line at or near the site is a central part of the remote." A phone hook-

TELEVISION PROGRAMMING

up was also used by the crew to establish IFB with the station.

Once a telephone was located, the truck was set up and the satellite was acquired. The acquisition of Anik is a matter of making two phone calls. The first call is a request for time (Mitchell says that is never a problem). The second call is made to verify programming—which is a way of making sure the truck will be uplinking to the correct satellite. But this call is not made until the truck is set up, and generally, it is not made until after the crew has done its own verification on board.

Newstar's setup is a simple matter of anchoring the truck, starting the generator, and opening the back door that exposes the dish. The dish is lifted hydraulically. Next, the dish is used to "scout across the arc in the south until you pick up the satellite," says Mitchell. (The Anik satellite is a few degrees off due south. Generally, the crew uses a compass to help position the dish.) At that point, programming is verified by the Newstar crew from on-board the truck. Mitchell says, "We have a good idea of what programming is on the sat-

ellite, so using our receiver in the truck, we search across that band until we find the correct satellite." The crew then makes the second phone call "just to make sure it is the right satellite before we ever put our transmitter on the air," says Mitchell.

How long does all this take? "From the minute you arrive on the site you can have generators going and acquire the satellite in easily less than 10 minutes. It's at least as fast as a traditional microwave setup," Mitchell says.

Newstar is able to set up and begin transmitting quickly partly because the mechanics of this system makes it a speedy process. But also, because it is a Ku-band system, the station is spared the time-consuming procedures C-band broadcasters must go through. As Mitchell explains, "With C-band, before you go out and do a remote feed—with Wold or any of those outfits—they have to go out ahead of time and do a spectrum search, which is very costly and time consuming. They have to scout the spectrum and make sure they're not going to interfere with any terrestrial broadcast or any other ex-

isting satellite facility. Then they have to file special requests with the FCC for that site. With Ku-band, none of that is necessary. You go out to a site and put it on the air. No spectrum analysis involved."

Costs

Ku-band broadcasting has certainly not been cheap for KSTP, however. Until recently, when KSTP's parent company, Hubbard, purchased a transponder on SBS-3, Ku-band has been a pricy proposition for the station. Mitchell says it cost "about \$500 per hour for time on Anik." And when travel, crew, and phone costs are added in, "It's considerably more expensive than doing local microwave programming," says Mitchell.

But Mitchell feels it was well worth the expense on the Ivanhoe shoot. The station was able to present live reports at 5:00, 6:00, and 10:00 every night for the two weeks the crew was there. These reports were transmitted along with tape packages, which the crew



Record, play and dub complete sports events and full-length movies... non-stop!

ME-238 Kit for Type-C VTRs

Extend record/play time to 3 hours on Ampex VPR-80, VPR-2, Marconi VTRs, Sony BVU 2000; 2 hrs. 40 min. on Sony BVU 1000/1100 recorders. Ideal for master playback when dubbing to small format machines or for automated programming.

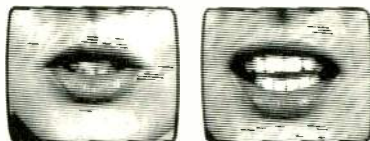

Restore lip sync to video transmission & processing



ME-278 Digital Frame Audio Delay

Correct audio-to-audio timing errors when programs are passed through framestores, standards converters, synchronizers or digital effects systems. Delay is selectable in frame or field increments using simple front panel control.

Remarkable Low-Cost PAL/NTSC Digital Image Processor

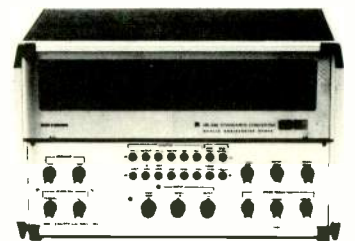

ME-288 Standards Converter

Unique in the field of digital video processing, the ME-288 combines TBC, noise reduction, color correction, synchronizer, field/frame store, H & V image enhancement plus NTSC to PAL/PAL to NTSC standard conversion in one integrated unit.

MERLIN ENGINEERING WORKS
1880 EMBARCADERO, PALO ALTO, CA 94303
(415) 856-0900 TWX 910-3731782

MERLIN

Merlin Engineering Works maintains complete design, engineering and fabricating capabilities for custom systems and special products. Call for further information

CALL TOLL FREE —
1-800-227-1980
(Calif. 415/856-0900 Collect)

To know how good your camera tube is, look it straight in the eye.

Saticon II



Plumbicon™



For better color pictures, compare the color of the photoconductors.

This simple comparison demonstrates why you'll get better broadcast quality with Saticon* II. The dark red faceplate of Saticon* II shows its selenium-arsenic-tellurium photoconductor. The lighter reddish-yellow faceplate of the Plumbicon™ tube reveals its lead-oxide photoconductor.

This color difference indicates significant Saticon II advantages. Because the darker photoconductor absorbs more light, picture quality is enhanced. On the other hand, Plumbicon's lighter color photoconductor reflects more light at all visible wavelengths, as shown in the chart below.

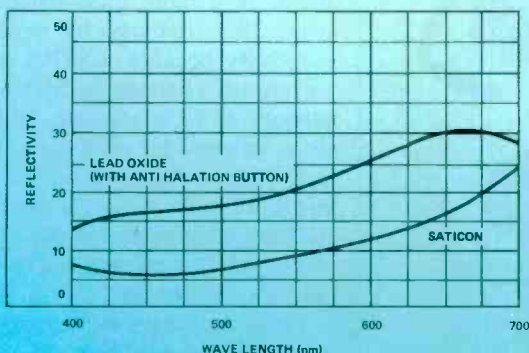

Because Saticon I reflects less light, you benefit with reduced flare and less blooming. Low-light colors maintain their integrity and accuracy.

As a consequence, Saticon II does a remarkably good job of handling high contrast scenes in uncontrolled lighting conditions because of its low flare. What's more, Saticon II's photoconductor is a glassy, amorphous, high resistivity film. Its structure serves to ensure high resolution, high sensitivity and unmatched depth of modulation.

For more information on Saticon II, contact your RCA distributor or write to RCA Camera Tube Marketing, New Holland Avenue, Lancaster, PA 17604-3140. Or call (800) 233-0155. In Penna., phone (717) 295-6040. Overseas, contact RCA Sunbury-on-Thames, Middlesex, England. Hong Kong. Mexico 16DF, Mexico. Rexdale, Canada.

*Used by permission of trademark owner.

RCA
Take out the doubt.

TELEVISION PROGRAMMING

edited on site.

One night in particular, "It really paid off," says Mitchell. "During the first week, the weather was very, very bad, and we were able to get our signal on the air. The other Twin City stations could not fly their tape out of Ivanhoe to get it back. We were the only ones to have anything on the trial that night."

When the Ivanhoe shoot was over, the news crew returned to the station, along with one of the engineers. The

other two engineers, one of whom was Tom Hartho, left the site the next day and headed for Duluth, MN, where they were to meet another news crew and cover a movie premiere. They never got there. At the end of their first day of travel (it's a two-day drive from Ivanhoe to Duluth), a tornado hit the Hoffman, MN, area. The station contacted the crew in the motel they were staying at, and rerouted them to Hoffman. The next morning, Newstar

was headed for Hoffman, and a news crew was sent up by helicopter to meet it.

No one knew exactly what to expect. There was no time for advance work. As Mitchell says, "The hurricane took us into a situation totally blind." And when the two crews met, at a devastated farm, the situation couldn't have been worse.

"The whole area was totally blown away," says Mitchell. "And there was no phone service—the whole area had been wiped out."

Hartho immediately went searching for phone lines. "He couldn't find any phones working," says Mitchell, "but he did find a telephone pole that had been blown over by the tornado. He dug around in the ground—in the rubble—until he found a piece of phone wire. He picked it up and tested it and there was power there, and there was a phone battery on the line and he hooked it up to the truck and away he went."

The setup proceeded smoothly from there, and everything was readied for the transmission, but there was one last twist in the scenario, this time at the downlink end. As Mitchell recalls, "The winds that night were really bad, even in Minneapolis, and it blew the station's receive dish which is on top of the KSTP building considerably out of alignment.

"We didn't realize that until shortly before air time. So we were scrambling back here to align our dish—and it's not motorized. We were just minutes away from air time when everything was finally straightened out."

The Newstar operation has been a bit more tranquil since then, though no less active. And with viewer response "very good—it's been a hell of a promotional tool," according to Mitchell, the future, for now, seems assured. Newstar was at both national conventions this summer, providing local coverage. And more long-distance coverage like that can be expected—especially because KSTP's Newstar will probably become part of a Ku-band network of local stations, which will share transponder time and programming. This is the business plan of Conus Communications, a division of Hubbard which operates out of KSTP, and which is marketing the trucks and the network concept.

The future, as the saying goes, seems to be looking up for Newstar. **BM/E**

Minolta Broadcast Meters

Remarkable versatility combined with superb accuracy—
Minolta meters conform to CIE Spectral Response Standard.

MINOLTA TV COLOR ANALYZER II

Used for monitor set-up in TV control rooms and for on-line quality control in the manufacture of TV sets.

- Analyzer mode for white balance
- Chroma mode for setting white standard
- Matrix system eliminates cross-over interference
- Four white-memory channels; four CRT memory channels

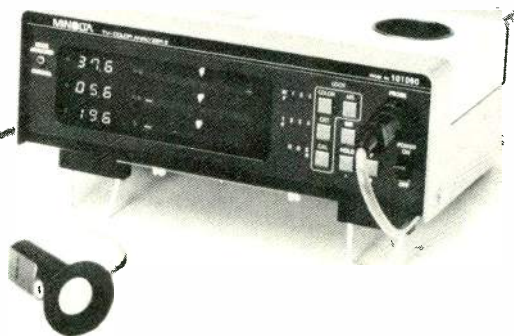

NEW CHROMA METER II INCIDENT



ILLUMINANCE METER



LUMINANCE METER 1°



MINOLTA HAND-HELD INDUSTRIAL METERS ARE:

- Lightweight and compact
- Battery powered for portability
- Rugged—ideal for field use

For more information, write Minolta Corporation,
Industrial Meter Div., 101 Williams Drive, Ramsey, NJ 07446

Or call 201-825-4000

© 1983 Minolta Corp

Product appearance and/or specifications subject to change without notice



Circle 126 on Reader Service Card

R-42 diversity receiver • Now with GaAsFET's.

Improved sensitivity and system range, with ultralow noise.

Cetec Vega's top-of-the-line PRO PLUS R-41 and R-42 wireless-microphone receivers have quickly become the worldwide standard of excellence. Overall quality of the PRO PLUS wireless system is equal to wired microphone systems, with respect to dynamic range, signal-to-noise ratio, distortion, etc. *We invite your comparisons.* Check these features of the new, improved PRO PLUS receivers:

- **GaAsFET front end.**

Provides the highest achievable sensitivity for maximum system range. Also incorporates a high-performance helical filter.

- **Lowest distortion.**

0.25% maximum, 0.15% typical.

- **Measurably the highest signal-to-noise ratio and widest dynamic range.**

Quiet as a wire. With DYNEX II (a new standard in audio processing), SNR is 101 dB (108 dB A-weighted). System dynamic range is 133 dB including transmitter adjustment range, from input for maximum nondistorting gain compression to noise floor.

- **"Infinite gain" receiver.**

Improved performance in the critical threshold region, superior handling of multipath conditions, better SNR, and constant receiver audio output level.

- **Professional audio circuits.**

Output is adjustable from +20

dBm to -60 dBm in four ranges. Also featured are selectable phasing and 0.2-watt independent headphone amplifier.

- **True dual-receiver diversity.**

The R-42 diversity system is the most reliable method to avoid dropouts. The R-41 nondiversity receiver has all of the other features of the R-42.

PRO PLUS wireless-microphone systems achieve the highest performance possible with today's advanced technology.

Write or call for further information and location of your nearest dealer: Cetec Vega, P.O. Box 5348, El Monte, CA 91734. (818) 442-0782.

The best wireless gets even better.

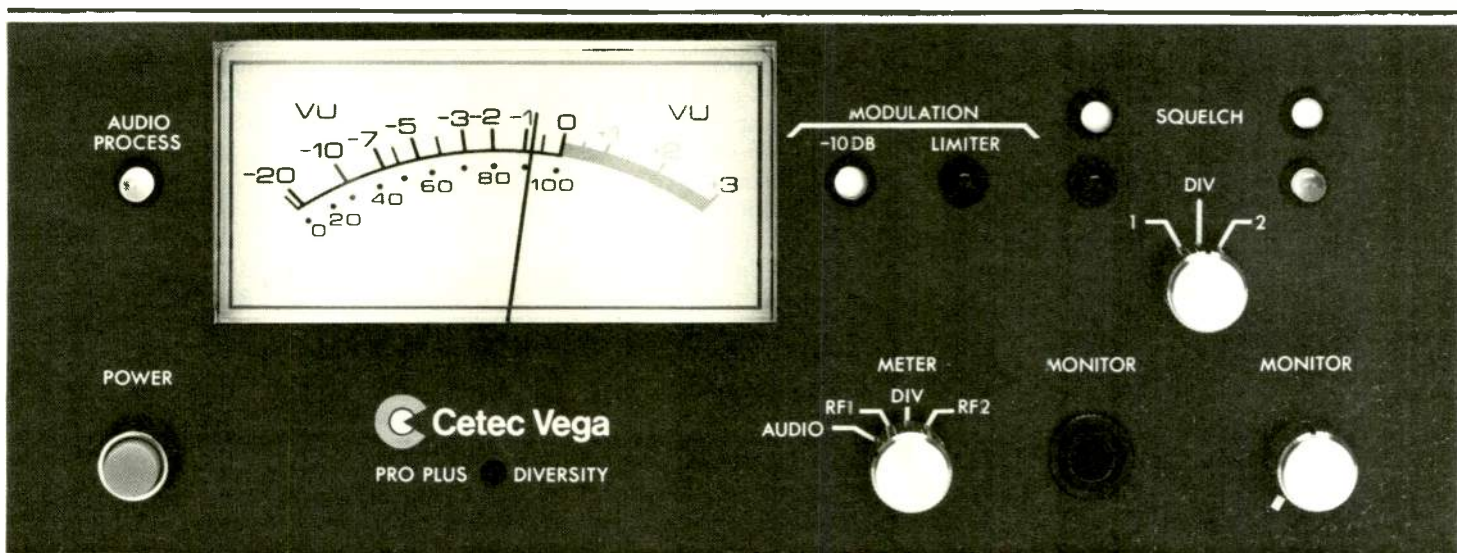

 **Cetec Vega**
... the professional's wireless

Circle 127 on Reader Service Card

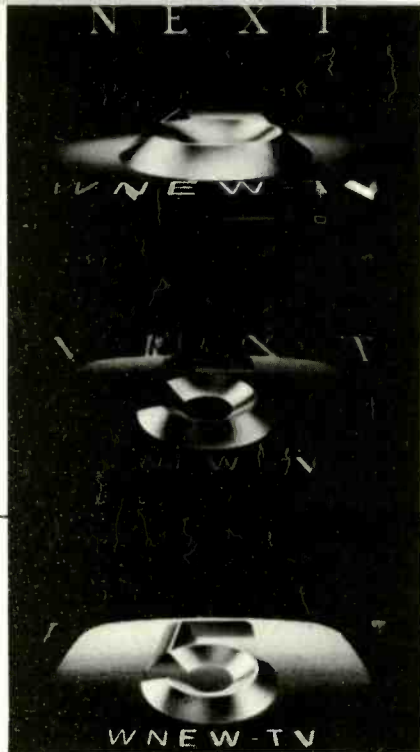

ON-AIR GRAPHICS PRODUCT

By Michael Greenhouse,
Associate Editor

A television or radio station must promote both itself and its programming. This is an indisputable fact of life. It must have an on-air campaign that features a logo or some sort of station identification. And it must promote, open, and tag specific programs.

The use of digitally created graphics—everything from neon-like lettering to fully three-dimensional solid models representing the station logo—is also, for the most part, a fact of life, particularly in competitive markets where one station outdoes the other from year to year with more and more elaborate graphics.

The high-tech look proclaims that a station is state-of-the-art, appeals to the younger generation, and so forth. Digital graphics also allow the station to compete with other users of the station break—national advertisers—who are using more and more digital special ef-

fects of their own.

Digital graphics are also very much in fashion, and stations who do not use them could be losing ground to the competition. As Donna Voght, promotion director of KTSP-TV, Phoenix, says, "You have to look state-of-the-art. It's getting so competitive that if you don't you'll be playing catch up forever."

The reasons for using digital graphics, then, are clear. But an issue of major concern now is how they should be produced. In the past, of course, there was no question. The promotion manager would simply invest whatever budget was available in a package from one of the graphics design houses. If the station had a lot of money, it would have its promos and IDs custom-designed. A station with less money might have to settle for a pre-prepared "package" of graphics—a "your name here" type of approach. Plus there were always the network-supplied packages in which affiliates



ION

Most stations recognize the need for sophisticated on-air graphics. But should they be produced in-house, or left to the experts at production companies? No matter what your choice, there are dangers at every turn.



Opposite page: "WNEW-TV ID sequence" by California Film; creative director Wendy Vanguard. "WKAQ Radio logo" by the Harold Friedman Consortium. Above: "WETE Channel 4" produced with Colorgraphics Art Star. Bottom left: "WOF-TV Channel 9," New York, by Pacific Data Images; creative director Karl Sjodahl, SjoCom Inc.; graphics designer Chuck Overton, SjoCom Inc.; Pacific Data animator Don Venhaus. Bottom right: "WTAE-TV logo" by Cranston/Csur, Productions; creative director Paul Sidlo; animator John Berton.

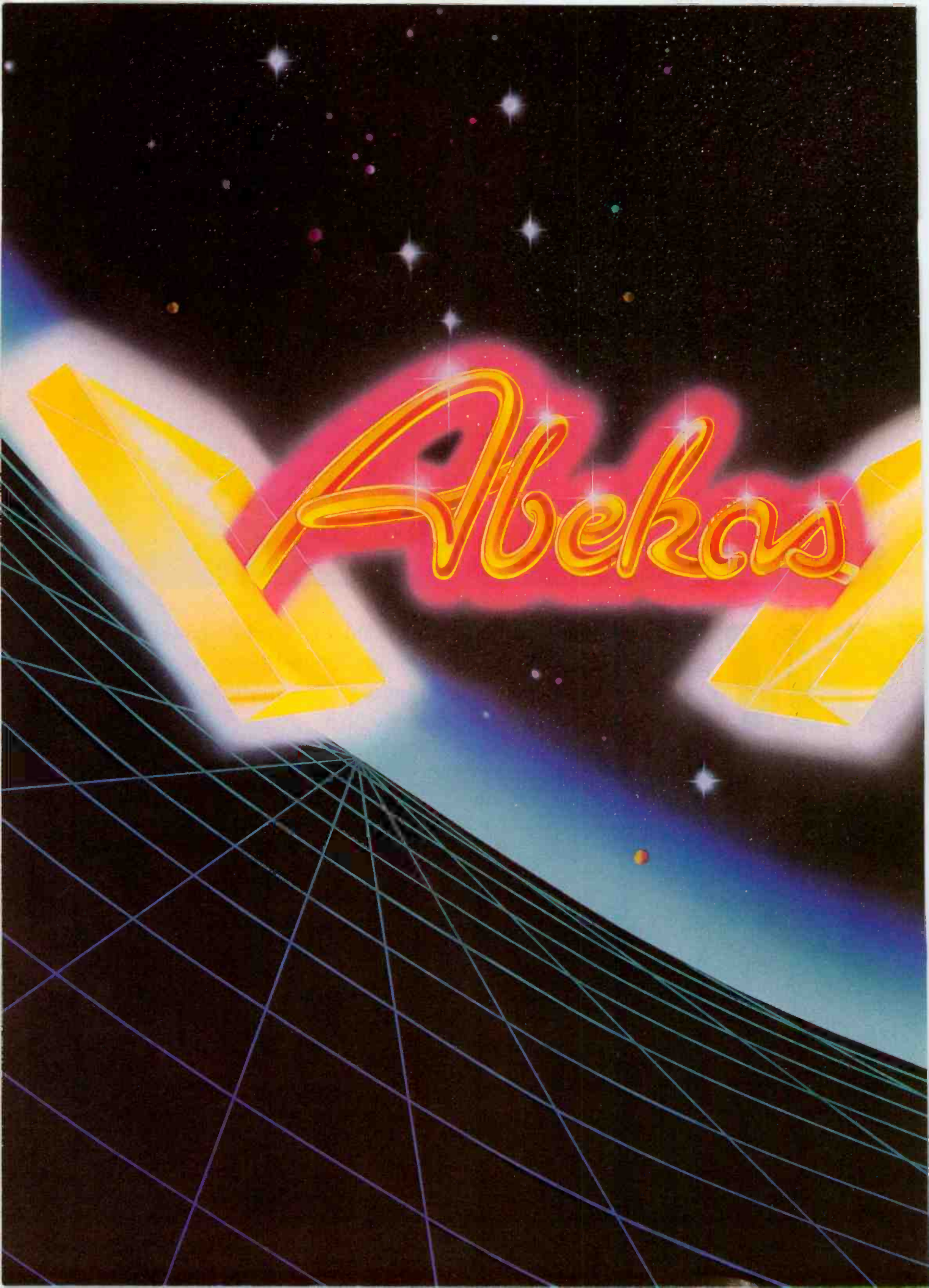

LET US SHOW YOU TWO WAYS TO IMPROVE YOUR IMAGE.

Abekas revolutionized the digital still store market in 1983 with the A42 Video Slide Projector. In 1984, we intend to set a new standard of performance with our A52 Digital Special Effects System.

The A52 Digital special Effects System provides extremely high signal transparency, smooth picture movement, and a control system ideal for both on-air and post-production applications. Effects include: variable axis compression to zero, infinite expansion, picture repositioning, mosaics, posterization, flips, tumblers, splits, freeze, multi-freeze, background and border. Single or multi-channel system.



The Abekas A52.

The A42 Video Slide Projector combines the very latest in 5 1/4" Winchester disk drive and full bandwidth digital video processing in a quality still store system that's both powerful and easy to use. Adaptive digital signal processing. Excellent multi-generation capability for graphics composition. On-line storage expandable to 1050 frames/2100 fields. Practical and economical off-line storage on 1/4" digital tape cartridge. Single or dual-channel system.



The Abekas A42.

Put the individual power of the new A52 or the A42 to use, or digitally interface them to form an awesome creative tool. For details, contact Abekas Video Systems, Inc., 319 Lincoln Centre Drive, Foster City, CA 94404, (415) 571-1711.

Abekas

Video Systems, Inc.

Circle 128 on Reader Service Card

See us at SMPTE Booth 704

could identify themselves with the network look yet have the promo created especially for each station.

The purchase of graphics from an outside production company is still widely practiced today. "It's an economic matter," explains Judson Rosebush of Digital Effects Inc., a New York City production company specializing in high-resolution digital creations. "Capitalizing a system which can produce the top-of-the-line images which the station wants is an extremely expensive endeavor. It would cost a station anywhere from a few hundred thousand to a million dollars to acquire a facility which could make state-of-the-art on-air graphics. And even if the station puts the equipment together, the volume of work at most stations doesn't warrant the capital investment.

"Besides, we specialize in image creation. We know the trends. And we're not competing with other departments such as news which always seem to have priority at a station."

And yet, with the wealth of electronic graphics equipment on the market (still stores, painting/drawing programs, 3D manipulators, digital effects devices tied in with sophisticated production switchers, character generators with frame buffers enabling them to do animation and graphics, video animation controllers, and even graphics software borrowed directly from the computer graphics industry), producing on-air graphics in-house has become more and more attractive.

There are those who argue that image-making of major pieces of station promotion—logos, IDs, bumpers,

openers, and so forth—should still be left to the experts, the production companies which specialize in this kind of work. Still others think a combination approach is called for—that the work can be designed in-house, then taken to a production/post-production house for execution. No matter what your choice, there are advantages as well as constant dangers resulting from wrong decisions.

Justifying in-house graphics

In-house graphics setups, no matter what digital devices are at their center, do not come inexpensively. A digital system with support equipment such as VTRs and editors could cost several hundred thousand dollars. This can be hard to swallow for many local stations that are now using nothing but tradi-

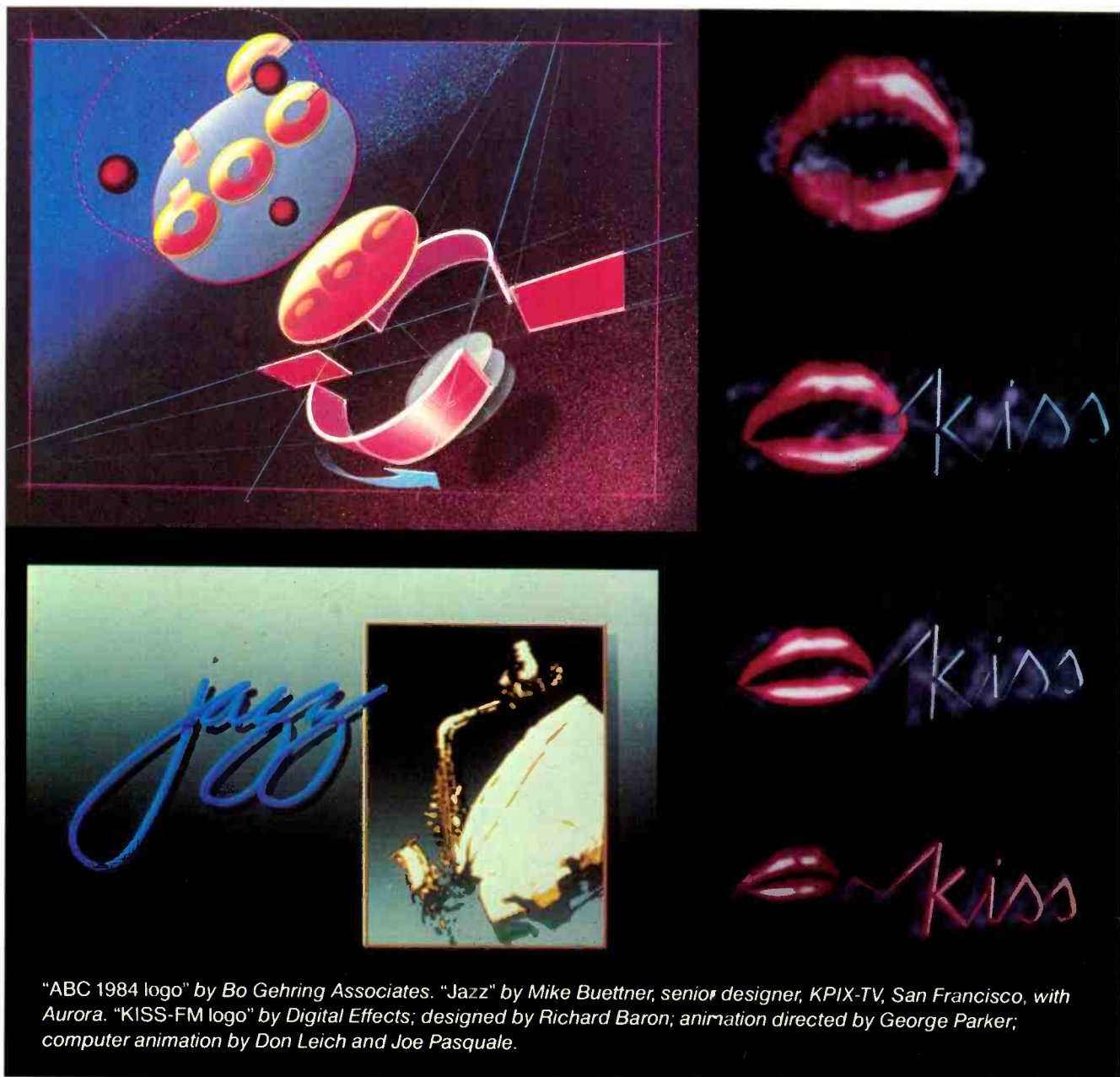

"ABC 1984 logo" by Bo Gehring Associates. "Jazz" by Mike Buettner, senior designer, KPIX-TV, San Francisco, with Aurora. "KISS-FM logo" by Digital Effects; designed by Richard Baron; animation directed by George Parker; computer animation by Don Leich and Joe Pasquale.

Now there's even more to look into



TM14-9RH



TM20-9RH

Ikegami's new Broadcast Color Monitors

Ikegami has just made it impossible for any quality-minded high resolution color monitor user not to consider looking into an Ikegami monitor.

They call it the 9-Series, two new monitors (13V and 19V) with standard features that include a High Resolution Shadow Mask CRT with a Self-Converging In-Line Gun; American Standard Matched Phosphors; a Comb Filter to preserve luminance resolution; pulse cross and R-Y/B-Y outputs. We think you'll call it just what you've been looking for. Along with its streamlined design and easily serviced modules, Ikegami's new monitors follow in a tradition of excellence. Each offers high stability, exceptional performance and proven reliability. Together with Ikegami's Delta-Gun Series, the 9-Series provides yet another reason to look into the monitors that more and more video users are spending their time looking into. Isn't it time you looked into Ikegami monitors?

Ikegami

9-Series monitors

Ikegami is the supplier of Color Monitors to ABC for its coverage of the 1984 Winter and Summer Games.

Ikegami Electronics (USA) Inc., 37 Brook Avenue, Maywood, NJ 07607 • (201) 368-9171 • Northeast: (201) 368-9171
West Coast: (213) 534-0050 • Southwest: (713) 445-0100 • Southeast: (813) 884-2046 • Canada: (201) 368-9179

Circle 129 on Reader Service Card

tional art materials (art cards and slides).

One way of justifying the purchase is to use the graphics system as much as possible—and not just for promotional work. Every area of the station must take advantage of the setup—news, programming, promotion, and, in some cases, commercial production.

At some stations, it is simply understood that news takes priority, and all other graphics production must fit around it. Other stations, however, have specific time slots scheduled to avoid any potential conflict. At KATV, Little Rock, AK, where a Dubner CBG-2 tied into a switcher and a Bosch Compositor I has been in use since July 1983, there is a 24-hour schedule with specific time slots. According to operations manager Eric Nelson, from 3:00 pm to 6:00 pm the Dubner is used for news and weather graphics. It is again dedicated to news from about 8:30 to

10:00 pm. But from 10:30 until 3:00 pm the next day, the setup does nothing but promotional graphics for the station (all promo work is done in-house) and production work for outside clients. The Dubner, which replaced slides at KATV, is amortized by using it for every facet of the station's graphics work, and by using it to produce graphics—including animated logos—for outside clients, some of whom are other TV stations.

Staffing

Another cost factor that must be evaluated in judging the economic impact of an in-house digital graphics setup is staffing. Does a station need to expand its staff, thus increasing its payroll, when it goes digital? Does it retrain its existing art personnel?

At KATV, both were done. The staff artists, under the supervision of art director Carol Abel, were trained on the

Dubner. Then a Dubner specialist was hired and put to work during the night shift.

At WOR-TV in New York City, the addition of three Chyron 4100s, one of which is used for promo work, has definitely added to the station's staffing. According to Joe Ondrik, director of advertising and marketing, the staff varies from three to eight, since different combinations of people work together on different projects.

"In-house graphics is probably saving the station money in production costs because we've certainly speeded up our time frame to get things done," he notes. "On the other hand it probably costs WOR more in personnel."

At WPRI, an ABC affiliate in Providence, RI, no one was added to the staff when the station got its Chyron IV in 1981. Back before WPRI bought its Chyron and married it to a Grass Valley Mark II DVE and 300 switcher, Con-

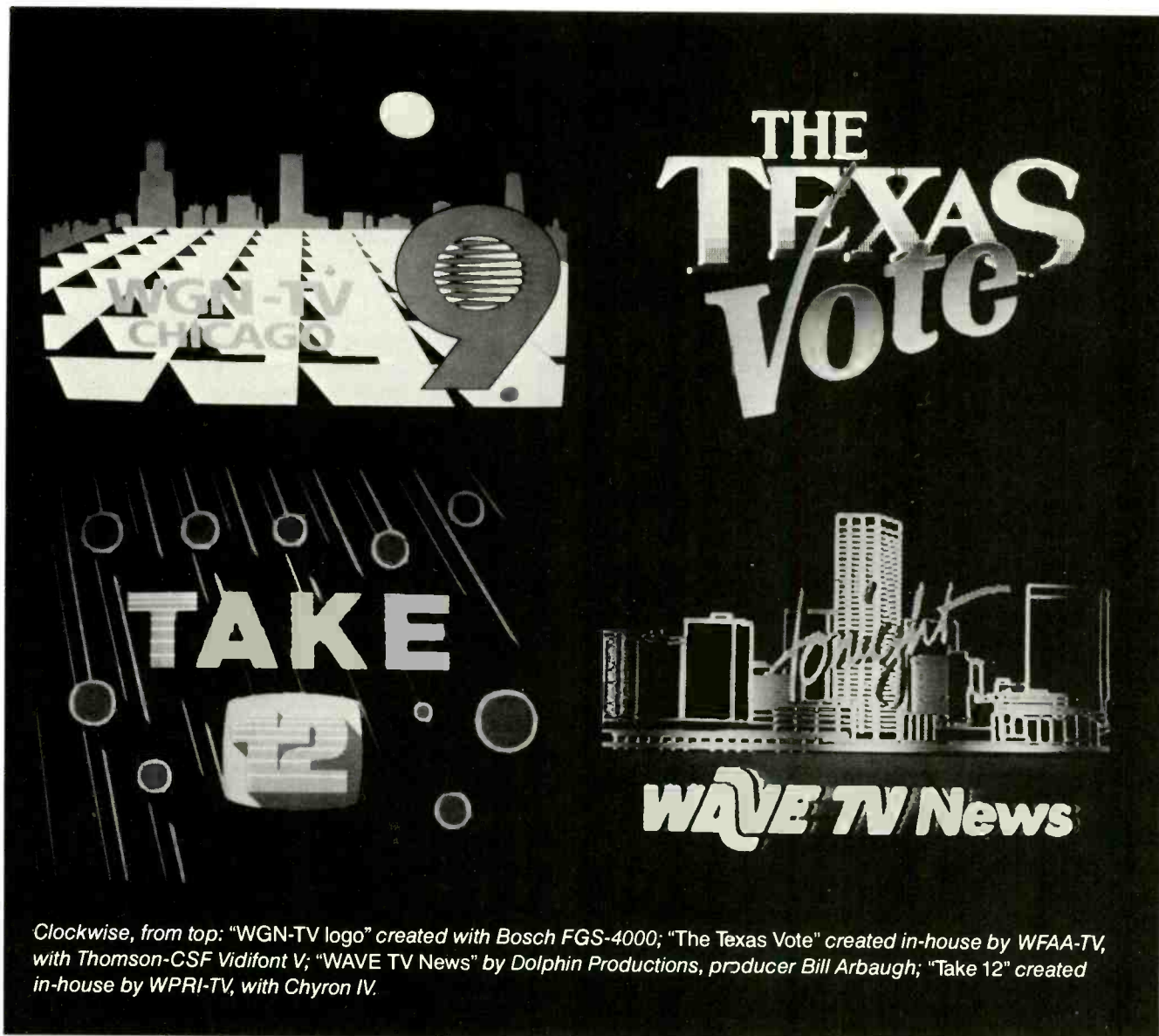

Clockwise, from top: "WGN-TV logo" created with Bosch FGS-4000; "The Texas Vote" created in-house by WFAA-TV, with Thomson-CSF Vidifont V; "WAVE TV News" by Dolphin Productions, producer Bill Arbaugh; "Take 12" created in-house by WPRI-TV, with Chyron IV.



Vidifont® Graphics V. Performance that's picture perfect.

Picture crisp, clean, coordinated graphics that capture attention, provide information and create a distinct perspective that sets you apart.

Picture the Vidifont Graphics V. Combining the features and functions of character generation, graphics, animation and information displays into a single integrated system. All the creative tools you need for news, dial-up services such as satellite weather and sports, commercial spots, promos, elections and special programs.

Vidifont Graphics V allows multiple-user access of up to eight channels. On-line creativity is combined with off-line input, making it easy to update and display raw information.

Vidifont. The picture of performance in over 500 TV and production studios around the world. Call or write Thomson-CSF Broadcast, Inc., 37 Brownhouse Rd., Stamford, CT 06902. Tel. (203) 965-7000. TWX (710) 474-3346. Telex 6819035-Answer Back 6819035 TCSB UW.

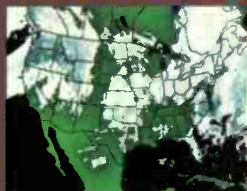
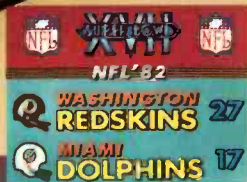

 **THOMSON-CSF BROADCAST, INC.**

Circle 130 on Reader Service Card

DIGITAL EFFECTS

321 WEST 44TH STREET, NEW YORK, NY 10036 PHONE: 212/581-7760



Is it real or is it Digital Effects?

Circle 131 on Reader Service Card

© 1983 Digital Effects Inc. Directed by George Parker. Computer animation by Alan Green and C. Robert Hoffman III for Compton Advertising Inc.

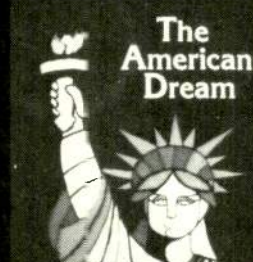

Left to right: "HBO logo" produced in-house by Chyron, with Chyron IV/MGM; "Rock On Seattle" by Artronix Computer Art Services, with MCI/Quantel Paint Box; "The American Dream" produced in-house by WPRI-TV, with Chyron IV.

vergence 104 editing system, ADDA ESP still store, and one-inch tape machines, the station's graphics work was produced primarily on slide under the supervision of an art director. In terms of staff number, nothing has changed. The art director now supervises two people, one of whom is from the engineering department; the other person comes from production. Both staffers do graphics work on a project-by-project basis, so in a sense the station is saving money because these people are doing two jobs. (Steve Davis, assistant chief engineer, admits that WPRI's non-union status allows the station to "draw the lines a little more fuzzily as far as who's in charge of the equipment.")

Davis says, however, that his in-house operation is definitely costing the station more money overall because, though personnel costs have not changed, the Chyron and all its support gear replaced a low-cost, slide-based art operation.

At WNEV, design director Maria LoConte claims to have "saved considerable amounts of money in terms of personnel with our Chyron systems." According to LoConte, this is because the presence of the station's two Chyron 4100s coupled with a Shintron 390 switcher (the whole graphics unit operates in RGB) has changed the job description of several of its union staff members. Before WNEV went on line with the Chyrons in the summer of 1982, members of different unions were required to do various tasks in the art department. A DGA member had to hang the art cards that were used, and a person from the electrician's union had to shoot the art card. When the Chyron came in, these two people were able to go back to their primary jobs. "At that point, we eliminated those two people" from the art process, says LoConte.

"The Chyron allows people with a particular expertise to go do their ex-

pertise," says LoConte. "In other words, a camera operator, who is in the electrician's union, can be off running videotape instead of working in the production session. And an AD, who would be the one who would have to hang the art card, is off AD-ing somewhere.

"Besides, digital lets you deal directly in the medium that is going to be aired. It's a more immediate kind of color resolution. It's just better looking stuff."

More for the buck

Still to be considered in any analysis of in-house graphics is the intangible factor of increased production capability. Bruce Lindgren, director of creative services at KRON, San Francisco, believes the station's Aurora Video-graphics setup is saving KRON money—in a sense. It gives the station more graphics for the buck. He says that since KRON got its two Auroras, his \$300,000 annual budget for on-air promotion has not gone up or down, but it has bought him more material than it used to. Why? Because the station is producing, in-house, material it may have sent out before and is therefore generating more graphics for less money. Also, now that he has the Auroras, he is producing material he could not have produced before unless he sent the work out; and since farming that work out to a production company would have cost a good deal of money, he simply wouldn't have done it at all.

Aesthetics

In evaluating how an in-house setup affects you economically, you also have to consider what these systems give you aesthetically. After all, a station's look could affect ratings. As in the case of KRON, an in-house system can give a station material it could not have produced before. Last Christmas, Lindgren says, his five-person staff

produced a series of six four-second IDs in which the station wished its viewers a merry Christmas. All were animated, and in one an antique train rode around a Christmas tree while lights sparkled.

KATV, which produces all its graphics in-house, recently produced its own animated ID sequence in which its channel number, seven, was manipulated in a 3D field. And WPRI this year is producing its own fall promotional campaign. The station turned down the ABC network package, which would have custom-fit the WPRI logo in the network's "We're With You" animated campaign.

At WFAA, an ABC affiliate in Dallas, electronic graphics systems supervisor Lillian Gonnell oversees an art department that features a Thomson-CSF Graphics V tied into a Quantel still store and a Grass Valley 300 switcher. According to Gonnell, the system is used for all titling, and for show promos—"quick promotion that needs a little sparkle," she says. The station recently did a series of animated promo spots for a week of animated cartoons called *Magic Moments*. Using the Thomson, the art staff drew an animated rabbit and had it hop across the words "Magic Moments." As it hopped across, the words compressed. When the rabbit reached the end of the words, it jumped into a hat.

Speed is one of the advantages of an in-house operation, because it allows a station to produce topical promotions. Brian Lay, engineering manager at WNEV, says, "We can take something that happened on the news and do topical news promotion for the next day." Being able to produce promo materials quickly is also important when the time you have on the system is very limited, as it is at many stations.

An in-house system can also help give a station a consistent, unified, integrated look. WNEV does a daily

CABLE REELS built for the professional environment

- Extremely durable tubular steel construction
- Heavy-duty, permanently lubricated bearings
- Stackable or with casters
- 3-position brake
 - lock for transporting
 - soft brake for spooling out cable
 - free wheeling for fast rewind

Request Canare's full line Cable & Reel Catalog.



R380S
SUG. RET. \$242

R300S
SUG. RET. \$217

CANARE T.M.

CANARE CABLE, INC.

10834 BURBANK BLVD./NORTH HOLLYWOOD, CA 91601
(818) 506-7602

Circle 132 on Reader Service Card

magazine show called *Look*. The graphics department has designed electronic logos for the show that go with the design of the set and the logo that's built into it. The station also recently did a public affairs show in which all the logos for the show were done on the Chyron 4100. That artwork was carried through the taping of the show, and it was also used in the promos, "even on something as simple as three-second IDs with 'Sunday at 8' keyed over them," says Lay.

Going outside

In-house graphics units generally seem to be cost-effective if they're used as much as they can be—if, as Bruce Lindgren says, "you push each of these computer graphic devices as far as you can." And they certainly give you a look you can't get with flat art. But almost inevitably, there is a point at which graphics work has to be sent out to a specialist: a post-production facility or computer graphics production company. Even Lindgren, who is clearly sold on his in-house operation, says, "These devices are not the panacea for all your graphic needs. They have their place." Their "place" seems to end at

the point where, as Lindgren says, a station wants "really high resolution, 3D chrome modeling with brilliant flashes and the like." And so it is for most stations that have in-house graphics setups; they will, on occasion, use a computer graphics company for a particularly important piece of animation, like a news opening or a station ID. Al Walton, executive producer of California Film, one of the production companies which benefits from this business, notes that "ours is a very specialized kind of design. Typically, a piece of work only lasts three to five seconds. There's a real specialty to orchestrating that in a memorable way that's going to wear well. And typically, a station is going to use that work over a period of two to three years."

The process of creating this kind of work is almost the complete antithesis of the quick turnaround material needed for newscasts. Some of California Film's work, for instance, is produced using a Hewlett-Packard plotter: the frames of an animation sequence are rendered one by one on the plotter, and the finished paper is sent off to a conventional film animation house for photography. In other instances, the design concept is sent to a company such as Pacific Data Images, where a Ridge 32 computer in conjunction with a Raster Technologies 24-bit frame buffer is used to model the image and then display it either on a color CRT for viewing or else on a high-resolution CRT which is photographed onto motion picture film.

This was the case with the highly metallic logo created by California Film for WNEW-TV, the first time an independent has gone to such elaborate measures for an on-air logo. PDI also did the NBC fall promotion campaign, creating the computer images for Harry Marks, considered one of the top designers of on-air graphics in the country.

California Film's services are not inexpensive; they range from around \$1500 to \$2500-per-second depending on the approach and the production values.

Rosebush, whose Digital Effects uses an extremely powerful Harris 800 as its host computer—again recording directly onto motion picture film—describes it as "a general purpose computational machine which will compute images and three-dimensional geometries at various resolutions." The company has developed its own software for the system, called Visions.

The New VPA-380 . . . from SIGMA

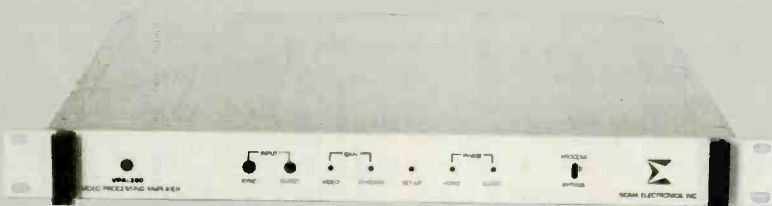

The answer to your processing need; an ideal blanking processor for a composite video switcher; a genlock processor for tape duplication and editing; a C.C.U. for studio or field.

Features:

- Two Genlock Modes, VTR and Stable Source
- Regenerates New Sync and Burst
- Internal or External Reference
- Adjustable Blanking Widths
- Differential Input

SPECIFY SIGMA!



SIGMA ELECTRONICS INC.

1830 STATE STREET, EAST PETERSBURG, PA 17520
(717) 569-2681

Circle 133 on Reader Service Card

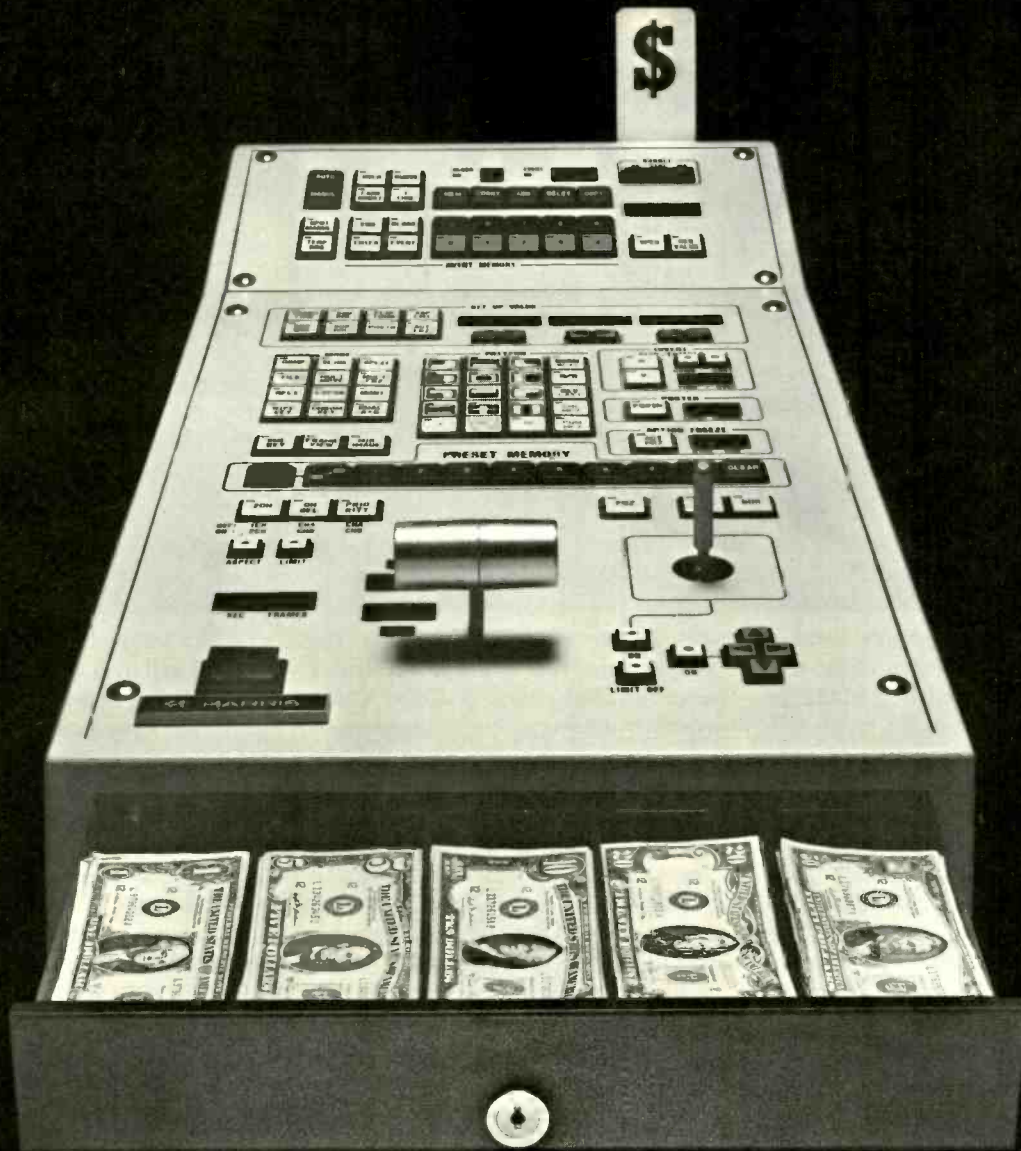

Production loves the effects, Accounting loves the effect on the bottom line.

Why did Harris decide to market the HDE digital effects system?

Well, first of all, it has the newest effects and features, like 150 event bubble memory, multi-move, mirror-reflect, programmable trajectory, mosaic, zoom, split, slide, compression, flip/tumble, and dual channel operation.

But that's not the real reason.

We know that our customers want a full range of

high quality video effects from a small, modular, yet rugged unit, sold by a U.S. company famous for its product support. And with a price an accountant can love.

That's the *real* reason.

So, for a brochure about any of the expandable and cost-effective HDEs from Harris, call or write:

**Harris Studio Division, Video Systems Operation,
1255 East Arques Ave., Sunnyvale, CA 94086.
(408) 737-2100**

© Harris Corporation. 1984

For your information, our name is Harris.



Circle 134 on Reader Service Card

PICTURE THIS



SUPERMARKET SWEEPSTAKES

"Picture This" produced in-house by KATV, with Dubner CBG-2. "Supermarket Sweepstakes" produced in-house by WFAA-TV, with Thomson-CSF Vidifont Graphics V.

Costs for this high-end service range according to the complexity of the job. (All the work is customized.) But for an ID or opening five-to-seven seconds in length, the price range is \$10,000 to \$25,000.

One of the newest computer graphics companies is Digital Productions, in Los Angeles. According to John Whitney, Jr., the president, the company (which has been in business less than two years), produces 3D, smooth-

shaded raster graphics. To do it, the company uses one of the world's most powerful computers, a Cray XMP, originally developed for military applications and capable of performing over 120 million calculations per second. To visualize the material before it is run up on the Cray and recorded directly onto film, Digital Productions uses a Ramtek graphics processor—the equivalent of what some in the broadcast industry are thinking of using for their entire

graphics setup. But then few in broadcasting will ever need the 4000 x 4000 pixel resolution which can be cranked out of the Cray in what at first appears to be almost real-time animation.

Recently, Digital Productions designed and produced the new WTBS cable channel logo—a five-second version, and two shorter versions, according to Whitney.

In addition to the companies mentioned above, there are perhaps a dozen

EDITOR CONTROLLABLE PRODUCTION SWITCHER

6109

32 PATTERNS • VARIABLE BORDERS • SOFT EDGE
RGB CHROMA KEYER • DOWNSTREAM KEYER
BLANKING PROCESSOR • AUTOMATIC FADER • TEST MODE
UNIQUE TEST MODE FOR SYSTEM TIMING

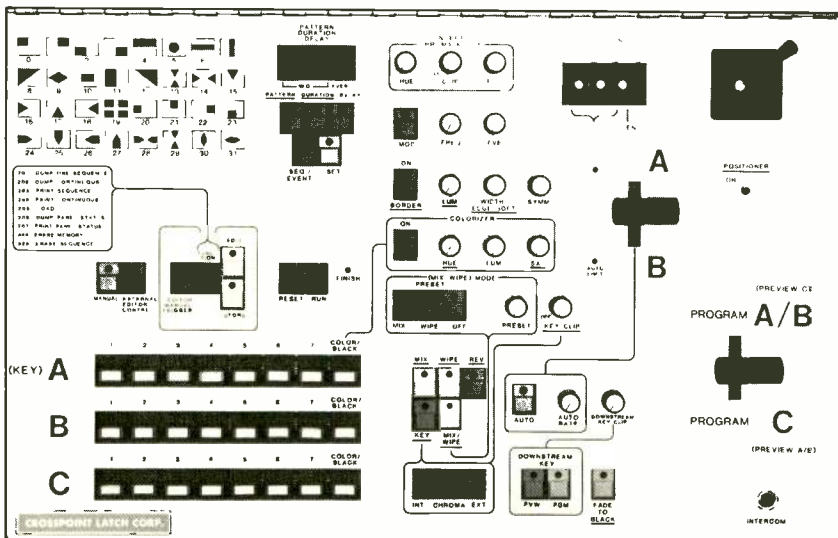

THE 6109 CAN BE UPDATED TO A FULL MICROPROCESSOR CONTROLLED SWITCHER (IN THE FIELD) WITH THE 7209

The basic 6109 has a standard RGB chroma key, and can produce a wipe behind a chroma key (with the optional second RGB or Encoded chroma keyer). Then with the 7209, it has full external computer control. Crosspoint Latch has by far the most advanced and comprehensive serial protocol in the industry. Options for the 7209 include 99 sequence storage, printer driver, battery back-up etc. The switcher is human engineered for operation; two fader arms and a true positioner (not a "rate controlled" joystick).

CROSSPOINT LATCH CORP.

6109 (NTSC) \$6,995. Basic 7209 \$3,000.

95 PROGRESS STREET • UNION, NJ 07083
(201) 688-1510 • TELEX 181160

The more you see, the more we hear



Look who's talking about Dubner now.

While we claim no responsibility for the famous line, "Build a better mousetrap and they'll beat a path to your door," we'd like to think it might have been said about the Dubner CBG-2 video graphics/animation system. In any case, we thought you might like to hear what your colleagues are saying about us:

"The CBG-2 is undeniably the most novel and flexible state-of-the-art real-time animation graphics device currently available.

—Mark Bernardo, Chief Graphics Design Engineer, Olympics ABC Television

"We needed a machine that would allow us to compete effectively in an already competitive market. The CBG-2 gave us the capability to create weather maps and news graphics quickly, it could be operated by department personnel, and it was the best buy on the market."

—Bob Plummer, Director of Engineering, Fisher Broadcasting KOMO (Radio & Television, Seattle)

"It's a digital computer and animation tool that allows artists to create quality animations independently. The CBG-2 is relatively inexpensive, it works fast and enhances the creative process with real-time imagery."

—Elaine Schwartz, Computer Animator Atlantic Image (New York animation house)

"The CBG-2 is much faster and less expensive than standard film animation. The real-time animation, clean key capability, expandability and great software support make it one of the best computers around."

—Corinne Sousoulas, Art Director Motion Picture Laboratories (Memphis post production house)

"The CBG-2 is a valuable tool due to its ability to create effective graphics quickly. It offers three dimensional animation, graphic enhancement, and character generation all in one unit. And these features are difficult to find in any one machine."

—Victoria Henigman, Electronic Graphic Designer WPBT-TV (Miami PBS Affiliate)

"The Dubner was purchased for its advanced animation capabilities, its ability to be upgraded via software, and its cost effectiveness. We love it!"

—Dan Sokol, Vice President, Engineering Video Post & Transfer (Dallas post production house)

With all the nice things being said about Dubner, all we can say is thank you. We plan to keep up the good work. You'll keep seeing it and we'll keep hearing about it.

For a free demonstration of the Dubner CBG-2, call (201) 592-6500, or write.

DUBNER



Dubner Computer Systems, Inc. 158 Linwood Plaza Fort Lee, New Jersey 07024

Circle 136 on Reader Service Card



others scattered around the country which also specialize in this kind of work. Omnibus Computer Graphics, in Toronto, New York, and LA, uses a proprietary Foonly FI computer and software—the system which created extensive special effects for the movie *Tron*. MAGI/Synthavision, in Elmsford, NY, which also created some of the effects for *Tron*, uses a Perkin-Elmer computer. Acme Cartoon in Dallas uses a DEC PDP-11/60 computer with a DeAnza frame buffer. Cranston/Csuri productions, a commercial outgrowth of research projects at Ohio State University, uses twin

VAX 11/780s and twin VAX 11/750s to produce some of the most stunning graphics around—including sports logos for all three networks, plus IDs for stations such as WCVB-TV, Boston, and WFLD Chicago. Then there is the Editel graphics network (see the story elsewhere in this issue.)

In all cases, the results are an astonishing array of digital special effects and animation which are truly the state-of-the-computer art. In a sense, going to these companies is like buying fireworks: you get what you pay for, and the more you spend the brighter and flashier it gets.

Video post-production facilities

A post-production facility can be an alternative to in-house production and the sometimes unaffordable production company. But sometimes a station producer simply can't get studio time at the station, or perhaps he needs some sort of post-production device his station doesn't have. Here a post house can be the answer. WCVB in Boston is a case in point. It has an MCI/Quantel Paint Box, and all logos, IDs, and show promotions are designed on it by the station's 11-person design staff which, for the last four years, has won New England Emmys for design. But the station's editing facilities are often booked by the news department, and besides, the station lacks DVE devices. When promotion needs a DVE, or simply when it can't get time in an edit suite, it goes outside to a post house.

But for a major promotion spot, the station recently used Charlex, a New York City production and post-production company. Why? For one thing, Charlex has two ADOs, a Paint Box, three CMX edit suites, 14 one-inch decks, an Elicon animation system, and a PES animation stand with IMC motion control. It simply has much more capability than WCVB. But Charlex also has expertise—particularly in matting and animation—and a kind of creativity that can't be found at WCVB. As Jill Katz, director of creative services at WCVB, says, "They understand the blending of film-to-video technology better than at our level. They know how to manipulate video much better than we do." Charlex also has a talent for humorous, surreal work.

For the WCVB spot, Charlex was given creative freedom, and the result was a 60-second piece done to the tune of The Jackson's "ABC" (WCVB is an ABC affiliate). As Alex Weil, one of the co-owners with Charley Levy, describes it: "A lady is sitting in a post-modern environment, with Boston through her window. Suddenly, the skyline starts to glow, and a huge TV set that says CVB on it comes to her window. It zaps things in her room and it turns black and white to color, and it makes busts come to life. It makes her TV come to life, and it zaps her and sucks her in. She falls through static and falls into the Ted Knight weekly series. She pops into the *Fame* montage...."

When accuracy counts...Count on Belar for AM/FM/TV MONITORS



BELAR
AM MODULATION MONITOR

Circle 137 on Reader Service Card



BELAR CALL ARNO MEYER (215) 687-5550
ELECTRONICS LABORATORY, INC.

LANCASTER AVENUE AT DORSET, DEVON, PA. 19333 • BOX 826 • (215) 687-5550

the **editel** group

COMPUTER GRAPHICS NETWORK

VIDEO INTERACTION LINE 1-800-692-6000

new york
Alfie Schloss
222 East 44th Street
New York, New York 10017
(212) 867-4600

chicago
Olita Kins
301 East Erie Street
Chicago, Illinois 60611
(312) 440-2360

los angeles
Richard McDougall
729 North Highland Avenue
Hollywood, California 90038
(213) 931-1821

Bell & Howell/Columbia Pictures Video Services

Kavouras

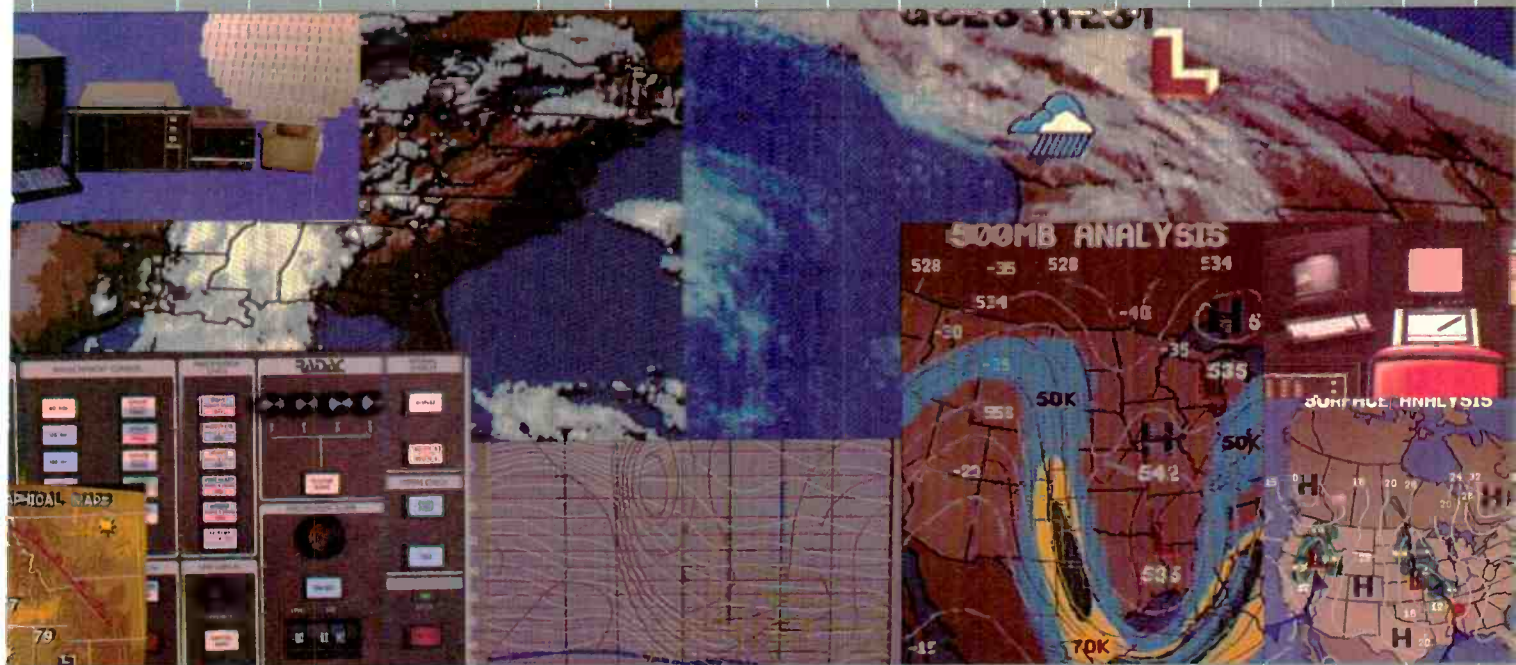

ADVANCED WEATHER TECHNOLOGY

Kavouras INC 6301 34th Avenue South, Minneapolis, Minnesota 55450
800-328-2278 612-726-9515

Circle 139 on Reader Service Card

Broadway Video, the New York post-production house, is another company known for its capabilities and creativity. It has three on-line suites and one off-line with four Sony BVE-5000 editing consoles, a two-channel ADO, a Paint Box, and a Quantel Mirage. A station producer who goes to Broadway Video and wants to use an on-line room with three machines should expect to pay the "book rate," \$425 per hour.

Johnson & Johnson, which underwrites *Nova* on PBS, had about 10 seconds at the top of the show to announce that fact. The company went to Broadway Video because, "They wanted something flashy that involves their logo," says Stacie Foster, VP of creative services. It took about six hours of painting on the Paint Box and about eight hours of editing. The Mirage was used for four of those eight hours, and the ADO for six of the eight. Four machines were used for some of the complicated prebuilds. The grand total was about \$8000 for three 10-second logos.

A number of local stations have also been to Broadway Video. WCBS is a fairly regular customer when it needs a device it doesn't have in-house, or

when its own post facility is not available. But many stations are attracted by the Mirage—a device that no station currently has, probably because of its \$300,000 price tag, and because a software programmer, while not required to run the Mirage, is a good idea for developing new effects. Broadway Video has programmers on staff, and it also has over a year of experience with the Mirage—more than any other company except TAV in Los Angeles.

The Post Group in Los Angeles is another post facility with a Mirage (and a programmer, Maury Rosenfeld, formerly of Broadway Video) and an arsenal of other gear that includes Aurora, six ADOs with a combiner for putting together up to four channels at a time, CMX editing, a Grass Valley Mark II DVE and a Bosch FGS-4000 graphics system. According to Linda Rheinstein, director of special projects, "The Bosch is really what we're using most for the station IDs." The FGS stands alone at the facility, and if frame-by-frame animation is being done, the recording is handled by a Sony BVH-2500 one-inch machine. Rheinstein says ADO is also used quite often for manipulating Bosch graphics.

Recently, The Post Group used the Bosch for a series of six station IDs for WJLA, Washington, DC. These IDs included the station ID, news ID, and "local promo ID—their whole new look," says Rheinstein. The facility also recently designed and produced a special news graphic for KNBC in Los Angeles. Called "The Game Plan," it was used every hour for the three weeks of the Olympics, when the station updated what was happening at the Games.

No matter how they are created, on-air graphics have never been fancier, costlier, or more guaranteed to grab and hold the viewer's attention. No matter what approach you take—in-house production, a graphic design specialist, or a video post-production facility—you can be certain that if the talent is right, the product is going to identify your station with the best that's available for the look of your station. **BM/E**

Please take a moment to complete the Electronic Graphic Systems Survey on page 40-A&B and return it to us postage-paid. For more information on graphics systems and suppliers, circle 300 on the Reader Service Card.

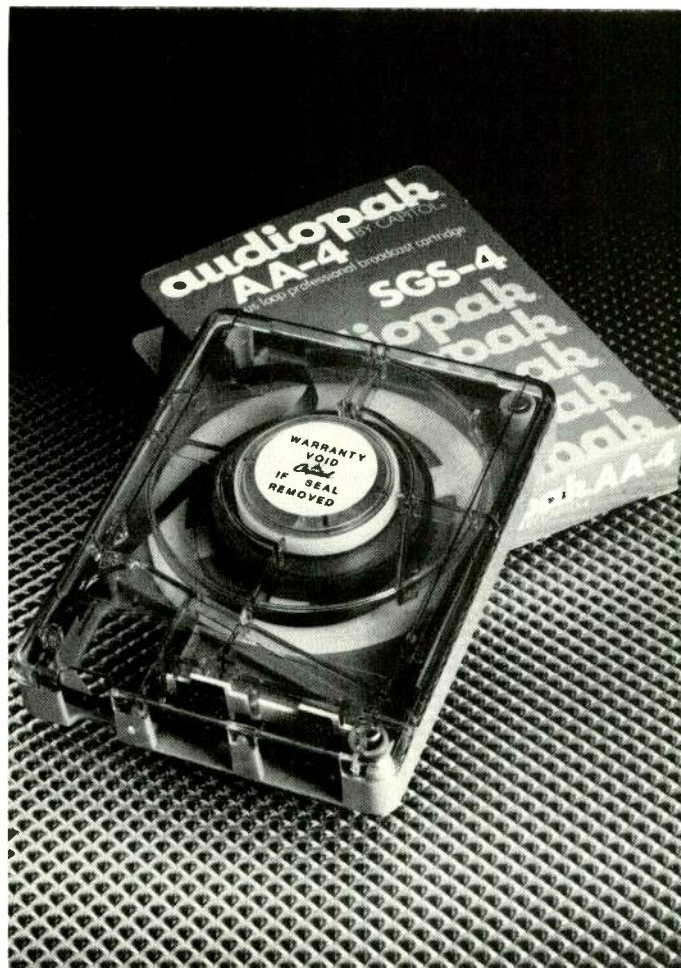

FOR ALL YOU WANT A CART TO DO, THIS CART'S FOR YOU!

- ▶ For... The best sound a cart can reproduce
- ▶ For... The exclusive SGS-4 broadcast mastering tape.
- ▶ For... Superb copies of CD's and digital masters
- ▶ For... Outstanding high frequency sensitivity and headroom
- ▶ For... Stable stereo phasing
- ▶ For... Maximum reliability and longest life
- ▶ For... Compatibility with all cart machines
- ▶ For... Stations who care how they sound

THE AUDIOPAK AA-4 IS FOR YOU

The True Blue Cart - From Capitol

© 1983 Capitol Magnetics Products, a division of Capitol Records, Inc. All Rights Reserved.



Q8 challenges the imagination

with... 2 Independent or Interactive Channels of
Hundreds of Fonts... and Millions of Colors...
and Automatic Keystroke Sequencing... and
"Unlimited" Roll & Crawl... and Pop-On Animation
...and Fade, Matte & Key ...and Full Studio Timing
...the possibilities are endless.

Q8 QUANTAFONT® Face-Loadable
Teleproduction Graphic Titling System.

a decade of commitment

QUANTA®

Quanta Corporation • 2440 So. Progress Drive, Salt Lake City, Utah 84119 • (801) 974-0992 TWX 910-925-5684

Circle 141 on Reader Service Card

FROM THE PEOPLE WHO BRING YOU THE CHARTS...

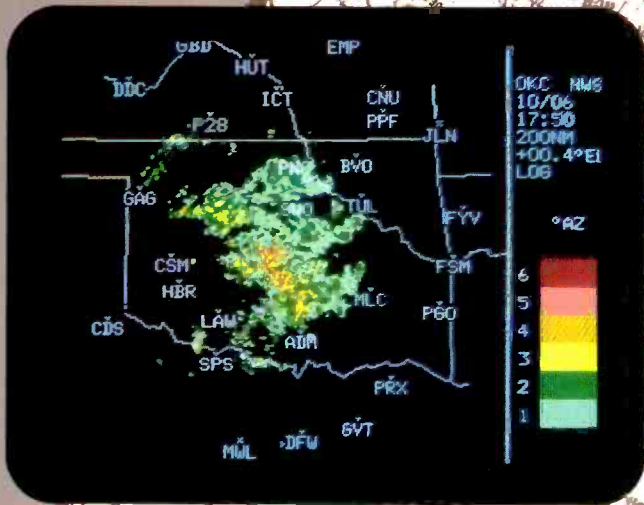

**LIVE RRWDS
COLOR WEATHER RADAR**

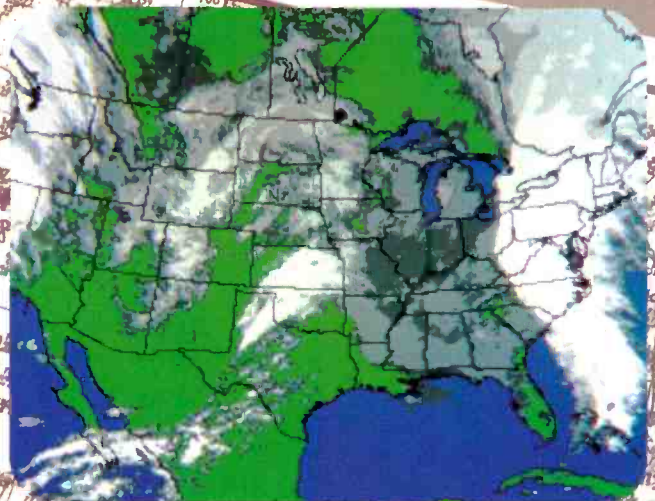

**PLUS COLOR SATELLITE
AND WEATHER GRAPHICS**

You already know Alden as the first name in facsimile weather chart systems. In fact, you probably already use one of our chart recorders.

Now Alden introduces a new family of systems to add live color radar and satellite/weather graphics to your information sources.

LIVE RADAR. Alden's C2000R system brings you live weather radar information via a new network of National Weather Service radar transmitters, called RRWDS. The C2000R accesses these radar sites easily and cost-effectively using standard voice-grade telephone lines on either a direct line or dial-up basis.

Display different precipitation levels in up to 6 colors, with level flashing for easy identification, or store multiple-region and time-lapse pictures. Numerous other features make its low price a pleasant surprise.

GRAPHICS. Alden's C2000S is a low-cost, high-performance unit for displaying weather information from private and government data bases. Color satellite pictures, surface weather, temperature contours and hourly NWS pictures are available, with 16 selectable colors, zoom, flash and loop capability.

BOTH. Alden's C2000R/S offers the combined capability in one system. Our "building-block" design permits field conversion of the stand-alone C2000R or the C2000S into the C2000R/S model at any time. All systems offer the flexibility to acquire not only today's data, but the data of the future.

Call or write us for complete information. Alden Electronics,
118B Washington Street, Westborough, MA 01581.
Telephone 017/366-8851

Name _____
Company _____
Address _____
City _____ State _____ Zip _____
Phone _____

ALDEN ELECTRONICS

The First Name in Weather

Circle 142 on Reader Service Card

EDITEL/ CHICAGO



Despite state-of-the-art technology, this large midwest facility places its emphasis on talent and techniques.

By Michael Greenhouse,
Associate Editor

"Hardware is a must, but people make the difference," says Doyle Kaniff. The Editel Group's president pauses for a moment, then adds, "This is the slo-

gan we use in our ads. It might sound a bit trite, but it really sums up our philosophy. We're never selling hardware, we're selling capability."

Trite or not, something is certainly making a difference; it could very well

be the people. Editel/Chicago is probably the largest facility in the Midwest. After an almost geometric growth period that began in about 1976, the company (which for the last two years has been a joint venture of Columbia Pictures Video Services and Bell & Howell) occupies 36,000 square feet of space. More than 60 people help run five edit suites, two negative/positive transfer rooms, a clean room for film preparation, an audio sweetening room, a graphics room, a Montage editing room, two production stages, and a remote operation.

The heart of the matter

TV commercials are the backbone of the facility's business. As Lenard Pearlman, the company's VP of technical services, says, "We do a tremendous amount of commercial work, and because Chicago is a film post-production town, people will shoot on film and then transfer to tape and edit on tape." The two film-to-tape and color correction rooms, along with the three one-inch edit suites, then, are central to the operation.

The film-to-tape rooms have Bosch FDL-60s, the first in Chicago, and, according to Pearlman "the most reliable hardware in house." The color correctors, which the facility helped develop, were bought about five years ago. Editel has also added the Bosch liquid gate option for the FDLs; this immerses the film in a bath of viscous liquid that

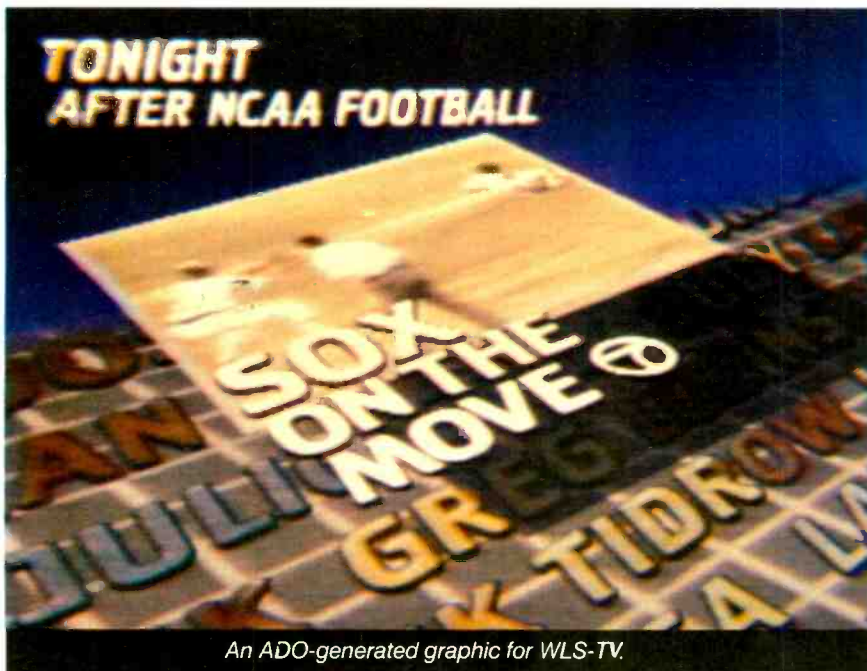

An ADO-generated graphic for WLS-TV.

TIME BASE CORRECTION RE-DEFINED

Introducing the first totally different approach to time base correction in 10 years.

Until now, the TBC has only been as good as its weakest link - the analog circuitry. So we have eliminated the input clock and introduced the industry's first totally digital sync separator in a TBC.

The DPS-103 single clock TBC uses component processing and an advanced interpolation technique to breakthrough to "picture perfect" video.

Designed to work with 3/4" heterodyne VTR's, the DPS-103 is the long-awaited solution to conventional time base correction. Only \$8950.

Features:

- Maintains lock through 40 times normal speed in forward and reverse
- Maintains color through 10 times play
- Velocity compensation
- 16 line window
- Auto color framing
- RS 170A output
- Internal test generator

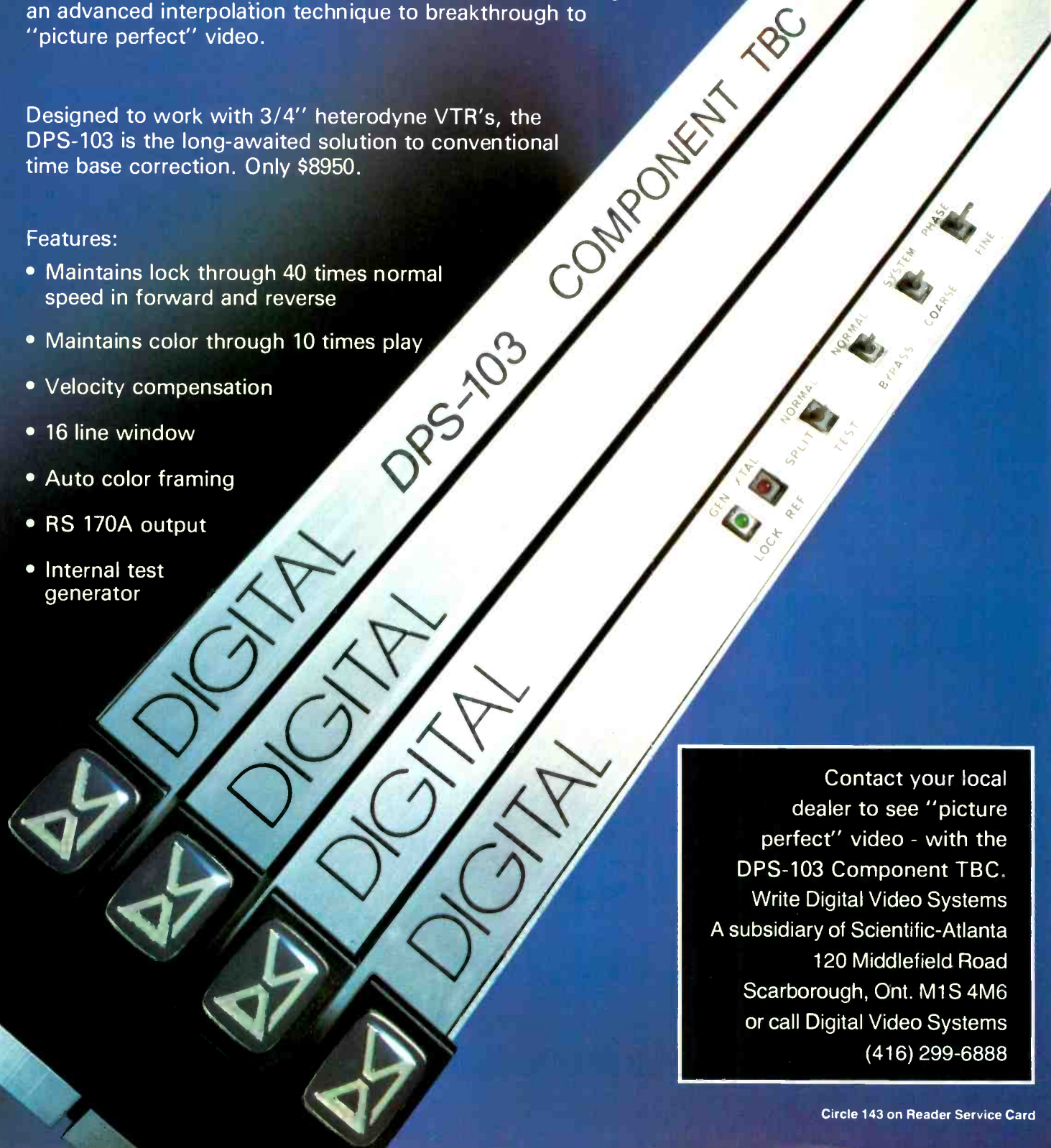

Contact your local dealer to see "picture perfect" video - with the DPS-103 Component TBC. Write Digital Video Systems A subsidiary of Scientific-Atlanta 120 Middlefield Road Scarborough, Ont. M1S 4M6 or call Digital Video Systems (416) 299-6888

fills in scratches in the film's surface and helps to diffract light as it passes through the scratch, making it appear more diffuse.

The one-inch edit rooms are based around two CMX 3400s, and a Bosch Mach One. Each of these systems controls up to four tape machines. Eight Sony BVH-1100As and four Ampex VPR-3s have been assigned to the rooms. The switchers are Grass Valley 300s and 1600s with E-MEM interfaces. Digital effects are handled by a Vital SqueezeZoom, a Mark II DVE, and a single-channel Ampex ADO. Pearlman says he will probably add a second ADO this year. The character generators are Bosch Compositors.

Pearlman stresses that the equipment in all three rooms is "understated." Only the gear that has to be used is next to the editor. "You don't need to put a switcher between you and the client, because even though the switcher is needed, the room is laid out to try to bring people together for creative ideas," he says.

How are the rooms laid out? Each room has two areas. In one, the client is directly involved. He can sit next to the editor and have his own working space without the two interfering with each other. In the second area, the clients who are not directly involved—except the various viewers and "opinion givers"—can continue doing work, or making phone calls, and yet still be part of the creative process.

Editel has customized its editing systems somewhat, specifically in the form of software modifications. "If we can," Pearlman notes, "we try to get as much of the source code listing and software for the system as we can so that we can generate our own programs."

One source code listing the facility got from Bosch allowed for the development of a computer software system that now runs with the Mach One, or with an off-line system. Essentially, it is a list management system for converting film frame numbers to time code. As Pearlman explains, "A client comes in with a pre-edited film. He's done a workprint and has taken down film frame numbers. We convert film frames to time code, so that we can plug those same numbers into the edit system without having to go back and start over from ground zero."

Graphics and the network

Editel/Chicago's new graphics setup (see last month's photo news story), which went on-line around August 1, is



Richard Mandeborg, technical coordinator, computer graphics, left, and Lenard Pearlman, VP, technical services, in one of the facility's 3/4-inch rooms.

based around the Bosch FGS-4000 real-time video graphics/animation system. Actually, the setup is a stand-alone graphics boutique. The 4000 sits in its own room with just an Ampex VPR-3 one-inch machine to record the output. It is not directly interfaced with any of the facility's other graphics equipment—ADO, NEC/Grass Valley frame buffers, Vital SqueezeZoom, Compositor CGs, or Grass Valley switchers—and jobs are billed differently because of that. Clients are charged on a bid basis, for the entire job rather than by the hour, as they would be if this were a typical on-line setup with all the gear ganged together in one suite.

One reason for configuring the FGS this way is to save money for the client. As Pearlman says, "If you put all these things in one room you're going to have to charge \$1200 an hour. So we separate them, and do FGS projects on a bid basis."

Although the FGS setup stands alone within the facility, within the Editel Group it is part of a graphics network. This network is one of the few formal connections (outside of common ownership) that unites the three-city group. The network is an organized way for the facilities in New York, Chicago, and Los Angeles to share the different graphics capabilities that each has. Also, the arrangement is an expression of management's feeling that graphics should sometimes be handled as a segmented process. Each computer-based system in the network has its own strengths and weaknesses (often a matter of speed), so the creative process is broken up accordingly.

Three computer animation consul-

tants—Alfie Schloss in New York, Olita Kins in Chicago, and Richard McDougall in Los Angeles—have been brought on board to help manage the network. The job, according to Kins, is "a combination of sales, client relationship, designing storyboards, and executing ideas." When it comes to execution, she will often get on a plane with a board or job-in-progress and take it to the facility she feels is best for that job. She feels the Mirage is especially good with curved surfaces, so she will either refer that type of job to Editel/New York, or she will take it there herself (which is not inefficient, she says). She says the System IV Scanimate, which is at Editel/Los Angeles, is "good on metallic surfaces. You can have many light sources—light coming from more than one point." The FGS-4000 is a high-resolution system that is excellent for, among other things, 3D effects, she says.

Kins also emphasizes that the FGS-4000 is "the most flexible machine." This helps explain why Editel/Chicago bought the FGS. With a clientele that includes ad agencies which demand high-end commercial quality, and industrial producers whose needs are less sophisticated, the FGS is versatile enough to handle both groups.

Pearlman adds that the lack of another high-end system in Chicago was another motivating factor. "There have been no sophisticated graphics devices in Chicago," he says. "When people think of doing animation of a sophisticated nature they think of going to the Coast. We felt this was a great area to really generate new business."

But aren't there a number of other flexible, sophisticated devices availa-



Edit room one features a Grass Valley 300 switcher, a CMX 340X editor, a Grass Valley Mark II DVE, and Ampex VPR-3 tape machines.

ble? Why did the company get this system in particular? "Because it offers 3D solid modeling with a good hardware base and real good software expandability," says Richard Mandeborg, Editel's technical coordinator of computer graphics. Mandeborg, who has worked in video production, computer graphics systems design, and research, splits his time between the Chicago operation and overseeing the graphics technology of the whole group.

It's also Mandeborg's job to think ahead, and as a forward thinker, he is taken with the FGS-4000. For one thing, he feels the device's specialized hardware—its "graphics engine"—will allow the system to grow with future industry developments. "The Bosch engine—the pipeline processor technique that they're using—is, I think, a real smart way to go," he says. "It allows for an intelligent way to manipulate, as fast as possible, the important aspects of the picture—the 3D modeling aspect. With a lot of other systems that we looked at, in a year or two from now they might not be technologically viable as new kinds of algorithms come into the TV industry—such as ray tracing, and smooth shading."

Just what is this graphics engine? "It's a bunch of bit-slice microcomputers," explains Mandeborg. "They're like special-purpose microprocessors that do picture processing by handling different aspects of the process—such as color changes and light shading. The information is then passed down the pipeline." In this approach to graphics, the image is processed in real time, much faster than a general purpose

microprocessor.

Software is at least as important as hardware, if not more so. According to Mandeborg, "You can't sell a hardware device without good software. And one of the reasons we're jumping into the 4000 now is because of where it is in its development curve. It's the kind of software we think we need to be competitive. And Bosch is keenly aware of the need for new software. The whole system will be able to grow."

It will grow partly through the efforts of Mandeborg himself, who will write new software. "We'll be writing a lot of software to develop some of our own 3D objects," he says. "We'll write software to do effects that we may use a lot—certain clients may want them. We may also take some of the existing primitives that Bosch already has and expand upon it."

Mandeborg also has some thoughts about why the FGS should be in its own room. "Computer graphics is creative in a different time line than editing," he says. "It's going to take a certain amount of time to produce a creative effort. Part of that might be the preparation of art, then there's the animation of the art, then the creation of the key frames, then everything has to be okayed with the client. So to put it in an edit room would denote to the client that this device is used in the same way as an editing system. This is not to say that editors aren't creative. They just work under different pressures and in different ways."

The Montage room

This same kind of thinking went into setting up the company's new Montage

editing room. The Montage, which arrived at the facility in August, represents an effort to get more creativity into the editing process. It has been set up, like the FGS, in its own room, alone, with no other gear. Billing, too, is handled on a bid basis. And the Montage itself is said to enhance creativity with its flexible, film-style design, and its elimination of time code numbers.

Pearlman says the Montage room will accomplish what the FGS room accomplishes: saving clients money, and promoting creativity. "When our clients walk into a typical editing room, 95 percent of that room is used for special effects. Only five percent is creative editing. Because of the cost of the room and the amount of equipment, it's very easy to lose sight of where the creative editing starts and stops because you're too busy laying on titles and ADO effects and freezes and slow-motion effects. This room is mainly dealing with decision making, and moving the elements around to get the most creative presentation."

In a sense, the addition of Montage represents an effort to satisfy a group of clients dissatisfied with the typical off-line process, but who can't afford the on-line rooms. But the facility also hopes the Montage will attract film people to video editing. As Pearlman says, the Montage could persuade film clients—who edit on film then transfer to tape at Editel—to do their first cut on

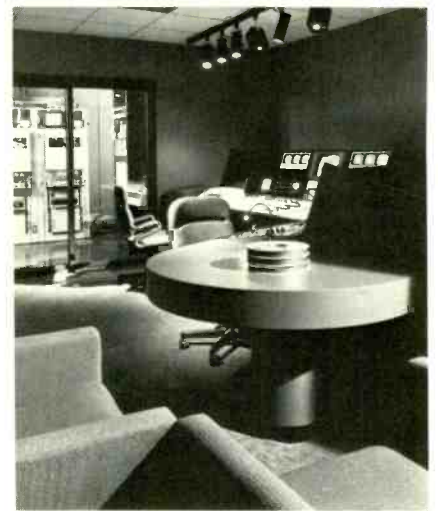

Edit room three, with a Bosch Mach One editor, a Grass Valley 1600 switcher, a Vital Squeezezoom, and ADO.

tape. This would bring more of the post-production process under Editel's roof. But Pearlman, who enjoys being a pioneer in this application, is still not certain who will make the most use of the system.

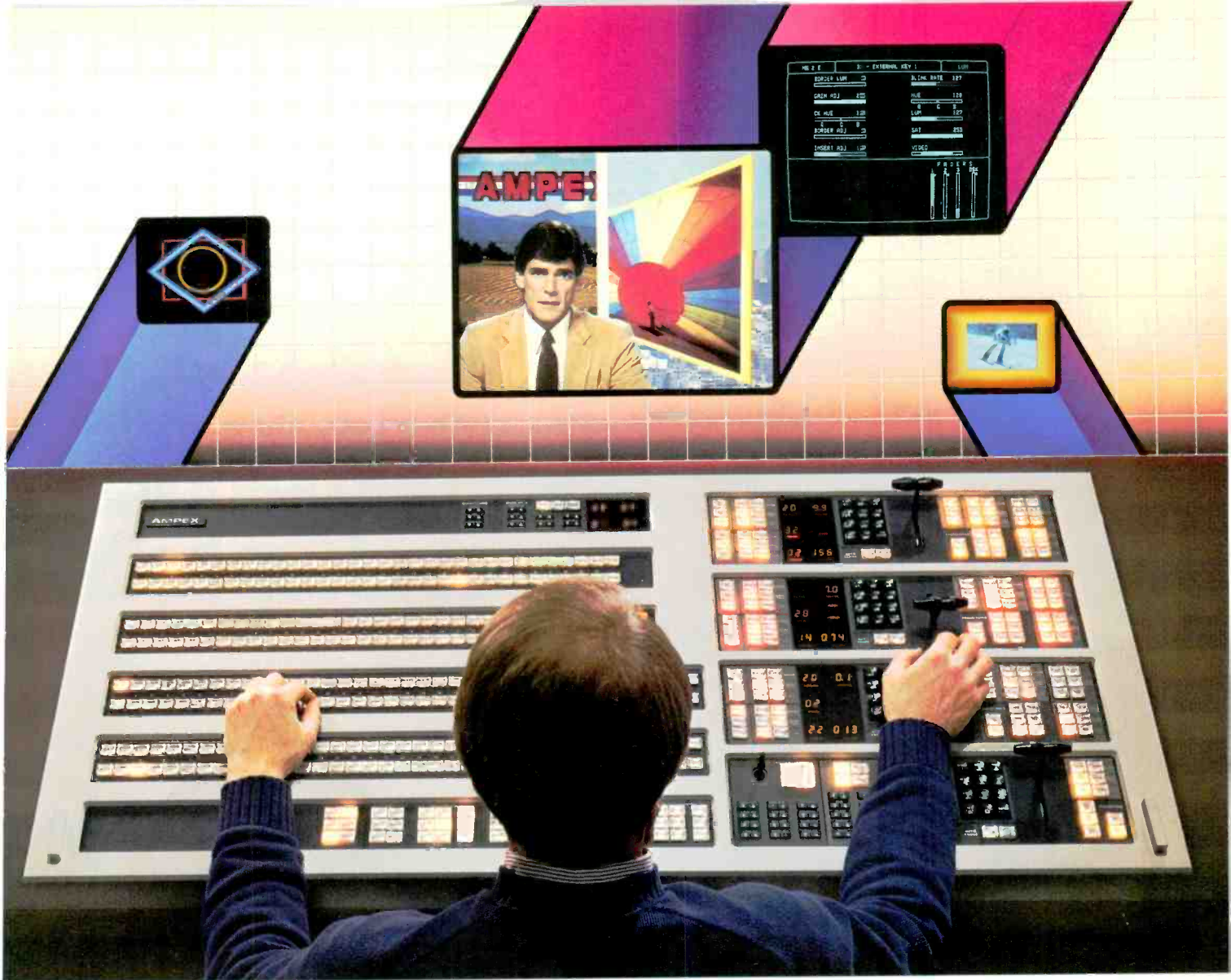

Technology to Power Your Creative Imagination

You can give your creative energies free rein when you have an Ampex AVC-series switcher at your command. These microprocessor-based production switchers provide more creative power per M/E than any other switcher. And they're so easy to operate that you're firmly in control at all times.

Unparalleled Key Flexibility

Every video input and two external inputs can become key sources on the AVC. The standard Key Memory System lets you store up to four completely different key setups for each key source. When a key source is recalled, Key Memory sets up the key exactly as it was stored—even when the key source is called up on a different keyer in a different M/E.

Three unrestricted, full capability keyers per M/E let you introduce any type of key on any keyer: RGB chroma key, character generator and special effects keys, luminance keys and—with an optional composite chroma keyer—encoded chroma keys. And every keyer has its own independent matte generator for matte fills or outlines.

Independent M/E Pattern Systems

Over 100 patterns are keypad selectable. Pattern borders can be hard, soft, soft colored (halo) and half-halo, a feature that allows a pattern to have one hard edge and one soft edge. All pattern borders can vary in width, color, luminance and saturation. These capabilities coupled with the AVC's exclusive pattern modifiers can produce a dazzling array of effects and effect combinations. Try rainbow border, pattern border hues that vary over time and with position, rocking and spinning patterns, even effects combining all these variables.

Simplified Controls

With all their innovative technology, AVC Series switchers are easy to operate, thanks to logical and familiar A-B operation and simplified controls. Pushbuttons are used exclusively instead of knobs for fast, simple setup and to let you set virtually every switcher adjustment from one compact central panel.

The AVC's unique Panel STAR Memory™ system with its extensive capabilities can

further speed and simplify even the most complex production tasks.

System Compatibility

AVC switchers from Ampex are designed for state-of-the-art on-air, production and post-production systems. RS-422 serial communications capability assures easy interface with other compatible equipment. Many users have teamed the AVC with an Ampex ACE editor, Ampex VTRs and ADO for an unbeatable system with completely compatible software throughout.

Find out what an AVC switcher can do for your creativity. Call your Ampex Sales Engineer for complete information.

AMPEX

Ampex Corporation • One of The Signal Companies

Atlanta 404/491-7112 • Chicago 312/593-6000 •
Dallas 214/960-1162 • Los Angeles 818/240-5000 •
New York/New Jersey 201/825-9600 • San Francisco
415/367-2296 • Washington, D. C. 301/530-8800



BFA Paint System \$31,995

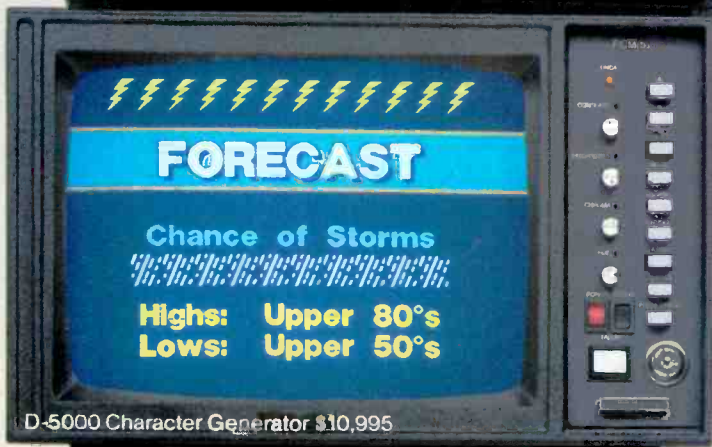

D-5000 Character Generator \$10,995



D-1512 Character Generator \$5,995

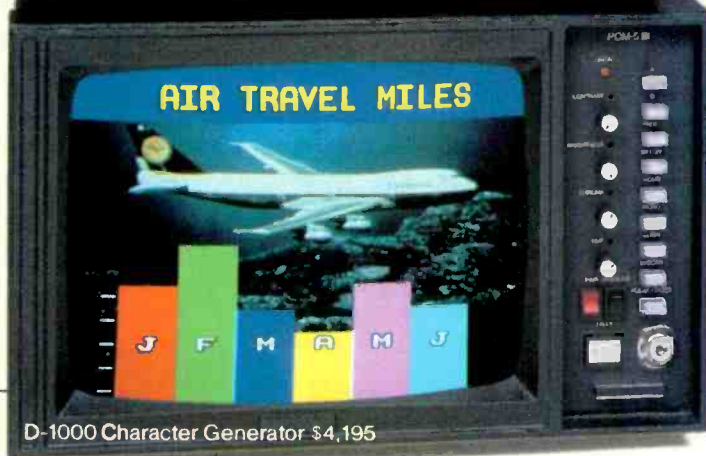

D-1000 Character Generator \$4,195

Dollar for dollar, our graphics stack up better.

3M offers character generators priced from \$4,195 to \$10,995. And our BFA Paint System, priced at \$31,995. In each case you can pay thousands more for comparable equipment without seeing any noticeable difference in quality.

Our D-1000 Character Generator is a self-contained, two-channel, full-featured generator with 70 nanosecond resolution.

Our D-1512 Character Generator is self-contained with two fonts, a genlock keyer and 512 color possibilities.

Our D-5000 Character Generator offers 35 nanosecond resolution for broadcast and production applications, over 150 fonts and 512 colors. It's expandable to multiple keyboards and channels.

And our BFA Paint System is a stylus-operated, menu-driven art station for broadcast news, weather and sports graphics, with 16 million color possibilities.

Comparable paint systems sell for three times the cost of our BFA Paint System. And the savings are similar with our three character generators.

So whether you're a small production studio or a flagship TV station, don't make a decision without looking into 3M graphics. Because the object is to look like a million, not to spend a million.

3M Broadcast and
Related Products Division.

3M hears you ...

3M

Facility in transition

Editel/Chicago is obviously well established as a high-end commercial house. But at the same time, it is a teleproduction facility in transition. Back in the late '70s, most of its business came from ad agencies; now, with the rise of corporate video and, to a lesser extent, cable, the picture has changed.



Editel's audio room features an MCI/Sony 618 console, an MCI/Sony JH-24, and a Mitsubishi digital two-track.

"Three years ago about 80 percent of our business was spot advertising," says Kaniff. "I would say about 65 percent of our business is spot-related now. The difference is being made up primarily by industrials and cable

programming."

The challenge for Editel/Chicago, in a marketing sense, has been to position itself for this new clientele. And that has involved trying to change its image, somewhat, as just a spot house.

"Editel/Chicago has sometimes been thought of as too geared to the advertising community, and maybe not concerned enough with the industrial," says Kaniff. "Part of our emphasis in Chicago involves addressing the fact that there's a lot of industrial work here."

In other words, the company does have noncommercial capabilities that may not have been publicized enough. Its two ¾-inch edit rooms are examples. One of the rooms uses Sony BVU-200s with a BVE-500 controller, strictly for cuts-only editing. The other room, which has Sony BVU-800 and 820 VCRs, is much more than a cuts-only bay. This brand new suite has a number of purposes, one of which is to serve as a control room for Editel's two-year-old 40-by-60-foot stage. And this arrangement, says Pearlman, is well suited to an industrial production. "It's perfect for the industrial producer," he says. "You can do a two-or

three-camera shoot and go right in and edit ¾-inch. That's totally opposite from the way most people shoot commercials."

The suite is actually referred to as the "on-line/off-line room." For industrial producers who master on ¾-inch, it is an on-line room; for commercial producers who will master on one-inch, the room can be used for off-line decision making. But things get more complicated than that. The bay has also been set up for animatics and interformat editing.

Generally speaking, a commercial producer will shoot an animatic in the facility's 25-by-35-foot insert stage using Editel's Ikegami 302s or Hitachi SK-70s. Post-production is handled in the on-line/off-line room, using a two-channel Vital SqueezeZoom, Grass Valley 16001X switcher, and Bosch Mach One editor, which controls the 800 and 820 tape machines. If the producer wants to master on one-inch, a Type C VTR is rolled in. More typically, though, the material is mastered on a BCN-50 Type B machine, which is always in the room to be used either for that purpose, or for editing interformat, ¾-inch to one-inch.

Introducing the ultimate FM Exciter!

Continental's Type 802A solid-state FM Exciter offers broadcasters unmatched performance.

Modulation performance of this new exciter exceeds all currently known or marketed FM exciters.

No tuning adjustments are required other than selecting the operating frequency.

Power output is 50 watts into a 50 ohm load at all FM frequencies.

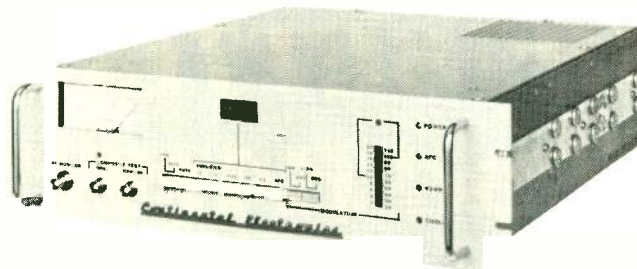

The exciter may be used as a low power transmitter.

Special circuits protect amplifier from mismatched loads. Automatic power control maintains output at preset levels from 5 watts up to the maximum level.

The Type 802A FM Exciter accepts composite baseband signal from a stereo generator, STL system or monaural and SCA programming.

A digitally-programmed, dual-speed, phase-locked frequency synthesis system generates exciter frequency.

Case design is very clean: front panel analog or digital meters and LED readouts give clear, accurate indications of system status and performance. A digital LED display shows true peak level of modulating signal in 5% increments with an accuracy of better than $\pm 2\%$.

Modular subassemblies may be removed from the exciter without removing the exciter from the transmitter. The exciter moves on slides for easy access from front of transmitter.

Call us for specs and prices.

© 1983 Continental Electronics Mfg. Co./5286

Continental Electronics

Continental Electronics Mfg. Co. Box 270879 Dallas, Texas 75227 (214) 381-7161



Circle 145 on Reader Service Card

Remote production

Editel/Chicago's remote operation has been around longer than any of its other services. In fact, the company started out, in 1969, as a Montreal-based remote facility. Today, the mobile facilities include a van with Hitachi SK-97 cameras, Ultimatte, one-inch B or C format VTRs, as well as 3/4-inch. Editel does not supply people, but its equipment and technical support is used to shoot commercials, industrials, and documentaries. The remote operation does a good deal of Ultimatte work for commercial clients, according to Pearlman. "We go out with two one-inch machines—a portable and a full playback machine, plus a camera," he says. "We matte two cameras, or one camera over two cameras, or a camera over a tape machine."

Audio, too, plays a major role at Editel/Chicago. At present, the facility has an MCI 618 audio console and an MCI 24-track ATR in its large studio. In the audio sweetening room, there is an MCI 618 console and a BTX computer interface. The company also owns an MCI four-track and a Mitsubishi X-80 digital two-track.



The 40x60-foot studio has Hitachi SK-70s, Ikegami 302s, and Strand Century lighting.

In the interest of improving sound on videotape, the company is doing a lot of "double system" work. With this method, Editel avoids having its audio go multiple generations on one-inch tape. As Pearlman explains, "We keep the audio separate until the last possible pass, then retrack it so you save a generation." Also, says Pearlman, "We're experimenting with using audio material that comes in in a digital format. We can then keep the audio that

much cleaner. And in cases of something going to Beta Hifi or VHS Hifi, we can keep the chain digital all the way through."

Future audio developments at the facility will probably include stereo in any new undertaking, though neither Pearlman nor Kaniff will say exactly what they have in mind.

As for some of the newer video developments, such as small format recorders, Pearlman doesn't see Editel/Chicago getting involved in the post-production end. "There's still a lot of 3/4-inch work out there," he observes, "and I don't think that M-format or Betacam is really going to find a place in post-production—unless you are working in a closed loop. If you have to take in anybody's material and release to anybody, then it's another format to deal with."

As for HDTV, "it's great," says Pearlman. "But it's a system that needs a lot of further development." He is even more optimistic on other technological fronts. "A digital tape machine is what we want most," he says, "especially because of our matting and graphics and other things. But it's going to take a while." **BM/E**

THE BETTER NiCad BATTERY PACK

PACO DP-1240 (12V/4AH) FOR ENG cameras and VTRs

Other Nicad Battery Packs have particular good features but **ONLY PACO HAS THEM ALL!**



- ◇ Replaces Sony BP-90
- ◇ Uses standard charger (Sony BC 210)
- ◇ Same small size
123 × 170 × 37 mm
(4 7/8" × 6 11/16" × 1 7/16")
- ◇ Lighter weight
1.50 to 1.55 Kg.
(3.3 to 3.4 lbs.)
- ◇ Higher capacity
4.0AH at 0.8A/rate
- ◇ Less recharging
- ◇ Reduced memory effect
- ◇ Special thermal protector
- ◇ No fuse replacement

WANTED....Sales Agent

PACO ELECTRONICS INDUSTRY INC.

807 Heights Aoyama, 5-10-5, Minamiaoyama, Minato-ku
Tokyo 107 Japan TEL: 03-486-6791
TELEX: 02427159 PACO FAX: 03-486-7204 GII, III



Get it out of your system.

Television is an electronic medium. Yet TV graphics still involve messy paints, glue, air brushes, razors, and other paraphernalia.

MCI/Quantel's Paint Box can put your TV graphics into the electronic medium.

So you can get all the messy paraphernalia out of your system. Digitally.

The Paint Box lets you do a lot more than you can do with traditional art materials. A lot faster. And with typical Quantel picture quality.

It gives you over 16 million colors. If that's not enough, you can mix your own, just like you'd do with paints.

It's incredibly versatile. You can produce the look of oils, watercolors, chalk, pencil. You can make stencils. Air brush. Cut and paste. Even animate.

You can grab TV frames off the air, resize them, retouch them, mix them with graphics.

You can set type from a large variety of the highest quality fonts.

And you can interface the Paint Box to Quantel's DLS 6000 Library System for a totally digital still-picture system. It's awesome.

Call your local MCI/Quantel office. They'll be glad to show you a demonstration tape. Or get in touch with us directly at 415/856-6226. Micro Consultants, Inc., P.O. Box 50810, Palo Alto, California 94303.

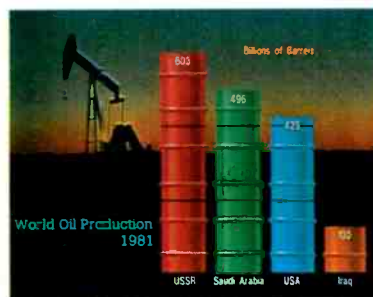

Graphics like this are easy on the Paint Box.



MCI/QUANTEL
The digital video people.

Circle 147 on Reader Service Card

Excellence



Philips LDK 26

Examine the excellence of the LDK 26, the new mid studio and field computer camera from Philips. Excellence in picture quality, operational flexibility and value for money. Following and benefiting from the technology, the brilliance of the top-of-the-line Philips LDK 6.

See LDK 26 consistent picture quality. The result of 18 mm (2/3") Plumbicon tubes and optimized digital scan correction, shading and dynamic focus.

Work with LDK 26 operational flexibility. To produce the best wherever you are – in the studio or on location – and whatever the weather and lighting conditions. That's one result of the interactive computer system with its memories for quick set-up and smooth operation in single or multi-camera configurations.



LDK 26 Master and Operational Control Panels.

Save with LDK 26 value for money. Its basic price is more than competitive with any other computer camera in its class. And a whole host of features contributes to low cost of ownership. There's triax cable as standard with minimum handling and maintenance costs. There's automatic set-up for quickly obtainable and consistently high picture quality. There's – optionally – instant recall of operational memories for increased production efficiency. There's diagnostics for surveillance and to ensure minimum downtime. And, if you want it, there's a second order diagnostics system for fault location.

The LDK 26 sets a standard of excellence in television camera systems that is unrivalled anywhere else in the world. Outside the Philips LDK 6 family, of course.

Circle no. 150

PHILIPS

Quality through experience

The finest family

The LDK 6 is the finest television camera that money can buy – whose perfect performance is now proved in studios and on location throughout the world.

Circle no. 151

The LDK 614 is the perfect portable partner with matching colorimetry to the LDK 6 and LDK 26. This rugged yet lightweight triax or multicore RGB camera is equally at home in the studio or mobile unit.

Circle no. 152



Transmitters - reliable, economic

UHF television transmitters from Pye TVT are famous the world over for their economy and reliability. They cover peak sync powers from 10 to 110 kW. They incorporate a highly sophisticated i.f. modulated drive system with solid state control logic for unattended operation.

Circle no. 153

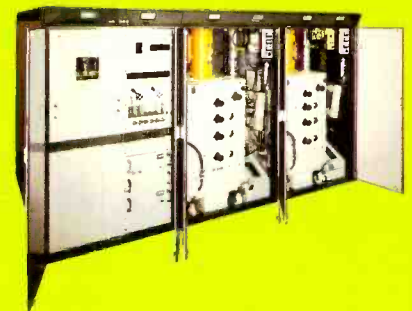

New 20" color monitor



There's now a new 20" color monitor from Philips in addition to the existing 14" monitor. That means you now have two opportunities to buy color monitors of amazing value and quality.

Both have super sharp pictures and color fidelity – and what is surely the best price performance in the market.

Circle no. 154

For further information send the coupon to:

PHILIPS TELEVISION SYSTEMS, INC.

900 Corporate Drive, PO Box 618, Mahwah, New Jersey 07430, USA

Tel: 201-529-1550 Telex: 37-62558

Canada: Electro & Optical Systems Ltd., 31 Progress Court,

Scarborough, Ontario, Canada M1G 3V5 Tel: (416) 439-9333 Telex: 065-25431

Please send me further information on:

- LDK 26 cameras **150**
- LDK 6 cameras **151**
- LDK 614 cameras **152**
- UHF television transmitters **153**
- Color monitors. **154**

Circle no. Name _____

Status _____

Organization _____

Address _____

BME 6 9 84

Sound Advice

ITC announces a revolutionary departure from the traditional triple deck cartridge machine. The Delta III's advanced modular design gives you three independently removable decks. This means that you can remove a deck for easy maintenance and still stay on the air.

That's great news for you and your listeners because the Delta III's superior sound will spoil everyone who hears it. You won't want to settle for less, and neither will they.

The Delta III is part of the Delta series, ITC's new generation of cartridge machines. Mechanically, electronically and physically superior to previous models, the Delta Series is fast becoming the new standard of the industry.

That's something you need to know. Because you wouldn't want to miss the revolution.

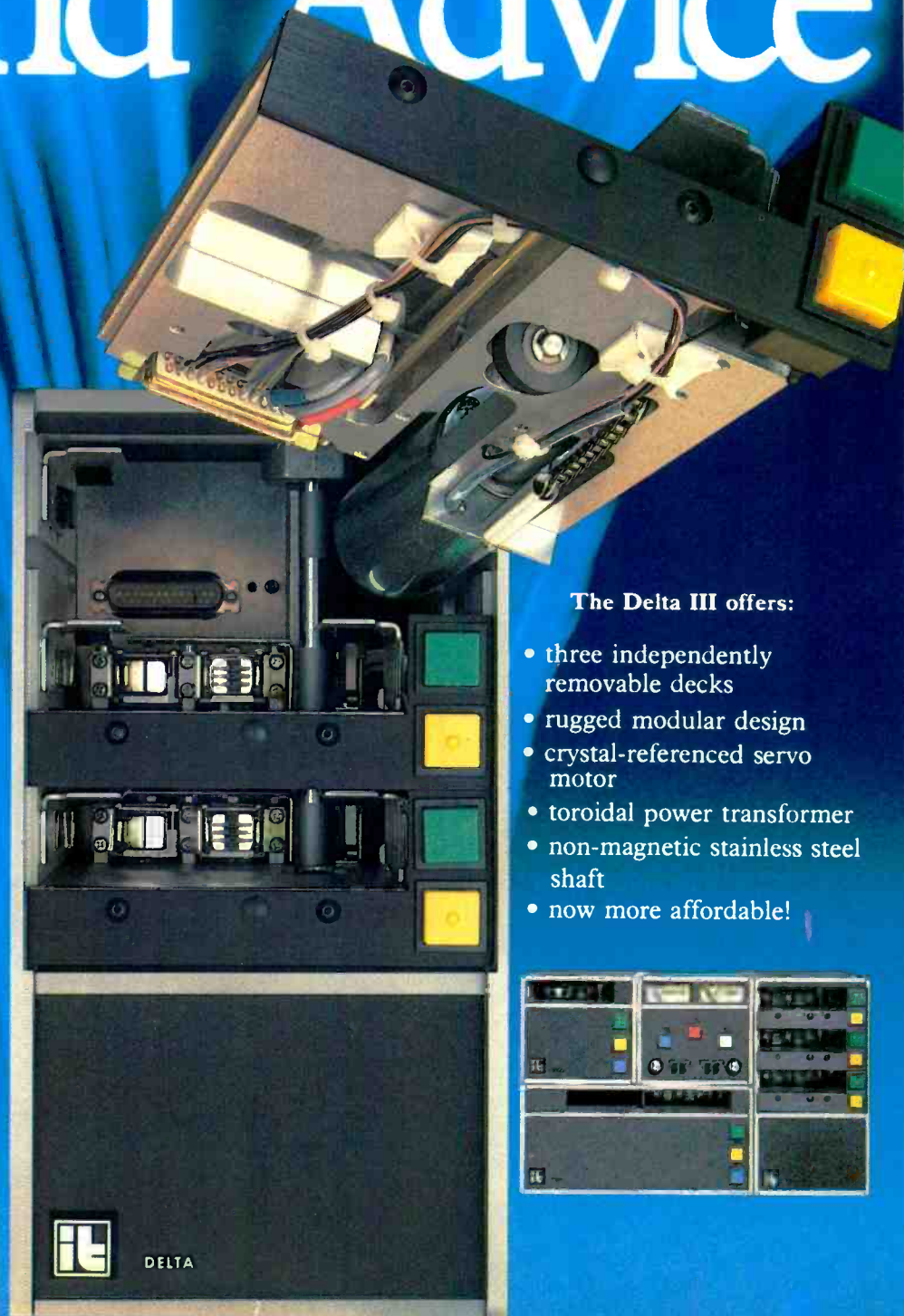

The Delta III offers:

- three independently removable decks
- rugged modular design
- crystal-referenced servo motor
- toroidal power transformer
- non-magnetic stainless steel shaft
- now more affordable!

Don't Miss The Delta Revolution

INTERNATIONAL TAPETRONICS CORPORATION

2425 South Main Street / P.O. Box 241 / Bloomington, Illinois 61701

Call Toll-Free: 800-447-0414

From Alaska, Hawaii and Illinois call collect 309/828-1381

Circle 148 on Reader Service Card

3M hears you...

Audio Production Reports

By Eva J. Blinder, Senior Editor

Spurred by advances in technology and the authorization of multichannel TV sound, radio and television stations and facilities around the country are excelling themselves with creative and unusual audio production work.



Minnesota Public Radio Launches Original Concert Series

Late in July, Minnesota Public Radio produced the first concert of its new monthly series, *High Performance*.

The King's Singers recording at Minnesota Public Radio for the station's *High Performance* series. A 3M digital recording system was used.

Generally, radio station concert series do not make for particularly exciting stories; a production that consists of dangling a microphone in front of a per-

former or orchestra is nothing to jump up and down about. But this session, and the entire series, was unique. This three-day recording session with the

English singing group the King's Singers (to be broadcast this Christmas time) was recorded exclusively for Minnesota Public Radio in one of the station's two studios, with a 3M digital mastering system.

"It was not unlike a classy multi-track digital recording session, only it was for the exclusive use of a radio program," says Tom Voegeli, VP of MPR. All the music was recorded live to a 3M 32-track digital machine—there was no overdubbing—and was then mixed to both a digital and analog tape, which will probably be the broadcast tape, according to Voegeli. The console was an MCI/Sony 636.

MPR's 60,000 cubic foot studio M was the scene of the session—a Christmas special titled "A Christmas Card from the King's Singers." Joining the King's Singers was a 28-person chamber orchestra. The group recorded Christmas carols, readings, and Christmas songs from around the world. It also introduced the songs and told stories of what Christmas was like in England.

Studio microphone techniques were used for the session. Sections were miked individually; in some cases mics were placed on individual instruments and singers. Neumann Cam 84s, U-87s, and KM-88s were used, along with AKG-414s, and Schemps EMT-56s. A Neumann SM-69 was also used for an overall pickup. All the mics were recorded on individual tracks, of course. Voegeli adds, "The monitor mix, the stereo mix that was being listened to, was being recorded on two other tracks, so that some of the tunes will not be remixed, and some will be."

The other piece of critical equipment used was a Lexicon 224X reversion system (the station has two). Also, a Compex limiter was used on the vocals.

MPR is by no means just a two-studio facility. It has seven control rooms (aside from the ones adjacent to the studios), which are used for day-to-day broadcasting, origination of news features, and record playback. All these rooms are equipped with Studer tape machines, and customized, 16-input, Neve broadcast consoles.

AT MTI, Audio Enters The Comedy Zone

Anyone who still thinks TV audio is a laughing matter should take a glimpse at a replacement show being produced at Modern Telecommunications, Inc.,



MTI's chief of audio services Jeff Pincus at the facility's Harrison TV-3 console during the taping of a new network show, *The Comedy Zone*.

in New York City. The comedy-based variety hour, taped live at MTI's uptown studios, involves elaborate audio work requiring not one, but two audio consoles.

According to Jeff Pincus, MTI's chief of audio services and the main mixer for *The Comedy Zone*, the company supplemented its Harrison TV-3 console with a rented Harrison MR-3 music board for a total of more than 50 inputs. The MR-3, operated by Tony May, handles the show's live bands and vocalists, including a number of wireless mic inputs.

"The music is being treated as it would in a recording studio," Pincus states. May's mix from the 32-input MR-3 is fed to the 24-input TV-3, where Pincus adds in the audience mics, two boom mics used for the comedy skits, and live sound effects. There are a total of 96 mic inputs off the studio floor, including Cetec Vega diversity RF mic systems and three Cetec Vega RF headset systems. No noise reduction is used, although compression, limiting, and de-essing are added.

Pincus then prepares mono, main, music-only, and vocal-only mixes (the show is produced in mono although the board is stereo-capable), which are recorded on Otari 1/4-inch and half-inch ATRs. The main mix is also recorded on audio track 1 of the three one-inch and three 3/4-inch VTRs that record the show, with various isolated elements

on track 2 to allow remix in post-production, if desired. The video is edited off-line and then conformed at MTI's midtown location; final sweetening is done at Compact Video.

"This is the first network show we've done," Pincus points out (MTI has concentrated on work for syndication and cable). "Most of the big comedy shows have been done on the West Coast, but the producers of *The Comedy Zone* felt the talent pool was so great here they wanted to do it in the East."

WABC Moves to Combo With Twin Audio Boards

New York's WABC-AM, whose name was for years synonymous with Top 40 radio, made headlines two years back when it retreated from the music battlefield and switched to a talk format. The station has operated with its music-style studios since that time. According to chief engineer Winston Lloyd, however, a new studio and control room now under construction will give WABC facilities designed expressly for its format.

The new studios will also introduce to the station the concept of combo operation, well-known in the industry but never before used at WABC. The station is live for 12 of its 24 on-air hours each day, Lloyd says. "Some of the shows we won't even attempt to



When it comes to who said what, Dictaphone's Veritrac™ loggers give you the last word.

Dictaphone's Veritrac™ voice communications recorder systems are as important to stock brokers as they are to public safety agencies. In fact, wherever people rely on phones they rely on Dictaphone's Veritrac loggers. They record up to 60 channels of telephone and radio messages simultaneously so verification of who said what is both simple and sure.

And Dictaphone microprocessor technology means you get a host of useful features along with Dictaphone reliability and service. Call your Dictaphone representative today.

 **Dictaphone**

A Pitney Bowes Company

For more information,
fill in the coupon or call toll-free:

1-800-431-1708

(Except Hawaii and Alaska)
In New York call 914-967-2249

Name _____

Title _____ Phone _____

Company _____

Address _____

City _____ State _____ Zip _____

Mail to: Dictaphone Corporation
120 Old Post Road
Rye, New York 10580

PBME-94

DICTAPHONE® and Veritrac are trademarks of
Dictaphone Corporation, Rye, N.Y. ©1984 Dictaphone Corp.

Studer Audio: Series 900



Our consoles have always been quiet. Have we been too quiet about our consoles?

Perhaps we have. Thanks to the success of Studer recorders, we're often thought of as strictly a tape recorder company. But, Studer has also been making audio consoles for over 16 years, and dozens of our 169/269 compact mixers are now at work in broadcast and video production facilities all across America. Recently, with the introduction of the Series 900, Studer has become a major supplier of studio production consoles.

So we're not keeping quiet about this any longer.

Name your frame. Series 900 frame sizes from 12 to 50-plus inputs are available for any application, from remote recording and OB vans to sophisticated broadcast production and multi-track recording. Within these frame sizes, we configure the console to fit your requirements. The secret is our wide array of module options.

Mix and Match Your Modules. The 900 is a true system console offering custom configurability at standard



prices. Choose from 10 different metering modules, 3 multi-track monitor options (including separate monitor EQ), mono or stereo faders, audio subgroups, automation compatible VCA groups, video switcher interfaces, subgroup reassignment modules, up to 3 solo systems, multi-function test generator, input selectors, limiters, compressors, patchbays with bantam or 1/4" systems, and up to 10 auxiliary busses.

Basic input modules feature 3 or 4 band EQ, microphone/line inputs, 5 pre/post-fade auxiliary sends, and channel overload indicators. Options include transformerless mic preamps on a subcard, separate transformerless TAPE input for remix, stereo input modules, stereo EQ, internal stereo X-Y/MS active matrix, stereo blend control, dual line inputs, variable HP and LP filters, user defined panel switches, and the list goes on.

Listen to the quiet. The

entire 900 console frame design is consistent with the advanced module design. A completely independent signal reference ground system assures preservation of individual circuit CMRR figures. The result is overall noise performance compatible with digital recording.

As time goes by, All 900 consoles adhere to strict Studer standards for precision and reliability. The frame is built on a rigid channel and brace structure, and each module uses pin-and-socket Eurocard connectors. Frame connectors are mounted on longitudinal master boards with solid support from horizontal and vertical frame members. All components, switches and pots are commercial/industrial grade from the best U.S. and European manufacturers. In sum, a 900 is built to last as long as a Studer recorder.

The Swiss alternative. If you have been considering a high quality mixing console from any American or English manufacturer, you should also look closely at the Swiss-made Studer 900. For quality, flexibility, and reliability, it ranks among the world's finest. Also, you may find the pricing surprisingly competitive.

For more information on Studer consoles, call or write: Studer Revox America, Inc., 1425 Elm Hill Pike, Nashville, TN 37210; (615) 254-5651.

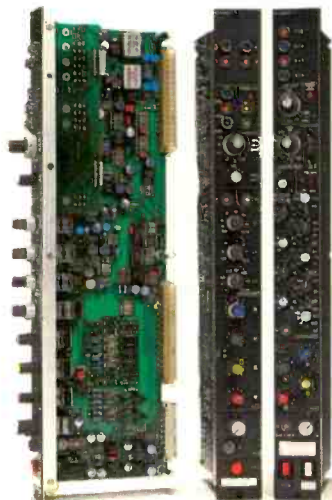

STUDER REVOX

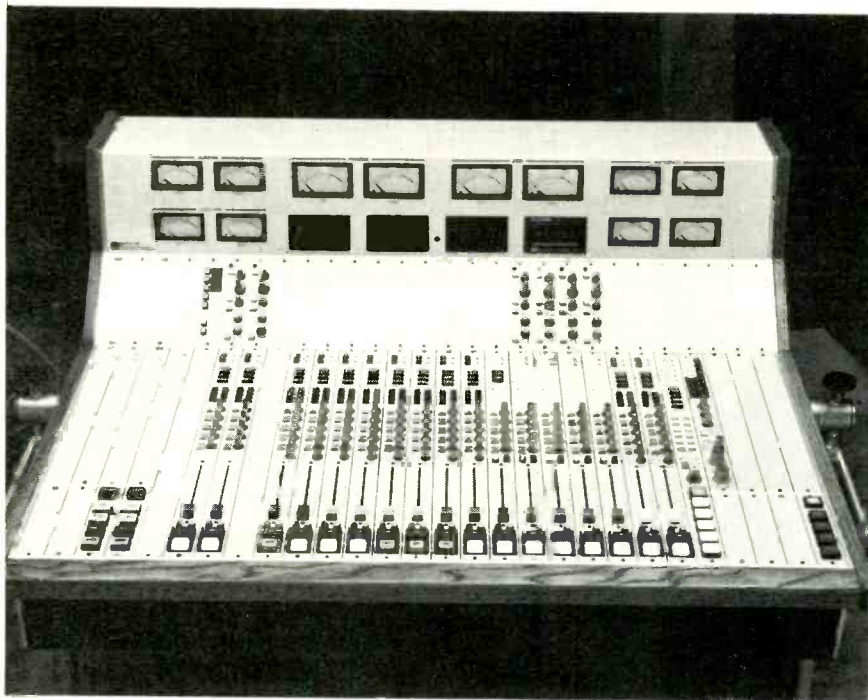

Pacific Recorders' ABX series console.

combo," he comments, "but in other cases we want the host to engineer his own show." To facilitate the choice, the station is installing twin Pacific Recorders ABX consoles, the company's featured product at last April's NAB show. The ABX in the on-air studio will be optimized for operation by

talent, while the board in the control room will be designed for on-air engineer operation and production of commercials and PSAs. In addition to the console, the control room will have Studer reel-to-reel machines and cassette decks, ITC cart machines, and Eventide efx.

Design of the new rooms, which are scheduled to go into operation by January 1, was a cooperative effort with input from the general manager, program director, maintenance engineer, and the chief engineer of sister station WPLJ-FM. Pacific Recorders is the primary contractor, not only supplying the consoles and other equipment but also building all the woodwork and cabinetry.

Sync Sound Sounds Out New York Audio Market

High-quality audio for television, a growing trend for the past several years, is about to receive its latest boost in the form of Sync Sound, a new New York facility that was nearing completion at press time. Partners Bill Marino and Ken Hahn have designed Sync Sound "specifically for post-production audio for tape and film," Hahn relates.

A special feature of Sync Sound will be a proprietary, staff-built electronic audio editing system. "We're building this because we don't think there's anything on the market that really suits our needs," Hahn explains. "We'll be using Adams-Smith synchronizers, readers,



Ken Hahn of Sync Sound at the company's SSL 6000E console.

THE TECHNOLOGY THAT REVOLUTIONIZED VIDEO

STILL STORE HAS COME TO AUDIO

SYSTEMEX™

THE COMPUTER BASED DIGITAL AUDIO STORAGE SYSTEM
WHICH PROVIDES INSTANT RANDOM ACCESS TO
COMMERCIALS, NEWS ACTUALITIES, STATION ID'S AND MUSIC
FROM WINCHESTER HIGH DENSITY DISK DRIVES.

From the company that brings you Neumann, EMT and Telefunken.

G O T H A M

AUDIO CORPORATION

741 Washington Street New York, NY 10014 (212) 741-7411 Telex: 129269 GTHM NYK

IN THE FOREFRONT OF AUDIO TECHNOLOGY FOR OVER 25 YEARS.

Circle 156 on Reader Service Card



WCKY's two-track production studio, which features an Auditrionics console.

and generators, but the editing system is ours." The primary design work on the editor was done by Marino. "Because we built it," Hahn adds, "we'll be able to custom-tailor it to specific sessions and client requirements. It'll also be able to grow with us."

Hahn and Marino have also paid particular attention to the physical construction of the facility's three planned editing rooms. (One was scheduled to open late last month; a second should follow shortly.) "Most of the rooms we've worked in lately look very good, but they don't sound as good and aren't as acoustically isolated as they should be," Hahn explains. He and Marino are taking pains to give their rooms excellent structural and acoustical characteristics.

The first room, Studio B, will feature a 40-input Solid State Logic 6000 console with slots for SSL's promised stereo modules. ("As soon as SSL can deliver them, we'll take them," Hahn asserts.) Other equipment will include Otari MTR-90 24-track ATRs, MTR-12 two-track machines, and Sony one-inch VTRs. The plant will have Dolby noise reduction throughout on nearly every channel, including the VTRs. The equipment list is still in formation, and other decisions will be made as needs arise. Eventually Sync Sound plans to add Foley capability, but Hahn says the emphasis will always be on "what we do best—mixing."

New Facility Increases WCKY's Production Capabilities

New facilities have an uncanny ability to inspire creative minds to their best work, as WCKY-AM/FM, Cincinnati, found out early this year. At that time, the station moved into its new home, an old downtown building the staff renovated and "designed around our news talk format for AM, and beautiful music format for FM," according to chief engineer Tom Kendrick.

The three new production rooms, each with Auditrionics 300 consoles, two MCI/Sony four-track recorders, and two two-track Otaris, are used for all the station's in-house promotion and for its very active commercial production operation. The facility also has six new studios.

Hugh Lutton, WCKY's production director, says that one recent commercial production pushed the station's four-track capability to the limit. It was a 60-second spot for Hamilton Moving and Storage, the trucking company that actually moved WCKY into its new facility. The idea of the spot, according to Lutton, was to dramatize "what you get when you call somebody else" for trucking services. The spot had five different voices, and four different sound effects layed into it.

"This called for a different kind of ambience, rather than just a studio sound," says Lutton. Three different sound effects packages were used, as well as some "remote" recording by Lutton in the building's garage, on its roof, and outside on the street. The idea was to make the action sound as if it was taking place in a warehouse, in a very noisy urban setting. Lutton's Nackamichi recorder was particularly useful for this.

In the garage scene, "a guy is talking on the phone to a potential customer and describing the things this company could do so well—that their people are very careful," says Lutton. "At that point a box crashes in the background." In another scene, the same person is talking on the phone about his company's promptness. A truck grinds its gears, then crashes into a wall as he's talking.

An announcer's part was recorded in the studio, then all the pieces—the dialogue, the crashing truck and the grinding gear effects, and the traffic noise—were all fed into the four-track and equalized with the Auditrionics console.

Computerized On-Air Board Debuts at KRIV

While audio boards used for production remain distinct from those used on air, there are increasing signs that the two

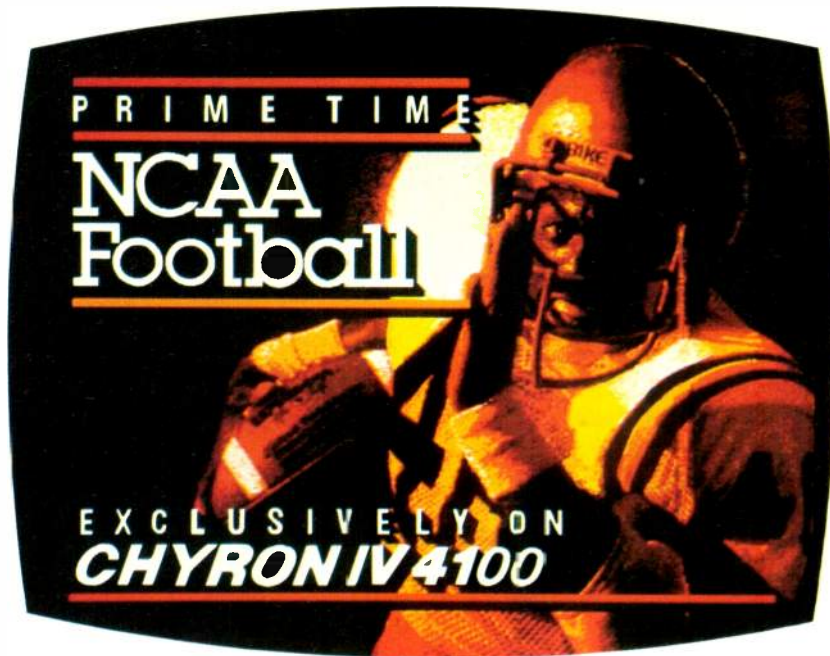

IT'S ALL CHYRON.®

Everything you see was created on Chyron IV.

Background graphics...
Foreground text...
Multi-color characters.
Electronic graphics have never
been easier. Or sharper.

Chyron IV does more.
CHYRON
TELESYSTEMS
A DIVISION OF CHYRON CORPORATION
265 Spagnoli Road, Melville, New York 11747
• 516-249-3296 • Telex 144522 Chyron Melv

Ampex International is exclusive distributor for Chyron Graphics Systems outside the U.S.A.

Circle 157 on Reader Service Card

*The New
Micromax*

How to get
the best of a
TOMCAT™. . . without
upsetting the kitty.

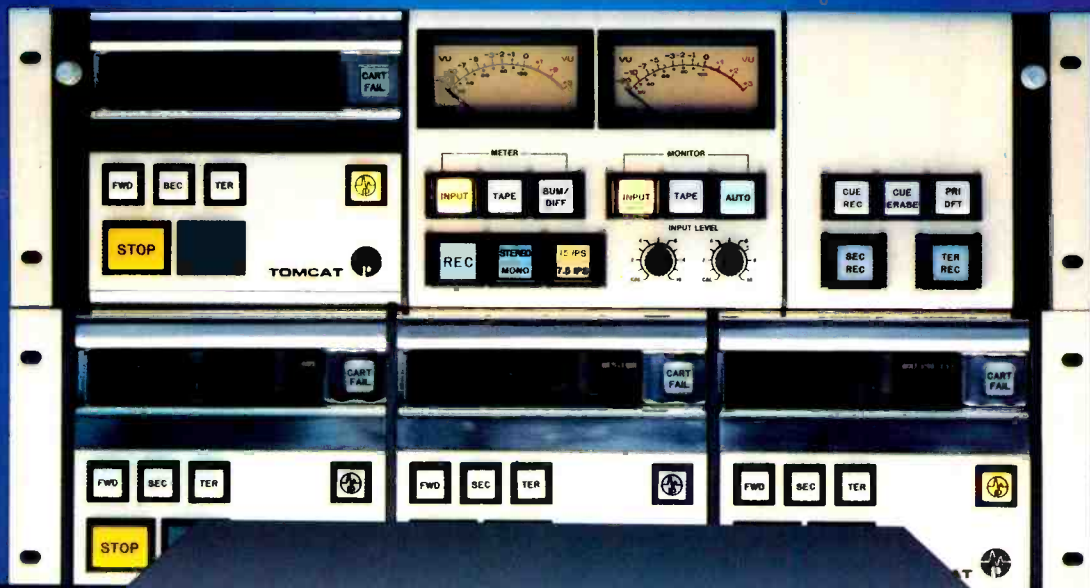

When performance comes first, the TOMCAT has become the paw-down, #1 choice for more #1 stations. Over 2,000 TOMCATS in those stations are proof that radio broadcasters are willing to invest their money where it can return the most on their sound.

Because TOMCAT isn't cheap (excellence never is), a lot of broadcasters who have wanted to upgrade their station's sound have been stuck: they've either had to get by with their existing tired, clunky and funky-sounding machines or compromise and settle for buying someone else's.

Now that's really bothered us TOMCAT-makers.

So, we've come up with a solution: the new Micromax: the best of a TOMCAT, without the pain of its price.

MICROMAX IS MORE THAN THE HIGH-TECH LOOK

Micromax's sleek, high-tech front panel only hints at the technology behind it. Our exclusive wide-track Maxtrax® stereo heads come standard because they give you more tape signal and less tape noise. If your tape library is 1/4 track (NAB standard), no problem — we've got an optional set of playback heads to get you over the hump until you can take advantage of our better-sounding MAXTRAX format. Naturally, the heads are fully adjustable and mounted in beefy, precision cast assemblies. The cartridge guides guarantee accurate, repeatable positioning. The deckplate is thick aluminum alloy, precision milled and surfaced.

The D.C. controlled capstan runs in sealed microfine bearings, and is driven by a servo/belt system developed from computer disk drives. The result is superb wow & flutter specs. The conventional pinchroller solenoid was eliminated (and thus the damaging heat) and replaced with a simple D.C. servo/motor that assures optimum, adjustable capstan-to-

tape pressure and remarkably rapid starts and stops. Center-supported by a floating ball bearing race, the pinchroller self-aligns to prevent tape skew.

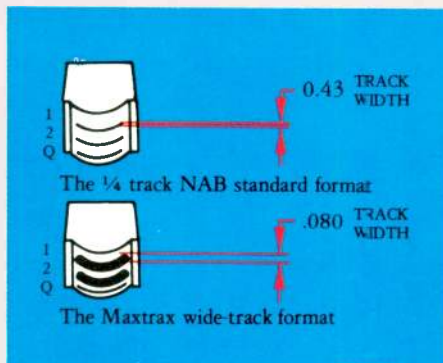

Nearly twice as much track width with Maxtrax. The bottom line is better sound.

THE ELECTRONICS ARE JUST AS IMPRESSIVE.

With Micromax you've got lots of headroom, better transient response, a wide frequency response, and +24 dBm active, balanced program outputs. We've even designed in super-fast, low-noise CMOS control logic.

Micromax has the standard three auxiliary cue tones and a high-speed recue (22.5 ips!). You can set a replay lockout, and assign a machine number to the front panel LED display (which also doubles as the power indicator).

IT SOUNDS AS GOOD AS IT LOOKS

The sound of Micromax isn't something that can be described with specs though: you have to hear it to appreciate it — a red-hot, crystal clear top-end, a fat, punchy low-end. Micromax can instantly put much better sound on-air for you. Now! Regardless of your station's choice of carts.

BUILT FOR THE REAL RADIO WORLD

If the above isn't enough, then maybe you should know that there isn't a machine around that's easier to keep running (even our own TOMCAT). All of the electronics are on three accessible boards and the elegantly simple mechanics couldn't be easier to get to for routine inspection and maintenance. Micromax is totally RFI-immune, and consumes only 7 watts, running! Because the attractive case doesn't require any ventilation slots and screens, there's less dust to worry about. The compact design lets you have two across in only 3 1/2" of rack space (playback version, the Recorder is coming soon). Of course, Micromax is pin-for-pin compatible with our TOMCAT.



The Cartcue splice finder/eraser. The fast 30 ips speed and better depth of erasure gives new life to old carts.

FOR THOSE WHO CAN'T WAIT.

If you've skipped ahead to find out the price — fine: \$1,445.00. FOB Carlsbad, California where it's entirely manufactured. Now go back and read about everything that you get — that is, if you're not too busy fixing a broken cart machine.

Give us a call now at 800-874-2172. In California, call 619-438-3911.

Ask us for the brochures on TOMCAT too. When you decide to get a few new Micromax reproducers there just might be enough scratch left in the kitty to get the best recorder.



Lots of technology and performance secured to a rugged, compact chassis-built to take abuse.



Pacific Recorders & Engineering Corp.
2070 Las Palmas Drive
Carlsbad, California 92008
Telex: 181777

The Choice for More #1 Stations.

Marco Polo uses SONEX a little differently...

10 ACOUSTICS
g Corporation
Street
23220-2075

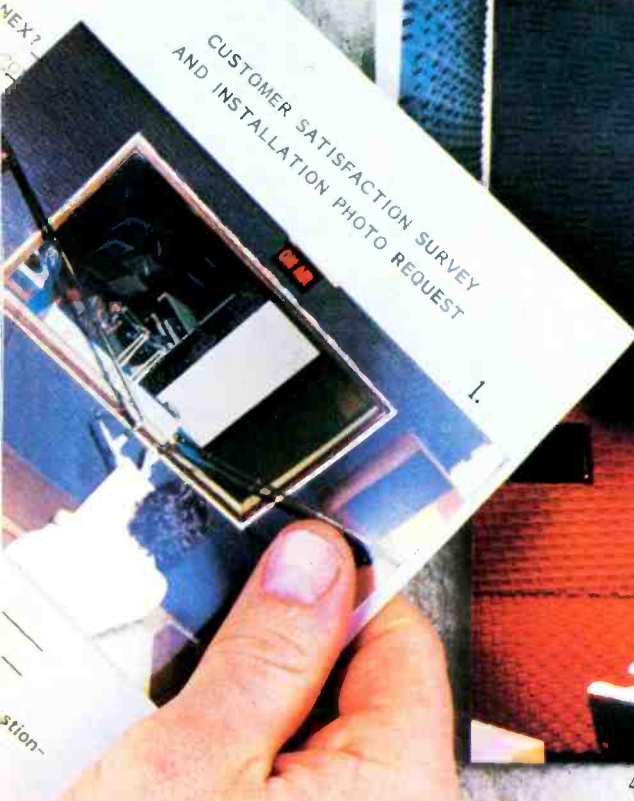

2.



3.

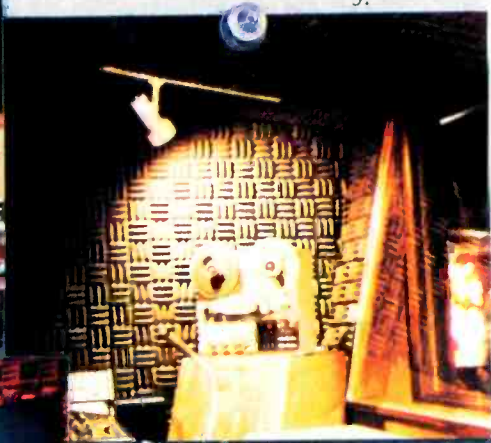

4.



5.

and so do thousands of others.

Just listen—1. He uses it in Ecuador. And his is the first station in Quito to import SONEX. "It is perfect. We are promoting it to our visitors and they are impressed. We are satisfied because of the acoustics. But it's also good-looking and easy to put up." Marco Polo Torres Vasco is General Manager at HCM-1 Radio, Quito, Ecuador.

2. "We use SONEX around the drums when recording basic tracks, and around the vocalist during overdubs. It works very well because sound waves are confined, not bouncing off walls." Rick Bacus of The Janet Jameson Band, Linwood, Kansas.

3. "SONEX is impressive-looking, and even better than that, it does what it is supposed to do for acoustics" in the church recording booth. Jim Moore, Audio Department Director, Northland Cathedral, Kansas City, Missouri.

4. Multi-Images Resources in Dallas uses SONEX for sound-proofing one wall of a "cavernous" presentation room. "SONEX is above reproach," says George Minton.

5. Tri-Video Productions, Lake Tahoe, Nevada, is 95% location TV. "SONEX ships well and performs beautifully. It's great—we use SONEX for cleaner location recording and sharper pictures," says J.P. Davis, Producer/Director.

Pictures do speak louder than words*

When we asked our customers to show us how they used SONEX, we weren't surprised to hear that it did the job. We knew that this patented acoustic foam with a specially sculptured anechoic design absorbs sound successfully. What really amazed us was the number of different applications they showed us. And what you're looking at here are just five responses out of the hundreds we've received. Even so, you can see (and hear) for yourself: Wherever sound is the problem, SONEX is the solution.

SONEX is manufactured by Illbruck/usa and distributed exclusively to the pro sound industry by Alpha Audio.

Get all the facts by calling or writing:

Alpha Audio®
2049 West Broad Street
Richmond, Virginia 23220 (804) 358-3852
Acoustic Products for the Audio Industry

*SUBMITTED BY FOURTH ROUND OF SONEX PHOTO CONTEST WINNERS.

species are crossing the line, at least occasionally. A case in point is KRIV-TV, Houston, which recently installed ADM's first 9000 series console. Intended primarily for production work, the 32-channel board also goes on-air during live shows, handling all mic and audio sources.

According to KRIV-TV's assistant chief engineer, Bob Badaeux, the console went on-air the weekend it was installed, handling all audio for a five-hour, live telethon. Badaeux gives the board mixed reviews so far. He calls it "highly flexible and fast," and notes that it was designed for television and can control the audio for two studios, automatically muting speakers as necessary to prevent feedback. Problems have arisen, however, with the software.

"The software is the limiting factor now," Badaeux notes. The board's computer control allows it to memorize multiple setups for almost instant recall, but problems, especially with the group muting function, have limited the board's capabilities. An ADM spokesman says the company is now replacing the PROMs at fault; he and Badaeux agree that the software, while at times problematic, is much easier to fix than hardware-based systems.

"We feel that once all the bugs are ironed out, we'll have the best thing in this market," Badaeux concludes. "The board will let us do back-to-back live shows from different studios," changing setups in seconds.

Will the idea catch on? ADM hopes so, and plans shortly to install similar systems at two other TV stations, WJBK, Detroit, and WAVE, Louisville, KY.

Digital Mixer/Recorder Could Replace Cart Decks

First deliveries are scheduled this month of a new digital multitrack recorder/mixer that the manufacturer claims could replace cart systems in radio stations.

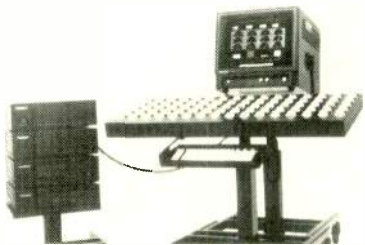

CompuSonics' DSP-2000 digital mixer/recorder system.

The CompuSonics DSP-2000 Series, a 68000 microcomputer-based, propri-



KRIV's ADM 9030 32-channel board.

etary system, is available in four-track modules that can be combined for up to a 128-track system, or customized to fit users' needs. It bears almost no physical resemblance to a conventional analog mixer and recorder. The recorder section consists of a typewriter-style keyboard, a console panel with 90 trackballs, and a color video monitor.

The trackballs are "sound shapers" that "allow you to shape tracks of mu-

sic on a completely individualized basis while the music is in the digital domain," according to a company spokesperson. Recording is on high-density magnetic disks; the machine also has playback capability. The company believes the DSP-2000 to be the first microcomputer system for all-digital audio signal processing, from mic inputs to final mixdown.

Although CompuSonics had origi-

Hypercardioid Lavalier Microphone with Vibration Isolation

For TV news, remotes, lectures, documentaries, and live productions, there has never been anything like the Isomax TVH from Countryman.

Its superior side rejection allows it to go where no lavalier has gone before. For live stage and television productions, the TVH offers at least 6 dB more gain before feedback compared to other lavaliers. For news work, it brings in usable audio from even the noisiest remotes.

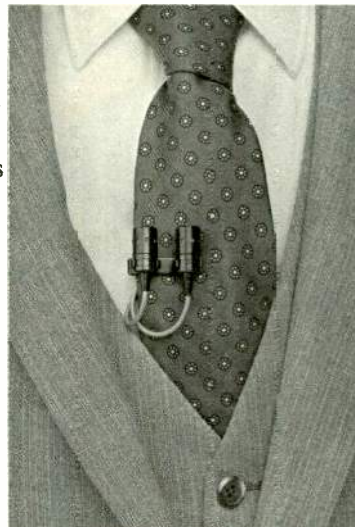

The Isomax TVH is the only hypercardioid lavalier microphone available today. And the TVH has something no other lavalier has: Vibration Isolation. Normally, directional microphones are 20 or 30 dB more sensitive to handling noise. Not the hypercardioid TVH. With its exclusive electronic vibration isolation it's even quieter than an omni!

Call or write for a free brochure or to arrange a demonstration.



COUNTRYMAN ASSOCIATES INC.

417 Stanford Avenue, Redwood City, California 94063 • (415) 364-9988

Circle 159 on Reader Service Card

Telex Intercoms help you give your best performance.

When that moment is at hand, lighting and sound experts know that cue signals can be critical to the best performances. Behind the stage, on location or at the sidelines, things can happen fast, and when they do, the professional must take action. There's only one chance to do it right.

AUDIOCOM gives professionals the help they need. It's the closed circuit intercom system for large, small, portable or fixed installations from television to stage productions, stadiums to race tracks, or industrial to public safety applications. Belt packs or wall mounted stations deliver crystal-clear communications for up to five miles, and may be "daisy-chained" or directly wired to the power source. All components, including intercom stations with LED signalling, headsets, mics, cables, switchboards and remote battery packs, are completely compatible with other systems.

Audiocom — so each performance can be your best. For more information and detailed specifications, write to Telex Communications, Inc., 9600 Aldrich Ave. So., Minneapolis, MN 55420.

For quick information, call toll free **800-328-3771** or in Minnesota call (612) 887-5550.

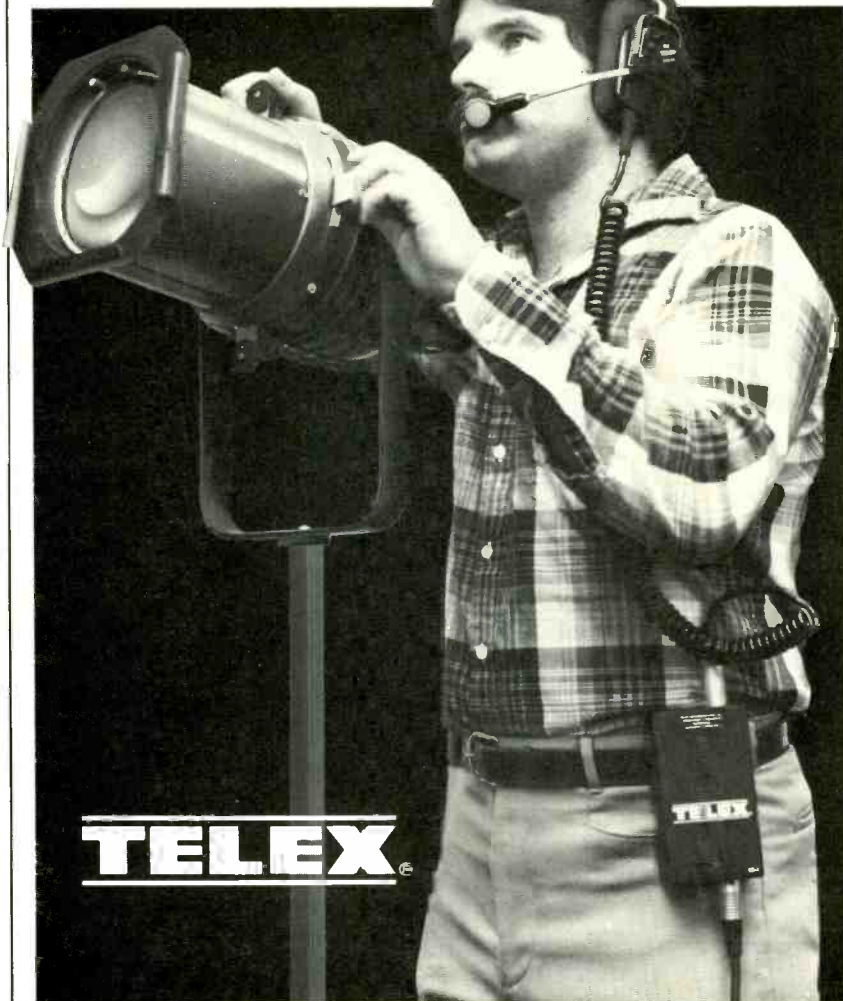

nally targeted recording studios as its primary market, the spokesperson said that initial interest was highest among radio stations, which could use the DSP-2000's instant random access capability to record, store, and play back digital material for on-air and archival use. The company has Beta test sites at "several" East Coast radio stations, but would not disclose the exact locations at press time.

A companion to the \$30,000 basic professional system is CompuSonics' home digital audio recording and playback system, which uses the same high-density magnetic disks. The consumer system is expected to be available next spring.

Tele-Image Expansion Emphasizes Audio

In moving from its old quarters to bright new facilities at the Dallas Communications Complex, video post-production facility Tele-Image is expanding not in size alone. Besides its three new multiformat edit bays, the company is adding significant multi-track audio capability.

"Our basic thrust for the past eight years has been exclusively video," relates Tele-Image vice president Chris Nicolaou. "With our new audio emphasis, our new philosophy will be to encourage our clients toward multi-

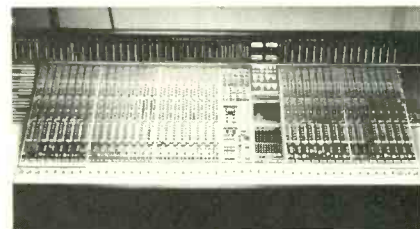

The SSL 4000E console.

track work very early in the editing process." Nicolaou plans to urge users of the new facility to use eight-track ATRs to save audio generations. "We feel that eight-track offers a very important option in the editing room," he adds. "We fully anticipate people using them to lay down their synchronous sound information. In the sweetening process they can then develop a sound track with effects on another eight-track, and then lock the two eight-tracks together for final mixdown."

In a related philosophical stance, Nicolaou says, "We're attempting to break down the professional barriers and distinctions between audio and video as much as possible," in part by seeking staff members comfortable in both areas.



To create the finest television audio mixing console, you have to do a lot of listening.

Neve's 51-series for television production.

To create great audio it's important to listen to and satisfy the needs of your marketplace. We know all about great audio. Neve has pioneered almost every major innovation in audio mixing from computer-assisted Necam systems to Digital (DSP) Systems. And we're very proud of that distinction.

That's why when we created a system designed to meet the growing needs of video post-production, we listened very carefully.

The result is that now video production facilities can enjoy the same superior audio quality that recording and film studios throughout the world have enjoyed, plus special features designed just for television production.

Human Engineered: First and foremost, from the size of the knobs and layout, to the straight-forward signal flow and powerful sub-grouping, the Neve 51-series is always easy to use, yet gives you all the features you want and need.

Four Band Equalizer and Filters: Our formant spectrum equalizer is renowned as the most musical sounding in the industry. No one else has the "Neve sound." Plus effective, high pass and low pass filters remove noises often encountered in live television production.

Dynamics Unit: Each input module contains a highly-regarded limiter/compressor and noise gate, perfect for processing those difficult tracks in post production or for use in live recording, from dramatic shows to musicals and sports.

Multitrack Capability: The 51-series separately controlled direct outputs, pre- or post-EQ, make simultaneous multitrack and live recording a snap.

Because Neve listened, the 51-series is what the television industry wants to hear.

For further information, call Neve's Television Production Sales Department at (203) 744-6230 or write:

51

S E R I E S

Demand Neve

RUPERT NEVE INCORPORATED: Berkshire Industrial Park, Bethel, CT 06801 (203) 744-6230 Telex 969638 • 7533 Sunset Blvd., Hollywood, CA 90046 (213) 874-8124 • RUPERT NEVE OF CANADA, LTD. represented by: Sonotechnique, 2585 Bates, Suite 304, Montreal, P.Q. H3S 1A9 Canada (514) 739-3368 Telex 055-62171 • NEVE ELECTRONICS INTERNATIONAL, LTD. Cambridge House, Melbourn, Royston, Hertfordshire, SG86AU England Phone (0763) 60776 • RUPERT NEVE GmbH: 6100 Darmstadt Bismarckstrasse 114, West Germany Phone (06151) 81764.

Circle 158 on Reader Service Card

Save \$10,000 every year for 20 years with the new Harris 60 kW UHF transmitter!

The new Harris TVE-60S is the most efficient 60 kW UHF-TV transmitter on the market today. And that translates directly into improved bottom line results for your operation.

With the TVE-60S, you can actually save an average of \$10,000 annually* on your power bills. Multiply this by the average 20-year life of a transmitter, and you come up with a \$200,000 savings! Without considering inflation.

How We Got There

The very latest in high power UHF technology has been incorporated into the TVE-60S. For instance, a single Varian 5-cavity VKP-7550 "S" Series klystron is used for full 60 kW visual power output.

This new integral-cavity klystron is an improved, ultra-high-efficiency version of the Varian VA-950 Series that has

been field proven in hundreds of UHF transmitters worldwide.

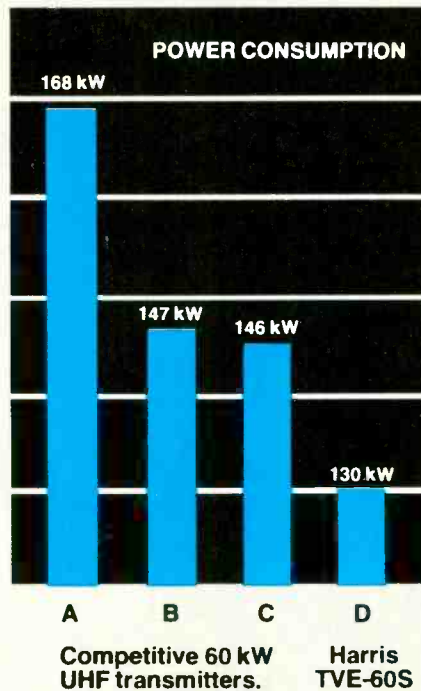

When operated with a variable visual output coupler and a mod anode pulser—both supplied as

standard in the TVE-60S—the new klystron provides visual beam efficiencies ranging from 63% to 68%.

Add to this an aural klystron coupler and an efficient vapor phase heat exchanger, and you have a 60 kW transmitter with power consumption of 130 kW or less. No other UHF transmitter in this power range comes close.

No Performance Sacrifices

There has been no sacrifice of performance for high efficiency. The MCP-2U visual exciter, with its Quadrature Corrector and unique, adjustment-free VIDEO SAW filter, provides unmatched color specifications and highest reliability. Also, the TVE-60S is designed for TV stereo, teletext and other services.

For complete information on the new TVE-60S, or the 120 kW and 240 kW versions, write or call: Harris Corporation, Broadcast Transmission Division, P.O. Box 4290, Quincy, Illinois 62305. 217/222-8200.

*Figured from the National Average Power Cost as published in "Electric Power Monthly", based on a 20-hour broadcast day, and compared with the published power consumption specification (as of Feb., 1984) on the next closest competitive 60 kW UHF transmitter. Comparisons in chart based on published specs as of Feb., 1984.

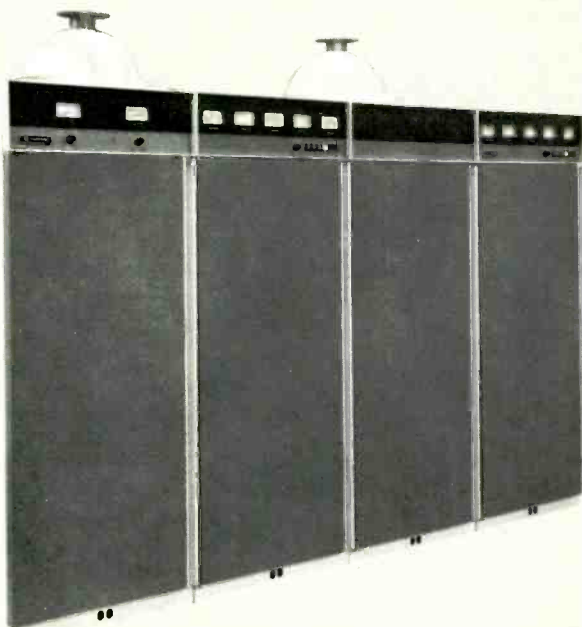

Circle 162 on Reader Service Card

Visit Harris Booth 1004 RC and PC Los Angeles Sept. 16-19

Equipment decisions were still underway at press time, but Nicolaou said Tele-Image was planning on "at least one" 24-track ATR, two eight-tracks, and three two-tracks with center-track time code. The largest of the audio control rooms will have a Solid State Logic 4000 computerized console with 32 inputs and SSL's Total Recall function, which stores complex setups on floppy disk for later use. "In video and audio we're trying to make it easy for people to work with us again and again," Nicolaou states. "Total Recall is kind of like what video people are doing with the edit decision list." Nicolaou also praises the design of the board's sync and machine control functions. The list of processing and efx gear, begun a year ago, is still in flux; according to Nicolaou, the large amount of processing built into the SSL console has made some of the originally specified efx gear unnecessary.

KOMO Hits the Streets With Portable Mixer

Quality audio is relatively easy to achieve in the controlled atmosphere of the studio, but field operations introduce a plethora of variables that demand ingenuity from a station and flexibility from a console. KOMO-TV, Seattle, spends plenty of time in the field, and the station's concern for top-quality audio created the need for a responsive portable board.



Sony's JH-800 portable console.

According to director of engineering Bob Plummer, KOMO purchased one of the first two preproduction models of Sony's JH-800 portable mixer about a year and a half ago, and has found the unit versatile enough for the station's wide-ranging needs. "Last year we did over 100 remotes with it," Plummer boasts. Those productions ran the gamut—sports remotes, live magazine shows, music pickups, raw footage for post-production, commercial production, and promotional material. ATRs

for the taped shows are MCI ¼-inch reel-to-reel two-tracks.

The ac-operated board is not tied to a truck, although it can operate off a generator as well as shore power. Location engineer Warren Severance recently used all 12 mic inputs for a basketball game, using the board's built-in compressors and limiters to deal with the event's drastically changing audio levels. In addition, the board has six mono or three stereo outputs for additional flexibility, making it ready for KOMO's conversion to stereo audio transmission (which could take place as early as this month).

Audio Automation on a Roll With Top-Flight Truck

Mobile audio in itself isn't a new concept, but Le Mobile, Guy Charbonneau's Canada-based recording truck, takes the idea just a little further—with a full console automation system. Le Mobile's NECAM 96 automated mixing system is the first to be installed in a truck, according to Neve. The automation allows the truck to produce finished mixes of events it has recorded in

Our consoles never die. They just keep fading away.

Built like a tank. Handle like a dream. Smooth, sure, responsive. And won't let you down.

That's LPB, for the air and production boards you see coast to coast—in local to network stations—from 100 watts to 100kw.

It isn't that we're all-solid-state, or that we make 5, 8 or 10 channel mixers, mono, stereo or both. It's simply because LPB consoles don't seem to break down. And that's on the record.

But features count, too. From pre-fader pushbutton cues to programmable muting logic, let's say if it's essential, we've got it!

If you're keeping current on consoles, get the specs on LPB equipment. Call 215-644-1123 or write LPB Inc., 28 Bacton Hill Road, Frazer, PA 19355. (Telex 703000.)

A lot of consoles will come and go in your time. But not if they're made by LPB.

Model M-8S

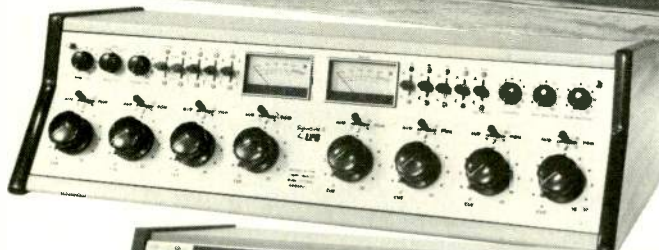

Model S-13C

Model C-8S



LPB®

Our call letters make news 'round the world.

Circle 163 on Reader Service Card

the field.

A good example was a recent live concert by rock singer Pat Benatar. After recording the concert, the truck was used to mix down the live album. Other artists that have used the truck for album mixdown have included Teddy Pendergrass, Billy Joel, and Peter Frampton. The versatile truck has not limited itself to rock concerts, however; it has also served as the audio facility for feature film and television work.

Charbonneau's attention to detail insures that the truck functions smoothly, inside and out. "I've built Le Mobile like a fine-tuned race car and I maintain it as such," he insists. "Each piece of equipment is modified to interface well with all the others. As a result, it's as comfortable to use for remix and post-production as for live audio recording, video, or film." He adds, "If something goes wrong we fix it right away—even a burnt light."

The recently installed NECAM 96 automation supplements the truck's trusty Neve 8058 console, which controls two Studer A800 24-track ATRs and two B67 two-tracks. Filling out the equipment roster are a pair of time code generators, a Sony BVU-800 3/4-inch



The Neve 5116/36 console.

cassette deck modified to read time code on any track (including the address track), Crown power amps with UREI crossover, and custom-built monitors with JBL drivers. Efx gear includes three digital reverb units (EMT 244 and Lexicon 200), three Eventide Harmonizers, and 15 limiter/compres-

sors. The truck itself has custom air conditioning, acoustic, electrical, foldback, and intercom systems.

Summing up the philosophy behind Le Mobile, Charbonneau says, "We didn't take a truck and put equipment inside—we took a studio and put wheels underneath." **BM/E**

Simply AWESOME!



The new PRIMUS audio & data amplifying/routing/switching system.

You name it, this system will handle it. Audio, SMPTE, time code, DC, ultrasonics or modems. Expandable from 8 in X 2 out to 128 in X 64 out. Extremely low noise,

distortion and crosstalk provide virtually transparent operation, in both mono and stereo mode. In addition, The means of control (BCD, 3 wire party line, or RS-232 personal computer) are limited only by your imagination. Three year warranty with prices starting as low as \$920.

Call toll free (800) 821-2545 for details and the name of your nearest dealer.



Can the Panasonic® AK-30 stand head to head with the bestselling broadcast camera in the world?

You bet it can. In fact, when you compare picture quality, automatic features and price, you'll discover the Panasonic AK-30 is far and away your best bet.

Compare pictures. You'll notice the AK-30 produces a superrefined video image. The kind of image broadcasters love to see. But that's not surprising with these kinds of specifications: Horizontal resolution is 650 lines center. S/N is a very quiet 62dB (-6dB gain), the highest ratio in the industry. Digital registration is 0.05%, 0.1% and 0.25%. And illumination is a mere 24 lux at f1.4 (+18dB gain).

This high level of performance is

achieved with a unique combination of image-enhancing circuitry and high-focus-field Plumbicon* tubes.

You'll also appreciate the AK-30's automatic circuits. Like auto-white balance with memory for setting 2 color temperatures. Presettable black stretcher. Auto-black balance, and a knee circuit for variable dynamic range. Together, they let you customize the image you're shooting for.

Still, the AK-30 has plenty more going for it. Consider its dual outputs. One works with standard NTSC. The other lets you set new standards because it's compatible with component recording. That

means you can use it as part of our famous M-format Recam system.

The Panasonic AK-30. Compare it to the world's bestselling broadcast camera. And see why it stands out far ahead. *Plumbicon is a registered trademark of N V Philips for TV camera tubes.

For more information call your nearest Panasonic regional office:

Northeast: (201) 348-7336

Midwest: (312) 981-4826

Southeast: (404) 925-6835

Southwest: (214) 257-0763

West: (714) 895-7200

In Canada call: (416) 624-5010

Panasonic
Industrial Company



High Definition Audio

For the complete picture

The new 300 Series Audio Production Console has been specifically designed to complement the latest audio and video technology. It's the only console in its class, offering mono or stereo inputs each available with or without equalization, output submastering, audio-follow-video capability, a comprehensive user-programmable logic system, and a wide range of accessories for custom tailoring to your specific requirements. Available now. Call us collect for further information.



auditronics. inc.

3750 Old Getwell Rd.
 Memphis, TN 38118 USA
 Tel: (901) 362-1350
 Telex: 533356

PART 14

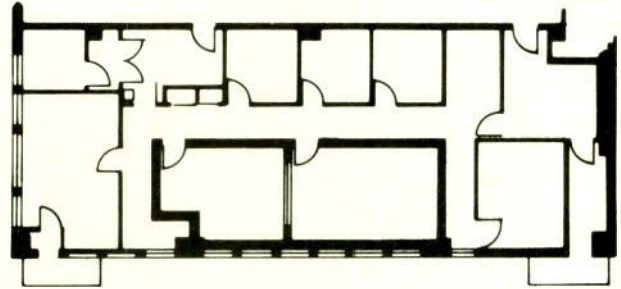

CHOOSING A LOW-COST AUDIO PRODUCTION/POST-PRODUCTION CONSOLE

BY DICK ROSMINI

In the good old days, the typical chief engineer in broadcasting was called upon to build a new facility from scratch so rarely that the planning of a new installation was an event that would happen only once or twice in a professional lifetime. The rapid advance of media technology has changed all that. With the explosion in formats, the safe and sane installation timetables of the past are becoming a fond memory, and the amount of new equipment that must be analyzed makes for a mountain of brochures, block diagrams, and schedules.

In this sea of new technology, audio has remained the one well-understood beacon of sanity, using technological solutions that haven't required any new thinking in years. What is changing, though, is the increasing importance being placed on audio production capabilities—both the amount now required to be produced, and the complexity of the sound. This has caused broadcasters to reexamine their priorities when setting up an audio post-production facility. To follow all the accepted rules of audio facility design, you run the risk of bleeding to death through your wallet. What is being called for is a studio, or even several studios, in which an audio engineer can get the job done efficiently and with enough complexity to meet the producer's needs.

DESIGN ALTERNATIVES

What are the design alternatives? The most obvious is the use of medium- to low-cost off-the-shelf audio production equipment, including an audio console. The problem here is that, for most broadcast engineers, any-

thing costing less than \$40,000 arouses deep suspicion.

The one comforting thought to ease you through this suspicion is the realization that there is a fundamental difference between on-air, on-line boards and the kind of board used for production, which is essentially off-line. Once you are relieved of the pressure of providing on-air security, you can depart from the rules with a fair guarantee of safety, and good confidence in the quality of the broadcast audio.

The technology of the off-air board is not the only area that arouses the suspicions in the broadcast engineer, however. There is also a question about whether on-air talent and equipment operators will have trouble working with a four-band parametric equalizer with variable Q on every input (one of the reasons you bought the console in the first place).

But like the problems with technology, these suspicions of operating talent can soon be laid to rest. Post-production gear is, by definition, designed to do the sound

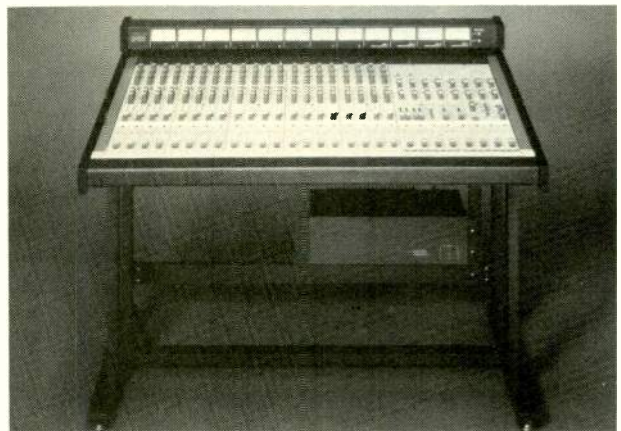

The Tascam M-520 console.

Dick Rosmini has been a consultant for the last 15 years, advising TEAC Corp., Yamaha, and JBL on the design, building, and marketing of audio consoles.

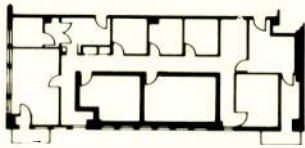

FACILITIES DESIGN AND ENGINEERING

processing which was formerly supplied prepackaged from the motion picture and record industries. In other words, audio processing is an integral part of the post-production process. Even if you currently only mix an announcer and sound effects with prerecorded music, or clean up the audio from a multicamera remote news crew into something airable, you will still need flexible equalizers, echo devices, independent buses to feed them, and multitrack recorders with overdub and sync capability. This is a new realm for the broadcast engineer, but one which must be taken into account.

In short, to do this type of sophisticated sonic manipulation, you will need all the tools of the multitrack/multichannel world. In consoles, that guarantees an extremely high knob density, a minimum of dummy lights, and a massive number of what appear, at first, to be redundant functions.

And if all these new concerns aren't enough, there is the added anxiety that even if it doesn't blow up, this equipment is unsafe for radio or TV. Get a firm grip on your subconscious distaste for complexity, however, and remember that you're feeding a tape track across the room (or the truck), not a transmitter across town, and we'll explain what all this is supposed to do and why.

THE TECHNOLOGY

The current generation of midrange audio production boards differs from its predecessors in several key technological aspects that may cause anxiety among engineers who haven't worked with them extensively. For one thing, transformers have been all but eliminated in the modern multibus audio consoles. These boards are usual-



Ramsa's WR-8616.

ly unbalanced internally, and therefore have no transformers between internal sections (indeed many use extensive IC circuitry, all but eliminating hard-wired components). Although major inputs and outputs are balanced, transformers have also been replaced here—by differential amplifiers.

There are also substantial differences in the way this new concept of "active balanced" circuitry is handled. With today's on-air broadcast standard of 600 ohms, active balancing will lead to major changes in the way you go about designing the new installation.

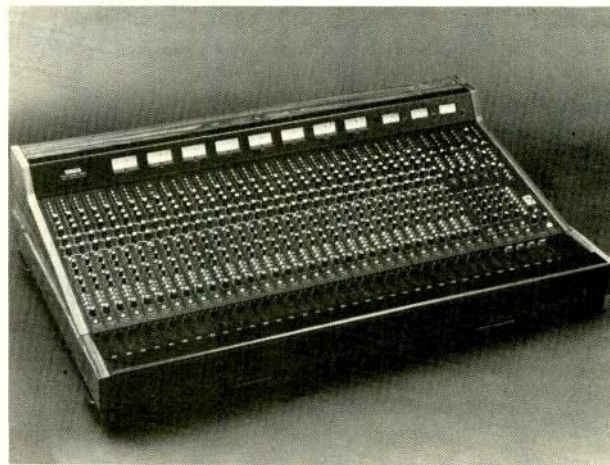

The Yamaha M1532 console.

Another difference is that the patch bay probably will be built into the console, and definitely will be single-ended. On smaller consoles, the back panel will have a complete complement of connectors, including XLRs for the microphones. If you can plan on using the built-in patch bay for your rerouting and switching, you can cut the cost of your post-production studio dramatically, and you will gain the advantage of quick setup and breakdown as well. Still another cost-saving alternative is the use of RCA cable and jacks for connections.

Already you can see that the old rules are in shreds. Consider, for example, that the lack of vacuum tubes in this equipment means that the power supplies are not giving you a dc power bus that is 100 V or more off ground and that must be kept "clean" at all costs. Bipolar dc at ± 15 to 24 V is much easier to control and isolate. Though the bulk of the circuitry in a modern console is housed within the console frame itself, rather than in a rack full of high-gain amplifiers which must be kept at some distance from the board, the lower-powered circuits can be fully isolated in the console frame.

Also ask yourself whether in the new installation you really have to be able to drive the transmitter link from any point in the patch bay—as is still common practice. This tradition dies hard; but getting a microphone signal out to the "stick" when a vacuum tube blows on the morning news—the original rationale for needing to be able to drive the transmitter from any location—is no longer reasonable. A medium-sized post-production board may have as many as 500 to 1000 gain stages, and using "emergency" thinking in your patch bay installation logic for this type of facility is just not practical. If you must have backup broadcast capability tied to this installation, it is far cheaper to have a simple battery-operated mixer on a switch for emergency use. The integrated circuit is infinitely more reliable than the vacuum tube, and the concept of patching around a dead amp is about as realistic here as wearing a parachute on a commercial airliner.

Does the patch bay have to be in a relay rack across the room, requiring raceway, 6000 feet of wire, Christmas-tree wiring, and a six-week installation time?

Unlike the old custom-built solid top consoles, these new, lower-priced mixers are highly modular, and most have modules that can be removed quickly from the installed frame with a screwdriver. You won't have to resolder anything, and in some cases you don't even have to turn the ac off to safely replace a defective strip!

THE WHEATSTONE SP-5 STEREO PRODUCTION CONSOLE

WHEATSTONE BROADCAST GROUP announces the SP-5 Stereo Production Console, the latest in a long line of high performance audio mixing systems from AUDIOARTS ENGINEERING, a company with an established reputation for technical excellence, quality production and product reliability.

Modular, and specifically designed for stereo broadcast production, the SP-5 offers true stereo subgrouping for mix-minus and stereo program work. Optional configurations allow mono subgroups and outputs, dual stereo line or mono mic/line inputs, and a wide variety of mainframe sizes accomodating 8 to 52 input modules.



 Wheatstone Broadcast Group

5 COLLINS ROAD, BETHANY, CT 06525 (203) 393-0887

Circle 167 on Reader Service Card

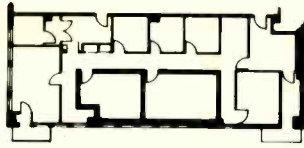

FACILITIES DESIGN AND ENGINEERING

The smaller power supplies used in these consoles also produce substantially less heat, and the general use of steel modules and frames offers an improvement in shielding as well as a substantial weight reduction compared to the custom-built console. Steel stampings may not inspire confidence in the engineer used to looking at machined aluminum extrusion, but the average custom builder uses aluminum only because he lacks the volume needed to justify the cost of the sophisticated mechanical engineering and more extensive tooling that steel requires.



ADM's VP-1603 console.

The changes in installation procedures and materials mean that since you don't have the benefit of the transformer, the line length and cable material combine with the amplifier stages at both ends of the line to make up a network that will require some calculation. Even though the true output impedances of this type of circuitry are quite low, the outputs are not capable of supplying an infinite amount of current. Therefore, low-loss, low-capacitance cable becomes important. This also applies to the "active balanced" stages.

TRANSFORMERLESS DESIGN

In the past, the bandwidth requirement for quality broadcasting was not what it is today, and many on the fringes of the technical department didn't read the fine print, assuming incorrectly that the stock phrase "600 ohms, balanced" was synonymous with "no problem, all pro." But the old-timers knew that there were limits to what you could expect from transformer circuitry.

Dispensing with the transformer in many of today's production/post-production boards provides enormous financial benefits to the rest of the system. A good transformer costs \$15 to \$50 and weighs several ounces. The replacement IC uses 3A, costs \$5 complete (less in quantity), and weighs just a few grams.

This alone doesn't explain the dramatic reduction in the price of the "new style" audio consoles, with no loss in audio quality. Consider that the mounting hardware and mechanical construction for a transformer-coupled module must provide room for the several transformers, screws and brackets for each, and extra strength in the

module to support the whole works. This expensive hardware makes no improvement in the sound and unavoidably increases the rigidity of the entire chassis to provide the necessary mechanical stability. Insist on the three-ounce transformer-coupled circuit and you quickly arrive at the 10-pound module, the 1000-pound frame, and the 3000-pound patch bay (that you will have to build on site and debug)—just for a 16-input console. Care to consider a 32-input multibus for your remote? Sure, you can call a custom builder and order one that is all transformer-coupled, but as soon as you hang up the phone, you'd better order a big semi and cab, because even a three-axle won't haul the load, and the van in your original budget will be used only for errands.

Reconsider the new technology, however, and you will get the same audio performance at one-tenth the price—and when all the figures are added up, you may find you'll be able to afford two matching trucks!

To sum up, this equipment comes from a mature industry. The first Tascam and Allen & Heath two-wire consoles are now 15 years old, and the original Sound Workshop and Soundcraft boards are not much younger. With very few exceptions (often due to fire, accident, or environment), all are still running.

Why has the broadcast industry shown so much reluctance to accept this equipment? Although many of these consoles are actually in service, producing IDs, client spots, and outside work, engineers often are reluctant for the installations to be examined too closely because they never expected them to work. Despite the suspicion, however, the new-style console has been the de facto workhorse of post-production for some time now. If you call around, and you push past the "foot scuffle" and the pained expression, we're positive that you will get a grudging admission that the gear is reliable, practical, and most certainly affordable and appropriate.

CHANGES IN THE CRAFT

Now that we have made our case for the technology, let's go over the reasons for that super-high knob density, the "bed of nails" console top panel used in the modern post-production audio facility.

A broadcast console is basically a one-way street that accepts a group of inputs (turntables, carts, tape, and live mics), combines them, routes the mix on to the station sound processors (multiband limiters, equalizers), and then on to the transmitter. Equalizers and echo are uncommon—how can you mess with the sound when you are on the air? Cue is a must (at least two for TV), and dummy lights are vital. FM stereo can be handled with just a stereo twin fader, not a pan pot.

The production console, on the other hand, is more complicated. Most broadcast engineers can figure out that Aux 1 is something like "cue" and that Solo is similar to PFL. But there are lots of knobs that control functions which have no parallel term in broadcast. Some of the confusion is due to differences in the terminology; but more often than not, it's the change in the way the system is used that makes for the differences in the layout and the labels. Let's take the systems apart, one at a time, starting with the ones that look similar but are quite different.

The monitor system. Because the job of multitrack production is divided into the three broad areas of basic tracking, overdub (sweetening), and remix (dubdown),

INTRODUCING THE CAMERA YOU'D BUY AT TWICE THE PRICE

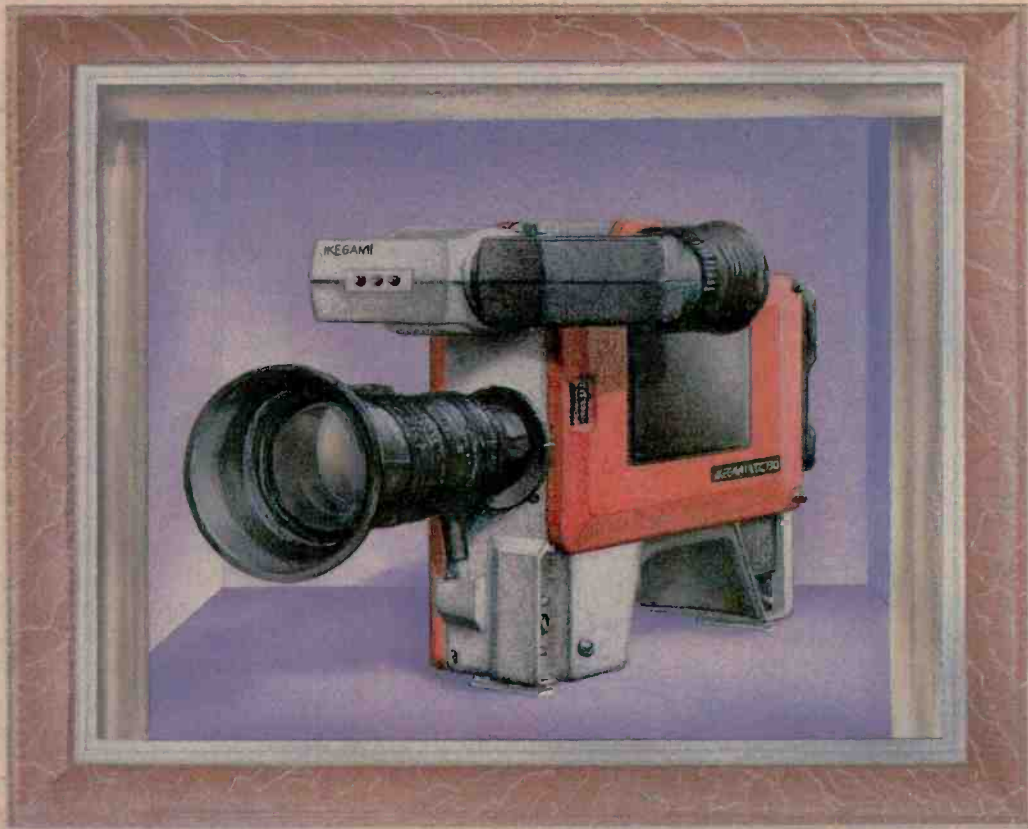

THE NEW BROADCAST QUALITY IKEGAMI ITC-730A

When you examine the quality of the Ikegami ITC-730A and then hear the price, you'll probably ask to hear it again.

The new ITC-730A is a truly low-cost, lightweight ENG/EFP camera that's designed to give you exceptional performance and value. Video gain has been boosted to +9dB/ +18dB for a maximum sensitivity of 4-foot candles when using an f/1.4 lens, while signal-to-noise ratio has been improved to -57dB. Center horizontal resolution now exceeds 650 TV lines, with corners optimized by dynamic focus. Dynamic range has also been expanded—without sacrificing resolution or S/N ratio in low-light image areas—through highlight compression circuitry. In addition, the ITC-730A generates Split Field Color Bars in accordance with EIA RS-189A and sync waveform meets the SC-H criteria of RS-170A. And for multi-camera setups an adjustable color video matrix

permits accurate color matching between cameras.

Yet the ITC-730A still incorporates features that made the ITC-730 the ENG/EFP camera for budget-conscious, high-quality ENG and production. Features that give you the edge, such as Saticon II® pickup tubes, dynamic beam stretch, a 2-H vertical detail corrector, and a host of automatics. In addition, the ITC-730A CCU lets you operate up to 1000 feet away through a flexible 13 mm cable in AC mode and up to 300 ft. away using DC at the camera head or CCU. And its well-balanced, lightweight design lets you work comfortably in the field.

The ITC-730A: Great value never looked so good. The standard of excellence goes on at Ikegami. For a complete demonstration of Ikegami Cameras and Monitors, contact us or visit your local Ikegami dealer.

Ikegami ITC-730A

Ikegami Electronics (U.S.A.), Inc., 37 Brook Avenue, Maywood, NJ 07607

■ East Coast: (201) 368-9171 ■ West Coast: (213) 534-0050 ■ Southeast: (813) 884-2046

■ Southwest: (713) 445-0100 ■ Midwest: (314) 878-6290

Circle 184 on Reader Service Card

Saticon: TM Hitachi, Ltd.

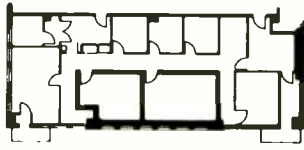

FACILITIES DESIGN AND ENGINEERING

this part of the console is much larger than the monitor on a broadcast console. Basic tracking first requires you to monitor the feeds to the recorder. You need two monitor controls: the pan pot to make a preliminary arrangement of the as-yet-unmixed tracks, and a volume control for each signal you are sending to the recorder *that does not affect the record level*. The individual levels sent to tape are optimized for the best S/N by the input and bus master faders on a track-by-track basis, and if there is no "second set" of independent level controls available in the monitor, you will have no way of making a preliminary judgement of what your production will sound like when mixdown is done. This monitor prebalance without tape compromise control will be necessary on the way out (one group per bus out), but it will be far more important on the first playback. Your console will need one group of monitor controls *per tape track*. Why can't you use the input modules to play back by switching to "tape?" Because that will force you to reset all the EQ and levels that you have worked up for the recorder, and if the playback is either technically flawed or artistically unacceptable, the entire recording setup will have to be done over before you can make a second take.

Can you use a "one-way street" PA or broadcast console for multitrack post? Yes, if it has enough inputs to allow the permanent assignment of an entire group of modules to the tracks of the recorder to allow for this separate playback requirement. For an eight-track recorder, a



The Ward-Beck LS3642 board.

16- or 24-track four-bus PA board will allow this permanent playback "patch." When you get to 16-track, however, you will be making big compromises in input flexibility, and you won't be saving any money. In addition, many of the little details that make for multitrack convenience, such as monitor pan and monitor solo, are seldom included in a PA style mixer.

All this implies that you can do eight-track work with a four-bus mixer. How is this possible? In multitrack, you seldom record all the tracks at the same time. In fact, even if you plan on "shooting" everything in one pass at a concert remote, it is possible to work 16- or 24-track quite comfortably with a four-bus console if there is a "direct" or module output on the patch bay and your mixer has sufficient inputs. Many tracks will be "one mic per track," and stereo is usually done in remix, recorded with a hard left/right pair of mics on two tracks (no buses or pan pots are needed for this) or restricted to the drums. Only the tracks that require more than one mic need a mix bus. This

four-bus board will only be convenient, however, if the monitor has *all* 16 or 24 tracks of playback available! You must have level control to hear this.

Back in the studio, where the bulk of recording will be done one track at a time, moving a patch cord to get bus 1 or module 6 to track 9 is simple. On the remote, a layout of "direct module outs" is made at the beginning of the concert and won't change. Having only four mix buses will not hurt you, but it will not be possible to work quickly in the studio or on the remote if the monitor is not complete. If you must switch half of your board to remix just to check playback, you will quickly go nuts.

Many first-time buyers of multitrack worry too much about hard-wiring the bus outs to one tape track each. "More meters" seems safer, so they buy more mixer buses than they really need and miss the real requirement for "speed"—which is a good patch bay combined with a complete and fully independent monitor system with a separate group of controls for each track.

The overdub. To add a part to a multitrack production, you have to hear what is already on the tape, as well as what you are adding. You need at least three separately controllable feeds. First, the new part must go to the recorder. Next, the old parts and the new part must both be available to the engineer for preliminary balance. This simultaneous operation of record and play will put a severe strain on the "one way" consoles used in broadcast or PA. Third, a cue mix must be made for the talent to insure that the part to be added will wind up in the right place and will relate properly to the rest of the production.

Why is this "third mix" in need of independent control on a part-by-part basis? Wouldn't it be enough to just take the control room mix and send it out to the headset? For that matter, why not just start the announcer with a hand cue through the glass and save a bunch? Two examples may shed some light on this:

- You are adding the final percussion part to a local commercial. The drummer is trying to hear the timing of the music track and asks you to take out the screaming announcer so he can find "bar 10."
- Even though the announcer is a pro, he asks you to put the echo effect the client wants in the finished spot "on the cue" so he can pace his delivery for added impact.

The second example also illustrates the "echo to cue" function and the use of the "effects return" group. It also identifies the need for a fourth, separately controllable echo send mix.

Remix. At first, remix looks like a return to the "one-way street" mode of operation. However, the addition of effects send and return adds some routing capability that you won't find in PA or broadcast consoles. And multitrack boards with remix add some significant bells and whistles to the simple PFL function of the on-air mixer. To handle the multiple functions, the multitrack console may have as many as six different solo functions per module. And unlike the broadcast PFL, many of them are not used for speed but for precision control. They may actually lengthen the process of mixdown. The six solo functions can include:

- **PFL** (pre-fader listen) works the same way as in broadcast, drawing the signal from the preamp, usually prior to the effects loop (the patch point on the module) and pre-EQ.
- **AFL/Solo** (after the patch point, the EQ, and the fader) should be the source of the signal when you only have one

THE ONE PIECE THAT SOLVES THE PUZZLE



THE ALL-NEW IKEGAMI HL-95 UNICAM®

If you're confused by the many tape formats and conflicting manufacturers claims, relax.

Ikegami's new HL-95 Unicam® is the only universal camera system that accepts all professional on-board VCR formats, 1/4-inch and 1/2-inch, and solves your buying puzzle by putting the picture you want into place.

Engineered to offer performance beyond the most rigid expectations, the HL-95 utilizes new 2/3-inch SM diode gun Plumbicons® resulting in a camera with higher sensitivity and S/N ratio, greater resolution, lower operating power requirements and less registra-

tion error than previously possible in a camera of its size and weight.

The HL-95 is also available as a stand-alone ENG camera, and in systems configurations using Triax or Multi-core cable base stations, or with the ML-95 ENG Microwave Link. Once you examine the HL-95 Unicam®, you'll agree that the system flexibility and picture quality puts it in a class all by itself. The standard of excellence continues at Ikegami.

For a complete demonstration of Ikegami Cameras and Monitors, contact us or your local Ikegami dealer.

Ikegami HL-95 UNICAM®

Ikegami Electronics (U.S.A.), Inc., 37 Brook Avenue, Maywood, NJ 07607
■ East Coast: (201) 368-9171 ■ West Coast: (213) 534-0050 ■ Southeast: (813) 884-2046
■ Southwest: (713) 445-0100 ■ Midwest: (314) 878-6290



THE CLASSIC PROFESSIONAL CASE for portable video recorders made and designed by Porta-Brace™. These cases are the result of over ten years of informed testing in the field by professionals. They are made with the finest materials available and are constructed by skilled Vermonters. They are imitated widely but never matched for quality, durability, originality and practical day to day usefulness.

For the professional user.

For other high-quality video carrying cases, camera cases, production cases, carts and backpacks, contact your dealer or call:



K and H Products, Ltd.
Box 246, North Bennington
Vermont 05257 (802)442-9118

Circle 193 on Reader Service Card

REPLACEMENT TRANSFORMERS GATES, COLLINS, RCA, CCA



PLATE TRANSFORMERS

20V-3\$550
CCA FM-4000E\$850
GATES BC1E, BC1F\$550
GATES BC1G, BC1H\$550
GATES BC1J\$550
GATES BC1T\$550
GATES BC5P 3 Phase\$1200
GATES BC500T\$400
GATES FM-250\$275
GATES FM-1B\$575
RCA BTA1G, BTA1H\$550
RCA BTA1R, BTA1S\$550
RCA BTA5G, BTA5H\$750
(Main or Teaser)\$750
RCA BTA10H (Main or Teaser)\$1500

MODULATION TRANSFORMERS

BAUER 707 Series\$695
COLLINS 20V Series\$695

COLLINS 21E Series\$1350
GATES BC1 Series\$695
GATES BC5 Series\$1350
RCA BTA1 Series\$695

MODULATION REACTORS

GATES BC1 Series, 40 Hy @ 600 MA DC\$400
GATES BC5 Series, 35 Hy @ 1.4 AMP DC\$650
10KW Universal, 20 Hy @ 2.5 AMP DC\$850

FILTER REACTORS

3 Hy @ 2.5 AMP DC, 10 KV INS\$300
5 Hy @ 1.0 AMP DC, 10 KV INS\$175
10 Hy @ 1.0 AMP DC, 10 KV INS\$200
10 Hy @ 2.5 AMP DC, 10 KV INS\$350
15 Hy @ 1.0 AMP DC, 10 KV INS\$250

Many other transformers also available. Call us for free quotations. Large stock and fast delivery. 12 Month Guarantee on all items.

PETER W. DAHL CO., INC.
4007 Fort Blvd., El Paso, Texas 79930
Telephone: (915) 566-5365

Circle 194 on Reader Service Card

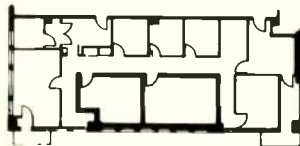

FACILITIES DESIGN AND ENGINEERING

solo button so you can hear the effect of the tone control and whatever accessory device (limiter, extra effects device) you have in the patch.

- *Solo in place.* If you work exclusively in mono, this function is hard to understand. It indicates that the solo bus is two-channel and that the solo function is affected by the position of the pan control, so that you can hold the stereo position when you check a single signal. This seems a little deluxe, to say the least, but there's more to it than you might think.

Solo in place also maintains the effects/echo send aux bus function, but *only* for the module you have soloed. When you have the echo for a signal in some stereo array that is separately controllable, a solo that allows you to hear the signal with *all* of its process and pan is not a luxury. This type of solo can't be used when you are working with talent, because it will kill the aux/cue buses, causing talent to lose the cue mix every time you solo something in the control room. Some manufacturers get around this problem by providing two buttons, one AFL and one solo in place. In the old days, you could get the solo in place logic by using the mute button.

- *Mute program* cuts off the signal from the preamp to the rest of the module. In mixdown, working "backwards" and muting everything at the start of the mix would allow pan and echo to be heard "in the clear," but as 16-track expanded to 24 and then to two machines running in interlock, going back and remuting 36 inputs just to look at one signal led to the demand for the solo in place function.

- *Solo program* indicates a "mass mute" function, where one button can be used to solo a single signal on the mix bus instead of the monitor. It is used to avoid having to mute 20 inputs to reduce noise at the beginning of a piece where only one instrument is playing.

- *Solo monitor.* Since the signal pickup point is usually taken from a monitor amp and no bus or aux shuts off when you press the button, this one can be made solo in place by using the monitor pan pot. You can then solo from here without disturbing the talent. This is also the solo that you use when you are making a playback.

THE PATCH BAY

The ability to do intermediate nondestructive mixes on a part-by-part and stage-by-stage basis, hear the results of an effect applied to a single part of an incomplete production, and in general change the flow of signal to suit the needs of the moment is the job of the monitor system. The more contingencies that you can identify in advance, the more likely it is that your post-production studio will work efficiently from day one. Miss one major requirement of this nonbroadcast expanded monitor logic and you will be forced to shut down and "fix it," or limp along with reduced profit and a surly post-production staff.

How do you prevent this? For starters, let's dismiss one of the methods that many have used in the past: the patch bay. Depending on the patch bay to deal with "the unor-

GET BEHIND THE CAMERA THAT'S OUT IN FRONT



THE IKEGAMI HL-79E

The HL-79E, Ikegami's crowning technological achievement continues to run ahead of all other cameras in its class.

That's why more and more top-of-the-line EFP camera buyers are getting behind the winner. Only by seeing this remarkable camera in action can it be fully appreciated.

Just how great is this camera? To begin with, it is the culmination of all that has gone into creating the legendary 79 Series cameras, the reference standard of the broadcast industry for both ENG and EFP applications.

HL-79E features—Dynamic Detail Correction, Chroma Aperture Correction, Highlight Aperture Correction and Auto Contrast Compression. Plus the HL-79E offers superior contrast range, S/N ratio, registration accuracy, resolution, viewfinder performance and more.

Available accessories include the ADC-79E Auto Set-Up Unit and the RDC-79E Remote Control—both digitally interfaced. The HL-79E is compatible for use with existing HL-79A and HL-79D Triax and Multi-core cable base stations, lenses, power supplies, VTR cables, and other accessories.

The HL-79E is part of the great and proud family of Ikegami products serving many satisfied users worldwide. For a complete demonstration of Ikegami Cameras and Monitors, contact us or visit your local dealer.

Ikegami HL-79E

Ikegami Electronics (U.S.A.), Inc., 37 Brook Avenue, Maywood, NJ 07607

■ East Coast: (201) 368-9171 ■ West Coast: (213) 534-0050 ■ Southeast: (813) 884-2045

■ Southwest: (713) 445-0100 ■ Midwest: (314) 878-6290 Circle 168 on Reader Service Card

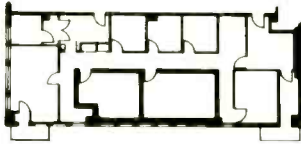

FACILITIES DESIGN AND ENGINEERING

thodox" is the final catch-all of the system designer. This method is okay for the occasional unique change in routing, repair, or interface, but don't ask the engineer to go to the bay every 30 seconds.

Obtain the schematics and the block diagrams for all the equipment you are considering and sit down with your working staff. Plan out realistic and timely solutions to as many of your "what if..." signal routing problems as you possibly can. A patch that you make once an hour, or the patch using one cable that has no other consequences, can be considered acceptable if your staff agrees. On the other hand, repatching half the modules, or moving 14 other controls just to get all your cues, echos, and monitors to work after one cable is reassigned, will clearly be too awkward, even if the route works technically.

True, this routing analysis is tedious and time-consuming, especially when you have to go over several "stock consoles" to make sure that all the features you need are, in fact, built-in. For every hour of analysis time you spend, however, you will save hundreds of hours of operator frustration, making the studio more cost-effective in the long run.

Another warning: Get all the literature! For this type of commercial product, sales literature is more than just pretty pictures and endless brag. At all price levels, manu-

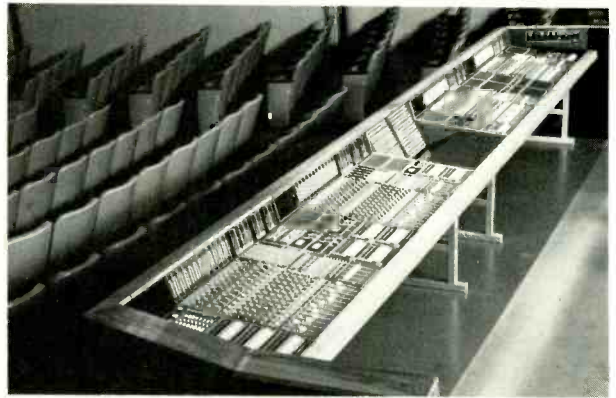

Harrison's PP1 post-production console.

facturers have brochures that detail the function of the top panel controls, and the reasoning behind the logic of the labels used. At the low-to-medium price point, Neotek, Tascam, Sound Workshop, and Yamaha, among others, explain the design logic of their layouts thoroughly and can be considered excellent guides. Soundcraft, Harrison, Amek, and MCI have function brochures separate from the full-color sales presentations that are fairly complete. The really high-ticket console makers such as Trident and Neve may offer sales engineers who will be glad to explain the intent of any unusual control.

Good luck with your choice of an audio board, and don't be overly frustrated by Murphy's Law. Remember, it happens everywhere, even in the most famous places. When Saint Peter electrifies his harp, he'll probably forget the extension cord for his amp. **BM/E**

NAGRA IV-S TC



Film and Video Time Code Versatility With Digital Display

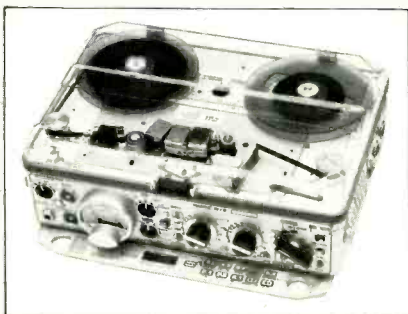

Post another advance in recording technology for Nagra! The new IV-S TC incorporates unique Time Code circuitry which permits Time Code record/playback (via switch selection) of the five film or video SMPTE/EBU standards. What's more, there's an eleven key, slide-out, mini key-

board to enter or read data and check system operation, plus a seven segment, eight digit LCD readout. Of course, the recording quality, the functionality, are what you've come to expect from Nagra...just this side of perfect. Send for specifications and details, you'll flip.

NAGRA KUDELSKI

"A PASSION FOR PERFECTION"

NAGRA MAGNETIC RECORDERS, INC.

East Coast
19 West 44th St. Room 715
New York, NY 10036
(212) 840-0999

West Coast
1147 N. Vine St.
Hollywood, CA 90038
(213) 469-6391

See us at Booth #105 AES NY Hilton

Circle 192 on Reader Service Card

Thomson LGT 5 kW transmitter :

COMPACT KNOW-HOW

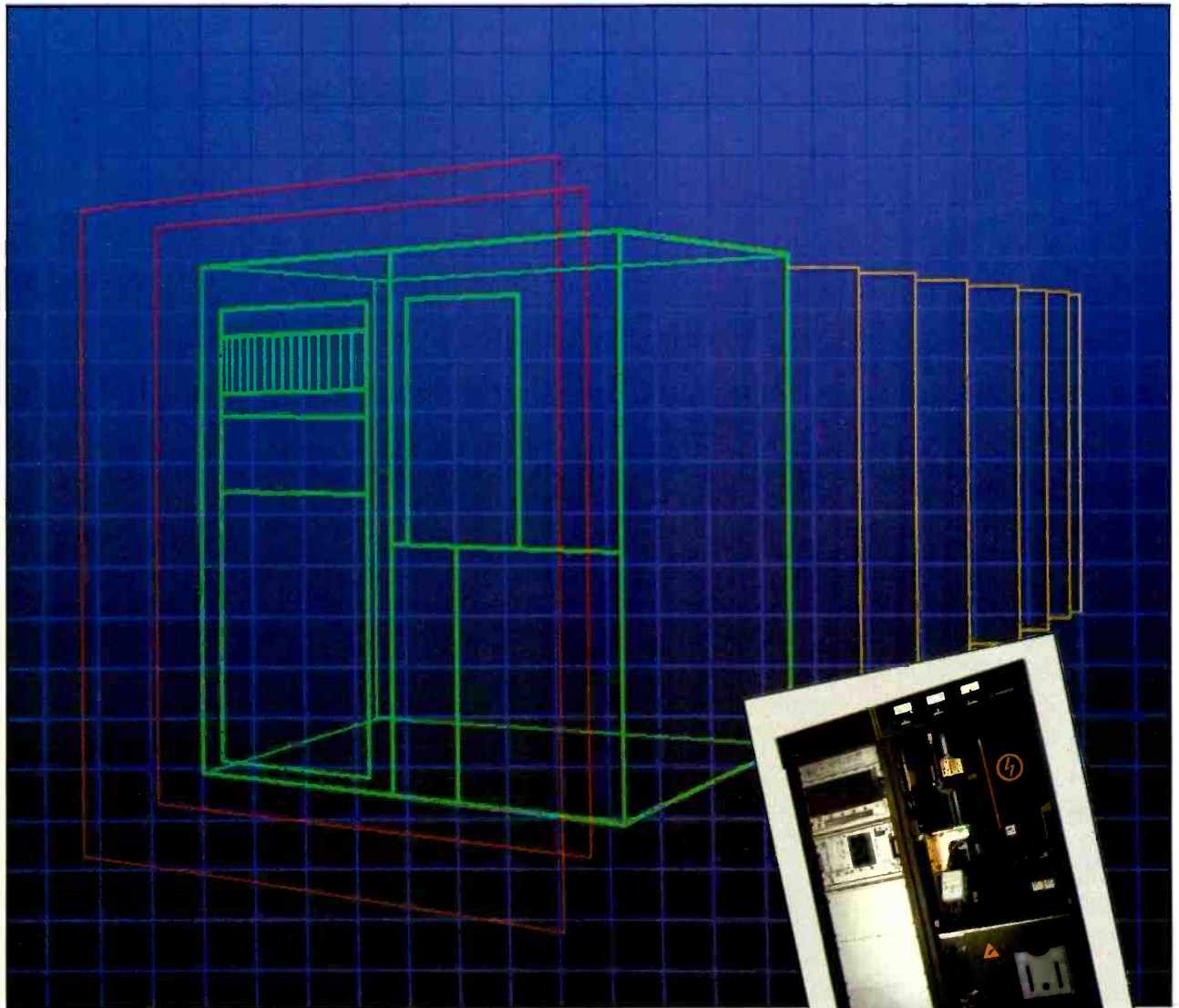

LGT, with the latest of its 5 kW UHF transmitters, the TRE 8510, offers you the following features :

High Profitability due to its competitive price, low floor area, low maintenance costs, and considerable energy saving through the use of a single very high efficiency TETRODE.

Enhanced Performance - this new transmitter, designed to meet the requirement of all new systems (MAC D, dual sound and videotext), uses a surface wave filter (SAW), a fixed group delay time corrector, precision off-set and a wide band configuration with optimised redundancy.

Improved Maintenance thanks to the use of a single air cooled tube, all the sub-assemblies being accessible from the front and a configuration specially designed to operate in Passive or Active Reserve Mode.

THE BEST POSSIBLE SIZE / EFFICIENCY

 **THOMSON-LGT**

LABORATOIRE GÉNÉRAL DES TÉLÉCOMMUNICATIONS
51, boulevard de la République / BP 51 / 78401 Chatou Cedex / France. Tél : (3) 071 92 60.

THE CRL MONEY MACHINE.



Introducing: The New CRL "Model A"

Now that the FCC has relaxed the rules pertaining to SCA use, your station can benefit from this new income source. Last year CRL introduced the SCA 300 that vastly improved the loudness and quality of background music services. But we found that many of our customers were using them for paging and were excited about the results they obtained.



There was no main channel interference and coverage was excellent. As a result, the CRL SCA 300 has become a "hot" new product. But here at CRL we are always looking for ways to make our products even better. So we are proud to announce the "MODEL A."

The CRL SCA 300A offers improved performance and some new features. The MODEL "A" will accommodate a wide range of telemetry and digital signals. There is a rear panel RS 232 connector as well as a standard BNC connector to allow insertion of digital or FSK signals directly into the modulator.

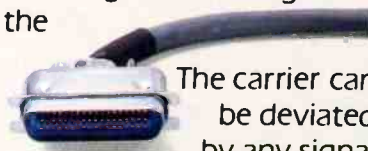

The carrier can be deviated by any signal from DC to 30 kHz with excellent linearity, low distortion and exceptional frequency stability.

Chances are, you'll find the "MODEL A" perfect for your application. We would love to talk with you about it. Better yet, we will be happy to arrange our famous two week trial. Just call Bob Richards at 800-535-7648. We'll do the rest.



Circuit Research Labs, Inc.

2522 W. Geneva Drive ■ Tempe, Arizona 85282

800-535-7648 ■ 602-438-0888

Circle 173 on Reader Service Card

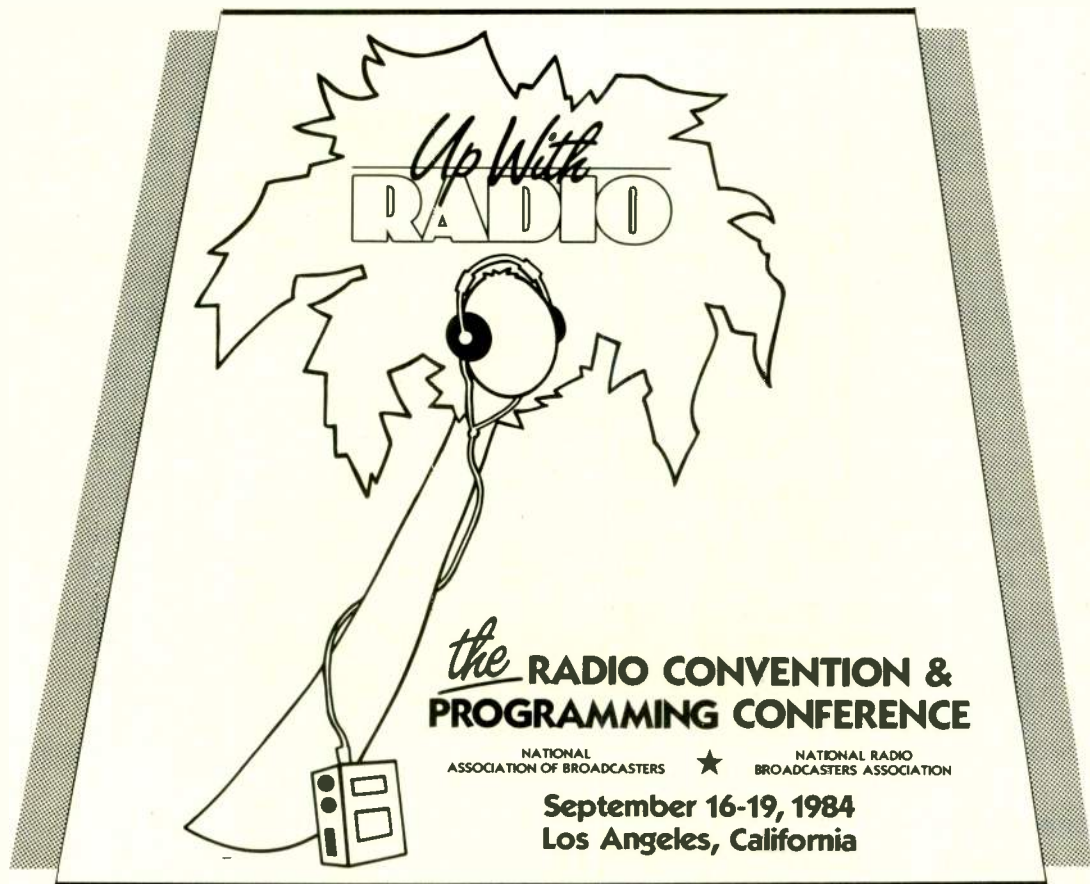

The Radio Show

"If you can't beat 'em, merge." Such is the reasoning that has led to the first Radio Convention and Programming Conference, being held this month from the 16th to the 19th in Los Angeles by the NRBA and NAB. The Radio Convention and Programming Conference, RCPC as it is called, will be the first major all-radio show with exhibits and sessions for engineers, programmers, managers, and sales people alike.

A special feature of this show, one which many people are looking forward to, will be the ability to mix with other departments of radio stations and learn their problems and languages.

The RCPC is expected to include around 125 exhibitors and 65 sessions (see lists), with hospitality suites opening their doors all during the show. Bob Hallahan of the NAB says he expects attendance to be up, and Tom McCoy of the NRBA says this year's show will feature "more exhibitors, more hospitality suites, and more people." He reports that a third exhibit floor had to be added to handle the increased number of booths. Engineering-oriented attendees will be staying at the Bonaventure Hotel where the exhibits will be located, and programmers will be at the Biltmore. Sessions will be held in both hotels.

Broadcasters and exhibitors planning to attend the radio show say they are looking forward to this new arrangement, and that they expect the new show will attract more numbers.

Broad issues

Bringing together traditionally separate engineering, management, and programming interests will prove once and for all that there's more to running a radio station these days than individual departments working alone can accomplish.

"During the past few years, the sound of a radio station has had to get better," observes Wilford Smith, head of engineering for the Greater Media broadcasting group, who will himself be attending. "Broadcasters now have to concern themselves with the psychological effects of their over-the-air sound. You have to know the right and wrong ways to affect your quarter-hour listenership." Thus he finds that engineers have to know how to help programmers, and conversely programmers need to become more aware of technology coming on the market, such as "production aids and new studio equipment that makes life easier for on-air talent."

Smith says he expects a "more exciting and dynamic" show since it will be the preeminent radio gathering. The main NAB show will not lose its attraction, he feels, since the distinctions between radio-only and television are "blurring." But he does look forward to the RCPC as a less hectic forum in which programmers and engineers can learn more about each other's problems.

For programmers, "the whole key to being successful is

getting new ideas," says Chris Witting, program director at KDKA (AM) in Pittsburgh, who will also be attending. "At this show I can count on finding at least a couple of new ideas." He thinks the RCPC's new arrangement should help in gaining the necessary broad perspective, which is a matter of "getting outside your own market." In fact, his only complaint with the new show is that he'd like to see it held somewhere in the east.

Among the many exhibitors that will be setting up at the show, Toby Arnold and Associates, a syndicator and music library from Dallas, feels that the combined conference has been needed for several years. Not having to choose between two shows, says James Kerr, national sales manager, will create more opportunity for all radio people and will allow both associations' members to attend.

Joe Novak, sales engineer for Delta Engineering of Alexandria, VA, agrees, and points out the programming and engineering cannot be "segregated" in the smaller markets. Both exhibitors expect to see more traffic at the RCPC than at previous shows.

Like some other companies, Broadcast Audio of Rancho Cordova, CA has found past attendance at both conventions to be weak, but this year Dave Evans, CEO, is "quite excited." NRBA has the best seminars already, he says, and this new arrangement will create a more attractive event for the radio community.

Expanded sessions

In addition to more exhibitors, the RCPC will feature an expanded sessions list. Besides the many specialized topics, there will be sessions pulling in people from separate departments, such as a management/programming/sales breakfast, grouped by market and format, or the SCA session for management and engineering. There will also be seminars tailored for those with specific markets and formats. NRBA's Tom McCoy predicts that broadcasters will have to make some "hard choices" over which sessions to attend.

Here are some other events planned for the RCPC:

Industry Leaders—Discussions with Kent Burkhardt, Ralph Guild, Gary Stevens, and others.

Computer Fair—Hard and software for research, logging, and billing.

Production Lab—Two hands-on workshops covering the latest equipment and techniques.

RCPC SESSIONS

Saturday, September 15

12:00am-5:00pm Registration Opens

Sunday, September 16

9:00am-5:00pm Registration Opens

12:00pm-5:30pm Exhibit Hall Opens

1:00pm-3:30pm Radio Labs:

Production, Legal, Consultants, Computer, Technical, Instant Book Analysis, Minority Broadcast Seminar, Daytimers Clinic

3:30pm-5:30pm Opening General Session with "Up With People"

5:30pm-7:00pm Radio Under the Stars, poolside cocktail party

7:00pm-9:00pm Engineering Rap Session

7:00pm-11:00pm Hospitality Suites

Monday, September 17

7:30am-8:45am Syndicators/Program Producers Breakfast

8:00am-5:00pm Registration Opens

8:00am-9:00am Radiorobics with Jayne Kennedy

9:00am-9:45am General Session

10:15am-11:45am Sessions:

Managing a Large Market AM Station To Success (*Management*)

In Search Of New Dollars (*Sales*)

SCAs Now! (*Management/Technical*)

Hit Radio—The Hot Format Of '84 (*Programming*)

The Newsroom After Deregulation (*Programming*)

And the Winner Is . . . (*Promotion*)

Network Panel (*Programming/Management*)

10:30am-7:00pm Exhibit Hall Open

11:45am-12:15pm Cash Bar

12:15pm-2:00pm Luncheon

2:30pm-3:45pm Sessions:

Writing the Great American Radio Budget (*Management*)

Changing Trends In National Business For Small Markets (*Sales*)

Selling Sports (*Sales*)

Meet the FCC (*Technical*)

Emotion vs. Science: Music Research (*Programming*)

Non-Rated Markets: Who's Listening & How To Prove It (*Programming*)

"Selling" Your Station: Marketing Through Other Media (*Promotion/Programming*)

4:00pm-5:15pm Sessions:

Managing a Small Market AM Station To Success (*Management*)

Developing Dollars Together (*Sales*)

Selling Special Stations (*Sales*)

Upgrade-Downgrade: 80-90 And Beyond (*Technical*)

The New Ratings Game: Trend Without Trauma (*Programming*)

Community Involvement . . . More Than Just an Obligation (*Promotion/Programming*)

Adult Contemporary Format Room (*Programming*)

5:30pm-7:00pm Wine & Cheese Party

7:00pm-9:00pm Field Trip to L.A. Radio Stations

7:00pm-11:00pm Hospitality Suites

Tuesday, September 18

7:30am-8:45am Sessions:

Radio Station Critique (*Programming*)

PDs That Sell: Fast Becoming a Reality (*Programming*)

There's More To a Wire Service Than News (*Management/Sales*)

continued on next page

AM Stereo Without Compromise



C-QUAM[®] AM Stereo System by Delta Electronics, Inc. FCC Type Accepted

Delta Electronics, Inc. introduces the ASE-1 AM Stereo Exciter and ASM-1 AM Stereo Modulation Monitor: FCC type-accepted C-Quam System transmission equipment for the AM Stereo broadcast market. C-Quam is the *Compatible* Quadrature Amplitude Modulation system developed by Motorola, Inc. C-Quam is the system of choice for more than 70 U.S. stations plus additional Canadian stations. Users range from kilowatt day-timers to full-time network flagships. These stations report enthusiastic response from listeners using multimode and full C-Quam stereo receivers as well as typical monophonic receivers. The key is compatibility without compromise. All listeners, stereo and mono, receive a clear signal with low distortion. Delta's twenty-year leader-

ship in the field of broadcast instrumentation solidly backs this technological advance.

The proliferation of receivers from GM's Delco Electronics, Inc., MacIntosh Labs, Sherwood Electronics, Chrysler Corporation, Concord Electronics, Samsung Electronics and others not yet announced, is creating a sizeable C-Quam audience. With the outstanding performance of this equipment, you can be sure that the audience will *stay* tuned to your Delta C-Quam AM Stereo transmission system.

For additional information, contact Bob Bousman at (703) 354-3350.

C-QUAM is a registered trademark of Motorola, Inc. Manufactured under license from Motorola, Inc.

DELTA ELECTRONICS

5730 General Washington Drive, Alexandria, Virginia 22312
Telephone: 703-354-3350 • TWX: 710-832-0273 • Telex: 90-1963

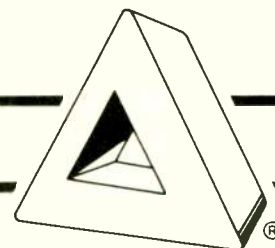

Circle 174 on Reader Service Card

Selling the Farm (*Sales*)
 Co-Op Is Easier Than You Think (*Sales*)
 Finding and Qualifying Engineers (*Technical*)
 The Sales Meeting (*Sales*)
 9:00am-10:15am Sessions:
 I'll Tell You Why I DON'T Use Radio
 (*Management/Sales*)
 Acquisition 101: Is Owning a Station In Your Future?
 (*Management*)
 Seven From the Street (*Sales*)
 Alexander Graham Bell Never Would Have
 Dreamed It (*Technical*)
 Music Managers: a Talk With Label Executives
 (*Programming*)
 News/Talk Format Room (*Programming*)
 The Radio Triangle (*Programming/Management*)
 10:30am-11:45am Sessions:
 I'll Tell You Why I DO Use Radio
 (*Management/Sales*)
 RAB Media Presentation (*Sales/Management*)
 Washington Update (*Management*)
 AM Stereo (*Technical/Management*)
 Format Compression: Why Stations Are Changing
 Formats (*Programming*)
 News And Public Affairs (*Programming*)
 Country Format Room (*Programming*)
 Urban Format Room (*Programming*)
 10:30am-6:00pm Exhibit Hall Open
 11:45am-12:15pm Cash Bar
 12:15am-2:00pm Luncheon With Howard Cosell
 2:30pm-3:45pm Sessions:
 "Collectables" (*Management*)
 Psychic Income—People Work For More Than
 Money (*Management*)
 Engineers' Survival (*Technical*)
 Marketing Your Station To the Advertiser (*Sales*)
 What Now, FCC? (*Management*)
 Managing a Small Market AM Station To Success
 (*Management*)
 Programming To Succeed: Is It the Talent Or the
 Station? (*Programming*)
 How To Do Your Own Research
 (*Programming/Management*)
 The Balance Act: Sales vs. Audience Promotions
 (*Programming/Promotion*)
 Beautiful Music/Nostalgia Format Room
 (*Programming*)
 4:00pm-5:15pm Sessions:
 AM Winners—Large Market (*Programming*)
 AM Winners—Small Market (*Programming*)
 Music Video (*Programming*)
 Programming Basics (*Programming*)
 AOR Format Room (*Programming*)
 CHR Format Room (*Programming*)
 Spotting Poison Ivy In the FCC Underbrush
 (*Management*)
 Selling Older Demographics (*Sales*)
 Selling Younger Demographics (*Sales*)
 Test Gear Workshop (*Technical*)

Acquisition 401: New Approaches To Financing
 And Acquiring Stations (*Management*)
 5:00pm-6:00pm Industry Leaders Probe Radio's
 Future
 6:30pm-7:30pm Pre-Concert Reception
 7:30pm-9:00pm Concert
 7:00pm-11:00pm Hospitality Suites

Wednesday, September 19

7:30am-10:00am Breakfast Roundtables
 (Management/Sales/
 Programming)
 8:00am-10:00am Field Trip To Wold Communica-
 tions (Technical)

CONVENTION EXHIBITORS

Exhibitor*	Booth #	Product/Service
The Ad Team	1324	Promotion
All Star Radio	1418	Programming
Allied Broadcast Equipment	2022	Production Eqpt.
American Broadcast Intl.	3003	Programming
American Image Productions	1117	Programming
Animation/Plus	1419	Promotion
Aphex Systems	1400	Production Eqpt.
Arbitron Ratings	1118/1219	Ratings
Toby Arnold & Assoc.	1121	Programming
Arrakis Systems	3005	Production Eqpt.
Associated Press 2B System	1007 1324	News Service Production Eqpt.
Barrett Associates	1404	Info. at show
Belar Electronics	3001	Transmission
Birch Radio	2007	Ratings
Broadcast Audio	1326	Production Eqpt.
Broadcast Cartridge	1426	Production Eqpt.
Broadcast Electronics	1104	Production Eqpt., SCA, Transmission
Broadcast Music, Inc.	1112	Music Licensing, Programming
Broadcast Programming Intl.	3031	Programming
Cablewave Systems	1208	Transmission
Capitol Magnetic Products	1307	Production Eqpt.
CBS Radio Stations News	1005	Programming
CBSI-Custom Business Sys.	1124B	Business Computers
Century 21 Programming	1133	Programming
Cetec	3019	Production Eqpt.

continued on next page

FUJINON'S revolutionary 2-door zoom lens.

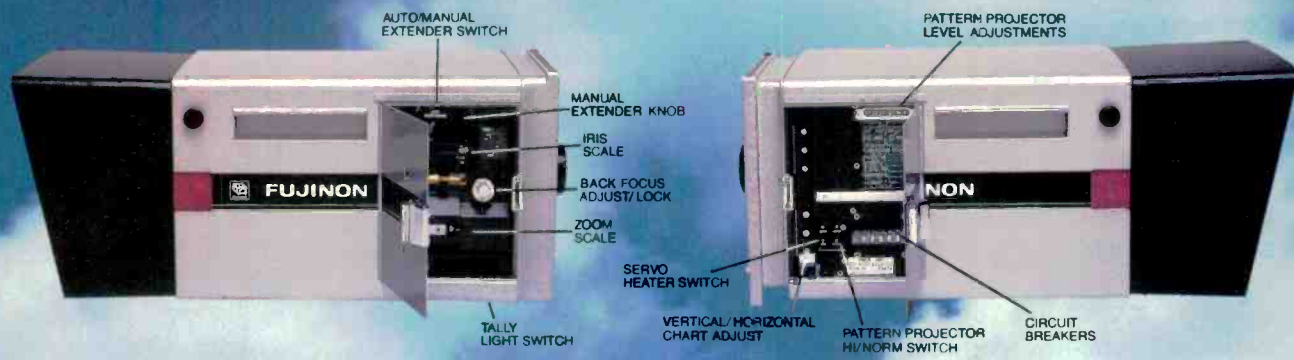

It works the way you do.

FUJINON's new 17X studio zoom will permanently change the way you use and feel about a lens. More than refining the studio zoom, FUJINON has revolutionized it to give you greater control, flexibility and efficiency than ever before.

Downtime for adjustments and repair is drastically reduced. And the need to remove a shroud is virtually elimi-

nated. For instant access to all important adjustments, just open one of the two doors.

The new 17X zoom incorporates more "FUJINON firsts" than any lens in our history. For example, you can pre-set limits on the zoom range to match the lens' outstanding ramping characteristics to the lighting levels of every production. (If necessary,

you can still override the limit from the pan bar.) To change the slow/fast zoom speed, you do it on the new pan bar zoom control instead of somewhere inside the lens. You also have the option of adjusting servo focus and zoom control tension—to get the exact "feel" you want.

With the new 17X studio zoom, every major component is modular to

make user servicing a practical reality.

FUJINON's new 17X zoom is the first generation studio lens of the future. And it's here, now.

For more information on the P17X16.5ESM studio zoom lens and other fine FUJINON products, contact the FUJINON office nearest you.

FUJINON INC.
672 White Plains Road
Scarsdale, NY 10583
(914) 472-9800
Telex 6818115

FUJINON INC.
2101 Midway
Suite 350
Carrollton, TX 75006
(214) 385-8902

FUJI OPTICAL SYSTEMS, INC.
118 Savarona Way
Carson, CA 90746
(213) 532-2861
4855 Atherton Avenue
San Jose, CA 95130
(408) 866-5466

Circle 196 on Reader Service Card



FUJINON

Colorgraphics Systems	1029	News Computers	McCurdy Radio	1011	Production Eqpt.
Columbine Systems	2016/2117	Automation	McMartin	1211	Antennas, Production Eqpt., SCA, Transmission
Communication Graphics	1021	Promotion	Meridian Communications	1412	Info. at show
Compucon	3020	Consultants	Miller, Kaplan, Arase	1025	Info. at show
Computer Concepts	1215	Automation	Mini-Bingo, Peter Powel	2003	Promotion
Comtech Data	2112	Transmission	Modulation Sciences	1314	SCA
Concept Productions	1012	Programming	Motorola	1212	Transmission
Continental Electronics	3010	Antennas, Production Eqpt., SCA	Music Director Programming	1308	Programming
Copley Radio Network	1414	Programming	Network Production Music	3037	Programming
Creative Works	1413	Programming	New World Audio	1422	Programming
Delta Electronics	1204	Production Eqpt., Transmission	Newsmaker Interviews	1316	Programming
Dorrough Electronics	1233	Production Eqpt.	Pacific Recorders & Eng.	2008/2109	Production Eqpt.
Eagle Syndication	1408	Programming	Potomac Instruments	1311	Test Eqpt.
The Fantasy Music Group	1320	Programming	Prismagraphics	2116	Promotion
Ficon	3006	Production Eqpt.	Public Interest Affil.	1322	Programming
Fidelipac	2002/2103	Production Eqpt.	Radio Arts	2017	Programming
Film House	2021	Info. at show	Radio Computing Services	1304	Info. at show
Gentner Engineering	2104	Production Eqpt.	Radio Syndication Network	1119	Programming
Gotham Audio	3013	Production Eqpt.	Radio Systems	1110	Production Eqpt.
Hammond Signal	1231	Info. at show	Register Data Systems	1310	Business Computers
Harris Broadcast	1004	Antennas, Pro- duction Eqpt., Transmission	Sacred Heart Program	1210	Programming
Harrison Systems	1421	Production Eqpt.	Satellite Music Network	1116	Programming
Howe Audio Productions	1407	Production Eqpt.	Schafer World Comm.	1206	Info. at show
International Tapetronics	1224	Production Eqpt.	Sea-Tex Div., Si-Tex	3004	Info. at show
Jefferson-Pilot Data	1309	Business & News Computers	Shane Media Services	2120	Promotion
The Jingle Machine	1411	Promotion	Soundcraft Electronics	3012	Production Eqpt.
Johnson Electronics	2102	Antennas, SCA	Spantel (REACH)	2013	SCA, Transmission
Kahn Communications	1113	Transmission	Spotwise Productions	3002	Programming
Kalamusic	3009	Programming	Strata Marketing	1020	Promotion
Kwikee Radio Broadcast	3030	Programming	Studer Revox America	3034	Production Eqpt.
Leonard Sloan & Assoc.	1410	Info. at show	Tapscan	2118	Production Eqpt.
LPB	1200	Production Eqpt.	TFT	1213	SCA, Transmission
3M	1306	Production Eqpt.	Thomson - LGT	1016	Transmission
The Management	2011	Business Computers	TM Communications	3021	Programming
Marcom	1035	Production Eqpt.	Transmedia Intl.	3014	Info. at show
Market Buy Market	1018	Promotion	United Press Intl.	1124A	News Service
Marketron	1013	Automation, Business Computers	U.S. Advertising Svce.	3018	Promotion
			Urban Decision Systems	3000	Info. at show
			U.S. Tape & Label	1106	Promotion
			USA Foundation/"Fallout"	1428	Programming
			Weather Services	1027	Programming
			Wold Communications	1207	Antennas, SCA, Transmission
			York Radio Network	3017	Programming

*In addition to these listings, many companies will maintain hospitality suites, the locations of which will be available at the show.

ONE BOX.

The MCX-106 Powered Recording Mixer gives you more functions than any other portable system.



WE STARTED WITH THE BASICS.

That means 6 input channels, each with trim control, LED peak indicator, and 3-band EQ. . . a stereo tape deck with dbx noise reduction. . . compression circuitry with an LED indicator. . . a full-octave graphic equalizer with a bypass switch. . .

. . . and so you can keep track of what's going on, there's a headphone monitoring system and fluorescent, assignable bargraph meters.

But that's just for starters.

MORE THAN A MIXER.

Four mixers, in fact. The MCX is an independent on-stage monitor mixer.

It's an effects mixer. Every channel has its own post reverb/effects send.

It's a main house mixer, with an extensive patch bay and an assignable auxiliary input.

And finally, it's a stereo recording mixer. A full-function, microprocessor-controlled cassette deck lets you record live performances, mixdown from multi-track, copy from masters, and do voice-over taping or sound-on-sound with the "pannable" aux input.

YOU CAN TAKE IT WITH YOU.

The MCX isn't another home-recording "ministudio." With its built-in, 300W power amp and tough road enclosure, it's a go-everywhere, do-

everything record/mix/playback system.

Take the MCX out on-the-road to record a live performance, then into the studio to create a demo tape. Or use it to *simultaneously* mix pre-recorded material with live singing tracks.

The MCX belongs wherever pro-quality audio is important.

FREEDOM OF CHOICE.

Employ the components of the MCX in one integrated system, or use them as separate and independent tools of production. Or put the MCX to work with other audio gear, using the patch bay for all your

re-routing techniques.

The MCX-106 provides a sound foundation for your musical recording project — your live

performance — your multimedia presentation — your A/V training film — or your video post-production strategy.

In just one easy-to-use, easy-to-move box.

Find out how much more the MCX-106 can do for you; call or write for our Applications Guide and complete technical data:



TOA Electronics, Inc., 480 Carlton Court
South San Francisco, California 94080
(415) 588-2538

In Canada: TOA Electronics, Inc.
10712-181 Street
Edmonton, Alberta T5S 1K8 (403) 489-5511

© 1984 TOA Electronics, Inc.
dbx is the registered trademark of dbx, Inc.

ADVERTISER'S INDEX

Use Reader Service Card on Facing Page ►

Manufacturer	Page No.	Circle No.	Manufacturer	Page No.	Circle No.	Manufacturer	Page No.	Circle No.
Abekas Video Systems	44-45	128	Gerstenslager	20	111	Orban Associates, Inc.	26	116
ADM Technology, Inc.	C-2	100	Harris Corp.	25	115		125	170-
A.F. Associates Products	123	181		129	190			172
Alden Electronics	60	142		88	162	Otari Corp.	33	122
Alpha Audio	84	161		119	179	Pacific Recorders & Engineering Corp.	82-83	
Ampex AVSD	65		Harris Video Systems	53	134	Paco Film	68	146
Ampex MTD	30	119	Harrison Systems	11	106	Panasonic/Matsushita	91	165
Antek	115	177	Hubcom	4	102	Panasonic/Ramsa	27	117
Ant Telecommunications	32	121	Ikegami Electronics USA, Inc.	47	129	Philips Television Systems, Inc.	70-71	150-
Auditronics, Inc.	92	166		97	168			154
Belar Electronics Lab, Inc.	56	137		99	169	Potomac Instruments	31	120
Bosch (Corporate)	1	101		101	184	QSI Systems, Inc.	124	182
Broadcast Audio Corp.	122	188	International Tapetronics Corp.	72	148	Quanta Corp.	59	141
Bryston Manufacturing	124	183	Kavouras, Inc.	57	139	Ramko Research	90	164
Cablewave Systems	36	123	K & H Products, Ltd.	100	193	RCA E/O	39	125
Camera Mart, Inc.	19	110	Leader Instruments	21	112-	Sharp Electronics Corp.	120	180
Canare Electric Co., Ltd.	52	132			113	Shure Bros., Inc.	127	187
Capital Magnetic Products	58	140	LPB, Inc.	89	163	Sigma Electronics	52	133
Cetec Vega	41	127	L-W International	126	185	Sonar Radio Corp.	18	109
Chyron Corp.	81	157	3M/Magnetic Tape Div.	14-15		Sony Broadcast	2-3	
Cipher Digital	24	114	3M/Pro-AV	66	144		34-35	
Continental Electronics Mfg Co	67	145	Maxell Corp. of America	7	104	Sony Tape	22-23	
Countryman Associates	85	159	McCurdy Radio Industries	C-3	191	Soundcraft Electronics	116	178
CRL Audio	104	173	MCI/Quantel	69	147	Studer Revox America, Inc.	76-77	155
Crosspoint Latch Corp.	54	135	Merlin Engineering	38	124	Telex Communications	86	160
Peter Dahl Co.	100	194	Midwest Corp.	8-9	105	Thomson-CSF Broadcast	49	130
Delta Electronics	107	174	Minoita Corp.	40	126	Thomson-CSF/DTE	128	175
Dictaphone Corp.	75	149	Moseley Associates, Inc.	5	103	Thomson-CSF/LGT	103	195
Digital Effects	50	131	Motorola, Inc.	28	118	TOA Electronics	111	176
Digital Video Systems	62	143	Nagra Magnetic Recorders, Inc.	102	192	Vision Fund of America	126	186
Dubner Computer Systems, Inc	55	136	NEC America, Inc.	13	107	Ward-Beck Systems, Ltd.	C-4	
Editel	56	138		122	189	Wheatstone Broadcast Group	95	167
Fuji Photo Film USA, Inc.	17	108	Rupert Neve, Inc.	87	158			
Gotham Audio Corp.	79	156						

The Voice of America is offering you the challenge and the opportunity to put your engineering skills to practical use while designing and updating a new, worldwide broadcast communications network. We need you to help us modernize our 10 overseas relay stations; construct new stations at locations abroad; and upgrade our domestic facilities — from the ground up and the air down.

The Voice of America is the international radio broadcasting service of the United States. It brings news, commentaries, and features in 42 languages to people around the world who need and want information. We are seeking skilled, experienced, degreed engineers and computer specialists who are prepared to make a significant contribution to the lives of millions of people.

There's no challenge like it in the world.



BUILD A BETTER VOICE FOR AMERICA



HF and MEDIUM WAVE SYSTEMS ENGINEERS

Experience required in short and medium wave antenna systems; high-power RF systems; RF propagation analysis; test & evaluation; integration and automation of broadcast networks; satellite communications systems; power generation systems; planning and advanced concepts; and facilities planning, design and evaluation.

COMPUTER APPLICATIONS ENGINEERS

Backgrounds should include scientific/engineering applications programming; interactive graphics/CAD; DBMS/data collection/display; computer operations/OS/utilities/Nets; broadcast/relay system automation — HW/SW; and remote control/sensing/data reporting.

STUDIO ENGINEERS

Candidates should be familiar with large broadcast studio design/acoustical analysis; master control systems and automation; and automated recording, processing, and retrieval systems.

PROJECT MANAGEMENT

Experience in the design, construction, implementation, and acceptance test of major radio broadcast facilities or other facilities housing major electronic systems. Positions also require establishing construction standards and specifications; test plans and evaluation of project acceptance process; applying CPM and PERT network schedules; applying cost benefit analysis, life cycle costing, and other economic analysis techniques; and developing configuration control systems for processing changes. BSEE desired. Advanced degree preferable.

OPERATIONS

Candidates should have experience in network operations and control; HF Propagation, analysis and prediction; station management for domestic and overseas locations; and logistics management.

The wide ranging benefits of Federal employment are enjoyed by all Voice of America personnel. They include salaries commensurate with experience (up to \$65,642), liberal vacation and sick leave program, health and life insurance for you and your family.

We would like to hear from you. We invite qualified professionals to submit applications for these uniquely challenging and rewarding positions. Write to us. You can expect an early response.

Voice of America

Director of Engineering
Suite B-8
Post Office Box 1625
Washington, D.C. 20013

U.S. citizenship required, a thorough background inquiry may be necessary. Travel may be required for most positions.

Voice of America is an equal opportunity employer.
The Voice of America is part of the U.S. Information Agency

Circle 201 on Reader Service Card

ON YOUR SIDE ON TIME ON THE AIR!

Antek is on to something. A new alternative consulting system that provides a clear understanding of your market and all FCC regulations. Providing the answers you need in acquiring licensing. At less cost. In less time. And with greater efficiency.

Antek utilizes the most advanced software systems and a thorough knowledge of the industry to provide you the following:

- Location of transmitter sites.
- Frequency selection.
- Prediction of service area.
- Signal level calculation.
- Understanding the relationship between your potential site and existing sites.
- Necessary assistance in completing all required exhibits for FCC applications.

Antek will provide answers to all your questions concerning licensing. Project managers Jim Swayze and Kelley Stalder are accomplished experts, with over 10,000 applications accepted by the FCC. Combining the experience and knowledge to recognize your specific needs and to adapt their own capabilities to those needs.

Now is the time to consult Antek. With the establishment of the Docket 80-90 FM Drop-Ins, the FCC is authorizing over 1,000 new additions to the Table of Allocations. Antek is clearly your alternative to licensing and market consultation. Clearly on your side. And clearly capable of getting you on the air in the least amount of time.



Radio's newest and most innovative audio console features premium modular design with

- Internal cartridge sequencing*
- Remote control facilities*
- Multi-band equalization*
- 4-line telco mix-minus*
- Delay control sub-system*
- 4 stereo inputs with logic*
- 3 stereo and 1 mono outputs, fully metered*
- 10, 16 and 24 input mainframes*
- Intermediate pricing*

SAC is a product of Soundcraft, the international audio company of Los Angeles, New York, Montreal, London and Tokyo. See SAC at the RCPC or send for our brochure.

*You are invited
To the coming out party
Of the year.*

*The Stereo Air Console
by
Soundcraft*

*Shall debut at the
Radio Convention
and
Programming Conference,
Booth 3012,
September 16 thru 19,
in Los Angeles*

SOUNDCRAFT broadcast

a division of Soundcraft Electronics, Inc.

1517 20th Street
Santa Monica, CA 90404
213-453-4591

Circle 178 on Reader Service Card

interpreting the **FCC** rules & regulations

Renewal Expectancy in the "Age of Deregulation"

by Harry Cole, FCC Counsel

In June, the U.S. Court of Appeals in Washington handed down its long-awaited decision in the case of Simon Geller, the licensee of station WVCA-FM, Gloucester, Massachusetts. The court sent the case back to the FCC for further consideration, but not before it took the time to shed some light on its views on the subject of "renewal expectancy." That topic, obviously, is (or should be) of primary interest to every broadcaster interested in getting his or her license renewed. Accordingly, we will dedicate this month's column to a review of that case, and the significance of the court's decision to the day-to-day life of most broadcasters.

The focus of this proceeding was an individual named Simon Geller, who, for approximately 20 years, has been the licensee of WVCA. He has run it himself, acting as operator, announcer, technician, and salesman. Apparently a maverick of sorts intent on marching to (or at least broadcasting) the beat of a different drummer, Geller has consistently chosen not to offer any of the standardized forms of programming. Instead, he has restricted his programming to symphonic music, which he has usually provided during more than 99 percent of his time on the air. His dedication to symphonic music has led to the exclusion of other types of music, and, more importantly, to the exclusion of virtually all nonentertainment programming (such as news and public affairs). Therein lies the rub.

The importance of nonentertainment

In his 1975 renewal application, Geller still proposed to dedicate less than one percent of his normal broadcast schedule to nonentertainment programming. Enter Grandbanke Corporation, a company which filed an application against Geller's 1975 renewal application. Grandbanke, owned by individuals already owning another broadcast station, proposed approximately 28.7 percent nonentertainment programming. The two applications were designated for a comparative hearing before an administrative law judge, who concluded that Geller deserved a renewal. The full Commission, as it turned out, did not agree. In June, 1982, it denied Geller's renewal application and granted Grandbanke's application.

Central to the Commission's decision was its conclusion that Geller's past broadcast performance, lacking as it was in nonentertainment programming, did *not* merit any renewal expectancy, which would entitle it to an advantage in the comparative renewal hearing against Grandbanke. In other words, because he had failed to broadcast news and/or public affairs aimed at his local audience, Geller was accorded the mere status of a new ap-

plicant (rather than a renewal applicant), a status which, in the greater scheme of things, is far from desirable for an incumbent licensee. The Commission went on to find that even though Grandbanke's principals own another broadcast station—a factor which would have otherwise represented a substantial demerit—Geller could claim only a moderate advantage as a result of this factor. This reduction in impact was based on the FCC's view that the "diversification" criterion governing comparative hearings is intended to increase the nature and amount of nonentertainment programming available. Geller's failure to provide any such programming, the Commission reasoned, meant that he could not claim credit for increasing the number of competing "voices" available to Gloucester listeners.

The Commission also found that, under the "integration" criterion, Geller did not deserve more than a little extra credit as a result of his full-time, single-handed operation of the station, since the operation of that station had proven to be less than what the Commission expected in the way of nonentertainment programming. Normally, personal involvement such as Geller's would have led to a substantial advantage.

Understandably enough, Geller appealed, challenging his loss of a renewal expectancy as well as the Commission's decision to give him diminished credit under the diversification and integration criteria. It was thought by some observers that the case would give the court a good opportunity to consider the question of renewal expectancy and to comment on the Commission's treatment of that question—and that it did. But, rather than criticize the Commission's treatment, the court upheld it, finding that Geller's demonstrated performance did *not* warrant any renewal expectancy. Significantly, the court found that, even under the FCC's scheme of deregulation—which imposes neither specific ascertainment obligations nor guidelines establishing minimum amounts of nonentertainment programming—licensees must still determine the major issues in their communities, and must still air programs directed at ascertained needs. Quoting the Commission's finding that Geller "broadcast no news, no editorials, and none of his [nonentertainment] programming was locally produced," the court agreed with the FCC's conclusion that Geller's previous service did *not* warrant a renewal expectancy.

All was not lost for Geller, however. With respect to the Commission's treatment of the diversification and integration criteria, the court was more sympathetic. It found that the FCC had departed from previous precedents—and common sense as well—in reducing

FCC RULES & REGULATIONS

Geller's diversification preference and, further, that the Commission's treatment of that point raised First Amendment questions. Similarly, the court concluded that the FCC had, in assessing the comparative value of Geller's integration proposal, failed to explain in sufficient detail precisely why it had done what it did. Thus, on these two bases the court sent the case back to the Commission for further consideration. The FCC may now reaffirm its earlier decision (although this time with more complete explanations), or it may reverse its earlier decision and decide that maybe Geller is not all that bad a broadcaster.

Irrespective of what the Commission does in the particular case of Geller, however, the court's opinion is now in the books. How does it affect other broadcasters? Well, it reemphasizes the need for all licensees to continue their efforts to remain familiar with the problems and needs of their respective communities of license, and to provide locally produced (or at least locally oriented) nonentertainment programming directed at those problems. It is obvious from the court's discussion that it is very comfortable with the notion that a licensee's right to claim a renewal expectancy should depend directly on the licensee's ascertainment efforts and the responsive nonentertainment programming arising from those efforts. The court made clear that its views in this regard had not been affected by the Commission's deregulation actions. And now that the court has given its seal of approval, the Commission may be somewhat reluctant to reconsider that notion in the near future. As a result, we should all get used to the idea that a failure to provide locally oriented nonentertainment programming may render a broadcast license open for successful challenge by a competing applicant.

Do not let it slide

The seriousness of this should not be discounted. As a result of the Commission's deregulatory program, it is possible, if not likely, that a number of broadcasters have let their nonentertainment programming slide somewhat. After all, radio deregulation has eliminated the need to undertake formalized ascertainment steps, and has removed the rule provision strongly suggesting that radio licensees provide certain minimum levels of nonentertainment programming. Additionally, radio licensees no longer have to maintain detailed program logs which would reflect the nature and amount of such programming. And even the license renewal application form no longer seeks any information concerning the applicant's programming practices. The FCC recently relieved television broadcasters of many of these regulations as well. Now, television licensees have most of the same freedoms from FCC oversight enjoyed by the radio industry. The clear, if inaccurate, inference which many may have drawn from this relaxed regulatory environment is that the Commission may no longer care about ascertainment or nonentertainment programming based thereon. But, as is apparent from the Geller case, that is clearly an incorrect inference. The Commission still does care about such matters and, even if it changes its mind on this score in the foreseeable future, it will have some heavy explaining to do before the court which has just expressly approved that approach.

In view of all this, broadcasters would be well advised to take a long hard look at their programming practices to see whether they really are providing their audiences with locally oriented nonentertainment programming responsive to the audiences' problems and needs. They should also check to make sure that they are, in fact, making some effort to determine what those problems and needs might be. Such efforts need not involve all the minutiae which characterized the Commission's ascertainment requirements at the height of the FCC's regulatory activism (in the mid-1970s). Current ascertainment efforts should include some regular, serious, affirmative attempts to contact representatives of the station's community of license who are likely to be knowledgeable about the community's problems and needs.

Keep records

Finally, broadcasters should be sure that they have some effective means of documenting all this. As you know, license terms are much longer now than they used to be—instead of three years, television license terms now run five years, and radio licenses last seven years. Thus, if your license renewal application in 1988 is challenged by a competing applicant, the entire license term from 1981 (for radio licensees) or 1983 (for television licensees) will be fair game during the comparative renewal hearing. It is not hard to imagine how difficult it would be in those circumstances to try, in 1989 or 1990 (*i.e.*, when comparative renewal hearings on renewal applications filed in 1988 would likely begin), to reconstruct six- and seven-year-old ascertainment and programming efforts without at least some contemporaneously prepared documentation. With that in mind, we suggest that you carefully review your operations to make sure that you have some routine record-keeping system designed to provide you with this ability. Such a system need not be particularly elaborate or detailed (like the Commission's former ascertainment and logging requirements for radio licensees); rather, they should be tailored to provide you with the information necessary to demonstrate the nature and extent of your ascertainment and programming activities. It would probably be best to design your system in direct consultation with your communications counsel, so that he or she can both contribute to its design and be aware of the particular aspects of your operation which will be reflected in your documentation.

As we have stated before, the age of deregulation may not be what it seems. Far from the freewheeling, "unregulated" industry which the present Commission occasionally conjures up in speeches and *obiter dictum* in its opinions, broadcasting remains a regulated industry, and broadcasters are allowed to operate only as long as they play by the rules established by the Commission. The difficulty with the renewal expectancy concept as it is evolving is that licensees are obviously under a definite obligation to ascertain and provide nonentertainment programming, but the Commission has not provided much, if any, specific guidance as to how one can satisfy that obligation. To an extent it has become a guessing game, a game which might be fun to play were one's license not at stake.

BM/E

Harris All-Solid-State SX Transmitters

Bring Back Your AM Listeners!

Contrary to what you may have heard, your "average" listener has a better-than-average knack for finding stations with a quality, transparent sound—even on a crowded dial. The lower your sound quality, the higher your audience tune-out.

Bring back those listeners with a Harris SX Series all-solid-state AM transmitter. Harris' exclusive Polyphase PDM modulation system provides a *discernible difference in sound*... a crisp transparency that virtually eliminates listener fatigue and compares with the best FM has to offer. The specs will show you why. On the SX-5, for example, Intermodulation Distortion (IMD) is less than 1%!

SX Series transmitters (available in 1, 2.5 and 5 kW) also offer diagnostic capability through a microprocessor-based, pushbutton information center. You get instant readings on vital parameters.

Solid-state design means you'll save up to 46% more power than with other transmitters currently in use. That's a plus you'll see immediately in lower power bills.

And Harris has designed the SX Series transmitters for optimum AM Stereo performance. Strict AM Stereo compatibility was a major design goal right from the start—not an add-on or an after-thought.

Make the investment in quality sound that can build and hold your listening audience. For more information on Harris SX Series AM transmitters, contact Harris Corporation, Broadcast Group, P.O. Box 4290, Quincy, Illinois 62305-4290. 217-222-8200.



HARRIS

Visit Harris Booth 1004 RC and PC Los Angeles Sept. 16-19

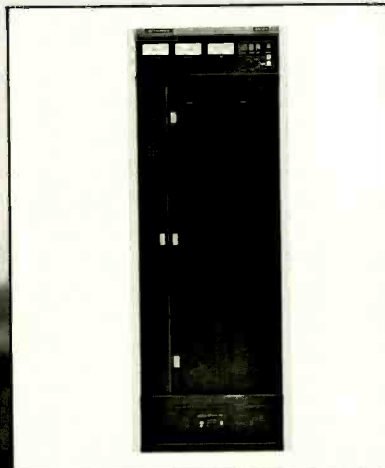

Circle 179 on Reader Service Card

"AFTER SCOUTING THE PROSPECTS, WE CHOSE THE CAMERA WITH THE BEST SHOOTING RECORD."

ROB DALTON, PRESIDENT AND GENERAL MANAGER, KAKE-TV, WICHITA



© 1984 Sharp Electronics Corp.

"At KAKE in Wichita, we're as demanding as they come. But let's face it. When you're Wichita's number one metro station, an ABC affiliate, and have a schedule as hectic as ours, you have to be. And when it came to buying new cameras last year, we made no exceptions.

To satisfy us, the units had to meet network standards and be Triax compatible. Plus they had to be able to take the abuse of being hauled in and out of our remote van, from the studio to the field, and still deliver brilliant quality shots. That's why we went with Sharp®.

From our four years of experience working with their XC-700 and XC-800 Saticon® cameras, we knew that Sharp cameras could take the punishment.

But what really sold us were the results we got when we tested out Sharp's Diode-Gun Plumbicon® XC-900D at a number of those 49 basketball games we produced last year. Of course Sharp's competitive price was an added incentive. But we would have bought the XC-900D anyway.

Now if your situation involves buying a new Plumbicon camera, I'd suggest the Sharp XC-900D. From what I've seen, it will go one on one with any camera on the market. And come out on top every time."

For a demonstration or more information, contact your local dealer or write Sharp Electronics Corporation, Broadcast Group, 10 Sharp Plaza, Paramus, NJ 07652. (201) 265-5548.

Saticon® is a registered trademark of NHK (Japan Broadcast Corp.) Plumbicon® is a registered trademark of N.V. Philips.



**FROM SHARP MINDS
COME SHARP PRODUCTS**

A/V EQUIPMENT, AUDIO, BANKING SYSTEMS, CALCULATORS, CASH REGISTERS, COMPUTERS, COPIERS, ELECTRONIC TYPEWRITERS, FACSIMILE EQUIPMENT, MICROWAVE OVENS, PROFESSIONAL/VIDEO CAMERAS & MONITORS, TELEVISIONS, VIDEO TAPE RECORDERS.

Circle 180 on Reader Service Card

broadcast EQUIPMENT

Ampex Unveils New VPR



Highlight at the Ampex IBC stand later this month, and again at the forthcoming SMPTE show in New York City in October, is the brand-new VPR-6, a one-inch Type C VTR with production capabilities in many ways the equal of the VPR-3, but with a price more like the current VPR-2B. Ampex stresses that although the 6 will eventually replace the 2B as the intermediate machine between the low-cost VPR-80 and the top-of-the-line VPR-3, it is infinitely more sophisticated than the current 2B model.

Heading the list of features is the inclusion of automatic scan tracking as standard in every unit. Together with the new TBC-6 time base corrector, optimized for the VPR-6's performance capabilities, the system price is \$12,500.

Other features are equally well thought out. There is, for instance, an automatic end-of-tape sensing mechanism which slows the rewind transports (achieving up to 500 inches per second in shuttle speed with viewable picture to 450 ips) to slow down when approaching the end of the reel, thereby avoiding both tape and head damage.

The scanner itself has been redesigned, and now features a brushless dc motor. The six scanner heads are individually replaceable, at a cost of approximately \$200 each. There is a

video confidence head, and, for the first time, an audio confidence head with only two frames delay between confidence playback and absolute sync.

The deck has an impressive list of audio features, including spot erase which permits erasing of even minute sound segments; an optional fourth EBU audio channel (for three full bandwidth audio tracks plus time code); high-quality stereo audio monitors built in; audio processing ports on the rear panel permitting easy connection with processing/noise reduction systems; and so forth.

Still another feature is the wide range of slow motion speeds, from full speed reverse to three times play speed, using a continuously variable wheel. In top frame, the VPR-6 offers the option (front panel selectable) of either frame or repeated field playback.

Editing capabilities are extensive, the most impressive of which is edit optimization which automatically rephases the scanner tach to the timing of the on-tape videosegment and therefore prevents color phase mismatches when using different sources.

All of these features are packaged into a console which is not only attractive, but extremely easy to maintain, with a pull-out chassis that permits instant access to the large computer boards which make up the control portion of the deck. Again, a completely new design approach has been taken, with edge lights and switches on the boards themselves held to an absolute minimum. Virtually all control of all functions is available through the front control panel, which features both dedicated keys and a keypad for entering numerical data (the system handles both SMPTE/EBU time code and digital timer information at the present; a VITC time code generator/reader is on the way).

Perhaps the best feature of all is that the VPR-6 is immediately deliverable.

**For More Information
Circle 225 on Reader Service Card**

Cart Player Unveiled by Pacific Recorders

Pacific Recorders has introduced the Micromax, a compact reproducer that is fully compatible with the company's Tomcat cart system. The machine incorporates an advanced transport design, wherein both the capstan motor and pinch roller system operate under DC servo control. The benefits of this approach are extremely low wow and flutter specs, reduced heat generation, rapid start and stop characteristics, and an overall reduction in the size of the complete package.

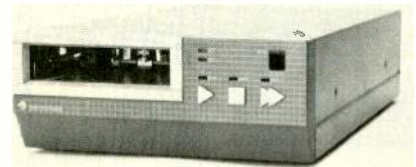

Micromax features the Maxtrax wide-track tape head format, which yields more tape signal and less tape noise. It also features a precision head mount and tape guide assembly, and an accurate, repeatable cartridge positioning system. The unit has active, balanced program outputs with -24 dBm capability, and high-speed recuing and CMOS logic with selectable replay lock-out option.

The reproducer also features user-settable LED deck number, and very low power consumption: seven watts running, six at idle. Micromax is priced at \$1445.

**For More Information
Circle 226 on Reader Service Card**

Multiplay CD Player from Technics

The SL-P15 is the latest programmable CD player from Technics. This player can load and program 51 CDs; up to 50 discs can be programmed while one is playing.

The player has two stereo channels, and features semiconductor circuitry with 12 original LSIs and ICs designed for compact disc reproduction. Major specs include: frequency response of

Presenting SYSTEM 12

Compact Broadcast Mixer



Our most popular audio console is the SYSTEM 12. With hundreds of these mixers in service around the world, it's no wonder they have an unequaled reputation for reliability and operator conveniences. P & G faders are now standard on all of our consoles; our special audio transformers are custom computer designed and not available from any other manufacturer. SYSTEM 12 is \$9,150.00 with 8 mixers — other consoles available with 5 to 20 mixing positions. WE SOUND GREAT!

**BROADCAST
AUDIO CORPORATION**

11306 SUNCO DR.
RANCHO CORDOVA, CA 95670
(916) 635-1048

Circle 188 on Reader Service Card

Independent Digital Audio Delay Up To 3 Channels?

**Call NEC Toll-Free
1-800-323-6656.**

AS-18 from NEC. A synchronizer with flexible delay and 16-bit quantization. Delivers audio-to-video compensation with any frame synchronizer. Or audio-only delay up to 12 seconds. Just call NEC toll-free. For a system that makes every second count.

NEC

IMAGINE WHAT WE'LL DO FOR YOU

NEC America, Inc., Broadcast Equipment Division
130 Martin Lane, Elk Grove Village, IL 60007
In Illinois 312-640-3792.

650-847

Circle 189 on Reader Service Card

EQUIPMENT

4-20 kHz; S/N of 96 dB or more; THD of 0.003 percent; and virtually no wow or flutter.



The SL-P15 is front loading with a motor-driven, slide-out compartment for disc loading. It has a multifunction fluorescent digital display that provides a numerical readout of the track number, playing time, and index number of the selections for the CD being played. The player also offers wireless remote control.

**For More Information
Circle 227 on Reader Service Card**

D-Streamer from R*Scan

The new D-Streamer is a solution to a problem: In most streaming data applications, only a fraction of incoming satellite data is needed. Typically, all data is printed and later sorted. This results in wasted time and paper. The D-Streamer lets you send only the data you select to the printer or attached device. Also, you can select which hours during the day you want the printer to run.

The D-Streamer is actually a Telera terminal that's been turned into a peripheral. You can dedicate it entirely to destreaming, or use it as an ANSI terminal. On "power-up" the D-Streamer is ready for entry of headers on the Header Entry Page. When a header is received from the data stream, the header and the data following it are sent to the printer. When the end-of-text terminator is received, data transmission to the printer is terminated. All incoming data can be seen on the "data page" as it is received from the satellite.

Features include: one to 70 header entries; header length from one to 75 characters; down-loadable headers; single keystroke switches from data page to header page; and an optional memory key feature.

**For More Information
Circle 228 on Reader Service Card**

HE'S ALL YOU NEED TO START YOUR MARCONI FULLY DIGITAL TELECINE!

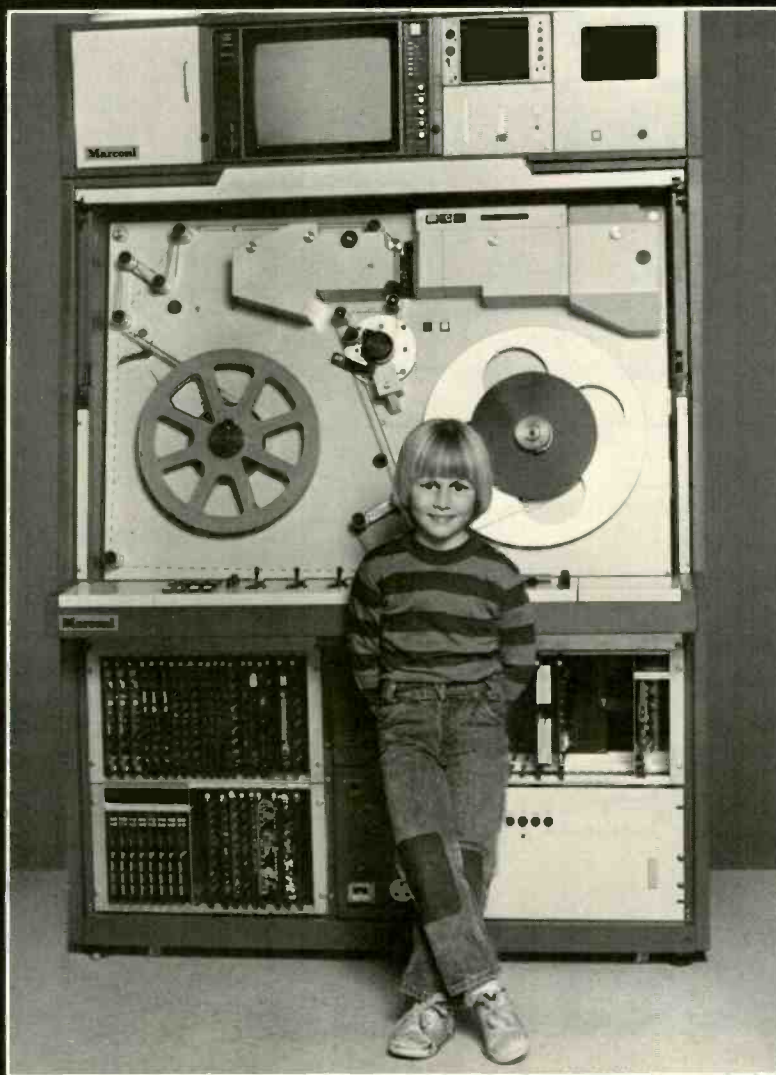

He's 5½ going on 6 and he isn't a genius. But the Marconi Line Array Telecine B3410 doesn't need a genius.

Unlike other telecines, the Marconi B3410 is fully digital. That means, among other things, it can deliver full performance within two minutes from the time you switch on. It does not require tweaking or day-to-day adjustments, and there is no registration drift or tubes to replace. The stability of its electronics is simply superb!

Once it's started, you'll appreciate the Marconi B3410 for its fully digital processing and CCD image sensors that provide an extraordinarily true video picture. Moreover, the Marconi B3410 has a light bias facility that resolves dark areas of the film. It converts into all international standards and interfaces with all available color correctors.

For more information on specifications and the cost of the Marconi B3410, call us in New Jersey (201) 767-1000 or in California (213) 466-5066.



A.F. ASSOCIATES INC.

ADVANCED SYSTEMS AND PRODUCTS FOR THE VIDEO INDUSTRY
AFA PRODUCTS DIVISION 100 STONEHURST COURT, NORTHVALE, NJ 07647

Circle 181 on Reader Service Card

EQUIPMENT



Phase three cameras automatically...

to insure phased chroma and sync at the switcher. New Automatic Blackburst Generator automatically compensates for differences in camera cable lengths.

Features

- Hi Z loop through inputs
- Use at distances up to 1000 feet
- Stand alone or genlock
- No camera tweaking for cable length



QSI Model AF-1000 Autophasing Blackburst Generator*

QSI systems, inc.

12 Linscott Road, P.O. Box 2176, Woburn, Massachusetts, 01888, 617-938-1403

Circle 182 on Reader Service Card

*patent pending

BRYSTON



Bryston's 2B-LP

Bryston has been known and respected for years as the manufacturer of a line of amplifiers which combine the transparency and near-perfect musical accuracy of the finest audiophile equipment, with the ruggedness, reliability and useful features of the best professional gear. Thus, Bryston amplifiers (and preamplifiers) can be considered a statement of purpose to represent the best of both worlds - musical accuracy and professional reliability to the absolute best of our more than 20 years' experience in the manufacture of high-quality electronics.

The 2B-LP is the newest model in Bryston's line, and delivers 50 watts of continuous power per channel from a package designed to save space in such applications as broadcast monitor, mobile sound trucks, headphone feed, cue, and any installation where quality must not be limited by size constraints. As with all Bryston amplifiers, heatsinking is substantial, eliminating the requirement for forced-air cooling in the great majority of installations. This is backed up by very high peak current capability (24 amperes per channel) and low distortion without limiting, regardless of type and phase angle of load. In short, the 2B-LP is more than the functional equivalent of our original 2B in spite of the fact that it occupies only half the volume, and will fit into a single 1.75" rack-space.

The usefulness of the 2B-LP is extended by a long list of standard features, including: Balanced inputs; female XLR input jacks; dual level-controls; isolated headphone jack; and individual two-colour pilot-light/clipping indicator LEDs for each channel. In addition, the channels may be withdrawn from the front of the amplifier while it is in the rack, vastly facilitating any requirement for field-service, including fuse-replacement.

Of course, in keeping with Bryston's tradition of providing for special requirements, the 2B-LP can be modified or adapted to your wishes on reasonably short notice, and at nominal cost.

Best of all, however, the 2B-LP is a Bryston. Thus the sonic quality is unsurpassed. The difference is immediately obvious, even to the uninitiated.

Other amplifiers in Bryston's line include the model 3B, at 100 watts per channel, and the model 4B, at 200 watts per channel. All ratings continuous power at 8 ohms at less than .01% IM or THD.

IN THE UNITED STATES

BRYSTON VERMONT
RFD#4, Berlin, Montpelier, Vermont 05602

IN CANADA

BRYSTON MARKETING LTD
57 Westmore Dr, Rexdale, Ontario, Canada M9V 3Y6

Circle 183 on Reader Service Card

New EIMAC Peak-of-Sync Cavity

Varian EIMAC has introduced a new VHF cavity, the CV-2252A. Operating in the tuning range of 170-228 MHz—U.S. channels seven through 13—the cavity uses the EIMAC 3CX12.000U7 high- μ power triad. In this configuration, the tube and cavity are capable of delivering up to 15 kW peak of sync in video service with a typical power gain of 14 dB.

In combined visual/aural service, the cavity can be operated at 3.75 kW peak-of-sync output with intermodulation distortion products of minus 52 dB or better. The cavity can be easily mounted on a 19-inch rack panel.

For More Information
Circle 229 on Reader Service Card

New MDS Transmitter from EMCEE

EMCEE Broadcast Products has introduced a new 10 W solid-state MDS TV transmitter, the TTS10GA. The unit features self-diagnostic circuitry to isolate and correct malfunctions. It is also equipped with front-panel LED alarm indicators for easy location and repair of modular level problems. Replacement modules require no tuning, which minimizes down time.

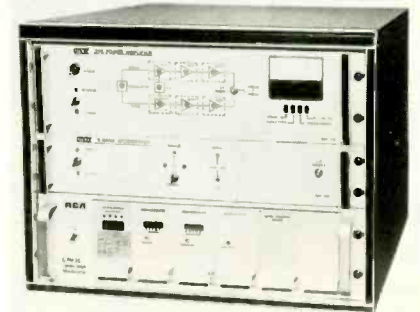

The small size of the TTS10GA—it is less than four cubic feet—makes it well suited to multichannel MDS transmissions. Several units can be stacked on top of each other, taking about the same room as current MDS transmitters.

If an MDS operator wishes to add a 100 W visual amplifier, outputs may be easily modified on site. The envelope delay and frequency response specs of the visual portion of the signal exceed FCC requirements. The TTS10GA aural amplifier also has the built-in capa-



Optimod / op'-tə-mod /

Op-ti-mod *n* [→Early Orbanian; deriv. of *optimum modulation*]

1. A broadcast audio processor built by Orban Associates to the highest standards of quality and reliability, incorporating patented circuitry to achieve a cleaner, brighter, louder airsound.

2. OPTIMOD-AM, Model 9100A; a high fidelity stereo or mono processor which achieves extraordinarily natural audio quality along with high loudness, remarkable source-to-source consistency, and FM-like brightness.

3. OPTIMOD-FM, Model 8100A/1 compressor/limiter/stereo generator; the industry's dominant choice for optimum FM processing, with or without the optional Studio Chassis and Six-Band Limiter Accessory Chassis.

4. OPTIMOD-TV, Model 8182A; a stereo processor that brings TV audio processing into the '80's by combining Orban's artifact-free multiband gated compressor with our clean "Hilbert Clipper" peak limiter and the commercial-taming CBS Loudness Controller.

5. OPTIMOD; a registered trademark.

Orban Associates Inc., 645 Bryant Street, San Francisco, CA 94107,
Toll Free (800) 227-4498, In California (415) 957-1067, Telex: 17-1480.

orban

ORBAN PROCESSING KEEPS YOU COMPETITIVE

**For any TV or
Film/Video
application**
we do it better for less

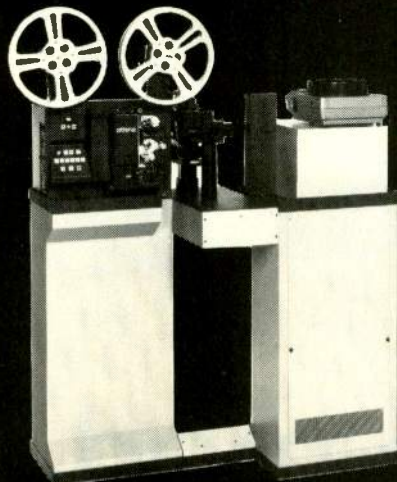

Contact us for our free catalog.

L-W
INTERNATIONAL

L-W INTERNATIONAL 50 W. Easy St.
Simi Valley, California 93065 U.S.A.
Telephone (805) 522-3284

Circle 185 on Reader Service Card

BROADCAST EQUIPMENT

bility to expand to a 100-watt signal. Other available options include video sense for transmitter on-off control, 75 kHz aural carrier deviation, an audio-modulator limiter, and programmable video message generation.

For More Information
Circle 230 on Reader Service Card

New Subcarrier Demodulation System

Modulation Associates has announced a new, fully synthesized, frequency agile, satellite video subcarrier demodulator system, the SR-13. The system has been designed specifically for users that need superior performance in program audio, multiplexed voice, and/or data transmission via satellite.

The SR-13 provides for ultralinear detection along with very low noise characteristics. It is a standalone unit, though it can be optionally configured along with Modulation Associates' Ku-band or C-band microwave downconverter and video discriminator to

provide a complete subcarrier receiving system. Optional audio low-pass filters and companding unit allow end-to-end compatibility with most subcarrier formats currently being uplinked.

For More Information
Circle 231 on Reader Service Card

Portable Hitachi Oscilloscope

Hitachi has introduced the V-1070, a low cost version of the recently introduced V-1100, the first "intelligent" 100 MHz portable oscilloscope with built-in frequency counter/DVM, CRT readout, and ground level display.

Using a built-in microcomputer, the V-1070 displays the panel setting information on the CRT as follows: vertical deflection factors, uncalibrated warn-

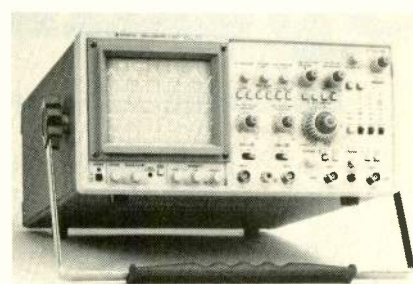

ing, magnification warning, vertical input coupling, band limiter, channel two inversion, horizontal sweep times for both A time and B time bases, and trigger sources for both, uncalibrated warning for A sweep time, sweep magnification warning, delay time, and 10X probe indicators for channel one and channel two. Further vertical deflection factors and sweep times are displayed on the CRT with the converted values at the magnified modes automatically.

The V-1070 is 13 inches wide, 6.3 inches high, and 16 inches deep; it weighs 22 pounds. The price is less than \$2000.

For More Information
Circle 232 on Reader Service Card

Low-Cost Multiplexers Introduced

Racal-Milgo has expanded its Omnimux series of statistical multiplexers with the introduction of two new models, the Omnimux 4 and Omnimux 8; both models are compatible with all models in the Omnimux series.

NEARLY 2,000,000 PEOPLE IN THE U.S. ARE VISUALLY IMPAIRED

The vast majority of them are partially sighted with remaining or residual vision that can be enhanced.

The Vision Fund of America (VFA) is an organization of concerned professionals and executives in the television and video industries dedicated to helping these partially-sighted people lead more useful, satisfying lives.

Your contributions will underwrite non-profit research into new optical, video, and related technologies and help apply those technologies to ways that benefit the partially sighted.

Many organizations raise money for the totally blind. VFA is the first to sponsor programs for the partially sighted.

HELP!

Send your tax-deductible contribution today, to:

THE VISION FUND OF AMERICA
Suite 1205, 136 East 57th Street, New York, N.Y. 10022
Telephone (212) 935-1840



The video industry helping the visually handicapped

Circle 186 on Reader Service Card



For 10 seasons now, you've taken the performance of Shure's remote mixers for granted. We haven't. Announcing the new Shure M267.

Over a decade ago, Shure introduced the M67 Microphone Mixer. Designed to provide on-location audio for major sporting and news events, the M67 became the most well known and widely used remote mixer in the broadcast industry.

Then came the new Shure M267. One look will tell you why we moved ahead.

Here are all the improvements audio engineers have asked for.

Every channel on the mixer now has a mic/line level switch for maximum flexibility. There's also a built-in limiter to keep the M267 from overloading at critical moments. The unit contains a built-in battery pack that utilizes three standard 9-volt batteries. Simplex (phantom)

power and a peak LED are standard, too.

The M267 oscillator provides a clean 1 kHz tone, and is located on the front of the unit for simple access. The headphone output is also on the front and includes a level control.

And IC design, along with active gain controls, provides greater headroom and quieter operation.

For location work or even studio post-production, the M267 carries on Shure's reputation for reliability and ruggedness.

After all, just because you create one legend doesn't mean you can't build another.

For more information on the complete line of mixers, call or write Shure Brothers Inc., 222 Hartrey Ave., Evanston, IL 60204, (312) 866-2553.

SHURE®

THE SOUND OF THE PROFESSIONALS... WORLDWIDE

50 KW

OF FM POWER:

JUST WHAT

YOU'D EXPECT...

*... From the inventor of
 - the Pyrobloc[®] grid
 - Hypervapotron[®] cooling
 Advanced technology as in all our FM-
 transmitter tubes, to guarantee their reliability.*

THOMSON-CSF
Components
 Corporation - Electron Tube Division /
 301 Route Seventeen North /
 RUTHERFORD, NEW JERSEY 07070 /
 Tel.: (1.201) 438-23-00 /
 TWX: 710 989.7286



ELECTRON TUBES



THE COMPONENTS OF SUCCESS

Brazil SAO-PAULO Tel: (11) 542 4722	Canada OTTAWA Tel: (513) 236-36-28	France BOULOGNE-BILLANCOURT Tel: (1) 604-81-75	Germany MÜNCHEN Tel: (89) 711 79-0	United Kingdom BASINGSTOKE Tel: (256) 29-155	Italy ROMA Tel: (6) 638-14-58	Spain MADRID Tel: (1) 405-18-15	Sweden STOCKHOLM Tel: (08) 63 50 60	Japan TOKYO Tel: (3) 264-63-46
--	---	---	---	---	--	--	--	---

Circle 175 on Reader Service Card

BROADCAST EQUIPMENT

The two multiplexers support up to four or eight asynchronous channels, with all channel configurations set independent of each other. The Omnimum 4 may be upgraded to support eight channels. The Omnimum 4 and 8 operate at data speeds up to 9600 bps on all channels. HDLC (modified) protocol between Omnimums provides error-free data transmission. Other features include aggregate and channel loopback capability, autoband, flow control, echoplex and visual error control, and automatic down-line loading of all configuration parameters.



The Omnimum 4 is priced at \$1200. The Omnimum 8 is \$1700 for the four-channel model, and \$2300 for eight channels.

For More Information
Circle 233 on Reader Service Card

New Print Imager from Kodak

Kodak's Instagraphic CRT print imager is a low-cost, modular system that enables users to make instant color prints of images displayed on a 9-, 12-, 13-, or 19-inch CRT. The system can also be used to produce conventional color slides and prints of the CRT image by using a 35 mm SLR camera—which is not provided with the system.

The imager is a second-generation design from Kodak. The original has a permanently mounted cone designed for 12- and 13-inch screens. The new imager has a cone, and a variety of cone adapters—which snap onto the cone—to match the above screen sizes. To create a print, the user snaps in the appropriate adapter, places the base of the unit on the CRT, and pushes the camera expose button. One or more test exposures may be required to arrive at the best exposure time for the brightness level of the CRT display.

Aside from the cone and adapters, the imager comes with the following modules: a camera back, which holds a 10-exposure pack of Kodak Instagraphic color print film; a print module, which includes the shutter and optical elements with a variable-focus lens;



color print film; and a 35 mm camera bracket. List price for the basic imager is less than \$300. Individual cone

adapters are less than \$40 each.

For More Information
Circle 234 on Reader Service Card

split equalizer design for flawless stereo performance

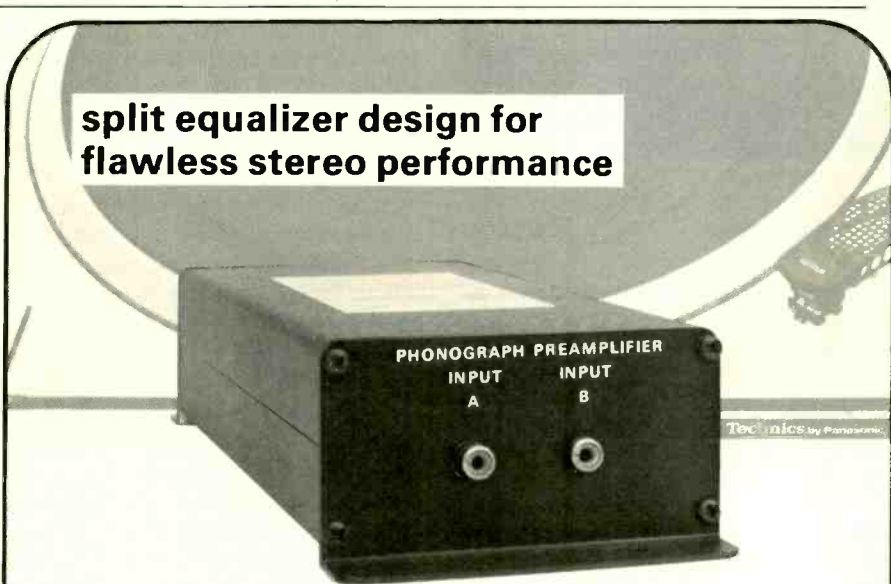

HARRIS PX-90 PHONO PREAMP

- Split equalizer meets stringent dynamic requirements not addressed by common static specifications.
- Polypropylene equalization components insure impeccable transient response.
- Unmatched immunity to RFI and other extraneous signals.
- Adjustable cartridge loading and high accuracy equalization of ± 0.25 dB from ideal RIAA curve provide optimum dynamic performance.
- Performance commensurate with Technics SP-10MKII turntable.
- Unmeasurable transient intermod and dynamic distortions assure faithful reproduction of demanding cuts, such as the cannon shot in Telarc's special recording of the 1812 Overture.

Buy the best—the Harris PX-90 "Mastering Quality" Phono Preamps...for your "best shot".

Contact Harris for the rest of the facts. Harris Corporation, Studio Division, P.O. Box 4290, Quincy, Illinois 62305-4290. 217-222-8200.



Visit Harris Booth 1004 RC and PC Los Angeles Sept. 16-19

Circle 190 on Reader Service Card

BUSINESS BRIEFS



George Heywood, VP and general manager of Omnibus, the newest computer graphics facility in New York.

Chyron announced recently that incoming orders for the fiscal year which ended June 30 were ahead of last year by 50 percent. The company attributes its improved business to the VP line of character generators—particularly the latest model, the VP-2.

Ampex has been granted licenses to use Matsushita's patents and technology to make a new generation of videotape.

Matsushita granted the same licenses to 3M and BASF in 1983....New York post house **Image Mix** has purchased 16 **Ampex** VPR-3s with TBC-3 timebase recorders, as well as two **Ampex** ADOs. The total value of the gear is nearly \$2 million....**Cine-Vid**, a New York post facility, will soon install a one-inch edit suite with all **Ampex** gear. The \$1.5 million room will be designed and built by **A.F. Associates**.

Tektronix recently made its biggest sale ever—to the U.S. Army. The Army bought 8000 of the company's 2235 portable oscilloscopes.... **Tektronix** has also expanded its distribution program. **EIL Instruments** will now market the **Tektronix** 2213A, 2215A, and 2235 portable oscilloscopes, as well as all **Tektronix** scope accessories.

RCA and **Bertelsmann AG** of West Germany have agreed to merge their worldwide record, music publishing, and music video businesses. According to record industry estimates, the merger will create a joint-venture company with annual sales of \$800 million to

\$850 million....**Image Communications** has purchased video gear from **RCA Broadcast** that will make it Tampa Bay's first interformat editing facility.

JVC's Electronic Dealer Information Service has recently gone on line. The service provides **JVC** dealers with access to information regarding new products, prices, and future events via personal computer....**Custom Mastering**, a Nashville, TN audio post-production facility, recently purchased a **Sony** PCM-1610 digital audio system....Four **Sony** VO-5850 U-Matic editing VCRs, and eight **Sony** CVM-1270 color monitors were used by reporters at the Special Olympics to edit their footage prior to transmission or air shipment to home stations, allowing for quick airing of the tapes, and almost simultaneous worldwide coverage of the Games.

Soundcraft has opened an office in New York City....**WCCO-TV**, Minneapolis, MN, has recently taken delivery on five **Soundcraft** Series 200 eight-channel stereo audio mixing consoles....Radio uplink company **IDB** has begun construction on a 10-meter **Scientific Atlanta** earth station to service **SATCOM 1R**. **IDB** is also building two earth stations on the grounds of **KUSC's** facilities in downtown Los Angeles to expand the audio transmission capability from L.A. to **Western Union's** satellites.

Positive Video has purchased **Eureka Teleproduction Center**, a \$10 million video/audio-for-video facility in San Carlos, CA....**Omnibus Computer Graphics**, which has computer animation facilities in Toronto and Los Angeles, has recently opened a facility in New York City....**Pinnacle Productions International** also opened a facility recently—a studio and post-production house in Spokane, WA....**Broadcast Marketing Associates** reports it has received and filled orders for 20 **NEC E-Flex** devices in the past 10 months.

Key personnel changes this month include the appointment of Kenichi Kano as senior VP and general manager at **NEC America**, broadcast division. Kano replaces Dennis Fraser, who becomes president of **ALCOA-NEC** Communications....At **Aurora Systems**, Alan Bridge has been named na-

tional sales manager, and Sheila Holmes-Ross has been appointed manager, video sales....**Biamp Systems** has named Richard MacLeod the new company president. MacLeod was one of the founders of **Biamp**, and most recently had been VP and director of engineering....**Comtech Data Corp.** has announced several management promotions: Robert Fitting is the company's new president, replacing Milton Deever, who has been transferred to the New York office of **Comtech Inc.** as senior VP and chief operating officer; Louis Harper, Jr. has been upped to assistant general manager; and Allan Scharf has been promoted to senior VP of business development and long range planning.

At **Audio Plus Video International**, Andre Macaluso has been appointed general manager....At **Moseley Associates**, Terry Sheffield has been named manager, U.S. sales.

SALES OFFICES

BM/E

Broadcast Management/Engineering

295 Madison Ave.
New York, New York 10017
Telex: 64-4001
William McGorry, Publisher

Eastern & Central States

295 Madison Avenue
New York, New York 10017
212-685-5320 *
James C. Maywalt
Gene Kinsella

Western States

5015 Birch Street, Office One
Newport Beach, CA 92660
714-851-1461
408-720-0222
Neal Wilder

United Kingdom/Europe

28 Eaton Row
London SW1W 0JA, England
Telephone: 01 235 8431
Bronwyn Holmes
Derek Hopkins
Ruben Veksner

Japan/Far East

Eiraku Building
1-13-9, Ginza,
Chuo-Ku, Tokyo 104 Japan
03 562 4781
S. Yasui
K. Yamamoto
Y. Yozaki

SWITCH TO THE FUTURE

McCurdy Has The Features You Want

Whatever you're looking for in Audio/Video routing switchers — capability, capacity and convenience, you'll find it in the comprehensive line of McCurdy broadcast quality switching systems.

- The latest in analog and digital microprocessor technology
- Failsafe single-pair industry standard RS-422 control wiring
- Redundant distributed control system architecture for ultimate reliability
- From the smallest unit to the fully computer automated

system shown here

- Efficient space utilization
- Ease of future expansion
- Numerous control and interface systems
- Wide range of control panels and options

McCurdy Delivers the Performance You Expect

When you need versatility and reliability that meets the highest of professional broadcast standards, you can count on McCurdy to come through — first time, every time.

- Quality • Versatility
- Solid State Reliability

McCurdy Prices Are Right

When cost-effective capital investment, economical operation and low maintenance are important criteria in your equipment choices, McCurdy's a winner in every category.

- Competitive prices make McCurdy your smart buy
 - Modular construction keeps maintenance costs to a minimum
 - Full future expansion capability
- The McCurdy Audio/Video Routing Switcher. Number 1 Choice Today and Tomorrow.

McCurdy

McCurdy Radio Industries

108 Carnforth Road, Toronto, Ontario, Canada M4A 2L4 Tel: (416) 751-6262 Telex: 06-963533
1051 Clinton Street, Buffalo, New York 14206 Tel: (212) 772-0719

Circle 191 on Reader Service Card

Eloquent Audio!

Custom designed production facilities make a substantial contribution to overall program quality. This is particularly true with the CBC French network's new daily TV news magazine, "Le Point".

The ability to combine voice inputs from numerous local and remote locations with studio originated sound effects and "color" is essential to the program environment.

For this custom console, Ward-Beck collaborated with CBC engineers to design a producer's dream in which one operator controls 24 inputs with submasters on the left, while another handles the 3 effects inputs and submaster on the right. A centrally located illuminated 24 x 6 integral switch panel assures clean, unambiguous switching from either station.

The results speak for themselves.



First by Design.

Ward Beck Systems Ltd.,
841 Progress Avenue, Scarborough,
Ontario, Canada M1H 2X4.
Tel: (416) 438-6550. Tlx: 065-25399.

