

APRIL 1984

\$3.00

BME

BROADCAST MANAGEMENT/ENGINEERING

NAB '84

DIR

0702 0371505 41 31
T W DENBROOK
DIR OF ENG
KUCW RADIO OF
325 CMU-U OF WASHINGTON
SEATTLE WA 98195

Also in this issue:
Live Radio Remote Goes Digital ■ Timetable
for HDTV ■ Broadband Your Antenna



Model
VP 1603



Model
2442



Model
1642



Model
ST 160

Standards for the world



Model 9032

ADM[®]
The Audio Company

ADM Technology, Inc., 1626 E. Big Beaver Road, Troy, MI 48084. Phone: (313) 524-2100. TLX 23-1114
WEST CENTRAL SALES (817) 467-2990 WEST COAST SALES (415) 945-0181 MAIN OFFICE AND EAST COAST SALES (313) 524-2100

VISIT US AT BOOTH 1223

Comark's "S" Series UHF Television Transmitters

Simply Superior

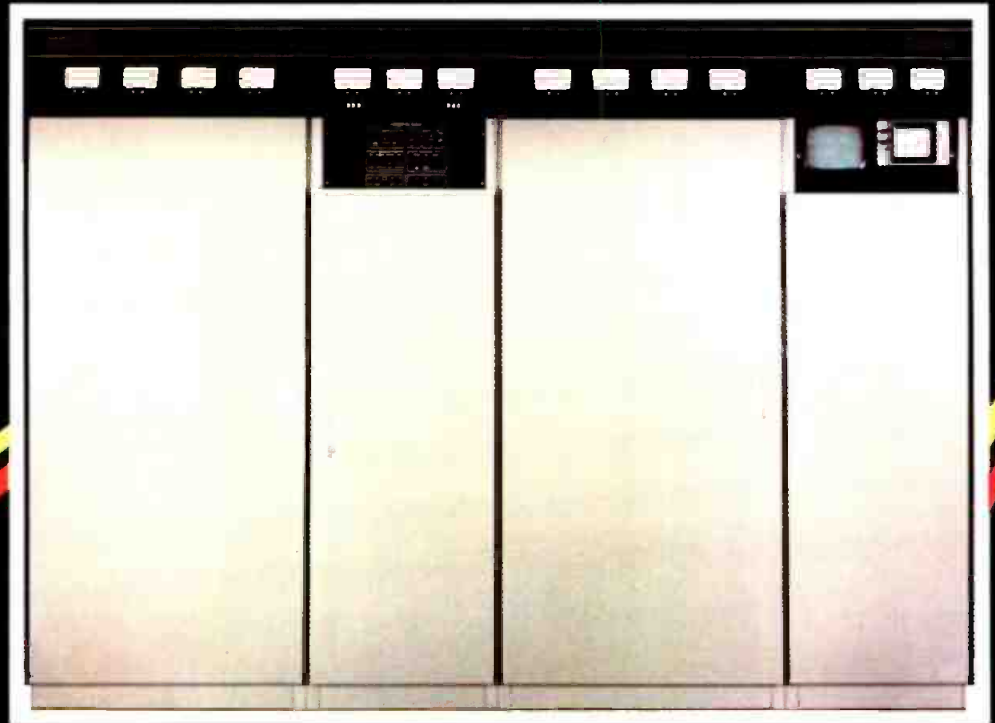

10kW/30kW/55kW model shown

Integrating high efficiency, reliability and low cost, each model incorporates state-of-the-art technologies to achieve a unique combination of unparalleled features:

- External cavity, full-band, field proven, klystron power amplifiers, combining highest efficiency and compact size.
- Broadband (no tuning), high power, Exciter System, featuring dual channel (redundant) operation as well as Comark's CM-100S Broadcast Modulator with IF S.A.W. filter.
- Space efficient, mechanical and electrical layouts, fully engineered for maximum EMI/RFI isolation and overall operator convenience.
- Fiber optic telemetry for all floating high voltage metering functions, incorporated into a complete, remote control-compatible, latched fault and status display system.
- Clean, fully isolated, high voltage compartments, with double-filtered air cooling and front access. (No exposed high voltage in klystron areas.)

Comark's "S" Series transmitters are available from 10kW through 220kW with advanced system options, including beam current pulsers, motorized RF switching systems, E.D. and ICPM correction systems, and the services of Comark's 24-hour field operations group.

Simply Superior

COMARK

Engineering
and Sales Offices
PO. Box 275
Colmar, PA 18915
(215) 822-0777
Telex: 84-6075

International Headquarters
PO. Box 229
Rt. 57, Feeding Hills Road
Southwick, MA 01077
(413) 569-5939

See us at NAB Booth #1217

Circle 101 on Reader Service Card

www.americanradiohistory.com

ON APRIL 29, 1984, THE TAKE ITS PLACE ALONGSIDE

The ferocious, profit-eating Cartosaurus, longtime predator of station manager and technician

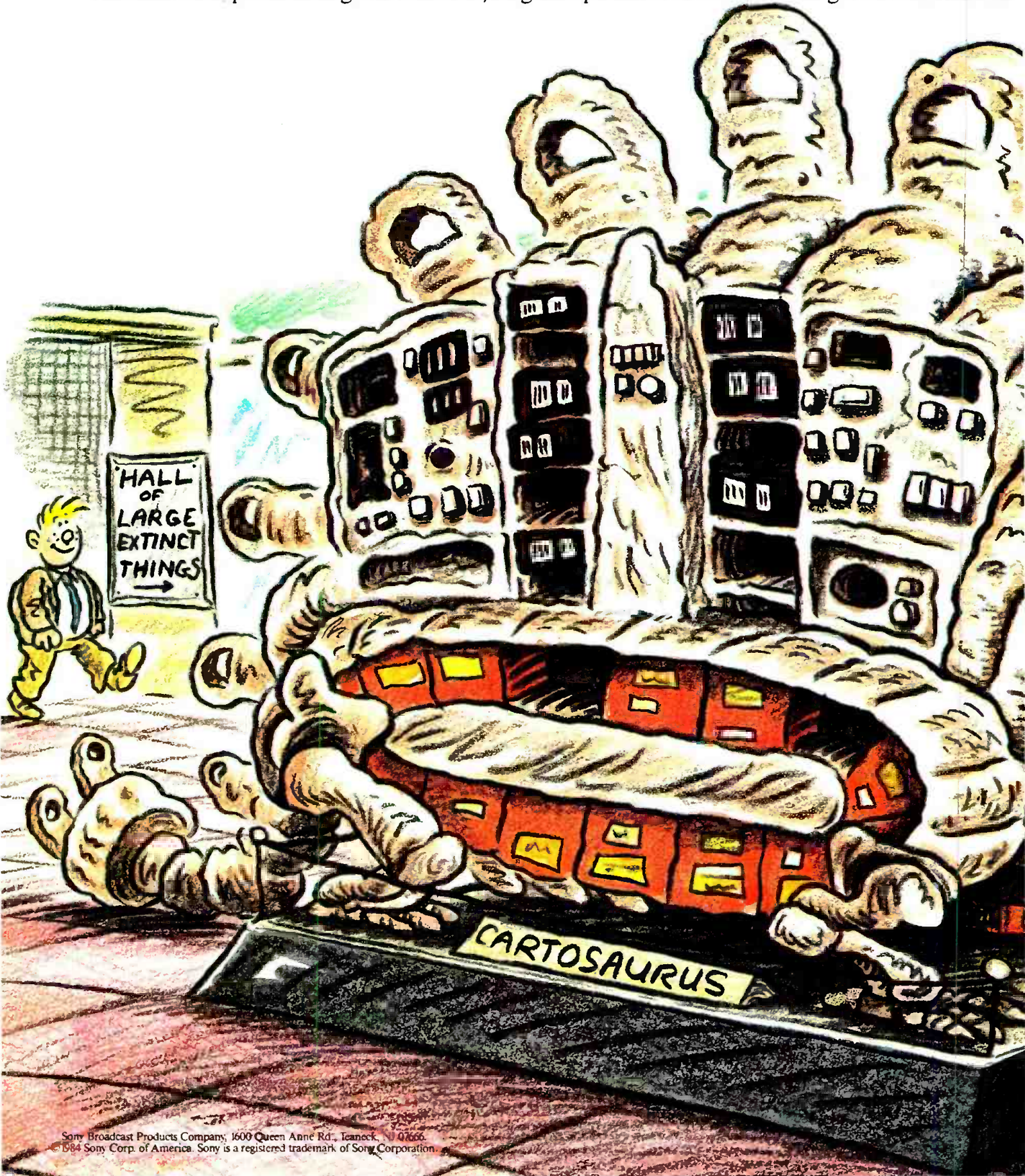

CARTOSAURUS WILL FINALLY THE BRONTOSAURUS.

alike, becomes extinct at NAB. Come see a whole new, higher order of species. **SONY**
Broadcast
Fast forward into the future.



THE **mbi** SERIES 24A BROADCAST MIXER



The Series 24A mixer has been designed for broadcast station and production house use where there is a requirement for versatile and reliable stereo sound mixing. Its modular design coupled with an expandable main frame permits the Series 24A to be used in a wide variety of different configurations including live 'self-op' programme presentation, engineer-driven programme production, master control room programme mixing, outside broadcast mixing, and general audio-visual production.

A wide range of input, monitoring, communications, and metering modules are offered and these may be fitted in any number and in any combination without modification to the expandable main frame of the mixer. Moreover, the total-modularity concept of the Series 24A permits modules to be changed at will allowing different mixer configurations to be constructed quickly and 'in-house'. A multi-studio facility with a requirement for simple and complex mixing may now be equipped with a common design of console providing engineering, operational and other advantages. And as the requirements of the facility changes, the Series 24A has the capacity to change format and meet the new demands made of it.

The Series 24A is robustly constructed and incorporates conservatively rated, long-life components. The controls are ergonomically displayed on three planes — horizontal faders, sloping channel controls, almost vertical meter hood — all are within easy reach, and major functions are illuminated. The mixer may be free-standing or be mounted in a wrap-round console and can be provided with a script area. The Series 24A is attractively finished and features silver on black double anodised permanent panel legends, a matt green meter hood, surrounded by a solid mahogany trim.

imagineering by

mbi **AHB**
group

69 Ship Street, Brighton BN1 1AE, England. Tel. (0273) 24928 Telex 878235 MBIAHB G
Five Connair Road, Orange, CT 06477, USA Tel. (203) 795-3594 Telex 643307

Circle 102 on Reader Service Card

BM/E

BROADCAST MANAGEMENT/ENGINEERING

Publisher
Charles C. Lenz, Jr.

Editor Emeritus
James A. Lippke

Editorial Director
Gerald M. Walker

Editor
Robert Rivlin
Senior Associate Editor
Eva J. Blinder

Associate Editor
Tim E. Wetmore
Copy/Research Editor
Suketu Mehta

Assistant to the Editor
Douglas Damoth
Editorial Assistant
Toria Smith

Special Assignments Editor
John S. Roberts
FCC Counsel
Bechtel & Cole
Broadcast Financial Consultant
Mark E. Battersby
Special Projects Editor
C. Robert Paulson

Art Director
Edwin Torres
Design Assistant
Annette Fernandez

Production Director
Janet E. Smith
Advertising Coordinator
Dana L. Kurtz

Associate Publisher
Neal Wilder
Marketing Services Director
Liz Schroeder
Marketing Assistant
Elaine Alimonti
Reader Service
Sharon Porges

Controller
Michael J. Lanni

BROADBAND INFORMATION SERVICES, INC.
295 Madison Ave., New York, N.Y. 10017
212-685-5320, Telex: 64-4001

Publishers of:
BM E—Broadcast Management/Engineering
BM/E's World Broadcast News



BM/E BROADCAST MANAGEMENT ENGINEERING (ISSN 0005-3201) is published monthly by Broadband Information Services Inc. All notices pertaining to undeliverable mail or subscriptions should be addressed to 295 Madison Ave., New York, NY 10017. BM E is circulated without charge to those responsible for station operation and for specifying and authorizing the purchase of equipment used in broadcast facilities in the U.S. and Canada. These facilities include AM, FM and TV broadcast stations, CATV systems, ETV stations, networks and studios, audio and video recording studios, telecine facilities, consultants, etc. Subscription prices to others \$24.00 one year, \$36.00 two years. Foreign \$36.00 one year, \$60.00 two years. Air Mail rates on request. Copyright 1984 by Broadband Information Services, Inc., New York City. Second class postage paid N.Y., N.Y. and additional mailing offices.

Part of your best work may never get past your camera tube.

SATICON II

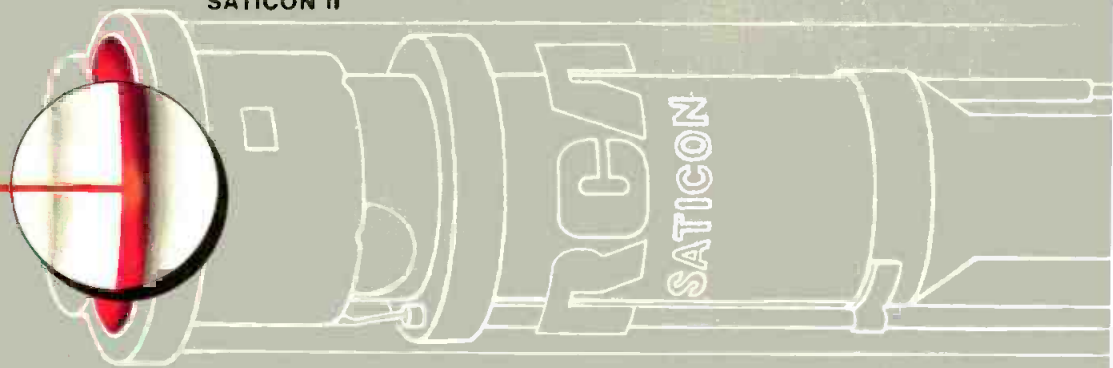

PLUMBICON

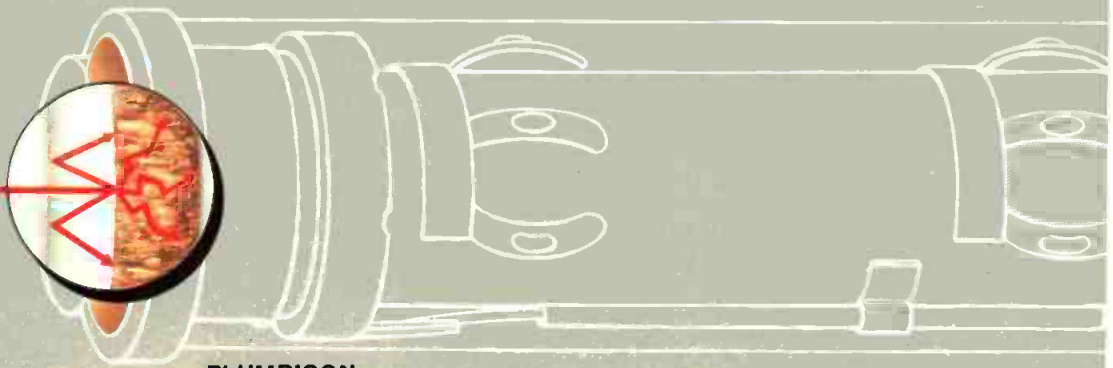

What you see is not always what you get. The character and quality of your pictures are dependent to a significant degree on the camera tubes you use.



With high performance Saticon* II tubes, you can expect distinctively cleaner, clearer and sharper pictures. The reason lies in Saticon II's newly improved photoconductor. Developed through computer-aided processes, this thin glassy film allows the light to pass through without color diffusion or distortion. The end result is high resolution,

distortion-free color, very low lag, high sensitivity and depth of modulation. Highlight memory (without red trail) is also significantly reduced with Saticon II.

With Plumbicon™ tubes, the polycrystalline structure of the photoconductor causes diffusion of incident light. The



Plumbicon photoconductor is three times thicker than Saticon II's, which limits its resolution.

Make sure your best work gets past your camera and on the air by specifying high performance Saticon II camera tubes in your original equipment and for tube replacements.

For our guide to camera tube selection, contact your RCA distributor or write to RCA Camera Tube Marketing, New Holland Avenue, Lancaster, PA 17603. Or call (800) 233-0155. In Penna., phone (717) 397-7661. Overseas, contact RCA Brussels, Belgium. Sao Paulo, Brazil. Sunbury-on-Thames, Middlesex, England. Paris, France. Munich, W. Germany. Hong Kong. Mexico 16 DF, Mexico.

RCA
Take out the doubt.

*Used by permission of trademark owner.

Circle 103 on Reader Service Card

BME

BROADCAST MANAGEMENT/ENGINEERING

APRIL 1984

VOLUME 20/NUMBER 4

FEATURES



NAB '84

You've Got What It Takes—Introduction and Program 57, What's Hot in TV Products 65, TV Exhibits 99, What's Hot in Radio Products 179, Radio Exhibits 203 ... *Staff Report*

55

Cover photo by Bob Geffken, Essential Slide Services

WGBH-FM MAKES A DIGITAL CONNECTION

243

The Boston radio station is using a digital audio recording processor as a transmission device, and the music is great! ... by Anita McFadden and Dave St. Onge

HIGHER DEFINITION TELEVISION: HOW FAR SHOULD IT GO?

251

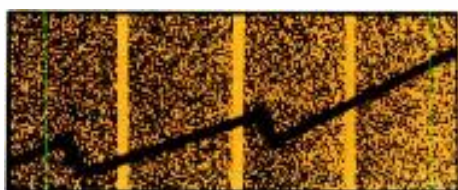

Proposals for higher definition are abundant. But when will the improvements actually come about, how much will they cost, and how will they affect current broadcasters? ... by Tim Johnson

BROADBANDING YOUR ANTENNA WITH AN EXTERNAL NETWORK

263

Narrow bandwidth loads can be compensated for by this special external network. Power efficiency and costs are carefully considered. Result: an almost universal solution. ... by Grant Bingeman

DEPARTMENTS

Editorial

10

SCAs in Perspective

Broadcast Industry News

14

FCC May Deregulate Transmitter Control; Installation Work Underway on NBC Satellite System; SMPTE TV Conference Sets Higher Goals

Radio Programming and Production

31

KGON Hooks Up to Its Listeners

Television Programming and Production

39

Irises Blossom For Local Production

Great Idea Notebook

275

Stereo Synthesizer

FCC Rules and Regulations

277

Tough Stance on Construction Permits

Advertisers Index

282

Broadcast Equipment

285

Business Briefs

292

COMING IN
MAY:
SPECIAL REPORT:
MOBILE VANS
FM SCA

EAGLE III.....A STATEMENT OF FACT



.....QUITE SIMPLY, THE MOST POWERFUL AND COMPLETE $\frac{3}{4}$ " AND $\frac{1}{2}$ " A/B EDITING SYSTEM AVAILABLE....REGARDLESS OF COST.

- System includes the Echo Lab's SE 3 computerized production switcher with special custom switcher software.
- Multi-Level transitions defined in the edit list and faithfully executed by the editor. Includes, key functions, wipes and dissolves beneath a key, hold key and pattern limits across events, dissolve keys in or out in the middle of a scene and switcher "LEARN" functions.
- 250 event memory.
- Complete list management.
- Auto-Match, Auto-clean, Auto-tag, and much more.

FROM **Videomedia** the leaders in Post Production Technology...Manufacturers of the largest line of editing systems in the world.

SUPER PERFORMANCE from

Midwest delivers for TBS

When TBS wanted a second fully-equipped mobile production unit, they chose Midwest Corporation, the company with the reputation for meeting every challenge in the field. From 47 foot teleproduction units to ENG vehicles, Midwest can custom-design a mobile system that insures network quality production in the most difficult locations. For TBS's wide-ranging sports and news coverage, Midwest used its M40 Series to develop the SuperTruck. 44

feet of unparalleled technical and production potential.

Large enough to cover any sports or major news event, it's stocked with state of the art video and audio equipment, from companies like Ikegami, Grass Valley and Ampex. Because only the finest equipment is utilized, everything Midwest builds has an amazing track record for enduring the demanding conditions of on-location shoots. TBS noticed, and moved to Midwest. For more information on how to keep your show on the road, call toll-free, today. (800) 543-1584.



Mobile Unit Group
One Sperti Drive
Edgewood, Kentucky 41017
(606) 331-8990
Telex 21-4370

Circle 105 on Reader Service Card

SUPER

Turner Broadcasting System

SuperStation WTBS
Cable News Network
TBS Sports

Designed and
Constructed by



SUPER COMPANIES

TBS delivers for you

To catch the action of a play-off game or a major news event, even a SuperStation needs the ability to keep its show on the road. So TBS asked Midwest to design a second mobile production unit that meets three criteria: First, it's large enough to handle any on-location assignment from a major sporting event to a live concert to a presidential visit. Second, with its equipment specifications it produces the finest results in the industry, and finally, it's ready for lease on an as available basis. Midwest's solution is the 44 foot SuperTruck II. When SuperTruck II goes on

the road, it will cover the assignment with:

- Five (5) Ikegami HK-357 Cameras with Fujinon 44:1 Lenses
 - Two (2) Ikegami HL-79 Cameras with Fujinon 17:1 Lenses
 - 24 Input Grass Valley 300/3A Production Switcher
 - Three (3) Ampex VPR-2B One Inch Slo-Mo Tape Machines
 - Abekas Still Store System
 - Solid State Logic Triple Stereo Audio Console
 - Ampex ADO Digital Effects Unit
 - Chyron 4100 Graphics Generator
- With two "SuperTrucks" TBS has increased its ability to generate a wide range of programming from sporting events to documentaries. In addition, TBS can lease one of its units for your

assignment that requires network quality. So for that major assignment in the field, put a SuperTruck on the road for you.

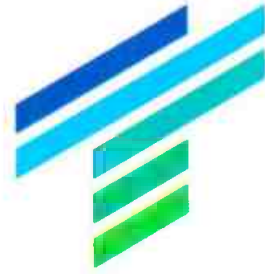

Turner Broadcasting System
Dick Dodson
Manager, Field Operations
1050 Techwood Drive
Atlanta, Georgia 30316
(404) 827-1717

TBS's SuperTruck will be on display at NAB '84 at the Midwest Corporation booth.



SCAs in Perspective

The initial enthusiasm over the FCC decision to open up Subsidiary Communication Authorizations (SCAs) using FM station subcarriers has settled somewhat as FM radio broadcasters have begun to recognize its problems and pitfalls. These pitfalls are legal, financial and technical, and involve risks.

On the technical side, engineers are debating the question of whether using the subcarrier for a subsidiary service reduces the power or coverage of the station in fringe areas. In metropolitan areas portable receivers may encounter multipath interference. This problem could affect portable pagers and stock market quote receivers.

On the financial side, unless an FM broadcaster is simply going to lease subcarriers, any effort to build a business with an SCA is going to require an investment in personnel, marketing, advertising, and the like. The world will not beat a path to the SCA door. Moreover, joining what may become regional networks linking SCAs offering a common service will also involve stations in new financial arrangements. One company is promoting an "affiliate" plan based largely on the way stations become affiliates of radio networks for programming. In short, it's getting complicated.

Even more complicated are the legal ramifications. For one, legal responsibility for what is carried on the SCA channel remains the broadcaster's even if the subscriber is leased. This responsibility holds even if the lease changes the original use as in one instance when a "legitimate" subcarrier lease was used as the communications link in a book making operation.

Another legal headache is state regulation. An SCA service such as paging could push a station over that murky line into common carrier status and involvement with state regulatory agencies. Regulations vary, definitions vary—it's a can of worms.

With all of these dangers, who needs it? Well, consider for one the paging market. According to a fairly reliable estimate made by Metromedia, the number of paging units in use will grow from about 2 million now to 40 million by 1990. Another, less dependable estimate puts air time revenue for paging at \$2.9 billion, repeat, \$2.9 billion by 1988. Leasing income is not bad either. These days a subcarrier lease can garner as much as \$6000 a month in a major market, and \$10,000 a month is not out of the question. For small markets, the price is about \$2000 a month.

The opportunities are there. To be sure, there are problems to solve and pitfalls to avoid. A lot depends on the commitment of the broadcaster—the willingness to take the risks to reap the profits or sustain the losses.

BM/E

CAMERA MART

**SERVING THE ENTIRE BROADCAST INDUSTRY
WITH QUALITY EQUIPMENT,
WORLDWIDE.**



The Camera Mart, Inc.
456 W. 56th St., New York 10019 (212) 757-6977

NAB Booth 1018

**HITACHI PUT
THE COMPUTER
INSIDE
SO YOU CAN TAKE
STUDIO QUALITY
OUTSIDE.**

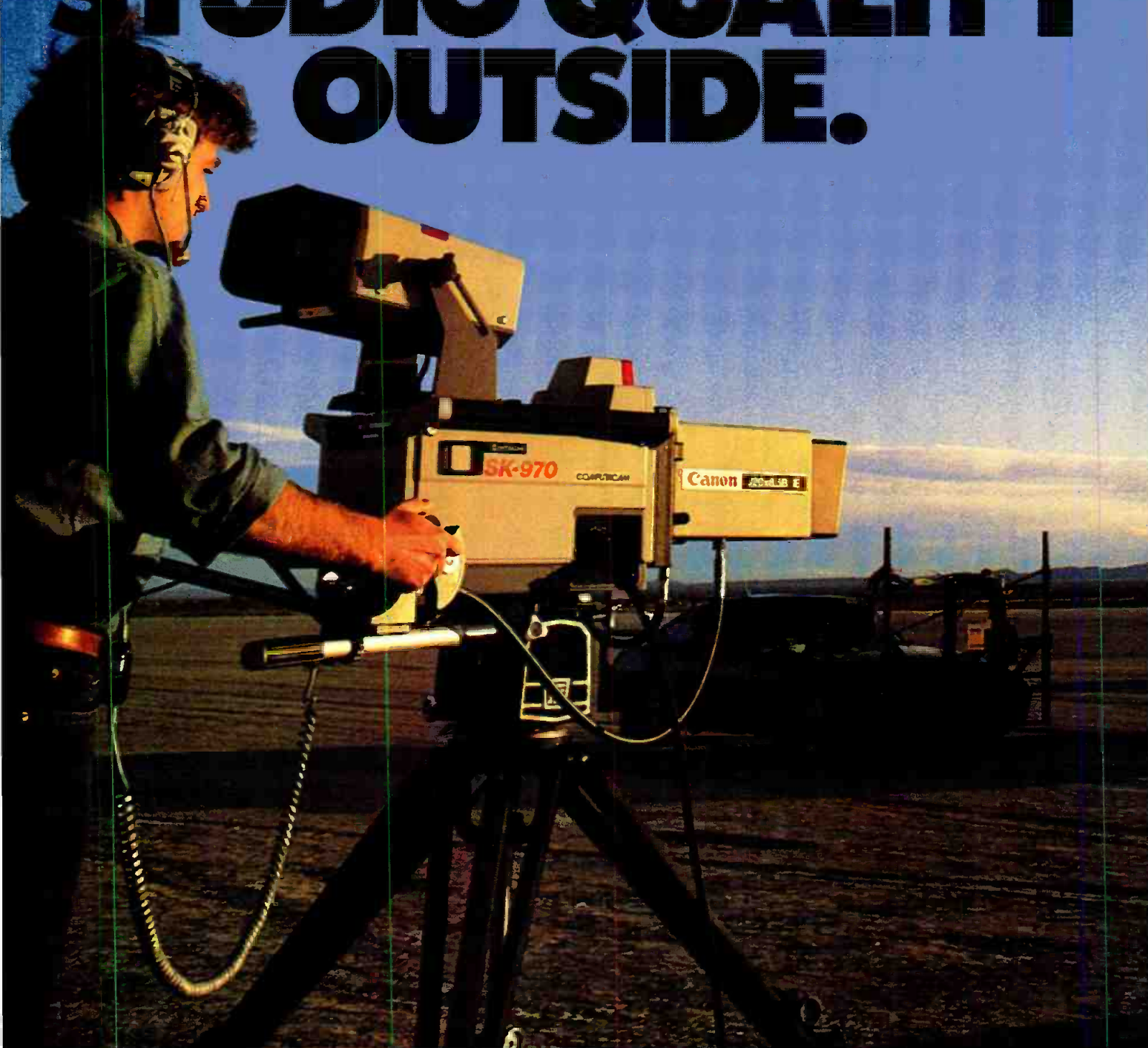

You're shooting the big one. A national political convention. The World Series. Or the most ambitious car commercial ever taped on location.

Until now, either you run the risk of ruining your best studio cameras in the field. Or go with your best field cameras and risk falling short of the quality you're looking for.

Well, agonize no longer. Hitachi's new Computacam™ is here. The first video camera with an on-board computer that sets up automatically in just 2 minutes—including the green channel. And that delivers big camera studio performance at virtually any location. Because the computer in Computacam gives you total control.

**POWERHOUSE COMPUTER
IN A 55-POUND PACKAGE.**

With the Hitachi Computacam SK-970, you don't set up cameras one by one using an external computer—which can waste all kinds of expensive time on a multi-camera shoot. And which means you can lose automatic set up on *all* your

cameras if the external computer should ever go down.

Your least experienced cameraman can balance all your Computacam cameras perfectly with the push of a button. Each camera has a built-in diascope. And each computer has data files that correct for everything from light to lenses. These files even "remember" conditions if you should ever have to reshoot. Yet all these electronics come in one small, incredibly rugged package.

Most important, the computer in Computacam is the *only* one that can store data to correct for registration errors caused by lens zooming and focusing. And it's the *only* computer that dynamically compensates for temperature so you'll know your picture's centered in either a blazing desert or a blinding snowstorm.

**PLUMBICONS AND OTHER
PLUMS FOR PERFECTIONISTS.**

For all its finesse in the field, don't forget you're also getting a *great* studio camera in Computacam SK-970. That comes with either Plumbicon® or Saticon®

high-performance pickup tubes that provide up to 700 lines of horizontal resolution. This means picture quality that can open up whole new markets.

Computacam is the beginning of a whole new family of cameras. We already have an EFP shoulder-mount version—the SK-97—that also has an on-board computer and the same technical features you get in the SK-970.

What will it cost you to have the camera for all places and all seasons? Put it this way. Even with a 7-inch viewfinder and a wide array of lenses, it's a whole lot cheaper than the finest motor car. And you'll be getting the same order of performance.

Only Hitachi has Computacam. And it's not excessive to say it's the next generation of video cameras.

For more information, contact Hitachi Denshi America, Ltd., Broadcast and Professional Division, 175 Crossways Park West, Woodbury, NY 11797. (516) 921-7200. Offices also in Chicago, Cincinnati, Dallas, Denver, Seattle, Atlanta, Los Angeles and Washington, D.C.



See us at NAB Booth #1402

Circle 107 on Reader Service Card

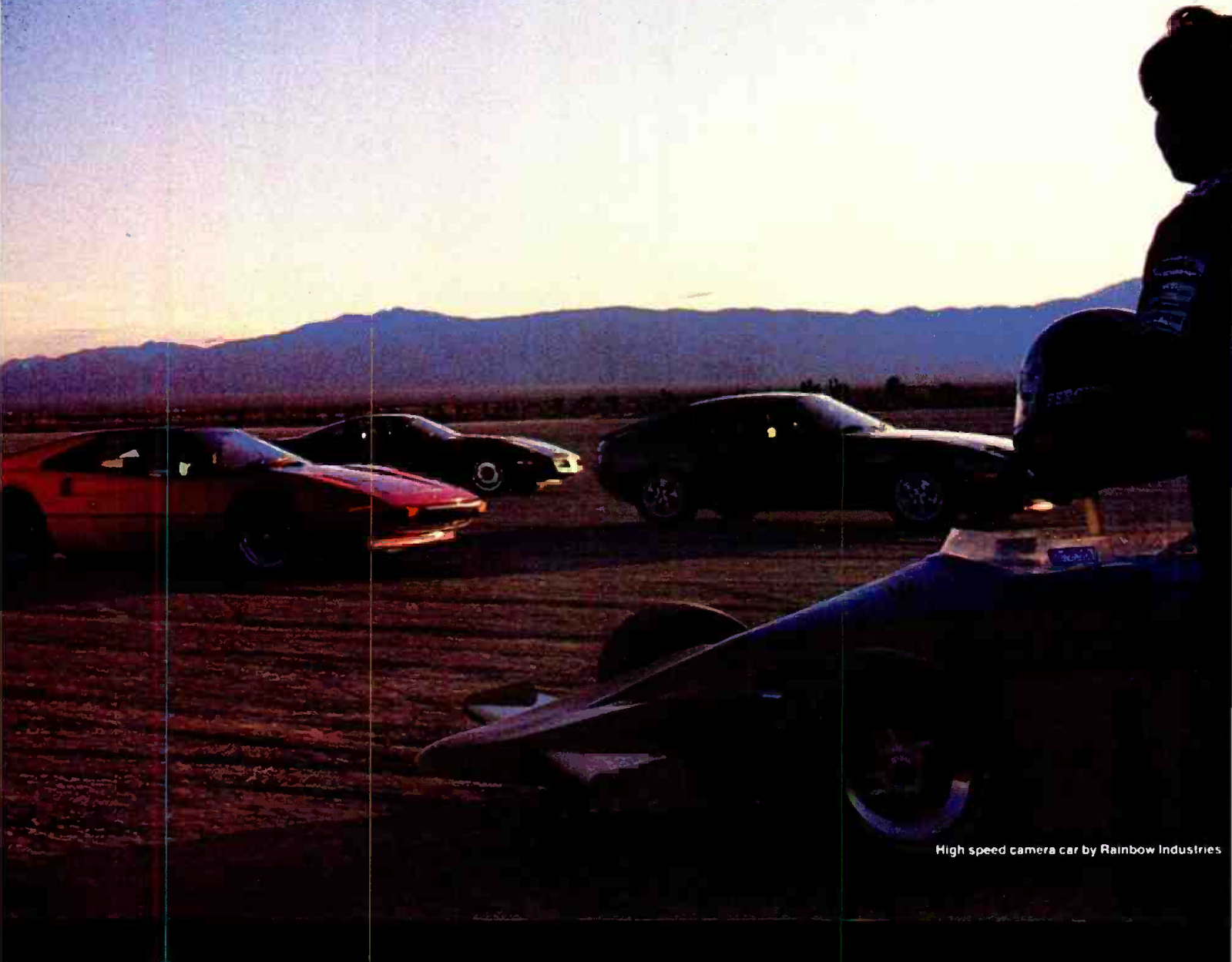

High speed camera car by Rainbow Industries

FCC May Deregulate Transmitter Control

The FCC has proposed rewriting its rules governing the remote control of AM, FM, and television transmitters to allow the use of any design or type of control system, or even none at all, as long as a station operates within its assigned limits.

As proposed, future remote transmitters could be controlled by anything from land lines to lasers, including "yet undeveloped" systems. Program or other dedicated circuits could be incorporated into the remote system. Only in cases where daily adjustments must be made by hand, not by an automatic system, would remote control be necessary. If there were no automatics, the FCC would merely require that the transmitter be turned off if it malfunctioned.

Both radio and television stations

would have three hours to correct telemetry failure before shutting down. AM stations also would have to pull the plug if power or directional antenna changes could not be made, although a switching clock could provide backup.

SMPTE TV Conference Sets Higher Goals

Montreal, Canada was the chilly setting for SMPTE's eighteenth annual TV conference. But while the weather outside dipped below zero, the debates inside raged hot and furious. "Image Quality: A Time for Decisions" was the theme of the conference, and at every turn it became obvious just how difficult the decisions are. It all came down to one question: Do we set simple goals for improved TV signals that can be implemented immediately, or do we

hold out for higher goals that may have longer lasting impact?

Two days of sessions were preceded by a day-long tutorial on digital processing of video signals, cosponsored by the CBC and several other groups. As newly elected engineering VP Richard Streeter observed, the sold-out event may indicate a strong need in the TV community for such ground-level information, and SMPTE may contemplate repeating the tutorials in the future.

At the SMPTE sessions themselves, there were almost 30 papers, divided into four session topics: Basic Concepts and Perspectives, New Recording Technologies, New Distribution Technologies, and New Display Technologies. The latter two, of course, represent an increased awareness among SMPTE's engineering management that transmission and display must go hand-in-hand with any changes made in the broadcast environment.

The central issue on just about everyone's mind was high or higher definition TV—whether to hold out for an ultimate TV scheme or go with an enhanced picture that could be made available almost immediately. One thing that became quite clear was that the early lead held by the NHK-proposed 1125-line system may be eroding, at least as a commercial broadcast standard (it is still widely thought of for a production tool). The extra cost required to record and transmit the bandwidth of an 1125-line signal cannot be justified, and more and more engineers are coming to believe that a progressively scanned (rather than interlaced) 1050-line signal, achievable within current standards, may be a better way to go. As the studies are showing, it is the wide-screen aspect ratio rather than the number of lines of resolution that excites viewers about the new TV formats, and Just Noticeable Difference figures for 1125- and 1050-line displays prove them almost equal. (For a full discussion of many of the issues of HDTV raised at SMPTE, see the story on higher-definition television elsewhere in this issue.)

Perhaps even more exciting than the papers themselves was the equipment exhibit, featuring, in addition to manufacturer's booth displays, a demonstration of some of the latest technological developments. The Philips lab, for in-

Installation Work Under Way On NBC Satellite System

NBC Television's Ku-band satellite delivery system is drawing closer to reality as installation work proceeds. Harris Corp.'s Satellite Communications Division, which is supplying and installing the earth stations for NBC and Comsat General, the prime contractor, has stepped up its Ku-band product development program to meet the tight deadlines imposed by the project.

The complete system—with earth stations in 180 cities and complete two-way network control via satellite—is scheduled for completion by the end of this year, and Harris is assembling equipment packages at the rate of one a day to meet its commitment. At press time, 22 earth stations had already been installed. The antenna is a Ku-band version of Harris's Delta Gain unit.

The network program signals will consist of one NTSC video signal and two accompanying audio signals. Two separate carriers will also be used as data links with local processors for status monitoring at each station. All



Harris's 6 m Ku-band antenna.

equipment throughout the network will be redundant. A master processor at one of the two control centers—New York City and Burbank, CA—will manage routing and switching through the local processors.

In addition to installing the system and supplying the equipment, Harris will provide full service and system maintenance.

HE'S ALL YOU NEED TO START YOUR MARCONI FULLY DIGITAL TELECINE!

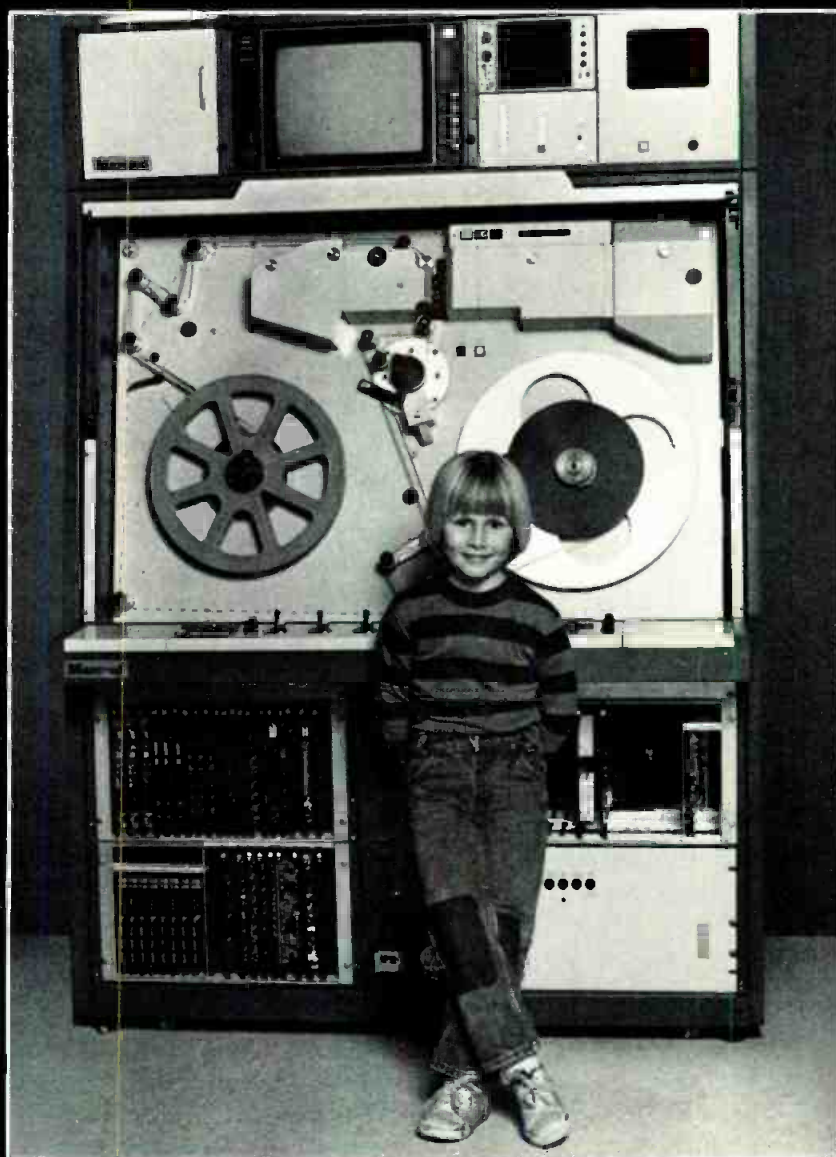

He's 5½ going on 6 and he isn't a genius. But the Marconi Line Array Telecine B3410 doesn't need a genius.

Unlike other telecines, the Marconi B3410 is fully digital. That means, among other things, it can deliver full performance within two minutes from the time you switch on. It does not require tweaking or day-to-day adjustments, and there is no registration drift or tubes to replace. The stability of its electronics is simply superb!

Once it's started, you'll appreciate the Marconi B3410 for its fully digital processing and CCD image sensors that provide an extraordinarily true video picture. Moreover, the Marconi B3410 has a light bias facility that resolves dark areas of the film. It converts into all international standards and interfaces with all available color correctors.

For more information on specifications and the cost of the Marconi B3410, call us in New Jersey (201) 767-1000 or in California (213) 466-5066.



A.F. ASSOCIATES INC.

ADVANCED SYSTEMS AND PRODUCTS FOR THE VIDEO INDUSTRY
AFA PRODUCTS DIVISION 100 STONEHURST COURT, NORTHVALE, NJ 07647

Circle 108 on Reader Service Card

See us at NAB Booth #1611

stance, showed its work on progressively scanned, motion adaptive receivers—converting standard NTSC signals into flicker-free images with no cross-color or dot crawl, using a digital framestore mounted within the TV set. The same kind of technology was on view at the Hitachi booth, except in a larger, more commercial version, designed for large audiences rather than home viewers.

On the transmission side, the technology exhibit included a demonstration by RCA of the advantages of multiplexed analog component (MAC) satellite transmission, especially when applied to DBS service. The advantages, proved through a live demonstration of a return satellite feed, include absence of color crosstalk because of the completely independent handling of luminance and chrominance. The system is compatible, it might be added, with current NTSC transmission.

Another exciting demonstration, from Germany's IRT, showed astonishing work with three-dimensional

television—both "genuine" 3DTV in which the original production camera is outfitted with special lenses providing side-by-side images that translate into 3D when viewed through special glasses, and also a "pseudo" 3D in which perspective is added to ordinary two-dimensional images.

Still another significant event at SMPTE was a series of test conducted by the Working Group on Component Analog Video Standards, chaired by Merrill Weiss. The working group is developing a series of interface standards for both parallel and serial interconnections at the studio level and for parallel interconnection of cameras and recorders in the field, and the tests were of a new time-division-multiplexed component analog video signal. The results of the tests will help to validate choices the working group has recommended with regard to the form of the signal to be used for single-cable serial interconnections in the studio and that of the waveform to be used to carry that signal.

Congress and NAB Argue Deregulation Bill

Though the House Telecommunications Subcommittee has hit a few snags in drafting its broadcast deregulation bill, more progress has been made than anyone expected. Deregulation of radio and elimination of comparative renewals for radio and television stations are expected to make up the main body of the bill, with amendments added on to settle remaining disagreements.

Two issues are children's programming and a possible review of radio deregulation. The subcommittee's chairman, Rep. Tim Wirth (D-CO), wants five hours a week of children's programming required of broadcasters and an FCC review of radio deregulation in five years with the power to institute controls. Both ideas are being fought by the NAB. Rep. Tom Tauke (R-IA), author of another deregulation bill that received industry backing, has suggested amendments deleting the first provision and writing in the second. Wirth and the NAB were considering the compromise as of press time.

Both parties have also disagreed on what percentage of broadcasters who air the least amount of local and informational programming should be required to improve their performance.

Wirth had established this need in return for the basic deregulation agreement and has suggested approximately 30 percent of stations, depending on category. The NAB wants no more than 15 percent.

Perhaps the most difficult obstacle has turned out to be equal employment regulations. Rep. Mickey Leland (D-TX) has staunchly held that broadcasters must match the EEO quotas included in the cable industry's bill, which is now awaiting action from the Energy and Commerce committee. That bill requires operators with five or more full-time employees to employ women and minorities in at least half their proportion in the local labor force. For companies with over 10 employees, 60 percent parity is specified. The NAB strongly objects to this provision, but Leland is said to be equally firm, having started with higher figures in mind.

Microband Announces Multichannel Service

Multichannel subscription television will start becoming available in cities across the U.S. this year, according to Microband Corp., the MDS common carrier and subsidiary of Tymshare, Inc. Microband has leased excess mi-

**IF YOU TOOK
THE PLUNGE INTO
THE GRASS VALLEY
MARK II DVE®...**

**NOW YOU CAN
ADD THE
E-FLEX
PERSPECTIVE/
ROTATION
ACCESSORY!**

Call us for details—
1-800-323-6656

NEC
IMAGINE WHAT WE'LL DO NEXT
NEC America, Inc.
Broadcast Equipment Division
130 Martin Lane
Elk Grove Village, IL 60007
In Illinois: 312-640-3792



Circle 109 on Reader Service Card



**ONE OF THE FEW EFFECTS YOU CAN'T DO
ON THE EXPANDED E-FLEX SYSTEM.**

YET. We're working on it, though.

In the meantime, almost anything else you can think of is possible. Because we've just expanded the E-FLEX DVE® system with a new Perspective/Rotation accessory. So now, you can rotate images through all three axes. Add depth through perspective. Combine those effects with basic E-FLEX effects including split, compression, mosaic, Multi-move, and trajectory. And store it all on NEC's bubble memory cartridges.

We can't resist noting that our new capabilities make E-FLEX the virtual equivalent of systems costing far more. But more importantly, they make E-FLEX an instrument of almost limitless possibilities. One that takes only a few hours to master—and perhaps a lifetime to fully explore.

What's more, the E-FLEX system is modular. So you can buy it all at once, or start small and add later. And as we develop more capabilities, you'll be able to plug them right in.

To find out what E-FLEX can do now, call NEC at 1-800-323-6656.

By the time you call, we may have perfected the effect in the picture.

NEC

IMAGINE WHAT WE'LL DO NEXT

NEC America, Inc., Broadcast Equipment Division
130 Martin Lane, Elk Grove Village, IL 60007. In Illinois: 312-640-3792

Circle 110 on Reader Service Card

crowwave capacity on a dozen instructional television fixed service (ITFS) stations so far and plans to cover 25 to 30 cities using scrambled signals. The new service, named Urbanet, will offer subscribers 12 to 18 channels of entertainment and instructional programming, with interactive services planned in the next five years.

Under agreements signed with educational and social service organizations, Microband will pay rental fees, which it has not released, for unused ITFS channels, some of which will be

available during the day and almost all at night and on weekends. It will also operate the transmission systems, upgrade existing ITFS equipment at institutions, and provide receiving units. Rates for the tiered entertainment channels are expected to be competitive with cable prices.

Microband estimates that its startup costs will run substantially less than a cable company's. Installment and hardware per subscriber are figured at \$250 to \$300, less than cable's, and no losses due to homes passed by will have to be

absorbed. It also says its operating costs will be fractionally lower.

As currently described, the system will broadcast to subscribers by microwave (2500–2596 and 2644–2688 MHz), supplementing the VHF/UHF channels they now receive. Programming will be distributed via satellite to receive-only dishes and then beamed by STL to microwave transmitters. Microband estimates that by locating its transmitters on the highest point available in each city, it will cover an average radius of 15 to 20 miles. Twin antennas will be installed on each subscriber's roof in addition to the regular VHF/UHF antenna, and the company plans eventually to provide one mast with a dual polarized antenna.

Once received, all signals will go through a downconverter, a preamp will enhance VHF/UHF signals, and a selector described as "very, very similar to a cable box" will provide hookup to the television sets. Using a remote keypad, subscribers will get VHF/UHF stations through their normal tuners and access Microband offerings through an unused VHF channel.

To make the system interactive, which Microband says will happen within five years, subscribers' telephones will be wired into the addressable selector. Teletext and videotex, pay-per-view, and downloading to VCRs and home computers are planned, using Tymnet, another subsidiary of Tymshare. Tymnet is a data communications company located in 350 cities.

Microband's plans for Urbanet are based on two requirements, the first of which is the leasing of ITFS channels. Last May, in response to a Microband petition, the FCC authorized ITFS stations to lease their channels, which have generally gone unused since being allocated in 1962. Currently Microband says it has contracts with license-holding institutions in New York, Chicago, San Francisco, Washington, DC (where operations are scheduled to begin this year), and nine other major cities. Agreements with institutions whose licenses are pending would deliver another 11 cities such as Miami, Denver, and Houston.

Institutions that have signed range from the University of California and Harvard to public school systems and hospitals, including the Network for Instructional Television. Though Microband will not say what it is paying, at this time a large part of the institutions'

Our consoles never die. They just keep fading away.

Built like a tank. Handle like a dream. Smooth, sure, responsive. And won't let you down.

That's LPB, for the air and production boards you see coast to coast—in local to network stations—from 100 watts to 100kw.

It isn't that we're all-solid-state, or that we make 5, 8 or 10 channel mixers, mono, stereo or both. It's simply because LPB consoles don't seem to break down. And that's on the record.

But features count, too. From pre-fader pushbutton cues to programmable muting logic, let's say if it's essential, we've got it!

If you're keeping current on consoles, get the specs on LPB equipment. Call 215-644-1123 or write LPB Inc., 28 Bacton Hill Road, Frazer, PA 19335. (Telex 703000.)

A lot of consoles will come and go in your time. But not if they're made by LPB.



LPB®

Our call letters make news 'round the world.

Circle 111 on Reader Service Card

LEADER

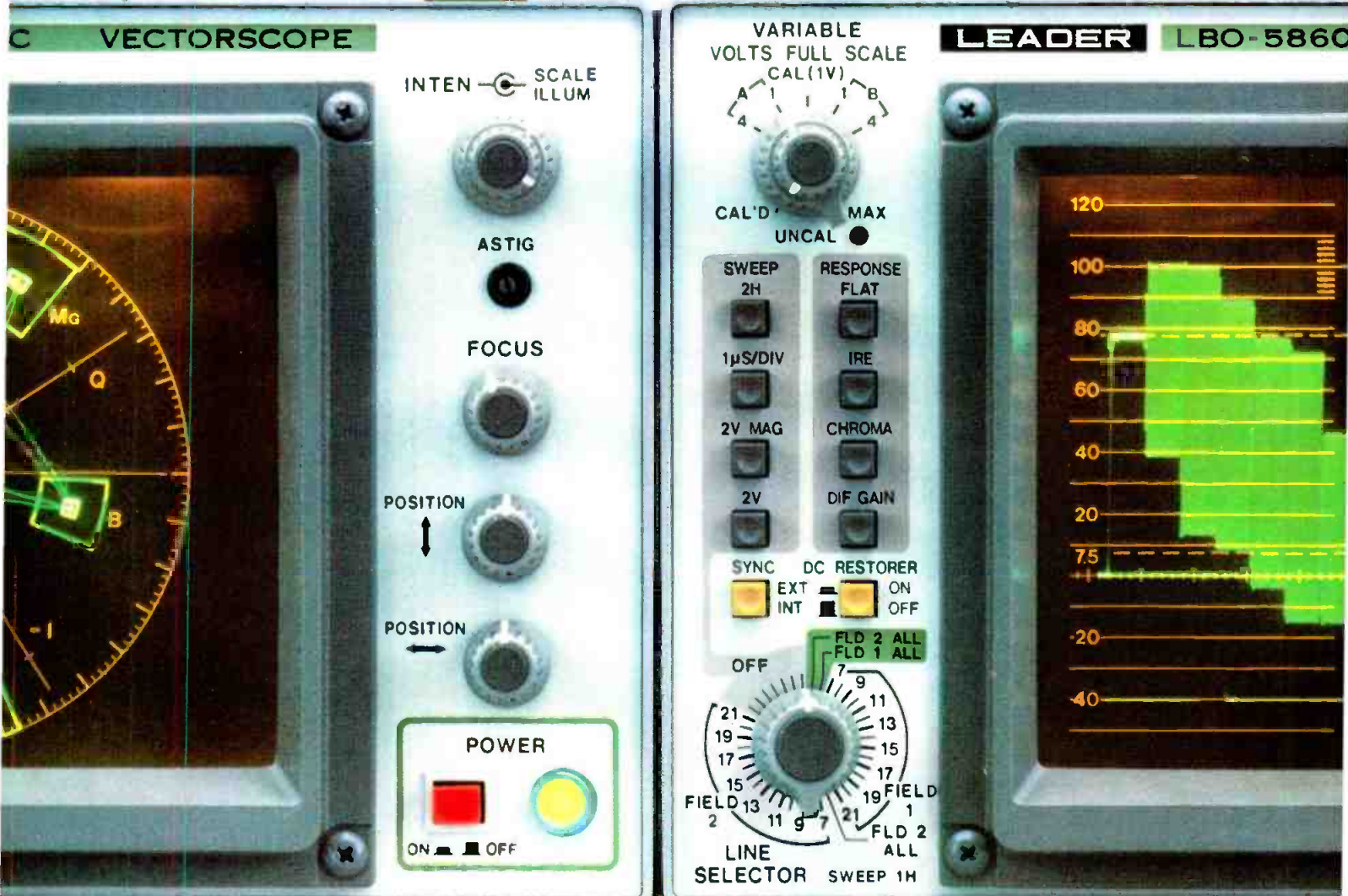

ACTUAL SIZE

Two Leaders with an important following.

Check the racks of the industry's leaders, and you'll find Leader instruments. At ABC, Sony Broadcast, Reeves, Zenith, HBO, RCA, A.F. Associates, Group W, ATC, Midwest Corporation, and NBC, to name a few... where quality is paramount, Leader has been their choice.

You could pay more for others. But you'll get more from Leader.

For instance, our half-rack LBO-5860A Waveform Monitor is the only one that lets you select

lines 14-21 (fields 1 and 2) from the front panel. And there's an L model that shows you lines 7-21 for coding information, too. Our half-rack LVS-5850B Vectorscope is the perfect mate, with selectable, electronically-generated targets* that can be read from across the room. Electronically-generated targets also provide the highest level of measurement accuracy, even if you misalign the CRT center dot. It also has an internal etched graticule, and gives a VITS display with strobe input.

More than just competitively priced.

The convenience of viewing both vector and waveform displays simultaneously gives you uninterrupted monitoring capability.

Top broadcasters rely on Leader quality. It's backed by a two-year warranty (including CRT's) and factory service depots on both coasts.

Ask for a catalog of our waveform monitors, vectorscopes, signal generators and other instruments; an evaluation unit, and the name of your nearest "Select" Leader distributor.

Call toll-free
(800) 645-5104

In New York State
(516) 231-6900

For professionals

who know the difference.

LEADER
Instruments Corporation

380 Oser Avenue
Hauppauge, New York 11788
Regional Offices:
Chicago, Dallas, Atlanta,
Los Angeles, Boston
In Canada call Omnitronix Ltd.
(514) 337-9500

Circle 112 on Reader Service Card

*patent pending

incentive lies in their simply being able to make use of the channels.

Microtime's other requirement is programming. Mark Foster, chairman of Microband, insists that most cable regulars such as HBO, Showtime, Disney, and CNN will sign though no negotiations were underway at the time of the announcement. Microband currently distributes HBO and Movietime as a single-channel MDS.

If the major programmers can be signed, Microband should be able to

position itself well in many urban markets, making cable's return on investment, already problematic, even more difficult. In cities not yet wired, Microband potentially could have first grabs on homes interested in premium programming. In areas that have been cabled, Microband expects to pick up subscribers in unwired sections, again skimming off subscribers. Foster will not comment on Microband's appeal in cities such as Milwaukee, where Warner cable is trying to renegotiate its

franchise. "Most people would not switch from cable to us," he says, "but if you do not have cable, we will be competitive."

KTTV Plans Teletext Service for Olympics

Metromedia's KTTV in Los Angeles has announced plans, in cooperation with Sanyo, Harris/VG Electronics, Zenith, Taft Broadcasting, and Keyfax to create a teletext service for the 1984 Olympics in Los Angeles. The technology to be used is World System Teletext, developed by the BBC and represented in the U.S. by Ameritext.

KTTV will install Sanyo and Zenith receiving terminals equipped with teletext decoders in approximately 200 high-traffic locations around the Los Angeles area. Using VG Electronics teletext origination equipment, KTTV will broadcast up-to-the-minute traffic information and news about Olympic events, as well as the Keyfax national teletext magazine.

The decision to use World System Teletext rather than its competitor NABTS was made, according to Lou Schatzer, VP of promotion at KTTV, because of price advantages and commercial availability of decoders for World System Teletext. However, Schatzer stressed, "This is strictly a short-term demonstration project for KTTV. Metromedia is making no commitment to any system at the moment." Metromedia's WFLD in Chicago has been broadcasting the Keyfax magazine using World System Teletext for the past three years.

Networks and Producers Wrangle a Stalemate

Negotiations between the networks and producers over financial interest and syndication regulations have come to a halt. CBS was the last network to pull out, citing unresolvable differences over the definition of "net profits" to be divided and when financial interest discussions with a show's producer would take place. ABC and NBC had already ceased their efforts, saying that producers were not showing good faith.

Both sides appear to think they have a strong position. Motion picture spokesperson Jack Valenti and the



Use the New SMART CHARGER from ALEXANDER!

Charge up to six battery packs without buttons to push or lights to monitor. Attach BP-90 type, or on-board type equipped with a QRSV mounting bracket, to one of the holders. This new charger will bring the unit to full charge in less than two hours, then automatically go to trickle. Add up to five more packs, and each will be brought to full

charge in sequence—again, automatically. There's no need to bother with monitoring, or worry about overcharging. The consistent 2-amp charge means you'll get fresh packs with no damage to the cells. And this new



BP-90 and on-board types can be intermixed.

charger is backed by the reputation of the nation's largest independent supplier of replacement battery packs.



BE SMART! See our line-up of new Smart Chargers, replacement battery packs, and battery analyzers at the NAB Show, Booth 1714.

Alexander Mfg. Co./1511 S. Garfield Pl/Box 1645/Mason City, Ia. 50401 515-423-8955

Circle 113 on Reader Service Card

A step ahead in creativity ... and affordability. **IMAGES II**

**New Price
Breakthrough!
\$46,000.**



Now the most advanced computer graphics system in the world is also one of the most affordable.

The **IMAGES II** System is designed for the artist to put everything at his fingertips to create any type of visual message, emulating any conventionally rendered effect... and beyond. With the **IMAGES II** computer based artist workstation the artist can do quick sketches or fine airbrush renderings, starting "from scratch" or utilizing scanned-in artwork, in a fraction of the normal time. The system may be configured to output in a variety of polaroid formats, 35mm transparencies, or videotape, in resolutions from 512 to 4096.

In applications as diverse as advertising and design, TV production, training, corporate communications, defense, education, and fine arts, **IMAGES II** ushers in the next step in creativity, providing the maximum utility for streamlining all of the artist's daily activities.

If your organization is ready for the next step, talk to us to see how affordable the future can be.

Ask about our 2-D cartoon animation and 3-dimensional animation systems.



Computer Graphics Laboratories, Inc.

THE CHRYSLER BUILDING, 405 LEXINGTON AVE., N.Y., N.Y. 10174 (212) 557-5130

Circle 114 on Reader Service Card

SAVE
\$340⁰⁰

DIGITAL AUDIO DELAY

BLEEPMATE™ 675/II

\$1285

~~\$1625~~

NAB Sale

Now you can buy this solid-state simplicity for hundreds less than many tape delays cost.

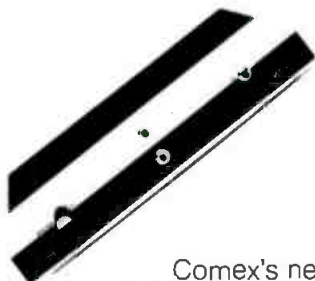

Comex's new Bleepmate-675/II a simple yet sophisticated, fixed, 6-second solid-state delay, has no moving parts (so technical and on-air talent aren't bothered by endless tape/head upkeep). And the 675/II has a broad \pm 1dB, 20Hz to 7.5KHz response. Its low price makes systems redundancy practical, too.

- Limited offer.
- Call or write now.
- Sale ends
6-30-84

Comex Systems
2 Columbia Drive
Amherst, N.H. 03031
(603) 889-8564
Telex 953120

Comex Systems
A Division of the Successor Corporation

COMEX SYSTEMS

Circle 115 on Reader Service Card

NEWS

Committee for Prudent Deregulation, a producers coalition, say they are ready to resume negotiations at any time. So far they have bargained the limit on network ownership of the network production schedule down from 40 percent to 27.5 percent. They have also angered the networks by suggesting new limits for network in-house production, a subject that was supposedly settled in consent decrees handed out earlier by the Justice Department.

As a result, rather than hold further talks, ABC and NBC indicated interest in extending the present moratorium on FCC action, which is due to expire May 10. CBS, however, has come out in favor of letting the Commission act, presumably on the assumption that it will continue last year's movement toward

deregulation of syndication and financial interest.

Another party to be reckoned with is President Reagan, who has said he favors holding off on any action for two years. FCC Chairman Fowler came under some criticism for meeting with the President in what Fowler calls a briefing and Rep. Wirth's Telecommunications subcommittee views as a possible Administration huddle.

The result of all this maneuvering may be a lack of action in 1984. Even if the FCC moratorium is not extended, as Reagan has proposed, Congress still faces election distractions, and the Commission's deregulation proposals could stay balanced between the contending forces.



At Z-Axis, a new Denver facility specializing in computer-generated graphics for the commercial production and industrial markets, senior VP Phil Zimmerman (seated) and president Steve Cohen work with the equipment. The system includes a Bosch FGS4000 computer graphics system, Ampex ADO, Chyron character/graphics system, and Ampex ACE editor.

Cable TV Will Grow, But at Slower Rate

Separate studies prepared by Veronis, Suhler & Associates, and Frost & Sullivan show an energetic past and promising future for cable TV. The VS&A study found a 55 percent revenue growth and a 41 percent pretax operating income growth for the average CATV operator during the five-year period ending in 1982. But it also

found that over the same period, average CATV profit margins were cut by a third, and the rate of revenue and income growth slowed during each of those years.

The Frost & Sullivan study predicts that by 1993, CATV revenues will hit \$21 billion, with 67 percent of TV households nationwide subscribing, and \$13 billion spent on programming. Advertising revenues are projected at \$4 billion.

BALANCE

The symmetry gained from the equalization of complimentary forces. Symmetry as in the precise blending of sensational chrominance with outstanding signal-to-noise. Symmetry resulting in a video tape of breathtaking balance. Ampex 196.

AMPEX

Ampex Corporation - One of The Signal Companies 

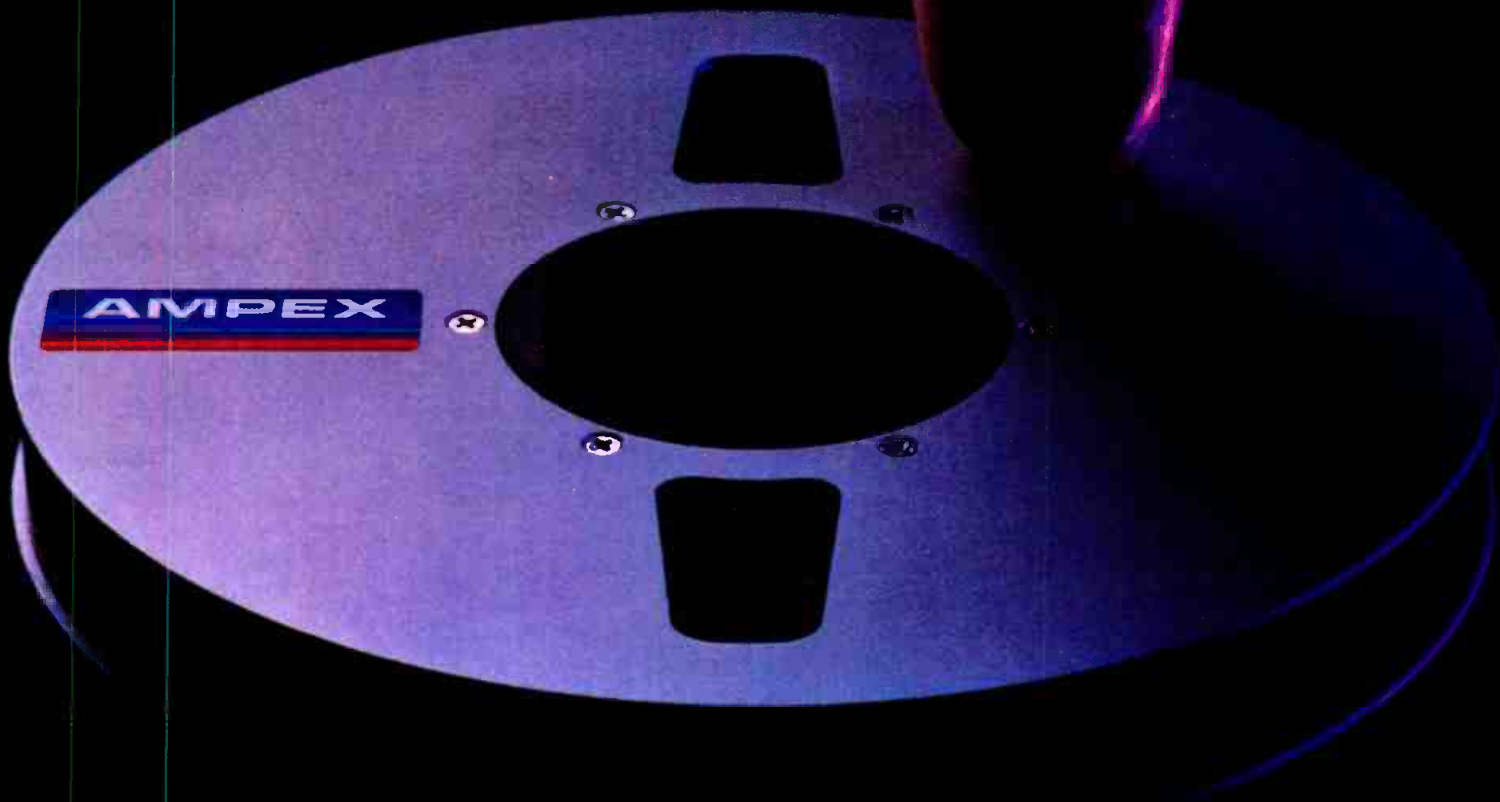

Ampex Corporation, Magnetic Tape Division, 401 Broadway, Redwood City, CA 94063, (415) 367-3809

Circle 116 on Reader Service Card

NEWS BRIEFS

The FCC's User II decision, allowing Comsat to function as a common carrier, has been reversed. The Court of Appeals for DC Circuit held that the Commission had not studied direct access and independent earth station ownership issues and that resulting increases in intercontinental cable rates would not be in the public interest. ITT, RCA, WUI, and TRT had filed petitions. . . . **Taft Broadcasting** now has a satellite communications office, headed by Jack Morse in Cincinnati, offering occasional use time on Westar

V and uplinks in Washington DC, Kansas City, and Birmingham. . . . **NPR** will share one full-time audio channel with The Moody Bible Institute, Chicago, and two full-time channels with WTSU, Montgomery/Troy, and the Troy State University Foundation.

The FCC has proposed allowing telephone common carriers blanket permission to provide **cable television** service outside their service areas. The Commission says that applications, about 20 a year, are always granted and

wants to save processing costs. . . . Testifying for the NAB, David Polinger of WPIX, New York city, told the House Judiciary Committee that H.R. 3419 would exempt "national cable broadcast networks" or Ted Turner from the Copyright Royalty Tribunal's **3.75 percent royalty rate**. House bill 2902, exempting the first three distant signals on any cable system, would just add three more signals for free, Polinger said. The NAB would rather have the 3.75 percent waived for all TV signals within the ADI where the cable system operates.

Audicom Corp. has received FCC approval for its **commercial verification system** (see *BM/E*, Nov. 1983, p. 24), which uses encoded audio signals.

Microwave boosters, or non-translating repeaters, have been approved by the FCC. No requirements were set for the STL and ICR equipment other than existing installation requirements. . . . NAB has asked FCC to act on **FM translator violations**, citing 30 second origination infractions, operators other than community groups running ads, and program feeds via microwave or satellite. . . . NAB has declined the FCC's offer to administer the compensation program for **Cuban interference** with U.S. AM stations, and has urged the Commission to create as little paperwork as possible. . . . NAB has filed its support in Washington DC's Appeals Court for the FCC decision to allow broadcasters to sponsor **debates between Presidential candidates**. The League of Women Voters is contesting the ruling. . . . NAB has issued a booklet explaining how to oppose **state and local attempts to tax broadcasters**. For copies contact NAB's Legal Dept.

SFN Companies, Glenview, IL, will buy WFTV from Channel Nine of Orlando for a reported \$125 million in cash. . . . Rockefeller Center said it has completed its acquisition of **Outlet Company** for \$332.1 million.

The application deadline for **SBE certification exams** is April 16. Exams will run June 15 to 23. . . . The **Defense Information School (DINFOS)** is compiling an alumni list for its 20th anniversary celebration this July. Alumni can supply details about their armed service, school attended, graduation date, present occupation and address to Public Affairs Office, DINFOS, Bldg. 400, Ft. Benjamin Harrison, IN 46216.

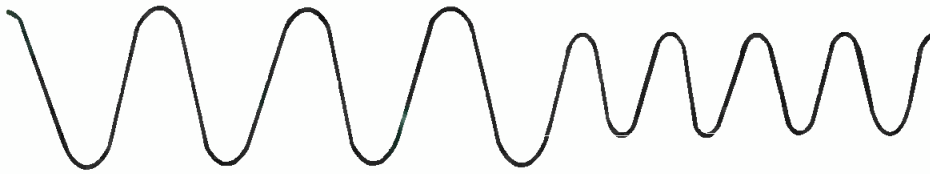

Overvoltage - Undervoltage Deal With It.

Proper and steady voltage is essential to the operating efficiency and tube life of a transmitter. Automatic voltage regulators are the most overlooked components of a transmitter installation. Don't ignore your transmitter's needs.

USE THE AVR MOST SUPPLIED BY TRANSMITTER MANUFACTURERS:

HIPOTRONICS AUTOMATIC VOLTAGE REGULATORS

Models Available

Voltage: 240 V, 380 V, 415 V, 480 V, 2400 V, 4160 V
Single & Three-Phase

Input Ranges: +9/-14%, ±20%
Correction Rate: Up to 20 volts/sec

Amps: 40 A - 900 A

Options:

Individual Phase Control
Line Bypass Switch
Special Output Adjustment (50-100%)
Custom Design

NAB: Booth 1779

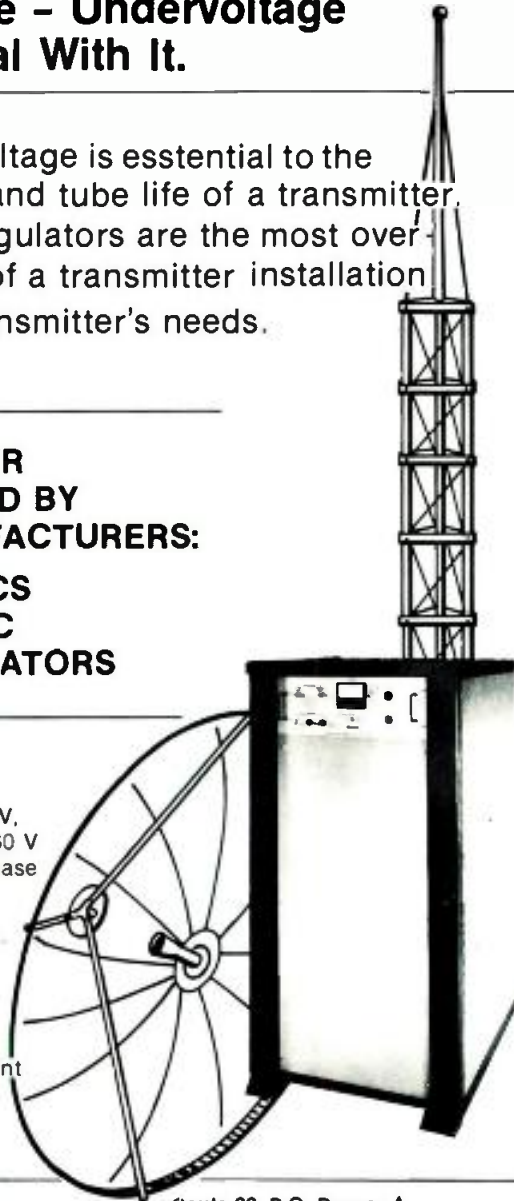

Route 22, P.O. Drawer A
Brewster, New York 10509
Phone: (914) 279-8091
Twx: 710-574-2420 HIPO BRWS NY

Circle 119 Send Literature Only

Circle 120 Have Salesman Call

CUSTOMIZED EXCELLENCE



WPMT Mohawk Broadcasting of York, Pa. had a clear vision of what they needed. They wanted a state of the art facility, turnkey operation, brought in on time and in budget. The Lerro Corporation came through on all counts.

The Lerro Corporation has the people, experience and creativity to design, engineer, install and provide the follow up support for your facility. Let us show you, face to face, what we can do for you.

For information, contact The Lerro Corporation, 3125 N. Broad Street, Philadelphia, Pa. 19132 • (215) 223-8200.

 **LERRO**
ELECTRICAL
CORPORATION

www.americanradiohistory.com

"Panasonic Recam™ made our



On Saturday mornings, children all over America are being entertained by a unique new CBS-TV series, "Benji, Zax and the Alien Prince." What makes this show unique is more than a lovable dog. It's the fact that this Mulberry Square Productions project is the first network series

entirely shot and edited on ½-inch tape. And the system they selected was Panasonic Recam.

One of the reasons Joe Camp selected Recam is its incredible YIQ M-Format picture quality. Another reason is its portability. It makes changing scenes and locations fast

and easy. And that's important on a tight production schedule.

What's more, this "Benji" production utilizes Recam's remarkable ½-inch off-line editing system, after which, each show is transferred to 1-inch for television broadcast.

Recam was also selected by ABC

new Benji TV series possible."

Joe Camp, Creator of Benji.

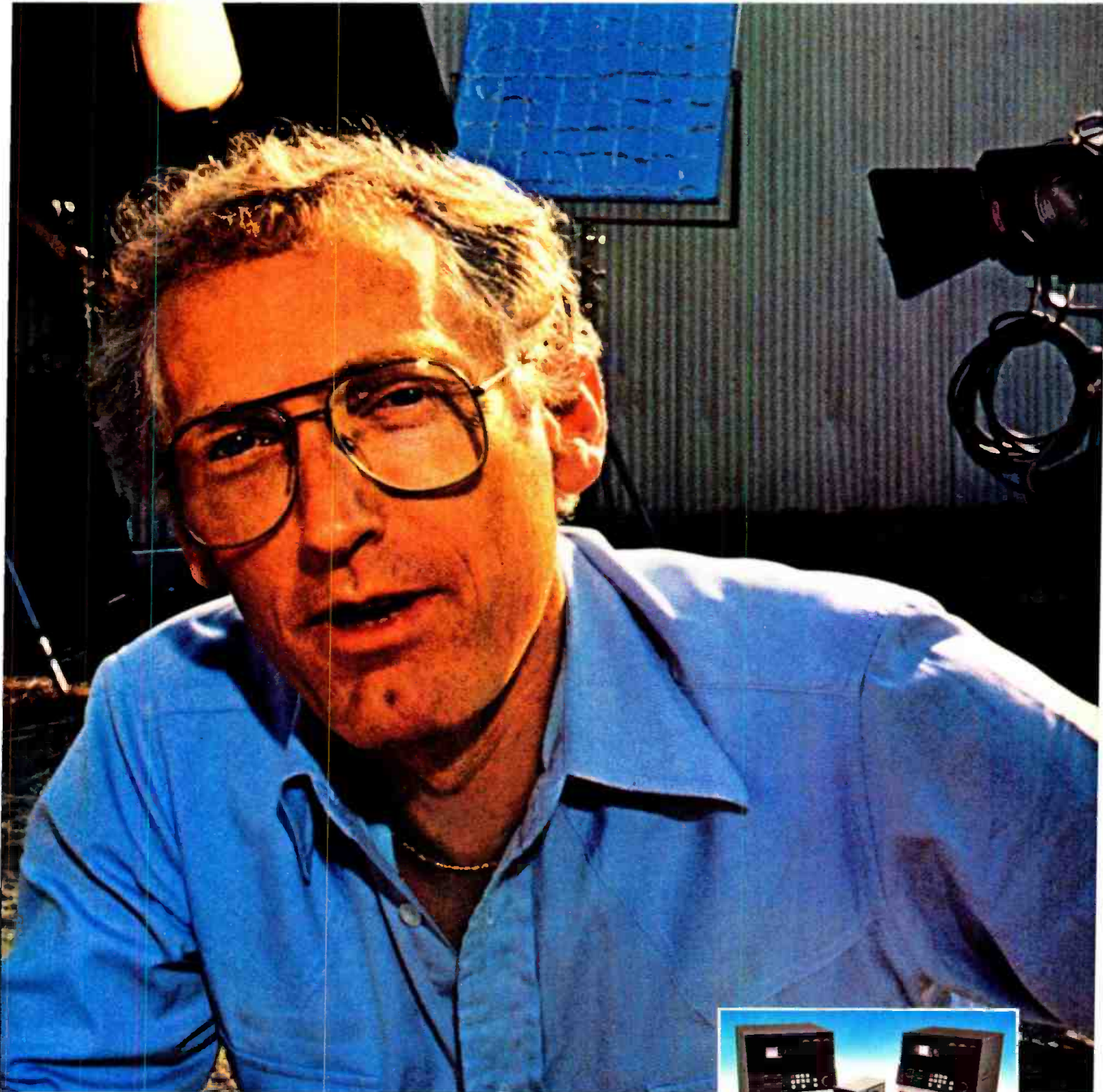

Sports to record their momentous ascent of Mt. Everest for "The American Sportsman." And by the producers of the epic science-fiction film "Dune" to record "The Making of Dune" for TV broadcast in 1984.

You can see "Benji, Zax and the Alien Prince" on Saturday mornings.

But you can see Recam right now. Just call your nearest Panasonic regional office:

Northeast: (201) 348-7336

Midwest: (312) 981-4826

Southeast: (404) 925-6835

Southwest: (214) 258-6400

West: (714) 895-7200



Panasonic
AUDIO-VIDEO SYSTEMS DIVISION

Circle 121 on Reader Service Card

155 STATIONS ARE WITH US! MORE RECEIVER BUILDERS CLIMB ON BOARD! MOTOROLA C-QUAM AM STEREO ROLLS ON!

And the bandwagon picks up speed! As of now, 56%* of the listening population of the U.S. is covered by C-Quam!

GM/Delco already offers C-Quam single system receivers in '84 models. Chrysler to follow in '85 models.

Concord, McIntosh, Samsung, Sherwood and other receiver manufacturers are gearing up for production right now!

If you expect those sets to play your kind of music, call Dick Harasek at (312) 576-2879, or Chris Payne at (202) 862-1549. Or see us at the NAB Convention, Booth 309.

*based on Hiber, Hart & Patrick estimates

MOTOROLA AM STEREO. THE WINNING SYSTEM.



RADIO programming & production

KGON Hooks Up To Its Listeners

One day in November last year, the deejay for KGON of Portland, OR announced that he would give albums to the first ten callers who could meet one condition. The call had to be made by a computer.

This bizarre request was the inauguration of KGON's computerized Bulletin Board Service, a free source of information put together for the rock-music community in Portland. Listeners who owned or had the use of a computer and modem telephone link could tap into a computer at KGON and choose from a dozen topics such as upcoming concerts, free software, or how their favorite group ranked on the station's top-40 playlist. By the end of that first day, over 100 calls had been logged, and KGON had strengthened its claim of being the trend-setting station in Portland.

Recalling the event, Dave Van Dyke, program manager of KGON, admits that no spots had been produced for the announcement. "We just wanted to see what kind of reaction we'd get," he says, then adds that the one-day-promotion was the only push needed to keep calls coming in all week. Currently, the Bulletin Board logs around 2000 accesses (calls) per month and has assembled a users' club of 250 members.

The idea of a computer service designed for radio listeners grew out of the personal interest that Van Dyke and several station members developed in computers last year. Electronic bulletin boards had been one of the first uses they had learned of when they bought their computers, and they were surprised to find out that local versions were already in operation in the Portland area. The station found it to be just "a natural extension" that as an established entertainment and information center, it should also provide those resources to the community via computer.

Something more

"Listeners like being able to do something besides listen," observes

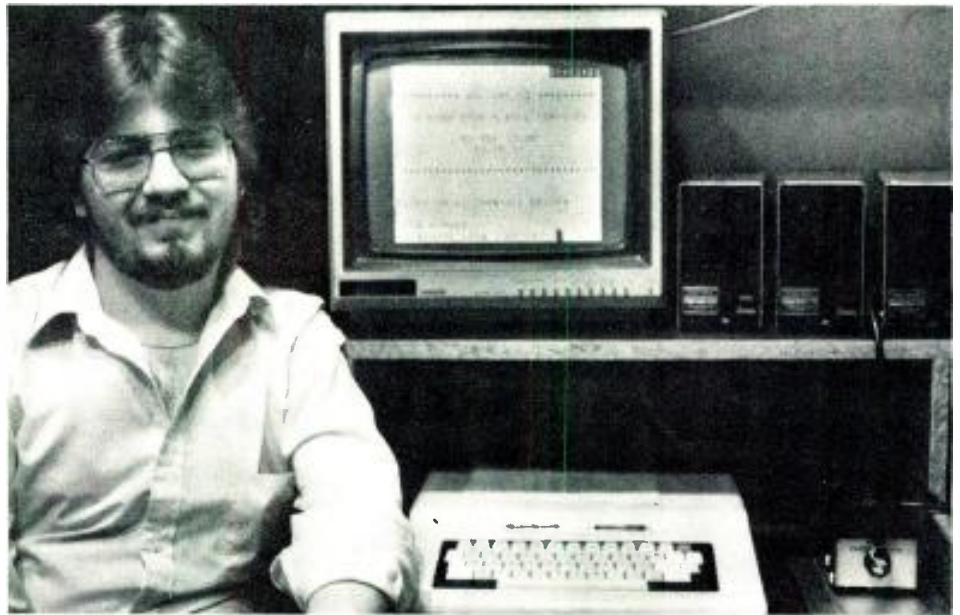

System operator Mark Vodka sits beside the Radio Shack color computer and disk drives which hold the Bulletin Board Service.

Sandra Glantz, who runs promotion for the album rock station. The Bulletin Board Service (BBS) certainly provides that. With 18 to 20 menu options or Rockfiles to choose from, plus the recently added interactive section, the problem today is handling the line of callers awaiting their turns. So much so, that BBS has had to impose a 15-minute limit per user.

The Rockfiles include lists of Portland's top-selling albums and videogames, top videocassette rentals and software sales, information such as concert reviews, a daily calendar of events, and rock news stories. Offbeat stories are pulled from news wires and the local news media and run in a file named "Real Stories". Users can also acquire from the computer free programs, often games, which the station has developed or are in the public domain. News and events are updated each day; playlists, each week—and all files are emptied at least once a month.

At the beginning of this year the Bulletin Board began offering an interactive message service which has already passed through what Van Dyke remembers as its golden age. In its first form, the interactive capability allowed any-

one to leave messages or notices for general reading on the Board. The Board thus became a real bulletin board serving the Portland computer/rock community.

Before long, however, the mother of a young Board user noticed some Anglo-Saxon expletives on her son's screen that did not look like computerese, and she called Van Dyke. It was not a completely unexpected development, he says, but he was obliged to lock off the message-writing section.

"You know computers have really reached the mass level," he comments wryly, "when you get people who are computer-literate leaving nasty messages to each other."

Interactive capacity

Under the Board's current set-up, when someone phones in, they are asked for a membership number. Those who don't have one are let into the Rockfiles section while members can go directly to a file. Before non-members exit, they are asked whether they would like to become a member. If so, they supply their name, address, phone number, and type of computer. Anyone can join, and those who share a

RADIO PROGRAMMING

computer, such as families, are not limited to one membership. The resulting list is reviewed each month, and infrequent users are deleted. Van Dyke says he keeps the total at 255.

The principal advantage for members is their computer "mailboxes," in which other members or the station can leave electronic messages called E-mail. These letters can be up to 64 lines long, and allow corrections like a word-processor. Van Dyke says that the volume of the mail varies quite a bit, as do the messages' content. The station also uses the boxes to conduct polls; members respond to questions using a message file. Topics range from Reagan's foreign policy to albums aired the night before. Since the Bulletin Board has been interactive only a few months and the sample is far from scientific, Van Dyke has not tried to draw any conclusions from the responses.

Members can also signal the station that they'd like to "talk" via computer if Van Dyke or someone else is available. The program manager sometimes initiates conversations with whoever happens to be using the Board, asking

about what music they like and whatever other subjects come up.

All this is done with relatively simple hardware and some software customized in house. A Radio Shack color computer with 64k capacity runs the show, augmented with three disk drives. The one phone line is hooked up using a Hayes smart modem. If more lines are added, a new disk drive may be able to handle each, Van Dyke estimates, but at present the total hardware has cost about \$2000, plus a maintenance check every month. Putting out a comparable newsletter, Sandra Glantz says, would cost \$5-10,000 per issue.

Hard and software

A lot of trial and error went into the BASIC software, which traces its origins back to a free program similar in function to the present version. Chris Burns, KGON's news director, and Van Dyke, along with the half dozen other computer "hackers" at the station, rewrote, experimented, and learned along the way since none has any formal training in programming. It meant a lot of "falling on your backside," Van Dyke recalls, but in four

months they had come up with a workable program which they continue to improve.

To find out what problems might be lurking in the system, friends were asked to call and take the system through its paces. After nearly a month of testing, KGON's Bulletin Board Service was ready.

The effort turned out to be well worth while. The Board was formally announced in mid-November, and during the following month of operation 1000 calls were received. The total jumped to 3000 in January, due to Christmas sales, Van Dyke assumes, then dropped back to 2000 and has held steady since.

Operating hours during the week are from about three to four in the afternoon to 10:00 a.m., Pacific time. On weekends the system is up 24 hours. The busiest period is from 6:00 to midnight; Van Dyke says that often he cannot get a call in until after midnight. He also finds that Portland's weather makes a big difference.

Besides giving rock fans something to do with their home computers, the Bulletin Board has boosted KGON's



It speaks for itself.

The Orban 622B Parametric Equalizer has achieved near-legendary status in the broadcast industry for good reason. It is the most flexible, musically-useful equalizer on the market today. And, it offers the broadcaster unlimited versatility in production room sweetening as well as the capability to be used on the program line to tailor the sound of the station.

The 622B combines full, 4-band parametric EQ along with tunable notch filters to offer extraordinary control. Our "constant-Q" design provides -40dB attenuation while allowing gentle broadband EQ as well. This means that the 622B can greatly reduce equipment requirements in the production studio.

The demanding broadcaster will also appreciate Orban broadcast-quality construction, stability, reliability, and responsive customer service. Call or write today for details.

orban Orban Associates Inc. 645 Bryant St.
San Francisco, CA 94107 (415) 957-1067
TLX: 17-1480



THE CHOICE FOR '84

	Electronic Switching & Attenuation	Number of Inputs per Channel	Number of VU Meters	Simultaneous Pgm. & Aud.	Single Button Chan. & Remote Functions Control	Cue Detent On Fader	Mic processing loop-thru	Clock	Timer	Mono Mixdown	Peak Audio Flasher	Mics on any input	Input level trims	Tone Oscillator	Price
RADIO SYSTEMS ESA-10	Yes	3	6	Yes	Yes	Yes	Yes	Yes	Yes	Yes	Yes	Yes	Yes	Yes	\$ 8,950
Pacific Recorders BMX-10	No	2	2 (3 op)	Yes	Yes	No	Yes	No	Op	Op	No	No	Yes	No	\$13,250
Audiotronics 212	Yes	2	3	Yes	Yes	No	Yes	Op	Op	1	No	No	Yes	No	\$12,389
LPB Citation C-10SL	No	3	2 (5 op)	Yes	No	Yes	Yes	Op	Op	Op	Yes	Yes	Yes	Op	\$10,205
Broadcast Audio System 12	No	3	5	Yes	Yes	Yes	No	No	No	1	No	Yes	Yes	No	\$ 9,600
Howe 7512A	Yes	1	4	No	Yes	No	No	Yes	Yes	1	No	No	Yes	No	\$ 9,100

The Radio Systems ESA-10 has more standard features than any other console in the industry. Consoles priced comparably equipped. Call Toll Free 800-523-2133. See us at NAB booth number #213. In PA (215) 356-4700

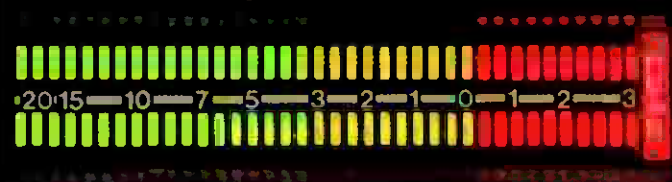

RADIO SYSTEMS

P.O. BOX 356 • EDGEMONT, PENNSYLVANIA 19028

RADIO PROGRAMMING

image in the Portland market. An affiliated television station has featured the computer service twice, and local papers have covered its progress. Van Dyke notes that this cutting edge image fits well with an AOR audience whether or not every fan has a computer. Other stations and formats, he suggests, might benefit even more.

Positioning the station

As the initial excitement over the Bulletin Board has worn off, the station has shifted to a low-key promotion campaign, occasionally running a spot full of futuristic effects. The ad is "not too far out" though, Van Dyke says, so that it won't put off people who may be intrigued by computers but aren't familiar with them either. To encourage this group, which he considers to be important, the Board has been expanded to include more topics relating not just to computers, such as storm and ski reports.

Though Van Dyke emphasizes that the Bulletin Board's appeal is limited, it has positioned KGON for the growing number of home computer users. When KGON researched the

subject last year, home computers were estimated to have penetrated 10 percent of Portland's 1.6 million population; the number of modems was not available. Van Dyke points out that people who have laid out several hundred dollars or more for their machines will probably be willing to pay \$150 for a modem to link up with the outside world. Once people have assembled their systems and have learned how to use them, they will want to take advantage of the ability to hook into a data base. The Bulletin Board helps satisfy this desire, and in doing so becomes another reason to buy a home computer.

That may explain the definite impact it has had on Portland's computer stores. In one file, similar to the traditional lists of top-selling albums, Bulletin Board users can access a ranking of the fastest-selling software in the U.S. Another file catalogues the hard and software sold by local stores, though names are not displayed. Instead, using the recently added interactive capability, the reader can mark items of interest and leave a name and address where literature should be sent. KGON only forwards the user names to the Portland

distributors; it does not supply the merchandise, Van Dyke says.

"Computer stores tell us, 'You don't know how many computers we've sold due to this!'" says Glantz, the promotion coordinator. Unfortunately, she has found that most of the stores' profits and thus their advertising budgets are in the business computer market. So for now KGON is holding off on installing another phone line for the Bulletin Board though doing that would increase the number of users. However, the home computer market is changing, Glantz notes, and the station will keep watch.

As for running ads in the Bulletin Board, Van Dyke finds the potential revenues small in comparison with the value of the users' sense of community. Part of the Board's attraction is that it is free, he says, and if the first thing you see is an ad, you won't feel that. And as a free item, KGON has become a focal point for owners of home computers. Considering what stations spend on promotion in hopes of identifying themselves to such a group, KGON may find the Bulletin Board to be a bargain. **BM/E**

With our Automatic Remote Control System your transmitter – and your personnel – will operate with increased efficiency

Have you ever wondered if your night operator will remember... to switch patterns at sunrise?... to periodically check critical levels?... the correct transmitter restart sequence? You'll never have to worry if Potomac Instruments' RC16+ is on the job. Because it'll do all these tasks for you. Plus a lot more. Automatically.

With its microprocessor based control logic, the basic RC16+ provides 16 telemetry channels with automatic out-of-tolerance alarms and remote raise/lower controls;

plus 16 status channels. The automatic functions — pattern shift, transmitter restart, power control — are pre-programmed in accordance with station license requirements and controlled with an accurate master clock.

The RC16+ is also expandable. In 16 channel increments, up to a total of 64 channels. With the remote video display option your chief engineer can get a detailed readout of all measured parameters. It's updated every 30 seconds and connects to any standard telephone. The optional plug-in automatic logger provides a permanent record of all transmitter activity. Log intervals, sequence, and alarm flags are user-selectable.

And, best of all, the RC16+ is cost effective. No other unit on the market offers these features and capabilities at this low price.

Basic System	\$4,995.00
Additional 16 Channels	1,865.00
Plug-In Automatic Logger	2,499.00
Remote Video Display Unit	650.00



POTOMAC INSTRUMENTS

932 PHILADELPHIA AVE. SILVER SPRING, MD 20910
(301) 589-2662

Circle 125 on Reader Service Card

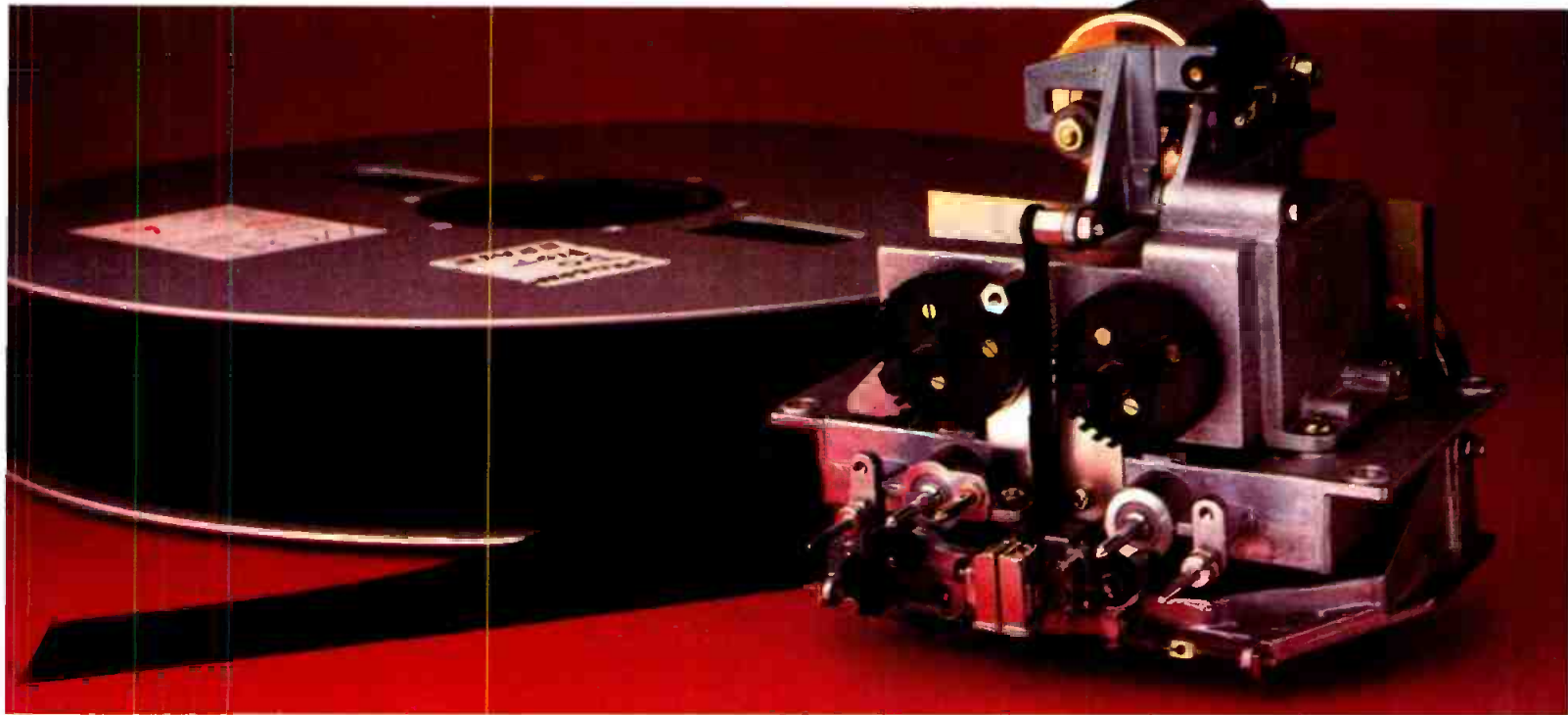

On designing a cassette transport to meet 2" mastering standards.

As an audio professional, you probably work with several tape formats. But your demands for reliability and performance are always the same.

In designing a transport for the Studer A710 and the Revox B710 MKII cassette decks, our engineers worked with the same principles established for our professional open reel decks. No cost-cutting compromises were permitted. For example, the Studer Revox cassette transport is built on a die-cast aluminum alloy chassis, not on stamped metal. This is the only way to assure precision machining and long term stability.

Four direct drive motors handle your cassettes smoothly and gently. Two quartz-locked, Hall effect capstan motors keep wow-and-flutter down to a conservatively rated 0.05% (DIN weighted). Two additional DC reel motors, both servo regulated and microprocessor controlled, provide constant speed fast winding, automatic start-of-oxide cueing, and motion sensing for positive tape protection.

No sleds allowed. Most other cassette decks use a sled mechanism to insert the heads into the cassette shell. The free play inherent in this design often contributes to azimuth misalignment.

In the Studer Revox design, a die-cast headblock pivots upward on two precision (0.001 mm tolerance) conical bearings and

locks into a solid 3-point mount. Because the headblock always locks into exactly the same position, absolute azimuth stability is assured.

One transport, two decks. This remarkable transport can be found in only two tape decks, the Revox B710 MKII and the Studer A710. Features shared by both units include 3 head design, internal 24 hour clock for programmable operation, tape type sensor, Dolby™ B and C noise reduction, plug-in modular PC boards, optional remote control, and adjustable headphone output with ample amplification.

A710: The Studer Version. This deck offers professional line level inputs and outputs, with output levels adjustable from -3 to +14 dBu. It also has calibrated input and output levels, XLR connectors, and a rack mount flange standard.

B710 MKII: The Revox Version. The lower priced B710 MKII has front panel mike inputs, mike/line mixing, and an optional infrared remote control.

For the long run. The Studer A710 and Revox B710 MKII are built for consistent, dependable performance. Hour after hour. Year after year. The kind of performance you expect from the world's most respected name in audio recording.

For more information on Studer Revox cassette decks, contact: Studer Revox America, 1425 Elm Hill Pike, Nashville, TN 37210, (615) 254-5651.

STUDER REVOX

Circle 126 on Reader Service Card



Revox B710 MKII

Studer A710

**We couldn't improve the
conditions you work under.
So we improved
the tape you work with.**

maxell[®]
PROFESSIONAL
INDUSTRIAL P/I

Epitaxial[™]
Videocassette **VHS**

**HGX
PRO** [™]
For ENG
Recording

T120

HGX Pro 1/2" Videocassettes.

Differences you can see, hear. And retain.

At last, tape performance impervious to the whims of weather and the rigors of editing. Maxell has harnessed new tape technology and with it, given ENG dramatic improvements you can see, hear and retain. In the field or under freeze frame.

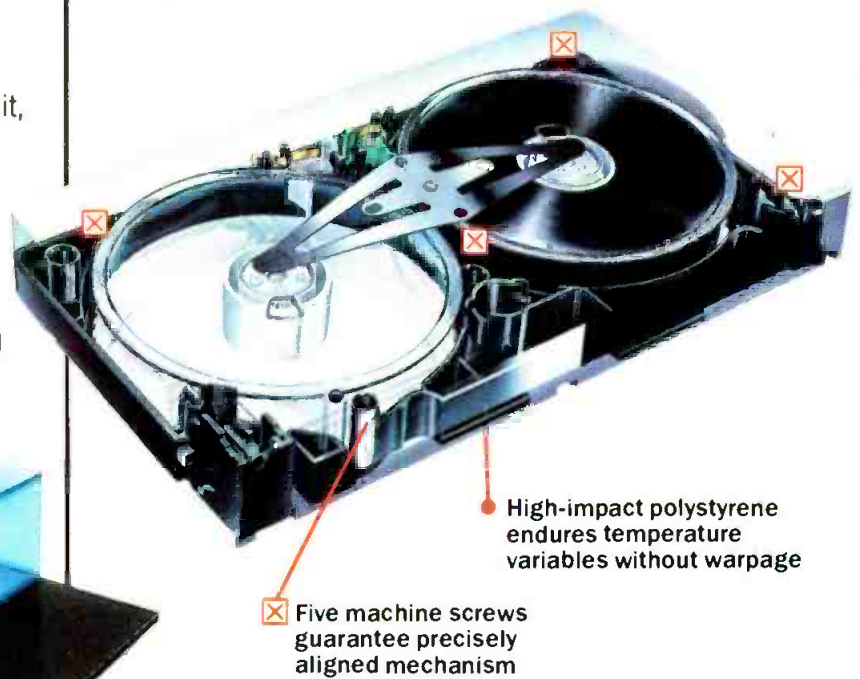

Smaller, more densely packed Epitaxial™ oxide

Molecular Fusion Binder for a stronger, cleaner bond

New base film with improved dimensional stability

Molecular Fusion Binder

Friction-balanced backcoating

High-impact polystyrene endures temperature variables without warpage

Five machine screws guarantee precisely aligned mechanism

A shell made to the industry's toughest standards.

Ours. The transport is smooth, quiet and jam-proof. The housing immune to temperature extremes. The construction leaves nothing to chance.

From open reel tapes to a complete line of KCS/KCA U-Matics, audio and VHS/Beta cassettes, we're getting quality down to a science. And in your hands, our science turns to art.

The Epitaxial™ contribution: higher video, brighter chroma.

Unique, uniform cobalt ferrite oxide particles, now even smaller (a mere 3 microns long), yield unprecedented packing density. Expect enhanced signal-to-noise ratios in audio and video. Better definition. Brighter chroma. And no significant signal loss despite endless editing replays.

Molecular Fusion Binder: longer life bonding for truer-to-life performance.

Gone are conventional adhesives that time and temperature tempt to the surface. In their place, self-curing resins fuse oxides to the base film. It's a bond immune to time and mechanical stress. Anticipate far fewer dropouts, less clogging and extended tape and head life.

New base, binder, backcoating. Better support for the signal.

No static. No noise. No dust. The molecular-fused backcoating provides a perfect balance between inside and outside surfaces. For controlled friction. Less mechanical and magnetic noise. And optimum running smoothness, even in high heat.

HGX Pro 1/2" Videocassettes are available in Beta and VHS formats.



maxell®

Maxell Corporation of America
60 Oxford Drive, Moonachie, N.J. 07074 201-440-8020
See us at the NAB Show, Booth #1624

Circle 127 on Reader Service Card

Series 80

just imagine...SFX video power plus...

- + Dual Chroma Keyers + Dual Luminance Keyers
- + Dual Matte Key Generators + Dual Key Borders
- + Super wide, SuperSoft borders
- + CAP, Computer Assisted Production
- + FlexiKey... Central Dynamics' new, powerful Digital Video Effects at a fraction of the cost... manipulates titles, logos and images with spin, flip, rotation, zoom, compression or any combination of these effects.

All this power is surprisingly affordable... the Series 80's modular, proven design assures fast

delivery and there is a model to meet any post-production and live programming requirement.

480. Compact versatility... 4 buses with the SFX Power+ system.

680. Exceptional big studio performance... 6 buses with the SFX Power+ system and the new Series 80 Program Processor.

1080. The ultimate switcher for the most sophisticated productions... 10 buses with 2 SFX Power+ systems and the new Series 80 Program Processor.

Call or write for complete details.



CENTRAL DYNAMICS

Central Dynamics, 401 Wynn Drive, Huntsville, AL 35805 (205) 837-5180

New York: (914) 592-5440 Washington, DC: Willtronix, Inc. (301) 258-7676 Chicago: (312) 991-4720

Texas: Gene Sudduth Co., Inc., Paris (214) 785-5764 and Flint (214) 894-6303 Los Angeles: (213) 766-8185

www.americanradiohistory.com

See us at NAB
Booth 1409

TELEVISION

programming & production

Irises Blossom for Local Production

When the Irises appear, it's a sure sign of spring—and an especially welcome one to the hardworking local stations honored by the annual awards, sponsored by NATPE International. This year's competition was the seventeenth annual, with awards announced at NATPE's annual conference last February.

Two winning stations must be singled out for special notice: WNEV-TV, Boston, and KATU, Portland, each of which took home a pair of Irises. The overall number of winners was up, too, thanks to the addition of two new entry categories: talk/service/information, and short subjects.

Of course, NATPE doesn't confine itself to handing out Irises. Talk show veteran Johnny Carson received its top honor, the Award of the Year, for his

"enormous contributions to television entertainment." The NATPE President's Award for "a lifetime of service to television" went to retired ABC vice chairman Elton H. Rule and TV personality Dick Clark.

As the following profiles illustrate, the environment for growing Irises is the fertile soil of localism and commitment to quality.

Double winner

Sharing double-award honors with KATU, Portland, was Boston's WNEV-TV, which won Irises in the large-market group for both the sports and talk/service/information categories. The latter award was captured by a segment from *Look*, the station's ambitious (and recently cancelled) two-hour, station-produced daily afternoon

show. (A full description of the technical preparations for *Look*, as well as the show's format, appeared in *BM/E's* December 1982 issue, p. 33.)

Look was scheduled with a different theme for each day of the week. The program submitted to NATPE for the Iris awards originally ran on a Thursday and therefore highlighted the coming weekend. That particular Thursday, the featured story was the Boston opening of the musical "La Cage Aux Folles," which was already a hit on Broadway.

"We previewed the show for our viewers before it opened in Boston," explains VP for programming Jeff Schiffman, who served as program executive for the show and for the station's other Iris winner. (*Look* was produced by Raysa Bonow.) Segments spaced throughout the two hours pro-

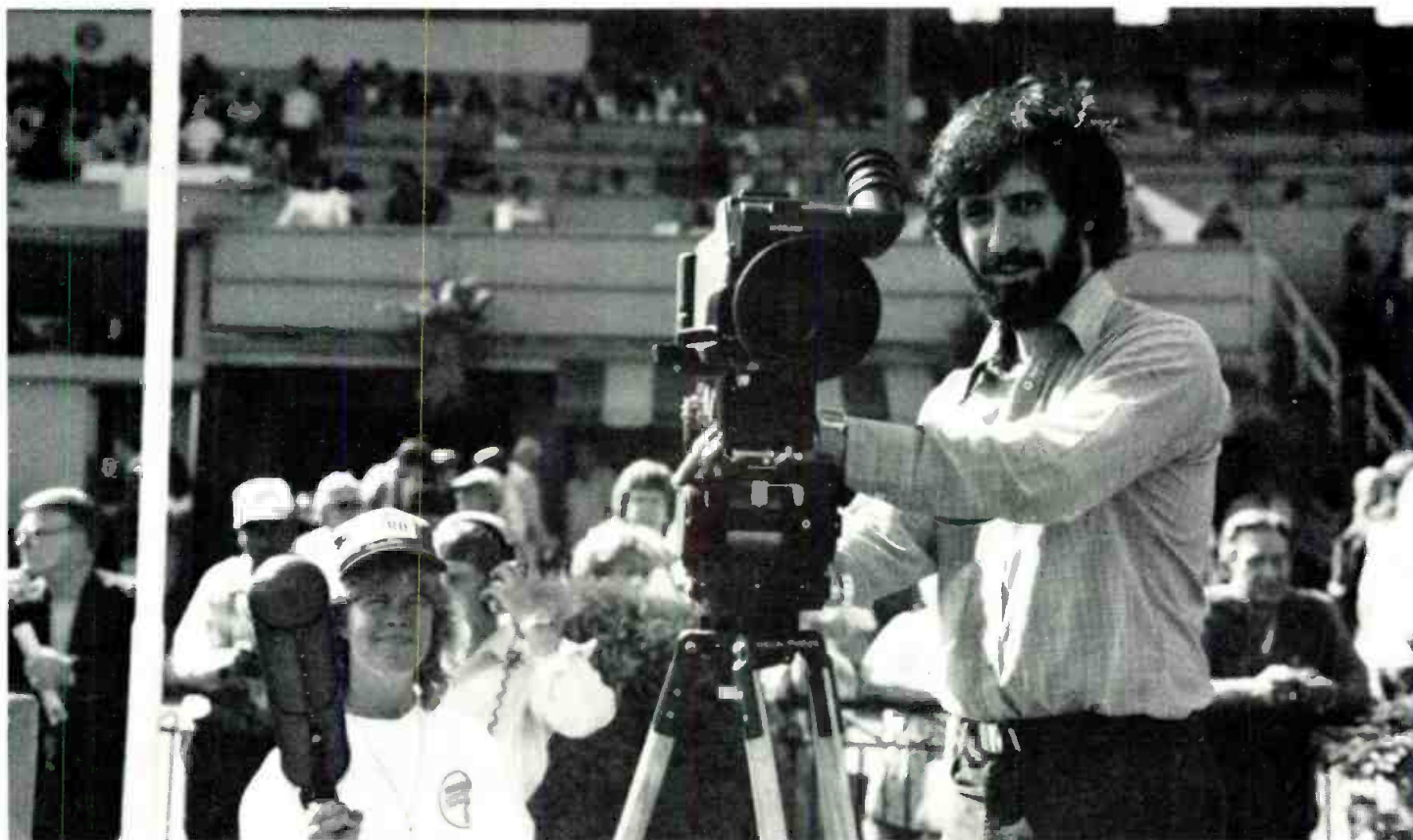

Mike Rosen, producer of KIRO's Iris-winner *DWI: Sorry Isn't Enough*, on location for the show with one of the HL-79s.

- More than a high speed reader
- More than a video character inserter
- More cost-effective than you thought possible

CIPHER DIGITAL'S MODEL 710A TIME CODE PERIPHERAL

The Model 710A — an evolution in Time Code Reader technology

Reads longitudinal time code forward & reverse at tape speeds from 1/30th to 80X • Updates from Control Track/Tach Pulse input • Compensates 1-frame serial decoding delay in forward & reverse • Displays Time or User data using easy-to-read front panel LEDs • Multi-function video character inserter displays both Time & User data simultaneously • Decodes and displays Field number • Full raster positioning of video display • Multi-size characters • Automatically deletes Field & Frame display at unreadable speeds • Switchable inverse video display • Incorporates Intelligent Error Bypass for glitch-free frame accuracy • Automatic sense of Frame Rate — 30-Frame SMPTE, 25-Frame EBU, 24-Frame Film • Reads burst code format for film • Locks in & retains last valid Time Code Reading • Restored Time Code Output or optional True regenerated Time Code Output • Optional Frame accurate program segment calculator • Optional Parallel/Serial RS-232/422 Data Outputs • Rack mounting — 1-3/4" high.

Price: an evolutionary \$2450

And there's more! For a complete Data Sheet listing all the benefits or for an in-house demonstration, contact: Cipher Digital's Sales department at (617) 267-1148 or write:



Sales/Marketing Headquarters:
150 Huntington Avenue • Boston, MA 02115
Tel: (617) 267-1148 • Telex: 940536

filed the show's principals, visited the stars' dressing rooms, showed some of the musical numbers in rehearsal, and brought cast members into the studio for live discussion.

"When we profiled the show, they didn't know if they had a hit or not yet," Schiffman recalls. "It was a most vulnerable time to talk about the show. The stars were most giving, and the people involved with the production were very willing to share with us.

"For most of our audience, it was a first exposure to the show, and a very daring one for us," he adds. The musical's theme of homosexuality made its acceptance with the Boston audience less than certain, although the show has since done well.

All field production for the program was done on the half-inch M-format recorders WNEV purchased when it set up *Look*, now used for all station field production. Those recorders, and their companion Ikegami HL-83 cameras, were also used for WNEV's second Iris winner, a sports special called "Conquering the Cape," which covered Cape Cod's first full-scale triathlon.

"We didn't want to do just a sports show," Schiffman explains. "The event was very lengthy, and the networks tend to tape events like that and then edit them and show the highlights. We aired in prime time, and we decided we wanted to do a series of profiles of the participants."

The production crew selected several athletes with interesting and moving stories—including one participant who'd recently been diagnosed as having cancer—talked to them before the event started, and followed them through the grueling day-long contest. Because of the timeliness of the event, the station wanted to air the show quickly.

"We turned it around incredibly fast," Schiffman relates. "We taped all day on the Saturday of the event, and the show aired the following Saturday." The station used seven full camera crews, all equipped with the half-inch recorders and HL-83 cameras, and 25 production people for the show. According to Schiffman, producers Lorie George and Matthew Mixon worked 60 or 70 hours each over the six days it took to put the one-hour show together.

All post-production was on half-inch

New Standards

The Widest Angle, The Highest Performance

Canon engineers have done it again, advancing the optical state-of-the-art so far forward that new standards must be considered.

The Canon P18 x 15 BIE offers the widest angle of any broadcast television zoom lens: 59° plus incredible edge-to-edge sharpness, fidelity and sensitivity throughout its 18X range.

Every one of these superb lenses will be supplied with both 1.5X and 2X built-in extenders and a pattern projector. Options include manual, semi-servo or full servo operation.

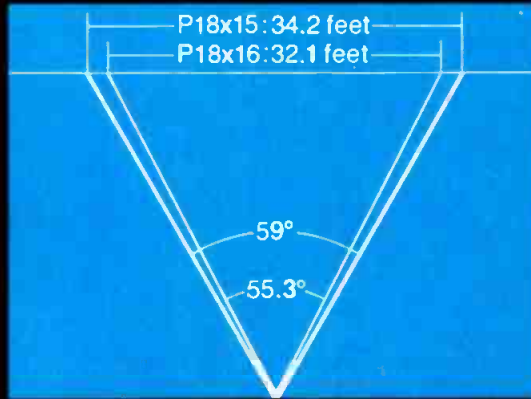

The Canon P18 x 15 is the most versatile studio lens ever made, setting new standards for years to come.

P18 x 15 BIE F2.1 for 30mm Cameras* KEY SPECIFICATIONS

- Focal length: 15-270mm
- Max. Relative Aperture: 1:2.1 (15-218mm)
- Aperture: 1:2.7 at 270mm
- Angular Field of View: 59° x 45.8° at 15mm
3.6° x 2.7° at 270mm
- Minimum Object Distance: 0.6 meter (2 feet)

*Also available: PV18 x 11 BIE F1.6 for 25mm Cameras



**OVER
500 CANON
18X LENSES NOW
IN SERVICE IN
THE U.S.A.!**

Canon Studio Standards



Canon®

Optics Division

Canon USA, Inc., Head Office: One Canon Plaza, Lake Success, N.Y. 11042 (516) 488-6700

Dallas Office: 2035 Royal Lane, Suite 290, Dallas, Texas 75229 (214) 620-2641 Chicago Office: 140 Industrial Drive, Elmhurst, Ill. 60126 (312) 833-3070

West Coast Office: 123 Paularino Avenue East, Costa Mesa, Ca. 92626 (714) 979-6000

Canon Canada, Inc., 3245 American Drive, Mississauga, Ontario L4V1B8, Canada (416) 678-2730

© 1983 Canon U.S.A., Inc.

Circle 130 on Reader Service Card

SEE US AT NAB BOOTH #1012

Who's Pulsing the Editors?

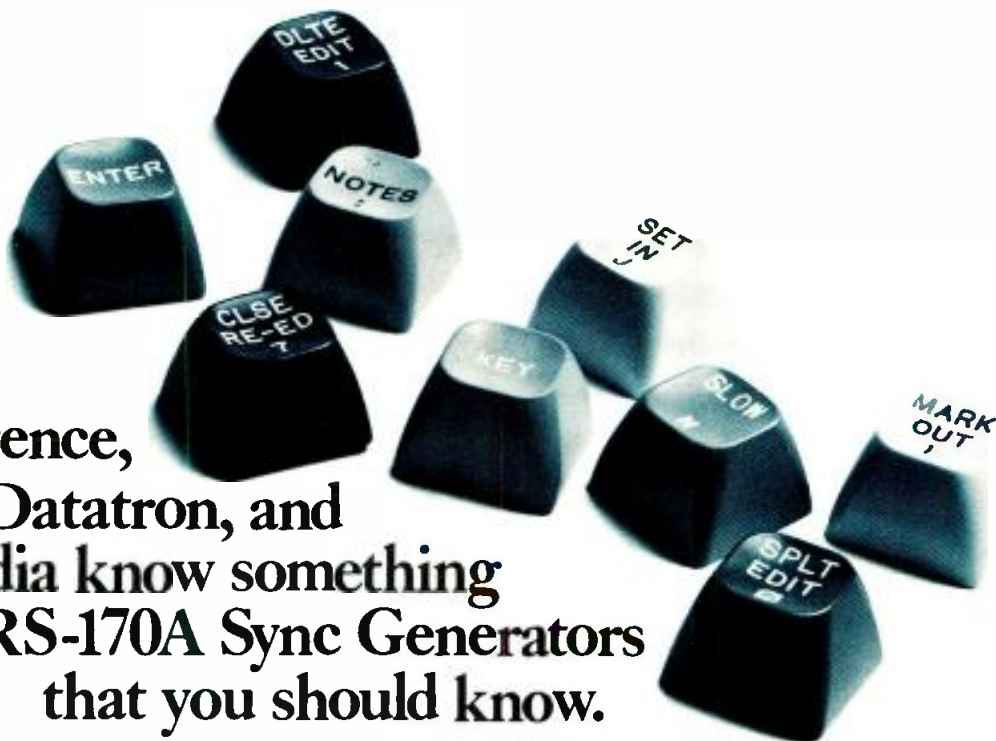

**Convergence,
CMX, Datatron, and
Videomedia know something
about RS-170A Sync Generators
that you should know.**

These and other leading manufacturers are committed to producing the ultimate in quality videotape editing equipment. How? By using the PMG-312 Master Sync Generator system to test and pulse their editing systems.

The complete dual sync system consists of a dual power supply frame, two RS-170A Generators, and an Automatic Changeover. The Automatic Changeover meters each generator pulse and DC voltage for fault indication. The PMG-312 offers chrominance subcarrier with an accuracy of .35Hz stability over a one year period. Subcarrier to horizontal phase relationship is maintained in reference to line 10, RS-170A. Black burst is optional. Professional broadcast quality at very attractive prices. Two year parts and labor warranty.

These manufacturers of editing systems know who's pulsing the system and now so do you. Is Lenco pulsing your editing equipment? Don't you think it is time we did?

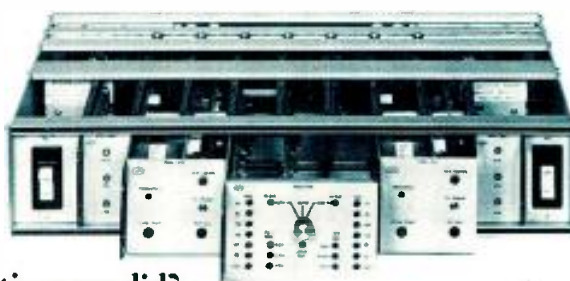

Lenco, Inc., Electronics Division 300 N. Maryland St. Jackson, Missouri 63755.
Telephone: (314) 243-3147

Engineered and manufactured in the United States



The Professionals' Choice

TELEVISION PROGRAMMING



Rosen (standing) gives final instructions on the set for the studio portion of DWI.

"DWI: Sorry Isn't Enough," was one of a series of shows the station did to highlight the serious national problem

of driving while intoxicated. The one-hour special consisted of a half-hour documentary-style segment, followed

by a half-hour produced in the studio. The program focused on several area residents whose lives had been struck

7200 COMMUNICATOR

TWILIGHT TOWN

7:00	THE JUDGE
8:00	MOVIE: AIRPLANE
10:00	6 EVENING NEWS
10:30	GUNSMOKE
11:30	THE LATE REPORT

Wright Sports

Everything for the active enthusiast!

PROJECTED RETURNS

1	2	3	4	5	6	7	8	9	10
10	10	10	10	10	10	10	10	10	10
10	10	10	10	10	10	10	10	10	10
10	10	10	10	10	10	10	10	10	10
10	10	10	10	10	10	10	10	10	10
10	10	10	10	10	10	10	10	10	10
10	10	10	10	10	10	10	10	10	10
10	10	10	10	10	10	10	10	10	10
10	10	10	10	10	10	10	10	10	10
10	10	10	10	10	10	10	10	10	10

NEXT: ON SPORTS

THUNDERBOAT REGATTA JUNE 26-27

ADD IT UP!

- 35 NSEC RESOLUTION
 - 4 RESIDENT FONTS
 - 32,768 COLORS
 - DUAL DISK DRIVES
 - GRAPHICS/ANIMATION
 - DUAL CHANNEL
 - FONT/LOGO COMPOSE
- = 7200 COMMUNICATOR

Come to NAB booth #1721 and see a top quality broadcast generator for under \$20,000.



LAIRD TELEMEDIA INC.®
 2424 SOUTH 2570 WEST • 801 972-5900
 SALT LAKE CITY, UTAH 84119

BOSCH**FDL 60**

UPDATE

F I L M T O T A P E T R A N S F E R S Y S T E M

An Advanced Film to Tape Transfer System

The advanced technology of the new BOSCH FDL 60 with PanScan and black stretch represents tremendous advantages over other transfer machines. The most significant advantages are: superb picture quality with resolution, excellent signal-to-noise ratio, and brilliant color rendition from either negative or positive film.

“CCDs make the difference.”

The use of solid-state CCDs (charged-coupled devices) completely eliminates electro-optical problems inherent to pick-up or scanning tubes.

Burn-in, afterglow, and fieldlag are non-existent because there's no photoconductive or phosphor layer to cause these problems. Shrinkage, flicker, vertical deflection, horizontal misregistration, and positioning errors of all kinds, are eliminated and those costly tube changes are gone forever.

Things You Should Know

Solid-State Savings

The solid-state devices used in the FDL 60, including the CCD sensors, have all the reliability and long operating life associated with semiconductors, and are maintenance free. The FDL 60 delivers a better picture, and saves you money on maintenance.

Operational Flexibility

The FDL 60 gives you the operational flexibility you'd expect of a modern videotape recorder, and you control like one as well. The servo deck with continuous capstan drive

and microcomputer control, ensures gentle film handling and is totally insensitive to perforation damage. Our Telecine also offers a unique feature called Select-A-Speed, which enables the operator to select any of 1,400 broadcastable speeds between 16 and 30 frames per second.

Our keyboard lets you enter time code cue points, and a changeover switch gives you disturbance-free transitions between two machines in parallel operation.

The FDL 60 can also be integrated into your VTR editing and film-to-tape transfer. A convenient Quick-Change Optical Block lets you run either 35mm or 16mm film in combination with both optical and magnetic types of soundtrack.

The FDL 60 also comes with other options which greatly enhance the system's capability such as our Film Grain Reducer and our six sector programable Color Corrector.

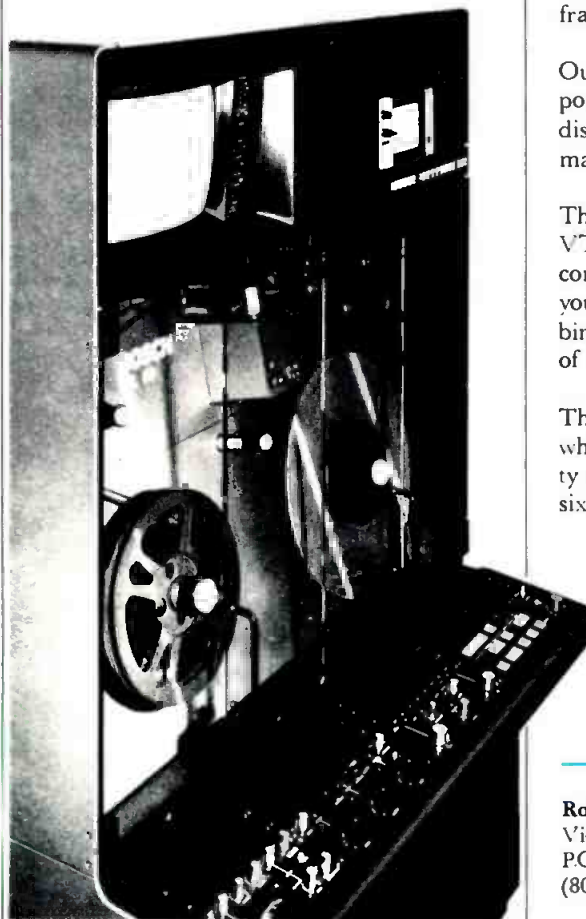

Robert Bosch Corporation
Video Equipment Division
P.O. Box 31816, Salt Lake City, Utah 84131
(801) 972-8000

**BOSCH**

TELEVISION PROGRAMMING

by drunk driving: the families of three small boys killed by an intoxicated driver a few years ago in Portland's Auburn suburb; Mike Buckingham, a state highway patrolman seriously injured and disfigured in a crash caused by a drunken driver; and a convicted drunk driver, interviewed in jail.

"Our point of view was to tell people what they could do about the problem, not just illustrate it," Law explains. The studio portion of the show—which was produced and post-produced before the documentary portion—featured a panel of experts on the problem of drunk driving, including an author, a municipal court judge, a member of the Washington State Patrol, and a member of the President's Council on Drinking and Driving, along with some of the victims interviewed in the first half.

According to Rosen, about an hour and a half of material was taped, with the show switched live on one of the three Ampex VPR-2 decks. "We wanted the conversation to start at the appropriate place," Rosen recalls. "It had to be exactly right emotionally and not recap what had just gone on." Once production was completed, the studio half was shown to the participants in the first half; a tape of their reactions was incorporated into the show.

The documentary half was then produced, entirely on one-inch. ("Mike is a nut for quality," Law exclaims.) Besides the interviews, the crew shot footage of a local judge and community figures taking a drunk driving test while sober, after light drinking, and at the 0.10 blood alcohol level, the definition of intoxication. Because of the slow-moving nature of the material, Rosen used two Ikegami HL-79s, one on a tripod atop the station's production van and another on the camera operator's shoulder, with the VTR in a backpack.

Off-line editing took place on 3/4-inch workprints in the futuristic editing suite station personnel call "The Enterprise," a sleekly designed room with a Sony BVE-800 editor, Tapco mixer, and JBL studio monitors. Because the room is used for commercial clients during the day, the staff had to work evening shift, starting around 7:00 p.m. and working until 2:00 a.m. "We averaged about two and a half hours per minute to edit the show," Rosen recalls, about average for station

"And the talent really loves their new wireless freedom"

Freedom of movement is a very good reason to use wireless microphones. Even though all wireless microphones offer the same freedom from cumbersome, noisy and ever present WIRES, there are plenty of real differences. After you've made the big decision to go wireless, take the time to: compare the sound, compare the options, and compare the price. Once you do, you'll choose Telex, the dependable performer!

W.E. (Bill) Thomson, audio engineer at KPRC-TV, Houston, Texas, already had wireless mics at his station. But, when he decided to go wireless with his on-camera weather people, it seemed like a good time to compare several brands. Audio quality is extremely important to this NBC affiliate. So, along with several others, he put the new Telex system through its paces. After weeks of careful evaluation, Bill determined

ACTUAL
SIZE

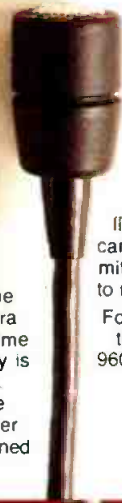

that the Telex system was superior. In his own words, he liked, "...the full range response and the ready option of diversity reception". Furthermore, he told us that he was "...impressed with Telex's ability to manufacture such a high quality product... at so reasonable a price."

We're pleased that Bill, along with many others, has recently discovered our unique diversity receiver, our lightweight, miniature lavalier mics and our cardioid dynamic handheld microphone/transmitters. Bill tells us that he wouldn't hesitate to recommend it to anyone. Neither would we.

For more information and detailed specifications, write to Telex Communications, Inc., 9600 Aldrich Ave. So., Minneapolis, MN 55420.

For quick information, call toll free
800-328-3771
or in Minnesota call (612) 887-5550.



W.E. (Bill) Thomson
Audio Engineer
KPRC-TV
Houston, Texas

TELEX

CANADA 705 Progress Avenue, Unit 10 Scarborough, Ontario M1H 2X1

Circle 137 on Reader Service Card

WHY ARE THEY ALL MOVING TO SCHNEIDER?

SONY
SHARP
PANASONIC
JVC
HITACHI
IKEGAMI
FERNSEH
PHILIPS
RCA
HARRIS
THOMSON
AMPEX

Because the economical, light weight Schneider 14X ENG/EFP lens brings out the best in today's cameras.

For convenient operation the servo zoom pistol grip with built-in iris control has all video controls within a thumb's touch. For maximum reliability the iris and zoom electronics are protected by a weather-proof housing. The lens can power zoom from 9mm to 126mm; with built-in 2X extender from 18mm to 252mm. Macro focus allows for sharp, up-close focusing, and the economical aspheric lens attachment provides distortion-free super wide-angle shots.

Contact us today for a demonstration. Schneider Corporation of America, 400 Crossways Park Drive, Woodbury, NY 11797 (516) 496-8500.



Schneider
14X ENG EFP

Circle 132 on Reader Service Card

TELEVISION PROGRAMMING

documentaries. Final conforming was done on the station's CMX 340X editor.

Perhaps one reason for the show's success is that no one at KIRO doubts the station's ability to have an impact. During the time it was focusing on drunk driving, the station set up a hotline in conjunction with local law enforcement agencies, encouraging citizens to report incidents. The toll-free number was funded by the station for a year, and the agencies have continued it since then. According to Law, deaths from drunk driving dropped significantly the year *DWI* aired, and were even lower the following year. Of course, the drop cannot be entirely attributed to KIRO's shows on the subject, but the station helped increase awareness.

Crossing the tracks

KTLA, Los Angeles, started out with a question: Did the city's East Los Angeles section deserve its unsavory reputation? Their quest for the answer took producers Ben Moses and Diana Buckhantz "East of the L.A. River—the title of their segment of the station's *Impact '83*, winner in the public affairs series category.

"East L.A. has a very unrealistic reputation," relates program executive David Simon. "People assume it's predominantly Hispanic, but many kinds of people live there. People assume it's dangerous and filled with gangs, but that's not necessarily the case. We went over to find out what it was really like, and we found it very much like any other part of L.A."

The *Impact* series, which began in 1982, has featured documentaries on a variety of issues since its inception. One show, "Hunger in the Promised land," hosted by actress Joanne Woodward, won first place in the World Hunger Media Awards for the 1982-83 television season. The station decided again to use well-known figures in "East of the L.A. River." Jose Ferrer was the show's host; it also featured comedian Paul Rodriguez of the new ABC series *AKA Pablo*.

At Simon's insistence, all production took place on one-inch tape. According to Moses, he initially fought for 3/4-inch production when he signed on to do the hunger special, his first job for KTLA. "I was really insistent on using 3/4-inch, but he wouldn't budge," Moses recalls. "We had an argument

that went on for weeks." Once the show was complete, Moses conceded the quality advantages of one-inch, although he continues to gripe about the weight of the equipment. "A one-inch recorder is so heavy you can't do a real ENG-style shoot," he complains.

For the production, Moses used an Ikegami HL-79D and a Sony BVP-330, a camera he particularly likes. The recorder, a Sony BVH-500, was the focus of several problems during production and post-production, although Moses says that improper setup could have been the cause.

Off-line editing, on 3/4-inch workprints, was done at an independent facility, Post Mark (now CCR). Again, things didn't go smoothly when the edit decision list was brought back to the station for on-line conforming on KTLA's Ampex ACE editor. "Strictly speaking, it was compatible with our editor," Moses says, "but we had gone down two generations in off-line editing, and the punchtape program didn't track properly when it cleaned itself. We had built the show off-line in four separate submasters, which were then used as playback for the fine-cut master. In effect, we were making edits over edits. We expected that the list cleaner would be able to follow what we had done, but it didn't, and the assemble program would botch every two or three minutes. On-line was horrendous."

The station pulled out the stops as far as special effects were concerned. "Our opening consisted of about two and a half minutes of everything the editing room could do," according to Moses. "We built several submasters on the station's one-channel ADO. They also have a GVG switcher with four or five levels of reentry. We used all the key buses on the switcher, plus three playback machines. We also built complex title effects on the SqueezeZoom."

As the liberal use of effects would indicate, the show took an upbeat look at an area of the city that had received its share of bad press in the past. The social problems of the neighborhood—including discrimination suffered by many residents—were not overlooked, but the station tried to present a well-rounded view that would dispel some myths.

"Basically, we tried to expose East L.A. to the rest of the population," Simon sums up. **BM/E**

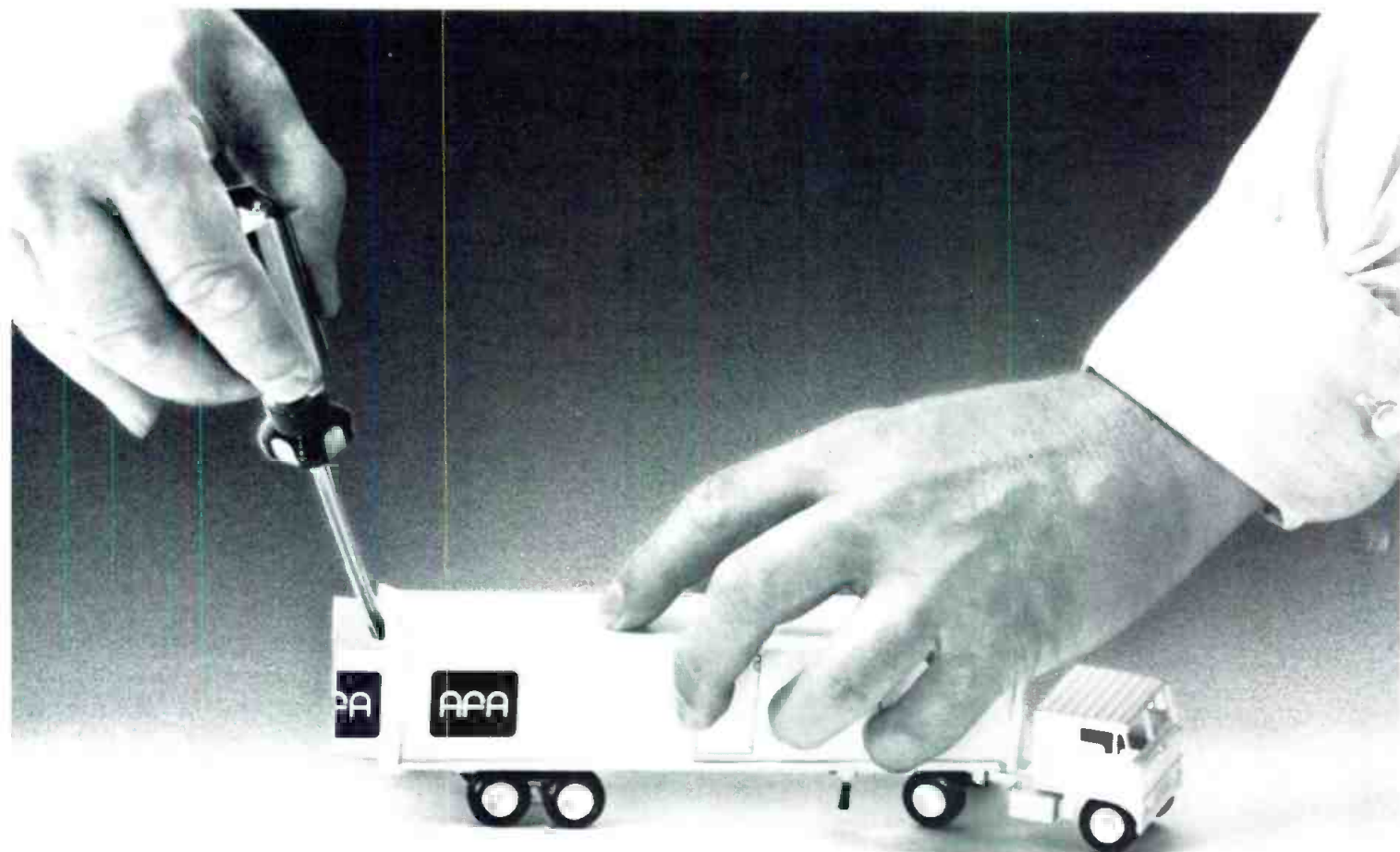

WE MAKE 'EM IN ALL SIZES!

We've been designing and building mobile video systems since 1976 when we delivered our first—a 40' production and post-production unit for the ABC-TV Network. Since then we've built video systems in every size and configuration.

And with each one—from "mini-vans" to giant units which put entire production and post-production operations on the road—we provide the same meticulous attention to planning and execution.



A.F. ASSOCIATES INC.

ADVANCED SYSTEMS AND PRODUCTS FOR THE VIDEO INDUSTRY

AFA SYSTEMS DIVISION/100 STONEHURST COURT, NORTHVALE NJ 07647 (201) 767-1000

Circle 133 on Reader Service Card

We make certain that all the equipment—from VTRs to switchers—is the most effective and efficient for the job. We design for safety, comfort and durability—carefully considering the problems of human engineering, power sources, air-conditioning, weight distribution and stress on the vehicle. And we see to it that your budget and delivery date is on target!

At AFA we believe there are no such things as *small* mobile systems. Only small designers!

**THE REASON
YOUR EDITING
COMPONENTS
DON'T WORK
TOGETHER IS
BECAUSE
THE PEOPLE
WHO CREATED
THEM DIDN'T.**

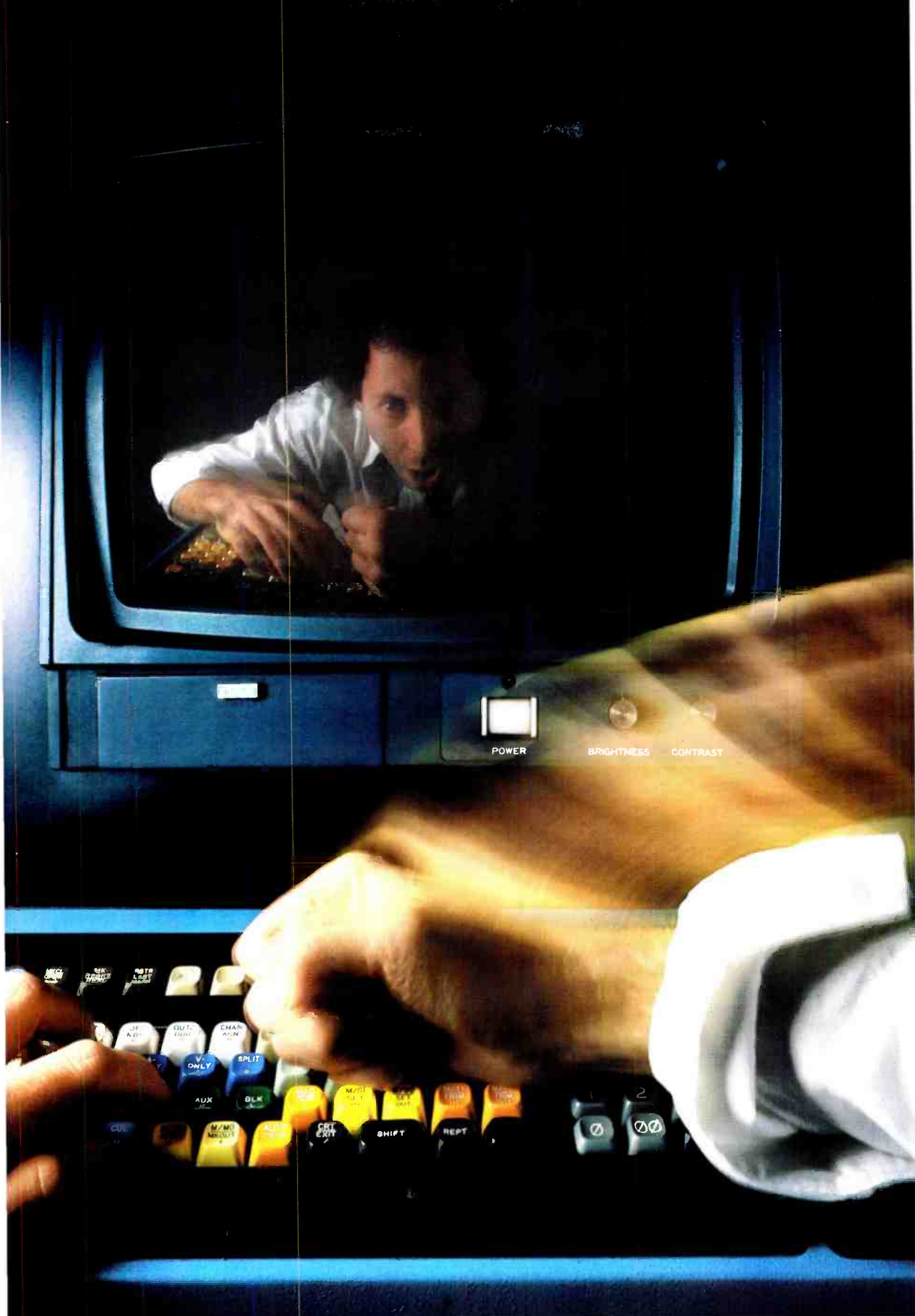

A SYSTEM IS ONLY AS GOOD AS THE SUM OF ITS COMPONENTS.

1" EDITING



BVH-2000 IN CONSOLE

- Multiple machine configurations, changeable and upgradable.
- Wide DT range: from -1 to $+3 \times$ standard speed
- Video/Audio confidence replay
- Self-diagnostics with visual and audible malfunction alarms

- Plug-in Time Code Generator/Reader (optional)
- Plug-in Timebase Corrector (optional)
- 2 hours record/play time

BKH-2015 OPTIONAL PLUG-IN TIMECODE FOR BVH-2000

- Generator/Reader with VITC/LTC capability
- Character Generator
- User Bit Display



BVH-2500 RECORDER

- All features of BVH-2000 plus:
- Full C Format compatibility
- Real time, variable and frame-by-frame recording, using DT head
- Full-color framing
- Instantaneous and repeatable re-writing by erasable DT head



BVT-2000 TBC

- 9-bit, 4 Fsc sampling
- Drop-out compensation with Y/C separation
- Built-in Velocity Compensation, Sync Pulse Generator, Video Processor and automatic Advanced Sync Generator
- Full remote-control function
- DT playback with BVH-1100/1100A/1180/2000 and BVU-820 VTRs

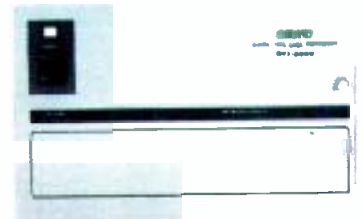

BKH-2100 OPTIONAL PLUG-IN TBC FOR BVH-2000

- Plug-in, 4-circuit board Digital TBC
- 8-bit $4 \times$ Fsc samplings
- Remote-control capability



3/4" EDITING



BVU-820 RECORDER

- Built-in, full-scale editing functions
- Dynamic Tracking
- Playback from -1 to $+3 \times$ standard speed
- Simultaneous video playback in record mode (Video Confidence)



BVT-800 DIGITAL TBC

- 15 H correction range
- DT operation with BVU-820 from -1 to $+3 \times$ standard speed
- Built-in digital DOC
- Single cable interconnect with BVU-800/820
- Remote-control facilities
- Recognizable monochrome pictures up to $\pm 40 \times$ standard speed

1/2" EDITING



BVW-40 BETACAM™ RECORDER

- Compressed Time Division Multiplex video recording system
- Built-in Timebase Corrector with Digital DOC
- Full Video/Audio insert and assemble editing, with preview/review, forward/reverse trim, selectable pre-roll and auto edit in/out functions
- 9-pin RS-422 serial and 36-pin parallel remote ports
- 7-pin Dub-in/Dub-out connection for BVU series U-matics™
- 12-pin Y/R/B-Y component input/output
- Component and composite outputs

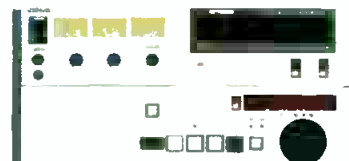

BVW-10 BETACAM™ PLAYER

- Full Shuttle and Jog functions
- Built-in TBC with Digital DOC
- Built-in Time Code Reader and LED display
- Selectable Dolby™ noise reduction
- Plug compatible with wide range of external systems
- Only front access required
- Component and composite outputs

At Sony, we do more than guarantee the best total system. We guarantee the best individual components.

The machines you see on these pages, which comprise the three established formats of the broadcast industry, represent only a small sampling of the Sony universe of post-production products.

Each component, while different in price and scope of features, shares five things in common. Unsurpassed quality, reliability, durability, ease of maintenance, and excellence of value that Sony is famous for.

So whether you buy the Sony system piece by piece, or an entire system at a time, you can be assured peace of mind.

For all the details contact Sony in New York/New Jersey at (201) 833-5350; in the Northeast/Mid-Atlantic (201) 833-5375; in the Midwest (312) 773-6045; in the Southeast (404) 451-7671; in the Southwest (214) 659-3600; in the West (213) 841-8711.

© 1984 Sony Corporation of America. Sony is a registered trademark and Betacam is a trademark of the Sony Corporation.

SONY
Broadcast



57

INTRODUCTION, PROGRAM

65

WHAT'S HOT IN TV PRODUCTS

99

TV HALL EXHIBITS

179

WHAT'S HOT IN RADIO PRODUCTS

203

RADIO HALL EXHIBITS

Testing
1...2...3...4...

**Exciting new
audio and video products
from JVC.**

**Test them yourself at
Booth**

1 2 3 4

NAB
JVC

JVC COMPANY OF AMERICA
Professional Video Division

41 Slater Drive, Elmwood Park, NJ 07407. Phone 1-800-JVC-5825

Circle 138 on Reader Service Card

www.americanradiohistory.com

~~NAB'84~~

YOU'VE GOT WHAT IT TAKES

There will be a special tempo to the proceedings of the 1984 NAB Convention starting April 29 in Las Vegas. This is an election year and the NAB plans to get attendees into the spirit of things with a rousing opening show. The patriotic program, complete with a U.S. Marine Corps marching band, will also usher in NAB's 1984 voter campaign.

Besides the election-year activities, there will be the usual line-up

Radio Program Highlights

Although the final program hours were not available at press time, the topics for the radio sessions are as follows:

Time Management. This three-hour forum will cover ways to set and meet deadlines and offer other hints on the subject.

One Minute Radio Manager. This three-hour session looks into one-minute goals, one-minute praises, and one-minute reprimands, as well as when and how to use them.

Making Money with New Technologies. Subcarriers and cellular radio could

bring new revenue to broadcasters. A panel will discuss how to use these technologies.

Hands-on Computer Lab. Demonstrations by broadcasters of computer applications will take place at this lab.

Small Market Idea Exchange. This free-form workshop will be moderated by NAB Radio Senior VP David Parnigoni, a former small market broadcaster.

EEO. A general discussion of the FCC's EEO requirements.

Motivation. This session will help you understand what you can do to help improve the productivity of your people.

Collections. Learn about some collec-

NAB '84

of general sessions, engineering and management sessions, regulatory discussions, awards, and of course the big show of equipment and systems. In short, the sixty-second annual convention promises to be a hit.

It will also be a challenge for broadcasters to get to everything in the time allotted. The "electronic supermarket," as NAB calls it, will fill the Convention Center with every possible item of equipment that broadcasters use. Show hours will be 9:00 to 6:00 on Sunday through Tuesday, and 9:00 to 2:00 on Wednesday. With well over 500 radio and television exhibitors on hand, it will be impossible to see everything. To find out what's hot in the booths involving the products of your interest, read through *BM/E's* overview prepared by product category and then check the booth-by-booth rundown of all the exhibits in the Television Hall and the Radio Hall. Both follow this introduction.

More for Engineers

The thirty-eighth NAB engineering conference has been extended to include the Saturday before the official opening. For television engineers the Saturday session will cover Production and Stereo Sound for Television, dealing with implementation of multichannel sound. This will be followed by papers on The State of the Art in TV Graphics and Special Effects; New Camera Technology; and Fiber Optics.

For radio engineers, the Saturday session features Radio Production Engineering and Transmission Systems. Production presentations include music, talk, sports, and stereo productions for both large and small stations. The transmission papers will cover common site FM antennas, towers, and AM grounding systems. Both the radio and TV sessions on Saturday will begin at 11:00. The regular engineering conference sessions will be held Monday through Wednesday as usual.

Management Sessions

The theme for the radio management meetings is "1984: Radio's Record Year." Topics to

Radio Program Highlights (continued)

tion techniques used by others that really work.

Attracting Political Advertising. How to draw up a game plan to solicit more political advertising and how to establish ground rules for processing last minute buys.

Faces Behind the Numbers: Qualitative vs. Quantitative Research. This is a clinic on how to use qualitative research.

Living with Dereg. Get on top of the latest changes going on at the FCC.

Political Debates. Now that broadcasters can plan their own debates, you can learn how to put one together in this session.

AM Stereo: Chapter II. Chapter II looks at the happenings of the past year and the overall effects AM stereo has had and will have.

What to Do Before the Computer Arrives. A panel of broadcasters from small, medium, and large markets will show you how to prepare for your new computer and get the most out of it in the least amount of time.

Accounting for Non-Accountants.

George Nadel Riven, CPA, will lead a discussion on the mysterious world of accounting.

Buying and Selling a Radio Station.

All you need to know about where to find a station to buy, how to determine its value, and where to go for financing.

Congressional Sessions. Find out what legislation is pending.

AT&T Workshop. A panel will discuss the impact on broadcasters of the breakup of AT&T.

Doing Your Own Research. A clinic will discuss research that can be done by your staff and how to do it.

Equal Time, Fairness, and Political Advertising. A team of lawyers will be on hand to answer questions on rule changes involving candidate advertising.

Great Sales Promotions. Broadcasters from all markets will describe how they handled successful promotions.

Specialized Programming. On Monday afternoon there will be three workshops on Minority employment, Spanish language radio, and Daytimers. No other clinics conflict with these workshops.

Flexibility... *on the move*



with Gerstenslager

Mobile studios designed for quick setup and strike so you can get all the action, all the time. Proven capabilities. State-of-the-art communications technology. Meeting the changing demands of on-location, whether at the concert hall or the sports arena.

Tell us your needs. We'll custom design to your exact specifications. Install the equipment you want — where you want it. And we'll deliver when you want it. A mobile unit that's as dependable as your home base.

Talk to us! About our transit bus, expandable semi-trailer, modular and semi-trailer style units. For a complete planning kit, write or call collect: Earl Daye (216) 262-2015; TWX 810-433-9242.



GERSTENSLAGER

The Gerstenslager Company
1425 E. Bowman Street, P.O. Box 390
Wooster, Ohio 44691

Circle 139 on Reader Service Card

NAB '84

be discussed cover a wide range such as computers, living with deregulation, SCAs, getting revenue from political advertising, cleaning up record lyrics, and that recent regular, AM stereo chapter II. Other topics include audience research, making money with new technology, contests and promotions, and making money with cable radio.

Under the theme "Television: Shaping the Future," the TV management sessions will also encompass a wide range of topics. These include:

- Deregulation. What's to gain, what's to lose.
- Marketing your news. How to get your news director and promotion manager to work together and what can happen when they do.
- Political advertising and programming for 1984.
- What's up there for your station on satellites.
- What's new and effective in children's programming.

- How to use news consultants in a smaller market.
- The near- and long-term outlook for cable networks, multichannel MDS, LPTV, SMATV, DBS.
- Broadcast automation and computers beyond traffic and accounting.
- Four ways you can position your station for maximum results over the next seven years.

Other highlights will be the report on the State of Broadcasting by NAB president Eddie Fritts and the closing luncheon address by FCC Chairman Mark Fowler.

All in all NAB '84 promises to live up to its theme, "You've Got What It Takes." When you get to the big show, be sure to get a copy of *BM/E's* Las Vegas Survival Guide. It will provide you with a comprehensive map of the exhibit halls, a complete listing of exhibitors alphabetically and by product category, plus late-breaking product information that could not be included in this report. The Survival Guide will also contain information about what to do and see in Las Vegas. With it, You've Got What It Takes To Survive!

BM/E

Television Program Highlights

The final program hours were not available at press time; however, here is a rundown of the topics:

Does Teletext Have a Future? A panel of believers will present the pro position so that you can judge for yourself whether your station should plan for this service.

LPTV—Where Is It Headed? This nuts and bolts session delves into the FCC log jam and explores the future.

The Future of the New Technologies. Industry experts Paul Bortz, Ellen Berland Gibbs, Bill Lilley, and Tom Wheeler will predict the future of cable networks, HDTV, DBS, MDS and other new communications technologies.

ENG Technology for GMs. Industry engineers and equipment suppliers will describe the changes in ENG equipment in terms that make sense to businessmen.

What's Ahead in Sales. Experts from the TvB will tell you what to expect in sales competition.

Marketing the News. In this session, RTNDA and BPA join forces to show how communication and common goals can

work wonders.

Computers—Beyond Traffic and Accounting. Find out the new possibilities for computers in the news room, in promotion and production, and in film scheduling.

You Too Can Organize a Debate. Learn from experts the pitfalls and possibilities in both practical and legal terms.

News Consultants in Smaller Markets. Find out from consultants and from managers who have used them how they can help and how much.

Setting the New Telephone Environment. The new way to do business with the telco will be discussed.

Innovative Revenue Sources for 100+ Markets. Ways to attract non-traditional advertisers and other useful hints will be aired.

Alcohol and Drugs: More Than a Personal Problem. Find out how you can use the Employee Assistance Program to combat these problems.

Children's Programming. Learn what's new in this important area from professionals from NATPE.

Employment of Minorities. You'll learn how to hire and keep minority job candidates.



One of the world's smallest digital still stores is also one of the largest.

Introducing "Snapshot" from MCI/Quantel. Only 12¼ inches high by 19 inches—including removable cartridge Winchester disk drive!

Snapshot is not only the smallest of MCI/Quantel's DLS 6000 series units—it's one of the smallest digital still stores in the world.

Snapshot lets you capture pictures from live asynchronous feeds, store up to 400 of them with titles, and replay them on demand. You can prepare and edit sequences or stacks of sequences. And you can search by title.

Need more? You can increase Snapshot's storage to 1,600 pictures. Or you can upgrade it to

a DLS 6020 with on-air cuts and dissolves. Or upgrade it further to a DLS 6030, the most powerful still store available with production effects that bring an exciting look to your stills.

If that's not enough, you can integrate up to seven Snapshots—or other DLS 6000 series units—as workstations into our Central Lending Library (CLL). Now you can store over 10,000 stills at each

workstation and have simultaneous access to 100,000 more from the CLL. Plus unlimited off-line storage on disc cartridges or videotape.

You can even include MCI/Quantel's Paint Box as one of the workstations. So you can create the finest electronic graphics ever seen in television and have them instantly available for on-air use as well as library storage.

So whether you want a small system or a big system, Snapshot is the place to start.

Call your local MCI/Quantel office for more details. Or get in touch with us directly at 415/856-6226. Micro Consultants, Inc., P.O. Box 50810, Palo Alto, California 94303.



MCI/QUANTEL

The digital video people.

MCI/Quantel and "Snapshot" are trademarks of Micro Consultants, Inc.

Circle 140 on Reader Service Card

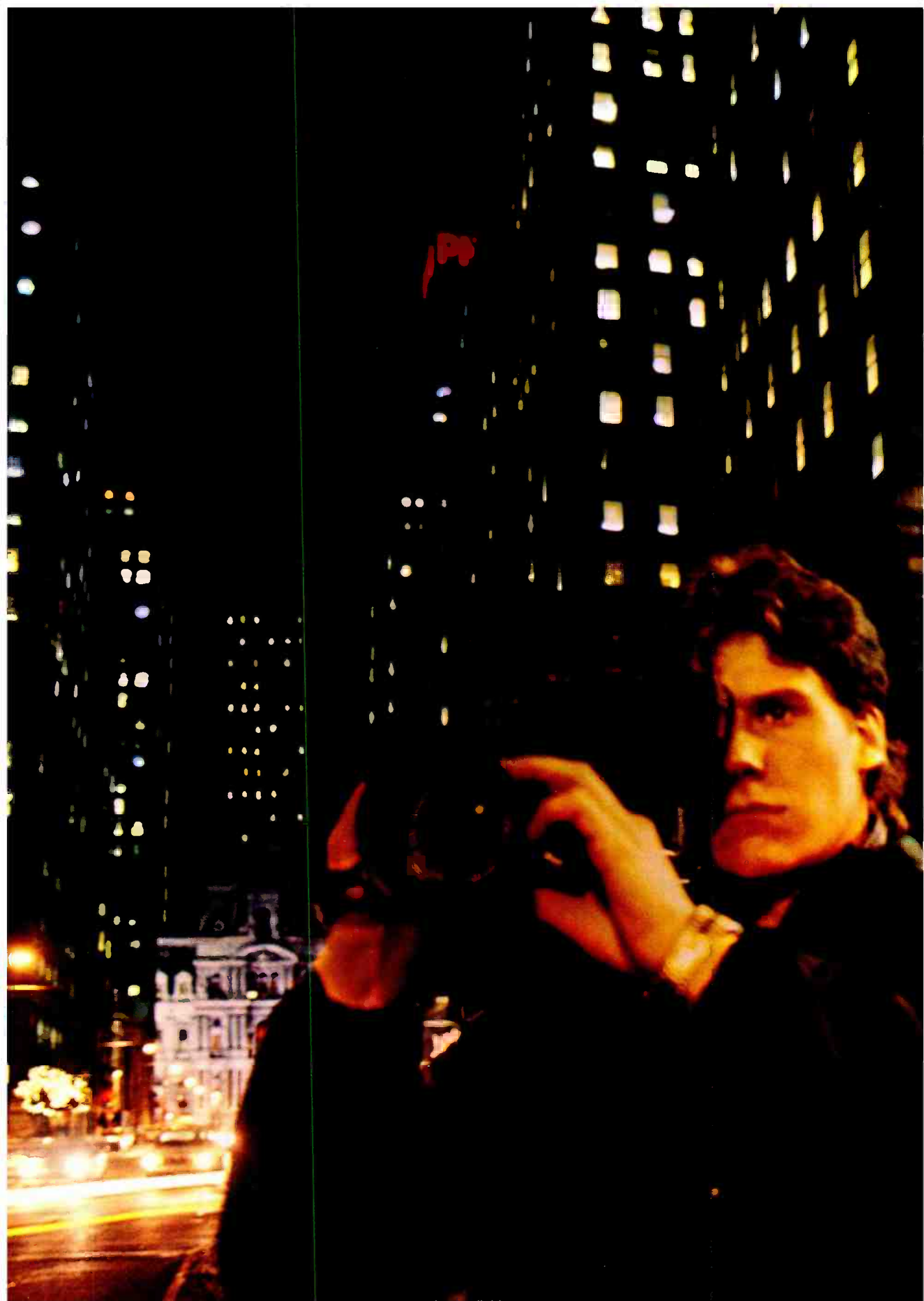

RCA Leads the Way with New Camera Technology

CCD

It's so good, it can practically see in the dark. But that's only the beginning. There's no lag, no burn-in. Just crisp, sharp, clear images. You never saw a camera so good!

But we don't want to keep you in the dark. We want you to see the new RCA CCD camera in action at our NAB exhibit.

You won't believe your eyes.

RCA Broadcast Systems, P.O. Box 900,
Gibbsboro, NJ 08026.

RCA

Circle 141 on Reader Service Card



WHO SAYS YOU CAN'T AFFORD GREAT ART?

The 3M Paint System delivers just about all the goodies that the expensive paint systems do. 28 brush styles. Control of hue, luminance and saturation. Cycling of colors for the illusion of animation. And a 16:1 zoom, among many other features.

We even offer a few things the expensive machines don't offer.

Like more than 16 million color possibilities.

Yet the 3M Model BFA Paint System is only \$31,995. And that's about \$70,000 less than those other paint systems.

For more information about the 3M Paint System, call us toll-free at 1-800-328-1008.

Broadcasting and Related Products Division/3M.



3M hears you

3M

Circle 142 on Reader Service Card

NAB '84

TELEVISION

WHAT'S HOT IN TV PRODUCTS

FIND IT FAST

- | | |
|---|---|
| 66 Cameras | 81 Telecines |
| 67 Lenses | 82 Newsroom Computers |
| 67 Pickup Tubes | 82 Routing Switchers |
| 67 VTRs and VCRs | 82 Technical Automation,
Master Control |
| 68 Tape, Accessories | 86 Test & Measurement, Monitors |
| 68 Production Switchers | 86 Audio For Video |
| 70 Special Effects | 88 Lighting, Power,
and Support |
| 70 Digital Art/Graphics, Weather
Systems, and Character
Generators | 92 Mobile Units |
| 76 Still Stores, Animation | 92 Television Transmitting |
| 76 Image Processing | 94 Satellite Systems |
| 78 Post-Production | |

You've GOT What it Takes is the NAB's message to broadcasters this year, spelling out the word VOTE. And this seems to be the real message to the TV industry in 1984—that the whole world will be watching as America decides on a President, and television performs the monumental task of bringing first the Conventions and then the elections themselves to the public. Not to be forgotten, of course, is that 1984 is also the year that the whole world will be watching America's coverage of the Summer Olympic Games. It's going to be a year to remember!

What directions is the lineup of equipment at NAB '84 pointing towards for television? Most significant is proba-

bly that digital processing of one kind or another is definitely here to stay, and being made affordable at every level of sophistication. Whereas a few years ago digital systems could only be afforded by the few, today they are available to many. And the types of systems which even a small market station can buy range everywhere from art/paint composers to digital still stores to complex digital effects.

Then, of course, there are recorder/cameras—along with a debate over formats that is still going on, despite the suggestions that advances may have been made in the SMPTE committee on quarter-inch formats. The "format

NAB '84

TELEVISION

war" has settled into the trenches now, with each side, having made its various allies among other manufacturers, now pushing like mad to get station sales. A new wrinkle this year will be the emphasis on large multicassette players to replace quad cart decks; "If we can get stations to commit to half-inch for on-air playback," reason manufacturers, "surely they'll adopt it for news."

Other major developments in the industry are sure to become hot topics of conversation at NAB. LPTV, for instance, once thought to be the savior of local broadcasting, then relegated to the ranks of a hopelessly bogged-down technology, is definitely on the rebound again, with over 3400 licenses having been issued. Then, too, the recent agreement on a standard for TV stereo audio will have many manufacturers scrambling to come up with new products to support the development.

CAMERAS

The big news in cameras is that this year RCA (1000) will show its long-awaited CCD cameras as a product.



The Thomson-CSF TTV-1525C.

This camera, heretofore seen only in suites (at Montreux and last fall's SMPTE in Los Angeles), will finally hit the exhibit floor in Las Vegas. The subject of long R&D work by RCA, the new camera is notable for its absence of lag and excellent highlight handling, inherent characteristics of CCDs. In addition, RCA seems to have largely overcome the sensitivity problems of solid state sensors; the camera, as shown in demonstrations last fall, operates well at low light levels. As late as SMPTE, RCA was cautiously refusing to predict when the camera would become a product; one engineer told BM/E it would be at least another year.

As if the CCD camera won't generate enough attention, RCA will also introduce the TK-47C, the latest addition to the well-established TK-47 line of studio/field cameras, with some further software advances.

Other major camera news is that Philips (1500A) is expanding its LDK 6 line of computerized cameras with two new additions. The LDK 614 is the new portable member of the family, designed for field production. The LDK 26, even newer, is a compact, computerized studio camera



Bosch's KBF-1 camera with Lineplex recorder.



A Hitachi CCD camera.

using $\frac{3}{8}$ -inch pickup tubes and offering triax operation.

Thomson-CSF (1001) will bring its TTV 1525 studio camera in a new version, the TTV 1525C. The company will also show its version of Betacam, the TTV 1623, discussed elsewhere. Ikegami (1011-1013) will also have its new HL-95 camera system, both as an integrated recorder/camera and in its ENG/EFP configuration. Ikegami's HDTV camera system, shown as a prototype last year, will now be custom-built for clients, according to the company. In addition, the company will show a brand-new high-definition electronic cinematography camera (not the EC-35, still being marketed by Cinema Products) and the ITC-730A ENG/EFP camera, an updated version of the ITC-730.

The new camera entry from Sony (1200) is the BVP-360, a high-end field camera which can also serve in the studio. Like Ikegami, Sony is also ready to "cash in" on the 1125-line HDTV system it developed with NHK. Although the system hasn't been standardized and Sony will make no promise about compatibility with future HDTV standards, the system—both the camera and recorder—is said to be available for those who want to make the investment.

Other camera manufacturers showing established products will include Harris (401), with the TC-85 computerized studio camera and the TC-90 ENG/EFP camera; Hitachi (1402), with its SK-110, SK-97, and SK-970 auto setup cameras; Toshiba (1631A) with the PK-41 computer-controlled camera, along with the PK-70 and PK-61 ENG/EFP cameras and the PK-60 ENG camera; JVC (1234) with its ProCam and KY camera lines; Sharp (1102) with the XC-900D and XC-800 cameras; and NEC (1415), with its FP-3 CCD camera.

LENSES

At the Angenieux booth (1201), the featured item will be the company's brand-new lens and optical system for RCA's CCD camera.

Canon (1012) will have new television camera lenses in all categories, including studio lenses for 25 and 30 mm format cameras, and EFP/remote lens for 18 mm cameras, and a very lightweight ENG/EFP lens.

Schneider (1403) has an improved version of its 15X zoom with built-in diascopes and range extender, in addition to its full lens line. Although Fujinon (1411) had not released information on its new lenses at press time, the company can be expected to offer some new models. Tamron (1640) will come to its second NAB show with its line of ENG lenses.

For those looking for specialized lenses, Century Precision (1781) will introduce the Periscope, a lens accessory for tabletop, motion control, and special effects shooting that allows the use of any taking lens. The company will also show its wide-angle adapter.

PICKUP TUBES

The new RCA Satcom III pickup tube will be the featured item at the Calvert Electronics booth (125). Amperex (1412) will have several new diode gun Plumbicons, including half-inch, 18 mm, and 30 mm versions, as well as a new 18 mm Plumbicon for low cost cameras.

Ceco Communications (1010A) will once again have its broad line of tubes from many manufacturers. Richardson Electronics (212) will also show camera tubes.

VTRs and VCRs

Heading into the NAB, it would appear that the VTR and VCR front will be quiet, at least concerning the introduction of new products. Last year saw a rush of new one-inch studio and portable Type C machines championed by Ampex, and a counter-rush of 3/4-inch units—studio and portable—under the JVC, Sony, and Panasonic banners. The half-inch wars have now settled into the trenches and the quarter-inch alliance of Bosch, Philips and Ikegami as well as Hitachi are set to join the fray.

The big news this year, however, will be multicassette MERPS decks (multi event recorder/player systems), finally offering relief for the quad cart decks now on their last legs. A major new contender here will be Asaca (1226) which will premiere its 300-cassette system with four M-format and/or Beta acting as playback sources. The system features completely automatic operation on single-event cassettes, with a system that identifies the cassette to the automation controller.

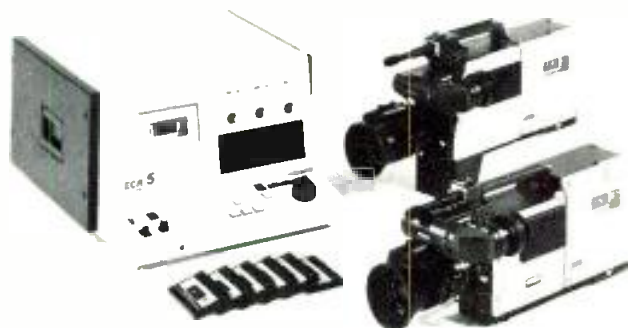

The Hitachi quarter inch recorder camera system, includes a single element CCD and 3/4 inch tube cameras.

Lake Systems (1165), a pioneer in videocassette automation, will be bringing its La Kart sequencer with some brand new software—plus capability of handling M format or Beta decks. United Media (1300) will show its new sequencer for automated 3/4 inch playback.

In one inch, the major event will be the full-scale showing of RCA's (1000) version of the VPR-3, the TH 400. Ampex (1400) will bring back the speedy VPR-3, along with the VPR 80 and the VPR 2B video recorders. The Ampex/Nagra VPR 5 one inch portable Type C VTR and half inch M format systems will also be shown.

What about Sony (1200)? Look for a surprise or two. One certainty is the premiere of the Betacam format multicassette player to match up against the M format multicassette systems touted in the VHS camp. The MERPS system supports 40 cassettes in four stacks and has a unique alignment system to permit the Betacam decks that serve as the playback heads to be removed and replaced with complete accuracy. Sony will also feature BVU 800/820 1P enhancements in 3/4 inch and the



The Asaca ACL-3000 300 cassette MERPS.

versatile BVH-2500 one inch recorder with single-frame animation capability.

RCA Broadcast Systems (1000) in addition to the TH 400 will feature its M format multicassette system, the TCR-10, along with the Hawkeye II cameras, recorders and accessories.

The hard sell in the Panasonic booth (1019) will be on its MVP-100 M format MERPS deck that it unveiled last year more or less in prototype form. The eight-transport unit was due to go into field test at the fall SMPTE. Also featured will be the portable NV 9540 3/4 inch machine for ENG/EFP applications.

On the Beta side, Thomson CSF (1001) will add two Betacam camera models to its line—the MC-613 three-

tube model and the TTV-1623 three-tube automatic model.

Supporters of the quarter-inch formats will create some action again this year. Hitachi (1402) is showing the SR-1 solid state quarter-inch recorder/camera and the SR-3 3/4-inch three-tube quarter-inch recorder/camera. Also part of the family is the ECR-5 quarter-inch playback unit. New in one inch will be the HR-230 Type C VTR. The other one-inch machines are the HR-200E and the HR-211.

Philips Television Systems (1500A), which announced its support of the Bosch quarter-inch system last year, will show the LDK-54 recorder/camera with the Lineplex recorders this year. Other introductions will support the recorder/cameras with a line of playback and post-production equipment.

Of course, Bosch (1603), which introduced the Lineplex system a couple of years ago, will be on hand with the Quartercam KBF 1, the BCF 10 studio recorder and the BCF 20 field editor—all quarter-inch equipment. Also in the Bosch booth will be the BCN 21 portable Type B for field playback and editing.

For its display JVC (1234) will have the VE-90A, BR-6400U, and CR-4700U 3/4-inch videocassette decks for editing, record-play, and play only.

In the A.F. Associates booth (1611) will be the Marconi B4624 VTR monitor unit, plus Type C models.

TAPE, ACCESSORIES

As usual there will be a raft of VTR support equipment as well as tape makers. Although much of the tape being displayed will be aimed at the half-inch-format machines, there will be plenty of other lines.

Agfa (1608), for example, may show a new line of professional Beta and VHS half-inch tape, but will also feature its line of premium grade Broadcast Plus U-matic cassettes and bulk duplicator tapes.

Among the most-watched booths will be Eastman Kodak (1214) which will introduce the new Eastman professional and broadcast-quality videocassettes and videotape in all formats, including half-, 3/4-, and one-inch sizes (the former TDK line). Also featured will be the Datakode magnetic control surface for films, Eastman LC low-contrast print film and high-speed color negative film.

Ampex Magnetic Tape (1400) will feature its full line of video tapes, the new 3/4-inch U-Matic 197 cassettes and the one-inch 196 tape reels in particular.

3M (1002) will be on hand with its full line of professional videotape products, featuring Scotch Color Plus U-matics in all lengths.

Sony (1200) is redoubling its videotape and videocassette product support efforts, promising rapid turnaround of orders from its new Alabama manufacturing plant.

Featured at the Fuji booth (1413) will be the new H451 Super XG videocassettes VHS T-120. Established products will include H701E two-inch videotape, H621 one-inch videotape B and C formats, H521/H521 BR U-Matic cassettes, and VHS and Beta cassettes.

Maxell (1624) will be showing its existing line including the 3/4-inch U-Matic KCS, half-inch HGX Pro videocassettes and the U-matic 3/4-inch KCA 5.

Among the accessories, Videomagnetics (1109) will introduce a random access videocassette changer for U-Matic format. Allsop (1177) will introduce its new 6700 pneumatic 3/4-inch and Ultraline VHS tape cleaners.

N.O.V.A. Corp. (1331E) is showing the Block universal sapphire tape cleaning device for reducing oxide buildup and dropouts. Research Technology International (1626) will be introducing a new line of one-inch videotape products, showing the VT-3100 professional videotape evaluator/cleaner.

Audico (1343) will premiere Model 619 cassette rewriter for all formats. CMC Technology (1425) is introducing a new line of replacement video heads for Ampex Type C VTRs.

PRODUCTION SWITCHERS

In the world of production switchers, news is still being made by the introduction of analog component systems that handle the signals being generated by various half- and quarter-inch recorder/cameras. Latest entry is the Crosspoint Latch (1321) Model 6116 which has four component inputs (Betacam or M-format) and three encoded inputs; RGB and encoded chromakeyers are standard, as

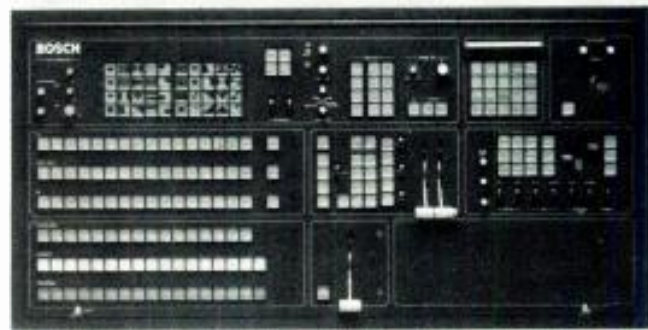

One of the new RME production switchers from Bosch.

are 32 wipe/mix patterns. A microprocessor-based control option is also available. (Crosspoint will also introduce Model 7239—a computer controller for 6139K series switchers, and a 99-event microprocessor controller for the 6109.)

The new component switcher joins the Grass Valley Group (1207) 1600-CF and Shintron (1417) Model 300 already introduced. Shintron will also unveil two production switchers featuring EMPRESS (Events Memory Programmable Effects Switching System)—effects automation controlled through the switcher/editor interface. The new switchers include the 374X, with double reentry and eight inputs under Z80 microprocessor control.

Brand-new from Bosch (1603) this year will be the RME production switcher. It comes in several configurations, with 16 or 24 inputs and one or two M/Es. Sixty wipe patterns are available, and a variety of chromakeyers and downstream keyers.

Central Dynamics (1409) will feature its 1080 switcher with an NEC DVE and new software for the CAP (computer-assisted production) switcher automation. Also new is Flexi-Wipe, which allows the switcher to capture any source image and use its outline for a soft key or soft wipe.

Ross Video (1110) will introduce the Encore Memory system, operating through a serial interface to video editors. It is available either as a standalone system, or as an option to most Ross 500 Series production switchers.

Vital (1212) will demonstrate its VIX-114 Series switchers, including Models -2ASQ, -4A, -10A, -16A, and -1A. The 250 P/N 10- or 16-input digitally controlled production switcher will be shown.

You Know Our Reliability...

New For '84

1 kW Single Cabinet UHF TV Transmitter



Acrodyne continues the tradition of innovative TV transmitter design and production technology with the all new TRU-1KAC 1 kW UHF **single cabinet** LPTV transmitter. This model provides compatibility with all U.S. and CCIR system broadcast standards on Bands IV and V. Our newly-developed modular upconverter uses a synthesized local oscillator and phase locked VCO to maintain exceptionally stable carrier frequencies and carrier separation. Capable of precise offset, the single cabinet transmitters feature full broadcast quality modulators. The synthesized local oscillator is programmable for any UHF channel between 471-830 MHz. Programmability permits simplified channel changes, retrofit to existing Acrodyne products and reduced maintenance and spares requirements for network stations.

Reliable, field-proven features for all 1 kW UHF Acrodyne transmitters include:

- Single tetrode output
- Wideband totally solid-state drivers
- Completely air-cooled
- IF modulated and low level diplexed
- Straight forward broadband solid-state circuitry
- Full capability for remote control interface
- Broadband, interchangeable, plug-in, high-power, solid-state R.F. amplifiers
- Adaptable for both primary and standby roles

Keep your broadcast capabilities at their peak. For low-maintenance, cost-effective TV transmitter equipment, **call or write Acrodyne today.**

ACRODYNE

Acrodyne Industries
A Unit of Whittaker Corporation
516 Township Line Road
Blue Bell, Pennsylvania 19422
215/542-7000 800/523-2596
Telex: 846358

The Signal
of Reliability

Industrial Sciences (232) will exhibit the 900 Series switchers with two new options, the 9016 auto transition unit and an automated production effects system.

Toshiba (1631A) will bring the WG-V wipe pattern generator, the DKG soft chromakey signal generator, plus a digitally controlled switcher.

New from ECHOlabs (1510) will be the AFS audio switcher, designed to work as a standalone unit or controlled by the ECHOlabs SE/3 special effects generator.

Graham-Patten (1227A) will bring new, lower-cost versions of its 1231 downstream video keyer system, plus the Model 612 audio post-production mixer.

SPECIAL EFFECTS

Even though digital special effects generators were among the first digital products on the market, they nonetheless continue to undergo development and refinements. And this year there are also some brand-new systems coming out, threatening to give established lines a

incorporates many of the features originally outlined by NHK specifications in Japan.

Digital Services Corp. (1302) will introduce Illusion, a video manipulation unit with digital effects including those of the company's existing Flexikey digital effects system, plus posterization, mosaics, barrel roll, chromakey manipulation, freeze frame, strobe, border, and border clipping, and optional perspective.

Ultimate (642) will introduce Newsmatte-2, featuring digital control, and Ultimate-5 with many new features.

NTI (1014D) will be making its first entry into the special effects area with the MEK-1000 multi-effects keyer, providing a glow around key signals.

Other developments can be expected by established companies in the area. NEC (1415) will have its E-Flex DVE system including perspective and rotation capability. Vital (1212) will show SqueeZoom. Ampex (1400) will, of course, demonstrate ADO, with the four-channel combiner. And MCI/Quantel (1631) will have its full range of DPE systems on hand.

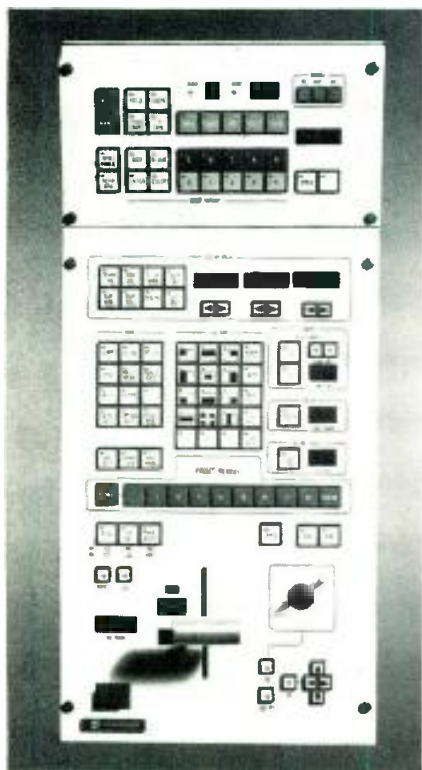

Harris will market a brand-new digital video effects processor.



The E-120 effects processor and control panel from Microtime.

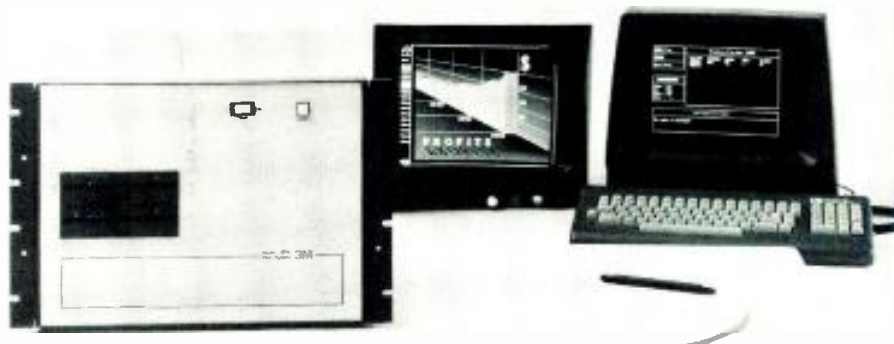

The brand-new digital art/paint system from 3M.

run for their money.

Among the new effects generators, the Model A52 from Abekas (1620A) is likely to cause the biggest stir. The company's philosophy, demonstrated in its low-cost still store, is to design single purpose systems which offer excellent image quality and extensive capabilities, but which use dedicated microprocessors rather than a distributed processing approach. One nice feature of the new unit is DataKey, a solid-state memory in the shape of a key; the user programs the effects setups into the key, then removes it for personal storage.

Another brand-new effects system is coming from Harris (401) which has had a major Japanese manufacturer design a system according to strict Harris specifications. Those who have seen it in action report extremely good key follow capabilities. The system uses a bubble memory for personal effects setup, and also offers the mosaic effects which have become so popular. The system

DIGITAL ART/GRAPHICS, WEATHER SYSTEMS, and CHARACTER GENERATORS

As has been predicted from time to time, there has been somewhat of a shake-out among the manufacturers of range of DPE systems on hand (although it has been rumored that the company may have a surprise or two in store in a hospitality suite).

computer graphics systems aimed at the broadcast market. Whereas just two and three years ago, when art/paint systems were newcomers to the scene, there were dozens of companies vying for attention, now the list has been narrowed considerably.

Still not certain is exactly how large the market will be once the major stations and facilities have bought systems. But Ampex (1400), at any rate, is convinced that the

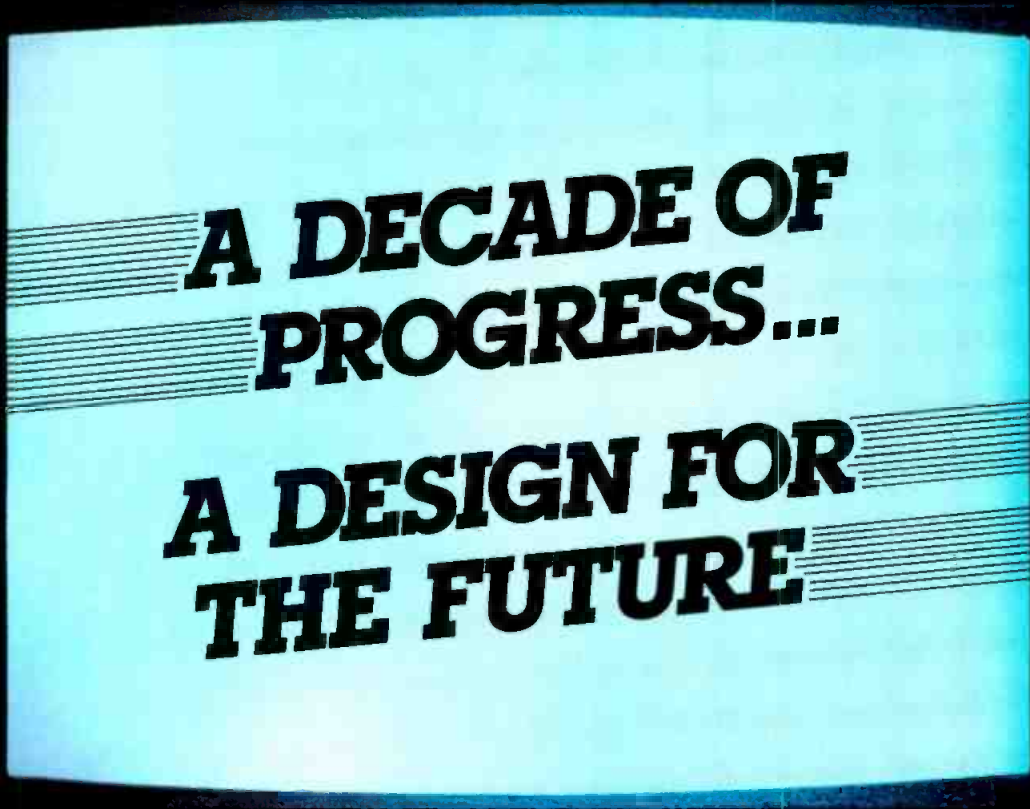

VIDEOTEK

Videotek, in only 10 years, has emerged as an industry leader on the strength of quality products, competitive pricing, and an unprecedented record of delivery and customer service.

The Studio 13 is the latest example of this Progress by Design. Incorporating more features and a higher level of quality than any color monitor in its class.

Line Select and 1H/2H Mode highlight the 1984 refinements to the ever-popular TSM-5A Waveform Monitor and VSM-5A Vectorscope.

As we enter our second decade, our commitment to offer the best products, prices, delivery, and service remains an uncompromised goal.



125 North York Street, Pottstown, PA 19464. (215) 327-2292. TWX: 710-653-0125/9625 North 21st Drive, Phoenix, AZ 85021. (602) 997-7523. TWX: 910-951-0621

© copyright 1984—Videotek, Inc.

Circle 144 on Reader Service Card

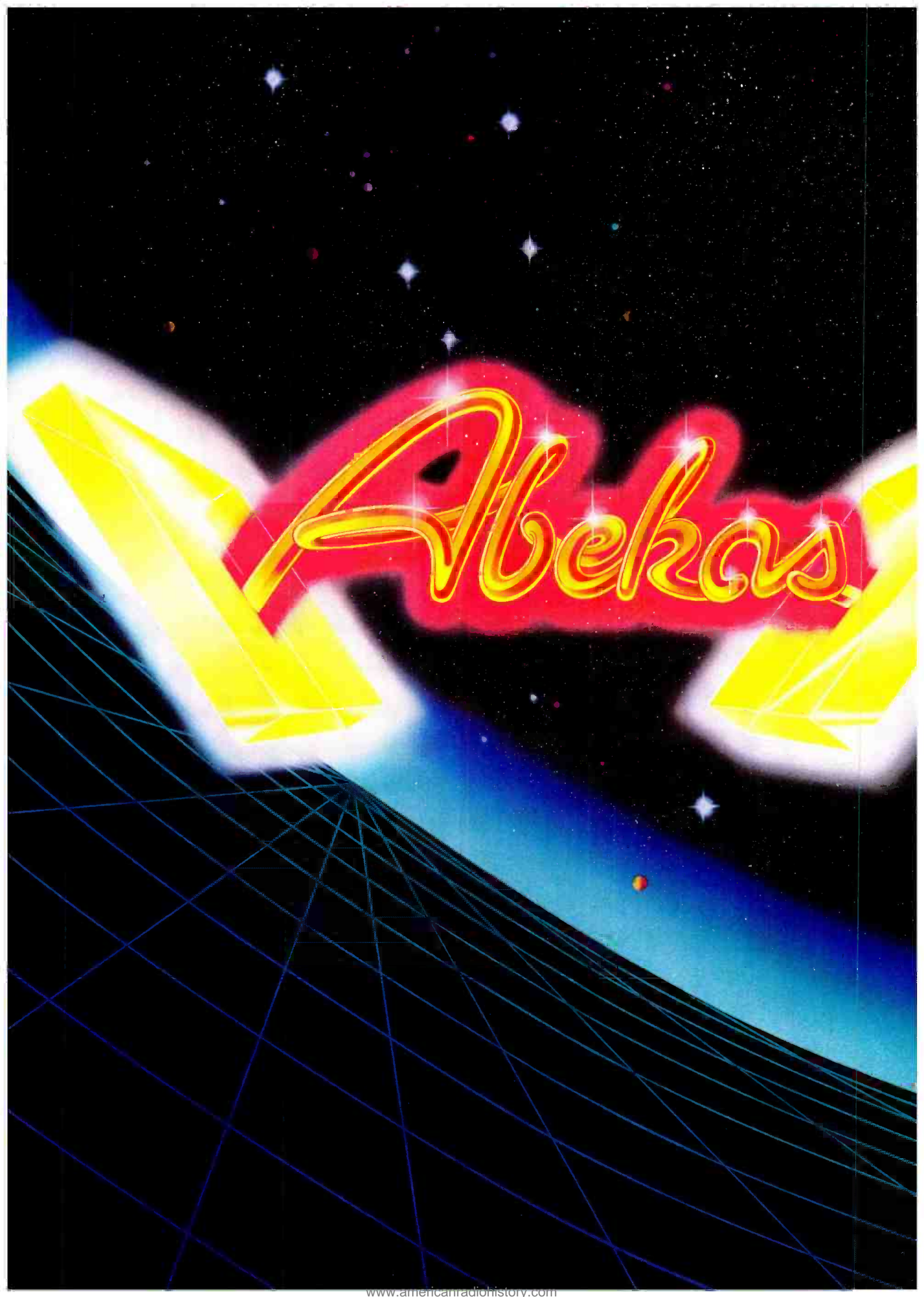

Abekas

LET US SHOW YOU TWO WAYS TO IMPROVE YOUR IMAGE.

Abekas revolutionized the digital still store market in 1983 with the A42 Video Slide Projector. In 1984, we intend to set a new standard of performance with our A52 Digital Special Effects System.

The A52 Digital special Effects System provides extremely high signal transparency, smooth picture movement, and a control system ideal for both on-air and post-production applications. Effects include: variable axis compression to zero, infinite expansion, picture repositioning, mosaics, posterization, flips, tumbles, splits, freeze, multi-freeze, background and border. Single or multi-channel system.

The A42 Video Slide Projector combines the very latest in 5¼" Winchester disk drive and full bandwidth digital video processing in a quality still store system that's both powerful and easy to use. Adaptive digital signal processing. Excellent multi-generation capability for graphics composition. On-line storage expandable to 1050 frames/2100 fields. Practical and economical off-line storage on ¼" digital tape cartridge. Single or dual-channel system.



The Abekas A52.



The Abekas A42.

Put the individual power of the new A52 or the A42 to use, or digitally interface them to form an awesome creative tool. For details, contact Abekas Video Systems, Inc., 319 Lincoln Centre Drive, Foster City, CA 94404, (415) 571-1711.

Abekas

Video Systems, Inc.

Circle 145 on Reader Service Card

See us at NAB, Booth No. 1620A.

www.americanradiohistory.com

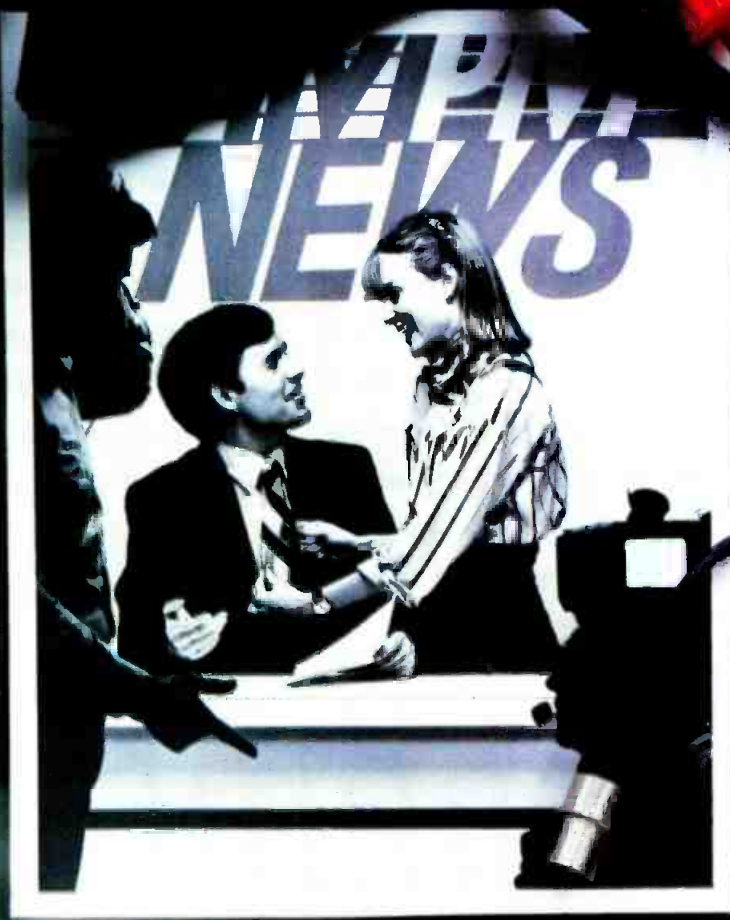

Our new lavalier mic makes everyone look good. Introducing the SM83.

People in news broadcasting have been using the same lavalier mic for a long time. But our new Shure SM83 is out to change all that. It's just what everyone has been asking for in an omnidirectional condenser microphone.

On-camera talent like the SM83 because its electronics provide for a dip in the mid-range, giving both male and female voices a smoother, more natural sound. And unlike its Japanese counterpart, the SM83 unplugs from the battery pack for easy storage.

Sound engineers appreciate the SM83 because its tailored frequency response requires less equalization. They like its low-frequency rolloff too, which quiets on-air rumbling and mechanical and clothing noise.

Set directors are impressed with the SM83's neat appearance on camera. The cord exits from the side and disappears from view, running down behind a tie, shirt or blouse.

Production assistants enjoy the SM83's mounting versatility. It comes with a single clip that works either vertically or horizontally, a double clip that holds two mics, and a universal mount that can be sewed, pinned or taped to clothing.

Repair technicians love the SM83's easy maintenance. The cartridge is easily accessible by unscrewing the end cap. And cable replacement requires only a screwdriver and tweezers; no soldering is necessary.

Field crews are also big fans of the SM83 because its electronic pack is powered by a standard 9-volt battery or by a mixer's phantom supply.

For more information on the Shure SM83, the little mic with big advantages, call or write Shure Brothers Inc., 222 Hartrey Ave., Evanston, IL 60204. (312) 866-2553.

SHURE®

THE SOUND OF THE PROFESSIONALS®...WORLDWIDE

Circle 146 on Reader Service Card

www.americanradiohistory.com

NAB '84

TELEVISION

market has barely been tapped here. And although it withdrew AVA, the "grandfather" of art/paint systems from the market several years ago, it is now ready with a brand-new product, AVA-3. It is positioned like the ESS-3 still store, an easy-to-use, not overly sophisticated or priced unit, ideal for news and weather applications at stations which can't afford the bigger systems. Given the recent success of ADO, it's likely to make a big hit at the show, and will be exhibited along with the ESS-3 in a simulated news set environment.

Among high-end systems, one of the leaders continues to be Computer Graphics Lab (1143) which will introduce the 3-DV, a computer graphics-based three-dimensional animation system. It will also show the Images-2, a low-cost version of the Images digital art/paint system.

Still a leading contender in the world of digital art and graphics, the Bosch (1603) FGS-4000 has become truly awesome in its capabilities, with astonishingly realistic three-dimensional perspective and movement. Since work continues on software modifications for the basic hardware, it will be necessary to visit the booth to see the latest effects. (Bosch will also have its low-cost FGS-1000 art/paint system on display).

MC1/Quantel (1631), of course, continues to make strides with both its DPB-7000 Paint Box and the Mirage 3D graphics system (extended into the Cypher ultra-sophisticated character generator with 3D image manipulation now in a production version). Rumor is that extensive new software will be available for the Paint Box.

Aurora's (1312) digital video graphics and animation system will now include 3D perspective transformations and additional animation capabilities. It now also supports single-frame animation with automatic control of a Sony BVH-2500.

Dubner (1630) has made substantial updates on the CBG-2 graphics system, now with higher resolution (37 ns), more colors per image (256), dual keyboard operation, new 3-D software, hardware anti-aliasing, and "third plane" electronic digital still store option.

Beston/McInnis-Skinner (1020) will have a brand-new product offering in this area—Data-Graphics, a computer graphics system generating maps, charts, and graphics for weather information and news applications. This is presumably an updated version of the erstwhile McInnis-Skinner Weathergraphics system.

3M (1002) will be coming onto the scene with a brand-new art/paint system, a standalone unit featuring a digitizing bit pad and host computer.

Colorgraphics (1116), too, promises a brand new art/paint system development, stepping away from its more weather-oriented traditional product line.

Chyron (1610) continues to amaze the industry with additions to the MGM (multimode graphics module) package that converts the Chyron IV character generator into a graphics system. New features include x,y,z (3D) rotation of graphics, cut-and-paste graphics functions, automatic as well as manual inter-character spacing,



Quanta's Quantafont character generator.

automatic word expansion, and an optional third channel.

Interand (1016) will unveil the Discon 1000 videographic teleconferencing systems with FastScan. The system operates over ordinary phone lines, coupling freeze-frame video with interactive audio and computer-aided graphics capabilities.

Newcomer Apis Corp. (1762) will introduce the Graph-Pac ultra-high resolution color real-time graphics display for TV production, and the Video Pointer graphic symbol generator, which uses a touch tablet membrane for x/y movement.

Also look for developments in the Thomson-CSF Vidifont Graphics V.

In addition to the art and graphics systems described above, there has also been considerable activity on the digital weather presentation systems front. Environmental Satellite Data (1509A), for example, will introduce the PMT-100 low-cost complete weather graphics and production system, featuring high-resolution graphics and font generation, framestore, animation with nine to 19 frame loops, RRWDS local color radar displays, Doppler radar display, automated broadcast and/or dial-up data acquisition, and more.

Vectrix (175), in its own booth for the first time this year, is offering several low-cost digital weather graphics systems. New is its basic WITS terminal, a standalone, low-cost weather and/or graphics terminal that accesses WSI, ESD, and Accu-Weather databases. But it will also introduce a graphics setup that can be run on an IBM PC with the addition of two computer cards—one presumably a color graphics board, the other an NTSC encoder; this system stores information on an IBM XT hard disk.

New from Kavouras (1635) this year will be the Triton XL high-resolution weather graphics and animation system; a high-resolution, real-time radar colorization system; and high-speed weather data transmission via Westar III.

Alden (1336) will introduce the C2000 Series of color weather graphics displays for live weather satellite pictures, live weather radar picture, and/or computer derived weather graphics.

R*Scan (1740) will unveil its LPATS (lightning position and tracking system), with self-contained animated color displays or interface with a station's weather computer. Also introducing the NVG video facsimile animator for satellite image animation.

WSI (1104) will unveil Meteosat imagery, providing hourly cloud cover satellite pictures from Europe and the Middle East and up to 20 new custom-prepared weather maps per day from Weather Central.

Rockwell International (1767) is getting into the weather business with a new weather radar system that eliminates ground clutter. It also displays air turbulence.

For hardcopy images of all of the above, Wavetek (1782) is offering a brand-new system for converting video into 64 grey levels on their printout. Lang (at the R*Scan booth, 1740) has the VideoSlide 35 for producing slides from graphics displays.

In character generators there are not many brand-new product offerings this year, although the upcoming election means that virtually every manufacturer with an election reporting system will have it on prominent display. 3M (1002) will have two new character generators, D-1000 and D-5000, both lower-end systems presumably designed to compete with Chyron's units.

Quanta (1432) will demonstrate the Q8 Quantafont font-loadable teleproduction graphic titling system with real-time easy edit/quick compose text handling.

Laird Telemedia (1721) will introduce a dual-channel option for its Model 7200 Communicator character generator.

Knox Video Products (1511), back in full operation, will introduce the K100 Chromafont character generator, offering multiple high-resolution fonts with proportional spacing and a palette with 250,000 colors.

Newcomer Mycro-Tek (1752) will introduce the Mycro-Vision MAX, a low-cost, high-resolution character generator.

STILL STORES, ANIMATION

In digital still stores, there will be few brand-new developments this year. One exception will be ADDA (1100), which will unveil the ESP II low-cost broadcast-quality still store; the unit has two channels, and also comes with extensive graphics and digital effects capabilities.

Harris (401) will have the Iris prominently displayed. A new feature is a removable 16 k solid-state memory, allowing the setup for the effects storage and the IGS compose station to be carried in a pocket. Previously introduced was the compression/effects package and the character generator option for subtitling graphics.

Also previously introduced but still of interest is the NTI (1014D) DSS-11, a digital still store providing 160 megabytes of storage for up to 1000 stills, with add-on capacity for up to 7000 stills.

Both Ampex (1400)—the ESS-3, and MCI/Quantel (1631)—the DLS line—will have major product demonstrations. In the case of MCI/Quantel, this includes the extensive DLS library system for storage and retrieval of massive quantities of graphics information; it can also be networked with the company's other digital production products such as the Paint Box.

But though still stores themselves are relatively quiescent this year, animation systems are springing to life everywhere. Partially this is because of the large promotional effort being put into the Sony BVH-2500 still frame recorder. Lyon Lamb (1632A), for instance, the leading manufacturer of video animation systems, will add the new VAS IV-Delta animation controller for the 2500 (as well as a new VAS IV low-cost, rack-mounted version of the VAS IV). As discussed earlier, Aurora now

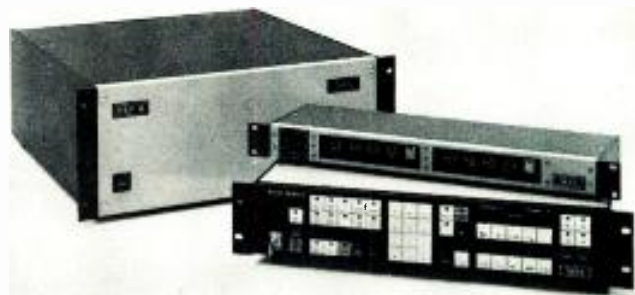

ADDA's new ESP II incorporates extensive graphics features.

offers control of the 2500 through its art/paint system.

The other interesting development in animation is that computer-controlled animation and model stands, once the exclusive domain of the feature film and TV commercials industry, are starting to make their way over into broadcast and teleproduction. First-time exhibitor Interactive Motion Control (138), for instance, will bring its computer-controlled camera system. A computer memorizes the camera moves, then repeats them with extreme precision so that multiple moves can be repeated over and over, giving extensive special effects capability. The same kind of system is offered by another NAB newcomer, Euro Equipment Service (1175), an automation system for animation stands. Forox (1620D), too, will show a computer-controlled animation camera system.

Not a digital product but interesting nonetheless, Frank Wooley's (1450C) Motionmaster uses a polarized light process that creates the illusion of motion, with over 70 animation patterns.

IMAGE PROCESSING

Many of the new image processing systems coming onto the market now also incorporate at least some limited special effects. Two of the best examples are the two-channel systems from both ADDA and Microtime. Microtime (1230) this year is introducing the S-230D TBC/frame synchronizer to add versatility to the T^{SE}-120 digital effects unit, and including additional effects capability.

Perhaps the most interesting development of all in digital processing is actually a combination digital recorder/still store/image processor from PEL (Picture Element Ltd., 1517B), at its first NAB. The VSP (video sequence processor) actually digitizes and stores up to eight minutes of video information on Winchester disk packs, then



The four-channel TBC from Transimage.

plays it back at any speed desired. Between the recording and playback, the image can be manipulated in any number of ways, including changing its aspect ratio and scan rate. One can also vary the frame readout sequence, al-

BUILT TO GO WHEREVER YOU GO

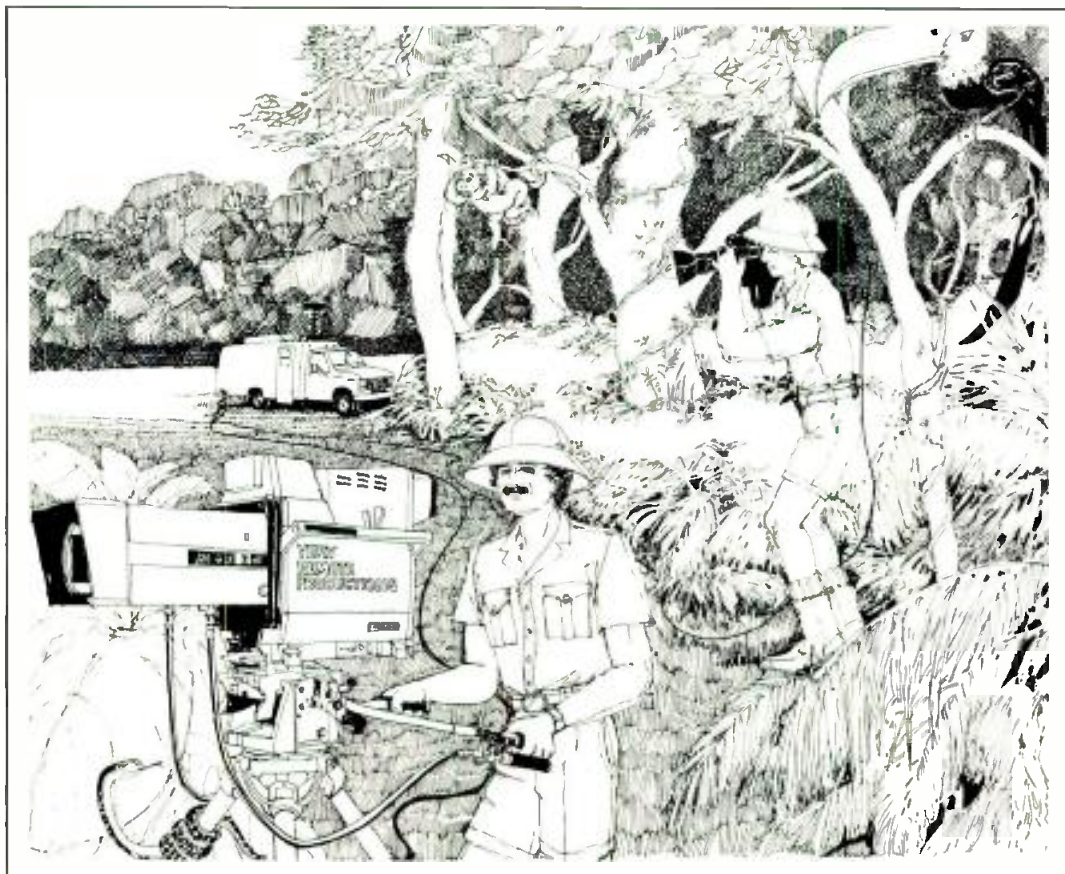

ENG & EFP CAMERAS

BY **Ikegami**

IKEGAMI ENG and EFP cameras deliver the ultimate in picture quality whenever and wherever you need them.

The IKEGAMI HL-79E ENG/EFP portable camera offers the highest possible picture quality in a slim, lightweight package. Flexible configurations include ENG and EFP systems with optional digital remote control and automatic set-up functions.

One of the most popular studio/field cameras is the IKEGAMI HK-357 microcomputer controlled camera. Whatever the location, the HK-357 arrives at the scene and is ready to produce studio quality pictures in minutes.

Wherever you go IKEGAMI reliability assures that the job gets done. After all, if it breaks down in the field there's a real jungle out there.

ENG & EFP VEHICLES

BY **GRAY COMMUNICATIONS**
CONSULTANTS INC.

GRAY COMMUNICATIONS constructs mobile production vehicles from custom designs that insure ruggedness and the ability to go where you go.

Since no two production assignments are the same, each ENG & EFP vehicle we construct is custom designed to meet your needs. The vehicle, whether it be a mini-van or tractor trailer, is selected according to environment and purpose. Production equipment selection is based on function, flexibility and durability. Top of the line equipment like IKEGAMI cameras insures superb picture quality and a minimum of maintenance.

GRAY COMMUNICATIONS delivers vehicles built to go wherever you go — and get you back. Sometimes it's a long walk home.

ALBANY, GA (912) 883-2121
ATLANTA, GA (404) 455-3121
BIRMINGHAM, AL (205) 942-2824
MIAMI, FL (305) 591-3637

NASHVILLE, TN (615) 883-9175
NEW ORLEANS, LA (504) 733-7265
ORLANDO, FL (305) 896-7414
TAMPA, FL (813) 885-1411

Circle 147 on Reader Service Card

lowing the VSP to be used for editing applications.

Another exciting new development is the TS-102 time-shared TBC from Transimage International (1512). The unit allows four VTRs to be plugged in at once, with front panel pushbutton selection among them, and featuring vertical interval switching of the video signal from one set of TBC parameters to the other. It comes in a basic version with the TBC circuits, plus add-in modules for audio follow (automatic audio display), video fade to black, subcarrier generation, etc.

There will also be several new product introductions in the TBC/framestore/fieldstore market. MCI/Quantel (1631) will introduce the 1750 digital framestore synchronizer in a single rack unit.

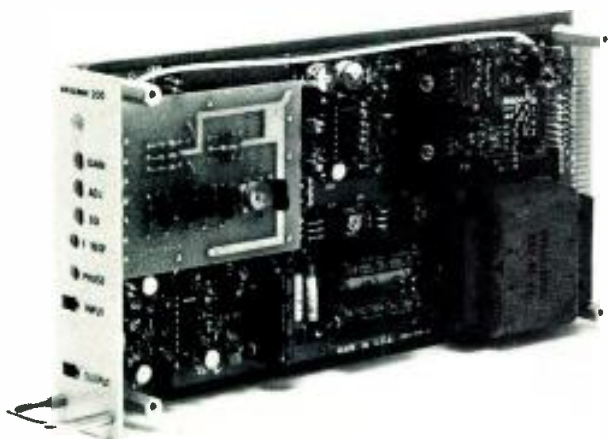

Model 200/210 video DA from Omicron.

Harris (401) will have the new HVS 632C component frame synchronizer with digital noise reduction, compress/positioner, and digital keyer, plus the HVS 690 frame synchronizer/TBC.

For-A (1306) will introduce the FA-430 digital TBC with digital image enhancement and color correction, and the CCS-4300 color corrector.

James Gruner & Assoc. (1760) will unveil the Cel Ltd. TBC/frame synchronizer with infinite window and color corrector with proc amp. It also has some digital effects including pixelization, posterization, and forced-color imaging. It is a seven-bit component device designed for all 3/4- and 1/2-inch systems.

Leitch (1021) will introduce a new framestore synchronizer and the VPA 331 video processing amplifier. Nova Systems (1345) will introduce the Model 500 compact, low-cost digital TBC with 8-bit, 4 x fsc sampling; the unit features only 50 W power consumption in one rack unit.

Fortel (1409B) will highlight the Digiblock FS-1 and FS-2 frame synchronizers, the Y-688³², total error corrector; and the C-YIQ³², TBC³², CCDHP, and CCDHPS TBCs. Tektronix (1601), relatively new in the digital processing field, will again demonstrate the 110-S 10-bit framestore.

Paltex (1005) will introduce its latest dual and single channel digital TBC/field stores with multiple inputs per channel, digital mixing and effects, picture processing, and enhancement.

Apert-Herzog (1703) will feature the H2 TBC synchronizer and A2 full frame synchronizer. Hotronic (1331B) will show its TBC/frame synchronizer with optional freeze frame and freeze field, capability, dropout compensator, and remote control.

Lenco (1419) will introduce a new PAL sync generator, as well as a PAL encoder and changeover unit, an

NTSC sync generator, and a standalone decoder. Grumman Aerospace (1631B) will highlight the 501 sync proc and Rainbow Sound system for encoding audio into the video format.

ICM Video (1766) will bring its new VC-2000P video corrector/proc amp/video enhancer/audio-video DA.

Distributor Broadcast Video Systems (1326) will show the BVS D-1000 NTSC decoder, Cox computer video processor, and component color corrector.

Among standards converters, the U.K.'s GEC McMichael (1772) will show the Ace four-field standards converter. Oki (1505) will demonstrate its LT 1210 portable digital TV standards converter. And MCI/Quantel (1631) will have its six-field DSC 4000 Series digital standards converter. Other standards converter developments can be expected from Video International (1524) and A.F. Associates (1609).

POST-PRODUCTION

Perhaps sparked by CMX's major new product introductions of last year, the video editing field is bubbling like a volcano. One major focus of attention will no doubt be the Convergence booth (1430), where the much-ballyhooed, top-secret EditDroid will finally make its first public appearance. Speculation and skepticism about the new system, developed in conjunction with LucasFilm and already used in some feature film projects, was high at press time. Convergence has remained mum on the actual details, and would only say that EditDroid is a high-tech, completely transparent approach, addressable in regular English, and accepting tape or discs as sources.

Even less information was available at press time about another top-secret editing system project, although an announcement was scheduled for mid-March. Look for Video Composition Corp. (1775) of Boston to show up at Las Vegas with its Montage Picture Processor editing system. Rumor has it that this new system—just installed at VCA/



The exciting new Montage video editing system.

Teletronics in New York City—offers a unique approach to large-scale editing, using 14 Beta decks to provide frame-by-frame, random access scene viewing.

Expect plenty of other significant news in editing.

Automatic, continuous, reliable broadcasting. Introducing the Panasonic® MVP-100.

Now broadcast automation takes a giant leap forward with the introduction of the MVP-100. To start with, it incorporates the YIQ ½-inch M-Format. And that means picture quality that not only surpasses ¾-inch and 2-inch, but actually rivals 1-inch tape. All with the reliability and economy of ½-inch, M-Format recording.

But the Panasonic MVP-100 will do more than make your programming look better; it will also make broadcasting easy. The reasons: its

automatically threaded, computer-controlled tape transport systems. The MVP-100 lets you schedule in advance and automatically air program length material, news spots, editorials, commercials, station IDs and promos. All with time-code accuracy. It all adds up to totally reliable automation of your station's broadcast day. The MVP-100's spot player and recorder will even make those unfortunate moments of "dead air" disappear since protection copies are easily dubbed

and are programmed to take over the moment broadcast continuity has been interrupted.

Still, with all the MVP-100 has to offer, you can put it to work at a surprisingly affordable price. Audition the Panasonic MVP-100. Once you do, don't be surprised if you end up carting your present video cart machine away.

For more information on what the MVP-100 can do for your station, call the Panasonic New Technology Products Group at (201) 348-7471.

Panasonic

NEW TECHNOLOGY PRODUCTS GROUP

Circle 148 on Reader Service Card



CMX/Orrox (1639) will probably have a working production version of its 3400 editor, although whether the 3400+ will be in production by show time remains doubtful. In both cases, some wrinkles on the original products are likely. CMX products also feature in the design of transportable editing systems packaged by Laumic (1771).

United Media (1300) will have a compact two- or three-machine controller called Mini-Comm, which is expandable to SMPTE time code and full A/B roll capabilities. (Of course, the company's Commander II will be shown, too.) Control Video (1157), now a subsidiary of ADDA Corp., plans to show an optional keyboard for its LightFinger touch-screen editing system, and Videomedia (1308) will have new user-programmable keys and upgraded software for its Z6000 editor.

EECO (1314) will break into the large editor market with a new computer-assisted system capable of controlling up to nine machines, plus a video production switcher and audio switcher. In addition, EECO's small IVES editor will be upgraded with A/B capabilities and special effects control.

One newcomer to the editing system field will be Omicron Video (1748), with the new EMX-7100, which controls up to four machines with A/B roll capability. BTX (1124), long known for its synchronizing products, will have an intelligent synchronizer and editor/controller called The System, along with a new transport command console with automation and editing capabilities. The company's Softouch audio editing system will have some new software features. And at least one other company may debut its first full-scale editing system.



The Asaca editing previewer allows the display of video frames.

Look for some new features on the Interactive Systems Co. (1167) System 41 large-scale editor. Applied Digital Technology (1730) plans to introduce a new disc-storage system for Sony's BVE-3000 editor. Attendees looking for Datatron's editing equipment are advised to drop by the Paltex booth (1005), where the company's new owners will have the Vanguard and Edit-Star systems.

In the synchronizer area, Adams-Smith (1724) is planning to show what it describes as a low-cost technique for synchronizing VCRs used as digital audio recorders with VTRs. NEC America (1415) will have a new audio synchronizer, the AS-18, and Omicron will show the Model 5500, a new VTR/ATR synchronizer. Tektronix (1601), too, is expanding its line of production/post-production equipment with a new audio synchronizer to complement the S-110 10-bit video frame sync.

AT NAB '84 SHINTRON ANNOUNCES...

EMPRESS 2000

A BRILLIANT NEW SWITCHER

690

A TIMECODE READER/GENERATOR

270

AUDIO FOLLOW VIDEO MIXER

And for component video people we will have...

MC1 LONG-AWAITED INTERMATRIX CONVERTER

12X SERIES ROUTING SWITCHER

VISIT US AT BOOTH #1417

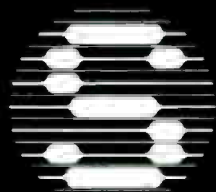

SHINTRON

SHINTRON Company Inc.
144 Rogers St., Cambridge, MA 02142
Tel: (617) 491-8700 Telex: 921497

SHINTRON Europe, 198 Avenue Brugmann, 1180 Brussels Belgium Tel: 02-347-2629/Telex: 61202

Circle 159 on Reader Service Card

Among established systems, look for BTX to bring its Shadow synchronizer. Audio Kinetics (1173) will have some new programs for its Q.Lock synchronizer, including Q.Soft, which adds audio special effects, track editing, and automatic dialog replacement capabilities.

The time code field will be expanded with Adams-Smith's introduction of a new family of modular time code controllers for TV audio editing and sweetening. Amtel (1745) will have several new time code products, including a SMPTE generator, reader, and character inserter; a VITC and longitudinal reader and character inserter; and a portable VITC and longitudinal reader and character inserter. ESE (1757) will have a new SMPTE code comparator with two-event capacity.

Evertz Microsystems (1745) will bring a raft of new time code products, including longitudinal generator/readers, a VITC/longitudinal reader, a VITC source identification system, and a portable VITC generator. The Cipher Digital (1606) longitudinal time code line will be in production this year and will include two readers, one with eight-channel event controller, and a VITC generator. Look for Gray Engineering (1755) and Skotel (1126) to bring their established time code lines.

TELECINES

The biggest news in telecines will be the new Rank Cintel (1219) ADS 1, a solid state telecine designed for on-air use at television stations. The product represents a new marketing direction in the U.S. for Rank, whose Mk III flying spot scanner is used primarily by production houses here (although it enjoys wide acceptance at broadcast stations overseas). Rank had information on the ADS

1 at last fall's SMPTE show, but this will be the machine's U.S. debut. Also look for it at the RCA booth (1000), where it will be marketed as the TKS-100.

This year may see some new wrinkles in the large-scale post-production telecines, but no revolutionary changes. Rank Cintel will again show the Mk III; A.F. Associates (1611) will have the Marconi B3410 digital line array telecines; and Bosch Fernseh (1603) can be expected to



Corporate Communications' System 2000 scene-by-scene color corrector.

feature its FDL-60 CCD telecine.

L/W International (1602) plans to introduce a new multimedia film/video transfer system, and should bring its established Athena line of film chains. Magnasync/

More Performance Per Dollar!

PowerPac — Compact Power for Better Results

Combine the world's most compact, full-power, frequency-agile transmitter with our complete range of central E.N.G. receivers, and achieve the best performance per dollar available anywhere!

RF Technology's PowerPac transmitters are available in both the 2 and 2.5 GHz bands. Standard features include two audios, switch selectable R.F. output power, and remote control capability.

Our dual down conversion central receivers are available in either band, or as a combined dual band system. Standard equipment includes built-in remote control interface, 2.5dB low noise amplifier, and dual audio channels.

For more performance for your dollar, come to the company where good delivery and service really count.

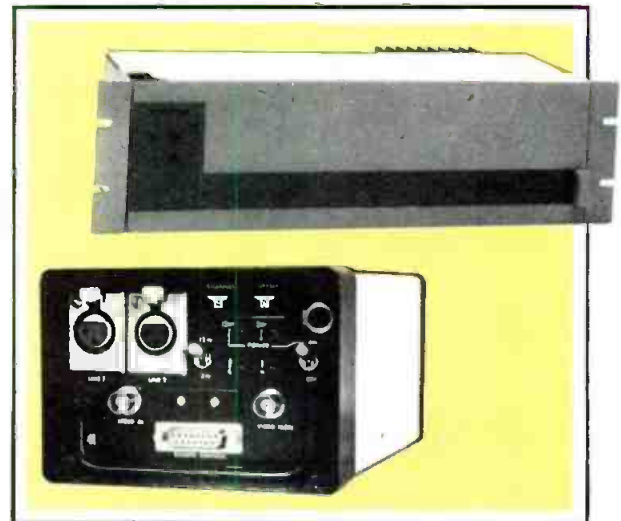

RF

TECHNOLOGY, INC.
A CONTINENTAL MICROWAVE PLC COMPANY

145 WOODWARD AVENUE, SOUTH NORWALK, CT 06854
PHONE: (203)866-4283 TELEX: 3722030 RFTECH

See us at Booth #171 at the NAB Show

Moviola (1147) will also show its telecine line. More film chains can be seen at the Laird Telemedia booth (1721).

Camera manufacturer Ikegami (1011-1013) will have a new auto setup telecine camera system this year, the TKC-990, in addition to its established TKC-970 telecine camera.

In color correctors, look to Broadcast Video Systems (1326) to introduce a new component color corrector. Another new color corrector, the CCS-4300, will be shown by For-A (1306). The biggest news, however, will probably be found at the Corporate Communications Consultants booth (1161), where several new products will be shown: the System 2000 interactive, computerized scene-by-scene telecine color corrector; the System 60C3 computerized scene-by-scene telecine color corrector, an updated version of the 60C2; and the System EBKM tape-to-tape color corrector.

NEWSROOM COMPUTERS

With more and more news departments automating, exhibitors of the various newsroom computer systems have become a vigorous force at NAB. At the same time computers have become more versatile and easier to use, making the new systems more attractive to broadcasters.

For instance, BASYS (1129), which is a leading designer of full scale systems, will introduce the Personal Assistant. This system uses an IBM PC, but has all the features of the larger News Fury newsroom computer. The News Fury and Clip Fury will also be demonstrated.

Jefferson-Pilot Data Systems (1629), which has various systems from ratings analysis to accounting, will also demonstrate the new ENP Electronic News Processing for larger multiuser operations as well as smaller newsrooms.

One of the early leaders in these systems, Beston/McInnis-Skinner (1020) will feature the NewsScan system, which offers script preparation, library, archive and producer rundown functions.

This being an election year, Telesource Communications (1700) will be stumping for its in-station election system based on the Motorola 68000 microprocessor for storage and voting updates. It will also have Series 2000 newsroom computers featuring wire capture, show rundown, scripts, and assignment.

Quanta (1432), also in the newsroom competition, will demonstrate Quantanews. This system is designed to expand as the user's needs expand. Colorgraphics/IT (1116) will be offering Newstar, another expandable system.

ROUTING SWITCHERS

Development will continue in the routing switcher area, although perhaps without the fanfare of last year's show, which saw major advances from such companies as Grass Valley, 3M, and Bosch. Nevertheless, plenty of new switchers will be on hand. 3M (1002), for example, will have two new models in its Series H hybrid routing switcher line, which uses hybrid circuits to cut down on switcher size.

The IRS intermediate routing switcher line from Hedco (1225) will appear this year in a new version featuring 28 x 48 video matrix with one audio channel. A line of self-powered routing switchers and distribution equipment will also be new.

Image Video (1341) will have two new routing switcher products, including a 16 x 16 high-density, broadband video RGB switcher and a 16 x 16 AFV switcher with

built-in power supply.

A new routing switcher with updated computer control, the 7934, will be featured by Telemet (1202).

Harrison Systems (1324) will unveil a new video switcher, the VSI, designed for audio-follow-video operation.

Bosch Fernseh's (1603) TVS/TAS-2000 video/audio distribution switching systems, notable for their voice activation and speech synthesizing functions, will make their second NAB appearance.

The BSM Broadcast Systems booth (635) is on the radio side of the hall, but don't forget to stop by and check out their new Series 5000 video and audio routing switcher.

Grass Valley Group (1207) will bring its Horizon and 440 lines of audio/video routing switchers, along with the Ten-X small audio/video routing switcher. Established lines of routing switchers will also be featured by Datatek (1428); Di-Tech (1301); and Dynair (1404), which may also offer some new products.

TECHNICAL AUTOMATION, MASTER CONTROL

The big news in technical automation are the multicassette players (MERPS), discussed in the section on VTRs and VCRs. Each of the new systems has elaborate facilities for microprocessor control of the deck, and most also offer interface with business automation systems which allow for total station automation. In addition to the Sony, Asaca, Panasonic, RCA, Lake Systems, United Media, and other systems mentioned there, Broadcast Systems (1500) will introduce the DC-8 MERPS deck for computer-controlled sequencing of 3/4-inch videocassettes.

There are some other significant developments in technical automation and master control as well. A.F. Associates (1611) will make the NAB debut of Protel, the English computer control company. In addition to an automation system for station breaks, promised is a full-scale automation system with interface with business and resource management as well.

Digital Services Corp. (1302) will introduce Conductor, a master control switching automation system, and the Statistician, a sports statistics package.

Vital (1212) is introducing the VIX-115 master control switcher, designed to be interfaced with SAM, Vital's station automation management system. Crosspoint Latch (1321) will premiere the Model 6150 master control switcher with 16 inputs.

Image Video (1341) will introduce a small master control switcher with 10-input program and preset buses; a medium-sized master control switcher; and a large master control switcher with 30 inputs per bus.

Landy Associates (1747A) will debut the Interphase M-400 machine control system with RS-422 control of VTRs and telecine equipment.

Utah Scientific (1114) will have new control panels for its machine control line, and will be showing the MC 502 master control switchers, one fully automated.

Auburn Instruments (1711) will feature its MC/1 two-wire machine control system for television and audio equipment. Grumman Aerospace (1631B) will highlight its distributed microprocessor-based modular and expandable remote control and status monitoring system.

CAT Systems (1014B) is introducing a new Model 4200 facility monitoring system with the RF switching

FLEXiKEY™

ILLUSION™

Two new digital effects systems

FlexiKey

The Key Manipulator designed for any budget... \$19,500! and now available with DSC's Optical Perspective option.

FlexiKey™ is the smart solution for your station's first digital effects system, or use it as a 2nd channel special effects system with your present digital effects.

Check all these standard FlexiKey special effects...

- variable image positioning • split images
- matrix wipes • horizontal and vertical title squeeze • flip, spin, tumble, compress, zoom, rotate or any combination of these effects.

Plus the new Key Klean-up mode... a great production tool that eliminates ragged edges from poor key sources.

Illusion

The new hi-tech full optical digital video effects system that puts cost in its proper perspective.

Illusion™ is a full frame effects system using the most advanced digital design techniques to provide a full range of video optical effects plus...

- barrel roll • posterization • strobe effects
- tumble • borders and border clipping
- chroma key manipulation • adjusts blanking widths... and with DSC's Optical Perspective as a standard optional accessory.

And the cost is as exciting as Illusion's effects.

Ask for FlexiKey and Illusion demo tapes when you call or write for complete details.

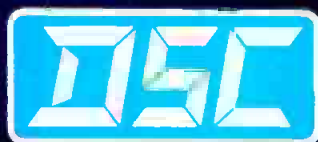

Digital Services Corporation
3622 NE 4th Street
Gainesville, Florida 32601
904-377-8013

Circle 161 on Reader Service Card

See Illusion and FlexiKey
at NAB... Booth 1302.

THE FIRST NAME IN FILM

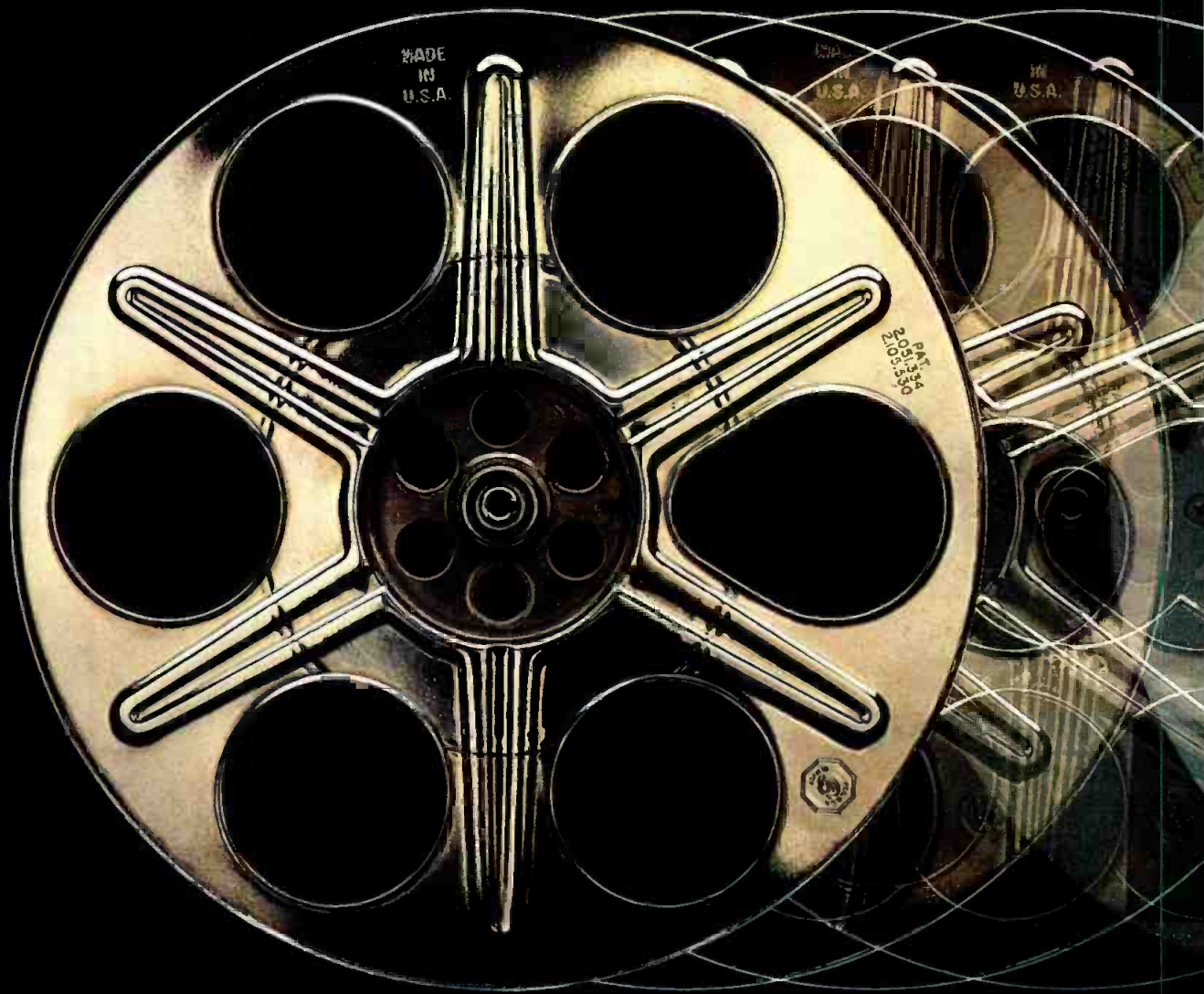

Introducing video tape with the quality, dependability, consistency, and backup service you expect from Kodak.

The virtues that have made Eastman Kodak Company the first name in film are now yours in new Eastman professional video tape.

A world leader in imaging technology for more than a century brings you a brand of video tape so good that we stake our reputation on it.

So can you. Because Eastman professional video tape offers you a unique combination of benefits.

Quality. Try our video tape and experience its quality. You'll see that Eastman professional video tape meets the same stringent performance standards that characterize all Eastman products.

Dependability. Establishing a reputation for reliability takes time and commitment. Our record speaks for itself. To satisfy your need for dependability, our products are made to our own demanding specifications.

Consistency. As the world's leading manufacturer of photographic film, Kodak appreciates the critical impor-

tance of video tape product consistency. Therefore, Eastman video tape is manufactured according to our strict uniformity requirements.

Technical service. You can count on our field force of skilled sales and engineering representatives to help you get the most from Eastman video tape products.

Availability. You don't have to wait for Kodak to set up shop. We already operate a worldwide marketing network. And a dealer organization also will soon be ready to supply you with Eastman pro-

IS THE NEW NAME IN VIDEO TAPE



professional video tape...when and where you need it.

You have the option of professional-quality and broadcast-quality Eastman professional video cassettes in both 1/2-inch (VHS and Beta) and 3/4-inch (U-Matic, standard and mini) cassette sizes. Broadcast-quality 1-inch tape (helical "B" and "C" format) is scheduled to be available in mid-1984. We offer an excellent selection of video cassettes and video tapes for use with NTSC as well as PAL/SECAM TV systems.

Now is the time for you to discover what the new name in professional video tape can do for you. To learn more, contact your Kodak sales and engineering representative.

ATLANTA (404) 351-6510	NEW YORK (212) 930-7500
CHICAGO (312) 654-5300	SAN FRANCISCO (415) 928-1300
DALLAS (214) 351-3221	TORONTO (416) 766-8233
HOLLYWOOD (213) 464-6131	VANCOUVER (604) 926-7411
HONOLULU (808) 833-1661	WASHINGTON, DC (703) 558-9220
MONTREAL (514) 761-3481	

Overseas, call the local Kodak company. Motion Picture and Audiovisual Markets Division, Eastman Kodak Company, 343 State Street, Rochester, NY 14650



EASTMAN Professional Video Tapes



Circle 149 on Reader Service Card

network schematic displayed on a color CRT.

Other manufacturers of MC and technical automation who can be expected to have developments include Central Dynamics (1409), Grass Valley (1207), and Industrial Sciences (1232).

TEST & MEASUREMENT, MONITORS

How do you like your vectorscopes and waveform monitors? At NAB you will be able to get them in a number of combinations or separately. In addition, there will be some new scopes to check out and a whole range of other new instruments for stations.

Among the aforementioned, Tektronix (1601) will be showing the new 1750 Series waveform/vector monitors with a unique display of SCH phase error on the same screen as the waveform and vector information. This unit



Thomson-CSF TTV-8400 Thom-Cat testing system.



The Tektronix 1750 waveform monitor/vectorscope with unique SCH phase display.

follows the 1740 Series, a battery-powered monitoring instrument also on hand. Tek will demonstrate the 2445 portable oscilloscope with TV option. And, not to be overlooked, the 380 test monitor, a combination waveform monitor, vectorscope, and oscilloscope.

New for Leader Instruments (1349) this year will be the LBO-5860L half-rack waveform monitor with front-panel lines seven to 21 select capability for fields one and two. Also on display will be the LBO-5860A half-rack vectorscope. Two video pattern/sync generators, LCG-400M and LCG-400S, will be shown.

In the Videotek booth (1633) will be the TSM-5A waveform monitor with switchable line select for lines 14-21. The VSG-100 sync generator with helical gen lock and color bars is also new.

Rhode & Schwarz (1203) is introducing several new test products including the UPSF2 video noise meter, LFM-2 group delay measuring set, mUF-2 TV transcope, and the EKF2K TV monitoring receiver. Also new will be the SMS signal generator, ESVP test receiver, and the UR050 transposer/receiver.

Bowen Broadcast Service (1770) will premiere Teleho, a computerized maintenance assistance system for broadcast equipment. Comsearch (1136) will feature its new Tempest test lab, offering electromagnetic pulse analysis and special testing in a variety of RF and microwave environments.

John Fluke (227) will exhibit the 9000 Series microsystem troubleshooter, including the Model 9010A, as well as the 9LC software, which allows the user to program the 9010 with a personal computer.

Pinzone Communications (1615A) will debut the RCD-100P computer diagnostic system for the RCA TCR-100 videotape cart machine.

Porta-Pattern (1427) returns with a complete line of large size studio test charts, the BBC zone plate chart and transparency in 525 and 625 line versions, and advanced depth modulation chart and transparency.

Minolta (1113) will be showing the TD color analyzer II, Chroma meter II, incident luminance meter, and additional luminance meters.

A sign of the not-too-distant future is the unveiling by Asaca/Shibasoku (1226) of the new CMO9A1 HDTV monitor. Other monitors include a 26-inch delta-gun and a nine inch in-line gun model.

Adding to its line, Ikegami will have the Series 9 precision in-line gun high-resolution color monitors; the Series 9 delta-gun versions and their established Series 8 and 9 monitors.

An all new 13-inch rack mount color monitor will debut in the Videotek booth (1633). It features three looping video inputs, pulse cross, underscan, A-B split screen, high voltage regulation, comb filter, and other features.

Another 13-incher will be the Sharp (1102) XM-1300 high resolution 13-inch rack mount color monitor.

This year Conrac (1401) will display the 6200 master Class I monitor with in-line gun; the 7300 1000-line noninterlaced monitor; and perhaps a new monochrome monitor.

Elector (1707) will have several new items from the Barco line, including the BarcoData video projection system, new color receiver/monitors, and two new series of color display monitors.

Not far away, Electrohome (1744) will show its established monitor line, including the EVM series high performance monochrome displays; the Tri-Ed color receiver/monitor in 19- and 25-inch sizes; and the ECM 1301 high resolution color monitor.

AUDIO FOR VIDEO

Trends in audio now more than ever affect what's happening in video, especially as they relate to developments such as stereo audio for TV and improvements in the sophistication of the audio/video interface. Whether the developments have come about because of higher interest from video people in audio quality, or from a natural progression for more efficient machine control, the fact is that video and computer interfaces in both consoles and tape machines will become a determining factor in the success of newly introduced audio products—analogue or digital.

GET BEHIND THE CAMERA THAT'S OUT IN FRONT



THE IKEGAMI HL-79E

The HL-79E, Ikegami's crowning technological achievement continues to run ahead of all other cameras in its class.

That's why more and more top-of-the-line EFP camera buyers are getting behind the winner. Only by seeing this remarkable camera in action can it be fully appreciated.

Just how great is this camera? To begin with, it is the culmination of all that has gone into creating the legendary 79 Series cameras, the reference standard of the broadcast industry for both ENG and EFP applications.

HL-79E features—Dynamic Detail Correction, Chroma Aperture Correction, Highlight Aperture Correction and Auto Contrast Compression. Plus the HL-79E offers superior contrast range, S/N ratio, registration accuracy, resolution, viewfinder performance and more.

Available accessories include the ADC-79E Auto Set-Up Unit and the RDC-79E Remote Control—both digitally interfaced. The HL-79E is compatible for use with existing HL-79A and HL-79D Triax and Multi-core cable base stations, lenses, power supplies, VTR cables, and other accessories.

The HL-79E is part of the great and proud family of Ikegami products serving many satisfied users worldwide. For a complete demonstration of Ikegami Cameras and Monitors, contact us or visit our local dealer.

Ikegami HL-79E

Ikegami Electronics (U.S.A.), Inc., 37 Brook Avenue, Maywood, NJ 07607
East Coast: (201) 368-9171 ■ West Coast: (213) 534-0050 ■ Southeast: (813) 884-2048
Southwest: (713) 445-0100 ■ Midwest: (314) 878-6290
Circle 162 on Reader Service Card



Solid State Logic's 6500E automated mixing console.

Tape machines with microprocessor control, rare just a few years ago, are now common as a result of the audio for video explosion. This technology allows easier remote control, search, and multiple and external machine control, and finds good examples in products from companies such as Otari (601) with its MTR-10 and its sophisticated MTR-90.

Studer (201) uses the microprocessors in its A-810 to improve transport control. The evolution of this machine, possibly in the very near future, will show the microprocessors being able to communicate with an outboard computer which would then have access to all signals within the tape machine. In addition, Studer will introduce its new TLS4000 SMPTE synchronizer, a modular design for translating all SMPTE/EBU and film time code standards, that mounts in the A-810 rack.

In a similar development, MCI/Sony (605/1200) will unveil the Sony SyncMaster, a time-code-based unit which incorporates such video technology as edit decision lists and communication with CMX-compatible video editors.

Sony will also introduce a new two-track recorder with center track time code, a trend which began a couple of years ago with companies such as Studer and Ampex (1400) among others, and is gaining momentum. Otari is reported to have a center track machine in development which will allow it to offer an audio machine easily locked to a film or video transport for a price that would formerly have been prohibitive.

Other companies that can be expected to influence the flow of audio for video tape recorder technology are TASCAM (1304), Soundcraft (219), and Nagra (1213) with its new T-Audio.

In addition to synchronizing developments, audio for video advances are taking place at the console, too. Once again, the MCI-Sony entry into this area will have an impact: the Option 23 for the JH 8000 console, providing an interface that allows a video editor to operate the mixing parameters.

Ward-Beck (1224) naturally has influence in this area, and is rumored to be unveiling a complete series of sophisticated post-production and audio sweetening boards.

Ramsa (437) has also revealed its latest creation, the 8616, intended for both on-air and post-production uses such as audio sweetening.

Two leaders in console automation and audio/visual boards are Neve (1410) and Solid State Logic (1723).

SSL's latest innovation is a Master Synchronizer Controller which is operable from the keyboard of the SL 6000 E and permits up to five machines to be controlled. Also introduced will be a Master Transport Selector which automatically switches time code, tach pulse, direction sense, transport controls, and tallies from the mixer keyboard.

Neve will have the latest improvements on its Necam automation with enhanced multitrack post-production capabilities and developments in its digital console technology. The digital display involves a working demonstration of the transmission of multichannel audio signals over fiberoptic cable, passing through integral AD/DA conversion equipment.

A new stereo TV console from ADM (1223) will be a versatile tool because of its on-air functions in addition to its facilities for production tasks. These facilities include line preselect, stereo line input modules, and stereo signal processing.

Harrison (1324) has recently developed new consoles especially aimed at the audio for television market and currently has quite a range to choose from. The Pro-7 is a recent stereo production board similar to its partner the Air-7 stereo on-air console. Of course, the TV 3 and 4 are suitable for stereo post-production and audio sweetening jobs, while the latest entry into this battery of equipment is the VSI video switcher interface for audio follow video needs.

Reinforcing the impact this trend for interfacing will have, Sound Workshop will introduce a serial console interface, allowing a console to be controlled from an RS-232 port driven by a video editor or outboard computer. Though no announcements have been made as to the nature of the latest Studer introduction relating to this area, there will be 10 new module options for the 900 Series production console.

Showing impressive advances last year in its early stages, the 300 Series from Audiotronics (505) will have interest this year for those concerned with full production capabilities such as four or eight outputs, submastering, and AFV capability.

Datatronix (1504) will continue its tradition of quality with the 1604A stereo production and post-production mixer.

Amek (620), attending its second NAB, will introduce the M 2500TV 56 x 48 audio production board with plenty of functional room to spare; the new Matchless 26 x 26 production mixer will also be exhibited.

Further, Audio Kinetics will introduce the Mastermix console automation, a floppy disc-based computer control unit that will fit most consoles without modification, but comes with retrofit packages including VCA faders.

LIGHTING, POWER, and SUPPORT

Arriflex's (1421) new contribution to the lighting field will be a series of portable lighting kits called Arrilites. They come with 650, 1000, and 2000 W lights plus grip equipment.

Another new location lighting kit, Starpack, will be shown by Cool Light (1329), along with the company's full lighting system.

Frezzolini (1107) will feature a new 100 W mini-fill light head with new diffused front protective glass and flip-up dichroic filter.

Stop by the Anton/Bauer booth (1337) to see the com-

THE ONE PIECE THAT SOLVES THE PUZZLE

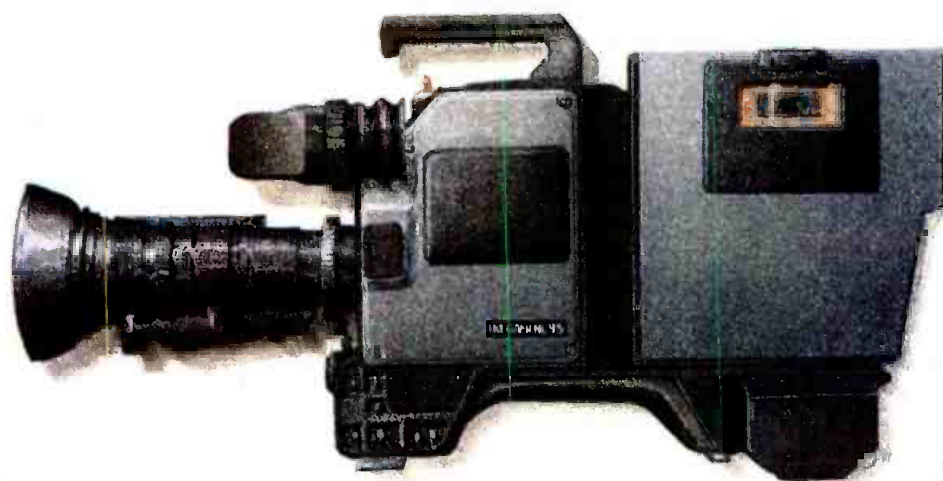

THE ALL-NEW IKEGAMI HL-95 UNICAM®

If you're confused by the many tape formats and conflicting manufacturers claims, relax.

Ikegami's new HL-95 Unicam® is the only universal camera system that accepts all professional on-board VCR formats, 1/4-inch and 1/2-inch, and solves your buying puzzle by putting the picture you want into place.

Engineered to offer performance beyond the most rigid expectations, the HL-95 utilizes new 2/3-inch SM diode gun Plumbicons®, resulting in a camera with higher sensitivity and S/N ratio, greater resolution, lower operating power requirements and less registra-

tion error than previously possible in a camera of its size and weight.

The HL-95 is also available as a stand-alone ENG camera, and in systems configurations using Triax or Multi-core cable base stations, or with the ML-95 ENG Microwave Link. Once you examine the HL-95 Unicam®, you'll agree that the system flexibility and picture quality puts it in a class all by itself. The standard of excellence continues at Ikegami.

For a complete demonstration of Ikegami Cameras and Monitors, contact us or your local Ikegami dealer.

Ikegami HL-95 UNICAM®

Ikegami Electronics (U.S.A.), Inc., 37 Brook Avenue, Maywood, NJ 07607

■ East Coast: (201) 368-9171 ■ West Coast: (213) 534-0050 ■ Southeast: (813) 884-2046

■ Southwest: (713) 445-0100 ■ Midwest: (314) 878-6290

Plumbicon:™ N.V. Philips

Unicam is a registered TM of Ikegami Electronics (U.S.A.), Inc.

Circle 163 on Reader Service Card

pany's new modular, portable lighting system, Microlight.

A new line of portable Fresnel lighting kits called Pepper Packs will be introduced by LTM (1518), which will also have a complete new line of studio incandescent Fresnels, a new 200 W HMI, and a new 12K focusing Fresnel HMI.

New Fresnels will also be shown by Mole-Richardson (1006), which will have a 12K HMI Fresnel solar spot, along with a 6K solar arc spot, other new lights and new dimmers.

Several new lights will be displayed by Belden (1628), including a new convertible softlight for 1K to 16K operation, plus a new Lee 8K HMI. Bogen (1705) will have a new mini video light, the M-100.

Strand Century (1418) will introduce a new solid state ballast for HMI lights, along with a new HMI switchable from 575 W to 1200 W operation in the field.

DeSisti (1131) will have several new lights, including a handheld focusing spot, followspots, HMIs, studio softlights, and Fresnels in various sizes. Cinema Products (1221) will show a new line of RDS/HMI lighting equipment.

Phoebus Manufacturing (1331C) will add the Ultra Arc Series II to its Ultra family of followspots.

New from The Great American Market (1108) will be the Lighthesizer lighting control console. The company will also show new patterns for its Scene Machine lighting special effects unit, along with a new Mini Scene Machine.

Electro Controls (1631) will have new portable dimming packs called Playmate II, in addition to its Celebrity lighting console. It will share the booth with Walter Brewer Co., which will show a new power entry box for location lighting.

Expect Colortran (1205) to bring the Patchman, the small lighting console it introduced last year, along with its full line of Fresnels and dimmers. Kliegl (1604) will



The Stand-Sit camera dolly from Keylite.



Compu = Prompt's new monitor-based prompter.

also bring its established line of lighting control equipment, including its memory lighting control consoles and dimmers, and Union Connector (1783) will have new 2400 W remote dimmer lighting systems.

The General Electric booth (1007) will feature the company's new Watt-Miser Quartzline lamps, first shown at SMPTE. Another lamp manufacturer, GTE (1401B), will introduce a new 200 W Sylvania Brite Beam lamp, a new family of Sylvania lamps with improved optical performance, and a new line of tungsten-halogen lamps for video cameras.

New lighting rigs will be displayed by Grosh Scenic Studios (1163A). Theatre Service and Supply (1513) and Theatre Visions (1318) will both show cyncs, track systems, and grids.

Among several new battery chargers at this year's show will be a new, lower-cost version of the ReFLEX-20 "burping" charger from Christie Electric (1403A). Perrott Engineering (1729) will show a new universal multiple fast charger for nicad battery packs, along with the new Cellmate discharger.

Frezzi will have some new additions to its power line, including a series of low-cost battery packs, brackets, and chargers. It will also show the BDC2 two-channel automatic battery cell conditioner and charger. In addition to its lighting equipment, Cool Light will introduce the new Olympic series of battery belts.

Alexander Manufacturing (1714) will also show its battery and charger lines, as will PEP, Inc. (1408) and Portable Energy Products (1153).

The ITE booth (1215) will feature a new pneumatic studio pedestal, the P1, along with a new fluid head, and ENG tripod, and the D8 heavy-duty dolly. An unusual dolly designed to allow the camera operator to stand or sit while shooting will be introduced by Keylite Production Services (1220).

Listec (1406) plans to introduce a new Vinten digital remote control camera system. Cinema Products (1221) will

INTRODUCING THE CAMERA YOU'D BUY AT TWICE THE PRICE

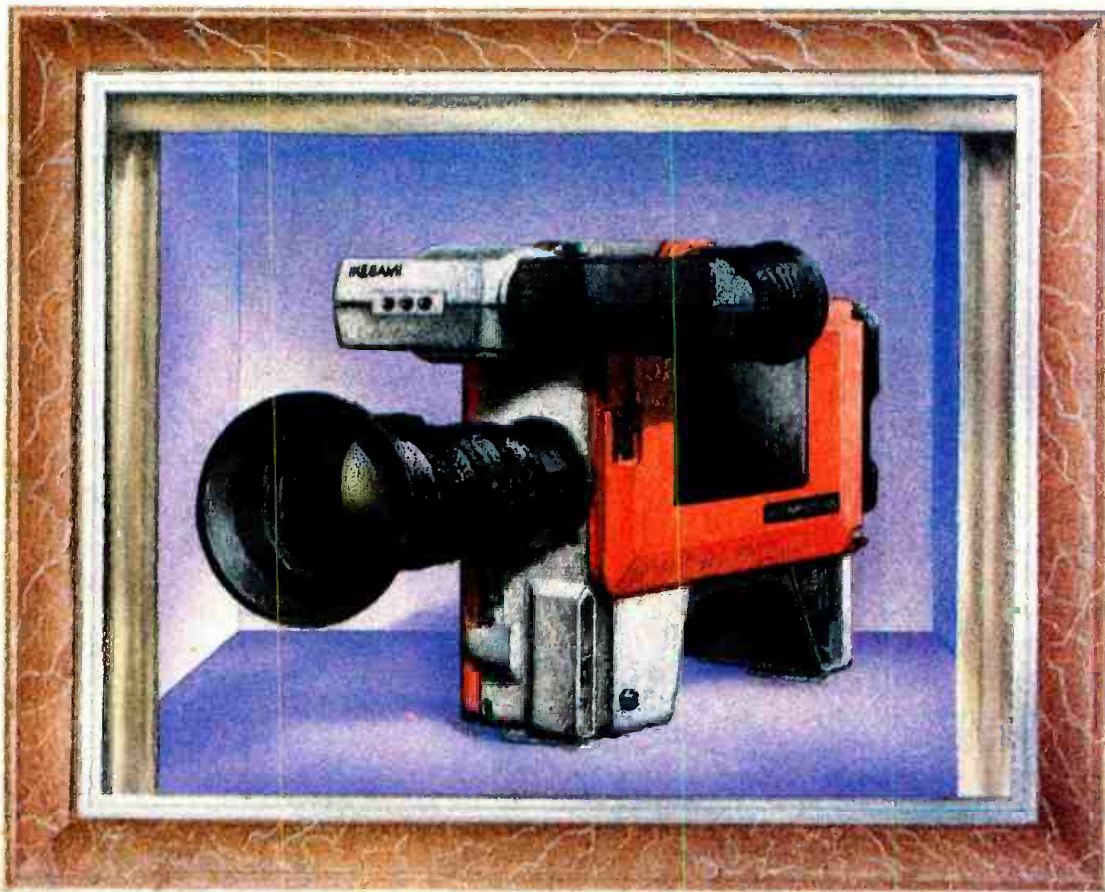

THE NEW BROADCAST QUALITY IKEGAMI ITC-730A

When you examine the quality of the Ikegami ITC-730A and then hear the price, you'll probably ask to hear it again.

The new ITC-730A is a truly low-cost, lightweight ENG/EFP camera that's designed to give you exceptional performance and value. Video gain has been boosted to +9dB/ +18dB for a maximum sensitivity of 4-foot candles when using an f/1.4 lens, while signal-to-noise ratio has been improved to -57dB. Center horizontal resolution now exceeds 650 TV lines, with corners optimized by dynamic focus. Dynamic range has also been expanded—without sacrificing resolution or S/N ratio in low-light image areas—through highlight compression circuitry. In addition, the ITC-730A generates Split Field Color Bars in accordance with EIA RS-189A and sync waveform meets the SC-H criteria of RS-170A. And for multi-camera setups an adjustable color video matrix

permits accurate color matching between cameras.

Yet the ITC-730A still incorporates features that made the ITC-730 the ENG/EFP camera for budget-conscious, high-quality ENG and production. Features that give you the edge, such as Saticon II® pickup tubes, dynamic beam stretch, a 2-H vertical detail corrector, and a host of automatics. In addition, the ITC-730A CCU lets you operate up to 1000 feet away through a flexible 13 mm cable in AC mode and up to 300 ft. away using DC at the camera head or CCU. And its well-balanced, lightweight design lets you work comfortably in the field.

The ITC-730A: Great value never looked so good. The standard of excellence goes on at Ikegami. For a complete demonstration of Ikegami Cameras and Monitors, contact us or visit your local Ikegami dealer.

Ikegami ITC-730A

Ikegami Electronics (U.S.A.), Inc., 37 Brook Avenue, Maywood, NJ 07607

■ East Coast: (201) 368-9171 ■ West Coast: (213) 534-0050 ■ Southeast: (813) 884-2046

■ Southwest: (713) 445-0100 ■ Midwest: (314) 878-6290

Circle 164 on Reader Service Card

Saticon: TM Hitachi, Ltd.

www.americanradiohistory.com

bring its new Mini-Mote, a remote-control pan/tilt head, along with Skymount, a new rig for aerial photography. Another new camera remote control system will be the Matthews Studio Equipment (1209) Cam-Remote.

Arri will have a new base for its CineJib crane. Karl Heitz (1747) will bring new additions to the Gitzo support line: heads, levelling balls, and mic fishpoles. Quick-Set (1105) will introduce a line of modular tripods and a new series of fluid heads.

Sachtler (1648) will expand its support line with the Video 14 light fluid head pedestal for sophisticated single-tube cameras. Davis & Sanford (1751) will bring three new fluid heads of its own manufacture. Bogen Photo will have new TSE video cases, along with a new tripod with micro fluid head, a portable video dolly, and a gliding rail system.

In prompters, Cinema Products will introduce a scaled-up version of its Camraprompter called the Camraprompter L. Compu-Prompt (1728) will introduce the CP-1000, described as the only full-color video prompter on the market, with a full range of capabilities. Listec will introduce an electronic memory scriptwriter for news-room prompters.

Q-TV (1401D), long a name in standard prompting equipment, will enter the electronic prompter market with its new VPS-500 ComputerPrompter system. Telescript (1407), too, will introduce Digis, a prototype digital prompting system based on personal computers.

New video equipment case designs can be expected from Porta-Brace (1746), Anvil (1112), Calzone (1179), William Bal (1614), Kangaroo (1151), and Viking (1731).

MOBILE UNITS

No details yet, but it's to be expected that AF Associates (1611) will have a spectacular video truck or two out in the parking lot.

As it did last year, Centro's booth (1101) will feature a full-sized, 45-foot tractor-trailer rig, built for One Pass Film and Video. Midwest Corp. (1710A) will show a pair of 44-foot teleproduction units, one built for Turner Broadcast and the other for TCS Productions.

Wolf Coach (1317) will feature its new B-103 news unit, which has a transferable body that can be shifted to a new power train when the old one wears out. Another



Midwest Corp. constructs TBS truck for NAB exhibit.

truck builder, Roscor Corp. (1181), will show its line of vehicles from small vans to 45-foot trailers.

In conjunction with Magnetic Media, Shook (1310) will show a mobile TV production system, Model 14-22/E. E-N-G Corp. (1022) will bring two of the microwave-equipped units the company is famous for, a GMC Suburban and a GMC van. MZB (1507A) will also show smaller video production trucks, as will Television Engineering (1700).

Film/Video Equipment Service (1153) will describe the fully equipped video production trucks the company rents to clients. Well-known coachbuilder Gerstenslager (1347) will describe its custom services, and ABP Systems (1707A) will also describe its van-building services, as will Gray Communications Consultants (1618A).

TELEVISION TRANSMITTING

Two topics likely to draw plenty of attention at this year's show will be concerned with television transmission systems. Those two topics are a renewed interest in

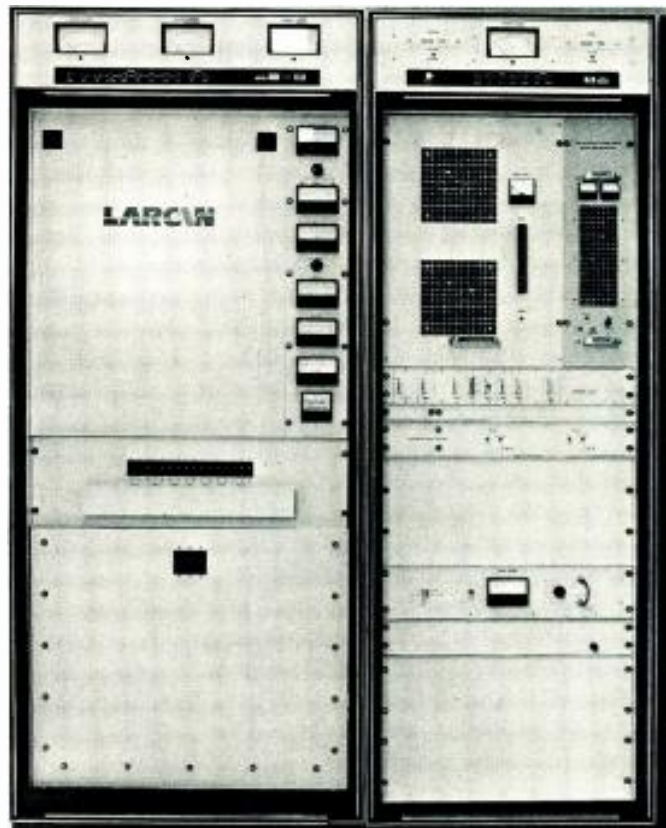

A 10 kW VHF transmitter from Larcana.

LPTV and, with the ostensible passing of a transmission standard, multichannel TV. Of course, there is also higher definition television and the upgrading of existing television transmitting technology, which is likely to be around for a while yet. Other areas of investigation are TV SCA and an upsurge in products related to MDS.

As the LPTV transmitter competition heats up, Acrodyne (1228) may have a head start with its introduction of a 1 KW UHF single-cabinet LPTV transmitter to go with its already extensive line. The company will also introduce a new modular upconverter with synthesized local oscillator. EMCEE (1621) has entered the fray with both UHF and VHF LPTV transmitters, in addition to introductions in the MDS transmitter area.

In TV SCAs the talk is energetic and some of the development is aggressive and advanced, though the volume of new products is not imposing. Modulation Sciences (294B) will add a companion to its existing FM SCA unit and reveal the TV SideKick, an integrated subcarrier generator for producing a second audio program for TV multichannel sound.

Regarding multichannel sound, and overlapping into the higher definition TV spectrum, Quante (1216A) will have surprises. Introducing a digital fiberoptic transmission system, Quante plans to improve the simultaneous transmission of component and composite video signals

Shown is WITS System
with optional color printer.



Finally. A high resolution weather & graphics terminal for under \$10,000.



Photographs are
of actual WITS
display & printout.



Introducing WITS (Weather Image Terminal System)

The first inexpensive weather graphics system for broadcast use also produces complex production graphics rivaling systems triple the price.

Quality computer imagery is now at a price most stations can afford.

APPLICATIONS

- Satellite, radar, facsimile display.
- Production Graphics System/character generator.
- Frame-by-frame animation of weather or production graphics.



3-D imaging and solid modeling. *



Create your own Station logos! **

FLEXIBILITY

- Acts as a computer terminal, weather graphics display, production graphics system, and/or 35mm slide generator.
- Interfaces to a wide range of computer systems, including newsroom computers.
- RS-170A & RGB output.
- User friendly production graphics software (Paint Pad Video Art System) requires no programming experience.
- Optional camera input for freeze frame.
- Unprecedented color and 3-D software: 16.8 million colors, scales, rotates and translates images.

For complete specifications on WITS, call
Vectrix Corporation, 2606 Branchwood Drive,
Greensboro, N.C. 27408 (919) 288-0520,
TELEX 574417.

Vectrix
THE COMPUTER GRAPHICS COMPANY

*"Martini" by Gray Lorig
Center for Interactive Computer Graphics
Rensselaer Polytechnic Institute

**Logo courtesy of WFMY-TV,
Greensboro, N.C.

Circle 188 on Reader Service Card

Demonstration tapes available, please write or call.

www.americanradiohistory.com

See us at NAB Booth #175

with multiple audio channels. Inovonics (304) will be uncovering its Model 260 stereo audio processor for educational markets in both FM and LPTV.

Despite the interest in new technologies, the existing realities of broadcast television—neither high definition nor stereo—remain with us. To improve what currently exists, Comark (1217) will introduce a new series of 110



The Pinzone 8250 microwave receiver.

KW UHF TV transmitters as well as a new power combiner and automatic multiplexed diplexer system, the CAP-110M. Once again, Harris (401) will be a motivator here as it introduces a 60 KW UHF transmitter with high-efficiency klystron. Also new will be the 30 KW high-band VHF transmitter.

In standard transmission, the competition achieves a much higher volume than in the evolving technologies. EEV (1335) has a new 55 KW high-efficiency broadband external cavity UHF TV klystron, Model K3372. Townsend (1420) also has introductions in tube-related products with the 25 KW VHF transmitter, which uses triode tubes (TA 25 NTH).

Tremors may be felt by domestic manufacturers as Philips introduces its PYE TVT line of FM transmitters to the U.S. for the first time. Products will range from 100 W to 20 KW, featuring common modular drive and comprehensive monitoring. The LDM 1208, a compact 55 KW transmitter, will also be displayed.

MDS seems to be experiencing a renaissance this year, with many product introductions planned. Micro Communications (1014) will have a new MDS/ITFS multichannel combiner for multiple channel transmissions. Information Transmission Systems (1734A) also plans announcements, including a 10 W MDS/ITFS transmitter line. The company will also introduce four new UHF transmitters ranging from 1 to 10 KW.

To make it all go, companies are responding with improved products. Larcan (1626A) will show the new TEC-IV TV exciter using IF modulation with SAW filter.

Remote transmission will get a welcome boost from Nurad (1426), which will introduce 13 GHz portable transmitters and receivers as well as 6.5 GHz transmission systems. Broadcast Microwave (1749) will debut the TBT-2K series of frequency-agile portable microwave transmitters, powered by ac or dc.

SATELLITE SYSTEMS

With the signal and program distribution changes of the last year, satellites take on a new order of importance. This will be reflected at the convention both in the outside antenna displays and on the exhibit hall floor as more companies with new products and services push the broadcast signal ever skyward. Earth stations will be more varied than ever as Andrew Corp. (1201A) introduces a 3.7 m Ku-band dish with associated radio equip-

ment. Other new products from Andrew will be 4.5 and 7.3 m antennas in the outdoor displays and a Plastidome earth station shelter in the booth.

GEC McMichael (1772) will also introduce Ku-band equipment with a low sidelobe elliptical antenna, to be featured along with a new transportable transmitting/receiving earth station. Antenna Technology (1737) will add to its Simulsat line with the new Simulsat-7 7 m antenna. Avantek (1742) also plans a new dish, the AR-2000 video receiver for simultaneous reception of multiple channels. A 6 m earth station with microprocessor-controlled pedestal will be unveiled by Broadcast Microwave Systems (1749). Comtech Data (314) will display its new 4 m antenna with offset feed, meeting FCC licensing requirements.

Antenna control and receiving equipment will also play a big role. Harris (401) will unveil its new Model 9165 computer-based satellite antenna control system. Modulation Associates (1737) will introduce the Data-Sat receiver for high-volume reception of 56 kbs data over satellite links, as well as a new uplink controller and frequency-agile video receiver that can select one of 24 satellite transponders. Sescom (1616), concerned with the studio end of things, will reveal its Sat-1 audio leveler for satellite receivers.

Pinzone (1615A) will debut a fully remoteable all-format satellite receiver, the 8250/R, while Videostar (1122) plans to exhibit the Express Ku-band satellite transmission facilities. Microdyne (1612) will be introducing the 1100 SDC synthesized SCPC downconverter for state, regional, and national radio networks. Further expansion into the burgeoning satellite industry will show Microdyne with a new 1100 BDC/DCR-12 72-channel Ku-band video receiver/LNA and block downconverter system. Cat Systems (1014B) plans to announce its new earth station remote operations capabilities, including uplinks, switching, and testing of antennas located in the Midwestern U.S.



Videostar's transportable satellite uplink.

Exciting new developments will take place this year in satellite services, with Meadowlands Communications (110) announcing the startup of its digital up/downlink capabilities using the AT&T Skynet system. Wold (1515) will also be detailing its satellite TV services.

**Where Does An
Editor Go to Discover
More Creative
Control with Fewer
Technical Constraints?**





Welcome to the Ampex

nyone who has ever integrated a complete post-production editing system knows that it's a complex, difficult and often confusing job. Products from different manufacturers don't always interface easily.

Ampex stands above the confusion by offering all the key elements of a sophisticated post-production system from one manufacturer, complete with fully integrated hardware and software. We call this the *Ampex Creative Command Center*.

This system consists of an Ampex ACE edit controller, Ampex switcher and VTRs and our Emmy-award-winning ADO digital special effects system. Since all these use SMPTE RS-422 serial communications, they are easily interfaced with each other and the peripheral equipment you need to fill out your system. No hidden costs for interface devices. Ampex products are designed from the ground up to work with each other in a fully compatible system.

This isn't exactly a new idea. Post-production facilities all over the world are discovering the business advantages of Ampex Creative Command Centers. A few of them are pictured above, and more are being installed every day.

Care-free Creative Control

ore creative power and control is the name of the game with an Ampex Creative Command Center. With a system based on a sound technical groundwork, editors are free to put their full creative energy into every job, confident that they are free of technical constraints.

At the heart of the Center is the remarkable ACE editing system, fast enough and smart enough to satisfy the most creative editors in the business. Depending on individual preferences, you may choose the Touchscreen option, or either the dedicated or ASCII-style keyboards. Using the ACE joystick control, you're in command of all the other products in the system. With the optional General Purpose Interface (GPI) you can command any product activated by an electronic "trigger."

And there's more flexibility. ACE disks are interchangeable with any other ACE system of any configuration. ACE can even read and write CMX-format disks. You can schedule system time much more effectively and conveniently.

That's only part of the story. There's more creative power, control and flexibility inherent in all the Ampex products.

System Flexibility

rod quality and reliability have long been associated with the Ampex name. In our Creative Command Center, you have a wide choice of Ampex products, each unsurpassed in its price/performance category. Complementing ACE, with its various options, you have a choice of Ampex production switchers, either 4100 Series, or the microprocessor-based AVC Series. AVC switchers offer awesome creative power, yet are simple and logical to operate.

You also can choose any of the Ampex VTRs: the VPR-2B, the VPR-80, or the VPR-3 (the mainstay of Olympic Games broadcasts) with unequalled speed and tape handling ability, or our ARC-40 M-format VTRs.

The very popular ADO has become the standard in the world of creative image manipulation, with over 250 in use around the world. Its abilities are constantly being expanded by the imaginations of its many users.

Your needs and budget determine the configuration of your own Ampex Creative Command Center. No matter what shape it takes, Ampex products will perform to support your business goals.



Ultimate Video International B.V.,
Hilversum, Holland



Crawford Communications,
Atlanta, Georgia



Atari, Inc.,
Milpitas, California

Creative Command Center

Can Management Love a Creative Command Center?

Very Ampex Creative Command Center is, we agree, a tool to help you attain your business goals. Editors who use these systems every day find that their solid technical foundation allows more efficient use of time for creative experimentation, or to meet tight client budgets and deadlines.

All this helps keep clients happy. Not only is the Creative Command Center an impressive system to see, but its performance can help you build the kind of goodwill that pays off on the bottom line.

Captive facilities find that Creative Command Centers can be equally effective for their needs, turning out sales and training programs, internal communications and a variety of other software. One interesting application can be found at the coin-operated games division of Atari, where a complete Center has been installed to produce the very latest in laser video arcade games.

So don't be intimidated by the sophistication of these systems. They're practical first and foremost, and designed to make management smile, even the controller.

Support That Keeps You Going

Exceptional dedication to the smooth working of your Ampex Creative Command Center is a characteristic of our service and support force. This tradition is well-known and appreciated by the many users of Ampex products.

It starts with the Ampex Sales Engineer you may call to explain how a Creative Command Center can fill your individual needs. He and your Ampex Service Engineer will work with you as your system is installed and checked out. They and all the other support people at Ampex in Spares, Technical Support, Training and Technical Documentation will be there when you need them, wherever you are.

Obviously, there's much more that you need to know about an Ampex Creative Command Center than we can tell you here. Your Ampex Sales Engineer is just the person to give you that information. Ask him to tell you everything you want to know.

What Our Customers Are Saying About Us and the Creative Command Center.

- "With ACE, I can put more creative energy in my work with peace of mind. I don't have to worry about technical problems."
- "ACE is really an awesome editor. And the *system* is even more awesome than ACE alone."
- "The thing I'm most impressed with is the Ampex software and how user-friendly it is."
- "We purchased the Ampex equipment as a system, rather than stand-alone products, because we believed Ampex's innovative power can be most effectively demonstrated in the total system."
- "Interface on all equipment was a key factor in our decision to purchase a full ACE system. We wanted a single source."
- "In 20 working hours, we went from an empty room to an ACE system in full operation. That's due to the basic quality of the Ampex equipment and the use of the RS-422 buss."
- "We've gotten good support from both Ampex sales and service. They seem to be interested in what we're doing and what we think."
- "We've been with Ampex for 11 years. We're a small company; we need the support of a large manufacturer."

Ampex ACE Post-Production System

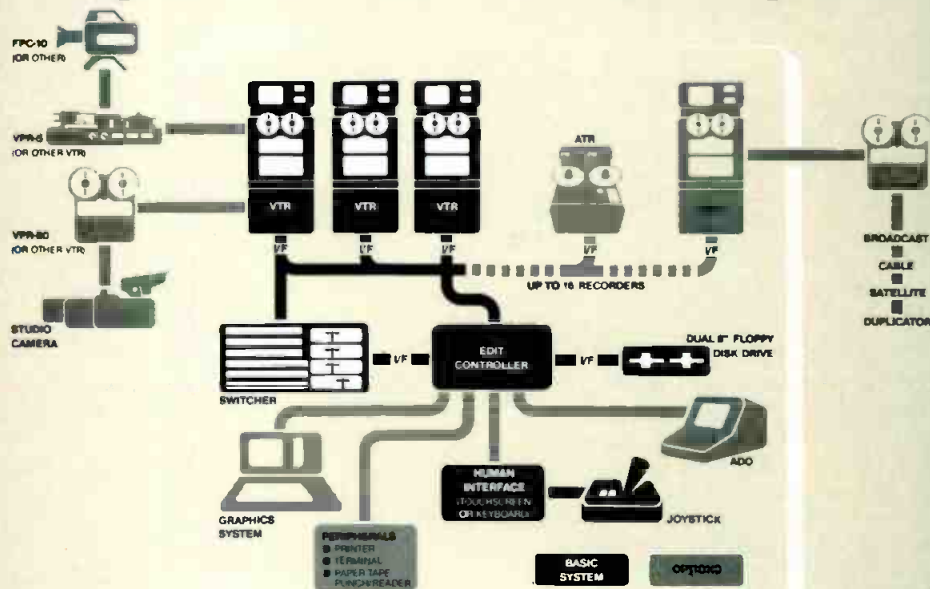

The Ampex "Creative Command Center" featuring ACE joystick control is a sophisticated post-production editing system offering many outstanding advantages including: hardware and software components tailored to user applications, extremely fast system speed, field-proven reliability, compatible software, easy interfacing, expandability, and single-source spares and service worldwide.

Call your nearest Ampex Regional Sales Office Today for more information about Our "Creative Command Centers."

CALIFORNIA
(415) 367-2296
Redwood City
(818) 240-5000
Glendale

GEORGIA
(404) 491-7112
Atlanta

ILLINOIS
(312) 593-6000
Arlington Heights

KENTUCKY
(502) 239-6111
Louisville

MARYLAND
(301) 530-8800
Bethesda

NEW JERSEY
(201) 825-9600
Aliendale
(212) 947-8633
New York

OHIO
(513) 254-6101
Dayton

TEXAS
(214) 960-1162
Carrollton

UTAH
(801) 487-8181
Salt Lake City

WASHINGTON
(206) 575-0156
Tukwila

AUSTRALIA
(02) 887-3333
North Ryde NSW

BAHRAIN
(973) 274139
Manama

BELGIUM
067/22.49.21
Nivelles

BRAZIL
(021) 274-8122
Rio de Janeiro

CANADA
(416) 821-8840
Mississauga, Ont.

COLOMBIA
236-7855
Bogota

CYPRUS
021-65174
Nicosia

FRANCE
(1) 270-55-00
Paris

W. GERMANY
(0611) 60580
Frankfurt (Main)

HONG KONG
3-678051
Kowloon

ITALY
(06) 546991
Rome

JAPAN
(03) 767-4521/2/3
Tokyo

MEXICO
539-68-70/71/72
Mexico D.F.

NETHERLANDS
030-612921
Utrecht

SINGAPORE
2239241
Singapore

SPAIN
(91) 241-09-19
Madrid

SWEDEN
08/28 29 10
Sundbyberg

SWITZERLAND
(037) 81.31.11
Fribourg

UNITED KINGDOM
(0734) 875200
Reading Berks

VENEZUELA
782-3255
Caracas

AMPEX

Ampex Corporation • One of The Signal Companies

NAB '84

TELEVISION

TV HALL

EXHIBITS

ABEKAS 1620A VIDEO SYSTEMS

Introducing the A52 digital special effects system in both single or dual channel versions with 4 x fsc sampling; inexpensive, single-purpose box has three-axis joystick and numeric keypad controls and is said to offer extremely good image quality. Effects setups can be stored with DataKey memory system, a removable solid state memory. Other video equipment will include the A42 still store with 5.25-inch disk drive and full bandwidth digital video processing for still storage.
See ad page 72-73

ABP SYSTEMS 1607A

Will describe studio design and construction services, as well as mobile van construction.

ACCU-WEATHER 1134A

Will describe its weather reporting, forecasting, and graphics services.

ACRODYNE INDUSTRIES 1228

Will introduce two new products. A new modular upconverter with synthesized local oscillator and phase-locked VCO for stable carrier frequencies is fully programmable on bands I, III, IV, or V. Also new is the 1 kW UHF single cabinet LPTV transmitter, compatible with all U.S. or CCIR broadcast standards on bands IV and V. Main and alternate transposer system will be dis-

played with automatic switchover and optional solar/wind power systems.
See ad page 69

ADAMS-SMITH 1724

Offering a whole new family of modular time code controllers, used in conjunction with other System 2600 modules to assemble TV audio editing and sweetening systems. The controllers can operate master and slave transports and implement events and edits. Also introducing low-cost technique for synchronizing VCRs used as digital audio recorders with VTRs. Full line of time code, tape synchronizing, and transport control products including VITC editing demonstrations will be on hand.
See ad page 286

ADC MAGNETIC CONTROLS 1320

Will bring a new line of switching co-

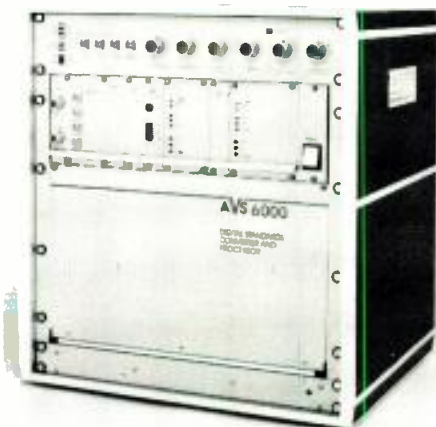

AVS 6000 standards converter from AFA.

axial components, a new humbucker, and new switching coax audio/video jackfield. Featured items will be the Pro-Patch and Ultra-Patch prewired jackfields, custom interconnect panels, and the line of connectors and jackfields.

ADDA CORP. 1100

Will introduce the ESP II low-cost broadcast-quality still store and graphics system, a two-channel system with digital effects. Other featured products will include the VIP digital video effects system, the ESPC still store and graphics system, the AC20A dual-channel TBC and synchronizer, and the VW2 frame synchronizer/TBC.

ADM TECHNOLOGY 1223

New this year will be a stereo TV on-air and production console with multiple stereo line preselection, stereo line input modules, and stereo signal processing. Also featured will be the 9000 Series microprocessor-based stereo on-air and production console; the VP Series audio post-production console; the 2442 Series II, 1642 Series II, and ST Series II consoles.
See ad Cover 2

ADVANCED MUSIC SYSTEMS (AMS) 1330

Will show its line of digital audio processing equipment, including stereo digital delays, digital reverb systems, and the A/V sync audio delay compensator for video synchronizers.

NAB '84 TELEVISION

A.F. ASSOCIATES 1611

Will introduce to the U.S. the Protel computer-assisted automation systems for the TV and film industries. Also exhibiting turnkey video systems and mobile units, including studios, post-production facilities, network playback centers, and corporate TV facilities. Also showing the Marconi B3410 digital line array telecine and the B4624 VTR monitor unit. To complete the display with other high technology television products, the Applied Video Systems AVS6000 digital standards converter will be on hand.

See ad pages 15, 49

AGFA 1608

May show a new line of professional Beta and VHS half-inch tape in addition to its line of premium-grade Broadcast Plus U-matic cassettes and bulk duplicator tapes.

ALDEN ELECTRONICS, INC. 1336

Will introduce the C2000 Series of color weather graphics displays for live weather satellite pictures, live weather radar pictures, and/or computer-derived weather graphics.

See ad page 258

ALEXANDER MFG. 1714

Showing a variety of VTR batteries and battery charging systems.

See ad page 20

ALLEN AVIONICS 1627

Introducing new line of Gaussian video filters, as well as a new miniaturized version of equalized filters, and MVFL Series of filters. From its line of delays and filters, an array of hum coils and eliminators will be shown along with rack-mountable and standard video delay lines.

See ad page 288

ALLSOP 1177

Will introduce its new 6700 pneumatic 3/4-inch videotape cleaner and the new Ultraline VHS tape cleaner, in addition to its standard line of audio, video, and record care products.

ALPHA AUDIO 1331A

Showing Sonex, the open-cell urethane acoustic foam designed to control reverberation time, eliminate stray reflections, and kill standing waves.

See ad page 234

AMCO ENGINEERING 1218

Exhibit will contain a newly expanded line of quick delivery enclosure systems in vertical, sloped front, and low-silhouette styles. Also new will be a line of fans and blowers with variable speed control, designed for Amco enclosures. The regular line of equipment consoles, computer desks, desktop cabinets, accessories, and hardware will also be displayed.

AMEK CONSOLES 1620

Will introduce two new consoles: the M 2500TV 56x48 audio production console and the Matchless 26x26 production console. Will also display the BCO-1 portable ENG/field mixer.

AMERICAN DATA CORP. 1409

See CENTRAL DYNAMICS

AMERICAN HORIZON, KELTRON 1122A

AMPEREX ELECTRONIC CORP. 1412

Introducing several new Plumbicon camera pickup tubes as well as the new YK1263 klystron transmission tube. The new diode gun Plumbicon camera tubes include the XQ4087 half-inch HS, the 83XQ 30 mm, 85XQ 2/3-inch HS, and 87XQ 2/3-inch MS. The new S4083 is a 2/3-inch Plumbicon for low-cost cameras.

AMPEX AVSD 1400

Exhibiting ACE editing systems, ADO digital special effects, ESS-3 still store, and a variety of production switchers. Also on hand will be the recently introduced VPR-3 VTR, along with the VPR-80 and VPR-2B VTRs. The Ampex/Nagra VPR-5 portable Type C VTR and M-format systems will be demonstrated, as will the FPC-10 portable color camera.

See ad page 95-98

AMPEX MAGNETIC TAPE DIV. 1400

Will display its complete line of video and audio magnetic tape products for the professional broadcast industry.

See ad page 23

AMTEL SYSTEMS 1745

New items will include the 880 Series video, audio, and pulse distribution system; the DVG 1100 digital vector-scope display; the 3600D SMPTE time code generator, reader, and character inserter; the 4900 VITC and longitudinal time code reader and character inserter; and the 4500 portable VITC and longitudinal time code reader and generator. Will also show the complete line of vertical interval and longitudinal time code mastering systems, master clocks and timing devices, and safe area and safe title generators.

See ad page 160

ANCHOR SYSTEMS, INC. 1618C

Will exhibit the line of Anchor powered sound systems and VJ Electronics powered and battery-operated sound systems, cabled intercoms, and snakes.

ANDREW CORP. 1201A

Will introduce a new 3.7 m Ku-band



AFA-built one-inch edit suite for Empire Video.



Artel Communications Corp. will introduce the SL2000 fiber optic transmission system.

earth station antenna and associated radio equipment. Will also display 7.3 m and 4.5 m earth station antennas and associated radio receiving equipment outside the exhibition hall, plus a Plastidome earth station shelter and broadcast antenna at the booth.

See ad page 115

ANGENIEUX 1201

Angenieux will be showing its brand-new lens for the RCA CCD camera as well as its design of the camera's optical system. It will also have a complete display of state of the art camera lenses for film and television. Lenses will be available for one-inch, 1.25-inch, 2/3-inch, and half-inch video cameras as well as a retro zoom telephoto attachment for 15/9 ENG/EFP cameras lenses. Lens accessories will be on display.

See ad page 270

ANTENNA TECHNOLOGY CORP. (ATC) 1737

Will feature the new Simulsat-7 7 m equivalent earth station for broadcasters, an addition to the established Simulsat line of multiple beam earth stations.

See ad page 271

ANTON/BAUER 1337

New product introductions will include the MicroLight modular portable lighting system, the MicroControl compact camera control unit for the Ikegami HL-79E camera, a fully portable under-cover recorder/camera system for light levels as low as 0.2 fc, and miniature camera/monitor safe area generators. Also featured will be the line of camera and VTR batteries, chargers, battery belts, lighting equipment, and camera control units.

See ad page 127

ANVIL CASES 1112

Will introduce several new designs of rack-mount cases in addition to the complete line of custom and standard cases for video, broadcast, and professional audio equipment.

APERT-HERZOG 1703

Will introduce the H2 second-generation, cost-reduced TBC/frame synchronizer, which accepts signals from heterodyne VTRs that accept 3.58 (SC) inputs. Also new will be another second-generation unit, the Model A2 full frame synchronizer with freeze from front panel or remote. Other products on view will include the Model H TBC for heterodyne VTRs, the 1x24 distribution amp for high usage signals, and the VBB-1 hybrid IC designed for use as a broadcast video DA.

APIS CORP. 1762

Will introduce the Graph-Pac ultra-high color real-time graphics display for TV production, and the Video Pointer graphic symbol generator, which uses a touch tablet membrane for x/y movement.

APPLIED DIGITAL TECHNOLOGY 1730

Will introduce a new disc-storage system for the Sony BVE-3000 editor. Will also feature improvements on its Relecon remote controller for video post-production and color balancing.

ARRIFLEX CORP. 1421

Introducing Arrilites, portable tungsten lighting kits made up of 650, 1000, and 2000 W lights and grip equipment. Also unveiling ATC (Arri Time Code) optical 80-bits-per-frame SMPTE time code for 16/35 mm film. CineJib base will also be new. Among other products on display will be film cameras and

editors, Zeiss film camera lenses, and a full range of HMI lighting fixtures.

ARTEL COMMUNICATIONS 1163

Will introduce a new long-distance fiberoptic system. Will also show its full line of portable and fixed fiberoptic systems for broadcast audio, video, and data. Multichannel systems for multiplexed video and dual audio, battery-operated ENG/EFP systems, and high resolution video systems for RGB computer graphics and HDTV will be shown. In addition, the use of rugged lightweight fiberoptic cables will be demonstrated.

ASACA/SHIBASOKU 1226

Will introduce the Asaca ACL-3000 automatic random access cart system, a MERPS player which handles 300 half- or 3/4-inch videocassettes. Also a production model of the Asaca multi-image viewer allowing the simultaneous display of eight consecutive frames during video editing. New from ShibaSoku will be the CM09A1 HDTV monitor, T15A1 HDTV pattern generator, SV-13 150 MHz video sweep generator, digital signal generator, 26-inch delta-tube monitor, nine-inch in-line tube monitor, and graphic display monitor. Standard products on view will include 20- and 14-inch monitors in delta and in-line versions, a nine-inch monitor, a video noise meter, a TV signal generator, and color encoders and decoders.

See ad page 257



BMS TBT-2K microwave transmitter.

AT&T INFORMATION SYSTEMS 1429

Will feature its System 85 private branch exchange, an integrated business system with voice, high-speed data, sensor-based energy and security management, office applications, and network capability in a single system. It also comes in an enhanced version with eight times the capacity of the basic

version. Also on view will be the Merlin communications system for small businesses, portable data entry terminals, and the Horizon communications system.

AUBURN INSTRUMENTS 1711

Will feature its MC/1 two-wire machine control system for broadcast and professional audio, video, and film equipment.

AUDICO, INC. 1343

Will premiere the Model 619 as an addition to its line of videocassette rewinders. The 619 is designed for U-matic, VHS, and Beta, with interchangeable modules, and can be used as a component of loading systems. Will also have video and audio cassette loaders, reloaders, and rewinders.

AUDIO DEVELOPMENTS 1743

Will show its line of multimixers and ENG mixers.

AUDIO KINETICS 1173

Will introduce the Mastermix console automation system, a floppy-disk-based concept that fits to most consoles without modification, as well as retrofit packages including VCA faders for non-automation ready consoles. The Q.Lock synchronizer will also be displayed with enhancements for digital audio editing. New programs for the synchronizer will be on hand, especially the Q.Soft special sound effects, track editing, and automatic dialog replacement packages.

AUDIO-TECHNICA 1141

Will be introducing two new battery/phantom-powered lapel microphones, the AT803A omnidirectional and the AT831A unidirectional. Accompanying this display will be the complete range of battery and phantom powered microphones including new shotgun designs, two studio dynamic microphones, both omni- and unidirectional, as well as a studio electret condenser microphone.

AURORA IMAGING SYSTEMS 1312

New features on the Aurora 100 digital video graphics and animation system will include 3D perspective transformations and additional animation capabilities. New also will be support

for cell animation for the Sony 2500 VTR.

AUTOCUE 1318A

Will show its Model 2000 memory prompter and on-camera prompter with trapezoidal mirror.

AVANTEK INC., TELECOMMUNICATIONS DIV. 1742

New will be the AR-2000 earth station video receiver for simultaneous reception of multiple channels. Also the full line of earth stations, LNAs, downconverters, signal distribution components, satellite earth station receivers, and CATV test equipment.

WILLIAM BAL CORP. 1614

Introducing Silverlan line of carrying cases incorporating a synergistic composite external shell and a medium density, layered polyurethane which can be cut to fit. Also showing Survivor line of transit cases for audio and video equipment as well as carrying cases for disks and reels, and tools.

BASYS 1129

Will introduce the Personal Assistant, an IBM PC-based package employing all the features of the larger News Fury newsroom computer system. The News Fury and Clip Fury will also be on display, along with full broadcast newsroom systems.

BEAVERONICS 1313

Will feature the DSK-4-DLB downstream keyer, which provides for multiple keys, automatic key fade-in, and fade-to-black. It accepts both video and key signals from character generators and other sources. Will also show the BI-156 video production switching system with downstream keyer, borderline, and chroma keyer options, as well as the line of Favag master clock systems.

BELDEN COMMUNICATIONS 1628

Will bring the new Modulight convertible softlight for 1 kW to 16 kW operation and the new Lee 8 kW HMI, along with the Lee 200 W portable sun gun, the Lee filter line, resin camera filters and polyester photo filters.

BESTON/McINNIS-SKINNER 1020

Will be introducing Data-Graphics, a

direct broadcast computer graphics system generating maps, charts, and graphics for weather information and all news graphics. Also showing NewsScan computerized electronic newsroom system with script preparation, library, archive, and producer rundown functions. The Marquee 2000 and 3000 character generators and the low-priced Data Prompter, an entry-level electronic news system, will also be displayed.

BIAS (DATA COMMUNICATIONS CORP.) 1014

Will bring a new newsroom computer system, developed by Beston/McInnis Skinner and based on the IBM PC. Also new will be Buyline, an umbrella of products and services for stations, reps, and agencies through one unified source, designed to speed up broadcast spot buying with fewer discrepancies. Will also show its master control automation system, feature film system, and financial and accounting systems for broadcasters.

BIRD ELECTRONIC CORP. 1625

Introducing, for dual transmitter installations, the new 15 and 25 kW forced-air cooled, dry load resistors; reject loads to 96 kW peak, field replaceable. Also new will be the relative field strength plug-ins for Thruline wattmeters. From existing line, instruments and components for RF power measurement will be demonstrated as will the heat exchanger loads, field replaceable water cooled loads, and air cooled line terminations.

BIW CABLE 1405

New this year will be fiberoptic cables, armored VTR cables, and VTR cables with quick-disconnect feature. The standard line of TV camera and VTR cables and assemblies, triax cable assemblies, and repair services will also be on view.

BOGEN PHOTO 1705

Will be introducing TSE video cases, M-100 mini video light, and the new 3124 tripod with micro fluid head. Also new will be the portable video dolly and Hi Glide rail system. The full line of tripods, fluid heads, dollies, light stands, quartz lighting, gaffing, and grip equipment will complete the display at the Bogen booth.

**NO ONE WATCHES
TELEVISION
CLOSER THAN
TEKTRONIX.**

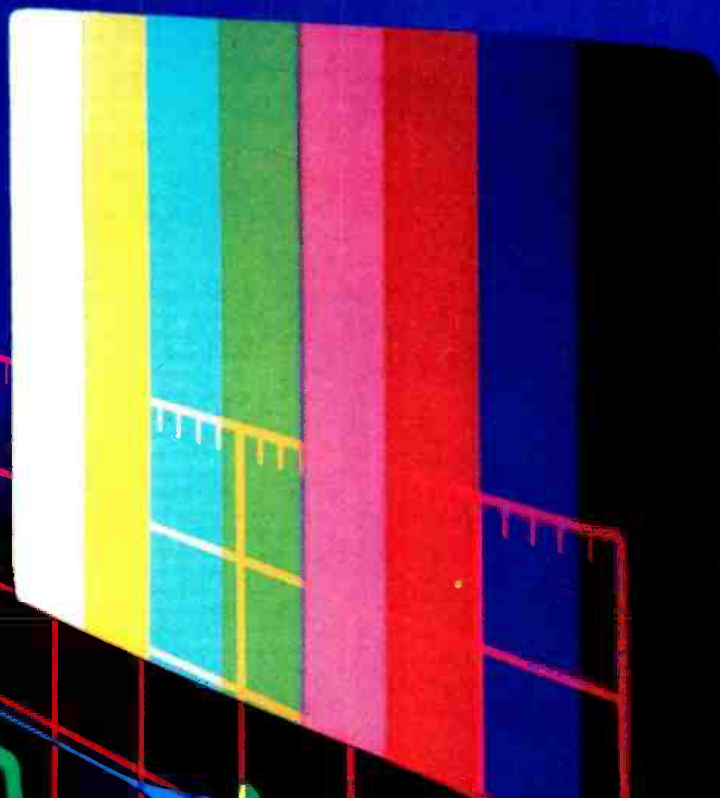
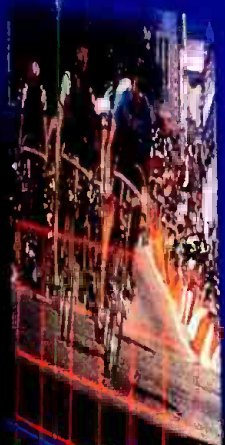

SEE IT, SYNC IT, SAVE IT, TEST IT...GET A CLEARER

**1740 Waveform/
Vector Monitor (Right)**
Tek's new waveform/vector
monitor saves space, power
consumption and cost. Both
dc power and battery pack
options are available. It's
ideal for mobile vans and
field applications.



Tektronix 110-S

POWER
SYSTEM
STATUS

118-AS Audio Synchronizer
(Above) No more lip sync
problems! Tek's new 118-AS
provides a practical solution
to the audio-to-video delay
caused by four-field memory
video synchronizers. The 118-
AS features wide dynamic
range, low distortion and auto-
matic and manual delay
correction.

**1980 Automatic Video
Measurement Set**
(Top center) Tek's Answer
System permits continuous,
unattended monitoring of all
your incoming and outgoing
video feeds. It generates
complete reports automati-
cally, alerts you when mea-
surements exceed specified
limits, and can be pro-
grammed to meet your
changing needs.

**Tek's newest product for
television:** — new measure-
ment capabilities detailed on
the following page. Take a
look!

PICTURE OF YOUR SIGNAL WITH TEKTRONIX!

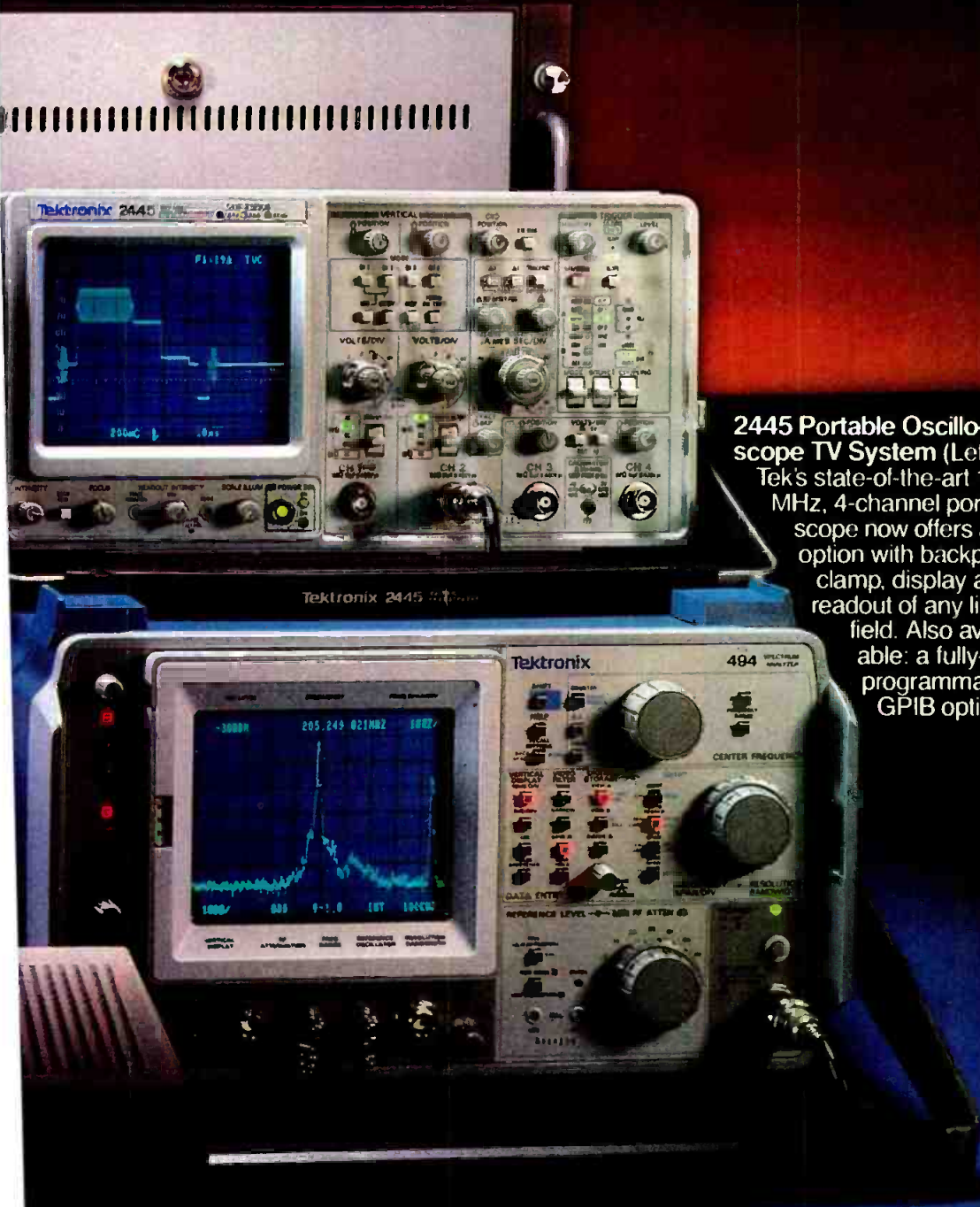

Behind the sets, the programming, the glamor of television, success still depends on signal quality.

2445 Portable Oscilloscope TV System (Left)

Tek's state-of-the-art 150 MHz, 4-channel portable scope now offers a TV option with backporch clamp, display and readout of any line or field. Also available: a fully-programmable GPIB option.

No one gives you better tools for measuring and maintaining video signal quality—quickly, consistently, confidently—than Tektronix.

For more than 30 years, Tektronix technology has stayed a step ahead to help you solve problems in color television: Whether you're broadcasting live feeds from a bike race in northern California... or sending signals via satellite to thousands of television stations around the world—our products are helping you get a clearer picture of the video signal.

Tek instruments give you broad test and measurement capabilities. They are accurate, easy to operate, and compatible with other broadcast equipment. Above all, Tektronix television products continue to meet the broadcast industry's needs. Take it from us: no one watches television closer than Tektronix.

494/494P Spectrum Analyzer (Above) An unprecedented value! Counter frequency accuracy, baseband through microwave coverage and unique HELP mode to guide

less experienced users. Store up to nine displays and ten set-ups in non-volatile memory. Portable and rugged, the 494 is backed by a three-year warranty!

Circle 165 for Literature for 494

Circle 167 for Literature for 1740

Circle 166 for Literature for 2445

Circle 168 for Literature for 118-AS

Tektronix
COMMITTED TO EXCELLENCE

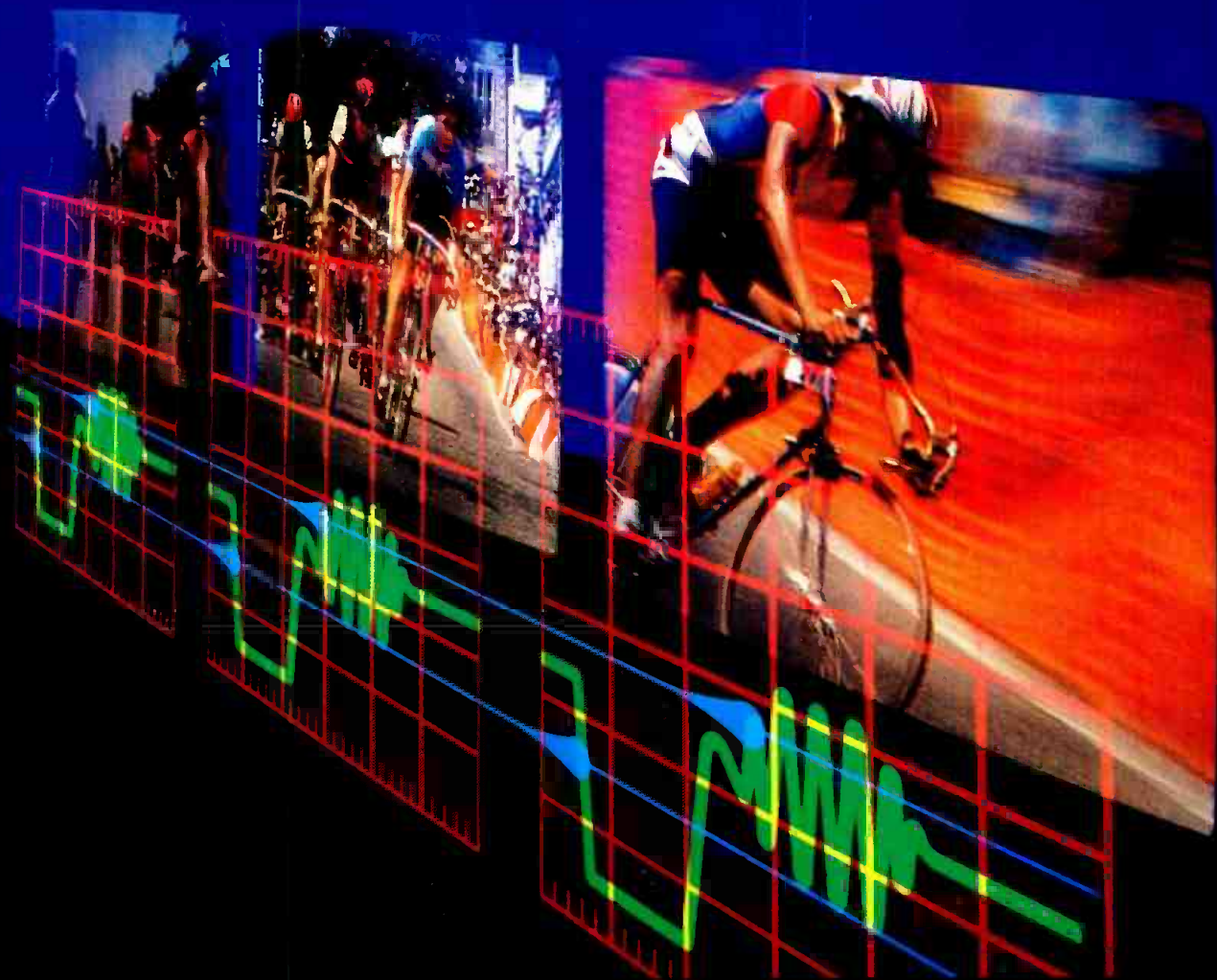

1750

WFM R-Y VECT SCH INPUT



POWER INTENSITY FOCUS SCALE VERT POS HORIZ POS

SWT PS

PHASE

GAIN

LINE SELECTOR

FIELD

LOCAL REMOTE

THE NEW TEKTRONIX 1750: HEADS OFF PROBLEMS YOU DIDN'T KNOW YOU HAD...UNTIL IT WAS TOO LATE!

Our new 1750 signal monitor gives you a unique, dynamic display of SCH phase relationships.

You can see at a glance if a video signal is properly SCH phased... or just as easily, compare two signals for color frame matching.

Hit-or-miss SCH phasing may have been tolerated in the past—but now it's costing you time and money every day.

The Tektronix 1750 can help you regain control. By maintaining consistent SCH phase... or by seeing potential problems *before* a glitch occurs, you'll avoid the frustration of multiple passes and enjoy getting it right the first time. Saving time saves you money and makes the best use of your valuable resources.

SCH phase, of course, isn't the only parameter you need to keep on track, and SCH display is only part of the 1750's comprehensive signal monitoring capabilities. At the push of a button it also displays vector mode... or waveform mode, enhanced by digital line selection through the vertical interval... or R-Y/sweep mode for easy interpretation of differential phase distortions.

Whether used for monitoring video in production and editing

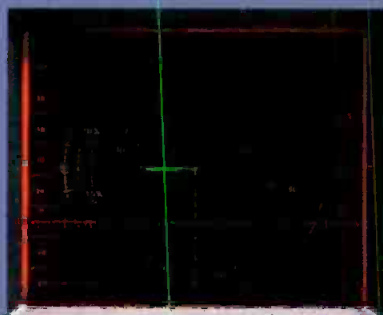

Correct SCH phase relationship is clearly displayed on the 1750 when dot on the calibration circle is aligned with the vector on the -x axis.

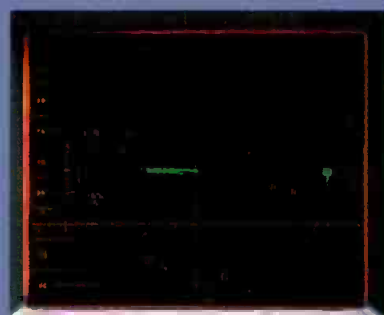

Dot placement on the +x axis indicates an error in the color frame matching of two signals.



This 17-degree offset, indicating a 17-degree SCH timing error, would be impossible to perceive on an ordinary waveform monitor display.

environments, or for making fast and accurate measurements during equipment maintenance, the 1750 Series is a new benchmark for comprehensive performance in both NTSC (1750) and PAL (1751) standards.

A compact 5.25 inch package, mechanically interchangeable with many other "half-rack" packages, allows

easy installation in new or existing facilities.

If you see the advantages of comprehensive signal monitoring, you'll like what you see in the 1750.

For more information on this or other Tek television products, or for the number of your nearest Tek sales office, call our toll-free information service today: (800) 547-1512. In Oregon, (800) 452-1877.

U.S.A., Asia, Australia, Central & South America, Japan
Tektronix, Inc., P.O. Box 1700
Beaverton, OR 97075

Europe, Africa, Middle East
Tektronix Europe B.V.
Postbox 827
1180 AV Amstelveen
The Netherlands
Telex: 18312-18328

Canada
Tektronix Canada Inc.
P.O. Box 6500
Barrie, Ontario L4M 4V3
Phone 705/737-2700

Tektronix
COMMITTED TO EXCELLENCE

Circle 169 for Literature

NAB '84 TELEVISION

BOGNER 1319 BROADCAST EQUIPMENT

Will exhibit its line of high-power UHF TV transmitting antennas to 220 kW, low and medium-power VHF and UHF slot and dipole transmitting antennas, circularly polarized FM transmitting antennas, MDS and ITFS transmitting and receiving antennas, and low-cost transmitting antennas for LPTV.

BOSCH FERNSEH 1603

Will premiere several new enhancements for the FGS-4000 graphics system. The new 3D editor for the FGS-4000 gives the operator complete freedom in the generation of true 3D objects; with the associated extruder the operator can take any 2D object and make it thick with ROB (Read Object). The new HQAS (high-quality animation system) for the FGS-4000 gives the operator tools for enhancing previously created animations by adding glows, sparkling effects, and streaking capabilities. Also new this year, the Paint option is a basic paint system that allows the operator to paint with a stylus and systems tablet. A new single-framing editor gives single-frame machine control and allows automatic control of VTRs via the FGS-4000, with real-time playback. Other new products will include the field editing unit for Quartercam, the new FRP-60 color correcting system for the FDL-60 telecine, the MCS-200 master control switcher, new switcher control panels, and CAP (computer-aided programming), designed to aid users in reconfiguring their own distribution systems. The TAS/TVS A/V distribution systems will feature enhanced audio and video performance. Also new will be the R-102ME, R-61ME, and R-51ME production switchers. Items from the established line will include the BCN Type B VTRs, the FDL-60 telecine, Mach One editor, and KBF, KCF, KCP, and KCA cameras.

See ad page 123

BOWEN 1770 BROADCAST SERVICE CO.

Will premiere Teleho, a computerized maintenance assistance system for broadcast equipment. Demonstrating service on all RCA quad VTRs in addition to TCR-100 refurbish and maintenance programs.

WALTER BREWER CO. 1631C

Will introduce a new power entry box for location lighting, in addition to its established line of telescoping hangers designed to raise and lower studio lights. Will also have new 1984 short-form catalogs with a new section on basic lighting applications.

BROADCAST MICROWAVE SERVICES (BMS) 1749

Introducing the TBT-2K series of frequency-agile portable microwave transmitters, powered either by ac or dc. Also introducing a 6 m earth station with microprocessor-controlled pedestal. Standard line of equipment includes GCA-1 gyro-stabilized helicopter ENG microwave system, which remains oriented to receive site regardless of helicopter movement.

BROADCAST SYSTEMS, INC. 1500

Will introduce the DC-8 MERPS deck for computer-controlled sequencing of 3/4-inch videocassettes. Also new will be the Pro-Pak rackmount TV equipment cabinets, the BJ-240A prewired audio jackpanels, and the BJ-200 prewired economy jackpanels. Other products on display will include the VTM-1000 monitoring and input switching system for TV and the VTC-1 video test system.

BROADCAST TECHNOLOGY 1701

Will be introducing the Vector 4000, a narrowband FM low-level, 24-channel generator that transmits on coax or single twisted pair for over a mile to 300 channel-selectable receivers. Also introducing Mix Minus MM2112 console with remote program interrupt. The PI 2320 and Mix Minus 2121 consoles will be displayed along with the full line of card amps, EQs, meters, power supplies, and headphone amps.

See ad page 249

BROADCAST VIDEO SYSTEMS 1326

Introducing the BVS D-1000 NTSC decoder, Cox computer video processor, component color corrector, and component switcher. Other Cox products on display will be the 600J encoded color corrector with time code control and the 303 NTSC/PAL encoder. Will also display the EV 4060 combination waveform/vector monitor and the SA-101 safe area generator.



Bosch FGS-4000 graphics system.

THE BTX CORP. 1124

Introducing new products to complement all SMPTE-based synchronizers, including The System, an intelligent controller/editor. Also the Model 4735 transport command console with automation and editing capabilities will be exhibited. Softouch audio editing system software additions will be included along with a mass storage device and printer output features. The complete line of Cypher time code automation systems, and longitudinal and VITC automation devices will be displayed.

BW LIGHTING SYSTEMS 1753

Will introduce complete line of Tall Cyc lights rated up to 2000 W per fixture for cyc systems 14 feet in height and over. Also featured will be cyclorama track systems with curtains available in single, double, triple, and user-specified configurations and in wall-mount or suspended versions.

CALZONE CASE CO. 1179

Introducing G-Spec detailed custom line of cases. Also exhibiting line of Escort, Proline II, and Convoy cases for all types of equipment.

CAMBRIDGE PRODUCTS CORP. 1328

Will introduce a new twist-on, right-angle BNC connector in addition to the standard line of connectors for broadcast video equipment.

THE CAMERA MART 1018

Will display its extensive lines of video, audio, film, lighting, and support equipment, available for rental and sale.

See ad page 11

CANARE CABLE 1732

Will unwrap two new video cables with 75 ohm impedance, plus a new line of paired data cable, Model D200 (up to 32 twisted pairs with overall shield),

FUJINON'S revolutionary 2-door zoom lens.



It works the way you do.

FUJINON's new 17X studio zoom will permanently change the way you use and feel about a lens. More than refining the studio zoom, FUJINON has revolutionized it to give you greater control, flexibility and efficiency than ever before.

Downtime for adjustments and repair is drastically reduced. And the need to remove a shroud is virtually elimi-

nated. For instant access to all important adjustments, just open one of the two doors.

The new 17X zoom incorporates more "FUJINON firsts" than any lens in our history. For example, you can pre-set limits on the zoom range to match the lens' outstanding ramping characteristics to the lighting levels of every production. (If necessary,

you can still override the limit from the pan bar.) To change the slow/fast zoom speed, you do it on the new pan bar zoom control instead of somewhere inside the lens. You also have the option of adjusting servo focus and zoom control tension—to get the exact "feel" you want.

With the new 17X studio zoom, every major component is modular to

make user servicing a practical reality.

FUJINON's new 17X zoom is the first generation studio lens of the future. And it's here, now.

For more information on the P17X16.5ESM studio zoom lens and other fine FUJINON products, contact the FUJINON office nearest you.

FUJINON INC.
872 White Plains Road
Scarsdale, NY 10583
(914) 472-8800
Telex 6818115

FUJINON INC.
2101 Midway
Suite 350
Carrollton, TX 75006
(214) 385-8902

FUJII OPTICAL SYSTEMS, INC.
118 Savarona Way
Carson, CA 90746
(213) 532-2861
4855 Atherton Avenue
San Jose, CA 95130
(408) 866-5486



FUJINON

Wilk's Video Precision character generators: generate impressive features and reliability.

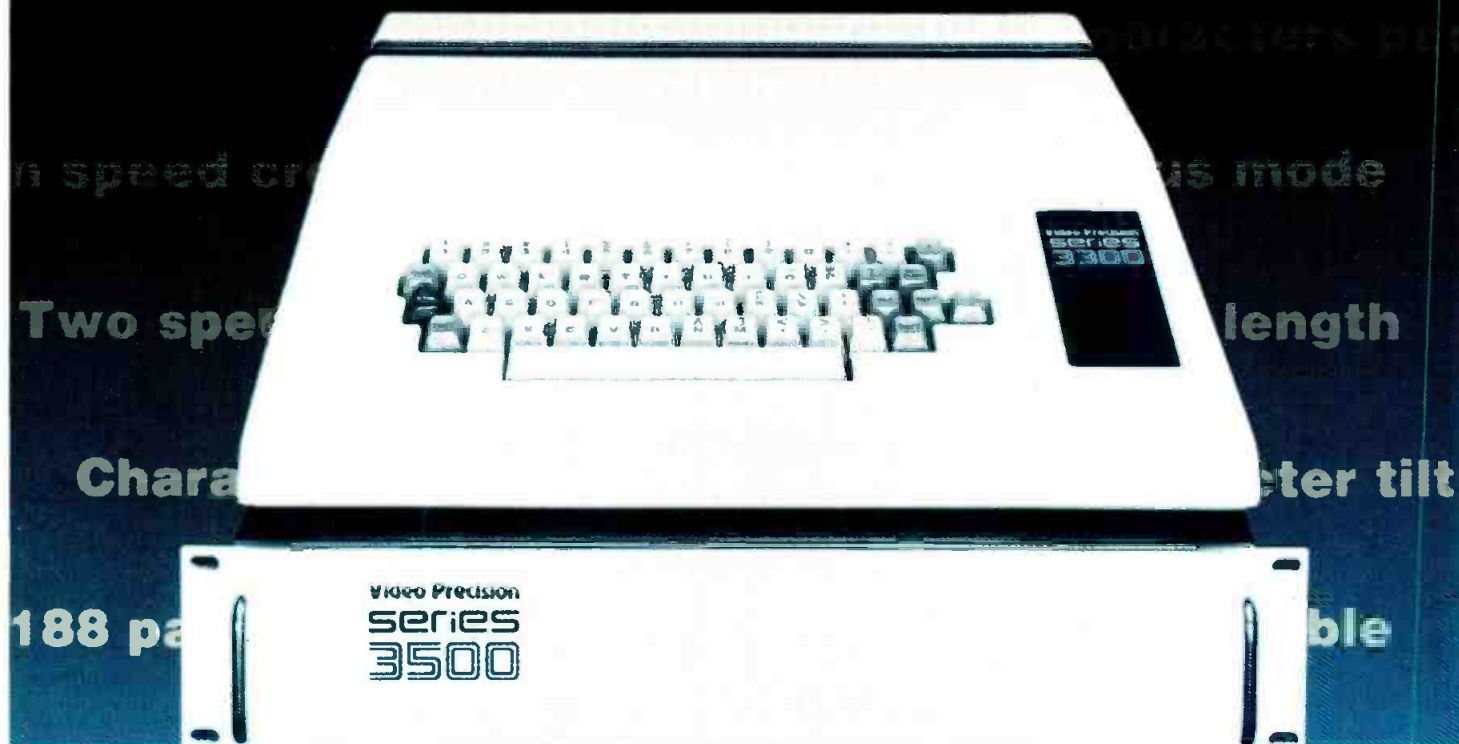

Wilk Power and Video's Character Generators are available as either stand alone desk top units or with separate keyboard and chassis. You'll discover that Wilk offers more value at less cost for all demanding Character Generator applications.

The 3300 Series stand alone desk top units are available as either a character generator, production titler or in a combination and offer the following features as standard:

- Characters can be individually colored any of six colors plus black and white variable line by line.
- 62 page memory with 8 lines of 25 characters per line.
- RS-232 I/O port for offline editing from computer from a second Series 3300 unit.
- Seven speed credit roll, one shot or continuous mode.
- Two speed bottom line crawl of elastic length.
- Page/line centering.
- Audio cassette tape storage and retrieval.
- Keyboard selectable baud rate from 150 to 2400 baud.
- Character accentuation by flash or character tilt.

The 3500 series chassis and keyboard are separate units connected by shielded audio cable locally or by telephone line at remote locations. The keyboard can be replaced by an Apple computer, and one or more chassis can be accessed by either the Apple computer or a keyboard. The 3500 Series offers the following features as standard:

- Up to 188 page memory
- 10 line display of 31 characters per line.
- Line by line color backgrounds with eight color choices (red, green, blue, black pearl, magenta, cyan, yellow).
- Top line two-speed crawl of elastic length.
- Bottom line time/temperature display with factory set 12 or 24 hour clock display and temperature reading either Fahrenheit or Centigrade degrees.
- Optional second display channel output with a separate memory.

The entire Wilk product line delivers performance features and reliability normally found only on much higher-priced equipment. Visit **Booth 1229** at the **NAB** Convention, and see Wilk's new state-of-the-art line of Character Generators and Routing Switchers.

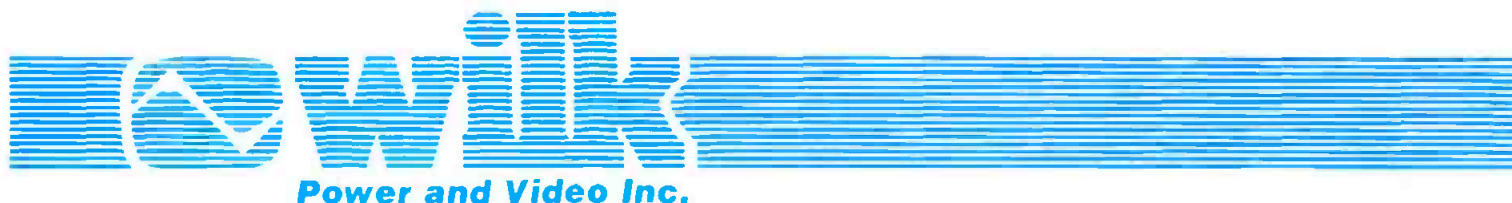

U.S. Corporate Offices: 16255 Ventura Blvd., Suite 1001, Encino, California 91436 / (818) 788-2338 / Toll Free: 800-782-9455
Eastern Regional Offices: 12 Terhune St., Oakland, New Jersey 07436 / (201) 337-8158 / Toll Free: 800-782-9455

Circle 171 on Reader Service Card

and Model M200 multichannel audio cable. In addition, the company will feature its previously shown Starquad audio cable.

CANON USA, INC. 1012

Will be introducing a new studio lens for cameras with one- and 1.25-inch pickup tubes. For the 1.25-inch, the P18X15BIE 15-270 mm f/2.1 is new, and for the one-inch, the PVI8X11BIE 11-198 mm f/1.6 is new; both offer wide angle and two built-in extenders. Other new products include a new EFP/



JSCP Series B FM antenna at Cetec Antennas booth (in radio hall).

remote lens for 2/3-inch pickup tubes, and a new ENG/EFP lens for 2/3-inch that weighs less than 2 kg. From the existing product line, the P12X18BIE, P14X16.5, P18X16BIE, and P40X18BIE for 1.25-inch tubes will be demonstrated. Four additional studio/field lenses will be available for 2/3-inch tubes, and three others in that pickup size will be available for EFP applications. ENG/EFP lenses for both 2/3- and half-inch tubes will also be shown.

See ad page 41

CAT SYSTEMS, INC. 1014B

Introducing new Model 4200 facility monitoring system with RF switching network schematic in color. Will also remotely operate an earth station in the midwest, from NAB floor, performing uplinks, switching, and testing.

CECO COMMUNICATIONS 1010A

Displaying electron, transmitting, receiving, and industrial camera tubes from Eimac, Amp, RCA, Westinghouse, GE, and Sylvania. Featuring video telecommunications department and CCTV design.

CENTRAL DYNAMICS LTD. 1409

Will feature a hands-on demo of its 1080 switcher with an NEC DVE and new CAP (Computer-Assisted Production) software, which controls video source machines and also allows colored analog key borders. Also new is Flexi-Wipe, which allows the switcher to capture any source image and use its outline for a soft key or soft wipe. Flexi-Wipe will be shown with the 1080 switcher. The 680 and 480 switchers will also be on display, along with the MC 990 master control system with automation, the SDS2 signal distribution system, the VAS1010 video/audio switcher, the 860/864 downstream keyer, the 800 series of audio/video DAs, and the 2300 series of video DAs.

See ad page 38

CENTRO CORP. 1101

The booth will feature a 45-foot tractor-trailer rig. The company will also demonstrate its custom-constructed editing console, and portable teleconferencing system as well as its facility design services.

See ad page 155

CENTURY PRECISION CINE/OPTICS 1781

Will premiere new Periscope lens for tabletop, motion control, and special effects shooting, featuring 1:1 relay allowing operator to use any taking lens without limiting field of view. From the line, a .7X wide angle adapter will be on hand, fitting most popular 2/3-inch video zoom lenses with macro or adjustable back focus.

CETEC VEGA 1401C

New RF microphone products this year will include the 66/D11 portable battery-powered receiver and 67A/D11 portable diversity battery-powered receiver, both with Dynex II low-noise processing; the T-81, T-82, and T-83 handheld transmitters with Dynex II, utilizing the Shure SM58 mic, Shure 85 condenser mic, and AKG C-535 condenser mic respectively; and the

ZC-177 impedance converter for musical instrument pickup. Will also show the line of pocket transmitters, Pro and Pro Plus receivers, wireless intercom master stations, transmitters, and receivers, and the C-466 quad case for RF microphone systems.

See ad page 229

CHESTER CABLE 1320A

Introducing Video20 multiconductor 75 ohm video cable, and Audio22, PRJ, 22 AWG jacketed and shielded audio pairs. Also showing all standard audio, video, and control cables.

CHRISTIE ELECTRIC 1403A

Will pull the wraps from a new, lower-cost version of the ReFLEX-20 "burping" battery charger. Also new will be a high-power maxERASE bulk tape degausser for video and audio tapes. The line of Super Ni-Cad battery packs and ReFLEX-20 chargers will also be displayed.

CHYRON CORP. 1610

The Chyron IV character/graphics system will be shown in a new expanded version with features such as x,y,z (3D) rotation of graphics, automatic as well as manual inter-character spacing, automatic word expansion, and an optional third channel. The MGM (Multi-mode Graphics Module) will also have new features, including cut-and-paste. The RGU-2 character/graphics system will also have a new feature, camera/font compose with automatic modification of fonts. The VP-1 system will have new software and genlock options and the VP-2, seen last year in prototype, will be shown in a production version.

See ad page 259

CINEMA PRODUCTS 1221

Introducing Camraprompter L, incorporating similar features as original Camraprompter but for larger-size cameras. Also new is the Mini-Mote, a remotely controlled pan-tilt head, and the CP EFP studio rig allowing a film-style studio setup for most EFP cameras. A new Skymount for aerial photography and RDS/HMI lighting equipment will also be introduced. Other equipment on display will include the Mini-Worrall geared head, the Steadicam Model III, J-6 joystick zoom control, Universal Matte Box, the digital remote control system, and lighting packages.

CINEMILLS CORP. 1140

Will bring its line of lighting equipment from Daymax. Cine 60, DeSisti, Lee, and others.

CINE 60 1423

Will show its standard line of batteries, chargers. Sun Gun lights, and lighting kits.

CIPHER DIGITAL 1606

Will bring its new line of longitudinal time code products, seen last year in prototype. Highlighted units will be the Model 710A reader, Model 735CD reader with eight-channel event controller, and 766 VITC generator.

See ad page 40

CLEAR-COM INTERCOM SYSTEMS 1502

New this year will be the CP-300 portable remote intercom station, which allows two channels on a single mic cable; also the TW-12 interface device, which enables Clear-Com-type intercom systems to be interfaced to RTS-type systems. Other featured products will be the MS-808 intercom mainframe and IS-808 remote station.

See ad page 24



Cinema Products Mini-Mote head.

CMC TECHNOLOGY CORP. 1425

Introducing a complete new line of replacement video heads for Type C VPR-3, VPR-2B, and VPR-80 VTRs, incorporating a proprietary autotracking record/reproduce video head. Also featuring the TD-800 bulk tape demagnetizer, as well as its line of quad heads and VTR accessories.

CMX SYSTEMS 1639

Featuring the 3400 and 3400+ large-scale videotape and disc editing systems, as well as the mid-sized editor, The Edge.

COLORADO VIDEO, INC. 1222

Showing Model 250 transmitter/Model 250 receiver for slow scan television. The system is an analog NTSC color SSTV unit transmitting still video images over a 10 kHz subcarrier bandwidth in several seconds.

See ad page 116

COLORGRAPHICS SYSTEMS 1116

Will introduce Artstar, a state of the art paintbox graphics computer, plus simultaneous work station, dual independent video, and higher resolution. Also new will be Ministar, a smaller, upgradable version of the large system, and a new freeze frame digital framestore. Other products on view will be the Newstar computerized newsroom system and LiveLine III real-time graphics and weather system for television.

Affordable Random Access Video Cart Systems

Cost effective, modular, and expandable



Component Switching and Processing

Modified 3/4" U-Matic Players with

Y-C/DOC outputs or 1/2" Type M with YIQ outputs are switched through our vertical interval Matrix Switcher into a component TBC.

HRS MINS SECS FRAMES



Automatic Directory Reading

Cassettes are loaded randomly into any empty deck. They rewind automatically to the head and the directory, containing a 4-digit reel ID number with precise start and finish times of each segment according to their location with reference to SMPTE time code is read into memory. The status indicating ID found and VTR location is displayed on the terminal.

Send for Brochure

Lake Systems Corporation, 55 Chapel Street, Newton, MA 02160 617/244-6881

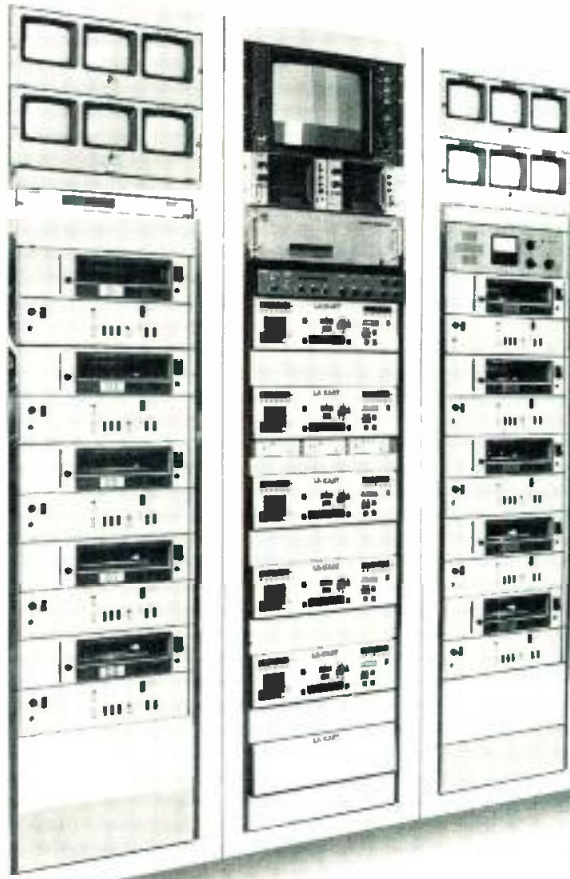
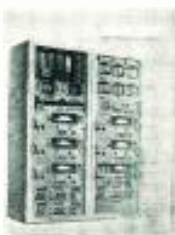

Any Tape Format

Choose from 1" Type C, 3/4" U-Matic, 1/2" Type M, or any combination.

1000 EVENTS

Or more with 68K Multi-Event Programmer and Disc Drive.

The computer identifies, searches out, and activates tape segments to be cued and aired in the order scheduled.

Lease Plans Available

LA-KART
LAKE SYSTEMS CORPORATION

Prices Start at \$89,900

© Lake Systems Corp 1983



WAIT 'TIL YOU GET YOUR HANDS ON OUR EDITORS.

We will be displaying our current line of video editing equipment at the NAB show this month.

Paltex invites you to visit our booth, look around, then sit down for a hands-on demonstration of the **VANGUARD,* EDIT-STAR,* ST-3,*** and the introduction of the first in a series of digital products—**GEMINI.**

We'd like nothing better than to allow you to put your creativity to the test.

NAB BOOTH #1005

Advanced Technology in Video Communications

2942 Dow Avenue
Tustin, California 92680
(714) 544-9970



California Paltex Corporation

For Sales Information contact:

Joseph Horning
National Accounts Manager
(213) 464-2222

S. Douglas Sorensen
Northeast Regional Sales Manager
(617) 681-7777

Thomas A. Greaves
Southeast Regional Sales Manager
(404) 299-2333

* Formerly manufactured by Datatron.

Circle 173 on Reader Service Card

www.americanradiohistory.com



Comprehensive's MS-1000 mini-switcher (top) and MS-2000 deluxe mini-switcher.

COLORTRAN 1205

Will bring its line of lighting control consoles, dimmers, and Fresnels.

COLUMBINE SYSTEMS 1323

Will feature its sales analysis, traffic billing, accounts receivable, film inventory and amortization, and music inventory and rotation products and services. Cash management programs,

automation interface, payroll, and media inventory will also be offered.

COMARK COMMUNICATIONS 1217

Introducing a new series of 110 kW UHF television transmitters, the CTT-U-100S. Also new will be the WTB-1500 power combiner, the CAP-110M automatic multiplexed diplexer system, as well as new pulsing, corrector, and exciter systems. The new CM-100S, a broadcast modulator with IF SAW filter, will be displayed, as will the CTP-20 anode pulsing system. The existing line of equipment will include UHF transmitters from 10 kW through 220 kW, in addition to waveguide and coaxial transmission systems and turnkey RF installations.

See ad pages 1, 246

COMEX CORP. 1508

Will feature its line of digital audio delay products.

See ad page 22

COMPREHENSIVE VIDEO SUPPLY CORP. 1145

Will be introducing its computer sys-

tems to aid in video production, scripting, scheduling, payroll, budgeting, etc., as well as mini video production systems. Comprehensive will also show items from its catalog of professional video accessories, audio products, power and lighting products, production aids, interface products, and storage and transport products.

COMPUCON, INC. 1405D

New broadcast services will include translator/booster application preparation, coverage analysis, market area analysis, and analysis of proposed or pending modifications for FM; analysis of returned or dismissed LPTV applications; and market area analysis, interference studies, listing of existing station operators, and application preparations for MDS.

COMPU = PROMPT 1728

Will introduce its CP-1000 fully computerized color video prompter for broadcast and production, offering instant electronic text editing, variable speed scrolling, on-screen timer, and automatic indicator of relative position to beginning and end of script, all in full color.

6112BH now with ILLUMINATED PUSH-BUTTONS BOTH A PRODUCTION AND A POST-PRODUCTION SWITCHER

Complete a mix or wipe on a 6112 (or any of our switchers for that matter), and there is **ABSOLUTELY** no **COLOR CHANGE** or **HORIZONTAL SHIFT**, we mean just that, absolutely none. That is because the 6112 has a blanking processor which replaces the sync and burst on all incoming video signals with a constant amplitude internally generated signal, completely eliminating the continuous problems caused by small drifts in your cameras and TBC's. **You never know the value of a blanking processor until you own a switcher that does not have one.**

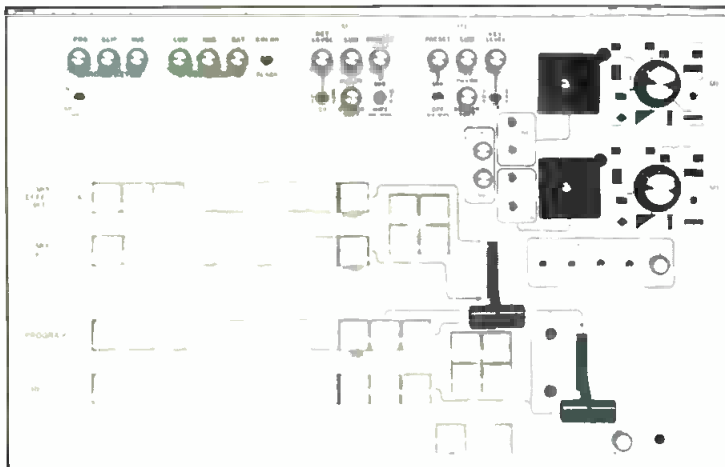

MODEL 6112 NTSC \$7950
Chroma Keys Encoded or RGB \$1050.
 (Encoded chroma keyer not available in PAL)
Model 6112BH - Illuminated Push Button - \$10,500

CROSSPOINT LATCH CORP.

OPERATE THE 6112 DIRECTLY FROM THE EDITOR KEYBOARD

The 6403 allows the the 6112 to interface directly with most editors. No modification to the editor is required

Under **6403** control the **6112** accepts commands such as duration times, pattern type, bus selection etc., directly from the editor keyboard. The **6403** also provides additional capability of accurate start and finish, size and position of pattern transitions.

Audio follow or split audio capability is provided by the **6800** mixer which has separate level controls for each stereo input. The **6803** can be driven either directly by the editor or via the **6403** interface unit.

- TREMENDOUS PRODUCTION CAPABILITY
- EASE OF OPERATION
- TWO FULLY INDEPENDENT MIX-EFFECTS SYSTEMS
- AUTOMATIC MIX AND WIPE
- DUAL BACK PORCH CLAMPS
- ROCK STABLE CIRCUITRY
- DOWNSTREAM KEYS
- TWO ADDITIONAL KEYS

DELIVERY LED, WITHIN TWO WEEKS; ILLUMINATED, FIRST QUARTER '84

95 Progress Street, Union, NJ 07083
 Tel. (201) 688-1510 • Telex 181160

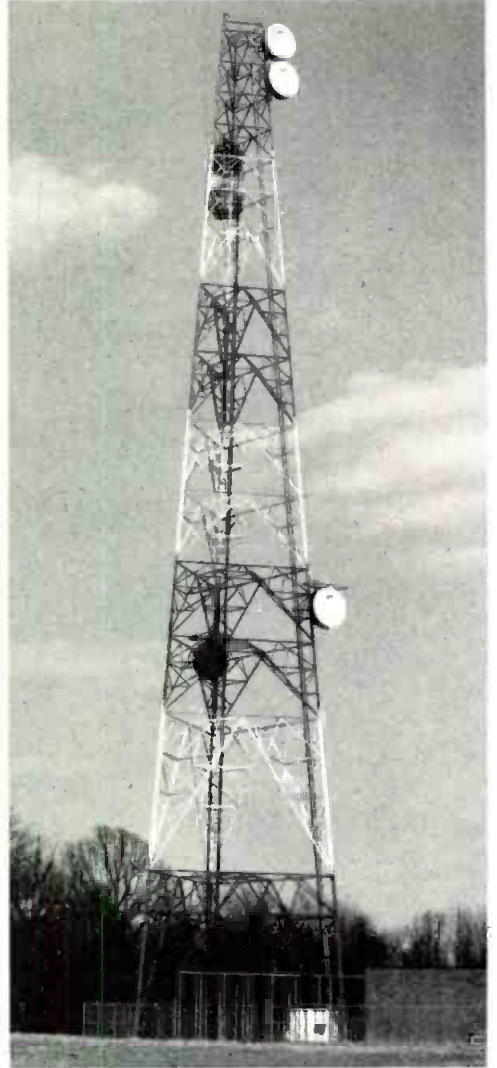
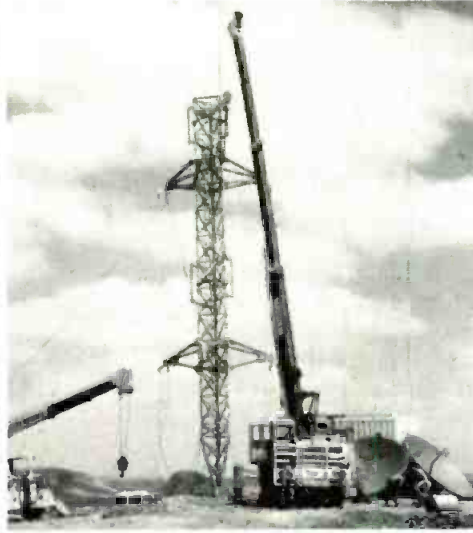

**LET US
DO IT
ALL!**

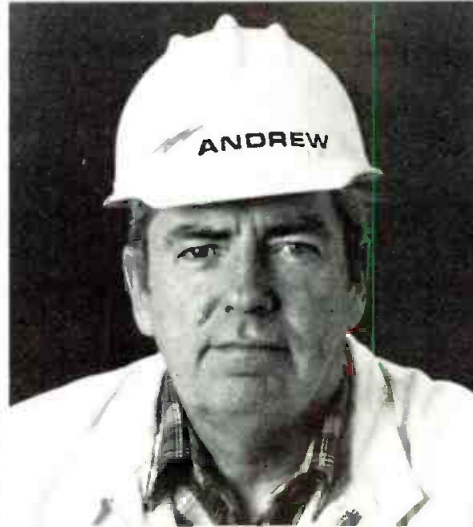

SERVICES

- Project Management
- Total Site Construction
- Electronic Systems Integration
- Delivery Service on Specialized Vehicles
- Sales and Manufacturing Support —Worldwide

PRODUCTS

- Equipment Shelters and Towers
- Broadcast Antennas and Transmission Lines
- Terrestrial Microwave Antennas
- Coaxial Cables and Elliptical Waveguides
- Earth Station Antennas



Our people in the booth wearing this button have all the answers.

Let's talk. Stop by. Visit Booth 1201A at the NAB Show.

Andrew Corporation, 10500 West 153rd Street, Orland Park, IL 60462.



ANDREW

Our concern is communications.

COMPUTER GRAPHICS LAB, INC. 1143

Will introduce the 3-DV, a computer-graphics-based three-dimensional animation system. Will also show the Images-2, a low-cost version of the Images digital art/paint system. Images itself will be displayed, along with the CAAS-2, a two-dimensional frame-by-frame computer-assisted animation system.

See ad page 21

COMSEARCH, INC. 1136

Will feature its new Tempest test lab, offering electromagnetic pulse analysis and special testing, with shielded en-

losures providing a variety of RF and microwave environments to test and analyze electronic equipment. Also new are specialized EMI measurements. The company will also feature its systems design and engineering services for satellite earth stations and point-to-point microwave, and FCC and FAA application and notification form preparation services, plus radio and facilities engineering.

COM-TEK COMMUNICATION TECHNOLOGY 1122B

Will introduce new models to its line of wireless communication systems and

microphones, including the M-72 and M-82 microphone transmitters, the RD 72-4 simultaneous duplex repeater, and the BR-72 cuing personal receiver. Will also display the M-72BF base station transmitter and M-72L and MR-72 RF mics.

CONNECT-AIR INTERNATIONAL 1764

Will show its broadcast cable assemblies, made to manufacturers' specifications.

CONRAC 1401

New this year will be the 6200 master Class I monitor with in-line gun; the 7300 1000-line noninterlaced monitor; and perhaps a new monochrome monitor. Will also feature its 6100 master monitor and the FNA, QQA, and DZB monochrome monitors.

CONTROL CONCEPTS CORP. 1751A

Will introduce the ISASIL magnetic isolator, companion to the ISLATRAL active tracking filter.

CONTROL VIDEO CORP. 1157

Under new ownership of ADDA Corp., will introduce an optional keyboard to the LightFinger editor with bidirectional search; soft keys will correspond to the LightFinger touchscreen display. Will also show new interfaces for audio and video recorders and switchers. The Sword editor will also be shown.

CONVERGENCE CORP. 1430

The featured new item will be EditDroid, the specialized post-production editing system for disc or tape, developed in conjunction with LucasFilm. Also new will be the Character Inserter, which inserts time code digits into video as it is being recorded, providing a window dub. The booth will also feature the Super 90 single-source edit system, along with the ECS-202, 203, and 204 systems.

COOL LIGHT 1329

Will introduce the new Starpack location lighting kit, the Olympic 12 V battery belts in 5, 12, and 17 Ah capacities, and a guide to lighting. In addition, the full Cool Light lighting system will be shown.

CORELLI JACOBS MUSIC 1120

Will bring 25 new recordings of music

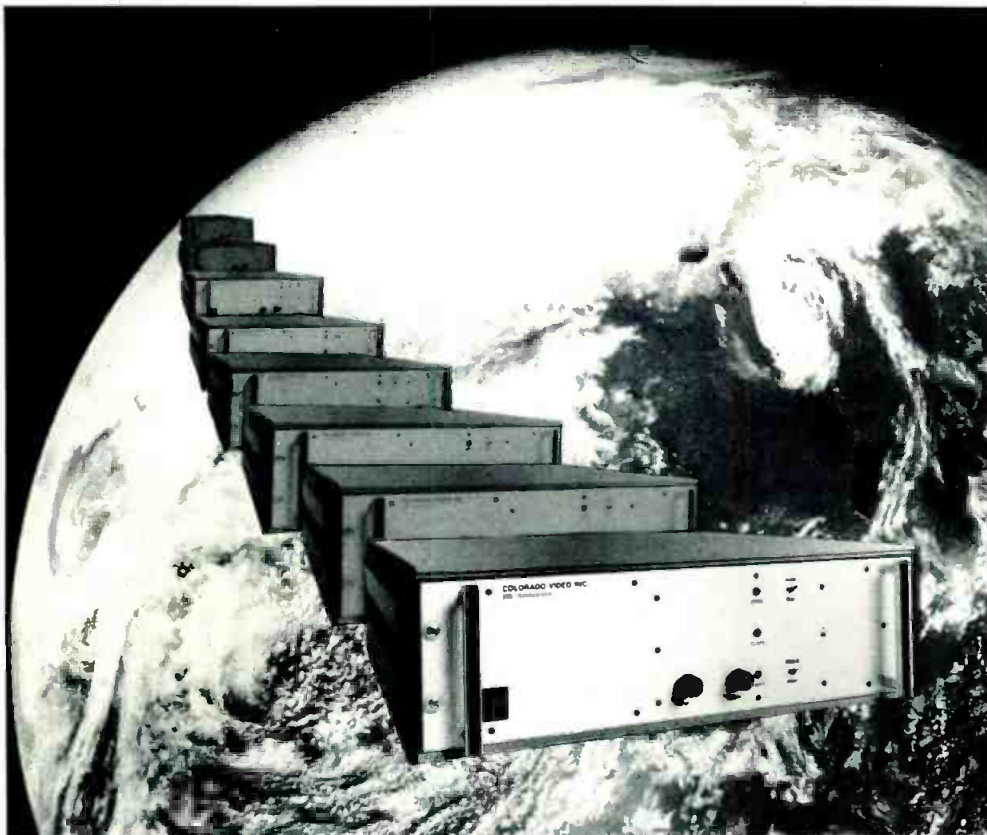

REACH THE WORLD WITH SSTV

High quality programming can be provided to a national audience using Slow-Scan television (SSTV). Both the digital Model 285C and analog Model 290C transmit still video color images over the subcarrier of a satellite transponder—at a fraction of the cost of full-motion satellite delivery.

With the addition of inexpensive earth stations, SSTV can be used to reach specialized audiences, like academic institutions, religious groups, or professional associations.

Slow-Scan television offers rapid "slide-show" programming. Use it for topics such as news, travel, weather, finance, art, real estate or geography.

To learn how specialized programming becomes affordable with SSTV, contact Colorado Video, Inc. Box 928, Boulder, CO 80306 303/444-3972.

COLORADO VIDEO

See us at the NAB in Booth #1222

Circle 176 on Reader Service Card

The new 30-kilowatt high band overachiever

The Harris TV-30H does it better at 30 kilowatts than any other high band TV transmitter. By design.

Better Performance

Specifications approach the measuring limits of the very best television test demodulators to easily handle the demands of new technology.

For example, highly linear amplifiers and the Harris Quadrature Corrector hold incidental phase modulation to $\pm 1.5^\circ$.

Our unique VIDEO* SAW filter provides visual sideband attenuation of -10 dB at 4.5 MHz.

*Visual IF Delay Equalized Output

These specs—vital for transmitting high-quality multi-channel (stereo) sound—are unmatched in the industry.

Greater Reliability

Because of the VIDEO SAW filter's built-in FCC receiver group delay pre-correction, the TV-30H is the only 30-kilowatt high band transmitter that needs no complicated receiver equalizer circuitry. Fewer circuits mean greater reliability.

And this is the only 30-kilowatt design linear enough to combine aural and visual signals at the exciter outputs for emergency multiplex operation (available as an option).

More Headroom

Other than the visual cavity and the cooling system—which were redesigned for maximum efficiency at 30 kilowatts—the TV-30H uses the same components and circuits as our field-proven 50-kilowatt high band transmitter. Result: a greater degree of headroom for added dependability, longer component life.

Find out more on why the new Harris Overachiever is your best buy at 30 kilowatts. Contact: Harris Corporation, Broadcast Transmission Division, P.O. Box 4290, Quincy, Illinois 62305. 217/222-8200.



HARRIS

See the TV-30H at NAB '84

Circle 177 on Reader Service Card

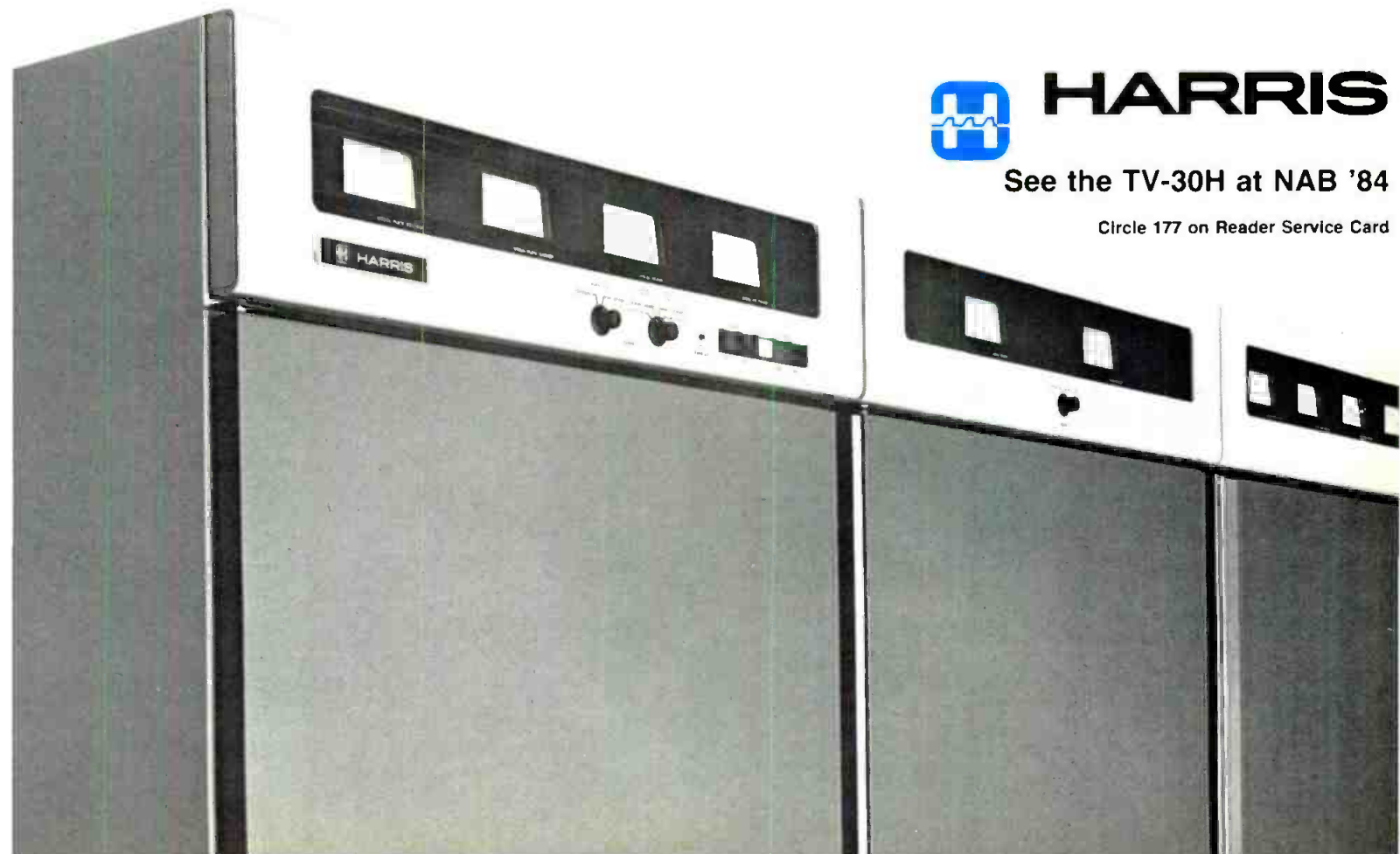

for broadcasters, cablecasters, and syndicators, plus a new sound effects set of 21 albums. Will describe its new 24-track recording studio, as well as its basic 600-album music library.

CORPORATE COMMUNICATIONS CONSULTANTS 1161

Will introduce System 2000 interactive computerized scene-to-scene telecine color corrector and the System 60C3 computerized scene-to-scene telecine color corrector. The System EBM tape-to-tape color corrector will also be introduced. From the existing line, the 60XLB2 and the 60C2 computerized color correctors will be shown.

COUNTRYMAN ASSOCIATES INC. 1720

Will unveil the new Isomax II podium extension microphone, plus the new TVH Isomax broadcast mic. In addition, the full line of Isomax and EM Series mics will be exhibited, along with Countryman direct boxes.

See ad page 160

CROSSPOINT LATCH CORP. 1321

Will unveil analog component switcher Model 6116 with four component inputs, three encoded inputs, and microprocessor control option. Model 7239 will be introduced as a computer controller for 6139K series switchers and the master control switcher Model 6150 with 16 inputs will also be premiered. A 99-event microprocessor controller for the 6109 switcher will be introduced, Model 7209. Other products will include Model 6112 switcher, several versions of the 6139 series of production switchers, audio mixers for editing applications, as well as the Model 6403 programmable editor/switcher interface and the Model 6124 production switcher.

See ad page 114

CYBERNETIC DATA PRODUCTS 1134A

DALSAT 1785

Will show its transportable earth stations and facility installation and consulting services.

BILL DANIELS CO. 1706

Displaying its high-tech purchasing library of dealer catalogs covering video, audio, computer, and broadcast applications.

DATA COMMUNICATIONS CORP. 1014

See BIAS

DATATEK CORP. 1428

Will introduce the destination-oriented D-2200 SMPTE standard bidirectional data matrix for distribution of data and machine assignment and control signals. Also featuring its microprocessor-based line of video and audio routing switchers for large and small systems in addition to a line of video, audio, and time code amplifiers, TV transmitter color phase equalizers, and SID systems.

DATATRON 1005

See PALTEX



Paltex/Datatron Vanguard editor.

DATATRONIX 1504

Will offer several new items, including the Series 2000 enhanced intelligent intercom system; the Series 1000 intelligent small studio intercom system; the 318 audio DA with extremely high common mode reject and acceptance; the PTIS user-programmable telephone interface system; the 1604A stereo production and post-production audio mixing console; the 2424 summing crosspoint matrix, expandable to 24x24; the 701A 18W audio power amp; and the 941 VCA automation fader. Established products will include the Series 300 modular amplifier system, Series 7000 remote-controlled amplifier system, Series 500 modular components, Series 8000 VU and PPM meters, and Series 440 conductive plastic illuminated scale faders.

DATUM 1708

Will introduce a series of new video control products, including the 5303 intelligent time processor, the new multi-row character generator/insert, a new full field video data encoder/reader, and a new automatic video mag tape search and control system. Also showing a full range of digital displays.

DAVIS & SANFORD 1751

Will bring three new Davis & Sanford fluid heads, along with the standard line of tripods and mounting equipment for cameras.

DELCOM CORP. 1638

Demonstrating design of custom and standard control room furniture and cabinetry, including racks and consoles.

DESISTI LIGHTING-AMERICAS 1131

New additions to the lighting line will include a 200 W CID handheld focusing spot; 200, 575, and 1200 W HMI PAR instruments; 500 W tin halide followspots; 1000 W CID followspot; 2500 W HMI softlight; wheeled travelling kit case; lightweight stands and grips; 1000 and 2000 W studio softlights; motorized video monitor hanger; cyc track and curtain; case for kit lamps; track lighting mountings; and 650, 1000, and 2000 W fresnels.

DE WOLFE MUSIC LIBRARY 1734

Displaying production music library for use in TV, radio, and cable productions, as well as 21-album sound effects library.

DIGITAL ENTERTAINMENT CORP. 1600

Will be demonstrating the Mitsubishi digital audio system comprised of the X-80 portable and X-80 A console digital master tape recorders, the XE-1 electronic editor, and the X-800 32-channel digital recorder.

DIGITAL SERVICES CORP. 1302

Will introduce Illusion, a video manipulation unit with digital effects including those of the company's existing Flexikey digital effects system



New mini-fill from Frezzolini.

FROM THE PEOPLE WHO BRING YOU THE CHARTS...

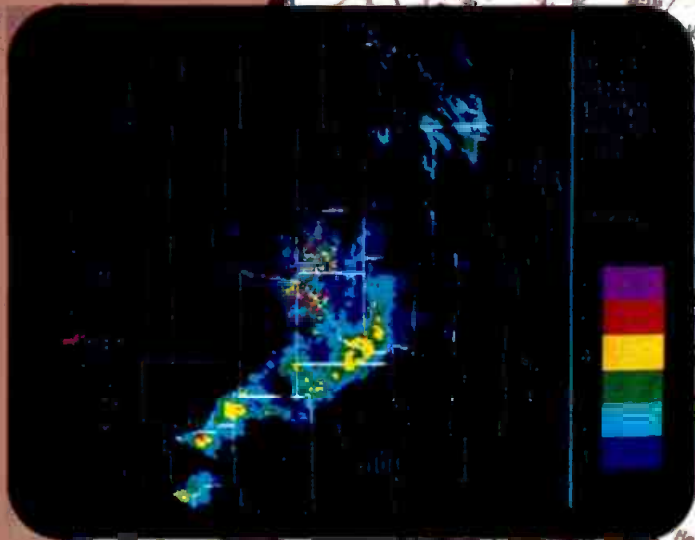

LIVE COLOR RADAR WITH FREE ACCESS

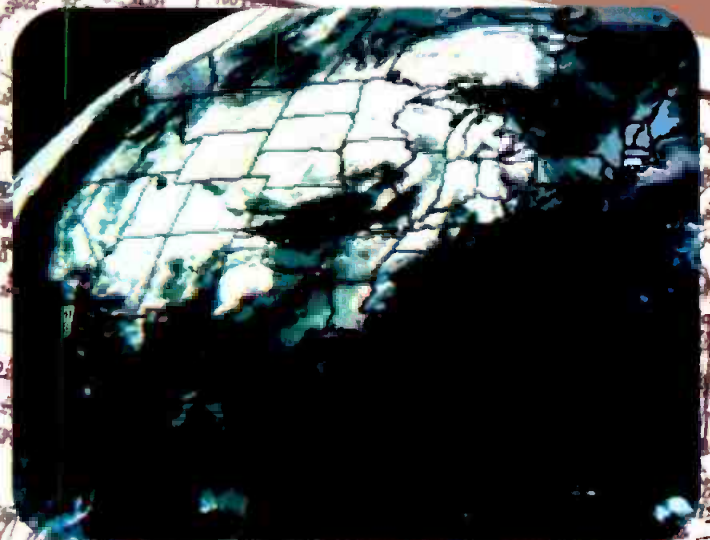

PLUS COLOR SATELLITE AND WEATHER GRAPHICS

You already know Alden as the first name in facsimile weather chart systems. In fact, you probably already use one of our chart recorders.

Now Alden introduces a new family of systems to add live color radar and satellite/weather graphics to your information sources.

LIVE RADAR. Alden's C2000R system brings you a new network of government weather radar transmitters (RRWDS). And provides you with live weather radar coverage anywhere in the country, with no annual access fees. Direct phone hookup is now available, with dial-up to all transmitters nationwide available in 1984.

Display different precipitation levels in up to 6 colors, with level flashing for easy identification, or store multiple-region and time-lapse pictures. Numerous other features make its low price a pleasant surprise.

Call or write us for complete information. Alden Electronics
121 Washington Street, Westborough, MA 01581.
Telephone 017-300-8831

Name _____
Company _____
Address _____
City _____ State _____ Zip _____
Phone _____

GRAPHICS. Alden's C2000S is a low-cost, high-performance unit for displaying weather information from private and government data bases. Color satellite pictures, surface weather, temperature contours and hourly NWS pictures are available, with 16 selectable colors, zoom, flash and loop capability.

BOTH. Alden's C2000R/S offers the combined capability in one system. Our "building-block" design permits field conversion of the stand-alone C2000R or the C2000S into the C2000R/S model at any time. All systems offer the flexibility to acquire not only today's data, but the data of the future.

ALDEN ELECTRONICS

The First Name in Weather

NOW YOU TERRIFIC FOR

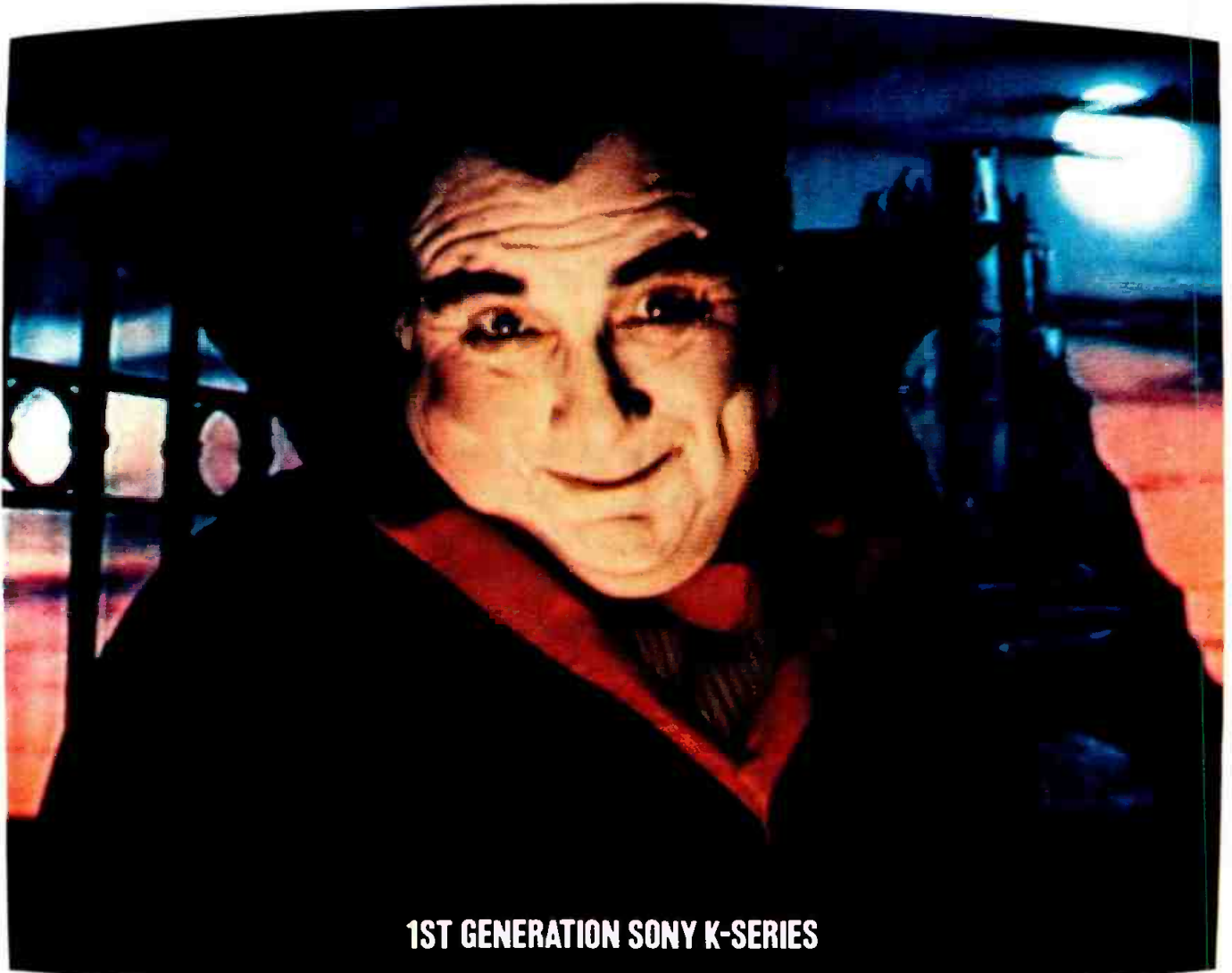

1ST GENERATION SONY K-SERIES

You can search the tape manufacturing facilities from Toledo to Transylvania and you'll go bats trying to find a 3/4" videotape that'll render pictures like the new Sony K-Series.

In the deep recesses of the Sony labs, our scientists have discovered the secret to long life. No longer will multi-generations draw the color out of your production. This is due in part to Sony's exclusive signal retention binder. It keeps the signal on the tape under the most demanding uses, even extreme temperature fluctuations.

The tape formulation is equally unique. Sony K-Series features Vivax™ magnetic particles, which are smaller than chrome oxide particles, and give you more information on the tape than ever before. So you start out with more vivid, lifelike pictures. Demons like dropouts, which have a nasty habit of puncturing holes in your video, have been dramatically reduced. As is the case for modulation noise. And the Sony K-Series has the highest color

Sony Tape Sales Company, Sony Drive, Park Ridge, New Jersey 07656. © 1984 Sony Corp. of America. Sony and U-matic are registered trademarks and Vivax is a trademark of Sony Corp.

CAN LOOK GENERATIONS.

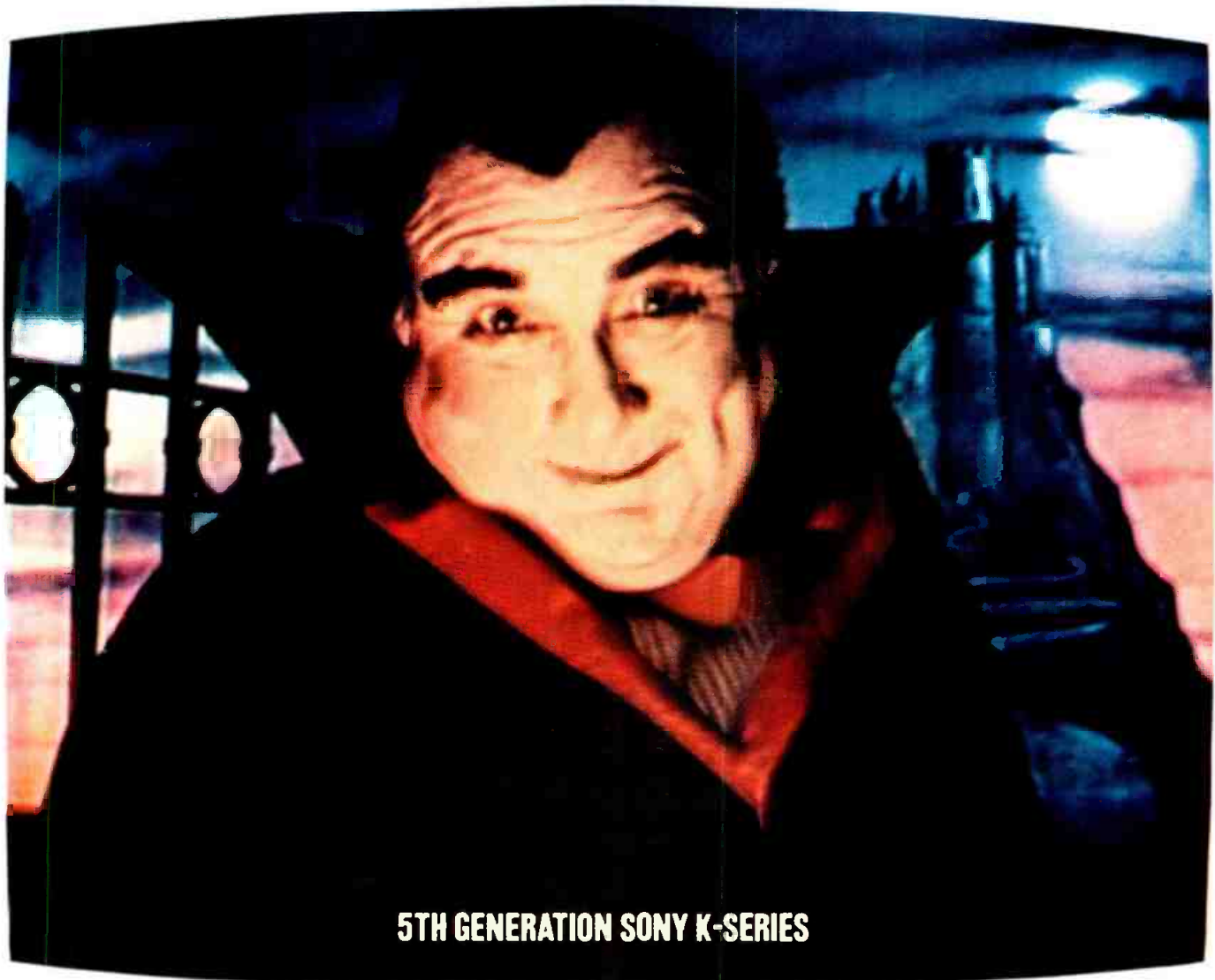

5TH GENERATION SONY K-SERIES

signal-to-noise ratio in the industry. This new Sony U-matic® tape is also distinguished by a smoother tape surface. It reduces headwear. So you not only increase your tapes' usability, but your tape recorder's as well.

And there's one other significant factor to consider. After close examination of videotape, we've discovered one thing is consistent: the inconsistency of tape. This is a problem you won't have to face with Sony K-Series. The millionth one you buy will be a mirror image of the first.

So if you're looking for a U-matic tape that gives you better pictures that last longer, look for the one designed for the run and rerun and rerun and rerun. New K-Series from Sony.

SONY
The Tape Measure In Video.



(also on view) plus posterization, mosaics, barrel roll, chroma key manipulation, freeze frame, strobe, border, and border clipping, with perspective available as an option. Also new will be the Conductor, a master control switching automation system, and the Statistician, a sports statistics package.

See ad page 83

DIGITAL VIDEO SYSTEMS 1017

See SCIENTIFIC-ATLANTA

DIGIVISION 1507

Will display its high-resolution digital video converter, the DRGB-343.

DILOR INDUSTRIES LTD. 1134B

DI-TECH 1301

Exhibiting a full range of audio/video routing switchers with two and three levels of audio, plus audio/video/pulse distribution amplifiers, video equalizers, and video presence detectors. Telephone-controlled systems and seven-day real time computer controllers will also be on hand.

See ad page 250

DOLBY LABORATORIES 1311

Will be introducing the Model 380 two-channel outboard audio noise reduction system for the Ampex VPR-3 and VPR-80. Also plans to display a complete line of audio noise reduction products for use with VTRS and audio recorders, including the Model 372 portable unit for use in the field.

DUBNER COMPUTER SYSTEMS 1630

Introductions this year all relate to upgrading the CBG-2 graphics generator. Demonstrated will be: higher resolution (3 ns), more colors per image (256), dual keyboard operation, new 3-D software, hardware anti-aliasing, and "third plane" electronic digital still store option. The CBG-2 itself will be on display with its electronic paint system, as well as the CCC-12 color corrector computer with automated control of film-to-tape and tape-to-tape transfers.

DYNAIR 1404

New products will be announced at the show. Established products on display will include the Series 25, Series 10, and System 21 routing switchers; the Series 5300 modular and Series 1500

standalone distribution equipment; the System 23 machine control; System 23 data switch; and Series 1600 switching equipment.

DYNAMIC TECHNOLOGY 1719

Will bring its line of studio lighting control units with both manual and memory systems, as well as remote machine control and data transmission equipment in the VIMACS range of products. Will also show distribution equipment, video patch panels, and audio jackfields.

EASTMAN KODAK COMPANY 1214

Will introduce the new Eastman professional and broadcast-quality videocassettes and videotape. Also featured will be the Datakode magnetic control surface for films, Eastman LC low-contrast print film 5380/7380, high-speed color negative film 5294/7294, Eastman video color monitor, TAF telecine analysis film, and Instagraphic CRT print imaging outfit.

See ad page 84-85

ECHOLAB 1510

New this year will be the AFS audio switcher, designed to work as a standalone unit, controlled by a video editor/controller, or controlled by the ECHOLab SE/3 special effects generator. The SE/3 with built-in microprocessor control will also be displayed.

ECONCO BROADCAST SERVICE 1759

This year's new item will be rebuilt 8990 tubes for FM transmitters. The company will also show its rebuilt power tubes for AM, FM, and TV transmitters.

EECO, INC. 1314

Will introduce a new multimachine, computer-assisted editing system featuring a distributed processing method capable of utilizing SMPTE/EBU longitudinal and vertical interval time code and/or control track. The system can control up to nine source/record machines, a video production switcher, and an audio switcher. Also new will be an enhancement to the IVES editing system, giving it A/B capabilities and special effects control. From its established line, EECO will display time code readers, generators, and reader/generators, the VCG-750 video character generator, MQS-100A multicue synchronizers,



Bosch Fernseh FDL 60 CCD telecine.

STC-100 multipoint search-to-cue controller, and time code reader/generator peripherals.

See ad page 255

EEG ENTERPRISES 1155

Brand-new from EEG will be the TE-501 teletext video data bridge; the Network Alert System, a vertical interval digital communications system for message transmission between a network and affiliated stations; and the Network Control System for automatic control of network switching functions via the vertical interval. Established products will include Line 21 closed captioning encoders, text processing computers, and decoding equipment.

EEV 1335

Will unveil the K3372 55 kW high-efficiency broadband external cavity UHF TV klystron with beam control device. New diode gun Leddicon models will include the P8490 one-inch, front-loading; P8496 one-inch, rear-loading; P8442 one-inch, low output capacitance; P8450 30 mm, LOC; and P8452 30 mm, LOC with barium aluminate cathode. Also new will be the P4320 electronically shuttered CCD camera. From the established range, front and rear-loading one-inch diode gun Leddicons, 2/3-inch diode gun Leddicons, 30 mm diode gun Leddicons, Vidicons, and power tubes for AM and FM transmitters.

See ad page 145

EG&G 1327

Will introduce the SS 125 flash head,



Quartercam™ from Bosch. If you're going half-inch, you're only going half-way.

Bosch Quartercam leapfrogs half-inch technology with a remarkable quarter-inch recorder-camera

Here's your current choice in recorder-camera combinations: either of two incompatible half-inch formats, or the breakthrough Bosch KBF-1 Quartercam.

Quartercam is smaller than the half-inch systems. Lighter—just 16 pounds including lens and battery. More maneuverable.

And the 20-minute quarter-inch cassette is about *one-fourth* the size of a Beta-cam cassette. *One-fifth* the size of a VHS. So small you can stuff it in your pocket. A couple in each pocket!



Quality? Outstanding. Bosch's unique Lineplex™ format produces quality so good you have to see it to believe it. Far better than current three-quarter inch tape. And the audio is beautiful, too.

There's a lot more including field editor, studio VTR, and other system components. Quartercam is a full system.

Is there any point in going half-way with half-inch? Go all the way with Quartercam—the new video recording standard.

Call your local Bosch-Fernseh office. Or get in touch with us directly: Fernseh Inc., P.O. Box 318186, Salt Lake City, UT 84131 (801) 972-8000.

BOSCH

Circle 179 on Reader Service Card

replacing the SS 123, with lighter weight, lower power consumption, and smaller size. Established products will include the SS 122 controller, SS 124 photo cell, and LS-159 antenna beacon.

See ad page 208

ELECTOR 1707

Will have several new items from the Barco line, including the BarcoData video projection system, new color receiver/monitors, and two new series of color display monitors. In addition, the full line of Barco color monitors will be shown.

ELECTRO CONTROLS 1631C

Will introduce the Playmate II portable dimming packs, along with the previously exhibited Celebrity lighting control console.

ELECTROHOME 1744

Will display its established monitor line, including the EVM series high-performance monochrome displays with rack, ceiling, and wall mounts; the Tri-Ed color receiver/monitor in 19- and 25-inch sizes; and the ECM 1301 high-resolution color video monitor and interface modules.

ELECTRO-VOICE 1159

Will introduce the Sentry 100EL studio monitor, essentially the Sentry 100A with an internal 50 W power amp. The company will also unveil its first piece of broadcast electronics equipment, the Series ELX line, with the ELX-1 four-input mono mixer, a mic or line level input device that operates on ac or battery. Also new will be the 8200 and 8400 production mixers. In addition, the full line of professional mics and Sentry 100A, 500, and 505 studio monitors will be shown.

See ad page 217

EMCEE 1621 BROADCAST PRODUCTS

Will unveil new multichannel MDS transmitters. Will also show its lines of 1-1000 W UHF and VHF LPTV transmitters; ITFS transmitters and repeaters; MDS and multichannel MDS transmitters; and complete RF system installation services.

See ad page 269

E-N-G CORP. 1022

The booth will feature a GMC Suburban and a GMC van, both equipped for television.

ENVIRONMENTAL 1509A SATELLITE DATA

Will introduce the PMT-100 low-cost complete weather graphics and production system, featuring high-resolution graphics and font generation, framestore, animation with nine to 19 frame loops, RRWDS local color radar displays, Doppler radar display, automated broadcast and/or dial-up data acquisition, and more. Will also feature its line of dial-up weather satellite pictures, infrared, visible data, and water vapor images, conventional weather graphics, composite pictures, and Accu-Weather graphics.

See ad page 161

E.R.A. 1618

ESE 1757

New will be Phone Patch, a high-quality, economical telephone interface, and the ES257 SMPTE code comparator with two-event capacity. Will also show the range of digital clocks, timers, master clock systems, programmable clocks and timers, time code readers and generators, audio level indicators, distribution amps, and time calculator.

THE NEW STANDARD FOR TV DEMODULATORS

Model EKF2/D



- 20mV - 1.5V input for Precision Transmitter-Site Monitoring
- Unique 2-Way Tuning: AFC Tuning across the complete broadcast range (Channels 2-83)

PLUS

One Crystal (any channel) for high-accuracy (All included! No plug-ins or modifications necessary)

- Demodulation Modes: Switchable Envelope/ Synchronous Demodulation Switchable Sound-Trap Zero-Reference Pulse
- Built-In Speaker for Direct Audio Monitoring
- Available from stock

New reduced price \$9800 • Call for details



Send for our new catalog



ROHDE & SCHWARZ

13 Nevada Drive, Lake Success, N.Y. 11042 • (516)488-7300 • Telex 96-0072

See us at NAB '84-Booth #1203

Circle 180 on Reader Service Card

**WE'VE DEVELOPED
A WAY TO
ELIMINATE
HORIZONTAL SHIFT.
AUTOMATICALLY.**

Grumman has solved the problem of horizontal shift caused by improper SCH timing. And solved it in a way that's not only economical, it's automatic. With our SYNC PROC™ unit you won't waste time, people and test equipment establishing SCH. And editors won't have to use trial and error to get the correct matched frame edit between two video signal sources.

SYNC PROC™ solves the problem in a simple way. It generates a color field identification signal that's positioned on the "front porch" of the TV signal. The ambiguity with RS-170A is thereby ended; you get positive identification for one field of the four-color field sequence. With color field identification, the SYNC PROC™ automatically maintains proper SCH timing, eliminating horizontal shift.

SYNC PROC™ provides the

most economical method of maintaining an SCH timed plant.

And it comes packaged with normally required features: a processing amplifier and sync generator and other optional features. Our expanding line of unique process and control products for the broadcast industry include color encoding, satellite transmission processing, machine control and many other state-of-the-art developments, and beyond.

For more information, write Business Development, Mail Stop A24-43, Grumman Aerospace Corporation, Great River, NY 11739, or call (516) 435-6001.



See us at the NAB Convention Booth #1631,
April 29-May 2, Las Vegas, Nevada.

Circle 181 on Reader Service Card

Circle 182 on Reader Service Card

www.americanradiohistory.com

GRUMMAN

GROVE VIDEO 1511

See KNOX VIDEO PRODUCTS

GRUMMAN AEROSPACE 1631B

Will emphasize its distributed microprocessor-based remote control and status monitoring system, modular and expandable, as well as the 501 sync proc and Rainbow Sound system for encoding audio into the video format for an additional audio channel.

*See ad page 125***JAMES GRUNDER & ASSOC. 1760**

Will introduce the Cel Ltd. P147-12 and P147-20 TBC/frame synchronizer with infinite window and color corrector with proc amp. It also has some digital effects including pixelization, posterization, and forced-color imaging. It is a seven-bit component device designed for all 3/4- and 1/2-inch systems.

GTE LIGHTING PRODUCTS 1339

Will introduce the new 200 W version of the Sylvania Brite Beam lamp, a new family of 18 Sylvania lamps with improved optical performance and new ceramic bases. Also a new family of Sylvania tungsten-halogen video camera lamps. Will also show the complete line of Sylvania lighting products for studio, theater, television, and video applications, plus the revised seventh edition of the Sylvania Lighting Handbook.

HARRIS CORP., BROADCAST DIV. 401

Will introduce a 60 kW UHF TV transmitter featuring a new high-efficiency klystron, a 30 kW high-band VHF TV transmitter; the TTS-4 teletext origination system; HVS 540 time base corrector; Challenger 2 GHz portable microwave transmitter with optional 3 W and 12 W power output; and the 2 GHz and 13 GHz STL transmitter and receiver. Will also show the established line, including TV transmitters and antennas, the 9165 computer-based satellite antenna control system, the TC-85 computer-controlled studio camera and TC-90 ENG/EFP camera, the Autotron Star business automation system, 9000 program automation, 9100 intelligent remote control system, Iris II digital still store system, frame synchronizers, time base correctors, 2 GHz, 7 GHz, and 13 GHz transmitters and receivers,

*Hitachi's HR-200E Type C VTR.*

and the Global IX portable microwave transmitter.

*See ad pages 117, 176-177, 245, 253, 276***HARRIS VIDEO SYSTEMS 401**

Will unveil a new, full-featured digital video effects system with bubble memory, curve and mosaic effects, and reportedly excellent key follow capabilities (said to be especially good with modulated wipe patterns). Also will introduce the HVS 540, a low-cost TBC with slow motion option for all 3/4-inch nonsegmented video recorders that accept sync and subcarrier inputs. Plus new HVS 632C component frame synchronizer with digital noise reduction, compress/positioner, and digital keyer. Items from the established line will include the Iris digital still store with ICS compose station/effects package, character generator for captioning, and library; and the HVS 690 frame synchronizer/TBC.

*See ad page 128-129***HARRISON SYSTEMS, INC. 1324**

Will unveil the Pro-7 stereo production console, the AIR-7 stereo on-air console, and the VSI video switcher for audio-follow-video operation. Established products on view will include the TV-4 stereo production and post-production console, the TV-3 stereo multitrack production and post-production console, the MR-3 multitrack scoring and remix console, the MR-2 dual multitrack scoring and remix console, and the PP-1 film post-production console.

*See ad page 211***HEDCO (HUGHES ELECTRONIC DEVICES) 1225**

Will bring a new version of its intermediate routing switcher line, the IRS, with 24 x 48 video and one channel of audio. Plus a new line of self-powered distribution equipment and routing switchers. In addition, the company will show its entire line of audio and video distribution equipment and routing switchers.

KARL HEITZ, INC. 1747

New items in the Gitzo line will be the 580/579 and 680/679 100 percent fluid and counterbalanced heads; the B421, BR421, and BC421 leveling balls for fluid heads, with or without height-adjusting column; the B621, BC621, and BCL621 leveling balls, with or without gearlift column for height adjustment; the 566M mini microphone fishpole; and the 386 quick release for cameras up to 20 pounds. Will also show the Gitzo lines of tripods, dollies, leveling balls, heads, monopods, mic fishpoles, and lightstands.

HIPOTRONICS 1779

Will exhibit its line of voltage regulators and high-voltage test equipment.

*See ad page 26***HITACHI DENSHI 1402**

Hitachi will unveil a whole new line of recorder/camera combinations, based on its 1/4-inch VCR format. Included are the SR-1 with a solid state camera, the SR-3 with a 2/3-inch three-tube camera, and the ECR-5 1/4-inch tape playback unit. Also featured will be the HR-230 one-inch Type C VTR for full production, post-production, and broadcast applications. Previously seen equipment will include the SK-110 computerized studio camera; the SK-97 2/3-inch computerized, auto-setup field camera; the SK-970 2/3-inch auto-setup studio camera; the FP-15 2/3-inch low-cost ENG/EFP camera; the FP-22 2/3-inch ENG/EFP camera; the HR-200E one-inch Type C VTR in deck or rack configurations; and the HR-211 Type C VTR console.

*See ad page 12-13***HM ELECTRONICS, INC. 1130**

New products on display will include System 82, a second-generation body-pac wireless microphone system with 115 dB dynamic range and extra-small transmitter. Also the System 280, a flat-pac receiver configuration for



Seven types of video tape, one reply card, and all you have to do is mail it in.

Please have a salesman contact me. Please send me more information.

My interest is in the following tape formats.

2" 1" 3/4" 3/4" BR 1/2" 1/2" Prof. Bulk Product (Specify _____)

Name _____ Title _____

Company Name _____

Address _____ Telephone _____

City _____ State _____ Zip _____

FUJI. Nobody gives you better performance.

© 1991 Fuji Photo Co., USA. Videotape Products Dept., One Appleton Avenue, New Haven, CT 06511, (203) 736-3330

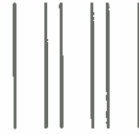

NO POSTAGE
NECESSARY
IF MAILED
IN THE
UNITED STATES

BUSINESS REPLY CARD

FIRST CLASS PERMIT NO. 5310, NEW YORK, N.Y.

POSTAGE WILL BE PAID BY ADDRESSEE

FUJI PHOTO FILM U.S.A., INC.
Attn: Thomas Daly
Magnetic Products Division
350 Fifth Avenue
New York, N. Y. 10118

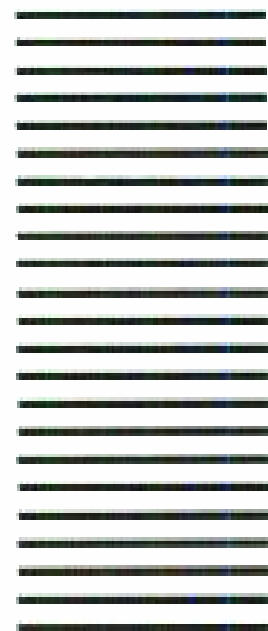



Five alarm hotel fire, 400 guests,
three competitors and one news editor
who eats cigars for breakfast.

Don't trust it to ordinary video tape.



Get it fast.
Get it right.
Get it done.

The pressure in this business
is extraordinary.

Which is why Fuji gives you
professional video tape that can
take anything you can throw at it.

Consider the latest advance in Fuji technology: the 3/4 inch H521BR U-matic video cassette. It gives you the absolute minimum number of dropouts possible—less than 4 per minute. Its video and color S/N ratio are boosted up to +2dB over the outstanding specs of our H521.

Superior back-coating technology and precision-engineering ensure that Fuji stands up to all the punishment dished out in the editing room. In fact, stop-motion capabilities increase to over 180 minutes. And Fuji's smoother, denser BERIDOX coating makes sure your tape heads suffer less abrasion than ever before.

To find out more about the new 3/4 inch H521BR and the other extraordinary video tapes we make, all you have to do is a very ordinary thing.

Just call Fuji.



FUJI.

Nobody gives you better
performance.

Philips products Philips products

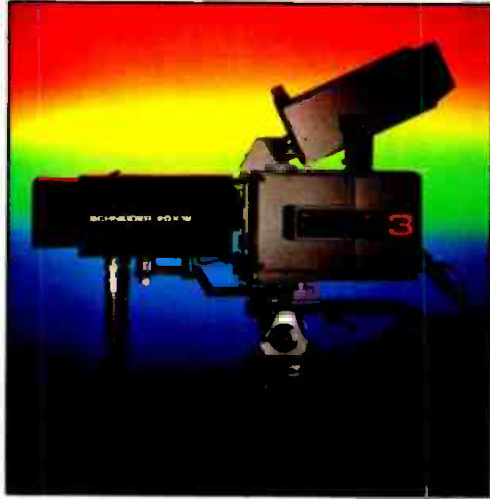

★ NEW LDK 14 RGB ★★★★★ NEW LDK 54 ★★★★★★ NEW LDK 26 ★★

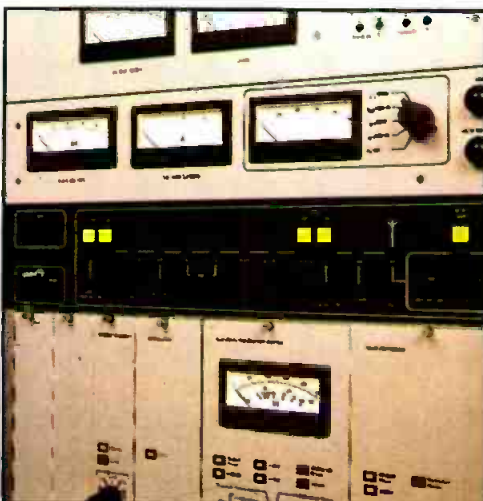

★ NEW 20" MONITORS ★★ NEW RADIO AND TELEVISION TRANSMITTERS

Philips products



at NAB
at NAB

Philips quality through experience

Philips has always produced a range of outstanding products and systems for the international broadcast industry, products that have been unrivalled for their quality and value.

This NAB will prove that 1984 will be the Philips year to remember.

The range of television cameras is most impressive. The LDK 6 leads the way with its total computer control and superb picture quality from 25 mm or 30 mm Plumbicon tubes.

There's a new member to the family too – the computer controlled LDK 26 with 18mm (2/3") tubes which will surely take its place alongside the LDK 6 as one of the world's great introductions. And the perfect portable partner for the family is the new LDK 614 triax portable production camera.

New also is the LDK 54 – a high performance full broadcast quality portable camera recorder with the remarkable 1/4" Lineplex tape system and many fine post production features.

The LDK 14 RGB offers the extra facility of full bandwidth RGB outputs for chromakey in addition to the normal CVBS video outputs.

The new 20" color monitor maintains the amazing value for money of the existing Philips 14" monitor.

For perfect sound, there's the professional Compact Disc Player – generally acclaimed as today's most revolutionary advance in audio reproduction technology.

Then Pye TVT shows why its ranges of UHF television and VHF radio transmitters are gaining more and more of the world market, with their great efficiency, reliability and low cost of ownership.

Visit NAB and see for yourself the quality that comes through Philips experience in the broadcast industry. If you are unable to visit the show, or want immediate information, write or telephone today.



★★★★ LDK 6 AND NEW LDK 614 ★★★★★



★★★★ NEW COMPACT DISC PLAYER ★★★★★

at NAB
PHILIPS

For further information use the reader reply nos or send the coupon to:

PHILIPS TELEVISION SYSTEMS, INC.

900 Corporate Drive, PO Box 618, Mahwah, New Jersey 07430, USA
Tel: 210-529-1550 Telex: 37-62558
Canada Electro & Optical Systems Ltd., 31 Progress Court, Scarborough, Ontario, Canada M1G 3B5. Tel: (416) 439-9333. Telex: 065-25431.

Please send me further information on	Circle no.
• LDK 6 camera	150
• LDK 26 camera	151
• LDK 614 camera	152
• LDK 54 camera	153
• LDK 14 RGB camera	154
• LDH 6200 and 6220 color monitors	155
• UHF television transmitters	156
• VHF radio transmitters	157
• Compact Disc Player	158

Name _____
 Status _____
 Organization _____
 Address _____

THE BEST DIGITAL TBC IS NOW DYNAMICALLY BETTER!

FOR-A's Digital Time Base Corrector (FA-410) now offers Dynamic Tracking¹ compatibility for both the SONY Broadcast U-Matic¹ (BVU-820) and the PANASONIC VHS (NV-8950)² VTRs. All of the FA-410 features from extraordinary transparency in operation to good human engineering (not to mention price!) are now enhanced with the ability to fully utilize Dynamic Tracking modes for fast and slow motion and still frame. For broadcast, cable and editing, the FA-410 is dynamically better than ever.

This, in addition to FOR-A's Performance-Plus features like 8-bit component encoding for highest signal-to-noise ratio and lowest

distortion, a digital dropout compensator and full compatibility with 3/4" and 1/2" VTRs, makes the FA-410 the first choice of professionals.

Call or write today for your copy of the new FOR-A Digital TBC brochure which covers all performance and engineering specifications including details on the new Dynamic Tracking options.

Seeing is believing. Comparing is convincing. Arrange for a demonstration by your FOR-A representative or dealer by

calling your closest

FOR-A Sales Office. **FOR-A**®

FOR-A®
INNOVATIONS IN VIDEO



FOR-A CORPORATION OF AMERICA

East Coast: 49 Lexington St., Newton, MA 02165 (617) 244-3223
West Coast: 1680 N. Mine St., Los Angeles, CA 90028 (213) 467-8412

¹Dynamic Tracking and U-Matic are trade names of Sony Corporation.

²The Panasonic VHS NV-8950 is V-locked with modification by FOR-A Corporation. Contact FOR-A Sales Department for complete information.

ENG, EFP, and film production. Also new will be the WL742 wall-mount speaker station for the 700 Series cabled intercom, and the BH710W wireless interface belt pac for half-duplex communications. Established products will include System 85 and System 58 professional handheld wireless mic systems; 150E wireless intercom series; and 700 Series cabled intercoms.

See ad page 210

HOTRONIC 1331B

New products will be announced at the show. The company will also show its established TBC/frame synchronizer with optional freeze frame and freeze field capability, dropout compensator, and remote control.

monitor systems seen in prototype last year; an all-new high-definition electronic cinematography camera with lenses and accessories; the ML-83/79 microwave system for the HL-79E and HL-83 cameras; the Series 9 precision in-line gun high-resolution color monitor; the Series 9 delta-gun high-resolution color monitors; and the TKC-990 auto setup telecine camera system. Ikegami will also bring its established line, including the HL-79E ENG/EFP camera, HK-322 and HK-357A auto-setup camera systems, HK-302 studio camera, Series 8 and 9 color monitors, Series 3 monochrome monitors, VTN-110A video and pulse modular distribution amplifier, and TKC-970 telecine camera system.

See ad pages 87, 89, 91, 261



System 82 RF mic receiver from HME.

IBM CORP. 1607C

Will display its videotex techniques and System 38 computer with broadcast management hardware.

ICM VIDEO 1766

Will introduce the VC-2000P video corrector/proc amp/video enhancer/audio-video DA. The line of video processors, DAs, and commercial-grade satellite receivers and accessories will also be on display.

IKEGAMI ELECTRONICS 1011

Will introduce a series of new products, including the HL-95 camera system in ENG/EFP configurations and as an integrated recorder/camera with Lineplex and M-format VCRs; the ITC-730A ENG/EFP camera system; a production model of the high-definition studio/field camera and

IMAGE VIDEO 1341

New product introductions will include: a 16 x 16 high-density, broadband component video switcher; a 16 x 16 AFV switcher with built-in power supply; a small master control switcher with 10-input program and preset buses; a medium-sized master control switcher; a large master control switcher with 30 inputs per bus; a 10 x 1 passive routing switcher; and an under monitor display. Established products on display will include the VMP-1 voltage monitor, the M6010 10 x 1 self-contained routing switcher, and the 8105 border generator with downstream keyer.

INDUSTRIAL SCIENCES, INC. (ISI) 1232

Will exhibit a completely new line of terminal equipment, including video, audio, pulse delay, and subcarrier

DAs, all displayed in new rack frames with power supply. The 900 Series switchers will be displayed with two new options, the 9016 auto transition unit and an automated production effects system. Also on view will be the full ISI line of production switchers and master control switchers.

INFLIGHT SERVICES 1316

INFORMATION TRANSMISSION SYSTEMS 1734A

Four new transmitters will include the ITS-230 1 kW UHF, the ITS-235 5 kW UHF, the ITS-240 10 kW UHF, and the ITS-1610 10 W MDS/ITFS. Will also introduce the ITS-254 50 W UHF power amplifier, ITS-1657 50 W MDS/ITFS amplifier, and ITS-1658 100 W MDS/ITFS amplifier. Established products on view will be the ITS-1 television IF modulator, the ITS-20 UHF exciter/modulator, and the ITS-664 ITFS response transmitter.

INNOVATIVE TV EQUIPMENT (ITE) 1215

Will introduce the P1 pneumatic studio pedestal, the H100 fluid drag camera head, the T3 ENG tripod, and the D8 heavy-duty dolly. In addition, the full ITE line of television camera support equipment will be exhibited.

INTERACTIVE SYSTEMS CO. (ISC) 1167/1171

Promises some undisclosed new features on its Model 41 on-line videotape editing system, which includes a DEC 11/23 CPU, 64K memory, dual disk drives, eight control ports for VTRs and switchers, four accessory ports, and many more features.

INTERAND CORP. 1016

Will unveil the Discon 1000 videographic teleconferencing systems with FastScan. The system operates over ordinary phone lines, coupling freeze-frame video with interactive audio and computer-aided graphics capabilities. The booth will also feature the company's Telestrator systems, which allow TV commentators to instantly add explanatory electronic markings, annotations, and graphic symbols to live scenes.

INTERFACE ELECTRONICS 1405A

Will display the Model 550 and the Model 200B audio mixers.

ITELCO U.S.A. 1338

Will show its line of UHF transmitters and translators.

See ad page 279

JEFFERSON-PILOT DATA SYSTEMS 1629

New product introductions will include upgraded ENP (Electronic News Processing) for larger multiuser operations as well as smaller newsrooms; AutoSelect music scheduling system; and Breakout ratings analysis system. Will also feature its established System 2000 for sales/traffic and general accounting, and the Program Management System+ inventory and financial programs for feature films and syndicated properties.

JENSEN TOOLS 1747B

Will introduce new JTK-43 telephone system maintenance tool kit; plus power line monitors, noise and spike suppressors, telephone test equipment, relay service tools, circuit board carriers, shipping containers, and coax cable tools.

JVC CO. OF AMERICA 1234

Information on new products not available at press time. Established products on view will include the ProCam and KY series cameras; TapeHandler 3/4-inch and VHS videocassette recorders and players; editing controllers; video monitors; special effects generators; and video presentation systems.

See ad page 56

KAMAN SCIENCES/KBS 1607

Will bring new complete in-house



ICS efx package for Harris Iris II.

business systems for broadcast stations, utilizing the database facilities of the IBM System 38.

See ad page 163-164

KANGAROO VIDEO 1151 PRODUCTS

New this year will be the Super-Tough top-loading camera case for video cameras or recorder/cameras. Will also display its Video Pack carrying cases for broadcast and industrial VCRs, and Nagra Pack case for Nagra audio recorders; the Gripper+, a padded, heavy-duty shoulder strap; and the Semi-Tough aluminum-reinforced padded video camera case.

KAVCO 1509B

Will feature the Kavcart broadcast video cart system, which includes a separate recording console with cassette label printer, full monitoring, and Sony VO-5850 master recorder.

KAVOURAS 1635

New this year will be the Triton XL high-resolution weather graphics and

animation system; a high-resolution, real-time radar colorization system; and high-speed weather data transmission via Westar III. Established products on view will include the Radac color weather radar remoting equipment, real-time atmospheric monitoring (meteorological services and database), and the Triton X weather graphics system.

See ad page 43

KEYLITE PRODUCTION SERVICES 1220

Shown for the first time will be the new Stand-Sit camera dolly, which allows the operator to stand or sit while shooting. Other items featured at the booth will be Strand Century HMI lights, Lowel Light kits, Matthews studio grip equipment, and Rosco and Lee filters.

K&H PRODUCTS 1746

See PORTA-BRACE

KINGS ELECTRONICS 1623

Will enhance its standard line of RF, coaxial, and triaxial connectors with a new field service kit, including connectors and tools for crimping coaxial connectors onto coaxial cable. Will also show the line of video patch panels and patch cords.

KLIEGL BROS. 1604

Will feature its studio lighting equipment, including the Entertainer, Performer II/III, and Command Performance memory lighting control consoles, plus K96 SCR digital dimmers.

GEORGE KLEINKNECHT, INC. 1769

Will describe its services as an electri-



Kangaroo Video's new Super-Tough case for cameras.

MAKING GOOD?

...THAT'S TOO BAD!

If make-goods have become a fact of life at your station, it's probably time to talk to someone from Utah Scientific about automating your on-air operation.

Here are some important facts about our Station Automation Systems:

Built around the Utah Scientific MC-500 Series Master Control Switcher—the only switcher specifically designed for automation.

Distributed processing throughout—where hardware failures are an inconvenience, not a catastrophe.

Interfaces directly with your business service computer—no manual entry required.

Generates media pull lists, FCC log and business service reconciliation.

Bar code reader available for direct entry of machine names and media numbers. Also interfaces with TCR-100 bar code reader.

Machine control interface included.

Also automates off-line operations such as network and satellite delays and feeds.

Come to NAB Booth 1114 and let us show you how to make make-goods a fact of history, not of life.

US **UTAH SCIENTIFIC, INC.**
a DYNATECH company

1685 West 2200 South, Salt Lake City, Utah 84119
TOLL FREE (800) 453-8782 PHONE (801) 973-6840
TWX: 910-925-4037

Circle 186 on Reader Service Card

www.americanradiohistory.com

cal contractor, performing installations of transmitter, microwave, and broadcast studio equipment, as well as installations for its telephone subsidiary, GK Telecommunications. Will also show the ControlLite automatic room/area light controller.

KNOX VIDEO PRODUCTS 1511

Will introduce the K100 Chromafont character generator, offering multiple high-resolution fonts with proportional spacing and a palette with 250,000 colors. Other products on view will include the K128B high-resolution character generator, the K50/60 low-cost character generator, the K700 video corrector, the K500 audio enhancer, and the Color Box dual colorizer/keyer/edger.

KOBOLD OF AMERICA 1725

LAIRD TELEMEDIA 1721

Will introduce a dual-channel option for the Model 7200 Communicator, which will be displayed, along with multiplexer/film chain equipment for transfer of film and slides to video.

See ad page 45

LAKE SYSTEMS 1165

New this year will be the La-Kart Matrix 6M random access video cart system with 68K multievent programmer offering floppy disk storage, three dual-machine programmer interfaces, computer terminal, six M-format players, YIQ AFV matrix switching system, component TBC, Asaca color monitor, and Tektronix waveform monitor and vectorscope. Other featured products at the Lake booth will be the La-Kart Matrix 10 and the Integral Striping Station.

See ad page 112

LANDY ASSOCIATES 1747A

Will feature scale models of the Arben Design Lebenset set design modules, new for Landy. Also introducing the Interphase M-400 machine control system with RS-422 control of VTRs and telecine equipment. Other featured items will include the Ikegami HL-79EAL and other cameras; Interphase CB-1 slate and border generator and S-202 10 x 1 switcher; JVC KY-310 camera; and Anton/Bauer nicad batteries and accessories. In addition,

Landy will also be showing Sachtler camera mounting equipment, and Ramsa/Panasonic WR-8210 and WR-130 audio consoles.

LANG VIDEO SYSTEMS 1780

Will introduce the 60825 video recording measurement generator. Another new item from Lang this year will be the new 60821E source ID with memory recall. The Lang line of video and audio routing switchers will also be exhibited.

LARCAN COMMUNICATIONS 1626A

Will unveil the new TEC-IV TV exciter, using IF modulation with a SAW filter. Established products at the Larcán booth this year will include the TTC-30000FH 30 kW high channel VHF TV transmitter and the TTC-10000FH 10 kW high channel VHF TV transmitter.

LAUMIC 1771

Will show its portable, rental CMX Edge editing system, this year featuring a new read-only address-track modification.

AT&T CAN DRIVE YOUR PROGRAMMING HOME.

How can a distributor of sports and entertainment programs reach a national audience?

AT&T SKYNET* Satellite Services.

Case in point: Meadowlands Communications, Inc.

Meadowlands Communications, Inc. chose the expertise of AT&T Communications for the design and implementation of a system to handle their radio and TV distribution needs. Now, through use of AT&T Communications' earth stations, terrestrial transmission and satellite transponders, Meadowlands Communications, Inc. will beam audio and video to radio and TV stations and cable systems in major markets coast to coast.

Working closely with Meadowlands Communications, AT&T designed a system which allows them to select a particular satellite, or even a particular transponder on a satellite, for the most efficient transmission of their programming. AT&T Communications designed the system to include an array of options that provide high-quality audio for either monaural or stereo programming.

The system design provides the customer with maximum hands-on control of the earth station, with AT&T standing by to provide necessary services.

Expand your horizons about SKYNET Satellite Services and find out how they can expand your operations. See demonstrations of SKYNET Services at the National Association of Broadcasters Convention, April 29th-May 2nd. Meadowlands Communications, Booth #110 and AT&T Communications, Booth #407.

Or call your AT&T Communications Representative or 1 800 221-8294 or 1 800 221-7680.



LEADER INSTRUMENTS

1349

New this year will be the LBO-5860L half-rack waveform monitor with front-panel selection of lines 7 to 21, fields one and two. Also on display will be the LCG-400M and LCG-400S video pattern/sync generators; LVS05850B half-rack vectorscope; LBO-5860A half-rack waveform monitor; LBO-51MV low-cost vector display; LSG-216 AM/FM synthesized signal generator; LHC-909B/V video head checker; LBO-518 and LBO-525L dual TBCs; LFC-945B CATV level meter; LSW-115/LBO-115 audio sweep/marker generator; LAG-125 low distortion audio generator; LAV-192 audio tester; and LFM-39A wow and flutter meter.

See ad page 19

LEBLANC & DICK COMMUNICATIONS

1149

Will add a new FM antenna to its standard line of broadband FM and TV antennas. Will also show representative samples of filters and combiners.

LEITCH VIDEO

1021

Will introduce a new framestore synchronizer; the HDS 481 high-definition switcher; the CTG 240 combination calibration test generator; the DTG 1010, an updated version of the digital test signal generator; and the VPA 331 video processing amplifier. Will also show its full line of broadcast terminal equipment.

LEMO U.S.A.

1334

Will bring its line of miniature coaxial connectors for audio applications and large connectors for TV broadcast applications.

LENCO

1419

Will introduce a new PAL sync generator, as well as a PAL encoder and changeover unit, an NTSC sync generator, and a standalone decoder. Will also show its established line of sync generators, encoders, color and monochrome monitors, and other products.

See ad page 44

LEXICON

1139

Will introduce the 1200C RS-422 high-resolution audio time compressor, the 1300S stereo audio/video delay compensator, and the 200 stereo programmable digital reverberator. Other items featured will be the 95 digital audio effects processor, the 97 programmable digital audio effects processor, and the 224XL digital reverb/effects processor.

See ad pages 207, 213

LIPSNER-SMITH CO.

1626

Will introduce the Reelwind high-speed micro electronic film rewinder with dual-gauge 16 mm and 35 mm capability and 3000-foot capacity. Will also display the CF200 compact ultrasonic film cleaner and the CF190 low-cost film cleaner.



Frame-Up, Lobo, and Lobo Arm from Lowel.

LISTEC TELEVISION EQUIPMENT

1406

New products at the booth will be an electronic memory scriptwriter for newsroom prompters, with resident memory of up to 360 22-character lines (6000 lines with disk). Also the Vinten Model 200 Microswift digital remote control camera system. Also featured will be the full line of Vinten camera support equipment and on-camera prompters.

See ad page 174

LOGICA INC.

1405E

Will feature its teletext editing and transmission systems.

LOWEL-LIGHT MFG.

1309

Will display its full line of photographic lighting equipment for the motion picture, video, and stills industries.

LTM CORP.

1518

Will introduce several new products: the Cinepar 200, a 200 W HMI; Pepper Packs portable, professional lighting kits using Fresnels; a complete new line of studio incandescent Fresnel fixtures from 1000 W to 10 kW; the A230 six-channel sound mixer; and a 12 kW Luxarc focusing Fresnel HMI light. The company will also show its large selection of HMIs and its Pepper miniature quartz-halogen lights.

L-W INTERNATIONAL

1602

Will show new multimedia film/video telecine systems, 16 mm film digitizer, 16 mm telecine systems, and 16 mm motion picture analyzers.

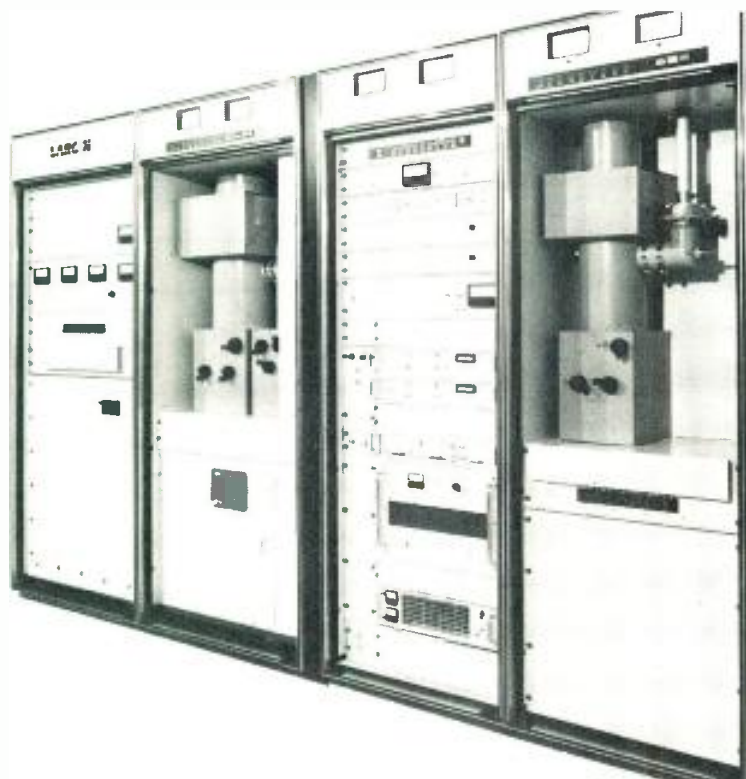

Larcan 30 kW VHF transmitter.

Nurad central ENG receivers single band and dual band.

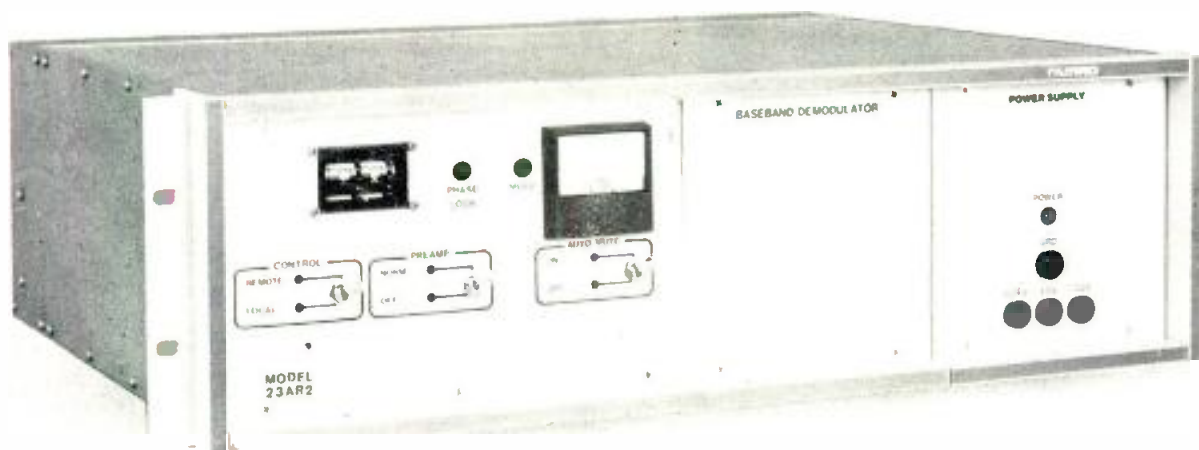

Nurad's AR2-Series of ENG/EJ central receivers complement the field-proven SUPERQUAD™ II, SILHOUETTE™, SUPERTRACK™, and QUAD receive antenna systems. Each receiver represents the state-of-the-art in microwave design with minimum

noise figures and maximum sensitivity. The remotely selectable 10/17 MHz IF SAW filter is an available option. This enables the operator to select the 10 MHz filter for maximum adjacent channel selectivity or the 17 MHz filter for dual audio subcarrier operation.

AR2-SERIES RECEIVERS

- Available for operations at 2, 2.5, 6.5, and 7 GHz
- Digitally synthesized for full frequency agility (primary channels and offsets)
- Narrow band SAW IF filters
- Built-in GaAS FET preamplifier
- Equipped with auto-mute
- Optional switchable IF filters

- Modular design for easy serviceability
- Remote control

DUAL BAND RECEIVERS

- Available for operation at 2 + 2.5 and 2 + 7 GHz
- Individual RF sections for each band including GaAS FET low noise amplifiers, mixers and local oscillators for redundancy

NURAD

2165 Druid Park Drive

Baltimore, MD 21211

Telephone (301)462-1700

TWX/Telex (710)235-1071

LYON LAMB 1632
VIDEO ANIMATION

Will add to its line of video animation controllers with the new VAS IV-Delta animation controller for the Sony BVH-2500 single-frame VTR and with the new VAS IV, which is a low-cost, rack-mounted version of the VAS IV.

3M, BROADCASTING 1002
& RELATED PRODUCTS
DIV.

Featuring two new character generators, D-1000 and D-5000+, both lower-end systems. Also will unveil brand-new digital art/paint system. Two new additions to the Series H Hybrid routing switcher line will be exhibited, along with a new 210 sync generator. From the Optical Recording Project, 3M will show custom mastering and replication of laser videodiscs from one- and 3/4-inch videotapes. Also in this project, EECO will show a converter that provides up to 150 hours of audio playback on a single laser videodisc, and Atari will show its latest use of interactive videodiscs.

3M, MAGNETIC 1002
A/V PRODUCTS DIV.

Highlighting the new 480 one-inch master broadcast videotape. Also featuring professional half-inch videocassettes and demonstrations of 250/226 audio mastering tapes. Plus Cinetrak + tape cycling and anti-static treatment of cassettes for improved performance.

See ad page 64

M/A-COM MVS 1004

Will be demonstrating its Skypod airborne ENG microwave system along with the 2, 7, and 12 GHz intercity microwave devices. The 23 GHz point-to-point microwave systems will also be displayed as will the Super Scan and Mini Scan auto track ENG central receive systems, and various types of portable ENG microwave.

MACROTEL INC. 1702

MAGNASYNC/ 1147
MOVIOLA

Will again show its Videola V-1000 film-to-tape transfer system.

MARCONI 1615
INSTRUMENTS

Will be introducing Model 6960 automatic RF power meter. Other products on display will be the Model S1100 audio transmission test set, Model 2305 AM/FM modulation meter, and the Model 2914A insertion signal analyzer which features measurements of pedestal and modulation depth. Will also demonstrate Model 2920 television interval timer.

MARK 1227
ELECTRONICS

Will bring its line of rack equipment.

MARSHALL 1331
ELECTRONICS

Will introduce new superflexible multiconductor cables for mics and cameras.

MATTHEWS STUDIO 1209
EQUIPMENT

Will introduce Cam-Remote, offering remote control of all functions of film or video cameras, including pan and tilt. Featuring the family of Tulip crane equipment as well as a full range of grip and support equipment.

The Quick-Draw



This case from **Porta-Brace™** is a new kind of camera case. It is the first completely practical case for professional video cameras.

THE QUICK-DRAW PROFESSIONAL

See Us at **NAB** Booth #1746



K and H Products, Ltd.
Box 246, North Bennington
Vermont 05257 (802) 442-9118

Introducing instant access optical disc recording.



The "DRAW" color system concept.

Presenting the Panasonic Optical Memory Disc Recorder (OMDR) series. The *only* optical disc systems available with Direct Read-After-Write (DRAW) capabilities in both full motion or frame-by-frame modes of operation.

The Panasonic OMDR series incorporates a host of important features. Two-channel audio. A standard remote control unit. The fastest access time (0.5 seconds) of any optical system available. And an RS-232 computer interface port. In addition, all of the Panasonic OMDR units utilize 8" video discs for both cost and storage space reductions.

But the real beauty of the Panasonic OMDR series lies in its simplicity of operation. Full motion or still frame images can be recorded from any video source. With four different models available in the new OMDR series, Panasonic provides you with the disc technology your applications demand. Training, computer simulation, graphics or still photography storage, in-house video production, medical image archives and interactive instruction are just a few of the possibilities. Applications are as unlimited as your imagination.

For more information on any of the three OMDR recorders and player, contact: Computer Products Division, Optical Disc Dept., Panasonic Industrial Company, Division of Matsushita Electric Corporation of America, One Panasonic Way, Secaucus, N.J. 07094; (201) 348-7000.



See us at NAB Booth #1019

Panasonic[®] Industrial Company

Circle 191 on Reader Service Card

MAXELL 1624

Will be showing its full line of audio and video tapes and cassettes.
See ad page 36-37

MCI, DIV. SONY CORP. 1200

See SONY PRO AUDIO

MCI/QUANTEL 1631

Will introduce the 1750 digital framestore synchronizer in a single rack unit, and the six-field DSC 4000 Series digital standards converter. Also showing the DPE 5000/SP small scale digital effects unit, the DPE 5000 and 5000+ effects systems, and the DLS 6010 and 6020 digital library system still stores. Other products on display include the DPB 7000 Paint Box, the Mirage 3D graphics system, and the Cypher ultra-high-quality character manipulator (in its production form this year).

See ad page 61

McMICHAEL, LTD. 1514

See GEC McMICHAEL

MERLIN ENGINEERING WORKS 1023

Will show its line of wideband VTRs, along with the extended-play conversion for Type C machines and modified BCN recorder for HDTV applications.

See ad page 150

MICRO COMMUNICATIONS, INC. 1014A

Will unveil the MDS/ITFS multi-channel combiners for multiple channel transmissions. Other introductions are a phase shifting combiner and a diplexer with detunable aural cavities, both for use with 'switchless' RF switching systems. The standard line of products on display will include high-power UHF systems; circular and rectangular waveguide transmission lines; MDS/ITFS, VHF, and UHF diplexers; and a full range of coaxial switches and microwave point-to-point antennas.

MICRODYNE CORP. 1612

Will be introducing the 1100 SDC synthesized SCPC downconverter for state, regional, and national radio networks. Also new will be the 1100 BDC/DCR-12 72 channel Ku-band video receiver/LNA and block downconverter system. Existing prod-

ucts on hand will be the 1214 TUL fully redundant Ku-band transportable video uplink in a self-contained 30 foot tractor trailer. Other products include a transportable SCPC radio uplink.

See ad page 227

MICRON AUDIO PRODUCTS 1122C

Will premiere the TX-203 hand-held wireless microphone transmitter with interchangeable mic heads, plus the MDR-3 mobile space diversity receiver and the MDS-2 modular multi-channel diversity receiver. Other products on display will be the CTR-101 mobile RF mic for ENG, and the CM-1 for mounting the MR-1 mobile receiver onto small recorder/cameras. Will also be showing the Mini-Max portable mic booms, and Tram miniature electret mics.

MINOLTA 1113

Showing the TD color analyzer II, Chroma meter II incident luminance meter, and additional luminance meters.

See ad page 154

MITOMO COMPANY 1509

Introducing three new models of random access disc changers for automated disc operations. Also introducing a portable audio mixer designed for ENG, a rapid battery charger for field use, and videocassette winder with eraser.

MITSUBISHI ELECTRIC 1600

See DIGITAL ENTERTAINMENT CORP.



Neve's 51 Series 24-channel, four-group audio board.

MICROTIME 1230

Introducing the S-230D TBC/frame synchronizer to add versatility to the E-120 A/B roll effects system. New effects will also be added to the T²E-120 digital effects unit and the S²E-120 single/dual channel TBC. Will have full line of TBC/frame synchronizers, TBCs, and digital effects systems along with the Video Image Processor 2100 and VTR machine controller, Digitrol 2.

See ad page 146-147

MIDWEST CORP. 1710

Long known as a video dealer and mid-size truck maker, will this year introduce two large scale 44 foot mobile teleproduction units built for Turner Broadcast and for TCS Productions.

See ad page 8-9

MINI-TD 1134**MODULATION ASSOCIATES 1737**

New items will include the Data-Sat satellite receiver for high-volume, reliable, low-cost reception of 56 kbs data over satellite links; the UC-10 uplink controller, a remote control and monitor system; and the SSTS-Sat, a frequency-agile video receiver that can select one of 24 satellite transponders. Also on view will be the R-Sat SCPC satellite receiver for state/regional satellite networks; the SU-10, a 10 W all solid state uplink; the MC-Sat multichannel SAT; and the AM-200 audio monitor.

MOLE-RICHARDSON 1006

Will be introducing a 12 kW HMI Fresnel solar spot, a 6 kW solar arc spot, and a 12 kW dc-only electronic dimmer. Other new products on

CHOOSE THE RIGHT SHAPED KLYSTRON FOR LOWER OPERATING COSTS.

Integral
Cavity Klystron

EEV
External Cavity
Klystron

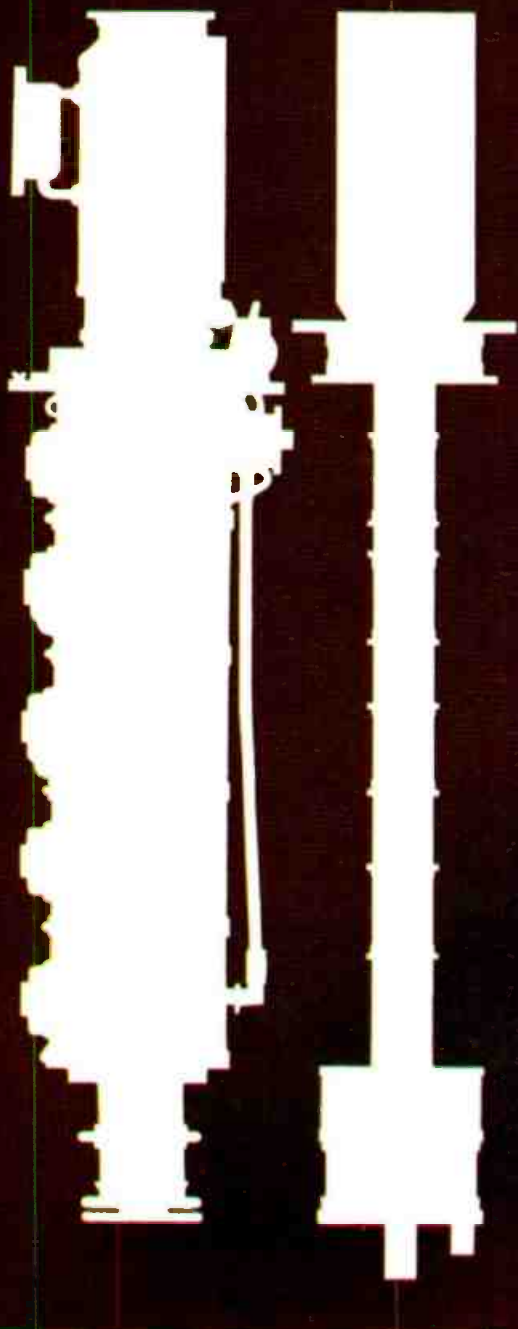

How are you shaping up on reducing your UHF transmitter operating costs? Not as well as you should be if you aren't yet using EEV external cavity klystrons.

The latest external cavity klystrons from EEV are achieving major savings for an increasing number of users.

With compatible drivers enabling efficiencies well above 40% compared to as low as 30% on some integral cavity installations, EEV klystrons are saving as much as 55 kW on beam power - and efficiencies above 60% are achievable with Beam Control Device (BCD) operation.



EEV was first to produce a high power (45-58 kW) wide band external cavity klystron to cover the whole UHF TV spectrum. What is more, instead of 6 different tubes, now only one is needed for either water or vapor cooled applications. This also applies to EEV's medium (30 kW) and low power (15 kW) klystrons - which all means a substantial saving in spares inventory!

All this adds up to a package which could pay for itself within three years and is easy to install.

Simple on-site tuning of these alumina ceramic external cavity klystrons allows greater efficiency than the pre-tuned integral types.

This is why we believe EEV external cavity klystrons are the shape of things to come.

If you'd like to know more, call us today.



EEV Inc, 7 Westchester Plaza, Elmsford, NY 10523, USA. Tel: 914 592 6050. Telex: 6818096.
EEV Canada Ltd, 67 Westmore Drive, Rexdale, Ontario M9V 3Y6. Tel: 416 745 9494. Telex: 06 989 363.
EEV, Waterhouse Lane, Chelmsford, Essex CM1 2QU, England. Tel: 0245 261777. Telex: 99103.

EEV Klystrons

See us at NAB-Booth #1335

Circle 192 on Reader Service Card

www.americanradiohistory.com

The new S-230D easily interfaces with new or existing Microtime T²E-120 A/B Roll Effects Systems to provide the ultimate in input signal flexibility and freeze effects capability.



The S-230D allows inputs such as in-house camera signals, external ENG, microwave, satellite, network and remote studio feeds, as well as 1/2" and 3/4" heterodyne VTR formats with or *without* capstan servos. You also have the choice of operating in either standalone heterodyne or 3.58 MHz sub-carrier feedback modes. And by using the S-230D on one or both channels of the E-120 A/B Roll Effects System, you get the additional "effect" of manual or automatic freeze.

Now there are three E-120 A/B Roll Effects configurations: T²E-120. This established configuration consists of two T-120D TBCs capable of

DYNAMIC TRACKING* operation with a SONY* BVU-820 U-MATIC* VTR.

TSE-120. This new configuration consists of:

- one T-120D TBC capable of DYNAMIC TRACKING* operation with a SONY* BVU-820 U-MATIC* VTR and
- one S-230D TBC/Synchronizer with freeze and auto mode switching.

S²E-120. This new configuration consists of two S-230D TBC/Synchronizers with freeze and auto mode switching for maximum flexibility in both channels.

*DYNAMIC TRACKING, SONY and U-MATIC are registered trademarks of Sony Corp.®

Flexibility is on a roll.

E-120 A/B Roll Effects System.

TBC/FRAME SY



Typical A/B Roll Applications with Effects

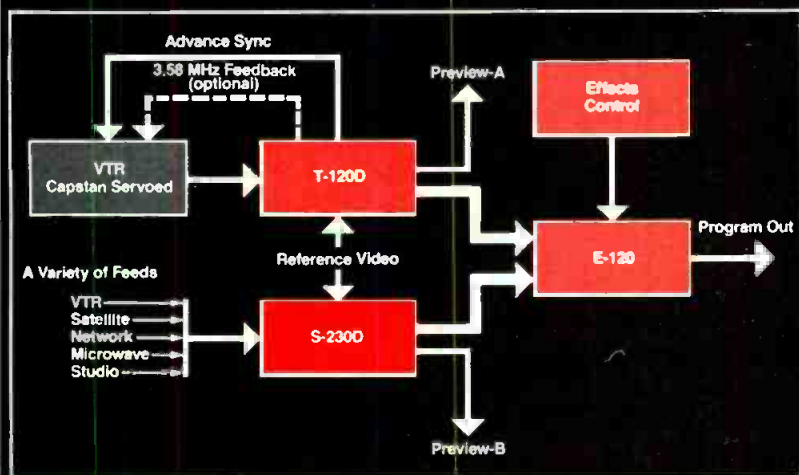

DT* operation is possible with the T-120D with a single cable interface to the SONY* BVU-820 U-MATIC* VTR.

from the systems for standalone operation.

Each E-120 System includes the E-120 A/B Roll Effects Processor and Effects Control with a 75' cable. Each features an 8 bit, 4x subcarrier design for high reliability and transparent performance and is controllable by VTR editor for preview and record. Each contains a RS-170A gen-lock sync generator to assure precise output timing. Each is made in the U.S.A., rigorously tested throughout the manufacturing process, and comes with a full one-year warranty on all parts and labor.

Microtime is on a roll. Contact us today. MICROTIME, INC., 1280 Blue Hills Ave., Bloomfield, CT 06002. (203) 242-4242. TWX 710-425-1165.

MICROTIME

A Subsidiary of ANDERSEN GROUP

See us at NAB Booth 1230

Circle 193 on Reader Service Card

RONIZER S-230D

na Phase

Setup

display will include a 12 kW ac electronic dimmer, and a new 200 W HMI par fixture.

MPCS 1121

Showing extensive lines of video and audio equipment for rental and sales.

MULTI-TRACK MAGNETICS 1712

Will show its high-speed magnetic film recorder/reproducers, designed to interface with solid state telecines and one-inch VTRs.

MYCRO-TEK 1752

Introducing Mycro-Vision MAX, a low-cost, high-resolution character generator. Also showing the Mycro-Vision Supra video editing system.

MZB & ASSOCIATES 1507A

Displaying video production trucks with various equipment configurations.

NADY SYSTEMS 1133

Will bring its line of wireless communications equipment, including RF microphones and wireless intercoms.

NAGRA MAGNETIC RECORDERS 1213

Showing the T-Audio portable studio recorder with detachable control console, designed for time code applications. Also exhibiting the full line of Nagra field recorders, including models 1S, E, 4.2, IV-S, and the SN. Will also show the Nagrafax facsimile meteorological chart receiver.
See ad page 170

NALPAK VIDEO SALES 1722

Will introduce Tripak and ATA high impact professional video equipment cases. Also the Tripod II case for holding tripods, and Accu-Chart test charts for broadcast applications. Other equipment on display will be cables for video and audio, and a small earpiece for communications.

NEC AMERICA 1415

Will be introducing the AS-18 audio synchronizer, the new FBN-9000 Series of FM transmitters, and the latest commercial message bank. The established line of equipment on display will offer the E-Flex DVE system including perspective and rotation ca-

pability. Also on hand will be the FP-3 CCD camera which provides 500-line resolution. Other new products demonstrated include the FS-18 frame synchronizer, the TVL-800-6F 7 GHz microwave unit, the DV-10 video multiplexer for combining two video signals on one bandwidth, and a variety of UHF and VHF TV transmitters.
See ad page 16-17

NET-COM INTERNATIONAL 1516

NETWORK PRODUCTION MUSIC 1138

Showing new sound effects library containing over 3000 stereo effects. Also offering a theme-oriented music library.

RUPERT NEVE, INC. 1410

Introducing the latest Necam console automation system, used with a multitrack post-production TV audio console. Will also demonstrate the latest developments in digital audio technology with a working exhibition of the transmission of multi-channel audio signals over fiberoptic cable, and A/D, D/A conversion equipment. From the existing line of consoles, the 51 Series of stereo production and post-production TV mixers will be shown, along with the 5116 (24, 36, or 48 inputs), the 5106, and the 5104.
See ad page 242

NEW YORK COMMUNICATIONS 1730A

Will describe its TV commercials and campaigns, created and produced for television stations.

N.O.V.A. CORP. 1331E

Showing the Block universal sapphire tape cleaning device for reducing oxide build-up and drop outs.

NOVA SYSTEMS 1345

Will introduce the Model 500 compact, low-cost digital TBC with 8-bit, 4 x fsc sampling; the unit features only 50 W power consumption in one rack unit.

NTI AMERICA 1014D

Will be unveiling the MEK-1000 multi-effects keyer which provides a glow around key signals. The DAS-2 digital audio store is also new, converting audio material to digital form and storing them on hard computer discs. The established line of products

on display will include the DSS-11, a digital still store providing 160 megabytes of storage for up to 1000 stills, with add-on capacity for up to 7000 stills.
See ad page 254

NURAD 1426

Introducing a new airborne ENG system with Loran control, along with 10 watt power amplifiers, 13 GHz portable transmitters and receivers, and 6.5 GHz transmission systems. A new series of linear parabolic antennas will also be displayed. Other products on display will be central receive systems with antennas, control units, and receivers. In addition, remote transmit systems and STL/ICR and ITFS antennas will be displayed.
See ad page 141

NYTONE ELECTRONICS 1135

Will show its line of 16 and 35 mm telecine projectors, as well as its optical multiplexers and telecine color correctors.

O'CONNOR ENGINEERING 1103

Will introduce the O'Connor 53 tripod dolly, in conjunction with its System 50 support equipment. Also new will be the Model 50 sideload platform, and the Model 51 column adapter. Exhibit will also feature O'Connor's full line of camera tripods, heads, and pedestals.

OKI ELECTRIC 1505

Will demonstrate its LT 1210 portable digital TV standards converter.
See ad page 262

OLESEN 1307

Showing turnkey studio packages with grid, lighting, curtains, and drapes, as well as separate lighting and dimming equipment.

OMICRON VIDEO 1748

Will introduce the EMX-7100 VTR editing systems with A/B roll capability for up to four machines. Also new is the 506 edit-master production switcher with interface to editing systems, and the Model 5500 VTR/ATR time code synchronizer. Other products on display will be the Model 200/210 video DA, the Model 240/250 audio DA, and the Model 410 sync generator.

J. OSAWA & CO. 1716

PALTEX**1005**

Will introduce its latest dual and single channel digital TBC/field stores with multiple inputs per channel, digital mixing and effects, picture processing, and enhancement. Also showing Edit-Star and Vanguard videotape editing systems formerly from Datatron.

See ad page 113

PANASONIC VIDEO**1019**

Will introduce the final production model of its MVP-100 multifunction video cart player. Also on view will be the ReCam recorder/camera system, including edit controllers and studio configurations, and the line of monitors, current model three-tube cameras, and other products.

See ad pages 28-29, 79, 143

PATCH BAY DESIGNATION CO.**1773**

Showing custom labeling for patch bays, control panels, and racks.

PEERLESS SALES**1618B**

Showing video accessory products including stands, carts, mounts, and brackets.

PEP, INC.**1408**

Will feature the Model OC1 On-Cam VTR and the playback unit, both for TC20 VHS cassettes. The full line of batteries, chargers, and other ENG accessories will also be shown.

PERROTT ENGINEERING LABS**1729**

Introducing Cellmate dishcharger for analyzing and rejuvenating batteries. Also introducing a universal multiple fast charger for a wide range of nicad battery packs. Other products on display will be power systems in clip-on or belt styles, single or multiple fast or overnight chargers, lighting systems, and camera/light Maxi power belt with built-in fast charger. Also showing computerized sequencer for multiple camera or light packs, and silver zinc BP 90 pack.

See ad page 167

PHILIPS TV SYSTEMS**1500A**

Will introduce to the U.S. market three new cameras. The LDK-614 is a portable companion to the recently introduced LDK-6. In the studio line, the LDK-26 is a new compact unit

with 2/3-inch tubes, computer control, triax, and LDK-6 family compatibility. Also new will be the LDK-54 as a display of the recorder/camera development with the quarter-inch Lineplex recorders. Other introductions will support the recorder/cameras with a range of playback and post-production equipment. The full range of color cameras will be on display including the new LDK-14-RGB lightweight production camera. The display will supplement the recent introduction of the 14-inch color monitor, the LDH 6200, with a 20-inch studio partner, the LDH 6220. Transmission equipment will involve the U.S. debut of the extended PYE TVT line of FM radio transmitters, ranging from 100 W to 20 kW, featuring common modular drive and comprehensive monitoring. The LDM 1208, a compact 55 kW transmitter will be displayed. The professional research lab will be demonstrating new developments in high definition television. The digital compact disc will also be demonstrated in its professional configuration. The Optical Disc will be shown in a presentation of the process of laser disc mastering techniques.

See ad page 132-133

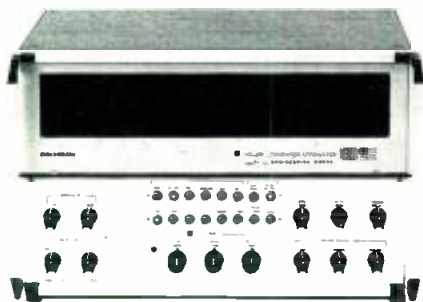
ME-288 PAL/NTSC Standards Converter**Remarkable Low-cost Digital Image Processor**

Unique in the field of digital video processing, the ME-288 combines TBC, noise reducer, color correction, synchronizer, field/frame store, H & V image enhancer plus PAL/NTSC standards conversion in one integrated unit.

ME-238 Kit for Type C VTRs**Record, Play & Dub Complete Sports Events & Full-length Movies . . . Non-stop!**

Extend record/play time to 3 hours on Ampex VPR-80, VPR-2, Marconi VTRs, Sony BVH 2000; 2 hrs, 40 mins on Sony BVH 1000/1100 recorders. Ideal for master playback when dubbing to small format machines or for automated programming.

MERLIN

Call Toll Free 800-227-1980 (Calif 415/856-0900 Collect)
MERLIN ENGINEERING WORKS
1880 Embarcadero Road, Palo Alto, CA 94303

**PHOEBUS 1331C
MANUFACTURING**

Adding to its Ultra family of followspot lighting, it will introduce the Ultra Arc Series II. Will also exhibit full range of lighting instruments and quartz followspots that are color temperature balanced.

**PICTURE 1517B/1772
ELEMENT LTD.**

Will demonstrate its VSP video sequence processor, a complete general-purpose, computer-based video processing system for TV production and post-production. It can record and play back up to eight minutes of digital video in real time and in virtually any video format, including NTSC, PAL, composite, YIQ, RGB, or HDTV.

**PIHER 1409A
ELECTRONICA SA**

Introducing the CG-4721 character generator, the ACQ-4700 RF automatic switching unit, and the new CT-4700 cable tester. Standard products on display will be the PM-4600 and -3600 broadcast color monitors, the HR3600 black-and-white moni-

tors, and the TR-4700 VHF/UHF LPTV translators.
See ad page 274

**PINZONE 1615A
COMMUNICATIONS**

Will debut the 8250/R fully remoteable all-format satellite receiver, and the RCD-100P computer diagnostic system for the RCA TCR-100 video cart machine. Display of established equipment includes the 8250 satellite receivers, Dexcel high gain LNAs, and 3.7 meter antenna system. Will also have exhibit in outside parking lot of its line of satellite receiving equipment.

**PORTABLE 1153
ENERGY PRODUCTS**

Will introduce the SLA 12120, a 12 V, 12.5 Ah battery pack that allows extended running time for cameras and recorders but with the portability of smaller packs. Will also show the line of sealed lead-acid battery packs and belts, the BP90R replacement battery, and the line of solar chargers for sealed acid and nicad batteries, all previously exhibited.

**PORTA-BRACE/
K&H PRODUCTS 1746**

Will feature new production cases with pockets, pouches, and center dividers for ENG-style shoots, plus its new Recam and Betacam camera cases. The line of grips, production carts, and video recorder cases will be shown.
See ad page 142

PORTA-PATTERN 1427

Will introduce a complete line of large size studio test charts; the BBC zone plate chart and transparency in 525 and 625 line versions; and advanced depth modulation chart and transparency. Showing full range of television test charts and telecine test slides.

PRECISION ECHO 1617

Will show its Budget Squeezer video compressor, along with its still store, effects and animation disc recorder, and PAL/SECAM video disc recorder.

**PRODUCTS 1125
INTERNATIONAL**

Will introduce new field portable electronic repair tool kit/work station.

Rx for SFX

At \$14,750, the totally new Chromafex 766 brings special effects within reach of every budget.

Posterize. Compress. Invert. Position. Slide. These microcomputer controlled special effects, and many more performed by the expensive image processors, can be yours in the Chromafex 766. That's right. Outstanding special effects. And for only \$14,750.

There's more. The 766 also includes time base correction and frame store capabilities with infinite window performance along with freeze frame and two full fields of memory. Drop out compensation will clean up the noisiest

of tapes. Perfect for remotes, it consumes only 85 watts of power.

Chroma Digital Systems has the engineering, manufacturing,



CDS

Chroma Digital Systems

marketing and service expertise, drawn from years of experience in the television equipment industry, to provide you with the support you need now and in the future.

And the Chromafex starts you with the most attractive SFX price/performance package anywhere.

If you have a problem with the high cost of SFX, we've got the solution. Chromafex 766. High priced effects. Affordably priced.

Chroma Digital Systems, 2065 Martin Avenue, Suite 104, Santa Clara, California 95050 (408) 986-8270

Also showing Pace desoldering equipment and PCB repair equipment and kits.

PHILIPS TEST & MEASUREMENT 1408A

Introducing two new color generators, Models PM5630 and PM5631. Also new is the PM5634 sync test generator, the PM5669 TV test modulator, and a range of TV modulators. Existing products on display include the PM5565 waveform monitor, the PM5567 vectorscope, the PM5580 IF modulator, and the PM5533 color signal generator. In addition, the PM5581/82 VHF/UHF converters and the PM3263X 100 MHz oscilloscope with TV triggering will be on hand.

See ad page 175

QSI SYSTEMS 1325

Will premiere the Phase III black burst generator for multiple camera systems. Showing existing line of color bar generators, some models with vertical interval identification and memory identification. Plus SID systems, 24-hour audio/video off-air loggers, demodulators, countdown generators, numerical video slates, and routing switcher input identifiers.

Q-TV 1401D

Introducing the VPS-500 ComputerPrompter system. Will also have the VideoPrompter cueing equipment and the Mini Q prompter system.

QUAD EIGHT/WESTREX 1636

Will introduce the Westar multitrack recording and post-production audio mixing console, an in-line design available in 20 to 52 inputs, field-expandable. It can be automated with an intelligent, microprocessor-controlled true digital fader coupled to a 10 Mbyte hard disk storage system. Will also show two of the 24B component series audio consoles, as well as the ST/6000 film recorder.

QUANTA CORP. 1432

Demonstrating the Q8 Quantafont font-loadable teleproduction graphic titling system with real-time easy edit/quick compose text handling. Also exhibiting the Quantanews newsroom computer system with distributed processing and individual intelligent work stations. The Select 7 graphics titler will also be on hand, offering seven resident fonts, real-time text handling and RS-232 I/O port.

The Microgen MG-100 titling system will be exhibited.

See ad page 158-159

QUANTE CORP. 1216A

Introducing digital fiberoptic transmission equipment for simultaneous transmission of component and composite video signals with multiple audio channels. Also exhibiting wideband digital video transmission equipment for video with subcarriers, in addition to 20 6 kHz digital program audio channels.

QUICKSCAN SYSTEMS 1405B

Exhibiting indexed electronic still frame system with demonstrations of unmodified Beta and VHS VCRs capable of reading Quickscan.

QUICK-SET 1105

Introducing modular tripods for studio and field, as well as a new series of fluid heads, remote controlled camera and microwave positioners, and microprocessor-based control and data

feedback for microwave. Other products on display will be the standard line of tripods, pedestals, dollies, fluid heads, and remote control positioners.

RANK CINTEL 1219

Will be introducing the ADS 1 multiplexed, solid state telecine for broadcasting directly from film. Also showing the MK IIIC telecine for high-quality film-to-tape transfers and the fully programmable Amigo software-based color corrector with soft key control panel and editing capability. Will also have FeRRIT separate magnetic sound follower for audio record/replay on film.

See ad page 168-169

RCA, BROADCAST SYSTEMS DIV. 1000

Major new product introduction will be the brand-new CCD camera under development for the past few years and offering lag-free, superb highlight handling in a Hawkeye-like body. Will be introducing the TKS-100 solid state telecine. Will also introduce the



RCA TKS-100 on-air telecine.

TOSHIBA Color TV Camera PK-41

Our PK-41 is a microprocessor-controlled fully automatic color camera with digital circuit reliability.

Controlled by a microprocessor with a non-volatile memory and over 100 controllable items, the fully automatic PK-41 can do practically everything for you. It also holds a data filing function for over 400 items.

The thinking PK-41 not only offers a fully automatic setup, it also displays the control and diagnostic data of the camera operating conditions on the picture monitor. Experience our incomparable 58dB high broadcast quality pictures.



**See Us
at NAB
Booth No. 1631A**

A name that communicates.

TOSHIBA

TOSHIBA CORPORATION

1-1, SHIBAURA 1-CHOME, MINATO-KU, TOKYO, 105, JAPAN
TELEX: J22587 TOSHIBA CABLE: TOSHIBA TOKYO

Circle 197 on Reader Service Card

TH-400 one-inch VTR as well as the TK-47C automatic studio camera with software advances. Other products on display will be the full line of VHF and UHF broadcast antennas, VHF and UHF transmitters, and the TKP-47 automatic portable camera. Will also show the Hawkeye II portable cameras, recorders, and accessories and the TCR-10 multicassette tape player and TK-290 telecine camera.
See ad page 62-63

RCA, NEW PRODUCTS DIV. (TUBE OPS.) **1000**
 Will be introducing to the display a

technology review of CCD imagers used in RCA's new broadcast systems cameras. Will also have the complete line of camera tubes including Saticon, Vistacon, and Telecine Vidicon tubes. In addition, the complete line of VHF cermolox power tubes and matching amplifier cavities will be displayed for power ranges from three to 55 kW. Other products on exhibit by RCA's New Products division will be a 1 kW UHF tube and cavity for LPTV and translator service, as well as FM power tubes and matching amplifier cavities with high efficiency for power ranges from five to 30 kW.
See ad page 5

R-COLUMBIA PRODUCTS **1111**

Introducing Ultra-light mono/stereo headphones, as well as the new Model 6058 hands-free telephone for IFB and ENG use. Will also display full line of headphones, wired and wireless intercoms with interface capability, and sportscasting tele-headphones.
See ad page 286

REAL WORLD TECHNOLOGIES **1520**

Introducing the uniMonster, a mono/stereo coherency evaluator available as a standalone unit or as a uniVUer option. Will show the uniVUer analog VU or PPM keyed over monitor video for production control rooms.

RECORTEC, INC. **1416**

Will introduce new videotape evaluators with three-hour reels, capable of handling both B and C formats. Will also display its established line of tape cleaners and evaluators and audio and videocassettes.

REES ASSOCIATES **1727**

Will show examples of broadcast facility projects involving the company's planning, design, engineering, and consulting services.
See ad page 236

RESEARCH TECHNOLOGY INTL. (RTI) **1626**

Will be introducing a new line of one-inch videotape products. Also showing the VT-3100 professional videotape evaluator/cleaner for U-Matic, Beta, and VHS. Other products on exhibit will be the TV-2000 film editing system and the CineScan tabletop film viewer/previewer.

RIVIERA BROADCAST LEASING **1784**

ROCKWELL INTERNATIONAL **1767**

Will be introducing a weather radar system with elimination of ground clutter and display of air turbulence. Also on hand will be the standard line of video transmission systems.

ROH CORP. **1634**

Will display its audio amplifiers and intercom systems.

ROHDE & SCHWARZ **1203**

Introducing several new test products including the UPSF2 video noise meter, LFM-2 group delay measuring set,

Minolta Broadcast Meters

Remarkable versatility combined with superb accuracy—
 Minolta meters conform to CIE Spectral Response Standard.

MINOLTA TV COLOR ANALYZER II

Used for monitor set-up in TV control rooms and for on-line quality control in the manufacture of TV sets.

- Analyzer mode for white balance
- Chroma mode for setting white standard
- Matrix system eliminates cross-over interference
- Four white-memory channels; four CRT memory channels

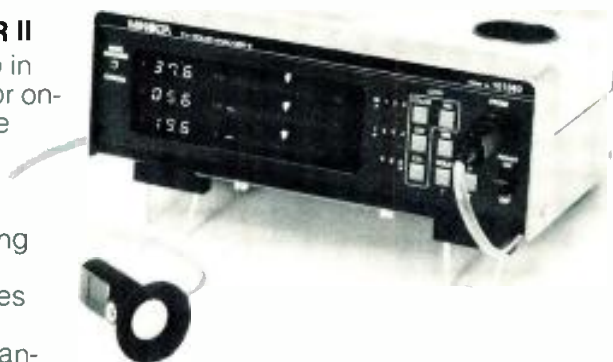

NEW CHROMA METER II INCIDENT



ILLUMINANCE METER



LUMINANCE METER 1°



MINOLTA HAND-HELD INDUSTRIAL METERS ARE:

- Lightweight and compact
- Battery powered for portability
- Rugged—ideal for field use



For more information write Minolta Corporation,
 Industrial Meter Div. 101 Williams Drive Ramsey, NJ 07446
 Or call 201-825-4000
 © 1983 Minolta Corp.
 Product appearance and/or specifications subject to change without notice.

Circle 198 on Reader Service Card

Centro does it all...

your best "turnkey" source for video editing, production and broadcast facilities...fixed or mobile.

A 35,000-square-foot plant... a staff of electronic engineers that know all the complex aspects of systems technology... a fully integrated architectural, design, construction and installation team... a demonstrated history of providing clients with telecommunications systems... and advancing the state of the art... that's what we're all about.

Centro "softens" the impact of high technology by designing and providing the comfort and special needs that make the difference for your operational staff.

We can deliver you a system that integrates today's highly sophisticated equipment into a productive and profitable telecommunications tool.

Call or write today:

Centro Corporation
9516 Chesapeake Drive
San Diego, California 92123
Telephone: (619) 560-1578
TWX: 910-335-1734 CENTRO SDG

 **Centro**

■ subsidiary of SKAGGS TELECOMMUNICATIONS SERVICE

See us at NAB Booth #1101

Circle 199 on Reader Service Card



MUF-2 TV transcope, and the EKF2K TV monitoring receiver. Also new will be the SMS signal generator, ESVP test receiver, and the UR050 transposer/receiver. The existing product display will consist of a range of TV modulators and demodulators, signal generators, distortion analyzers, and

duction switchers. Also showing the RVS 524 and the RVS 508 video switchers, available with a range of inputs and features.

R*SCAN 1740

Unveiling LPATS (its lightning position and tracking system), with

full line of zoom lenses, extenders, and attachments for all camera configurations.

See ad page 48

SCIENTIFIC-ATLANTA 1017

Introducing the Model 7555 Ku-band video exciter; the Model 8252 transportable TV earth station; and the new 7622 RF matrix switch. Also showing the 8251 11-meter transportable earth station. Other products on display will include the Model 7500 video receiver, 7620 receiver protection switch, 7630A LNA protection switch, uplink protection, remote control and antenna control, and a seven-meter antenna.

See ad pages 183, 157

SENNHEISER 1137

Will unveil a complete line of wireless microphones, including body packs and handheld systems, as well as a new ultra-light headset/boom combination for post-production, announcing, and sports. Also a new version of the MKE-2 lavalier microphone. The complete line of professional microphones and headphones will also be on display.

See ad page 247

SESCOM 1616

Will add to its line the new SAT-1 audio leveling unit for satellite receivers; the MLD-5 individual microphone-to-line amplifier in a rack-mount unit; and the TST-1 mic or line field tester for audio lines. The regular line of audio transformers, modules, direct boxes, splitters, and DAs, in addition to a newsbridge and intercom system, will also be on hand.

SHARP ELECTRONICS 1102

Will introduce the XM-1300 high resolution 13-inch rack-mount color monitor. Also new will be the XC-803TX triax control system for the XC-900D and XC-800 color cameras, allowing operation up to one mile from the base station. Other products on display will include the XC-900D camera with Plumbicon tubes, the XC-800 with Saticon II tubes, and a complete line of accessories and optional equipment.

SHINTRON 1417

Showing two production switchers featuring EMPRESS (Events Memory Programmable Effects Switching System) effects automation controlled

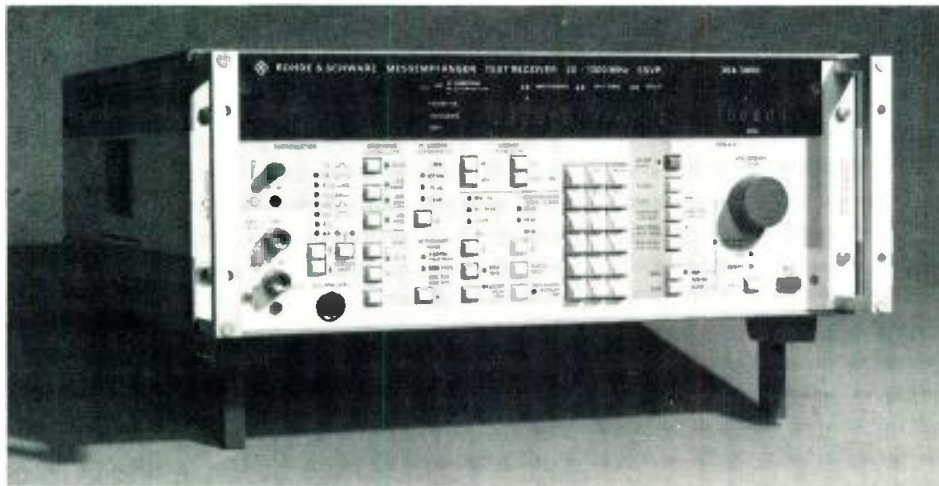

Rohde & Schwarz ESVP test receiver.

TV data distortion meters. The SKF VITS insertion generator and the SWOB 5 polyscope will also be on hand.

See ad page 124

ROSCO LABS 1235

Will introduce a new range of precise chroma key and Ultimatte paints. Also showing color and diffusion filters for light, patterns, and specialized TV paints and scenic materials.

ROSCOR CORP. 1181

Introducing a full line of TV remote vehicles for production and news, ranging from the Minivan to 45-foot trailers. Also introducing a complete line of station automation systems in addition to engineering design services.

See ad page 290

ROSS AMERICAN LOGIC 1332

Will feature its alphanumeric, light-bulb-array readout system for game shows, elections, and telethons, along with its computerized control light wall for theater backdrops and light shows and its custom system design services.

ROSS VIDEO 1110

Will introduce the Encore Memory system with serial interface to computerized videotape editors, available either as a standalone system or as an option to most Ross 500 Series pro-

standalone color animated displays or interfaces with a station's weather computer. Also introducing the NVG video facsimile animator for satellite image animation and the new Lang VideoSlide 35 for producing slides from 35 mm film.

RTNDA 1501

RTS SYSTEMS 1142

Will premiere the new System 2500 high-performance plug-in amplifiers for its communications systems, and the new Series 17 intercom, a low-cost conference line system for single-channel portable and permanent applications. Also new will be the display of Plantronics/RTS line of three ultra-light communications headsets. Will also show the TW intercom conference line systems, Series 800 intercom, microprocessor-assisted master station, and Series 4000 IFB.

See ad page 195

SACHTLER 1648

Introducing the Video 14 system, a lightweight fluid head pedestal for sophisticated single-tube cameras. Also showing the Panorama news-gatherer and several other fluid head tripods and pedestals for all broadcast camera applications.

SCHNEIDER CORP. 1403

Showing an improved version of the 15X zoom lens with built-in diascope and range extender. Also showing the

TIME BASE CORRECTION RE-DEFINED

Introducing the first totally different approach to time base correction in 10 years.

Until now, the TBC has only been as good as its weakest link - the analog circuitry. So we have eliminated the input clock and introduced the industry's first totally digital sync separator in a TBC.

The DPS-103 single clock TBC uses component processing and an advanced interpolation technique to breakthrough to "picture perfect" video.

Designed to work with 3/4" heterodyne VTR's, the DPS-103 is the long-awaited solution to conventional time base correction. Only \$8950.

Features:

- Maintains lock through 40 times normal speed in forward and reverse
- Maintains color through 10 times play
- Velocity compensation
- 16 line window
- Auto color framing
- RS 170A output
- Internal test generator

DIGITAL DPS-103 COMPONENT TBC



Contact your local dealer to see "picture perfect" video - with the DPS-103 Component TBC. Or call Digital Video Systems. (416) 499-4826 Digital Video Systems a subsidiary of Scientific-Atlanta.

CREATE WITH Q8

from the keyboard:

- roll it** - instant readout for roll timing - "elastic" roll pages - insert/delete with auto ripple
- shade it** - 4-quadrant shadow or fine and bold border edging - any color
- crawl it** - continuous compose with horizontal scroll - instant insert/delete with no retyping
- fade it** - built-in downstream fade in and out at selectable rates
- key it** - keyboard selectable upstream/downstream operation
- change it** - no retyping to redefine font characteristics - tuck characters horizontally - tuck rows vertically
- call it** - rapid sequence recall - any list of pages - page selectable dwell time
- stamp it** - rapid duplication of any row - "cut and paste"
- step it** - assign a series of keystrokes to a single key for effects and animation
- store it** - dual 8" floppy double-density discs - up to 400 pages per disc
- underscore it** - emphasize with variable weight and underline
- color it** - 16 million interactively mixed colors - background, edge, characters
- size it** - instant keyboard sizing from 16 to 64 scanlines - instant condense/extend
- italicize it** - instant italics left and right

**The QUANTAFONT® Q8 Face-Loadable
Teleproduction Graphic Titling System ...
26 nsec. Base Resolution ... priced from
\$32,500.00.**

a decade of commitment



QUANTA®

QUANTA CORPORATION, 2440 SOUTH PROGRESS DRIVE, SALT LAKE CITY, UTAH 84119

Circle 201 on Reader Service Card

Every Monitor Can Be a Vectorscope

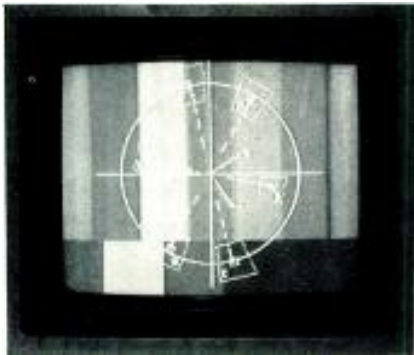

The DGV-1100 Vectorscope uses digital techniques to create NTSC compatible vector displays. It features:

- A Store/Compare Mode for easy source phasing
- Full intensity VITS monitoring
- An output which can be routed where needed
- An easily visible display for viewing at a distance without parallax



For more information call
Mark Wronski
AMTEL Systems Inc.
617-938-8551

Product manufactured by Ellis & Stowell
Waltham, Ma.

or see us at NAB Booth 1745

Circle 202 on Reader Service Card

Hypercardioid Lavalier Microphone with Vibration Isolation

For TV news, remotes, lectures, documentaries, and live productions, there has never been anything like the Isomax TVH from Countryman.

Its superior side rejection allows it to go where no lavalier has gone before. For live stage and television productions, the TVH offers at least 6 dB more gain before feedback compared to other lavaliers. For news work, it brings in usable audio from even the noisiest remotes.



The Isomax TVH is the only hypercardioid lavalier microphone available today. And the TVH has something no other lavalier has: Vibration Isolation. Normally, directional microphones are 20 or 30 dB more sensitive to handling noise. Not the hypercardioid TVH. With its exclusive electronic vibration isolation it's even quieter than an omni!

Call or write for a free brochure or to arrange a demonstration.



COUNTRYMAN ASSOCIATES INC.

417 Stanford Avenue, Redwood City, California 94063 • (415) 364-9988

Circle 203 on Reader Service Card

through the switcher/editor interface. The new switchers include the 374X, with double reentry and eight inputs under Z80 microprocessor control. Also showing its new analog component switcher and matrix converters, as well as a personal computer adapted for use as an NTSC framestore. The 390 switcher will be on hand, as will the 200 Series of DAs.

See ad page 80

SHOOK **1310** ELECTRONIC ENTERPRISES

Introducing a mobile TV production system, Model 14-22/E, featuring equipment from Magnetic Media. Also showing network production trailer Model 45-60, owned by John Crowe, and a facility-owned TV system (Craddock Surls).

SHURE BROS. **1401A**

Introduced at the NAB will be the FP31 mini field mixer, in addition to the new SM 83 lavalier microphone. The Automatic Microphone System will be set up in a display with video cameras. Also on hand will be the standard line of microphones, mixers, and microphone accessories and options.

See ad page 74

SIGMA **1333** ELECTRONICS

Will unveil the Model GLC-1000, which provides genlocking between a personal computer and other video signals. Also introducing Model VPA-380 video proc amp with built-in sync generator. Will also show the complete line of RS-170A color sync generators and distribution equipment.

See ad page 236

SKOTEL **1126**

Featuring a full complement of time code generators, readers, and character inserters, and RS-232 intelligent interfaces for use with VITC. Will show Skotel PLUS, with an integral LTC reader for jam/slave purposes. Also showing the DM-1000 digital metronome and the PTC-100 portable time code generator/reader.

SMPTE **1632**

WARREN **1717** R. SMITH CO.

Will show its snorkel and telecine lenses, animation stands, servo slide positioners, and title positioners.

**SOLID STATE
LOGIC**

1723

Will introduce a programmable equalizer with three bands of continuously variable controls. Also introducing a master synchronizer/controller, permitting up to five machines to be controlled from the SSL keyboard and with a master transport selector that automatically switches time code, tach pulse, direction sense, transport controls, and tallies. These new products are accessories for the existing audio console, the SL 6000 E stereo video system for post-production and live broadcast, incorporating both an in-board computer and an events controller.

See ad page 240-241

H.A. SOLUTEC

1517

**SONY, PRO
AUDIO DIV.**

1200

Will introduce SOAR, a VHF wireless mic system with 48-channel frequency synthesis; system choices include hand-held or lavalier mics and diversity and nondiversity receivers, power supplies, and antenna dividers. The Synmaster (AVS/AVP-500), a SMPTE/EBU synchronizer that allows sync of multiple audio, video, film, and special effects units will also be unveiled. A center track time code recorder/reproducer will be announced, the MCI JH-110C-3-TC. Also from the MCI line, Sony will introduce the JH 8000 option 23 video editor interface for video editor control of the audio console. Other products on display will be the professional modular CD player and controller, and a audio/video post-production system designed according to the DASH standard.

SONY **1200**
BROADCAST PRODUCTS

Will premiere the Beta multicassette player, a replacement for quad cart decks featuring four stacks of 10 cassettes each, with multisegment cassettes automatically identified and cued by the system. Also introducing the BVP-360, a high-end field camera that can also double for studio use. Also on display will be the 1125-line HDTV system including production and playback equipment. Also featuring the complete half-inch Betacam recorder/camera system with one- and three-tube cameras, field playback units, and recorder/editors.

See ad pages 2-3, 50-54, 120-121

Now, a weather graphics and production system that does it all!



PMT-100

The most powerful standalone weather system for the money

- Hi-res Graphics, Animation, Font-Generation,
- Local Color Radar and Doppler Displays,
- Dial-up or Broadcast Acquisition* of . . .

SATELLITE VIEWS — updated hourly from GOES East and West. None more accurate, more flexible, more dependable.

CONVENTIONAL WEATHER DATA — updated hourly from surface observations. None more complete, more useful, more informative.

Compare Performance . . . Price There's nothing near the PMT-100

The cost of the basic PMT-100 system plus two full years of UNLIMITED DATA SERVICE from ESD . . . is less than the cost of the hardware alone from our nearest competitor.



See the difference
NAB Booth #1509A

Stop by. Or call us to see how the leader in broadcast weather can help you broadcast the leading weather.

ENVIRONMENTAL SATELLITE DATA, INC.

In the U.S. —

Call Ken Geremia

Terry McClain or

Terry Hambrick

(301) 423-8247

World Weather Building, 1st Floor
Suitland, Maryland 20746

In Canada —

Call Lorne Kenney

(705) 743-1804

884 Terrace Road

Peterborough, Ontario
K9J 1J5

*Via Zephyr Weather Transmission Service

SOPER SOUND 1620B

Will introduce three new contemporary sound music programming series totaling seven albums. Also showing MusicSelector software for Apple II personal computers for locating, sorting, and selecting music from the sound library.

SOUND IDEAS 1620C

Exhibiting a complete sound effects library.

SOUNDOLIER 1704

Will come to its first NAB show with its line of metal equipment cabinet racks, including the 1044 Series sloped-front cabinets, the 2000 Series vertical racks, and the 700 Series cabinets and accessories.

STAGE LIGHTING 1128

Showing new digital dimming systems ranging from 1200 to 6000 W, and new lighting control systems. Also new will be the Autocolor computerized automatic color changer for studio fixtures. A full complement of stage and studio lighting fixtures will also be shown.

STAINLESS, INC. 1315

Introducing Verda, a distributed lighting deterrent. Also showing the complete line of AM, FM, and TV towers.

STANTRON 1123

Featuring a full range of metal consoles, cabinets, and racks for video production, post-production, and dubbing operations.

STEENBECK 1424**STEPHENS ELECTRONICS 1318B**

Will bring its line of portable and studio audio tape recorders, audio editing equipment, and SMPTE time code synchronizers.

STOREEL 1008

Exhibiting instant-access modular transit and storage systems for videotape, cassettes, or film. The company will also show its setup trucks for transporting tape or film, as well as high-density audio cart storage for FM and AM use.

See ad page 223

STRAND CENTURY 1418

Introducing a new solid state ballast for HMI lighting. Also introducing an HMI Par fixture that is field-



Production console from Stantron.

interchangeable from 575 to 1200 W. Will show selections from Strand/laniro line of TV and film lighting equipment, including Fresnels, cycs, portable lighting kits, and the TV Light Palette.

SWINTEK 1503

Highlighting the 200-D Series full duplex communication system with rechargeable battery pack, plus the complete line of RF microphones and accessories. Also on display will be a multi-rack system for mounting six transmitters and receivers in news and communications applications.

See ad page 238

SWR 1644

Will show its range of high-power rigid coax line in all sizes with super flange, switchers, and coax components.

SYLVANIA/GTE 1401B

See GTE

SYM-TEC, INC. 1522**SYSTEM ASSOCIATES 1331E**

Discussing its used broadcast equipment brokerage service.

TAMRON 1640

Exhibiting video camera lenses for all broadcast applications.

TASCAM 1304

Will unveil a half-track broadcast recorder/reproducer prototype and a new 20x8 production mixing console. Also bringing its full line of SMPTE time code compatible recorder/reproducers including Models 42 and 52 (half-track), 44 (four-track), 48 and 58 (eight-track), and the 85-16B (16-track). Mixing consoles on hand will include the M-50 20x8 and the M-16 24x8.

TEATRONICS 1786

Will feature its line of studio and stage lighting equipment, including lighting control boards and dimmer packs.

TEKTRONIX 1601

Showing the new 1750 Series combination waveform monitor/vectorscope, which also incorporates a unique display for SCH phase measurement and alignment. Also the new 494 spectrum analyzer for 10 kHz to 325 GHz measurements, featuring a "Help" mode. Also new will be the 118-AS digital audio synchronizer, a companion to the 110-S digital video frame-store, that provides automatic audio delay when video signals are fed through the digital processor. Existing products on display will be the 1740 Series of waveform/vector monitors with optional battery pack; the 1980 Answer Option 04 automatic, microprocessor-controlled video monitoring system; and the 690SR color picture monitor. In addition, other products on exhibit will include the 2445 portable oscilloscope with TV option, the AA501 audio analyzer with supporting equipment, and the 380 test monitor, a combination waveform monitor/vectorscope/oscilloscope.

See ad pages 103, 104-105, 106-107

TELE-CINE CORP. 1403

See SCHNEIDER

TELEMET, DIV. GEOTEL 1202

Will introduce the 7934 routing switcher with updated computer control. Also showing a setup with a working fiberoptic STL and phone equalizer. Other products on display will be transmitter test equipment, demodulators and demod testers, synchronous testers, and an envelope delay test set.

Circle 205 on Reader Service Card ►

HERE'S WHY THE KAMAN BROADCAST MANAGEMENT SYSTEM IS THE CHOICE OF THE INDUSTRY.



The KAMAN Broadcast Systems are designed to be the most comprehensive and advanced in the industry. They are truly state of the art.

The Kaman Broadcast Systems are a "Station Operations" solution designed for today and the future. The interactive data base ties together all the various departments within your station. Information can be put in the systems anywhere . . . is immediately part of the systems everywhere. Speed is one of its greatest attributes!

The Kaman Broadcast Systems are totally "in-house," and are available at all times, unlike other systems which have operating hours and days. Timely, deci-

sion-producing information is now available at your fingertips anytime. Your sales staff can log spots immediately when a buy is made and avails will be updated. Information ripples through the entire system: to traffic, billing, and even production. The Kaman Systems are designed for your station's future needs: to produce information, data, and reports in an ever-changing industry.



1500 Garden of the Gods Rd • Tel: 303/599-1500 • Telex 452412
Mailing Address: P.O. Box 7463 • Colorado Springs, CO 80933-7463

The Kaman Broadcast Systems are designed exclusively for the IBM System/38 which can provide uninterrupted, multiterminal access for your entire station. The System/38 has outstanding capacity for data and is backed by IBM's reputation for superior service.

The Broadcast Management System reflects Kaman's in-depth broadcasting background . . . a background unique among broadcast computing companies. Kaman has a strong commitment to the broadcasting industry and it shows through a solid reputation for service and reliability of its products.

At Kaman, today's quality is tomorrow's reputation.

KAMAN BROADCAST SYSTEMS

A TOTAL SOLUTION FROM A SINGLE SOURCE

REPORTS TO INCREASE PRODUCTIVITY

AVAILS:

- Multiple formats
- 365 days
- Budgets
- Average pricing
- Constant updating



PROJECTIONS:

- 9 different calendars
- By salesperson, agency or advertiser
- Budgets
- History
- Pace

LOGS:

- Complete pre-logs, engineers logs, final logs

CONTRACT/CONFIRMATIONS

PSA/PROMO LISTS AND AFFIDAVITS

DAILY LOG VALVE

FCC LOG ANALYSIS

COMPLETE PREEMPT/MAKEGOOD HANDLING

TAPE CARTRIDGES:

- Automatic allocation
- Inventory control
- Dub lists
- Cartridge labels

BILLING:

- Invoices – airtime/production
- Statements
- Accounts receivable
- Cash receipts
- Co-op reports
- Salesperson journal
- Rep report
- Revenue analysis by:
 - Time, Show, Salesperson,
 - Agency, Advertiser, Product,
 - All with history

Standard reports are formatted but may be changed, and other reports can be tailored by the user through the use of the IBM System/38 "Query" function.

FLEXIBILITY

The Broadcast Management System is completely interactive and geared to maximize sales. As a contract is being input, it immediately checks the avails

and places every spot according to the station's priorities; i.e., highest rate, client preference, length of unit, national or local, rate section, personal preference, length of contract. The priorities are set by the station to their sales philosophy. Each time a spot is ordered, the spot is placed according to these steps and according to space availabilities on the log or avails. If space is not available but can be acquired by moving or juggling spots, the system will maximize the area by the station's logging priorities. The system logs and avails spots automatically in horizontal and vertical rotations following sports programs, specials, etc.

THE IBM SYSTEM/38

The IBM System/38 is engineered to grow as your station work load and business requirements change and grow. It is a system that can adapt easily to the addition of a work station in one of your satellite offices or the addition of a new disk file ... all without major programming changes. The System/38 has integrated many large system features into a single system design ... at an affordable price.

For various station departments, it can provide accurate, timely information where it is needed, when it is needed, and in the desired form, without support from data processing personnel.

The IBM System/38 lends itself to networking with other IBM Systems and multistation operation from a single site. Our programs incorporate the ability for corporate reporting and electronic mail.



1500 Garden of the Gods Rd • Tel 303 599-1500 • Telex 452412
Mailing Address P O Box 7463 • Colorado Springs, CO 80933 7463

Let us show you more about how the Kaman Broadcast Systems can provide you with present and long-term solutions to your problems now. Developing software for broadcasters is our business. Call us at 303-599-1470.

Security is also built into its operation ... users enter their assigned password, and the system determines the information they can use. Your employee files, for example, can be restricted to a select few.

OTHER KAMAN BROADCASTING PRODUCTS

Autoswitching Interface System: passes the log directly to engineering and retrieves following airing for automatic billing.

Accounting: includes capabilities for General Ledger, Payroll, Fixed Assets and Accounts Payables.

Film System: inventories feature and syndicated films. Amortizes as you prefer. Includes payables to vendors. The system is unique in that it is designed to forecast for your station ... what you have

contracted for the future, costs versus cash flow so you know what you can afford to bid. This system is scheduled for release in late 1984.

Interface your Broadcast Management System with your National Reps. Your Reps will be able to have access to whatever you want them to have (and no more) to help them close sales on your hot avails. Currently under research and design.

All new Kaman Systems software modules can be interfaced with all other Kaman Broadcast Systems software, even if added at a later date.

THE KAMAN DIFFERENCE

We pride ourselves on the fact that our training, installation and customer services people are broadcasters. Our systems are designed from the user point of view and in broadcast language. All Systems are easy to learn, operate, and bring up. Our program consists of station personnel being in Colorado Springs for advanced training, and our installation team being at the station for instruction and live conversion. We have Customer Service personnel available thereafter.

At Kaman, today's quality is tomorrow's reputation.

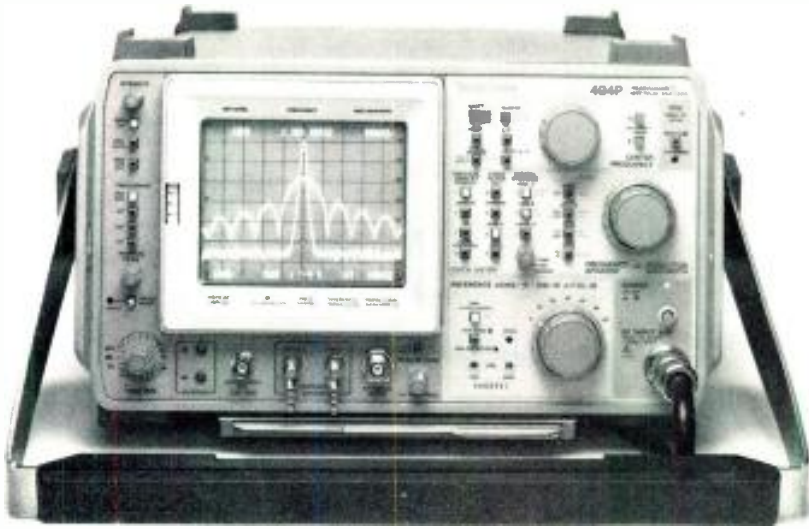

The 494P programmable spectrum analyzer from Tektronix.

TELESCRIPT 1407

Introducing Digis, a prototype digital prompting system using currently available personal computers. Also showing MPS-100 monitor prompting system with 1000-line resolution, in addition to 15- and 17-inch monitor/promoters, with the Telecue or Telecriptor transport.

TELESOURCE COMMUNICATIONS 1607B

Exhibiting an in-station election package based on the Motorola 68000 microprocessor for automatic vote tabulation and storage. Will also show Series 2000 newsroom computers featuring wire capture, producer rundown, scripts, and assignment.

TELEVISION ENGINEERING CORP. 1700

Will show a new design in remote vehicles, and a complete broadcast system installed in a production vehicle.

TELEVISION EQUIPMENT ASSOCIATES 1216

Representing a new line of equipment from Racal, including an emergency field telephone using any two-wire system, and a new range of headsets for airborne traffic reporters. Will also show Matthey delay lines, comprised of the Series 175 dual in-line packaging for rack mounting and the Series 350, which mount vertically and hold 16 PCBs.

TELEX COMMUNICATIONS 1605A

Featuring the full range of wireless microphone systems, microphones, closed circuit intercom systems, head-

sets, open-reel and NAB cart recorders and loggers, high speed duplicators, and the Singer 16 mm and filmstrip projectors. Also showing 35 mm slide projectors including front and rear screen combinations with built in audio cassette player/recorder and dissolve controls.

See ad pages 47, 193

TENNAPLEX SYSTEMS 1127

Will introduce broad signature dipole panels for triangular masts, in addition to its line of hybrid combiner modules.

TENTEL 1613

Unveiling the HPG-1 universal head protrusion and video drum eccentricity gauge. Plus the new T2-H18-CBD Tentelometer tape tension gauge for VTRs and audio recorders. Will also show the TSH spindle height gauges for VTRs.

THEATRE SERVICE & SUPPLY 1513

Exhibiting cyc curtains and track sys-

tems, lighting support grid and track systems, scenic and set supplies, and studio and location lighting equipment.

THEATRE VISIONS 1318

Will show curtain tracks and grids, lighting systems, power distribution for field lighting situations, and complete production setups.

THERMODYNE INTERNATIONAL 1637

Will feature its line of equipment transportation cases.

THOMSON-CSF BROADCAST 1001

Will debut the TTV 1525C color studio camera, in addition to the new TTV-1623 three-tube Betacam line. Unveiling a new series of products for video post-production, the TTV-4400 automatic contrast corrector, the TTV-5305 image processor for special effects, and the TTV-8400 computer-aided test instrumentation. Other new products will include a 2 kW VHF transmitter, 2.5 and 1 kW FM transmitters, and a new 200 W FM translator. From the existing line of equipment, will display mono and stereo Volumax peak controllers, AM Volumax peak controller, Audimax level controller, and dual audio distribution amplifier. In addition, the display will include the 5500B NTSC color correction system, 8010 image enhancer, 9010NM and 9020NM vidiplex encoder and decoder, as well as a color slide scanner, and the Vidifont V character generator/graphics system.

See ad Cover 3

THOMSON-CSF, ELECTRON TUBE DIV. 1003

Will exhibit three series of klystron tubes, including the TH 2417C C-band



Econoline TV van built by Television Engineering Corp.

24-channel unit, the TH 2426 Ku-band, and the TH 2445 DBS klystron. Travelling wave tubes on hand will include the TH 3591B for Ku-band and the TH 3640 3 kW C-band unit. Tetrodes will range from 100 W UHF, the 1 kW LPTV, to the 20 kW UHF. In VHF tetrodes, the TH 298 1 kW through the TH 371 20 kW will be displayed, along with the TH 320 50 kW FM.

See ad page 171

THORN EMI LIGHTING 1331D

Will show its lighting equipment line.

TIFFEN 1422

Will feature its special effects and color correction filters for cine and video cameras.

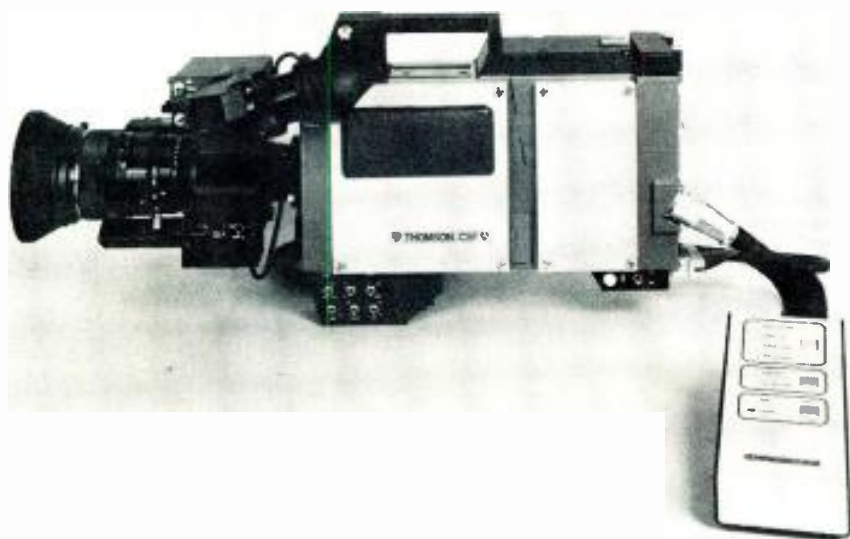

The TTV-1623 is Thomson-CSF's new three-tube Betacam.

TOSHIBA 1631A

Will show a complete range of cameras, highlighted by the computer-controlled PK-41, along with the PK-70 and PK-61 ENG/EFP color cameras and the PK-60 ENG camera. Also on view will be the WG-V wipe pattern generator, the DKG soft chromakey signal generator, plus a digital switcher and a complete series of PA amplifiers.

See ad page 153

TOWNSEND ASSOCIATES 1420

Introducing a 25 kW VHF transmitter, the TA 25NTH, using triode tubes. Also new will be the TA 1000ATU-M low cost 1 kW UHF LPTV transmitter. A universal high-power UHF amplifier, compatible with any current klystron amp, will be exhibited along with exciter updates and transmitter input

equipment, and the MDS transmitters and other LPTV products.

TRANSIMAGE INTERNATIONAL 1512

Will introduce the TS-102 time-shared TBC, which allows four VTRs to be plugged in at once, with front-panel pushbutton selection among them and vertical interval switching of the video signal from one set of TBC parameters to the other. Basic version includes TBC circuits plus add-in modules for audio follow (automatic audio delay), video fade to black, subcarrier generation, and more.

TROMPETER ELECTRONICS 1211

Will unveil the new miniature Twin X

crimp type connector and a full line of connectors and patch panels.

TV1 1318

Showing new distribution system for video lighting, as well as a complete range of grids, cycs, and lighting.

ULTIMATTE 1642

Will introduce Newsmatte-2, featuring digital control, and Ultimatte-5 with many new features, in addition to the original models.

UNION CONNECTOR 1783

Will unveil remote dimmer lighting systems up to 2400 W that eliminate RF interference and contain a computer-controlled, Skirpan-designed controller. Also showing connectors and distribution equipment.

UNI-SET CORP. 1236

Will bring its modular newsroom furniture system.

UNITED MEDIA 1300

Unveiling the Mini-Comm compact two- or three-machine videotape edit controller, capable of expansion from control track to SMPTE/EBU time code control and from cuts-only to full A/B roll with intelligent interface. Will also introduce the Model 500 sequencer, offering contact closure control of up to 16 VTRs and ATRs. Other products on display will include the Commander II, a computer-assisted multisource editing system with new list management, and the Director, a computer-assisted programmable video automatic dialog replacement controller. In addition the exhibit will demonstrate the Models 215 and 305 character generators, Model 310 time code reader, and the Model 425 audio router/dissolver with eight crosspoints, interfaceable to Comander II.

UNR-ROHN 1605B

Will discuss new information on completely engineered equipment shelters in standard and custom sizes. Also will offer information on the complete Rohn line of towers, accessories, and obstruction lighting.

UTAH SCIENTIFIC 1114

Will introduce new control panels to operate with its complete line of audio and video routing switchers. Also new will be control panels for the full machine control line. In addition, the MC 502 master control switchers, one fully automated, will be exhibited along with other machine control products and video and audio DAs.

See ad page 137

VALENTINO MUSIC LIBRARY 1231

Introducing four new music albums with several additions to the main music library of contemporary sounds. Also showing the complete sound effects library.

VARIAN/EIMAC 1605

Will introduce a wide range of new products this year, including two new power tetrodes of 3.5 and 7.5 kW, as well as three new multiphase power tetrodes from the 4CM line in powers of 25, 100, and 400 kW. Other new products include a 40 kW power tet-

WHY BUY OFF THE RACK WHEN YOU CAN AFFORD TAILOR-MADE?

THE ONLY SPECIALIST
POST-PRODUCTION
TELECINE.

THE ONLY SPECIALIST
DIRECT-BROADCAST
TELECINE.



Some broadcast equipment manufacturers would have you believe that one telecine will neatly fit both film post-production and direct broadcasting.

But there's one manufacturer who just doesn't agree – and that's Rank Cintel. Now, the only telecine specialist in the world has two products that clearly make the point: the Mk III C and the ADS I.

The Mk III C is internationally recognised as the best when it comes to high-quality film transfers. Thanks to X-Y Zoom, it's the only advanced telecine capable of optical zooms and moves at full tv resolution. True still-frame reproduction is another plus made possible by flying-spot scanning technology. And as for the pictures, they are outstanding – from positive or negative stock shot for wide-screen as well as normal presentation. Of course, this impressive post-production capability – even secondary colour – can be programmed on Amigo, the simplest, most powerful telecine computer. And the FeRRIT sep. mag. sound-follower brings Rank Cintel quality to post-production audio.

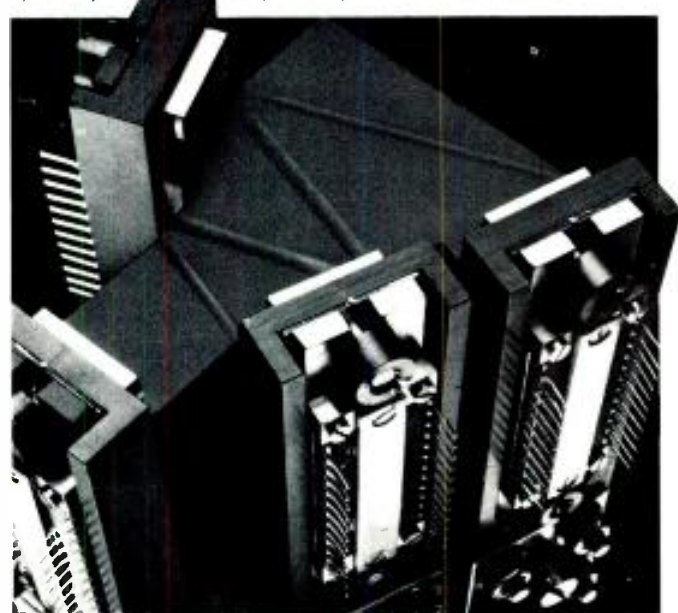

ADS I CCD SENSOR BLOCK

MK III C FLYING SPOT SCANNING CRT

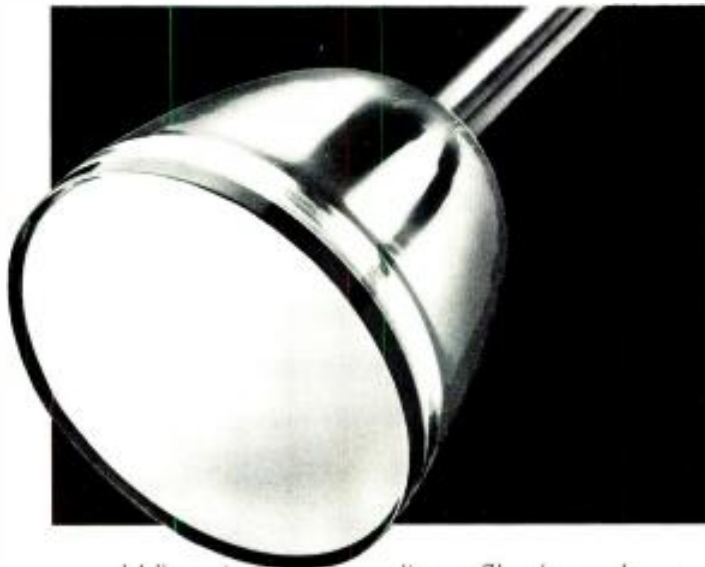

When it comes to direct film broadcasting, everybody can appreciate the versatility and sophistication of the Mk III C – but not everybody needs it. The new alternative is the ADS I.

Designed specifically to meet the direct-broadcast needs of today's tv-station, ADS I offers the right performance at the right price. This is achieved by combining compact, multiplexed design with modern manufacturing techniques and the latest in solid-state technology. For the broadcaster, this approach pays off handsomely at time of initial purchase. Then it pays off with low daily running costs. Then it pays off yet again when it's time to expand. And important features like variable speed, programmable A/B roll and a unique dirt and scratch concealment system prove that these economies have not been made at the expense of performance.

So, the next time someone tells you there's only one telecine, you can tell them there are only two – and they're both made by Rank Cintel. If you'd like to find out more about the world's finest telecines, contact one of our sales offices listed below.

 **Rank Cintel**
The world leader in telecine

SALES AND SERVICE RANK PRECISION INDUSTRIES INC.

260 North Road 303, West Nyack, New York 10994 Telephone (914) 353 1914 CONTACT: David Fenton.

15540 Sunset Street, North Hollywood, CA 91605 Telephone (818) 765 7265 CONTACT: Neil Kempt.

1411 E. Lake Street, Aurora, Des Plaines, Illinois 60018 Telephone (312) 297 7720 CONTACT: Claire Brogni.

rode, a new Klystron VHF power amp, and six new VHF cavity amps. Also bringing the full line of high-frequency VHF power triodes in 800 W powers as well as several other tetrodes. The Salt Lake division of Eimac will bring four LPTV transmitters, a new ceramic triode for FSB, 2CX 1200A7, and the new economy version of the 4-500A, 4-500B.

**VARIAN, 1605
MICROWAVE EQUIPMENT
DIV.**

Bringing established products: VAW-6700 klystron test set, VZU-2701G klystron high-power amp and the VZJ-2700G klystron high-power amp, VKC-7980 klystron 5.925 to 6.425 GHz, and the VCU-6995AZ 14 to 14.5 GHz 500 W TWT HPA.

**VIDEO 1303
ASSOCIATES LABS**

Will bring its software systems to convert personal computers into video graphics systems.

**VIDEO 1775
COMPOSITION CORP.**

Will introduce the Montage Picture Processor video editing system.

**VIDEO 1524
INTERNATIONAL DEVEL-
OPMENT**

Will show its STC-2003 and STC-1003 digital standards converters.

See ad page 138

VIDEOMAGNETICS 1109

Will unveil a random-access video-cassette changer for Sony U-Matic format, as well as describing its complete quad video head refurbishing service.

VIDEOMEDIA 1308

Introducing Version 2 software for its DOS-based editing systems. Also demonstrating complete editing systems including the V6000 Series with Models A through E, and the Eagle Series with Models 1 through 3. Other equipment on display will be the Q-Star station automation sequencer and the VMC-200 total automation control system.

See ad page 7

**VIDEOSTAR 1122
CONNECTIONS**

Exhibiting the Express, a mobile Ku-band satellite transmission facility.

VIDEOTEK 1633

Will demonstrate a range of new equipment, concentrating on the TSM-5A waveform monitor with switchable line select for lines 14 through 21. Also highlighted will be Studio-13, a professional 13-inch rack-mount color monitor with three looping video inputs. Other new products will include the VSG-100 sync generator and the APM-2RA audio program meter. In addition, rack-mount color monitors will be displayed along with color receiver/monitors, routing switchers, DAs, demodulators, audio program monitors, waveform monitors, and vectorscopes.

See ad page 71

VIKING CASES 1731

Will exhibit a complete line of heavy-duty reusable shipping cases and lightweight carrying cases for all broadcast equipment, highlighting the ATA-type cases with quarter- or half-inch plywood and ABS plastic exterior. The Carrylite lightweight equipment carrying case for small equipment will also be on hand.

film or video sound by

NAGRA KUDELSKI

a passion for perfection

Sheer enthusiasm inevitably leads the Stefan Kudelski-Nagra design team to build the best, as with our IV-S. This portable, stereo mastering recorder incorporates all the functional specifics professionals need... Like instant read-out of channel level differences, weighted signals for disc groove depths, current consumption and battery voltages. And, there's a 6-position filter circuit to correct undesirable acoustical effects, plus two switchable, ganged potentiometers. Share the enthusiasm. Ask for details.

NAGRA MAGNETIC RECORDERS, INC.
A Subsidiary of Nagra-Kudelski, Switzerland

East Coast
19 West 44th St. Room 715
New York, NY 10036 (212) 840-0999

West Coast
1147 N. Vine St.
Hollywood, CA 90038 (213) 469-6391

**SEE US AT
BOOTH 1213
NAB**

50 KW

OF FM POWER:

JUST WHAT

YOU'D EXPECT...

... From the inventor of
 — the Pyrobloc[®] grid
 — Hypervapotron[®] cooling
 Advanced technology as in all our FM-
 transmitter tubes, to guarantee their reliability.

THOMSON-CSF Components
 Corporation - Electron Tube Division /
 301 Route Seventeen North /
 RUTHERFORD, NEW JERSEY 07070 /
 Tel.: (1.201) 438-23-00 /
 TWX: 710 989.7286



ELECTRON TUBES

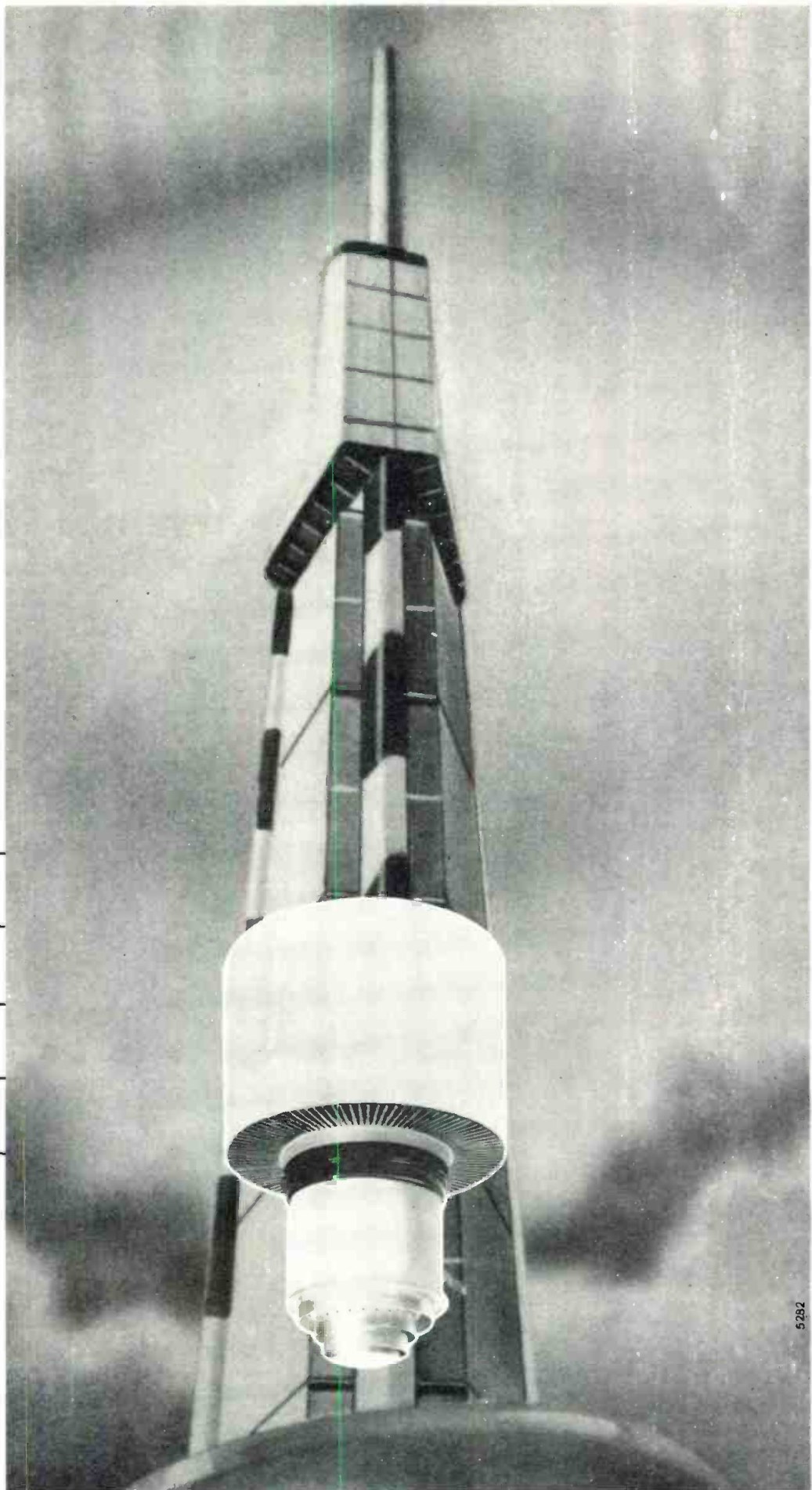

5282

COMPONENTS FOR SUCCESS

Brazil SÃO PAULO Tel: (11) 542 4722	Canada OTTAWA Tel: (613) 236 3628	France BOULOGNE-BILLANCOURT Tel: (1) 604-81-75	Germany MÜNCHEN Tel: (89) 78 79-0	United Kingdom BASINGSTOKE Tel: (1256) 29-155	Italy ROMA Tel: (6) 538-14-58	Spain MADRID Tel: (1) 405-16-15	Sweden STOCKHOLM Tel: (08) 63 50 60	Japan TOKYO Tel: (3) 264 63 46
--	--	---	--	--	--	--	--	---

Circle 208 on Reader Service Card

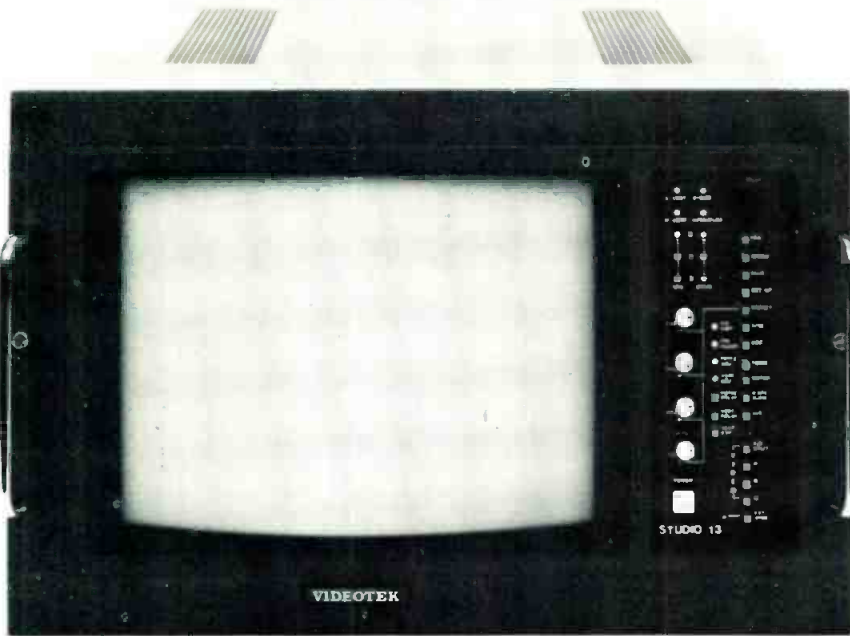

Videotek Studio 13 professional rackmount color monitor.

VITAL INDUSTRIES

1212

Will demonstrate from its existing line the VIX-114 Series of video production switchers including Models -2ASQ, -4A, -10A, -16A, and -1A. The 250 P/N 10- or 16- input digitally

controlled production switcher will be shown, in conjunction with the VIX-115 master control switcher with SAM station automation management. The PSAS production switcher automation system and the SqueeZoom digital video manipulator will also be exhibited.

VLAHOS-GOTTS-CHALK RESEARCH

1642

See ULTIMATTE

WARD-BECK SYSTEMS

1224

Will premiere a totally new, microprocessor-controlled audio console system. Will also feature its line of broadcast audio consoles and TV broadcast communications systems.

See ad Cover 4

WAVETEK

1782

Will introduce the CompuTrace 1500 video hardcopier, which creates 64 gray shade photographs from video signals in 18 seconds, with no trace of TV scan lines. The device also produces negatives by continuous tone separations from R, G, and B signals.

WHITE INSTRUMENTS

1318A

Will exhibit audio real-time analyzers in addition to pink noise generators and graphic equalizers.

WILK POWER & VIDEO

1229

Will introduce a 10 x 10 modular

We have to draw the line somewhere. Then we cross it.

This line symbolizes state-of-the-art. We cross it by involving the kind of people who know they can.

That's how Forox developed the first computer-controlled system for production of slide/cel animation and multi-image. And a videotape system for creation of direct video animation. We also introduced microprocessor controls and the most extensive software.

Consistently crossing the line has resulted in new technologies that help make your work more productive. Which is why — worldwide — more professionals rely on our products and sales/service network: Forox Corporation, 393 West Avenue, Stamford, Connecticut 06902.

Forox®



See us at NAB-Booth #1620-D

Circle 209 on Reader Service Card

IT'S A WRAP

One Pass Unveils Mobile One

 **Centro**
Booth 1101

NAB

April 29-May 2

Las Vegas

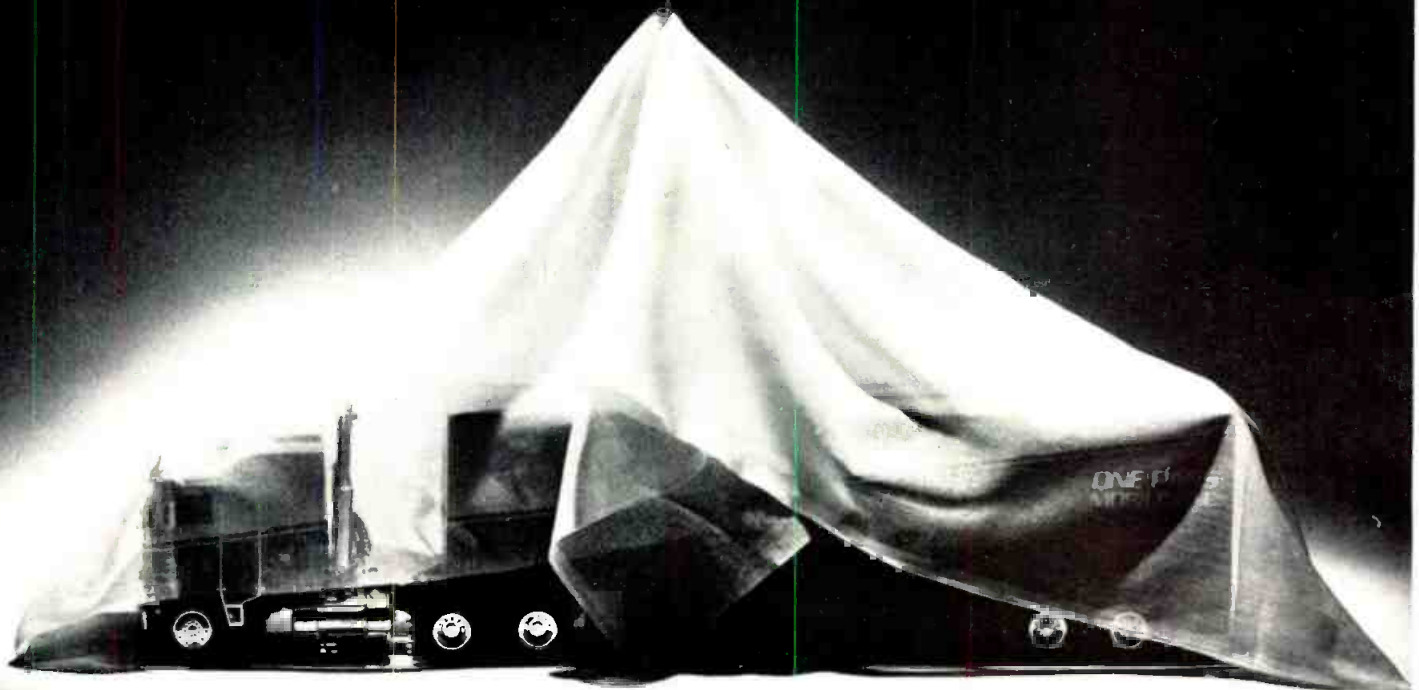

FILM AND VIDEO

One China Basin Building, San Francisco, California 94107 415 /777-5777

switcher, upgradable to any size in increments of 10 by adding modules. Also new will be the 4400 character generator with optional plug-in floppy or hard disk memory with full joystick graphics, operator-generated custom fonts, and other features. Established products will include its line of video precision character generators, audio and video switchers, audio and video distribution equipment, and LPTV tunable audio and video encoder and decoder.

See ad pages 110, 273

WINSTED CORP. 1238

Exhibiting the full line of professional video support systems, video consoles, stands, vertical racks, cabinets, tape trucks, high-capacity tape storage systems, and stationary dubbing racks.

See ad page 256

WIREWOKS CORP. 1014C

Showing a new series of multipin input microphone splitters and phantom power supply components in 15 and 48 V models. Prism components for multipin inputs in variable channel sizes will be displayed, along with a range of multitrack input units and

transformer isolated mic splitters.

WOLD COMMUNICATIONS 1515

Exhibiting material related to radio and TV satellite transmission services, as well as mobile microwave and mobile uplink services and the SSTS system.

WOLF COACH 1317

Introducing the Model B-103 production vehicle, complete with a microwave mast, designed to suit daily requirements of ENG/EFP operations, and with a body that can be transferred to a new drive train for longer service. Also showing the S-102 converted Suburban for ENG use, and describing the full range of available vehicles from small vans to trailers.

FRANK WOOLLEY & CO. 1405C

Will exhibit the Motionmaster, a video animation system using a polarized light process that creates the illusion of motion, with over 70 animation patterns.

WSI 1104

Will unveil Meteosat imagery, provid-

ing hourly cloud cover satellite pictures from Europe and the Middle East and up to 20 new custom-prepared weather maps per day from Weather Central. Will also introduce dot matrix maps for high-speed printers and will show SuperSat satellite images and other weather graphics.

YAMAHA INTERNATIONAL 1340

Will unveil the REV 1 digital reverberator using proprietary LSIs and new software to create up to 40 early reflections and provide up to 99 seconds of subsequent reverberation. The timing between early reflections, the absolute level, and when they begin is also controllable. Another new product will be the YDD 2600 digital delay, for sophisticated signal processing or use as a tool in satellite/microwave links to adjust the audio to sync with video signals. In addition, the full line of audio consoles will be demonstrated including the PM 2000, 2408, and 1608, as well as the M1500 Series and EMX Series. Power amplifiers and a wide range of audio processing equipment will be on hand.

See ad pages 219, 220

Introducing
THE DYNAMIC DUO

Affordable ELECTRONIC SCRIPTWRITER and ULTRA LIGHTWEIGHT DISPLAY

- Electronically generated characters (no more fuzzy pictures)
- Store as many stories as you like and edit "on-air" (no more paste jobs or messy rub outs)
- Separate script operator's variable speed scroll control (puts it where you need it)

SEE IT AT BOOTH 1406 NAB

LISTEC TELEVISION EQUIPMENT CORPORATION
 39 CAIN DRIVE / PLAINVIEW, NEW YORK 11803 / (516) 694-8963 / Telex: 640470
LISTEC (WEST) CORP.
 1619 COSMIC WAY / GLENDALE, CALIFORNIA 91201 / (818) 247-9247 / Telex: 182686

Circle 211 on Reader Service Card

TV test equipment from the inventors of the Plumbicon® tube.

At long last a new, reliable source of TV test equipment. One that offers fast, predictable delivery. One with a name all the world trusts—Philips. Four quick examples:

PM5565 Waveform Monitor

Enjoy the luxury of examining one line and one field at a time. On top of this, there's a convenient front probe input so you can use the monitor as a troubleshooting oscilloscope.

PM5567 Vectorscope

If you want more accurate decoding and the ability to have an external reference from composite video signals, choose our vectorscope.

Both waveform monitor and vectorscope mount side by side, fit all existing hardware and use less power than the competition.

PM5539 Color Analyzer

Take it on a quick trip through your studio or control room and adjust all monitors to the same color temperature in a matter of minutes.

With four different memories, there's no problem in quickly calibrating four different phosphors.

Variable full-scale, from less than set up to more than reference white, allows measurement of color tracking as a function of APL.

PM5534 Color Pattern Generator

Our universal pattern contains all the signals needed to verify overall system operation—directly from the picture. No wonder virtually every set manufacturer uses our pattern for their TV set alignment.

Of course our TV test equipment line doesn't end here. Today Philips offers a wide range of equipment including sync and pattern generators, VITS generators and analyzers, and TV modulators and demodulators.

For nationwide sales and service information call 800-631-7172, except in Hawaii, Alaska and New Jersey. In New Jersey call collect (201) 529-3800, or contact Philips Test and Measuring Instruments, Inc., 85 McKee Drive, Mahwah, New Jersey 07430.

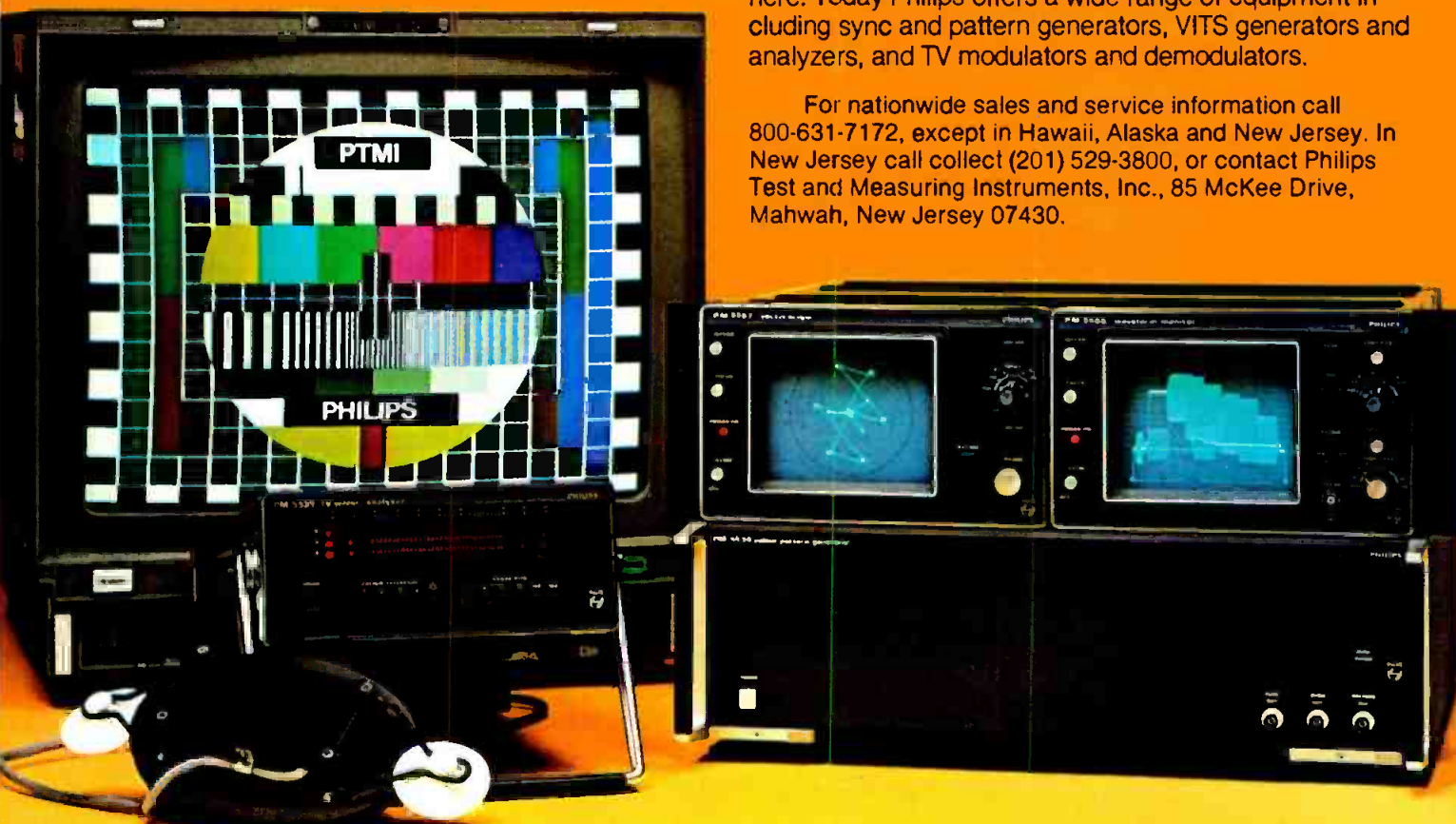

Philips, of course.



Test & Measuring
Instruments

PHILIPS

Circle 212 on Reader Service Card

www.americanradiohistory.com

If your HL-79 beats we'll



See the Harris TC-90S at NAB '84
North Hall, Las Vegas Convention Center

our TC-90S, give you the TC-90S!

Comparison. The real test. When you have to make a choice between two superb competitors, it usually comes down to a shoot-out—a side-by-side objective comparison of those features and capabilities that mean the most to you.

FREE

Harris has made a substantial investment in the TC-90S—because we knew that we could design and manufacture an American camera with features that would make it the new industry standard. We wouldn't make this offer unless we were sure we had succeeded.

So look over these TC-90S features and read our offer. Then, if you want a shoot-out, let us know. We're ready.

The Facts

1 Colorimetry

Mixed-field LOC, half-inch diode gun tubes, and an advanced new beam splitter provide winning colorimetry and better registration than larger tubes.

2 Smart Package™

Exclusive microprocessor time code generation lets you record SMPTE and VITC time code *as you shoot*, so editing hassles disappear. Automatic encoder balance, auto registration, diagnostics and camera status (in English) keep your camera out of the shop and in the field where it belongs.

3 Automatics

Auto registration
Auto beam control
Auto encoder balance
Auto iris
Auto white balance
Auto black balance
Auto scan failure protection

4 Gain Tracking

The TC-90S maintains black level under all conditions to eliminate color shift, even with changes in gain.

5 Noise

Minimal apparent noise at +18 dB gain for superb low light level performance.

6 Weight

The TC-90S, with standard lens and battery, and including the viewfinder, weighs less than the HL-79, similarly equipped. No more "sagging shoulder" feeling, and your pictures will show it.

7 Profile

You can see to the right! Even when you're shooting, you have an unobstructed view to the right over the top of the camera.

8 Price

The TC-90S, with microprocessor, tubes, batteries and a 15:1 zoom lens—a top-of-the-line camera—is list priced under \$30,000!

9 24 Hour Service

Call us. 24-hours-a-day, 7 days a week. Our telephones are constantly manned by service engineers, and we're ready when you need help.

The Challenge

The details of the shoot-out are simple: We must have on file the coupon below filled out by the cameraperson at your facility, and a letter signed by your chief engineer or general manager on your organization's letterhead, requesting the shoot-out and stating that you are in the market for a new ENG camera. Then, if your current model Ikegami HL-79 (or an HL-79 you secure for the shoot-out) meets all, and exceeds one or more, of the TC-90S features given above, we'll leave without our camera—it's all yours.

There's More

To those of you who believe that time is the true test of a product, we'll make another offer: Forget about filling out coupons and writing letters—call us today and order a TC-90S. Then use it in the field for 30 days. If it doesn't live up to our specifications, we'll refund your money.

Either way, the TC-90S is a winner. In a shoot-out, or on your shoulder.

OK Harris, prove it!

Mail to: Mark Gray, Director of Marketing,
Harris Corporation, Studio Division,
P.O. Box 4290 Quincy, IL 62305,
(217) 222-8200 TLX 404347

CAMERAPERSON

STATION OR COMPANY

ADDRESS

CITY

STATE

ZIP

TELEPHONE

Hurry, our incredible offer expires June 30, 1984.
And good luck. Your HL-79's going to need it.

Circle 213 on Reader Service Card



HARRIS

NAB BOOTH 321

Above all...

Howe Audio
consoles . . .

Simply Reliable

Over 70% of Howe Audio customers are repeat customers. They know we provide them with reliable, quality products. Here are just four of the stations that have purchased more than one Howe Audio console:

KIMN KYGO

Denver, Colorado
Chuck Waltman, C.E.
(303) 234-2200

WNUS

Bellevue, Ohio
John Patten, G.M.
(614) 423-3213

WNNC

Newton, N. Carolina
Dave Lingafelt, C.E.
(704) 464-4041

KQEU

Olympia, Washington
Dale Zabriskie, C.E.
(206) 491-9200

Howe Audio has been making quality audio consoles for the past 6 years, supplying broadcasters world-wide with quality products at affordable prices. Quality in the form of VCA Control, unparalleled specs, 22 stereo inputs, 2 stereo outputs, one mono output, a spare parts kit, and many other features on each Howe Audio console.

Call the users listed, or call Howe Audio for the name of a user near you. You'll discover even more reasons why your station should be equipped with the best console on the market.

**HOWE AUDIO . . . ABOVE ALL
. . . QUALITY!!**

the Sound Solution



howe audio productions, inc.

3085 A Bluff Street
Boulder, Colorado 80301

303/444-4693

For more information: 800/525-7520

Circle 214 on Reader Service Card

NAB '84

RADIO

WHAT'S HOT IN RADIO PRODUCTS

FIND IT FAST

180 Audio Consoles

180 Modulation Processing

182 Noise Reduction/Processing/
Effects

182 ATRs, Cart Decks

190 Audio Production
Equipment

190 Intercoms

192 Test And Measurement

194 Remote Control

194 Program Automation
RPU, STL

196 Radio Transmitters/SCA

196 Radio Syndication

Radio is alive and well. In fact, judging by the excitement generated by this year's showing of equipment on the radio exhibitors' side of the show, it promises to be one of the hottest years ever.

Technology advancements and new product announcements touch every aspect of the broadcast equipment industry this year, ranging from new cable to satellite gear and including everything in between: consoles, mics, intercoms, processing units, and tape machines. And the revelations don't stop in the studio either.

Special transmission products are hitting the market faster than ever before, perhaps as a result of SCA deregulation, expected new FM station dropins, and a need to have a higher degree of control over satellite uplinking and downlinking—there is a big upsurge in an-

tenna remote control devices. Then there are the ubiquitous AM stereo transmission developments (helped this year by an increase in the number of multiple-system consumer receivers available). It seems that after a fairly dormant year in 1983, the least glamorous and most important aspect of radio broadcasting will garner much attention this year.

These developments come at just the right time since an industry survey has indicated a rise in interest for purchasing new transmitting equipment in 1984 over 1983 levels. Yet it doesn't take an industry survey to realize that interest for all broadcast equipment is up over last year. This year's NAB show will boast more exhibitors than ever before, and attendance is expected to rise to record breaking levels as radio broadcasters try to keep up

NAB '84

RADIO

with a rocketing technological pace.

For audio-for-video equipment see "What's Hot In TV Products," beginning on p. 65.

AUDIO CONSOLES

The complexity and extent of recent developments in broadcast consoles is such that most on-air boards have taken on the extra facilities to handle a good range of production needs. Perhaps demonstrating this most boldly is the recent ABX Series of consoles from Pacific Recorders (113), which are also suitable for television production. The ABX mixers come in 18-, 26-, and 34-input models

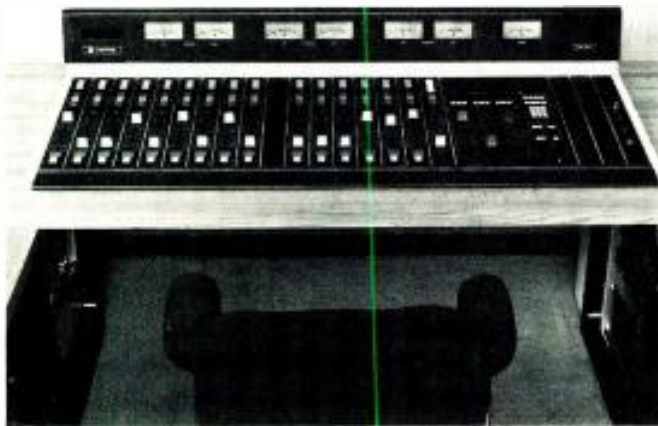

Harris will bring its Micro Mac console line along with its successful Medalist Series.

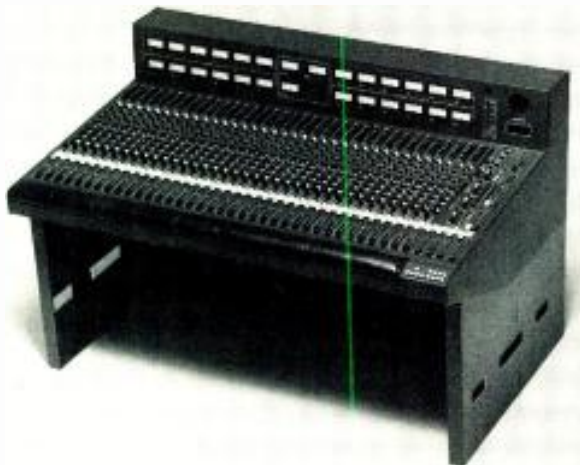

Among the many radio and production consoles from MCI is the JH-636 for multitrack production.

with multiple stereo bus operation.

Ward-Beck (1224), of course, will have consoles for every radio use, including transportable field units and sophisticated production boards for radio program use and for on-air purposes, in addition to its range of medium-sized consoles for mobile production. Other companies will show new products in field and portable mixers. One of this year's highlights will be an ENG introduction, the FP31 from Shure (1401A). Still expanding an already extensive line, Ramko (415) will debut a new four-channel

field mixer, the P-4PM, with carrying case, nicad battery option, and master level control.

A versatile console for production in either television or radio, set up in a 20x8 input/output configuration will be unleashed by TASCAM (1304). Harris (401) will be adding a 12-channel version to its very successful Medalist line for on-air radio use. Howe Audio (321), pursuing the market for integrated production systems, will introduce a new series of modular expandable boards in six to 24 channels, each channel with three inputs, plus digital logic for machine control.

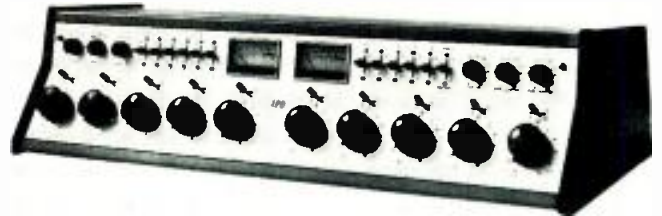

LPB will bring many on-air mixers, including the Signature Series 10 mixer stereo units.

In air consoles, Harrison (1324) is showing the Air-7 along with its full range of other mixers. Another music industry manufacturer among the broadcasters will be Soundcraft (219), with a new version of its SAC-2 stereo on-air console, previously seen only in prototype.

Arrakis (211) continues the versatility of expansive consoles with the introduction of its modular 3000 Series in eight, 15-, and 24-channel versions. In a 10-channel console with dual outputs and 30 inputs, the Audio Metrics line from Radio Systems (213) will unveil the ESA linear units. Also interested in the production boom is Logitek (613), which is introducing the Perfectionist board with up to 32 selectable inputs.

Broadcast Audio (319), in an effort to expand the capabilities of its existing line, will introduce optional accessory modules for all of its consoles to add flexibility and greater control potential for all on-air and production applications.

MODULATION PROCESSING

In modulation technology, there are more refinements than revolutionary discoveries this year, though those refinements promise to help keep a clean and strong signal on the air. Inovonics (304) will be uncovering its Model 260 stereo audio processor for educational markets in both FM and LPTV and will also show the multiband system, which can be programmed for AM, FM, or TV, and for the precise action wanted.

Orban (607) can be expected to show an important lineup of processing equipment to enhance the already well-entrenched Optimod brand of modulation processors. Audio & Design (402) will introduce the Complex Limiter MK2, a processor combining multi-ratio com-



CRL will bring, in addition to its SCA equipment, a full complement of modulation processing gear.

Let's face it. Listeners will never know that the Delta Series, ITC's new generation of cartridge machines, has improved cart guides, a crystal-referenced servo capstan motor with a vapor-honed non-magnetic shaft, and high-speed recue. They won't care that the Delta's modular design makes alignment and service convenient.

Listeners won't know about Delta's microprocessor-controlled digital cue tone detector and exclusive ITC playback head. Delta's compact size and choice of four configurations won't matter to them.

Give people great sound and they'll come back for more!

And the average listener won't know that ITC sells more professional cartridge machines than all other manufacturers combined. Or that the Delta Series replaces the Premium Line, previously the standard of value in the industry.

A lot of the things that make the Delta Series special. . . features that matter to you . . . don't matter to your listeners.

But that's okay. Because the thing your listeners care the most about is exactly what the Delta Series gives them . . . great sound.

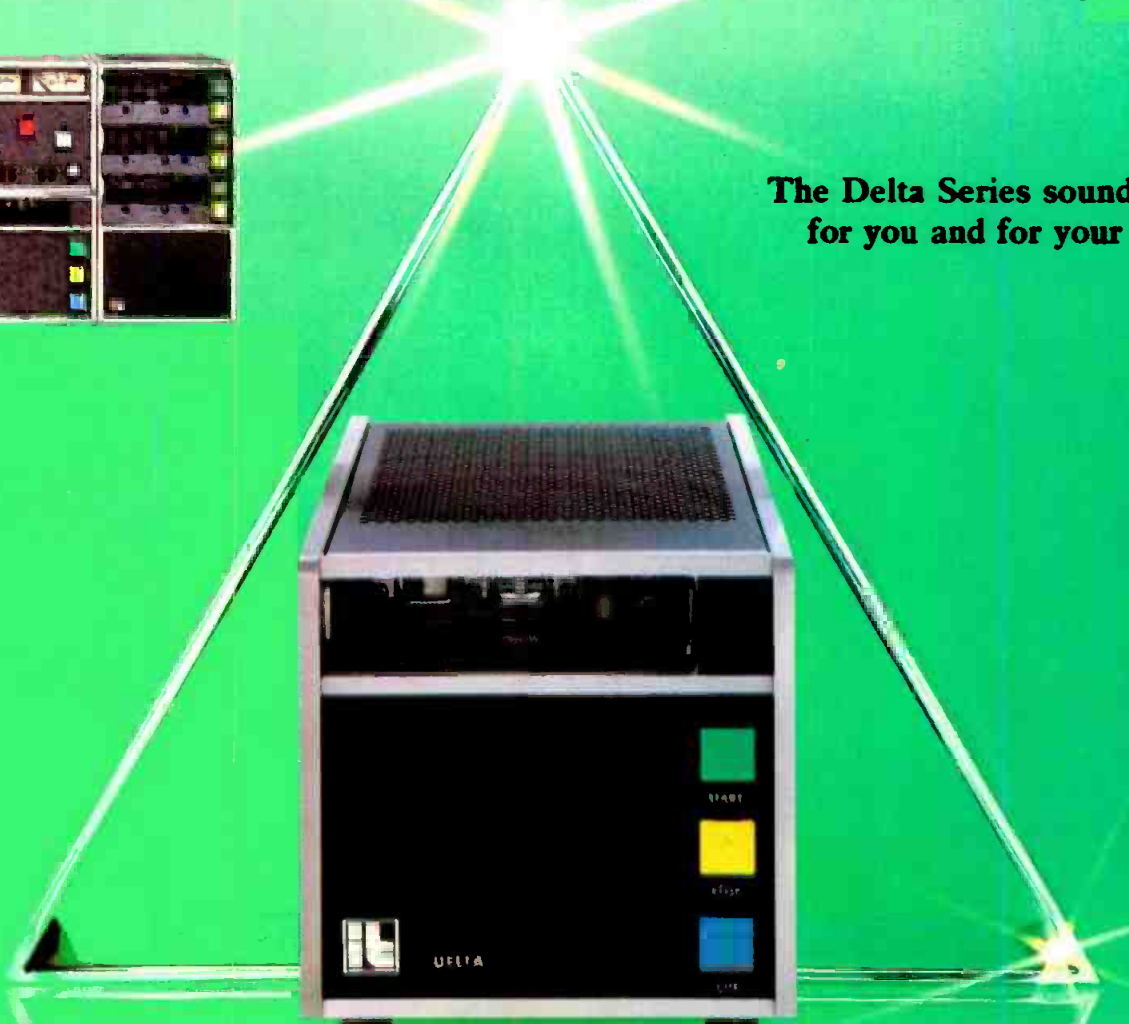

The Delta Series sounds great... for you and for your listeners!

INTERNATIONAL TAPETRONICS CORPORATION

2425 South Main Street / P.O. Box 241 / Bloomington, Illinois 61701

Call Toll-Free: 800-447-0414

From Alaska, Hawaii and Illinois call collect: 309/828-1381

3M hears you...



Circle 215 on Reader Service Card

pressor, peak limiter, and noise reducing expander gate using VCA technology.

Marcom (306) will be introducing the C.N. Rood 114 portable BAX modulator bandwidth extension system

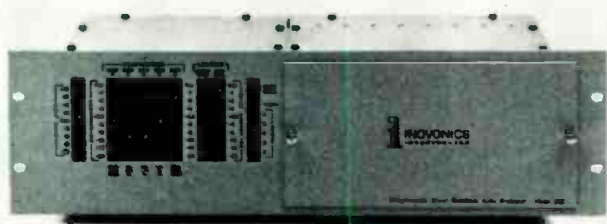

The Inovonics Model 250 is a programmable stereo audio processor with front panel display.

and a bank of stereo generators. Dorrough Electronics (312) with its Discriminate Audio Processor now has a programmable EPROM that automatically sets attack and release times, something shown in the past, but with further refinements. Circuit Research (106) will have an audio processing system lineup including multiband AGCs gated to prevent noise pull-up, compressor/expanders, and peak controllers.

There will, of course, be several firms displaying products of an established nature for this category. Such companies are Elcom-Bauer, McMartin, Symetrix, Thomson-CSF, UREI, Harris, and Kahn.

NOISE REDUCTION/ PROCESSING/EFFECTS

Just as the rise in production capabilities for consoles has corresponded with the increase of production techniques in the radio station, so too have special effects and processing devices risen. Noise reduction systems expand in number and type as analog recording systems lay claim to the higher dynamic range of digital audio.

Yamaha (1340) will expand the horizons of special effects with the introduction of two new systems. The REV 1 is a digital reverberation unit based on proprietary LSIs and new software to create up to 40 early reflections and up to 99 seconds of subsequent reverberation for sonic manipulation to match artificially any kind of listening environment. Also new is the YDD 2600 digital delay unit with variable channel configurations and a wide range of programmable delay time settings.

Well known for its audio effects units, which are simply computers dedicated to audio signal manipulation, Eventide (323) will announce new capabilities for the SP2016 audio effects processor/reverb unit with new ROMs. Another heavyweight in digital processing of audio signals, Lexicon (1139) will introduce the 1200C high

resolution audio time compressor with RS-422 interface. The new 1300S is a stereo audio/video delay compensator and the Model 200 stereo programmable digital reverb is also new.

Digital reverb units are not the only devices with programmability. Orban (607) will open eyes with the introduction of a programmable parametric equalizer and compressor/limiter, and Auditronics (505) will return with its programmable parametric. The full production version of another compressor/limiter will be seen from Aphex (513) as it introduces the Compellor compressor/leveler/peak limiter, which uses a single VCA per channel, with side chain adjusting parameters on a program-dependent real-time basis.

Of course, noise reduction always implies Dolby (1311), and the company's 1984 announcements come in the video domain with Model 380 two-channel outboard noise reduction system designed for the Ampex VPR-3 and VPR-80 VTRs. The full line of audio noise reduction will also be on hand. With no brand-new products in the standard noise reduction realm, dbx (107A) this year will concentrate its innovative efforts in a new stereo audio



Yamaha is going after the increased market for radio and television special effects production with the REV 1 digital reverb.

system for multichannel TV in addition to its signal processing gear and digital audio conversion units.

ATRs, CART DECKS

Even though a digital tape recorder standard is still not settled, shoppers at NAB will find a variety of ATRs in the familiar analog form as well as entries from the digital competitors.

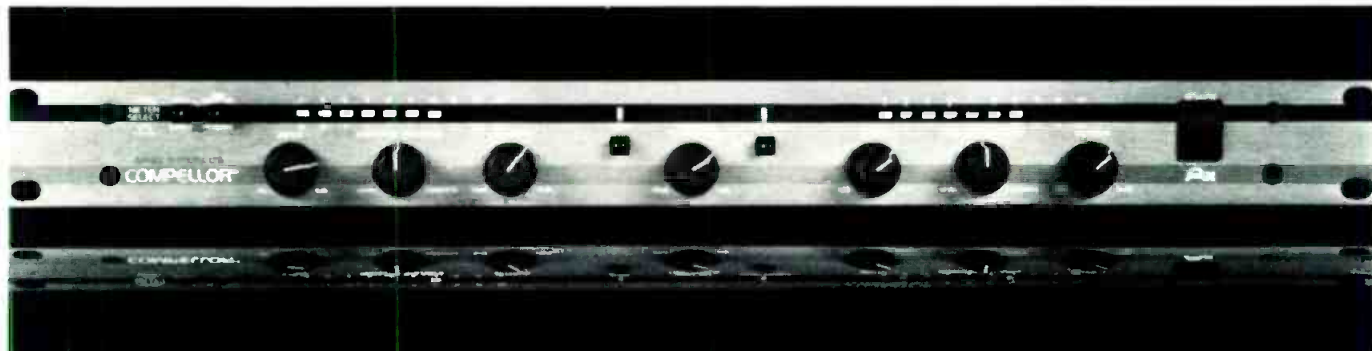

Aphex will show the completed production version of its new processor, the Compellor.

**Scientific
Atlanta**

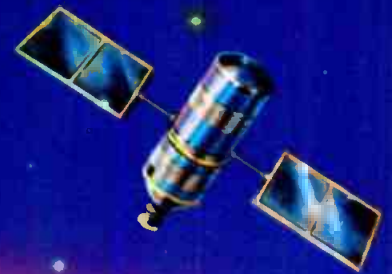

A BIG SOLUTION FOR A BIG DECISION.

Satellite transmission of broadcast programming is creating new standards of excellence in program distribution and new challenges for specifiers of broadcast equipment.

Scientific-Atlanta offers some criteria to consider in your quest for the best satellite earth station.

SCIENTIFIC-ATLANTA OFFERS THE MOST COMPLETE LINE OF SATELLITE VIDEO AND AUDIO PRODUCTS...

Your two priorities in earth station selection should be the quality of individual products as well as complete system performance. (Remember, you're buying more than just an antenna.)

Scientific-Atlanta's uplink and downlink earth stations are complete systems — antennas, exciters, receivers, low-noise amplifiers, switching equipment, highpower amplifiers, plus every accessory. Even mobile uplinks for location work. Each component is designed to function in perfect tandem with other Scientific-Atlanta components.

You get a fully integrated system with no interface problems. It's more cost efficient, too, because you get only the features you need.

Scientific-Atlanta earth stations are always available. There's no waiting for your system to be specified, assembled and shipped.

Every step in the design, every component in the engineering is true state-of-the-art...to provide you unremitting performance.

...PLUS THE MOST COMPREHENSIVE AFTER-SALE SUPPORT.

Another important factor is accountability. As a single-source manufacturer of turn-key systems, we can provide full, continuous, after-the-sale support.

We can help you install your new Scientific-Atlanta system and bring it on-line. We offer comprehensive training for your operations staff. And we inventory replacement parts to give you the fastest possible turnaround for maintenance and repairs.

WE OUTSELL ALL OTHER EARTH STATION MANUFACTURERS.

A final decision factor is track record. How long has your intended supplier been in this business? Who are their satisfied customers? Scientific-Atlanta has been instrumental in the actual development of broadcast earth station technology. Many of our innovations have shaped the earth station concept as it exists today. And, right from the beginning, we have maintained the leadership of the market. Every year we continue to outsell every other manufacturer of satellite earth stations.

It's a big decision. But there is a big solution. That solution starts now with your first call to Scientific-Atlanta. Do it today. Find out exactly how Scientific-Atlanta uplink and downlink earth stations can be your best solution. Call Dan Landreth at (404) 449-2844. Or write us at Scientific-Atlanta, Dept. AR, Satellite Communications Division, 3845 Pleasantdale Road, Atlanta, GA 30340.

SEE US AT NAB, BOOTH 1017.

Circle 216 on Reader Service Card

To its line of recorders, Studer Revox (201) will introduce the Revox PR99 Mk II compact recorder with new electronic real-time counter, return to zero, and autolocate. Also making its first NAB appearance is the TLS4000 SMPTE synchronizer for translation of all SMPTE/EBU and film standards. Other products on hand include the A810 line of recorders with center channel SMPTE code and computer interface, plus the A800 multitrack and A80 multitrack and two-track units. Professional cassette recorders A710 and B710 will also be shown.

Among its ATRs, Sony/MCI (605, 1200) will have the MCI JH-110C-3-TC, a center track time code recorder/reproducer.

Otari (601) will be unveiling new one-inch eight-channel and one-inch 16-channel ATRs as well as the EC-400 Series tape-speed resolvers. Featured will be the two-channel MX-5050-BII and Mark III/2 recorders, the MTR-10/12 in quarter- and half-inch versions and the MTR-90 eight-, 16-, and 24-channel recorders.

TASCAM (1304) is showing a prototype half-track broadcast recorder reproducer and also has Models 42 and 52 half-track, 44 four-track, 48 and 58 eight-track, and the 85-16B 16-track machines, all SMPTE compatible.

Nagra Magnetic Recorders (1213) will be showing the T-Audio portable studio recorder, designed for time code applications with detachable control console. The company is also exhibiting its full line of field recorders, including the IS, E, 4.2, IV-S and the SN.

Premiering from Soundcraft Electronics (219) is the Series 20 two-track master recorder with complete microprocessor control for automatic alignment to five

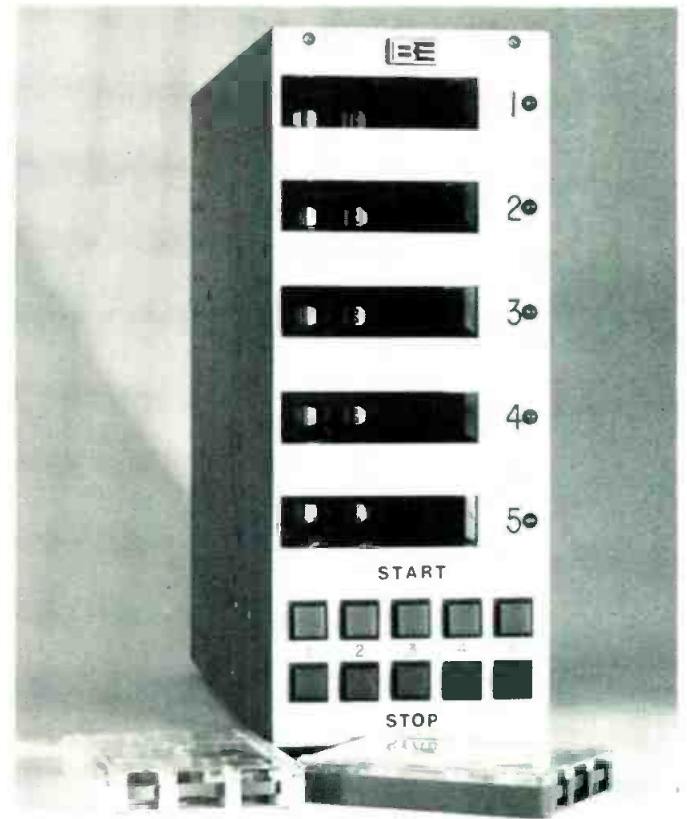

The recently introduced 5500B from Broadcast Electronics will accompany a full line of cart machines.

different kinds of tape and three EQ standards.

Spencer Broadcast (406) is introducing an all solid state audio recorder with up to six tracks. Ampro/Scully tape

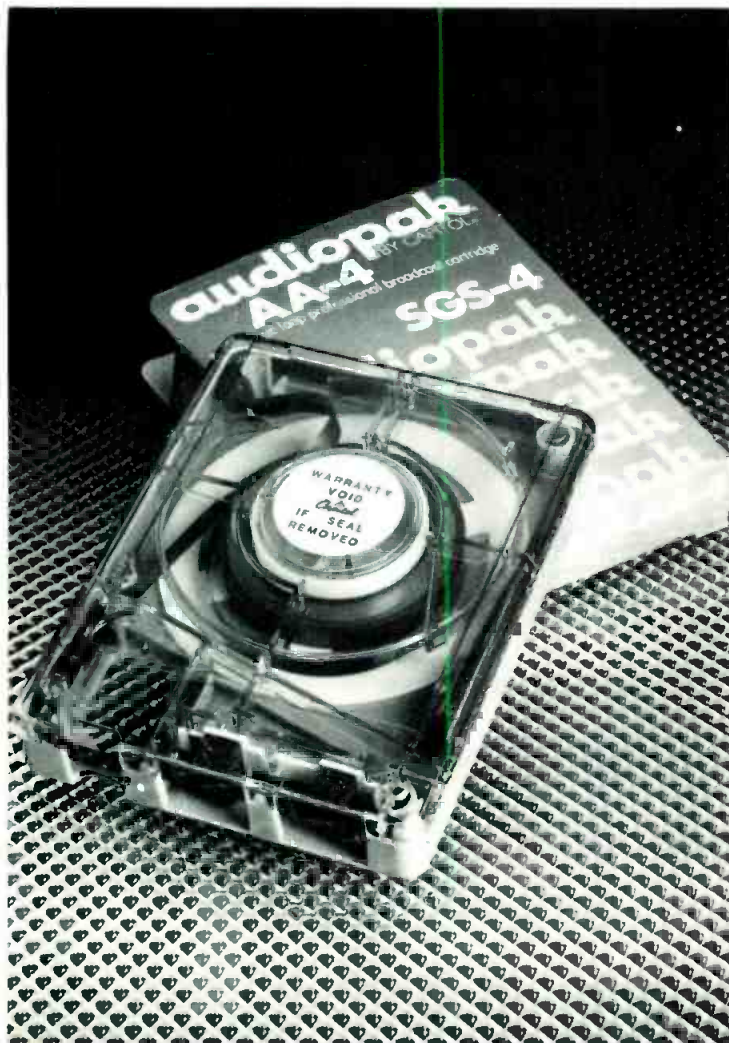

FOR ALL YOU WANT A CART TO DO, THIS CART'S FOR YOU!

- ▶ For... The best sound a cart can reproduce
- ▶ For... The exclusive SGS-4 broadcast mastering tape.
- ▶ For... Superb copies of CD's and digital masters
- ▶ For... Outstanding high frequency sensitivity and headroom
- ▶ For... Stable stereo phasing
- ▶ For... Maximum reliability and longest life
- ▶ For... Compatibility with all cart machines
- ▶ For... Stations who care how they sound

THE AUDIOPAK AA-4 IS FOR YOU

The True Blue Cart - From Capitol

© 1983 Capitol Magnetics Products, a division of Capitol Records, Inc. All Rights Reserved.

See us at Booth #206 NAB

Circle 217 on Reader Service Card

Your winning combination for AM Stereo

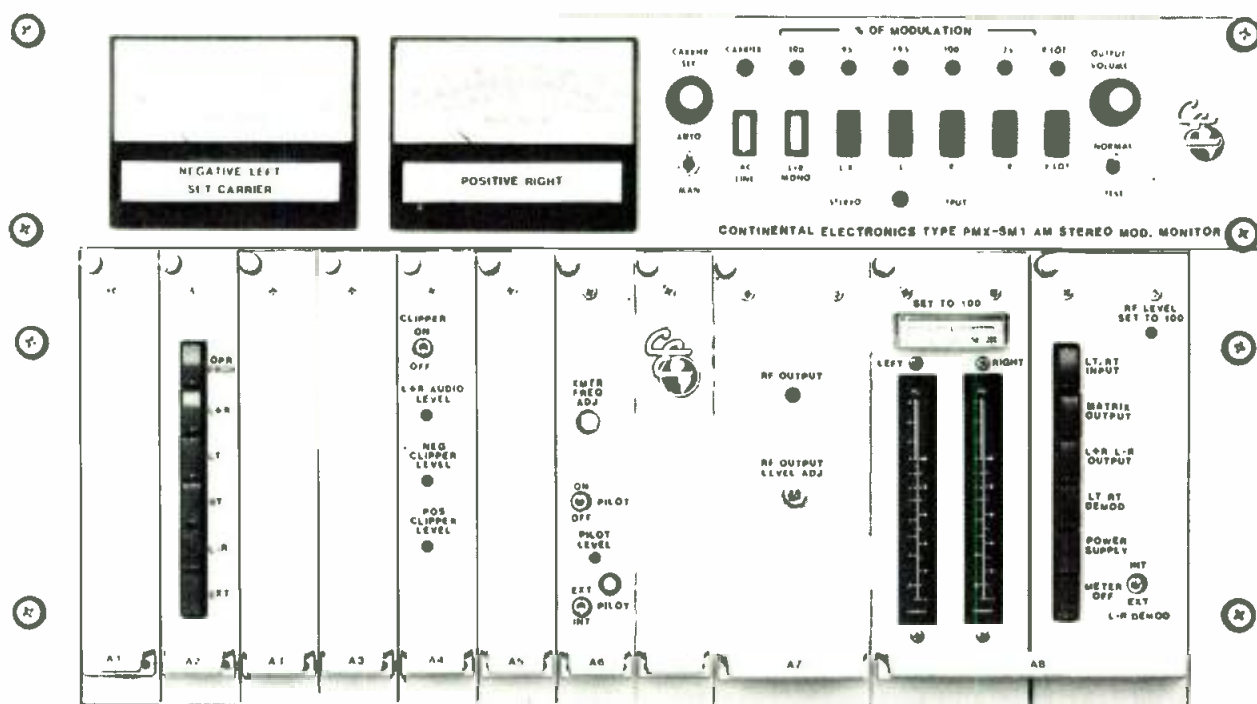

Is AM Stereo ready to move up?

Market-place decisions notwithstanding, the recent introduction of receivers able to decode signals from any of the four systems in use today makes it easier for broadcasters to move ahead with AM Stereo plans.

Which system is #1?

The PMX (Magnavox) System was first selected by the FCC to be the Industry Standard for AM Stereo.

We established the system's viability during the 1979 NAB Show.

The politically-inspired "market-place" decision hasn't affected the technical performance of the PMX System.

Hearing is believing.

With the PMX System, AM Stereo music sounds like FM Stereo music. So it makes for higher listener appeal and better numbers: For audience and the bottom line.

The Winning Combination

Our Type 302A Exciter was developed for the PMX System, and our new Type PMX-SM1 AM Stereo Modulation Monitor gives you a superior package for AM Stereo broadcasting.

We've built a world-wide reputation for high-quality AM transmitters that offer unmatched on-air reliability with complete transparency.

Ultimately, the day-to-day operation of your AM Stereo System will depend upon equipment and service.

We stand on our track record of providing the best of both.

If you're considering AM Stereo, or if you just want more facts, give us a call. You can't lose.

Continental Electronics Mfg. Co.
Box 270879 Dallas, Texas 75227
Phone (214) 381-7161

© 1983 Continental Electronics Mfg. Co./5452

Continental Electronics



Circle 218 on Reader Service Card

See Us At The NAB Show Booth #101



Studer's new TLS4000 synchronizer can work alone or connected to several units and mounts in the A-810 frame.

decks will live again in the Television Technology booth (305).

Telefunken's new M 21 microprocessor-controlled quarter-inch tape recorder will be at the Gotham Audio booth (509A).

Activity is once again visible and audible on the cart deck front. Capitol Magnetic Products (206) will feature the new AA4 broadcast cartridge to accompany its established A2 cart. A completely equipped radio production room will be located at the company's Hilton Hotel suite for a hands-on production clinic demonstrating recordings onto cart from a compact audio disc.

Fidelipac (411), in a major move, is introducing a new product line, Dynamax, which includes audio recording tape manufactured by Fidelipac (a first), reload kits for Fidelipac tape cartridges, and new 1/4-inch plastic tape reels and boxes. Also featured will be the Master Cart and Master Cart II tape cartridges, plus other accessories.

Described as a stereo reproducer for budget-minded stations, the new Omega Series cartridge machine will be introduced by International Tapetronics/3M (311). Estab-

lished products on view will be the Delta Series cart reproducers and recorder/reproducers, the Series 99B cart machine, and ScotchCarts audio cartridges.

Look for a new, updated version of the Instacart instant multiple cartridge playback unit from IGM Communications (403). Also on display is the Go-Cart random-access cart playback unit, manual assist and full automation systems.

At the Ramko Research booth (415) is the Phase-Master, a cart machine that allows AM or FM to program in full stereo.

As usual (and for the last 25 years, in fact), Broadcast Electronics (303) will have its complete line of single, triple, and five-deck tape cart machines. Audi-Cord (123) will introduce a new twin-deck cart player, the TDS series S line, and show the full A and S series cart players introduced last year.

UMC Electronics (114) is introducing the System 8 automatic news recording system plus a motorized azimuth audio cart recorder. Other products on hand will be the A, B and C size cart recorders and multideck cart machines.

Once again Pacific Recorders (113) will be highlighting its Tomcat cart machines.

Telex Communications (600/1605A) is showing NAB cartridge recorders and loggers. And Procart (112) will be showing its line of NAB AA audio cartridges.

Here's what's hot on the accessories shelf: Fidelipac (411) has its handheld and tabletop bulk tape erasers; Garner Industries (1233) also has a full line of tape erasers.

Sprague Magnetics (705) has a complete line of replacement tape heads for reel-to-reel and cart recorders plus refurbishment of recording heads. Also on hand with replacement heads and refurbishing services, Taber Manufacturing & Engineering (711) will introduce the Model 1500 automatic tape degausser.

While not a tape playback system, the digital compact disc is nonetheless an increasingly important playback device. Philips (1500A) will demonstrate the player and controller in its professional configuration. The Optical Disc will be shown in a presentation of laser disc mastering techniques. Sony Pro Audio (605/1200) too will display its CD player and controller for broadcast use.



System 58 is the latest wireless microphone product to come from HME.



Optimod / op'-tə-mod /

Op-ti-mod *n* [*>*Early Orbanian; deriv. of *optimum modulation*]

1. A broadcast audio processor built by Orban Associates to the highest standards of quality and reliability, incorporating patented circuitry to achieve a cleaner, brighter, louder airsound.

2. OPTIMOD-AM, Model 9100A; a high fidelity stereo or mono processor which achieves extraordinarily natural audio quality along with high loudness, remarkable source-to-source consistency, and FM-like brightness.

3. OPTIMOD-FM, Model 8100A/1 compressor/limiter/stereo generator; the industry's dominant choice for optimum FM processing, with or without the optional Studio Chassis and Six-Band Limiter Accessory Chassis.

4. OPTIMOD-TV, Model 8182A; a stereo processor that brings TV audio processing into the '80's by combining Orban's artifact-free multiband gated compressor with our clean "Hilbert Clipper" peak limiter and the commercial-taming CBS Loudness Controller.

5. OPTIMOD; a registered trademark.

Orban Associates Inc., 645 Bryant Street, San Francisco, CA 94107, Toll Free (800) 227-4498, In California (415) 957-1067, Telex: 17-1480.



ORBAN PROCESSING KEEPS YOU COMPETITIVE

Hear the Optimods live in
N.A.B. Booth #607



**Enough. From now on we
make our own tape.**

...and here it is: **Dynamax**.™

Here's Dynamax.™ A new brand of brilliant audio tape, formulated to satisfy the special requirements of the broadcast professional. And not the mass production standards of consumer tape.

To create Dynamax, we built a brand new manufacturing facility, and had each piece of production equipment designed to our own specs. Now we can monitor and control the manufacture of every inch of tape we put in our cartridges.

As a result, the mechanical and electrical properties of Dynamax are superior to those of any lube tape available in the world today.

The 1 mil Mylar® base film used for Dynamax broadcast tape is almost twice as thick, and twice the weight, as that used in the ScotchCart.™ And our cross-linked urethane resin binder system guarantees the best possible bonding of the oxide, totally unlike the cheap vinyl adhesives used by 8-track manufacturers in consumer tape.

The bonding is so positive, so permanent, that oxide shedding, and the problems shedding creates are virtually eliminated.

This combination of features means that tape life of 10,000 plays or more can be expected from

Dynamax broadcast tape, in Fidelipac cartridges, will deliver 10,000 plays—or more!



Fidelipac is making a new brand of broadcast tape, Dynamax, formulated to satisfy the special requirements of the broadcast professional.

Fidelipac cartridges loaded with Dynamax.

Phase stability is enhanced by maintaining constant tape width, and smooth, clean edges. On our own tape slitting equipment, we can control tape width to 1/1000 of an inch. So, the stereo phase performance of our Master Cart,™ loaded with Dynamax, is truer than ever.

I'd like to send you a sample Fidelipac Master Cart loaded with Dynamax broadcast tape. Just circle our number on the reader response card in this magazine, or write me, Arthur

Constantine, at the address below. Test Dynamax broadcast tape yourself. Measure the long life. Delight in the transparent sound.

See us at NAB Booth 411.



Fidelipac Corporation □ P.O. Box 808 □ Moorestown, NJ 08057 □ U.S.A. □ 609-235-3900 TELEX 710-897-0254 □ Toll Free 800—HOT TAPE

"Dynamax" trademark applied for. "ScotchCart" trademark applied for. • Registered trademark of DuPont.

Circle 222 on Reader Service Card

www.americanradiohistory.com

AUDIO PRODUCTION EQUIPMENT

Whether for radio or television, microphones are required for audio production and the exhibits this year show how versatile mics are for field and studio use. Shure Brothers (1410A) will set up a display with video cameras for its Automatic Microphone System. Also on hand will be the standard line of mics and mic accessories.

Sony Pro Audio (605/1200) will debut SOAR, an elaborate VHF wireless system with frequency flexibility in the same unit. Elements include handheld lavalier bodypack mics, diversity and nondiversity receivers, power suppliers, and antenna dividers.

For its part HM Electronics (1130) will unveil System 82, a second-generation body-pac wireless microphone system with 115 dB dynamic range and System 280, a



New, light earphone type intercom hardware will be introduced by R-Columbia.

flat-pac receiver configuration for ENG/EFP production. Established products include System 85 and 58 handheld wireless mics.

New RF microphone products this year from Cetec Vega (1401C) will include the 66/DII portable battery-powered receiver and 67A/DII portable diversity battery-powered receiver, both with 02 Dynex II low-noise processing. Also on hand are the T-81, T-82, and T-83 handheld transmitters with Shure SM58, Shure 85, and AKG C-535 mics, respectively.

Micron Audio Products (1122C) will introduce its TX-203 handheld wireless mic transmitter with interchangeable mic heads and the MDR-3 mobile space diversity receiver and MDS-2 modular multichannel diversity receiver. These join the CTR-101 mobile wireless mic for ENG.

At the Sennheiser Electric booth (1137) will be a complete line of wireless microphones including body packs and handheld systems, plus new lightweight headset/boom combinations. There is also a new version of the



Micron Audio has entered the microphone fray with its introduction of a diversity wireless system.

MKE-2 lavalier unit.

The Calrec Mark 4 soundfield mic and the proprietary Ambisonics surround sound system, as well as a full range of condenser mics, can be found at the Audio & Design Recording booth (402). Audio-Technica (1141) will be introducing two new battery/phantom-powered lavalier mics, the AT803A omnidirectional and the AT831A unidirectional. Accompanying this display will be the complete range of battery- and phantom-powered mics, including new shotgun designs, two studio dynamic mics, and a studio electret condenser mic.

Both shotgun mics and headsets will be featured in the Beyer Dynamic booth (426). New are the MC 736 short shotgun and the MC 737 long shotgun condenser units. In addition, the DT 108 single-muff and 109 dual-muff headsets will be on hand.

At the high end, Bruel & Kjaer Instruments (511A) will show its line of studio mics. Meanwhile, Countryman Associates (1720) will unveil the new TVH Isomax broadcast mic plus the Isomax II podium extension mic as part of its full line.

Two new models to its line of PSM mics, the 180 and 12SP, can be found at the Crown International booth (428). Electro-Voice (1159) will be back with the RE34 cardioid condenser mic, introduced last year. And Fostex (1765) will have a line of mics featuring the printed ribbon series.

Once again the complete range of Neumann mics will be found in the Gotham Audio booth (509A). Stanton Magnetics (102) will be exhibiting the PBR Series of lightweight earphones as well as its pickups. In turntables, there will be the RTQ-7 direct drive unit from Russco (413).

INTERCOMS

Intercom systems, especially those aimed at TV stations, have become so complex that any new feature has to be big to raise much excitement. New features will indeed make the NAB scene, but on the whole things will be quiet on the intercoms.

New from Clear-Com (1502) this year will be the CP-300 portable remote intercom station, which allows two channels on a single mic cable. Also check out the TW-12 interface device, designed to interface Clear-Com-type intercom systems to RTS-type systems. Other featured products will be the MS-808 intercom

AM Stereo Without Compromise



C-QUAM[®] AM Stereo System by Delta Electronics, Inc. FCC Type Accepted

Delta Electronics, Inc. introduces the ASE-1 AM Stereo Exciter and ASM-1 AM Stereo Modulation Monitor: FCC type-accepted C-Quam System transmission equipment for the AM Stereo broadcast market. C-Quam is the *Compatible* Quadrature Amplitude Modulation system developed by Motorola, Inc. C-Quam is the system of choice for more than 70 U.S. stations plus additional Canadian stations. Users range from kilowatt day-timers to full-time network flagships. These stations report enthusiastic response from listeners using multimode and full C-Quam stereo receivers as well as typical monophonic receivers. The key is compatibility without compromise. All listeners, stereo and mono, receive a clear signal with low distortion. Delta's twenty-year leader-

ship in the field of broadcast instrumentation solidly backs this technological advance.

The proliferation of receivers from GM's Delco Electronics, Inc., MacIntosh Labs, Sherwood Electronics, Chrysler Corporation, Concord Electronics, Samsung Electronics and others not yet announced, is creating a sizeable C-Quam audience. With the outstanding performance of this equipment, you can be sure that the audience will *stay* tuned to your Delta C-Quam AM Stereo transmission system.

For additional information, contact Bob Bousman at (703) 354-3350.

C-QUAM is a registered trademark of Motorola, Inc. Manufactured under license from Motorola, Inc.

See us at NAB booth 105

DELTA ELECTRONICS

5730 General Washington Drive, Alexandria, Virginia 22312
Telephone: 703-354-3350 • TWX: 710-832-0273 • Telex: 90-1963

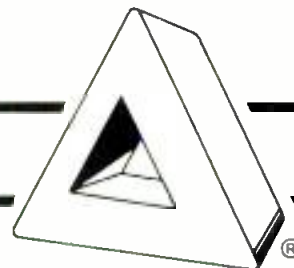



134 East Center Street, P.O. Box 1422, Manchester,
CT 06040 (203) 646-1839 TWX 710-427-0732

UPLINKS AVAILABLE

Multiple Transportable Uplinks
And Transponder Time Available
To Most Domestic Satellites And
Access To International Gateways
For The Following Events:

DEMOCRATIC NATIONAL CONVENTION

- Direct Feed From
Convention Floor

1984 SUMMER OLYMPIC GAMES

- Uplinks Available With Access
To The International
Broadcast Center
- Remote Playback And
Production Facilities Available

REPUBLICAN NATIONAL CONVENTION

- Dallas Convention Center
- Edit And Playback Positions On
Convention Floor/Remote
Locations

CONTACT:

*Denise Parrish
Event Coordinator
Telephone 203-646-1839
TWX 710-427-0732*

mainframe and the IS-808 remote station.

Along with its established 150E wireless intercom and its 700 Series cabled intercoms, HM Electronics (1130) will bring to NAB the new BH710W wireless interface belt pack for half-duplex communications and the WL742 wall-mount speaker station for the 700 Series.

Cetec Vega (1401C) will also show a line of pocket transmitters, receivers, wireless intercom master stations, transmitters, and receivers.

New from RTS Systems (1142) will be the Series 17 intercom, a low-cost conference line system for single-channel portable and permanent applications. Also to be shown are the new System 2500 amplifiers for high performance plug-in applications and a display of the Plantronics/RTS line of three ultra-light communications headsets. Existing products will include the TW intercom conference line system, the Series 800 intercom, and the microprocessor-assisted master station.

The MicroCom high-end microcomputerized hard-wired systems from Ward-Beck (1224) will also have some new features to check. Another highly flexible system is the ROH (1634) Series 300, which performs in several combinations of configurations in eight-, 16-, 24-, or 32-channel versions.

Swintek Enterprises (1503) is highlighting its 200-D Series full duplex communication system with rechargeable battery pack. Also on display will be a multitrack system for mounting six transmitters and six receivers in news applications.

Farrtronics (1709) will be represented with the Model 525 intercom stations and the Model 175 intercom stations. And from Nady (1133) look for the Model PRC-3 duplex system. R-Columbia (1111) is displaying Ultra-light mono/stereo headphones as well as the new Model 6058 hands-free telephone for IFB and ENG use.

Speaking of ENG use, Motorola C&E (309) will be unveiling an ENG vehicle communications system for IFB and general applications, completely synthesized with automatically programmed power levels. New cellular mobile phones, headset amplifiers, and alphanumeric papers will also be introduced. Other new products will include the 2002 communications system analyzer and the MSF 5000 fully synthesized base station/repeater.

TEST AND MEASUREMENT

Thanks to the microprocessor, audio test equipment has become more versatile over the last few years. For example, Amber Electro Design (422) is introducing at NAB the 5500 programmable distortion and noise measuring system with fully automatic audio analysis featuring IEEE-488 interface capability, and balanced inputs and outputs. Returning is the Model 3501 distortion and noise measuring system.

Sound Technology (500), too, will have its highly versatile 1510A "all-in-one" tape recorder/audio test instrument, which performs several tests on just about every kind of audio sound equipment.

At the Tektronix booth (1601) will be the new 494 spectrum analyzer for 10 KHz to 325 GHz measurements. It features a HELP mode that guides the user through the test steps when needed.

This year Leader Instruments (1349) will again have an extensive line including the LSG-216 AM/FM synthesized signal generator and the LSW-115/LBO-115 audio sweep/marker generator. Also new are the LSG-125 low distortion audio generator; LAV-192 audio tester; and

Circle 224 on Reader Service Card

It copies tape

Fast!

What else is there to say?

Well . . . to be perfectly clear we should say that the Telex 6120 Duplicator copies reel or cassette tapes fast. Then we should add that it does it automatically, easily, efficiently and economically. In fact, we really should say that the 6120 produces **high quality** tape duplicates — fast.

Yes, the Telex 6120 high speed duplicator has many time-saving, money-saving benefits, including many **automated** features such as end-of-tape stop and auto rewind on the reel master, with a choice of auto or manual rewind on the cassette master. These automated features can eliminate unnecessary down time between copy cycles. All key set-ups and adjustments are **efficiently** accomplished from the front of the system, with all operating, function controls and LED level indicators **conveniently** grouped together on the easy-to-read control module. These automation and convenience features allow even non-technical employees the ability to operate the 6120 **easily**.

You won't have to buy more system than you need because the 6120 allows practical "building block" growth. The modules simply plug together for easy **economical** additions to your system. Each cassette slave position on the 6120 is independent, so a jammed tape won't shut down the entire system creating costly downtime. An LED indicator warns you of an incomplete copy in case a cassette tape jams or ends before the master, thereby preventing expensive mistakes.

Make no mistake, the 6120 is fast. It has a speedy 16 to 1 speed ratio and copies both sides at once, so it will duplicate full one hour programs in less than two minutes. As you can see it's not just another high speed duplicator. To learn more about the 6120, call or write today for complete specifications and production tables. While you're at it, make an appointment to see our informative video tape presentation entitled "Beating Real Time."

Call Toll Free in U.S. 800-828-6107
In Minnesota Call (612) 884-7367

TELEX

TELEX COMMUNICATIONS, INC.

9600 Aldrich Ave. So., Minneapolis, MN 55420 U.S.A.
705 Progress Avenue, Unit 10 • Scarborough, Ontario M1H 2X1 Canada
Le Bonaparte—Office 711, Centre Affaires Paris-Nord, 93153 Le Blanc-Mesnil, France.

Circle 225 on Reader Service Card





The APM-2RA, a brand-new audio program monitor from Videotek, is rack-mountable.

LFM-39A wow & flutter meter.

Potomac Instruments (100) will have on hand the MPC11 modulation and power controller for equipment testing, along with its full line of instrumentation.

On display at the Marconi Instruments booth (1615) will be the Model S1100 audio transmission test set, Model 2305 AM/FM modulation meter, and the Model 2914A insertion signal analyzer. The company will also introduce Model 6960 automatic RF power meter.

Eventide Clockworks (323) will again have its real-time audio spectrum analyzer SPX252 for use with the Apple II computer. New at Bird (1625) will be the relative field strength plug-ins for the ThruLine wattmeters.

Among monitor manufacturers at the big show, Electro-Voice (1159) will introduce the Sentry 100EL, which is essentially the Sentry 100A with an internal 50 W power amp. Belar Electronics Lab (203) will once again have its line of low-distortion AM and FM units as well as AM stereo monitors.

JBL (615) products on display will include the 411 direct radiator loudspeaker system, the two-way 4301 broadcast monitor, two-way 4401 compact studio monitor, and three-way 4312 compact studio monitor.

To hear the Klein & Hummel line of self-powered broadcast monitor loudspeakers, go to the Gotham Audio booth (1227A).

PROGRAM AUTOMATION

At last year's NAB it appeared that the computers for program automation and the computers for station "housekeeping" chores might be ready to merge into total systems. As this year's show gets underway, the possi-



Moseley is introducing this year a new CRT option for its MRC-1600 remote control system. All system parameters can be controlled from the outboard location.

bility of this merger is still unclear.

The program automation systems are still generally standalone. Broadcast Electronics (303), which last year had been involved with Computer Concepts (404) in the Total Station Automation system, this year is touting again the Control 16x microprocessor control automation system for radio programming and the SAT-16 for satellite programming.

Harris Corp.'s Broadcast Division (401) covers all the bases with separate systems. The 9000 is for program automation, Autotron Star is for business automation, the 9165 is for satellite antenna control, and the 9100 is for remote control.

Barrett Associates (103) will introduce the Davbar Corp. DB-8 Space Saver broadcast audio cassette automation system. IGM Communications (403) has in its line a full automation system for the Go-Cart.

Several companies such as Computer Concepts (404), General Computer Systems (308), The Management (627), Phoenix Systems (609), and Cetec Broadcast Group (509), have general station operations computer systems.

REMOTE CONTROL, RPU, STL

Remote control and STL technologies have experienced greater competition over the last year as more companies enter the market. The heavyweights are mostly familiar, with Harris (401) introducing STL transmitters and receivers in both 2 GHz and 13 GHz models. LPB (405) will premiere new high-efficiency 15 m AM STL antennas, as well as a new low-power AM STL transmitter. Telemet (1202) will make use of new technological advances with the demonstration of a working fiberoptic STL and phone equalization system.

Marti (501) once again will have an impact with its new STL-10 line-of-sight FM communications unit, providing a broadcast audio channel with two optional subcarriers in either mono or stereo. The company will also unveil a full line of RPU transmitters and the ARS15 repeater stations with digital remote control, as well as the ATS automatic transmitter switcher. A new AM stereo STL and remote control system will be introduced by Micro Controls (104).

Still innovative in this field is Moseley (301), which will show new options for the MRC-1600 remote control system including a CRT terminal option for full control of



SERIES 2500 AMPLIFIER SYSTEM

Introducing a series of super high-performance audio amplifiers designed to be part of a versatile three rack-unit card-frame system. The Series 2500 will offer a variety of 20 plug-in amplifiers. The first four are featured in this bulletin.

Thorough circuit design coupled with industrial high-grade components assure unconditional stability and long-term reliability. A full-frame steel housing surrounds each amplifier for structural support and electrical shielding.

Some of the exceptional specifications common to 2500 Amplifiers are: +28 dBm into 600 ohm loads from 30 Hz to 20 kHz all outputs driven; +32 dBV max input level; SNR > 100 dB; input CMRR typ 75 dB @ 50 Hz; 4 μ s rise time; max phase shift +22.5° @ 20 Hz, -22.5° @ 20 kHz; output source impedances of 80 ohms or less.

Interconnection to external equipment is simple and reliable via .025 square post terminations. This universally accepted technology is inexpensive and easy to install or modify.

MODEL 2510 1 X 6 Audio Distribution Amplifier. Isolation between outputs typ 70 dB @ 1 kHz. Maximum output level with <0.1% THD from 30 Hz to 20 kHz into 150 ohms is +35 dBu and +28 dBm into 600 ohms. The output transformers do not require termination and exhibit less than 1% overshoot.

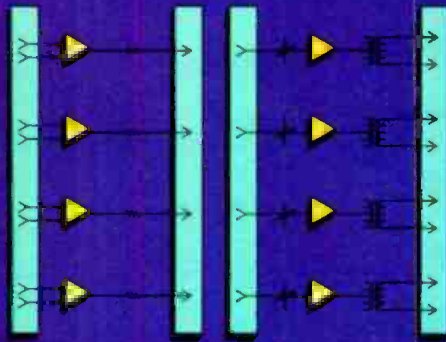
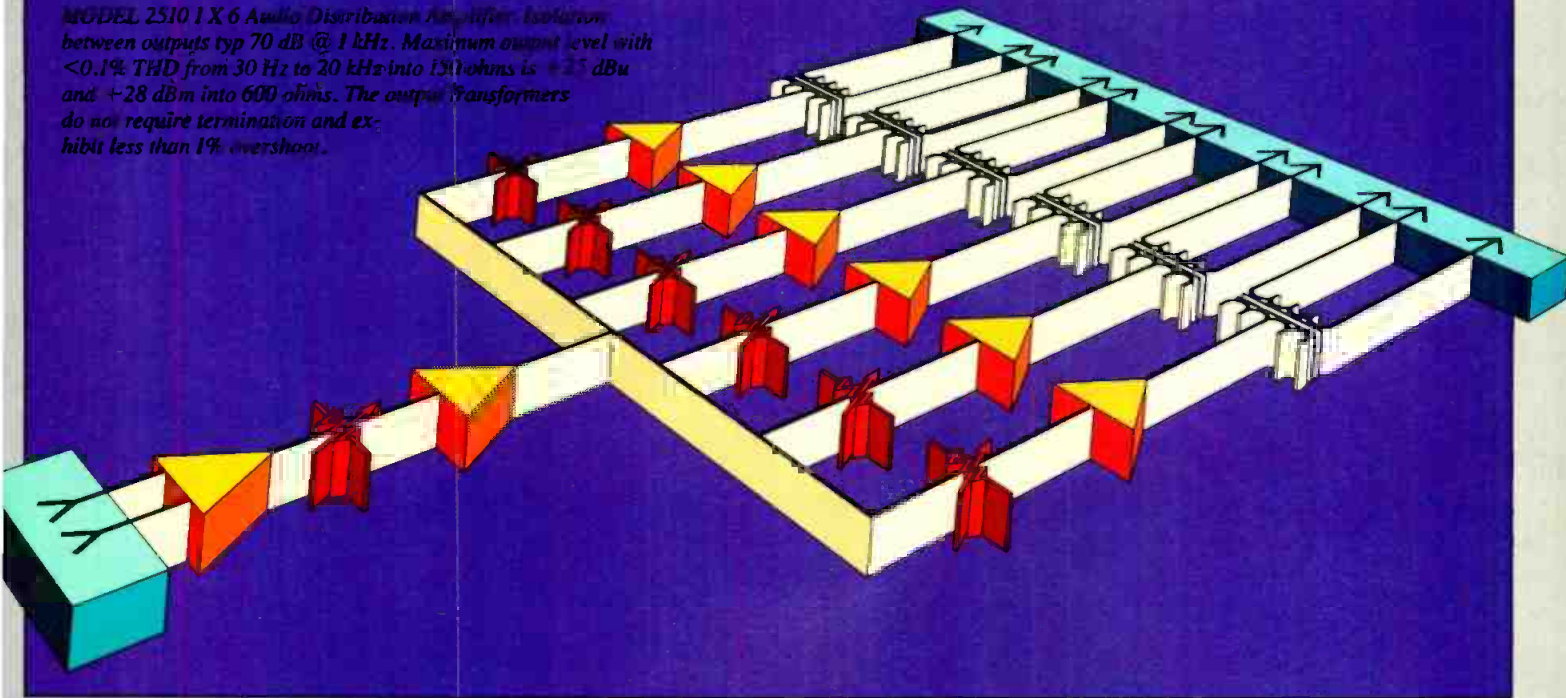

MODEL 2512 Stereo 1 X 6 Audio Distribution Amplifier can be used as a single 1 X 12 or a dual 1 X 6 distribution amplifier. Optional remote-gain VCA circuitry is available.

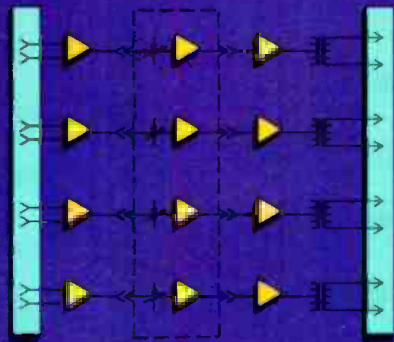

MODEL 2514 Quad Line Amplifier can be used as four discrete amplifiers or two stereo pairs. Optional remote-gain VCA circuitry is available.

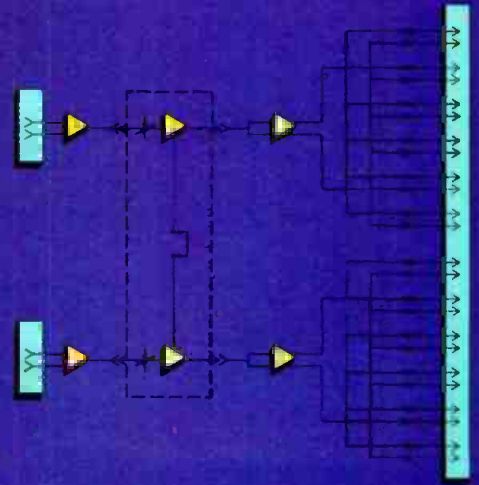

MODEL 2516 Quad Buffer Amplifier is primarily designed to interface unbalanced -10 dBV THF level equipment to balanced +11.8 dBm professional equipment.

the transmitter from the terminal keyboard. Modulation Associates (1737) will also have new impact with a remote control and monitor system, the UC-10 uplink controller. Potomac Instruments (100) plans a new product, the RC16+ remote control system.

Symetrix (616) has used new capabilities in microprocessor design in its new remote control system, the DCS-16, while Hallikainen & Friends (208) will introduce the DRC 190 with 10 channels of remote control capacity.

RADIO TRANSMITTERS/SCA

Though SCA is one of the hottest topics of discussion in radio these days, as much equipment development is focusing on signal improvement in the basic AM and FM transmitter department as it is in the reborn subcarrier business, though both areas show a healthy load of new products. One indicator of this type of concern can be seen in the CSI (507) announcement of a complete redesign of its line of FM transmitters, gearing up for the signal qualities demanded today.

Tremors may be felt by domestic manufacturers as the Dutch giant Philips (1500A) introduces its PYE TVT line of FM transmitters to the U.S. for the first time. Products will range from 100 W to 20 kW, featuring common modular drive and comprehensive monitoring. The LDM 1208, a compact 55 kW transmitter, also will be displayed.

Harris (401) will introduce a new transmitter among the vast array of transmitting products it is planning for this show. The newest item is the MW-50C 50 kW medium wave transmitter. Another large company, Thomson-CSF (1001), will have transmitter introductions with new power. A 2.5 and 1 kW FM transmitter and a new 200 W FM translator will be unveiled along with three series of new klystrons for 24 channel C-band transmission.

NEC (1415), too, will introduce a new series of FM transmitters, the FBN-9000. Always with something to say in tubes, Amperex (1412) will premiere the new YK1263 klystron tube. QEI (307) will unveil a new 25 kW transmitter using a single grounded grid tube for stability, in addition to introducing the new 695 transparent plus FM exciter.

Broadcast Technology (1701) will draw attention with the new Vectrix 4000 narrowband FM low-level 24-channel generator, which transmits on coax or twisted pair for over a mile to 300 channel-selectable receivers. In another extension of the limits of transmitting technology, Bird Electronic (1625) will introduce 15 and 25 kW forced-air-cooled dry load resistors for dual transmission installations. Singer Broadcast (101A) will have several new products this year, among them a new FM 30F exciter and ST 30F stereo generator, in addition to the SC 30F SCA generator.

SCAs are on everybody's mind to some degree, and that includes CRL (106), highlighting the SCA 2 main channel interference protector as well as a new FM stereo generator for improved transmission specifications. Modulation Sciences (294B) has geared up its Data Sidekick for digital information transmission on SCA with a baud rate of 4800. Micro Controls (104) will show new SCA paging equipment for broadcasters. Emergency Alert (508) will be adding new SCA receivers to its line.

Many companies expecting a hot market will have an impact in the AM stereo sector, Kahn (625) plans to show an extensive AM stereo transmission system including re-

ceivers. Broadcast Electronics (303) will be showing new developments in the AM stereo department along with its complete supply of transmitting equipment. One of the biggest forces in AM stereo is Motorola (309), which will demonstrate complete AM stereo systems in addition to having a car in the parking area for a receiver demonstration.

In the standard AM market, LPB (405) should turn a few heads with its introduction of low-power AM transmitters for PSRA, PSSA, STL, and LPRT uses with levels from 5 W to 150 W. LPB will also show new 15 m AM antennas for STL and LPRT sites. Spencer Broadcast (406) will debut a new low-power AM transmitter.

In the antenna phase of transmission, several

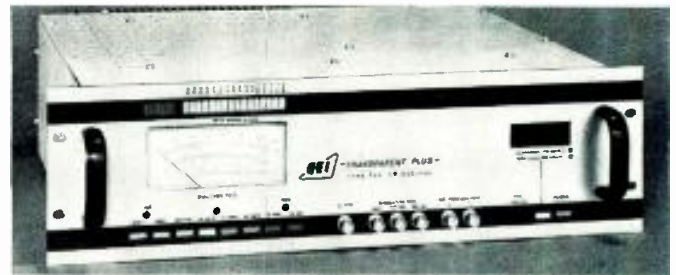

QEI continues to show new products in transmission-related areas; the Model 695 FM exciter will be the new product this year.

companies are expanding their lines. Celwave RF (202) will introduce a new FM antenna series and coaxial transmission line. Cetec (509) is going after the broadband FM market with a new FM panel antenna.

RADIO SYNDICATION

With radio programming formats still in a turmoil, the search for the right combination goes on. At NAB some syndicators are showing up with what they hope is the secret formula.

Toby Arnold (107) will add Unforgettable II foreground contemporary MOR, Your Favorites soft-hit adult contemporary, and Music Radio CHR. The company will describe other previous offerings as well.

Broadcast Programming International (112A), under new management, is changing the music selections and rotation system of its country, adult contemporary, and AOR formats, with personality or music service for country and AC instead of announce tapes.

CBS Radio Stations News Service (606) will feature Byline Magazine, 14 90-second news and information feature broadcasts shipped weekly by cassette and available with market exclusivity.

Concept Productions (423) will introduce Concept 5, the 1984 Disneyland and radioaction telephone game. It will also display automated radio programming services in five different music formats.

DeWolfe Music Library (1120) is displaying its production music library as well as a 21-album sound effects library. Musicworks International (209) will feature new radio programming designed for all formats, live assist, or automated operations.

Soper Sound Music Library (162B) will debut three new music programming series totaling seven albums in contemporary sound. Also showing MusicSelector software for the Apple II for locating and selecting music from the library. Valentino Music Library (1231) will have four new music albums added to its main contemporary music library.

New, updated features and options

- 12, 24, 36 or 48 cartridge capacity, mono or stereo
- New microprocessor controlled front panel
- Individual microprocessor control for each bank of 12 cartridges
- New audio pre-amps, data and program amplifiers, all with NE5534 IC's
- New improved 150 Hz and 1 KHz sensors
- Audio mute at the end of the 150 Hz tone - each tray
- Pre-amp equalization and level controls - each tray
- Meets NAB or IBA (United Kingdom) specifications

The Mainframe

Instacart's instant access capability is made possible because each play position has its own playback head, solenoid for actuation, tray assembly, pre-amp, 150 Hz tone detector, and 1 KHz stop detector.

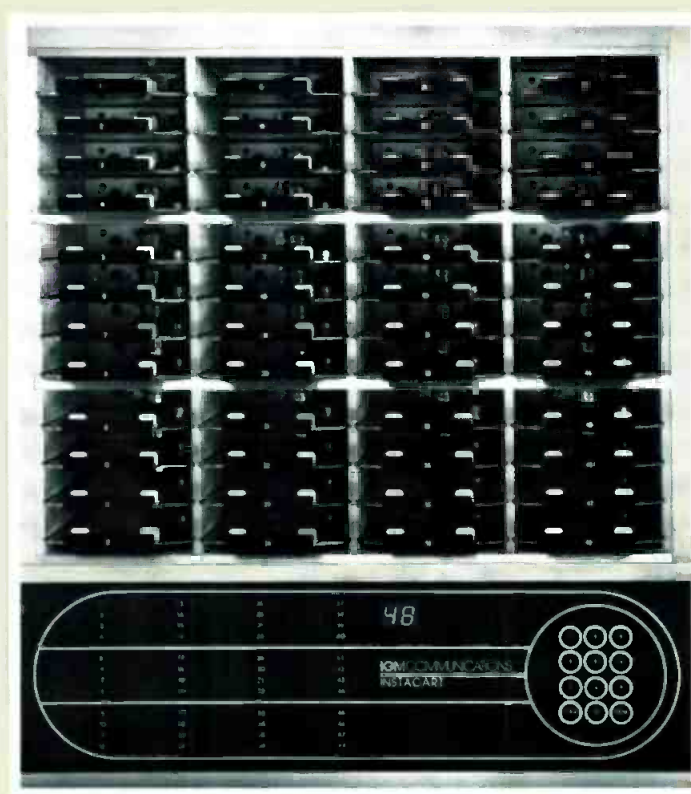
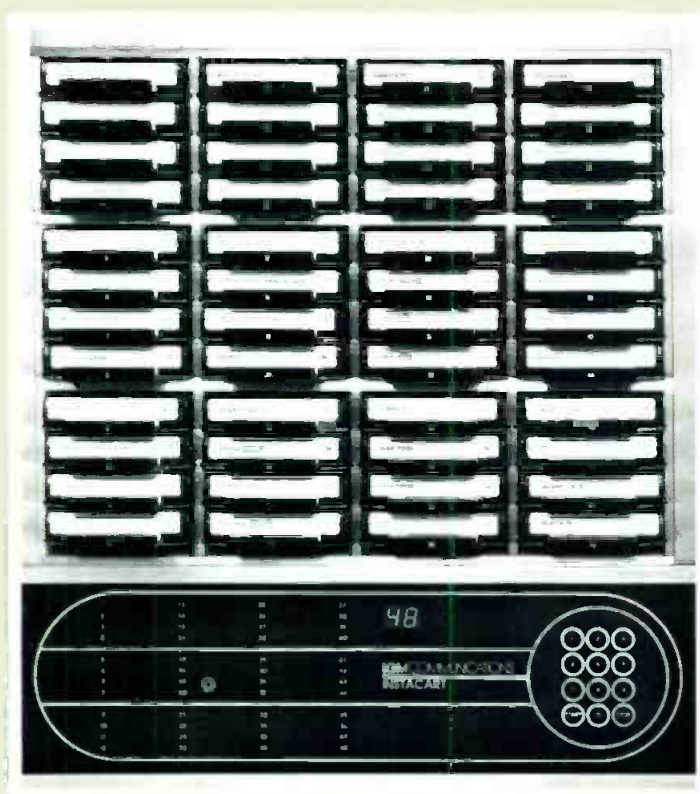

- Available with Maxtrax™ (wide track) heads
- New individual, modular power supplies
- 60 or 50 Hz, 120 or 240 VAC operation
- RS422 serial interface for computer control
- Parallel interface - duplicates older Instacart
- Optional multiple audio outputs from each bank of 12 cartridges
- New head connectors
- Improved access and modular construction for maintenance and service

Each patented linkage assembly, head and solenoid, which are accessible for service or replacement, remain stationary in the mainframe. When a cartridge is started, the solenoid is engaged and pulls the cartridge in by 1/16 of an inch to contact the capstan drive shaft. This 1/16 inch movement is the only mechanical motion encountered in the Instacart, except that of the capstan and motor.

Newly redesigned main audio and control printed circuit boards (one for each stack of 12 trays) feature individual pre-amps, 150 Hz sensors and 1 KHz stop tone sensors for each tray. Audio level controls as well as equalization controls are also included.

A microprocessor on each board handles all control functions and audio switching for 12 cartridges, along with communications to the main microprocessor located on the front panel.

Audio muting for each tray is standard, audio switching is all solid state, each pre-amp is switched on the audio bus at tray start, and switched off the

In Instacart the playback heads and drive assemblies remain stationary. When a cartridge is called to play, the solenoid is energized and pulls the cartridge in by 1/16 of an inch to contact the capstan drive shaft. This 1/16 inch movement is the only mechanical motion encountered in the Instacart, exclusive of the capstan and motor.

The direct tape drive system consists of high quality, high torque motors especially designed for continuous duty (in some stations, the Instacart is turned on during system installation and not turned off again for literally years . . .).

Each motor drives a precision capstan shaft for each stack of 12 cartridges. Each capstan drive shaft is fully supported by three precision fixed position sealed bearings and two motor bearings.

Each precision head assembly with its solenoid/linkage is removable for service and parts replacement or adjustment.

Instacart's audio characteristics are better because there is virtually no movement of the cartridge or carrier after insertion. The cartridge lies on a perfectly rigid carrier made of stainless steel that slides forward smoothly, allowing the pinch roller to contact the capstan drive shaft and causing the tape to play.

When the message or music selection is completed, the carrier returns to its "at rest" position 1/16 inch from the drive shaft. Because the mechanism moves only 1/16 inch, the cartridge tape, tray and head always maintain precise alignment relationships. It is this degree of tolerance that allows radio stations to use Instacart so effectively for stereo music, the most demanding of cartridge tasks.

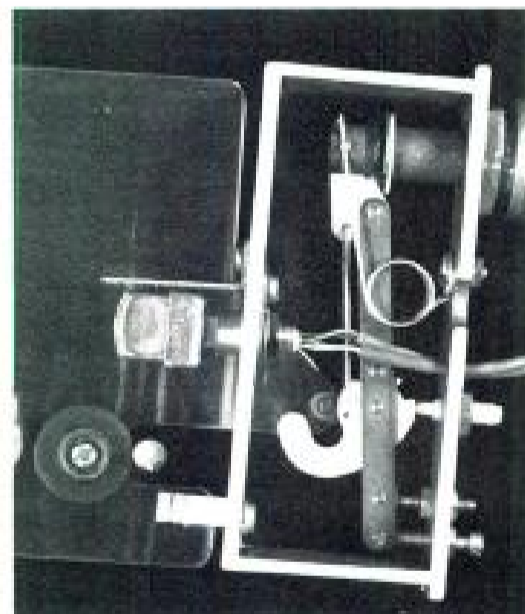
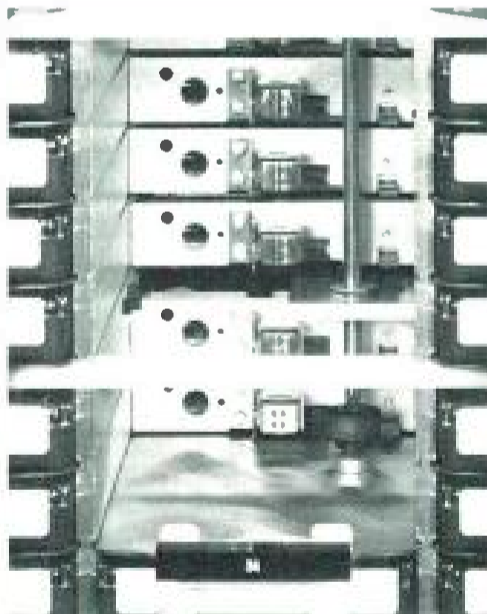
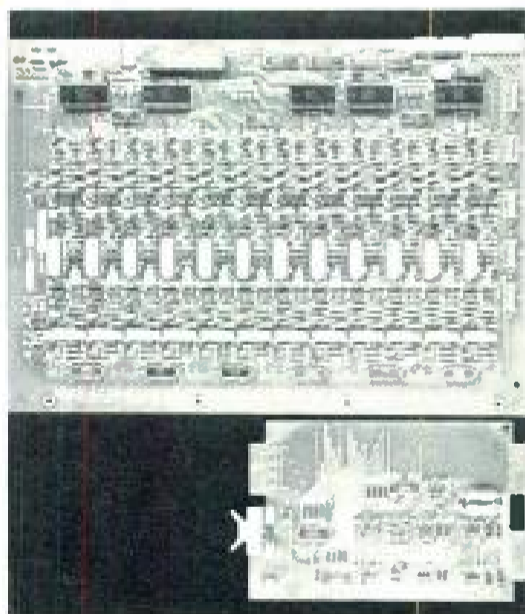

audio bus at the end of its 150 Hz tone or at the 1 KHz tone, whichever arrives first.

Solenoids are switched on at full voltage and then held on at a lower voltage to eliminate heat buildup.

The new program and data track amplifier board features 600 ohm balanced, transformerless audio outputs, 10K ohm unbalanced data output along with the main audio and data level controls. NE5534 IC's are used exclusively for all audio in the new Instacart.

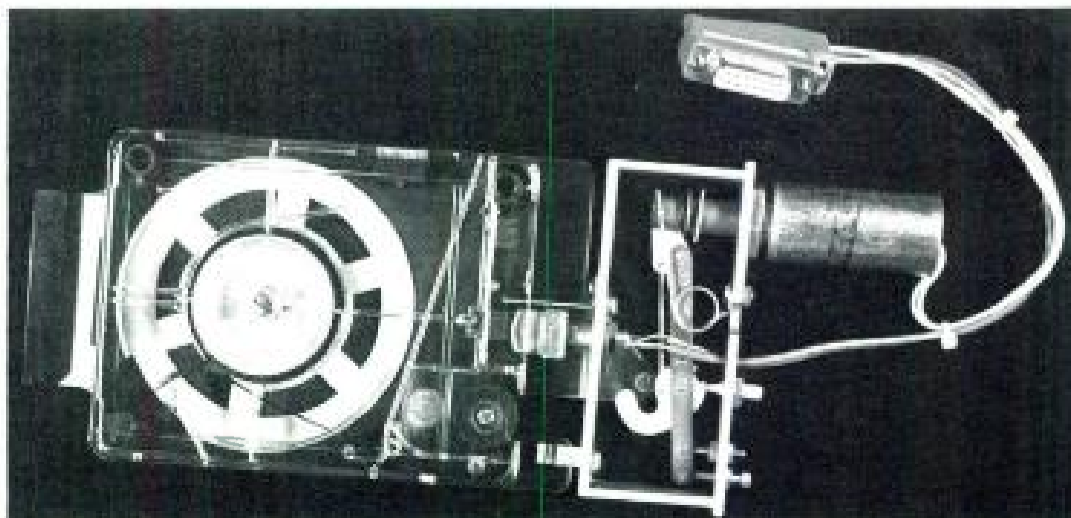

INSTACART

Lowest Maintenance Multiple Cartridge Playback Unit On The Market Today

Instacart was designed with the station engineer in mind. Accessibility to the unit is simple and direct for inspection, cleaning, routine adjustment and functional tests.

A plug-in connection mates each removable precision head to its associated electronics.

As in all IGM products, components throughout are the highest grade available. Circuitry is fully solid state. Components are mounted on Mil Spec fiberglass printed circuit cards.

Because of the unique cartridge/tray combination, individual playback heads can be contacted only by playback tape. It is physically impossible for any part of

the cartridge or tray assembly to touch the playback head in an Instacart. Therefore, alignment and adjustment of head assemblies, once set at the factory, are now a thing of the past.

Virtually the only maintenance required by Instacart is routine head, capstan shaft and pinch roller cleaning.

Easy to understand electronic circuitry, proven, simple, reliable mechanics combine to make Instacart the lowest maintenance multiple playback unit on the market today.

The IGM Instacart has found wide acceptance in both broadcast and industrial fields. This ingenious device has established an impeccable record of reliability and performance in highly demanding, continuous-duty applications.

Instacart Specifications

Wow and Flutter: Less than .15% weighted peak
 Timing Accuracy: .1% or better
 Start Time: Less than 100 mSec
 Stop Time: Less than 40 mSec
 Tape Speed: 7.5 ips. One direct drive hysteresis motor for each bank of 12 cartridges.

Output Impedance:
 Load: 600 ohm balanced or unbalanced.
 Source: 150 ohm balanced, 75 ohm unbalanced.
 Output Level: 0 dBm nominal
 Maximum Output Level: +25 dBm balanced, +9 dBm unbalanced.
 Amplified Distortion: Less than .5% THD
 Signal to Noise, Stereo: -50 dB unweighted
 Signal to Noise, Mono: -53 dB unweighted
 Cross Talk Between Channels: 45 dB or better
 Equalization: NAB standard (others available on special order)
 Frequency Response: Amplifier \pm .5 dB NAB curve
 Cue Signals: 1 KHz primary, 150 Hz secondary
 Data Output: .5 Volt into 10K ohm load
 External Connectors: XLR Type - audio and data
 Power Requirements: 120 VAC, 60 Hz, 110 watts (240 VAC, 50 Hz on special order)

Weight: 160 lbs.
 Dimensions: Height 21"
 Width 19"
 Depth 19 3/4"
 Mounting: Requires 25" deep rack with center mounting rails.
 Models: 12, 24, 36, or 48 cartridge playback, mono or stereo

12•24•36•48

Instacarts opened up a new dimension in programming and sound production for all broadcast modes, whether live, manual assist or fully automated. The significance of the instant access capability to radio or TV production and on air programming allows operators and sound production personnel to be completely freed from concern about the location of a particular "carted" feature, PSA, commercial, sound effect, music selection, or news insert. They simply command any cartridge to follow any other cartridge from the same machine --instantaneously.

It's easy to see why the Instacart has indeed become, and still is, the standard of the industry.

Custom Configurations

Instacart is available in many custom configurations for special applications in TV, motion picture and radio post production, sound sweetening and sound effects, in configurations for non-broadcast applications, including an FCC approved system for telephone inter-connect. We invite interested persons to request our separate brochure on the Instacart for post production and information systems. Requests for custom applications and special configurations are also invited.

Options

RS422 serial interface
 Parallel interface (duplicates older Instacart)
 Multiple audio outputs - left or left and right from each bank of 12 carts
 IBA (United Kingdom) audio specifications
 Standard NAB specifications with improved frequency response
 50 Hz 120/240 VAC operation
 Maxtrax™ wide track heads
 Maxtrax™ heads and matrix audio switching
 Light or heavy spare parts kits
 Service and alignment kit

Specifications and options subject to change without notice

Maxtrax is a trademark of Pacific Recorders & Engineering Corporation

IGM COMMUNICATIONS

4041 Home Road
Bellingham, Washington 98226
(206) 733-4567 TELEX 704983

NAB '84

RADIO

RADIO HALL

EXHIBITS

ADVANCED DESIGNS 146 CORP.

Will show its DOPARAD Doppler weather radar system with new features including severe storm detection using pulsed-pair Doppler processing, ground clutter elimination, and path attenuation compensation.

ALAMAR 187 ELECTRONICS

ALLIED 639/641 BROADCAST EQUIPMENT

Introducing to its various lines of broadcast equipment the Telemix IX 15 telephone talk show hybrid interface, the Comtech digital downlink products, the Cat Tabbie splicer, Strobe series of on-air lights, and Moseley MRC 1600 remote control with CRT and printer logger. Will also have Bonneville DAs, consoles from Broadcast Audio and Auditorionics, and the Moseley MRC-1.

ALLIED TOWER 409

Will display its line of AM, FM, TV, and LPTV towers, both supported and self-guyed.

See ad page 230

ALPHA AUDIO 210

Showing Sonex, the open-cell urethane acoustic foam designed to control reverberation time, eliminate stray reflections, and kill standing waves. Employing the anechoic wedge principle, the material optimizes noise dissipation through its spectral geometric shape and offers a 450 percent increase in surface area over flat material.

See ad page 234

ALPHA VIDEO & 645 ELECTRONICS

ALTRAN 124A ELECTRONICS

AMBER ELECTRO 422 DESIGN

Introducing the 5500 programmable distortion and noise measuring system with fully automatic audio analysis featuring IEEE-488 interface capability and balanced inputs and outputs. Will again bring the Model 3501 distortion and noise measuring system.

AMERICAN 176 DIVERSIFIED



Alpha Audio's Sonex foam.

AMERICAN IMAGE 653 PRODUCTIONS

Will unveil a new radio promotion for TV, "It feels like coming home," as

well as a new, high-tech-approach video promo for urban contemporary radio formats. Will also feature its sound production libraries, audio and video station image campaigns, and custom and syndicated TV campaigns for radio and TV.

AMERITEXT 808

Will show World System Teletext equipment and services.

AMP SPECIAL 634 INDUSTRIES

Will show the line of BNC and video connectors.

AMPEX MAGNETIC 1400 TAPE DIV.

Will display its complete line of video and audio magnetic tape products for the professional broadcast industry.

See ad page 23

APHEX SYSTEMS 513

Will introduce the Compellor and also add the MP-1 to existing line of audio processing gear. The Compellor combines the functions of a compressor, leveller, and peak limiter using a single VCA per channel with side chains adjusting parameters on a program-dependent, real time basis. The MP-1 is a new microphone preamp. Among the existing audio processing equipment will be the Aphex II Aural Exciter and the B Aural Exciter in addition to the EQF-2 three band sweep EQ with hi/low pass filters. The CX-1 modular

LOOK INTO IT!

THE SP-5 STEREO PRODUCTION CONSOLE
A new line of high performance mixing systems
on exhibit at the 1984 NAB Convention,
April 29 thru May 2 at the Las Vegas Convention Center.
Also on display: Our A-500 Radio Broadcast Console
and our V-800 Television Console.
Come see us at Booth #121!

LOOK INTO IT AT NAB 84!



 Wheatstone Broadcast Group

5 COLLINS ROAD, BETHANY, CT 06525 (203) 393-0887

Circle 228 on Reader Service Card

www.americanradiohistory.com

NAB '84 RADIO

compressor/expander gate and the 1537A (a 100 dB dynamic range VCA IC) will also be on hand.

ARBITRON 802 RATING CO.

Audience rating services for radio and television.

TOBY ARNOLD & 107 ASSOC.

New additions to its syndicated radio formats include: Unforgettable II foreground contemporary MOR, Your Favorites soft-hit adult contemporary, and Music Radio CHR. Will also describe its Unforgettable nostalgia format, two production libraries, Fun Factor contest and promo package, and specials.

ARRAKIS SYSTEMS 211

New stereo routing switchers at this show will include Models 1100A 16 x 4, 1100B 16 x 8, 1200A 32 x 4, and 1200B 32 x 8. All are also available in mono. Also new will be the 3000 Series modular audio consoles in eight-, 16-, and 24-channel versions.

ASSOCIATED PRESS 419 BROADCAST

Will describe its broadcast news services.

ASSOCIATED 150 PRODUCTION MUSIC

Will show production music libraries for broadcasters.

ATI (AUDIO 420 TECHNOLOGIES INC.)

Introducing the Encore Series DA208 and DA416 low-cost audio distribution amps; dual and quad 1 x 4 models provide up to 16 balanced +18 dBm out-

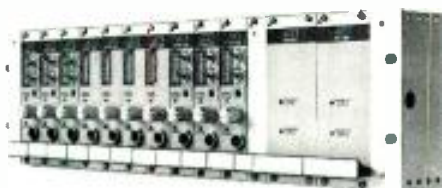

ATI's DA10000 modular DA.

puts, each with individual log taper level control and clipping LEDs for overdrive output. Full range of audio

DAs will include the DA10,000 modular system for up to 10 plug-in amp modules with dual, fail-safe power supplies in a closed front, 5.25-inch Eurocard format enclosure. Also on hand will be the DA1008 and DA2016 independent output and the DA1000 and DA2008 mass feed power DAs. The L1000 dual channel line/buffer amp will also be displayed.

ATLAS 443 TOWER CORP.

Will show its towers, guys, self-supporting towers, tower-related products, and tower leases and leasing packages.

AT&T 407 COMMUNICATIONS

Will describe its Skynet satellite capabilities, featuring audio, TV, and transponder services; the Dial-it 900 service; and terrestrial broadcast services. Will also display the Alliance family of teleconference bridging equipment, and a 45 Mb fiberoptics demonstration.

See ad page 139



Calrec soundfield mic at Audio & Design.

AUDI-CORD CORP. 123

Will introduce a new twin-deck cart player, the TDS series S line. Will also show the full A series and S series cart players, introduced last year.

AUDIO 637A BROADCAST GROUP

Will describe its audio studio furniture, design and construction services, with one-day installation, as well as facility turnkey installations.

AUDIO & DESIGN 402 RECORDING

Introducing the Compex-Limiter Mk2, an audio processor combining a multi-ratio compressor, peak limiter, and noise reducing expander gate using VCA technology. Other audio effects and processing equipment include the SCAMP S31 compressor/limiter and the separate four-band processing system using the new S27 module. Also

demonstrating the Calrec Mark 4 soundfield microphone and the proprietary Ambisonics surround sound system, as well as digital time correction, program control, multi-band processing, and a full range of condenser microphones.

AUDIO ENGINEERING 174 ASSOCIATES

Will introduce a new, low-cost professional record cleaning machine. Also showing BBC ribbon microphones, a line of mic stands, and Schoeps condenser mics.

AUDIO METRICS BY 213 RADIO SYSTEMS

Will unveil the new ESA 10 linear, stereo, 10-channel audio console. Other products on view will be the PA-1 stereo turntable preamp, the DA-8 audio distribution amp, and the PM-1 studio timer. The company will also describe its turnkey installation services.

See ad page 33

AUDITRONICS 505

Featuring the full production version of the 300 Series audio production console, available with four or eight outputs and including submastering to stereo and mono outputs, VCA level control with audio follow video capability, and a comprehensive user-programmable logic system to perform routine stop/start/muting functions. The full range of consoles for broadcast, on-air control, and multichannel mixing will also be displayed with audio accessory systems, and RTW peak program meters.

See ad pages 25, 268

AUTOGRAM CORP. 120

Will feature the AC-6 six-channel audio console, AC-8 eight-channel audio console, AC-10 10-channel audio console, and Microgram—an all microprocessor-controlled console with live assist programmable to 792 events.

AVC SYSTEMS 331

Will show the several lines of audio and video equipment it carries, including Harrison consoles, BTX synchronizers, and Soundcraft consoles.

BARRETT 103 ASSOCIATES

Will introduce the Davbar Corp. DB-8 Space Saver broadcast audio cassette

automation system. Will also describe its offerings of used and reconditioned broadcast equipment.

BAYLY ENGINEERING 124

Will introduce the new CCS-100 coaxial changeover unit. Also on display will be the 100 W and 500 W solid state transmitters and the line of radio equipment.



Audio-Technica AT813R electret mic.

B&B SYSTEMS INC. 222

BELAR ELECTRONICS LAB 203

Will bring its line of AM, FM, FM stereo, and TV monitors.

See ad page 288

BELDEN 166

BEYER DYNAMIC 426

Introducing two new microphones, the MC 736 short shotgun and MC 737 long shotgun condenser mics, suited for broadcast and film work. In addition, the DT 108 single muff and 109 dual muff headsets will be on hand, available in numerous impedances from 8 to 2 k ohms.

See ad page 224-225

BGW SYSTEMS 421

Will add a new high-performance distribution amplifier to its five lines of broadcast audio power amps and its line of pro mobile industrial audio musical instruments.

BIAS (DATA COMMUNICATIONS CORP.) 1014

Will bring a new newsroom computer system, developed by Beston/McInnis Skinner and based on the IBM PC. Also new will be Buyline, an umbrella of products and services for stations, reps, and agencies through one unified source, designed to speed up broadcast spot buying with fewer discrepancies. Will also show its master control automation system, feature film system,

and financial and accounting systems for broadcasters.

BLACK'S COMMUNICATIONS CONSULTANTS 657

BOONTON ELECTRONICS CORP. 228

Will show its line of modulation monitors, RF power meters, wattmeters, voltmeters, RF signal generators, and impedance bridges.

See ad page 228

BRADLEY BROADCAST SALES 186

BRET FORD MFG. 183

BROADCAST AUDIO CORP. 319

Introducing optional accessory modules for its complete line of audio consoles, and unveiling analog version of System 14 stereo audio consoles and new furniture. From the existing line will show Series II modular stereo consoles, System 14 and System 20 stereo consoles, as well as line of accessory amplifiers.

BROADCAST CARTRIDGE SERVICE 611

Will introduce the Capitol/Audiopak AA-4 audio tape cartridge. Displaying full line of broadcast cartridges including Aristocart, Capitol/Audiopak, Fidelipac, and 3M Scotchcart. Also demonstrating reloading service, storage systems, alignment tools, stereo phase meter, and Fone box.

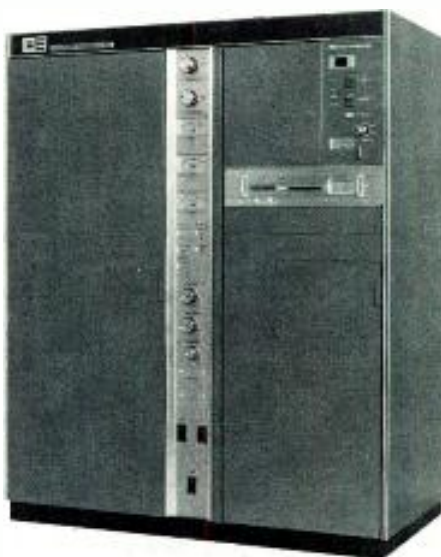

Broadcast Electronics FM-30 transmitter.

BROADCAST ELECTRONICS 303

Announcing the company's twenty-fifth anniversary of making single, triple, and five-deck tape cartridge machines. Showing audio consoles from Series 150 and 250, 5 - 10 mixer models, and from the Series 350, a slide attenuator 10 mixer. Demonstrating Control 16x microprocessor control automation system for radio programming, and the SAT-16 for satellite programming, plus Econo Control 16. Will have full line of FM transmitters including Model FM-30 30 kW, FM-1.5 1500 W, FM-5A 5 kW, and the FM-3.5A 3500 W one-tube transmitters. Also on hand will be the Model FX-30 synthesized FM exciter, FS-30 stereo generator, various turntable models, turntable preamps, and Rek-O-Kut tone arms.



Comrex 2x frequency extender.

BROADCAST MUSIC, INC. (BMI) 619

Discussing music licensing arrangements in the broadcast industry.

BROADCAST PROGRAMMING INTL. 200

The company, now under new management, is changing the music selections and rotation system of its country, adult contemporary, and AOR formats, with personality or music service for country and AC (instead of announce tapes) and a new promo service. Easy listening, MOR, beautiful music, and classical formats will also be described.

BROADCAST SUPPLY WEST 112A

Will introduce new Prorax carousel cartridge racks. Model C80 holds 80 cartridges with 40 viewable at one time, and Model C120 holds 120 carts with 60 viewable at once. Also new

Add Color to Your Audio

In growing numbers, broadcasters and postproduction houses are using the 200 to add ambience to their audio. The 200's Hall and Chamber programs add reflected energy to dry voices, delivering fullness while maintaining clarity and articulation. Simple adjustments of the 200's size control can produce ambiances that identify an unlimited variety of spaces, such as a wooden cabin, an empty factory, a long corridor, or a stone temple. Scenes and dialog acquire more meaning – and the audience's ears appreciate ambience as much as their eyes appreciate color.

A reliable, cool-running, affordable package.

Human-engineered panel controls for easy, intuitive operation.

On-board mixing.

Programmable nonvolatile memory for storing up to 10 user setups with instant recall.

Now with the Lexicon Model 200 Digital Reverberator, broadcast audio takes on new color.

Size control – from the smallest closet to grandest canyon.

Balanced input and output connections with a maximum signal level of +24 dBm – in full stereo.

Hall, Chamber, and Plate programs – each with 10 preset variations.



lexicon

60 Turner Street
Waltham, MA 02154 USA
(617) 891-6790
Telex 923468

Export:
Gotham Export
Corporation,
New York, NY 10014

will be the Proamp stereo phono preamplifier. Established products will include the Prorax 100 mahogany wall rack for cart storage, Probase bases for Technics turntables, and Protech tonearms.

BRUEL & KJAER 511A INSTRUMENTS

Will show its line of high-quality studio microphones for recording, broadcasting, and reinforcement.

BRYSTON MFG. 517

Will introduce the 2B-LP audio amplifier, which fits in one rack unit. Will

also show its 100 and 200 W amplifiers and control preamplifier.

See ad page 231

BSM BROADCAST SYSTEMS 637

Will introduce the Series 5000 video and audio routing switchers. Other products will include 10 x 1 audio switchers, 10 x 1 video switchers, 10 x 10 audio switcher and audio DAs.

CABLEWAVE SYSTEMS 108

Will show its line of annular copper corrugated transmission line, plus air

and foam dielectric copper corrugated Wellflex transmission line, RF connectors, microwave parabolic antennas, mounting hardware, and pressurization equipment.

CALVERT ELECTRONICS 125

Introducing RCA's new Saticon III camera pickup tube as well as the newest Thomson-CSF replacement tubes for TV translators and LPTV. The full range of replacement tubes for broadcast applications from pickup to transmitting from several manufacturers will be on display.

CAPITOL MAGNETIC PRODUCTS 206

Will feature the new AA4 broadcast cartridge, in addition to its established A2 cart. A completely equipped radio production room will be located in a suite in the Las Vegas Hilton Hotel for a hands-on production clinic demonstrating recordings onto cart from a compact audio disc.

See ad page 184

CAPITOL PRODUCTION MUSIC 165

Will show its production music libraries.

DWIGHT CAVENDISH CO. LTD. 442

CBS RADIO STATIONS NEWS SERVICE 606

Will feature Byline Magazine, 14 90-second news and information feature broadcasts shipped weekly by cassette and available with market exclusivity.

CBX INC. 160

CELESTIAL MECHANIX INC. 441

Will describe its promotional TV campaigns for radio stations.

CELWAVE RF, INC. 202

Introducing a new series of FM antennas, coaxial transmission line, and RF components. Will display full range of mobile cellular antenna systems.

CENTURY 21 PRODUCTION & PROGRAMMING 204

Will feature its syndicated radio programming services.

STROBEGUARD®

HIGH INTENSITY
OBSTRUCTION

LIGHTING SYSTEMS*
FOR TELEVISION AND
RADIO TOWERS AND
SIMILAR SKELETAL
STRUCTURES.



TECHNICAL PRODUCTS GROUP — BEDFORD DIVISION
35 CONGRESS ST., SALEM, MASSACHUSETTS 01970
TEL: (617) 745-3200

ATTENTION: GEORGE MANDEVILLE, PRODUCT MANAGER

* FAA APPROVED as meeting or exceeding the requirements of Advisory Circular AC 150/5345-43 and FAA/DoD Specifications L-856 plus FAA AC 70/74601

IN 1994, YOUR STATION IS SURE TO HAVE ONE FAMILIAR FACE.

The compact console version of the legendary OTARI 5050 "B" is built to be around for many years. It's the 1/4" two-channel professional machine that has been designed with the performance, features and flexibility a broadcaster needs—today and well into tomorrow.

The rugged MARK III-2 has three-speed capability (field-selectable in pairs of 7.5/15 or 3.75/7.5 ips) with $\pm 7\%$ vari-speed, dynamic braking for gentle tape handling, and it's the only machine in its price category that's available with a full-func-

tion autolocator. The MARK III-2 also features an external machine control interface connector for use with SMPTE time code-based synchronizers or the autolocator. Front panel record calibration adjustments, two-frequency oscillator and an extra 1/4-track playback head are just a few of the helpful production features we've built in.

After you compare features, performance and price, you can feel comfortable making an investment in the machine that's built for the real world.

We're confident of our new MARK III-2. And you can be too.

Contact your nearest dealer who represents The Technology You Can Trust.

Otari Corporation
2 Davis Drive
Belmont, California 94002
(415) 592-8311
Telex: 910-376-4890



Technology you can Trust.



Crown's PZM 180 microphone.

CETEC ANTENNAS 509

Will unveil new series of broadband FM panel antennas with low windload. Also showing the JTC spiral TV transmitting antenna as well as the

JSCP FM antenna, JHCP super power FM, JBCP broadband high power, and the JSP line of spiral panel antennas.

CETEC BROADCAST 509 GROUP

Will feature its automation systems, including VIC, Series 700, and Series 700GLS, along with the complete line of IBM business systems for broadcasters, 2000 and 8000 Series audio consoles, and the MAPS system for station business management.

CHANNELMATIC 328

Will show its automation sequencers,



dbx 700 digital audio processor.

audio and video DAs, video cart and cassette automation systems, remote control systems, and digital clocks.

CHEMIGRAPHIC PRODUCTS CORP. 659

CIRCUIT RESEARCH LABS (CRL) 106/300

Introducing a new stereo generator for improvement of FM transmission. Also displaying full range of audio processing equipment for AM, FM, and TV broadcasters. Systems include multiband AGCs gated to prevent noise pull-up, compressor/expanders, and peak controllers. Will also show the SCA 2 system for main channel interference protection. Another featured item will be the SMP 900 AM matrix processor for AM stereo.

See ad page 239

CLYDE ELECTRONICS 204A

Will feature its lines of audio mixing consoles, pushbutton news presentation mixers, and specialized 19-inch rack-mounting broadcast products.

COLUMBINE SYSTEMS 118

Will show its business and program automation systems.

COMMUNICATION GRAPHICS, INC. 630

Will add silk-screened T-shirts to its line of promotional window decals and bumper stickers.

COMPUTER BROADCASTING INC. 624

COMPUTER CONCEPTS CORP. 404

Introducing a new broadcast computer system, Copy and Co-op Management, for invoices, rotation plans, co-op billing, and copy-related utilities. Micro-Bridge 80 is a software enhancement for users of Wang hardware and will be introduced at the show along with a rate card optimizer program.

NEW!

BIG CLAIMS FROM THE SMALLEST CONTENDER

The HME System 82 Wireless Microphone!

Smallest professional body-pac transmitter made. Weighs only 2½ oz., without battery. Easy to conceal, stays in place.

High-impact resistant ABS plastic case with molded-in color. Point to wear off keeps its new look.

Detachable, recessed belt clip — Allows antenna and microphone cables to be positioned either up or down without damage or kinking.

Color identification dot matches transmitter to receiver, prevents confusion in multi-system applications.

Four pin microphone connector allows interchangeable use of dynamic, positive or negative-ground electret elements... no switching needed.

Dynamic Expansion II — Provides highest dynamic range of any wireless microphone today (over 115dB!)

Improved RF performance reduces multi-system interference. Over 20 systems can be used interchangeably.

Easy access battery compartment is separate from electronics enclosure. Prevents moisture and unauthorized fingers from damaging PC board.

Rock-solid radio performance, sound quality that's indistinguishable from a cable and day-to-day reliability our competitors would rather not discuss. These are benefits our professional users have enjoyed for years. So how did HME improve the System 82 over the legendary System 22? We made it a delight to use. Look at the thoughtful convenience features above, starting with a transmitter package that's 9cc smaller than our closest competitor. We designed a belt clip that can quickly be added or removed, and which allows the transmitter to be mounted top-up or top-down for versatility. Color-coded dots match transmitters to receivers to prevent confusion in multiple-system applications; this is important since you can use up to twenty systems together now, thanks to advanced RF technology. Join the thousands of users who have put HME out in front in wireless microphone acceptance. The all-new HME System 82 is waiting for your evaluation... contact your nearest HME dealer or the factory for a demo.

HME also makes the world's most advanced wireless and cabled Intercom Systems.



6151 Fairmount Ave., San Diego, CA 92120 Phone (619) 280-6050 Telex: 697-122

Circle 232 on Reader Service Card

Three hundred years ago, it took the hand of a master craftsman to create a concert violin. It also took commitment—a commitment to producing the highest quality, purest possible sound.

Today, at the new Harrison, we still follow the craftsman's tradition—and we share that unwavering commitment. We realize that, even today, there is no substitute for the enduring quality and value of precision craftsmanship. That's why we take the time to listen to your ideas and needs, and why we use that input to build every Harrison console with the same painstaking care that the master violinmaker devoted to his craft.

For the future, we'll continue to bring you the best possible workmanship, technology and service. Yet, even as we engineer for the future, we're also committed to the careful tradition of the past. We know that's where our best example lies.

THE NEW
Harrison

P.O. Box 22964, Nashville, Tennessee 37202
(615) 834-1184, Telex 555133

See us at NAB Booth #1324
and at NSCA Booth #B-57

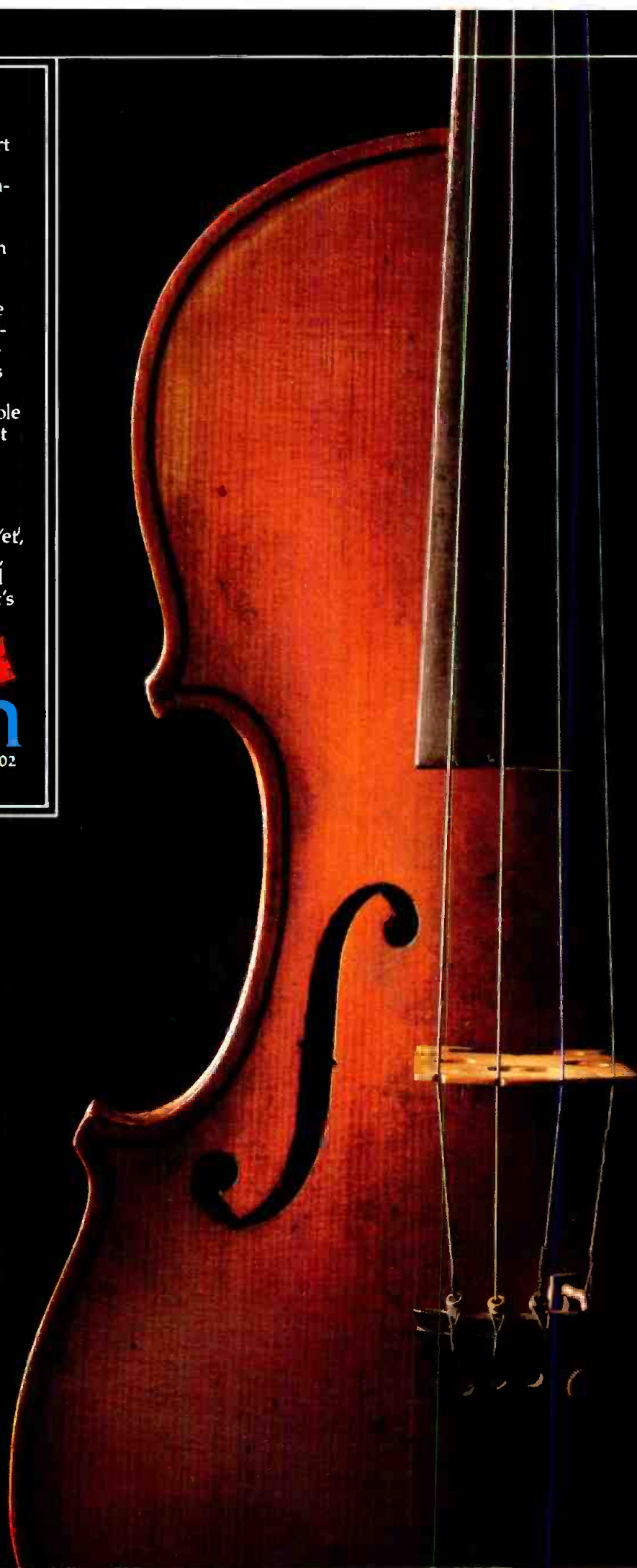

COMMITTED TO A SOUND FUTURE

www.americanradiohistory.com



Mitsubishi digital ATR at DEC booth.

COMREX CORP. 400

Will be introducing a 2X frequency extender/multiband compander providing a quiet 5 kHz response over phone lines. Will also have full line of frequency extenders, studio/telephone talk show interface systems, and RF IFB cue system for ENG.

COMTECH DATA CORP. 314

Will introduce a new four-meter antenna with offset feed, meeting FCC licensing requirements. Also on display will be the DART-384 digital audio receiver equipment, the Model 360 single channel per carrier satellite radio distribution equipment, and a 3.8 m transportable antenna.

See ad page 214

CONCEPT PRODUCTIONS 423

Will introduce Concept 5, the 1984 Disneyland radioaction telephone game and dollar bonanza. Will display automated radio programming services in five different music formats with full service syndication and custom voice-tracking.

CONNECTRONICS CORP. 608

New items this year will include the Mark 3 Great British Spring spring reverb unit; the Seck Producer B production mixing console; the Studiflex 16 shielded and jacketed color-coded cable pairs; low-cost XLR-type connect-

ors in male and female versions; and PCB belt connectors.

THE OTIS CONNER PRODUCTIONS COMPANIES 414

Will feature Hot-30, a new weekly adult contemporary countdown show; the new Sound System sales/promotion library service; a complete line of new station ID packages for all formats; and Power-Pac, a new CHR ID series. Will also describe its radio specials.

CONTINENTAL ELECTRONIC MFG. 101

May announce new products at the show. The full line of broadcast transmitters for AM and FM will be shown, along with the 302A AM stereo exciter, the 802A 50 W FM exciter, FM antennas, and eight- and 10-channel stereo audio consoles.

See ad page 185

CREATIVE TRADE (CTAB) 217A

CREST AUDIO 204C

Will introduce its 1001A and 2001A professional power amplifiers for A/V monitoring, cue, and headphone use. In addition, will bring the full range of Crest professional power amps.

CRL 300

See CIRCUIT RESEARCH LABS

CROWN INTERNATIONAL 428

Will add two new models to the line of PZM microphones, the 180 and 12SP. The full line of PZM mics, professional broadcast amplifiers, and monitor tuners will also be displayed.

CSI ELECTRONICS 507

Will bring a completely redesigned line of transmitters, including models FM-3000E, T25F, T10A, T5A, and T25A.

CSP INC. 440

Will show its RF filters, loads, switches, power dividers, diplexers, and AM sampling systems.

CUBICOMP CORP. 235

CUSTOM BUSINESS SYSTEMS 317

Will add to its software packages with the introduction of new accounts receivable and sales/coop management programs. Will also offer its full line of

business software systems, including ledgers and accounts payable.

PETER W. DAHL CO. 612

Exhibiting an extensive line of heavy duty plate, power, filament, and modulation transformers and reactors in power ranges from 100 VA to 50 kVA in single- or three-phase configurations. Also featuring high voltage rectifiers and primary transient suppressors in full wave center tap, bridge, voltage doubler, or three-phase stack designs at PIVs up to 40 kV.

DATAWORLD 315

Recent additions to the company's broadcast station database include an ITFS/MDS database and a Towerstudy program listing FCC/FAA tower coordinates and heights. Will describe its computerized data services, including AM, FM, TV, LPTV, and translator directories, FLAG service for FCC notifications, terrain elevation retrieval programs, and cellular radio predicted contours.



MicMix Dynafex noise reduction system.

dbx 107A

Exhibiting its full range of audio signal processing equipment including the latest introduction, the Model 700 digital audio processor. Also the new stereo audio for TV system. A full complement of noise reduction systems will be displayed in modular building block style, including compressor/limiters, stereo gated compressor/slaves, noise gates, parametric equalizers, and various signal enhancers.

DELTA ELECTRONICS 105

Will be introducing both a new AM stereo exciter, the ASE-1, and a new AM stereo modulation monitor, the ASM-1. Other new products include the RG-4 receiver/generator and the ATS option for RCS-1V remote control system. Featured products include the full line of RF instrumentation

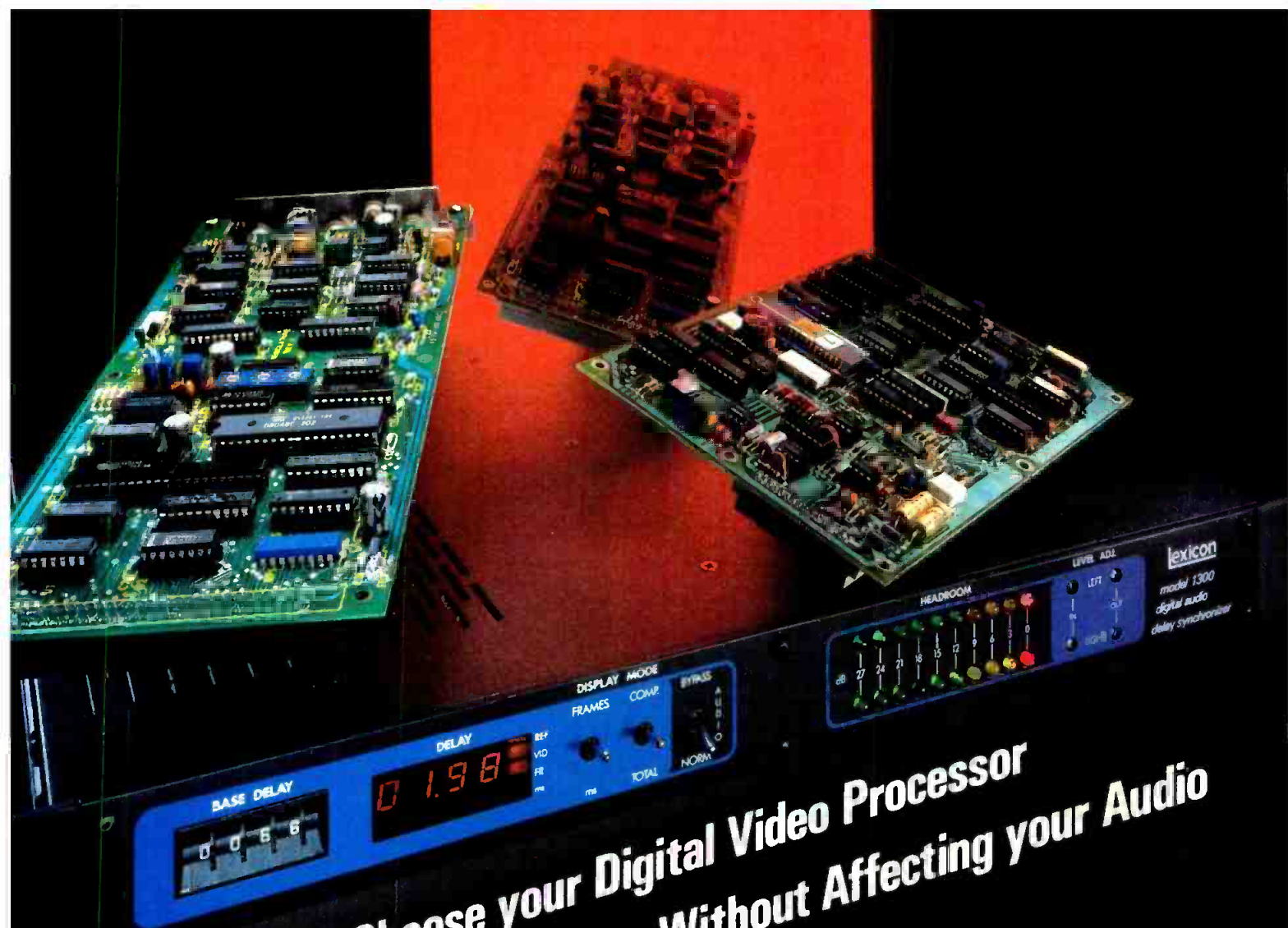

Freedom to Choose your Digital Video Processor or Transmit by Satellite Without Affecting your Audio

*That's what is designed into
Lexicon's Model 1300 audio-to-video
delay compensator.*

20-kHz bandwidth

< 0.025% harmonic
distortion

Transformer balanced inputs
and outputs

Delay from 0 to 340, 680, 1365,
or 2048 ms - 1300s (stereo)
0 to 680, 1365, 2731,
or 4096 ms - 1300 (mono)

+24-dBm input/output level

Your video devices should communicate with an audio delay unit that precisely* compensates for video delay, holding lip sync.

The Model 1300 does just that - with any video device you own or expect to own. The Model 1300's advanced engineering provides transparent audio processing and conforms to the 16-bit standard, offering the highest quality broadcast audio even when your signal is passing through a series of delay processors.

The Lexicon Model 1300 has been evaluated and approved by ABC, CBS, and NBC network laboratories and is in use at all three facilities. For more information call or write Lexicon.

Lexicon-designed and
manufactured converter
subassembly with 16-bit
linear PCM encoding and
48-kHz sample rate

Software-based input
control module that measures
video timing differences or
recognizes pulse widths,
RS422, or a variety of other
sync protocols

Lexicon, Inc.
60 Turner Street
Waltham, MA 02154 USA
(617) 891-6790
Telex 923468
Export: Gotham Export Corporation
New York, NY 10014

*Hysteresis prevents video sampling alone from doing the job - for more technical information call or write for our Delay Synchronizer Applications Note.

lexicon

Now is the Time to Cut Your Land Lines!



It's really very simple. Just switch from expensive phone lines to Comtech's new DART 384 (Digital Audio Receiver Terminal) and receive your network audio directly from the satellite with full fidelity, less cost, and greater control than ever before.

Six Major Benefits

Ordering the DART 384 Terminal gives you six immediate benefits:

1. 10-20% lower cost than the other guys (Lease or Purchase).
2. Better performance under marginal conditions.
3. Immediate off-the-shelf delivery.
4. Avoid phone troubles—forever.
5. User-friendly.
6. Quick response to customer's problems.

DART 384 is priced 10-20% below the other guy's model and yet our bigger 3.8 meter antenna gives it more performance margin per dol-

lar. It gives you everything you need to match or exceed all network audio quality requirements. Comtech's 3.8 meter antenna also operates better under the proposed 2° satellite spacing compared to the competition's 2.8 meter.

The DART 384 is user-friendly. It is designed for easy installation and maintenance. The indicators are **really** useful for accurate antenna pointing and isolating problems. If you need help, Comtech and Allied are ready to respond quickly.

The DART 384 Terminal consists of Comtech's high-performance 3.8 meter antenna, low-noise amplifier, antenna-mounted down converter and demodulator shelf with 8-chan-

nel program capacity. Channels can consist of a mixture of audio channels and one voice cue channel.

And there you have it. Better service. Lower costs. The proven path to profits since the beginning of business.

For a closer look at this audio receiver terminal alternative, call Allied Broadcast Equipment toll free at 1-800-428-6954.

ALLIED
Broadcast Equipment
1-800-428-6954

The DART 384 is produced by

COMTECH

Comtech Data Corporation Comtech Antenna Corporation
Subsidiaries of Comtech, Inc.





Electro-Voice (in TV hall) will show Sentry 500 monitors.

equipment including ammeters, impedance bridges, antenna phase monitors, and modulation controllers.

See ad page 191

DIELECTRIC COMMUNICATIONS 455

Exhibiting complete selection of FM circularly polarized antennas, FM panel antennas, RF switches, and patch panels. Also on display will be transmission line and RF loads, waveguide dehydrators, and combiners.

DORROUGH ELECTRONICS 312

Will feature the Model 610 discriminate audio processor, along with loudness meter Models 40-A and 40-B. Stereo generator Model FM-81 will also be on display.

DX COMMUNICATIONS 465

ECD INDUSTRIES 229

ELCOM BAUER 412

Will feature its line of AM/FM transmitters.

ELECTRO IMPULSE LAB 117

Will bring its line of dry, forced-air-cooled FM dummy loads, RF calorimeters, wattmeters, and attenuators.

ELECTRONIC RESEARCH INC. 105A

ELECTRONIC SYSTEMS LAB 406A

ELICON 143

EMCOR PRODUCTS/CRENLO INC. 429

Will bring its line of enclosures for electronics equipment, including CRTs, TV and radio studios, and DJ consoles.

EMERGENCY ALERT RECEIVER 508

Will add new SCA receivers to its established line of EBS receivers.

ESE 116

New will be Phone Patch, a high-quality, economical telephone interface, and the ES257 SMPTE code comparator with two-event capacity. Will also show the range of digital clocks, timers, master clock systems, programmable clocks and timers, time code readers and generators, audio level indicators, distribution amps, and time calculator.

EVENTIDE CLOCKWORKS 323

Will show new capabilities for the SP2016 audio effects processor/reverb unit, plus added simply with new ROMs. Established products will include the BD955 and BD931/932 broadcast delay lines; time compression systems for film, audio and videotape; the H949 Harmonizer audio effects unit; and real-time audio spectrum analyzers for use with the Apple II computer.

See ad page 216

FENWAL INC. 196

FIBERBILT 232

Will show its line of ATA foam-insert equipment cases.

NEW DTMF REMOTE CONTROL PRODUCTS FROM MONROE ELECTRONICS

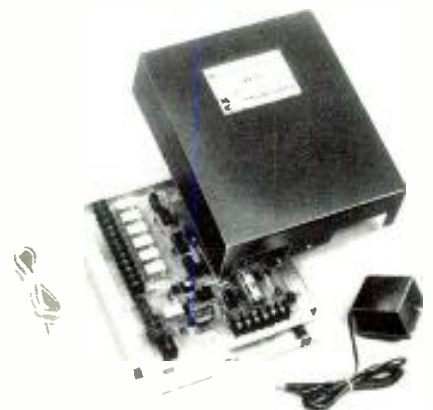

6000 Series Remote Control From \$395

Systems available for either telephone or 2/4 wire and radio communications to monitor and control unattended equipment.

- Selectable access code.
- 6 or 12 independent relays and status inputs.
- Audio input to monitor remote audio source.
- Internal test tone generator.
- Power supply for 117 VAC, 60 Hz.

Write or phone for further information or literature. Dealer inquiries invited.

MONROE ELECTRONICS, INC.

212 Housel Avenue
Lyndonville, N.Y. 14098
Phone: 716/765-2254 Telex 91-9188

In Canada: Maruno Electronics, Ltd.
299 Evans Ave., Toronto, Ontario,
Canada M8Z1K2
416/255-8231 - Telex 06-967578

Circle 236 on Reader Service Card



The Harmonizer audio effects device from Eventide.

FICON BROADCAST

202A

This software development company, exhibiting at NAB for the first time, has prepared the Broadcaster software package for radio station financial accounting needs.

FIDELIPAC CORP. 411

Will introduce a new product line, Dynamax, including audio recording tape manufactured by Fidelipac directly, reload kits for Fidelipac tape cartridges, and new 1/4-inch plastic tape reels and boxes. Also featured will be the Master Cart and Master Cart II tape cartridges, studio warning lights, cart storage racks, alignment and calibration tapes and gauges, handheld and

tabletop bulk tape erasers, and wow & flutter meters.

See ad page 188-189

FILM HOUSE INC. 231

JOHN FLUKE MFG. 227

Will exhibit the 9000 series microcomputer diagnostic tool featuring Model 9010A with software which allows the system to be programmed with a personal computer.

GENERIC COMPUTER SYSTEMS 308

Will unveil new software for Apple IIe and IBM XT to automate TV station

and cable operations, including traffic and billing, daily logs, statements, invoices, affidavits, avails, projections and more.

GENTNER ENGINEERING 636

New this year will be the Telemix IX 15, a totally programmable and remotable microprocessor-based on-air telephone system which mixes and balances two or more callers. Also the SPH-4 full-featured, single-line telephone hybrid with built-in monitor speaker amp and transient suppression. Previously seen products will include the SPH-3 single-line telephone hybrid and the complete line of prewired patch panels.

GEISE ELECTRONIC 327

G&M POWER PRODUCTS 339

GOLDNUGGET 628

GORMAN-REDLICH MFG. CO. 506

Will display its full line of EBS

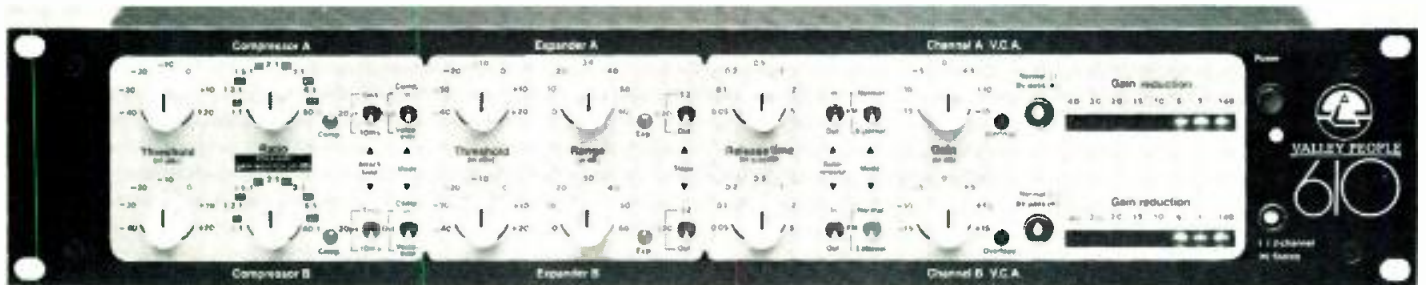

Nothing else is Quiet as good!

To reduce dynamic range while enhancing signal-to-noise ratios and apparent loudness, compression is the answer. But, compressors are not without fault. They "pump up" or accentuate noise levels during quiet passages or pauses in program material.

Gating the output of a compressor begins to cure the problem. However, this method typically replaces elevated noise levels with a new problem, gate "turn on" noise.

The Model 610 Dual Compressor/Expander offers two independent channels consisting of a compressor and an expander, both of which control a common channel VCA, the patented Valley People TA-101. A special release coupling circuit provides symmetrical release

characteristics for both the compressor and expander, making interactive processing possible.

Expanded Compression with the Model 610 allows the audio signal to be compressed for reduction in dynamic range, while automatically eliminating noise level recovery through interactive expansion. The unique coupling employed in the VCA release circuit makes transitions between compression and expansion imperceptible.

Once you've tried the 610, you'll know that nothing else is quiet as good.



VALLEY PEOPLE, INC.

P.O. Box 40306/2817 Erica Place
Nashville, Tenn. 37204 • 615-383-4737
TELEX 558610 VAL PEOPLE NAS
Export: Gotham Export Corporation, NY, NY/Telex 129269

Circle 262 on Reader Service Card

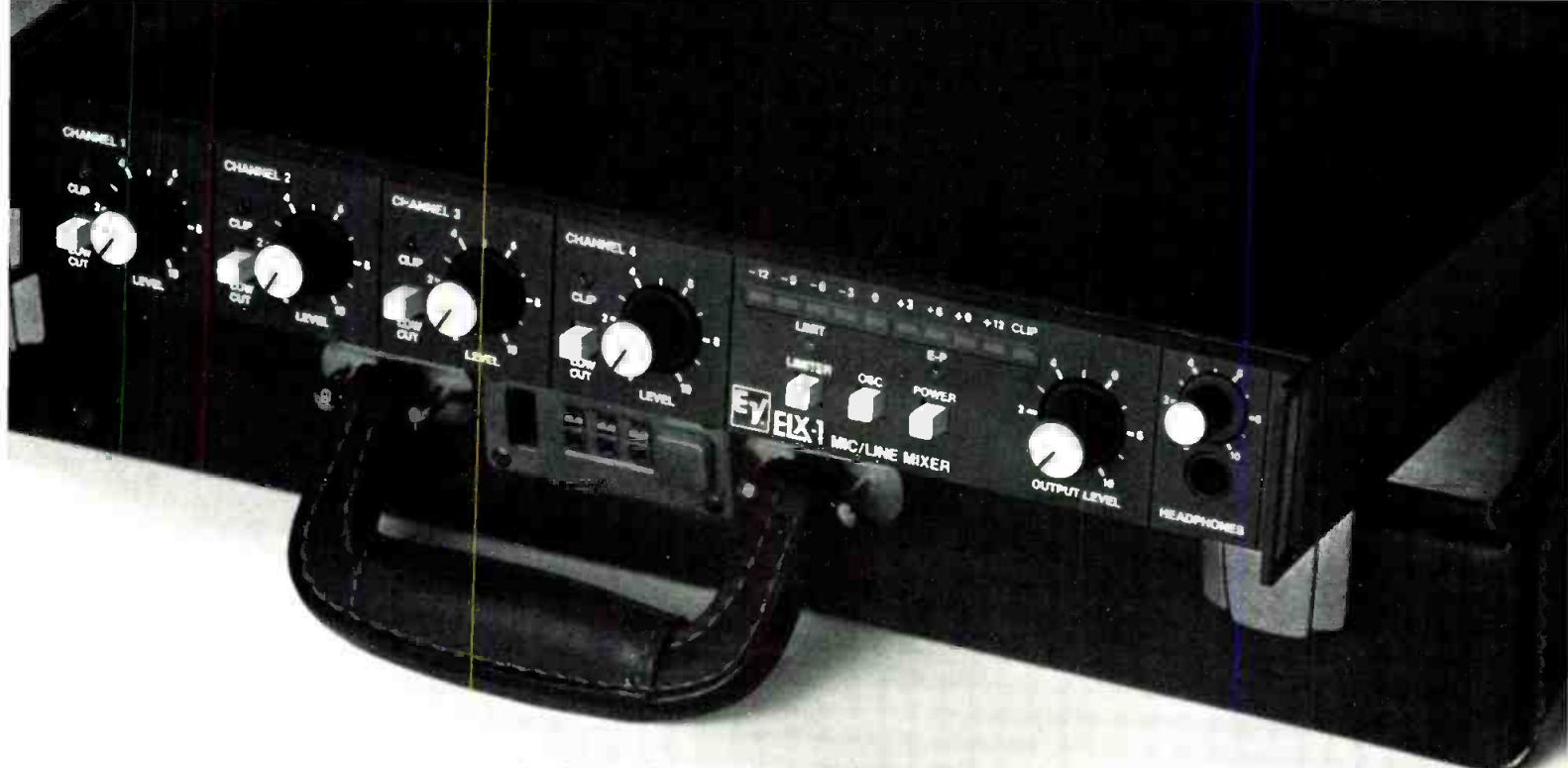

Travel light with the new Electro-Voice® ELX™-1 Mixer

It's big enough to handle the toughest
field assignments—small enough to carry there

Our new Electro-Voice ELX-1 Microphone Mixer has the compact design, rugged construction and self-contained performance features that assure dependable, efficient field operation. For all these same reasons...and more...the ELX-1 will also meet your quality standards for a wide range of studio applications.

Rack-it...

With the optional mounting brackets, the ELX-1 fits in a standard equipment rack and provides more performance options than you would think were possible in 1.75 inches of space.

Stack-it...

Multiple units can be used in combination through an integral stacking system to provide as many inputs as you need.

Pack-it!

Detach the AC power cord, snap on the shoulder strap, place the ELX-1 into your equipment bag and your portable sound studio is ready for action. The ELX-1 automatically switches to internal battery power for dependable performance on the run.

Greg Silsby talks about the ELX-1 Microphone Mixer:



"Whether this is your first and only mixer—or your fifty-first—we at Electro-Voice know there are three things you need: versatility, dependability, and uncompromising audio performance."

"If your job is news gathering, sports

coverage, studio production, or all three—the ELX-1 meets the challenge."

"I'd like you to see the ELX-1 in action. For the complete ELX-1 story along with information on the rest of the Electro-Voice line of professional products, please write to me:
Greg Silsby, Electro-Voice, Inc.,
600 Cecil Street, Buchanan, MI 49107."

Market Development Manager, Professional Markets



When quality really counts, professionals count on Electro-Voice.™

Circle 238 on Reader Service Card

www.americanradiohistory.com

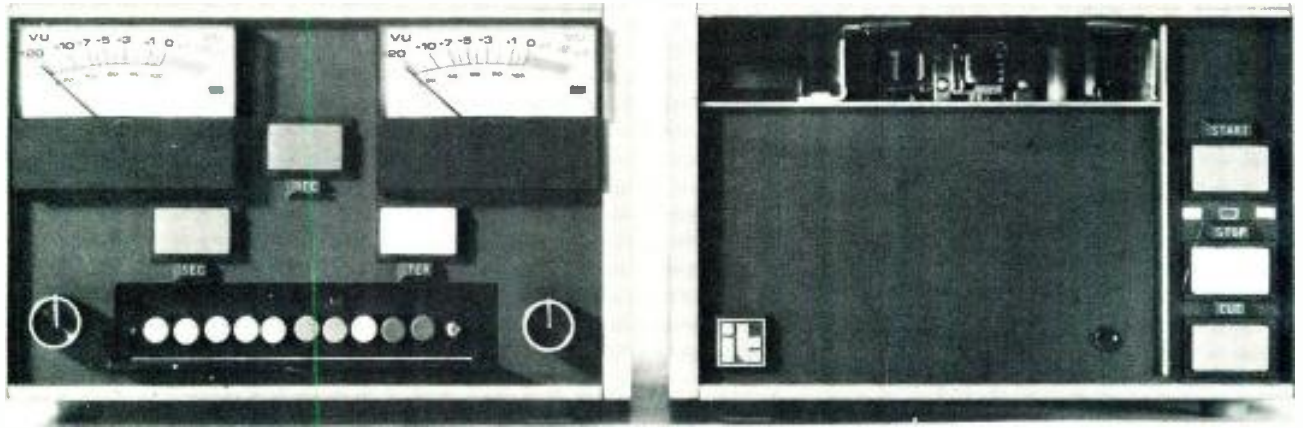

The International Tapetronics/3M booth will feature the Series 99B audio tape cartridge machine.

encoders and decoders, NOAA weather receivers, and digital antenna monitors for directional AM arrays.

GOTHAM AUDIO 509A CORP.

Will highlight the Systex digital audio system, which offers instant access to audio information stored on 14-inch Winchester disk drives of an H-P host computer. Also featured will be the complete line of Neumann mics; Telefunken's new M 21 microprocessor-controlled 1/4-inch audio tape recorder; EMT's 938 and 948 direct-drive turntables, 266 transient limiter, 277 AM broadcast limiter, and 10.02 recording/broadcast console; the Klein & Hummel line of self-powered broadcast monitor loudspeakers; and Gotham's full line of double reusen layer shielded cable.

GRALAN 230 DISTRIBUTORS

DAVID GREEN 417 BDCST. CONSULTANTS

Will show its complete line of equipment for radio stations, including weather radar.

GREGG 438 LABORATORIES

Will show its line of audio processing equipment and audio consoles.

HALLIKAINEN & 208 FRIENDS, INC.

Will show a production model of the new DRC190 remote control system, seen last year in prototype, offering 10 channels of remote control for \$3000. On display from the standard product line will be the TEL171 and TEL172 digital telemetry adapters for Moseley TRC-15A and PBR-30A remote controls; the PCC180 series transmitter

control computers for automating operation of Moseley TRC-15A, DRS-1A, and TFT 7610 remote controls; and the TVA series audio mixers with AFV control.

HARRIS CORP., 401 BROADCAST DIV.

Will introduce a 12-channel model in its Medalist family of audio consoles. Also the MW-50C 50 kW medium wave transmitter. Items from the established line will include AM and FM transmitters, FM antennas, the STX-1 AM stereo generator and monitor, 9165 computer-based satellite antenna control system, audio consoles, Autotron Star business automation system, 9000 program automation, and 9100 intelligent remote control system.

See ad pages 117, 176-177, 245, 253, 276

HOLADAY 206A INDUSTRIES INC.

Will introduce a new fiberoptic link for remote readout of its isotropic broadband field strength meters. Optional digital outputs RS-232 or IEEE-488 are available for the new unit to enable field levelling by computer-controlled systems.

HOWE AUDIO 321

Will introduce a new series of modular, expandable audio consoles, available in six- to 24-channel models. Each channel will have three inputs plus digital logic for machine control. Established products on view will include the Series 7000 consoles in rotary configuration and the 7500 with linear faders, digital logic for machine control, real-time clock, and up-count timer; also featuring the 2100 Series Phase Chaser, which corrects phase errors created by stereo sources.

See ad page 178

HUNGERFORD & CO. 310

Will feature its broadcast accounting services, with primary emphasis on monthly radio revenue reports.

IGM 403 COMMUNICATIONS

Will bring a new, updated version of its Instacart instant multiple cartridge playback unit, plus new custom controllers for radio and television post-production. Will also display its standard line, including the Go-Cart random-access cart playback unit, manual assist and full automation systems, and custom control systems.

See ad pages 197-202

INDUSTRIAL 322 ACOUSTICS

Will introduce a completely engineered, prefabricated studio with double-wall construction, in addition to its line of acoustical doors and windows and sound absorptive panels.

INOVONICS 304

New items will be the Model 250 stereo audio processor for educational FM and LPTV, and the Model 387 multichannel magnetic reproduce electronics for playback-only applications in recording, broadcast, and magnetic film work. The line of audio processors, 241 Dynex audio noise suppressor, magnetic recording electronics, and audio instrumentation will also be shown.

INTERACTIVE 138 MOTION CONTROL

First time NAB exhibitor IMC will introduce its modular motion control system for model and motion control photography, as well as computer graphics, computer and traditional animation, and slide production. Full computer-controlled, repeatable

And now
a
message
on
Yamaha's new
RM1608
recording
mixer.



RM1608

SPECIFICATIONS

TOTAL HARMONIC DISTORTION (T.H.D.)

Less than 0.1% at +4dB *output, 20Hz to 20kHz (all Faders and controls at nominal)

HUM & NOISE (20Hz to 20kHz) $R_s = 150$ ohms (INPUT GAIN "-60")

- 128dB Equivalent Input Noise (E.I.N.)
- 95dB residual output noise: all Faders down.
- 80dB (84dB S/N) PGM Master volume control at maximum and all CH PGM assign switches off.
- 64dB (68dB S/N) PGM Master volume control at maximum and one CH Fader at nominal level.
- 73dB (77dB S/N) STEREO Master Fader at maximum and all CH STEREO level controls at minimum level.
- 64dB (68dB S/N) STEREO Master Fader at maximum and one CH STEREO level control at nominal level.
- 80dB (70dB S/N) ECHO SEND volume at maximum and all CH ECHO volumes at minimum level.
- 75dB (65dB S/N) ECHO SEND volume at maximum and one CH ECHO volume at nominal level.

CROSSTALK

- 70db at 1kHz: adjacent Input.
- 70db at 1kHz: Input to Output.

MAXIMUM VOLTAGE GAIN (INPUT GAIN "-60")

PGM	74dB: MIC IN to PGM OUT.	ECHO	70dB: MIC IN to ECHO SEND.	
	24dB: TAPE IN to PGM OUT.		C/R	74dB: MIC IN to C/R OUT.
	34dB: ECHO RETURN to PGM OUT.		STUDIO	24dB: 2 TRK IN to C/R OUT.
	14dB: PGM SUB IN to PGM OUT.			74dB: MIC IN to STUDIO OUT.
STEREO	74dB: MIC IN to STEREO OUT.	24dB: 2 TRK IN to STUDIO OUT.		
	24dB: TAPE IN to STEREO OUT.			
	34dB: ECHO RETURN to STEREO OUT.			

CHANNEL EQUALIZATION

± 15 dB maximum

HIGH: from 2k to 20kHz PEAKING. MID: from 0.35k to 5kHz PEAKING. LOW: from 50 to 700 Hz PEAKING.

HIGH PASS FILTER - 12dB/octave cut off below 80Hz.

OSCILLATOR Switchable sine wave 100Hz, 1kHz, 10Hz

PHANTOM POWER 48V DC is applied to XLR type connector's 2 pin and 3 pin for powering condenser microphone.

DIMENSION (W x H x D) 37-1/2" x 11" x 30-1/4" (953 mm x 279.6 mm x 769 mm)

Hum and Noise are measured with a -6dB/octave filter at 12.47kHz; equivalent to a 20 kHz filter with infinite dB/octave attenuation.

*0dB is referenced to 0.775V RMS.

• Sensitivity is the lowest level that will produce an output of -10dB (245mV), or the nominal output level when the unit is set to maximum gain.

• All specifications subject to change without notice.

The specs speak for themselves. But they can't tell you how natural, logical and easy the RM1608 is to work. All the controls and switches are logically arranged to help you get the job done quickly and accurately.

And in the tradition of Yamaha's sound reinforcement mixers, the RM1608 sets new standards of reliability as well as ease of operation. For complete information, write: Yamaha International Corporation, P.O. Box 6600, Buena Park, CA 90622. In Canada, Yamaha Canada Music Ltd., 135 Milner Ave., Scarborough, Ont. M1S 3R1.

movements on model stages and animation stands.

**INTERNATIONAL 311
TAPETRONICS CORP./3M**

Will unveil the Omega Series audio tape cartridge machine, described as a stereo reproducer for budget-minded stations. Established products on view will be the Delta Series audio tape cartridge reproducers and recorder/reproducers, the Series 99B audio tape cartridge machine, and ScotchCarts audio cartridges.

See ad page 181

ISIS ELECTRONICS 337

**JBL/UREI 615
ELECTRONIC PRODUCTS**

JBL products on display at the booth will include the 411 direct radiator loudspeaker system, the two-way 4301 broadcast monitor, two-way 4401 compact studio monitor, and three-way 4312 compact studio monitor. From the UREI line will be the 1650 and 1680 series broadcast consoles, the LA-4 RMS compressor/limiter, the 535 dual optiband equalizer, and the 565T notch filter.

THE JINGLE MACHINE 200A

Syndicated radio promotions.

JOHNSON ELECTRONICS 162

Will show its EBS systems, SCA equipment, and FM antennas.

JONES BROADCASTING SYSTEM 326

KAHN COMMUNICATIONS 625

Will exhibit its AM stereo transmission system and receivers, and introduce a new AM stereo reception system for automobiles.

KAY INDUSTRIES 122

Will introduce new rotary phase converters with automatic power switching, in addition to the standard line of rotary phase converters for radio and television transmission.

KINEMATRICS/TRUE TIME 115

Will introduce the NBS synchronized master and remote timing systems. Will also bring its line of frequency



Lexicon (in TV hall) will show its digital delay processor.

and time receiving measurement equipment.

KUTV INC. 223

LEA, A DYNATECH CO. 302

Will bring its new model Perfect Power Source, a combination surge eliminator, RFI/EMI filter, and voltage regulator of power lines for transmitters, studio equipment, etc. Also new is the CPS continuous power source line, from 250 VA to 5000 VA. Other products will include surge eliminators; Klean Line filters; guy-charged chokes; transient eliminators for telephone lines, video lines, control lines, digital lines, and current loops; and dissipation arrays for the prevention of lightning strikes.

See ad pages 256, 291

LIGHTING METHODS 182

LOGITEK ELECTRONIC SYSTEMS 613

Will unveil the Perfectionist audio console, which handles up to 32 selectable inputs on eight rotary or slide mixing channels and features silent electronic switching. New accessories will also be featured, including the PAI-4 pro audio interface, PWR-80 audio power amp, MAS-ADJ and MAS-PAI audio modules, a new rack-mount housing for the Pyramid MET-7 speakers, and the Audio Preselector 10 x 2 switcher.

PAM LONTOS, INC. 120A

Will feature a video sales training course for broadcast sales personnel.

LPB 405

Will introduce low-power AM transmitters for PSRA, PSSA, STL, and LPRT uses with power levels from 5 W to 150 W, plus high-efficiency 15

m AM antennas for auxiliary, STL and LPRT sites. Will also feature its lines of audio consoles, audio DAs, and modular studio furniture.

See ad page 18

MAGNUM TOWERS 119

Displaying the full range of radio and television broadcast towers.

THE MANAGEMENT COMPANY 627

Introducing to its line of software for broadcast traffic and billing, new IBM PC compatible programs. Also showing Superlog multi-user software for the TRS-80 computer.

MARCOM 306

Introducing the C.N. Rood 114 portable BAX modulator bandwidth extension system. Will also show the Marcom Model 516 audio monitor/switcher; and the C.N. Rood BAX 110 and 112, and SC-203 stereo generator.

MARTI ELECTRONICS 501

Introducing the STL-10 system, a line-of-sight FM communications unit providing a broadcast audio channel with two optional subchannels in both stereo and mono forms. Full line of hand-carried 15, 25, and 40 W RPU transmitters will be shown, along with the ARS 15 automatic repeater station, the TSL 15 telemetry return link, a digital remote control, and the ATS 15 automatic transmitter switcher using pin diode RF switching.

MBI/AHB 148

McCURDY RADIO 207

Will highlight the new CS 9400 enhanced microprocessor-based intercom with off-line programming. Plus the new Century Series of high quality large format audio routing switchers with microprocessor control. Also new

THE COST OF RUNNING A RADIO NETWORK JUST WENT UP AGAIN!



The Telephone Company
21310 Lathrop Ave
Hometown, U.S.A.

404 355-4204
Jan 11, 1994 1105 H
Page 1

State Radio News, Inc.
11-11 Ridgemoor Road
Anywhere, USA

Total Amount of Last Bill	\$1,200.00
Less Payments Applied thru Jan.	1,200.00
Current Charges (See page 2)	1,279.00
Charges Due to Increase in Rates	3,675.00
Total Amount Due	\$4,954.00

722L 419
Please Return Enclosed Card With Your Payment

Total Amount Due \$4,954.00

One look at your phone bill will tell you—doing business over land lines is getting more and more expensive all the time. While at the same time, satellite space costs have actually come down.

That's one reason why Satellite Music Network, CNN Radio, Armed Forces Radio, and over a dozen other radio networks have made the smart choice. The economical choice. When they opted for the convenience, added reach and improved signal quality of satellite audio, they chose Wegener Transmission equipment, exclusively.

When it comes to quality satellite audio, either SCPC or subcarrier, Wegener leads the way with a

choice of bandwidths and satellite optimized noise reduction systems—including the revolutionary Panda™ II, with noise reduction capabilities that challenge even digital source program materials.

Service is also important, and our reputation for the fastest and friendliest customer assistance is well known within the industry.

Why wait for another month and another staggering phone bill to go by? Launch your network into the era of reliable, quality satellite audio today.

Call the Wegener Satellite Communication specialists at (404) 448-7288.



WEGENER COMMUNICATIONS
150 TECHNOLOGY PARK/ATLANTA
NORCROSS, GEORGIA 30092
(404) 448-7288

Visit Booth 515 at NAB Show

Circle 240 on Reader Service Card

will be the AT 317 audio DAs. Other equipment on display will include the SS 8800 family of audio on-air and production consoles with complete studio packaging options. Will also show the CS 9000 family of intercom systems and the DA 300 set of DAs.

MCG ELECTRONICS 167

Will display its surge protectors.

See ad page 280

**McGRAW-EDISON, 124
POWER SYSTEMS DIV.**

Attending its first NAB show, the company will exhibit its communications and control system that utilizes the AM SCA to send low-data-rate messages and also system timing to reduce power consumption at peaks and provide full supply at valleys; other applications include controlling equipment, paging, emergency alert, intrusion alarm, and traffic light control.

**MCI, DIV. SONY 605
CORP.**

See SONY PRO AUDIO

**McMARTIN 701
INDUSTRIES**

Introducing Communi-Quik network using new Super S transmission system offering five simultaneous subchannel services from one FM station. Other new products include the TVR-2 SCA receiver for TV, a TV stereo monitoring system, a new FM translator, the PS-1K and -5K power reducers for daytimers, BF-400 400 W FM transmitter, and the BF-30M 30 kW FM transmitter. From the existing line, the 1000 Series eight-channel and 500 Series five-channel consoles will be shown as will the TBM Series of FM monitors, RPU remote pickup unit, stereo and SCA generators, and the BR-400 four-channel remote mixer amplifier.

**MEADOWLANDS 110
COMMUNICATIONS**

Introducing new digital satellite uplinking and downlinking service for live audio and video transmission. Will feature live switches to earth stations at major league baseball stadiums in Los Angeles, Dallas, Chicago, Washington, and to the company headquarters in Rutherford, NJ.

**MEDIA GENERAL 410
BROADCAST SERVICES**

Will show IDs and libraries for radio

promotion as well as program and commercial production services.

**MEDIA SOFTWARE 622
SYSTEMS**

**MICMIX AUDIO 106A
PRODUCTS**

Will show its reverb units and noise reduction equipment.

**MICRO CONTROLS, 104
INC.**

Introducing an AM stereo STL, an FM exciter, and an FM SCA paging system. Other products on exhibit will be the composite STL, remote control systems, narrowband STL, automatic switching systems, repeaters, antennas, power amplifiers, and SCA equipment.

**MICROPROBE 221
ELECTRONICS**

Will display its program and business automation systems.

**MITCHELL 224
CAMERA CORP.**

MODULAR DEVICES 325

Introducing the Model 4824 Eurocard 1 x 8 DA, the Model 4046 line/mix amp card, Model 4950 Eurocard mounting frame, and the new Model 2100 power supply. Also showing the complete line of microphone preamps, line amps, VCAs, equalizers, compressor/limiters, oscillators, monitor amps, noise generators, and power supplies.

**MODULATION 204B
SCIENCES, INC.**

Will introduce the TV Sidekick, an integrated subcarrier generator for producing a second audio program (SAP) channel for TV multichannel sound. Also new will be the Data Sidekick, a system for transmitting 4800 baud of digital information on any standard bandwidth SCA channel. The Sidekick integrated audio SCA generator will also be exhibited, along with the company's composite line driver and composite processor.

**KEITH MONKS 132
AUDIO**

Standard line of equipment on display will include mic stands, cable drums, record cleaning machines, and impedance and phase testers.

THE INNOVATORS

Innovative design, engineered exclusively for the broadcast industry make STOREEL's high-density storage systems the practical solution for all your storage problems.

Convert your overcrowded film and VTR libraries into a STOREEL "instant-access" storage system built to your specific needs and requirements.



"The Room Stretcher"



"The Rollrider"

Built on a patented track-system, STOREEL's modular shelving maximizes the tape and film stored per square foot of floor space while minimizing costly retrieval time.

call or write:

STOREEL CORP.
THE SPACE-SAVING ENGINEERS

2050 C Carroll Ave., P.O. Box 80523, Atlanta, GA, 30341
(404)458-3280

Circle 241 on Reader Service Card



Beyer provides typical condenser accuracy

At Beyer, we maintain the singular notion that a condenser mic *can* combine typical precision and sensitivity with a smooth, natural sound. Beyer Condenser Microphones give you the accuracy and higher output of a condenser without a "hyped," larger-than-life sound. Beyer condensers offer the high-performance specs required by digital recording without reinforcing the occasionally clinical aspect of this process.

More Options – More Versatility

The Beyer MCM Condenser System's comprehensive selection of interchangeable mic capsules means total applications versatility in the most logical and cost-effective format. A choice of mics with cardioid, lobe, omni or figure-8 patterns and

the option of integral shock-mounting is instantly available for use in the studio *and* out in the field.

New Super High Performance Mics

The ongoing technical evolution of Beyer condensers has produced several newly designed mics offering matchless performance and long-term reliability. The new MC 737 long shotgun (lobe pattern) and MC 736 short shotgun (cardioid/lobe) utilize a built-in switchable bass rolloff to effectively suppress low end noise and rumble below 200 Hz and provide increased intelligibility for optimum speech and music recording. A 12 dB attenuator prevents high sound pressure levels from overloading the mic's internal electronics without coloration. These mics also feature an extended frequency

The Dynamic Decision



without typical condenser sound.

response of 40 Hz to 20 kHz (± 2.5 dB) and an excellent signal-to-noise ratio of 74 dB.

The new MC 734 is the only "studio" condenser mic that delivers the highest standards of performance in any recording or live concert situation. An extremely flat frequency response from 20 Hz to 18 kHz (± 2.5 dB) insures total accuracy while a 3-step filter compensates for proximity effect in close-miking situations. To maximize the MC 734's performance onstage, a unique stage resonance filter which reduces rumble and extraneous noise is combined with the mic's ability to withstand sound pressure levels of 138 dB (1 kHz \leq 0.5% THD).

Condenser System Accessories

For added back-up flexibility, the Beyer Condenser

System includes a full complement of accessories including windscreens, power supplies, pistol grips, suspension mounts and our one-of-a-kind MZA 716 telescoping "fishpole" boom with an adjustable tilt variable from 0 to 360°.

Beyer Dynamic has firmly established itself as a leading force in moving-coil and ribbon microphone technology, but don't let our name mislead you. Instead, consider the uniquely natural sound, applications versatility and wide variety of accessories that make up the Beyer Condenser System.

Visit one of our select professional dealers for a complete demonstration. To obtain a Beyer Condenser Dealer List, please write to: Beyer Dynamic, Inc., 5-05 Burns Avenue, Hicksville, New York 11801 or call us at (516) 935-8000.

beyerdynamic



51 Series console from Neve (in TV hall).

MOSELEY ASSOCIATES 301

Will introduce new options for the MRC-1600 remote control system, including a CRT option giving full control of the transmitter from the keyboard of the control terminal. There is also an automatic logging option. Products on display from the standard line of equipment will be the MRC-2, -1, and -1600 microprocessor-based transmitter remote control and supervisory systems. Also on display will be the studio transmitter and multiplexed data links, telemetry return links, subcarrier generators and demodulators, audio limiters, and stereo generators and demodulators.

MOTOROLA C&E 309

Will be unveiling ENG vehicle communications system for IFB and general communications applications, completely synthesized with automatically programmed power levels. New cellular mobile phones, headset amplifiers, and alphanumeric pagers will also be introduced. Other new products will include the 2002 communications systems analyzer and the MSF 5000 fully synthesized base station/repeater.

MOTOROLA 309

Will show AM stereo exciters and monitors, as well as AM stereo receivers for the car and home. Will have a car in the outdoor exhibit area to demonstrate a receiver.

See ad page 30

MUSIC DIRECTOR PROGRAMMING 709

Showing new music preference re-

search based on listener testing across the country regarding different programming formats. Exhibiting oldies libraries, adult contemporary, and Christmas programming.

MUSICWORKS INTERNATIONAL 209

Will demonstrate new radio programming, as well as existing shows designed for all formats, live assist or automated operations.

NAUTICAL ELECTRONIC LABS 216

Nautel will be highlighting a live display of an AMPFET-1 1 kW AM transmitter operating with Motorola AM stereo. Will also have the AMPFET-10 solid state transmitter, and a new compact, low-power transmitter for daytimers, operating at any power level from 10 to 400 W.

OMNIMUSIC 185

ORBAN ASSOCIATES 607

Introducing the programmable parametric equalizer with fully adjustable frequency, bandwidth, boost/cut, and input gain. Also new will be the 412A compressor/limiter. Products from the established line will include the Optimod AM and FM with six band limiter, and Optimod TV with loudness controller. A full range of pro au-



Model 412A compressor/limiter, new from Orban.

dio products including spring reverb, stereo synthesizer, de-esser, parametric equalizers, and compressor/limiters will be shown.

See ad pages 32, 187

OTARI CORP. 601

Will be unveiling the EC-400 Series tape speed resolvers, as well as the new one-inch eight-channel and one-inch 16-channel ATRs. Will feature, in addition to its full line of multi-channel open-reel decks, the two-channel MX-5050-BII and Mark III/2 recorders, the MTR-10/12 in quarter- and half-inch versions, and the MTR-90 eight-, 16-, and 24-channel recorders. The Industrial Products division will show videotape loading equipment for U-matic, VHS, Beta, and 8 mm formats, and audio duplicators.

See ad page 209

PACIFIC RECORDERS 113 & ENGINEERING

Highlighting its new ABX Series of production consoles featured in 18-, 26-, and 34-input sizes with multiple stereo bus operation. Also featuring the BMX on-air consoles, SDA-8 distribution amplifiers, Tomcat cartridge machines, and the LSM-10 line selection modules and cabinet systems for production and news.

See ad page 233

PANASONIC PRO AUDIO 437

See RAMSA

PENNY & GILES 436

Will show its line of rotary and slide attenuators.

PHILADELPHIA RESINS 126

Will feature Philly Stran HPTD tower guy system for high power applications.

PHOENIX SYSTEMS 609

Introducing an IBM PC (and compatible) version of its broadcast management system, designed for smaller facilities. Also showing an integrated broadcast management system for traffic and billing, general ledger,

"Microdyne's satellite radio network gives us better signal quality and saves us over \$120,000 a year."



Paul Stone, General Manager, Georgia Radio News Service

Reduced costs — fast payback

State and regional networks saved all the money they can save. That's why the Georgia Radio News Service installed a Microdyne SCPC satellite radio network system.

They found that it reduced monthly distribution costs 80% while improving signal quality.



Microdyne we manufacture nearly everything in this system, from the precision-molded 5-meter link antenna . . .

Where the network once paid 2,000 a month for land lines to feed over 105 affiliates, they now lease a 10-dBw carrier on Westar IV for just 2,000 a month. That results in savings of \$120,000 a year.

"We expect a fast payback on

the equipment," General Manager Paul Stone adds.

Greater programming flexibility

But lower costs and superior performance aren't the only advantages of a Microdyne radio network. Our system is frequency agile and has an optional bandwidth selection feature that lets you change formats when you change channels.

That means you can receive any of the many radio programs now being carried on a single satellite. And that gives you more programming options and greater flexibility.

Turnkey systems

At Microdyne we manufacture nearly all of the components that make up a satellite radio network, from the uplink antenna to the downlink demodulator. And we not only design and build custom systems, we can also manage the complete instal-

lation. So all you have to do is tell us what you need and when you need it.

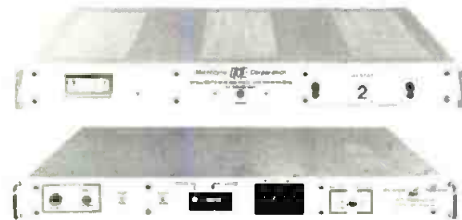

. . . to the rack-mounted downconverter and unique bandwidth selectable, frequency-agile demodulator that lets you change formats when changing channels.

And of course all of our products are backed by our 48-hour repair or replacement policy and our 24-hour toll-free number for emergency engineering support.

Let us custom-tailor one for you

If saving thousands of dollars a month while improving performance appeals to you, call our Marketing Department at the number below. Ask for our free brochure on satellite radio systems. It could brighten your budget for years.



Microdyne Corporation

P.O. Box 7213 • Ocala, FL 32672 • (904) 687-4633 • TWX: 810-858-0307

Boonton Helps You Clean Up Your FM Composite Baseband

The quality of your FM composite baseband, consisting of L + R and L - R information, 19 kHz pilot tone, and 67 kHz SCA subcarrier, is the key to low distortion and good stereo separation. All paths from the stereo and SCA generators to the FM modulator should be linear in both amplitude and phase versus frequency.

The Boonton 82AD Modulation Meter is an ideal tool for measuring and adjusting your FM signal. Its wide and flat baseband response, low distortion, low residual noise and high stereo separation all contribute to a demodulated baseband output that accurately displays the quality of your transmission. Automatic tuning, that needs no crystals, and automatic leveling are great for checking your 900 MHz studio links and 2-way radios.

For a convincing demonstration — and a technical paper that describes how to put theory into practice to improve the quality of your FM composite baseband, contact your local Boonton representative.

Boonton Electronics Corporation

791 Route 10, Randolph, NJ 07869
Telephone (201) 584-1077

Signal Generators Modulation Meters
RF Power Meters RF Millivoltmeters
Capacitance Meters and Bridges Audio Oscillators

See us at NAB Booth 228
South Concourse.

DIRTY — demodulated baseband spectrum, stereo (L or R = 4.5 kHz) plus unmodulated SCA through a narrowband r.f. path

CLEAN — same demodulated baseband spectrum through a wideband r.f. path

BOONTON

Circle 272 on Reader Service Card

payroll, word processing, and sales management.

PLASTIC REEL 170
CORP. OF AMERICA

Will introduce a new anti-static videotape reel to its line of videocassette containers and Beta, VHS, and 3/4-inch videotape reels.

POLAR RESEARCH 511

Will display its rotating VHF and UHF antenna mounts.

POTOMAC 100
INSTRUMENTS

Will introduce RC16+ remote control system, and the new MPC11 modulation and power controller for equipment testing. Also new will be the FIM-72 UHF field test system. Existing product displays will include the full line of broadcast instrumentation equipment.

See ad page 34

PRISMAGRAPHS 110A



Otari MX5050 Mark III/8 ATR.

PROCART 112

Will show its line of audio tape cartridges.

PROCESSING PLUS 638

Showing the IMP 3 audio processor and the IMP 3X AM stereo processor.

PROCOMMOTION 434

QUANTUM 509A
AUDIO LABS

A Gotham Audio subsidiary, will be demonstrating its Series 22 modular broadcast/production audio consoles.

QEI CORP. 307

Will unveil a new 25 kW transmitter using a single grounded grid tube for stability. Also on display will be the new 695 FM exciter featuring built-in ultra-linear calibrated demodulator and spectrum display output. Existing products on display will be the single tube 3.5 kW and the solid state 1 kW transmitters with optional built-in remote control and diagnostics.

QSC AUDIO 626

Introducing the Model 3800 power amplifier and the new Model 1080 1.75-inch power amp intended for low and medium power broadcast monitoring. Will exhibit the entire Series I and Series III amplifier line.

NEW

Your best value in wireless.



Cetec Vega's R-31 PRO is your best value in a wireless-microphone receiver. When you compare the price, compare the performance too. And the size. And the features:

- **"Infinite gain" receiver technology.** Improved performance in the critical threshold region, superior accommodation of multipath conditions, better signal-to-noise ratio, and constant receiver audio level output.
- **High signal-to-noise ratio and wide dynamic range.** 97 dB (103 dB A-weighted) with DYNEX[®] II; 77 dB (83 dB A-weighted) non-DYNEX.[†]

- **DYNEX[®] II, a new standard in audio processing.** Can be switched in and out, to accommodate transmitters with or without DYNEX[®] II.
- **Power-source flexibility.** Dual 115/230 Vac, 50-60 Hz operation, and external +12 to +24 Vdc for vehicular and portable use.
- **Attractive, compact case.** Only 7.15 inches wide, 1.72 inches high, and 8.25 inches deep.
- **True helical-resonator front-end filter.** Plus all of the other standard features expected in Cetec Vega's professional

wireless equipment, famous for quality and reliability.

Write or call for further information on the R-31 PRO wireless-microphone receiver, and for the location of your nearest dealer: Cetec Vega, P.O. Box 5348, El Monte, CA 91734. (213) 442-0782, TWX: 910-587-3539.

 **Cetec Vega**
the professional's wireless

Circle 244 on Reader Service Card

THE 1980'S IS A DECADE OF CHALLENGES AND OPPORTUNITIES TO MEET THESE CHALLENGES. NEW RULES AND DEREGULATIONS ALLOW THE BROADCAST INDUSTRY TO IMPROVE AND EXPAND NEW AND EXISTING MARKETS.

WE, AT ALLIED TOWER COMPANY, ARE READY TO HELP YOU MEET THE FUTURE. USING COMPUTER AIDED ENGINEERING, WE CUSTOM DESIGN EVERY TOWER TO YOUR SPECIFICATIONS. WE SUBJECT EACH TOWER QUOTED TO A THREE DIMENSIONAL FLUID ANALYSIS TO ASSURE MANY YEARS OF RELIABLE SERVICE. FROM A FORTY (40) FOOT TOWER WITH A SINGLE STL DISH TO FIFTEEN HUNDRED (1500) FEET WITH SEVERAL BROADCAST ANTENNAS, WE HAVE BUILT WHAT YOU NEED FOR OVER TWENTY FIVE (25) YEARS.



(713) 486-7691

Circle 246 on Reader Service Card



Shively Labs will show its new TV/AM isocoupler.

RADAC MARKETING 218

RADIO ADVERTISING BUREAU 217

RADIO ARTS 418

Showing new and existing radio programming packages for all types of formats.

RADIO SYSTEMS 213

Introducing the ESA-10 console, a 10-channel linear mixer with dual outputs and 30 inputs—the latest addition to the Audio-Metrics line. Also showing the PA-1 stereo turntable preamp, the DA-8 and -16 mono and stereo DAs, and the TM-1 studio timer. Also on hand will be prewired patch panels and turnkey studio installations.

See ad page 33

RAMKO RESEARCH 415

Will be unveiling the P-4PM four-channel portable mixer with carrying case, nicad battery option, and master level control. From the existing products, the display will include broadcast audio consoles, tape cart machines, Phasemaster reproduction systems, line equalizers, mic, line, and power amplifiers, as well as paging systems, turntable preamps, solid state meters, and audio routers.

RAM BROADCAST/WHEATSTONE 121

RAMSA/PANASONIC PRO AUDIO 437

Introducing the 8616 modular console for broadcast on-air and post-production applications. Other products on display will be the WR130, WR500, and the standard line of consoles including the 8210A, 8118, 8112, and 8816. Turntables will also be

shown, with models from the SP10 Mark II and V lines in addition to the SP15 Mark V, as well as the EPA-250 tonearm and WP9210 amplifiers.

REACH, INC. 341

Showing its growing capabilities in nationwide SCA paging networks, including message storage and retrieval, all through its paging network affiliates.

See ad page 237

REGIS/BLT 152

REGISTER DATA SYSTEMS 128

Will show its business and traffic computer systems and hardware.

REIMAN SYNDICATION NETWORK 172

RESTORATION 705

Introducing a new line of tape head replacements for MCI and 3M machines, in addition to equipment for film, electro sound duplicators, and Sony VTRs, as well as tapes from the BASF line.

RF TECHNOLOGY 171

Will bring its line of microwave equipment, microwave STLs, and RF amps.

See ad page 81

RICHARDSON ELECTRONICS 212

Along with a new equipment catalog, the line of electron tubes for both camera and transmission will be on hand as well as RF power transistors, power semiconductors, and RF power amplifiers.

RUSSCO ELECTRONICS 413

Will feature its line of turntables, phono preamps, mixers, and consoles.

SAKI MAGNETICS 416

Introducing long-life metal cart machine heads, and also showing a full complement of hot-pressed, glass-bonded ferrite heads for Ampex, Mincom, Otari, Revox, Scully, Studer, and Technics audio tape machines.

SAMSON MUSIC PRODUCTS 324**SANSUI ELECTRONICS 130**

Highlighting the DCPCM digital converter for making digital audio recordings on videocassettes. Will also show the PCD 1000 digital recorder, and the PC XI tricode digital audio system, which allows digital audio to be recorded on the slow-scan mode of a VCR.

SCRIBE RECORDERS 214

Demonstrating the NewsCorder audio cassette recorder, designed for ENG, with talk-over capability and a custom carrying case. Will also have accessories for the NewsCorder.

SHIVELY LABS 623

Will introduce TV/AM isocouplers, VHF and UHF isolation units for mounting of TV antennas on AM towers. Also new will be a reflectometer display and protection system to monitor actively for calculation of true VSWR, incident power, and reflected power. Also on display will be a complement of FM side-mount antennas of varying powers, UHF panel antennas, horizontally and vertically polarized antennas, and a three-port RF patch panel.

SINGER BROADCAST PRODUCTS 101A

Will premiere the FM 30F exciter, the SC 30F SCA generator, and the ST 30F stereo generator.

SOLWAY INC. 139**SONO-MAG CORP. 707**

Showing the ESP-II automation programmer, the MSP automation system, and the Model 450 bidirectional cart machine.

SONY, PRO AUDIO DIV. 605

Will introduce SOAR, a VHF wireless mic system with 48-channel frequency



More Audio. Less Visual.

Fender's new M-1 miniature cardioid condenser mic performs so well in creative, unusual applications that you might not think to try it for vocals.

In fixed-stand vocal applications you'll get a natural, musical response that's immune to overload. And there's a switchable hi-pass filter to eliminate unwanted low frequencies. (Pop filter recommended for close-mic vocal use.)

The M-1 excels as a vocal mic. That's one more reason why every serious sound engineer needs a couple of M-1's in his bag of tricks.



Circle 247 on Reader Service Card

BRYSTON

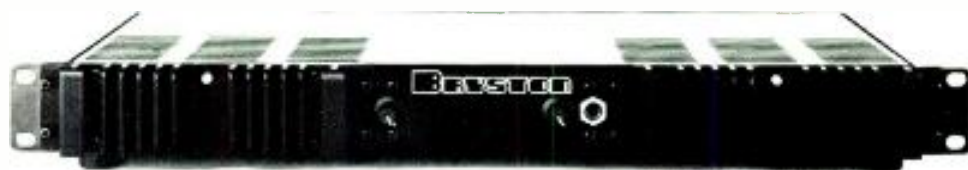

Bryston's 2B-LP

Bryston has been known and respected for years as the manufacturer of a line of amplifiers which combine the transparency and near-perfect musical accuracy of the finest audiophile equipment, with the ruggedness, reliability and useful features of the best professional gear. Thus, Bryston amplifiers (and preamplifiers) can be considered a statement of purpose to represent the best of both worlds - musical accuracy and professional reliability to the absolute best of our more than 20 years' experience in the manufacture of high-quality electronics.

The 2B-LP is the newest model in Bryston's line, and delivers 50 watts of continuous power per channel from a package designed to save space in such applications as broadcast monitor, mobile sound trucks, headphone feed, cue, and any installation where quality must not be limited by size constraints. As with all Bryston amplifiers, heatsinking is substantial, eliminating the requirement for forced-air cooling in the great majority of installations. This is backed up by very high peak current capability (24 amperes per channel) and low distortion without limiting, regardless of type and phase angle of load. In short, the 2B-LP is more than the functional equivalent of our original 2B in spite of the fact that it occupies only half the volume, and will fit into a single 1.75" rack-space.

The usefulness of the 2B-LP is extended by a long list of standard features, including: Balanced inputs; female XLR input jacks; dual level-controls; isolated headphone jack; and individual two-colour pilot-light/clipping indicator LEDs for each channel. In addition, the channels may be withdrawn from the front of the amplifier while it is in the rack, vastly facilitating any requirement for field-service, including fuse-replacement.

Of course, in keeping with Bryston's tradition of providing for special requirements, the 2B-LP can be modified or adapted to your wishes on reasonably short notice, and at nominal cost.

Best of all, however, the 2B-LP is a Bryston. Thus the sonic quality is unsurpassed. The difference is immediately obvious, even to the uninitiated.

Other amplifiers in Bryston's line include the model 3B at 100 watts per channel, and the model 4B at 200 watts per channel. All ratings continuous power at 8 ohms at less than 01% IM or THD.

IN THE UNITED STATES

VERMONT
RFD#4, Berlin Montpelier Vermont 05602

IN CANADA

MARKETING LTD
57 Westmore Dr., Rexdale, Ontario, Canada M9V 3Y6

Circle 248 on Reader Service Card



Studer Revox's A810 ATR.

synthesis; system choices include handheld or lavalier mics and diversity and nondiversity receivers, power supplies, and antenna dividers. The Syncmaster (AVS/AVP-500), a SMPTE/EBU synchronizer that allows sync of multiple audio, video, film, and special effects units will also be unveiled. A center track time code recorder/reproducer will be announced, the MCI JH-110C-3-TC. Also from the MCI line, Sony will introduce the JH 8000 option 23 video editor interface for video editor control of the audio console. Other products on display will be the professional modular CD player and controller, and an audio/video post-production system designed according to the DASH standard.

SOUNDCRAFT ELECTRONICS 219

Premiering the Series 20 two-track master recorder, with microprocessor control of automatic alignment to five different kinds of tape formulations and three EQ standards. Also new is the SAC 2 stereo on-air broadcast console. Other products on display will be the Series 1600 post-production audio console, the Series 400B audio mixer, the Series 200 portable stereo console, and the SCM 760 multitrack audio recorder/reproducer.

SOUND TECHNOLOGY 500

Will display its line of audio test equipment, including its all-in-one audio and ATR test system, plus the distortion measurement system and the tape recorder test system.

SOUND WORKSHOP 461

Introducing a new serial console interface, allowing the console to be controlled through an RS-232 port driven by a video editor or other computer. Also offering an MS-DOS-compatible software package that allows console presets and edit decisions to be entered or downloaded from a PC-type computer. In addition, will show the Series 30-TV eight-bus console for video edit suites.

SPECTRUM PLANNING 510

Exhibiting communication system engineering services.

SPENCER BROADCAST 406

Will introduce an all-solid-state audio recorder with up to six tracks and totally self-contained design. Plus a new low-power AM broadcast transmitter. Also showing bubble memory technology, a separation optimizer for production purposes, the ATK-1 phono preamp, and the PTA line of audio power amps.

SPRAGUE MAGNETICS 705

Showing a complete line of replacement heads for reel-to-reel audio and video recorders, cart decks, and duplicators. Also demonstrating refurbishment of audio and audio/video recording heads.

STANTON MAGNETICS 102

Will introduce the PBR Series of lightweight earphones for camera or communications applications. Also exhibiting several new lightweight professional headphone models, and a new carbon fiber brush for record cleaning.

STRAIGHT WIRE AUDIO 408

Will show a new UAPA adaption of a universal amplifier as a power amp.

and the new PHUP low-noise phono preamp with passive EQ. Will also show the ITC 3D replacement card amp.

STRATA ARCHITECT (MEDIA SVCS.) 614

STUDER REVOX 201

Will premiere the TLS4000, a SMPTE synchronizer featuring modular design for translating all SMPTE/EBU and film time code standards, which mounts in the A810 rack. Also new will be the Revox PR99 MKII compact recorder with new electronic real-time counter, return to zero, and autolocate. Other new products will include the A726 FM monitor with quartz digital synthesizer tuning and 10 new module options for the 900 Series consoles. Standard products on display will be the A800 multitrack recorders, the A80 multitrack and two-track recorders, the A810 line of recorders with center-channel SMPTE code and computer interface, and the 169/369 and 900 Series consoles. In addition, the A710 and B710 professional cassette recorders, the PR99 playback, and B77 broadcast logger will be exhibited.

See ad page 35

SWITCHCRAFT, INC. 427

Will attend its first NAB show with its line of audio connectors, audio cables, and ECs.

SYMETRIX 616

Will be introducing the DCS-16 microprocessor-based remote control system and the 511 noise reduction system. Also showing Model 501 peak-RMS compressor/limiter, CL-150 compressor/limiter, the A-220 stereo amplifier, SE-400 stereo parametric EQ, and the TI-101 telephone interface.

TAFT BROADCASTING CO. 136



Symetrix will introduce the Model 511 noise reduction system.

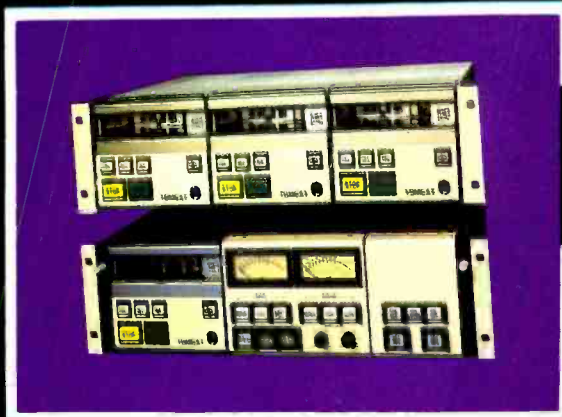

TOMCAT — The preeminent console recorder and reproducer, offering superb reproductive quality. Matrix, 7½ and 15 IPS. MONO/STEREO, 3 tones and fault detection are standard.

BMX — The undisputed leader of on-air audio consoles. Exacting design and construction yield optimal performance quality. Modularity combines user-friendliness with maintainability. Source machine control is standard in 10, 14, 18, 22 and 26-input consoles.



ABX — This new WORLD-CLASS OPERATIONS console is the first console designed for production requirements of radio broadcasting. In 18, 26, and 34-input sizes, the ABX provides the positive attributes of BMX in a 2, 4 or 8-TRACK production configuration. With additional busses, 2-MIX/MULTITRACKING, SLATE/OSCILLATOR, multi-studio TALKBACK, 4 SENDS/RETURNS, full metering, 4 telephone MIX-MINUSES and much more, the ABX is unique.



**PACIFIC RECORDERS
& ENGINEERING CORPORATION**

Call TOLL-FREE 800-874-2127 for your full-color brochures on TOMCAT, BMX, ABX, STUDIO CABINETS systems or other quality PR&E products.

NAB Booth #113

Rodney Kobayakawa uses SONEX a little differently...



and so do thousands of others.

Just Listen — 1. You might even say that Rodney Kobayakawa's use is off-the-wall. He lines the ceiling of KGMB-TV's remote video truck with SONEX. "Controls the high ambient noise...Close speaker mounting caused problems with sound orientation...and they look so nice! White audiotiles match the chrome look of our equipment." He's the Audio Engineer at KGMB, Honolulu.

2. "Musicians are always impressed by your SONEX products." Dennis Scott of Chelsea Entertainment Organization, who won a Grammy in 1981 for *Sesame Country*, an album featuring Crystal Gayle, Loretta Lynn, Glen Campbell and the Muppets.

3. "Takes the 'ping' out of hard walls." Don Bachmeier, KFYP-TV, Bismarck, N.D. uses SONEX on wheeled, portable panels to kill voices on adjoining news sets.

4. "Delighted with SONEX's effectiveness...pleasing aesthetics... audio professionals notice reduced standing waves...increased sound-proofing." Sherrie Thomas, Producer, recording studio for the General Conference of Seventh-Day Adventists, Washington, DC.

5. "Good!...in radio station's master control and production room." Craig Falkenstine, WJCF, Morgantown, W.V.

Pictures do speak louder than words.

When we asked our customers to show us how they used SONEX, we weren't surprised to hear that SONEX did the job. We knew that SONEX's special acoustical foam — with its sculptured anechoic design — absorbs sound successfully. What really amazed us was the number of different SONEX applications they showed us* See (and hear) for yourself: **Wherever** sound is the problem, SONEX is the solution.

SONEX is manufactured by Illbruck/usa and distributed exclusively to the pro sound and A/V industries by Alpha Audio. Get all the facts by calling or writing:

Alpha Audio[®]
2049 West Broad Street
Richmond, Virginia 23220 (804) 358-3852
Acoustic Products for the Audio Industry

*SUBMITTED BY FIRST GROUP OF SONEX PHOTO CONTEST WINNERS



Telex 3000 Series recorder/reproducer.

TAPSCAN 106

Introducing an IBM PC-based automatic spot planning and trending system, as well as software packages for sales support based on Arbitron data.

TELEGEN 806

TELEPAK SAN DIEGO 192

TELEVISION INFORMATION OFFICE 806

TELEVISION TECHNOLOGY CORP. 305

Will feature the newly acquired Ampro/Scully division with its full lines of audio consoles and tape decks. Will also show equipment from the Wilkinson Radio division: FM-3 surge protector, FM 2500 E 2.5 kW transmitter, FM 25000 25 kW transmitter, and the AM 2500B AM transmitter.

TELEX COMMUNICATIONS 600

Featuring the full range of wireless microphone systems, microphones, closed circuit intercom systems, head-

sets, open-reel and NAB cart recorders and loggers, high speed duplicators, and the Singer 16 mm and filmstrip projectors. Also showing 35 mm slide projectors including front and rear screen combinations with built-in audio cassette player/recorder and dissolve controls.

See ad pages 47, 193

TFT, INC. 109

Will introduce the Model 830 SCA generator, capable of handling voice and data, as well as the new Model 840/841 AM stereo exciter/monitor. Existing products on display will include aural STLs, TV monitors, AM and FM monitors, microprocessor-based remote control systems, and EBS systems.

See ad page 265

TFTP, INC. 161

JAMES THOMAS ENG./ALUMIFEX 163

TORPEY CONTROLS & ENGINEERING 463

Will show its character generators,

TABER MFG. 711

Will introduce the Model 1500 automatic tape degausser. Also showing the Model 409 tape degausser, as well as refurbished recorders and replacement heads for audio recorders.

TANDBERG OF AMERICA 614

Will show its line of open-reel and cassette recorder/players, FM monitor tuners, audio monitors, preamps and power amps, and receivers.

Now Your Station Can Try An Eventide H949 Harmonizer®

FREE For 30 Days . . . With No Obligation.

• LIMITED TIME OFFER

For some time, we've been telling you why your station should own an Eventide H949 Harmonizer. Hundreds of stations have gotten the message. But if you're still "on the fence" . . . here's the offer you've been waiting for. Order an H949 Harmonizer from an authorized Eventide dealer by May 31, 1984. Try it for thirty days at your station. If you don't agree that the H949 is the most versatile audio production tool you've ever used . . . just send it back to your dealer and tear up the bill.*

• WHY YOU SHOULD TAKE US UP ON THIS OFFER

We're sure that once you get your hands on an Eventide Harmonizer, you'll find it irresistible. The H949 is a complete audio special effects department in a single box. Pitch change capabilities create new voices instantly. You can get variable delays, echo and reverb effects. Double tracking and chorus effects are available. For really way out sounds, there's time reversal and infinite repeat. The H949 is a super flanger, too. And the H949 can do more than one effect at a time. Combinations of the various effects, as well as variable mixes and recirculation of output/input let you create an infinite number of new vocal, musical and sound effects.

• IT'S A TIME COMPRESSION SYSTEM, TOO

Best of all, the H949 is a complete audio time compression system. You get the audio time compression and expansion capabilities of competitive single-purpose units costing well over twice as much. You can even control a VTR, by adding our

economical PTC960 control module.

• BRINGS OUT YOUR STAFF'S CREATIVITY

When your station's H949 trial begins, you'll find that the Eventide Harmonizer brings out the creativity in people from every department at your station. The sales manager will discover an enticing tool for local commercial production. A clever air personality can create a whole roster of new characters. Your station's promotion director will have a field day, creating really distinctive promos, intros and custom jingles. News directors even use the H949 to protect the identities of confidential sources, by altering their voices. And the music director can use the H949 to create custom music mixes, even altering tempos.

• DON'T MISS OUT

This thirty day no obligation free trial offer must end on May 31, 1984. So, if you've been reading our ads, and thinking about getting an Eventide H949 for your station, now's the time to act. Contact your Eventide dealer, or call Eventide for more information.

*Offer limited to licensed U.S. radio and television stations, valid upon receipt of purchase order. Unit if returned must be in as-new condition, in original packing. Customer pays shipping. Trial offer limited to one unit per station



Eventide
the next step

One Alsan Way
Little Ferry, N.J. 07643
(201) 641-1200



Ursa Major's Model 323 digital reverberator.

machine control system, and timing products.

TOTAL SPECTRUM MFG. 142

TRIDENT (USA) 633

Will show a wide range of audio production and post-production consoles for use in film and television and audio sweetening. The Trimix Series will be on hand in an eight-bus expandable on-air configuration. Optimix automation systems will be demonstrated to retrofit any console.

TRUE TIME INSTRUMENTS 115

See KINEMETRICS

TURNER BROADCASTING SYSTEMS 621

Will describe its programming services.

TWEED AUDIO 313

Exhibiting a full line of recording studio and broadcast audio consoles and channel modules.

TYLER CAMERA SYSTEMS 184

ULTIMATE SUPPORT SYSTEMS 651

UMC ELECTRONICS 114

Introducing the System 8 automatic

news recording system and a motorized azimuth audio cartridge recorder. Other products on hand will be the A, B, and C size cart recorders, multideck cart machines, stereo on-air consoles, auto splice finder, and audio heads and replacement motors.

UNITED PRESS INTERNATIONAL 430

Will describe its broadcast news services.

UNITED RESEARCH LAB 604

Introducing Auto-Tec Model S audio tape recorder in a half-inch format. Also showing the full line of Auto-Tec recorders, solid state conversion amplifiers, coated pinch rollers, MRL alignment tapes, and Tapestrobes.

UREI 615

See JBL/UREI

URSA MAJOR 512

Will introduce the StarGate 323 audio special effects processor. Also showing 8x32 professional reverberator and the SST-282 Space Station.

SIGMA Announces . . . THE GENLOCKING COMPUTER



. . . now you can superimpose graphics on any video signal, even VTR, without a TBC and production switcher.

THE SIGMA MODEL GLC-100 features:

- Color Graphics
- Characters
- Graphics Keyer
- Processing Amplifier
- Real-time Captioning

SPECIFY SIGMA GLC-100!



SIGMA ELECTRONICS INC.

1830 STATE STREET, EAST PETERSBURG, PA 17520
(717) 569-2681

Circle 263 on Reader Service Card

SOMEBODY UP THERE LIKES US.

(way down there, they think we're great, too.)

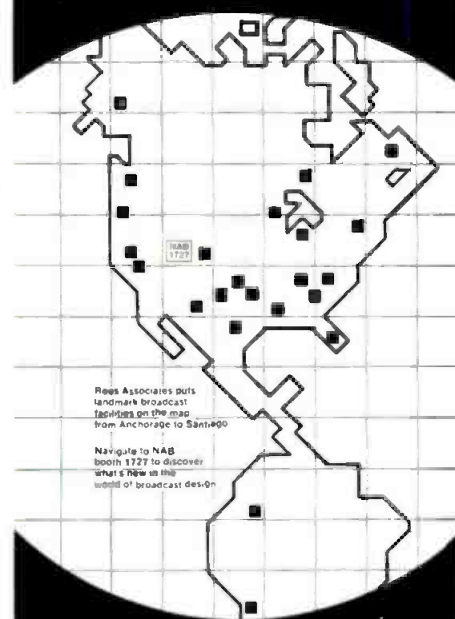

**Rees Architects
Associates
Planners
Inc Engineers**

4200 Perimeter Center Drive Suite 245,
Oklahoma City, Oklahoma 73112
(405) 946-9800

Circle 264 on Reader Service Card

subcarrier (səb-kă ě-ər) *n.* Subchannel attached to main carrier of FM broadcast station. Can be used by station licensee or leased to another party. Revenue potential often misunderstood or exaggerated. Has solid opportunity if handled correctly. *See Reach.*

reach (rēd' ē) *n.* First successful company in use of subcarriers for paging. Wide choice of options. Solid revenue potential. Ready to discuss your plan today...*See paging.*

*Want the facts? ...we're writing the book.
Call 800-228-2230, extension 353.*

 **Reach**TM
NETWORK BY SPANTEL DIVISION

Wheel it in, plug it in... it's working!

Swintek's new portable wireless microphone rack system makes it that easy to eliminate on-the-road setup headaches.

- Up to 10 channels
- Over 100 frequencies available
- Built-in diversity antenna system
- Modular design - field serviceable
- International distribution
- 48 hour factory service plus back up



Swintek
TELECOMMUNICATIONS DIVISION

1180 ASTER AVE. UNIT J / SUNNYVALE, CA 94086
(408) 249-5594 / TELEX 172-150 SWINTEK SUVL
CANADA Toronto, Ontario Cinequip
Vancouver, BC Commercial Electronic Ltd.

NAB Booth #1503
Circle 266 on Reader Service Card



Valley People's Model 610 dual compressor/expander.

U.S. TAPE & LABEL 602

Exhibiting bumper strips and window labels for broadcast promotions.

UTILITY TOWER CO. 703

Showing actual tower sections, lighting equipment, and base insulators for use in AM, FM, TV, and LPTV installations.

VALLEY PEOPLE 318

Will introduce the Advantage Model 310 audio noise and level meter for accurately analyzing noise performance in audio equipment. Also new will be the HH 2 x 2B balanced level matching interface, a complete stereo system (or two independent channels) that resolves the level and impedance matching problems associated with interfacing -10 dB equipment with studio and broadcast standards of +4 and +8 dB. Will also bring the Model 610 dual compressor/expander, capable of interactive signal processing. Other products include the 430 Series Dynamite processors, Model 810 Keyable program expander/gate, and Model 811 Gain Brain.

See ad page 235

VDO-PAK PRODUCTS 220

VECTRIX CORP. 175

Will introduce its basic WITS terminal, a standalone, low-cost weather and/or graphics terminal that accesses WS1, ESD, and Accu-Weather databases. Also introducing a two-card set for IBM PCs that takes functions of graphics boxes and weather terminals and stores them on the IBM XT hard disk. Also offering VX-128 and VX-384, which convert a microprocessor into a graphics work station.

See ad page 93

WEGENER COMMUNICATIONS 515

Displaying satellite audio transmission products for subcarrier, SCPC, and band edge SCPC applications. Will also exhibit the Panda II noise reduc-

tion system and multiple audio transmission systems for international satellite circuits. Other products include SCPC and subcarrier data transmission systems up to 220 kb/s, and vertical interval data transmission systems for data insertion, bridging, deletion, and reception.

See ad page 222



RC unit for Yamaha REV1 reverb.

WHEATSTONE CORP. 121

Will premiere the SP-5 stereo production console. Also showing the A-500 radio broadcast console and V-800 TV console.

See ad page 205

WHIRLWIND 329

Will show its interface cables for audio and video, as well as matching transformer systems and multipair cables.

WILKINSON ELECTRONICS 305

See TELEVISION TECHNOLOGY CORP.

WORLD TOWER CO. 519

Will show its line of antenna towers.

SEE HOW OUR NEW STEREO GENERATOR STACKS UP!

Last year CRL introduced the SCA-2 Subchannel Control System. This unit was the first to incorporate a digitally synthesized carrier that provided a major improvement in FM technology.

This year, we invite you to hear another improvement: The SG-800. At last, a stereo generator **designed** to handle highly processed audio. Because we don't think you should give up fidelity for maximum loudness.

Separation: Typically 60 db or better.

Distortion: .009% THD and IM or less.

S/N: Better than 80 db.

This is made possible by CRL's exclusive Pulse Amplitude Modulator in conjunction with our digitally synthesized carrier. But specs don't tell the story. We invite you to stop by booth 300 at the NAB Convention and hear for yourself how it stacks up. You'll love the sound **and** the price.

Don't just optimize . . . maximize your signal with CRL.

CRL AUDIO

THE PROCESSING SPECIALISTS

Circuit Research Labs, Inc.

(602) 438-0888 or
(800) 535-7648

2522 W. Geneva Drive
Tempe, Arizona 85282

Circle 267 on Reader Service Card

Buying an audio post-production system. The long and the short of it.

BUY AN AUDIO MIXING
CONSOLE.

ADD 6 BUS MIX MATRIX
ADD PATCHFREE ROUTING
SYSTEM.

ADD COMPRESSORS/
LIMITERS.

ADD NOISE GATE/
EXPANDERS.

ADD MULTITRACK TRACK
REMOTES.

ADD AUTOLOCATOR.

ADD AUTOMATED MIX
PACKAGE.

ADD SYNCHRONISER
CONTROLLER.

ADD MASTER TRANSPORT
SELECTOR.

ADD REAL TIME MIX
SYSTEM.

ADD EVENTS CONTROLLER.

ADD PROGRAMMABLE
EQUALISER.

ADD VIDEO SWITCHER

ADD COMPUTERISED LIST
MANAGER.

ADD PRINTER.

ADD EFFECTS RACKS

ADD AUTOMATIC DIALOGUE
REPLACEMENT SYSTEM

EMPLOY A FULL TIME
SOFTWARE ENGINEER.

OR
BUY AN SL 6000 E SERIES
STEREO VIDEO SYSTEM.

In the competitive world of video production, providing the right facilities is one of the first requirements for success.

Getting it right can prove difficult, however. Especially in the area of audio post-production.

For people expect the same sophisticated standards of sound that they hear from the recording industry. But they usually expect it in a fraction of the time.

Which means a post-production studio, if it is to meet these demands, must not only give first-rate stereo sound, it must be streamlined to give it as quickly and efficiently as possible.

Unfortunately, because the video business is still young, much of the equipment on offer is new and unproven. With different suppliers working to differing standards.

And even if you choose the individual components of your system wisely, they can't work together with maximum efficiency. Because they weren't designed to do so.

So, at best, assembling your audio facilities will be complicated, time consuming and not entirely satisfactory. At the worst, it will be very costly and potentially catastrophic.

Unless of course you choose the Solid State Logic SL 6000 E Stereo Video System. The world's first fully integrated audio post-production system.

Designed in consultation with several leading post-production houses and broadcasters, the SL 6000 E Series provides outstanding audio quality. Combined with systematic design and practical innovation, aimed specifically at the needs of the video and broadcasting industries.

The Stereo Mix Matrix, for example, contains three stereo mix buses. Allowing the simultaneous creation of separate music, effects and dialogue mixes, and giving the greatest possible flexibility for both stereo and mono post-production.

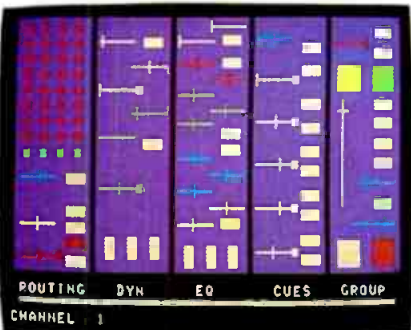

on each input/output module gives easy patchfree routing and sub-grouping.

on each input/output module gives easy patchfree routing and sub-grouping.

The SSL Primary Studio Computer handles automated mixing, autolocation, and list management. It interfaces with the remarkable Total Recall system and links with the Synchroniser Controller to provide direct control of the entire system via its keyboard and in-built TV monitor.



As a result, an enormous amount of time (and money) is saved. Giving the engineer a new freedom to concentrate on the more creative aspects of his work.

These features, incorporated into the SL 6000 E's cohesive and comprehensive design, are of great benefit to post-production and broadcast studios alike.

And because of the system's modular nature, it can be built up from the basic mainframe as your needs and budget dictate. Making it an affordable proposition for any size of studio.

So if you're in the market for an audio post-production system, you can fall into the trap of trying to assemble one piece by piece.

Or you can drop a line or call Antony David in the UK or Piers Plaskitt in the USA, and find out more about SSL's Stereo Video System.

Solid State Logic

Please send me further information on the SL 6000 E Series Stereo Video System.

Name _____
 Position _____
 Company _____
 Address _____

Solid State Logic, Churchfields, Stonesfield, Oxford OX7 2PQ, England
 Tel: (099) 389 8282. Telex: 837400 SSL OX G. Facsimile: (099) 389 8227.
 Solid State Logic, 228 East Main, Milan, Michigan 48160, USA.
 Tel: (313) 439 8866. Telex: 230504 SSL MLAN. Facsimile: (313) 439 8516.

Circle 268 on Reader Service Card

The only big thing about Neve's video editing console is the quality.



Neve's 5455 4 bus console

That's why more facilities demand Neve.

More and more video editing suites are being equipped with Neve's 5455 4 bus consoles, part of the highly successful 542 range of 6, 8, 12 and 16 input 2 bus consoles that have become an industry standard in all facets of production: Complete Post Production, Vidtronics, Telemation Productions, Windsor Total Video, Teletronics, and Reeves Teletape to name a few. It's no wonder.

The 5455, engineered and designed to offer the exceptional Neve quality you've come to expect of the larger units, is uniquely suited for video editing.

Features include two types of interface to video editing systems: Post-fade balanced line level direct outputs from each channel for those switchers/editors requiring independent audio sources; or a VCA interface that provides DC voltages to control the input channels gain. Cross-fades and cuts on the 5455 may now become part of the EDL.

The 5455 4 bus with 12, 16 or 24 inputs is available in a "drop-through" mounting configuration, providing excellent control access in minimum space.

For further information, please call (203) 744-6230 or write.

Demand Neve

RUPERT NEVE INCORPORATED: Berkshire Industrial Park, Bethel, CT 06801 (203) 744-6230 Telex 969638 • 7533 Sunset Blvd., Hollywood, CA 90046 (213) 874-8124 Telex 194942 • RUPERT NEVE OF CANADA, LTD. represented by: Sonotechnique, 2585 Bates, Suite 304, Montreal, P.Q.H3S 1A9 Canada (514) 739-3368 Telex 055-62171 • NEVE ELECTRONICS INTERNATIONAL, LTD.: Cambridge House, Melbourn, Royston, Hertfordshire, SG86AU England Phone (0763) 60776 • RUPERT NEVE GmbH: 6100 Darmstadt Bismarckstrasse 114, West Germany Phone (06151) 81764.

WGBH

goes live
with digital

This Boston radio station is using a digital audio recording processor as a transmission device, allowing it to go live from Symphony Hall. The music is great.

By Anita McFadden and Dave St. Onge

For over 30 years WGBH Radio has broadcast Boston Symphony Orchestra concerts live from Symphony Hall. It was on October 6, 1951, that we signed on the air (in mono) for our first broadcast of the famed BSO. Over the years WGBH has taken pains to provide listeners with the best possible sound for these live presentations. In the 1950's, before FM stations broadcast stereo, we collaborated with local stations to create stereo sound by feeding the "left" channel to one station and the "right" channel to another. Listeners were able to recreate stereo at home using two radios. During the 1960's we adopted the current stereo FM system. And in the 1970's, we pioneered quadrophonic broadcasts of the Boston Symphony Orchestra.

Because of the distance between our studios and Symphony Hall, a micro-

wave link had been impractical. WGBH had to rely on New England Telephone broadcast lines to bring music performances to our listeners. Over the course of these 33 years, with the introduction of new technologies and more sophistication in audio consoles and recording equipment, not to mention the demands of our listeners, we have found that one of the continuing problems we have had has been in the transmission of music on Telco lines. Even with dedicated broadcast lines installed on a full time basis from Symphony Hall, we still had problems. Boston's Telco broadcast lines are crowded with other users thereby increasing circuit crosstalk. The demand for service in concert hall areas of Boston causes the telephone company to "borrow" our lines on occasion, often right before air time.

The signal to noise ratio (S/N) usually available on our lines from Symphony Hall is only 55 dB. The breakup of AT&T caused us further concern, not only about the reliability and availabili-

ty of existing circuits, but the likely increase in cost for Telco services in the future.

Microwave connection

As a result, we began to reinvestigate microwave as a transmission alternative. Because our sister station, WGBH-TV, had acquired space for ENG microwave antennas atop the Prudential Insurance Tower (the "Pru"), one of Boston's highest office buildings, the use of microwave became a distinct possibility. The advantages of the microwave system became apparent when we considered that we would control the equipment and its use for radio and TV, compared with paying ever-increasing monthly rental for Telco service.

The most logical answer to our transmission problems from Symphony Hall was the "double-hop" microwave system: Symphony Hall to the Prudential Tower to the transmitter site. The WGBH engineering staff investigated the possibility of using subcarriers on

Anita McFadden is operations manager and **Dave St. Onge** is chief engineer for WGBH Radio in Boston.

HCF-ONE TELECINE CAMERA

Pre-NAB Offer...

\$29,950



Here is the field tested, maintenance free, direct replacement for your TK-27 and TK-28, PE-240 or any of those old tired telecine cameras. Two different optical systems are available to assure direct interface with your existing film island.

Compare...

**FEATURES
BENEFITS
... PRICE!!**

Visit us at Caesar's Palace

HUBCOM
HUBBARD COMMUNICATIONS, INC.

10383 Oak Street N.E.
St. Petersburg, FL 33702-1894
(813) 577-7759
Twx: 810-863-0471

Circle 270 on Reader Service Card



In March WGBH-FM used two dbx 700 Digital Audio Processors to send Boston Symphony Concerts direct from Symphony Hall to the transmitter site. Bill Busiek, engineer-in-charge initiated the transmission.

the video links. But it became clear that digital audio, which uses the video spectrum, would be preferable because of better S/N ratios, frequency response and reliability. We began to seriously investigate digital-audio transmission in late 1980.

Two years later, in October of 1982, we learned of the introduction of the dbx model 700 Digital Audio Processor. The timing was perfect. We contacted dbx's Professional Products Division about the possibility of their involvement in our annual live broadcast from the Salzburg (Austria) Music Festival held in July of 1983. A mutual interest was determined and we began to test the system.

After conducting several listening tests with the dbx 700 at our studios, we were impressed by the unit's exceptional sound quality. We then arranged for transmission tests by sending the digitally-encoded video signal from WGBH Boston to KQED in San Francisco via the PBS satellite system. The dbx 700 was designed for digital audio recording. Therefore, WGBH's new application for the unit as a transmission device required a simple circuit modification, making it possible to genlock the dbx 700 with the WGBH TV sync generator. After this change, we tested the dbx system again from WGBH to the Hartford PBS uplink via microwave and land lines. We accomplished downlink of the program in Boston successfully.

Complex links

With increased confidence, we arranged for an international test with an uplink from Reistang, West Germany, and a downlink at Etam, WV transmitted, via AT&T circuits, to the public television outlet WETA in

Washington, DC. WETA then fed the West German radio test program to WGBH Boston, via the Eastern Educational Network (EEN) land lines. The signal left Germany clearly and the downlink (also in Reistang) was clear and sounded great. But WGBH, where we decoded the program, there were audible errors. Upon investigating the one inch video tape recorded in Washington, we found the same errors present. Without a recording from West Virginia, we surmised that the Telco circuits from West Virginia to Washington introduced video processing that had rearranged the digital-audio bit stream to the point where it was not recognizable as "good" data by the 700 decoder.

Although we did not use the 700 for our "Live from Salzburg" broadcast, we continued to test and evaluate possible uses for the dbx 700. The obvious problem with previous tests was the use of processing amplifiers, by the Telco lines and the PBS stations between Washington, DC and Boston. The effects of processing, especially during sync pulses, generate enough changes in the digital data to create decoding errors. On a large scale, these errors can cause the dbx 700 to mute. With this in mind, we decided the next experiments should be totally within the control of WGBH engineering.

Digital BSO

The regular weekly Boston Symphony Orchestra broadcasts were appropriate for the test. We set up a 2 GHz microwave shot from Symphony Hall to our ENG receive point atop the Pru. This signal was then IF inserted to our 13 GHz link and fed back to the Allston-based studios. The 13 GHz receiver signal was brought down to

Why our new radio is heavier than you'd expect.

When we introduce a brand new portable microwave transmitter with innovative features like continuously variable power from 3 to 12 watts and a linear GaAs FET power amp, our customers also expect it to be "bulletproof".

So, we build in modular plug-in circuit boards for quick service; multilevel RFI shielding for superior integrity, and an integral heat sink to eliminate dependence on the antenna bracket. Plus, a linear power amp eliminates spurious response to provide excellent spectral purity, while its *one* stage (versus the usual 4) reduces still further the probability of failure.

You see, when you buy either our *Challenger* at three watts, or the *Challenger 12* with 3 to 12 watts variable, you get unexpected state-of-the-art features. But you also get what you expect from Harris — reliability, ease-of-service, and the best product support in the business.

For information about our complete line of ENG equipment call or write, **Harris Broadcast Microwave, 967 Stierlin Road, Mountain View, CA 94043. Phone: 415-969-9100. Telex: 17-2584 HARFARVID**



Class A Linear
GaAs FET Power Amp

Challenger 12
with 3 to 12 watts
variable power



COMARK

Comark's RF Transmission Lines and Components

Simply Superior

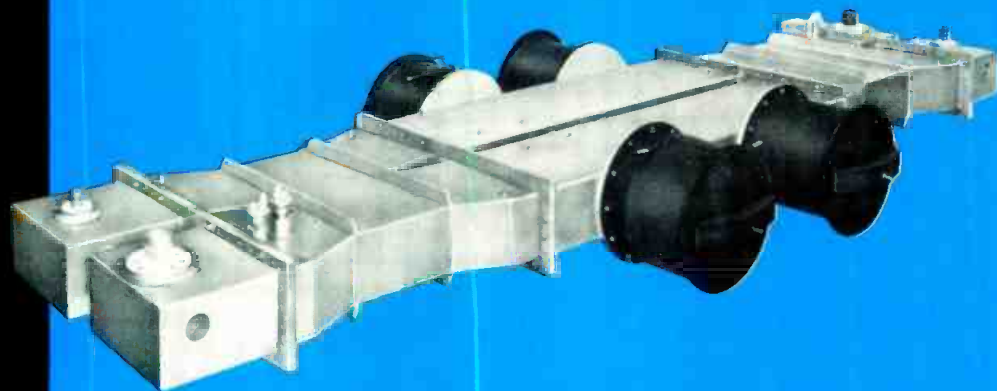

Comark has continuously been the leader in innovative UHF television transmission technologies. The same superior quality, reliability and competitive pricing found in our TV transmitters, are also available in our complete offering of transmission lines, components and accessories. For all of your RF needs, Comark's products will meet or exceed your most demanding technical requirements.

Major product component categories that are offered by Comark:

- Coaxial Transmission Lines
- Waveguide Transmission Lines
- FM Transmitting Antennas
- Elbows
- Couplers
- UHF Diplexers
- Low Pass Filters
- Color Notch Filters
- RF Patch Panels
- Power Dividers
- Quadrature Hybrids
- Switches
- Tuners
- Quickstep Transitions
- VHF Diplexers
- Gas Barriers
- Hangers
- Flanges
- Anchor Connectors
- Clamps
- End Caps
- Impedance Transformers
- Insulators
- O Rings
- Phase Shifters
- Sleeve Couplings
- Turnkey Systems

For your free, engineering design manual/product guide, contact John Molta today.

COMARK

International Headquarters
PO. Box 229
Rt. 57, Feeding Hills Road
Southwick, MA 01077
(413) 569-0116/569-5939
Telex: 95-1159

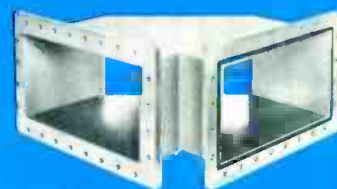

See us at NAB Booth #1217

Circle 295 on Reader Service Card

baseband where it could be monitored. This gave us the option to insert either a dbx 700 encoded signal from our air studio or have the original encoded signal feed-through from Symphony Hall. We used a 2 GHz microwave link to set up the next leg of the signal path from Allston to our transmitter site on Great Blue Hill in Canton, MA.

At the transmitter site, provisions were made to switch from the output of our Mosley analog STLs operating on 960 MHz, to the MA-2 digital-encoded signal arriving on 2 GHz. Our decoding dbx 700 and the Mosley STLs could be tied directly to the inputs of our Orban FM Optimod[®] processor.

The initial tests were done very early on the morning of December 16, 1983. RF from our Harris FM-25K transmitter did pose a slight problem with the decoder; some time was spent trying to find an area within our transmitter building to mount the unit. The location chosen was only four feet from the 25kW amplifier, and a minimum amount of RF shielding was used. Even with exposed clip leads used for the test measurements, the S/N ratio available out of the dbx 700 was a remarkable 80 dB with 20 dB headroom. When our transmitter feeds were switched from analog to digital, the effects were immediately audible. The first and most noticeable improvement was that our noise floor, which normally runs at -63 dB, dropped to -75 dB. As one of our more critical listeners later stated, "After the music ended and before the announcer's mike came on, there was nothing but total silence."

With the success of this early morning test, we decided to continue using the dbx 700 link for our STL. As the hour of the Symphony broadcast approached, engineers stood ready at Symphony Hall, WGBH's master control, and Blue Hill for the switch direct from Boston's Symphony Hall. At 2:00 PM, we began what some called "our best symphony broadcast in 20 years." The broadcast sounded clearer and quieter, and there was a psychoacoustic effect of greater presence—feeling closer to being in Symphony Hall than ever before.

The results of the experiments surpassed our expectations—the dbx 700 worked in all its locations. The biggest problem encountered was with the high congestion of signals on the 2 GHz ENG band. We had informed our neighboring TV stations of our planned experiment and had asked if they would postpone their alignment of ENG shots for their nightly news until 4 PM. Al-

Finally! A radio automation system for under \$5,000

- State-of-the-Art Ingenuity at Off-the-Shelf Prices.
- \$4,900 buys everything you need to operate your present live equipment. You get a Commodore[™] 64 computer with the Automate-64 operating system on a plug-in ROM cartridge, a Commodore[™] Datasette recorder, a Zenith[™] Data Systems monitor, a 3"-high rack-mount interface unit, interconnecting cables, plus easy to understand installation and operating manuals. Low-cost printers and disk drives are optional.
- The Automate-64 system is easy for EVERYONE in your station to learn to use because you converse with it in English.
- No compromising of your format. You can air satellite networks, syndicated programming, or locally-produced music tapes, using almost any playback equipment.

Automate 64

Call us, the price isn't the only good news.

Mid-Am

Mid-America Automation Corporation
206 Southwind Place Manhattan, Kansas 66502
PHONE: 913-537-3289, call collect



Circle 273 on Reader Service Card

MINUSCULE.

Until you use it.



SHOWN ACTUAL SIZE

The job of a good lavalier microphone is to be heard and not seen. So we're introducing the new MKE 2 micro-miniature electret lavalier mic—our smallest ever. It comes with a variety of clothing attachments and can even be taped to the wearer's skin. So whether your talent is fully costumed for an epic or scantily clad, they'll hardly know it's there.

You'll know it's there, though. Thanks to Sennheiser back-electret technology and an extremely thin, low-mass diaphragm, the MKE 2 gives you uncanny transient response, and frequency response from 40 to 20,000 Hz, all with low sensitivity to mechanical noises. Which means you hear clear voices, not ruffled clothing. See the MKE 2 for yourself, but be prepared to look closely.

SENNHEISER[®]

Sennheiser Electronic Corporation (N.Y.)
48 West 38th Street • New York, NY 10018 • (212) 239-0190
Manufacturing Plant D-3002 Wedemark West Germany

© 1983 Sennheiser Electronic Corporation (N.Y.)

Circle 274 on Reader Service Card

Visit us at NAB Booth No. 1137

FIRST DIGITAL MICROWAVE PATH

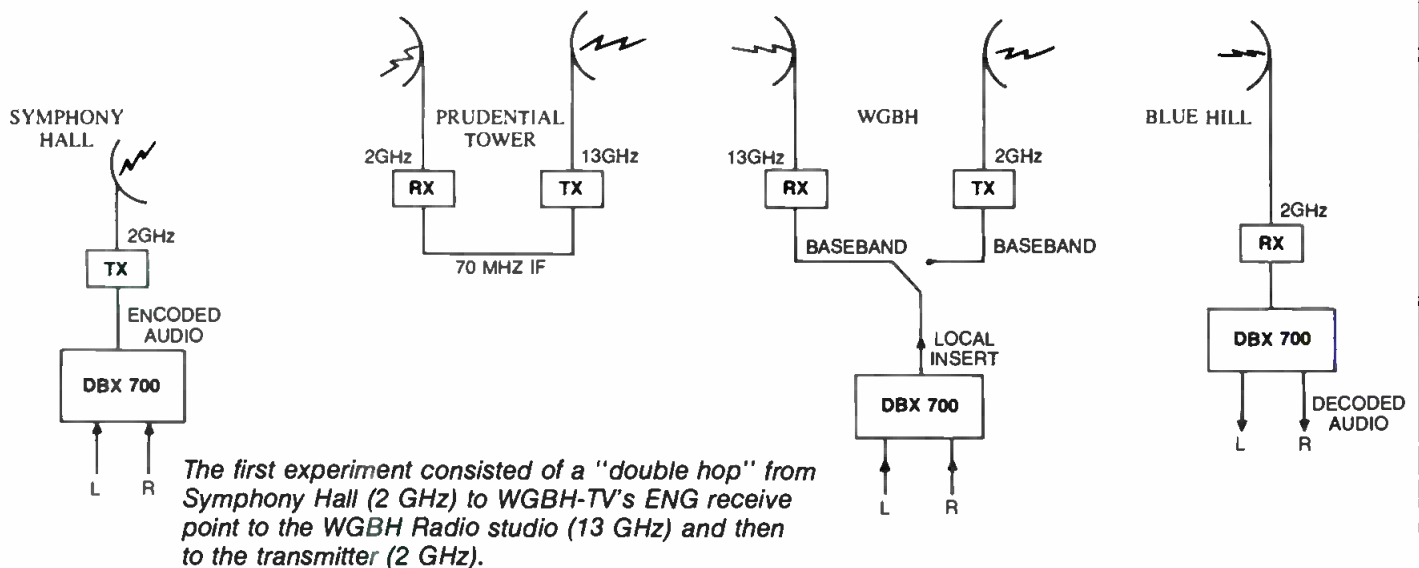

PRESENT MICROWAVE PATH

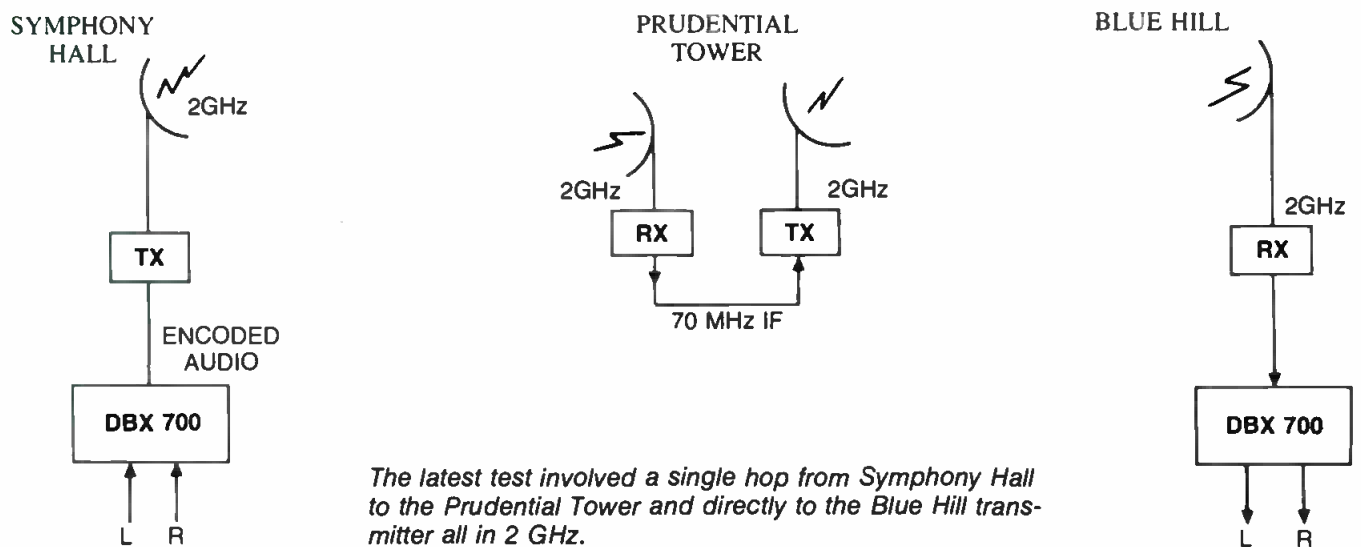

though the concert was scheduled to end at that time, it unfortunately ran over. Shortly after the 4 PM deadline a local TV station set up a more powerful microwave shot parallel to our digital path. The co-channel interference garbled the bit stream, sending the dbx 700 into mute. Instead of noise we went to silence. Immediately, we switched to the back up telephone lines and the Mosely STL. Upon investigation, we found only the Symphony Hall to Prudential Tower signal was impaired, so we then switched back to dbx 700 for our STL for the rest of the concert. We left the digital STL running for another twenty-four hours.

More to come

Given the results from our experi-

ments, on March 23, WGBH Radio began transmission of a digital-encoded signal direct from Symphony Hall to our transmitter via the Prudential Tower Building. In order to prevent another garbled bit stream, we installed a bandpass filter at the Pru to minimize interference from neighboring ENG shots.

WGBH is looking into the possibilities of using a different frequency spectrum (18 GHz or 23 GHz). Another possibility we have discussed with dbx is the development of a digital-audio bit-stream datalink for STL use. In addition, we are gathering the necessary funds to purchase and install a permanent digital-audio STL.

In the future, WGBH would like to use digital audio for live remote broad-

casts establishing an ENG-style receiving location for remotes. The digital transmissions have had an unexpected result. With the improved quality of the digital-transmission system, we now realize our shortcomings on air, such as air conditioning noise, record surface noise and any low level electronically induced noise in our air audio chain. Also, we look forward to updating our Harris exciters to increase its S/N ratio by 5-10 dB. The dbx 700 system will allow us to obtain higher quality remote programs and the ability to control the costs of live remote broadcasts. At WGBH Radio, we will continue using the dbx Model 700 Digital Audio Processor as part of our ongoing quest to provide our listeners with the highest quality audio service available. **BM/E**

INTRODUCING A SIMPLE SOLUTION TO A COMPLICATED PROBLEM

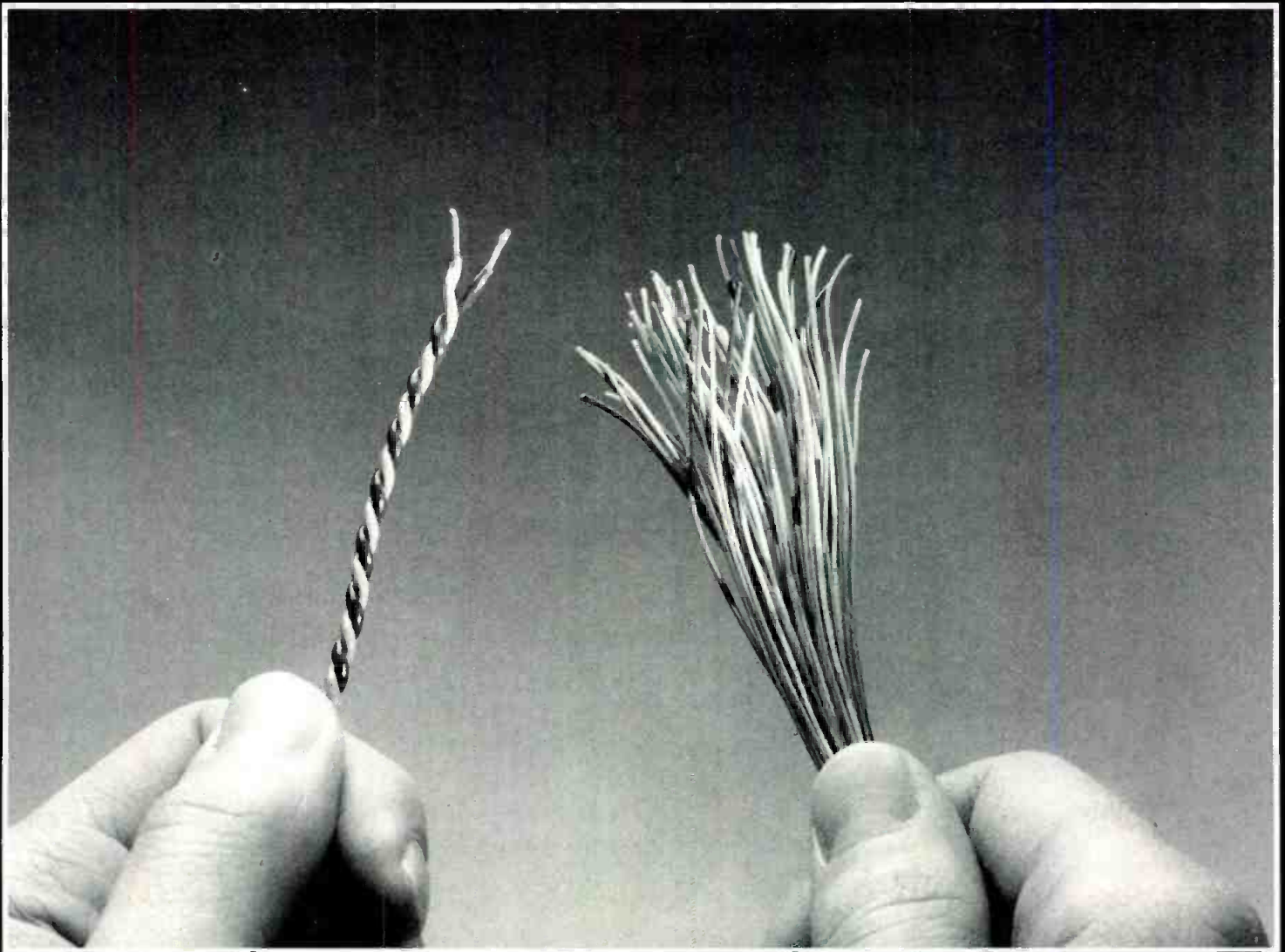

THE VECTOR 4000

Imagine monitoring up to 24 different audio programs or communication lines on one single pair of wires, telephone "dry pair" or a video coax. The incredible Vector 4000 Monitor System gives you 24 simultaneous, selectable channels of audio with a 50Hz to 5kHz bandwidth at distances of over a mile. The new Vector 4000 accommodates over 300 listening stations without any degradation.

Install the Vector 4000 in field or fixed locations in a fraction of the time and at considerable savings over current bulky systems. The possibilities are endless from multi-camera events to newsroom monitoring. All because of unique BTI technology.

Be the first on line at the N.A.B. with the new Vector 4000. See it in use at booth 1701.



broadcast technology, inc.

33 Comac Loop, Ronkonkoma, NY 11779 • (516) 588-6565

BTI is proud to be a supplier of IFB equipment to ABC for the 1984 Summer Games.

Circle 275 on Reader Service Card

www.americanradiohistory.com

Imagine The Features That Will Answer Your Present And Future Needs ... Then Call **Di-Tech**

Audio/video routing switchers come in many different shapes and sizes, offering a variety of features. Since your requirements change from year to year, shouldn't you select the one that fits today's budget AND can meet your present and future needs? Then try **Di-Tech**. We've got that small 4 x 1 matrix switcher and the 200 x 200 switchers. We've even got a selection of in-between sizes for audio only, video only or audio follow video with 1, 2 or 3 channels of audio per input.....

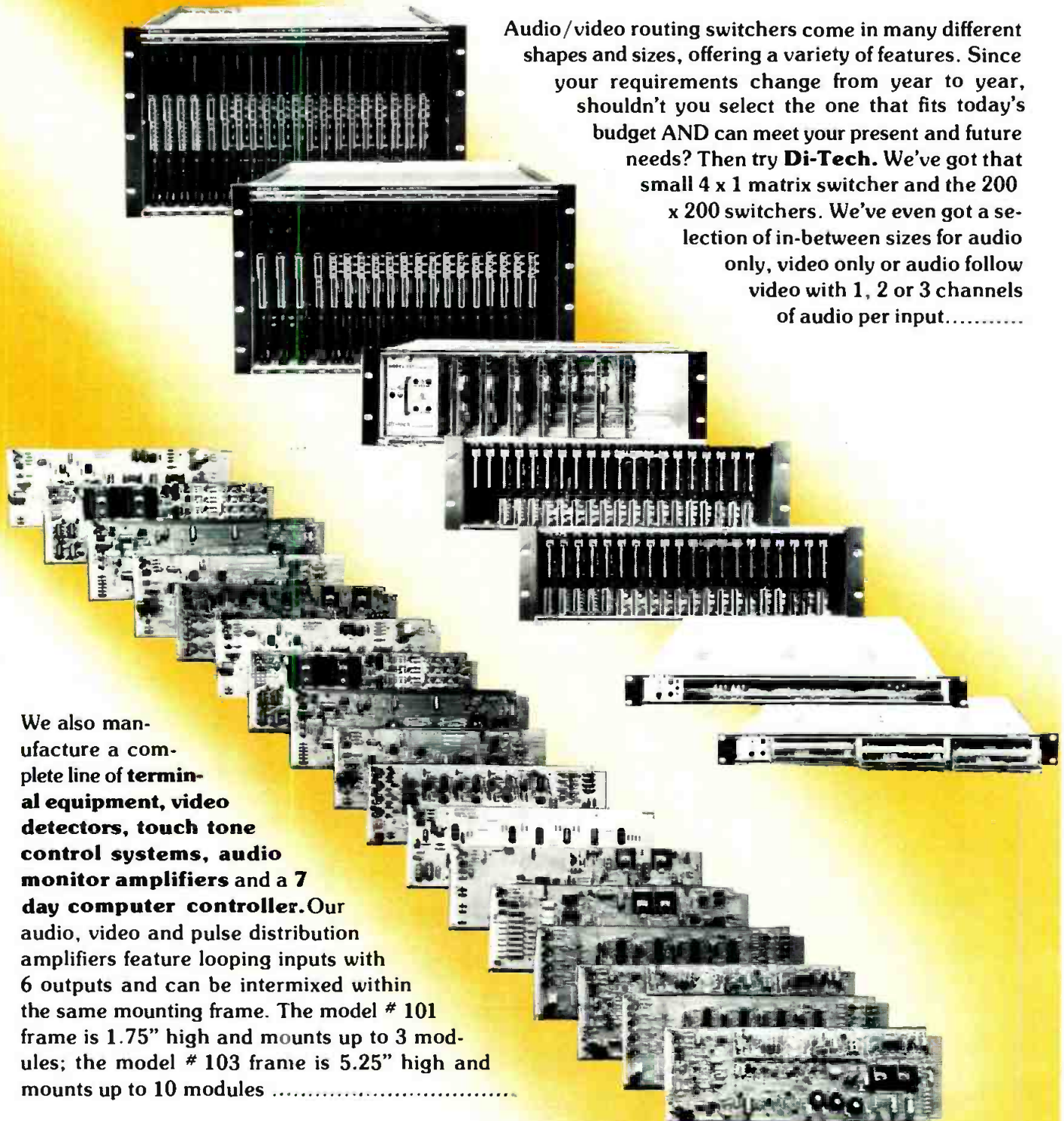

We also manufacture a complete line of **terminal equipment, video detectors, touch tone control systems, audio monitor amplifiers** and a **7 day computer controller**. Our audio, video and pulse distribution amplifiers feature looping inputs with 6 outputs and can be intermixed within the same mounting frame. The model # 101 frame is 1.75" high and mounts up to 3 modules; the model # 103 frame is 5.25" high and mounts up to 10 modules

Whatever your present or future needs are, call **Di-Tech** for the high quality, reliable, easy-to-operate answer.



di-tech

our **NEW**, bigger location:
48 JEF RYN BOULEVARD
DEER PARK, N.Y. 11729
TEL. # (516) 667-6300

Higher Definition Television:

How Far Should It Go?



Improved TV, Enhanced TV, Ultimate TV. Proposals for higher definition are abundant on both sides of the Atlantic. But when will the improvements actually come about, how much will they cost, and how will they affect current broadcasters?

by Tim Johnson

These are historic times for television technology—even though many people in the industry are not yet aware of what is happening. The advances in satellites, cable, digital very large scale integration (VLSI), and projection television are opening up a new frontier of television standards. By the 1990s it will be feasible to provide the ordinary home with a viewing experience a whole generation better than the television today.

The industry will begin a new period of rapid growth, as it sets about creating high definition TV

Tim Johnson is author of the report *Strategies for Higher-definition Television*, based on his extensive visits during 1983 to most of the world's leading centers of higher definition TV research.



(HDTV) systems which will provide the premier visual medium of the twenty-first century.

The distant horizon may be bright, but the immediate reality is proving expensive and frustrating for many participants. The Advanced Television Standards Committee (ATSC) has begun meeting in Washington to try and agree on a substantially new set of standards. These should come to mean as much to the industry as the NTSC color standard written 30 years ago. But anyone who tries to develop a balanced and durable TV standard today is shooting at a moving target—and a fast-moving one at that. Picking an HDTV system which will still look sensible in the 1990s, and which will last well into the next century, involves making delicate and controversial judgements about which technologies will develop fastest and furthest.

In the meantime, the uncertainty and

rapid changes are having a dizzying effect on broadcasters planning to use the new distribution channels, particularly direct broadcast satellite service. In the USA, CBS has presented proposals for a two-channel compatible HDTV DBS which are completely different from those they put forward two years earlier. The NHK (Japan Broadcasting Company) HDTV system, which caused so much interest a few years back, no longer seems relevant as the basis for a broadcasting standard, although it may be used in production and specialized applications. At least one would-be DBS operator, Rupert Murdoch's Skyband, has cut its DBS plans at considerable cost. And in Europe, the BBC has cancelled its proposal to provide Europe's first fully operational DBS service, largely because of the uncertainty about the choice of a standard.

In the midst of all the confusion, TV managers and engineers need to have

faith. A new era of higher definition television could be a great deal easier to achieve than anyone imagined a few years ago. And the new television standards can maintain a high degree of compatibility with the existing television system and with the receivers in people's homes.

The strategy for achieving these objectives depends on an evolution through three distinct stages of higher definition:

- The first will be an "Improved" TV, where the signal received by the home remains the same—or essentially the same—as now, but special circuitry in the receiver processes the signal to improve the image quality. The special circuitry could range from the comb filters already being introduced, through digital processing to remove noise and impairments, to the use of a full framestore in each receiver which could provide major improvements in quality and apparent resolution. The Improved TV market has already arrived in a sense, with the introduction of projection sets for the home.

- The next stage is often referred to as "Enhanced" TV. At this level, the broadcast signal would be changed or supplemented significantly, although a standard, NTSC-compatible television channel would probably be embedded within it. The extra information in the signal would be combined with signal processing techniques in the receiver to provide a wider picture which could have doubled the resolution of the present NTSC standard—but without a larger increase in the number of scanning lines.

- The third stage, high definition television, will probably use over 1000 scanning lines, or at least twice the number in the 525-line NTSC standard. This approach was pioneered by the NHK system, first demonstrated in the early 1970s, which raises vertical resolution by increasing the number of lines to 1125. By the time horizontal resolution is also raised and a wider screen provided, the signal transmitted requires around five times the standard NTSC bandwidth. And so, although the NHK format may have a role in the production studio and for movie distribution, it is generally agreed that a more efficient approach must be found for the HDTV broadcast signal.

One way in which all these different possibilities and proposals might fit together is presented in Figure 1. In this scenario, both improved TV and the NHK version of HDTV will play a relatively minor role in the short-term

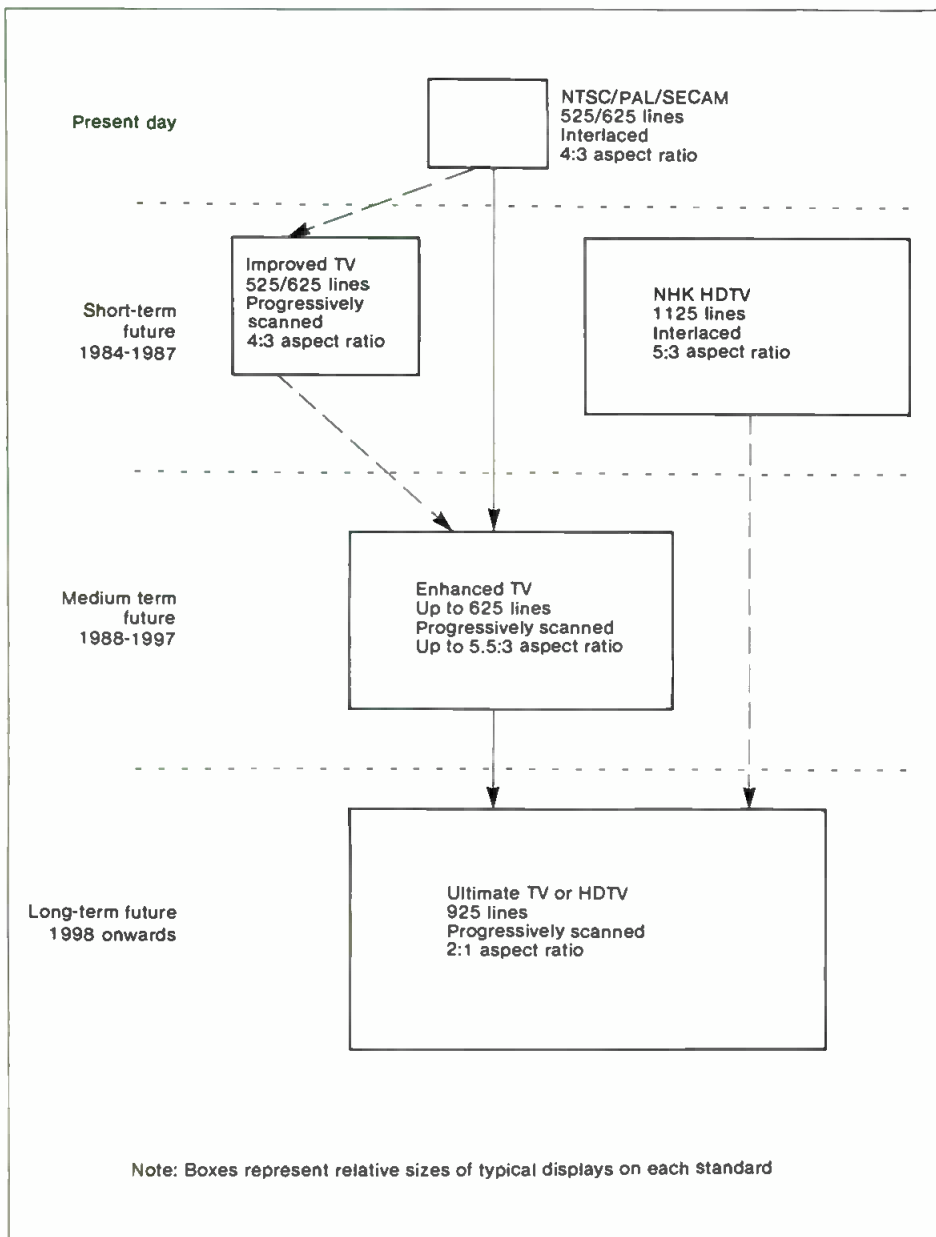
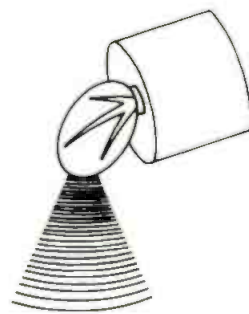

Fig. 1. Timetable for higher definition television, illustrating possible developmental stages for an advanced TV system in the U.S.

Taft and Harris team up again... for satellite uplinks



As a pioneer in the installation of TVRO satellite earth stations, it is only natural that Taft Broadcasting is taking the lead in the use of satellite uplinks.

"A few years ago, when we decided that satellite communications was the wave of the future, we took a good, hard look at all of the TVRO equipment available," says John Owen, Taft Vice President for Television Engineering. "The Harris high-speed, positionable kingpost antenna system was the one that best fit our needs, with its ability to reposition between any two satellites in less time than a normal station break.

"We started out equipping three of our stations with Harris systems, and soon expanded the service to all of our TV stations. Most of these TVROs paid for

themselves in a year's time—with network fees and switching cost-savings contributing a majority of the payback.

"Now, with the growing opportunities in satellite uplink business, Taft has installed four Harris redundant 9-meter uplinks, all with facility control for a totally automatic approach.

"At WDAF-TV in Kansas City, we are uplinking Royals baseball. At WBRC-TV in Birmingham, it's Stallions football. And at WDCA-TV in Washington, D.C., Black Entertainment Television is transmitted six hours a day. We are also using our uplinks for news feeds to the major

networks, and we're renting time to private users for teleconferencing and other requirements. Also, we own and operate Transponder 12X on Westar V to support our satellite activities."

Taft's extensive commitment to satellite communications is just one example of the company's foresightedness and solid business sense. Its choice of Harris satellite equipment is still another.

For more information on how Harris can help you get ready for the future, contact Harris Corporation, Broadcast Transmission Division, P.O. Box 4290, Quincy, Illinois 62305. (217) 222-8200.



HARRIS

Circle 277 on Reader Service Card

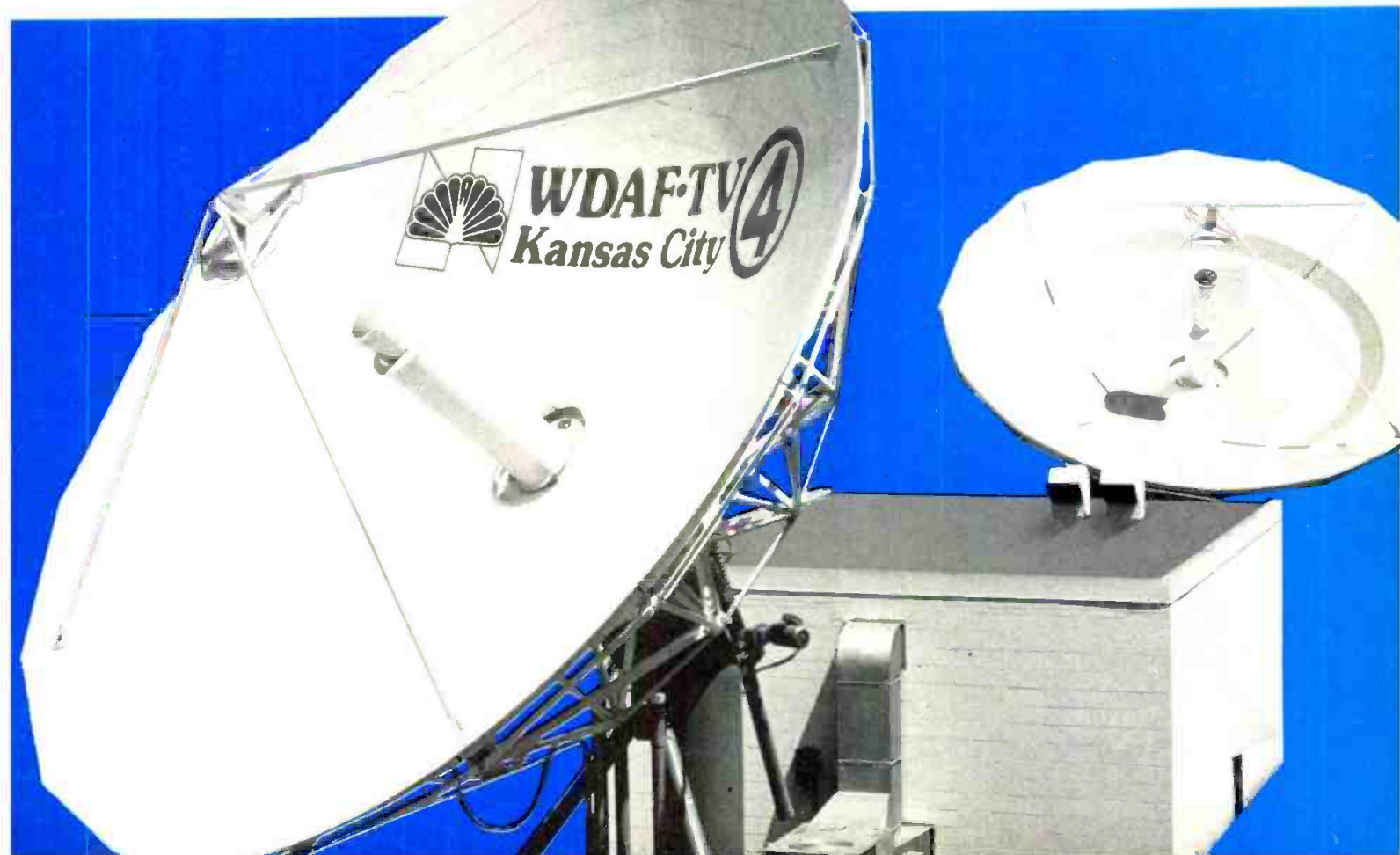

future, while the main thrust of development will be towards Enhanced TV, which will be able to provide a vastly improved picture by making maximum use of digital signal processing technology, particularly for progressive scanning (discussed in more detail below). A big increase in the number of scanning lines will not be required. And though it may be worthwhile to go from 525 to 625 or 657 lines in the U.S., in Europe the existing 625 lines could be quite adequate. Beyond Enhanced TV, there will be another generation of standards with more lines and an even wider aspect ratio—Ultimate TV, or true HDTV. The name Ultimate

TV was chosen because, given the space available for a TV set in the ordinary home, it should offer the highest resolution and biggest screen sizes required in the foreseeable future. Even this level of quality is estimated to require no more than 925 lines if digital signal processing techniques are fully used.

Enhanced TV

If the scenario of Figure 1 is correct, then it is Enhanced TV which should be the main focus of research, development and standardization efforts today. This is the technology which could provide the basis of a TV boom continuing



Ikegami's high-definition color TV monitor.

throughout the 1990s.

But what is the justification for these claims, and what are the prospects of them being realized in practice? The answers can be found by examining some of the proposals being put forward for higher definition television, the technology required to make them effective, and the markets they can be expected to command if they succeed.

A great deal of progress has been made in the last two years, and most, if not all, of the new proposals being put forward have important points in common which were not generally accepted until recently.

- First, most work is proceeding on the assumption that higher definition must not require more bandwidth than two channels of standard definition TV. Despite the increasing number of channels made available by DBS and modern cable systems, an allocation of more than two channels is unlikely and would be a wasteful use of a fixed resource.

- Second, the high definition transmission must have sufficient compatibility to provide a viewable signal for viewers with only standard definition sets—even though they will not see the full high definition image.

- Third, for the DBS-oriented proposals, the "time multiplexed component" (TMC) format for the broadcast color video signal is now generally advocated. The TMC format separates the color and luminance components of the signal by transmitting them at different times, rather than simultaneously on different frequencies as is the norm with existing terrestrial TV standards. The advantages are the elimination of cross-color and cross-luminance, and a better signal-to-noise ratio. A similar format could also be used for the cable distribution of Enhanced TV.

On the other hand, there are some major areas of controversy remaining. They center around the issue of how

**Now Every Cartridge System
for Airing Commercials
Is Obsolete.**

**MODEL
DAS-2**

If your station is still using a cartridge system for broadcasting commercials, you're using out of date equipment. Every cartridge system ever designed is subject to mechanical breakdowns and requires the full-time attention of an engineer. The new DAS-2 Digital Audio Store from NTI converts audio material to digital signals and stores them on a hard computer disk. You then program the system to air the commercials at any time or in any sequence that suits your needs. The revolutionary DPCM-AQ-AS recording method is used to ensure unequaled audio quality, virtually unlimited dynamic range, and a high degree of stability. The large storage capacity of the DAS-2 means that it can even be used to control, edit, and play full-length programs. Built-in redundancy for total reliability and a host of valuable functions make the DAS-2 Digital Audio Store the only logical answer to the drawbacks of cartridge systems. If you're interested in taking a look at the future today, contact NTI America. There's a new generation of broadcasting equipment waiting in store for you.



NTI America, Inc.

1680 North Vine Street, Los Angeles, California 90028
® Phone: (213) 462-8945 Telex: 215468

SEE US AT NAB BOOTH #1014D

Circle 278 on Reader Service Card

Q: WHAT'S THE BEST KEPT SECRET IN EDITING?



A: EECO's Pioneering Past.

- 1967—EECO develops first television time code editing system, called ON-TIME™.
- 1970—EECO works with the SMPTE to help establish an industry standard for longitudinal time code.
- 1971—EECO is presented an Emmy Award citation for outstanding engineering achievement for the development of time code and equipment for videotape editing.
- 1972—EECO pioneers first synchronizing system utilizing time code and a microprocessor to control both sprocketed and non-sprocketed transports.
- 1974—EECO introduces first low power time code generator CMOS chip.
- 1976—EECO, jointly with RCA, develops first microprocessor controlled videotape editing system—the RCA AE600 for the RCA TR600 VTR.
- 1978—EECO receives an Academy Award citation for the application of code and control systems in motion picture production.
- 1980—EECO works with the SMPTE to help establish industry standard for vertical interval time code.
- 1980—EECO, jointly with RCA, develops videotape editing system incorporating longitudinal and vertical interval time code editing capabilities—the RCA AE800 for the RCA TR800 VTR.
- 1982—EECO introduces IVES™ Intelligent Video Editing System, a complete post-production system for two VCR's.

A: EECO's Innovative Future.

EECO is unveiling new solutions in multi-machine editing control. Our latest innovative milestone: A computer-assisted videotape editing system, capable of multi-machine control of any mix of up to 9 professional 1/2", 3/4" and 1" VTR's or multitrack ATR's and a production switcher.

Providing ease and speed of operation, our new editing system utilizes distributed processing and multiple keyboard configurations for use by either videotape or film editors.

We've also expanded our IVES Editing System with the addition of complete A/B control of three 1/2" and/or 3/4" VCR's...the IVES A/B™ enhancement option.

EECO's forward direction in editing is backed by a history as an industry pioneer and product innovator, including a full line of longitudinal and vertical interval time code generator and reader peripherals to fit every price and capability range and a multi-tcue synchronizer for enhancing audio for video.

For additional information or the name of your nearest EECO Authorized Distributor call (714) 835-6000 Ext. 419. EECO Incorporated, 1601 E. Chestnut Ave., P.O. Box 659, Santa Ana, CA 92702-0659.

EECO®

Computer Controls For Video Production

SEE EECO'S NEW SOLUTIONS FOR EDITING AT
NAB BOOTH #1314



Panasonic's BT-P4500D computer graphic video projector.

higher resolution is to be achieved—by the method demonstrated by NHK of transmitting more scanning lines, or by the Enhanced TV route of signal processing in the receiver.

CBS proposal

CBS has taken the traditional "more lines" approach in its latest proposal for a compatible HDTV system. The

system would use two DBS channels, each coded in TMC format and occupying 24 MHz of FM bandwidth. The first channel would carry a standard 525-line, 4:3 aspect ratio NTSC signal; the second "augmentation channel" would carry a wider, 5:3 aspect ratio, 525-line picture of the same scene. The two channels would be interlaced in the specially-equipped receiver to produce an image of 1050 scanning lines in the 4:3 aspect ratio central region, and 525 lines at the edges.

The main attraction of the CBS proposal is that it provides an NTSC-compatible signal and a form of high definition without the need for expensive digital circuitry, such as a framestore, to combine the two channels in the receiver. On the other hand, the system would stretch present-day satellite technology to its limits. To increase the horizontal resolution in step with the vertical resolution, the DBS carrier has to be modulated with a 12 MHz bandwidth, compared with the 7.5 MHz or so that is required for an ordinary NTSC signal. This would mean a substantially poorer signal-to-noise ratio which would have to be offset at considerable expense by using more powerful satellite signals, bigger

rooftop antennas, and high performance, low-noise electronics in the home.

In fact, the vertical resolution is not doubled, because the two channels have to overlap to a large extent in the information they provide to allow for NTSC compatibility. The lower resolution at the edges of the screen could also prove a troublesome limitation.

Opposite approaches

Other proposals have taken the opposite approach to the one favored by CBS. They assume that it will be feasible to provide a framestore in the receiver and make maximum use of its power, both as a way of combining two separate channels into one picture, and as the means of carrying out enhanced resolution processing on the received signal. A number of groups in the U.S., Europe, and Japan are already working on these lines; one of the most advanced is a team led by Dr. Joe Nadan at the Philips Laboratories in Stamford, CT.

Nadan's two-channel system is aimed at cable networks in the first instance. As with the CBS proposal, one channel would be standard NTSC. The augmentation channel would provide

Winsted

THE PERFECT MATCH
for your video equipment

ROLLING CABINETS

Double your
tape storage
space!

TC-88 TYPE

Store up to 161 of the 1/4" videocassette tapes in each of these space-saving cabinets. Units move effortlessly on low-profile steel tracks to give you easy access to cabinets positioned behind them. Similar storage systems available for 1"-2" video tapes, cartridges & film.

For full-line catalog of video consoles, tape and film trucks, film and videotape storage systems call toll-free or write

THE WINSTED CORPORATION
9801 James Circle, Minneapolis, MN 55431 • (612) 888-1957

PHONE TOLL-FREE **1-800-328-2962**

TELEX: 910-576-2740

LIGHTNING BARRIER™

100% LIGHTNING STRIKE PROTECTION GUARANTEED

You name it, LEA protects it.
Broadcast towers, buildings, power lines, plant sites, tank farms, substations, water towers, radar installations, missile launch pads... any application.

LIGHTNING BARRIER Dissipation Array Systems from LEA bleed off and control high energy electrostatic buildup between the clouds and the ground.

LIGHTNING BARRIER Dissipation Array Systems take full account of differences in structure size and height, storm patterns, altitude, and Keraunic Number.

And LIGHTNING BARRIER Dissipation Arrays are storm activated, so there is no power consumption.

No conventional lightning rod approach can possibly give you the protection that LEA'S LIGHTNING BARRIER Dissipation Array Systems provide.

So strike back at lightning. Get complete details today from LEA, Inc., a Dynatech Company, 12516 Lakeland Road, Santa Fe Springs, California, 90670 (213) 944-0916, TWX 910-586-1381.

"the LEAder in pure power technology"
See LEA at NAB booth 302

See us at NAB
Booth #1238

Circle 280 on Reader Service Card

Circle 281 on Reader Service Card



SMART

Asaca/Shibasoku's new high resolution monitors have the capability to deliver color performance other monitors simply cannot produce. Using R-Y, B-Y decoding no longer meets the demands of today's professional standards.

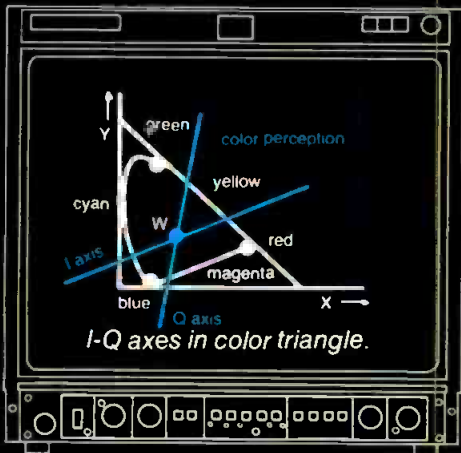

The Asaca/Shibasoku monitor like the human eye resolves certain colors best; reds, oranges, yellows, and flesh tones. The I-Q decoding system enables the monitor to display these colors at a higher resolution using wide band demodulation of 1.3 MHz rather than 0.5 MHz as in R-Y, B-Y systems.

We cared enough to give you a monitor with the I-Q to reproduce the best possible pictures. We know you're smart enough to buy it.

SHARP



COLOR

FEATURES

- 20" and 14" models available—high resolution delta CRTs.
- I-Q wide band demodulation system.
- Complete board interchangeability between models.
- Switchable high performance comb filter and aperture correction.
- Multi-standard capabilities (NTSC, PAL, SECAM) on all models. Switchable from the front panel (20" model). No adjustments necessary because of digital sync circuitry.
- Dynamic focus insures perfect focus on all areas of CRT. Adjustable from the front panel.
- Special feedback circuits guard against color changes due to variations in temperature.
- Active convergence—40 controls allow precise adjustment on all areas of CRT.
- Pulse cross with expanded vertical blanking interval.
- OPTIONS... Built-in color bar or cross hatch patterns. Built-in safe title marker generator. Multi-standards. RGB inputs.
- TWO YEAR WARRANTY ON ALL PARTS AND LABOR INCLUDING THE CRT.



ASACA/SHIBASOKU CORP. OF AMERICA

12509 Beatrice Street Los Angeles, CA 90066 (213) 827-7144 (800) 423-6347

Circle 282 on Reader Service Card

www.americanradiohistory.com

the additional information to create a 657-line picture with 5.33:3 aspect ratio. (The 657-line standard was chosen because it bears a convenient ratio to the 525-line NTSC standard and the 24 frames-per-second movie standard.) The framestore in the receiver is essential to combine the two channels in this more complex way.

The framestore is also used to provide a progressively scanned image, achieved by reading the whole frame into a digital computer memory and then scanning it out in line sequence. Theory and experiment show that this technique can increase the apparent resolution of the picture by a surprisingly large 67 percent without any increase in the number of lines transmitted.

Because of this advantage, a 657-line progressively scanned picture should provide twice the apparent vertical resolution of the 525-line NTSC standard. The augmentation channel is used to raise the horizontal resolution by the same factor. If anything, the system should offer somewhat higher resolution than the CBS 1050-line interlaced proposal. In this way, an Enhanced TV picture could be delivered within the 9 MHz bandwidth of two standard cable channels—considerably

less than the bandwidth required by the CBS proposal.

European MAC proposals

In Europe, several centers including Philips' European research laboratories, the BBC, and Dortmund Technical University are working on similar ideas, particularly as they might apply to processing a DBS signal. It now seems likely that at least some countries will adopt a form of the MAC (Multiplexed Analog Component) system originally proposed by Britain's Independent Broadcasting Authority. Now Prof. Broder Wendland at Dortmund, and others, are proposing a form of "stretched MAC" which would combine the CBS ideas for making maximum use of satellite technology with those for making maximum use of digital circuitry.

A stretched MAC system would carry a 625-line signal of up to 11.6 MHz bandwidth in the European standard 27 MHz DBS channel. The vertical resolution would be enhanced by progressive scanning and the bandwidth would be sufficient to provide equivalent horizontal resolution for an image of up to 5.5:3 aspect ratio. Conventional receivers, with only 4:3 aspect ratio,

would identify the part of the signal to be displayed with "service identification" codes.

In practical terms the system would provide something very close in performance to the CBS proposal, but in 27 MHz of FM bandwidth instead of 48 MHz. It would certainly be much more attractive than a CBS-type two-channel system in European countries which are allocated only five DBS channels each. These channels are a little wider, and the power flux significantly higher, than allowed for in the U.S. DBS plan, so it will be easier to accommodate a signal of increased bandwidth.

The clear conclusion to be drawn from all these proposals is that a wide screen, high definition picture, with twice the apparent resolution of the television signal received today, can be provided within an acceptable bandwidth if a framestore and enhanced resolution processing can be used in the receiver. Add to this the other advantages of a framestore and digital electronics, which could turn the familiar TV receiver into a high performance image processing device, with features seen only in studio equipment today, and the case for using framestores begins to look very strong.

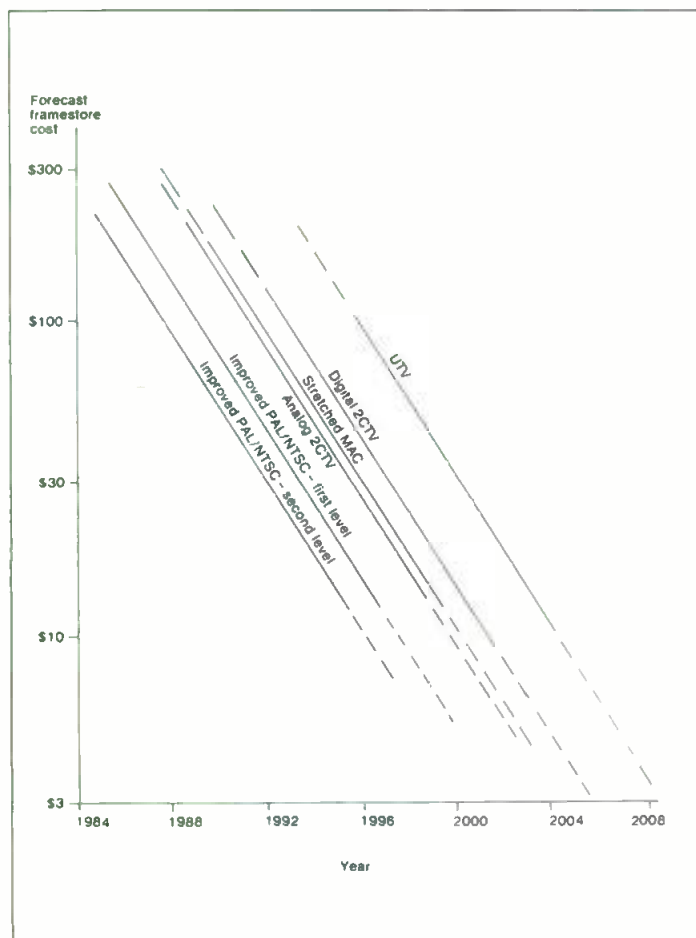

The first experiment consisted of a "double hop" from Symphony Hall (2 GHz) to WGBH-TV's ENG receive point to the WGBH Radio studio (13 GHz) and then to the transmitter (2 GHz).

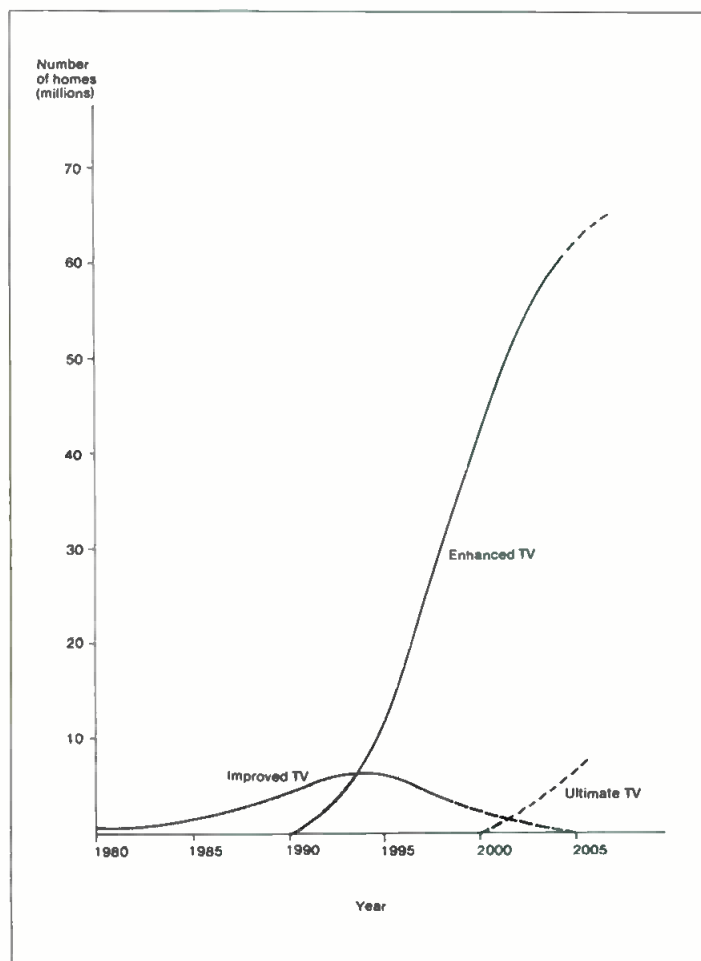

The latest test involved a single hop from Symphony Hall to the Prudential Tower and directly to the Blue Hill transmitter all in 2 GHz.

Now the CHYRON® RGU-2

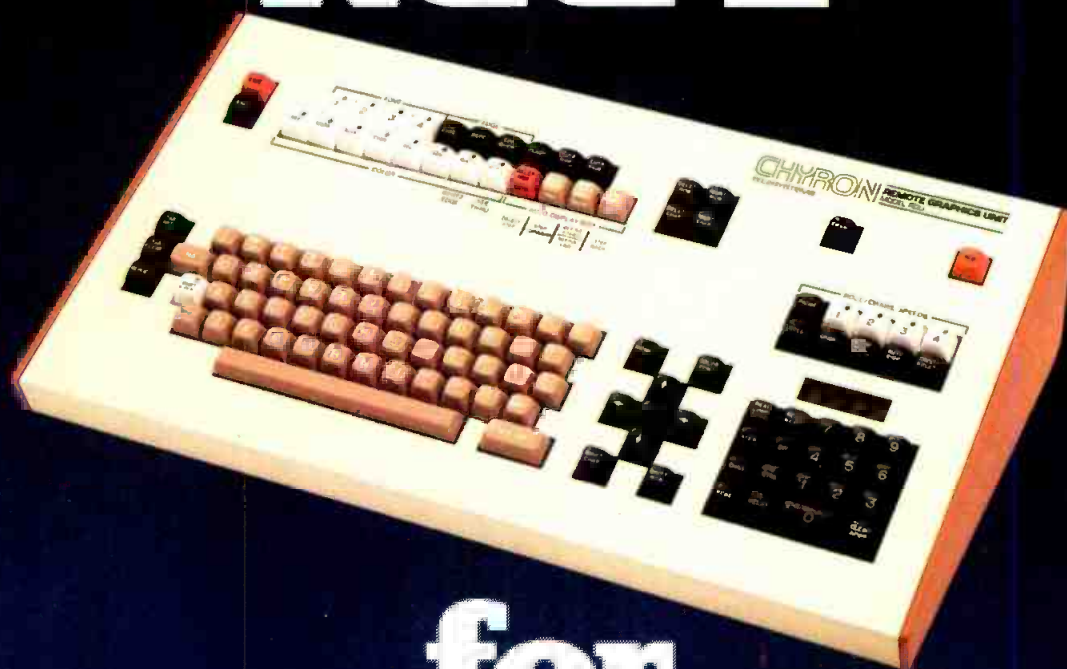

for
under
\$20,000.

Now's the time to buy a brand new, latest model CHYRON RGU-2 graphics and tilting system at a price that's hard to resist.

The high-quality RGU-2 provides many of the most-wanted features of the industry-standard CHYRON IV: unsurpassed character resolution of 27 nanoseconds...programmed graphics animation...color for background and text on a character-by-character message basis (with the optional CHYRON Color Encoder)... a versatile multi-font library... automatic color/font change...64 color choices...and much more.

With the optional Channel Control Module, mixes, wipes and fades are available at the touch of a key.

Operation is flexible and uncomplicated. Just load a software program and automatic instruction displays appear on the monitor to provide an interactive communications channel between operator and RGU-2.

So, don't delay. There may never be a better time to buy the character

generator that offers most of the features found in units costing twice as much—the CHYRON RGU-2.

Follow the Leaders with

CHYRON
TELESYSTEMS

A DIVISION OF CHYRON CORPORATION
265 Spagnoli Road, Melville, New York 11747
• 516-249-3296 • Telex: 144522 Chyron Melv
Amplex International is exclusive distributor for
Chyron Graphics Systems outside the U.S.A.

Price subject to change without notice

Circle 283 on Reader Service Card

Technology timetable

This is where it is necessary to turn from the different proposals under discussion to consider whether the technology needed to implement them will be available. DBS and multi-channel cable networks are already with us, or in reach. The problems of providing large screen, high quality receivers on which to view high definition images may prove rather more difficult, but major advances in projection TVs are expected in the next few years, and even the flat screen set may not be far behind. Most concern at the moment seems to center on the availability of framestores, and in particular on whether they will be available soon enough at a low enough price.

Framestores for progressive scanning of a standard NTSC picture—of the kind that might be used in an Improved TV set—require about 4 megabits of storage. A progressively scanned Enhanced TV picture, of up to 657 lines, would require at least 12 megabits. At 1984 prices, the components for a 12 megabit memory would cost about \$600, and a framestore would be many times more expensive once built into a receiver and sold at a retail markup. But the cost of memory

is falling very fast. Figure 2 shows the projected trends, with the components for a 12 megabit framestore costing about \$80 by 1992, and \$12 by 1999. Some other recent projections even suggest that the figures could fall to \$120 in 1987 and \$12 as soon as 1992.

All this suggests that Enhanced TV DBS or two-channel cable (2CTV) services could be launched by 1987 or 1988. The first viewers would probably have to pay about \$3000 for their receivers, but that is not out of line with what the first color viewers paid in today's money in the 1950s, or what many people have been paying recently for satellite antennas. The price should fall rapidly with increasing volume of sales—assuming that the quality enhancement is enough to achieve the "just valuable difference," the point at which 50% of households will change their buying decisions in favor of the new product.

Public acceptance

Will the wider screen, doubled apparent resolution, elimination of impairments, provision of true stereo sound, plus all the extra facilities of a framestore set, be enough to make Enhanced TV a successful product? Only

the marketplace will be able to provide the definitive answer, and nobody at this stage can make a confident forecast of what the demand might mean in terms of numbers of high definition sets. But it seems reasonable to compare what happened with the introduction of color television and plot a similar curve for higher definition (Figure 3). The numbers are very exciting. If the new medium takes off about 1990—the way color TV did about 1962—then the industry could be selling as many as seven million Enhanced TV sets a year in the U.S. by the late 1990s.

But the takeoff date is a much more sensitive part of a scenario for the future than the eventual size of the market. After all, color TV languished with low sales through the 1950s until the technology and the market were ready. A takeoff for Enhanced TV in 1990 implies that all parties will get their act together much more quickly this time.

BM/E

Mr. Johnson's report Strategies for Higher-Definition Television is published by Ovum Ltd., 14 Penn Rd., London N7 9RD, and is also available in the U.S. from Knowledge Industry Publications, White Plains, NY.—Ed.

Fancy Footwork... for the champion shots



SHOTOKU camera mounts win hands down. Aim onto your subject, and they glide smoothly and surely with never a slip. No wonder cameramen all over the world put their trust in our wide variety of products and reliable technology. Our products range from mini-cranes for handy cameras, TV studio cranes and camera pedestals, to cam heads, friction heads and many others.



SHOTOKU LTD.

Head Office: 707, Futako, Takatsu-ku, Kawasaki,
Kanagawa 213, Japan
Tel. 044-833-3351

Fukuyama Plant: 107, Daimon-cho 4-chome, Fukuyama,
Hiroshima 721, Japan
Tel. 0849-41-3335

Circle 284 on Reader Service Card

World's most accommodating camera.

You'd expect the Ikegami HK-322 to make beautiful, crisp, color-true pictures. It does. You'd also expect it to offer the latest in computer set-up convenience with its third generation microprocessor control plus comprehensive operational automatics and 8 scene files and 8 lens files. It does that too. But what you might not expect, is just how incredibly flexible the HK-322 is.

Consider that you can specify 30mm or 25mm Plumbicons,* and for each size select standard, Anti Comet Tail or diode gun operation. The same holds true for cabling. You choose from triax, multicore or, if you'd like, specify an HK-322 version that's compatible with your existing TV 81 cable. You also have a choice of optional camera control configurations.

There are also some unique features such as trim files that compensate for differences between the internal pattern projector and the external scene caused by chromatic aberrations in the lens.

Finally, compare its performance to any other camera. An honest resolution of 800 lines at center, a practically noiseless S/N ratio of up to -58 dB and a virtually unmeasurable .05% registration error over the entire raster.

Best of all, the HK-322 is ready right now to fit into *your* idea of an ideal studio/field camera. Without compromise, but with plenty of accommodation.

Contact Ikegami. See for yourself. Ikegami Electronics (USA) Inc. 37 Brook Avenue, Maywood, NJ 07607

*T.M. of N.V. Philips

Northeast: (201) 368-9171
Midwest: (219) 277-8240
West Coast: (213) 534-0050
Southwest: (713) 445-0100
Southeast: (813) 884-2046

Ikegami HK-322

Circle 285 on Reader Service Card

Visit us at NAB Booth #1011-1013



Cost-Performance to OKI Doesn't Mean Less Performance for Lower Cost. Performance Takes Priority!



LT1210 Digital Television Standards Converter

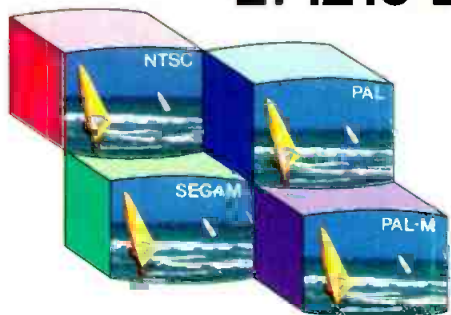

LT1015Σ

Professionals demand an uncommon level of picture quality in TV standards conversion. And production on the road requires a compact, reliable unit. Oki Electric built the LT1210 to deliver. It's the world's smallest converter able to handle NTSC, PAL, and SECAM, with PAL-M conversion as an option. Yet it incorporates every function and feature needed for producing studio-quality programming. The image enhancement function, for example, ensures a high-definition picture with outstanding image clarity. This converter is also a totally integral unit so no adaptor or changing of encoder/decoder modules is required for conversion between NTSC, PAL and SECAM.

The cost-performance of the LT1210 is nothing less than outstanding. Oki Electric's proven expertise in standards conversion combined with the latest in LSI technology results in a highly reliable, easy-to-use converter. The LT1210. Check it out. Anywhere.

Oki also produces the high-end LT1015Σ Digital TV Standards Converter.

In the U.S.A. and Canada, contact:

OKI Electric Overseas Corp.
One University Plaza
Hackensack, New Jersey
07601 U.S.A.
Tel: 201-646-0011-0015
TWX: 7109905004 OKI ELEC HAK

In other areas, contact:

Head Office:
Overseas Marketing & Sales
10-3, Shibaura 4-chome,
Minato-ku, Tokyo 108, Japan
Tel: (03) 454-2111
Telex: J22627
Cable: OKIDENKI TOKYO

OKI
electric
industry
company, Ltd.

Circle 286 on Reader Service Card

www.americanradiohistory.com

See us at NAB, Booth No. 1505.

BROADBAND YOUR ANTENNA WITH AN EXTERNAL NETWORK

Narrow bandwidth loads can be compensated by this special external network. Power efficiency and costs are carefully considered. Result: an almost universal solution.

By Grant Bingeman

The technique of external broadbanding described here will work with all loads, but may not always be realizable because of practical component rating limits. Consider a 5 kW DA-2 with the following common-point impedances:

KHz	DAY	VSWR	NIGHT	VSWR
990	40 - j30	2.0	20 + j20	2.96
1000	50 + j0	1.0	50 + j0	1.00
1010	100 + j0	2.0	45 - j55	3.02

Grant Bingeman, PE, is a senior engineer with Continental Electronics.

Beginning with the day antenna, which has the better bandwidth, we need to rotate the common-point impedances by +22.8 degrees (Figures 1 and 2) in order to obtain the kind of impedance sweep that can be treated with this broadbanding technique. Then we need a network that looks like a leading tee at 990 kHz and lagging tee at 1010 kHz, but is transparent at carrier, 1000 kHz (Figure 3).

L_1 and C_1 are series-resonant, while L_2 and C_2 are parallel-resonant at 1000 kHz. L_1/C_1 looks capacitive below resonance and inductive above resonance. L_2/C_2 , on the other hand, looks inductive below and capacitive above resonance. The phantom reactance, X , is

part of the transformed common-point impedance. This reactance is zero at carrier.

In order to avoid extremely high circulating currents and other problems, the parallel-resonant tank is best replaced by the lumped-parameter version of a shorted stub (Figure 4). A -90 degree tee (C_3 , L_3 , and L_4) makes the series-resonant circuit (L_2 and C_2) appear parallel-resonant at the junction of C_1 and X .

In order to keep component size and loss reasonable, it is a good idea to transform down from the carrier impedance (five to one is typical) while performing the phase rotation. Therefore, a second network must transform back

▼Figure 1. Smith chart showing common-point impedance.

Figure 2. Transformed common-point impedance for broadband operation.▶

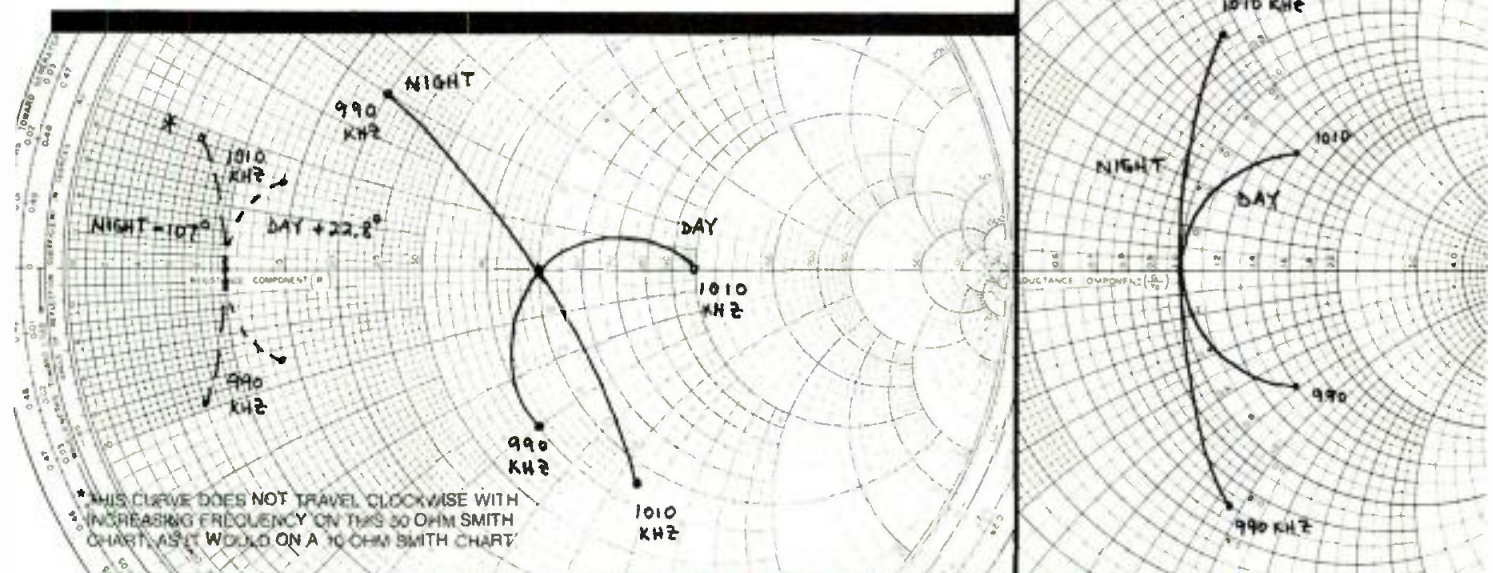

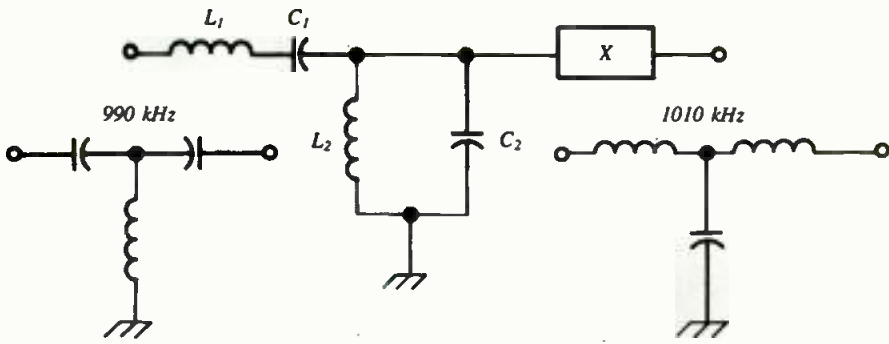

Figure 3. Basic tee-network to achieve transformation.

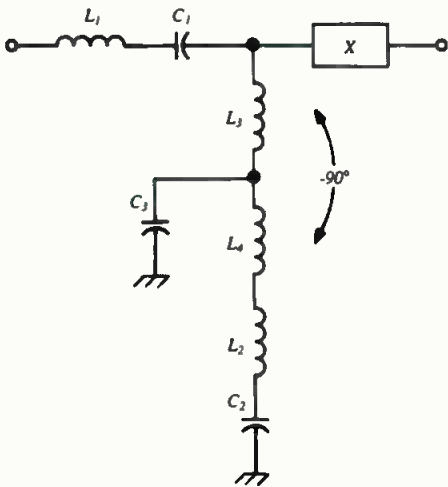
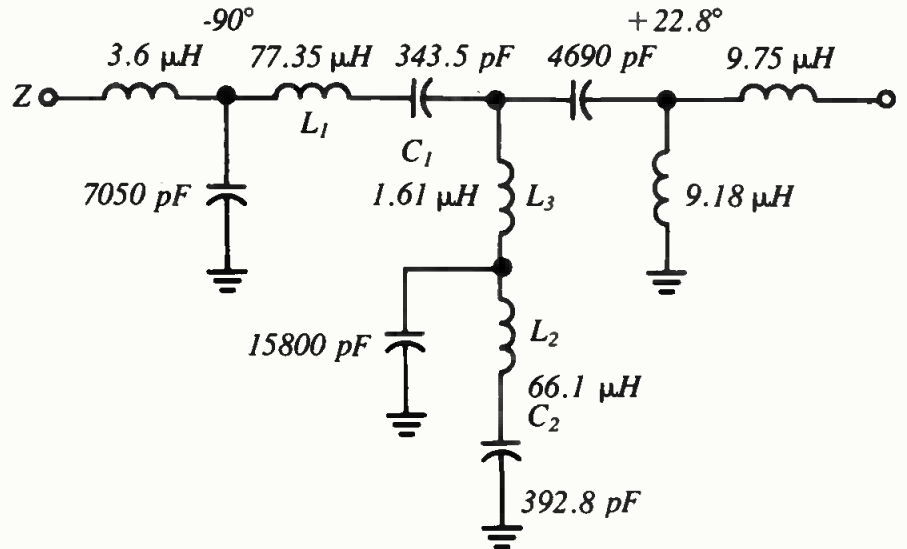

Figure 4. Parallel-resonant tanks should be replaced with lumped-parameter shorted stubs.

to the original carrier impedance following the broadbanding circuits (Figure 5). So if we combine the coils which are directly in series, the total component count is 11, not including padder capacitors. This is not bad for a network which can flatten your bandwidth under all circumstances.

The overall result for the day common point is pictured in Figure 6. If we

assume a capacitor Q of 2000 and a typical coil Q of 500, losses total 21 percent of input power*. If we replace L₁ and L₂ with toroidal coils having a



kHz	INPUT IMPEDANCE, Z			
	(QL = 500)	VSWR	(QL = 1500)	VSWR
990	46.5 + j8.8Ω	1.22	49.8 + j5.8Ω	1.12
1000	49.4 + j0.1	1.01	50.2 + j0.1	1.00
1010	46.6 - j9.5	1.23	50.5 - j6.5	1.14

Figure 6. Final circuit for common-point impedance transformation, day antenna.

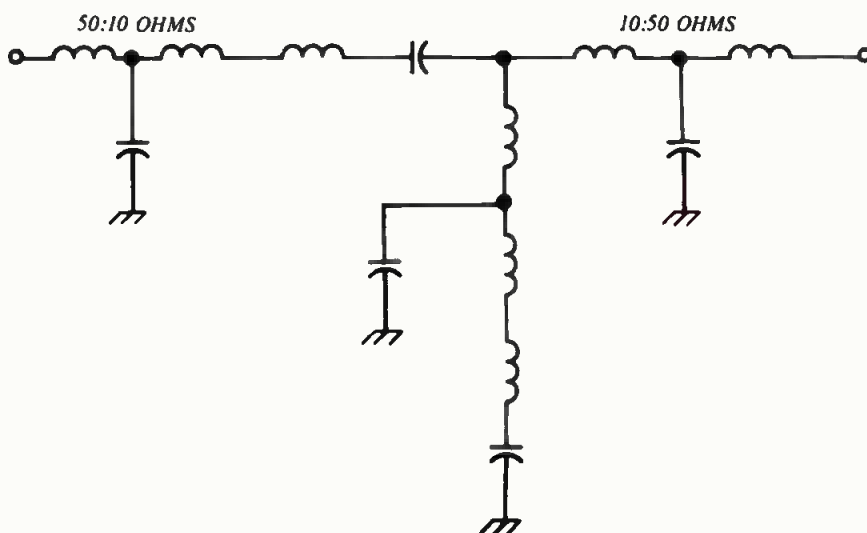

Figure 5. Carrier impedance transforming networks added to keep component size down.

Q of 1500, losses are reduced to 11 percent. Thus for 6000 W in we get 5400 W out. If your transmitter cannot operate at 6 kW, a small reduction in radiated field might be considered. An 11 percent power loss is equivalent to a 5 percent (0.45 dB) field loss.

The circuit of Figure 6 does not pull the sideband VSWR all the way to 1.0, but it could be made to do so with some iteration of component values. However, if we pull the VSWR down at 10 kHz, it may very well pop up at, say, 5 kHz. Usually some compromise is necessary, but it is not unreasonable to achieve a VSWR of 1.2 or better continuously from 990 to 1010 kHz with

this method of broadbanding, when starting with a 2.0 VSWR 10 kHz from carrier.

Because the loaded Qs of the series-resonant (Q = 46) and the stub (Q = 21) circuits are so high, adjustment is touchy. Adjustment of L₂ is very critical. Stray coupling and capacitance have to be compensated during the adjustment process. All components must have a very low temperature coefficient as well. Toroidal coils are ideal for this type of network because, in addition to their low loss, they have a very small external field, hence low coupling.

Impedance transformation step by step

At this point, it is instructive to follow the impedance transformation of

TFT 8300 STL

Clearly Above The Crowd

In Price and Performance



The 8300 STL outperforms *any* other STL, even in the densest RF environment. Yet, it's priced way below the nearest competitor.

The 8300's superiority is clear in its overall performance. Like a 75 db SNR and stereo separation of 50 db, or better.

The transmitter features IF modulation for low distortion and high stereo performance, a technique pioneered by TFT, which has been further refined in the 8300.

In the receiver, too, the TET 8300 stands above the rest, with a sensitivity of 30 μ v or less for a 60 db SNR; front panel selection of wide or narrow I.F. bandwidth; and a Surface

Acoustics Wave (SAW) filter to ensure outstanding selectivity.

Additionally, the 8300 receiver features continuous, independent display of signal strength and a bargraph display of modulation.

The 8300 is also ready for AM stereo. An optional, plug-in demodulator provides both R and L channel without any external devices.

So, be selective about your STL and specify TET to put your station clearly above the crowd. Call or write today.

Exclusive Two Year Warranty

The TET 8300 carries a full two year warranty, which is backed by around-the-clock factory service.

* Free computer STL path analysis at NAB Booth 109.



Committed to keeping you, on the air!

3090 Oakmead Village Dr., Santa Clara, CA 95051 • (408) 727-7272 • TWX 910-338-0584

Figure 6 step by step from output to input. Referring to Figure 1, we see at the input to the +22.8 degree network 10 ohms at 1000 kHz, and no reactance. We see 14.0 - j7.9 at 990 kHz, and 13.9 + j8.0 at 1010 kHz. We know that we need to transform the 14.0 ohms to 10 ohms at 990 kHz with a tee network that requires -j7.9 ohms in its output leg. We also know that we need to transform 13.9 ohms to 10 ohms at 1010 kHz with a tee network that requires +j8.0 ohms in its output leg. Also, both of these networks have to produce the same magnitude (but opposite sign) input reactance so that a series-resonant circuit can act as the input leg. Naturally the lower sideband reactance required of the tee network input leg must be negative, and the upper sideband reactance must be positive. The opposite holds true for the shunt leg.

Thus the only parameter available to adjust the upper and lower sideband phantom tee networks to these constraints is phase shift. We can use Equation 1 to find the approximate phase shift. Then, with some iteration, we can find the best set of lower and upper sideband phase shifts that fit the characteristics of a series-resonant circuit in the input leg of the tee network.

Now we can solve for the input reactance, X_1 , using Equations 2 and 3. Keep in mind that you must add the correct sign to the phase shift of Equation

$$|\theta| = \text{TAN}^{-1} \frac{|X_2|}{R_2} + \text{TAN}^{-1} \left[\frac{X_2^2 + R_2}{R_1} - 1 \right]^{1/2}$$

$R_2 = 14.0, X_2 = -7.9, R_1 = 10.0$ at 990 kHz
 $R_2 = 13.9, X_2 = 8.0, R_1 = 10.0$ at 1010 kHz

EQ. 1

1, knowing that it is positive below carrier and, negative above carrier. Equations 2 and 3, however, account for the sign of the phase shift, so there is no additional reckoning necessary to find the correct signs of X_1 or X_3 .

$$X_3 = \sqrt{R_1 R_2} / \text{SIN } \theta$$

EQ. 2

$$X_1 = R_1 / \text{TAN } \theta - X_3$$

EQ. 3

The phantom tee network is not bad at all; but there will be times when some compromise is required between sideband symmetry of X_1 and constancy of R_1 . What is required is a series-resonant circuit that produces a

PHANTOM TEE NETWORK

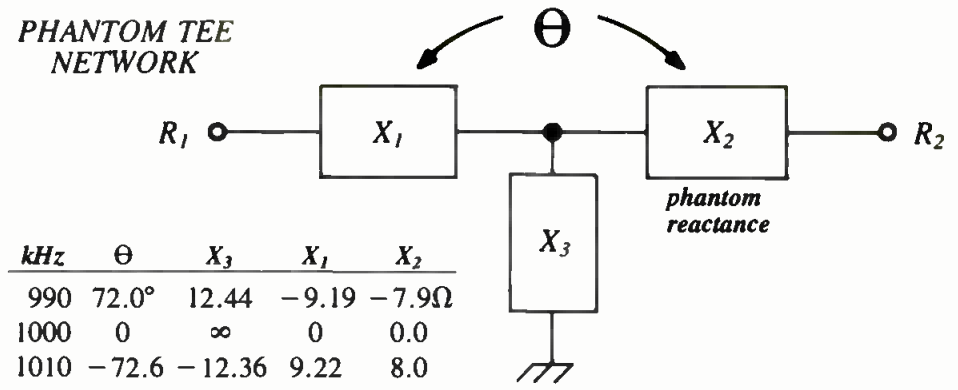

reactance of about 9.2 ohms 10 kHz from carrier (Equations 4 and 5). We also need a parallel-resonant circuit which produces about 12.4 ohms at the same sidebands. Considering the stub as a simple quarter-wave transformer, we can use Equation 6 to find the required series-resonant sideband reactance. Then we use Equations 4 and 5 again to find the component values.

You will find that you will not get the same result for L in Equation 4 for the lower sideband as for the upper. This is because the distances between the

$$L = \frac{X}{2\pi (f - f_0/f)} \mu H$$

EQ. 4

$$C = \frac{1}{W_0^2 L} \mu F$$

EQ. 5

$$X_s = Z_0^2 / X_p$$

$f_0 =$ carrier frequency in MHz
 $f =$ sideband frequency in MHz
 $w_0 = 2\pi f_0$

EQ. 6

sidebands and carrier are arithmetically, but not geometrically, identical. In other words, 990/1000 is not equal to 1000/1010 (but it is pretty close). If this bothers you, simply select phantom tee phase shifts which require a lower-sideband reactance slightly larger than that of the upper.

We can vary Z_0 in Equation 6 to compensate for unequal sideband VSWRs, but we do not want to get too far from the initial 10 ohms. If Z_0 is too low, currents become a problem, and if Z_0 is too high, component size becomes a problem, and so on. The phase shift can also be varied from -90 degrees in order to compensate for unequal sideband VSWRs.

The final 50-to-10 ohm transformation is designed with the understanding that it will not provide the same match at the sidebands as at carrier, but that the difference will be small. For example, a -90 degree tee designed to transform 50 to 10 ohms at 1000 kHz would have an input VSWR of 1.04 at 990 and 1010 kHz, for a constant 10 ohm load. If this is unacceptable, there is a simple technique for finding the right sideband impedances which will transform exactly to 50 ohms. Terminate the input of the tee network in a flat 50 ohms, and measure the impedance as seen looking into the output leg. For the lossless case, you would see 10 ohms at carrier, of course, but 10.2 - j0.4 at 990 kHz and 9.8 + j0.4 at 1010 kHz. If the preceding stages of the broadbanding network are designed to present 10.2 + j0.4 at 990 kHz and 9.8 - j0.4 at 1010 kHz, we would see a perfectly flat 50 ohms at the input to the -90 degree tee. Note that the sign of the reactance was reversed from the "looking backwards" impedance, Z' , in order to obtain the desired load, Z (Figure 7).

The losses in the shunt leg can also significantly affect the impedance

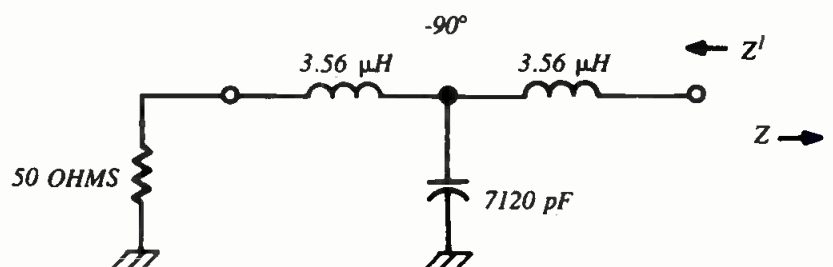

Figure 7. Circuit for measuring right sideband impedance.

BOSCH**FGS 4000**

UPDATE

V I D E O G R A P H I C S Y S T E M

The FGS-4000 Produces Video Image Quality Unsurpassed in the Industry.

Bosch, looking to the future, introduced at the 1983 NAB, the ultimate graphics system, the FGS-4000. A system so limitless, it provides a medium for the graphic artist to accomplish effects yet to be imagined, both today and tomorrow.

“A video graphic system so limitless that wonders will become realities.”

Bosch developed technology to introduce real time 3-dimensional animation. Highly defined 3-dimensional objects move in a real 3-dimensional world. Move the object, move the viewer, move the light source, travel within objects, see it with 'reality.'

The FGS-4000 is a powerful computer graphic system. Its versatility in combining the functions of a character generator, graphic art system, 2D and 3D animation into one unique system is, to date, unparalleled in the television industry.

The FGS-4000 will have a tremendous impact on the way you are doing business today. Imagine the time savings and increased productivity of your creative people that can be realized. This is due to the ease of image entry and the real-time interactive workstation, allowing you to actually see and manipulate the images, to establish your animation sequences, and to play them back in real time.

The image quality of this system is the highest in the industry. Our special anti-aliasing circuitry maintains edge quality at all times.

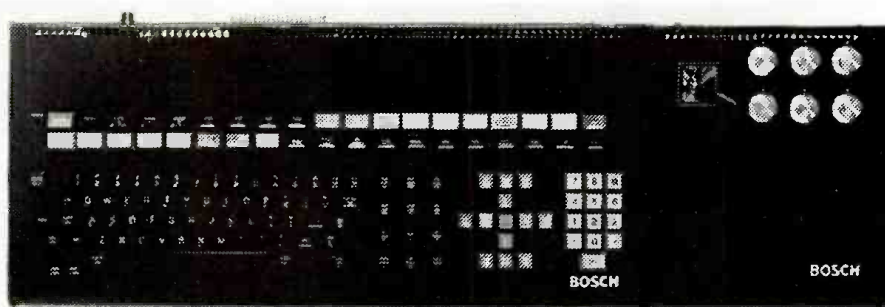

84' NAB Highlights

In addition to the now existing 2-Dimensional Editor, Real-Time Text Editor, Off-Line Text Editor, and Animation Editor, Bosch will highlight at the 1984 NAB:

3-Dimensional Editor: This editor gives complete freedom in the generation of true 3-D objects. With the extruder, the operator can take any 2-D object and make it thick. With ROB (Read Object), the operator can type in X, Y, and Z coordinates and produce any 3-D object, or 3-D objects can be produced via surfaces of revolution or by redefining objects by gluing existing 2-D and 3-D objects together.

HQAS: High Quality Animation System gives the operator tools for enhancing previously created animations by adding glows, sparkling effects and streaking capabilities. Also, texture mapping and multiple, moveable light sources will be included.

Paint: Also available at this year's NAB is a Basic paint system. By using the stylus and the system's tablet, the operator may paint with all the FGS-4000's 16 million colors, change brush size or shape, air brush or blend. This is an expandable package with more features to be introduced.

Single Framing Editor: Single frame machine control allows automatic control of VTR's via the FGS-4000. This gives the operator the ability to record frame-by-frame and then play them back in real time.

Things You Should Know

Ease of operation: Bosch enlisted the talents of professional graphic artists to help design the operational functions of the FGS-4000, thus making this graphic system as easy to operate as a pencil and paper.

Image quality: Images of the FGS-4000 are indistinguishable from actual video. No aliasing, stair stepping, breaking up or tearing of edges when scaling, positioning, or rotating objects.

Animation: The FGS-4000 allows the artist to create, animate and display 2- or 3-dimensional objects together or independently, as well as automatically assigning special effects such as transparency, light source and perspective.

Robert Bosch Corporation
Video Equipment Division
P.O. Box 31816, Salt Lake City, Utah 84131
(801) 972-8000

**BOSCH**

transformation. The difference between the lossless transformation and the lossy, real-world, transformation can be seen by removing R_3 from Equations 7 and 8. The equivalent 10 kHz sideband loss resistance, R_3 , is typically about 1 ohm when high-Q toroidal inductors are used in the shunt leg. The approximate value of R_3 can be found by adding the loss resistance of L_2 and C_2 to X_3 of Equation 6, forming Equation 9.

$$R = \frac{R_2^2 R_3 + R_2 R_3^2 + X_2^2 R_3 + R_2 X_3^2}{(R_2 + R_3)^2 + (X_2 + X_3)^2}$$

EQ. 7

$$X = \frac{X_2^2 X_3 + X_2 X_3^2 + X_2 R_3^2 + X_3 R_2^2}{(R_2 + R_3)^2 + (X_2 + X_3)^2}$$

EQ. 8

$$R_p + jX_p + \frac{Z_0^2}{R_s + jX_s}$$

EQ. 9

The effect of the shunt losses is to reduce the required size of the series-resonant circuit, L_1 and C_1 . Instead of needing $\pm j9.2$ ohms at the sidebands, we really only need $\pm j8.1$ ohms. Whenever losses are added to a system, bandwidth naturally improves.

Although the input resistance has been pulled down a bit by the losses, this effect is not very frequency-dependent. Looking into the top of L_3 in Figure 6, we see about $210 + j0$ at

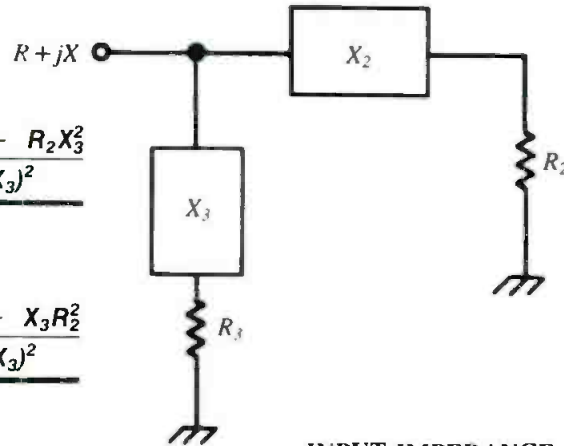

INPUT IMPEDANCE

kHz	INPUT IMPEDANCE		R_2	X_2	X_3
	$R_3 = 0$	$R_3 = 1.0$			
990	10.0 + j9.20	9.93 + j8.08	14.0	-7.9	12.44
1010	10.0 - j9.22	9.94 - j8.09	13.9	8.0	-12.36

carrier. This pulls the 10 ohms at this point down to 9.55 ohms. The loss resistance of L_1/C_1 then adds to this, bringing it back up and somewhat higher than the nominal 10 ohms. The loss resistance of L_1/C_1 is also not very frequency-sensitive over the range in which we are interested.

If we had used a somewhat larger value for C_1 and a somewhat smaller value for L_1 , the match would have been a little better than shown in Figure 6. However, we may need the extra stored energy at the other sideband frequencies, so we may have to settle for a small mismatch at the 10 kHz sidebands.

A word about stray shunt capacitance is wise at this point. It may seem at first glance that stray capacitance in a 10 ohm system is not very significant in the standard broadcast band. However, we are not dealing with just a 10 ohm system. For example, consider the junction of L_1 and C_1 in Figure 6. Looking into C_1 we see $10 - j463$ ohms. If we have $-j1000$ ohms of strays, the

RTW Peak Meter

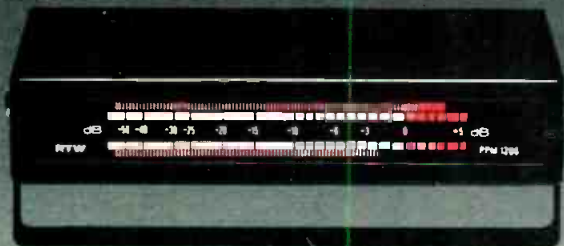

Stereo Peak Program Meter Model 1206

- 101 segment display permits precise peak level metering
- Automatic ON/OFF switching dependent on signal presence
- Auxiliary input for full scale metering of low level inputs

Available exclusively through



auditronics, inc.

3750 Old Getwell Rd.
Memphis, TN 38118, USA
Tel.: (901) 362-1350
Telex: 533356

Circle 289 on Reader Service Card

SMPTE/EBU TIME CODE READER AND CHARACTER GENERATOR



THE STANDARD OF THE INDUSTRY MODEL DR-107B

- Provides for unsurpassed code reading using "The McFadin Window"™ technique for decoding time code from VTR's at speeds of 1/100 to 100 time. (machine dependent)
- Very useful for window dubs for off-line editing and video monitor viewing. Highly legible and unique 'Font'.
- All front panel control for easy positioning of character display including vertical interval insertion.
- Drop frame indication, choice of Time Code or User-Bit display, restored Time Code output for dubbing, 1-3/4" rack mounting and parallel BCD output.
- A five year warranty, including parts and labor.



GRAY ENGINEERING LABORATORIES

504-P West Chapman Avenue
Orange, CA 92668 • 714/997-4151

AT NAB
BOOTH 1755

Circle 290 on Reader Service Card

**When you need to know anything
about low or medium-power TV...**

**Design
Installation and Check-outs
Field Service
Parts Availability
Microwave
Solid-State Transmitters
Translators
LPTV
MDS
ITFS
OFS
Towers*
1 and 5kw (medium-power)
transmitters**

**You
need
to know
us.**

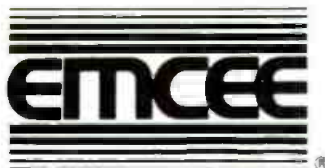

EMCEE has been accumulating knowledge and experience for over two decades. Along the way, we've recorded a number of singular accomplishments. Like putting the first LPTV station on the air in 1981. And being chosen over all others for the Salt Lake City multi-channel experiment in MDS in 1982. At the same time, we've earned a reputation for quick response to any customer need.

Try us. All it takes is a toll-free phone call to 1-800-233-6193 (in Pennsylvania, call 717-443-9575). If it has to do with low or medium-power TV, EMCEE has already done it. And we'll be happy to put our unparalleled knowledge and experience to work for you.

**Visit our booth,
#1621 at NAB convention.**

*Through Del's Tower Service,
a wholly-owned subsidiary

EMCEE BROADCAST PRODUCTS a division of ELECTRONICS, MISSILES & COMMUNICATIONS, INC.
White Haven, PA 18661 717-443-9575 • 800-233-6193 • TWX: 510-655-7088

Circle 291 on Reader Service Card

www.americanradiohistory.com

junction impedance is transformed to $4.7 - j317$; this is undeniably a very significant effect.

One means of compensation is the addition of a $+j1000$ ohm inductor across the stray capacitance. However, this adds losses to the system, and affects the sideband impedances. Another method is to simply live with the stray capacitance. Instead of transforming to 10 ohms, we might transform to 15 ohms. Then we would end up with about 7 ohms at the input to L_1 instead of the nominal 10 ohms. Higher shunt sideband reactances would also be required at the top of L_3 , which can be accomplished by increasing Z_0 of the 90 degree tee, or by changing the transformation ratio of this same tee. This would allow us to keep L_2 and C_2 as they are. However, if there are similar shunt strays from L_2 to ground, they must also be dealt with. Remember that the symptom of these strays is reduced resistance. If we break the connection of L_2 at the L_3/C_3 junction, we see a lower resistance looking into L_2 . This in turn increases the resistance seen at carrier when looking into the top of L_3 (everything connected). It is possible for the current in L_2/C_2 , and hence the voltage across them, to increase. If this

is the case, it may be desirable to add the compensating shunt inductor mentioned earlier. Number 10 magnet wire close-wound on a three- or four-inch-diameter form will keep the compensating coil small. Because of the high voltage gradient on the "hot" end of the coil, a corona ring and low-loss dielectric should be used—do not use phenolic for the coil form, use G10 fiberglass as a minimum. In order to keep the current, and the losses, in the compensation coil reasonably small, the inductance of the coil should be somewhat higher than necessary for resonance. Just so long as resonance is approached, the overall shunt stray reactance will rise high enough to remove most of the undesired impedance transformation.

The way to avoid the problems created by shunt stray capacitance is to have a very large cabinet, or an open panel configuration. The volume required for a typical broadbanding network of this type is around 500 cubic feet, or about 10x8x6 feet. This will vary slightly according to power level, but is mostly predetermined by the requirement of high-Q inductors. A 25 μ H toroidal inductor with a Q of 1500 is about 18 inches tall and 30 inches in

diameter, if made of aluminum. In order to keep the shunt strays to a reasonable value, this inductor should be mounted at least 18 inches from all walls, floors, or ceilings. Thus we have created a space requirement of about 100 cubic feet for a single inductor. If space is at a premium, the same inductor could be mounted as close as three inches from walls, at its closest point. Then a shunt compensating inductor would be required, and its attendant power loss. You can probably figure on an additional one to two percent overall loss if compensating inductors are used, since they are necessarily placed at the highest voltage points in the circuit.

Night antenna

The night antenna has higher-sideband VSWRs, so it will require a broadbanding circuit with somewhat higher losses than the day circuit. As before, capacitor Q is 2000, and coil Q is 500, except for L_1 and L_2 , where it is 1500. The power losses for the circuit of Figure 8 are 13 percent—not much more than the previous case. Note that the loaded Q of L_1/C_1 is not much higher than that of the day circuit, but the loaded Q of L_2/C_2 is considerably

The world sees more through Angenieux than through any other lens

That 7 of every 10 video cameras used to shoot the '84 Winter Olympic Games in Sarajevo were equipped with Angenieux lenses shouldn't surprise you. Or that the COPAN Olympics were shot with 39 Angenieux lenses. After all, Angenieux was the first video lens to send pictures from the moon and is still NASA's prime choice in space.

Obviously, reliability is a major factor in choosing Angenieux. But, there's much more.

Innovation for one thing. Angenieux has never believed in leaving well enough alone. We invented the retro-focus design and the finest practical zoom lens.

We have a lifelong commitment to optical superiority in everything we design and make. That's why cameramen, broadcasters and major studios consistently look to Angenieux to enhance their images.



angenieux Corp. of America

FOR MORE INFORMATION ON OUR WIDE RANGE OF PRODUCTS CONTACT THE FOLLOWING ANGENIEUX BROADCAST SALES OFFICES

North/South Americas 7700 N. Kendall Drive
Miami, FL 33156
Tel. (305) 595-1144 Telex 80-8425

Canada 190 Don Park Road
Markham, Ontario L3R-2V8
Tel. (416) 475-5454

Remainder of World Opticam S.A.
Case Postale 91
1211 Geneva 17, Switzerland
Tel. (22) 362266
Telex 27670-Opti-CH

Circle 292 on Reader Service Card

“WITH SIMULSAT, WE CAN PICK UP 5 SATELLITES AT ONCE.”

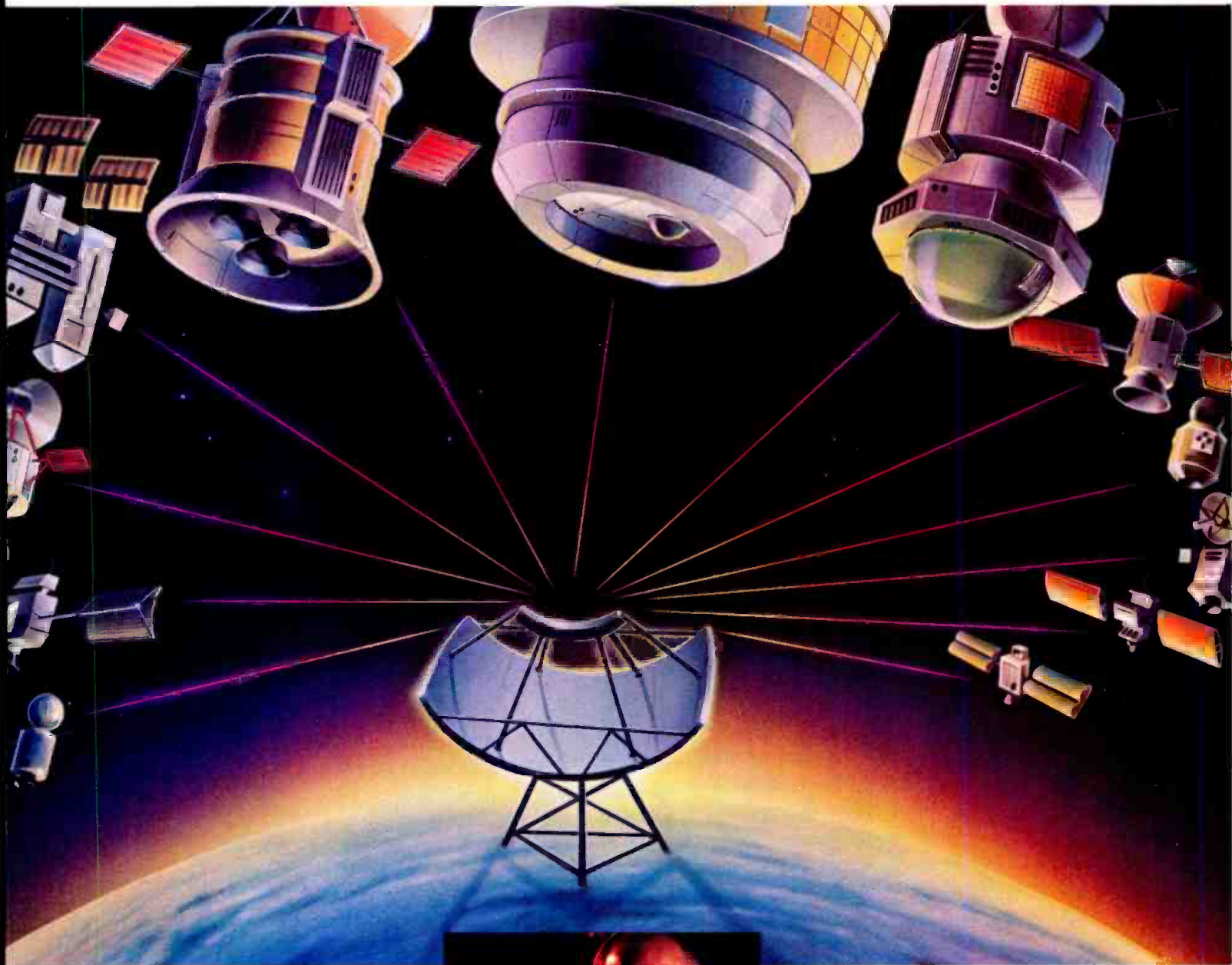

SIMULSAT, the multi-beam antenna from Antenna Technology Corporation, that can simultaneously see all domestic satellites at once with consistent broadcast quality performance. It is being heralded as a major breakthrough by broadcast and cable operators everywhere.

Listen to what Chief Engineer Gerald Dreger of KTVO, one of SIMULSAT's more than 200 nationwide customers has to say:

“We purchased SIMULSAT 8 months ago. We're very pleased with it. SIMULSAT does everything



Mr. Gerald Dreger
Chief Engineer
KTVO, (ABC affiliate)
The Post Corporation
Kansas City, Missouri

I was told it would do and more. We now pick up 5 satellites simultaneously, and also run our low power station K40AI off SIMULSAT, which, before was impossible. On top of that, it has the capabilities to help us

expand even more. We could reach 13 (domestic) satellites at once. SIMULSAT will pay for itself over and over again.”

Call or write Antenna Technology Corporation for a full-color brochure, and information on turn-key installation and two-year warranty for 3m, 5m and 7m SIMULSAT. SIMULSAT sees all C-Band satellites simultaneously and has K-Band capabilities.

ANTENNA TECHNOLOGY CORPORATION
8711 East Pinnacle Peak Road, C-103
Scottsdale, Arizona 85255
Call (602) 264-7275



Circle 293 on Reader Service Card

www.americanradiohistory.com

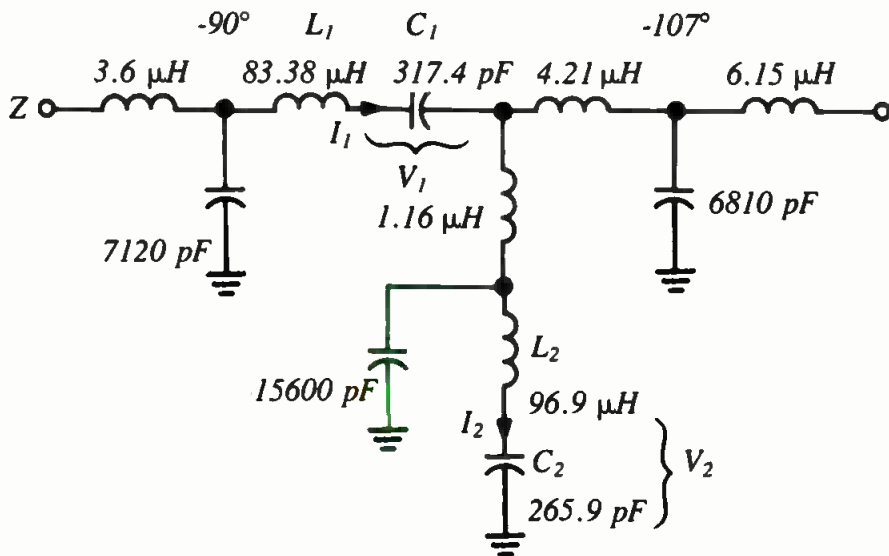

kHz	Z	VSWR	I1	I2	V1	V2
990	47.5 + j8.7	1.20	23.5A	30.6A	11.9	18.5 kV RMS
1000	50.0 - j0.1	1.00	24.6	22.6	12.3	13.5
1010	46.1 - j7.8	1.20	23.3	30.2	11.6	17.9

Figure 8. Night antenna circuit for common-point impedance transformation.

higher. Since I_2 , the current in L_2/C_2 , is higher at the band edges than at carrier, losses are higher at the sidebands: 19 percent. Preemphasis can fix this.

Special consideration must be given to the voltage and current stresses in this type of network, since they vary quite a bit over the band. It is not always safe to simply multiply the RMS quiescent carrier voltage by 3.18 to obtain the peak voltage at 125 percent modulation. In the special case where the sideband impedances are quite different from the carrier impedance, and assuming an ideal generator that produces $0.625 V_0$ at the sidebands for 125 percent modulation, we can find V_2 of Figure 8 this way:

$$V_2 \text{ at 125\% modulation} = 13.5 + 0.625(18.5) + 0.625(17.9) \text{ kV RMS} = 36.3 \text{ kV RMS} = 51.3 \text{ kV peak}$$

If V_2 is figured the simplistic way as 3.18(13.5), we obtain a significantly lower figure of 43.0 kV peak. Note that the phases of the sideband and carrier voltages have been ignored; since all three are running at different frequencies, no matter what the initial phases, they will periodically all sum up in phase. In order to reduce the voltage across C_2 to a manageable level, we can split the series-resonant circuit into two sections (Figure 9).

Similarly, the RMS or heating value of the currents must be carefully considered. The flat-load value for I2 at 100 percent sinusoidal modulation is 1.225(22.6) or 27.7 amperes RMS.

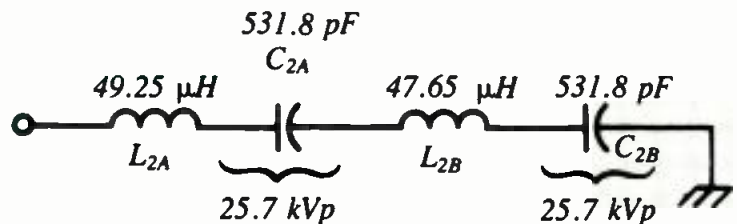

Figure 9. Splitting a series-resonant circuit to reduce capacitor voltage.

However, the sideband currents are higher than what they would be if the load were flat, so we have to find I_2 as a true RMS:

$$I_2 \text{ at 100\% modulation} = [22.6^2 + [0.5(30.6)]^2 + [0.5(30.2)]^2]^{1/2} = \text{amperes RMS}$$

In summary, this method of broadbanding consists of the following:

1. The narrowband load impedances are rotated and transformed down so the lower sideband reactance is negative, the upper sideband reactance is positive, and their magnitudes are about the same.

2. A value of tee network phase shift is found for each sideband which will fit the reactances produced in step 1. This tee has a one-to-one transformation at carrier; since its input leg reactances must fit those of a series-resonant circuit (L_1 and C_1), they are constrained as in step 1.

3. The shunt leg reactances of this same tee need not be symmetrical, although they should be close; the 90 degree tee of the stub does not have to be

exactly 90 degrees, nor does its transformation have to be one-to-one, nor does its Z_0 have to be identical to R_1 .

4. The broadbanded impedances are transformed back to the original load carrier impedance; at this point, the losses will have added some resistance, so if the down transformation was 5:1, the return transformation will be something like 5:1.1.

Regarding cost, toroidal coils and high-voltage vacuum capacitors will run the tab on this type of network pretty high. And there is also the increased power consumption to consider. But this approach may compare favorably with the cost of modifying the phasing and coupling networks, since the latter can require a lot of adjustment labor. And sometimes no practical amount of tinkering with the phaser will significantly improve the common-point bandwidth, while external broadbanding will. (Some phaser designs employ broadbanding circuits at the base of each tower, but this approach is not recommended, since it does not al-

low a transmitter power increase to compensate for losses**, and it is usually more expensive and complicated

than a single broadbander at the common point.)

Regarding long-term stability, or sensitivity to changes in the common-point impedances, one need only to compare the day and night broadbanders described earlier to see that they have much in common. A certain adjustment range needs to be designed into the networks, or course, but it need not be exorbitant. One other caution: the common point should be stable. If measurable changes occur with weather, they need to be cranked into the design of the broadbanding network to determine if the circuit will work under all conditions. **BM/E**

*Losses are slightly higher at the band edges.
**FCC 73.51(b)(1) & - (2).

Wilk's audio/video distribution and routing equipment —

Our features only look expensive.

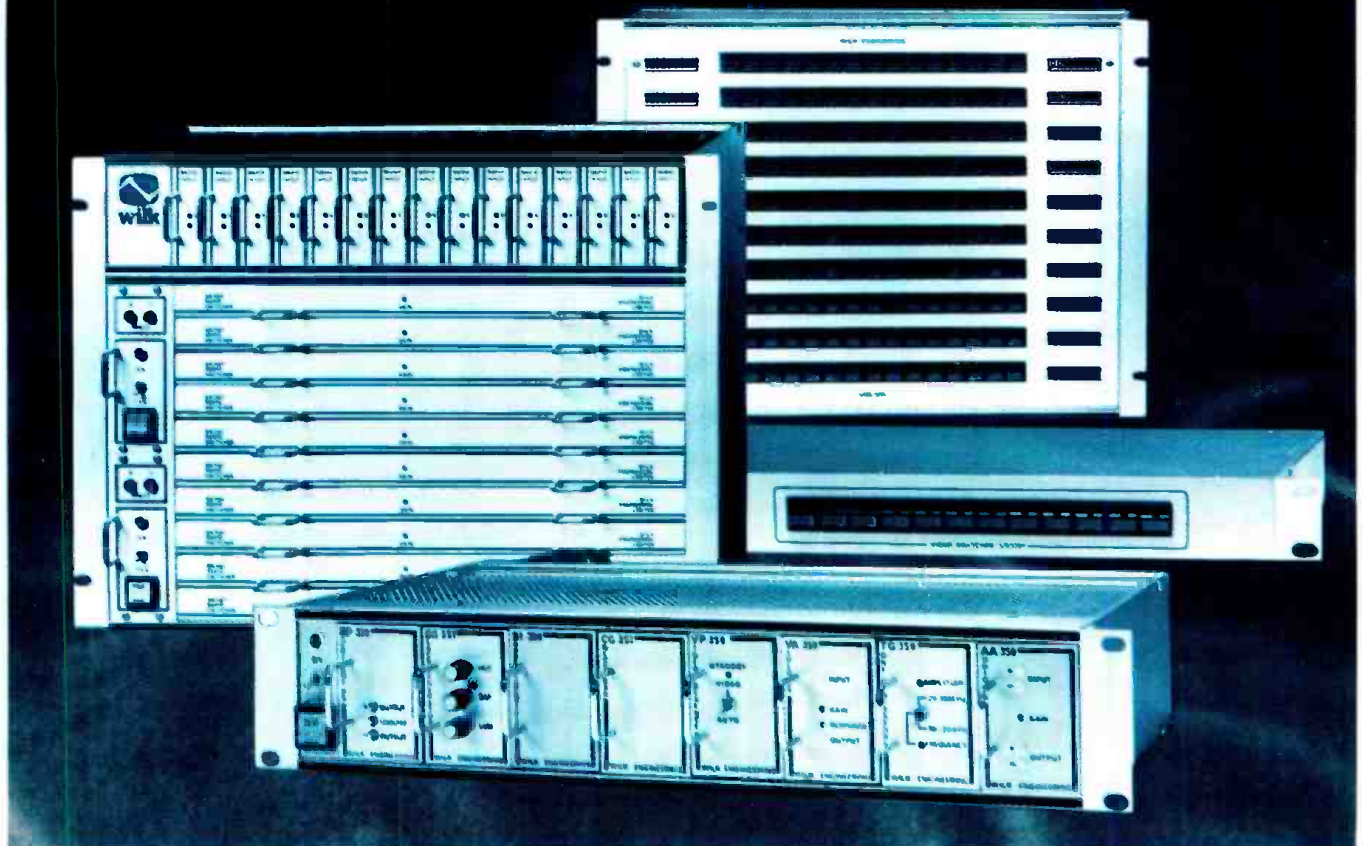

Wilk's complete line of audio/video routing switchers and distribution equipment provide state-of-the-art performance and unsurpassed reliability. Design technology features solid state electronic circuitry and virtually "transparent" operation where distribution or switching of audio and video signals is required.

The WILK "Transparent" Routing Switcher product line comprises a series of basic switchers which can be utilized to fit all switching requirements. Expansion of numbers of inputs to multiple outputs can be economically achieved by the use of these units. All switchers utilize separate video and audio matrices, thereby allowing video or audio only switching as well as multiple audio following one video signal. It also allows easy integration in systems where commonly separate audio and video racks are utilized. All AR switchers are ideally suited for 2 or 4 channel stereo switching.

The Wilk 350 Series Modular Video and Audio Distribution product line is based on a standard 19" EIA Rack Frame with Power Supply, and which will accept up to seven 2" wide modules. Modules available include AA-351 High Level Audio Distribution Amplifier, TG-350 Tone Generator, BG-351 Color Black Background Generator, CG-350 Color Background Generator, SI-350 Source Identification Unit, VA-350 Video Distribution Amplifier, VP-350 Video Presence Detector. These are standard off-the-shelf items available for immediate delivery.

The entire Wilk product line delivers performance features and reliability normally found only on much higher-priced equipment. Visit **Booth 1229** at the **NAB** Convention, and see Wilk's new state-of-the-art line of Routing Switchers and Character Generators.

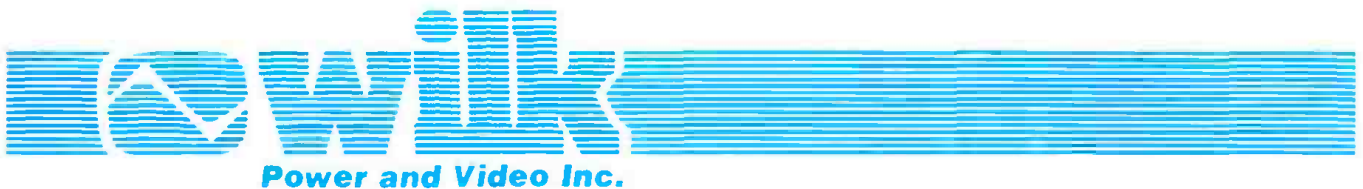

U.S. Corporate Offices: 16255 Ventura Blvd., Suite 1001, Encino, California 91436 / (818) 788-2338 / Toll Free: 800-782-9455
Eastern Regional Offices: 12 Terhune St., Oakland, New Jersey 07436 / (201) 337-8158 / Toll Free: 800-782-9455

Circle 294 on Reader Service Card

www.americanradiohistory.com



PESA

Character Generators High reliability.

The CG-4721 is the latest character generator designed and manufactured by PESA. If all our products are of high reliability, what can we say about our latest product? Would very high reliability suffice?

These are the characteristics of CG-4721, PESA's Character Generator.

- Resolution: 50 ns in horizontal and

one line in vertical.

- 126 characters per source.
- 16 pages of internal memory with 16 lines per page and 32 characters per line.
- Floppies have a storage capacity of 8 sources of maximum size or 140 pages.
- A repertoire of 112 colors

for characters, backgrounds and edges.

- Character shading extensible into all four quadrants with variable depth.

Its price is a surprise.

PESA, always within its field of Professional Electronics, also manufactures complete Television Networks, Transmitters and TV Transposers, News Service Centers, Production and Post-Production Studios, TV O.B. Vans, Professional Video Equipment and TV Monitors. For its high reliability, PESA can be trusted.



huella, s.a.

 **PESA**
PIHER ELECTRONICA S.A.

Albalá, 12. Madrid-17. SPAIN

Phone 204 70 32. Telex: 43203 PIHE E. Cables: PIELESA, P.O. Box 35015



Electronics and Data Systems Division of INI.

GREAT IDEA NOTEBOOK

Stereo Synthesizer

Allen D. Kass, CE, WISP/WQDH
Radio, Kinston, NC

This device is a stereo synthesizer that I use for our remote broadcasts. We do at least three or four remotes a week on our FM station, WQDH, and because we are stereo I wanted to somehow enhance the audio that was received from the remote site. We usually originate the music from the remote and send it back to the station via a Marti RPU transmitter; the RPU receiver is then connected through switching equipment to the stereo synthesizer and on to an input card in our Schaffer 903 automation system. We use a modified tape deck I/O card for this input because, at the remote location, we inject a 25 Hz tone (just as on automation tapes) in the program line when we want to leave the remote location to play commercials, news, or IDs. Then we program the automation system with when to put the remote source back on the air.

The synthesizer idea really came about after playing around with, at that time, a new IC that Radio Shack was stocking, the SAD-1024 dual analog delay line (276-1761). After some experimenting, I came up with a configuration that produced an interesting effect when using a microphone as the

input device. It seemed possible to use this device along with some opamp stages to produce a pseudo stereo effect.

The system functions as follows: the RPU audio is fed into the unit through an input transformer, and low pass is filtered with a second order modified Butterworth filter whose -3 dB point is set for 8 kHz (switchable in/out of circuit). The filtered audio is then split three ways: the input of the delay line IC, the "left" output amplifier, and the "right" output amplifier. The delayed audio from the SAD-1024 IC is then fed to the "right" amplifier and is also inverted and fed to the "left" amplifier. So we have in the "left" channel the direct audio added to inverted delayed audio, and in the "right" channel the direct audio added to the non-inverted delayed audio.

The result of these combinations is a comb filter effect in one output and a complimentary signal in the other channel that will produce a pseudo stereo effect. The trim pot in the filter section is used to adjust both the cutoff frequency and the damping of the lowpass filter and is adjusted to give a response of -3

dB at 8 kHz. The input level trim pot after the 8 kHz filter is used to reduce the audio input level to approximately 200 μ v going to the delay line. There are bias trim pots on both delay line sections; this bias voltage is approximately 2.2 V dc. The trim pot at the output of the second delay section is a clock null control and is adjusted for minimum clock signal output. The output trim pot of the delay line sections is adjusted to provide the desired depth of the comb filter effect. The two "output" trim pots are to adjust and balance the signals that feed the automation.

The SAD-1024 delay line IC is a dual 512 stage bucket-brigade device that uses a two-phase clock realized by using a CD4011 quad two-input CMOS and gates connected as inverters to form a clock oscillator with complimentary outputs. The trim pot at pin 6 of the CD4011 is used to adjust the clock frequency and will change the perceived "separation" of the circuit. A clock frequency of approximately 35 kHz will produce a delay of 14 ns when the audio passes through all 1024 stages of the delay IC, and this will produce a pleasing effect. **BM/E**

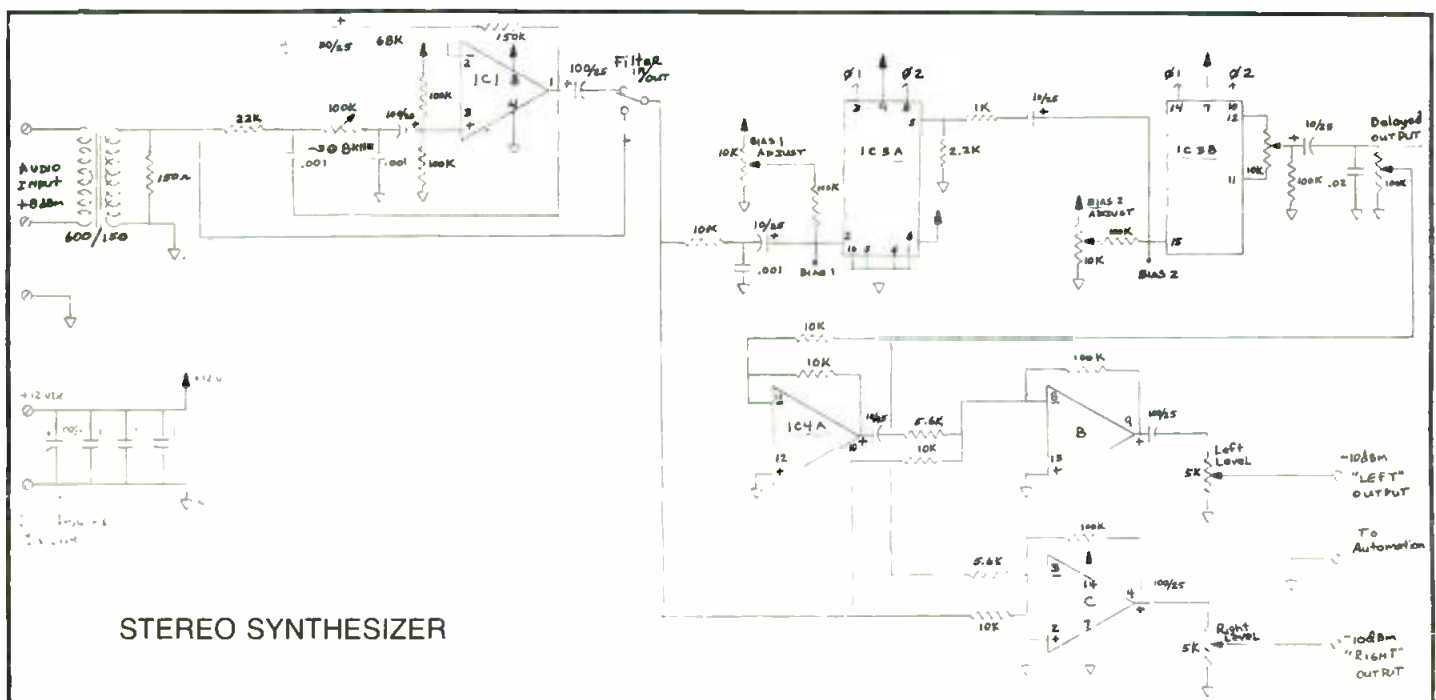

STEREO SYNTHESIZER

Save \$10,000 every year for 20 years with the new Harris 60 kW UHF transmitter!

The new Harris TVE-60S is the most efficient 60 kW UHF-TV transmitter on the market today. And that translates directly into improved bottom line results for your operation.

With the TVE-60S, you can actually save an average of \$10,000 annually* on your power bills. Multiply this by the average 20-year life of a transmitter, and you come up with a \$200,000 savings! Without considering inflation.

How We Got There

The very latest in high power UHF technology has been incorporated into the TVE-60S. For instance, a single Varian 5-cavity VKP-7550 "S" Series klystron is used for full 60 kW visual power output.

This new integral-cavity klystron is an improved, ultra-high-efficiency version of the Varian VA-950 Series that has

been field proven in hundreds of UHF transmitters worldwide.

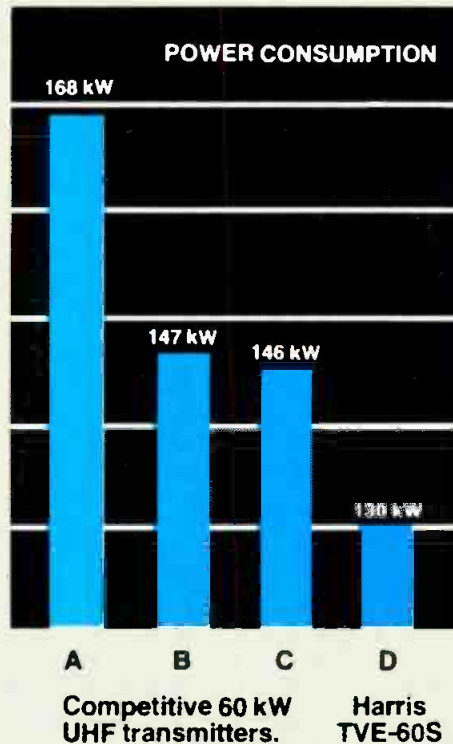

When operated with a variable visual output coupler and a mod anode pulser—both supplied as

standard in the TVE-60S—the new klystron provides visual beam efficiencies ranging from 63% to 68%.

Add to this an aural klystron coupler and an efficient vapor phase heat exchanger, and you have a 60 kW transmitter with power consumption of 130 kW or less. No other UHF transmitter in this power range comes close.

No Performance Sacrifices

There has been no sacrifice of performance for high efficiency. The MCP-2U visual exciter, with its Quadrature Corrector and unique, adjustment-free VIDEO SAW filter, provides unmatched color specifications and highest reliability. Also, the TVE-60S is designed for TV stereo, teletext and other services.

For complete information on the new TVE-60S, or the 120 kW and 240 kW versions, write or call: Harris Corporation, Broadcast Transmission Division, P.O. Box 4290, Quincy, Illinois 62305. 217/222-8200.

*Figured from the National Average Power Cost as published in "Electric Power Monthly", based on a 20-hour broadcast day, and compared with the published power consumption specification (as of Feb., 1984) on the next closest competitive 60 kW UHF transmitter. Comparisons in chart based on published specs as of Feb., 1984.

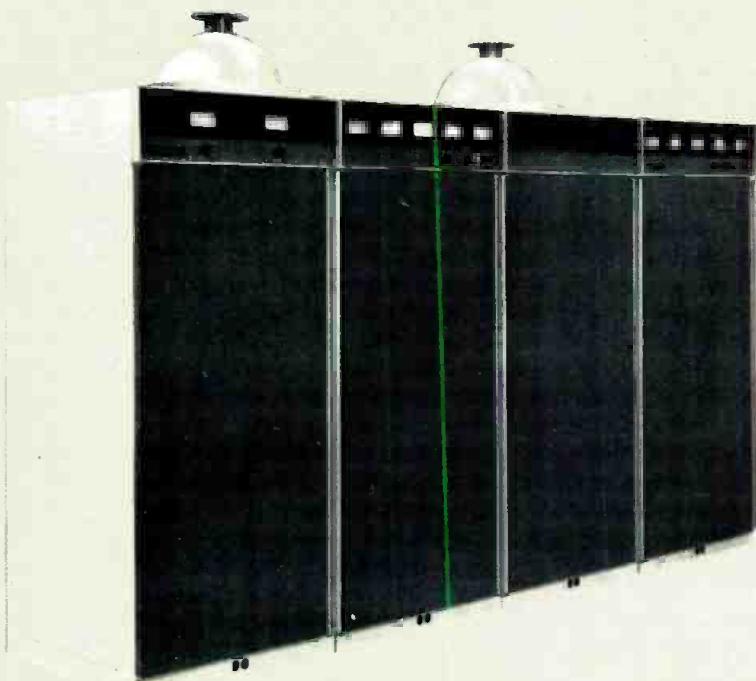

See the TVE-60S at NAB '84

Circle 297 on Reader Service Card

interpreting the FCC rules & regulations

Tough Stance on Construction Permits?

By Harry Cole, FCC Counsel

Looking at the Commission's deregulatory program in terms of a "carrot and stick" approach, it may appear that the Commission is opting almost exclusively for the "carrot" aspect, while ignoring the "stick." In other words, from the broadcaster's point of view deregulation has consisted of easy to swallow changes with no corresponding downside aspects—with the possible exception of some increased competition, particularly in the FM area as a result of the influx of new stations expected in the wake of the adoption of BC Docket No. 80-90. After all, the Commission has eliminated a boatload of petty rules and obligations, has streamlined most of its application procedures, and has seemed to back off enforcement of some of the rules and obligations still on the books.

The Commission would doubtless dispute this assessment, however. Obviously it is not in the FCC's interest to let its regulatees go on thinking that maybe, just maybe, they aren't really being regulated anymore. Because of that, the Commission will occasionally make some veiled noises about continued enforcement to keep licensees from flouting the Commission's new and streamlined rules. One clear example of such noises is the question of extensions of construction permits.

The general question of CP extensions arose most recently when the Commission adopted the LPTV rules. The Commission was aware that a number of LPTV applicants may have filed their applications primarily for the purpose of getting bought out, either while their applications were still pending or after they received a construction permit. While there is nothing wrong with getting bought out, the FCC obviously has an interest in processing only those applications that are intended to result in new service in the immediate future. Thus, while an applicant might see no harm in filing an application the primary purpose of which is *not* necessarily to get a station, the FCC would prefer not to have to deal with such applications. However, the FCC cannot simply put a question on the application form reading, "Do you really want this station?" and expect to have anybody answer "no," even though that might be the correct answer.

In an effort to confront the problem somewhat less directly, the Commission instead said in its Report and Order adopting the LPTV rules that it was going to hold all LPTV permittees to a very strict one-year time frame in which their stations would have to be built or their permits would expire. Further, to put some teeth into this threat, the FCC went on to say that it did not intend to grant any extensions of construction permits without a very strong

showing that causes beyond the permittee's control had prohibited timely construction of the station. This approach is similar to the one the FCC had taken a couple of years earlier, when it relaxed the financial showing requirement imposed on full-service broadcast applicants. Then the fear was that applicants would simply certify that they were financially qualified even if they weren't, on the theory that it would be easier to obtain funding commitments if they had a construction permit in hand. To discourage such practices, the FCC indicated that it would be tightening up on the grants of CP extensions, to assure that any such extensions were necessitated by reasons beyond the permittee's control. The Commission described this as a "get tough" policy of not extending CP's for applicants "who are either financially unwilling or unable to construct." That was in 1981.

Get tough policy

Fast forward from 1981 to 1984. In February, the Mass Media Bureau actually invoked that very "get tough" policy. The Bureau's February action involved a UHF television construction permit that had been issued in July 1978, and that gave the permittee until January 1980 to get on the air. In January 1980—still a year or so before the "get tough" policy, of course—the permittee came back to the Commission for an extension because, among other things, it was in the process of preparing an application to change its site. That application was not filed until June 1980, six months later. The FCC then added its own delay by not acting on either the site change proposal or the extension request until April 1981. To make matters worse, the permittee came back in for yet another extension later in 1981—when the "get tough" policy was supposedly in force—and was granted until June 1982 to complete construction, one and one-half years after the deadline.

What happened in mid-1982? It will probably come as no surprise that still another extension request appeared at the FCC. In this request the permittee argued that the unfavorable economic climate at the time made construction unwise. Finally the Commission got tough and, in late May 1982, advised the permittee that this excuse was not good enough and that, if it wanted its application granted, any such grant would be subject to a condition that the applicant commence construction and report satisfactory progress within 90 days. That was not exactly a real "get tough" policy, but it was certainly closer than what had gone before. The permittee, rather than respond directly to the Commission's advisory, filed an application for re-

NAB '84
Stand 1514

The GEC McMichael Satellite Earth Terminal.



GEC McMICHAEL

The shape is heaven sent.

Conventional antennae of more than twice the size cannot meet the performance of our latest generation of highly cost-competitive elliptical shaped antenna.

Sidelobe performance is impressive, meeting the 29-25 log Θ regulation in the more difficult minor axis whilst considerably exceeding the requirement in the major axis.

The Gregorian Feed system, derived from satellite payload technology, optimises efficiency and overall sidelobe performance.

Receive-only installations, facing increasing interference problems, also benefit from the high RFI immunity provided by this advanced antenna design.

When you've done 'the rounds' of conventional shaped antennae you'll see that GEC McMichael have the only one that really shapes up to the demands of today's regulatory requirements. It's heaven sent.

The number you want now is +44 2816 2797. Call it today and speak to Steve McGuinness. He'll give you all the facts. And the figures.

GEC McMICHAEL

Elliptical Satellite Terminal

GEC McMichael Ltd., Sefton Park, Stoke Poges, Slough SL2 4HD, ENGLAND. Telex: 849212.

Circle 298 on Reader Service Card

FCC RULES & REGULATIONS

view of the action, a pleading which even the Commission acknowledged was not an appropriate vehicle to address the matter.

The application for review was filed in May 1982. Nothing then happened until September 15 1983—another 15 months or so down the line—at which point the Commission realized that construction still apparently had not commenced. Why it took so long to reach this conclusion is not clear. In any event, in September 1983 the FCC directed the permittee to advise the Commission within 90 days as to whether it intended to construct the station. Ninety days later, in December 1983, the permittee responded that it intended to build it eventually, and that it hoped to be able to make appropriate arrangements within 120 days. This proved too much for the Commission and, in February 1984 it cancelled the construction permit.

Fines threatened

This story may be unique and not at all illustrative of the Commission's determination to enforce what rules remain after deregulation. It is striking, however, that the Commission articulated its "get tough" policy on construction permit extensions during the middle of the five and one-half year period during which this permit was outstanding. The FCC's actual approach hardly seems consistent with its 1981 description of the policy. If this were a unique situation, it might not be particularly scary. In January 1984, however, the FCC issued notices of a couple of fines and forfeitures it had assessed in late 1983. This included a \$2000 notice of apparent liability issued to an FM station for "constructing and operating a facility with a different antenna, at a different height and with reduced power, at substantial variance from those authorized under the construction permit." They also included a notice of apparent liability for \$7500 issued to an FM station for "operating pursuant to automatic program test authority at an unauthorized location and with an antenna height at substantial variance from the terms and conditions of the construction permit." In other words, in each of these two cases, the permittee had apparently built its station with facilities not authorized, and, in the latter case, at a site different from the one originally proposed.

These fines represent something of a "good news, bad news" story. The good news is that the Commission caught the permittees and penalized them for their transgressions. The bad news is that a \$2000 or even a \$7500 fine may not be sufficient.

Worse news is that the Commission is still considering a proposal to permit FM applicants to "self-certify" their engineering, so that the Commission's staff generally would not review the technical aspects of a new FM application. Part of the Commission's reasoning is that FM applicants, shouldered with this new responsibility, will be inclined to make sure both that their engineering is accurate and in compliance with the rules, and also that construction of the station conforms to the construction permit and the original technical proposal.

Such voluntary compliance would be absolutely essential if any such self-certification scheme were to be adopted. But the two fines described above indicate that, even under the current system (which involves much greater FCC scrutiny of applications and, presumably, much

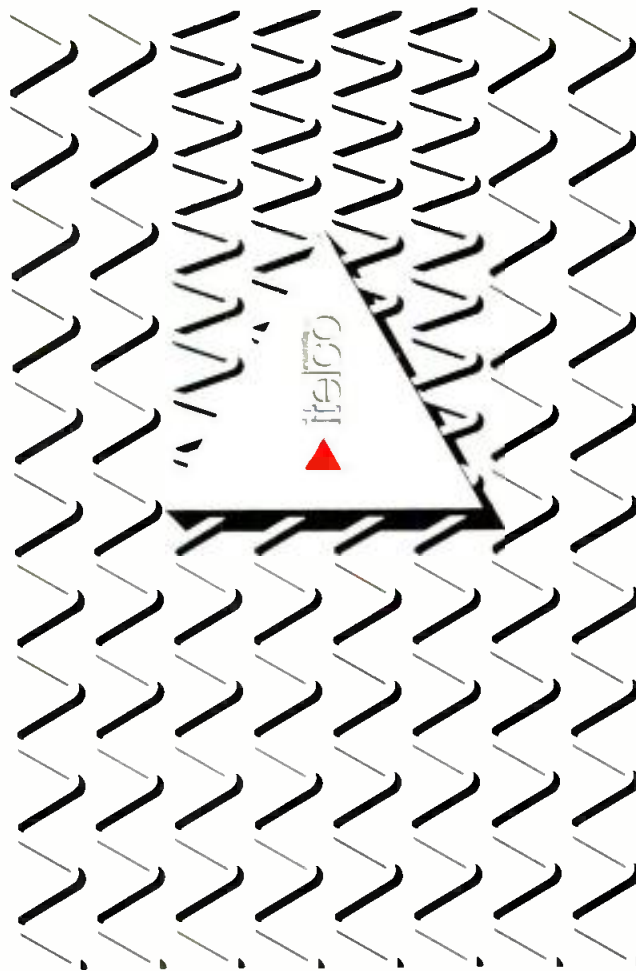

signals from italy

► ITELCO provides:

- a complete line for FM-RADIO and TELEVISION BROADCASTING
- LO-HI VHF TRANSMITTERS up to 40 KW
- UHF TRANSMITTERS up to 40 KW
 - solid state and tube technology
 - FCC - CCIR standard
 - PAL - SECAM - NTSC
- MICROWAVE RADIO LINK
- TURN KEY SYSTEMS DESIGNED ON REQUEST

ITALY: ITELCO S.p.A.
Piazza Febei, 3
tel.: 0763/40131-2-3-4. tlx.: 661013 05018 ORVIEETO

ESPAÑA: FRATEL
Ricardera, 55
tel.: 8887176. tlx.: 52407E FOLGAROLAS (Barcelona)

GREECE: LEMAR LTD
Hermou str. 8
tel.: 8952406 tlx.: 214752GR ATHENS

U.S.A./AMERICA LATINA: CONTINENTAL
1620 W. 32nd Place
tel.: (305) 8221421. MIAMI FLA.

CANADA: M.S.C. ELECTRONICS LTD
254 Wildcat Rd.
tel.: (416) 6614180. tlx.: 623494 DOWNSVIEW ONT.

SEE US AT NAB'84

Circle 300 on Reader Service Card

One **SPIKE** Can Cost **DOWNTIME!**

Overvoltage transients can bring the biggest installation down in a microsecond, or damage it cumulatively.

Surge-Master Heavy Duty Power Line Protectors give complete protection against all transients.

All audio and video transmission equipment is vulnerable to transients on AC power lines caused by heavy motors starting up (even elevators or testing your auxiliary power system), power company load adjustments—and of course, lightning. Even if your equipment operates from batteries charged by a UPS, you're not safe. If lightning knocked out your UPS, how long could you keep going?

The MCG Surge-Master offers two stage protection. The first reacts in nanoseconds to absorb lesser transients and the leading edges of major ones. The second stage absorbs the big ones, and has three modules on each line. So, in the unlikely event that one module should be knocked out, there are still two protecting you. And a system of indicator lights tells you not only when a fault has occurred, but exactly where it is. Modular construction (and the fact that Surge-Master is connected in parallel) makes replacement of damaged modules quick and easy. Initial installation requires minimal power interruption.

Available with capabilities from 100 to 3000 amps; for 120, 240 and 480 VAC; and for single, 3-phase, wye and delta power systems. MCG also manufactures smaller units for protecting individual pieces of equipment. To learn more, contact Department 31017 at 516/586-5133 or at the address below.

Protecting industry since 1967

MCG

ELECTRONICS, INC.
160 Brook Avenue
Deer Park, N.Y. 11729



See us at the N.A.B. Booth #167

Circle 301 on Reader Service Card

FCC RULES & REGULATIONS

smaller possibility of abuse), at least two recent applicants have constructed their stations at substantial variance from the facilities authorized to them. Needless to say, this does not bode well for a self-certification system.

But more significantly, the level of the fines does not suggest that the Commission is as concerned as it might be about such violations. The Commission after all, has authority to issue fines for as much as \$20,000. Thus, even the \$7500 fine falls far short of the maximum. The conclusion that can easily be drawn from this is that the Commission, for whatever reason, did not deem this violation to be among the most important.

Now it may be that the particular facts of each case warranted some mitigation of the penalty. But even so, the Commission has a very serious interest in assuring that its permittees construct their facilities as authorized. That interest is shared by existing broadcasters whose signals are, at least in theory, protected by the rules for granting new facilities. If stations are constructed with facilities at variance from those authorized, interference is possible. Further, even if no interference is created, such construction will complicate any future changes in existing facilities, since the FCC's records would reflect, presumably, the authorized facilities, and not the actual facilities. In that event, changes by existing stations, while consistent with the "authorized" facilities, could conflict with the actual facilities.

This potential problem should make enforcement of the precise details of its authorizations among the Commission's highest priorities. This is much more the case if the Commission is inclined to go forward with its proposed self-certification scheme. Unfortunately, the two recent fines do not suggest that the FCC necessarily shares this assessment of its priorities. Whether or not this reflects an attitude that will be maintained remains to be seen.

Election reminders

Shifting gears somewhat, we would be remiss if we did not take this opportunity to remind you that we find ourselves in yet another election year. That, of course, triggers all the various political broadcasting rules that beset broadcasters. While some campaigns may still be in their early stages, others—notably those of the presidential hopefuls—have kicked into high gear. In any event, broadcasters would do well to review their files, notes, handbooks, and any other available materials to make sure they are still familiar with their legal obligations relative to political broadcasting. Such preventive steps generally prove useful since political broadcasting problems often pop up with little or no notice, and usually need to be resolved in extremely short order. An ounce of prevention can easily prove to be worth a pound of cure, which could take the shape of legal fees, hassles with the FCC, and bad relations with candidates and their supporters.

For those interested in obtaining a general overview of the current political rules, the National Association of Broadcasters conducted a three-hour teleconference on the subject in February 1984. Tapes of the conference, which featured a number of communications attorneys and other experts, are available for a fee from the NAB. This could prove a useful refresher course. And, as always, broadcasters should not hesitate to consult with their own communications counsel both for general information and as specific questions arise. **BM/E**

Schlumberger's

Know-how

Turnkey installations (studios - broadcasting centres)

Equipment for :

- studios
- O.B. Vans
- professional sound
- broadcasting
- television
- etc...

- **Switching grid matrices**
 - Talkback systems
 - Master F 462
tape recorders
- **F 500 tape recorders**
 - UPS 5000 sound
mixing desks
 - UPS 6000 sound
mixing consoles

ENERTEC

Schlumberger

ENERTEC DEPARTEMENT AUDIO-PROFESSIONNEL

1 rue Nieuport B.P. 54

78140 Velizy-Villacoublay Cedex France

TEL. (3) 946.96.50 TELEX ENERSON 697430 F

U.K. REPRESENTATIVES : CROW OF READING LTD. P.O. Box 36 · READING RG1 2NB · Berkshire · Tél (0734) 59.50.25 · Tx 847056

ADVERTISER'S INDEX

Use Reader Service Card on Facing Page ►

Manufacturer	Page No.	Circle No.	Manufacturer	Page No.	Circle No.	Manufacturer	Page No.	Circle No.
Abekas Video Systems	72-73	145	The Gerstenslager Co.	59	139	Oki Electronic Industry, Ltd.	262	286
Acrodyne	69	143	Gray Communication Consultants, Inc.	77	147	One Pass Film & Video	173	210
Adams-Smith	286	303	Gray Engineering Labs	268	290	Orban Associates, Inc.	32	123
ADM Technology, Inc.	C-2	—	Grumman Aerospace	125	181		187	219-221
A.F. Associates Products	15	108				Otari Corp.	209	231
A.F. Associates Systems	49	133	Harris Broadcast Products Div.	117	177			
Alden Electronics	119	178		253	277	Pacific Recorders & Engineering Corp.	233	249
Alexander Manufacturing Co.	20	113		276	297	Paltex	113	173
Allen Avionics, Inc.	288	304	Harris Broadcast Microwave Operation	245	271	Panasonic Industrial Co.	143	191
Allen & Health Brenell USA, Ltd.	4	102	Harris Studio Division	176-177	213	Panasonic/Matsushita	28-29	121
Allied Tower	230	246	Harris Video Systems	128-129	183		79	148
Alpha Audio	234	261	Harrison Systems	211	233	Perrott Engineering	167	206
Ampex AVSD	95-98	—	Hipotronics, Inc.	26	119-120	Philips Television Systems, Inc.	132-133	150-158
Ampex MTD	23	116	Hitachi Pro-Video	12-13	107	Philips Test & Measuring Inst.	175	212
Amtel	160	202	HM Electronics, Inc.	210	232	Piher Electronica	274	299
Andrew Corp.	115	175	Howe Audio Productions, Inc.	178	214	Potomac Instruments	34	125
Angenieux Corp. of America	270	292	Hubcom	244	270			
Antenna Technology	271	293				Quanta Corp.	158-159	201
Anton/Bauer, Inc.	127	182	IGM Communications	197-202	227			
Asaca Corp. of America	257	282	Ikegami Electronics USA, Inc.	87	162	Radio Systems Inc.	33	124
AT&T Communications	139	—		89	163	Rank Cintel	168-169	207
Auditronics, Inc.	25	118		91	164	RCA Broadcast Systems	62-63	141
	268	289		261	285	RCA E/O	5	103
			International Tapetronics Corp.	181	215	R-Columbia	286	302
Belar Electronics Lab, Inc.	288	305	Itelco	279	300	Reach Inc.	237	265
Beyer Dynamics, Inc.	224-225	242				Rees Associates	236	264
Boonton Electronics	228	272	Japan Electronics Show	287	314	RF Technology	81	160
Bosch Corporate	46	136	U.S. JVC Corp.	56	138	Rohde & Schwarz	124	198
	267	288				Roscor Corp.	290	309
Bosch (Fernseh)	123	179				RTS Systems	195	226
Broadcast Technology, Inc.	249	275	Kamen Broadcasting Systems	163-164	205			
Bryston Ltd.	231	248	Kavouras, Inc.	43	131	Scientific-Atlanta	183	216
			K & H Products, Ltd.	142	195	Sennheiser Electronics Corp.	247	274
Camera Mart, Inc.	11	106				Shintron	80	159
Canon USA, Inc.	41	130	Laird Telemedia, Inc.	45	135	Shotoku	260	284
Capital Magnetic Products	184	217	Lake Systems Corp.	112	172	Shure Bros., Inc.	74	146
CBS Musical Instruments	231	247	LEA, Inc.	256	281	Sigma Electronics	236	263
Central Dynamics Corp.	38	128		291	312	Solid State Logic	240-241	268
Centro Corp.	155	199	Leader Instruments	19	112	Sony Broadcast	2-3	—
Cetec Vega	229	244	Lenco, Inc.	44	134		50-54	—
Chroma Digital Systems	151	196	Lerro Electrical Corp.	27	—	Sony Tape Products	120-121	—
Chyron Corp.	259	283	Lexicon, Inc.	207	229	Storeel Corp.	223	241
Cipher Digital	40	129		213	234	Studer Revox America, Inc.	35	126
Circuit Research Labs	239	267	Listec Television Equip. Corp.	174	211	Swiderski Electronics, Inc.	290	310
Clear-Com Intercom Systems	24	117	LPB, Inc.	18	111	Swintek	238	266
Colorado Video	116	176						
Comark Communications, Inc.	1	101	3M/Pro-AV	64	142	Tektronix Inc.	103	—
	246	295	Magna-Tech Electronic Co., Inc.	149	194		104-105	165-168
Comex Systems	22	115	Magnetic Media	288	306		106-107	169
Computer Graphics Labs, Inc.	21	114	Marcus Satellite Systems Inc.	192	224	TeleCine Corp.	48	132
Comtech Data Corp.	214	235		291	311	Telex Communications	47	137
Continental Electronics Mfg. Co.	185	218	Maxell Corp. of America	36-37	127		193	225
Countryman Associates	160	203	McMichael Ltd.	278	298	Terminal Systems Corp.	289	307
Crosspoint Latch Corp.	114	174	MCG Electronics	280	301	Thomson-CSF Broadcast	C-3	313
			MCI/Quantel	61	140	Thomson-CSF/DTE	171	208
			Merlin Engineering	150	190	Time & Frequency Technology	265	287
Delta Electronics	191	223	Microdyne	227	243	Toshiba America, Inc.	153	197
Digital Services Corp.	83	161	Microtime, Inc.	146-147	193			
Digital Video Systems	157	200	Microwave Mobile Systems	289	308	Utah Scientific, Inc.	137	186
Di-Tech, Inc.	250	276	Mid-America Automation Corp.	247	273			
			Midwest Corp.	8-9	105	Valley People, Inc.	216	262
Eastman Kodak Co.	84-85	149	Minolta Corp.	154	180	Vectrix Corp.	93	188
EECO, Inc.	255	279	Monroe Electronics	215	236	Video International	138	187
EEV, Inc.	145	192	Motorola, Inc.	30	122	Videomedia	7	104
EG & G	208	230				Videotek, Inc.	71	144
Electro-Voice	217	238	Nagra Magnetic Recorders, Inc.	170	296			
Emcee Broadcast Products	269	291	NEC America, Inc.	16	109	Ward-Beck Systems, Ltd.	C-4	—
Enertec	281	245		17	110	Wegener Communications	222	240
Environmental Satellite Data, Inc.	161	204	Rupert Neve, Inc.	242	269	Wheatstone Corp.	204	228
Eventide Clockworks, Inc.	235	237	NTI America	254	278	Wilk Power & Video, Inc.	110	171
			Nurad, Inc.	141	189		273	294
						Winsted Corp.	256	280
Fidelipac	188-189	222						
For-A Corp.	134	185						
Forox	172	209						
Fujinon Inc.	109	170						
Fuji Photo Film USA, Inc.	131	184						

broadcast EQUIPMENT

Scientific-Atlanta Transports Earth Station

Designated Model 8251-11, the fully integrated, transportable earth station with 11 meter antenna is capable of providing full C-band Domsat and Intelsat Standard B performance from any location. The entire earth station, including antenna, electronics shelter, and optional diesel powered generator is contained on one 48 foot long standard highway trailer. The self-contained generator allows the earth station to be operated independent of primary ac power mains.

During transport, the components of the antenna (panels, structural trusses, feed and subreflector) are stowed in a storage rack located between the equipment shelter at the front and the antenna mount in the rear of the trailer. Removable, flexible side covers on the storage rack protect against dirt and dust during transit over poor roads.

Setup time for the antenna is said to be about eight hours with outriggers deployed to stabilize the system. The storage rack is designed to be a work platform from which the antenna is assembled, while placement of heavy items such as the feed and subreflector is enhanced by the use of a manually operated swinging boom. All the work is designed to be performed by a crew of four or five persons.

The 8251-11 can be equipped to handle FM or digital SCPC uplink/downlink, FDM FM uplink/downlink, telephone interface, and teleprinter. Other capabilities include orderwire, wideband digital uplink/downlink, and television uplink/downlink. Options for the antenna are parametric or solid state LNAs, beacon receive and



steptrack, built-in test equipment, and total redundancy.

The antenna is available in alternate configurations and two other sizes: Model 8251-10 is a C-band 10 meter and the 8251-7.7 is a Ku-band 7.7 meter antenna.

**For More Information
Circle 250 on Reader Service Card**

ADA Reveals Digital Delay



The new 2.56i digital delay is a full function delay processor for both live performances and studio use. The unit produces delay times from 0.3 ms for high flanging to over 2.5 seconds for digital tape loop effects, and all at a full 16 kHz bandwidth. An LED rate indicator blinks at a rate equal to the delay time for accurate, real time echo setting.

For producing special effects, the unit has regeneration, modulation, and repeat hold functions. The regeneration hi-cut control reduces high frequency content in the delayed audio signal as it recirculates for a natural decay, and is variable between 16 kHz to 1.0 kHz. The modulation section has an 8:1 sweep range which produced flanging that sweeps over three octaves.

Waveform control continuously blends the shape of the modulation from a triangle to a sine wave to a square wave. In addition, modulation LEDs give a visual indication of the sweep to its upper and lower limits. The unit is priced at US\$799.95.

**For More Information
Circle 317 on Reader Service Card
Sabor Announces Voice
Recorder**

The new Sabor TR-10 is a 10 track, quarter-inch tape recording unit especially designed for voice communications and logging. The unit features recording time of 24 hours and 45 minutes with automatic shutoff and remote start/stop. A monitor speaker is provided

which can be switched to any channel during recording, or to an earphone output jack while an indicator light displays which channels are recording.

The TR-10 has a full track sensing head configuration and records the tracks in a 5 + 5 staggered pattern, and reproduces 5 + 5 staggered. Tape speed is 15/32 ips with a speed deviation of ± 0.7 percent. Flutter is 0.3 percent (WRMS, NAB). Fast forward in 160 seconds, rewind is 150 seconds. The system frequency response is 300 Hz to 3 kHz (telephone range) ± 3 dB with a reproduce S/N ratio of better than 40 dB. Distortion for the TR-10 is less than four percent 1 kHz at 0 dB and crosstalk is better than 40 dB at 1 kHz.



EQUIPMENT

Among the optional features offered with the TR-10 are an electronic tape counter and a time code generator/reader. The recorder mounts in a standard EIA 19-inch rack with a unit height of 19.25-inches and a total weight of 66 pounds. Input is +4 dBm, -1 dBm, -11 dBm, and -16 dBm switchable for each channel, 20 kohms balanced. The monitor speaker output is 5 W/8 ohm while the headset output is 300 mW/8 ohm.

For More Information
Circle 251 on Reader Service Card

Tektronix Provides Waveform/ Vector Monitor With SCH

The new 1750 Series, similar in appearance to the recently introduced 1740 Series, is a combined waveform/vector monitor that also offers SCH (subcarrier to horizontal sync) monitoring and measurement capability, and full function vertical interval line and field selection.



Unlike the 1740, which was intended for portable operations, the new 1750 Series is designed for bench and rack operation and does not come with dc power capabilities. The half rack width instruments are intended for use where space and power consumption are prime considerations, and where simultaneous waveform and vector displays are not required. The 1750 weighs about 16 pounds.

The new instrument provides SCH display capability, line and field select with LED readout, and includes the features of the 528 waveform monitor and the 1420 vectorscope series. The unit requires only a half-rack space and costs \$5600. Though suitable for all television environments, the 1750 was designed for VTR, editing, and post-production applications, where maintenance of consistent SCH phase and monitoring of vertical interval informa-

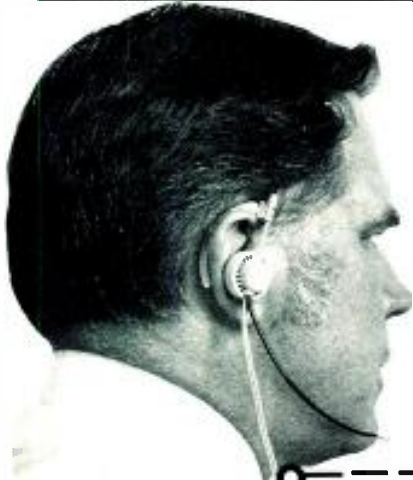

IFB/ENG
“ULTRA-LIGHT”
TELEPHONE
 for
“HANDS-FREE”
COMMUNICATION

Model 6058/T - A complete electronic “Touch -Tone” telephone which uses R-Columbia’s 1 ounce headphone/mic. Unit operates directly into any modular telephone jack, and can be clipped to the user’s belt. Features include a mic mute switch, auxillary mic input, and auxillary headphone output. \$149.95

Model UL-85/M - 1 ounce headphone/mic - Ideal for broadcast, communication or telephone work. Available in impedances from 8 to 2K ohms, with or without mic boom. Request bulletin 2X (As pictured above) \$129.95

VISIT US AT NAB BOOTH 1111 or ICA BOOTH 2168

Intercom Systems: Self Powered, AC Line Powered, FM Wireless, Infrared, Headphones: Cameraman’s, Broadcast, Professional, and Ultra Light. Impedances from 8 to 50K ohms. Request new SHORT FORM CATALOG bulletin 1X

R-COLUMBIA PROD. CO., 2008 St. Johns Avenue Highland Park, IL 60035-2499
 Phone: (312) 432-7915 TWX: 910-692-2160

Circle 302 on Reader Service Card

WE DIDN'T LUCK INTO IT!

We set out to make the best time code and tape synchronizing equipment in the industry.

We wanted to meet all specs, handle all standards, work with all formats.

We wanted to make it controllable by its own front panels, by dedicated remote panels, or by external computer equipment.

Besides doing all the routine things, we wanted it to meet emerging professional requirements like —

- Reading VITC up to full VTR wind speed, so VITC could be used for editing in addition to edit decision-making.
- Translating VITC into LTC, for adding VITC capability to existing editing systems — without VTR/editor modifications.
- Syncing all sorts of ATRs and VTRs together (including digital audio recorders) for jobs like layback, chase synchronizing, TV sound editing and transport control.
- Providing sub-millisecond TV audio editing capability for dialogue replacement.
- Using VITC to free-up the LTC audio track — for TV stereo and multi-language use.

and

We wanted it to be cost effective, modular, purchased as needed, and added to as required — available as individual stand-alone products which could be networked to provide a system greater than the sum of its parts.

WE SUCCEEDED —

SYSTEM 2600 from ADAMS-SMITH.

NAB-84
 Booth 1724

The industry leader in time code and tape synchronizing technology.



ADAMS•SMITH

34 TOWER STREET, HUDSON, MA 01749 U.S.A.
 TEL: 617-562-3801 TWX: 710-347-0096
 NEW YORK: 516-352-2341 LOS ANGELES: 213-388-8218

Circle 303 on Reader Service Card



Inter BEE '84

October 23 ~ 25 Tokyo Ryutsu Center (TRC)

Something NEW under the Sun !

The newest designs in Audio/Video equipment
Computerized models/Digital models
Systems for radio/Systems for television
Equipment from Europe/Asia/The Americas

See it all

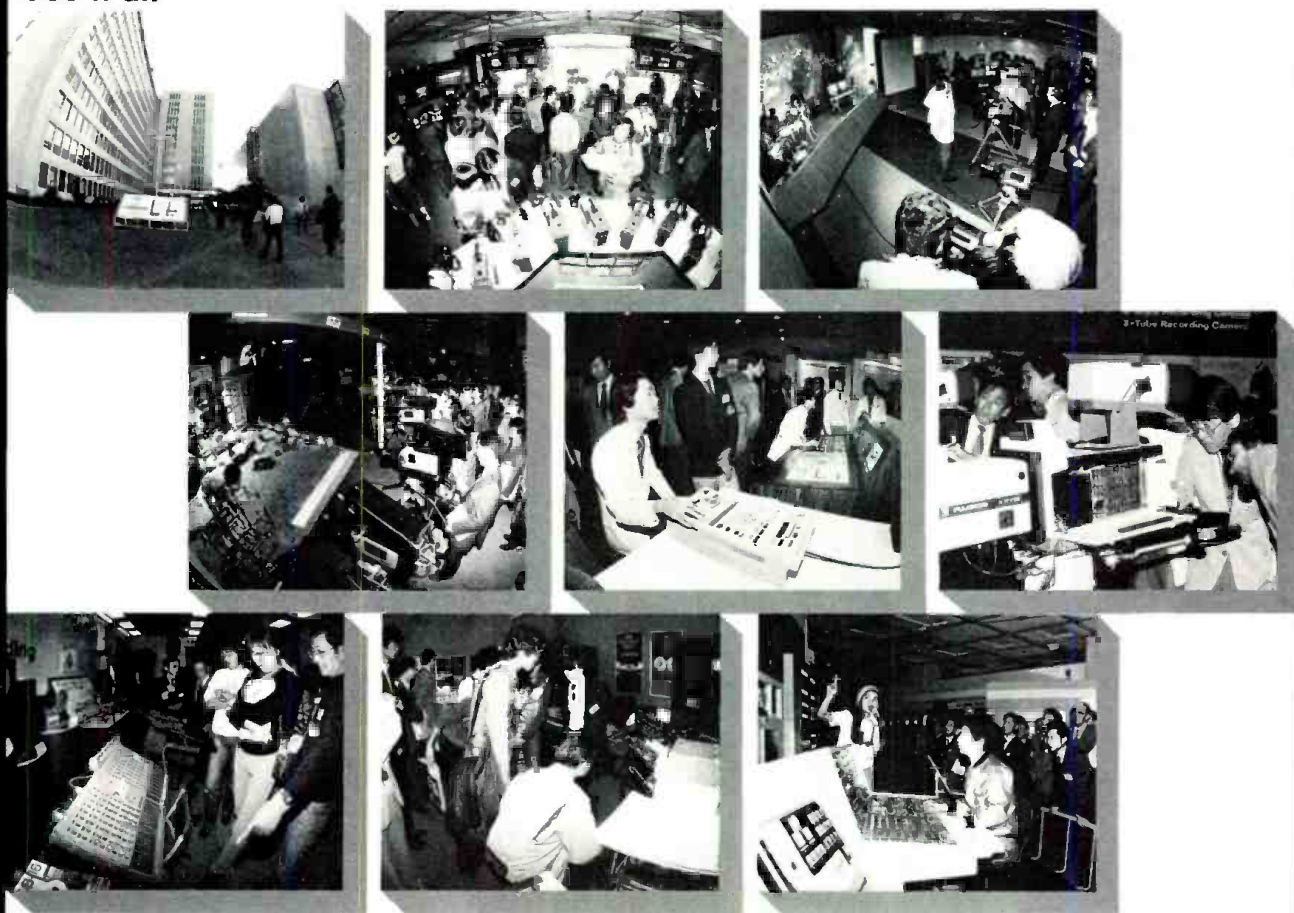

Sponsor: Electronic Industries Association of Japan
Co-Sponsor: The National Association of Commercial Broadcasters in Japan
NHK (Japan Broadcasting Corporation)
Management: **JAPAN ELECTRONICS SHOW ASSOCIATION**
The Tokyo Chamber of Commerce & Industry Bldg.
3-2-2, Marunouchi, Chiyoda-ku, Tokyo, Japan

Circle 314 on Reader Service Card

www.americanradiohistory.com

BROADCAST EQUIPMENT

tion is necessary. Such mixing and switching functions require the 1750 to examine the incoming signals to determine if each signal is properly adjusted for SCH phase and if the signal is color frame synchronized.

The 1750 Series has all the capabilities in waveform and vector monitoring, but finds its most significant application in SCH phase measurement, allowing proper determination of composition of individual signals (compliance with RS170A) and determination of relative color framing of two signals. Color framing is necessary to avoid poor edits and technical problems related to shifts in sync timing. The unit has front panel line and field selection with readout of the selected line number. Vertical interval line and field selection allows in-service monitoring of VIR, VITS, and ITS as well as other vertical interval information, such as teletext.

The 1750 is mechanically compatible with the 528A waveform monitor, 1420 Series video monitoring vectorscopes, and 1740 waveform/vector monitors. The 1750 display is

comprehensive (burst phase and sync timing simultaneously) and dynamic. The immediate and continuous response of the analog display makes it easier to observe rapid or transient changes in SCH phasing and to correlate changes with other components of the signal. Jitter and timing crosstalk can be observed, measured, and correlated in what the company claims is the most advanced state of this type of engineering.

For More Information
Circle 254 on Reader Service Card

Vidicraft Enhances Images



The 1310 horizontal and vertical image enhancer offers the manipulation of picture elements line to line, as well as within a single scan line. The unit is intended for use in minimizing detail loss in tape duplication and improving the visual clarity of pictures reproduced by

3/4- and half-inch format VCRs.

Featuring 2H processing, the system offers improvement of vertical detail, and provides noise reduction and split screen comparison. This type of processing uses information from three successive lines to form a symmetrical enhancement signal. Noise, usually increased by enhancement, is minimized by a combination of two techniques: coring, which reduces noise in all areas of the picture, and a level-dependent circuit which suppresses enhancement in the darker areas of the picture where noise is more visible. The split screen mode allows side by side comparison of unenhanced and enhanced video images.

Features of the 1310 include horizontal aperture correction, vertical chroma delay switch, enhancement signal gating, and white/black level clippers to insure freedom from picture tearing or recording level changes caused by over-enhancement. Loop through video input with switchable 75 ohm termination is provided as are four source terminated video outputs, and a special video output consisting of en-

RACK MOUNTABLE VIDEO DELAY LINES

A complete Rack Mountable series of Video & Pulse Delay Lines, with the capability of replacing up to 1450 feet of 75 ohm coaxial cable. The units reduce size, weight, installation costs, save time and effort in making delay changes.

Part No.	Delay Range (Nano-Sec.)	Delay Steps (Nano-Sec.)	Method of Variation	Maximum Insertion Loss @ 100 KHz (db)	Amplitude Flatness At Any Delay Setting 100 KHz to 5.5 MHz (db)	Max. Rise Time (Nano-Sec.)
VRM0255	0-255	1.0	Slide Switch	.40	.4 Max.	20
VRM0637	0-637.5	2.5	Slide Switch	*1.00	.4	28
VRM1275	0-1275	5.0	Slide Switch	*3.00	.4	33
VRM2270	0-2270	10.0	Slide Switch	*3.00	.5	40
VRS0317	0-317.5	2.5	Strap	.40	.5	26
VRS0635	0-635	5.0	Strap	.75	.5	35
VRS1270	0-1270	10.0	Strap	1.50	.5	37
VRS2260	0-2260	20.0	Strap	3.00	.5	40

*±.2db variation at any delay setting.

Circle 304 on Reader Service Card



Call/Write for Catalog
See us at NAB Show
BOOTH 1627

ALLEN AVIONICS, INC.
224 EAST SECOND ST.
MINEOLA, NY 11501
Phone: 516-248-8080

YOU'LL BE SURPRISED AT NAB —

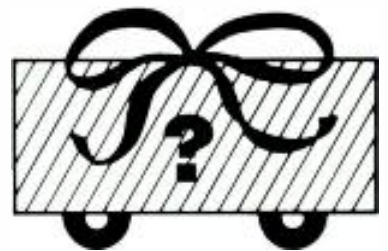

When you see what Magnetic Media, Shook, & Hitachi have put together for 1984, Visit the Cost Effective Team at **Booth #1310** during the NAB-84 Convention in Las Vegas.

MAGNETIC MEDIA

VIDEO SYSTEMS PROFESSIONALS

4801 KELLER SPRINGS RD.
Dallas, Tx 75248

(214) 931-0404

Hitachi Denshi America, Ltd.

Circle 306 on Reader Service Card

When accuracy Counts...Count on Belar for AM/FM/TV MONITORS



BELAR
AM MODULATION MONITOR

BELAR CALL ARNO MEYER (215) 687-5550
ELECTRONICS LABORATORY, INC.
LANCASTER AVENUE AT DORSET, DEVON, PA. 19333 • 80X 826 • (215) 687-5550

Circle 305 on Reader Service Card

hancement signal with 50 percent setup and sync.

For More Information
Circle 252 on Reader Service Card

Phasemaster From Kay Industries

The Phasemaster T-Series rotary phase converter is engineered for use with all types of radio and television transmitters. It converts single phase power to three phase lines.

The Phasemaster is valuable in applications where the high cost of installing utility-supplied three phase power is prohibitive since the unit can be installed, according to the manufacturer, for a fraction of the cost of obtaining three phase utility lines. Because utilities often use an open delta system to reduce distribution costs, the absence of a third transformer allows the line voltage to fluctuate excessively across the open end. This condition is unacceptable for broadcast use. The Phasemaster closes the delta, eliminating undesired fluctuations and regulating all three lines.

The voltage produced through the unit is regulated within a range of two to five percent of the single phase primary electrical supply and output wave forms and phasing are nearly identical to utility-supplied three phase lines. The converter has the ability to buffer line transients and voltage spikes and contains integral lightning protection. Systems are available to accommodate dual power output ratings and are also available with automatically controlled high/low power switching. The Phasemaster converter is designed to operate on a continuous 24 hour per day basis, with or without a load, and can be remotely controlled.

For More Information
Circle 255 on Reader Service Card

Channelmatic Develops Automatic Logger

The new Logmatic Jr. is an automatic four channel logging system that provides the operator with a printout of the time, date, and channel of any commercial insert along with encoded advertis-

er and spot information.

A built-in real time clock furnishes the time and date information, while advertiser and spot identification are read from DTMF data previously added to the unused channel one audio track of the commercial videotape. The unit uses standard 2.25-inch wide thermal calculator tape for printout and features built-in clock memory battery back-up. The unit takes up 1.75-inches of rack space and is compatible with any commercially available insert system.

For More Information
Circle 256 on Reader Service Card

Hotronic Reveals Drop Out Compensator

As an option to the Model AD-51 time base corrector/frame synchronizer, Hotronic has introduced a digital drop out compensator (DOC). The DOC provides pixel by pixel correction of both luminance and chrominance information in the event of tape drop outs.

Sampling is at four times subcarrier,

Visit TSC at the NAB . . .

Acorn/TSC Wire Service Terminals

Sorts and records wire stories on 10 million character hard disk. Send only stories you will use to your system. Archive on floppy disk. Automatically prints flashes and bulletins.

Reporter and Bureau Terminals - Copy Control IV

Stand-alone terminals with disk storage and telephone communications to your system. Receives and records stories and messages automatically, unattended. CP/M operating system.



Terminal Systems Corporation
901 Columbia Circle
Merrimack, NH 03054
(603) 424-5033

Circle 307 on Reader Service Card

MICROWAVE MOBILE SYSTEMS

POINT-TO-POINT
From anywhere to anywhere
SATELLITE INTERCONNECT
To & from uplinks & downlinks
PRODUCTION SERVICES
Mikes, IFB's, Mixers, etc.

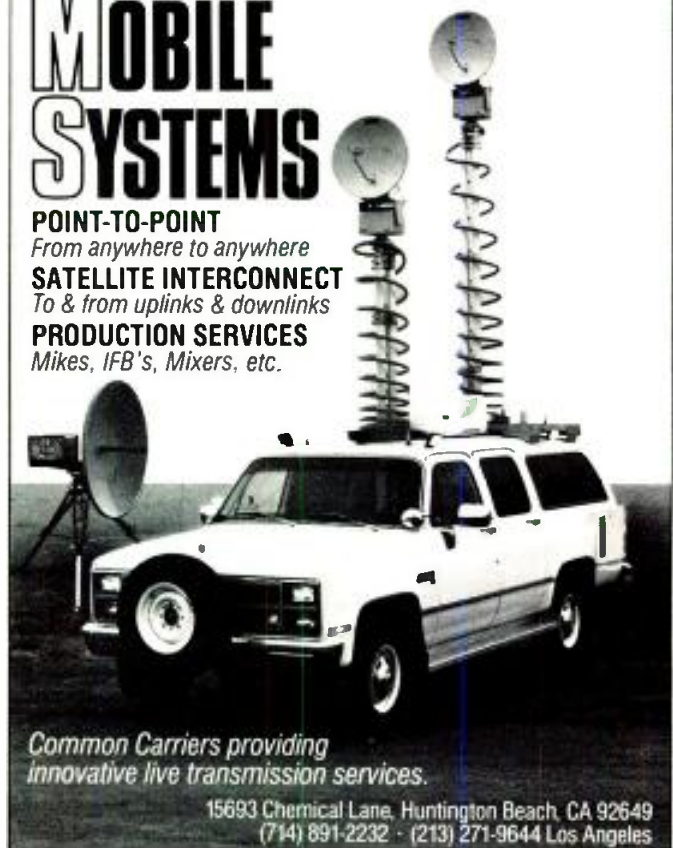

*Common Carriers providing
innovative live transmission services.*

15693 Chemical Lane, Huntington Beach, CA 92649
(714) 891-2232 - (213) 271-9644 Los Angeles

Circle 308 on Reader Service Card

BROADCAST EQUIPMENT

and correction is achieved at a 70 ns rate. Detection is either by monitoring the RF carrier or the actual digital words. The selection of either method is at user's option and the DOC can be retrofitted to all AD-51 units.

For More Information
Circle 258 on Reader Service Card

American Laser Infrared Transmission

The ALS Optical TV Transmission system is designed as a short haul link for transmitting video and audio signals through the air on an optical infrared, license-free system. The system is designed as an alternative to microwave, telephone lines, coaxial cable, and fiber optics.

The system will operate up to one mile in moderate weather conditions (except extreme fog) day or night. The transmitted signal meets broadcast standards. Consisting of two units, the system contains a transmitter and a receiver, each of which is smaller than 17 inches in length and 10 inches in width and height.

System specifications include a video signal bandwidth of 5.5 MHz \pm 1 dB or 7.0 MHz \pm 3 dB. The differential gain at 3.58 MHz is less than two percent, while the differential phase at 3.58 MHz is less than two degrees. Transient response is rated at less than two degrees overshoot and S/N ratio at a range of 2500 feet is 54 dB weighted.

For More Information
Circle 257 on Reader Service Card

Industrial Research Markets Mic Mixer



The Voice-Matic microphone mixer Model DE-4016 is an automatic four channel unit with remote control feature. The electronic circuitry providing the remote control capability is contained in the chassis of the mixer. The remote control function is provided by



the DE-207 control box which passes only dc voltage signals.

Channel sensitivity, master level, and standard/automatic mode are passed on the DE-207 when it is connected to the DE-4016 chassis and again returned to the main unit when the DE-207 is disconnected.

The mixer has dynamic threshold sensing which allows the automatic unit to provide the gain, stability, low background noise, and reverberation pickup of a single microphone system.

For More Information
Circle 259 on Reader Service Card

TEAM COME TRUE.

Elite Fleet & JVC

For a real dream come true in mobile video production, consider the team of ROSCOR's Elite Fleet of television remote trucks and quality JVC video equipment.

All of the trucks in ROSCOR's Elite Fleet represent the industry standard for quality, durability and beauty.

Whether a 12' remote vehicle, a 19' ENG van or a 44' broadcast remote truck, each unit is meticulously designed and tested to provide



the ultimate in remote production facilities. JVC's line of extraordinary video equipment also represent the industry standard for excellence.

The exceptional quality in cameras like the KY-310, JVC's full series of color monitors and the KM-2000U

special effects generator are ideal for EFP and remote productions.

ROSCOR's Elite Fleet and JVC: a dream come true in mobile video production.

ROSCOR

VIDEO SYSTEMS ENGINEERING

ROSCOR CORP. • 6160 W. OAKTON ST. • MORTON GROVE, IL • 312/539-7700

Circle 309 on Reader Service Card

Videotape Editing

Videotape Editing-Communicating With Pictures And Sound answers every videotape editing question:

When to edit? When to (and when not to) use a dissolve or wipe? How to cut? How to use complex sync roll editing and audio sweetening? How to affect the mood and pace of a show? Why and how to perform computer editing without losing creative control? It even takes the mystery out of time code and user bits.

Beginning editors, experienced pros, film editors and media managers will all appreciate *Videotape Editing*. This new book is your guide through the world of videotape editing including time code and computer assistance.

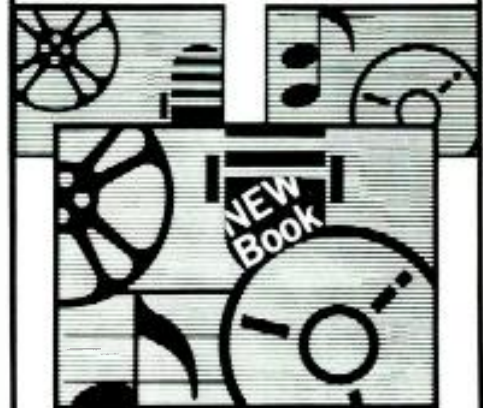

Videotape Editing-Communicating With Pictures

And Sound By Michael D. Shetter
• 165 pp. • 144 illus. • 6" x 9" Hardbound
\$32.20 (\$34.30 in 1L)

Order Today! • Major Credit Cards Accepted
Brochure Available • (312) 364-1900 Ext. 825

SE Swiderski Electronics
Audio/Video Engineers

1200 Greenleaf Ave • Elk Grove Village, IL 60007 • (312) 364-1900

Circle 310 on Reader Service Card

Hitachi Introduces 100 MHz Portable Scope

Hitachi has introduced what it claims is the world's first intelligent 100 MHz portable oscilloscope, the V-1100. The

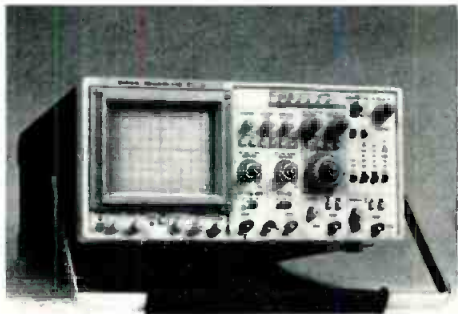

unit is a full function scope featuring a CRT readout that displays frequency counter and DVM functions as well as constant ground level display.

With the use of built-in microprocessor circuits, the V-1100 displays the measurement of voltage value between ground level and reference cursor or between two cursors and the time difference between two points. The unit then

determines panel settings on the CRT screen.

Additional features include quad channel with independent position controls, eight trace with alternate sweep, displayed on an 18 kV, six-inch rectangular CRT. Minimum deflection factor for the scope is 1 mV/div, with maximum sweep time rated at 2 ns/div. Further specifications for the V-1100 are TV sync, X/Y operation up to 1 MHz (three degrees or less), variable hold off, gate output for A and B sweep, and CH 1 signal output to 100 MHz (-3 dB).

Measurements on the CRT are: digital volt meter (through CH 1) dc/ac 50 Hz to 10 MHz; frequency counter (through CH 1) 10 Hz to 99.9 MHz. The unit weighs 22 pounds with width x height x depth dimensions of 13 x 6.3 x 16.

For More Information
Circle 253 on Reader Service Card

CEL Announces Digital Frame Store Sync

The P147-20 is a digital frame store synchronizer incorporating the latest digital technology and operable from a

newly designed front panel. Advanced seven bit digital processing offers improved signal to noise and stability characteristics and a widened range of special effects functions including pixelation, posterization, false color imaging and pixel related color matting. The unit's effects are fully com-

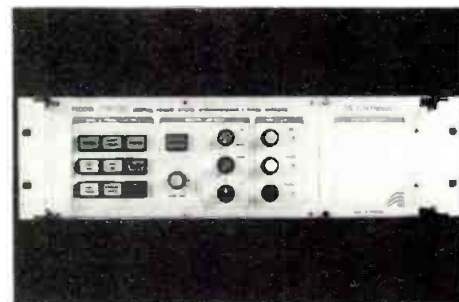

patible with the P151 range of effects controllers giving facilities such as picture compression and inversion and joy stick manipulation.

The P147-20 is priced at approximately US\$8047, excluding VAT suggested retail.

For More Information
Circle 315 on Reader Service Card

BROADCAST ENGINEERS WANTED

For the 1984 Summer Olympic Games and Political Conventions. Must have F.C.C. License and Experience in Transmitter Operating and Maintenance of Klystron Amplifiers.

Senior Engineers

How About Spending Your Summer Vacation at the Olympics With Pay?

Summer Jobs and Full Time Positions Available with Expanding Uplink Firm-New Trucks Under Construction. Persons Applying Must Be Willing To Travel Within The U.S.

Please Send Resume To:
MARCUS SATELLITE SYSTEMS, INC.
134 East Center Street, P.O. Box 1422
Manchester, CT 06040

or call: DENISE PARRISH, Event Coordinator
MARCUS SATELLITE SYSTEMS, INC.
203-646-1839



Circle 311 on Reader Service Card

PURGE THAT SURGE.

Don't let high current surges, high voltage spikes, high voltage noise, RFI or lightning strikes put your equipment or facilities out of commission.

LEA has a line of exclusive surge eliminators no competitor can match. Everything from household use to industrial service in excess of 4,000 amperes. Protects against surges up to 50,000 joules and 200,000 amperes.

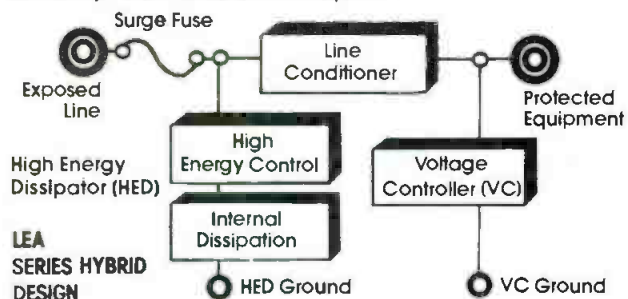

LEA
SERIES HYBRID
DESIGN

FEATURES

- Multistage concept
- Nanosecond reaction
- Total protection for all applications
- Functionally guaranteed
- Satisfies EMP requirements

Call us today for a lightning-quick response. LEA Inc., a Dynatech Company, 12516 Lakeland Road, Santa Fe Springs, California 90670, (213) 944-0916, TWX 910-586-1381.

"the LEADER in pure power technology"

See LEA at NAB booth 302



Circle 312 on Reader Service Card

BUSINESS BRIEFS

NCGA (the National Computer Graphics Association) will hold its annual conference May 13-17 in Anaheim. A special series of technical sessions on videotext technology has been organized by Peter Black of Xiphias, covering topics such as videotex, teleconferencing, videodiscs, and Election '84 coverage. **BM/E** editor Robert Rivlin will chair a session on computer graphics in news, weather, and sports.

Atlanta-based **VideoStar Connections** and **TeleSat Canada** have sealed an agreement that will allow, for the first time, for direct uplinking from an origination point on either side of the US-Canadian border to downlinks located anywhere from the Rio Grande to the Arctic Circle. . . . **Wold** has signed to do 312 hours of mobile uplink services for the 1984 political conventions.

Antenna Technology has announced the recent signing for an exclusive Canadian distributorship. **Texscan Corp.** will be the exclusive supplier of Simulsat earth station antennas in the Canadian marketplace.

RCA has reported record sales and higher earnings in the fourth quarter and full year 1983 over 1982. Sales in the fourth quarter of 1983 rose to \$2.48 billion as compared to the 1982 total of \$2.12 billion. . . . **Arvin Industries** announced record sales of \$601 million for fiscal 1983 over the 1982 total of \$514 million. . . . **Chyron's** sales figures for the fourth quarter of 1983 were \$5.1 million.

dbx has announced a new price for

the Model 700 digital audio processor: \$4600, down from the original price of \$5000. . . . **McClane Video Productions**, of Boca Raton, FL has completed its underwater housing for the **Hitachi SK-91** cameras. The housing will be used on the "Fishing Fever" syndicated television series. . . . **The Post Group** has taken delivery of, and is on line with, a new **Mirage** from **Quantel**. . . . **Meyer Broadcasting** of North Dakota has spent \$500,000 on 18 new **JVC ProCam 950** video cameras.

The **RCA** update kit for the **TK-47** camera is now available, consisting of three replacement modules for the camera head, central processing unit and setup terminal, adding many of the features of the **TK-47B**. . . . **Netcom** has leased three **RCA Americom Satcom IV** transponders, making **Netcom** the third largest television programming customer on the **Satcom** system.

ADM Technology has completed, after a year and four months of assembly, the consolidation of all of **NBC-TV's** Burbank intercommunications needs through a single, massive communications grid.

Philips Television has won a contract valued at over \$1.75 million to supply a **Pye TVT** transmission package to a television studio in Nashville, TN. Included in the package is a 110 kW UHF transmitter with beam control klystrons. . . . **Harris** has received an order from **Arch Communications** of Hartford, CT valued at over \$3 million. The order is for UHF TV transmission and control equipment for **WETG-TV**, channel 61.

The People's Republic of China has ordered 30 kW and 55 kW UHF television transmitting systems worth over \$800,000 from **Comark Communications**.

VSA Videographic Systems has signed an agreement with **Information Systems Leasing** whereby teletext and videotext clients may lease **VSA** equipment and systems through a variety of **ISL** lease programs.

Pacific Video now has on line the **Thomson-CSF Vidifont Graphics V** for video artwork. . . . **Intercontinental Televideo** has announced the introduction of its **Quantel DSC-4002 SILK** standards converter to its New York clients.

Digital Entertainment Corp., the U.S. affiliate of **Mitsubishi Electric** re-

sponsible for all professional digital audio system marketing in North America, has opened its New York City sales and support facility. . . . An address change has been revealed for **Sennheiser**. They are now on West 38 St. in New York. . . . **Angenieux** has expanded and announced the opening of its new national headquarters for broadcast and cine lens sales in Miami, FL.

Fortel has moved to a new and larger facility on Gateway Drive in Norcross, GA. . . . **M/A-Com DCC** has awarded a contract for the expansion of its current 165,000 square foot building to approximately 285,000 square feet. . . . **EEV** has opened a new west coast sales office in Westminster, CA. . . . **Comprehensive Video Supply** has a new facility on Franklin Ave. in Tustin, CA.

SALES OFFICES

BM/E

Broadcast Management/Engineering

295 Madison Ave.
New York, New York 10017
Telex: 64-4001

Eastern & Central States

295 Madison Avenue
New York, New York 10017
212-685-5320
James C. Maywalt
Gene Kinsella

Western States

1021 South Wolfe Road, Suite 290
Sunnyvale, CA 94086
408-720-0222
Neal Wilder
Charleen Kennedy
5015 Birch Street, Office One
Newport Beach, CA 92660
714-851-1461
Neal Wilder

United Kingdom/Europe

28 Eaton Row
London SW1W 0JA, England
Telephone: 01 235 8431
Bronwyn Holmes
Derek Hopkins
Ruben Veksner

Japan/Far East

Eiraku Building
1-13-9, Ginza,
Chuo-Ku, Tokyo 104 Japan
Telephone: 03 562 4781
S. Yasui
K. Yamamoto
Y. Yozaki



For the finishing touches on the feed horn, engineers were lowered by harness into the 30-foot satellite uplink installed at the Meadowlands Communications headquarters in Rutherford, NJ. After the installation in February, the company started its full time service using AT&T Skynet on April 1.

BIG NEWS. SMALL PACKAGE.

Announcing Thomson Betacam™. The smallest, lightest 1/2" camera/recorder ever. All in one neat package. With superior signal-to-noise performance. Designed with both ENG and EFP operators in mind. For on-the-spot news gathering or complicated field production, now there's a system just right for you. And your budget. Because Thomson Betacam also carries the lowest price tag.

Available in one- or three-tube camera models, Thomson Betacam utilizes the newest electronics and manufacturing techniques. A 2/3" "Mixed Field" Saticon tube design that virtually eliminates beam ce-focusing. A VTR featuring a rugged new recording format with



greater chrominance bandwidth and signal-to-noise ratio. Built-in Dolby® noise reduction for high-quality audio. And a cassette player with TBC as standard providing full broadcast quality output. Plus, the playback unit can be interfaced with U-Matic® and one-inch editing systems. This makes Thomson Betacam the ideal complement

to your existing production equipment. It's the smallest, lightest, most precise, camera/recorder system.

It's easy to operate. And it's energy efficient. Thomson Betacam is setting new standards for performance and flexibility in a fully integrated camera/VTR system. All of it at a very affordable price.

Get the whole story. Call or write Thomson-CSF Broadcast, Inc. 37 Brownhouse Rd., Stamford, CT 06902. Tel (203)965-7000. TWX (710)474-3346. Telex 6819035- AnswerBack 6819035 TCSB UW.



**THOMSON BETACAM.
ONE FOR ALL.
ALL IN ONE.**

**THOMSON-CSF
BROADCAST, INC.**

Circle 313 on Reader Service Card

Dolby is a registered trademark of Dolby Labs.
U-Matic and Betacam are registered trademarks of Sony Corp.

See us at NAB Booth #1001

Witness Ward-Beck Wizardry!



Visitors to **NAB '84** can witness a great leap forward in audio technology. It's the most significant advance since **MicroCOM** was introduced two years ago. Witness Ward-Beck wizardry as this totally new microprocessor controlled console system is unveiled. New modules. New circuitry. New flexibility. It leads broadcasters into the next generation of standards . . . Now!



First by Design.

Ward-Beck Systems Ltd.
841 Progress Avenue, Scarborough,
Ontario, Canada M1H 2X4.
Tel: (416) 438-6550.
Tlx: 065-25399.

Booth # 1224.