

# BROADCAST ENGINEERING

AN INTERTEC PUBLICATION

October 1992/\$4.50

## Managing technology

Making money  
with technology

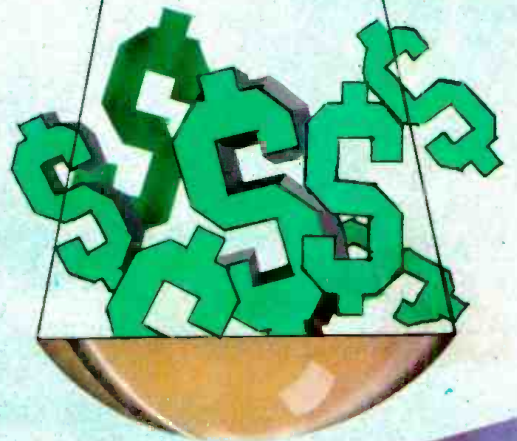

Studio camera update  
p. 64



**This Is No Time To Take Your  
Studio Lens For Granted...**

**WEATHER FORECAST**



For instant  
spec sheets and  
product information  
via FAX, dial  
**1-800-553-6611**

**Fujinon's A20 x 7 F1.4 wide angle CCD studio zoom lens catches every drop.** Fujinon does it again with the fastest wide angle CCD studio lens in the industry. It features the unparalleled performance, quality and reliability needed for the most demanding video productions.

Fujinon's A20 x 7 studio zoom lens, the forecast for a shining performance is always excellent.

FUJINON INC. 10 High Point Dr., Wayne, NJ 07470-7434 (201) 633-5600  
Southern 2001 Midway, Ste. 114, Carrollton, TX 75006-4916 (214) 385-8902  
Midwestern 3 N. 125 Springsvale, West Chicago, IL 60185-1560 (708) 231-7888  
Western 129 E. Savarona Way, Carson, CA 90746-1406 (310) 532-2861  
FUJI PHOTO OPTICAL CO., LTD. 1-324 Uetake, Omiya City, Saitama 330 Japan;  
Phone: 048-668-2152, FAX: 048-651-8517, TELEX: J22885



**Focused on  
the Future.**

See us at SMPTE Booth #705

Circle (1) on Reply Card

[www.americanradiohistory.com](http://www.americanradiohistory.com)



# Don't Get Snowed Under.

Your transmitter failed. Now you're faced with drifting viewers, falling ad revenues, and your problems are snowballing.

It's an avalanche you can prevent with Harris Platinum Series VHF television transmitters.



Their unsurpassed reliability stems from Harris Allied power-block architecture. The solid-state modules operate at low junction temperatures, extending their life. Parallel redundancy ensures that a control failure won't stop

your broadcasts cold. And the interchangeable visual and aural power amplifier modules are self-protected against six fault conditions.

Broadcast quality? It's top of the line. Plus, Platinum Series transmitters are available in all international broadcast standards and at power levels from 1Kw to 60 Kw

Don't chance it with a flaky transmitter. Choose a Harris Platinum Series transmitter. From the company that's building the future of broadcasting.

**USA 217-222-8200**

**FAX 217-224-1439**

**International 217-222-8290**

**FAX 217-224-2764**

**Canada 800-268-6817**

**FAX 416-764-0729**



Circle (4) on Reply Card



# Contents

## BROADCAST engineering

October 1992 • Volume 34 • Number 10

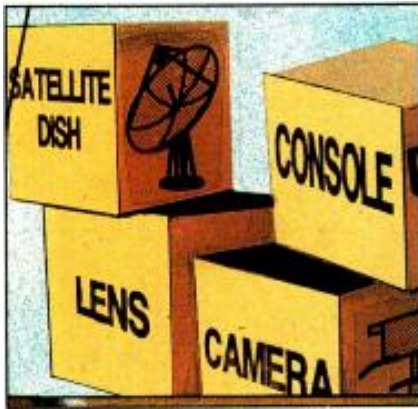

Page 26



Page 36



Page 46

### MANAGING TECHNOLOGY:

Effectively managing today's technological advances at a broadcast or production facility is a challenge at best. The decisions get harder, and mistakes are costlier. Success often depends on how effectively you can meld people and technology together to form a winning combination.

### FEATURES:

#### 26 Annual Salary Survey

By Brad Dick, editor

A new and detailed look at broadcast salaries.

#### 36 Software for Production Facility Management

By Chris Leonard, business and marketing consultant

Computers can put dollars and sense into your production facility.

#### 46 Making Money with Technology

By Marvin C. Born, WBNS stations

Put your thinking cap on and your equipment to work.

#### 52 Closed-Captioning for TV

By James Goodhart, Zilog

Soon, the hearing impaired will have greater access to the rich world of television.

#### 60 Contracting for Maintenance Services

By Kirk Harnack, Harnack Engineering

Choosing a contract engineer may be the most critical decision a manager makes.

### DEPARTMENTS:

- 4 News
- 6 Editorial
- 8 FCC Update
- 10 Strictly TV
- 12 re: Radio
- 14 Management for Engineers
- 16 Circuits
- 18 Troubleshooting
- 20 Technology News
- 68 Applied Technology: Codecs and Channel Compression
- 78 Field Report: Digital Audio Research Soundstation II
- 84 SBE Update
- 86 Field Report: FM System's SPM-I Stereo Performance Meter
- 88 Industry Briefs
- 93 New Products
- 101 Preview
- 102 Classifieds
- 104 Advertisers' Index

### OTHER FEATURES:

#### 64 Studio Camera Update

By Carl Bentz, special projects editor

Is it time to modernize your studio cameras?

### ON THE COVER

This month's cover illustrates the challenge many broadcasters face when trying to maintain a balance between financial resources and technological demands. (Cover design by Nenita Gumangan, BE graphic designer.)

# It doesn't care *what* your problem is.



Our new generation of Audiocom intercoms are so versatile, they can adapt to practically any configuration. Wet or dry applications... balanced or unbalanced lines... limited rack space—no problem. Easily expandable, too: standard mic cable connects up to 18 channels with almost any combination of our station, power supply or speaker components.

Other unique features include: voice-activated mics; independent channel Call lights

and Talk/Listen controls; true, built-in IFB; and backlit, pressure-sensitive key pads that “latch on” or let go, depending how you press.

See your Telex pro audio dealer or call 1-800-554-0716 for more information.

Audiocom. So versatile, you'll have to find something besides your intercom system to worry about.

**TELEX**



By Dawn Hightower,  
senior associate editor

## TV industry supports ghost-canceling standard

After a 6-week letter ballot of the membership of the U.S. Advanced Television Systems Committee (ATSC), the Philips CGR ghost-canceling reference signal has been adopted as the industry standard.

The ATSC filed a Petition for Rulemaking with the Federal Communications Commission (FCC), seeking the use of line 19 of the vertical blanking interval for the ghost-canceling reference signal. At present, line 19 is reserved for the vertical interval reference (VIR) signal. That signal is no longer being used to improve home TV reception, and receiving equipment using the VIR signal has not been manufactured since 1985.

## SBE expands internationally

Two major cooperative agreements have been signed by the Society of Broadcast Engineers (SBE) and broadcast associations in Canada.

SBE president Richard Farquhar has signed agreements with the Central Canada Broadcast Engineers (CCBE) and the Western Association of Broadcast Engineers (WABE). The SBE hopes the agreements will lead to the exchange of information and ideas, cooperative educational efforts and attendance at each group's meetings and conventions.

## USA Digital Radio tests DAB system

USA Digital Radio has successfully tested its over-the-air AM digital audio broadcasting (DAB) system after receiving an experimental license from the Federal Communications Commission (FCC).

The AM test was conducted Aug. 26 in Cincinnati, OH. It was the first in-band, on-channel, over-the-air AM DAB broadcast. "Project Acorn" transmitted MUSICAM-generated digital stereo audio in a standard AM channel. An FM DAB test by Project Acorn is expected to be performed in the near future.

## SMPTE issues call for papers

A call for papers has been issued for the annual Society of Motion Picture and Tel-

evision Engineers (SMPTE) Advanced Television and Electronic Imaging Conference, to be held Feb. 4-5, 1993, at the Sheraton Hotel and Towers in New York City.

Papers that are selected for the conference will be compiled and published in a book that will be sold at the conference.

## SMPTE announces award recipients

The Society of Motion Picture and Television Engineers (SMPTE) has announced the recipients of its annual honors and awards presentations. The awards will be presented Nov. 10, during the 134th SMPTE Technical Conference and Equipment Exhibit, Nov. 10-13 at the Metro Toronto Convention Centre in Toronto, Canada. This year's recipients include: Ray Dolby (Honorary Membership), James R. Davidson (Citation for Outstanding Service to the society), Milton R. Shefter (Citation for Outstanding Service to the society), Peter D. Symes (Citation for Outstanding Service to the society), Ronald W. Jarvis (the Presidential Proclamation), Howard Miller (the Presidential Proclamation), Charles A. Steinberg (the Presidential Proclamation), William F. Schreiber (the Journal Award), Bob Elkind (Journal Certificate), David Fibush (Journal Certificate), Leroy DeMarsh (Journal Certificate), Kenneth F. Holland (The Agfa-Gevaert Gold Medal Award), Ott H. Coelln (Eastman Kodak Gold Medal), Robert M. Greenberg (The Fuji Gold Medal), James Murray (The John Grierson International Gold Medal), Joseph Pepe (The Herbert T. Kalmus Gold Medal), Chojuro Yamamitsu (The Alexander M. Poniatoff Gold Medal for Technical Excellence), Charles W. Rhodes (The David Sarnoff Gold Medal), Edward Zwaneveld (The Samuel L. Warner Memorial Medal Award) and Fraser Morrison (The SMPTE Progress Medal).

## IBC award renamed

In recognition of the services of John Tucker, one of the founding members of the International Broadcasting Convention (IBC), the IBC Award has been renamed. In the future, it will carry the title, "The IBC John Tucker Award."

### EDITORIAL

Brad Dick, Editor  
Carl Bentz, Special Projects Editor  
Skip Pizzi, Technical Editor  
Dawn Hightower, Senior Associate Editor  
Stefanie Kure, Associate Editor  
Tom Cook, Senior Managing Editor  
Pat Blanton, Directory Editor

### ART

Nenita Gumangan, Graphic Designer

### BUSINESS

Cameron Bishop, Group Vice President  
Duane Helner, Group Publisher  
Tom Brick, Marketing Director  
Czislawa Inan, Group Director, Special Projects  
Evelyn Hornaday, Promotions Manager  
Sue Edwards, Promotions Coordinator  
Dee Unger, Advertising Business Manager  
Mary Birnbaum, Advertising Production Supervisor  
Michele Costlow, Advertising Coordinator  
Stephanie K. Carlson, Classified Advertising Coordinator  
Lori Christie, List Rental Sales

### ADMINISTRATION

R.J. Hancock, President  
Carol Sharp, Circulation Director  
Customer Service: 913-967-1711

### TECHNICAL CONSULTANTS

Eric Neil Angevine, Broadcast Acoustics  
John H. Battison, Antennas/Radiation  
Dennis Ciapura, Radio Technology  
Dane E. Erickson, P.E., Systems Design  
John Kean, Subcarrier Technology  
Donald L. Markley, Transmission Facilities  
Harry C. Martin, Legal  
Curtis Chan, Audio/Video Technology

### MEMBER ORGANIZATIONS

Sustaining Members of:  
• Acoustical Society of America  
• Society of Broadcast Engineers  
• Society of Motion Picture and TV Engineers

Member:  
Association of Business Publishers

ABP

Member:  
Business Publications  
Audit of Circulation

BPA

**BROADCAST ENGINEERING** is edited for corporate management, engineers/technicians and other station management personnel at commercial and educational radio and TV stations, teleproduction studios, recording studios, CATV and CCTV facilities and government agencies. Qualified persons include consulting engineers and dealer/distributors of broadcast equipment.

**BROADCAST ENGINEERING** (ISSN 0007-1794) is published monthly (plus three special issues) and mailed free to qualified persons within the United States and Canada in occupations described above. Second-class postage paid at Shawnee Mission, KS, and additional mailing offices. POSTMASTER: Send address changes to **Broadcast Engineering**, P.O. Box 12960, Overland Park, KS 66282-2960.

**SUBSCRIPTIONS:** Non-qualified persons may subscribe at the following rates: United States and Canada: one year, \$50.00. Qualified and non-qualified persons in all other countries: one year, \$60.00 (surface mail), \$115.00 (air mail). Subscription information: P.O. Box 12937, Overland Park, KS 66282-2937.

Photocopy rights: Permission to photocopy for internal or personal use is granted by Intertec Publishing Corporation for libraries and others registered with Copyright Clearance Center (CCC), provided the base fee of \$2.00 per copy of article is paid directly to CCC, 21 Congress St., Salem, MA 01970. Special requests should be addressed to Cameron Bishop, group vice president. ISSN 0007-1794 \$2.00 + \$0.00.

### CORRESPONDENCE

Editorial and Advertising: P.O. Box 12901, Overland Park, KS 66282-2901. Telephone: 913-341-1300. Editorial fax: 913-967-1905. Advertising fax: 913-967-1904.

©1992 by Intertec Publishing  
All rights reserved.

Advertising offices listed on page 104.

**INTERTEC**  
PUBLISHING CORPORATION



**Nikon ENG/EFP lenses.  
All you need to look good.**

When you're on location with a CCD camera reaching for the best shot possible, you need ENG/EFP lenses that are compact, lightweight, and easy to maneuver. Lenses with the flexibility to adapt to any situation. Lenses with all the star qualities found only in a Nikon.

Our ENG/EFP precision lenses are created from the same superior glass and coating technology that have made Nikon the world renowned name in optics. Which means they're made with Nikon's exclusive Extra-Low Dispersion (ED) glass. And treated with special anti-reflection coatings to minimize ghosts and flare. Plus, their strong magnesium housing makes them extremely durable. So no matter how tough the assignment, Nikon ENG/EFP lenses are even tougher.

Our full line of outstanding ENG/EFP lenses includes the Nikon S9x5.5 wide angle lens — perfect for tight, close-up shots. The Nikon S19x8, with its unsurpassed focal length and range. The all-purpose Nikon S15x8.5. And the economical Nikon S13x9.

Want to create special effects with your CCD camera? We have two ENG/EFP converters that will allow you to use your whole bag of Nikkor 35mm SLR lenses. One lets you use wide angle lenses down to an effective focal length of 2 mm. The other lets you use long focal lenses out to 1200 mm.

And in the unlikely event something should

happen to your Nikon lens, a simple call to our Nikon Express Loaner Service hotline will get you a loaner lens overnight. So you don't ever have to worry about a crew being out of action until you can get a lens repaired.

To learn more about how Nikon

ENG/EFP lenses can make you look good, call 800-52-NIKON or (516) 547-4355 for our complete brochure. Or write: Nikon Electronic Imaging, Dept.D1, 101 Cleveland Avenue, Bayshore, NY 11706.

# SHOOTING STARS.

A collection of Nikon ENG/EFP lenses and converters arranged on a dark, textured surface. The lenses vary in size and are some are attached to camera bodies. The Nikon logo is visible on several of the lenses and camera bodies.

# Nikon

## ELECTRONIC IMAGING

r e c r e a t i v i t y

# Editorial

## The illusive digital panacea

The widespread use of digital technology has been good for almost everyone. Without it, many of the products we've come to enjoy wouldn't be available. Perhaps one of the best examples of the advantages offered by digital is the personal computer. Just a few years ago, the thought of having computers small enough to tote around seemed far-fetched. Yet, I composed these words on my laptop computer while winging my way from New York back to Kansas City.

Today, consumer products, broadcast and production equipment have benefited from the use of digital technology. Professional video and audio hardware now provides features that would be impossible or too expensive in the analog world.

Despite these advantages, I can't help but wonder if we've become too enamored with the term *digital*. Sometimes, even we engineers and managers expect digital to be a panacea of solutions, perhaps when analog would be equally satisfactory.

Some examples of the misuse of the terminology and aura associated with digital became evident during a recent trip to a local variety store. While strolling among the many items, I was struck at how many times the term digital was used. There were, of course, many examples of digital technology in the entertainment area. Everything from CD players to receivers to even headphones touted digital performance or features. How about digital telephones? OK, so it stores numbers, but the actual voice processing wasn't digital.

Less justifiable examples also were evident. How about a digital blender. I kid you not. What makes a blender digital? I don't know, but it must be better than an analog one because it cost \$12 more than the one next to it without the digital label. I also found digital microwave ovens, digital electric blankets and, not to be outdone, even digital greeting cards.

Perhaps the greatest misuse of the term digital was seen at the local electronics store. There I could purchase digital-compatible audio cable. Does the consumer believe that a digital CD player must be connected to a digital receiver with digital-compatible cable? Minutes later, I located the latest model of digital speakers. Enough already.

Unfortunately, manufacturers have taken to the label "digital" like ducks to water. There seems to be the perception that the public will pay more (or choose) a product labeled digital.

Have we professionals fallen into the same trap? Do we look for the term digital in a product's name or description simply because we've come to believe that digital products are always better? Do we expect our products to be digitally based even if the result is an increase in cost without a commensurate increase in performance?

Ask yourself just how important digital technology is to each piece of equipment you buy. Is the extra cost of digital worth the expense? Is the increased complexity and lack of serviceability an equal trade-off against what an analog version might provide?

What I'm suggesting is that some of us may have lost sight of the real goal when buying equipment. Start by looking at what the product needs to do. Only after you've defined carefully the needs can you consider how they can best be met. Starting from the premise that whatever is purchased must be digital is not only bad engineering, but also bad business sense.

Please don't get me wrong. We should always look for ways to improve our operations. If that requires digital techniques, go for it. But, it just makes good business (and engineering) sense to consider all the alternatives before limiting your options simply because the word digital isn't in the product name or description.

I don't need a digital blender — the analog version will be quite fine, thank you.



By Brad Dick,  
editor

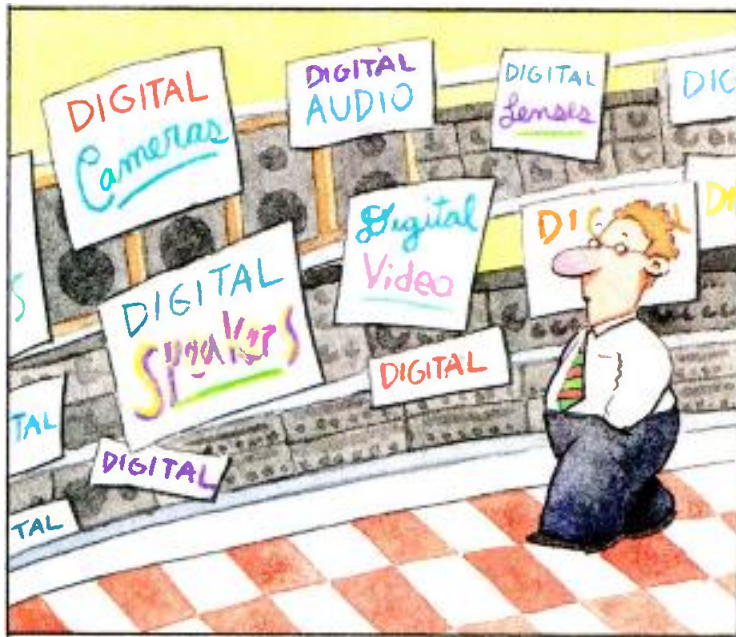



# TOTALLY TRANSPARENT TRANSMISSION PROTECTION.



## TRANSMISSION LIMITER 4000

### Pure Sound.

Protecting transmission systems from peak overload without audible artifacts—while stringently preserving natural sound quality—is the primary objective of many of the world's finest broadcast operations. That is why so many facilities around the world are choosing the Orban Transmission Limiter 4000. The 4000 provides the peak control they need, without audibly adding, subtracting or interfering with their signal in any way.

### Don't Take Our Word for It.

The 4000 provides transparent limiting with any source. Blind tests confirm that the sound of the Orban Transmission Limiter 4000 is virtually indistinguishable from the original source when driven as much as 15dB into limiting—even to trained listeners. Try it for yourself and hear what your facility can deliver when it is protected, not just restricted.

### Sophisticated, Easy to Use.

Orban engineers took years to develop the complex algorithms which permit the 4000 to protect inaudibly. Yet, they kept the front panel of the 4000 clean, clear and businesslike. The precision LED displays indicate any action of the compressor or HF limiter circuitry. The only adjustments are for INPUT level and OUTPUT level. The built-in tone generator and test mode permit rapid system setup and alignment.

### Orban Signature Quality.

The Transmission Limiter 4000 is one of a family of reliable, quality Orban products designed for demanding broadcast applications. Call your local Orban dealer for a hands-on demonstration of the Orban Transmission Limiter 4000—another breakthrough product from the leaders in broadcast audio processing.

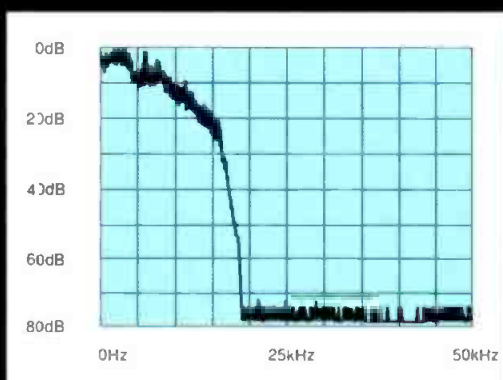

Power spectral density at the 4000's output using "maximum peak hold" measurement. (5kHz/div. horizontal; 10dB/div. vertical)

# FCC Update



## Radio ownership rules revisited

By Harry C. Martin

In August, the commission made final revisions to the national and local radio ownership rules that it adopted in March. The amended national rules will permit ownership of up to 18 AM and 18 FM stations with an increase to 20 AMs and 20 FM stations in two years. The amended local rules will permit an owner to have up to two AM and two FM stations in markets with 15 or more stations.

The commission also adopted an investment incentive for stations that are minority controlled or controlled by small businesses. It would permit a single entity to own an attributable interest in an additional three radio stations in each service if these stations are controlled by small business entities or are more than 50% owned by one or more members of a minority group.

In markets with fewer than 15 stations, the FCC will permit ownership of three stations, no more than two of which may be in the same service, provided that the group owner's stations represent less than half of the stations in the market. A *market* is defined with reference to a city grade (3.16mV/m for FM, 5mV/m for AM) contour overlap standard. Non-commercial stations will not be counted in determining the number of stations in a market.

Applicants in markets with 15 or more stations will be required to demonstrate in an application exhibit that the proposed combination will not result in excessive concentration in the local market. If market share data (e.g., from Arbitron, another ratings service or other published source) is readily available, the applicant must provide information on the resulting market share in the exhibit. Where an applicant certifies that market data is not readily available, or where the market share exceeds 25%, the applicant will be permitted to acquire the additional station in its market if it can describe other indicia establishing a lack of concentration.

The FCC, in revising its radio ownership rules, decided not to impose additional restrictions on time-brokerage (LMA) agreements. Under the rules, a station that brokers another station in its market will be considered to have an attributable interest

Martin is a partner with the legal firm of Reddy, Begley & Martin, Washington, DC.

in the station for multiple ownership rule purposes.

### Cut-off procedures set for FM petitions and applications

New procedures for resolving conflicts between FM rulemaking petitions and applications for new FM stations, or for changes in facilities, were adopted in July.

FM applications will become protected from rulemaking petitions at the same time that they gain protection from other mutually exclusive applications. FM applications for new commercial stations or major changes filed during a filing window will be protected from rulemaking petitions filed after the close of the filing window.

Applications for new NCE-FM stations, or major changes, will be protected at the end of the 30-day period for filing mutually exclusive applications as established in periodically released public notices. All other FM applications will be protected as of the date they are received at the FCC.

Conflicting rulemaking petitions filed before these cut-off dates will be considered mutually exclusive with FM applications, and the conflicts will be resolved under the commission's existing policy for making substantive choices between conflicting proposals.

### One-step allotment change proposed for FM

The commission is seeking comments on whether FM licensees should be allowed to request, by filing only an application, upgrades on adjacent and co-channels, modifications to adjacent channels of the same class, and downgrades to adjacent channels. Currently, FM stations must request these changes through a 2-step process whereby the party first files a petition for rulemaking and then, if granted, an application.

In order to prevent the allotment of channels that would conflict with its present allotment standards, the commission proposed limiting the availability of the new 1-step procedure only to those proposals that comply with the application criteria and current allotment standards. Thus, showings of contour protection, by use of a DA or otherwise, or of substan-

tial compliance with the city-grade coverage requirement (now permitted in the FM application process) would not be acceptable in an application that would effect an allotment change.

To accomplish its objectives, the FCC would either require that any application meet minimum distance separation and city grade standards as applied in the allotment context at the site specified in the application, or allow an applicant to apply for a station modification at a site that would not meet allotment standards, provided the applicant can demonstrate that an available site exists that would comply with allotment standards.

The proposed procedure would be available only in the context of modifications that require no changes to the Table of Allotments other than a change in the allotment of the station seeking the modification. Further modifications on non-adjacent channels would be excluded from the scope of the new process.

### LPTV/translator renewals to conform with AM/FM/TV

The commission has proposed changing the license renewal dates of FM and TV translator stations and low-power TV (LPTV) stations, to make them consistent with those of full-power radio and TV stations operating in the same state. It also proposed revising FCC Form 303-S to permit the use of a single renewal application form by licensees of full-power broadcast stations that also seek to renew their commonly owned translator or LPTV stations having the same renewal dates.

Currently, translator and LPTV stations are licensed for terms determined by a uniform renewal schedule for the state in which they are located. However, this schedule is not concurrent with the renewal schedule for full-power stations.

In order to comply with the Communications Act, the commission proposes to leave the terms of full-power TV and radio licenses unchanged. For existing LPTV or translator stations, the commission would renew licenses, when the occasion arises, for a shorter term to expire in accordance with the schedule for full-power broadcast renewals stated in the rules. ■





## The Odetics TCS90 - The Only Cart Machine Designed with Your Future in Mind

With the TCS90, Odetics Broadcast gives new meaning to the word versatility. Featuring a unique ability to handle multiple cassette sizes and virtually all available broadcast formats, the TCS90 provides incomparable flexibility plus an open window to the future.

### Field Changes Made Simple

Don't waste time second-guessing future tape deck format changes. The TCS90's simple straight-forward design makes field upgrades easy and affordable. You can take advantage of technology upgrades as they become available.

### Mix cassette sizes to match your needs

Odetics put its award-winning electromechanical expertise to work and developed a system that makes handling dual-sized cassettes simple and foolproof. With a capacity of 150 carts, there is enough on-line access for a full day of programming plus twelve to twenty-four hours of spots and

promos, depending upon your format. And, with Odetics Multicut Software, the TCS90 can store several hundred spots on-line.

### The Decision is Yours

Full compatibility with any news or station automation system lets you make choices that make sense for your station's needs. Built-in redundant hardware and software features make choosing Odetics a decision you can be sure of.

### Buy for the Long-Term

Because Odetics products are fully compatible with each other, system obsolescence is never a concern. The TCS90 includes the same advanced features as the Odetics TCS2000 large library Cart Machine and all TCS2000 software and hardware options and accessories. It's no wonder Odetics Broadcast is the world-leader in large library automation systems.



© NATAS

1515 South Manchester Avenue, Anaheim, California 92802-2907 (800) 243-2001 or (714) 774-2200

Director of Sales  
Bill Keegan  
(714) 774-2200

Northeast  
Ray Baldock  
(201) 305-0549

Southeast  
Emerson Ray  
(813) 960-0853

West  
Chuck Martin  
(818) 999-9796

North Central  
Bill Boyd  
(612) 894-2121

South Central  
David Scally  
(404) 917-9506

Circle (8) on Reply Card

# Strictly TV

## Handling audio during video post-production

By Michael D. Patten

Video post-production suites based on the new generation of VTRs must accommodate numerous analog and digital audio signals. An audio mixer in this environment must be small, flexible and intuitive in its operation. It also must provide all of the benefits of digital recording, where applicable, while allowing analog signals to be freely intermixed.

In recent years, the number of audio signals being handled in video editing suites has drastically increased. During a typical video editing session, as many as 30 or 40 analog or digital audio signals might be encountered in a 4-machine suite. (See Figure 1.) From these various sources, editors must be able to quickly find the specific material to be incorporated into the final product. Conventional audio consoles are, quite simply, too large to be located in an edit suite. A different approach is required, using small, assignable panels and flexible I/O assignments, including the accommodation of digital or analog signals. Furthermore, level control and signal

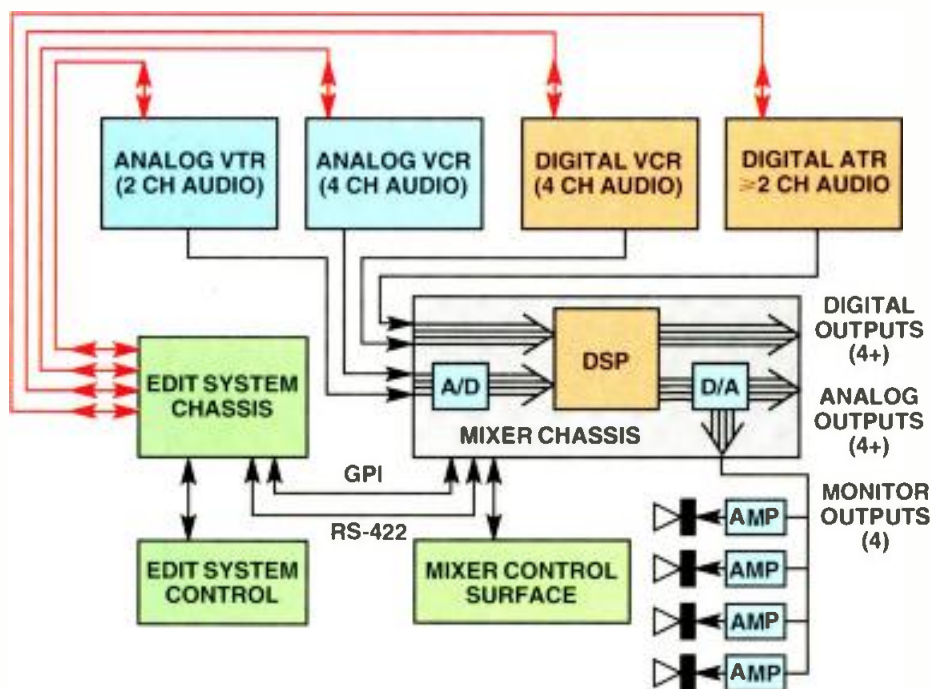

Figure 1. Block diagram of a video editing suite with analog and digital audio mixing capability.

**A new approach is required, using small, assignable panels and flexible I/O assignments.**

processing must be integrated within the editing process.

Developments in analog-to-digital converters have now made it practical to digitize each analog audio source within the edit suite prior to mixing. Parallel advances in DSP technology also allow real time EQ and mixing to be achieved by affordable systems.

### Assignable console functions for editing

Full, individual control for each input in a reduced panel size implies assignability. But to make free-form assignability assist (rather than hinder) the editor, the as-

Patten is vice president of engineering and co-founder of Graham-Patten Systems, Grass Valley, CA.

ignment process must relate closely to the elements used in each edit. To understand why this is imperative, consider the basic process of video editing:

Prior to an editing session, the appropriate reel of videotape is loaded onto a machine, which is then assigned an edit-controller name, such as A-VTR. Suppose an editor wants to dissolve from video already on the record machine to a segment on the new reel. The original source, from the C-VTR, is reconstructed exactly on the switcher program bus for the match-frame cut. The new video, from the A-VTR, is set up on preset ready for the dissolve. After the in-and-out points have been marked, the edit is made.

Setups for the *FROM* configuration (on program) and the *TO* configuration (on preset) are performed at separate times. Therefore, it would seem logical to use the *same* controls for both functions, via assignment. Although in video such savings would be minimal, in *audio*, with dozens of sources routing to four or more buses, literally hundreds of bus-selection buttons become redundant.

Second, once an edit controller name,

such as A-VTR or C-VTR, has been assigned to a specific replay/record transport, that machine can be accessed only by this "logical" name. If the various transports required to perform an edit could be assigned to a limited number of fader channels using the same logical name, the editor's train of thought would not be disrupted. The setup can be handled by performing the familiar assignment process at the mixer rather than the edit controller, so that a logical track is associated with the correct physical track.

By sharing the same selection buttons between program and preset, the number of required bus rows can be reduced by 50%. The large number of input racks from physical machines also can be assigned to a smaller number of faders. In both cases, the assignment process blends seamlessly with conventional editing techniques. This type of user- and facility-friendly design increases the audio capacity of video post suites without increasing their size, and eases the transition of operators into a new and more appropriate method of handling multiple audio signals. ■





## The V-Series headsets. Unquestionably accurate. Even if what they say isn't.

After nearly fifty years in the professional headphone business we've outdone ourselves — and the competition — with a line that delivers a unique combination of comfort, modular flexibility, and unsurpassed sound reproduction.

Available in three models, the V-Series features a newly designed driver assembly for an exceptionally clean 10-20,000 Hz response with 90dB sensitivity.

Revolutionary floating earcups automatically adjust to any head size

to give you the most comfortable fit, allowing each soft, supple earcup to move independently in all directions. And interchangeable mic and cable assemblies mean you won't have to change headsets for different applications.

Like all performers, they must be heard to be appreciated. So see your Telex pro audio dealer for a comparative demonstration or call 1-800-554-0716 for more information.

The V-Series. At least one thing will be perfectly clear.



*The V-Series headsets, models V-220 and V-210. (Model V-200 headphone not shown.)*

**TELEX**

Circle (9) on Reply Card

## Improving older installations

*New solutions to old problems*

By John Battison, P.E.

This summer, I spent some time traveling around the country talking to station chiefs and contract engineers. It is interesting to observe the new breed of radio engineers emerging from the chaos that once was a well-regulated, orderly profession and industry.

When I entered broadcast engineering in 1945, I was the youngster. Almost all the station engineering staffs and chiefs were oldtimers who had cut their teeth on wet electrolytics and wet rectifiers—some almost went back to Alexanderson alternators. They had none of the fantastic (by comparison) test equipment that is available today. Instead, they developed methods and home-brewed equipment to make the necessary tests that their operations required.

The FCC was much more in evidence as a heavy-handed "uncle," and we intoned with reverence the names of the engineers at the old Post Office Building (then the address of the FCC, now it's a shopping mall).

### A different world

Today's broadcast engineer is far better informed, in part because of the tremendous volume of broadcast engineering literature that is available. Another reason is the vast amount of knowledge about radio engineering that has accumulated over the past 70 years. Finally, there are more technical schools, and more radio engineering technology is being taught. Even so, in the rapid forward movement of computerized and "calculatorized" math, some basic principles tend to be overlooked, and fundamentals are not known or observed.

Today, any reasonably intelligent individual can insert numbers into a computer program and come up with directional antenna parameters that will suit most situations. An extension will even compute phasor and line-length effect data, presenting a complete package for the builder and installer with ATU component values and phasing throughout the

Battison, BE's consultant on antennas and radiation, owns John H. Battison and Associates, a consulting engineering company in Loudonville, near Columbus, OH.

## re: Radio



whole installation.

This is a far cry from the gyrations that were required less than 30 years ago, using such devices as a Burroughs Comptometer or a similar calculator. By combining trial and error results from previous experience, engineers developed usable radiation patterns for their stations. They may not have always been the most appropriate in terms of bandwidth or other parameters (such as operating impedance and tower spacing), but if a pattern fit the shape and size requirements and produced a viable rms that met FCC specifications, it would be used.

---

*It is interesting to observe the new breed of radio engineers emerging from what once was a well-regulated industry.*

---

Sometimes, if time or energy remained, other combinations of current and phase were tried, to verify that the pattern produced was the best overall. But more often than not, as soon as requirements were met, the pattern was pressed into service. Today, many of those old patterns have had their coverage and operation improved through computer iterations that calculate in minutes what used to take days.

### Improving on the past

Some of today's station and contract engineers are using these new tools to check and improve AM stations' antenna patterns. Normally, it is not feasible to move towers, nor is it easy to change tower heights. (Any attempt to increase height involves a great deal of tower engineering work to assure that such an alteration can be safely accomplished. Assuming that this is possible, the FAA must also approve any height increase.) Nevertheless, in many cases it is possible to improve operating parameters by reviewing the an-

tenna design on a computer, and simply changing currents and phases.

If an improvement in operation is possible, it is essential to file a Form 301, Application for a Modification of License, before making any changes to the antenna operating parameters.

Several computer programs are available from a number of engineers across the United States that simplify directional antenna work. Some computer bulletin boards also have information about directional antennas. This is one of the great differences between broadcast engineering nearly 50 years ago and today. Back then, the directional antenna engineers were gurus who worked their magic cloaked in secrecy. Today, their secrets are available, thanks to the computer.

### No substitute for the basics

Fundamentals are still important, however, and such principles should be known by those who apply computer programs to solve and improve existing DAs. Some modern radio engineers have expressed a desire to rework their phasors. When asked why, they often cite difficulties in adjustment. Typically, these include lack of travel on variable inductors, insufficient power adjustment range or dirty contacts.

---

*Today, computer iterations calculate in minutes what used to take days.*

---

Perhaps most critical from a system design perspective is the lack of adequate power adjustment range. This can usually be remedied by changing the taps for the *jeep* coils on the main power divider tank coil. (Before making any changes, you must *mark the taps and write down the turn count* in your log.) This is an area of considerable importance, and next month's column will cover it in detail by examining the three basic types of power dividers, their uses and their adjustment.



# We maintain a Double Standard

The Audio Precision product line includes two different standard-setting products.

The automated System One – the industry standard for lab bench and factory test station.

- Graphic results on PC screen, copies to printers and plotters.
- GO/NO-GO testing, automated procedures.
- State-of-the-art performance and speed.
- Complete analog and digital domain testing.
- 2 to 192 channels.

The self-contained Portable One *Plus* and Portable One – for service bench and field.

- Compact and affordable.
- Both feature comprehensive capability, high performance.
- The Portable One *Plus* adds sweeps, graphs and printer port.
- Robust polycarbonate purpose-designed case.
- Full stereo capability.

System One and Portable One... two families of test sets designed for different jobs, each with the quality and performance that you have come to expect from Audio Precision.



System One

Audio precision

PO.Box 2209, Beaverton, OR 97075-3070

503/627-0832 1-800/231-7350

FAX: 503/641-8906, TELEX: 283957 AUDIO UR



Portable One

Circle (10) on Reply Card

INTERNATIONAL DISTRIBUTORS: Australia: IRT Electronics Pty. Ltd., Tel: (61) 2 439 3744 Austria: ELSINCO GmbH, Tel: (43) 222 812 1751 Belgium: Trans European Music NV, Tel: (32) 2-466 5010 Bulgaria: ELSINCO, h.o. Sirelishte, Tel: (359) 92 581 698 Canada: GERRAUDIO Distribution, Tel: (416) 696-2779 China, Hong Kong: A C E (Int'l) Co. Ltd., Tel: (852) 424-0387 Czechoslovakia: ELSINCO GmbH, Tel: (43) 222 812 1751 Denmark: npn Elektronik aps, Tel: (45) 86 57 15 11 Finland: Genelec OY, Tel: (358) 77 13311 France: ETS Mesureur, Tel: (33) (1) 45 83 66 41 Germany: RTW GmbH, Tel: (49) 221 70 91 30 Hungary: ELSINCO KFT, Tel: (36) 112 4854 Israel: Dan-El Technologies, Ltd., Tel: (972) 3-544-1466 Italy: Medea S.r.l., Tel: (39) 2/4840 1780 Japan: TOYO Corporation, Tel: (81) 3 (5688) 6800 Korea: Myoung Corporation, Tel: (82) 2 784-9942 Malaysia: Test Measurement & Engineering Sdn. Bhd., Tel: (60) 3 734 1017 Netherlands: TM Audio B.V., Tel: (31) 034 087 0717 New Zealand: Audio & Video Wholesalers, Tel: (64) 7 847-3414 Norway: Lydconsult, Tel: (47) 9 19 03 81 Portugal: Acutron Electroacustica LDA, Tel: (351) 1 9414087 / 9450862 Poland: P.H.U INTERLAB, Tel: (48) 22 335 454 Singapore: TME Systems Pte Ltd., Tel: (65) 298-2608 South Africa: SOUND FUSION, Tel: (27) 11 477-1315 Spain: Telco Electronics, S. A., Tel: (34) 1 531-7101 Sweden: Tal & Ton Elektronik AB, Tel: (46) 31 80 36 20 Switzerland: Dr. W.A. Gunther AG, Tel: (41) 1 910 41 41 Taiwan: ACESONIC Intl Co., Ltd., Tel: (886) 2 716-8896 United Kingdom: SSE Marketing Ltd., Tel: (44) 71 387-1262

# Management for Engineers

## Dealing with the difficult employee

*The employee improvement process*

By Judith E.A. Perkinson



One station had a chief engineer who everyone hated. Technically, he was quite competent, but no one wanted to work for him. Whenever a problem arose, his first response was to determine who was to blame. Until the guilty party was identified, little or no effort was made to solve the problem. According to him, most of his problems were caused by "difficult employees."

Although he may have been a good engineer, he was an inept manager. If he had devised an effective way to deal with "difficult employees," he would have been able to differentiate between people problems and other problems.

### A process for change

The first step that any manager must make in dealing with difficult employees is to develop a process through which these people can change. To do so, the savvy manager must develop a standardized employee improvement process, which operates on the premise that employees want to do a good job.

### The five steps

The following five steps are involved in the employee improvement process:

*Step 1. Define the deficiency.* Four possible deficiencies that may result in unsatisfactory performance are:

- lack of information,
- lack of equipment or materials,
- time problems, and
- lack of skills or understanding.

As a supervisor, you should explore the employee's performance and attempt to determine if any of these deficiencies exist. This may be apparent from the employee's behavior or job performance. It may be necessary to sit down and discuss the situation with the employee.

*Step 2. Take measures to correct the deficiency.* Once the deficiency is determined, take action to correct it. The action taken will directly relate to the nature of the deficiency identified.

If information is lacking, the supervisor should provide that information. This can be done through training, by providing

written materials, by making resource information available and/or by developing an information communication system.

If there is a lack of equipment or materials, the supervisor should provide suitable substitutes or modify the responsibilities of the employee to reflect that which is available.

If time is the problem, examine time constraints, demands and work flow, so that you can adjust the job responsibilities and/or schedules accordingly. Be sure that the employee is involved in these changes, because his or her input will go a long way toward the successful implementation of those changes.

Training definitely will be required to correct a lack of skills or understanding. *Step 3. Communicate expectations and consequences.* None of the previous steps will be of any value unless the supervisor communicates the expectations and consequences of lack of compliance. Never assume that this should be self-evident. The communication of this could include specific prescription for improvement, a time table for the improvement process, and an explanation of how you will measure progress or success when you evaluate the employee in the future.

Clarity in this step is extremely important. It is unfair and counterproductive to be vague about how a person's progress will be measured. In addition, it is equally important that you spell out the consequences. If your station has a progressive or incremental discipline policy, be sure to follow it. If not, develop one.

A commonly used progressive discipline system includes:

1. Verbal warning.
2. Written and verbal warning (a record of this is added to the employee's personnel file).
3. One day off without pay.
4. One week off without pay.
5. Dismissal.

Each step in this progressive discipline should include the proper communication, prescription for change and performance documentation. This will protect you as a supervisor, and provide a fair and equitable employee improvement process.

*Step 4. Document performance.* When

you reach this step, your job is only half done. Often, supervisors do not follow through on an improvement process. It is critical that you keep the appropriate documentation of the employee's performance. The documentation on any employee should include the good and the bad. An employee record that only contains negative reports is not considered legally equitable, and will not stand up in an arbitration process or legal proceeding.

*Step 5. Review progress.* Your job is not finished until you complete the loop. To do so, you must review the employee's progress at the agreed upon time.

If satisfactory progress has been made, the employee should be praised and rewarded. If the progress has been unsatisfactory, the employee should be critiqued on the performance, documentation offered to support this critique and the appropriate action taken. The appropriate action should always be the consequences of lack of performance that were spelled out during the initial communication of expectations and consequences. This action should follow any formal personnel policy established by the company or by you as the supervisor of your department.

### Words of caution

A word of caution: This process requires an investment in time and effort from the employee and supervisor. It is important that the supervisor remain objective in the event of unsatisfactory performance.

### When all is said and done

If you follow these steps, several things should be accomplished:

1. You will have provided a work environment that will enable you to help your employees perform satisfactorily and perhaps better than they did before.
2. You will have established a reputation for fairness.
3. You will have successfully sorted out the employee who wants to do a good job from the employee who doesn't really care.
4. You will have developed a legally defensible system to discipline or dismiss the employee who doesn't really care.

Perkinson is a senior member of the Calumet Group Inc., Hammond, IN.





## AMPEX REDEFINES THE STANDARD IN BETACAM SP.

Introducing new Ampex 398. It's like no other Betacam SP videocassette you've ever seen.

We started with the most demanding design goal—to be the best of the best—and we didn't stop until we reached it.

That's why we engineered a new metal-particle formulation for lower dropout performance and increased durability, specified a new basefilm for improved coating adhesion and

stability, and developed a new backcoat for better handling and reduced wear.

That's why we designed new cassette plastics for precision operation, used new materials for greater reliability, and incorporated over a dozen improvements to the cassette mechanism alone for uncompromising dependability.

And that's why we employ the latest in coating technology, automated

assembly, and statistical process control to ensure consistent performance cassette after cassette.

In fact, from its package to its performance, new Ampex 398 doesn't just meet the Betacam SP standard, it sets an entirely new one. And that's the most exacting standard of all: yours.

# AMPEX

# Circuits

## Automatic scan tracking

AST mechanics

By Gerry Kaufhold II

Ampex Corporation won an Emmy in 1979 for the development of Automatic Scan Tracking (AST). AST provides a method for automatically adjusting the position of the rotating playback heads of a helical scan videotape recorder while a tape is being played.

The ability of an AST system to automatically align the mechanical positioning of the playback head made two things possible. First, a freeze frame could be obtained by completely stopping the tape motion and repeatedly scanning the same two fields. Second, AST provided a way for the helical scanning head assembly to dynamically correct tracking to eliminate misalignment of the tape caused by speed variations.

### The AST system

The AST is a servo-control system that has three parts: an error detector, an error signal processor, and a circuit that drives current to accomplish the repositioning of the mechanical head assembly. This 3-part series will look at the operation of each of these three circuits.

Because the error detector and error signal-processing circuits work in conjunction with the circuit that controls the mechanical head subassembly, we will examine the mechanical system first.

### Bimorphs

The head-mounting design selected for the VTR record and playback heads involved a bimorphic strip that was built into the helical scanning assembly. Bimorphic material is made of an insulator layer that has an electrically conducting material bonded on top, which has a positive coefficient of expansion. On the other side of the insulator, a layer of electrically conducting material exhibits a negative coefficient of expansion.

Simple bimorphic strips often are found in climate control equipment as switches. When a current flows through the device, the layers of conduction material are heated. The material with a positive coefficient expands, while the other material con-

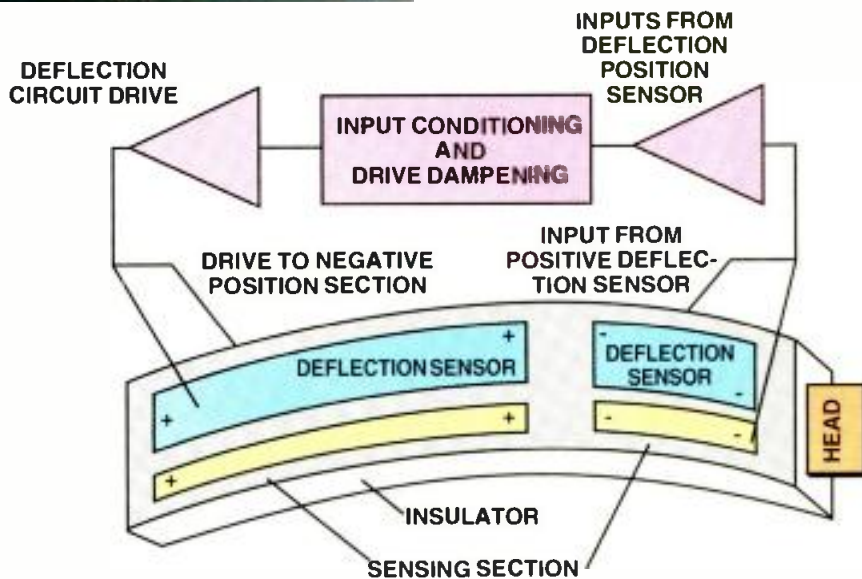
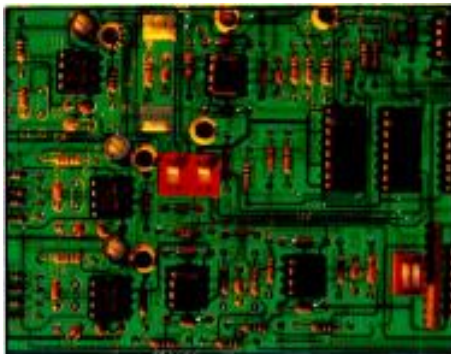

Figure 1. A bimorphic strip with sections for positive and negative deflection and position sensing.

tracts. The bimorphic strip, caught between the two opposing forces, is forced to flex up and down.

In addition to being able to cause mechanical deflection by applying a DC voltage, bimorphic strips can be made to vibrate at up to several kilohertz by applying

**The AST is a servo-control system that has three parts: an error detector, an error signal processor, and a circuit that drives current to accomplish the repositioning of the mechanical head assembly.**

an appropriate AC waveform. This is because bimorphic strips have extremely small mass. AST systems take advantage of both of the features to control positioning of the VTR heads.

### AST head deflection

Figure 1 illustrates the active portions

of this bimorphic strip. An AST system uses several tricks to monitor the present position of the VTR head and to compensate for small errors that occur when a large bimorphic strip bends.

The long, wide, shaded sections are the basic bimorphic strip that is driven with DC and AC voltages. The top layer is positive, and the bottom layer is negative. This portion provides the basic up and down deflection necessary to adjust the position of the VTR heads.

The narrow shaded section is biased with a low DC voltage and connected to a sensitive amplifier that uses changes in the incoming signal to tell the direction and amount of deflection that has been accomplished by the basic bimorphic strip.

In the figure, a cross-hatched section indicates a small bimorphic strip that is polarized exactly the opposite of the large strip. This small section is used to fine tune the position of the head to compensate for errors in tracking, which result from moving the head up and down at the end of the long bimorphic strip.

Next month, we will consider the error detection circuit that monitors the video signal and decides which direction to bend the bimorphic strip to obtain the best video quality from the tape.

Kaufhold is an electronics industry analyst based in Tempe, AZ.



# PURE DIGITAL.

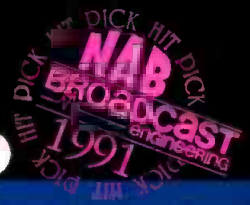

## Bottom Line Orientation.

Creating a "sound" that attracts and holds the largest possible audience is the bottom line in the radio business. And the new OPTIMOD-FM Digital 8200 is a technological breakthrough with bottom line impact.

## Digital Makes the Best Even Better.

The power of digital propels the 8200 to new levels of performance and functionality. OPTIMOD-FM 8200 is a *true* digital audio processor—the audio is digitized and all control functions are digital.

What is the value of digital processing and control? In addition to a better sound, digital makes the OPTIMOD-FM more user-friendly, more programmable, more flexible. Simply put, because the OPTIMOD-FM is easier to adapt to a station's programming needs, it will produce more benefit, more of the time.

## The Processor with Multiple Personalities.

With most conventional processors, multiple processing configurations require multiple boxes. With the 8200's Multiple Variable Processing (MVP) architecture, processing configurations can be

changed with the push of a button—select the protection MVP for total transparency, or the two-band MVP for an improved version of the traditional open, bright and natural OPTIMOD-FM sound which helped make thousands of stations successful. Choose the optional multi-band MVP and meet the challenge of competitive major-market processing with selectable speeds to match any format.

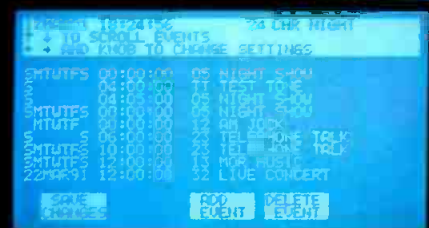

Use the 8200's Automatic Preset Switching to automatically change the processing on a program-scheduled schedule. Ideal for dayparting or multi-format stations.

## Power. Potential. Profitability.

Take advantage of the power, potential and profitability of the OPTIMOD-FM 8200. Call your dealer now for a personal, hands-on evaluation of the 8200.

The OPTIMOD-FM 8200 is a technological breakthrough with bottom line impact. The power of OPTIMOD— in pure digital.

# OPTIMOD-FM

D I G I T A L

**orban**

A Division of AKG Acoustics, Inc.  
1525 Alvarado Street  
San Leandro, CA 94577 USA  
Tel: (1) 415/351-3500  
Fax: (1) 415/351-0500

© 1991 AKG Acoustics, Inc.  
Orban and Optimod are registered trademarks of AKG Acoustics, Inc.  
AKG is a registered trademark of Akustische U. Kino-Geräte Ges.m.b.H. Austria.

# Troubleshooting

## Maintaining telephone systems

Troubleshooting PBXs

By Steve Church

In last month's column, we learned that the big mass of wires in the phone closet serves to cross-connect the various inputs and outputs from block to block, as the system requires. You might have noticed that this is similar in concept to the studio patchbay, except for the bidirectional nature of many of the telco system's paths.

In a proper installation, there will be an inch or two excess length at each block to facilitate the "pull-to-find-the-other-end" tracing method. In my experience, more than half of all phone-related problems come from faulty phone closet wiring.

### Rules of the game

If a phone set stops working, the troubleshooting procedure is straightforward: First confirm that the set is good by swapping another into the same jack, then begin tracing from the jack toward the PBX port associated with that phone. There is a handy gadget (available from most phone suppliers) that can simplify this process. It has a modular jack on one end and a "plug" (actually a socket) for 66 block terminals on the other. (It comes in versions for one to six pairs.) Unless the port you are troubleshooting is intended for a generic "500" set, you will have to use the proprietary phone set normally used on that port for any testing.

If one telco line is consistently bad on every phone set in the facility, you should suspect the wiring from the PBX to the demarcation point. Here, a standard phone set may be used for tracing on the telco side of the PBX, but only if telco service is provided in the typical *loop-start* mode. To determine this, try a standard phone set on a known good telco line. If you hear a dial tone, you have a loop-start line. If you don't, you probably are dealing with *ground-start* circuits.

For loop-start situations, simply make your way from the telco demarcation point toward the PBX, using the telephone to listen for a dial tone as you go. You may want to remove the bridging clips that may be on some of the blocks to rule out the possibility of a downstream short. When the tone disappears, you've found the cause. If you reupunch the wires you

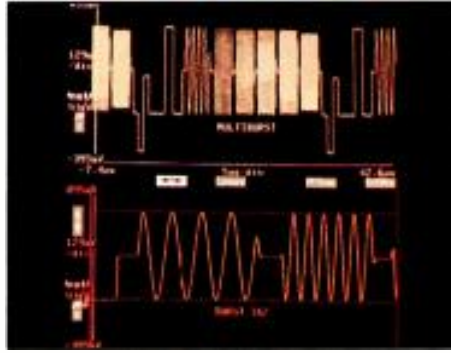

*More than half of all phone-related problems come from faulty phone-closet wiring.*

will likely be ready for the next caller.

### The inner sanctum

What if you're not so fortunate and the dial tone seems to be making it all the way to the "big box" — the PBX switch? Fortunately, many PBX systems are supplied in a modular card-frame format, facilitating board-swap diagnostic methods. Modern PBXs are really just dedicated computers with special-purpose, phone-related peripherals. For this reason, many of the troubleshooting techniques used for computers apply. There will be plug-in modules present for the various functions, and although each manufacturer has its own approach to the division of labor among the modules, the usual configuration will look something like this:

- A central processing unit (CPU), perhaps including some memory, disk drives and other support on separate modules.
- One or more modules for tone generation and detection.
- A number of telco line interface modules (each handling multiple lines).
- Several phone set interface modules (each handling multiple sets).
- A power supply.

A little head-scratching should lead you fairly directly to the appropriate module. In the aforementioned case of a single bad line throughout the house, look at the telco interface module associated with the failed line. Because there likely will be more than one such module in the system, swapping can be easily performed to determine if the problem moves to another line. If a particular phone instrument/extension is out, check the set interface module for that extension with the same swapping approach. On the other hand, if the entire system is down, the power

supply and the CPU are clearly the suspects. The supply probably has a circuit-breaker and/or a fuse or two — you'll want to look at them before digging deeper.

Regarding module swapping, most phone systems are designed to permit hot removal and insertion of cards. If so, there will be some notation of this in the installation manual, or there may be some instructions screened on one of the cover surfaces. When in doubt, the safest course is to wait until after hours and power the system down before swapping cards.

Smaller systems may not be modular. Still, there is a chance that you may be able to find the trouble. Check the small fuses or resistors in series with the telco line input that most systems use to prevent damage to sensitive components from lightning-induced line surges. If these are at fault, they can be replaced or temporarily jumpered to restore service.

### The PBX defined

While we're on the subject, you should know that PBX stands for *private branch exchange*. Today, although virtually all electric phone systems are actually private *automated* branch exchanges (PABXs), PBX has become a catchall nomenclature. Although these phrases evoke something much more impressive than our modest phone systems, PBX has become the accepted way to refer to *any* phone system not at the telephone company's premises.

Further confusion arises from the ambiguous application of the term PBX, sometimes used to designate the entire system, including phone instruments and wiring, and other times referring only to the computer in the phone closet. (Ironically, telco people usually refer to their multimillion dollar hardware as a *switch*.) Today's smaller installations are often called *key systems*. Back when PBXs were always racks of stepping relays and key systems were always wall-mounted boxes, this distinction had real hardware meaning. Now, it's just language overhang, and connotes the size of the system.

Next month, you'll learn what to do when you find a defective card in your PBX. Hint: You won't need to heat up the soldering pencil. ■

Church is president of Telos Systems, Cleveland





B R O A D C A S T

OFFICES & ENGINEERING  
MARIA MOLINER, 74-76  
50007 ZARAGOZA  
SPAIN

FACTORY  
CMNO. DE LOS ALBARES, 14  
CUARTE DE HUERVA  
ZARAGOZA - SPAIN

OMB AMERICA  
TIB3555 N.W. 79 TH. AVE.  
33122 MIAMI FLORIDA  
U.S.A.

*Solutions*

# Engineering by Broadcasting Experts

*In OMB you will find the answer for your radio or television transmitting station.*



FM TUBE TRANSMITTER

88-108 MH: 5.000 WATTS

*Many broadcasters came to us with doubt and went away satisfied, technically and financially.*

*Today we are able to help you.*

*If you want the best quality and the best value for money*

*OMB can supply them both.*

*Have confidence in our services.*

*Facilities:*

*• System projects • Installation*

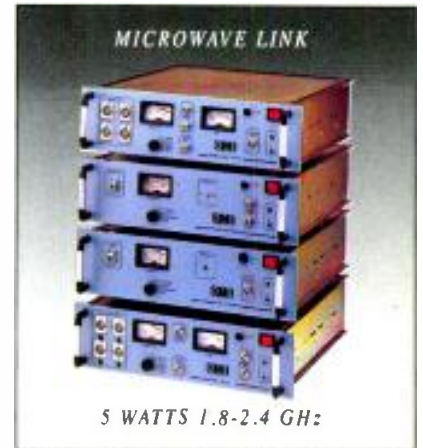

MICROWAVE LINK

5 WATTS 1.8-2.4 GH:z

*• Short delivery time • After sales service • Full technical data*



FM TRANSMITTER SOLID STATE

88-108 MH: 500 WATTS

*Indicative prices in US\$ FOB Zaragoza and Miami*

DIGITAL STEREO GENERATOR 45-60 dB SEPARATION	1.375
3 kW RADIATING SYSTEM 4 DIPOLES POWER DIVIDER 1/2" CELLFLEX	2.750
PORTABLE TRANSMITTER 12 V 88-108 MH: 10 WATTS SYNTH.	1.550
STL 200-400 MH: 10 WATTS 800-960 MH: 5/6 WATTS TELEMETRY SYNTH.	
μPROCESSOR MONO MPX 2 SCA	4.685
FM TRANSMITTER 88-108 MH: 20 WATTS SYNTH μPROCESSOR	2.475
FM TRANSMITTER SOLID STATE 88-108 MH: 500 WATTS	8.890
FM TRANSMITTER TUBE 3CX1500 88-108 MH: 1.000 WATTS	10.890
FM TRANSMITTER TUBE 4CX3500 88-108 MH: 5.000 WATTS	25.375
TV REPEATER 5 WATTS	6.500
PANEL RADIATOR UHF STAINLESS STEEL	790
MICROWAVE LINK 5 WATTS 1.8-2.4 GH:z	15.150

SPAIN

TEL: +34 76 274537 & 37 03 00 FAX: +34 76 37 23 36  
TELEX: 57866 OMBZ-E

Circle (13) on Reply Card

AMERICA

TEL: +1 305 4770973 & 4  
FAX: +1 305 4770611

TELEPHONE, FAX OR TELEX US NOW

www.americanradiohistory.com

# Technology News

## Optical eye openers

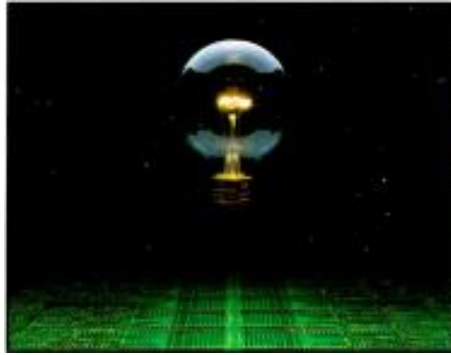

By Curtis Chan

From an admittedly slow start, optical technology has grown into a mainstream memory tool. Although many optical devices are being used today in the broadcast and production world, future developments promise spectacular benefits in speed, capacity, price per unit of storage and reliability. This month, we will take a glimpse at some present milestones to envision what the future might hold.

The basic objective of optical recording, either rewritable or write-once-read-many (WORM), is to create spots on the media surface that effect a change, which can be detected. You can do this by a shift in polarization (magneto-optic memory) or an alternation in reflectivity, as used in phase-change or bubble writing.

### Fundamentals

Magneto-optic recording is probably the leading approach for rewritable recording. Basically, a laser beam operating in conjunction with a magnetic coil (which produces a magnetic field) is the fundamental building block. In this first method, a single spot on the media surface is heated by a diode laser to the Curie point, while a magnetic field is applied. This results in a magnetic flux reversal at the heated point. Because MO disks store data in the form of magnetic flux rather than in physically deformed spots, they can be written to and erased repeatedly with no measurable media wear or data degradation. Error rates of one in  $10^{14}$  are not uncommon.

The second method, *phase change* technology, uses a plastic disk with a special metal layer. Heat generated by the drive's laser changes the molecular structure of spots on the metal layer from an amorphous state to a crystalline state and vice versa. When reading, the optical head detects changes in the reflectivity. The problem associated with this technology is that the drive requires an expensive high-power laser and, at present, will not endure many rewrite cycles.

The third method, *dye-polymer*, uses a translucent plastic (an elastomer base lay-

er with a thermoplastic top layer) disk with a colored layer that absorbs heat from the drive's laser beam. The dyes in each layer absorb differing wavelengths of light generated by twin lasers in the read/write head. A bump is created on the area heated by the laser, and detection is based upon the reflectivity of light from the bumps. Although promising a lower media cost, the drive is more complex, requiring two lasers, each with a different wavelength. This makes the drive more expensive. The other problem at present is that the media wears out quickly. In fact, lab tests may show wear starting as soon as 1,000 write cycles, and definite signs by 10,000 cycles.

### Thinking quaternary coding

A recent optical development by Optex Corporation in Rockville, MD, is working toward bringing *electron trapping optical memory* (ETOM) to the market. This revolutionary all-photonic optical memory technology uses the movement of electrons between energy states to store data in a multilevel media base. Data is written to the material with a blue light laser and read with infrared. No significant amount of heat is generated, resulting in faster read and write times.

The development of multilevel media is based on the unique characteristic of precise linear amplitude response to recording light intensity, allowing the use of multiple amplitude data recording. This type of technology has already demonstrated the recording and playback of a quaternary (as opposed to binary) coding. Going beyond the 0 or 1 states, ETOM opens the way to code with 0, 1, 2 and 3. This method increased the capacity fourfold without extra physical storage space.

The other improvement centers on the wavelength of light necessary to read data. Because of infrared, a shorter wavelength can be used, which provides roughly a 2:1 increase in capacity and also touts a much less complex head assembly. What does this mean to near future users? Imagine what you can do with an optical drive system using a data transfer rate of 120Mbit/s and a capacity of 14Gbytes all with a 5.25-inch cartridge.

### An irister by any other name

Some time ago, Sony developed a memory capacity technology that enhanced MO performance. The *Irister* used an ultra-high density MO disk, with a magnetically induced super resolution in exchange-coupled magnetic multilayer film.

As you know from optical basics, the linear density of an optical disk is limited by the spot size of the readout light, which is focused on the recording media through an objective lens. The spot size is proportional to a light wavelength and reciprocally proportional to a numerical aperture. Irister's benefit is that it reduces the spot size without shortening the lightwave or enlarging the numerical aperture.

The basic principle centers on the fact that only the heated or excited portion of the light spot is capable of readout. It uses a magnetic film, consisting of a low coercivity readout layer and a high coercivity recording layer. The signal in the readout layer is eliminated by an initializing magnet prior to the read cycle. A region of the spot is optically masked during the read because data is erased. Data in the recording layer is copied onto the read layer and becomes accessible. This results in a two-fold increase in spatial frequency of the recorded signal with record/read sizes of  $0.3\mu\text{m}/\text{bit}$ . Linear density under this approach is better than three times the current MO options. A doubled track density is possible because of diminished crosstalk.

### Future economies

Although multimedia has yet to be completely defined, optical technology will be a key to enabling technology for the storage of a variety of information. The advantages of optical to a multimedia package includes removability, extremely dense storage, durability, random access, erasability, long shelf life and economy. Just think of the benefits that these technologies could have on our future everyday lives. This is truly a case of more bang for the buck.

Chan is a principal of Chan & Associates, Fullerton, CA.



# New!

- 1992 Full serial CCU interface. ● Full serial redundant networking control system. ● Production operation by TD. ● 100% redundant controller upgrade. ● Enhanced VGA graphics. ● MCB-3 vector solving Heads-Up North local manual control. ● EMMY Award.
- 1991 AutoCam ACP-8000S, 486/33 collision avoidance and studio set mapping. ● ACP-8000 on-screen air tally. ● Multiple screen files for quick transition for back-to-back shows. ● EMMY Award. ● Powerful single screen operation. ● Battery Pack option for SP-200/X-Y. ● AutoCam Full-Motion control editing. ● ACP-8000 local manual control box. ● Real-time CCU control. ● MCB-1 local manual control box. ● ROP Remote Operating Panel. ● "free-roaming," full-motion X-Y base.
- 1990 AutoCam SP-200/X-Y. The world's first "free-roaming," full-motion X-Y camera controller. ● Real-time CCU control. ● ROP Remote Operating Panel. ● ROP Remote Operating Panel. ● ROP Remote Operating Panel.
- 1989 AutoCam SP-200/X-Y. The world's first "free-roaming," full-motion X-Y camera controller. ● Patent awarded for SP-200/X-Y targeting system. ● AutoCam SportsFocuser automatic focusing system. ● Copyright for ACP-8000 touch screen software. ● AutoCam SP-200 Servo Pedestal for HS-110P and HS-105P. ● AutoCam ACP-8000 touch screen. ● menu-driven eight camera controller.
- 1988 AutoCam Newsroom Computer Interface for ACP-8000. ● AutoCam SP-200 Servo Pedestal for HS-110P and HS-105P. ● AutoCam Newsroom Computer Interface for ACP-8000. ● AutoCam Newsroom Computer Interface for ACP-8000.
- 1987 AutoCam HS-105P ENG/EFP camera pan/tilt head. ● AutoCam HS-105P ENG/EFP camera pan/tilt head. ● AutoCam HS-105P ENG/EFP camera pan/tilt head.
- 1986 Tandem operation of MultiControllers for four cameras. ● Tandem operation of MultiControllers for four cameras. ● Tandem operation of MultiControllers for four cameras.
- 1985 AutoCam HS-110P studio camera pan/tilt head. ● AutoCam HS-110P studio camera pan/tilt head. ● AutoCam HS-110P studio camera pan/tilt head.
- 1984 MultiController full-motion control system for the future family of AutoCam camera automation products. ● MultiController full-motion control system for the future family of AutoCam camera automation products. ● MultiController full-motion control system for the future family of AutoCam camera automation products. (The launching platform for the future family of AutoCam camera automation products.)

## The promises we've kept weren't made in the dark.

You had the foresight and experience. You encouraged us to make a commitment. And today, thanks to you, AutoCam is performing with "honors" at television stations...from the 1st to the 81st TV markets...and approaching 100 station installations...all within six short years. And the really good news is...

AutoCam starts earning its way the first day on-air (the average return on investment for a typical three camera studio system is less than twelve months). The average "from box to on-air time" is less than three days and AutoCam performs every day with a reliability record approaching spectacular.

*And it gets better every day.*



Get "On target"  " with AutoCam. Call to arrange a demo for your station.

TOTAL SPECTRUM MANUFACTURING, INC.  
709 Executive Blvd., Valley Cottage, NY 10989 • 914-268-0100 • FAX 914-268-0113

Circle (15) on Reply Card

# Managing technology

An upshift in technology has brought a good news/bad news scenario. Take control by learning how to deal with and implement these changes.





***“Technological progress has merely provided us with a more efficient means of going backward.”***  
— Robert Maynard Hutchins

**A**s professionals involved in a highly technological business, the above phrase often seems entirely appropriate. Just as technology solves one problem, it often creates two more.

One major change technology has brought to our industry is the ability to do more things with fewer people. That is a good news/bad news situation.

The last half of the 1980s was particularly difficult for technical staffs, because many operating positions were eliminated through the use of machines. Fortunately, the hell-bent speed with which some facilities ran toward machine-based solutions has slowed. The companies that looked for an oasis of solutions in machines often found they had opened a Pandora's box in terms of reliability and costs. One step forward, two steps backward. B.F. Skinner said it best, “The real problem isn't whether machines think, but whether men do.” Just because a machine can do something doesn't mean it should be used in every application.

One thing managers of technology can do to help protect their facilities from technological disasters is to take control from the onset. Identify problems and seek technologically correct solutions.

This month's issue will provide insight into some of those solutions. Although some of the answers proposed in the following articles may not meet with every reader's approval, they represent real world answers to some of today's tough problems. The key to your company's success could depend on how effectively you can implement some of them.

- “Annual Salary Survey” .....page 26
- “Software for Production Facility Management” .....36
- “Making Money with Technology” ..... 46
- “Closed-Captioning for TV” ..... 52
- “Contracting for Maintenance Services” ..... 60

*Brad Dick*

Brad Dick,  
editor

# EVER WONDER WHAT THE OTHER 282 BUTTONS ON YOUR SWITCHER ARE FOR?

Big panels look impressive. But, in fact, most switchers used in Post-Production today are actually hold-overs from the days of live television, when you needed lots of inputs to handle all the sources.

*Digital Post-Production* environments, however, typically require only a few inputs. And you really don't need to pay for more than that.

Which means those huge switchers with bus after bus, row after row, not only are being wasted, but are also taking up a lot of valuable real estate in your suite. Not to mention wasting a lot of your valuable time rolling your chair back and forth to reach the few buttons you actually need.

**Finally, the power you want in a size you can use.**

Ampex takes a different approach. Rather than being bound to some outdated television tradition, we looked at how a Post-Production switcher *should* work in a digital environment.

The result is the Ampex DCT 700s Post-Production Switcher. It may well be the first sensible digital Post-

Production switcher you've ever seen. Yet you can do as much with it as you can with even the biggest panels.

Why? Because the Ampex DCT 700s has been optimized for Post-Production, and offers you unprec-

edented transparency with a full 4:2:2 digital component signal system.

With two key layer processors, you get unmatched performance, flexibility, and versatility, including soft masking and full bandwidth mask store. You can perform linear luminance keys, ISO keys, and, with our proprietary Spectrakey™ chroma-nulling feature, chromakeys of spectacular crispness and clarity.

Plus with our 4:2:2:4 framestore and our exclusive Digi-Loop™ feature, you can create trails, blurs, layer composites, even dramatic "flying logo" and other digital effects—all within the switcher.

The DCT 700s gives you big-switcher performance in a small package. It gives you the freedom to be more creative...and the power to be more competitive.

**More than a new product, a new perspective.**

The DCT 700s Post-Production Switcher, however, is only part of the story.

DCT from Ampex is actually

a *system*. In fact, it is the first system conceived and optimized for Post-Production in the digital component environment. It is the first system to remove the barrier of multigenerational image degradation found in the analog world.

And while each device in the system offers unparalleled performance on its own, when taken together, they offer a Post-Production solution with a level of precision integration and efficiency never before achieved in this industry.

The Ampex DCT System is also the first complete digital component system available from one manufacturer. In addition to the DCT 700s switcher, it includes a new tape drive, new tape cartridges, new computerized edit controllers, ADO® digital special effects, and interconnect equipment.

It is a compact, sophisticated, practical digital component system that unlocks a whole new world of creative—and competitive—possibilities.

**How we developed the best editing tape drive in the world.**

The Ampex VPR-3 is widely acknowledged to be the best analog recorder in the world. And our Zeus™ signal processor is renowned for bringing true transparency to analog recording. Both have set the standard in the analog environment.

And now we've set the standard in



the *digital* environment as well. We've built on the technical innovation of the VPR-3/Zeus to now offer the best digital editing tape drive in the world: the Ampex DCT 700d.

The DCT 700d Tape Drive is built for demanding professionals. It is the most advanced tape transport mechanism ever designed. It is precision engineered to maintain ultratight tolerances through the rigors of Post-Production, edit after edit, hour after hour, day after day.

Yet for all this rugged precision, the DCT 700d is also the *gentlest* drive in the world, floating the tape on frictionless air-lubricated guides. This is one reason why its high performance ballistics can accelerate the tape with the gentlest of tape handling to 60X play speed in less than one second—without damaging the tape!

The point is, the DCT 700d Tape Drive has been optimized in every detail to meet the demands of Post-Production. There is no other machine like it in the world today.

**Tape is tape unless it's this tape.**

Some people don't think much about tape. They should.

Whether it's a \$30,000 commercial or a \$3,000,000 made-for-TV feature, when you lay it down on tape, neither you nor your client can tolerate inferior performance.

And unfortunately, the first

time most people think about tape problems is in the last place they can afford them: the edit suite.

That's why we developed the DCT 700t Series Tape Cartridges in parallel with the rest of the DCT System.

The cartridges perfectly match the operational characteristics of the DCT



700d Tape Drive. This not only delivers optimal performance, consistency, and interchange, but also ensures that no digital errors—particularly the kind that can cause concealments—will ever exceed the system's data management threshold, assuring you of outstanding picture quality—with room to spare.

The tape incorporates new dispersant technology and a tough, highly crosslinked binder system that provides clean-running performance and increased durability over extended multiple passes. When combined with the gentle tape handling of the DCT 700d Tape Drive, you may never have to worry about your tape again during heavy editing.

And the result you can see for yourself: stunning picture quality.

**It's not where you are, it's where you're going.**

DCT is the digital component Post-Production system from Ampex, the company that has been creating video solutions longer than anyone in the world. A company that has been the leader in applying technical inno-

vation to solve practical problems.

That's why the DCT System *today* is already more than a generation ahead of any other digital component system on the market—or on the drawing board.

So while other people keep waiting for the "next" millennium, you can wisely seize all the creative and competitive advantages of this one.

With DCT from Ampex.

**AMPEX**  
**DCT**<sup>™</sup>

Ampex Systems Corporation  
401 Broadway, M.S. 3A-01 Redwood City, CA 94063-3199  
©1992 Ampex Systems Corporation

Circle (16) on Reply Card

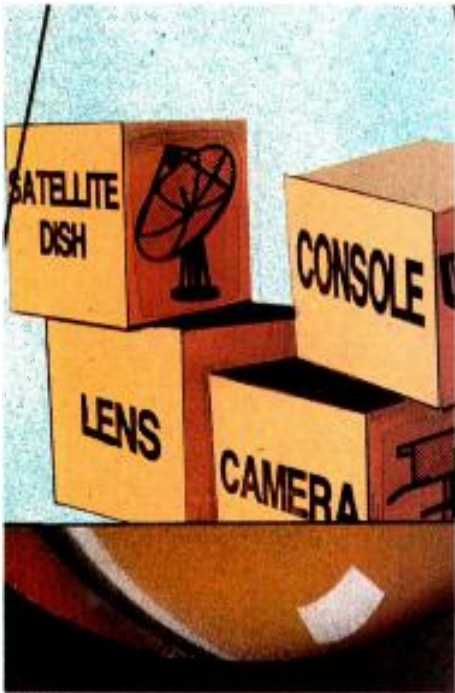

# Annual salary survey

A new and detailed look at broadcast salaries.

By Brad Dick, editor

## The Bottom Line

*Salaries are always a hot topic. Even though we all want to know how much the other guy makes, most of us are unwilling to talk about our own earnings and benefits. This is where the Broadcast Engineering annual salary survey comes to the rescue. The survey results are among the most sought-after features published during the year. Readers look for and trust the results published in this annual special report. If you want to know more about how your salary stacks up against your fellow broadcaster, read on. You might not like what you discover, but at least you'll be armed with hard facts that might help you negotiate an improvement in your own financial situation.*



In this day of economic uncertainty, having a job is usually everyone's first priority. The second concern is to make sure that your salary for that job is comparable to what others make in similar positions. In many cases, it's difficult to find accurate information on industry salaries — not so for broadcast engineers.

Every October, *Broadcast Engineering* magazine examines the salaries and benefits for broadcast personnel. Through information provided by *BE* readers, the survey results provide detailed and highly accurate information about the financial packages available to technical personnel.

### New look

This year's survey contains new information and a different presentation. Based on reader feedback, this year's survey was modified to provide easier-to-read, more detailed information based on job titles. Previously, the results were broken down into three categories: management, engineering and operations. This made it difficult to know how your particular job category ranked within the major categories.

The results of the 1992 survey are divided into five job categories. The *executive management* salary category includes such titles as general manager, vice president and executive-level personnel. Operations salary data covers just what it says — operator titles.

The survey results for technical salaries are grouped into three categories. The first, *VP/director of engineering*, includes

management engineering titles: vice president of engineering, director of engineering, and director of engineering and operations. The second technical job category, *chief engineer*, includes chief engineers and technical directors. The third technical job salary category, *staff engineer*, contains the titles engineer and technician.

The 1992 *BE* survey was conducted by the Intertec marketing research depart-

---

***One surprising fact is that the highest median salary, measured across all similar titles and market sizes, is for the vice president and director of engineering category.***

---

ment. Questionnaires were mailed to 4,014 *BE* readers. As of Aug. 12, 1,641 usable surveys were received, representing a response rate of 41.4%. The data contained in this report is based on those responses.

### A quick summary

The major results of the survey are displayed in Table 1. It shows the median values for important factors across all job



## Some Machines are so Advanced They Defy Comparison

Just as aviation technology has soared to new heights on the wings of advanced aircraft, CRT projection technology has reached its zenith with the new BarcoGraphics 1200. The most advanced large screen projection system ever made.

With an unprecedented horizontal scanning range of up to 135 kHz, displayable resolution of 2500 x 2000 pixels, RGB bandwidth of 120 MHz, peak light output of more than 1000 lumens and powerful 9" electromagnetic focus CRTs, the BarcoGraphics 1200 is truly in a class by itself.

Yet, ground-breaking specifications are only part of the story. While the BarcoGraphics 1200 brilliantly illuminates your presentations with pinpoint accuracy and unsurpassed resolution, advanced features such as digitally controlled magnetic focus and an intelligent memory management system skillfully keep your image quality consistently perfect. Operating the BarcoGraphics 1200 becomes as simple as flying on autopilot.

If you've been searching for breathtaking large screen images, contact us today for more information on the new BarcoGraphics 1200. We're sure you'll find it beyond *all* comparison.



*The BarcoGraphics 1200*



# BARCO

BARCO, Inc.

1000 Cobb Place Blvd. • Kennesaw, GA 30144  
(404) 590-7900 • (404) 590-8836 FAX

In Canada call our distributor TELAV (514) 340-1986  
In Mexico call our distributor Foto Niza (525) 207-0888

Circle (17) on Reply Card

# WHEN YOU WANT MORE THAN JUST AN ANTENNA

JAMPRO has been providing the broadcasting industry with state-of-the-art antennas for over 35 years, longer than any other US antenna manufacturer. With over 3000 antenna systems delivered, at JAMPRO you don't just buy an antenna, you invest in experience.

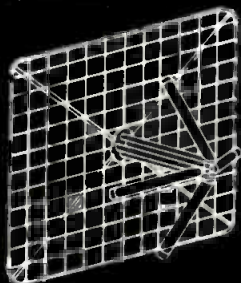

JAHDCP  
Arrowhead  
Screen Dipole

## THE LEADERS IN ANTENNA TECHNOLOGY

- Complete line of FM & TV broadcast antennas
- RF components, Filters & Combiners
- Modern 7000 ft FULL SCALE test range
- Directional antennas and pattern studies.

Call or fax us your needs today.

(916) 383-1177  
Fax (916) 383-1182



6340 Sky Creek Dr.  
Sacramento, CA 95828

Circle (18) on Reply Card

titles. One surprising fact is that the highest median salary, measured across all similar titles and market sizes, is for the vice president and director of engineering category. In no other previous *BE* survey has the median technical salary been higher than the corresponding salary for the broadcasting manager category.

Furthermore, a higher percentage of technical and technical management personnel received salary increases than did the managers. More than 65% of those with technical manager titles received salary increases, whereas only 38% of the managers did.

Those with the most industry experience, however, tend to be the managers, with a median tenure of 22 years. On the average, technical managers have 20 years of experience, followed by 18 years for chief engineers and 15 years for staff engineers.

Chief engineers have the highest percentage of those doing free-lance work. And it's the *radio engineers* who are doing most of the free-lance work. Measured across all markets, 63.7% of the radio chief engineers do some type of free-lance. Now, let's get into the details of the survey, first by job title.

### VP/director of engineering

Not surprisingly, median salaries vary by market size. The salary for TV vice presidents of engineering and directors of engineering is \$46,500. In the top 50 mar-

*Those with the most industry experience tend to be the managers, with a median tenure of 22 years.*

kets, this salary jumps to \$58,750. The 51-100 market salary is \$40,000. In the below top 100 markets, the salary is \$41,250.

Radio salaries tend to be lower. The salary for a radio vice president of engineering or director of engineering is \$33,636. The top 50 market median salary for this category is \$44,000. In the below top 100 markets, this salary drops to \$31,111. See Table 2 for a summary of the results.

### Chief engineers

Measured overall, the median salary for chief engineers in both radio and TV categories is \$34,565. Chiefs for TV stations make \$39,138. Other salaries by market size are: top 50, \$50,000; 51-100 markets, \$41,250; below top 100 markets, \$35,000.

The radio engineers' median salary

measured across total markets is \$29,605. The top 50 market salary is \$41,538, while in markets 51-100 it is \$32,500. The below top 100 markets is \$22,708. Table 3

*Chief engineers have the highest percentage of those doing free-lance work.*

contains a summary of the results.

### Staff engineers

The median salary measured over all markets for radio and TV staff engineers is \$29,100. Staff engineers at TV stations have a median salary of \$30,893. However, top 50 market positions pay significantly more — \$42,917. The 51-100 market salary is \$28,571. The below top 100 market salary for a TV staff engineer is little more than one-half of the top 50 market salary, which is \$24,211.

Measured over all markets, radio staff engineering salaries are \$22,727. The top 50 market salary is \$29,000. (See Table 4.)

### Operator salaries

Salaries for operator positions remain fairly consistent. Measured across all markets for both radio and TV stations, the median salary is \$27,661. The TV operator salary is \$29,894. The following are earnings by market: top 50 market, \$40,500; 51-100 markets, \$29,750; below top 100, \$22,895.

Radio operator salaries range from a low of \$19,773 in the below top 100 markets to a high of \$30,000 in the top 50 markets. Table 5 summarizes the results.

### Executive management salaries

As expected, executive management salaries are among the highest. Measured over all markets for radio and television, the median salary is \$35,882. The TV category salary is \$45,625. Top 50 market managers have a median salary of \$65,000, and the below top 100 market

*Salaries for operator positions remain fairly consistent.*

median salary averages \$35,000.

Radio manager salaries vary from a low of \$29,423 in the below top 100 markets to a high of \$42,222 in the top 50 markets. Other values include the 51-100 markets, where the salary is \$40,833. Measured overall, radio managers receive



**Totally in sync with your needs.**



### **Sony PCM-7000 Series Time Code DAT Recorders**

Film and video professionals agree that DAT is rapidly replacing 1/4" analog tape as the standard audio interchange format—it's faster, smaller, more economical and provides superior sound quality.

And now the leader in DAT technology brings you the PCM-7000 Series, professional DAT recorders that offer time code recording and sophisticated serial control for the most advanced electronic editing.

Whether you're involved in video post production under editor control, audio sweetening configured with built-in chase synchronization or on-air broadcasting requiring instant-start and variable-speed playback, the PCM-7000 Series DAT recorders will keep you totally in sync. For more information, call the Sony Professional Audio Group at 1-800-635-SONY, ext. 7050.

**SONY**

**TABLE 1 — MEDIAN VALUE PROFILE OF BROADCASTERS (RADIO AND TV COMBINED)**

CATEGORY	EXECUTIVE MANAGEMENT	VP/DIR. OF ENGINEERING	CHIEF ENGINEER	STAFF ENGINEER	OPERATOR
Salary level	\$35,882	\$41,731	\$34,565	\$29,100	\$27,661
Received salary increase	38.6%	65.6%	52.6%	68.8%	59.7%
Amount of increase	5%	5%	4.4%	4%	4.5%
Years in present job	6	5	6	7	4
Years in broadcasting	22	20	18	15	13
Does free-lance work	35.1%	42.6%	55.4%	41.5%	48.8%
College graduate	56.3%	47.6%	31.3%	28%	62.4%
Age, years	45	43	42	39	37

**TABLE 2 — ENGINEERING MANAGEMENT SALARIES**

	VP/DIR. OF ENGR. TOTAL	TV SUBTOTAL	TOP 50	TOP 51 TO 100	BELOW TOP 100	RADIO SUBTOTAL	TOP 50	TOP 51 TO 100	BELOW TOP 100
<b>BASE = ALL RESPONDENTS</b>	183 100%	111 100%	53 100%	24 100%	34 100%	72 100%	24 100%	11 100%	37 100%
Less than \$15,000	4.4%	1.8%	1.9%	0%	2.9%	8.3%	8.3%	9.1%	8.1%
\$15,000 to \$24,999	10.9%	7.2%	3.8%	4.2%	14.7%	16.7%	8.3%	18.2%	21.6%
\$25,000 to \$34,999	18%	9.9%	1.9%	20.8%	14.7%	30.6%	16.7%	27.3%	40.5%
\$35,000 to \$49,999	34.4%	37.8%	22.6%	62.5%	44.1%	29.2%	29.2%	36.4%	27%
\$50,000 to \$74,999	21.9%	30.6%	43.4%	12.5%	23.5%	8.3%	16.7%	9.1%	2.7%
\$75,000 or more	10.4%	12.6%	26.4%	0%	0%	6.9%	20.8%	0%	0%
Estimated median	\$41,731	\$46,500	\$58,750	\$40,000**	\$41,250	\$33,636	\$44,000**	NA*	\$31,111

**TABLE 3 — CHIEF ENGINEER SALARIES**

	CHIEF ENGINEERS TOTAL	TV SUBTOTAL	TOP 50	TOP 51 TO 100	BELOW TOP 100	RADIO SUBTOTAL	TOP 50	TOP 51 TO 100	BELOW TOP 100
<b>BASE = ALL RESPONDENTS</b>	390 100%	139 100%	42 100%	39 100%	58 100%	251 100%	81 100%	68 100%	102 100%
Less than \$15,000	7.4%	0.7%	2.4%	0%	0%	11.2%	6.2%	2.9%	20.8%
\$15,000 to \$24,999	19.7%	10.1%	2.4%	12.8%	13.8%	25.1%	8.6%	20.6%	41.2%
\$25,000 to \$34,999	24.1%	22.3%	7.1%	15.4%	37.9%	25.1%	14.8%	35.3%	26.5%
\$35,000 to \$49,999	32.8%	44.6%	40.5%	51.3%	43.1%	26.3%	40.7%	32.4%	10.8%
\$50,000 to \$74,999	14.1%	20.9%	42.9%	20.5%	5.2%	10.4%	23.5%	8.8%	1%
\$75,000 or more	1.8%	1.4%	4.8%	0%	0%	2%	6.2%	0%	0%
Estimated median	\$34,565	\$39,138	\$50,000	\$41,250	\$35,000	\$29,605	\$41,538	\$32,500	\$22,708

\$33,571. See Table 6 for a summary of the survey results.

**Salary ranges**

Remember that the median salaries are only one criterion to consider when comparing your salary. So, let's look at another important guideline: The percentage of

those with salaries in any particular salary range.

Table 2 summarizes the salary information for engineering management personnel. Note that 34.4% of the TV respondents say their salary is between \$35,000 and \$49,999. This was the largest category of responses. The second largest re-

sponse (21.9%) was in the category \$50,000 to \$74,999. It is worth noting that these two ranges account for almost 60% of the responses.

Radio engineering management salaries vary across a lower range. Although 30.6% of the radio engineering management respondents claim their salary is in



# Introducing a value-packed platform for waveform/vector monitoring.



Products shown with optional white phosphor display.

## See it. Believe it.

You can expect more from your next waveform/vector monitor — more performance, more convenience, more value — now that the 1740A, 1750A and 1760 Series from Tektronix have arrived.

An intuitive user interface, streamlined front panel and outstanding display capabilities — all in a half-rack package — make up a new platform for future products to follow. The platform is built on actual input from TV engineers — people whose time is too valuable to be spent learning and re-learning equipment.

Eight video input channels, 12 user presets, waveform and vector cursors, time code display, stereo audio phase monitoring, full field line select and a host of other features are easy to put to work, without slow, hierarchical menus or ambiguous results. You can even view actual pictures at the push of a button.

The 1740A Series offers all this and much more. The 1750A Series adds SCH phase

monitoring, and the 1760 Series provides capability for component TV.

Each series includes NTSC, PAL and dual standard monitors — all with an unsurpassed 3-year warranty.

### Seeing is believing.

Just call your Tek representative to arrange a demonstration — get a closer look at the quality Tek delivers in a new platform

for waveform/vector monitoring.



## Tektronix

Television Systems

Copyright © 1992, Tektronix, Inc. All rights reserved. TVG-121

Circle (19) on Reply Card

[www.americanradiohistory.com](http://www.americanradiohistory.com)

the range of \$25,000 to \$34,999, almost as many (29.2%) say their salary is between \$35,000 and \$49,000. A smaller number (16.7%) claim a salary between \$15,000 and \$24,999. The lower-end loading comes from the below top 100 markets, where more than 20% of these respondents are in the \$15,000 to \$24,999 range.

There is less concentration of salaries

into ranges for the chief engineer titles. (See Table 3.) The most common salary range for TV chief engineers (44.6%) is \$35,000 to \$49,000. However, both the next higher and lower ranges had an equal amount of responses, about 20%.

Radio chief engineer salaries are evenly distributed into three categories: \$15,000 to \$24,999; \$25,000 to \$34,999; and \$35,000 to \$49,000. Here, the market

size is the dominant factor. Smaller markets equate to lower salaries. Although this may seem intuitive, that degree of similarity is less for TV management engineering salaries, which do not see such a market dependence.

Measured overall, salaries for TV staff engineers (see Table 4) are evenly distributed into three ranges: \$15,000 to \$24,999; \$25,000 to \$34,999; and \$35,000 to

**TABLE 4 — STAFF ENGINEERS SALARIES**

	STAFF ENGINEERS TOTAL	TV SUBTOTAL	TOP 50	TOP 51 TO 100	BELOW TOP 100	RADIO SUBTOTAL	TOP 50	TOP 51 TO 100	BELOW TOP 100
BASE = ALL RESPONDENTS	282 100%	219 100%	98 100%	62 100%	59 100%	63 100%	30 100%	13 100%	20 100%
Less than \$15,000	9.6%	4.1%	3.1%	4.8%	5.1%	28.6%	16.7%	38.5%	40%
\$15,000 to \$24,999	26.2%	25.1%	6.1%	30.6%	50.8%	30.2%	23.3%	15.4%	50%
\$25,000 to \$34,999	29.1%	31.5%	21.4%	41.9%	37.3%	20.6%	23.3%	38.5%	5%
\$35,000 to \$49,999	23.4%	25.6%	39.8%	21%	6.8%	15.9%	26.7%	7.7%	5%
\$50,000 to \$74,999	9.9%	11.4%	24.5%	1.6%	0%	4.8%	10%	0%	0%
\$75,000 or more	1.8%	2.3%	5.1%	0%	0%	0%	0%	0%	0%
Estimated median	\$29,100	\$30,893	\$42,917	\$28,571	\$24,211	\$22,727	\$29,000	NA*	\$17,500**

**NOISE**  
can blow digital audio compression to bits.

**Not with the WavePhore AUDIO 2000™ System.** We've developed a unique dynamic encoding scheme based on psycho-acoustic properties of the human ear. So even when bit error caused by noise exceeds one in a thousand, we gracefully degrade rather than mute. You still get a clear, CD quality signal and all the advantage of 4:1 digital audio compression (noise tolerant voice grade version also available).

Want to hear more? Give us a call.  
**We tolerate noise others can't.**

WavePhore, Inc. ■ 2601 West Broadway Road ■ Tempe, AZ 85202 ■ USA  
602/438-8700 ■ FAX 602/438-8890

Circle (20) on Reply Card



At **BTS**,  
the power  
of the future  
is now.

**VENUS**<sup>®</sup>  
ROUTING SWITCHER

Now there's a switcher designed to make the routing power of the future a standard today... the new Venus from BTS.

Its flexible 4-in-1 chassis will take you from analog to digital incrementally with simplicity and ease. With the Venus switcher, you can mix video and audio—both analog and digital—in the same frame. And the Venus is readily expandable into larger configurations.

The BTS Venus switcher is future technology that you can apply today. It won't become obsolete like so many other "hi-tech" devices, but will work for you during your entire transition from analog to digital.

So turn to the name that is synonymous with routing power...BTS.

Call for more information on how the Venus can help to streamline your operation.

**BTS**

A PHILIPS AND BOSCH COMPANY

94 West Cochran Street  
Simi Valley, California 93065 USA

(800) 962-4BTS

Outside the U.S. and Canada  
(801) 977-1551

*Creative Television Technology from BTS*

Circle (21) on Reply Card

TABLE 5 — OPERATOR SALARIES

	OPERATIONS MGMT. TOTAL	TV SUBTOTAL	TOP 50	TOP 51 TO 100	BELOW TOP 100	RADIO SUBTOTAL	TOP 50	TOP 51 TO 100	BELOW TOP 100
BASE = ALL RESPONDENTS	447 100%	302 100%	113 100%	98 100%	91 100%	145 100%	47 100%	26 100%	72 100%
Less than \$15,000	9.6%	4.6%	0.9%	4.1%	9.9%	20%	12.8%	26.9%	22.2%
\$15,000 to \$24,999	33.1%	30.5%	17.7%	27.6%	49.5%	38.6%	21.3%	34.6%	51.4%
\$25,000 to \$34,999	25.5%	27.5%	15%	38.8%	30.8%	21.4%	27.7%	30.8%	13.9%
\$35,000 to \$49,999	21.5%	23.5%	32.7%	25.5%	9.9%	17.2%	31.9%	7.7%	11.1%
\$50,000 to \$74,999	7.8%	10.9%	26.5%	3.1%	0%	1.4%	2.1%	0%	1.4%
\$75,000 or more	2.5%	3%	7.1%	1%	0%	1.4%	4.3%	0%	0%
Estimated median	\$27,661	\$29,894	\$40,500	\$29,750	\$22,895	\$22,273	\$30,000	19,375**	\$19,773

# The Digital Audio Cart Machine

People like the sound of Digital Audio. It's revolutionized the way listeners respond to radio. Today, 360 Systems' DigiCart brings consistently great sound to spots and ID's too.

DigiCart delivers the production values of an expensive workstation in a cart-sized format. Seamless back-to-back cuts. Smooth fades. Fast and precise editing. Your production people will appreciate its ease of



operation the first time they use it. But the best reason to go digital is for quality, and DigiCart delivers on every count. Rugged Bernoulli cartridges with a ten-year field track record. Dolby AC-2 data compression that puts six times more audio on every

disk. Optional hard disks by Hewlett-Packard, with a 250,000 hour MTBF figure. And premium audio specs that leave every other cart machine in the dust.

At \$3,995 DigiCart is the most cost effective record-play stereo cart machine on the market today. And it's also the best sounding one ever made. Call us today for a brochure on how DigiCart can bring an even better on-air sound to your station.

# DigiCart™

by 360 Systems

18740 Oxnard Street, Tarzana, California 91356 U.S.A.  
Telephone (818) 342-3127 • Fax (818) 342-4372

Bernoulli is a trademark of Iomega Corp. Dolby and Hewlett-Packard are trademarks of the respective companies. © Copyright 1992 by 360 Systems. DigiCart is made in the U.S.A.

Circle (22) on Reply Card

\$49,999. However, this belies hearty salaries paid for staff in the top 50 markets. Here, the three ranges shift up by one, and therefore cover the \$25,000 to \$74,999 range. The result is that more than 64% of the staff engineers in the top 50 markets make at least \$35,000. A shift to lower salaries for TV staff engineers is evident in the below top 100 markets, where more than 77% of the respondents report salaries below \$34,999.

You can take the three predominant TV staff engineer salary ranges and shift them down one step for radio. Almost 80% of the radio staff engineers earn less than \$34,999. Also, more than 58% of the radio staff engineers make less than \$24,999. Even worse, more than 28% of the respon-

**Remember that the median salaries are only one criterion to consider when comparing your salary.**

dents say their salary is less than \$15,000. In the below top 100 markets, that balloons to 40%. If money is what you want, becoming a radio staff engineer isn't the way to get it.

And don't look for huge raises in broadcasting, because they aren't there. For all job categories, raises ranged from approximately 4% to 5.5%. Executive management and technical management median raises were 5%. Other engineering titles had median raises of about 4%. Most operations personnel received 4.5% salary increases this year.

### SBE certification

Once again, the survey examined the differences between SBE-certified and  
*Continued on page 99*



# Formats come and go. Your routing system shouldn't.

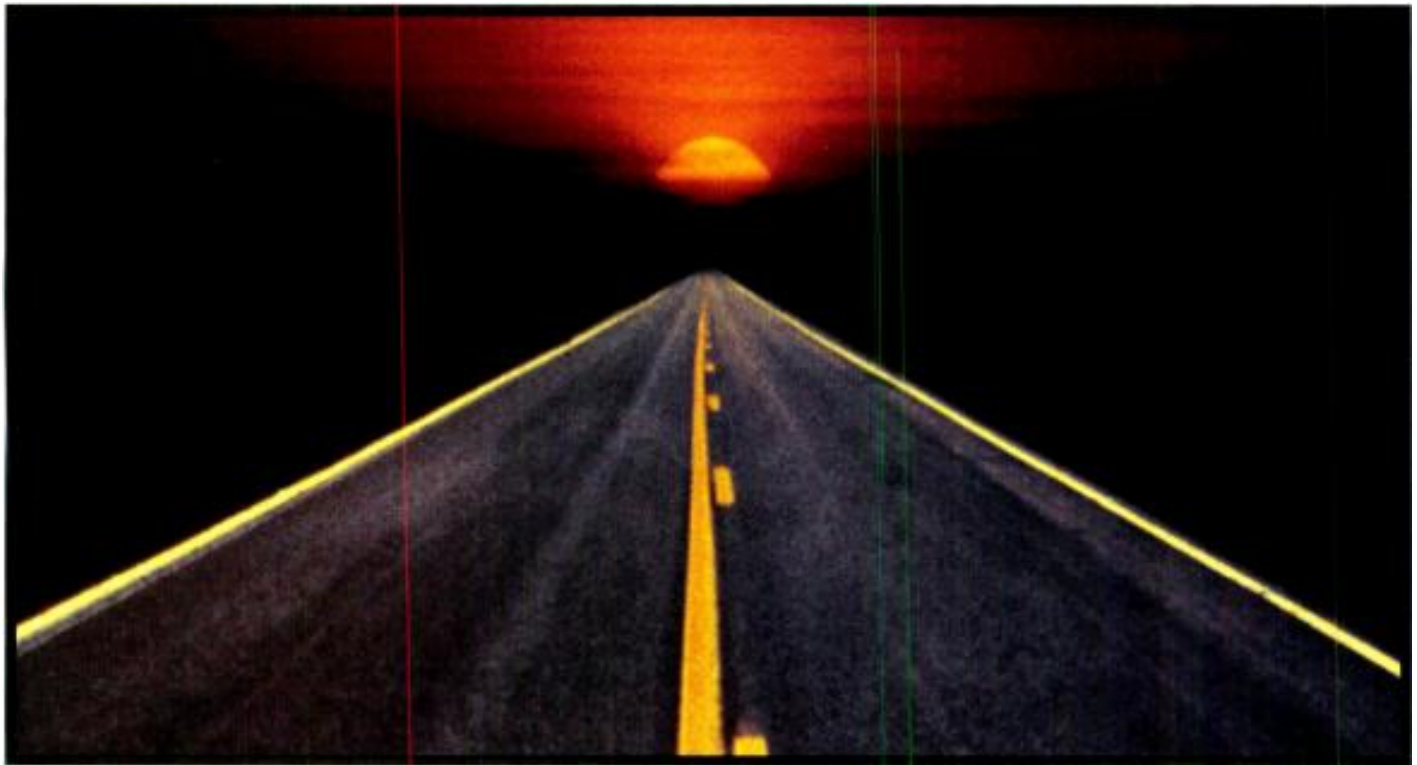

If the television industry can't commit itself to a video format, why should you? Now you can declare your format independence with the Series 7000 Signal Management System from Grass Valley Group.

It's the first system that lets you make the transition from analog to digital, and change video formats – without changing your router. With up to 32 control levels, virtual matrix mapping, and fully programmable source, destination and level names, the Series 7000 is designed for virtually limitless growth.

It all adds up to the fastest, most responsive control system you can use. And best of all, the Series 7000 system is fully compatible with your existing Horizon™ routing system matrices.

Put yourself years ahead. Call your GVG customer representative for full details about the competitively priced Series 7000 Signal Management System. Multi-format capability you can't outgrow.

**Grass Valley Group**

A TEKTRONIX COMPANY

NORTH AMERICA Grass Valley, CA (916) 478-3000 SOUTH AMERICA Miami, Florida (305) 477-5488

Europe Basingstoke, UK (0256) 817817 ASIA Hong Kong (852) 5987118 JAPAN Tokyo (03) 5992-0621

© 1992 The Grass Valley Group, Inc.

Circle (23) on Reply Card

[www.americanradiohistory.com](http://www.americanradiohistory.com)

# Software for production facility management

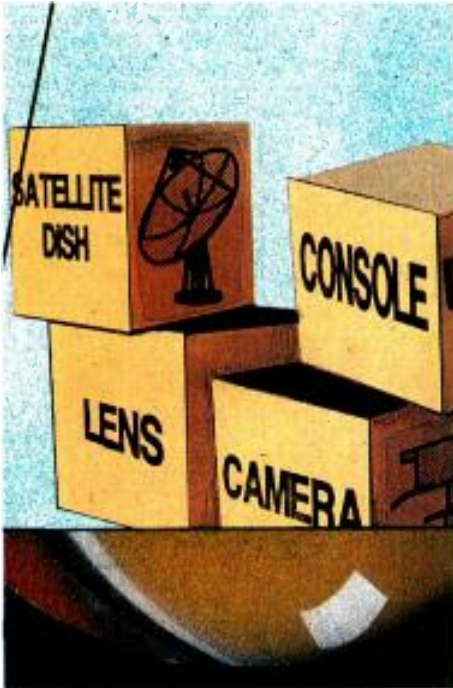

Computers can put dollars and sense into your production facility.

By Chris Leonard

## The Bottom Line

*A broadcast facility's production operation can be a boon or a bust to its bottom line. Finding the right balance of inventory, scheduling, staffing and hardware can be an elusive goal. If a station leases its excess capacity to outside clients, these issues take on even more importance. As elsewhere, the computer may offer a solution. Read on to find out if such an approach is right for you, and how to convert to automated facility management.*

\$

Leonard is a business and marketing consultant to the teleproduction industry based in Woodland Hills, CA.

It's become a familiar refrain: production and operation managers at stations everywhere are looking for new and creative ways to reduce expenditures and increase revenues. Many have found that the shortest route to improved resource management and new market development is via a computer system. Whether a production department remains stable or branches into new areas, the speed, quality and sophistication of such a process can make the difference between forging ahead profitably or struggling to tread water.

The first issue to consider is the motivation for computerizing. What are your objectives? Clarity is a necessary tool in this process. You must be clear and realistic in evaluating what computers can and cannot accomplish.

### What computers can do

One of the most important functions that computers can perform for your production department is give you better information on which to base management decisions. Whether it be personnel or equipment productivity, client status or department profitability, the right computer system can give you timely and accurate information for better informed decisions, and increase the control you wield over your business.

Another benefit is improved cash flow. Through fully integrated, computerized credit checks, your billing, accounts receivable and accounts payable cash management can be greatly enhanced.

This applies whether the finances are handled departmentally or merged into the general station accounting system. Hidden or seemingly lost costs can be tracked, retrieved and appropriately billed.

Inventory management also can be eased. Through the use of advanced tape library programs, raw stock can be maintained at a profitable level, and client inventory can be stored and retrieved more efficiently.

Furthermore, a good system provides a

---

***Be clear and realistic in evaluating what computers can and cannot accomplish.***

---

platform for planning future growth. It can help detect new paths of increased profitability, and help to identify ailing business practices that may either need bolstering or dissolution.

Extremely real but intangible effects of automation include increased customer satisfaction and improved employee morale. Clients can receive timely and accurate information, bids, billings and service. Employees feel more in control, work more effectively and spend their time on more interesting (and less tedious) job functions. In such competitive times for both good clients and good staff, this can



# Increase Efficiency and On-Air Quality

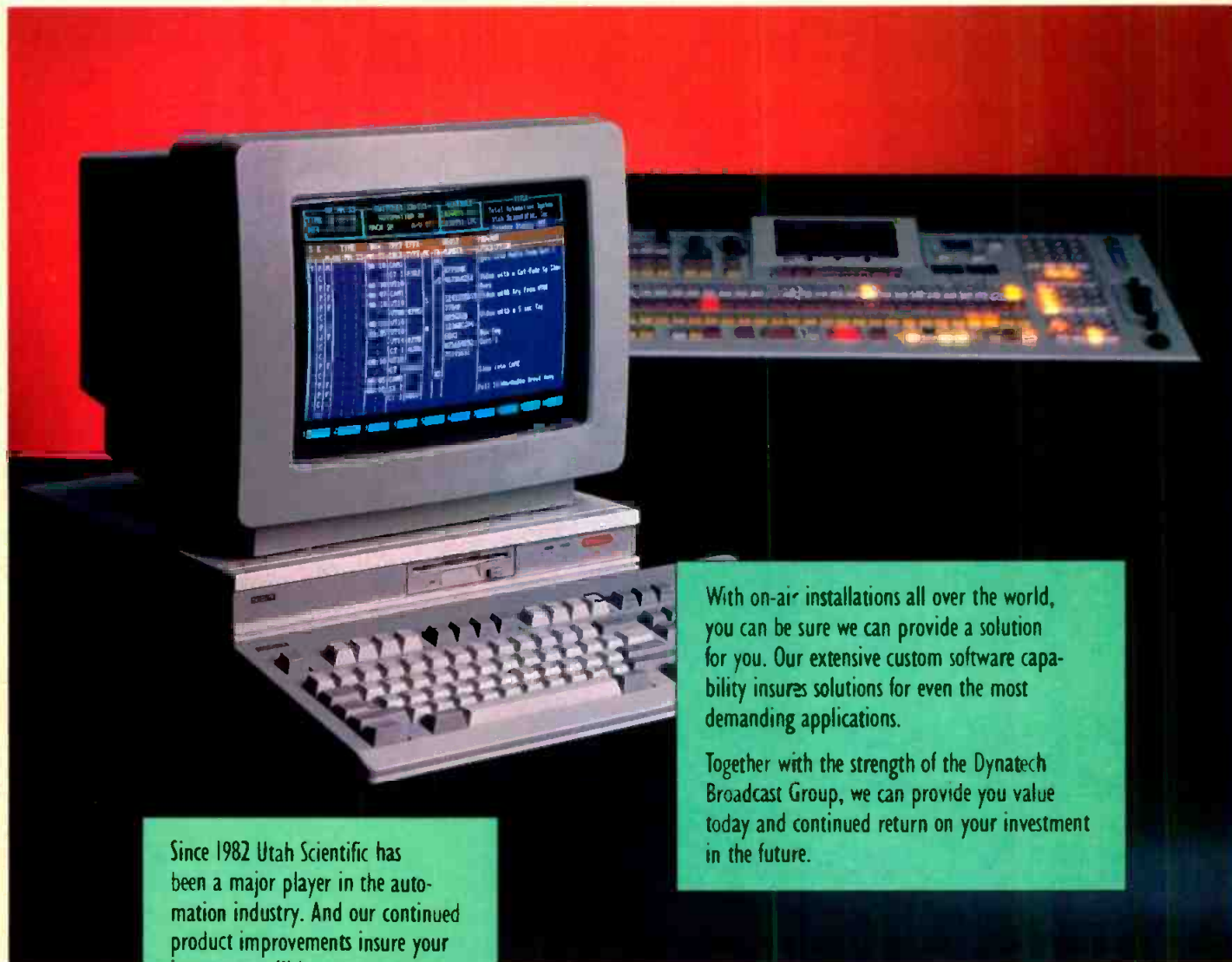

Since 1982 Utah Scientific has been a major player in the automation industry. And our continued product improvements insure your investment will keep pace as your needs expand.

Our systems approach to your automation problems has created a complete family of products. Router Automation System (RAS) offers complete control of the routing switcher. Total Automation System (TAS) provides you with a 100% accurate as-played list, allows instant manual intervention, and provides complete reconciliation to your business traffic system.

With TAS you can be sure the right spot will air at the right time, boost station performance, free operators for more important tasks.

Instead of a headache, managing the playlist becomes a simple, easy job.

With on-air installations all over the world, you can be sure we can provide a solution for you. Our extensive custom software capability insures solutions for even the most demanding applications.

Together with the strength of the Dynatech Broadcast Group, we can provide you value today and continued return on your investment in the future.

DYNATECH BROADCAST GROUP

**US** UTAH SCIENTIFIC, INC.

V I S I O N.  
V A L U E.™

To GET THE PICTURE Contact US at:  
4750 Wiley Post Way  
Salt Lake City, UT 84116  
800-453-8782 or 801-575-8801

Circle (24) on Reply Card

# SYNC To An All Time Low.

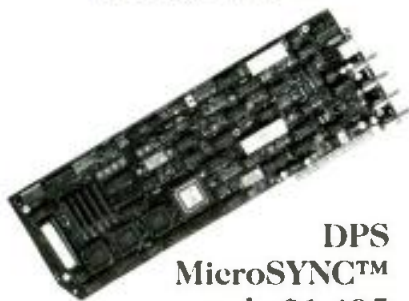

DPS  
MicroSYNC™  
only \$1,495

It's the first TRUE Video Synchronizer on a PC® card, giving you an affordable way to synchronize satellite, network and CATV feeds or any other



remote video signal. Featuring 4-Field Composite Processing for transparent NTSC performance, you can plug DPS MicroSYNC cards into one of our ES-2000 Series multi-channel rackmount expansion systems or any IBM compatible computer. Either way, you'll get broadcast quality performance for a very attractive price. So call DPS today, and get the low-down on the new MicroSYNC.

**SEE US AT SMPTE BOOTH 837**



**DIGITAL**  
PROCESSING SYSTEMS INC.

*If you want to look your best*

11 Spiral Drive • Florence, Kentucky 41042  
• (606) 371-5533 Fax: (606) 371-3729  
55 Nugget Avenue, Unit 10 • Scarborough,  
Ontario M1S 3L1 Canada • (416) 754-8090  
Fax: (416) 754-7046

MicroSYNC™ is a trademark of Digital Processing Systems, Inc.  
PC® is a registered trademark of IBM Corp.

Circle (25) on Reply Card

be the most crucial aspect of all.

### What computers cannot do

People are often unrealistic about what they expect a computer system to do. Remember that a computer is only a tool — it cannot *think* for you. It cannot replace qualified personnel or your accountant. It will, however, give these people the opportunity to be more productive and efficient.

A computer also cannot make up for poor manual procedures or solve all of your business problems. Almost everyone knows the "garbage in-garbage out" concept. At best, automation provides a framework for establishing clean and concise procedures and business practices.

---

***The right computer system can increase the control you wield over your business.***

---

Keep in mind that most computer software does not take kindly to changes made by amateurs. Software is extremely complex and interwoven. If clear documentation does not accompany any change, staff can be left in the dark on how to apply these changes. The best idea is to request your software supplier to make any necessary modifications. If this is impossible, as a last resort, you should use an experienced programmer to make the changes, and to thoroughly document them.

### Common mistakes

The following are some general, but crucial, pitfalls to avoid:

- *Not accepting responsibility.* Consultants, management information systems (MIS) staff and vendors all have valuable input, but top management must accept ultimate responsibility for the successful conversion to any computerized system.
- *Not doing your homework.* A committed project leader must see the conversion through from initial internal analysis all the way through implementation.
- *Ignoring hidden costs.* Don't forget to figure in the staff hours that will be required to study and implement the system.
- *Assuming that your station will immediately appreciate the new system.* People resist change. Involve them at every possible stage, and allow enough time and training for them to become comfortable



Courtesy of Xymox Systems

with the new procedures.

### The process of selection

No matter how formal or informal the process may be, there are four essential steps to selecting a system that will meet your needs.

1. *Internal evaluation and needs assessment.* This is the first and most important phase. It is the foundation upon which your system will be based. A comprehensive review of current practices must be completed. You might begin by asking these questions:

- Where is there a duplication of effort (e.g., data entry)?
- Specifically, how are areas of scheduling, job costing, invoicing, bids, sales, lead management, tape management, personnel, equipment and facility management handled?
- What is the flow of work?
- What is the current or desirable client profile?
- What more should be known about clients and how can it be accessed?
- What areas represent losses or missed opportunities?
- What areas represent anticipated growth?
- What are common complaints by staff (e.g., double booking, lost work orders, lost client tapes)?
- What reports or information are needed for better control and better management of business?
- What is the facility's current financial situation, cash flow and credit line?
- Is the current staff capable of handling the conversion to automation? What steps should be taken to prepare them?
- What needs for training are anticipated?

2. *Staff input.* After the initial management review, each employee should be asked for input in terms of improvements upon current practices and wish lists. All suggestions should be substantiated as much as possible by what the staff thinks expected results will be. This approach can provide a more realistic and comprehensive cost/benefit analysis.

3. *Cost/benefit analysis.* Such evaluation should take place in an environment that has not prejudged the need for computeri-





Some things you outgrow.  
Some you don't.

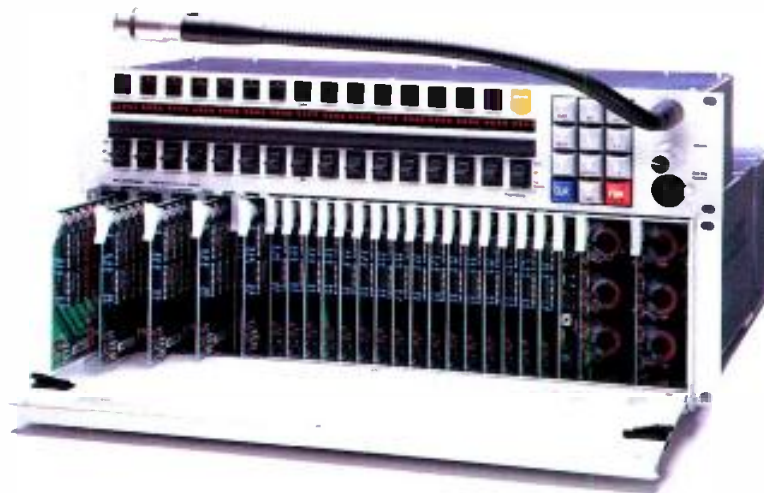

*The RTS CS Series Digital Intercom System*

It begins with a compact 50 x 50 capability, and can grow to 150 x 150. And beyond.

The CS Series lets you start with the configuration you currently need and expand as your needs do. Or go straight to the max: a fully out-fitted CS9700 system can handle a matrix of over 450 x 450.

Completely adaptable to a wide variety of production scenarios, its modular design and user programmability allow you to quickly set up or reassign your options in real time: point

to point, single point to multi-point, party lines, IFBs, telephone interfaces, two-way radios and more. Even just minutes before a deadline.

Find out how flexible and affordable a digital intercom can be. In New York, call (201) 891-6002; in the Midwest: (313) 360-0430; in Burbank, CA: (818) 566-6700.

It's one piece of equipment you can depend on for years—no matter how big you get.

**RTS** BY **TELEX**



OTARI

OTARI AUDIO UNIT  
DIGITAL AUDIO RECORDER - EDITOR PD-668

PRODISK 400

OTARI AUDIO UNIT  
DIGITAL AUDIO RECORDER - EDITOR PD-668

PRODISK

OTARI AUDIO UNIT  
DIGITAL AUDIO RECORDER - EDITOR PD-668



# There are a lot of multitrack digital audio workstations out there, but only one with Otari's name on it.

Right now, it seems like everyone is building audio disk recorders. The difference is, we'll still be building them three years from now.

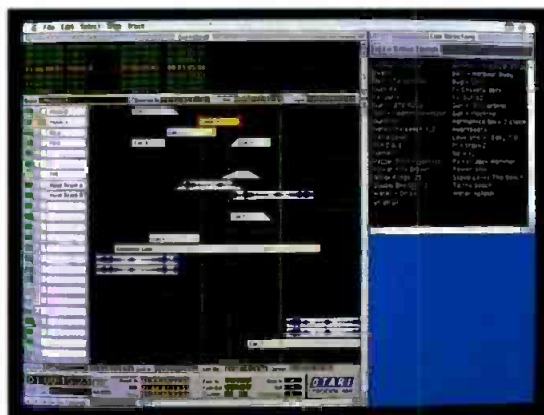

*ProDisk's new Graphical User Interface for Digital Editing (guide™) combines several windows into an intuitive, easy-to-use display. Far from just an EDL list, the relationship between all tracks is shown.*

Sure. Otari's new ProDisk™ 464 is the only system to give you up to 64 tracks. True, it's one of the few to use standard SCSI devices so you won't be locked-in as technology advances. But as much as we'd like to tell you about the rest of its great features, the most important thing about the ProDisk system (given the changes that are certain to occur in this technology) is the Otari name up front — a name that professionals around the world have come to trust for product support and customer service.

Speaking of the future, you can be sure that ProDisk's open architecture allows for hardware, software, and storage media enhancements as they come along, and that it's plug-compatible with your current equipment. And if you're familiar with Otari's product philosophy, you know you're getting the best possible value on the market.

Most of all, you can be sure you've purchased "The Technology You Can Trust."

Call Otari at (415) 341-5900 for complete information.



**OTARI**

**Otari Corporation**  
378 Vintage Park Drive  
Foster City, CA 94404  
U.S.A.  
(415) 341-5900  
Fax: (415) 341-7200

Circle (27) on Reply Card

Otari Corporation  
U.S.A.  
(415) 341-5900  
Fax: (415) 341-7200

Otari Inc.  
Japan  
(0424) 81-8626  
Fax: (0424) 81-8633

Otari  
(UK) Ltd.  
United Kingdom  
(0753) 580777  
Fax: (0753) 42600

Otari  
Deutschland GmbH  
Germany  
02159 50861-3  
Fax: 02159 1778

Otari Singapore  
Pte., Ltd.  
Singapore  
(65) 743-7711  
Fax: (65) 743-6430

Circle (28) on Reply Card

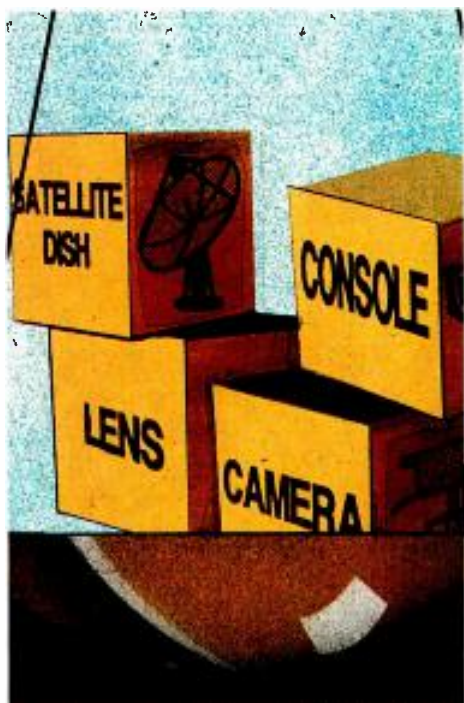

# Making money with technology

Put your thinking cap on and your equipment to work.

By Marvin C. Born

## The Bottom Line

*Much of the hardware a station owns may not earn its keep. Opportunities for improving the station's bottom line may exist by simply using this hardware in different or more efficient ways. In other cases, a small additional investment in new equipment can be turned into a profit machine. Creative applications of technology are the crux of today's engineering talent at broadcast facilities. They also may be the best proof of an engineer's worth to management. This article will give you a few examples.*



Born is vice president of engineering for WBNS stations, Columbus, OH.

The broadcast industry has moved from spark, through tubes, to transistors, integrated circuits and, now, microprocessors. It is probably safe to say that thousands more active devices are contained within the processor used to write this article than there were in the entire broadcast facility of yesteryear.

Yet, for all of their vast quantity, these devices spend most of their time *waiting for input*. Processors are not being used to their fullest potential. The same can be said for some of the technology within stations in general. That potential power could be used more efficiently to increase the "financial input."

For example, most facilities have at least one personal computer. These machines are useful for accounting, word processing and financial planning. To stretch their usefulness, think in terms of how they can reduce costs or increase revenue.

### Information management

Most of us see and hear about the "ratings" four or five times a year. The data from those ratings is available (for a fee) on floppy disks. The data contains information that tells you how many people are watching your station, as well as who they are in terms of gender, age, location and income. Furthermore, similar data is available for your area that is indexed to zip codes and product preferences.

Armed with the proper program, your computer can compare your ratings to various consumer groups. Not only can

you tell your station's commercial clients how many people watch your news, but you also can tell them what kind of products your viewers may buy and what their income is.

You can turn this information around and possibly gain new clients by searching for their customers in the time periods of your broadcast day. For example, someone from your sales department can walk into a business and say, "There will be 50,000 people who buy your product watching my station at 11 p.m."

***Most of a microprocessor's time is spent waiting for input.***

### The wireless salesperson

Taking technology a little further, imagine what might happen if your sales staff had laptops with cellular modems. The account representative could access the traffic system and obtain the avails directly for the client on-site.

Here is one scenario: It's 5 p.m. on Friday, 10 minutes before the log closes for the day, and there are still several avails after midnight and Saturday and Sunday. This client can and will buy all those positions at a discount if he knows they exist. The client purchases the spots on the



FIRST

*To Build and Ship Air-Cooled IOT Transmitters*

FIRST

*Public Demonstration of High Definition Television Broadcasting*

FIRST

*To Develop and Ship Solid-State FM Radio Transmitters to 8kW*

FIRST

*To Offer Self-Correcting Intelligent Controllers*

FIRST

*To Offer All Current Transmitter Amplification Technologies*

FIRST

*To Develop a Digital Quality FM Exciter*

FIRST

*To Offer Transmitter Power Levels From 1 W to 240kW*

## HOW IN THE WORLD DOES TTC DO IT?

Only one company keeps coming up first in the broadcast transmission industry - TTC. Surprised? Don't be. Only TTC offers all five current television amplification technologies. And, that same company pioneered the development of solid-state FM transmitters. In fact, TTC has been designing and building products for the broadcast transmission

industry around the world for 25 years. No other company can offer you our knowledge and experience in low power television, translators/transposers, high power television and FM radio. No other company is as dedicated to supplying you with the highest quality broadcast equipment to suit your needs. That's how TTC does it.

FIRST.

*A Global Force In Broadcast Transmission Technology*



TELEVISION TECHNOLOGY CORPORATION

650 S. Taylor Ave. Louisville, CO 80027 USA Facsimile: (303)673-9900 Telephone: (303)665-8000

Circle (30) on Reply Card



air, and the station sells out the day.

Certain businesses will buy this way, and your sales department knows who they are. Engineering can make sure those businesses run at the last minute. Also, some clients consistently make last-minute changes. Make those changes possible.

Now, consider the ideal system for this process. The account representative sells

---

***Think in terms of how to reduce costs or increase revenue with the station's computers.***

---

a block of spots for tonight, and enters the information directly from the client's office. The sales department processes and confirms the order. Next, traffic downloads the changes to the master control computer via a local area network, and the cart machine loads the break. You can make changes right up to air time.

The cart machine in this ideal system holds 500 to 1,000 mother tapes, each containing 30 commercials. Because two copies of each spot are in the system, 15,000 commercials are available. Our imaginary client has several spots in the machine, allowing the order to be placed from his office. Master control runs the spots "after midnight," and passes the as-run log back to traffic, who bills the client the next morning. The ideal system has no slow-moving paper to hamper the system.

Is this pie in the sky? Not quite. The magic cart machine is real. Several manufacturers have machines housing 1,000 or more spots under computer control. The laptop with cellular modem is widely available, and several companies offer master control automation systems that are microprocessor-controlled via a local area network.

**Reactive (spot) loading**

Another possibility to consider is the "premium" sale for the account reps. An important client wants to run one spot if the local college team wins (or is winning), but wants a different spot if the team loses. Can you do that? With computer-controlled switching and cart machines, it's easy. Load both carts in the machine and tell traffic to download the log in the most likely scenario for the game outcome. Your sports department can give you an idea which way the game should go. Master control has at least a 50/50 chance of the log being correct. If the game goes the other way, make a log edit and reorder the carts. This can be done at the station or remotely via cellular or wired modem, in

about 60 seconds. Most systems allow this to be performed up to two minutes or less before the break runs.

This is a win-win situation for the sales department. The client receives special service, and the station will get a premium for that special service in the form of additional revenue and/or good will with the customer.

A competent engineering department can handle such requests, but a great engineering department will suggest such a service. The days of, "Sorry, we've never done that," are gone.

**Opportunities in ENG**

In most of today's markets, the electronic newsgathering (ENG) vans are staffed by three people: talent, a photographer and a van operator. The van usually has a 42-foot mast, a generator, IFB and a videotape system — usually an editor. Larger trucks also have a battery/inverter system as a backup to the generator.



The average van costs approximately \$100,000 before tape equipment.

The cost of the crew is another factor. Assume a photographer or technician in your market makes \$35,000 per year. Add your company's share of Social Security, health and dental insurance, plus the retirement and life insurance. Those figures can add another \$10,000 to \$15,000 to the salary. Therefore, the company is looking at \$45,000 to \$50,000 per person on that truck. But what if the truck could be operated by only one person (in addition to the talent)? The company could save \$50,000 per year. (Plug in the real numbers for your market and you'll get the idea.)

The next time a technician retires or moves on, use the salary to build a minivan. Then, let the photographer drive it to assignments. The company likely would have purchased a vehicle for this person's transportation anyway, so the \$50,000 can actually go toward the mast and microwave equipment. The news department probably will jump at the chance to have its photographers drive

ENG vans instead of radio cars during their daily work.

From an engineering perspective, several issues must first be resolved. Can one person really operate such a vehicle? Is a short mast enough? What about the tape system? How much power is required, and where does it come from?

Although engineering usually wants to use the best equipment and maintain the most redundancy for any possibility, consider how often you really need a 42-foot mast. Or, ask yourself how often you need the back-up batteries. When was the last time the generator failed?

The answers to those questions may surprise you. A 20-foot mast can do a lot of ENG shots. (Remember when 4-foot dishes were used on the roof of the truck?)

Build one truck and work it two shifts per day, seven days a week. It will last approximately two years. Then, remove all the equipment and build it again in a new chassis.

Roughly conceptualize your expenses in the following fashion: A minivan chassis costs about \$17,000 with the usual equipment. Logos add approximately \$700. A microwave system costs around \$19,000, and a mast runs about \$4,000. Add another \$5,000 for radios, IFB and miscellany, plus another \$5,000 for the basic modifications to the truck. That's the beginning. The finishing electronic work can come from the station's maintenance department. Total cost will be close to \$50,700. Although you could say that the vehicle would be purchased anyway as a radio car, you can get the complete package for the price of one year's salary. The second year you can buy another van, or pass the savings to the bottom line. The replacement cost after two years is another \$22,000. You only lose the installation costs of \$5,000 because, regardless, you would be replacing a vehicle.

The biggest advantage of this van is that it is on the scene when the photographer arrives. The station also has one more

---

***Imagine what might happen if your sales staff all had laptops with cellular modems.***

---

microwave truck on the street — and then another and another.

On the negative side, the short mast has less range than a normal van. To counteract this problem, dispatch a full-size van to the scene when the small van's range capabilities are exceeded. The assignment desk will have to be aware of the limitations of the small vans (and the local ter-



**There's more than one way to get to digital video.**



**SONY**

## For More Detailed Directions To The World Of Sony Digital Video, Get The Book.

### You Can Get There From Here.

Whichever path to digital is the right one for you, Sony can show you the way by offering the most extensive, most flexible line of digital video recorders available today. Whether D-1 or D-2 is the appropriate choice, Sony makes it easier for you to get there.

There's no better way to ensure top quality in your video production than by starting with the highest quality recorded image. The best format for video acquisition is still component. So why invest in lesser quality?

Thanks to our newest Betacam SP® recorders with digital inputs and outputs, your current Betacam SP camcorder is all you need to start the digital production process. The BVW-D75 Recorder/Player and the BVW-D265 Player can convert your component analog video signal directly to either component serial digital or composite serial digital, respectively. So no matter where you're headed in the digital world, Sony can take you there.

And, in addition to D-1 component and D-2 composite digital VTRs, Sony offers a complete family of digital switchers, digital routers, digital multi-effects and digital/analog converters. And now we have the Serial Digital Interface to put it all together.

So no matter when, where or how you decide to move to digital, Sony is ready to get you there.

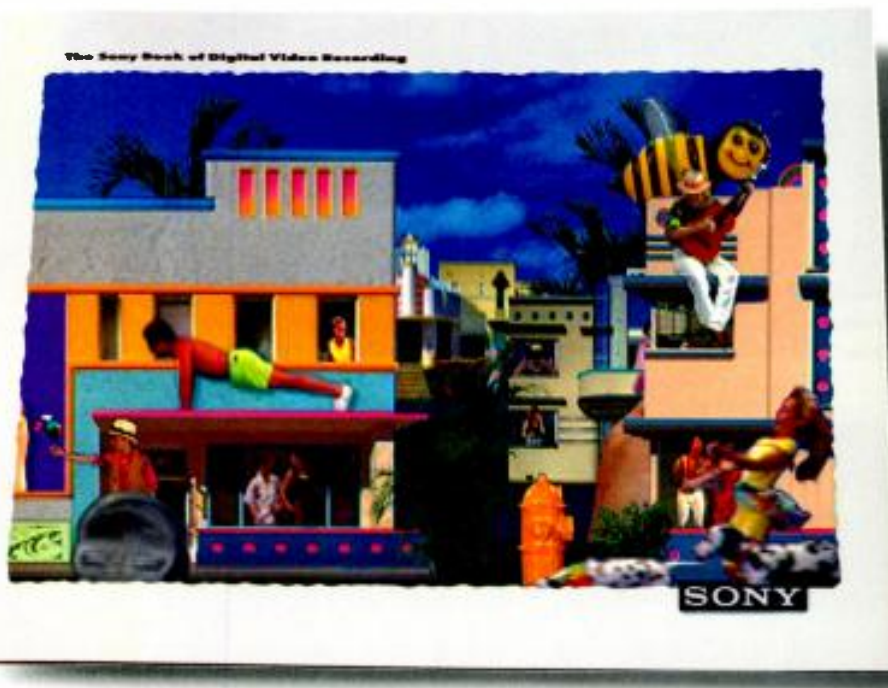

Actual image generated from Sony D-1.

### Make The Right Connections.

To make it easier to work in the digital world, Sony helped develop Serial Digital Interface (SDI).

SDI uses nothing more than a familiar coaxial cable for digital to digital interconnection between composite and/or component devices. It allows for quick, easy and efficient connection. It even allows analog VTRs (such as Betacam SP products with SDI inputs and outputs) to be readily integrated into digital production systems.

SDI sounds simple to use. And it is. It's the product of years of research spearheaded by Sony. The result: wiring, connecting and timing a digital video suite has become simple to achieve.

You've now read just the beginning of the Sony digital video story.

Sony provides just about everything you'll need for the journey into digital recording. Whether you're just getting started or well on your way to a full digital system, we're on hand to help you go the distance. And only Sony offers such an unparalleled reputation for product quality and reliability plus experience and support.

If you'd like more details, call 1-800-635-SONY, ext. 814. We'll send you the Sony Book of Digital Video Recording.

We think you'll find it compelling reading. And further proof that, on the road to digital, the best companion you can have is Sony.

©1992 Sony Corporation of America

Sony, Betacam SP and Dynamic Tracking are trademarks of Sony.

Digital frame produced by Forti-Layne Entertainment in cooperation with Limelight Video.

# SONY

Sony Business and Professional Group  
3 Paragon Drive  
Montvale, New Jersey 07645.



rain), and dispatch accordingly. However, no time is lost, because most news operations dispatch all vans from a central point. The small vans also lack redundancy. If the power fails, then the signal fails. Nevertheless, the microwave system of the small van can be battery powered from a large (diesel-type) truck battery, and minimal loss of shots will occur.

The biggest problem is the concept of a 1-person truck. One person can be in only one place. When the shot is just outside the truck, things are fine. If the shot is inside on a long cable, the operator will have difficulty running back and forth be-

tween the shot location and the truck. However, small vans are quick to set up. The mast is fast, and you don't have to worry about jacks. Just put up the mast, set the shot and spool the cable. You will find that some people like the independence of their own truck, while others loathe the idea of working solo. Just assign the truck to someone who expresses an interest in the idea. Those people probably will make themselves known as the truck is being assembled. Part of the acceptance process involves building the truck in the station's shop and allowing the possible driver/photographer to influence

its design.

The basic concept in using small vans combines common sense with a change in the basic thinking process of the people involved. If these kinds of approaches seem like they'll work, give them a try at your station.

This article contains a few ideas that may be groundbreaking to some and yesterday's news to others. In either case, remember that these are just a few of the ways you can increase revenue for your company by using new technology in different capacities.

## Better backhaul using Switched-56

By Daniel Joffe

What do you do when your high-priced on-air talent wants to work at home? Or, how do you get the feed from the ballpark back to the station? And what about that special session of city council that you have to cover?

Analog telco program circuits are a costly and relatively untimely option. You could use a plain old telephone service (POTS) line, but the lack of fidelity can be annoying to your listeners, especially for longer feeds. You just need a high-fidelity remote connection for a few minutes or hours. What do you do?

Radio networks and some forward-looking stations are getting affordable high-fidelity transmission from remote locations by using *Switched-56* data transmission services, now offered by most local and long-distance telcos.

As the name implies, Switched-56 is a dial-up type of service. Telcos handle billing in a similar fashion to POTS, in that you pay a one-time installation charge, a monthly service fee and by-

the-minute charges for long-distance (and, in some cases, local) calls.

All of these fees generally cost a small to moderate amount more than the equivalent costs of POTS. However, this makes it extremely cost-effective (especially for long-haul use) relative to telco program circuits, because a Switched-56 path can provide the audio equivalent of an 8kHz telco loop. (Per-minute long-distance fees are almost identical to POTS costs — a coast-to-coast Switched-56 call averages less than 30 cents per minute. Large scale users may pay half that amount.) Add the fact that Switched-56 service is *bidirectional*, and the picture becomes even brighter. This means that a single circuit can bring the remote audio feed into the studio and simultaneously return a cue or off-air feed (also at 7.5kHz bandwidth) to the remote site at no additional cost.

### What you'll need

To derive this performance out of the Switched-56 network, some special terminal hardware is required at each end, as shown in Figure 1. The *channel service unit/data service unit* (CSU/DSU) is

the equivalent of the POTS telephone instrument, handling call direction, control and status indication. Anyone using Switched-56 needs a CSU/DSU on each end of the call. For high-fidelity audio use, an additional codec is required on each end, which is used to compress and reconstruct 7.5kHz analog audio to/from a 56kbit/s digital signal. (Most of these codecs use the internationally standardized CCITT G.722 bit-rate reduction algorithm.)

CBS Radio now uses Switched-56 service with G.722 coding for much of its sports backhaul, including all of its major-league baseball games, and for the 1992 Winter and Summer Olympics coverage. Audio from the Republican and Democratic National Conventions this summer also was backhauled by CBS Radio via Switched-56. The network's technical managers estimate that backhaul costs for a typical baseball game are one-tenth that of the methods used previously.

### Switched-56 economics

Monthly service fees for Switched-56 vary widely from state to state. (Differ-

Joffe is director, Network Access Systems at Integrated Network Corporation, Bridgewater, NJ.

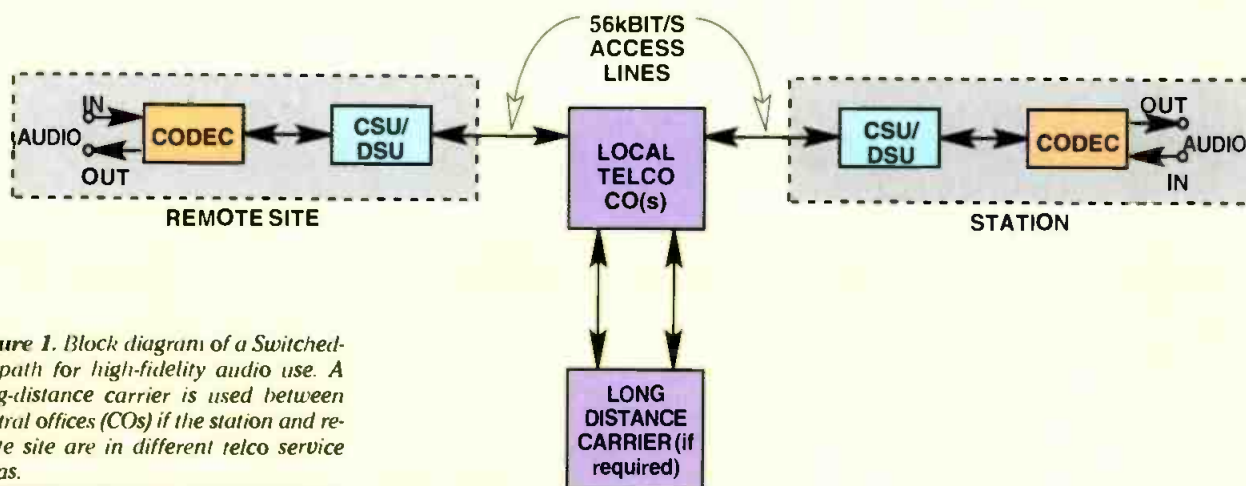

**Figure 1.** Block diagram of a Switched-56 path for high-fidelity audio use. A long-distance carrier is used between central offices (COs) if the station and remote site are in different telco service areas.

ent telcos quote anywhere from \$45 to \$200 per month, with most in the \$50 to \$80 range.) In some cases, the installation charge can be steep compared to a POTS line, but it is typically well below the price of installation for an 8kHz program channel. (Switched-56 installation fees quoted by telcos range from \$150 to \$725 per line, with most in the \$300 to \$400 range.) When comparing costs, remember that you get a cue/backfeed channel essentially for free with Switched-56. Analog program circuits from the telcos are a dying breed anyway, and telcos have begun to phase out such service, especially in long-distance applications.

You might consider a *non-switched* (i.e. dedicated) digital circuit of the same basic variety (typically referred to by telcos as *DDS* or *DSO* service), if it is available. However, this only makes sense if you need the circuit between a pair of nearby points for more than two to four hours per day (weekday business hours), or more than eight hours per day between a pair of long-distance points. For shorter durations or for feeds from multiple originating locations, Switched-56 service is usually more cost-effective. In

some areas, another switched digital service called *Integrated Services Digital Network* (ISDN) is becoming available, offering bidirectional 64kbit/s paths. Although this shows promise for the future, Switched-56 service is far more widely offered today. (Where ISDN is offered, it may actually be cheaper than Switched-56 service, but the locations accessible on the ISDN network are still quite limited. The Switched-56 and ISDN systems use different terminal hardware, but a Switched-56 endpoint can call an ISDN endpoint without difficulty. Audio codecs are typically switchable for use with either system.)

If this all sounds a bit daunting, a growing number of companies offer circuit-booking services free of charge to clients. Operating much like travel agents, these operations collect fees from the telcos whose lines they book. A radio station need only tell this circuit "broker" the particulars of when and where service is needed, and the broker will do the rest, arranging for the best possible routing and rates.

Switched-56 also makes a cost-effective STL backup, and it can work well for ad-hoc network transmissions.

Furthermore, it can be used between advertising agencies and stations for real time feeds of last-minute changes to commercials, or for occasional news feeds to stations from off-site bureaus. Perhaps its best application is local or long-distance remote backhaul of long-form programming, where it saves time and money compared to leased program lines or satellite feeds. And your listeners most likely will appreciate the good sound.

- For a free guide to Switched-56 service in the United States, with rates, names and contact numbers at each telephone company, circle Reader Service Number 306.
- For more information on Switched-56 equipment, circle Reader Service Number 307.

**Acknowledgment:** Thanks to David Lin of Corporate Computer Systems, Holmdel, NJ, for his contributions to this article. □

## Hidden profits for radio

By Steve Walker

There are several ways that any radio station — AM or FM, large or small — can increase revenue.

- **SCAs.** If you have an FM with an unused (or under-used) SCA, put it to work for you. Although background music services are generally moving away from SCA and into VSAT distribution, there are many new applications for your SCA. These include data transmission, reading services for the blind, second language translations of your programming or that of your AM sister station, simulcasting of a local TV station and paging.
- **Tower leasing.** These days, the larger nationwide paging companies typically seek out 100kW FMs with SCAs for paging. If this doesn't describe your station, you can probably rule out the big paging operations as clients. However, a little investigation may uncover several possible local tenants for your tower's extra load capacity.

Some local paging companies still use their own transmission systems instead of SCAs. Perhaps one of these companies in your town could use a better antenna location. Many automobile service companies, delivery services and others use 2-ways and could possibly benefit from what you have to offer as well.

LPTV stations often look for stations with existing towers rather than purchas-

Walker is a consulting engineer based in Dallas.

ing their own. If your local college has an LPTV operation or even a radio station, contact them to see if they're interested in what you have to offer.

- **Studio time.** Unless your spot production schedule is so tight that even your own people can't seem to get enough production time, you can use this room to make money for your station around the clock. With the decreasing prices of MIDI equipment, you can outfit your production room as a simple general-purpose recording studio, and lease time at anywhere from \$15 to \$100 an hour.

If your only production room is already too cramped or too busy, a little market research may tell you that it would pay to build an additional room.

- **Phones.** The possibilities for making money with the phone system are almost endless now that 900 numbers are so easy to acquire. But if you want to stay away from the stigma often associated with 900 numbers, there are still ways to generate income through phones.

Telephone interface devices are available from nearly any broadcast equipment dealer, and some can handle a virtually unlimited number of lines. The simplest of these boxes can cost under \$100, and it can control one of your existing cart machines.

You also might consider working with an existing voice-mail provider to offer your own information on their lines — again, sponsored. Companies that provide services, such as *Select Talk* or *On*

*Call*, offer users the ability to call a single number and press the appropriate 4-digit code to hear the time, sports, weather, news, local events or the joke of the day.

If you already have a voice-mail system at your station, you can easily create your own version of an interactive information system, charging a reasonable fee to sponsors for each menu item they would like to present.

- **Desktop publishing.** Some stations use desktop publishing capabilities to create a substantial income stream. For a few hundred dollars, the sales staff can generate thousands in print advertising in a special tabloid that your station could produce for seasonal events, such as back-to-school, Christmas and the Fourth of July.

- **The radio store.** Other stations generate income by running their own "stores" at which they sell autographed photos of TV, movie, music and sports stars, and a selection of clothing, coffee mugs and other promotional items. The store is plugged on the air often. This idea should be tailored to the target audience of your station, and would probably work best for CHR, urban or contemporary country stations.

For more ideas on how to make money with technology in radio, keep a close watch on industry trade journals and newsletters. CompuServe's Broadcast Professionals Forum (GO BPFORUM) and SBE newsletters from your own and other chapters. □





# BIG EASY.

The M700 is a 32-buss production console series that combines sonic purity and a familiar, flexible architecture in standard configurations up to 128 input channels. Designed using a minimal number of active components, the M700's signal path is clean and efficient, which results in a natural sounding mix that's open, robust and transparent.

The ease and flexibility of the M700 Series can be extended by means of TASCAM's new Moving Fader Automation (MFA) package, a full-featured, stand-alone automation system which can be enhanced with a computer as a display terminal. The very responsive MFA package includes TASCAM-designed motorized faders with 12-bit resolution, along with capabilities for sub-grouping faders, mutes and solos.

If you haven't yet seen the remarkable M700/MFA production console in action, you can easily do so by calling (213) 726-0303. Or by writing TASCAM, 7733 Telegraph Road, Montebello, CA 90640.

## TASCAM II.

© 1991 TEAC America, Inc.

Circle (31) on Reply Card

[www.americanradiohistory.com](http://www.americanradiohistory.com)





# Closed-captioning for TV

Soon, the hearing impaired will have greater access to the rich world of television.

By James Goodhart

## *The Bottom Line*

*The license of every broadcast facility includes a mandate to serve the public trust. That mandate primarily requires that program material meet the needs of the community of service. A logical extension is the requirement to make the program material accessible to all, including the hearing impaired. New regulations for consumer products require that closed-caption decoders be integral to the receiver as a means to further implement captioning. Other financial opportunities will also become available to the broadcaster with this implementation.*

**\$**

Goodhart is strategic marketing manager for Zilog, Campbell, CA.

Television has brought a vast amount of information into our homes. This access to the world's data and activities provides tremendous opportunities for almost any viewer. Soon, that will include the hearing-impaired who, until recently, have been unable to take full advantage of the broadcast fare. An amendment to Part 15 of the FCC regulations implements "Provisions of the Television Decoder Act of 1990" (GEN Docket No. 91-1, dated April 15, 1991) and requires that TV receivers with 13-inch or larger CRTs must incorporate line 21 closed-captioning capability by July 1993. Through this capability, the hearing-impaired will gain greater access to the rich world of information that many take for granted.

Benefits of closed-captioning go beyond simple subtitling. A variety of services — on-line TV guides, emergency broadcasting and many other text services — are possible and are being instituted. This article describes how a one IC-level solution can implement the new law and offers opportunities for innovative design from an applications point-of-view.

### **What is closed-captioning?**

Closed-captioning is a process by which text, representing the audio portion of a TV program, is encoded in digital form into scan line 21 (odd field) of the NTSC video signal. In the receiver, this information is recovered by a decoder and displayed as subtitles, enabling the viewer to follow the program dialogue without au-

dio. Essentially, such captions can be placed in nearly any position on the screen. The location is often used to more clearly indicate the speaker (in the case of dialogue).

Closed-captioning becomes visible only with equipment incorporating a special decoder to receive and display the information. The user may elect to enable or disable the display. (Open-captioning, by

---

***An amendment to Part 15 of the FCC regulations requires that TV receivers with 13-inch or larger CRTs must incorporate line 21 closed-captioning capability by July 1993.***

---

contrast, becomes part of the video image and cannot be controlled by the user.) Because it allows individuals the capability of the optional display, closed-captioning is an ideal technique for conveying other information as well: On-line services and supplemental text information are areas for which closed-captioning holds tremendous potential.





## WE MAKE IT VERY, VERY HARD TO BLAME IT ON THE TAPE.

While we can't fix all your problems, we can make sure 3M tape isn't one of them. You get consistently high quality in every audio and video format. And flawless support from the people who know more about tape than anyone. **We won't be satisfied until you are.**



3M Professional Audio/Video Products Div.  
3M Center, St. Paul, MN 55144  
36USC380 © 1992 3M

**3M** |   
Worldwide Sponsor 1992 Olympic Games

Circle (32) on Reply Card

[www.americanradiohistory.com](http://www.americanradiohistory.com)

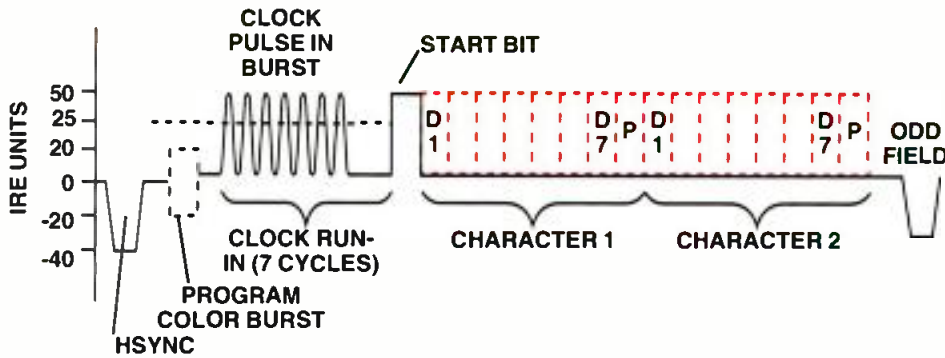

Figure 1. Encoded composite video signal showing line 21, the captioning clock burst and the positioning of bits for two characters. D refers to databits, P is parity.

### How does closed-captioning work?

As noted, closed-captioning consists of information that is electronically added to the normal NTSC transmission. (See Figure 1.) Creating a captioned program therefore involves several steps. Dialogue from the movie or program must be scripted and broken down into segments called captions. These caption blocks are identified as to where and when they are to appear on the screen. Different attributes can be associated with each block or each word within a caption block.

The caption editing process produces a datastream encompassing displayable characters and commands that determine what information is to be displayed. This

***Closed-captioning is a process by which text, representing the audio portion of a TV program, is encoded in digital form into scan line 21 of the NTSC video signal.***

data is encoded into line 21 of the odd field of the program video to produce a captioned master tape.

The line 21 editing commands control the placement of these alphanumeric captions on the screen, while others affect visual appearance attributes (colors, underline, blinking and italic) or control different display modes (such as pop-on, paint-on and roll-up). Commands also identify which of four data channels — two for captions and two for text — are to be used. This multiple data channel capability is useful for bilingual countries. Canadian programs, for example, are routinely produced with English and French captions on the same videotape or broadcast.

Figure 2 shows an example of how this

data is formatted for sending two data channels of information. The method is similar to other data communication transmission formats, which open with a header or beginning field followed by the actual data. Data for all of these channels is transmitted as a time multiplexed datastream on line 21 of odd video fields. The beginning of a particular channel's data is signified by a command that identifies the channel and type of data that follows. Commands are transmitted as two byte pairs, in the same field, and consist of a non-displayed (non-printing) character followed by a printing character. The decoder recovers the data and submits it to the command interpreter.

Following the non-displayed data is the actual dialogue intended for display. In Figure 2, the caption data channel is in French, followed by English. If the decoder is programmed to receive French information, it will receive and decode the initial information stream. If not, that information is ignored until a data channel is received corresponding to the decoder's preset selection.

Verbal communications are quite slow compared to the electronic world. There is more than enough time, electronically, to receive and display the necessary information for several data channels and still keep up with program dialogue. But what happens during a rapid-fire dialogue?

***Benefits of closed-captioning go beyond simple subtitling.***

New captions would appear so fast that new information forces the old data off the screen before it can be read. Pop-on and paint-on captioning are used when time permits; where it does not, a scrolling roll-up display mode is used. Two or four rows of data are displayed, with new rows appearing at the bottom scrolling smoothly

into a disappearing top row. This is easier for the viewer to read as the last rows of dialogue move onto the screen during lively verbal action.

### Inside the caption controller chip

The electronics to perform these functions and to support multiple display modes are not trivial. Indeed, much of the debate before Congress centered on the added expense to include full-blown closed-captioning capabilities in all TV receivers — an expense ultimately passed on to the consumer. Fortunately, the current state of the VLSI device has reached a point where everything necessary to receive, decode and display NTSC line 21 closed-captioning as specified by the FCC is integrated into a single IC.

***Closed-captioning becomes visible only with equipment incorporating a special decoder to receive and display the information.***

The digital side of IC design represents the more easily understood and implemented part of the device. More difficult was the analog input. The NTSC transmission signal is typically received at 1Vpp with the sync pulses making a greater excursion in the negative direction. The closed-caption information is confined above 0IRE (1Vpp = 140IRE) and has an amplitude of 50IRE. A 7-cycle clock run-in burst is provided to allow the electronics to lock onto the data rate, and a start bit is used to delineate the 2-byte character information. (See Figure 1.)

Two inputs drive the decoding function: A composite video input (CVI) carries the NTSC video, while a horizontal flyback input (HFI) is used to pull an on-board voltage-controlled oscillator (VCO) within locking range of the horizontal scan rate. The analog circuitry locks onto the video signal, separates sync and data from the video, recovers the black level for video output, and provides the digital information to the command interpreter. An on-board command interpreter then decodes data submitted to it and displays the appropriate information at designated locations on the TV screen.

### TV application

Figure 3 illustrates how these ICs fit into consumer receivers with a minimum of external circuitry. The horizontal flyback



# WHAT YOU NEED IS WHAT YOU GET.



BT-H1350Y 13 INCH COLOR VIDEO MONITOR



BT-S1360Y 13 INCH COLOR VIDEO MONITOR



BT-S1370Y 13 INCH COLOR VIDEO MONITOR

In video monitors, it always seemed you either couldn't get exactly what you were looking for or you got more than you actually needed. That was before the Panasonic BT-series family of monitors.

Panasonic's new BT-H1350Y (13-inch\*) Color Video Monitor gives you SMPTE C Phosphors and an extra sharp 750 horizontal line resolution for the demanding requirements of presentation and measurement.

The new BT-S1360Y (13-inch\*) Color Video Monitor couples a wide range of professional features with underscan, cross pulse, selectable color temperature (9300K/6500K) and more.

The new BT-S1370Y (13-inch\*) Color Video Monitor gives you many of the same essential

professional features like 4-system compatibility, comb filter for NTSC, and blue signal only, at a resolution of 420 TV lines.

The new BT-S900Y (9-inch\*) monitor offers underscan, cross pulse, S-VHS compatibility, blue only, comb filtering and AC/DC operation. The

BT-S901Y offers the same professional features in an AC, dual rack-mountable configuration.

This entire family of professional monitors couples today's modern technology with Panasonic's

quality and stable performance.

When you're choosing professional video monitors, it's great to know that with Panasonic you never have to pay for more than you need. In our minds, that may be the most important feature of all.



BT-S900Y COLOR VIDEO MONITOR



BT-S901Y RACK MOUNTABLE COLOR VIDEO MONITOR



Screens have been simulated.

For more information call: 1-800-524-0864 (Upon request, enter product code 06)

Panasonic Communications & Systems Company  
Division of Matsushita Electric Corporation of America  
One Panasonic Way, Secaucus, NJ 07094

\*Measured diagonally

# Panasonic

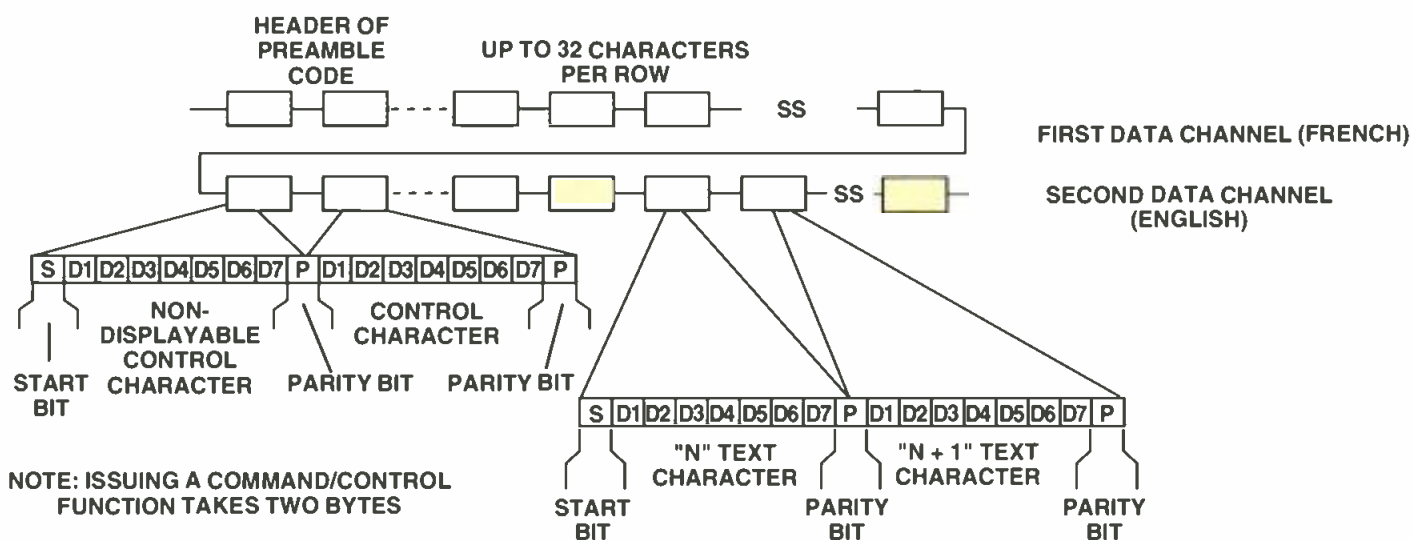

Figure 2. The format for transmitting multiple data channels includes predefined header blocks of preamble code to indicate the beginning of information for another channel.

signal is fed to the device. Either polarity is acceptable as long as the signal is within  $\pm 3\%$  of 15.73kHz (the basic TV horizontal timing frequency). Composite video is capacitively coupled into the CVI through a simple filter. Additional connections with the host receiver include a sync slice level (SSL) input and horizontal loop

filter (HLF) input.

Although the application shown in Figure 3 uses a TTL multiplexing IC serving as the insert keyer, a different video output configuration could use a diode matrix on the lines driving the video amplifiers. The output video keyer disables the TV's normal video in a specific area, in-

serting the closed-caption display into the resulting window.

Suppose that a caption is required at the bottom middle row of the screen. At the left side of the caption box, the BOX output terminal of the device goes active, disconnecting the program video and connecting the controller video to the TV

# We're Committed To Your

The only certainty about the future is that things will change ... the economy, technology, styles that dictate your business. That's why Graham-Patten Systems designed the *D/ESAM* with *virtual flexibility* ... to deliver what's needed today and adapt to changes in the future.

- The D/ESAM (Digital Edit Suite Audio Mixer) handles digital and analog audio together, and can be easily reconfigured or upgraded to accommodate your changing needs.
- A virtual input matrix lets you define how audio signals are used, eliminating the need for hardwired patch bays and routing.
- Like all Graham-Patten mixers, the D/ESAM operates with any edit controller using ESAM II protocol.
- The D/ESAM is designed specifically for videotape editing. Switcher-like styling makes it intuitive to operate for any type of work from off-line to auto assembly.



Winner, 1990-1991 Emmy Award for Outstanding Achievement in Engineering Development

- Compact packaging allows the D/ESAM to fit into the most crowded spaces giving editors a clear view of the panel and easy access to the controls.
- D/MEM memory offers a wide range of storage and transfer capabilities. It's designed to be compatible with the various methods used by edit controllers to handle switcher set ups.
- DATS (Digital Audio Transmission System) lets you distribute digital audio throughout your facility over coax. An affordable solution to an emerging problem.

For more information contact Graham-Patten Systems at 800-422-6662



RGB, BLANKING FROM VIDEO SOURCE

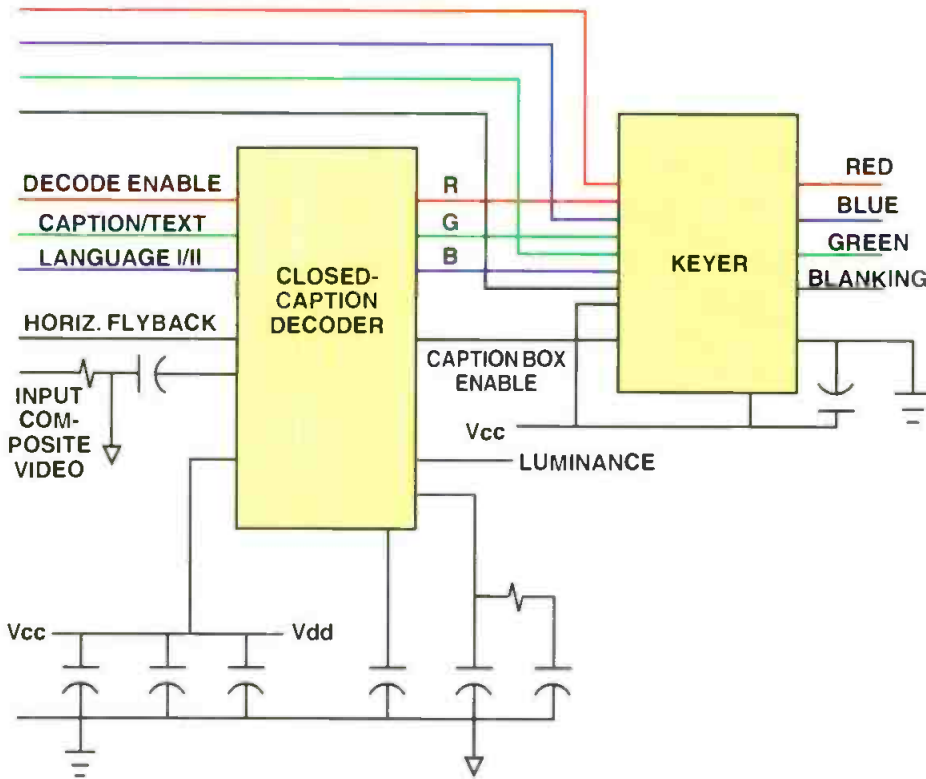

display circuitry. The caption scan line is displayed, and at the right side of the caption, the BOX terminal is deactivated, re-establishing the TV's normal video display. Individual receiver design will determine which is the more effective approach. Receivers using VLSI ICs to control the video section may use the TTL mux circuit. Those without easy interface for TTL-compatible RGB video may opt to use a diode circuit.

**VCR and stand-alone decoder applications**

Stand-alone decoder and VCR applications are more complicated, because horizontal sync pulses and a digital video source are lacking. As compensation, some analog operations performed by the IC must be duplicated externally. It is necessary to place a clamp on the video input and establish a black level externally. This ensures that both video sources will display the same black-and-white vid-

*Figure 3. A schematic illustrating interconnections for a Z86128 closed-caption control device. A minimal number of components are used in filters for PLL and device power, as well as coupling for the composite video.*

# Future



**D/ESAM 800**  
Digital Edit Suite Audio Mixer



**GRAHAM-PATTEN SYSTEMS**  
P.O. BOX 1960, GRASS VALLEY, CA 95945  
TEL: (916) 273-8412 FAX: (916) 273-7458

eo levels on the TV screen.

VCR and stand-alone decoder applications use the same circuitry to perform closed-caption decoding. The unit senses NTSC composite video, separates closed-caption and sync information, generates a black-and-white video luminance output, and inserts a box to display the captions on the screen. In this case, the video keyer is an analog switch between composite video and the decoder luminance output (a logical OR of the RGB outputs) to the display. The circuit shown is applicable to nearly all video sources and many different receivers. Although color could be used, black-and-white captions are implemented rather than adding the expensive circuitry necessary to separate the RGB information.

The output of the keyer may require special driver circuits specific to particular TV monitors. These driver circuits will differ with each application and will generally be much simpler than those illustrated. Compensation resistors and capacitors remain, as shown in Figure 3.

In the TV receiver application, a horizontal pulse is available, but not in VCRs and decoders. To operate, the device re-

quires a timing input pulse to lock onto the NTSC composite video. A simple 555 timer generates the pulse.

---

***Closed-captioning consists of information that is electronically added to the normal NTSC transmission.***

---

#### Summary

Closed-captioning is the result of the concern to serve viewers better. Originally available to those who wished to purchase an external decoder system, closed-captioning has grown in its use in local and network programming. Unfortunately, a limited number of the decoders were originally constructed, and when they proved less than a fast-selling, mass-appeal product, these units became scarce. A mandated line 21 caption decoder integral to the receiver will bring the special serv-

ice for the hearing impaired to a broader audience. At the same time, such devices, through closed-captioning, will introduce other text-based information services to all viewers.

■ For additional information on captioning systems, circle Reader Service Number 303. ■

## ARE YOU IN CONTROL OF YOUR RF?

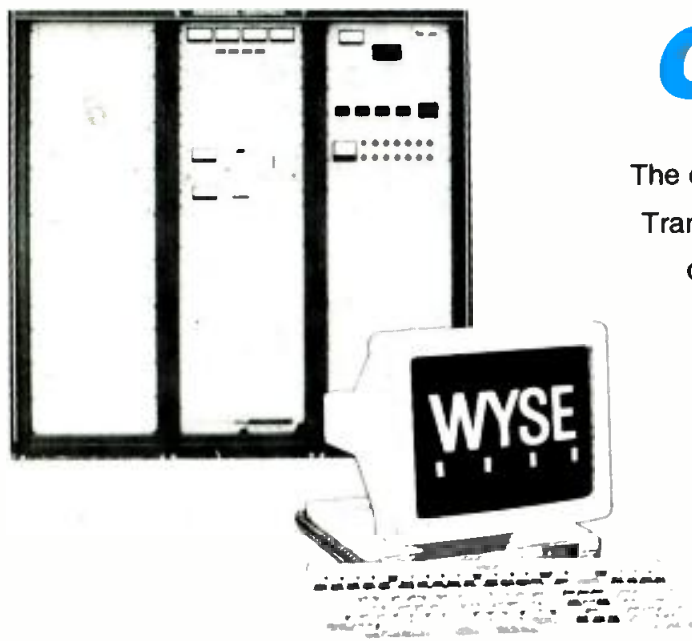

## Get TranStat™

The complete transmitter control and monitoring system. TranStat™ provides for control of RF system functions, daily monitoring and meter readings and annual statistical information for budgeting. TranStat™ also provides programmable functions that allow you to customize its operation to your specific installation.

*To get complete control of  
your RF system  
contact Continental first.*



# Continental Electronics Corporation

P.O. BOX 270879 DALLAS, TEXAS 75227-0879 214-381-7161 TELEX: 73-398 FAX: 214-381-4949

Circle (34) on Reply Card





# Engineers and Producers Agree On The Versatility, Variety and Dependability of Maxell.

That's Why Over 2,000 Pros Nationwide Use Maxell Exclusively.

It's all on your shoulders. You have to create, enhance, preserve, make it work. So you do what you've done reach for Maxell. Rugged, reliable Maxell tapes for state-of-the-art performance... punish it, push it to the limit, these superb video and audio tapes just won't quit. Durable Maxell tapes for the glorious sound, the brilliant image and the superior specs you *must* have when your reputation is on the line.

**maxell**<sup>®</sup>

Maxell Corporation of America, 22-08 Route 208, Fair Lawn, NJ 07410, 1-800-533-2836.

Circle (35) on Reply Card

© Maxell Corp. of America

[www.americanradiohistory.com](http://www.americanradiohistory.com)

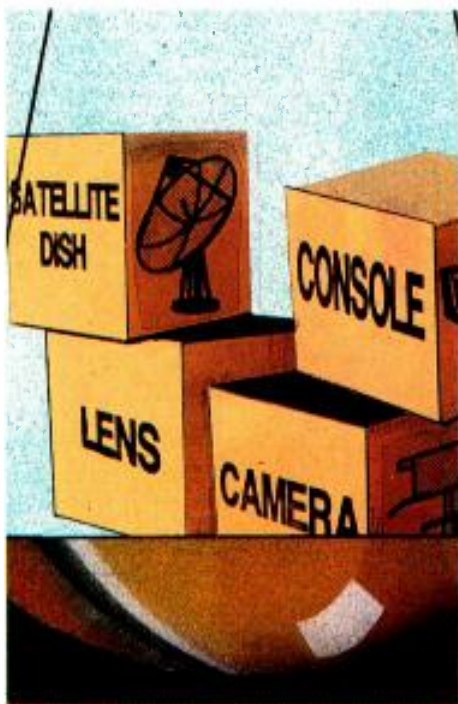

# Contracting for maintenance services

**Choosing a contract engineer may be the most critical decision a manager makes.**

By Kirk Harnack

## ***The Bottom Line***

*The facts of life at today's radio stations have caused many owners and managers to consider contracting for technical maintenance services. Although such a move might improve the bottom line, other facets of station operation can suffer if an inappropriate contractor is chosen. The problems that result may put the station into an even worse fiscal position, through direct and indirect means. Here are some tips that may aid you in making this important choice.*

**\$**

An increasing number of general managers, engineering directors and radio station owners face the dilemma of selecting a contract engineer. Most blame changes in business practices and downturns in broadcast revenues for the necessary elimination of full-time engineering positions at many radio stations across the United States. Whatever the cause, once the decision has been made to use a contract engineer, station management faces an even bigger decision in selecting a particular contractor. The criteria listed in this article may help you to make the required assessments.

Medium- to large-market radio stations also may use contract engineers to fill-in while a new full-time engineer is hired. Some decide to continue the contract engineering arrangement when a suitable staff engineer cannot be found or when the benefits of working with a qualified contract engineer become evident. Other stations using a contract engineer have been doing so for years and are accustomed to the arrangement. Nevertheless, these stations may want to re-evaluate their expectations for service against the benchmarks that appear later in this article.

### **Moving from staff to contract engineering**

Those considering the use of contract engineering services should be aware of the benefits and risks of such arrangements. Furthermore, they should strive to balance them for the station's optimum benefit under technical and economic

analyses.

In many parts of the country, there are enough skilled, honest and knowledgeable contract engineers in business to satisfactorily serve local broadcasters' needs. Other regions, however, are sorely lacking in qualified engineering services. In these areas, radio station managers may find themselves choosing between a local CB repair shop technician and an out-of-town broadcast engineering professional. Typically, the professional charges more per hour. The real cost, though, is not the hourly rate, but the overall cost of long-term reliability, legality and smooth operation — or the lack of it.

Often, the general manager or station owner is not aware of the qualifications needed in a reliable contract engineer or firm. A negative experience may result if the contract engineer turns out to be inept, overconfident or dishonest.

For those GMs, engineering directors and station owners who plan to hire a contract engineer, the following qualifications and attributes are presented to aid in the personnel search. Based on these criteria, a station can make informed decisions in choosing a contract engineer.

### **Engineering qualifications**

It is fairly safe to assume that the prospective contract engineer has training and experience with technology specific to the broadcast industry. Nevertheless, it can't hurt to verify this assumption by checking some references and background information, especially if the engineer is new to the consulting trade.

Harnack is president of Harnack Engineering, Memphis, TN.



# 1992 EMF Conference Tapes And Transcripts Now Available!

In March 1992, *Transmission and Distribution Magazine* sponsored a full two-day conference on the much-debated issue of **Electric and Magnetic Fields** – a subject of critical importance not only to the t&d industry, but to the entire world. At stake potentially is the rewiring of America – and the re-design of almost anything electrical, at great cost to consumers, manufacturers and businesses around the world.

Now you can hear a distinguished panel of experts offering hours of commentary and discussion on this most urgent issue.

The entire two day conference has been recorded on high-quality audio cassettes – and fully transcribed – allowing you to share in this important event.

**Listen/read at your convenience, in office, car or home.**

**Review over and over the ideas and information most significant to you.**

## EMF How Dangerous?

**The Conference  
Is History.  
Now You Can  
Hear It For  
Yourself.**

### Who Should Receive This Valuable Information:

Electric Utilities, Telephone Companies, Electrical Contractors, Electricians, Broadcast Engineers, Federal, State and Local Governments, School Systems, Health Agencies, Legal Firms responsible for litigating the issue, Trade Organizations and other concerned groups.

### Detailed Information and Current Dialog On These Critical Issues. . .

- An International Perspective of the EMF Issue
- A Complete Review of Scientific Research
- What to Expect from Government
- Regulating EMF and Litigating EMF in Court
- The Potential Impact of EMF on Workers– Electric Utility and Telephone Workers, Electrical Contractors, and Electricians
- What Consumer Groups are Doing About EMF
- Case Studies– Industry's Position and Perspective on the EMF Issue
- The Costs of EMF to Industry

### 1992 T&D EMF Conference Transcript/Tapes Order Form

- Yes!** Please send me \_\_\_\_\_ (qty) complete set(s) of audio-cassette tapes recorded at the 1992 EMF Conference.  
@ 120.00/set = \$ \_\_\_\_\_
- Please send \_\_\_\_\_ (qty) complete printed transcript(s) of the Conference.  
@ \$105.00 ea. = \$ \_\_\_\_\_
- Please send **both** the printed transcript and the complete audio cassettes for just \$195.00 per set = \$ \_\_\_\_\_  
State Sales Tax: CA-7.25% (LA & SF- 8.25%), CO-3.7%, IL-6.25%, KS-5.85%, MI-4%, MN-6%, NJ-7%, NYC-8.25%, NYST-4%, OH-5%, PA-6%  
Shipping & Handling Charge: \$7.50

Payment or credit card information must accompany order.  
Make checks payable to **Intertec Publishing Corp. d.b.a. T&D Magazine**  
(U.S. dollars only, please.)

- My check is enclosed.  
 Please charge to my credit card.\*  
 Visa  Mastercard  American Express

Account #: \_\_\_\_\_ Expiration Date: \_\_\_\_\_  
Signature: \_\_\_\_\_

Name \_\_\_\_\_

Title \_\_\_\_\_

Company \_\_\_\_\_

Address \_\_\_\_\_

City \_\_\_\_\_

State \_\_\_\_\_ Zip \_\_\_\_\_

Mail to:  
T&D Magazine  
Intertec Publishing Corp.  
P.O. Box 12901, Overland Park, KS 66282-2901  
(913)341-1300

\*Credit card orders may be sent via fax to (913) 967-1898.  
attn: Jayne Mixon. Please allow 4-6 weeks for delivery.

Beyond this obvious initial step, a few other important questions are worth asking:

- *Does the contract engineer know his or her own limitations?* If your contract engineer doesn't know when to call in someone else with real expertise on a particular problem, you should look for one who does.
- *Does the contractor have a large network of contacts in broadcast engineering and related fields?* It is not only important to know when to ask, but also to know whom to ask in order to receive a knowledgeable answer.
- *Does the contract engineer have any federal licenses or organizational certifications?* Although an FCC General Class License demonstrates a certain level of understanding, many qualified engineers have one or more certifications from the Society of Broadcast Engineers (SBE).
- *Does the contract engineer own all required tools and test equipment?* If not, to whom do they belong? Are the tools and test equipment properly maintained and kept in calibration?
- *Does the contract engineer regularly seek out continuing education activities?* This includes factory training from any equipment manufacturers.
- *How does the contract engineer keep in touch with others in the engineering community?* Ask about attendance at industry trade shows, regular reading of industry journals, and membership in any on-line service or computer bulletin board.
- *Is the contract engineer familiar with your equipment?* For example, if you operate an AM directional facility, find out if the contractor has previous, successful hands-on experience, as well as knowledge of directional systems and the applicable FCC rules.
- *Can the contract engineer tell the difference between an important engineering concern and an urgent one?* Being able to make that determination accurately is crucial to offering a worthwhile contract service.
- *Is the contract engineer aware of safety procedures?* A well-qualified engineer will not expose himself or station employees to the danger of electrocution or fire, and will be alert for such potential hazards.

#### **Reliability and commitment**

Perhaps the greatest *disadvantage* to using contract engineers is their unavailability on-site. This is a calculated risk that station management takes when it opts for contract rather than staff engineering services. Given this limited availability, here are some points to consider:

- *Does the contract engineer operate as a contractor full-time or part-time?* A part-time contract engineer (one with a full-

time job elsewhere) may not be available during many hours of the day, and may be using the resources of an employer to do your part-time engineering work.

- *Does the contract engineer have liability insurance?* Find out who pays if a piece of station equipment is damaged or stolen while in the possession of the engineer.
- *Is the contract engineer easy to reach?* How? Is an answering service, page or cellular phone used? Does the contract engineer have one forwarding phone number, or does the client have to check at several numbers? How can the engineer be reached when out of the area, whether on vacation or on business?
- *What kind of backup service is offered?* If the station has a serious problem and the contract engineer is not immediately available, what happens?
- *Is the contract engineer overcommitted?* Can qualified personnel always be provided to you quickly in an emergency?

#### **Business ethics and operation**

The business reputation of the contract engineer also is important. This is another risk station management takes when using a contractor, so pay careful attention to these issues:

- *Is the engineer honest and up-front about FCC/legal problems at your station?* As a licensee, you are ultimately responsible in the commission's (or the court's)

---

### ***A contract engineer should endeavor to save you money and help your business operate more efficiently.***

---

eyes, even though a violation may clearly be the contractor's fault.

- *Is equipment returned promptly when repairs are made off your premises?* Is your equipment inventory list up-to-date? Is all your equipment engraved or otherwise identified? In addition to discouraging theft, these practices may simply help a multistation contractor deliver similar pieces of equipment from different stations back to their rightful owners.
- *Is the contract engineer properly registered to do business in your jurisdiction?* Are all applicable sales taxes for materials or labor invoiced and collected?
- *Does the contract engineer adequately document work performed, time spent and expenses incurred?* What about the contractor's attitude toward correcting misunderstandings or mistakes?
- *How do other clients feel about the contract engineer?* How is the contractor

viewed by peers and associates?

- *Is the contract engineer sensitive to the particular requirements of daily broadcast operations?* Broadcasting differs in many important ways from other types of electronics work. Therefore, the contract engineer must understand why it is necessary to schedule work at unusual hours or conform in differing ways to these peculiarities.
- *Can the contract engineer be trusted to maintain the propriety of your station's operations?* The same contract engineer often works for two or more stations in direct competition. Are you confident that your station's competitive advantages are not being leaked? Are you sure that the engineer does not have ulterior motives for recommending changes in equipment or procedures?

#### **Cost of services**

One point that has not yet been mentioned is cost. How much is the right price? How do you know if the asking price for hourly or contractual work is too high? More important, how do you know if you're paying too little on the front end only to have to redo the project?

Most qualified contract engineers will agree that there are two ways for a station to overpay for its engineering services. First, by contracting with a less-capable engineer than the task requires, the job may have to be repeated by a more qualified and experienced engineer. Second, by contracting with an overqualified engineer, you may be paying for expertise that is not required.

Savvy managers or owners will either contract with different engineers for projects appropriate for each or they may contract with an engineering firm that offers engineering expertise at various levels with appropriate rates for each. A competent contract engineer will point out the most cost-effective method for handling different technical projects. The benefits of contracting with an informed and well-connected engineer really become evident in these cases.

Finally, as a general manager, engineering director or station owner, examine your own expectations of a contract engineer. You have the right to expect honesty, good working skills and a desire to improve your particular technical operation. Your contract engineer should try to save you money in the long run, and help your business operate more efficiently. A good contract engineer will perform this service for you many times over.



# LOG 14 DAYS OF AUDIO ON ONE DAT, PLAY IT BACK WHILE STILL RECORDING!



MDL-14



**RCS TRACKER**

The RCS TRACKER records up to 3 audio sources simultaneously, and provides random access to any logged time segment - even by phone - without interrupting the recording.

The RCS TRACKER consistently sounds better, costs less to operate, and is easier to use than any other logging technology.

The RCS TRACKER is a complete hardware-software system.

**RCS**

2 Overhill Road, Suite 100, Scarsdale, NY 10583  
Voice (914) 723-8567 Fax (914) 723-6651

Circle (37) on Reply Card

[www.americanradiohistory.com](http://www.americanradiohistory.com)



# Studio camera update

Is it time to modernize your studio cameras?

By Carl Bentz, special projects editor

## The Bottom Line

*Sometimes, even the best equipment becomes outmoded. Those cameras that have been in use in your studio for five or six years may still be producing excellent video — and, yes, they are paid for in full. But consider operation and upkeep expenses for a moment. Do they take a significant amount of setup time? Are their signals stable? Can they be matched with other cameras for special events? This survey of studio camera features highlights some capabilities that you might find useful.*

\$

Your studio cameras are how old? If you haven't looked at the camera market recently, you'll find that some changes have been made. In general, the changes are good news. But if you are a hard-line tube-type person, the news will be disturbing. Just as portable, ENG and EFP camera lines have turned almost entirely to CCD image sensors, so too have studio systems succumbed to the solid-state technology. Overall, however, studio cameras are looking better than ever.

### Sensing with CCDs

Not long ago, one technical session at a SMPTE conference featured a discussion on the state of sensor technology. Proponents of lead oxide tubes and of charge-coupled devices (CCDs) explained the advantages and disadvantages of their products. Much of that discussion was directed toward producing images for HDTV. In the end, both parties concluded that tubes still held an edge on higher resolution than CCDs, but that resolution was a moving target.

Today, the target is still moving (upward), but the ammunition being used is now nearly all CCD-based. Specifications recently released by camera manufacturers include horizontal resolutions reaching as high as 850 TV lines. New processing enhances vertical resolution beyond 400 lines. These two numbers suggest that the pixel arrays of CCDs are increasing in density, because the imaging formats remain at  $\frac{2}{3}$ -inch. Current literature for studio cameras shows pixel arrays from 406,000 to nearly 600,000 as examples of densities.

The signal-to-noise (S/N) rating for today's studio cameras averages 62dB for NTSC (59dB to 60dB for PAL). The increase in the S/N ratio is due largely to improvements in the sensors themselves. Most of the cameras are based on two types: FT (field transfer) and microlens FIT (field interline transfer).

Of the two CCD structures, the FT has a greater surface area of light-sensitive material. By contrast, each pixel of the latest FIT technology includes a miniature

---

***If you haven't looked at the camera market recently, you'll find that some changes have been made.***

---

lens structure to concentrate light into the CCD pixel wells, counteracting the area required for the transfer paths. (See Figure 1.) Sensitivity for the latest generation of FT devices is noted as  $f/7.3$  for 2,000lx illumination. For microlens FITs, a value of  $f/8$  has been given. (Both are based on a  $\frac{2}{3}$ -inch format.) Maximum sensitivity is given at 9lx and 7.5lx, respectively, for the two types of sensors. (See "CCD vs. Tube Technology: A Comparison," May 1991, pg. 90, for additional information on these devices.)

A few years ago, fixed pattern noise was considered a detrimental characteristic of



CCDs. The increase in sensitivity of the devices generally reduces the dark current characteristics. This, in turn, reduces fixed pattern noise in the output.

Vertical smear in CCD imaging was another drawback that has been eliminated. The solution to smear is the implementation of a shutter effect electronically within the CCD structure. Without some type of shutter, charges accumulated by each pixel can change, even as the information is being transferred from the sensing area to the storage area. That change is what caused smear to appear.

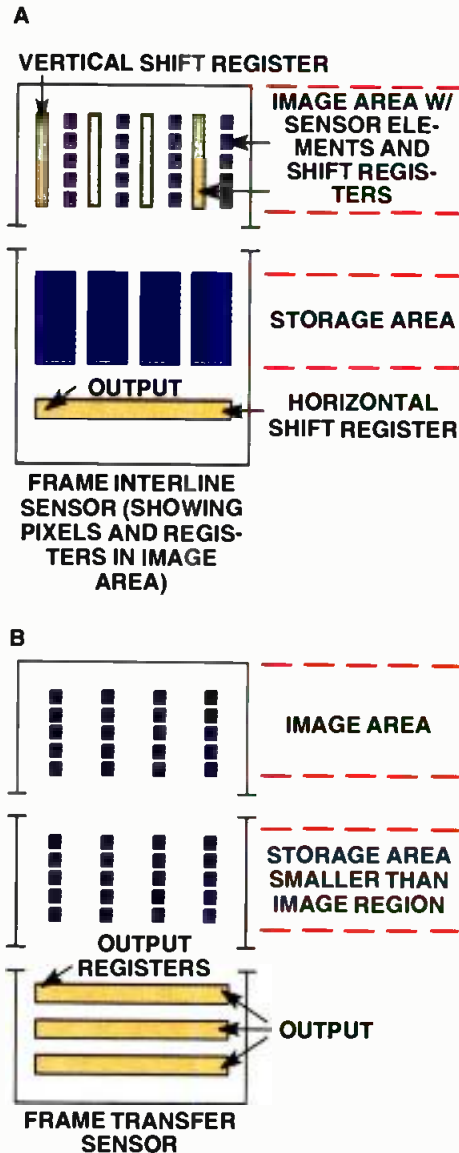

Figure 1. The structure of the FT and FIT CCDs.

### Quicker on the trigger

Achieving greater clarity in images is the goal of most camera manufacturers. Several steps have been taken, including increased sampling frequencies in sensors to 18MHz, to reduce the aliasing effects inherent in sampling processes. That design includes low-pass optical filtering as an additional security against aliasing.

Furthermore, a change in the charge sampling methods can enhance vertical

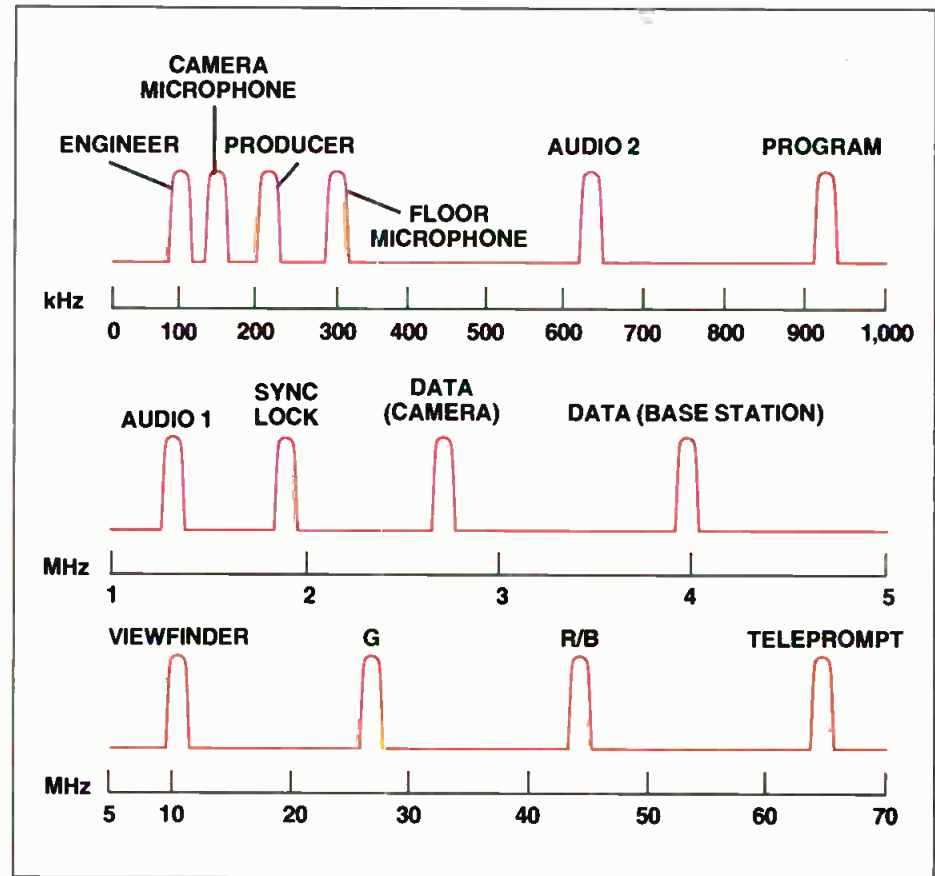

Figure 2. Frequency carriers for one triaxial camera cable system. (Courtesy of BTS.)

resolution. For example, if charges (from either the odd or even field) are read every  $1/30/s$  with a  $1/60/s$  shutter speed using appropriate timing, vertical resolution exhibits an apparent increase.

### Making connections

Triaxial cable was once an option to multicore camera cables for some models. Today, triax has become more common. However, differences of opinion abound. What form of signals should be sent via triax to the camera control and processing equipment — wideband RGB or wideband  $YCrCb$  components? Both methods are available. Although the advocates of color-different components suggest that highest quality images can be obtained on cable lengths to 3,000m, proponents of RGB components propose lower crosstalk, better linearity and a higher S/N rating over cables to 2,400m. The choice between the two would best be made only after seeing both in operation, preferably side by side. (See Figure 2.)

Almost all studio cameras include an automated setup routine that checks camera parameters against preset files. Such files may be stored in various forms, including credit card-size memory cards. To simplify technical operations, most systems permit access to multiple setup files, which may include specialized scene and lens information. Setup operations are typically handled through a multicamera master control unit. As a rule, up to eight

cameras can be handled through one master control unit. In addition, multiple control units can be linked together to increase the number of cameras addressed.

Automating the internal setup and adjustment of the cameras adds consistency to the images produced. Automating camera operation in the studio also can add consistency in often used shots through the use of robotic support sys-

*Each pixel of the latest FIT technology includes a miniature lens structure to concentrate light into the CCD pixel wells, counteracting the area required for the transfer paths.*

tems. In order to bring the pedestal and pan/tilt robotics together with the camera, an appropriate interface must exist at the camera CCU or master control unit. Through RS-422 or RS-323, the robotics controller should, at a minimum, converse with the lens focus and zoom servos. Facilities that are investing in automated camera support systems probably will wish to consider such systems that allow

full control of the camera as well. Be aware that some systems have extended the control capabilities to lighting, audio and video mixing, transport control and even technical power. (See Figure 3.)

#### Digital processing

The continual introduction of new models of processing and recording equipment gives testimony that the trend toward digital video is growing. But if you are to achieve the greatest advantage from the digital environment, at what point should the signal be digitized? For example, would it be possible to sample the outputs of the CCDs and remain in the digital domain throughout? Possible, yes; practical, not at this time. The major stumbling block is the dynamic range of the video signal as it emerges from the CCD. Most believe that eight (or even 10) bits

**The continual introduction of new models of processing and recording equipment gives testimony that the trend toward digital video is growing.**

is insufficient to retain the desired degree of detail in the video.

Developmental work has been done to provide adaptive highlight compression for CCD cameras. With contrast ratios as high as 1:100 in studio scenes and higher (1:1,000) in outdoor work, some means was necessary to bring such diversity under control. Certain products now available include such highlight compression circuitry, which allows the video to retain more of a "film look" through the use of "sliding knee" circuits. Presently, such functions are best kept in analog circuitry.

However, after the basic processing is completed, the introduction of digital circuits does have practical value. The goal must be to gain the advantages of digital processing without compromising performance. For that reason, digital devices are not likely to be introduced into the signal path prior to gamma adjustment, but can effectively be used to generate Y/R-Y/B-Y components, if desired. Furthermore, digital encoders have been found to produce excellent results.

**Today, triax has become more common.**

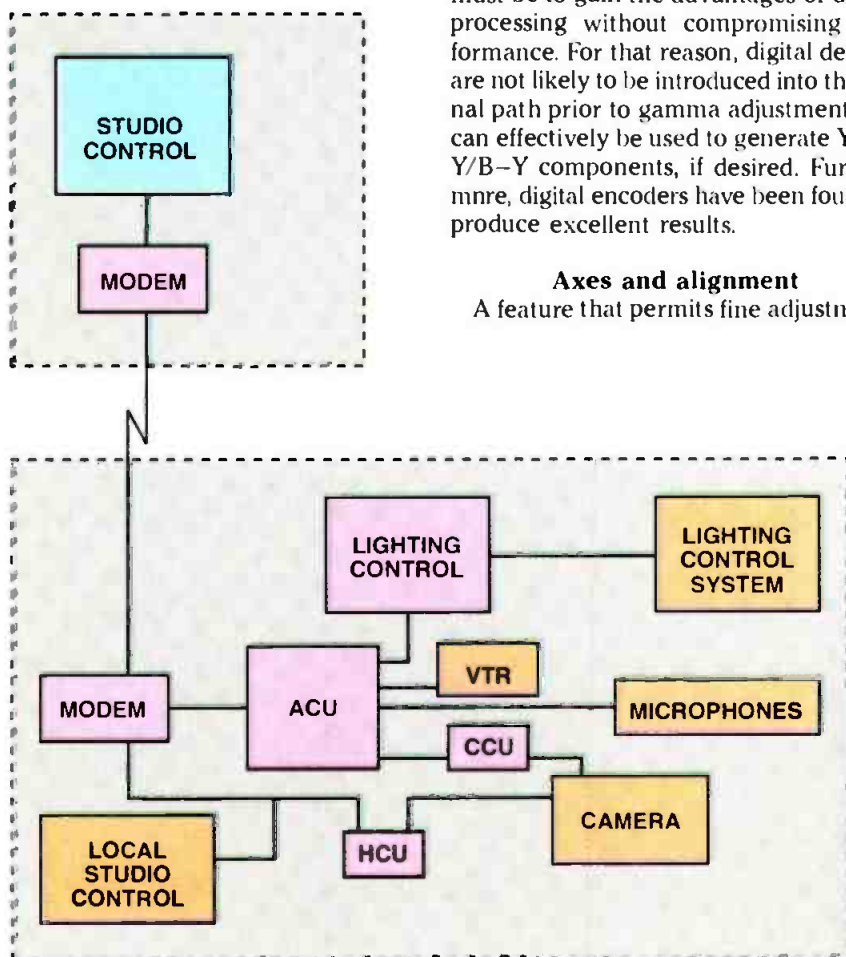

#### Axes and alignment

A feature that permits fine adjustments

on the optical alignment of the camera has been introduced. Following the same type of procedure used in aligning a telescope, the scene is first viewed with minimum zoom using generated crosshair-type markers. The lens is then adjusted to maximum zoom, and the positioning of the marker is compared to the first view. If there is any movement away from the original point in the scene, precise adjustments may be made to bring the lens and optical block into alignment.

#### Final comments

For several years, manufacturers have offered portable companions to their studio camera lines. Although the companion product is enclosed in a smaller package, the electronics are essentially identical. Beyond physical size, the next major difference in the studio camera and

**Digital encoders have been found to produce excellent results.**

its companion has to do with control. The studio system includes all control facilities, while the companion unit provides an interface, allowing it to be used with studio models and controlled by the same type of CCU and master control equipment found in a multicamera system. In addition, the cost of the companion camera is less than the full studio configuration.

Most of today's cameras produce pictures that are better than ever. That includes studio systems as well as the portable ENG/EFV designs. A number of interface products also are available that permit various control functions typically found in studio cameras to be implemented with the smaller, less-expensive cameras. Full control capability and the creative power that accompanies it is still available only with a camera designed specifically for studio use.

For more information on studio cameras, circle Reader Service Number 306.

Figure 3. A suggested system interconnection with robotic camera support equipment.

Free Catalog & Audio/Video Applications

Routing Switchers (St-A/V) (24, 16, 12, 8, 4, 2 stations)

Mic, EQ, Line, Tape, Phono, OAC, Trans., Video, ACN, Pwr. Supp.

Press Boxes 1-in/16-out Video/Audio 2-in/24-out Audio

Video & Audio Dist. Amps. RGB-Sync Dist. Amps.

OPAMP LABS INC (213) 934-3566  
1033 N Sycamore Av LOS ANGELES CA, 90038

Circle (53) on Reply Card



**“EVERYTHING...ALL  
THE TIME.”**

**ANNOUNCING  
THE NV5000**



**UNIVERSAL SYNC GENERATOR**

Now there's a 1 RU chassis that will *simultaneously* lock your NTSC video, PAL video, AES/EBU digital audio, and SDIF-2 digital audio to a common reference.

The NV5000 Series from NVISION may be locked to an external timing reference or will free-run to lock all your video and digital audio equipment to a common source.

**NVISION®**

NVISION, Inc.  
P.O. Box 1658  
Nevada City,  
California 95959  
Tel: 916.265.1000  
FAX: 916.265.1010

Circle (38) on Reply Card

[www.americanradiohistory.com](http://www.americanradiohistory.com)

# Applied Technology

## Codecs and channel compression

By John T. Lynch

Video contains an enormous amount of information, which becomes extremely expensive to transmit between locations. What is needed is a device that transmits only the necessary information based on the human visual color-perception threshold. This device is called a *codec*, which is an acronym for enCOder and DECoder.

A codec system encodes standard video and audio signals for transmission over a limited bandwidth path to a decoder, which receives the incoming signals and restores them to their original bandwidths before viewing.

Ikegami and KDD, respectively, have joined efforts to develop the hardware and software of a broadcast-quality codec. It is designed to optimize a low bit-rate coding algorithm, and the system is housed in a compact package. The system is capable of transmitting up to four video signals and eight audio signals over a single 45Mbit/s (DS3) standard line. This system will contribute to cost-saving transmission applications from fiber-optic cable networks to satellite transponders.

### Analog vs. digital

The Advanced Television Systems Committee (ATSC) and the Federal Communications Commission (FCC) are investigating new transmission techniques that could replace our current system. Such a transmission system will be digital. The main reason for selecting digital rather than analog is because of signal ruggedness. Analog signals deteriorate from the starting point and become worse as distance increases, while digital signals are of constant quality throughout the transmission path. (See Figure 1.)

### Data compression

Various types of data compression techniques are available for digital video. (See Table 1.) The Joint Photographic Experts Group (JPEG), for example, has adopted the discrete cosine transform (DCT) method as its main algorithm. Most low bit-rate coding techniques first store uncompressed video data in a large memory space, and then perform the coding process.

Lynch is assistant director of engineering at Ikegami Electronics, Maywood, NJ.

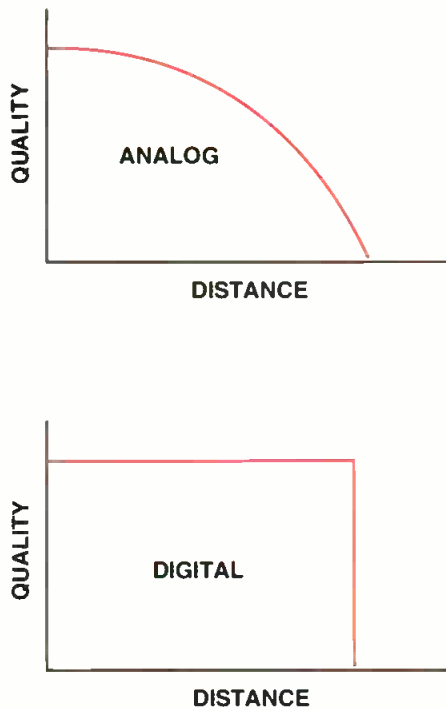
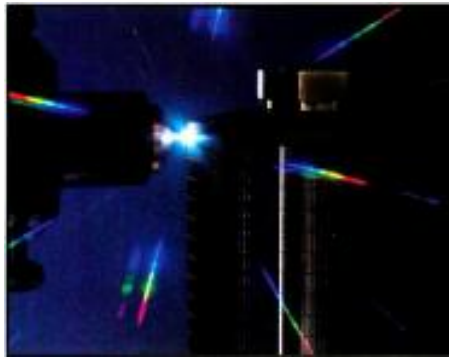

Figure 1. A comparison of transmission quality vs. path distance for analog and digital signals.

ess, which can rearrange the data within the video frame and sometimes with temporal processing. The resulting data can be outside the video frame, which would lead to motion artifacts.

Another approach is to combine transform coding (Hadamard Transform) with entropy coding (Huffman coding) to

achieve a low bit rate with all processing performed within each video frame. The result is no video degradation within the frame, even when quick motion occurs in the scene.

This latter approach has been integrated into a codec system, which consists of an encoder and decoder with digital multichannel compression and capable of transmitting 1, 2, 3 or 4 video signals on one DS3 data channel. In comparison to other methods, the multichannel feature adds an advantage of economy.

### System configuration

The following examples illustrate applications of codec systems. Although the number of channels may vary, or the transmission path may take it through satellites, modems or fiber-optic cables, the codec output always remains at 45Mbit/s.

In Figure 2, the DS3 signal contains one video and one or two high-quality audio channels. The video signal from a D-2 VTR represents approximately 115Mbit/s. The D-2 recorder samples composite video at four times the subcarrier rate and uses an 8-bit system ( $4 \times 3.579545 \times 8 = 114,545,440$  bits, approximately 115Mbits.)

The codec compresses the video to a 39.1Mbit/s signal for transmission. Because a single video signal is involved, this application provides the best quality with resulting images being indistinguishable from the original signal. Such a configura-

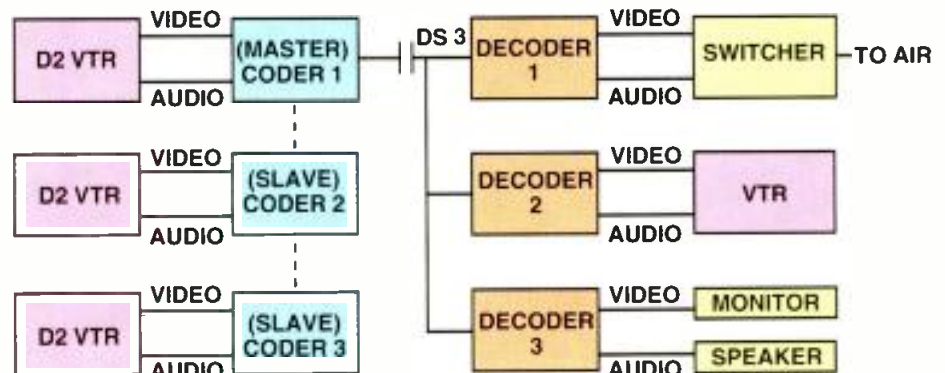

Figure 2. A codec and DS3 link carries video from a D-2 VTR to a monitoring station. The output from the VTR is 115Mbit/s. The transmission system compresses data to achieve a 39.1Mbit/s transmission channel. For three channels of operation, one coder is the master, the second and third are slaves, although all units are identical. Decoders are not so distinguished.



# Which type of CD player is right for your station?



# Denon

With its hugely successful DN-970 and DN-950 CD Cart™ Players, Denon helped make CDs the broadcast media of choice. Given the success of these industry-standard players, there were only two things Denon could do: 1. Make a CD Cart player that is smaller, faster, smarter and better; 2. Make a pro CD player that is *not* a Cart player. Denon did both.



ACD-5B CARTRIDGE WITH ATS BAR CODE

The new DN-961FA Drawer-Loading CD Player is Denon's answer to the many broadcasters who *formerly* had to choose between the drawer-type player they needed and the Denon performance they wanted.

Its Eject-Lock during play adds another most-wanted feature to its list of attractions. Meanwhile, the new DN-951FA CD Cart™ Player dramatically improved functionality with its Auto Track Select (ATS) system, which reads bar-coded carts to *lock-in*, *lock-out* or *auto-cue* to a specific track.

That's not all; three-in-a-rack mounting, true instant start, and end-of-message signals with selectable time-to-end are just a few more key features of these cost-effective new players.

The DN-961FA and DN-951FA. Denon just made it twice as easy to decide which CD player is right for you.

**DENON**  
The first name in digital audio.

ration is targeted for the transmission of program material.

If two or more coders are used on the origination side, one is referred to as the master. (See Figure 2.) Others are called slaves. Each has identical capabilities of handling one video and two audio signals. On the receive side, all units receive the DS3 signal, and no distinction is made between the units. Although there is no need to gen-lock the video inputs, a stable sync signal is required. Note that there is no actual difference between masters and slaves — all units are the same.

With two video and four audio channels, each of the two video signals is compressed to 18.6Mbit/s. If the DS3 signal contains three video with six audio channels, compression to 11.8Mbit/s occurs for each video signal. Adding a fourth video signal and its attendant audio pair increases the rate of compression for each channel. At a maximum of four channels, each channel represents an 8.4Mbit/s rate. Because these images are compressed to a much higher degree, some visible degradation may occur. The user must decide which multiplexing mode should be selected, considering the trade-off between transmission costs and image quality.

Note that although coders of multiple channels must be located at the same point, decoding equipment may be placed at various locations. (See Figure 3.)

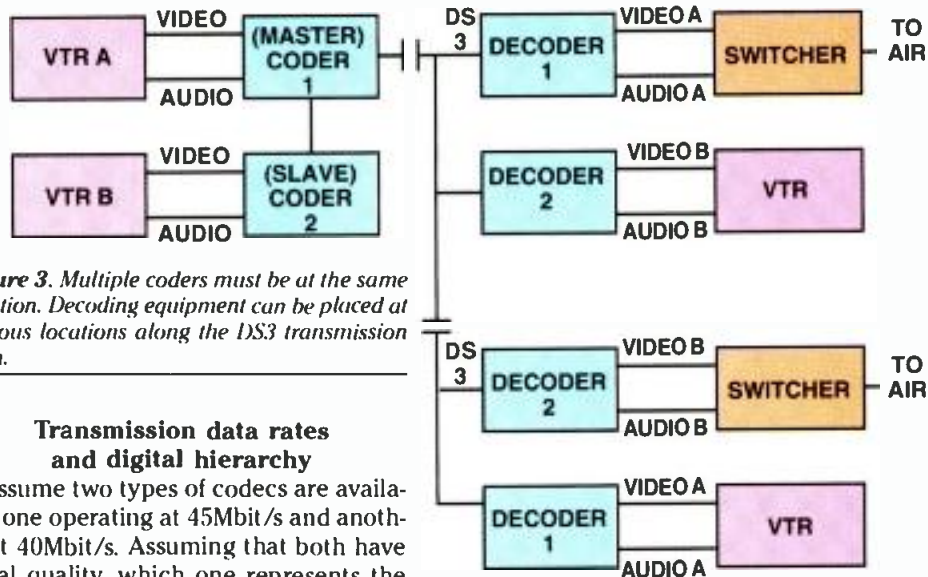

Figure 3. Multiple coders must be at the same location. Decoding equipment can be placed at various locations along the DS3 transmission path.

### Transmission data rates and digital hierarchy

Assume two types of codecs are available, one operating at 45Mbit/s and another at 40Mbit/s. Assuming that both have equal quality, which one represents the better selection? Although you might think the 40Mbit unit does a more practical job, in reality the 45Mbit system should be selected because there are no common carrier transmission paths using 40Mbit/s. Although it is technically possible to lower the bit rate (some manufacturers are attempting to do that), the DS3 paths are widespread and their rate of operation is fixed by telecommunications standards.

What kind of bit rates are used for digital transmission paths? (See Table 2.) The first thing you may think of is a common telephone channel, but this audio is digitized and multiplexed into a 64kbit/s sig-

nal. Twenty-four 64kbit/s signals are packaged into a 1.544Mbit/s signal, which comprises the telephone industry's DS-1 channel.

### Broadcast-quality codec design goals

Depending on the algorithm's ability to reduce the bit rate as far as possible without sacrificing image quality, the bit transmission rate for broadcast television falls at 45Mbit/s, based on the information shown in Table 3.

Note that home TV reception quality is considered to be approximately 10Mbit/s.

### Technical information

The input NTSC analog video first undergoes a conversion from analog to digital. (See Figure 4.) The A-to-D conversion is on composite NTSC video. There is no separation of luminance from chrominance and, therefore, no need to re-encode the retrieved signal. This process maintains saturated colors intact with original clarity. The A-to-D conversion uses an 8-bit system of pulse code modulation operating at four times the subcarrier frequency for a starting bit rate of 114,545,400bit/s.

Level compression affects only those signals that are abnormally high, such as an unterminated video input. The preprocessing circuit removes all blanking and sync, so that only the video signal itself is sent. A quadrature converter is the first step in the Walsh Hadamard transform coding technique. It separates the DC values and subcarrier values for efficient quantization by differential pulse code modulation, which is the difference in value between the current and previous pixel. The remaining AC signal is fed through an adaptive quantization control, which pre-estimates the amount of information to be generated based on the amount of information in the frame. (The number of available data points within each macroblock [32x8 pixels] and the distribution of data within each block.) An adaptive scanning is performed on each 8x8 pixel block, de-

Predictive coding	•Prevalue prediction, linear prediction, adaptive switching prediction, mid-value prediction
	•1st-order, 2nd-order, 3rd-order prediction
Intraframe prediction	•Intrafield prediction
	•Interfield prediction
Interframe prediction	•Frame difference coding
	•Conditional pixel supplement
	•Motion compensation/interpolation
	•Background prediction
Transform coding	•DCT, DFT, Hadamard transform, Slant transform, K-L transform
	•1st-order, 2nd-order, 3rd-order transform
	•Zone-bit coding, adaptive coding
Vector quantization (VQ)	•Mean-value discrete normalization VQ, gain/shape VQ, multilevel VQ
	•All-search VQ, tree-search VQ
Hierarchical coding	•Bit-plane coding, level-plane coding
	•Sequential reproduction coding
Bandwidth division coding	•Subband coding
	•Block truncation coding
Structural extraction coding	•Contour coding, area-division coding
	•Analytical synthesis coding, recognition synthesis coding, intelligent coding
Entropy coding	•Huffman coding
	•Run-length coding
	•Arithmetic coding

Table 1. Image compression coding algorithms.



# Trust the Power



## You Can Rely on Varian Tubes.

When the name on your transmitter tube is Varian, you're getting something no other tube can offer — Varian reliability. Varian's klystrons and Eimac® tubes keep your signal strong and on-the-air for years of worry-free dependability.

Varian reliability is beyond the ordinary because we understand the demands you place on broadcast tubes. Before a Varian tube is shipped to a customer, it undergoes stringent tests to insure maximum performance when you power up.

Since we invented the klystron and designed the first Eimac tube over 50 years ago, we have been delivering reliable power for broadcasters worldwide. And with our commitment to continuous improvement, we have increased tube life, power levels, and efficiency to meet your evolving requirements.

Call us today and see for yourself why Varian tubes are the ones broadcasters trust. In the U.S. call 1-800-544-4636. From other countries, call 415-424-4819.

**varian**

Circle (40) on Reply Card

[www.americanradiohistory.com](http://www.americanradiohistory.com)

“Northern Alaska, is a harsh, unforgiving country,” says Frank Bello. “Make a mistake and you pay for it. That’s why it’s critical I carry in only the most durable equipment. And why I choose to use Sony Professional Hi-8 Videotape.”

Unless you enjoy sub-zero temperatures, ice, and blinding snowstorms, we suggest you take Frank’s word on the reliability of Sony Hi-8. He’s the President of the Association of Visual Commun-

icators. To produce his latest video documentary, he had to go well above the Arctic Circle, following Caribou herds to areas that could only be reached by seaplane, raft or on foot.

If something went wrong, Frank was out of luck. The nearest repair shop was over four hundred miles away, across frozen Tundra. Thankfully, Sony Profes-



The new Hi-8 HMPX and H-MEX videocassettes and exclusive Sony album case.

sional Hi-8 Videotape performed admirably and Frank got his footage on the first try. Time and time again. With a sharpness and clarity he found nothing short of astounding.

“It’s smaller, lighter and much more rugged than 35mm,” he notes.

Producers like Frank Bello inspire us to continually improve our Professional Series Hi-8 H-MEX tape. They are a new generation of evaporated metal tapes

that produce high density recordings of unrivaled quality and unprecedented signal-to-noise ratios.

And the improvements don’t stop there. For editing and cart machines, we’ve also made a more resilient professional metal particle tape.

And our new HMPX Series sets industry standards for greater durability and lower dropout rate.

At Sony, we take the needs of people like Frank into account when we design the shells and packaging for our tapes too. Our shells are equipped with an anti-static lid, to further guard against dust and debris, and come with a unique professional album case.

Improvements that come in handy in Northern Alaska, where the climate can quickly change from rain to ice. And where below freezing temperatures, dew and moisture create real problems for once-in-a-lifetime footage.

As Frank Bello has discovered, it truly is an unforgiving country. But with a tape as rugged as Sony Hi-8, you’ll never have to make any apologies.

**SONY.**  
SONY RECORDING MEDIA





**ONLY  
ON  
SONY**  
RECORDING MEDIA

pending on the nature of the input video. A horizontal, vertical or diagonal scanning pattern can be switched and used accordingly. (See Figure 5.)

The high-order truncating block eliminates only high-frequency data, which exceeds the DS3 transmission capacity. During this reduction process, consideration is given to the overall image, leaving high-frequency components important to image quality intact.

The combined quantized data is put through a variable length Huffman coding scheme, which provides additional bit-

Digital Type/Rate	U.S.	Europe	Japan
DS-1	1.544	2.048	1.544
DS-2	6.312	8.448	6.312
DS-3	44.736	34.368	32.064 44.736
DS-4 <sup>1</sup>	139.264	565.000	397.200

<sup>1</sup>This data rate is currently under consideration only. All values are in megabits/s (Mbit/s)

Table 2. A comparison of DS channels in use and proposed.

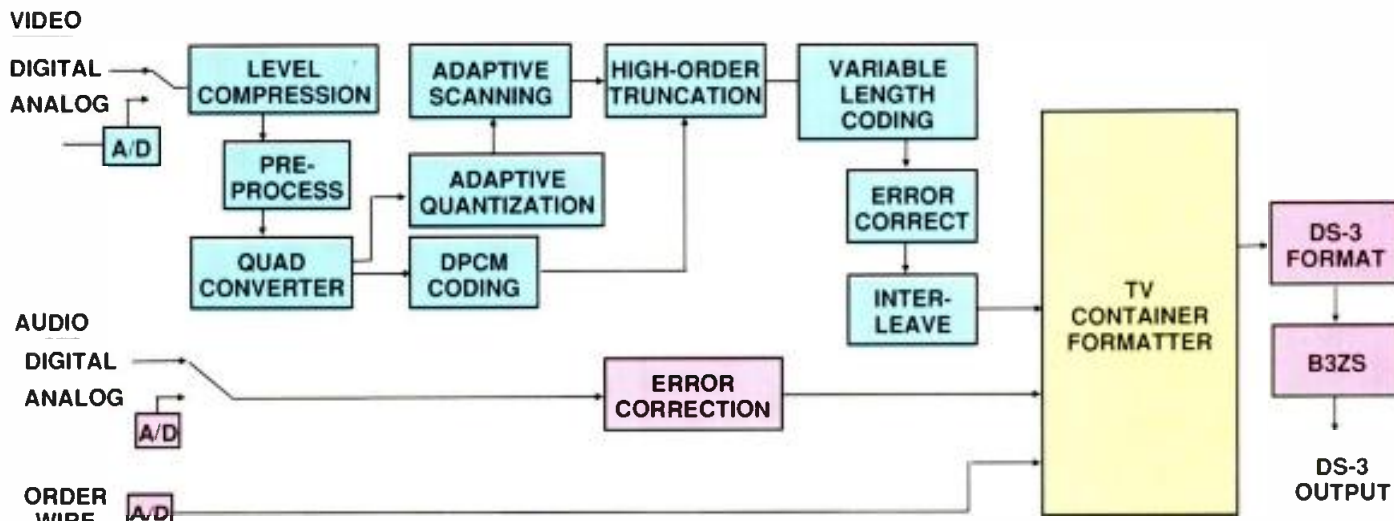

Figure 4. Block diagram of a codec coder.

## Lakeside Associates

- Acoustic Consultants
- Facility Designers
- System Engineering
- Fabrication & Construction

Recent assignments include:

- ❖ Multi-room production and post complex for **KRCA-TV**, Burbank.
- ❖ Multi-room mixing and post-production complex for **Serafine, Inc.**, Venice, CA.
- ❖ Dual mix-to-picture and sweetening rooms for **Editel/Chicago**.
- ❖ Re-designed "Studio A" mixdown room for **The Plant, Sausalito, CA**.

... and many, many more state-of-the-art recording/production facilities around the world!

## Studio Design for Tomorrow

9272 Jeronimo Road, Suite 123C, Irvine, CA 92718 © 714/770-6601 • Fax 714/770-6575

Circle (41) on Reply Card



It's carbon fiber. See the difference. Feel the light.



## VISION™ LT

The new VISION LT relies on the most advanced carbon fiber technology to create the industry's lightest, strongest and most rigid, two-stage ENG tripod.



Multiple axial and radial layering of the carbon fibers achieves outstanding rigidity and resistance to torsional forces.

Simply put, it works better while weighing 20% less than conventional tripods.

Teamed with a VISION 5, 10 or 20 head, you get perfect camera balance at any angle ( $\pm 90^\circ$ ) and the smoothest pans possible with Vinten's patented dual fluid drag system. All this plus a greater height range — from 15.5" to 62".

Easier to take and faster to set up,



the VISION LT comes as a special package at a special package price. In addition to the tripod and head, you get a new telescoping pan bar, spreader, and shoulder strap plus a padded, soft-sided travel bag. When you hear the price, you'll find the VISION LT is also very light on your budget.

Get the facts and see the light for yourself. For more information, call the Vinten location nearest you.

Vinten Broadcast Inc.,  
44 Indian Lane East, Towaco, NJ 07082  
(201) 263-4000 FAX (201) 263-8018  
South - Sunrise, FL (305) 572-4344  
West - Sun Valley, CA (818) 767-0306

**Vinten**

FOR EMMY® WINNING ROBOTICS,  
IT'S VINTEN MICROWIFT

Circle (42) on Reply Card

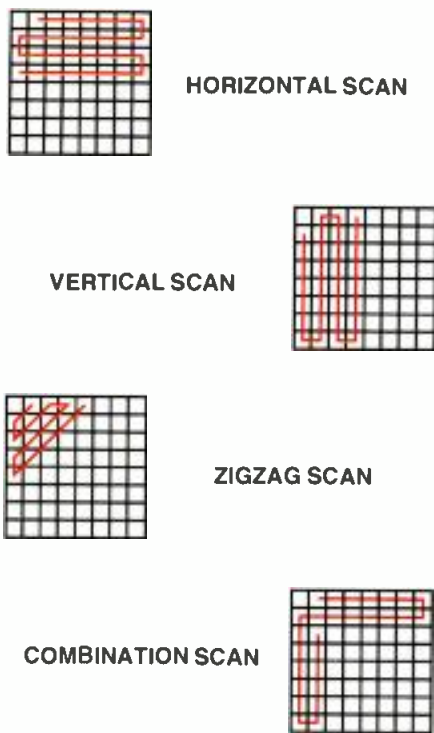

Figure 5. Different scanning systems of pixel blocks in the frame.

rate reduction without loss of information by assigning short codes to the most often used values and longer length codes to the least used values. A forward Reed Solomon error-correction code word is added to the data at 16 bytes per 239 bytes of data. Therefore, each group of 239 bytes of data becomes 255 bytes of forward error-corrected data.

This signal is then mixed out of sequence in an interleave process, which takes adjacent blocks of 255 bytes and alternately switches one byte from each block until all data has been combined in an almost interlaced fashion. If the transmission should suffer from a short error, this error would appear random and less significant when the data is rearranged back into order.

This video data is combined with two audio channels, which would have been A-to-D converted using a 16-bit pulse code modulation signal sampling at 48kHz, creating 768kbit/s per audio channel. The error correction provides delay for the audio signal to match delays from video processing. Note that there is no specified video delay as such, but because processing does take time, a delay results.

It is also possible to provide a lower-quality voice channel or order wire. This is a 64kbit/s telephone quality, 1-way voice channel typically used for cuing purposes.

Associated with a multiple channel codec is a TV Container Formatter, the architecture of which depends on the number of codecs in use. (See Figure 6.) A DS3 formatter maintains the DS3 signal format of 56 blocks of 85 bits for a repetitive pattern of 4,760 bits. (See Figure 4.)

Also appearing in Figure 4 is a section labeled B3ZS. This block is a binary (number) zero substitution circuit, which assures that sufficient 1s are present to al-

Transmission image		Original rate	Transmission rate	Compression ratio
HDTV	High quality	1.2Gbits/s	140Mbits/s	1:9
	General	600Mbits/s	60-140Mbits/s	1:5-1:10
Broadcast TV	Contribution	216Mbits/s	45-60Mbits/s	1:4-1:5
	Distribution	216Mbits/s	30-145Mbits/s	1:5-1:7
SNG, CATV		100Mbits/s	10-20Mbits/s	1:5-1:10
TV conferencing		100Mbits/s	384kbits/s	1:50-1:250
TV telephone		100Mbits/s	48-64kbits/s	1:2000

Table 3. The relationship between programs and transmission bit rates.

Block	Quantity	Purpose or code
F	28	Alternating 1 and 0
X	2	Both must be the same, 1 or 0
P	2	(Parity) Both must be the same, 1 or 0
M	3	Alternating 010
C	21	TX/RX functions and future use
Subtotal	56	These 56 bits are "overhead"
Databits	4704	This is multiplexed video and audio
Total	4760	One "M frame" of DS-3

Table 4. Data block designations and number of bits in a DS-3 frame.

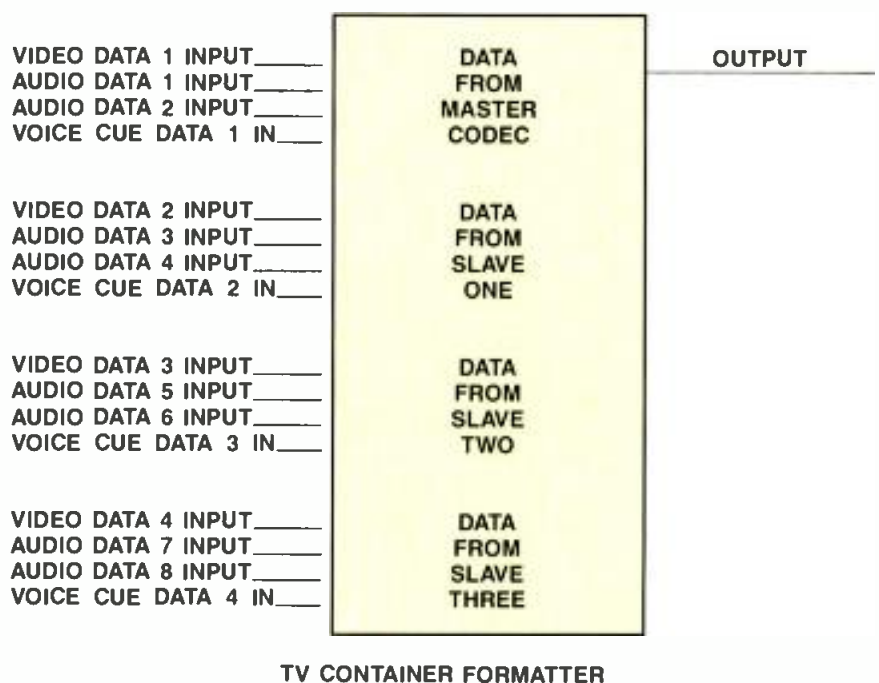

Figure 6. A TV container formatter based on a 4-channel system.

low for correct timing. In operation, this circuit changes binary (near square wave) data to a tri-level (near sine wave) signal for transmission over lower bandwidth transmission paths.

#### A codec in your future?

Today, the transmission of video via codecs in a digital form is becoming more common. Two important advantages of this kind of operation include reduced signal degradation and reduced transmission costs via data compression. Whether your

requirements are broadcast quality, teleconferencing or other video applications, a codec with video data compression will be among the equipment items you will need. Signal quality, system economy and compatibility with telecommunications standards are considerations to be investigated.



# More than just another meter

✓ Meter

✓ Sweeps

✓ Graphics

✓ Hardcopy

✓ PC-Link

✓ Phase

**A1** PROFESSIONAL AUDIO & TEST SERVICE SYSTEM  
It contains a sweepable (internally and externally controlled) generator, analyser and oscilloscope.

It measures level, noise, crosstalk (in absolute or relative terms), Frequency, THD, Wow & Flutter, drift and noise all with reliability and cost efficiency.

The large backlit LCD shows single measurements numerically along with a horizontal bargraph. Response curves are shown in a graphical form. The selectable cursor allows you to display an X-Y coordinate of a response curve for in-depth analysis from either the LCD or a standard matrix, ink jet, or laser printer.

Options available are; RS232 interface with an easy to use menu-based software package and our new phase function (model A1P). This thoroughly user-friendly instrument is auto-ranging, -tuning, -nulling, -scaling, calibrating and replaces up to eight conventional instruments.

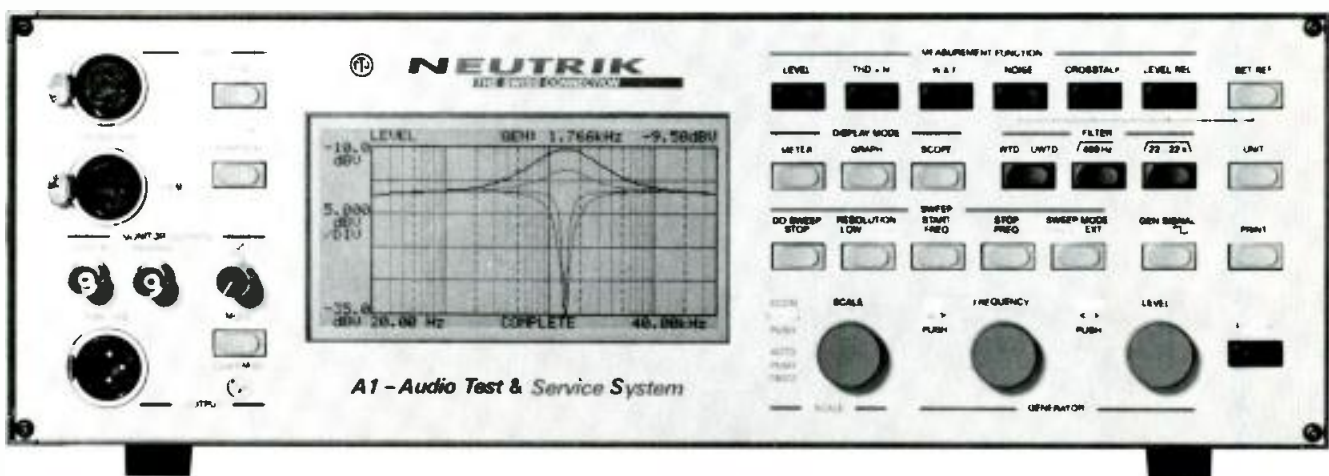

Call today for a demonstration!



## NEUTRIK

**CONNECTING THE WORLD**

NEUTRIK AG  
Liechtenstein  
Tel 075/29666  
Fax 075/25393

NEUTRIK USA INC.,  
USA  
Tel 908/901-9488  
Fax 908/901-9608

NEUTRIK Marketing Ltd.  
United Kingdom  
Tel +44/71/792 8188  
Fax +44/71/792 8187

NEUTRIK Zürich AG  
Switzerland  
Tel 01/7340400  
Fax 01/7343891

Circle (43) on Reply Card

# Field Report

## Digital Audio Research Soundstation II

By Mike Brooks

When Television South (TVS) decided to completely rebuild the audio post-production facilities at its Southampton TV production center, a prime requirement was a suite specifically geared to quick turnaround post-production of single-camera, on-location video material.

One of the areas in which production time could be saved was the search and retrieval of sound effects (SFX). TVS' SFX library is distributed throughout several rooms and on many different formats. This prompted the investigation of CD-jukebox systems, coupled with computer databases, as a method of accessing effects from a dubbing suite off-line. Under this plan, the dubbing mixers would have a database terminal in each suite through which they could search for suitable SFX. When one was found, the CD-jukebox would be instructed to play the relevant track and the output would be recorded onto 1/4-inch tape in the suite. This tape would then be played in the on-line suite by a tape operator.

It soon became apparent that time would be wasted if SFX had to be copied in real time onto another format before use, and that the system would be better if it could be made on-line from the start. However, this concept also became obsolete when disk-based editing systems became available with sufficient capacity to record complete edited dialogue tracks, and TVS realized that the SFX retrieval and dubbing processes could be combined.

When using systems of this sort, the manipulation of audio in an on-board library is purely conceptual. In theory, all that is needed is a playlist of effects against time code, which is used by the system to access audio data only when it is actually being played. (In practice, with multiple disk banks, some copying of data is necessary, although this is usually faster than real time.) Consequently, through editing of the playlist, any elements of dialogue, music or SFX can be added, copied, looped, slipped and truncated at a fraction of the time it would take in most traditional dubbing suites. Add to this the many



### Performance at a glance

- Digital audio workstation with touch-screen control
- Up to 16 channels of simultaneous I/O
- Removable magneto-optical disk drive option
- Wide-range stereo time compression
- Unique WORDFIT ADR software
- Slaves to external time code and controls VCRs

other facilities that disk-based systems have (such as time compression), and you have an extremely potent tool for dubbing.

### Choosing a system

Armed with this knowledge, TVS decided to invest in a disk-based system. Because of its inherently digital nature, proper system design would avoid multiple conversions between the analog and digital domains, especially because most new SFX and music are sourced from CD and DAT. Therefore, we made the decision to build an entirely digital dubbing suite, with

---

**Thanks to the random-access nature of the disk storage medium, lockup times are short.**

---

A/D and D/A conversions only taking place during lay-off and lay-back. TVS hoped to eliminate many of the problems of maintaining quality throughout the multiple generations needed when dubbing with film or multitrack.

We studied many of the disk-based editing systems on the market before settling on the Soundstation II from Digital Audio Research (DAR). Although the reasons for this are many, one of the biggest advantages of this system over others in its class is the currently unique WORDFIT soft-

ware. This software makes the system ideal for automatic dialogue replacement (ADR or looping), which is traditionally a time-consuming process.

### The system

The standard Soundstation II consists of a 9-rack unit (15<sup>3</sup>/<sub>4</sub>-inch x 19-inch) main processor and storage unit, and an ergonomically designed control console, incorporating a high-resolution plasma touch-screen. Connection between the two is a single custom multiway cable. This, plus a mains feed for each unit, is all that is necessary to get the system up and running. Installation of both units is straightforward — just make sure that sufficient space is left above and below the processor rack for adequate ventilation, and that enough rear access is available to allow the large circuit boards in the processor rack to be withdrawn.

Additional equipment supplied includes an outboard magneto-optical disk drive (MOD) and an RS-232 terminal. The latter is for maintenance access to the computer in the main processor.

The processor and console are standard to all Soundstation II editing systems. However, each system has a specific configuration of hardware and software that determines its particular characteristics. The system TVS purchased is arranged as a 16-channel machine with eight track hours of storage held on four 720Mbyte inboard Winchester disks, plus an outboard MOD system connected via a SCSI link. The latter provides an extra 650Mbytes of removable storage per disk, used here for SFX.

Audio connections to the outside world are via four analog inputs and outputs (for lay-off and lay-back, up to 16 are available), two AES/EBU stereo inputs (up to eight are available) and eight AES/EBU stereo outputs. Routing of these inputs and outputs, along with other secondary functions, is under software control through a series of menus accessed by a single hardware keystroke.

One of these secondary functions is the choice of clock reference. This can be internal, if the system is to operate as a stand-alone unit, or one of many forms of external reference, including linear time

Brooks is supervisory planning engineer for TVS-Nexus, Southampton, England.



An affordable, easy to learn multitrack disk recorder for radio.

For around \$7000, Roland's DM-80 will speed up your spot and promo production amazingly! This

**WITH EVERY NEW TECHNOLOGY, THERE COMES A DAY WHEN PRICES DROP AND PERFORMANCE JUMPS. TODAY IS THAT DAY.**

means you'll have the freedom to experiment with many different approaches—a creative process that will make your programming more exciting. And, because you can remove and add lines almost instantly, updates are a snap!

And there's no computer shock! The DM-80's optional controller makes it "look" like a tape recorder, so it's extremely easy to learn, and even faster to use.

The DM-80 is easily upgraded from 4 to 32 tracks, and for on-air applications you can add SCSI compatible disk drives for



Roland's custom VLSI chips give the DM-80 amazing power at a price that will astound you!



up to 12 hours of recording time per 4 tracks.

And because it all comes from Roland, you'll get great service, too!

Call (213) 685-5141, ext. 337 for a brochure, or to schedule a demo at your station.

**Roland**  
  
**Pro Audio Video**

Roland Corporation US, 7200 Dominion Circle, Los Angeles, CA 90040-3696

©Roland Corporation US 1992

Circle (44) on Reply Card

code (LTC). At TVS, the reference clock for the whole suite is a digital-audio word clock derived from the station's 25-frame video sync. (This can be generated by the Soundstation II. But in our case, it comes from the same manufacturer's DASS 100 unit.)

An important part of any dubbing system is how it works with a VCR. The normal mode of operation is that of chase synchronization, whereby the Soundstation II acts like any other slave transport, with the audio playback merely following the video transport's LTC output. With the machine control software installed, a con-

ductor on the rear of the Soundstation II allows direct connection to the Sony 9-pin serial protocol, enabling transport control from the Soundstation II's own controls, including full locate facilities. (It can also control any DAT machine that emulates this protocol.)

Thanks to the random-access nature of the disk storage medium, lockup times are short, thereby reducing much of the time wasted waiting for traditional slave machines to locate.

Additional software packages purchased with the system include TIMEWARP (a

non-pitch-shifting, stereo time-compression package) and WORDFIT, the adaptive ADP package.

The digital inputs to the Soundstation are connected via the DAR DASS 100 digital audio synchronizer, which allows non-synchronous digital sources (such as CD players) to be recorded without having to worry about changing the whole suite's clock reference. It also performs digital signal routing, format conversion, pre-emphasis removal or addition, test signal generation, level metering and adjustment, status bit inspection and alteration and (perhaps most important) sampling frequency conversion. Sampling frequency conversion allows operators to choose the optimum sample rate, depending on source and destination formats and program duration. If the Soundstation II is to be integrated into a facility with other digital audio equipment, the DASS 100 will be a helpful ancillary device.

The Soundstation II is fan-cooled, so TVS opted to place the processor in a separate machine room. It makes little sense to us to build a high-quality dubbing suite only

---

***The system is easy for operators to get used to, and yet it has a lot of power on hand when needed.***

---

to pollute the environment with unnecessary and distracting fan noise. If this option is not available, however, the unit's fans are almost quiet enough to allow installation in the control room.

Audio mixing in the suite is performed by a pair of digital mixers that interface to the digital outputs of the Soundstation II via the mixers' digital input interfaces.

#### **Maintenance**

Included with the Soundstation II is a fairly comprehensive diagnostics manual (the latest version of which includes a useful fault-diagnosis flow diagram), aimed at helping suitably qualified personnel to isolate faults in the system. The manual also includes a section on known bugs. This shows the importance that DAR places on its own credibility, because they don't try to pretend bugs don't exist. Most custom software of this size has bugs, but many companies conceal them from prospective purchasers by not deviating from a well-prepared demonstration.

In keeping with many companies these days, however, DAR does not supply much information on hardware maintenance.

## Rack Up A Versatile Routing System

When it comes to small and medium-sized routing switchers, Sierra Video Systems has a model to fit your needs. Our broadcast-quality routers are available in sizes from 5x1 to 32x32, in either composite or component video formats, with or without audio. With up to eight switching levels, multiple control panels and our three-port serial control system, one is "just right" for your application.

So whether you're into OB vans, wideband RGB graphics, post-production editing, desktop video, multimedia presentations or a host of other applications, Sierra Video Systems has a router for you.

With Sierra Video Systems, you know you've made the right choice.

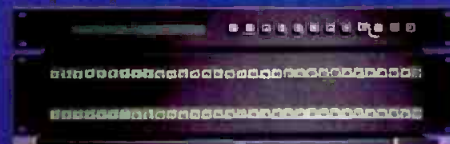

**SIERRA  
VIDEO  
SYSTEMS**

*... you can see the difference*

Sierra Video Systems • P.O. Box 2462 • Grass Valley, CA 95945 • USA  
Telephone (916) 273-9331 • Facsimile (916) 273-9390

Circle (45) on Reply Card



# GLOBAL ADVANTAGE

**Where You Need Us.  
When You Need Us.**

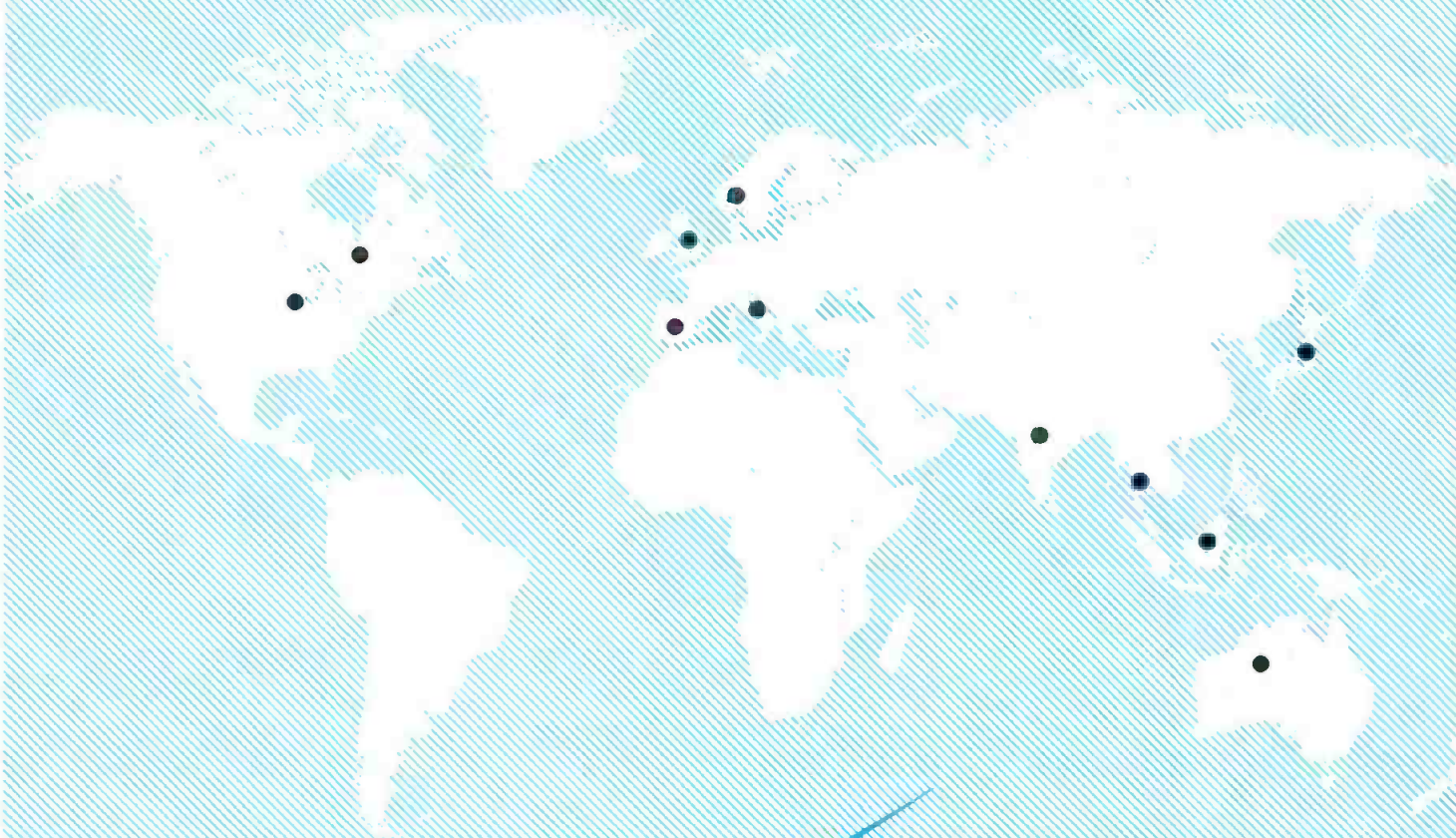

**MCL**

31 Years Of Service

## Global Support For Global Communications.

For over three decades, MCL has provided quality HPA systems backed by a Worldwide Service Organization. With eight support centers throughout the world, MCL provides responsive service on an international level.

Plus the 24-Hour Emergency Numbers means you can reach MCL's team of experts anytime. Any day. You get the expertise to troubleshoot installation or service problems and the replacement parts you need - NOW!

In fact, we guarantee 24 hours maximum parts replacement whether your amplifier is under warranty or not.

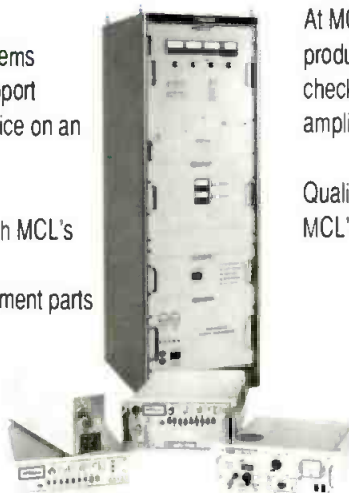

At MCL the commitment to customer satisfaction begins with quality products. Each HPA goes through rigorous testing and quality checks before it leaves our facility, ensuring you unsurpassed amplifier performance.

Quality products backed by a Worldwide Service Organization. Let MCL's 31 years of proven performance go to work for you.

### MCL INC.

501 S. Woodcreek Road  
Bolingbrook, IL 60440-4999  
(708)759-9500 • FAX: (708) 759-5018

Circle (46) on Reply Card

**MCL provides a 24 hour, seven day a week service and maintenance support throughout the world.  
24-Hour Emergency Service Number: In the USA 1-800-743-4MCL. Outside the USA: (312) 461-4536.**



## How does your salary stack up against the competition?

If you're involved in determining salary compensation for broadcast personnel, you can gain valuable insight from the 1992 Salary Survey.

Arm yourself with all the facts by ordering the results of this survey for only **\$145**.

This bound edition is filled with more than 125 pages of data, tables, graphs and charts detailing survey results.

You can purchase this valuable survey by calling Diane Mason at (913) 967-1735.

MasterCard, Visa or American Express cards are accepted.

Or you can mail your check to:

**Broadcast Engineering**  
**1992 Salary Survey**  
P. O. Box 12901  
Overland Park, KS  
66282-2901

Please allow three to four weeks for delivery.

**BROADCAST**  
engineering



*The DAR Soundstation II in use at TVS's digital dubbing suite.*

Even the company's maintenance course does not cover the hardware in enough detail to allow engineers to fault find down to component level. Instead, DAR has opted to provide a board replacement service on a 24-hour basis. It is this hardware documentation shortcoming that has attracted the strongest criticism from our maintenance staff.

Nevertheless, we are pleased with the service provided. DAR has dealt with all questions that arose during the construction of the suite promptly and efficiently, even when they concerned other manufacturers' pieces of equipment. Conversations with other users and dealers in the United Kingdom have indicated that this speed and courtesy is universal.

The relatively long life expectancy of equipment in the broadcast marketplace elevates the importance of long-term product support. It frustrates a broadcaster's maintenance department to be told, "I'm sorry but we no longer support those." DAR claims to have designed its products around a central philosophy that allows for support in the future, even if the specific technology changes. Up to now, we have no reason to doubt them.

### Operation

From an operator's viewpoint, the Soundstation II is an ideal system. It appears intuitive and familiar, with the balance between touchscreen and "real" controls being thought out and complementary. The touchscreen has only two main displays, the record and edit pages, which deal with all of the functions needed to perform these tasks. Other setup pages are accessed as required through menus selected by touching relevant areas on the screen or by pressing one of the hardware switches. The simplicity of the system in this respect means that it is easy for operators to get used to, and yet it has a lot of power on hand when needed.

Finally, we have a small complaint about the current state of the digital marketplace. During the construction of this—the first all-digital dubbing suite of its kind in

the world—we learned quite a bit, both technically and operationally. It is clear that there is a need for standardization. This is understood in the analog domain, where 1/4-inch tape, running at fractions of 30ips, is still a universal interchange medium (ignoring differing flux levels and noise-reduction systems for the moment), and line levels relating to 0.775V are standard throughout the industry. Once you set foot down the digital road, however, things become difficult. If TVS purchases its next digital system from a different manufacturer, you can guarantee that we won't be able to take a disk from the Soundstation II and put it in the new system with any hope of extracting the audio data. OK, so all we have to do is send it down an AES/EBU line and transfer in real time. (Hang on, isn't this where we came in?) Even if we do that, pitfalls still exist.

---

*The system has lived up to expectations, with great savings in turnaround times.*

---

### Conclusion

It is easy to criticize a system and not give credit to the parts that work well. The system installed at TVS has certainly lived up to the expectations of the post-production department, with great savings in turnaround times. Dialogue replacement is frequently brought in from other suites on 1/4-inch tape because of the ease of performing the task on the Soundstation II and the quality of the results. (For example, parts of an opera have been replaced with sections from another take, with little fuss.)

One of our operators describes using the system as "painting with sound." He first applies a "background wash of atmosphere," then "picks out details with spot effects from the palette of sounds at his disposal." As with most creative processes, he can only do this to the best of his abilities, when the technology doesn't get in the way. As far as he is concerned, the Soundstation II is the most transparent system he has used.

---

Editor's note: Field reports are an exclusive BE feature for broadcasters. Each report is prepared by the staff of a broadcast station, production facility or consulting company.

In essence, these reports are prepared by the industry and for the industry. Manufacturer's support is limited to providing loan equipment, and to aiding the author if requested.

It is the responsibility of Broadcast Engineering to publish the results of any device tested, positive or negative. No report should be considered an endorsement or disapproval by Broadcast Engineering magazine. ■



# Wireless cuing has come a long way!



Joshua Weisberg (left) and Peter Scharff of Scharff/Weisberg in Green Turtle Studios, New York, New York

## Introducing the IFB-12 from Vega Wireless

Vega's new wireless Interrupt Fold Back system, the IFB-12, is today's means of talent cuing in the studio, in the field, or wherever else you require simplex communications to a virtually undetectable miniature receiver. The system operates in the 174-216 MHz VHF high band and utilizes companding to make this the best sounding wireless IFB system on the market.

Fifty milliwatts of RF power from the RMT-10 base-station

transmitter, and remote antenna capability, allow full studio coverage using the dual-channel, crystal-controlled PL-2 miniature receivers. Audio-frequency shaping plus linear and ALC modes let you tailor the IFB-12's audio to meet your specific requirements.

The factory-matched system is available on any of more than 1600 stock frequencies and can be coordinated with any other wireless microphone systems you may be

operating. The PL-2 receiver's multiple RF and IF tuning stages and outstanding sensitivity and selectivity make the IFB-12 *the* wireless talent cuing system for the professional.

Call our toll-free 24-hour Fax-Back system at 1-800-274-2017 for instant technical information, or call our toll-free main number at 800-877-1771 for technical support. Vega wireless...the choice of professionals the world over.

# VEGA

a MARK IV company

9900 East Baldwin Place • El Monte, California 91731-2294  
Telephone: (818) 442-0782 • Toll-Free: 800-877-1771  
Fax: (818) 444-1342 • FaxBack: (818) 444-2017 / 800-274-2017



Circle (60) on Reply Card

www.americanradiohistory.com

# SBE Update



## 2GHz battle continues

By Jerry Whitaker

The SBE has entered round two of the battle to save the 2GHz ENG band. The SBE filed comments to engineering technology (ET) Docket 92-9, which is attempting to find spectrum for "emerging technologies," such as personal communications services (PCS).

The SBE comments urged the commission to uphold the findings reached in a January 1992 internal study. That analysis concluded the 1.990-2.110GHz ENG band could not be moved to another band to make spectrum available for PCS. The SBE pointed out that it is possible to reallocate fixed links to another band, if money is no object and high performance or ultrahigh performance antennas can be used at will, but it is not possible to relocate mobile microwave stations to other bands; mobile stations need their own dedicated band. The SBE comments pointed out that most fixed links in the 2GHz TV auxiliary band have already been voluntarily relocated to the 7GHz TV auxiliary bands for this reason.

A review of the comments filed in response to ET Docket 92-9 revealed that two PCS proponents, Motorola and Communications Satellite Corporation (COMSAT), filed comments that would spell the doom of the 2GHz ENG band. Motorola is ignoring the FCC study and is urging that the commission reallocate existing TV auxiliary stations to other bands. COMSAT acknowledges the impracticality of attempting to move mobile ENG stations to some other band where mobile stations would have to co-exist with fixed stations, but argues that 2GHz ENG stations could share their frequencies with proposed mobile satellite service (MSS) stations. Because there would be hundreds, if not thousands, of mobile or portable uplink stations in the MSS scenario, ENG receive sites would be at risk of receiving interference from these uplinks.

Extensive SBE reply comments to ET docket 92-9 have been filed. Those comments point out the flaws in the Motorola comments and the COMSAT comments. The SBE comments additionally point out that TV stations have their own emerging

technology in the form of HDTV, and that continued allocation of the 2GHz ENG band is needed to support that technology, which also can claim to have national economic advantages.

### SBE files comments to EBS docket

The SBE has filed comments in field operations (FO) docket 91-171, regarding improvements to the Emergency Broadcast System (EBS). Issues raised in the SBE comments include:

- Changing the philosophy of the attention signal by not using the signal for tests, so the public will know to take notice when they hear the attention signal.
- Implementing an automatic alerting system for national-level alerts based on the primary entry point (PEP) project under control of the Federal Emergency Management Agency (FEMA), the FCC and the White House Communications Agency.

The SBE comments conclude that the SAGE Radio Data System (RDS) would not be appropriate for the commission to adopt, because the system places AM stations at a competitive disadvantage to FM stations.

The SBE comments also request the commission to clarify the proper modulation levels for the attention signal. The commission was asked whether the requirement that each tone modulate the transmitter at 40% modulation refers to peak or to quasi-peak modulation levels, and whether both tones together must result in a composite modulation level of at least 80%.

Finally, the SBE comments ask the commission to clarify whether remotely accessed EBS receivers, which rely on the availability of the conventional switched telephone system in order to meet monitoring requirements, are acceptable. The SBE comments point out that such techniques assume the availability of the switched telephone network at the time when that service is most at risk.

### Chapter liaison news

The SBE board of directors has implemented a system to assign special responsibility for specific chapters to each nation-

al officer or board member. Each chapter has been assigned a specific national-level person as an SBE contact. Chapters with specific questions or concerns about national SBE policies or proposals should call their contact person directly for a quick answer. The contact person also provides members with a mechanism for quickly relaying chapter concerns to the SBE officers and the board.

Questions concerning membership, certification and other matters should continue to be directed to the regular national office staff.

The national-level chapter contacts will keep in regular communication with their assigned chapters and attend chapter meetings whenever possible. The goal is to have every chapter visited at least once each year by a representative from the SBE national office.

To make this system work, a full-duplex link must be established. Chapter chairs should place their contact person on the chapter mailing list, and inform them of meeting dates and locations. The officers and board members are expected to contact each chapter chair assigned them and provide office and home phone/fax numbers and possible travel schedules.

### Bulletin board proposal

The Chapter Liaison Committee is investigating the possibility of using a nationwide BBS network to expand communications to the chapters. President Richard Farquhar has directed the committee to investigate the possibility of providing national-level support for a nationwide chapter BBS system that would include various host systems and provide near-instant electronic communication and file sharing among all chapters at the cost of a local phone call.

The board believes it is in the professional interest of each member to become computer literate, improve writing, programming, and thinking abilities, and become more familiar with the role of data processing and communications equipment. A nationwide SBE chapter BBS system could do this.

Whitaker, a technical writer based in Beaverton, OR, is vice president of the Society of Broadcast Engineers.



# Belden has **BIG NEWS** for the broadcast industry



**Belden is on the air with the industry's largest portfolio of new broadcast cables.**

More than 60% of the products listed in Belden's new Broadcast Catalog didn't even exist just 2 years ago! Belden's new 48-page Broadcast Cable and Connector Catalog provides specifications for the industry's most complete line of cabling products, including audio multi-conductor cables, microphone cables, video coaxial cables, video triaxial cables, audio & video composite cables, bundled coaxial composite cables, fiber optic cables, cable assemblies and connectors.

### **New levels of excellence and innovation**

During the past few years, Belden has introduced more product innovations for more broadcast cabling applications than any other cable company. This commitment to innovation and technical excellence is the reason Belden remains the broadcast industry's No. 1 cabling choice worldwide. It's a position we've worked hard to earn and will fight hard to keep with new products, new options and even higher levels of excellence in the future.

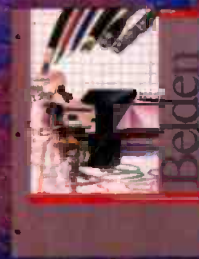

For a FREE copy of Belden's new Broadcast Cable & Connector Catalog plus updates on our latest

product innovations, contact your local Belden distributor or call toll-free: **1-800-BELDEN-4**

**COOPER**

**Belden**

Quality from Cooper Industries

Circle (47) on Reply Card.

[www.americanradiohistory.com](http://www.americanradiohistory.com)



# Field Report

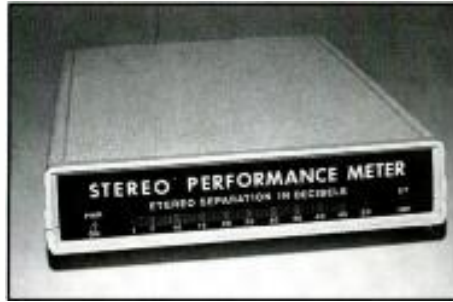

## FM System's SPM-1 stereo performance meter

By Dennis R. Ciapura

These days, it is rare to encounter a truly unique test instrument. Although there are many new versions of familiar measurement devices, few measure something different. But the FM System's SPM-1 stereo performance meter boasts the ability to measure the stereo separation of program audio and off-air signals with both channels active.

Not only does the unit measure simple L-R, but also actual *dynamic separation* on a nearly instantaneous basis. This is not as easy as it might seem. Simple analog difference information will not do the trick, because any intrachannel level and phase differences that may exist in your audio path between the source and the meter are included in such an L-R sample. (That data is already displayed by your stereo monitor's L-R indicator, typically on a fast-moving analog meter.) If you are trying to measure actual, dynamic *program audio* channel separation, you probably don't want your results corrupted by static intrachannel phase and level anomalies, so a much more complex analysis (and appropriate display) is required.

The SPM-1 is an unimposing box with a single LED display calibrated from 0dB to 50dB separation in 1dB increments. The LEDs are green, except for yellow LEDs at 5dB intervals, and a separate, single red LED to indicate stereo channel polarity inversion. The device is energized by an external power cube. Overall, its appearance belies the sophistication of its circuitry and its measurement capability.

### How it works

The SPM-1 can be described as a cross-correlation computer. The pure definition of stereo separation is the degree to which each channel is kept out of the other. As a hardware specification, this usually refers to the leakage of left-into-right and vice versa, using sine wave tone at a specified frequency. The SPM-1 displays this fairly standard measurement when it sees signal on only one channel.

However, when audio is presented on

### Performance at a glance:

- Dynamic display of stereo separation in program audio
- Useful in proofing or troubleshooting stereo audio chains without interrupting programming
- An aid to proper stereo production techniques in the studio or on remotes
- Indicates stereo channel polarity-reversal
- Helpful in off-air monitoring of AM stereo, FM multiplex or MTS TV broadcasting

both channels, the SPM-1 uses its digital analysis to compare left and right program signals, continuously calculating the degree of non-commonality between channels. Static level and phase differences between channels are not included in this

### *Its appearance belies the sophistication of its circuitry and its measurement capability.*

display. Thus, only dynamic separation (which can only be caused by stereophonic program audio) will be seen in this mode. Any static loss of separation caused by the audio chain (as a result of intrachannel crosstalk) will *always* be included in the display, leading to perhaps the most useful application of the device as a monitor of stereo problems.

The microprocessor's data output is actually faster than what the eye can use, so the LED display updates at approximately a 1ms rate. The instructions that came with the sample unit stated that the case was sealed and should not be opened for any reason, so the inside of the device was not examined. Externally, the construction quality appears to be excellent. The company claims that the unit is accurate  $\pm 1$ dB from 0dB to 30dB of separa-

tion, and  $\pm 2$ dB between 40dB and 50dB. Before exploring potential applications, these claims were tested.

### Lab test results

To test the static separation measurement accuracy, pink noise was fed at precise 15dB, 30dB and 45dB ratios in left-into-right and right-into-left simulations. The left-into-right accuracy under these conditions was exactly correct at all three levels of separation. The right-into-left indications were precise at 15dB, 1dB low at 30dB and 2dB low at 45dB. The SPM-1 successfully held that level of accuracy in the 30dB separation range with input level variations from  $-17$ dBm to  $+10$ dBm. Below  $-17$ dBm, the error was only 1dB until the input level dropped below the minimum usable threshold at approximately  $-25$ dBm. These figures confirm the manufacturer's specifications, at least in a static mode.

Dynamic separation accuracy under program conditions is a bit more difficult to determine. In simulating two separate (uncorrelated) pink noise sources, the SPM-1 indicator fluctuated between 35dB and 40dB. It is unclear whether this result represents the limit of the unit's separation-discerning capability under dynamic conditions, or whether it is more reflective of the probability of random correlation of two pink noise sources. The point is probably moot, however, because normal stereo program material rarely exhibits more than 30dB of dynamic separation, and most mainstream products hover around 10dB to 15dB. Inverting one channel with typical program sources confirmed that the stereo inversion indicator worked as advertised. It flickers occasionally during normal program material (when significantly out-of-phase audio is momentarily encountered) but stays solidly on when a channel is polarity-inverted.

### Applications

The SPM-1 actually performs two roles at a broadcast facility. It serves as test equipment for the maintenance engineer (useful for proofing and troubleshooting audio chains), and it also can function as a monitor for the studio or master control

Ciapura, BE's technical consultant on radio technology, is senior vice president, Noble Broadcast Group, and president of TEKNIMAX Telecommunications, San Diego.



technician (providing an ongoing indication of stereo audio status during production or off-air).

Perhaps the most attractive function of the unit is its ability to provide a stereo separation check without interrupting normal programming. For example, in radio

---

**Perhaps most attractive is its ability to check stereo separation without interrupting normal programming.**

---

applications, current program material can be screened to disclose a few cuts that exhibit excellent separation, and these can be used as signal sources for either routine separation checks of the air chain or for an instant response to reports of possible stereo problems. A quick dual noise burst would provide even more accurate results.

The SPM-1 can be valuable in MTS TV

applications, where relatively slight problems can result in serious separation losses due to tracking errors in the dbx-encoded L-R channel. This is particularly true if discrete stereo audio is provided to a cable TV carrier who then encodes the BTSC stereo format at its head-end. Crosstalk between channels or loss of separation from reduced L-R modulation can occur at the cable head-end, but easily go undetected until the cable viewers perceive diminished stereo performance.

An SPM-1 connected to a monitor on the cable would quickly disclose the deterioration. Many TV stations have news show theme music with sufficient separation to function as a test source. Run the theme through the unit directly on-site, then check the reading against the theme when it airs through the cable.

Installation of the unit involves simply plugging the power cube in and connecting the audio samples to the high-impedance balanced inputs. Unfortunately, the input connections are via screw compression connectors (wire into hole, screw down to fasten) rather than the XLR types that broadcasters would probably find more normal. Even a standard barrier strip would be preferable because spade

lugs could be used. Nevertheless, this is the only drawback that can be leveled against the device. The connector does unplug, making it easier to connect the input wires.

At \$1,250, the SPM-1 is not inexpensive for a plastic box instrument with an LED

---

**The SPM-1 can be described as a cross-correlation computer.**

---

readout. But considering its electronic complexity and unique capabilities, many broadcasters will find it a good value.

---

Editor's note: Field reports are an exclusive BE feature for broadcasters. Each report is prepared by the staff of a broadcast station, production facility or consulting company.

In essence, these reports are prepared by and for the industry. Manufacturer's support is limited to providing loan equipment and to aiding the author if requested.

It is the responsibility of Broadcast Engineering to publish the results of any device tested, positive or negative. No report should be considered an endorsement or disapproval by Broadcast Engineering magazine. ■

## Now Available:

### The Industry's Most Comprehensive Survey on Non-Linear Video Editing Systems

You can use the results of this survey to gain insight into the impact of non-linear video editing systems.

**S**YPHA has conducted the industry's most exhaustive survey on non-linear editing systems from the user's point-of-view. The survey examines:

- Awareness and opinion of systems and technology
- Reasons for system selection and purchase
- Expectations of system performance
- Manufacturer/supplier support
- Operational and technical support
- Applications and features required
- Investment decisions and future plans
- Sources of information and advice

---

*SYPHA, an independent consulting firm, conducted a survey of more than 200 editors, producers, production and post-production facilities and broadcast companies in the United States and the United Kingdom. Broadcast Engineering magazine, Avid Technology, Imp Electronics, OLE, Weynand Training International and Audio Visual provided the sponsorship necessary to conduct the survey. However, they had no control over the method or results.*

---

.....

Broadcast Engineering readers are entitled to a reduced price of \$285 (reg. \$350). To order your copy of *Non-Linear: A Survey from the User's Point-of-View*, enclose this ad with your order and mail to:

Weynand Training  
22048 Sherman Way, Ste. 212  
Canoga Park, CA 91303  
(818) 992-4481 Fax (818) 992-8641

OR

SYPHA  
216A Gipsy Road  
London SE27 9RB UK  
Tel +44 81 761 1042

# Industry Briefs

## BUSINESS SCENE

**Sony**, Park Ridge, NJ, has sold a DVS-8000C component digital switcher, a DME-5000 3-D effects processor and a BVE-9100 high-end on-line editor to Pacific Ocean Post, Santa Monica, CA.

In addition, Sony has supplied four Dutch broadcast and post-production customers with equipment packages. Also, the British Broadcasting Corporation (BBC), London, is upgrading the hardware on 21 of its Sony BVE-9000 editors.

**Solid State Logic**, Oxford, England, has supplied an SL 8000 G series console to Abbey Road Studios, London.

Solid State also has taken orders for three 96-channel desks from Enterprise, GTV-9 and Record Plant.

**Panasonic**, Secaucus, NJ, has delivered a Digital M.A.R.C. cart machine to KIRO-TV, the first TV station in the United States to purchase one.

Furthermore, Broadcast Edit, Los Alamitos, CA, has purchased an AJ-D350 1/2-inch composite digital studio VTR from Panasonic. California Video Center, Los

Angeles, also has acquired three AJ-D350 1/2-inch composite digital studio VTRs.

**Vega**, El Monte, CA, supplied ABC, CBS and NBC with UHF wireless microphone systems for TV coverage of the Democratic National Convention.

**Vistek**, Palo Alto, CA, has sold a VMC standards converter to Intercontinental Televideo, New York.

**Grass Valley Groups'** (Grass Valley, CA) series 7000 serial digital routing system and related products has been selected by CBS Operations & Engineering. It plans to modernize and improve its technical operations at its New York Broadcast Center and at its studio facilities in Los Angeles. Installation of the routing system will begin later this year and will be completed in mid-1993.

**Videotek**, Pottstown, PA, has delivered 30 Prodigy switchers, 15 TSM-61P waveform monitors, 35 VSM-61P vectorscopes and four TVM-710P video analyzers to R.A.I., the Italian national broadcasting network headquartered in Rome.

**FOR.A**, Natick, MA, supplied NBC, New York, with 40 PAL color correctors (CCS-4300P) for use at the Summer Olympics in Barcelona, Spain.

**AVS**, Surrey, England, has sold an AVS Integra digital vision mixer and 3-D DVE system to J. Walter Thompson, London.

**TFT**, Santa Clara, CA, has supplied KWMX-FM, Seattle, with a synchronous booster/reciter system.

**Soundcraft**, Hertfordshire, England, supplied 85 consoles for use at the 1992 Summer Olympics.

**Neve**, Herts, England, has received orders for its Neve 55 series analog broadcast console from seven broadcast organizations in the United Kingdom and the United States.

In addition, the Canadian Broadcasting Corporation has purchased three Neve non-custom consoles for use at its broadcast center in Toronto, Canada.

**Systems Wireless**, Herndon, VA, was selected by NBC, New York, to supply

## TETRODE REPLACEMENT SERVICE



PEMA 28

*For premier performance, go directly to the source!*

Your transmitter has been designed for a Thomson Tube. To maintain optimum performance, buy the tubes you need directly from Thomson. We offer:

- Rapid delivery
- Competitive prices
- Full value warrantee
- Customer support.

Make sure your next tetrode is from Thomson and relax!

**THOMSON TUBES ELECTRONIQUES**

U.S.A. Totowa, NJ - Tel (1-201) 812-9000 - Fax (1-201) 812-9050

Circle (48) on Reply Card

## Everything To Go.

Test and Trouble Shoot a Stereo Broadcast Television System with One Handheld Device...



### TS-12 Handheld NTSC Video, Character & Stereo Tone Generator

- Up to 12 precision test signals & VITS.
- Black burst output
- 16 message, 32 character ID
- Inserts 16 char. vertical interval ID in ext. video (RM only).
- Stereo audio tone, 3 frequencies, mic. & line levels.
- AC & DC operation with 4 AA batteries, up to 11 hours.
- Automatic by-pass of external video/stereo audio (RM only).
- Lip-sync, audio & video synchronizing signals.
- Handheld and rack-mounted.
- American made. 3 year warranty.



Signal excellence

Visit us at SMPTE booth # 1428

**Multidyne**™ Innovations in broadcast television

1-(800)-4TV-TEST in the U.S. and Canada  
1-(800) 488-8378 (516) 628-1495 FAX (516) 628-1496  
244 Bayville Avenue, Bayville, NY 11709

Circle (49) on Reply Card



wireless microphones for use at the Summer Olympics in Barcelona, Spain.

**Digital Audio Research's** (Surrey, England) SoundStation SIGMA digital audio production system with WordFit was chosen by Rudas Studios, Dusseldorf, Germany, to expand its audio-for-video and film operations.

Furthermore, the Capital Radio production, "Michael Jackson, King of Pop," was edited on a SoundStation Sigma digital audio production system. Also, Gemini Audio, London, has purchased its second DAR digital audio production system.

**Audio Follow**, Paris, has delivered two D.D.O.2 direct-to-disk optical digital recording systems to Skyrock.

**NewsMaker Systems**, Moorpark, CA, has sold a NewsMaker Electronic Newsroom to Westcountry Television, London.

**BEC Technologies**, Seattle, has been chosen to supply a multichannel digital fiber-optic audio transmission and distribution system for the World Headquarters Complex of the Reorganized Church of Je-

sus Christ of Latter Day Saints (RLDS) in Independence, MO.

**Konig & Meyer**, Wertheim, Germany, has sold its millionth model KM210/2 all-purpose boom stand.

**Studer Digitec**, Cedex, France, has been awarded a contract to construct a post-production studio for West German Radio Station, Köln, Germany.

**B&B Systems**, Valencia, CA, has been chosen to build a duplication facility for Multimedia Services, Chicago.

**Basys**, Yonkers, NY, has sold integrated newsroom systems to two of ITV's franchises — London News Network, London, and Good Morning Television, London.

**Vyvx**, Tulsa, OK, has linked together 16 independent video production facilities via a broadcast-quality digital fiber-optic TV transmission network called Vyvx First Video.

This network will eventually connect more than 50 video production facilities across the country.

**api audio products**, Springfield, VA, has sold 50 api 550s console EQ modules to Sony Music Entertainment's recording facility in Santa Monica, CA.

**Radamec EPO**, Northvale, N.J. has been awarded a contract to provide the House of Lords, Westminster, England, with a fully automated 5-camera broadcast system that includes two advanced robotic control (ARC) panels.

Three franchises recently acquired by ITV, London, have also selected Radamec EPO robotic camera systems.

**Vyvx**, Tulsa, OK, has signed an agreement with ABC/Capital Cities, New York, which calls for the network to increase over the next year its use of fiber optics for various nationwide occasional TV transmission requirements.

**Canon U.S.A.**, Englewood Cliffs, N.J. has delivered four J20x Super studio lenses to KHOU-TV, Houston.

**Ampex's** (Redwood City, CA) 499 Grand Master Gold analog mastering tape has been chosen by Woodland Digital, Nash-

# Labels

The largest selection of video and audio cassette labels for laser and pin-fed printers. Available blank or custom printed with your company logo.

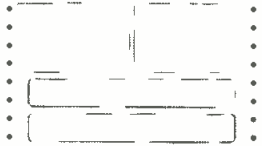

Tape status and management labels, too.

## United Ad Label

has the labels you need.

Call (800) 423-4643  
for information and brochure.



United Ad Label Co., Inc.  
P.O. Box 2216  
Brea, CA 92622-2216

Circle (61) on Reply Card

# UNEQUAL FLANGE EQUIPMENT RACK



- Compatible with telephone industry standards
- Heights from 7' to 11'8"
- 19" or 23" mounting
- Available in open or closed duct
- Complete with a large selection of accessories

Write or call for our free catalog and engineering manual, complete with helpful illustrations on installation procedures.



# NEWTON

## INSTRUMENT COMPANY, INC.

Manufacturers of Aux. Framing, Cable Racks, Misc. Hardware, Equipment Racks, Main Frames & Card Storage Cabinets.  
111 East "A" St. • Butner, North Carolina 27509-2426 • Phone (919) 575-6426 or FAX (919) 575-4708

Circle (62) on Reply Card

ville, TN, for use in a recording session that will use analog and digital formats.

**Neotek**, Chicago, has sold a custom color Élan 32 input console to Technisonic, St. Louis. Denmark Radio has also acquired its sixth Élite, and the Australian Broadcasting Corporation has ordered its second Esprit.

**AVS**, Surrey, England, has sold ADAC standards converters to Holloway Film and Television, London, and Magnetic Image Productions, London.

**BTS**, Simi Valley, CA, has delivered a TVS-3000 wideband distribution switcher, a TAS 2000 modular audio switching system, a BCS 3000 machine control system and an MCS 2000 master control system to KNBC-TV, Los Angeles.

In addition, WUAB-TV, Cleveland, has acquired three BTS LDK 9 studio cameras and an LDK 92 portable camera.

**Sachtler**, Freeport, NY, has acquired a majority ownership of RDS Studio Planning and Suspension Systems (RDS-Lichttechnik GmbH). RDS suspension systems and track systems are now available through the worldwide Sachtler network.

With the products developed by RDS, Sachtler will be able to offer TV and film studios comprehensive lighting systems planning, design and product equipment service that is customized to the needs of the consumer.

A combined manufacturing facility is planned. The first joint product of RDS and Sachtler was presented at Photokina '92 Professional Media Exhibition, Sept. 16-22, in Cologne, Germany.

**Digital F/X**, Mountain View, CA, has acquired Microtime, a wholly owned subsidiary of the Anderson Group. Microtime manufactures products for the broadcast video market.

**Vega**, El Monte, CA, is offering a toll-free "fax back" service that provides customers with production and company information, as well as a variety of other services. Available information includes instruction manuals for current and discontinued Vega products; maintenance information on current and discontinued products; all Vega product data sheets and pricing information; a list of demo stock available and a special network listing of used equipment for sale; a list of Vega wireless equipment reported lost or stolen (with serial numbers); a list of all UHF and VHF wireless system stock frequencies; all technical white papers; and application notes and technical tips.

The system is operational 24 hours a day, seven days a week. The number is 800-274-2017 or 818-444-2017.

**Panasonic**, Secaucus, NJ, has authorized 19 sales representatives to sell its D-3 1/2-inch digital product line.

Authorized sales reps are: Alpha Video & Audio, Bloomington, MN; Audio Video Supply, San Diego; AVEC Electronics, Richmond, VA; A-VIDD Electronics, Long Beach, CA; Avonix Video Systems, Brookfield, WI; C.T.L. Communications Tele-video, Silver Spring, MD; Communications Systems Group, Oak Park, MI; Crescent Communications, Kenner, LA; Crimson Tech, Cambridge, MA; Custom Supply, Birmingham, AL; Florida Video Systems, Miami; Industrial Broadcast Services, Tulsa, OK; Modern Communications, St. Louis; Professional Video Supply, Overland Park, KS; R.P.C. Video, Verona, PA; Swiderski Electronics, Elk Grove, IL; Technical Video Systems, Winston-Salem, NC; TV Specialists, Salt Lake City; Video Supply Sales, Atlanta; Video Technical Services; Albuquerque, NM; Vidicom Distributors, Houston.

**Television Technology Corporation** (TTC), Louisville, CO, has appointed Applied Communications Technologies, Fort Wayne, IN, and Technology Resources and Supply, Seffner, FL, as radio products dealers.

**NWL Capacitors** has relocated its headquarters. The address is 204 Carolina Drive, Snow Hill, NC 288580; phone 919-747-5943; fax 919-747-8979.

**Richardson Electronics**, LaFox, IL, and **Shure Brothers**, Evanston, IL, have signed a distribution agreement that names Richardson as a stocking distributor of Shure's line of microphones, mixers, accessories and other related audio products.

**Symetrix**, Seattle, has appointed Musik Productiv as its German distributor.

**Chromatic Technologies** has moved its headquarters. The address is 9 Forge Park, Franklin, MA 02038; phone 508-520-1200; fax 508-528-9950.

**Dolby**, San Francisco, has selected AudioTechniques, New York, as its exclusive Pro Audio products dealer for the metropolitan New York Area.

**Tektronix**, Beaverton, OR, has added Softimage, Montreal, to the list of companies distributing its Avanzar video system and VideoDesktop software.

**TFT**, Santa Clara, CA, has proposed a cost-effective means of upgrading the current EBS system. The company's proposed enhancement would use three seconds of a minimum 8-second 2-tone attention signal to transmit a variety of information as digital data.

The 3-second message could include the source(s) of the emergency information; the area to which the emergency applies; the nature of the information or the type of emergency; the level of severity of the situation; and the format of the incoming message (phone, teletype, printer and fax).

In addition, the TFT message could contain user-programmable data and commands to operate external devices. Because it is an in-band system, the proposed enhancement is compatible with all present audio transmission systems.

TFT also notes that recent developments in microprocessor technology would allow these functions to be provided on a chip that would add approximately \$5 to the cost of a consumer radio or television.

**Computer Concepts Corporation**, Lenexa, KS, has been issued a patent for its digital commercial system (DCS).

**Videotek**, Pottstown, PA, has been awarded U.S. patent 5,122,863 for its 3-D vector display.

**Digital F/X**, Mountain View, CA, has formed an audio division based on the acquisition of assets from Hybrid Arts, a Los Angeles-based company that develops digital audio editing equipment.

**Studer Revox South Africa Pty Ltd.**, Johannesburg, South Africa, has been chosen to represent Wohler Technologies product line throughout the southern part of Africa.

**RGB Computer & Video** is expanding its facilities by 2,200 square feet to allow for additional technical support and manufacturing growth.

**NXT Generation**, Greendell, NJ, has been founded by John R. French and Dennis Charney. The company specializes in routine maintenance and periodic overhauls on Sony professional DAT recorders. The address is 249 Kennedy Road, Greendell, NJ 07839; phone 201-579-4849; fax 201-579-6021.

**Hughes Communications**, Los Angeles, has created a subsidiary to operate its 150-channel DirecTV direct-to-home satellite service. The subsidiary, DirecTV Inc., will be headquartered in El Segundo, CA, and is responsible for development and



# Sachtler ENG Support stands firmly during the decisive seconds.



■ Often seconds decide your pictures. And Sachtler ENG systems will give you those valuable seconds. Sachtler ENG support is:

- Comfortable and easy to transport.
- Sets up in seconds.
- Stands firm.

Combined with Sachtler's dynamic counterbalance and unsurpassed, patented friction-free fluid dampened heads, Sachtler makes taking the best pictures easy. Sachtler has the perfect ENG support for you and your camera.

- "Hot Pod" - the fastest ENG support

system ever.

- Tripods constructed of aluminum or carbon fiber.
- Single or two-stage extensions for extra stability, and heavy duty versions available.

All these support systems easily take the Video 14 II, Video 18 III and Video 20 III ENG fluid heads. Throughout the world, more professional cameras use Sachtler camera support.

Call or write today for more information and the location of your nearest Sachtler dealer for a hands-on demonstration.

Sachtler ENG Support – is all your camera needs.

**sachtler**  
corporation of america

55 North Main Street  
Freeport, N.Y. 11520  
Phone (516) 867-4900  
Telex 140 107 sac frpt  
Fax: (516) 623-6844

California office:  
3316 West Victory Blvd.  
Burbank, CA 91505  
Phone (818) 845-4446

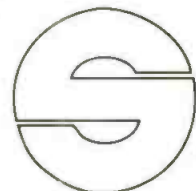

Circle (50) on Reply Card

implementation of the United State's first high-power direct broadcast satellite (DBS) system, scheduled to begin operation in early 1994.

**Computer Engineering Associates** (CEA), Baltimore, appointed Crow Broadcast Equipment and Metromedia Broadcasting Systems as exclusive representatives of the CEA Newsroom system for Singapore, Malaysia and Brunei.

**Quantel**, Darien, CT, has established a team of broadcast specialists to enhance the sales and support operations of its broadcast and graphics divisions.

**Digital F/X**, Mountain View, CA, has acquired the assets of WaveFrame, the Los Angeles-based manufacturer of high-performance digital audio recording and editing systems. WaveFrame will merge with the Digital F/X Audio Division.

In addition, WaveFrame has made plans to relocate its non-sales-related activities to offices in Southern California. Plans include the immediate consolidation of the company's Colorado operation into its ex-

isting Sherman Oaks, CA, and Long Beach, CA, facilities.

**Editing Machines Corporation** (EMC), Washington, DC, has announced its support of the Aaton Keylink database for match-back of 16mm and 35mm keycode during the digital off-line editing process.

**Columbine Systems**, Golden, CO, and **Peter Storer & Associates**, Milwaukee, have signed an agreement to market Storer's Program Manager system in all countries and territories outside the United States. Storer will retain marketing rights within the United States.

**Apogee Electronics**, Santa Monica, CA, has relocated its office within the city. The address is 3145 Donald Douglas Loop South, Santa Monica, CA 90405, phone 310-915-1000; fax 310-391-6262.

## PEOPLE

**Karen Schweikher** has been named director of corporate communications for

Ampex, Redwood City, CA.

**Dave Howland**, **Cindy Edwards** and **Jack Conners** have been appointed to positions with Audio Broadcast Group, Grand Rapids, MI. Howland is sales and marketing manager. Edwards is sales representative. Conners is transmitter and RF sales engineer.

**Dan Zimbleman** has been chosen as director of console sales, North America, for API Audio Products, Springfield, VA.

**Matthew Allard** has been appointed Western regional sales manager for FOR.A, Natick, MA.

**Joel A. Potts** has been named chief engineer of operations for HCJB World Radio technical services division, Pifo, Ecuador.

**Julius Barnathan**, former senior vice president of technology and strategic planning for Capital Cities/ABC, has been retained as a consultant for Video Services Corporation (VSC), Northvale, NJ. ■

NEW FROM CANARE

## Coaxial Cable Stripper

FOR CANARE 75Ω BNC CRIMP PLUGS



# 15 Second Quick



**1**  
Insert end of cable into the stripper.



**2**  
Rotate the stripper.



**3**  
Press down lever and pull out cable.



**4**  
Peel off jacket & you're ready to crimp!

MODEL SELECTION		
Model	CANARE Cable	Others
TS-4C	LV-61S	RG-59B/U
TS-5C	LV-77S	8281



511 5th ST., UNIT G SAN FERNANDO, CA 91340  
PHONE: (818) 365-2446 FAX: (818) 365-0479



## SONEX baffles.

Acoustical control in a hanging baffle.

- Lightweight
- Reinforced
- Patented SONEX pattern

Find out how Sonex Baffles can work for you.

Free Acoustical Information Packet!



SONEX Acoustical Products Division  
3800 Washington Avenue North  
Minneapolis, MN 55412

# 1-800-662-0032

Circle (52) on Reply Card



# New Products

## DA adaptation

By *Multidyne*

• **A1A-8550:** panel adapts screw terminals of GVG 8550 series audio DAs to XLR-style connectors; an interface board and XLR-terminated ribbon cable bring all signals to the panel; companion products available for GVG 8560 DAs, TEN 20/20 TEN and TEN-XL routers.

Circle (418) on Reply Card

## Digital audiotape

By *Sony Professional Tape Division*

• **Pro DAT Plus:** professional digital audiotape; formulation designed specifically for professional music, sound and dialogue recording; includes features to reduce dropouts and protect the tape in the field and archive.

Circle (415) on Reply Card

## Universal sync source

By *nVision*

• **NV5000 series:** single reference source simultaneously locks NTSC/PAL video, AES/EBU and SDIF-2 digital audio to an external reference; digital audio functions include sample rates of 48kHz, 44.1kHz, 44.056kHz; use as free-running sync generator or drive from a crystal timing or video reference.



Circle (416) on Reply Card

## Audio level control

By *JBL Professional*

• **LA-22:** dual-channel compressor/limiter with expansion capability; LA-12 dual channel and LA-10 single channel without expansion; spectral agility for compression or expansion of selected frequency spectra; LA-22 provides feedback reduction, de-essing, reduced distortion; side-chain monitor feature.

Circle (377) on Reply Card

## Digital distribution, interfacing

By *Leitch*

• **MIX-7000:** solutions for serial digital interfacing including multistandard serial DAs, serial-to-NTSC/PAL monitoring DAs, 4x1 router, composite and component serializer/deserializer; PROM-SLIDE; MIX-7000 rack holds any four units, 2-rack unit frame holds up to 10.

• **VSE-/VSD-6800:** serial digital DAs for

data rates from 143Mb/s to 270Mb/s; one DA meets D-1, D-2 and D-3 requirements; rack holds 10 modules, each with eight outputs.

Circle (379) on Reply Card

## Mini data terminal

By *Magnavox/Nav-Com*

• **HSD option:** for MAGNAPhone portable satellite communications system; transmission speeds to 64,000 bits/s supports transmission of digitized audio/video; uses 7.5kHz audio bandwidth; operates through Inmarsat satellite.

Circle (382) on Reply Card

## FO transmission; mic pre-amp/controller

By *BEC Technologies*

• **FB-2:** fiber-optic transceiver for ProLine series digital audio transmission equipment; combines, resynchronizes multiplexed datastreams to place up to 64 audio channels on one fiber; transmission distance with LED driver to two miles.

• **MP16/MX16:** mic pre-amp and remote gain controller; includes functions of 16-channel 2-way splitter with mic-to-line am-

plification; gain control of second stage by digital signal for boost or attenuation by 30dB.

Circle (352) on Reply Card

## Test generators

By *Multidyne*

• **TS-12, TS-12-RM:** hand-held and rack-mount video generators provide 12 test signals, blackburst, character source ID and 2-channel audio tones; standard test package includes SMPTE bars, multiburst, NTC-7 composite and combination; optional test packages include (sin X)/X, 0 IRE black without burst, a series of signals for monitor setup and LIP-SYNC, and aid to synchronizing video and audio.

Circle (417) on Reply Card

## Complete editing suite

By *Grass Valley Group*

• **Pro-Suite:** fully wired editing system designed for smaller facilities, industrial, corporate, educational facilities; includes VPE-131 controller; DPM-100/700 effects system; model 110 switcher and AMX-170 audio mixer.

Circle (357) on Reply Card

**BIRD WROTE THE BOOK ON RF POWER MEASUREMENT FOR THE BROADCAST INDUSTRY. NEED OUR LATEST EDITION?**

- ▼ **THRULINE\*** RF Directional Wattmeters
- ▼ Line Sections, Directional Couplers and Samplers
- ▼ **WATTCHEER\*** RF Power Monitor/Alarms
- ▼ Digital High-power RF Calorimeters
- ▼ **TERMALINE\*** RF Absorption Wattmeters

- ▼ **TERMALINE\*** Coaxial Load Resistors
- ▼ **MODULOLOAD\*** and **ECONOLOAD\*** Coaxial Load Resistors
- ▼ **TENULINE\*** Attenuators
- ▼ All needed accessories including carrying cases, adaptors, connectors, cable assemblies, batteries, dollies

*who else but*  
**BIRD**

30303 Aurora Rd., Cleveland OH 44139 U.S.A. • (216) 248-1200 • TLX: 706898 Bird Elec UD • FAX: (216) 248-5426  
WESTERN REGION OFFICE: Ojai CA • Phone: (805) 646-7255

© Copyright 1991 Bird Electronic Corp

Circle (54) on Reply Card

### Component digital switching

By Abekas Video Systems

• **A83 component digital video switcher:** full support of D-1 parallel digital, serial digital and analog component formats; provides 32 user-definable inputs, three mix-effects modules with extensive keying and compositing features.

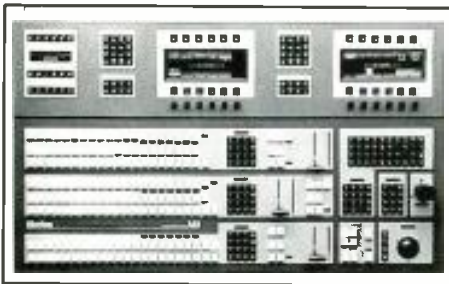

Circle (351) on Reply Card

### Digital video mixing

By Grass Valley Group

• **Model 1000:** 10-input serial digital component production switcher; patterned after models 100/110 for editing, graphics facilities; extensive keying features include depth keying; switchable between 625/50 and 525/60.

• **Model 3000:** composite digital switcher not available in PAL.

• **Model 4000:** component digital video mixing with 24 (-2A) or 16 (-2B) inputs; I/O for analog and digital components; switchable between 525/60 and 625/50; key-follow-video architecture; wipe function in program preset mix.

Circle (355) on Reply Card

### Spot duplication

By Cycle Sat

• **AUDISTRIB:** radio audio spot duplication service; for reel, cassette and DAT material transmitted via satellite from Los Angeles, Chicago or New York Cycle Sat offices to Memphis, where dubbing facilities

boxes, labels and ships via Federal Express.

Circle (353) on Reply Card

### VCR control

By DNF Industries

• **ST60-PVW:** parallel interface; permits an interconnection between parallel machine control systems and simple momentary switch control with Sony PVW and BIS PBC Betacam equipment; includes all normal transport controls in addition to tally indications for record, play, stop, rewind, fast forward and standby.



Circle (354) on Reply Card

### Disk recorder

By Grass Valley Group

• **DDR-4400:** disk-based video recorder; 10-bit component digital format without compression permits seven minutes of material to be stored or 28 minutes with additional disk capacity; connects directly to other GVG image manipulation, switching, mixing and graphics equipment; stores data for Z-Key depth keying; optional 4-track AES/EBU digital audio, VITC and LTC features.

Circle (356) on Reply Card

### Video scan conversion

By RGB Dynamics

• **TR-1500 translator:** package develops NTSC or PAL composite video from EGA,

SVGA, VGA or Macintosh outputs; auto-senses source type; gen-lock capability; integral DSK for direct key or overlay of PG graphics on video input.

• **DEF-CC7, DEF-CC8:** color-correction systems for broadcast, production; DEF-CC7 is programmable with parameter presets and delay/dissolve transitions between settings; RS-232/422 port; NTSC or PAL; extensive correction functions; both are available for composite or component signals.

Circle (359) on Reply Card

### RF analysis

By MIRCEB

• **Model 2110:** antenna analyzer; covers 100kHz to 15GHz measuring RF current distribution, close field analysis, signature analysis and phase balance in an antenna network; internal or external modulation functions; front panel display as linear or log, absolute or relative values in polar or Cartesian coordinates; GPIB compatible.



Circle (358) on Reply Card

### RF analysis software

By H2A Communications

• **Professional Transmission Planner:** MS-DOS software computes FCC FM/TV, Carey curve contours to 360 radials; with 3-foot terrain data, calculates radial HAAT; plots radial coverage with field strengths, total loss, Fresnel zone shadowing, terrain elevations.

Circle (375) on Reply Card

## ARE YOUR LEVELS O.K.?

Highly attractive and extremely accurate L.E.D. audio level indicators, with **NEW RACKMOUNT OPTIONS!**

- PANEL MOUNT, CONSOLE MOUNT AND RACKMOUNT
- MONO, DUAL MONO, STEREO, DUAL STEREO AND TRI STEREO
- PEAK AND VU MODES
- \$66 - \$930



142 SIERRA STREET, EL SEGUNDO, CA 90245 • (310) 322-2136

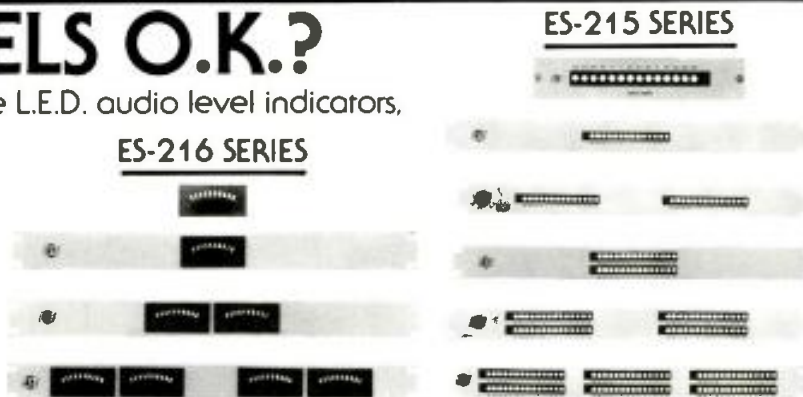

Circle (55) on Reply Card



### Audio production tool

By Neumann (USA)

- **KFM 100 microphone:** stereo pickup system with two pressure mic elements mounted flush on a 20-inch wooden sphere; diametrically opposed mic mounting reproduces acoustic depth of environment; response to 10Hz; nearly constant directivity factor; smooth diffraction of sound waves.

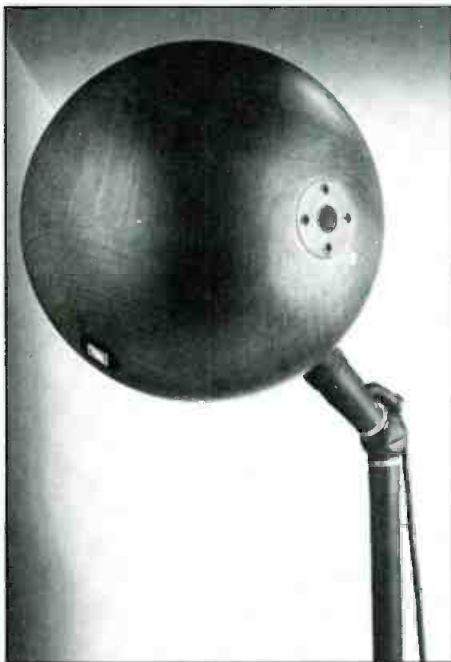

Circle (389) on Reply Card

### Sync, test source

By Leitch

- **SPG-1302 NTSC/D-2 test generator:** compact modular master or slave unit

with high-accuracy, digitally generated outputs; supports most 525-line standards, including NTSC, RGB, YIQ, B-MAC, MII, D-2 and others; customized output group option: parallel or serial remote-control feature.

Circle (380) on Reply Card

### Weather graphics and display

By WSI Corporation

- **WEATHERspectrum 9000 1.1:** enhanced product combining true color art, animation, advanced forecast and weather analysis features; permits multiple 8-bit color animations over 24-bit true color maps for sharp images.

Circle (413) on Reply Card

### Data circuit tester

By Consultronics

- **TX-4 responder:** operates with Auto-Tims data line analyzer to test 4-wire leased data circuits; passive until queried by Auto-Tims with DTMF tones; total test time less than two minutes for loopback, four minutes for end-to-end circuit test.

Circle (364) on Reply Card

### Enhanced digital audio editor

By Digital Audio Research

- **SoundStation Ver 5.0:** segment-based digital mixing, editing and track laying on SoundStation Sigma multichannel disk-based audio editor; permits dialogue, effects or music segments to be processed segment-by-segment, then mixed internally to stereo or mono; full on-screen metering; segment-based sends for adding effects to any segment.

Circle (365) on Reply Card

### Studio lighting equipment

By Great American Market

- **RDS Technolight system:** combines TACT lighting control console, a distribution box for six fixtures, and fixtures for 1kW and 2kW lights with Fresnel lenses; control includes pan, tilt, focus, color change and leaves of 4-way motorized barn doors; by RDS Corporation, Tokyo.

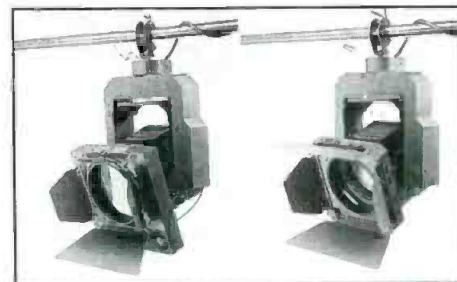

Circle (374) on Reply Card

### Semiconductor device literature

By Motorola Semiconductors

- **SG79/D Rev 4 SWITCHMODE publication:** designer's guide for switching power supply circuits and components.

Circle (387) on Reply Card

### Digital exposure meter

By Spectra Cine

- **Spectra Professional IV:** light metering system indicates direct illuminance levels shown in footcandles or lux; f/stop measurements shown in LCD display; digital numeric, analog bar graph displays with backlighting; sensitivity range of nearly one million to one.

Circle (406) on Reply Card

## OPTIMUM PERFORMANCE BROADCAST QUALITY CABLES FOR THE PROFESSIONAL

SEE US AT  
SMPTE "92"  
TORONTO  
NOV. 10-13  
BOOTH 1517

### LATEST NEC COMPLIANCE, UL LISTED, INDUSTRY PROVEN

Audio Cables • Video Cables • Composite Video and Audio Cables • Studio Set Lighting Cable • Portable Cordage • Portable Power Cables • Control Cables • Fiber Optic Cables • Telecommunications Cables • Local Area Network Cables • Custom Marked Pre-Cut Shrink Tubing & Sleeving • Custom Cable Assemblies • Breakout Boxes • Custom Panels • Rack Rails • Cable Reelers • Gep-Pak—Reeless One-Man Payout System

CABLE PRODUCTS DESIGNED, DEVELOPED, AND PROVEN FOR THE PROFESSIONAL TECHNICIAN:



**Gepco International Inc. COMING THROUGH LOUD AND CLEAR™**  
Corporate Headquarters  
2225 West Hubbard St., Chicago, IL 60612  
Tel: (312) 733-9555 (800) 966-0069 Fax (312) 733-6416

Eastern Regional Sales Office Tel: (904) 732-4123 Fax (904) 732-5799

Circle (63) on Reply Card

### RF power measurements

By Electro Impulse Lab

- **CA-100, CB-100:** solid-state RF calorimeters reading true RF average power; CA-100 rated to 100W with  $\pm 2\%$  accuracy from DC to 1GHz; CB-100 bridge with accuracy of  $\pm 1\%$  of reading includes two loads for direct comparison of two RF sources or operation as single load calorimeter; both include NBS traceable calibration.



Circle (367) on Reply Card

### Satellite video exciters

By LNR Communications

- **LVM series:** video modulator and data-capable upconverter for fixed or mobile satellite uplinks; 70MHz interface; combines analog transmission with immediate capability for digital modulation or SCPC data channels through a satellite transponder; for C, Ku and 17GHz DBS operation.

Circle (381) on Reply Card

### Enclosure design software

By Rittal

- **Rilay:** software assembles enclosure components into a complete system, shows realistic image and lists all critical details.

- **Power Plan:** computes electrical, mechanical and thermal values, based on information from the customer.

- **Therm:** determines appropriate climate-control device for the customer's needs; brochure describes products.

Circle (399) on Reply Card

### Equipment cabinet literature

By Eupto Electronics

- **Catalog FCC-92:** equipment rack/cabinet data includes FCC/VDE level shielded systems.

- **CAB-NET:** PC design software program for standard, custom equipment racks.

Circle (369) on Reply Card

### Stock video footage

By Firstlight Productions

- **Multimedia Video Library:** license-free footage; 130 scenes of 10-18s; original and edited sound effects; for laserdisc, BetacamSP or U-matic SP.

- **Master Library:** longer scenes of video footage on buy-out basis; most originated on Betacam SP or 35mm film, others on various film formats.

Circle (370) on Reply Card

### Power line security

By EFI Power Quality Systems Group

- **Omni-Phase filters:** protects equip-

ment against power surges to 50kVA; sine wave tracking improves uniform clamping of transient disturbances in any phase angle or polarity; redundant for all phases; Y and Delta configuration modules.

Circle (366) on Reply Card

### Large screen monitor

By Mitsubishi Professional Electronics

- **AM-2752A color video monitor:** 27-inch diagonal with wide H/V scan ranges; NTSC, PAL and SECAM composite signal capability as well as S-video and analog or digital RGB inputs; dynamic beam-forming design for better corner and edge focus.



Circle (386) on Reply Card

### Paint, animation equipment

By Getris Images

- **ECLIPSE:** 2-layer graphics station with video live layer; full Betacam control, 300Mbyte hard and magneto-optical disks.



# FLEXIBLE VIDEO MATRIX

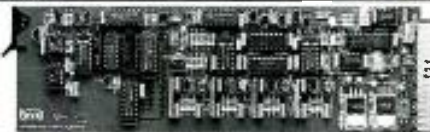

See us at SMPTE,  
Booth #527

- 4x2 V.I. Routing Switcher on a single DA card
- Plugs directly into GVG or LEITCH VDA frames
- Expandable to multi buss, multi layer, 8 input
- Composite or Component
- Single coax remote
- 30 MHz response
- Clamped inputs
- Optional GPI

## broadcast video systems ltd.

40 West Wilmot St., Richmond Hill, Ontario L4B 1H8  
Telephone: (416) 764-1584 Fax: (416) 764-7438

Circle (64) on Reply Card



“I compete with the giant studios, so my business image is very important.”



—Stewart Tilger, Photographer, Seattle, WA

“That’s why I replaced my old dot matrix with the HP LaserJet IIIIP printer,” says Stewart Tilger.

Now his proposals and invoices look every bit as good as anything his bigger competitors put out. Thanks to the scalable typefaces and HP’s patented Resolution Enhancement technology, the print quality, Tilger notes, “is great. The type is so crisp and really smooth. You don’t get any breakup in the letters.”

The HP LaserJet IIIIP printer comes

with great customer support, too. There’s a Customer Support Center to help Tilger get the most out of his printer. What’s more, the IIIIP is compatible with virtually all popular software packages. So he doesn’t have to worry about whether his old software will work with his new printer.

To learn more about the most

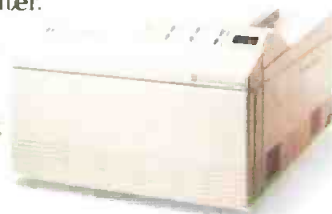

affordable HP LaserJet printers—the IIIIP and IIIIP *plus*—dial 1-800-LASERJET (1-800-527-3753), Ext. 7016\* for our free video.

HP LaserJet Printers.



\*In Canada, call 1-800-387-3867, Ext. 7016.  
© 1992 Hewlett-Packard Company PE12269

Circle (56) on Reply Card

www.americanradiohistory.com

## Twinax/Triax Patching System



Trompeter's New J74 family of dual twinax/triax self-normalizing jacks are designed for use in **mil/aero and commercial 78Ω/124Ω applications** where signals must be protected from extraneous noise through non-signal-carrying shielding, and interfacing connectors must provide contact surfaces isolated from each other and their outer shields. The series features the **J74T-R, a self-terminating normal-through, dual patch jack** which automatically provides a normal-through signal (without the use of looping plugs) and terminates the unused side.

**J74T-R is the same size as our J14 coax patch jacks** allowing you mix up to 20 jacks on a 3.5"x19" panel. Trompeter's new twinax/triax patching system (jacks, plugs, looping plugs, monitor plugs, panels, patch cords and cable assemblies) combined with Trompeter's proven lines of Twinax/Triax products provide for improved transmission capabilities and interference rejection of data transmission systems.

**Send for a Free 4-page Product Bulletin.**

For pricing and availability contact your Local Trompeter Rep or call our New 800# for Sales/Service/Technical Support.

(800) 982-COAX

Inside California Call... (800) 655-2028

*Quality doesn't cost...  
It pays.*

**TROMPETER**  
ELECTRONICS, INC

31186 La Baya Drive • Westlake Village, CA 91362  
See us at SMPTE, Toronto, Booth #1707.

(818) 707-2020 Fax (818) 706-1040

Circle (57) send literature  
Circle (67) call now

digitizer, cordless pressure stylus; full graphics capability for restricted budgets; optional animation module; expands for two additional layers, macrocommand paint functions.

Circle (372) on Reply Card

### Quiet HMI lighting

By OSRAM

- **Whisper Quiet lamps:** high-efficiency HMI units in double-ended types rated for 2.5kW to 12kW, single-ended types for 575W and 1.2kW; designs eliminate acoustical resonance to reduce noise generation; three to four times more light with same power-rated tungsten halogen incandescent units.

Circle (392) on Reply Card

### Digital audio recorder enhancement

By OTARI

- **CB-158 control panel:** for dedicated transport, edit functions instead of mouse and keypad control of PD-464 disk-based digital record/edit system.

- **ProDisk Ver 4.0:** software upgrade with GUIDE graphical user interface for digital editing; includes CMX-EDL auto-conform feature to read data from 3.5-inch Macintosh-format disks.

Circle (393) on Reply Card

### Auto CD playback

By Pioneer Communications of America

- **CAC-V3000:** autochanger for CD playback; for radio, cable radio, sound library, production house applications; capacity of 300 CDs; double player design with RS-232C or RS-422A computer control port; system expansion possible to 32 units.

Circle (394) on Reply Card

### Production, broadcast mixer

By Soundcraft USA/JBL Professional

- **Delta DLX console:** modular design audio mixer with 8- to 32-channel frame sizes; mono and stereo input modules include six auxiliaries per module, dual-line input, two mono-line input channels; to four group modules, including 2-band EQ, bar graph metering; master module with L/R bar graph metering.

Circle (404) on Reply Card

### High density VDAs

By Grass Valley Group

- **8800 series:** a family of video distribution amplifiers; compatible with 8500 series with two additional outputs per module; 8800 utility VDA for professional video includes cable EQ feature; 8801 general-purpose units do not have equalization; six outputs if used in 8500 series frames, eight outputs in 8800 series rack frames.

Circle (425) on Reply Card

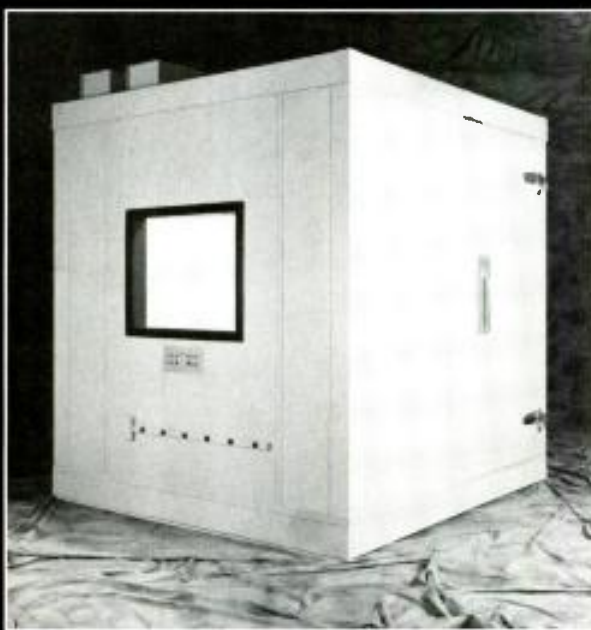

## VOICE OVER BOOTHS

Acoustic Systems' Voice Over Booths combine acoustic integrity with the ordering simplicity of standard models. Voice Over Booths, which include eleven BB models, are self contained, acoustically engineered enclosures with isolated floor

systems, panel construction with predetermined acoustic performance, sealed doors, acoustically engineered ventilation and prewired electrical service. Starting at \$6,000, BB Voice Over Booths provide stations, studios and production facilities a fast-track alternative to conventional, standard construction. Designed as modular units BB Voice Over Booths can also be disassembled, relocated and reassembled if changes in location occur.

**ACOUSTIC SYSTEMS**

415 E. St. Elmo Road • Austin, TX • 78745  
(800) 749-1460 (512) 444-1961  
FAX: 512/444-2282

Thomas Register

Sweets Catalog 13.C

Circle (58) on Reply Card



**TABLE 6 — EXECUTIVE MANAGEMENT SALARIES**

	EXEC./GEN. MGMT. TOTAL	TV SUBTOTAL	TOP 50	TOP 51 TO 100	BELOW TOP 100	RADIO SUBTOTAL	TOP 50	TOP 51 TO 100	BELOW TOP 100
<b>BASE = ALL RESPONDENTS</b>	339 100%	85 100%	34 100%	14 100%	37 100%	254 100%	48 100%	45 100%	161 100%
Less than \$15,000	8.8%	9.4%	2.9%	7.1%	16.2%	8.7%	4.2%	4.4%	11.2%
\$15,000 to \$24,999	15.9%	7.1%	2.9%	7.1%	10.8%	18.9%	2.1%	15.6%	24.8%
\$25,000 to \$34,999	23.6%	16.5%	5.9%	21.4%	24.3%	26%	25%	17.8%	28.6%
\$35,000 to \$49,999	24.2%	25.9%	26.5%	28.6%	24.3%	23.6%	37.5%	28.9%	18%
\$50,000 to \$74,999	15.9%	22.4%	20.6%	35.7%	18.9%	13.8%	18.8%	22.2%	9.9%
\$75,000 or more	11.5%	18.8%	41.2%	0%	5.4%	9.1%	12.5%	11.1%	7.5%
Estimated median	\$35,882	\$45,625	\$65,000	NA*	\$35,000	\$33,571	\$42,222	\$40,833	\$29,423

**TABLE 7 — TECHNICAL SALARIES: SBE CERTIFIED VS. NON-CERTIFIED**

JOB CATEGORY	ALL MARKETS		TV ONLY		RADIO ONLY	
	Certified	Non-Certified	Certified	Non-Certified	Certified	Non-Certified
VP/Dir. of engineering	\$44,999	\$39,444	\$52,500**	\$45,625	NA	\$31,667
Chief engineers	\$37,813	\$33,194	\$44,999	\$37,917	\$34,286	\$28,333
Staff engineers	\$37,000	\$28,333	\$38,750	\$30,370	NA	\$21,500
All engineers	\$40,132	\$32,469	\$43,684	\$35,893	\$35,385	\$27,436

## Something Magical?

There's nothing magical about the latest innovations in equipment and technologies...

*nothing magical...* until you put it all together with experience, expertise & creativity.

That special synergy is what STI creates to provide solutions in design, installation and technical support to the broadcast and production industries.

Become part of the synergy and make your own vision a reality.

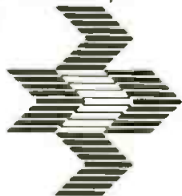

**SYNERGISTIC TECHNOLOGIES INCORPORATED**

PITTSBURGH, PA • COLUMBUS, OHIO • 1-800-659-7715

Circle (59) on Reply Card

After 25 successful years of making high-performance intercom, we must admit our profile has been a bit subdued. It's time for a change!

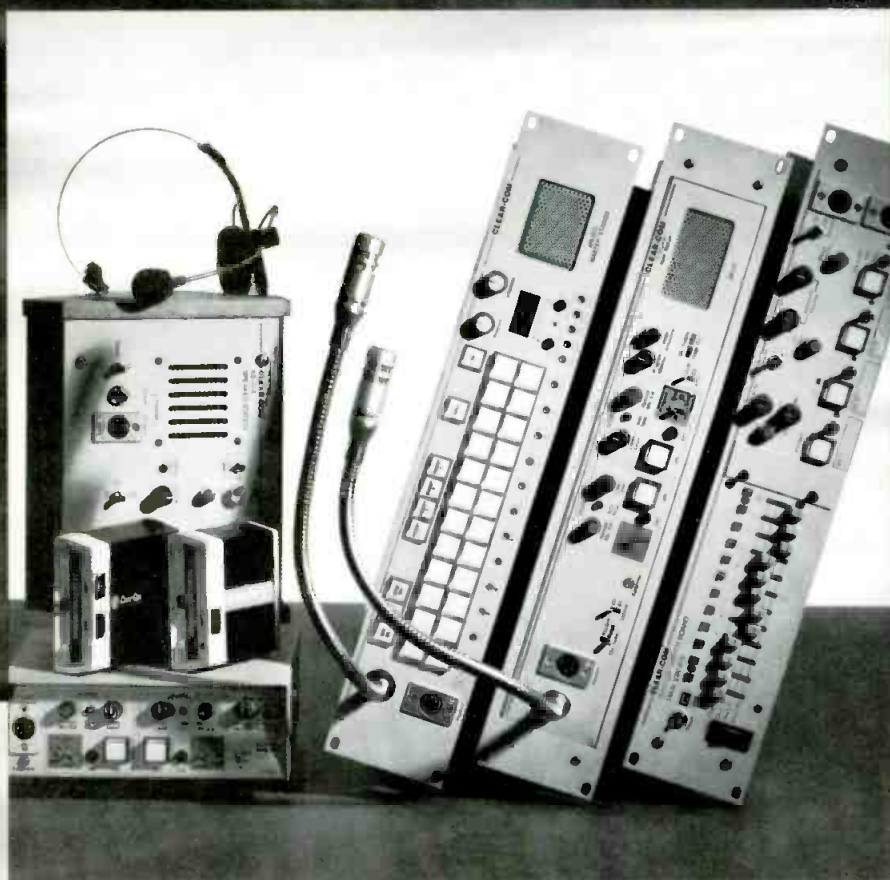

While we've always been known for our super-reliable, surprisingly-flexible, amazingly-adaptable intercom systems, we've always been somewhat reserved in telling you about them.

Now we're making changes and improvements that are sure to get your attention.

And we think you'll be suitably impressed.

We'd like to tell you more.

Please call or write for product literature on our *high-performance* intercom systems.

Fresh ideas from



Circle (68) on Reply Card

non-certified salaries. Not surprisingly, those with SBE certification tend to make more money. Having SBE certification does pay. And according to this year's survey, it pays more than ever.

According to the results, which are summarized in Table 7, SBE-certified personnel earn at least 15% more than their non-certified counterparts. The salary for a certified TV VP/director of engineering is \$52,500. The non-certified counterpart salary is only \$45,625 — a 15% difference.

The median salary for a certified radio chief engineer is \$34,286, which is almost \$6,000 more than the non-certified version, \$28,333. That represents a whopping 21% difference.

Salaries for TV staff engineers reflect similar differentials. The SBE-certified TV staff engineer earns \$38,750, whereas the non-SBE-certified counterpart earns only \$30,370, for a 21.7% difference.

One of the strongest indications of the importance that the industry places on SBE certification is reflected in the category measured across all engineering job titles across all markets. In this example, the SBE-certified engineer earns \$40,132. The non-SBE-certified engineer earns only \$32,469. This represents a 23% difference

---

***Those with SBE certification tend to make more money.***

---

*in salaries.*

When salaries were first examined for the SBE difference, some readers doubted the results. "Chance occurrence," "Won't happen again," and "Not valid," were just some of the comments we received. Well, bury those comments. The comparison was originally valid, and this sixth year of results continues to prove that point.

If you don't have SBE certification, it would certainly be in your best professional and monetary interest to do so. Using the all-engineer category for comparison, SBE-certified engineers earn \$147 more each week than those without SBE certification. Even at today's prices, that's not chicken feed.

**Editor's note:** Some results must be interpreted with caution. For example, those table entries marked with an asterisk (\*) indicate medians with a base of less than 20 respondents and are not applicable because of the small base. Those table entries marked with a double asterisk (\*\*) are medians with a base of less than 30 respondents, and results should be used with caution and for directional purposes only.

**Survey results available:** The complete results of the 1992 salary survey are available for only \$145. This bound edition, filled with more than 125 pages of data, includes tables, graphs and charts that detail the survey results. If you are involved in determining salary compensation for broadcast personnel, you will gain valuable insight from this research. Contact Diane Mason at 913-967-1735 for more information.



# Preview

NOVEMBER...

## *9th Annual Facility Maintenance Report*

- **Using Video Test Equipment**

Servicing video equipment can require sophisticated test devices. This article will look at how a well-equipped facility keeps its video hardware in top-notch condition.

- **The AES Digital Testing Standard**

A look at the new AES digital testing standard. The standard describes testing procedures and required equipment.

- **Maintaining RF Systems**

Keeping the transmitter and antenna system operating properly is crucial.

- **Ruggedness Testing for Transmitters**

With a decreasing amount of technical support, stations must make sure equipment operates reliably.

- **Measuring Camera Performance**

It's now possible to accurately and objectively measure the performance of video cameras.

- **Maintaining Proper SC/H Phase**

All video systems rely on timing pulses to frame-synchronize their signals with other signals. The article will show how to adjust video equipment for proper operation.

DECEMBER...

## *Annual Technology Forecast*

- **State of the Industry Report**

The annual examination of where the broadcast industry is and where it may be going.

- **Perspective: An Industry in Transition**

The article will be based on interviews of experts within and without the industry. The feature will provide a glimpse of how the "experts" view the future of broadcasting.

- **Manpower Issues for the '90s**

A look at how facilities are going to have to be more efficient and how to do that with better trained engineers.

- **Interactive TV: Tomorrow's Opportunity**

Interactive television is coming, and the article will relay how it works and how to plan for its implementation.

- **Satellite and Cable Radio: The Next Frontier**

Already, cable radio stations are on the "air," and DAB satellite radio stations are not far behind. The article will look at how the technologies work and how stations can plan now for their arrival.

# IT'S AIR TIME! DO YOU KNOW WHERE YOUR AUDIO IS?

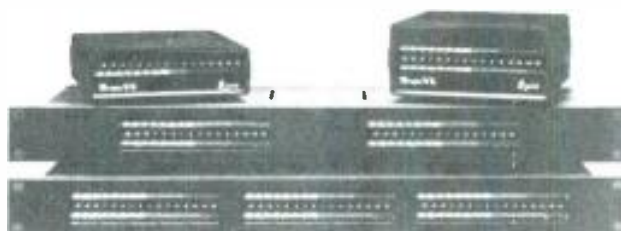

## Bright-VU

### LED Audio Level Displays

Sometimes, a VU meter just doesn't tell you enough. That's when you need a Logitek Bright-VU LED Audio Level Display.

With its highly visible, color coded LEDs, the Bright-VU can easily be seen and read across a large room.

In rack-mounted or stand-alone versions, Logitek has a Bright-VU problem solver for you.

**Logitek**

When it has to  
work right!

Call 800-231-5870 for your nearest Logitek Dealer.  
(Alaska, Hawaii, Canada : 713-782-4592)

Circle (65) on Reply Card

# Winsted®

# FREE!

## Cabinet Design Kit



This simple design kit helps you plan and order equipment cabinets more efficiently. Specially designed "Rack Ruler" lets you measure electronics equipment for accurate rack size. With this information, Winsted will design rack cabinets specifically for your electronics.

Write today or call **TOLL-FREE**  
**1-800-447-2257**

**THE WINSTED CORPORATION**  
10901 Hampshire Ave. So. • Minneapolis, MN 55438 • (612) 944-8556  
FAX: 612-944-1546

**Preferred by Professionals Worldwide**

Circle (66) on Reply Card

October 1992 *Broadcast Engineering* 101

# Professional Services

**East Coast Video Systems**  
ON LINE IN-TIME

A full service company providing...

- Consultation
- Engineering & Design
- Installations
- Training

Serving...

- Cable Systems
- Corporate Facilities
- Broadcast Facilities
- Teleproduction Facilities

52 Ralph Street, Belleville, NJ 07109 (201) 751-5655

**JOHN H. BATTISON PE.**  
CONSULTING BROADCAST ENGINEER,  
FCC APPLICATIONS AM, FM, TV, LPTV  
Antenna Design, Proofs, Fieldwork  
2684 State Route 60 RD #1  
Londonville, OH 44842  
419-994-3849

**HCI INTERNATIONAL**

Satellite Systems Engineering Design & Construction  
T1 BUSTING • TRACKING SYSTEM • TRANSPORTABLE & FIXED UPLINKS  
1-800-444-0856  
PH: (805) 963-3765 FX: (805) 962-0920  
425 E. Montecito St. Santa Barbara, CA USA 93101  
A DIVISION OF HEMEC COMMUNICATIONS

**NETCOM**  
STATE-OF-THE-ART ENGINEERING FOR AUDIO & VIDEO  
TURN-KEY SYSTEMS  
DESIGN & DOCUMENTATION  
EQUIPMENT SALES  
CAD SERVICES  
1465 PALISADE AVE., TEANECK, NJ 07666 / (201) 837-8424

# Classified

## EQUIPMENT WANTED

WANTED: USED VIDEO EQUIPMENT. Systems or components. PRO VIDEO & FILM EQUIPMENT GROUP: the largest USED equipment dealer in the U.S.A. (214) 869-0011. 4-91-tfn

## TRAINING

FCC GENERAL CLASS LICENSE. Cassette recorded lessons with seminars in Washington, Newark, Philadelphia. Bob Johnson Telecommunications. Phone (213) 379-4461. 5-90-tfn

## HELP WANTED

TV MAINTENANCE ENGINEER opening in Upstate New York. Large facility loaded with state of the art equipment. Must be capable of troubleshooting studio equipment to the component level. Experience in maintaining digital and microprocessor-based equipment required. UHF experience a plus. Send resume to: WXXI Human Resources, P.O. Box 21, Rochester, NY 14601. EOE. 9-92-2t

TV MAINTENANCE ENGINEER: Needed in Gulf Coast Vacation Market. Must be a highly motivated and versatile individual who is a team player. Must have 3-5 years experience repairing 3/4", M-2 1" tape equipment and other ENG and studio equipment. FCC General Class License required. Send resume to A. Dallas, WJHG-TV, P.O. Box 2349, Panama City, Florida. 32402 EOE. 9-92-2t

MAINTENANCE ENGINEER: The WBNS Stations is seeking a maintenance engineer with at least three years experience in a major market TV and Radio engineering department that includes SNG, ENG, D2 and computer automation. A degree and SBE certification is necessary. Shift changes and over night trips are part of this position. Send resumes and applications to Marvin C. Born, WBNS-TV, 770 Twin Rivers Drive, Columbus, Ohio 43215. 614-460-3914. EOE. 10-92-1t

MAINTENANCE ENGINEER NEEDED at WINK-TV. Primary responsibility will be operation and maintenance of an Outside Broadcast Van. Other responsibilities include routine and corrective maintenance of modern video equipment. Five years experience in broadcast or related fields required. FCC license or SBE certification preferred. Should have a clean driving record. Reply to: Director of Engineering, WINK-TV, P.O. Box 1060, Fort Myers, FL 33902-1060. EOE. 10-92-1t

ENGINEERING/DATA SATELLITE COMMUNICATIONS STARS/IDB Communications, a leading supplier of world-wide telecommunications services, has an immediate opening for engineer in our fixed facility/transportable maintenance department. Must have minimum of 3 years experience in repair of C-band and Ku-band high power amplifiers, video and data baseband equipment. Limited travel required. Also seeking Data Operations Technician with 3 years experience in Data Communications Operations. NO PHONE CALLS PLEASE. Send resume and salary history to: STARS/IDB Communications, 3003 Moffett Lane, Houston, TX 77489. Attn: Personnel Dept. 10-92-1t

TECHNICAL PROJECT MANAGER to assist in the planning, design and implementation of TV and Radio engineering projects. Requires extensive experience in and knowledge of: transmitters, microwaves, antennas and satellite systems; studios, recording, editing, video and pulse distribution systems; and accepted technical standards. Requires bachelor's degree in engineering and five years related experience or an equivalent combination. Salary range \$32,895 to \$49,342.

MAINTENANCE TECHNICIAN to maintain, install and operate complex television and stereo equipment. Requires extensive knowledge of various format video recorders, studio and portable camera systems, production and routing switcher equipment, digital effects systems, and test equipment. Requires an associate-degree in electronics and four years of progressively responsible experience in the repair and maintenance of complex television systems or an equivalent combination. Salary range \$24,035 to \$36,052. Employees benefits: paid hospitalization, dental, and life insurance plan; three weeks annual leave, 12 Holidays. EEO. Applications and complete resumes maybe submitted to: South Carolina Educational TV Commission, Personnel Department, Post Office Box 11000, Columbia, SC 29211. Telephone (803) 737-3457. 10-92-1t

# Classified

## HELP WANTED

## HELP WANTED

## TELECOMMUNICATIONS ENGINEER

Radio Free Europe/Radio Liberty, Inc., headquartered in Munich, Germany seeks an energetic and experienced individual for its Engineering Division, comprised of over 400 employees at transmitter stations and offices in Germany, Portugal, Spain and other locations. RFE/RL is widely recognized as the leading Western broadcaster to Eastern Europe and the former Soviet Union, and is on the air just under 900 hours per week in both shortwave and on leased FM and/or medium-wave networks in the countries of broadcast. The ideal candidate will have:

- minimum of BSEE or equivalent
- experience in one or more of AM, FM, TV or (preferably) high power shortwave
- broadcast telecommunications background with emphasis on world-wide satellite systems, antenna and transmitter system design and EM radiation analysis
- background in PSN
- willingness to travel occasionally to Portugal, Spain, Eastern Europe and the CIS
- knowledge of German is a plus but not required, as would be knowledge of Iberian languages and the environment of Eastern Europe and the former Soviet Union.

RFE/RL offers a competitive salary and excellent benefits program, often including housing.

Applicants should send a comprehensive resume and cover letter to either address below:

RFE/RL, Inc.  
Personnel (TELENG)  
1201 Connecticut Ave., N.W.  
Washington, DC 20036  
FAX (202) 457-6974

RFE/RL, Inc.  
Staffing & Training  
Box 86 (TELENG)  
Oettingenstr. 67  
D-8000 Munich 22  
GERMANY  
FAX (4989) 2102-3404



RADIO FREE EUROPE  
RADIO LIBERTY

Equal Opportunity Employer

LEAD SERVICE TECHNICIAN needed for San Diego based industrial and broadcast video equipment dealer. Must have 3-5 years experience in trouble shooting and the repair of professional and broadcast equipment. Must be a self starter, customer service oriented and a team player. Report to top management. Supervise department. Send resume, references and salary history to: Audio Video Supply, 4575 Ruffner Street, San Diego, CA 92111, Attention Pat Birch. 10-92-1t

ENGINEERING TECHNICAL SUPERVISOR. WRAL-TV is seeking a professional with leadership and technical skills to supervise engineering staff. Minimum 5 years experience in troubleshooting broadcast and computer related equipment. Managerial skills and experience a must. BSEE or related degree preferred. Send resume to Human Resources, Capitol Broadcasting Co., P.O. Box 12800, Raleigh, NC 27605. EOE/M-F. 10-92-1t



# Classified

## HELP WANTED

### DIRECTOR OF ENGINEERING AND OPERATIONS

Leading independent station in top-ten market seeks a take-charge individual to head Engineering/Operations department.

Strong managerial skills required. Five to ten years major market or network experience, including solid background in air operations, automation, studio production, post-production and remotes required. Bachelor's degree in Electronics or Electrical Engineering preferred.

Responsible for budgetary control and planning, plus negotiation and administration of labor contracts.

This is a once-in-a-lifetime opportunity for a uniquely talented individual. Excellent benefits and growth potential.

An equal opportunity employer. Send resumes to:

Broadcast Engineering  
P.O. Box 12901  
Dept. 734  
Overland Park, KS 66212

## SERVICES

TRANSMITTER TUBE REBUILDING SINCE 1941: 3CX2500, 4CX5000, 4CX15000 and many others. Write for details. FREELAND PRODUCTS INC., 75412 Hwy. 25, Covington, LA 70433. (504) 893-1243 or (800) 624-7626. 1-91-11n

## FOR SALE

TUBES 4CX3000A, 833A, 4-1000A, 4CX10000D, and more. We carry large inventory, all major brands (EIMAC, AMPEX, RCA) Call Stew 1-800-842-1489. 1-91-11n

SCA DECODERS! BUY DIRECT & SAVE \$\$\$ Prices start at just \$15. Pre-assembled & tested. Any frequency available. SCS Radio Technology—417-881-8401 8-92-3t

MISC. POST PRODUCTION EQUIPMENT; G-P 612 AUDIO, Calaway c2's, GVG-NEC DVE's, E-Flex, and much more. Call or Fax for equipment list. Contact Elizabeth at 213-463-7064/Fax 213-461-2561. 8-92-3t

**NEW! MET-ERASER ME-II**



**ERASES BETA SP -85dB  
TAPER M II TAPES down**

**\$2,495**

2417 EMBARCADERO RD. PALO ALTO, CA 94303 415-493-3811

## HELP WANTED



### TELEVISION ENGINEERS

Turner Broadcasting System, the leading News, Sports and Entertainment system in satellite communications, has career opportunities for engineers with *broadcast maintenance* experience. These positions demand an extensive background in television engineering and at least two years of training in electronics technology. Turner Broadcasting System offers an excellent benefit and compensation program. Send resumes to Jim Brown, Corp. Engineering Turner Broadcasting System, Inc. One CNN Center, Box 105366 Atlanta, Georgia 30348-5366 TBS is an equal opportunity employer.

## HELP WANTED

### ENGINEERING ASSISTANT

For 50 kw AM. Should have knowledge of AM transmitters, directional antenna systems, studio equipment and maintenance skills, and experience in installation of new studio facilities. Salary commensurate with experience. Send resume to:

### WKNR

9446 Broadview Road  
Cleveland, OH 44147-2397  
Attn: Engineering

An Equal Opportunity Employer M/F

## FOR SALE

### SONY • AMPEX • BTS • DUBNER GRASSVALLEY • PANASONIC

If You're Looking For the Best in Used Equipment  
and You Want the BEST: • DEAL • VALUE • SERVICE  
CALL MIDWEST: (708) 251-0001 • CANADA (604) 850-7969



AUDIO/VIDEO EXCHANGE, INC.  
1131 Central Ave. Wilmette, Illinois 60091  
International Brokers and Appraisers Serving the Audio / Video Industry

Circle (100) on Reply Card

### RS422 VTR REMOTE CONTROL

SONY, AMPEX, JVC  
PANASONIC, HITACHI  
Low Cost - Lots of Features  
DNF INDUSTRIES (213) 650-5256  
1032 N. Sweetzer Avenue, #212  
LA, CA 90069

### CALL US For New and Rebuilt Radio Broadcast Equipment



(804) 974-6466

1305-F Seminole Trail • Charlottesville, Va. 22901

ODC OPTICAL DISK DUPLICATING SYSTEM Complete and working. For details contact: CMX (408) 988-2000. 10-92-2t

ANDREW 6' SOLID DISH, 2 ghz feedhorn and mount bracket. \$900. A. Bowab (205) 928-5770. 10-92-1t

SONY 1 INCH-BVH-2000, 1100A, 1100, or 1000s—Warranty. Refurbished slant guide assemblies—\$150.00. Betacam, Cameras, TBCs, Decks, Monitors, or call for replacement parts. We buy clean late model equipment. (609) 786-1709 (215) 836-7669. 10-92-1t



**THE 6X GPI MATRIX**

- 4 GPI's, 24 Devices
- Opto-Isolated
- Lighted Switches
- Solid State Relays
- One Rack Unit High
- Easy to Gang

OEI ELECTRONIC SYSTEMS INC. • 908-735-0543  
RR2 Box 365, Pittstown, NJ 08867



**THE B-MAC MONITOR**

- OC of Baseband Video, Audio & Data
- Additional Data Line Viewing Option
- Buffered Control Output Option

OEI ELECTRONIC SYSTEMS INC. • 908-735-0543  
RR2 Box 365, Pittstown, NJ 08867

Circle (101) on Reply Card

**PARALLEL INTERFACE FOR NEW  
SONY PVW and BTS PBC  
Betacam VTRs**

LOW COST — \$400.00

DNF Industries (213) 650-5256  
1032 N. Sweetzer Ave., #212, LA, CA 90069

# Classified

## FOR SALE

Classified advertising now available as Classified Display or By-the-word.

**Classified Display:** \$112 per column inch, per insertion, with frequency discounts available. 1 inch minimum, 10 inches maximum per ad. Blind ads \$40 additional. Reader Service number \$50 additional. Spot color available for \$150 (color determined by publisher).

**By-The-Word:** \$1.75 per word, per insertion. Initials and abbreviations count as full words. Blind ads \$40 additional. Minimum charge \$40 per insertion. No agency discounts allowed for classified ads.

Contact Renée Hambleton, at (913) 967-1732, for information on frequency and pre-payment discounts. To place your classified ad send your order and materials to Broadcast Engineering, Classified Ad Mgr., P.O. Box 12901, Overland Park, KS 66212-2215.

**FALL SALE**

**C-FORMAT VTRS**  
SONY BVH3100 & 2500 from \$22,000

**BETA-SP VTRS**  
SONY BVW-70 from \$18,500

**STILL STORE**  
ABEKAS A42 for \$22,000

**EDIT CONTROLLERS**  
SONY BVE-600 & 900 from \$3,000

**TIME BASE CORRECTORS**  
FOR-A FA-420 for \$2,500

**MICOR VIDEO EQUIPMENT**  
CHICAGO 312 334 4300

CALL FOR A CATALOG

## Advertising sales offices

### NEW YORK, NEW YORK

*Gordon & Associates*  
210 President Street  
Brooklyn, NY 11231  
Telephone: (718) 802-0488  
Fax: (718) 522-4751  
*Joanne Melton*  
Telephone: (212) 332-0628  
Fax: (212) 332-0663  
888 7th Avenue, 38th Floor  
New York, NY 10106

### OXFORD, ENGLAND

*Richard Woolley*  
Intertec Publishing Corp.  
Unit 3, Farm Business Centre,  
Clifton Road, Deddington,  
Oxford OX15 4TP England  
Telephone: (0869) 38794  
Fax: (0869) 38040, Telex: 837469 BES G

### CHICAGO, ILLINOIS

*Vytas Urbonas*  
Telephone: (312) 435-2361  
Fax: (312) 922-1408  
55 East Jackson, Suite 1100  
Chicago, IL 60604

### TOKYO, JAPAN

*Mashy Yoshikawa*  
Orient Echo, Inc.,  
1101 Grand Maison  
Shimomiyabi-Cho 2-18  
Shinjuku-ku, Tokyo 162, Japan  
Telephone: (03) 235-5961,  
Fax: (03) 235-5852,  
Telex: J-33376 MYORIENT

### SANTA MONICA, CALIFORNIA

*Herbert A. Schiff,*  
Telephone: (310) 393-9285  
*Jason Perlman,*  
Telephone: (310) 458-9987  
*Schiff & Associates*  
501 Santa Monica Blvd, Ste. 401,  
Santa Monica, CA 90401  
Fax: (310) 393-2381

### FREWVILLE, SOUTH AUSTRALIA

*John Williamson/Hastwell,*  
*Williamson, Rep. Pty. Ltd.*  
109 Conyngham Street  
Frewville 5063, South Australia  
Phone: 799-522, Fax: 08 79 9522  
Telex: AA87113 HANDM

### CLASSIFIED ADVERTISING OVERLAND PARK, KANSAS

*Renée Hambleton*  
P.O. Box 12901  
Overland Park, KS 66282,  
913-967-1732

# Ad Index

	Page Number	Reader Service Number	Advertiser Hotline		Page Number	Reader Service Number	Advertiser Hotline
Abekas Video Systems	*19	14	415-369-5111	Newton Instrument Co., Inc.	89	62	919-575-6426
Acoustic Systems	98	58	512-444-1961	Nikon Electronic Imaging	5	6	800-NIK-ONUS
Ampex (ASVD)	24-25	16	415-367-2011	NVISION, Inc.	67	38	916-265-1000
Ampex Recording Media	15	11	415-367-3809	Odetics, Inc.	9	8	800-243-2001
Audio Precision	13	10	800-231-7350	OEI Electronic Systems, Inc.	103	101	908-735-0543
Barco, Inc.	27	17	404-590-7900	OMB Sistemas Electronicos	*19	13	347-627-4537
Belden Wire & Cable	85	47	800-BEL-DEN4	Opamp Labs, Inc.	66	53	213-934-3566
Bird Electronics Corp.	93	54	216-248-1200	Orban, Div. of AKG Acoustics	7,17	7,12	510-351-3500
Broadcast Video Systems Ltd.	96	64	416-764-1584	Otari Corp.	40-41	27	415-341-5900
BTS Broadcast TV Systems	33,33A-D	21	800-962-4BTS	Panasonic Broadcast & TV	55		800-524-0864
Canare Cable, Inc.	92	51	818-365-2446	Radio Computing Services	43,63	28,37	914-723-8567
Canon USA Broadcast Lens	IBC	2	201-816-2900	Roland Corp. US	79	44	213-685-5141
Clear Com	100	68	510-527-6666	RTS Systems	39	26	818-566-6700
Continental Electronics	58	34	214-381-7161	Sachtler Corp. of America	91	50	516-867-4900
Denon	69	39	201-575-7810	Sierra Video Systems	80	45	916-273-9331
DPS	38	25	416-754-8090	Sony Business	29,48A-D		800-635-SONY
Dynair Electronics, Inc.	*64A-D	99	800-854-2831	Sony Pro Video Tape	72-73		800-635-SONY
ESE	94	55	310-322-2136	Synergistic Technologies	99	59	800-659-7715
Fujinon, Inc.	IFC	1	201-633-5600	Tascam	51	31	213-726-3030
GEPCO	95	63	312-733-9555	Tektronix, Inc.	31	19	800-TEK-WIDE
Graham-Patten Systems, Inc.	56-57	33	800-422-6662	Telex Communications, Inc.	3,11	5,9	800-554-0716
Grass Valley Group	35	23	916-478-3000	Thomson Tubes Electroniques	88	48	201-812-9000
Harris Allied	1	4	800-622-0022	Total Spectrum Mfg., Inc.	21	15	914-268-0100
Hewlett Packard Printers	97	56	800-LASERJET	Trompeter Electronics	98	57,67	818-707-2020
illbruck	92	52	800-662-0032	Television Technology Corp.	47	30	303-665-8000
Jampro Antennas, Inc.	28	18	916-383-1177	United Ad Label Co., Inc.	89	61	800-423-4643
JVC Professional Products Co.	45	29	800-JVC-5825	Utah Scientific	37	24	800-453-8782
Lakeside Associates	74	41	714-770-6601	Varian Associates, Inc.	71	40	800-544-4636
Leitch Video International	BC	3	800-231-9673	Vega, A Mark IV Company	83	63	818-442-0782
Logitek	101	65	713-782-4592	Vinten Broadcast, Inc.	75	42	201-263-4000
Maxell Corp. of America	59	35	800-533-2836	Wavephore, Inc.	32	20	-602-438-8700
MCL, Inc.	81	46	708-759-9500	The Winsted Corporation	101	66	800-447-2257
Midwest Audio	103	100	708-251-0001	3M Pro Audio/Video Products	53	32	612-733-1959
Multidyne Electronics	88	49	8004TV-TEST	360 Systems	34	22	818-342-3127
Neutrik U.S.A.	77	43	908-901-9488				

\*Denotes demographic coverage.



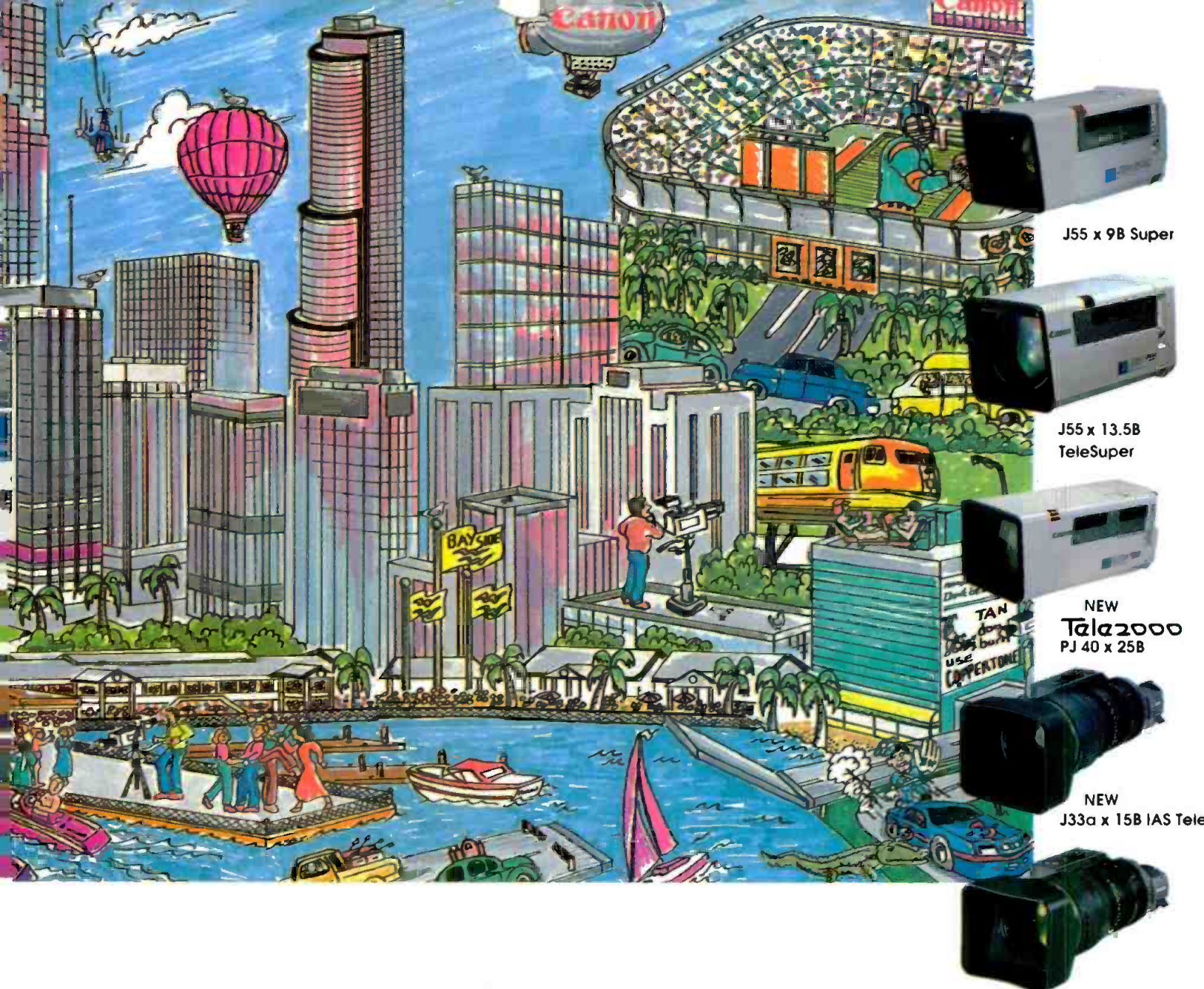

J55 x 9B Super

J55 x 13.5B  
TeleSuper

NEW  
**Tela2000**  
PJ 40 x 25B

NEW  
J33a x 15B IAS Tele

J33a x 11B IAS

# Fielder's Choice

Canon offers the widest choice of powerful field lenses available. Product variety is important and demonstrates our commitment to the industry and our product lines. Variety may even be the spice of life, but our specs add zing to any broadcast.

The new **Tela2000** is the longest lens in the world with 2000 mm of focal length, and the new **J33ax Tele** is the longest portable lens available.

And Canon's dedication to quality means you can depend on us for superior products and unparalleled service. That's why we're ranked as The Number One Lens.

So, if long distance shots are an important part of your life, Canon has the perfect choice for your field.

**Canon**  
The Number One Lens

610 Palisade Avenue, Englewood Cliffs, NJ 07632  
Telephone: (201) 816-2900 Fax: (201) 816-9702

Circle (2) on Reply Card

# ONE TOUCH... AND YOU'LL SHIFT TO LEITCH

Now  
4:2:2 and D2

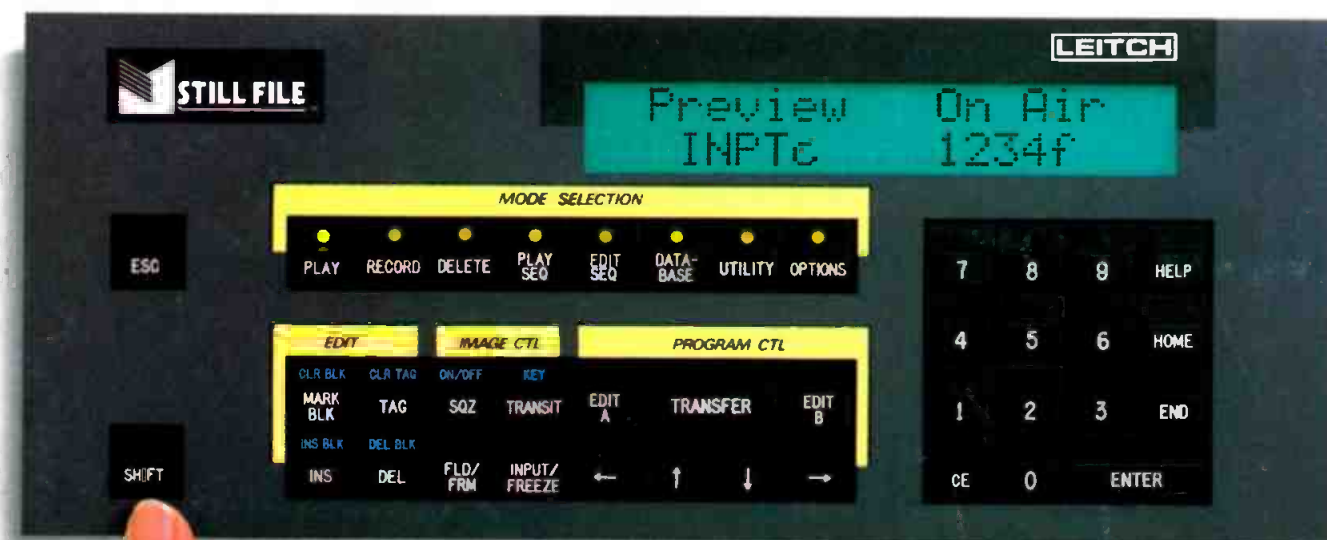

Once you get your hands on a STILL FILE by Leitch, you won't want to let go. The reason is simple ... the STILL FILE is the best designed still store on the market ... fully integrated and with a host of features that are as easy as the touch of a button.

Call Leitch today for a hands-on demonstration, and we'll even leave a STILL FILE at your studio for a while.

We're confident we won't have to pick it up again.

Don't just reach for the nearest brand name ... reach for the best, STILL FILE by Leitch.

1-800-231-9673

**LEITCH**

**D-2**

Leitch Incorporated, 920 Corporate Lane, Chesapeake VA 23320 Tel: (800) 231-9673 or (804) 548-2300 Fax: (804) 548-4088  
Leitch Video International Inc., 220 Duncan Mill Rd. #301, Don Mills ON, Canada M3H 3J5 Tel: (800) 387-0233 or (416) 445-9640

Circle (3) on Rapid Facts Card

www.americanradiohistory.com