

BROADCAST[®] ENGINEERING

AN INTERTEC PUBLICATION

June 1992/\$4.50

NAB convention replay

A3J100-----MYE7570J0 XXXX BEQ
F104072000000 23 A 001
RAYMUND MEYERS PRES DIR
BENCHMARK COMMUN CORP
4700 SW 75TH AVE FL 33155
MIAMI

Increasing your
audience through
technology

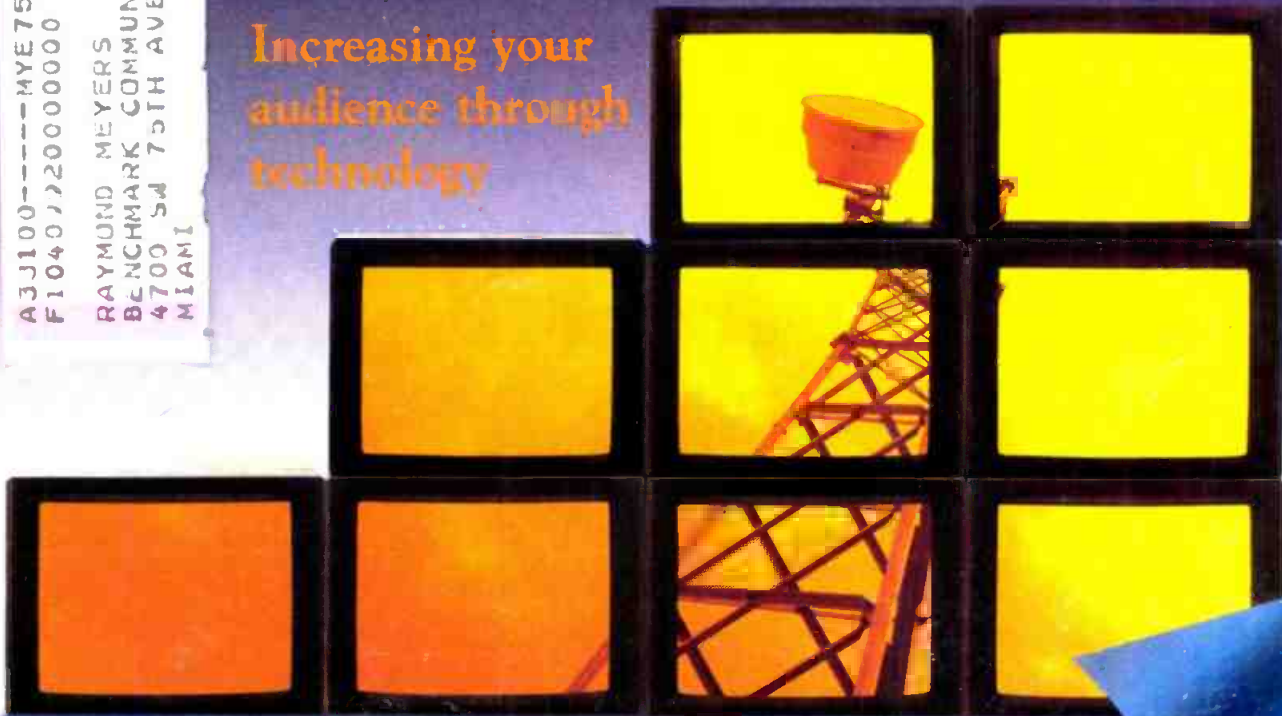

Pick Hits of '92
P. 30

“but have you ever

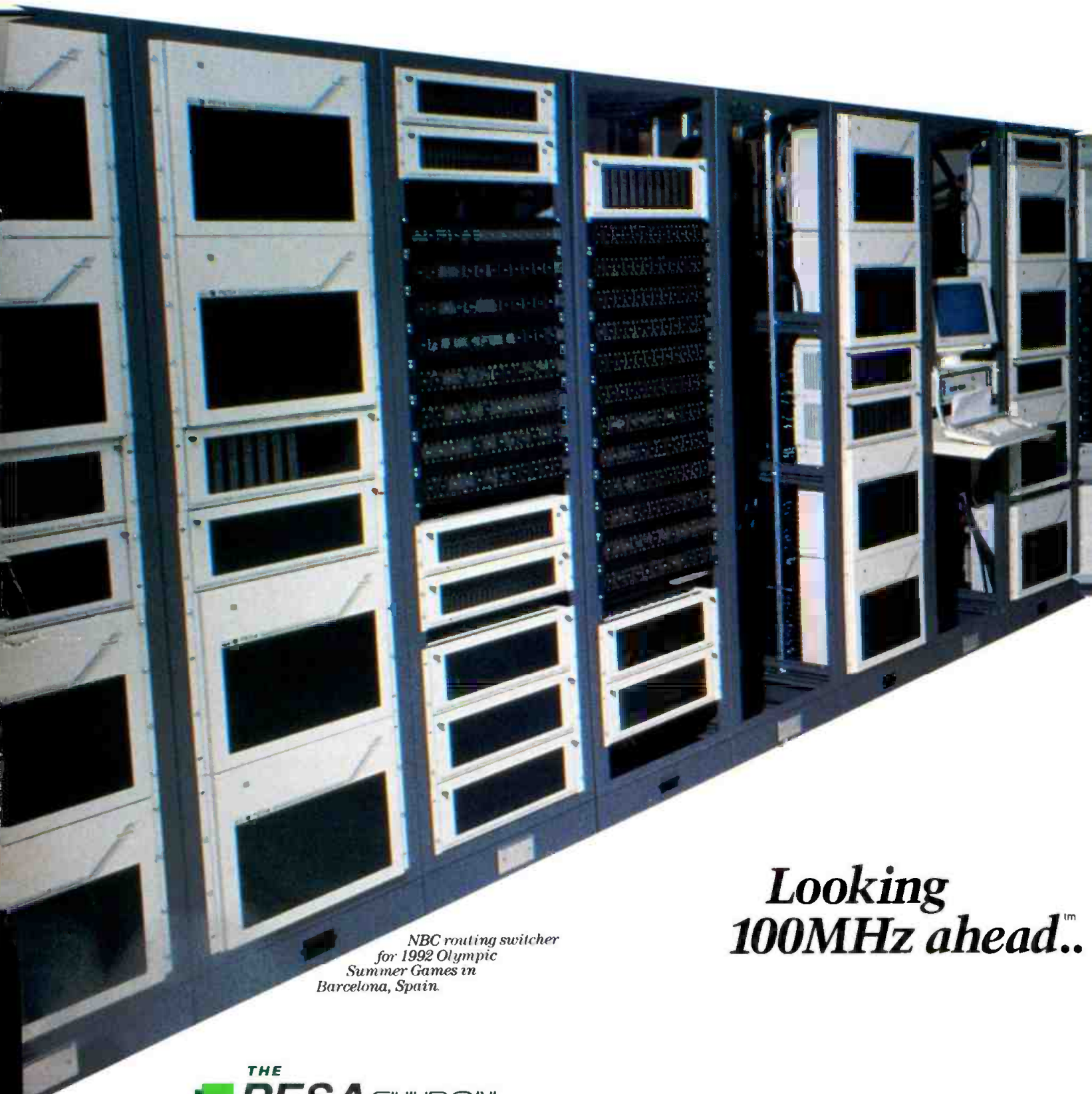

*NBC routing switcher
for 1992 Olympic
Summer Games in
Barcelona, Spain.*

Looking 100MHz ahead.™

THE
PESACHYRON
GROUP

PESA

CHYRON

CMX

AURORA

built a *big one?*”

asked NBC, CBS, RTO 1992 Olympics (International Broadcast Center), Sunset Post, Video Post & Transfer, U.S. Air Force, Mills/James Productions, University of Arizona, The Family Channel, NEP and The United Nations.

SYSTEM 5 A/V routing switcher met their specs. Its 100MHz bandwidth is essential for computer graphics and advanced TV signals. It can be configured up to 1024 x 1024 with multi-level control (up to 16). SYSTEM 5 is a disc based system, has virtual matrix mapping, full system reconfiguration...and it maintains system specification integrity. And there are scores of smaller SYSTEM 5s installed by a wide range of users from airlines to telco companies.

“Are you *competitive?*” Call us.

PESA
Switching Systems

Pesa America, Huntsville, AL
205-880-0795 · Fax 205-881-4828
Burbank, CA 800-323-7372
New York City 800-328-1008

*Carrying
the torch
for Albertville
and Barcelona.*

Circle (1) on Reply Card

Contents

BROADCAST engineering

June 1992 • Volume 34 • Number 6



Page 24



Page 30



Page 112

NAB CONVENTION REPLAY:

Signs of recovery abounded as vendors and attendees spoke of better times at hand. This year's show also produced a record number of new products, all of which are covered in this issue. Even if you missed the show, your comprehensive coverage of this important industry event is in your hands.

FEATURES:

24 NAB '92 Perspective

By Brad Dick, editor

An upbeat mood on the floor couldn't hide the worries about the cost of HDTV.

30 The Pick Hits of NAB '92

By Rick Lehtinen and Skip Pizzi, technical editors

This year's judges picked products with cost and high functionality in mind.

44 NAB Engineering Conference Report

By Skip Pizzi, technical editor

Fewer, but better, sessions kept the meeting rooms full at NAB '92.

50 Show of Shows

By Carl Bentz, special projects editor

DEPARTMENTS:

- 4 News
- 6 Editorial
- 8 FCC Update
- 10 Strictly TV
- 12 re: Radio
- 14 Management for Engineers
- 16 Circuits
- 18 Troubleshooting
- 20 Technology News
- 22 SBE Update
- 118 Station-to-Station: An Outboard PL Extender
- 122 Field Report: Avid Media Composer
- 125 Industry Briefs
- 128 New Products
- 133 Preview
- 134 Classifieds
- 136 Advertisers' Index

OTHER FEATURES:

112 Increasing Your Audience Through Technology

New systems provide new opportunities.

- **Integrating Digital Workstations**

By Russell Gentner, Gentner Communications

- **Weather Radar Can Increase Ratings**

By Rick Lehtinen, technical editor

ON THE COVER

As broadcasters grapple with rapidly changing technology, so do manufacturers. Finding ways to get improved performance from traditional technology is often the key to success. (Cover credit: Microwave Networks.)

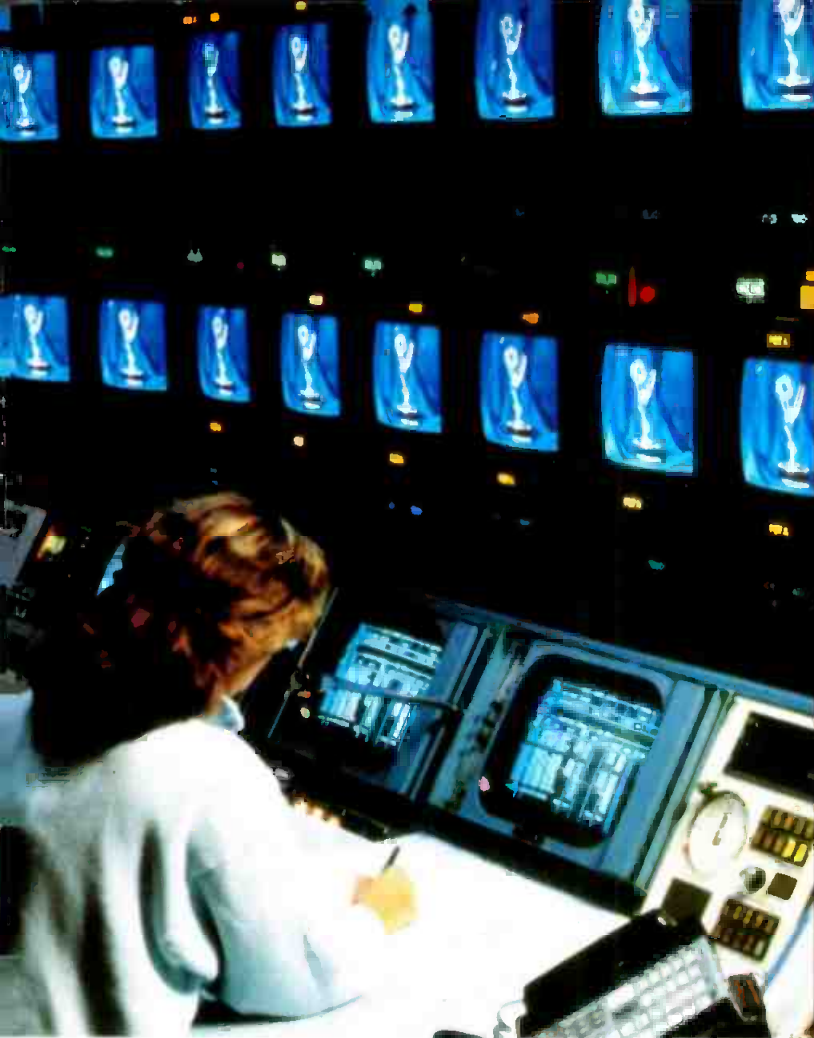

From **MISSION CRITICAL** To **CRITICAL MISSIONS**, *There's a BARCO Monitor for Every Broadcast Need*

At BARCO, we've been pioneering commercial broadcast and display systems since 1934. Today, we have the broadest product offering of any company in the industry. Bar none.

Just look around. You'll find BARCO intelligent monitors and control equipment in network studios, post-production and editing suites, control rooms, OB vans, electronic theaters and hundreds of other television facilities. Anywhere the need for crisp, clear and visual information is critical.

The same creative spirit and ingenuity that was behind one of our first innovations, a television set that received different European signal formats, is evident in all of our intelligent monitors today. In the broadcast industry, BARCO intelligent monitors are standard equipment in production facilities worldwide. In the emerging fields of HDTV and LCD projection, BARCO makes innovative products that allow large audiences to see sharp, larger-than-life images.

BARCO is an international leader in multi-standard visual communications. After we combined the broadcast monitor with the microprocessor, our intelligent monitors won an EMMY Award for their unique design and engineering. And because we're known for our reliability and technology, BARCO monitors and projectors will be used for large screen, on-site transmission of HDTV at both the Olympic Games and the World Exposition in Spain in 1992.

At BARCO, every application is critical!

So if you have a broadcast display requirement, talk to the company that offers more solutions than anyone in the industry. Chances are we already have a product that's ideal for your needs. If we don't we can build it for you.

For more information, call us today. And remember, at BARCO every application--big or small--is critical!

BARCO

1000 Cobb Place Boulevard Kennesaw, GA 30144
Telephone: (404) 590-7900 (Ext. 1297) Fax: (404) 590-8836

Circle (3) on Reply Card

By Dawn Hightower,
senior associate editor

VOA listeners tune to Poppele transmitter

Voice of America (VOA) listeners in Central America, South America and the Central Pacific Ocean area are now tuning their radios to programs transmitted from the Jack R. Poppele transmitter station in Delano, CA.

The transmitting site, once known as the Delano relay station, was renamed last month after Jack R. Poppele, who served as director of the VOA for two terms in the 1950s. Poppele began his career as a ship's wireless operator. He later developed the directional signal, worked on the first trans-Atlantic broadcast and the first portable radio studio. He also introduced stereo sound to AM radio.

The transmitter station is located in San Joaquin Valley, CA. It is one of 14 worldwide radio facilities of the VOA.

The station's three 250,000W automatic-tune Collins transmitters and four 250,000W Brown Boveri transmitters are used for regular AM shortwave broadcasting. In addition, two 50,000W Continental Electronic independent sideband transmitters are used exclusively to relay VOA programming to other overseas relay stations. The transmitters can be connected by a full-matrix antenna-switching system to any of 12 curtain or five rhombic transmitting antennas. These antennas are capable of beaming VOA's signal into Latin America, the Pacific Ocean and the Far East.

To fulfill its mission, the Jack R. Poppele transmitter station broadcasts approximately 10.5 transmitter hours daily of VOA programs in English, Spanish and Creole. Programming is distributed to the station from Washington, DC, via the Satellite Interconnect System (SIS).

Broadcasters tell FCC to overhaul FM radio

To avoid the same regulatory missteps and other types of inaction that have hurt AM radio, the National Association of Broadcasters (NAB) has urged federal regulators to overhaul the procedure by which FM station licenses are granted.

In reply comments to the Federal Communications Commission (FCC), NAB said "prompt, comprehensive and remedial action" is needed to correct "the current FM allocations and licensing scheme." NAB pointed out that regulators are overpacking the FM airwaves with too many sta-

tions, measures that cause signal interference, stymie the ability of broadcasters to upgrade their FM signals and erode the quality of FM sound for radio listeners.

NAB has asked the FCC to temporarily suspend the allotment of FM station licenses until the FCC can adopt some remedial measures to deal with the interference and congestion problems on the FM band. NAB said the FCC took the same action when it recently restructured AM radio, and also noted that in July 1991, Canada took similar steps to deal with FM station crowding and interference.

NAB said, "Relying on marketplace forces to remedy the (FM) problem is much like relying on the clapping of hands to save Tinkerbell. It doesn't work in the real world." In 1990, more than half of all AM and FM stations lost money. The 1991 numbers will be released this summer.

Recent FCC efforts to control FM congestion have failed. For example, NAB noted recent FCC actions permitting FM directional antennas and additional short-spacing, asserting these measures have actually "contributed to reduced service areas and increased interference."

NAB to launch Multimedia World conference

The National Association of Broadcasters (NAB) will premiere a new conference and exhibition in 1993 called "Multimedia World: Merging Video, Audio & Computers."

Multimedia World will be an annual event for post-production business video and computer professionals and broadcasters. In 1993 it will run concurrently with the NAB '93 convention (April 19-22).

As with other conferences and exhibitions under the NAB convention umbrella, registration to Multimedia World will be included with registration to NAB '93.

The exhibits of Multimedia World will be located in the Hilton Center. The Multimedia World conference program will be developed in consultation with post-production and business video executives, computer and broadcast industry leaders.

Currently, the exhibits of NAB's HDTV World will complete their planned transition to the main NAB convention. The conference component of HDTV World will continue, together with those exhibits, to serve broadcasters and production houses as they plan for conversion to HDTV.

EDITORIAL

Brad Dick, *Editor*
Carl Bentz, *Special Projects Editor*
Rick Lehtinen, *Technical Editor*
Skip Pizzi, *Technical Editor*
Dawn Hightower, *Senior Associate Editor*
Stefanie Kure, *Associate Editor*
Tom Cook, *Senior Managing Editor*
Pat Blanton, *Directory Editor*

ART

Nemita Gumangan, *Graphic Designer*

BUSINESS

Cameron Bishop, *Group Vice President*
Duane Hefner, *Group Publisher*
Tom Brick, *Marketing Director*
Czaldana Inan, *Group Director, Special Projects*
Evelyn Hornaday, *Promotions Manager*
Sally Nickoley, *Promotions Coordinator*
Dee Unger, *Advertising Business Manager*
Mary Birnbaum, *Advertising Production Supervisor*
Michele Costlow, *Advertising Coordinator*
Mia Fountain, *Classified Advertising Coordinator*
Lori Christie, *List Rental Sales*

ADMINISTRATION

R.J. Hancock, *President*
Doug Wilding, *Circulation Director*
Customer Service: 913-967-1711

TECHNICAL CONSULTANTS

Eric Neil Angevine, *Broadcast Acoustics*
John H. Battison, *Antennas/Radiation*
Dennis Ciapura, *Radio Technology*
Dane E. Ericksen, *Systems Design*
John Kean, *Subcarrier Technology*
Donald L. Markley, *Transmission Facilities*
Harry C. Martin, *Legal*
Elmer Smalling III, *Cable/Satellite Systems*

MEMBER ORGANIZATIONS

Sustaining Members of:
• Acoustical Society of America
• Society of Broadcast Engineers
• Society of Motion Picture and TV Engineers

Member,
Association of Business Publishers

Member,
Business Publications
Audit of Circulation



BROADCAST ENGINEERING is edited for corporate management, engineers/technicians and other station management personnel at commercial and educational radio and TV stations, teleproduction studios, recording studios, CATV and CCTV facilities and government agencies. Qualified persons include consulting engineers and dealer/distributors of broadcast equipment.

BROADCAST ENGINEERING (ISSN 0007-1794) is published monthly (plus three special issues) and mailed free to qualified persons within the United States and Canada in occupations described above. Second-class postage paid at Shawnee Mission, KS, and additional mailing offices. POSTMASTER: Send address changes to **Broadcast Engineering**, P.O. Box 12960, Overland Park, KS 66282-2960.

SUBSCRIPTIONS: Non-qualified persons may subscribe at the following rates: United States and Canada: one year, \$50.00. Qualified and non-qualified persons in all other countries: one year, \$60.00 (surface mail); \$115.00 (air mail). Subscription information: P. O. Box 12937, Overland Park, KS 66282-2937.

Photocopy rights: Permission to photocopy for internal or personal use is granted by Intertec Publishing Corporation for libraries and others registered with Copyright Clearance Center (CCC), provided the base fee of \$2.00 per copy of article is paid directly to CCC, 21 Congress St., Salem, MA 01970. Special requests should be addressed to Cameron Bishop, group vice president. ISSN 0007-1794 \$2.00 + \$0.00.

CORRESPONDENCE

Editorial and Advertising: P.O. Box 12901, Overland Park, KS 66282-2901. Telephone: 913-341-1300; Editorial fax: 913-967-1905. Advertising fax: 913-967-1904.

©1992 by Intertec Publishing
All rights reserved.

Advertising offices listed on page 135.



**Nikon ENG/EFP lenses.
All you need to look good.**

When you're on location with a CCD camera reaching for the best shot possible, you need ENG/EFP lenses that are compact, lightweight, and easy to maneuver. Lenses with the flexibility to adapt to any situation. Lenses with all the star qualities found only in a Nikon.

Our ENG/EFP precision lenses are created from the same superior glass and coating technology that have made Nikon the world renowned name in optics. Which means they're made with Nikon's exclusive Extra-Low Dispersion (ED) glass. And treated with special anti-reflection coatings to minimize ghosts and flare. Plus, their strong magnesium housing makes them extremely durable. So no matter how tough the assignment, Nikon ENG/EFP lenses are even tougher.

Our full line of outstanding ENG/EFP lenses includes the Nikon S9x5.5 wide angle lens — perfect for tight, close-up shots. The Nikon S19x8, with its unsurpassed focal length and range. The all-purpose Nikon S15x8.5. And the economical Nikon S13x9.

Want to create special effects with your CCD camera? We have two ENG/EFP converters that will allow you to use your whole bag of Nikkor 35mm SLR lenses. One lets you use wide angle lenses down to an effective focal length of 2 mm. The other lets you use long focal lenses out to 1200 mm.

And in the unlikely event something should

happen to your Nikon lens, a simple call to our Nikon Express Loaner Service will get you a loaner lens overnight. So you don't ever have to worry about a crew being out of action until you can get a lens repaired.

ENG/EFP lenses can make you look good, call 800-52-NIKON or (516) 547-4355 for our complete brochure. Or write: Nikon Electronic Imaging, Dept.D1, 101 Cleveland Avenue, Bayshore, NY 11706.

To learn more about how Nikon

SHOOTING STARS.



Nikon ELECTRONIC IMAGING

r e c r e a t i v i t y

Don't be intimidated

"There is nothing I love as much as a good fight."
Franklin D. Roosevelt.

At the recent NAB Convention, the FOR.A company announced they were being sued for infringing patents originally held by Consolidated Video Systems (CVS).

The suit was brought against FOR.A by Video Patents Limited, a.k.a. Video Processing Technology, a California-based corporation formed in the late 1980s by Carl Cooper, a former CVS employee, and his business partner, attorney Daniel Leckrone. A press release from FOR.A acknowledged the suit, and stated that threats also may have been made against other video equipment manufacturers.

Great, this is just what we need — a few people trying to shut down the entire video production industry by claiming infringement on patents, some of which have either expired or are within a year or so of expiring. Those I talked with noted that for the most part, the patents were never enforced, most likely because there was widespread industry knowledge of prior art.

Don't misunderstand me. Patent infringement is wrong. But so is the frivolous attempt to reap unearned profits from those who push forward the edge of technology. The companies that research and then develop new products should be rewarded from the sales of those products. We don't need people who try to unfairly claim a piece of the pie when they may not have had anything to do with baking it in the first place.

In today's litigious business climate, everyone sues everyone. The result is that no one wins. And in this case, the equipment users lose. It's time to say no.

I urge the companies being challenged to stand firm and protect their own rights and their customers' rights. Don't allow those who may be trying to profit through the buying of old and obsolete patents prevent you from bringing new products to market. Protect your company's future and integrity by standing your ground. In the long run, your company, the industry and your customers will

be far better off — even if it takes a good fight to gain victory.

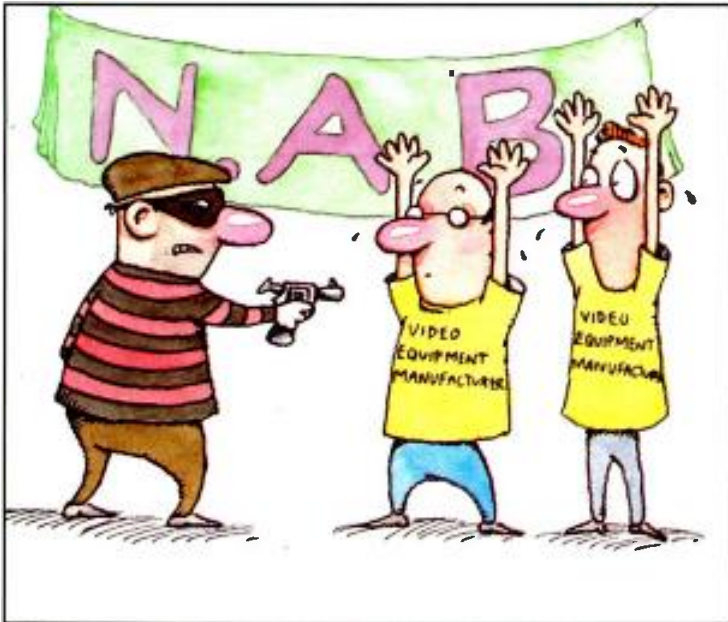

Brad Dick

Brad Dick, editor

TOTALLY TRANSPARENT TRANSMISSION PROTECTION.



TRANSMISSION LIMITER 4000

Pure Sound.

Protecting transmission systems from peak overload without audible artifacts—while stringently preserving natural sound quality—is the primary objective of many of the world's finest broadcast operations. That is why so many facilities around the world are choosing the Orban Transmission Limiter 4000. The 4000 provides the peak control they need, without audibly adding, subtracting or interfering with their signal in any way.

Don't Take Our Word for It.

The 4000 provides transparent limiting with any source. Blind tests confirm that the sound of the Orban Transmission Limiter 4000 is virtually indistinguishable from the original source when driven as much as 15dB into limiting—even to trained listeners. Try it for yourself and hear what your facility can deliver when it is protected, not just restricted.

Sophisticated, Easy to Use.

Orban engineers took years to develop the complex algorithms which permit the 4000 to protect inaudibly. Yet, they kept the front panel of the 4000 clean, clear and businesslike. The precision LED displays indicate any action of the compressor or HF limiter circuitry. The only adjustments are for INPUT level and OUTPUT level. The built-in tone generator and test mode permit rapid system setup and alignment.

Orban Signature Quality.

The Transmission Limiter 4000 is one of a family of reliable, quality Orban products designed for demanding broadcast applications. Call your local Orban dealer for a hands-on demonstration of the Orban Transmission Limiter 4000—another breakthrough product from the leaders in broadcast audio processing.

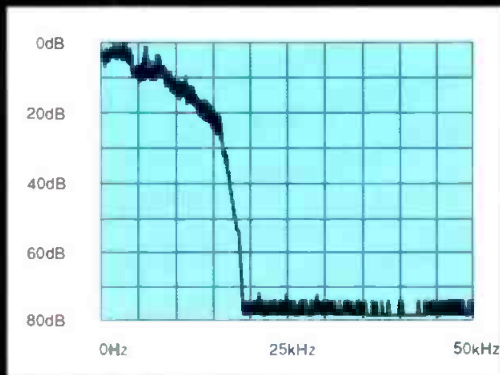

Power spectral density at the 4000's output using "maximum peak hold" measurement. (10kHz/div. horizontal; 10dB/div. vertical)

orban[®]

a division of AKG Acoustics, Inc.
1525 Alvarado Street, San Leandro, CA 94577 USA
Tel: (1) 510/351-3500 Fax: (1) 510/351-0500

© 1992 AKG Acoustics, Inc. Orban is a registered trademark of AKG Acoustics, Inc.
AKG is a registered trademark of Akustische u. Kino-Geräte Ges.m.b.H., Austria.

Circle (5) on Reply Card

www.americanradiohistory.com

FCC Update



Rules adopted for implementing HDTV

By Harry C. Martin

At its April 9 meeting, the FCC adopted a number of rules to implement advanced or HDTV service in the United States. The most significant decisions were:

- To make a block allotment of frequencies for HDTV and limit initial eligibility for those frequencies to existing broadcasters for a period of two years. (Others will be allowed to apply for HDTV licenses only where opportunities for additional allotments can be found.)
- To consider all allotment issues and issue a draft Table of Allotments this month.
- To adopt a 2-year deadline for initial applications by broadcasters for a paired HDTV channel, and a 3-year deadline for construction of an HDTV facility.
- To use vacant non-commercial reserved channels for commercial HDTV only when no feasible alternative exists.
- To pair vacant non-commercial allotments with an HDTV channel, except where that possible channel pair is needed to permit HDTV service by an existing broadcaster, and careful engineering analysis uncovers no other practical alternative.
- To continue the secondary status of LPTV stations vis-a-vis new HDTV operations, but continue to allow displaced LPTV stations to file non-competitive applications for another channel in the same community. (The commission concluded that LPTV stations should be free to broadcast in either the HDTV or NTSC format.)
- To condition selection of an HDTV system on a winning proponent's adoption of reasonable and non-discriminatory patent licensing policies.
- To direct the Advisory Committee on compatibility issues to address new audio development as well as proposals for flexible apportionment of audio and data in the selection of a system.

Further rulemaking notice

The commission is also seeking comment on other proposals to resolve outstanding questions concerning HDTV implementation. Specifically, the commission

proposed:

- To rank, in the event of a spectrum shortfall, the classes of parties initially eligible for HDTV frequencies in the following order: a) licensees and permittees with constructed facilities; b) permittees with unbuilt facilities; and c) applicants.
- To allow broadcasters a fixed period of time to negotiate channel assignments once a final Table of Allotments has been posted for public comment and, in cases where broadcasters are unable to agree, to make channels available on a first-come, first-serve basis.
- To suspend the "dual network" rule to permit networks to give their affiliates a second feed for HDTV.
- To require LPTV stations to convert to HDTV at the point that full-service broadcast stations would be required to do so.

***The commission put
broadcasters on notice
that when HDTV
becomes the prevalent
medium, they will
have to convert to
HDTV.***

Conversion issues

The commission also put broadcasters on notice that when HDTV becomes the prevalent medium, they will have to convert to HDTV (i.e., surrender one of their two broadcast channels and cease broadcasting in NTSC). It will also be necessary to establish a date certain for conversion. The FCC is tentatively proposing a conversion date 15 years from the date when either an HDTV standard or a final Table of HDTV Allotments is effective, whichever is later.

Relatedly, the commission has preliminarily concluded that a 100% simulcasting requirement should be implemented no later than four years after the initial 5-year application/construction period has passed. The agency is seeking comment on whether simulcasting should be phased

in prior to this point, and whether simulcasting should be required at a point earlier than the proposed 4-year deadline.

Comparative selection policies examined

The commission is seeking comments on revisions to the comparative criteria used to select among competing applicants for new broadcast facilities.

The agency will consider whether to retain, eliminate or modify four of its existing criteria: integration, proposed program service, past broadcast record and auxiliary power. The FCC has also proposed two new comparative factors — a service continuity preference and a finder's preference. The service continuity preference would be awarded to applicants committed to owning and operating the station for a minimum of three years. A finder's preference would be awarded to applicants who successfully request the allotment of new broadcast frequencies through rulemaking.

In addition, the FCC is considering evaluating applicants through the use of a point system. Under the proposed system, the weight of each preference would be defined in terms of an absolute number of points, rather than in terms of relative preferences and demerits. The system also would precisely define the circumstances in which points are to be awarded under each criterion, and a tie-breaker procedure would be used to resolve cases in which no applicant receives a dispositive preference under the revised comparative criteria.

In accordance with Congressional enactments intended to prohibit the elimination or dilution of the preference awarded for minority ownership, the commission will not change the proportionate weight currently afforded to minority ownership in the comparative evaluation.

The agency proposes to apply the revised criteria to all applicants for new facilities that are not in a hearing as of the effective date of action in this proceeding.

Martin is a partner with the legal firm of Reddy, Begley & Martin, Washington, DC.



The Odetics TCS90 - The Only Cart Machine Designed with Your Future in Mind

With the TCS90, Odetics Broadcast gives new meaning to the word versatility. Featuring a unique ability to handle multiple cassette sizes and virtually all available broadcast formats, the TCS90 provides incomparable flexibility plus an open window to the future.

Field Changes Made Simple

Don't waste time second-guessing future tape deck format changes. The TCS90's simple straight-forward design makes field upgrades easy and affordable. You can take advantage of technology upgrades as they become available.

Mix cassette sizes to match your needs

Odetics put its award-winning electromechanical expertise to work and developed a system that makes handling dual-sized cassettes simple and foolproof. With a capacity of 150 carts, there is enough on-line access for a full day of programming plus twelve to twenty-four hours of spots and

promos, depending upon your format. And, with Odetics Multicut Software, the TCS90 can store several hundred spots on-line.

The Decision is Yours

Full compatibility with any news or station automation system lets you make choices that make sense for your station's needs. Built-in redundant hardware and software features make choosing Odetics a decision you can be sure of.

Buy for the Long-Term

Because Odetics products are fully compatible with each other, system obsolescence is never a concern. The TCS90 includes the same advanced features as the Odetics TCS2000 large library Cart Machine and all TCS2000 software and hardware options and accessories. It's no wonder Odetics Broadcast is the world-leader in large library automation systems.

**Odetics
Broadcast**



© NATAS

1515 South Manchester Avenue, Anaheim, California 92802-2907 (800) 243-2001 or (714) 774-2200

Director of Sales
Bill Keegan
(714) 774-2200

Northeast
Ray Baldock
(201) 305-0549

Southeast
Emerson Ray
(813) 960-0853

West
Chuck Martin
(818) 999-9796

North Central
Bill Boyd
(612) 894-2121

South Central
David Scally
(404) 917-9506

Circle (6) on Reply Card

www.americanradiohistory.com

Strictly TV

3-D graphics provide leading-edge look

By Omar Perez

Regional TV stations are constantly engaged in the never-ending race for leadership in their market. They constantly search for ways to distinguish their air product from the competition. One way to set a station apart is with a dynamic on-air look. Important elements in a station's appearance include eye-catching news graphics, distinctive program opens and station IDs.

One way to set a station apart is with a dynamic on-air look.

Recently, many stations have been turning to 3-D animation as a way to tune their image. However, until recently, purchasing a 3-D system was a costly proposition. Advances in RISC-based architecture, and the ability to use the same image data in 2-D and 3-D applications are changing that.

3-D growth

Although many stations own a 2-D or paint system for bread-and-butter graphics, most are just beginning to bring 3-D in-house. Several reasons have delayed the onset of 3-D at the local level:

- Earlier 3-D modeling, scripting and rendering software required operators to have a technical programming background. This often shut out production artists and art directors who were not computer literate.
- Most stations' art departments have only a few hours to create graphics for each evening's newscast. This is particularly the case if any late-breaking stories occur. Unfortunately, 3-D rendering — the process in which the computer calculates the color, position and lighting of each pixel — formerly took days, not hours.
- The price of sophisticated 3-D systems, which could run into six figures, was not uncommon and made 3-D animation something the affiliate market could eas-

Perez is a staff artist with KTRK-TV, Houston.



ily do without.

However, certain signs indicate the situation is turning:

- Many stations need to update or upgrade their aging paint systems. Some are considering the advantage of adopting unified systems in which paint, 2-D and 3-D animation software can access the same image files. This saves time and effort, particularly in jobs that require several views of a 3-D object or objects over the same or different backgrounds.
- RISC-based and parallel processors have increased computer processing speed dramatically. The same animation that once took days can now render in hours or minutes.
- The cost advantage of taking 3-D work out of house is less attractive now that the price of the required hardware and software has fallen.
- Today's 3-D systems are much more user-friendly. Almost anyone with an art background can master the tools and create

fairly complex animations.

Bringing 3-D work in-house also solves several creative problems:

- If the project is in-house, changes can be made on the fly, without incurring additional charges.
- The less local the control, the more likely projects will acquire a generic look. This is because most production houses are less willing to follow creative hunches if the station artist isn't there to approve them. The station artist is usually needed back at the station, and cannot spend the day off-site, looking over the shoulder of the outside facility's artist.

New ground

Today's 3-D software and hardware now permits regional stations to compete in a territory that was once left to the large players. Overall, the cost/performance ratios of current generation equipment is high. Expect to see more 3-D animation as stations scramble to gain market share.



An integrated graphics system can use its 2-D sections to create colorful backgrounds and stationary objects. Animated objects that might rotate to reveal new faces (such as the satellite) can be created in 3-D. They can then be combined with the 2-D background.



WE MAKE IT VERY, VERY HARD TO BLAME IT ON THE TAPE.

While we can't fix all your problems, we can make sure 3M tape isn't one of them. You get consistently high quality in every audio and video format. And flawless support from the people who know more about tape than anyone. **We won't be satisfied until you are.**



3M Professional Audio/Video Products Div.
3M Center, St. Paul, MN 55144
36USC380 © 1992 3M

3M | 
Worldwide Sponsor 1992 Olympic Games

Circle (7) on Reply Card

www.americanradiohistory.com

re: Radio

Digital radio picks up the pace

By Skip Pizzi, technical editor



For those who thought digital radio broadcasting had become dead in the water, or was still a far-future concept, the first half of this year has certainly been an eye-opener.

In early March, the World Administrative Radio Conference (WARC-92) issued its pronouncements on spectrum allocations for future satellite and terrestrial digital radio service. Although a worldwide standard of 1,452-1,492MHz (L-band) was designated, footnotes and other fine print in the agreement render the actual allocations much more complex. (See Figure 1.) In fact, the true impact of the WARC-92 decisions for digital radio is still being digested. Subsequent rulings and conferences will be required before this issue is fully clarified.

For example, current plans call for the United States to use a different frequency band than its North and South American neighbors. Europe is expected to use interim "parking" of AM and FM digital replacement channels (terrestrial only) in the VHF TV area. Eventually (after 2007), a European DBS/terrestrial hybrid system would operate at L-band. On the other hand, Japan, China, CIS and other Asian nations have opted for a higher S-band allocation of 2,535-2,655MHz. Finally, India has accepted all three possibilities.

So, the WARC-92 worldwide standard is not really much of a standard at all. Under the current arrangement, intracontinental frequency coordination will be especially cumbersome for satellite applications, and receivers will vary significantly between countries.

CCIR has set a goal for standardization of a digital radio system by fall of 1994. These efforts may help, but their task is really aimed toward a standard *format*, not necessarily a common frequency allocation (although the two issues are somewhat intertwined). Whatever transpires, activities in the next two years will greatly affect the future of radio broadcasting worldwide.

U.S. digital radio actions

Because of the apparent unattractiveness of 2,300MHz broadcast operation, the U.S. S-band allocation has spurred activi-

ty among in-band (i.e., operating in existing broadcast spectrum) proponents. Meanwhile, the Canadians are off and running with their L-band Eureka 147 system, with a full-scale experimental station scheduled to be operational by this fall. A North American digital radio race may be forthcoming.

At the same time, the Electronic Industries Association (EIA) and its Consumer Electronics Group (CEG) have taken a fast track toward standardization of a (U.S.) digital radio system. The Digital Audio Radio (DAR) subcommittee of EIA/CEG has called for detailed system descriptions to be submitted by proponents no later than Dec. 15, 1992, with hardware for testing delivered by April 15, 1993, and format selection(s) to be made later that year.

Although it may seem difficult to maintain this pace, all digital radio proponents represented at NAB 1992 accepted the EIA time line, and announced their intent to

conform to it. Demonstrations at this year's NAB convention showed that for at least some formats, such a schedule might indeed be workable.

In contrast, some other digital radio formats introduced last year have not shown similar progress, and thus this year's NAB convention served as a benchmark in the expected thinning of the herd.

Digital radio is no longer a far-fetched theory. Although important development and many difficult decisions still lie ahead, this year's events so far have shown that digital radio is on a roll. Experimental broadcasts could be on-air by mid-decade, and digital radio could be a well-established service by 1998. This is much sooner than most would have guessed even last year at this time. For those who still think it's just a pipe dream, or who haven't gotten up to speed on the issues and involved in the process, it's later than you think.

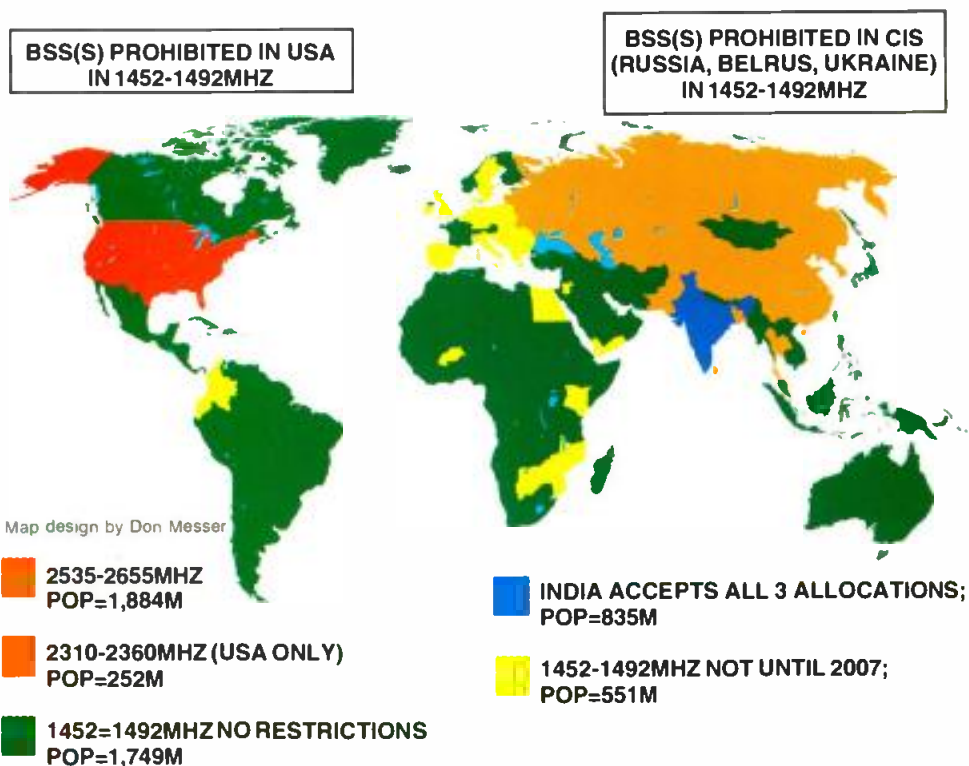

Figure 1. World allocations for new digital radio spectrum resulting from WARC-92. Official title for this allocation is Broadcast Satellite Service (Sound) (BSS(S)). (Courtesy of VOA.)

Extreme Measures

-118.0
-115.0
-120.0
-125.0
130.0
135.0
140.0
145.0
150.0

High-performance Audio Testing With System One + DSP

DESIGNING, MANUFACTURING and MAINTAINING high-performance analog & digital audio equipment places **extreme** demands on your test equipment. Your test set must have **extremely** low residual noise and distortion as well as **extremely** high accuracy... and the variety of systems under test calls for **extremely** flexible test set-up and control.

System One + DSP from **Audio Precision** is the solution. The trace below is a **System One + DSP** FFT spectrum display showing the residual distortion performance of our generator and analyzer. 2nd harmonic distortion of the sine wave is 125dB below the 1kHz fundamental level before nulling. The 3rd, 5th & 7th are all even lower!

This self test is typical of the high-performance, high-accuracy measurement capability of **System One + DSP**.

System One + DSP features include:

- **Dual Channel FFT Analyzer** — Signals up to 80kHz may be acquired and analyzed with 16 bit resolution.
- **Waveform Capture** — Acquire and display signals on the PC screen for analysis in time domain "digital storage oscilloscope" mode.
- **Harmonic Analysis** — Perform harmonic analysis such as measurements of individual distortion components, with automatic tracking to 9th harmonic.
- **Processing Power** — Dual high-speed 24 bit internal DSPs and precision 16 bit analog I/O conversion.
- **Low residual THD + N** — Total analog system THD + N (22kHz bw) .001%. DSP analysis permits resolution of distortion as low as 145 dB below fundamental.

System One + DSP... When you're serious about performance.

0.0 5.00k 10.0k 15.0k 20

System One

Audio
precision



P.O. Box 2209, Beaverton, OR 97075
503/627-0832 1-800/231-7350
FAX: 503/641-8906, TELEX: 283957 AUDIO UR

Circle (8) on Reply Card

INTERNATIONAL DISTRIBUTORS: Australia: IRT Electronics Pty. Ltd., Tel: (81) 2-439 3744 Austria: ELSINCO GmbH, Tel: (43) 222 812 1751 Belgium: Trans European Music NV, Tel: (32) 2-466 5010 Bulgaria: ELSINCO, h.e. Strelbishte, Tel: (359) 92 581 698 Canada: GERRAUDIO Distribution, Tel: (416) 696-2779 China: Hong Kong: A C E (Int'l) Co. Ltd., Tel: (852) 424-0387 Czechoslovakia: ELSINCO GmbH, Tel: (43) 222 812 1751 Denmark: nbn Elektronik aps, Tel: (45) 86 57 15 11 Finland: Genelec OY, Tel: (358) 77 13311 France: ETS Mesureur, Tel: (33) (1) 45 83 66 41 Germany: RTW GmbH, Tel: (49) 221 70 91 30 Hungary: ELSINCO KFT, Tel: (36) 112 4854 Israel: Dan-El Technologies Ltd, Tel: (972) 3-544-1466 Italy: Medea S.r.l., Tel: (39) 24840 1780 Japan: TOYO Corporation, Tel: (81) 3 (5688) 6800 Korea: Myoung Corporation, Tel: (82) 2 784-9942 Malaysia: Test Measurement & Engineering Sdn. Bhd., Tel: (60) 3 734 1017 Netherlands: TM Audio B.V., Tel: (31) 034 087 0717 New Zealand: Audio & Video Wholesalers, Tel: (64) 7 847-3414 Norway: Lydconsul, Tel: (47) 9 19 03 81 Portugal: Acufon Electroacustica LDA, Tel: (351) 1 9414087 / 9450862 Poland: P.H.U. INTERLAB, Tel: (48) 22 335 454 Singapore: TME Systems Pte Ltd., Tel: (65) 298 2608 South Africa: SOUND FUSION, Tel: (27) 11 477-1315 Spain: Telco Electronics, S. A. Tel: (34) 1 531-7101 Sweden: Tal & Ton Elektronik AB, Tel: (46) 31 80 36 20 Switzerland: Dr. W.A. Gunther AG, Tel: (41) 1 910 41 41 Taiwan: ACESONIC Int'l Co., Ltd., Tel: (886) 2 716-8896 United Kingdom: SSE Marketing Ltd, Tel: (44) 71 387-1262

Management for Engineers

The human network: a management tool

Maintaining your FEN

By Judith E.A. Perkinson

When Knight Ridder built WPRI in Providence, RI, a network of resources was assembled to complete the job. The chief engineer employed the services of contractors, electricians, carpenters, pipe fitters, design engineers, architects, painters and a wide variety of ancillary services — in other words, a network. It was made up of companies and individuals who worked together to finish an important task. Although the network was disbanded as soon as the project was completed, for a time, this group of professionals worked together as a team. They did so because individually none of them could have done the job alone.

A project often serves as the first step in building a flexible engineering network (FEN). Last month, we mentioned the fire that raged through the PBS Technical Center. Although the network of resources that was assembled to keep PBS on the air no longer formally exists, an informal professional network remains that will serve as an ongoing resource for the company.

Building a network without a crisis

It doesn't necessarily take a tragedy to start a network. Many productive networks have been established from an understanding of the potential value in network participation and a willingness to invest the time and effort.

A FEN needs a purpose and a direction. Once you have exchanged information and completed the network member survey, it is time to define the network's purpose and direction. Start with a project. However, certain pitfalls must be avoided.

Network maintenance

The basic rules needed to maintain a network include:

- *Purpose.* A network should have a purpose that is re-examined periodically. This ensures that the network has a reason to exist. The purpose also helps the network define the goal(s) to be accomplished.



***If you cultivate
networks, you cannot
help but benefit in
some way.***

- *Direction.* Knowing the destination is important, but knowing how to reach that destination is critical. You must have a plan that spells out the steps to be taken on the way to the network goal(s). The plan should be clear, reasonable and have a strong potential for success.

- *Measurability and time frame.* A network should not be an endless exercise. Open-ended projects, unclear time lines and lack of clear, measurable objectives will take a serious toll on a network's credibility. Every project should have a definite beginning, middle and end.

When an ongoing problem faces a group, people tend to create a project designed to improve performance, or decrease cost or lost time. Although these goals are important, they are too vague. Therefore, they create a never-ending process.

Moreover, although the work of the network may be successful, no end is in sight. It is better to set well-defined goals, such as a 10% improvement, a \$10,000 cost reduction or a 5% decrease in lost time. Some method of measuring the network's success must be specified.

It is equally important to establish a time frame. Do so by communicating that the goal will be reached within a certain period of time. Always set a time frame, and make sure that it is reasonable.

A FEN is not a leftover project

Just as a FEN is not a social club, neither is it a leftover project. Once the project is complete, the group must assess its continued viability. A network is not a goal in and of itself, and meeting endlessly to maintain its existence is a waste of time.

As new projects are defined, the membership of the network may change. New FENs will be created out of existing net-

works, and some will disband. If this is not occurring, chances are the FEN has lost its sense of direction, its purpose or its reason for existence.

To avoid these problems, it is essential to reassess the FEN periodically (at least every six months). The following questions should be asked:

1. *How is the project progressing?*
 - Are the appropriate people working on it?
 - Is the time frame realistic?
 - Is the project bogged down?
 - What problems have occurred?
 - Are additional resources needed?
 - Is headway being made?
2. *Is the network's continued existence worth the effort?*
 - What has been accomplished in the past six months?
 - Is it worth the time and effort?
 - What does it take to make it worth the time and effort?
 - What happens next?

The future of your FEN

Participation in a FEN can be a valuable resource for you and your station. It can also be a waste of time. The difference is *you*. A successful FEN does not happen by accident. It is the result of careful planning and ongoing network maintenance. Every member of the group is responsible for both. If you decide to develop, participate in or maintain a FEN, be sure to do the following:

- Choose the members of your network well.
- Be prepared to give and get.
- Define your common problems realistically.
- Do not allow any member to be victimized.
- Define your goals.
- Evaluate your progress.
- Re-examine the membership.

The effective use of a network is a valuable tool in working smarter. It also can help you leverage your resources, solve problems, control change, obtain knowledge and training, stretch your budget and provide a helping hand when you need it most.

Perkinson is a senior member of The Calumet Group, Inc., Hammond, IN.

A GLOBAL FORCE IN BROADCAST TRANSMISSION TECHNOLOGY

TTC has served the Television and Radio Community for 25 years, designing and building television and radio transmitters and translators that have become industry standards.

Thousands of TTC systems are delivering unparalleled

performance and reliability across six continents. Our products have earned their place as the preferred choice of broadcast engineers and managers around the world.

If you too, want technically superior equipment, built to suit your exact needs, call TTC today.

A Global Force In Broadcast Transmission Technology



TELEVISION TECHNOLOGY CORPORATION
650 S. Taylor Ave. Louisville, CO 80027 (303) 665-8000

Circle (9) on Reply Card

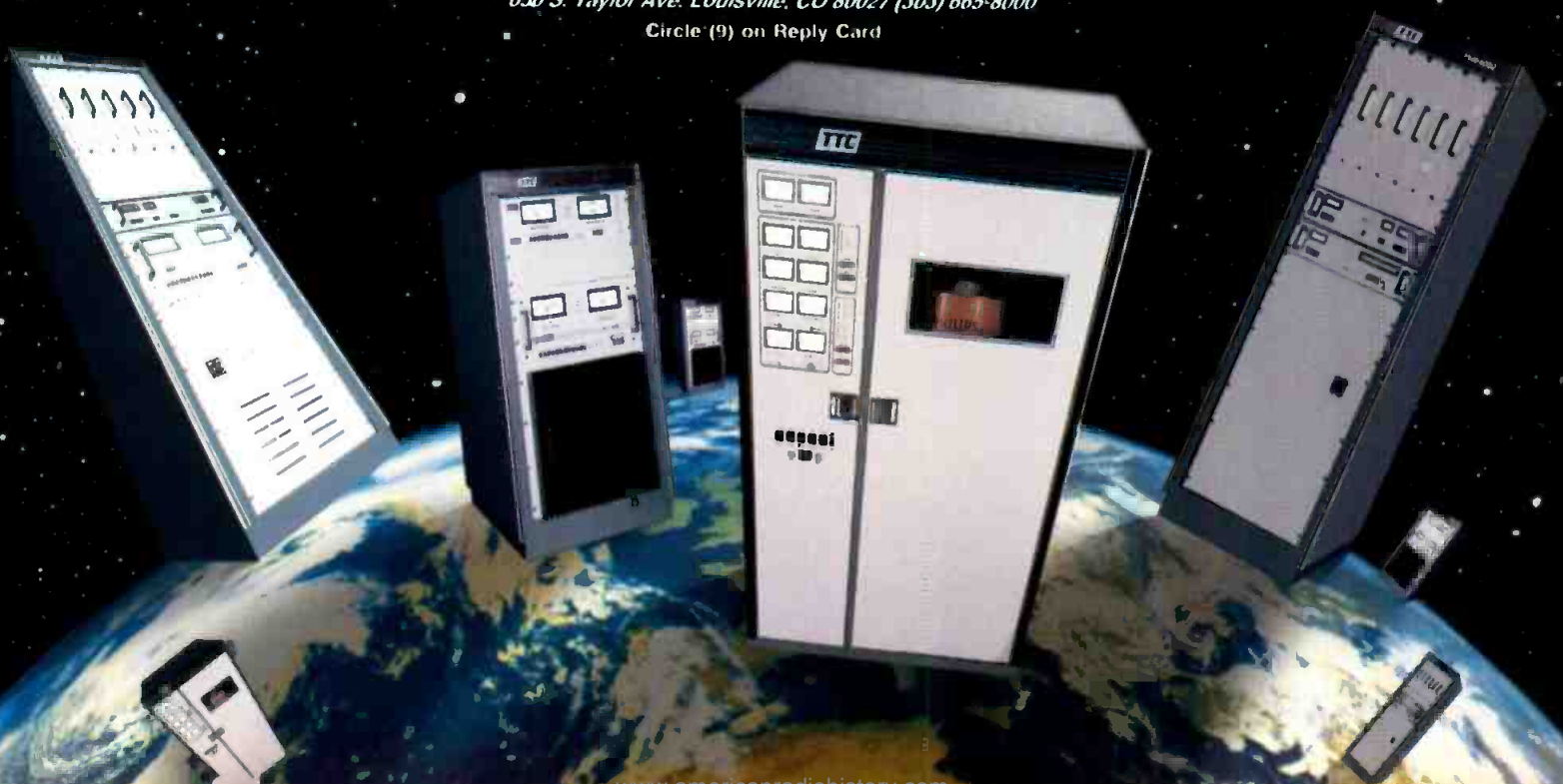

Circuits

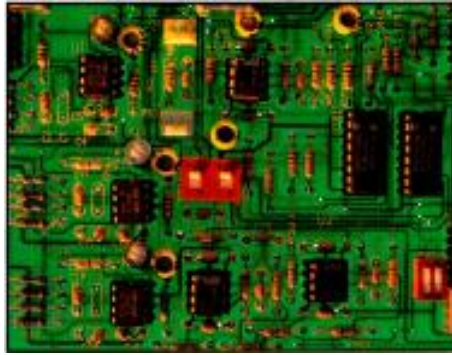

Looking into CCDs

Inside CCDs

By Gerry Kaufhold II

Last month's column introduced charge-coupled devices (CCDs) and discussed their use as image-sensing devices for broadcast cameras. This month, we will look at what goes on inside an individual CCD cell.

Semiconductor physics and CCDs

CCDs are a unique type of semiconductor device. They were originally developed in 1970 in the process of searching for new memory technologies.

Figure 1 shows the basic structural elements of a CCD cell. A metallic electrode is deposited onto a silicon dioxide substrate. Silicon dioxide is pure glass, which is an excellent insulator. Underneath the silicon dioxide is a layer of p-type semiconductor material. This contains positive and negative charge carriers that can be moved by applying an electrical potential to the electrode.

When a positive voltage is present, it attracts negative charge carriers (electrons) to the underside of the silicon dioxide. This collection of minority charge carriers is called a *potential well*. This nomenclature comes from the way the minority carriers collect near the underside of the silicon dioxide. They displace positive charge carriers, creating what appears to be a dugout or well of negative potential. The number of negative charge carriers (depth of the well) is proportional to the strength of the positive voltage on the electrode.

CCDs as microcapacitors

Each CCD cell acts as a low-leakage capacitor. Its low loss means it can store extremely small signals. This makes CCDs useful for image pickup. They have the ability to collect and store the tiny, arbitrary voltage created by each photodiode in the array.

A similar technology — using semiconductor elements as capacitors — is used in dynamic random-access memories (DRAMs). However, DRAM storage cells leak much more than CCD cells. This makes them usable only for storing binary

(1 or 0) signals. They leak too much to store true analog information.

Charge shifting

The contents of each cell represent the voltage created by the photodiode. The output of each photodiode is dependent on the amount of light that strikes it. The amount of light is a function of the scene that is before the lens. So how can you transfer the X/Y array of stored voltages and preserve the image?

bucket brigade fashion. In a sense, CCD chips provide their own scanning circuitry.

The last cell outputs its stored value to the output circuit of the CCD array. Cycling through all of the cells will output all of the stored analog values and discharge all cells. With the CCD capacitors back at their ground potential, they are ready to take in a new analog voltage value. This takes place when the camera's shutter re-opens and re-exposes photodiodes.

This self-erasing characteristic is another

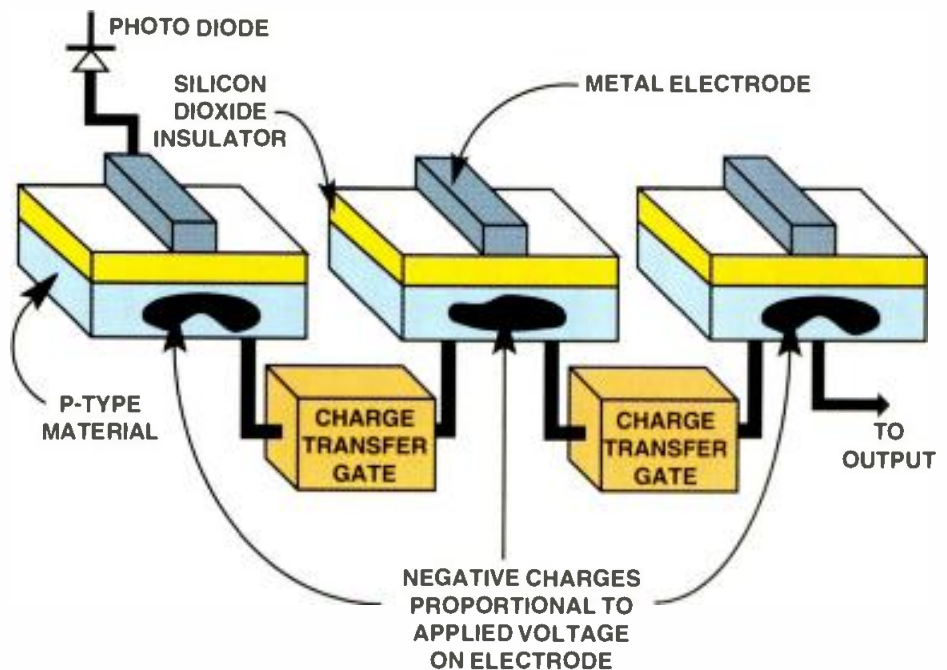

Figure 1. A CCD consists of a metal electrode that conducts the voltage generated by the photosensitive device, a layer of silicon dioxide (an insulator) and p-type semiconductor material. Charges can move from cell to cell, bucket brigade fashion, via the charge transfer gates.

This is the magic of the CCD. It can transfer voltage from cell to cell without loss. This process, called *charge coupling*, is the phenomenon from which these devices get their name.

When the transfer gate of a CCD image sensor is activated, the CCD's clocking circuitry moves the contents of each picture cell to the adjacent cell. When the transfer gate is deactivated, the negative charge carriers remain in place. Clocking the shift registers in this manner transfers the light input value of each cell to the output in

reason CCD sensors are such successful video imagers. Tube-type video cameras require complicated circuitry to reset pixels on the image target to black after scanning. CCDs have no such requirement.

Next month, we will finish this series by examining the external connections that provide power, timing and output functions to a CCD device.

Kaufhold is an electronics industry analyst based in Tempe, AZ

PURE EXCITEMENT.



“ It’s louder and cleaner than the 8100A. ”

Bill Ruck, Engineering Manager,
KFOG, San Francisco.

“ This is the most incredible audio processor I have ever heard!! ”

Ronald Sweatte, Engineering Manager,
KUBE, Seattle.

“ Looks like you did it again; what a machine, and the manual is great! ”

George Bisso, Director of
Engineering, KMPS, Seattle.

OPTIMOD-FM
DIGITAL

“ Sounds so good that the jocks thought they were monitoring program. ”

Chip Morgan,
Chip Morgan Broadcast Engineering.

“ There are 8200 units in WQHT, New York and KPWR, Los Angeles. Both have exceeded our expectations. ”

Terry Grieger, Vice President of Engineering,
Emmis Broadcasting.

“ During evaluation, we had it sounding like we wanted in 10-12 minutes. ”

Jeff Gulick, Chief Engineer,
WNCI, Columbus, Ohio.

Stations around the country are taking advantage of the power, potential and profitability of the OPTIMOD-FM 8200. Don't be the last in your market.

Call your dealer now to hear the power of OPTIMOD—in pure digital.

orban

© 1992 AKG Acoustics, Inc.
Orban and Optimod are registered trademarks of AKG Acoustics, Inc.
AKG is a registered trademark of Akustische u. Kino-Geräte Ges.m.b.H. Austria.

A Division of AKG Acoustics, Inc.
1525 Alvarado Street, San Leandro, CA 94577 USA
Tel: (1) 510/351-3500 Fax: (1) 510/351-0500

Circle (10) on Reply Card

www.americanradiohistory.com

Troubleshooting

Maintaining STLs

System performance testing

By Chris Durso

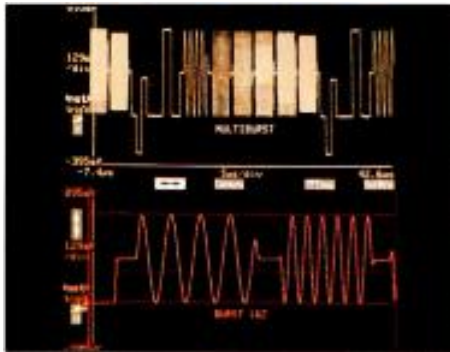

Regular attention to the operating parameters of the STL transmitter and receiver can lead to early fault detection and effective preventive maintenance.

Performance testing of STL transmitter equipment considers three primary operating parameters: power output (in watts or decibel referred to one milliwatt [dBm]), operating frequency and modulation level.

To perform these tests, a wattmeter, RF terminator, frequency counter, RF coupler, DVM and oscilloscope will be required. These tests should be conducted on the bench, because access to the internal sections of the equipment may be required.

Transmitter measurements

Output power is measured with the transmitter on the bench, connected to a 50Ω termination of suitable rating for dissipating the power. It is imperative that the termination is designed for use at the frequency of operation. Inexpensive terminations become highly reactive at frequencies above 500MHz. An improper termination can cause erroneous readings and can damage the transmitter's final output stage.

Use a direct-reading thermally coupled wattmeter and select a "slug" that will result in the desired reading on the upper third of the meter scale. Although these systems require specific calibration for utmost accuracy, this procedure can be waived for such regular performance measurements. For frequencies above 2GHz, a microwave power meter and attenuators are required. A calibrated spectrum analyzer can also be used for power output measurements.

The power output reading should be within the manufacturer's specifications. If it is out of tolerance, further troubleshooting will be required to isolate the problem. Verify power supply voltages and check to make sure all RF connections in the test setup are sound.

Write down the power output reading and a brief description of the test setup in the maintenance log. Later reference to the log should help you detect a PA that is problematic. In transmitters that use par-

allel output transistors, the failure of a device should be readily apparent, because RF output level will have dropped by an amount equal to the contribution of the failed device(s).

Frequency measurements are also made at the bench, but with the addition of an adjustable RF signal sampler or directional coupler. The sampler or coupler is used to channel some of the RF energy into the frequency counter. *Never* connect a transmitter RF output directly to the RF input connector on a frequency counter. The counter is designed to only accept extremely low levels of RF power and could be severely damaged with a direct connection.

Adjustment of STL systems requires proper test equipment and knowledge.

If your transmitter uses a crystal-controlled oscillator, allow a reasonable warm-up period before attempting to make a frequency measurement. Frequency must be maintained within +0.005% (see "FCC Rules," Parts 74.561 and 74.661). If your reading is out of tolerance, carefully adjust the frequency trim as described in the equipment maintenance manual to these specifications.

Modulation level compliance is necessary to prevent interference to adjacent-channel systems, and to minimize distortion in the receiver's demodulator. Proper bench setup of deviation requires the use of a spectrum analyzer and Bessel null techniques. In some cases, it may be possible to set deviation with reference to the receiver IF. At any rate, this setting will not require frequent adjustment.

Use of standard baseband levels (1Vpp for video, 3.5Vpp for composite aural or +4dBm for discrete aural) or reliance on built-in metering will ensure that the transmitter is operating at the proper modulation level. Baseband levels can be observed on an oscilloscope. Overmodulation can cause interference and distortion,

while undermodulation will add noise to the demodulated signal.

If you have a spectrum analyzer, use it to check the transmitter for spurious emissions, second-harmonic output level and carrier deviation.

Receiver measurements

To conduct receiver measurements, a test signal must be generated. In the absence of a calibrated signal generator, the properly adjusted transmitter can be used to set the operating frequency of the receiver. The receiver may be connected to the same sample port used for the frequency counter, or it may be hooked up to the transmitter output through a series of attenuators. Be careful not to exceed the receiver's maximum RF input level, because damage may result.

Using the built-in test meter or a DVM on the appropriate test point, adjust the receiver frequency for the proper indication. In most instances, you will be adjusting for a discriminator reading of 0V in the absence of modulation.

With the signal source connected, observe the RF input signal reading. If you have a calibrated source, the reading should correlate with the generator output level. If a discrepancy is noted, it may be necessary to peak the RF input preselector. Do not attempt to adjust a waveguide channel filter. These must be swept over their bandwidth for proper alignment.

Adjust the receiver's baseband output level to match the level that is being sent through the transmitter. System frequency response should be checked with test signals. Color bars and audio spot frequency tests should be performed on video systems. Similar audio testing can be done on dual-mono aural systems. Composite aural systems require a baseband analyzer or demodulator to carry out adequate testing.

Adjustment of STL systems requires the proper test equipment and the knowledge to apply the correct testing procedures. Without this equipment or knowledge, it is best to return the equipment to the manufacturer for checkout.

Durso is chief engineer at KPBS-FM, San Diego.



AMPEX REDEFINES THE STANDARD IN BETACAM SP.

Introducing new Ampex 398. It's like no other Betacam SP videocassette you've ever seen.

We started with the most demanding design goal—to be the best of the best—and we didn't stop until we reached it.

That's why we engineered a new metal-particle formulation for lower dropout performance and increased durability, specified a new basefilm for improved coating adhesion and

stability, and developed a new backcoat for better handling and reduced wear.

That's why we designed new cassette plastics for precision operation, used new materials for greater reliability, and incorporated over a dozen improvements to the cassette mechanism alone for uncompromising dependability.

And that's why we employ the latest in coating technology, automated

assembly, and statistical process control to ensure consistent performance cassette after cassette.

In fact, from its package to its performance, new Ampex 398 doesn't just meet the Betacam SP standard, it sets an entirely new one. And that's the most exacting standard of all: yours.

AMPEX

Technology News

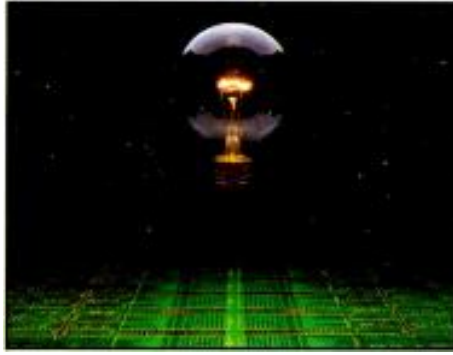

Upping the b/s

By Carl Bentz, special projects editor

If everyone had a choice, today's demand for data transmission would easily overwhelm current transmission technology. Some suggest an impasse has already been reached. The problem has one faction scurrying to find the steps and algorithms to significantly compress the data. (See "Data Rate Reduction Technologies," and "Digital Audio Data Compression," February 1992.) Another faction seeks new media to transport higher bit rates. Keep in mind that, today, data involves audio and video as well as the standard connotation of the computer world.

Keep in mind that, today, data involves audio and video as well as the standard connotation of the computer world.

The future of advanced television, video phones, interactive video and other "communications" services is clouded somewhat by the matter of data rates. NTSC, sampled as analog RGB components, requires a data rate of approximately 201.6Mbit/s without special processing. A large part of the problem is the bandwidth required to support that rate. With-

out a complete reallocation of the RF spectrum, over-the-air transmission becomes impractical. Copper and optical media, as we know them today, present too much attenuation for transmission over realistic, useful distances.

A possible solution

Help beyond a theoretical level is on the way. In fact, demonstrations have pushed data transmissions to 32Gbits/s. To achieve this feat, AT&T Bell Laboratories employed solitrons through dispersion-shifted fiber. Unlike most fiber-optic transmission systems, the soliton is a type of light pulse that keeps its shape as it travels through the fiber medium. (See Figure 1.) The 1,550nm source is a mode-locked external cavity laser, a device that is still in the development stage.

The dispersion-shifted fiber exhibits a varying index of refraction through the diameter of the fiber. In one type of material, the index decreases linearly outward from the center of the fiber core. In the cladding layer, the index remains constant for part of the thickness, but increases significantly toward the outer surface. This material is now commercially available. A second fiber material uses pure silica without germanium doping. The signal strength is higher, permitting distances as much as 10% longer between repeater or amplifier units.

The secret of the soliton is its ability to

maintain its shape as it moves along the cable. This characteristic results from its generation at a high optical power level and from the non-dispersive behavior in the confines of the fiber. An interrelationship between the pulse and the fiber causes the high power level to compress the pulse relative to the dispersion.

The secret of the soliton is its ability to maintain its shape as it moves along the cable.

A question of storage

Even higher data rates are expected as the development of components continues. However, there is a point of contention to consider. Is high-speed data transmission without appropriate storage media at both ends of value other than as an intellectual curiosity? Consider the somewhat dismal performance of the PC hard disk to CPU — a 16Mbit/s transfer rate, assuming everything operates optimally. CD-ROM exhibits a rate nearly 10 times slower.

On a brighter note, an optical system using photonics, the motion of electrons between quantum energy levels, as the storage mechanism has promise of a transfer rate exceeding 120Mbit/s from a 5¹/₂-inch optical disc with a 14Gbyte capacity. (See "Technology News," December 1991.) Multilevel digital recording could push that rate even higher.

Obviously, the storage capacity and transfer rate will continue to be problematic, but only for the immediate future.

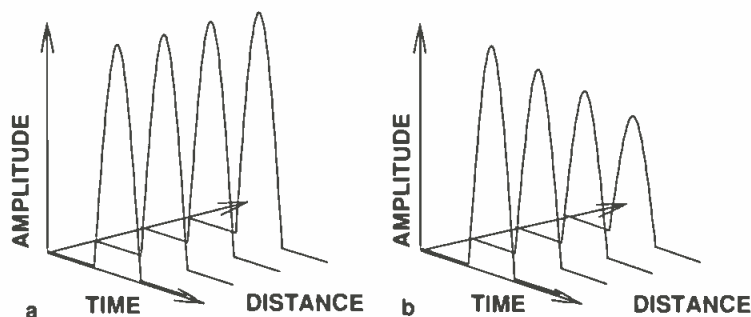

Figure 1. Soliton pulses (a) retain their shape over much longer distances, a result of the compression caused by a high level drive and fiber attenuation characteristics. In (b), with standard fiber, attenuation reduces the amplitude and changes the shape of the pulse.

Editor's note: Background information for this article was taken from "New Components Drive Optical Systems Faster and Closer to Home," *LIGHTWAVE*, December 1991. ■

New!

- **1992** Full serial CCU interface. ● 100% redundant networking control system. ● Production switcher interface for AutoCam operation by TD. ● MCB-3 vector solving Heads-Up North local manual control.
- **1991** AutoCam ACP-8000S, 486/33 controller upgrade. ● Real-time, enhanced VGA graphics. ● Collision avoidance and studio set mapping. ● Enhanced VGA graphics. ● Multiple screen files for quick transition for back-to-back shows. ● EMMY Award.
- **1990** AutoCam Full-Motion control editing. ● ACP-8000 on-screen air tally. ● Powerful single screen operation. ● MCB-1 local manual control box. ● Battery Pack option for SP-200X-Y.
- **1989** AutoCam SP-200X-Y. The world's first "free-roaming," full-motion X-Y base. ● AutoCam Full-Motion control editing. ● ACP-8000 on-screen air tally. ● Real-time CCU control. ● MCB-1 local manual control box. ● Battery Pack option for SP-200X-Y. ● ROP Remote Operating Panel.
- **1988** AutoCam SportsFocuser automatic focusing system. ● AutoCam SP-200 Servo Pedestal for HS-110P and HS-105P. ● Patent awarded for SP-200X-Y targeting system. ● Copyright for ACP-8000 touch screen software.
- **1988** AutoCam ACP-8000 touch screen, menu-driven eight camera controller. ● AutoCam SportsFocuser automatic focusing system. ● AutoCam SP-200 Servo Pedestal for HS-110P and HS-105P. ● Patent awarded for SP-200X-Y targeting system. ● Copyright for ACP-8000 touch screen software.
- **1987** AutoCam Newsroom Computer Interface for ACP-8000. ● AutoCam Newsroom Computer Interface for ACP-8000.
- **1986** AutoCam HS-105P ENG/EFP camera pan/tilt head. ● AutoCam HS-105P ENG/EFP camera pan/tilt head.
- **1985** Tandem operation of MultiControllers for four cameras. ● Tandem operation of MultiControllers for four cameras.
- **1984** AutoCam HS-110P studio camera pan/tilt head. ● AutoCam HS-110P studio camera pan/tilt head. ● MultiController full-motion control system for the future family of AutoCam camera automation products. (The launching platform for the future family of AutoCam camera automation products.)

The promises we've kept weren't made in the dark.

You had the foresight and experience. You encouraged us to make a commitment. And today, thanks to you, AutoCam is performing with "honors" at television stations...from the 1st to the 81st TV markets...and approaching 100 station installations...all within six short years. And the really good news is...

AutoCam starts earning its way the first day on-air (the average return on investment for a typical three camera studio system is less than twelve months). The average "from box to on-air time" is less than three days and AutoCam performs every day with a reliability record approaching spectacular.

And it gets better every day.



Get "On target"  with AutoCam. Call to arrange a demo for your station.

TOTAL SPECTRUM MANUFACTURING, INC.
709 Executive Blvd., Valley Cottage, NY 10989 • 914-268-0100 • FAX 914-268-0113

Circle (12) on Reply Card

SBE Update



Membership recruitment drive

By Jerry Whitaker

The largest membership recruitment drive for the SBE took place at the beginning of last month. The society is now challenged with the opportunity to introduce its benefits to prospective members and share with them the importance of being a part of the organization.

The SBE member who signs up the most new members will receive round trip coach airfare for one and paid registration, which will include the Ennes workshops, to the 1993 SBE Convention in Miami. The second place winner will receive an SBE jacket. The third place winner will receive an SBE hat and golf shirt from the SBE Company Store.

There are three simple rules to follow:

1. The contest started May 1, and will continue through Oct. 2. All applications must be postmarked by midnight Oct. 2. Make sure your name is attached to or written on the application in order to receive credit for sponsoring the applicant. All applications are to be mailed to the national office at 8445 Keystone Crossing, Suite 140, Indianapolis, IN 46240.
2. Credit will be given to members for applicants signed up who are not listed on the current SBE membership roster. This also applies to those who may have been members in the past, but whose membership is presently listed as "expired." No contest credit will be given for renewals of present members.
3. In the event of a tie, the winner in each category will be selected by a drawing held at the national office.

Running tabulations of those in the lead positions will be updated on CompuServe and in the SBE newsletter.

Richard Farquhar, SBE president, will present a plaque to the top recruiter during the banquet at the 1992 SBE convention in San Jose, CA. The winner will be featured, with photo, in a later edition of the newsletter. Special recognition will also be given to the second and third place

winners at the banquet and in the newsletter.

Application forms are available through the national office or through your local chapter chair or secretary.

Sustaining membership

As broadcast professionals, our job is to provide the working hardware necessary to produce and transmit radio and TV signals. Some of us install and repair the equipment, others design and manufacture the equipment. The SBE can be important to all of us, and we can each serve a role in the society.

The healthier the support, the healthier our profession becomes.

The sustaining members dues are \$500, which is much higher than other members, but the dues are critical in order to keep the society functioning. Most of the sustaining members also purchase booth space at the national convention, provide programs for chapters and offer additional support to the society.

In return, the organization offers exposure of their products and services, reduced advertising rates and discounts on use of the SBE mailing list. A list of the sustaining members has been run in the SBE newsletter. Supporting the sustaining members makes sense because they support the working broadcast engineer.

Likewise, it makes sense to be a sustaining member. Supporting the society supports the educational, communication and regulatory agenda of the SBE, which is designed to make the broadcast engineering occupation an informed and progressive profession.

The number of prospective sustaining members is quite large. We have the opportunity to assist manufacturers and other companies, and help the society at the same time. The healthier the support, the healthier our profession becomes.

The sustaining membership committee is the group charged with marketing the SBE to sustaining members, and improving the services for this important part of our industry. Contact Fred Baumgartner, chairman of the sustaining membership committee, or the national office for more information.

Ennes Foundation

From time to time, SBE members have questions about the Ennes Educational Foundation and its history. Here is a brief sketch of how the organization came to be.

The Ennes Foundation was incorporated in 1986 in memory of Harold E. Ennes. He was the author of many textbooks for broadcast and broadcast-related communications training.

He was a member of the national certification committee and made many contributions to the early development of the certification program. After his death, the Indianapolis chapter set up a scholarship in his honor.

A small group of officers and past presidents of the society expanded the scholarship program to include other SBE educational activities and the certification program. Chris Imlay, SBE attorney, developed the idea and incorporated the foundation along with the original group.

The foundation administers the SBE certification program, technical workshops and other educational activities of the SBE, including the awarding of Ennes scholarships to students in the broadcast and related technical fields.

Some of the goals of the foundation are to encourage the entry of minorities and women into broadcast technical fields, evaluation of technical training courses, and liaison with similar international organizations to develop and enhance common technical training courses.

For more information on the Ennes Foundation, contact the SBE office.

Whitaker, a technical writer based in Beaverton, OR, is vice president of the Society of Broadcast Engineers.

Introducing Datatek's D-2700DVS Serial Digital Video Routing Switcher

400 Mbits/s Performance

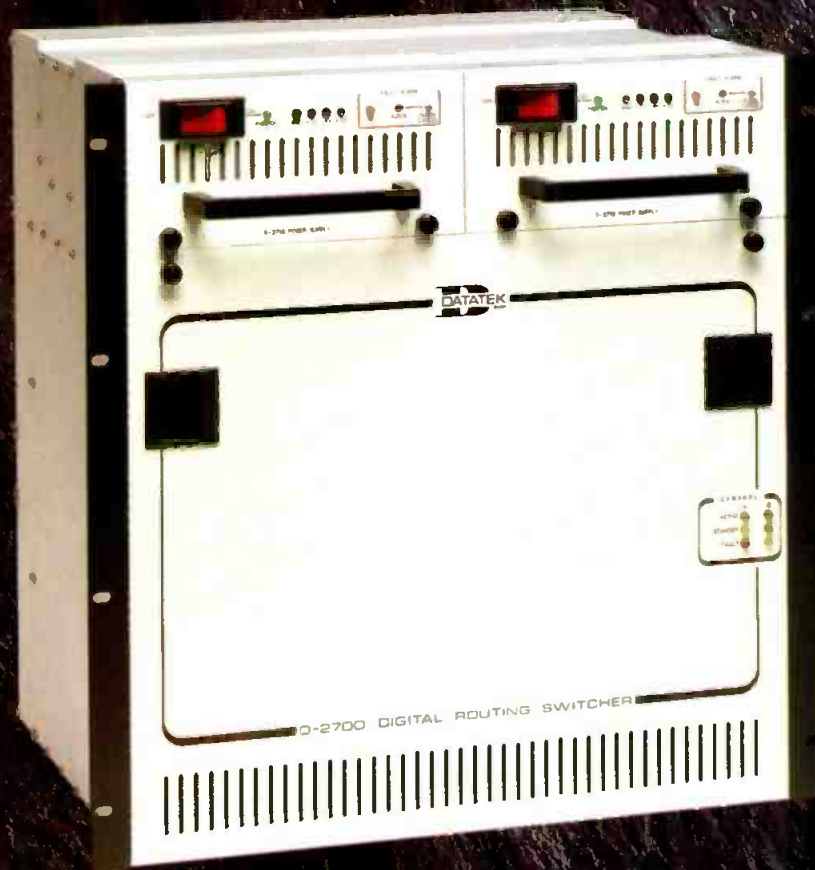

- Multiple Data Standards to 400 Mbits/s for D-1, D-2 and EDTV – an investment in the D-2700DVS protects against future obsolescence due to technological advances

- Basic 64x64 matrix frame includes facilities for direct field expansion to 256x256 and larger. Basic matrix may be populated initially in 16x16 increments, and expanded to meet growing system requirements

- Compact – 128x128 in one equipment rack

- Comprehensive control facilities -- coaxial cable, RS-232C/422, computer, eight independent control levels, high speed update, salvo, complete matrix salvo, virtual matrix mapping, status retention, etc.

- Interfaces to other Datatek routing switchers:

- Digital Audio, AES/EBU
- Digital Video, 400 Mbits/sec, 20x10 and 20x20, Expandable
- Analog Video, 40MHz and 100MHz
- Stereo Audio
- Time Code
- RS-422
- Passive Relay

- Full line of customer reprogrammable control panels

- Designed and manufactured in the U.S.A.

For more information, call.

D
DATATEK
CORP.

1121 BRISTOL ROAD, MOUNTAINSIDE, NEW JERSEY 07092
PHONE: 908-654-8100 ● TOLL FREE: 800-882-9100 ● FAX: 908-232-6381

Circle (43) on Reply Card

NAB '92 perspective

An upbeat mood on the floor couldn't hide the worries about the cost of HDTV.





The official song of Kansas, "Home on the Range," contains a phrase that aptly depicted the mood of the 1992 NAB Convention floor, "Where never is heard, a discouraging word..." That phrase reflected the feelings of vendors and attendees at this year's show.

Everyone seemed happy with the tone and results of the convention. Vendor after vendor talked of making sales, moving products and, in general, having a good show. In talking with more than a hundred exhibitors and company officials, not one had negative comments about his or her company's show results. Everyone appeared pleased with the overall upbeat nature of this event.

Further confirmation on the optimistic nature of the show came from NAB attendance figures. The association announced that a record 52,704 attendees registered for the event. Although total registration was up only 3%, international registration, according to NAB officials, was up by a healthy 20%. The growth in international attendance underscores the importance placed on the show by non-U.S. buyers.

What's new?

According to *BE's* "Show of Shows" records, more new products were introduced at the 1992 NAB Convention than any time in recent history. A complete wrap-up of all these new products begins on page 50. In case you missed the show or weren't able to visit all the booths you wanted to see, additional information on any of the products listed is available through the Reader Service Card located at the back of this issue.

This year's show contained truly innovative products and improved versions of the old and reliable. One technological aspect

that continues to grow is the digital nature of the hardware. If your favorite device isn't already available in a digital version, it may be soon. Today, even transmitters aren't immune from digital implementation.

HDTV: The clock is ticking

The big issue for TV broadcasters continues to be HDTV. Although meetings and public demonstrations on HDTV abounded, broadcasters en masse were grumbling with the action taken by the FCC at its April 9 meeting.

Under the proposal, which is out for comments, broadcasters would have five years, beginning in 1993, to apply for and build an HDTV station. Broadcasters would be given first shot at the new HDTV channels, but only for two years. After the initial 5-year license application and construction ends, phase two begins. During this 4-year period, the station could program the HDTV channel separately from the NTSC channel. This would allow a station to retain its NTSC audience, while enticing those with HD sets to tune to the higher-quality picture.

At the end of this 4-year period, the programming on the HDTV and NTSC channels would have to be the same. Finally, in 2008, broadcasters would have to turn in their conventional channels and broadcast solely in HDTV.

If the commission's proposal is approved without modification, broadcasters are faced with serious financial and technical issues and little time to resolve them. Stations could choose to embrace HDTV, but at the cost of millions of dollars. Or, a station could risk its entire future by staying with NTSC, hoping that something changes along the way. Convention atten-

dees saw little good in the FCC's announcement.

The real issue isn't picture quality

It's obvious that station managers don't see HDTV as a road to higher profits. Initially, HDTV will be implemented the same as color, via network-delivered programming. Only later, as the technology becomes widely implemented and less expensive, will local stations begin purchasing the equipment needed to produce HD programming. Therein lies the major rub as far as station owners are concerned. Why spend perhaps millions of dollars on new equipment if it won't result in additional revenue?

The real force behind the implementation of HDTV technology is the receiver manufacturers. They want HDTV and they want it bad. However, because of the strong objections being raised by broadcasters about the cost and no certain return on their investment, a new tact was evident at this year's show.

Broadcasters are now being told that digital television (what they mean is HDTV) will usher in an era of new digital services. Stations will be able to transmit, and most important, charge for data services. This could conceivably allow a station to become a point-to-multipoint transmission system. A TV station would lease its data transmission capacity. The result would be instant revenue to help offset the cost of implementing HDTV.

Others are suggesting that with the advances in compression technology, stations will be able to provide new digital services in addition to the HDTV transmission. Some have predicted that the new compression technologies will allow

OVER 3000 WORLD WIDE

With over 35 years experience manufacturing quality FM and TV antennas, **JAMPRO** is the leader in broadcast antenna technology.

With more than 3,000 systems delivered **JAMPRO** has helped more stations truly penetrate their markets.

- Complete line of FM & TV broadcast antennas
- RF components, Filters & Combiners
- Modern 7000 ft FULL SCALE test range
- Directional antennas and pattern studies.

**FOR DETAILS
CALL**

(916) 383-1177

Fax (916) 383-1182



6939 Power Inn Road
Sacramento, CA 95828

Circle (13) on Reply Card

broadcasters to transmit up to five separate signals in an allocated channel. The additional transmission services would equate to new potential revenue streams. However, no one is yet suggesting that a station could transmit HDTV while simultaneously transmitting additional high-quality video images. The pipe is still only so big.

What stations clearly want is the ability to provide new, as opposed to enhanced, services. That brings us back to the original point. The issue isn't about picture quality, it's about additional revenue.

What about improved NTSC?

Why not consider an interim, improved NTSC image? Despite the advantages of *not* forcing an HDTV system on the American public and broadcasters, few now seem willing to propose such a plan.

Start-up costs would be lower for transmission and reception systems. In addition, more time could be allowed for development of a real high-definition transmission system. It does not take a rocket scientist to recognize that a 1,000-line image is not equal to film, and anything less is still just another step toward the film-like quality that is talked about.

Attendees also worried about the cost of the hardware required for a full-blown HDTV transmission. Knowing that they might have to make HDTV hardware purchases within a short time frame, manufacturers could try to keep prices artificially high. Such an approach could create not only hardships, but also strong resentment in many sectors. Improved NTSC transmission has none of these drawbacks.

There are many good reasons to consider an improved NTSC system. However, that may not be possible, given the runaway truck called HDTV that is about to flatten broadcasters and viewers alike.

Even so, not all broadcasters fear the future. Fox Broadcasting announced at the show that a contract with Harris/Allied had been signed for the purchase of HDTV equipment. The contract calls for the installation of HD transmission equipment at Fox's New York, Los Angeles and Washington, DC, TV stations, once a standard is adopted. Other cities to receive the equipment include Chicago, Houston, Dallas and Salt Lake City.

A technology looking for an application

After spending five days at the show, I was still not convinced that either broadcasters or the American public want HDTV. Oh sure, there were plenty of HDTV proponents in the Hilton exhibit hall. But if you looked closely, they were not traditional broadcast equipment manufacturers. And they weren't American public interest groups promoting the advantages of HDTV. The big promoters in

the Hilton exhibit area had their minds on one goal — selling TV receivers.

The main ones who have everything to gain from the implementation of HDTV and who are promoting the technology are the TV set manufacturers. There is little evidence that broadcasters stand to gain anything from transmitting HD. In fact, session speakers openly spoke of broadcasters being forced to implement HD merely to survive — not to succeed.

Also, don't be deceived into thinking there is a huge pent up demand to go out and buy HDTV receivers, because there isn't. Seminars at the convention showed research that goes a long way toward supporting the position that the American public doesn't see a worthwhile difference in HDTV images.

An MIT study, using 18-inch and 28-inch NTSC and HD monitors, showed that although 62% of the subjects preferred the HD image, 31% still preferred the NTSC image. Even the 2-to-1 ratio in results belies a more important issue. Will viewers be willing to pay for the improved images?

This same study showed that only 6% of the respondents said they would pay \$500 more for the HDTV-quality receiver. A little more than 50% said they'd pay \$100 more, but the remaining 37% said they would *not* pay more for an HDTV receiver. So much for this huge demand for HD we've been hearing about.

Given the current estimate of \$3,000 for an HDTV receiver, the \$500 price difference used in the survey was bogus. Try telling viewers that their new set is going to cost *five times more than an NTSC box* and see how important HDTV is to them. I suspect they'll tell you where to put your HDTV technology.

What we have are people who make their living by building TV sets, and they want to make a better living. The way to do that is to sell more TV sets. But without a new gimmick, that's not possible.

Unfortunately, somewhere in the process, the needs of broadcasters and American TV viewers have been forgotten. Broadcasters want new services that can be sold to generate additional revenue, not a technological albatross that may bankrupt them. American TV viewers just want a good (not necessarily a 1,000-plus lines) video image at a low price.

It reminds me of the adage, "You can lead a horse to water, but you can't make him drink." What these set manufacturers need to remember is that they may be able to entice viewers to the dealer's showroom with bigger pictures, but getting consumers to fork out \$3,000 for a TV set may be much more difficult.

Brad Dick

**Brad Dick,
editor**

SATELLITE SOLUTIONS



THEY COME IN ALL SHAPES AND SIZES

And who's the creator of all these shapes and sizes for the last 15 years, worldwide? Harris Allied.

From news gathering and network programming to teleconferencing and business, government and emergency communications, we have your solution.

We offer you the high performance of KU or C-Band systems in analog or digital. And we can design this solution in the shape of a simple flyaway uplink to the size of a redundant network quality uplink.

To make a 15 year old story short, just remember Harris Allied... Satellite Solutions.

 **HARRIS
ALLIED**
SYSTEMS
Television and Satellite Systems: (606) 572-6880

Circle (14) on Reply Card

Lost two miles down beneath dark, frigid seas, the Titanic has been buried from human sight for over 80 years.

But after a joint expedition from the U.S., Canada and Russia last summer, the secrets of the Titanic are no longer submerged.

After using over 300 Sony Betacam SP video cassettes to capture more than 155 hours of footage beneath the North Atlantic seas, a video documentary has shed new light on events of that ill-fated night.

The entire six week outing was preserved on Sony Betacam SP tape by Al Giddings, the renowned underwater photographer and director/producer of the research mission.



New Sony BCT-MA Series Betacam SP Videocassette

Just to reach the ship, tiny subs had to undergo a three hour freefall. And now living on Sony Betacam SP videotapes are haunting images of a huge hulk frozen in the curl of a 50 foot mud wave, with a gaping hole under the bridge.

“The results have been nothing but phenomenal,” said Giddings. “In the course of seven dives to the Titanic, we

did not see a single dropout on tape. The imagery we captured was clear, bright and dramatic. I’ve tried other tapes and had only mixed results. Sony Betacam

SP cassettes will continue to be the tape of choice for all of my future projects.”

It’s adventures like this that help inspire our engineers to pursue ever deeper expeditions into the realm of metal tape technology.

Because for all the strengths that make it the professional’s choice, we felt our Betacam tape could be even stronger.

So now in our new BCT-MA series Betacam SP video cassettes, you’ll find further improvements to ensure optimum tape durability and performance. Plus a greater archival life. All to provide picture quality of startling clarity, and tapes that hold up in virtually any environment.

We never stop refining, because we never stop listening to the people who use our tapes.

So thanks, Al, from the Professional Tape Division of the world’s most innovative recording media manufacturer. By going to such depths, you’ve helped us raise our technology even higher.

SONY

SONY RECORDING MEDIA



**ONLY
ON
SONY
RECORDING MEDIA**

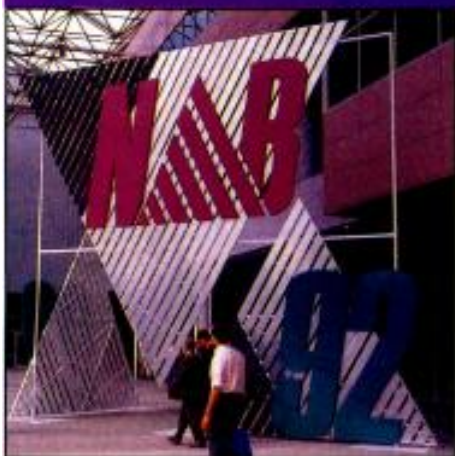

The Pick Hits of NAB '92

By Rick Lehtinen and Skip Pizzi, technical editors

This year's judges picked products with cost and high functionality in mind.

Once again, *BE* presents its annual Pick Hits of NAB. The products that have been selected can act as a barometer of the attitudes of the industry. This year, a conservative mood seems to prevail. The judges uniformly nominated products that promise the highest productivity for the dollar.

In a way this is unfortunate, because it comes at a time when many manufacturers are releasing equipment that significantly advances the state-of-the-art. In another era, these new products would have captivated the judges. However, it is obvious that "bang for the buck" is currently eminently attractive.

For the past eight years, *BE* has selected a panel of independent judges from among our readers. They are contracted to walk the floors of the exhibits with open eyes and open minds to hunt for outstanding video and audio products. Before they leave the show, they compare notes with the other judges to produce their lists of the top 10 Pick Hits for television and radio.

We present the Pick Hits of NAB '92 in alphabetical order:

TV Pick Hits

Accom: RTD 4224 real time disk recorder



This system uses Winchester disk drives to record and play back 10-bit 4:2:2 digital video. The system can instantly access any image on the disk. Playback is available up to $\pm 100\times$ normal speed. The unit provides 32 seconds of record time with a single disk drive. Additional drives can be chained in to increase record time to 30 minutes. The machine records in CCIR 601 parallel digital format. A serial 601 option is available. A dual-channel machine provides multi-user capability. The unit can be controlled from its control panel, RS-422 link or ethernet. Users can configure the second channel to provide either video or a linear key signal. A smooth motion option automatically interpolates intermediate frames, improving slow-motion performance.

Circle (300) on Reply Card

Canare Cable: Coaxial cable stripper



Ever run out of hands when putting a BNC connector on a coaxial cable? This product speeds stripping — usually to under 15 seconds. It offers several improvements over conventional strippers. Precise cable cutting is important because it assures a good physical and impedance match between cable and conductor. Most strippers are designed to prepare cables for a specific brand of connector. This tool

has three unique features. First, the cutter's three hardened steel blades are circular. This makes the cuts extremely clean and keeps the cutting surfaces fresh. Second, a side-mounted blade slits the jacket as the cable is withdrawn. This speeds cable assembly. Finally, the cutter gently twists the stranded center conductors of flexible coaxial cables. This eases insertion into the BNC connectors.

Circle (301) on Reply Card

Echolab: PC-3 PC card switcher

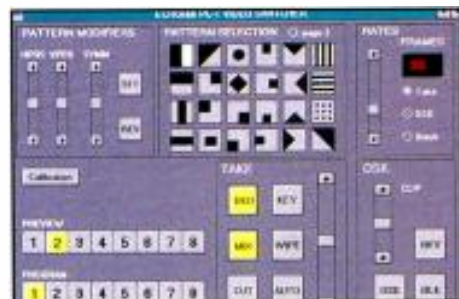

Evidence of the PC/video merger abounded at NAB this year. One product that caught a judge's eye was the PC-3, a broadcast-quality video switcher on an IBM card. Operating under Windows, the switcher can combine three composite video sources and two key sources. An on-board Z-180 processor controls all the switcher operations. This prevents the unit from monopolizing the PC's CPU. The PC-3 runs on a 286 or 386 PC, under Windows 3.0. An optional RS-422 serial interface handles SMPTE standard edit control functions. Interface is via a standard 9-pin D-type connector that uses standard Grass Valley protocol. Alternatively, PC-based editing systems may control the switcher using a special bus-to-bus protocol.

Circle (302) on Reply Card

How to make certain the news always comes from a reliable source.

Sony Business and Professional Group, 3 Paradise Drive, Manville, NJ 07045-1235. © 1992 Sony Corporation of America. Sony is a trademark of Sony. Actual size.

They say you can't believe everything you hear. But when you're listening to a Sony lavalier microphone, they're wrong. Sony lavaliers offer exceptional reliability. And we have a full line to suit every application — from sound reinforcement to TV Broadcast. For the complete story, call the Professional Audio Group at 1-800-635-SONY, ext. 913.

SONY

John Fluke Manufacturing: Fluke 97 scopemeter



Did you ever wish you could take your trusty waveform monitor on the road with you? Now you can. This product combines a 2-channel, 50MHz digital storage oscilloscope with a digital multimeter. The result is a rugged, hand-held troubleshooting tool suitable for the test bench and outdoor remote broadcast environments.

The digital storage scope lets engineers capture waveforms to analyze illusive problems. It can freeze and store transient events, as well as the events leading up to them. Powerful processing in the built-in autoranging digital multimeter enhances the display. For instance, it can display the input waveform while reading out the voltage. A function generator is included. The device can even connect to many computer printers, making printouts of on-screen or stored displays.

Circle (303) on Reply Card

Pioneer Communications of America: VDR-V1000 rewritable videodisk recorder



The judges found the VDR-V1000 videodisk recorder to be an attractive tool for automation and editing. The system uses a Betacam-like time-compressed analog component format for high image quality. The system's 12-inch erasable disks offer 32 minutes of record time. The disks are rewritable and capable of at least a million record and erase cycles. Playback cycles are potentially unlimited because no contact is made with the disk. The video, stereo PCM audio and time-code tracks are individually accessible. The unit can operate either non-linearly, using both heads to seamlessly play back arbitrary disk segments, or it can simultaneously record and play back. The unit's ability to store 57,000 frames also makes it attractive for use as a still-store.

Circle (304) on Reply Card

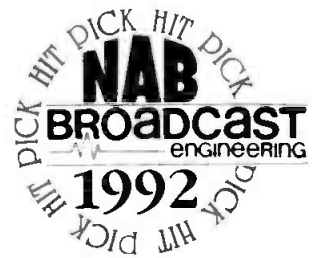

Winsted® Exclusive

TAPESTOR Tape Control System

Simplifies tape filing and retrieval, speeds handling.



Designed for Beta, MII and VHS, this protective case of high impact plastic hooks securely on extruded aluminum rail, keeps tapes organized, instantly accessible. Matching ID code on tape and case for easy identification.

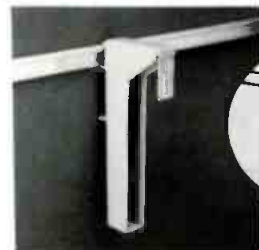

SPECIAL FEATURE!

When tape is removed, hinged ID tab on case flips down to identify missing tape.

Toll-free: 800-447-2257

Call or write for FREE sample

Specify: either Beta or MII, VHS.

THE WINSTED CORPORATION

10901 Hampshire Ave. So. • Minneapolis, MN 55438 • (612) 944-8556
FAX: 612-944-1546

Preferred by Professionals Worldwide

Circle (17) on Reply Card

BUY DIRECT

Cole Wire & Cable

"Your Best Source"

Featuring . . . a multi-million dollar inventory inclusive of virtually all broadcast related wire and cable.

CWC

1-800-323-1403
(BROADCAST DIVISION)

Cole Wire & Cable Co., Inc.
6430 N. Hamlin Ave., Lincolnwood, IL 60645
Fax (708) 673-2243

Circle (18) on Reply Card

There's more than one way to get to digital video.



SONY

For More Detailed Directions To The World Of Sony Digital Video, Get The Book.

You Can Get There From Here.

Whichever path to digital is the right one for you, Sony can show you the way by offering the most extensive, most flexible line of digital video recorders available today. Whether D-1 or D-2 is the appropriate choice, Sony makes it easier for you to get there.

There's no better way to ensure top quality in your video production than by starting with the highest quality recorded image. The best format for video acquisition is still component. So why invest in lesser quality?

Thanks to our newest Betacam SP® recorders with digital inputs and outputs, your current Betacam SP camcorder is all you need to start the digital production process. The BVW-D75 Recorder/Player and the BVW-D265 Player can convert your component analog video signal directly to either component serial digital or composite serial digital, respectively. So no matter where you're headed in the digital world, Sony can take you there.

And, in addition to D-1 component and D-2 composite digital VTRs, Sony offers a complete family of digital switchers, digital routers, digital multi-effects and digital/analog converters. Putting it all together is Sony's remarkable Serial Digital Interface.

So no matter when, where or how you decide to move to digital, Sony is ready to get you there.

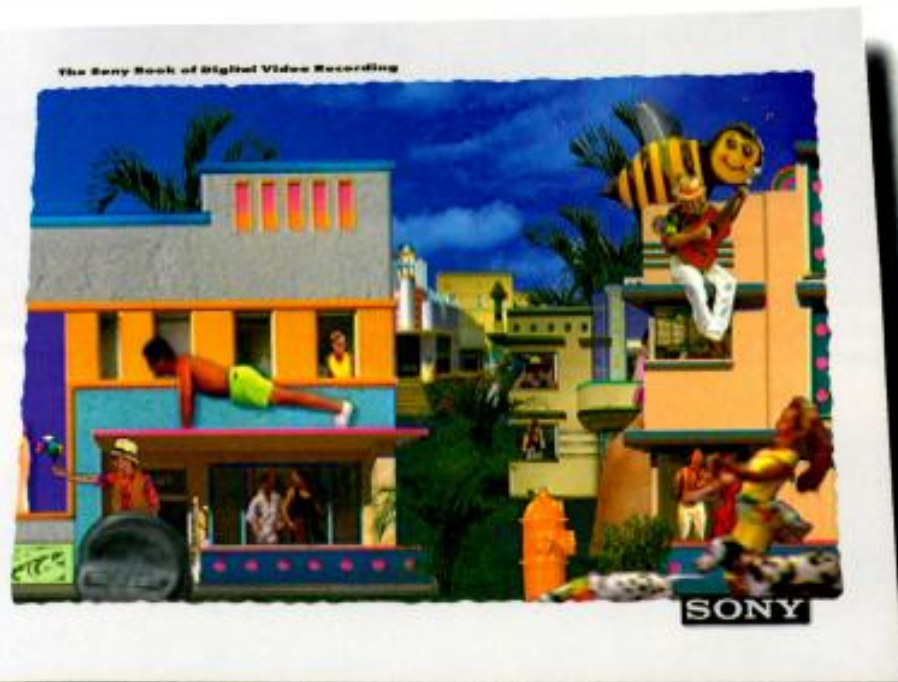

Actual image generated from Sony D-1.

Make The Right Connections.

To make it easier to work in the digital world, Sony developed Serial Digital Interface (SDI).

SDI uses nothing more than a familiar coaxial cable for digital to digital interconnection between composite and/or component devices. It allows for quick, easy and efficient connection. It even allows analog VTRs (such as Betacam SP products with SDI inputs and outputs) to be readily integrated into digital production systems.

SDI sounds simple to use. And it is. It's the product of years of research spearheaded by Sony. The result: wiring, connecting and timing a digital video suite has become simple to achieve.

You've now read just the beginning of the Sony digital video story.

Sony provides just about everything you'll need for the journey into digital. Whether you're just getting started or well on your way to a full digital system, we're on hand to help you go the distance. And only Sony offers such an unparalleled reputation for product quality and reliability plus experience and support.

If you'd like more details, call 1-800-635-SONY, ext. 814. We'll send you the Sony Book of Digital Video Recording.

We think you'll find it compelling reading. And further proof that, on the road to digital, the best companion you can have is Sony.

©1992 Sony Corporation of America.

Sony, Betacam SP and Dynamic Tracking are trademarks of Sony.

Digital frame produced by Forti-Layne Entertainment
in cooperation with Limelight Video

SONY

Sony Business and Professional Group
3 Poragon Drive
Montvale, New Jersey 07645

Quantel: Henry concurrent editing system



Most people are sold on non-linear editing. It combines the ease of film (rearranging material does not require re-recording with the immediacy of video (no lab work is required). This new editing system combines simultaneous multilayer digital compositing with random-access editing. Henry has five channels of digital video effects and color correction, called superlayers. The superlayers and a background layer can be processed simultaneously, giving editors the ability to assemble the equivalent of 42 layers of video and mattes. A unique pen-based editing system speeds the basic processes of cutting, splicing, copying and stretching. The disk-based storage system holds up to five minutes of video. Although Henry is expensive, it provides a complete digital production environment, which increases its cost-effectiveness.

Circle (305) on Reply Card

SoftTouch: CCE/PC closed-caption encoder for PCs and compatibles



Like it or not, stations will soon have to invest in closed-captioning equipment. The judges felt this product is cost-effective. It allows stations to use a simple PC to encode a closed-captioning signal using 7-bit or 8-bit data into the vertical blanking interval of NTSC signals. The CCE/PC produces a standard line 21 waveform that can be decoded by standard telecaption decoders for the hearing impaired. It can also support other applications that encode a datastream on other VBI lines. The judges felt this product would aid them in inexpensively meeting the closed-captioning mandates for U.S. TV stations. The PC need not be elaborate. Older ones that are too slow for other station requirements will suffice.

Circle (306) on Reply Card

Sony: DFS-500 combination video switcher and digital effects unit



The DFS-500 combines a video switcher with a powerful digital multiple effects (DME) unit. The switcher has four inputs, a title keyer, and internal color, color bar and matte generators. An optional DSK is available. The effects portion provides 2-D and 3-D linear and non-linear effects. An optional board provides drop shadows, trails and lighting effects. The unit offers more than 200 effects, including mirror, ripple, flag, melt-down, zigzags, twists and page turns. Effects are recalled by entering their number on a numeric keypad. A snapshot function stores panel setups for instant recall. The unit processes all signals internally in the digital component domain. This makes the DFS-500 an excellent complement to high-performance component analog VTRs, such as Betacam SP.

Circle (307) on Reply Card

Sony: Flexicart multicassette system

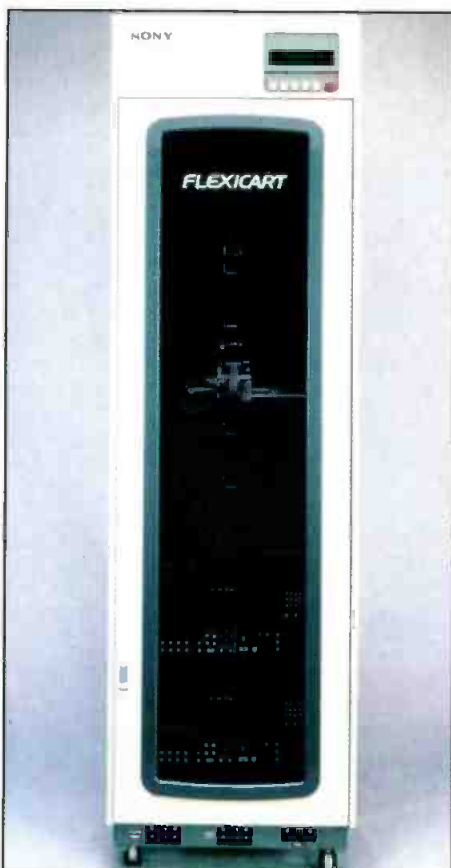

The judges felt this cost-efficient LMS system could provide multiple-cassette capability for the smaller operation. It also can provide a low-cost augmentation to existing LMS systems, say for spot replacement in split feed applications. The system is flexibly configurable. Users select between one and four VTRs to fit their application. The system uses decks of any Sony-supported format, including D-2 and Betacam. The fewer the decks, the more tape bins allowed. Each bin holds two S-sized tapes or one M/L cassette. System control is by the unit's versatile cart controller (VCC) interface. This is accessible by various application drivers, such as an automation system. One possible driver is software running on a PC/AT computer under Windows.

Circle (308) on Reply Card

Tektronix: VM700A Option 21 camera measurement system



The Option 21 camera measurement system for the VM700A video measurement system is a semi-automatic camera measurement package that provides detailed CCD camera measurements in minutes. Option 21 currently offers four measurements — colorimetry, CD defects, fixed pattern noise and frequency response. Future releases will address geometry and registration errors, vertical smear, detail and gamma. Option 21 measures many CCD errors by averaging multiple frames. It compares each pixel to a threshold. If exceeded, it highlights the corresponding point on the display. This quickly detects errors that conventional methods may miss.

It checks colorimetry by examining RGB signals from a camera focused on a Macbeth color checker chart. The VM-700A compares the camera signal with stored color references, then prints out precise variances.

Circle (309) on Reply Card

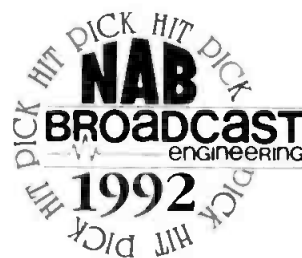

**World
Monitor**
DEMANDS
DOLBY SR

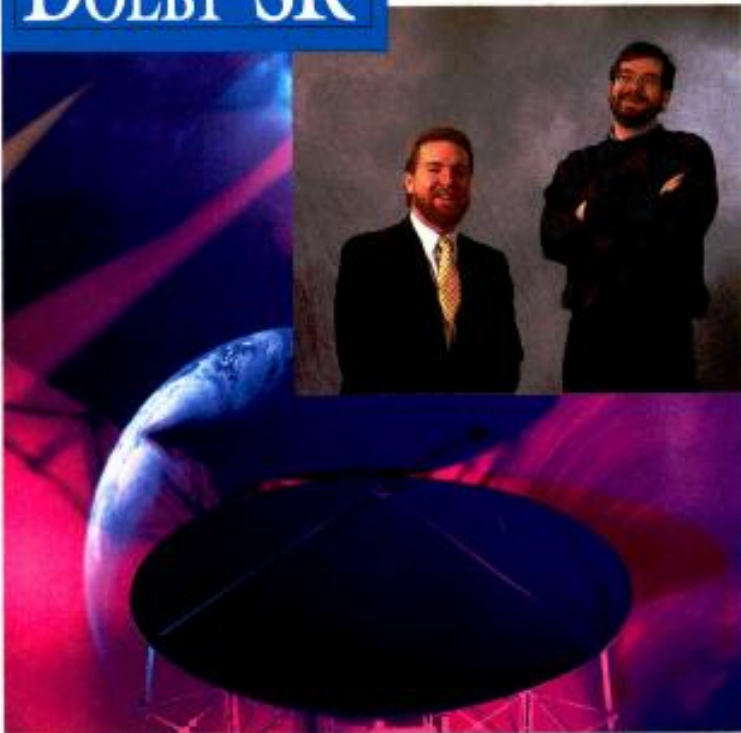

Vincent Maricese, Scott Peterson

Steve Colby and Bill McNamara of World Monitor, Boston

“**With Dolby SR we get the dependable, high-quality audio that fast-breaking news stories deserve.**”

“Our London, Tokyo, and Washington bureaus each have only 10 minutes a day to send us their raw footage and feature stories. That brief window allows no margin for error when it comes to audio quality.

“Before Dolby SR, our transmission headroom was so limited that to avoid clipping, we lowered our send levels and suffered lots of noise. With Dolby SR, we get a dramatic improvement in S/N. Plus, SR’s anti-saturation feature lets us go back to normal send levels without worrying about the high-frequency peaks, such as speech sibilants, that used to crash the feed.

“The line-up of the system was quickly mastered by field editors and transmission engineers alike. Dolby SR is a snap to use.”

*Bill McNamara, Director of Transmission Services
Steve Colby, Senior Audio Engineer*

*World Monitor is a television presentation
of the Christian Science Monitor*



Call us at (415) 558-0200 for more information
on how you can benefit from Dolby SR.

Dolby SR: now 50,000 channels worldwide

Dolby Laboratories Inc. • 100 Potrero Avenue, San Francisco, CA 94103-4813 • Telephone 415 558-0200 • Telex 34409 • Facsimile 415-863-1373
346 Clapham Road, London SW9 9AP • Telephone 071 720-1111 • Telex 919109 • Facsimile 071 720-4118
Dolby and the double D symbol are trademarks of Dolby Laboratories Licensing Corporation. © 1991 Dolby Laboratories 591 9200



Circle (15) on Reply Card



Radio Pick Hits

A.R.T.: Phantom series consoles



The judges were impressed with the cost-effectiveness of these audio mixing consoles. They come in 16-, 24- and 32-input versions, and are intended for recording or high-quality reinforcement use. The two smaller models are rack-mountable. Eight inputs of each unit are line-in only, with all other inputs mic/line switchable (the latter includes insert points and phantom power). Eight dedicated tape return channels are also featured on each model, along with eight auxiliary sends (four pre- and four post-fader) and four subgroup outputs. Three-band EQ, solo/mute functions and clipping indicators are included on each input. Flexible monitoring, metering and talkback functions add versatility for broadcast applications. Reliability is addressed by heavy-duty physical construction and RF shielding.

Circle (310) on Reply Card

Burk Technology: LX-1 stereo selector



This 6-input stereo audio switcher fills many common needs at the radio station in elegant fashion. Its high audio quality makes it suitable for permanent placement in the air chain, where it can select the on-air studio/source, thereby freeing up a master control console or eliminating patching. Switching is silent and lev-

The Digital Video Jack For The Future...

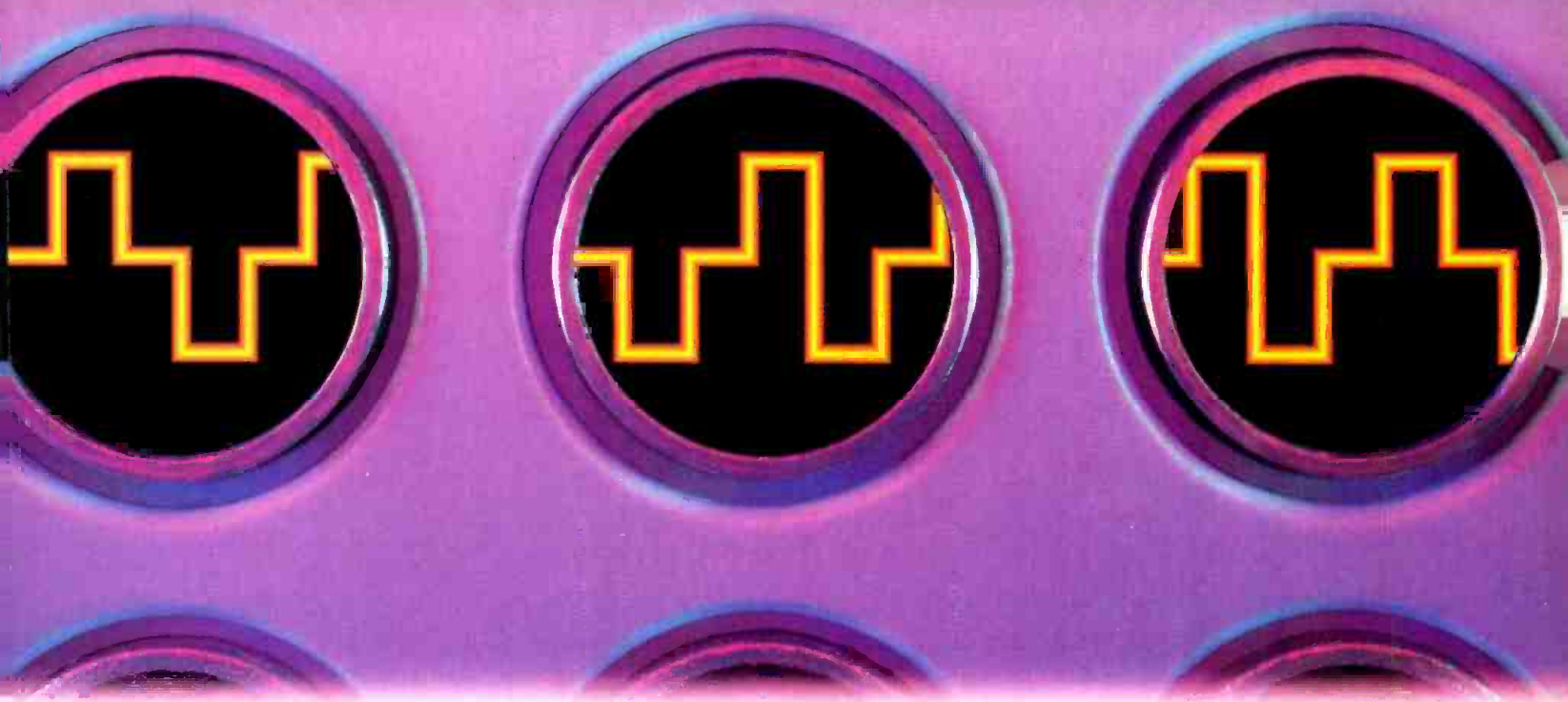

Is The One You Already Have.

As you prepare for advanced high bandwidth applications such as serial D1, D2, D3, HDTV and high resolution computer graphics, one thing is for sure. The ADC SJ2000 Dual Video Jacks you've been using for years are ready to handle any high rate digital application you can throw them. Because the SJ2000 is designed to



provide low return loss and true 75 ohm impedance, it can easily handle high rate digital signals up to 600 MHz.

For more information and the name of your local distributor, call us at 1-800-726-4266.

ADC Telecommunications

4900 West 78th St., Minneapolis, MN 55435

Circle (16) on Reply Card

www.americanradiohistory.com

els stable. IHF or professional levels can be accommodated. The device can be controlled from its front panel or remotely, and it provides tally outputs for remote status indication. Off-premises installation is possible. Any source can be locked out, and two sources can be mixed. A loop function allows a processor to be switched in and out of circuit, and individual start/stop pulses for each source can control associated equipment.

Circle (311) on Reply Card

EG&G Electro-Optics: FlashGuard 3000 tower lighting system



The judges considered this innovative lighting system to provide the best of both worlds in tower lighting. The strobe and red beacon are combined into a single, compact and cost-effective unit. Strobe operation by day and red beacon operation

by night eliminates the need for obstruction marking of towers, and avoids complaints from nearby residents from nighttime strobe flashing. The system includes a previous innovation by this manufacturer that replaces traditional single bulbs and Fresnel lenses with triple quartz lamps and adjustable parabolic reflectors. The efficiency of these lamps reduces power consumption, and their smaller size minimizes windloading on the tower. Their narrower vertical beam reduces ground scatter light as well. Initial cost is lower (and reliability higher) than separate dual beacon systems.

Circle (312) on Reply Card

Henry Engineering: DigiStor audio storage device



Primarily intended for use with listener call-in lines, this solid-state digital memory can store four minutes of speech-quality audio. The memory is backed up by an internal battery to prevent loss of message in case of power failure. An internal microphone pre-amp allows messages to be recorded directly into the device with a user-supplied microphone. Line-level input is also provided, along with a (headphone) monitor output. Record, play and stop functions are all remotely controllable, allowing easy interface with auto-answer phone systems. The unit can be programmed to play its message once or to continuously repeat its message until a stop command is issued (for example, by the caller hanging up). Storage time can be expanded to 16 minutes.

Circle (313) on Reply Card



GREAT PICTURES DESERVE GREAT SOUND

In digital video and film editing, the aim is to be "picture perfect." And yet that's only part of the story. To fully complement your images, you need the best digital audio.

For years, the world's top CD mastering and recording professionals have benefitted from Apogee conversion technology...and now film and video professionals can too. Apogee's AD-500 is a stand alone converter that truly stands alone. In addition to providing superior A/D conversion, the AD-500 is the only converter of its kind that syncs to video.

Whatever your application, the Apogee AD-500 has a lock.

- ▲ Syncs with D1, D2, D3 and HDTV systems.
- ▲ Syncs to NTSC, PAL and 60 Hz Video, while outputting 32, 44.056, 44.1, 47.95, and 48 KHz sample rates.
- ▲ Syncs to AES/EBU, S/PDIF and Word Clock inputs.
- ▲ Sync input can be shifted up or down by 0.1% (1.001) (for instance, can output 44.1 KHz locked to 44.056 KHz sync input.)
- ▲ Outputs AES/EBU, S/PDIF, Optical and Word Sync.
- ▲ Genlocks Digital Audio Consoles and Workstations.

The Apogee AD-500. For picture perfect sound.

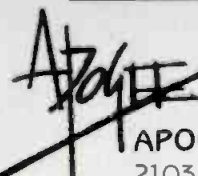

For more information, please contact

APOGEE ELECTRONICS CORP.
 2103 Main St., Santa Monica, CA, USA
 Tel. (310) 399-2991, Fax. (310) 399-7665

Circle (19) on Reply Card

**PRODUCERS AT
TV STATIONS,
NETWORKS,
STUDIOS,
POST-PRODUCTION
HOUSES AND
CORPORATE
TELEVISION
FACILITIES
HAVE NOTHING
IN COMMON,
EXCEPT...**

D-3

THE SHARED VISION OF DIGITAL.



Even before Panasonic developed D-3, video producers had their own vision of what they wanted in a digital videotape system.

They'd seen D-1, but most couldn't justify the expense of component digital video recording. They saw D-2, but recognized that its applications and production features were severely limited. So, many let D-2 go by. Though D-1 and D-2 were digital, they weren't *their* kind of digital.

Now they've seen D-3, and they're using D-3. Professionals from Hollywood to Manhattan, from prime-time to private television, from production and post to duplication mastering see that

D-3 uses a half-inch metal particle tape cassette. It has variable search speeds with picture in shuttle up to 100X. It has an ingenious 8-14 channel coding system for great pictures. It has slow-motion, 4-channels of digital PCM

For more information call: 1-800-524-0864
One Panasonic Way, Secaucus, NJ 07094.



D-3 has the price and performance requirements they need to finally replace Type C and move into the digital world. In fact, almost every D-2 user we've invited to try D-3 has wound up buying D-3.

The Panasonic D-3 format has a one-piece camera/recorder, plus a field-portable recorder, studio recorder and M.A.R.C. Automated Cassette Library System. And, it needs just a fraction of the maintenance and adjustment required by analog and earlier digital formats.

Now, isn't it time for you to share in the vision of digital—the way *you* want it?

audio, a unique edit guardband for frame accurate edits and trouble-free cassette interchange.

Panasonic
Broadcast & Television Systems Company

Holiday Industries: HI-3701 induced body current meter



Clearly innovative, this device sits on the floor like a bathroom scale. It measures RF exposure of the person standing on it with respect to the new IEEE/ANSI C95.1-1992 standard for induced body current. Usable frequency response ranges from 3kHz to 100MHz, with dynamic range of 60dB (0.3mA to 300mA). The analog meter has five scale settings. A NiCad battery pack provides more than 30 hours of operation on a charge (standard charger included, quick charger optional). Meter drive output (0-5VDC) is provided for feeding to a chart recorder or data logger. An optional fiber-optic link allows remote monitoring of induced current levels without generating any additional radiation.

The link can also be fed through an optional serial interface to a PC.

Circle (314) on Reply Card

Marantz: CDR600 compact disc recorder



Once again, the judges were attracted by cost-effectiveness. This professional write-once CD recorder is dramatically lower in price than other similar devices. It is a 3-rack-space stand-alone component, producing finished CDs that play in any standard CD player. Analog I/Os are balanced XLR (+4dBu) or unbalanced RCA (-10dBV), with digital I/O in S/PDIF or TosLink (optical) formats. Analog microphone inputs are also included. Maximum record time is 74 minutes. An infrared remote control is also supplied, and a skip feature avoids misrecorded tracks. Because it is a professional device, SCMS is not implemented on this recorder, allowing unlimited digital copying. High-quality A/D and D/A converters are used, and playback features fast (125ms-340ms) ac-

cess times.

Circle (315) on Reply Card

Radio Design Labs: 10 new Stick-On audio products



The problem-solving nature of this new release once again won the favor of our judges, just as some Stick-On products did in the 1990 Pick Hits. The devices can be mounted using their adhesive underside surfaces or with the manufacturer's optional racking accessories. Most of the series use 24VDC single-ended power. Among the new releases are a 2x1 silent audio switcher, an audio-controlled switch, a compressor/limiter, a 3-band equalizer, a voice-over/paging ducker, a 3-channel mic-level mixer, a high-gain mic pre-amp, a 3-channel mic/line level mixer, a utility power amplifier and a 2-input mixing power amplifier. The units offer versatility, adjustability and quality audio specifications. Numerous application ideas are included in the accompanying literature.

Circle (316) on Reply Card

Sabine Musical Manufacturing: FBX-900 feedback extermiator



This clever and low-priced device automatically controls acoustical feedback by sensing system resonances and notching the offending frequencies. Up to nine bands of 1/10-octave digital filtering are available, each capable of reducing levels by up to 50dB, across a range of 50Hz-15,000Hz. Each filter can be set either to seek and lock on a resonant frequency, or to roam and seek resonances as they occur. Typical response time of the unit is 0.4s, and dynamic range is greater than 92dB. The judges felt this item could be particularly beneficial to broadcasting where concern for sound reinforcement during remote broadcasts is often secondary to the on-air mix. The unit may also be useful for in-studio applications and teleconferencing.

Circle (317) on Reply Card

ANTENNA CONCEPTS. THE SAFE WAY TO TAKE TO THE AIR.

It's a fact. Today's broadcast environment hasn't room for "near misses." Survival hinges on: (1) getting a powerful signal right on target, (2) minimizing costs, and (3) using reliable equipment — backed by in-depth support.

That's exactly why more and more broadcasters rely on Antenna Concepts for the technologies and commitment that mean clearer images, economical pattern-to-market matching, responsiveness to special design needs, and ongoing assistance, easily accessed.

Call or write for details. And begin building a secure future in the air.



3234 Saddlehill Court ▲ Placerville, CA 95667
Phone: 916-621-2015 or FAX: 916-622-3274



Circle (65) on Reply Card

Their kind of NETWORKING.



Our kind of NETWORKING.

The Abekas A82's NETWORKING technology lets you time-share your switcher between multiple edit

bays. You don't need to buy three complete switchers just because you have three rooms.

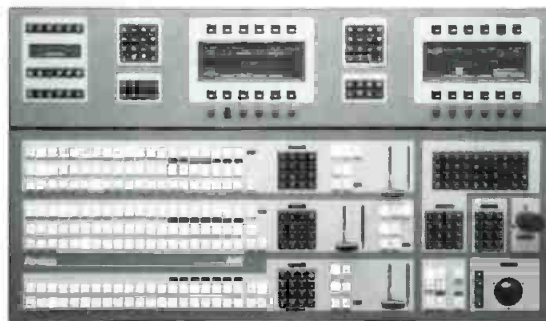

An A82 will make your post facility more profitable. It's also an excellent means of segmenting live and

post production in a broadcast facility. For more information call your local sales office.

Abekas
A Carlton Company

ABEKAS VIDEO SYSTEMS, INC., 101 Galveston Drive, Redwood City, California 94063. For details: 415-369-5111; Atlanta 404-451-0637; Chicago 708-699-9400; Dallas 214-385-4544; Los Angeles 818-955-6446; New York 516-829-0820; San Francisco 415-369-6791.

Circle (20) on Reply Card

www.americanradiohistory.com

Telos: Telos 100 Delta digital telephone interface



Fourth-generation digital telephone interface technology from this pioneer in the field provides improved trans-hybrid loss. Adjustable control of the interface is offered, so its operation can vary from full-duplex hybrid to complete caller-gating (speakerphone) action. Digital ducking and pitch shifting have been added, allowing greater gain-before-feedback for open-speaker monitoring. The judges, however, were most impressed with the system's digital dynamic equalization and gain control. Three-band EQ and a fast, adaptive AGC automatically improve caller intelligibility. Comprehensive metering displays input, output, gain reduction and EQ activity. Two mixed inputs (one with mic-level capability) are provided. One of two independent outputs provides caller audio only, while the other offers a continuous-

ly variable mix of caller and studio backfeed.

Circle (318) on Reply Card

TFT: DMM-92 digital STL modem



This flexible digital modem can be used to convert existing composite 950MHz STLs to digital transmission without modification of the radios. Unlike competing systems, it does not include a bit-rate reduction algorithm (source coder), but accommodates any outboard source coder's 256kbit/s stereo digital audio output, plus two 64kbit/s digital audio channels, through V.35 interfaces. The system also accepts a 9.6kbit asynchronous control data channel via RS-232. High spectral efficiency allows this data to travel within a 200kHz bandwidth. Adaptive signal equalization and forward error correction maximize link robustness. Alarms on the

decoder monitor faults in various link parameters. Thresholds for error rate alarms are user-selectable, allowing them to be set to the needs of the source coder employed.

Circle (319) on Reply Card

The judges

This year's NAB Pick Hits were selected by the following distinguished and experienced industry experts:

Radio:

Talmage Ball

Vice president, engineering
Bonneville International
Salt Lake City, UT

John Battison

Consultant
Battison & Associates
Loudonville, OH

Margaret Bryant

Chief engineer
WMAQ
Chicago, IL

Dennis Ciapura

Vice president, engineering
Noble Broadcasting
San Diego, CA

Continued on page 131

The PROM-SLIDE™



the card to play

Whether you're frustrated with maintaining your old master control slide chain, or tying up expensive equipment for those same few stills, the Leitch 2600ES PROM-SLIDE™ is what you've been waiting for.

This single compact card, which plugs into any Leitch 1300 and 2600 Series Sync or Test Generator, will ensure that your station ID, logo, standby message, or custom test signal is always available, with full color frame resolution, at the input of your switcher.

Play your cards right and call us today to find out more about the PROM-SLIDE™.

In U.S.A.: 1-800-231-9673

In Canada: 1-800-387-0233

LEITCH

Leitch Incorporated/HEDCO, 920 Corporate Lane, Chesapeake, VA 23320, U.S.A. - Tel: (804) 548-2300 Fax: (804) 548-4088
Leitch Video International Inc., 220 Duncan Mill Rd., #301, Don Mills, ON, Canada M3B 3J5 - Tel: (800) 387-0233 or (416) 445-9640 Fax: (416) 445-0595
Leitch Europe Limited, 24 Campbell Court, Bramley, Basingstoke, Hants., U.K. RG26 5EG - Tel: (256) 880088 Fax: (256) 880428

Circle (21) on Reply Card

It might be a good rule to never buy another switcher without Cache.



Cache recording lets you store your video, key, and audio elements on disk rather than tape. Coupled with the Abekas LINC technology, Cache provides the benefits of non-linear editing in the on-line edit bay. The advantage is faster, cleaner, more accurate editing free from tape drop-out errors. In the broadcast world an Abekas switcher with Cache recorders can be used to playback moving graphics and still images. For more information call your local sales office.

Abekas
A Carlton Company

ABEKAS VIDEO SYSTEMS, INC., 101 Galveston Drive, Redwood City, California 94063. For details: 415-369-5111; Atlanta 404-451-0637; Chicago 708-699-9400; Dallas 214-385-4544; Los Angeles 818-955-6446; New York 516-829-0820; San Francisco 415-369-6791.

Circle (23) on Reply Card

www.americanradiohistory.com

NAB Engineering Conference

report

Fewer, but better, sessions kept the meeting rooms full at NAB '92.



By Skip Pizzi, technical editor

The Bottom Line

Keeping up with technological change has never been more challenging, but the conference papers at NAB '92 gave broadcasters a fighting chance. If it was important to the broadcast industry, it was on the program. Using technology to reduce operating expenses and increase productivity was a central theme, with most presenters taking a decidedly real world look at even the most exotic new developments. Future planning processes were well-informed by this annual gaze into technology's crystal ball.

S

The 1992 NAB Engineering Conference followed the trend of recent years by highlighting advanced TV and digital radio issues. Yet, the significant progress reported in those areas did not preclude the emergence of several other important themes, with cost-effective operation predominating.

Fewer papers were presented this year, and the sessions' overall quality (and their attendance) was improved as a result. In another new trend, the Society of Broadcast Engineers (SBE) presented one full day of its engineering conference. The EBU handled one day of the *HDTV World* sessions, adding some different perspectives to the technology coverage.

Digital audio and radio

As expected, digital audio bit-rate reduction (data compression) occupied considerable discussion. The systems are increasing in their sophistication, and various standardization processes are under way. Rather than a single audio standard, a range of compression systems will likely be set forth, using a hierarchical approach. This implies that as a digital audio signal makes its way from the original source to ultimate listener playback, its data rate will be gradually reduced. For example, a stereo signal that requires 1.5Mbit/s upon initial conversion may be sent to a network production facility at 384kbit/s, which in turn sends it to a station at 256kbit/s, who then broadcasts it at 192kbit/s.

The full impact of these systems on the audio industry is becoming clear, and the likelihood of an audio signal encountering multiple generations of different types of compression algorithms seems high. Therefore, according to several presenters at NAB '92, a comprehensive, multipass scenario is required for design of system architecture and subjective testing.

Multirate codec designs that generate

identifying headers during encoding appear to be the trend. Also on the rise is the use of *joint stereo* coding, by which the typically large amount of audio common to left and right audio channels is exploited for further data rate reduction in stereo signals. NAB '92 also featured further discussion and refinements of the use of auxiliary data in digital radio broadcasting, with data rates ranging from 16kbit/s to 144kbit/s.

Some new concepts for digital radio broadcast delivery were described, including an in-band interstitial FM system using a frequency-hopping multiplex approach. The use of multiple small transmitters for optimum *shaping* and power efficiency of digital radio broadcast coverage was also noted. Meanwhile, the Eureka 147 partners announced the addition of two new members, RAI (Italian radio/TV) and Swedish Telecom.

Digital radio format progress

Strother Communications and LinCom Corporation presented their adjacent-channel FM in-band digital radio system, in which the digital carrier is approximately 15dB below the adjacent FM carrier. Mutual non-interference was demonstrated. Perhaps even more impressive was USA Digital's demonstration of full on-channel compatibility of a digital signal under an FM carrier. Again, mutual non-interference was shown, but most notable in this demonstration was the extraction of the digital carrier some 40dB below an FM carrier on the same frequency. This technology, completed only days before the exhibition, may have substantial impact on the broadcast industry and other telecommunications technologies in general. Many considered this demonstration to be the most significant single item at the show.

USA Digital also discussed in some de-

tail (but did not demonstrate) its compatible digital AM in-band/on-channel (IBOC) progress. The company claimed that encryption of the digital signal under the AM carrier is a relatively elementary process, but the extremely narrow bandwidth of existing AM channels presents a considerable challenge for digital application. The proponent also announced that it is moving into a Beta-testing phase of its FM system, using a single VLSI chip that incorporates FM detection, extraction and demodulation of the digital signal, and demodulation of the analog FM signal. The eventual production chip will include equivalent processes for AM reception.

Also on the receiver side, Delco seems highly motivated toward early implementation of domestic digital radio, whichever format is accepted. It cited customer research that showed a desire (and an expressed willingness to buy receiving hardware) for such services. Digital signal processing (DSP) architectures continue to penetrate the broadcast industry in this area and others. This was a trend reflected in several conference presentations.

Meanwhile, as the prospects for in-band digital radio service increase, so do concerns about interference. This was a topic of considerable interest and some debate at this year's conference. The NAB's Science and Technology Office presented

research showing that the type of modulation used for in-band digital transmission will have significant effect on adjacent-channel interference levels. For QPSK, the NAB report showed relatively high interference potential, and suggested that minimum shift keying (MSK) or orthogonal frequency-division multiplexing (OFDM) would provide better results in this regard.



Digital radio at S-band was discussed in the context of an existing system's case study. Results of a successfully operating terrestrial S-band installation in Mexico City using MMDS (wireless cable) frequencies were shown, in which a 10W ERP omnidirectional transmission provides coverage across a 25-mile radius from a mountaintop antenna site. Two 6MHz channels (2,650-2,656MHz and 2,662-2,668MHz) are used in the system, each carrying 10 stereo, CD-quality digital audio channels. The system serves fixed receivers only, using programmable and addressable set-top receivers (similar in operation to cable TV tuner/decoders) to select and decode any of the 20 available stereo signals, and present high-quality analog audio to a stereo reproduction system.

Another paper presented an update on the emerging U.S. digital cable audio industry, indicating its significant growth and potential, and discussing possible opportunities for radio stations to form coalitions with these operators on a local or national (superstation) basis.

Radio data system (RDS)

As expected, RDS was a contentious issue at the conference. Just prior to the convention, the NAB had surprised the industry by insisting that AM stations be accommodated in the U.S. RDS standard from its inception, rather than adding AM station capability later, as had been previously suggested. Meanwhile, receiver manufacturers are anxious to start producing RDS radios for the American market. During deliberations at the NAB convention, a number of approaches were suggested to achieve a compromise solution, and continue to move RDS toward standardization for use in the United States. Most promising was an adaptation of ID

CLEAN AS YOUR AUDIO

This compact yet powerful 11 kW FM transmitter receives your high quality audio and transmits it with the same quality provided by your compact disc. Combining efficiency with outstanding specifications provides your station with another competitive advantage.

All Continental transmitters come standard with a 2 year limited parts warranty and 24 hour technical service via phone. Leasing packages are available upon request.

Contact your local Continental sales manager to get information on increasing your competitive advantage.

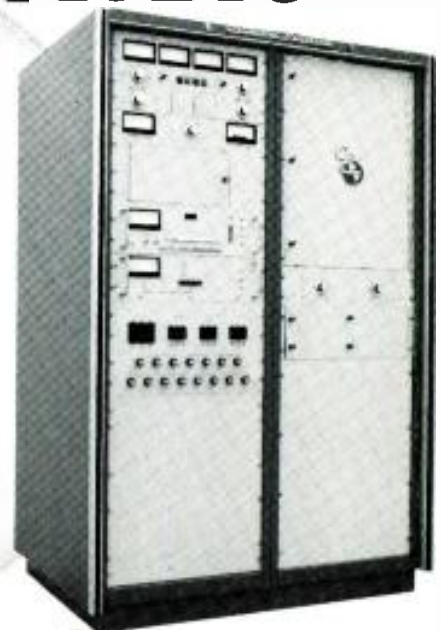

Continental Electronics Corporation

P.O. BOX 270879

DALLAS, TEXAS 75227-0879

214-381-7161

TELEX: 73-398

FAX: 214-381-4949

Circle (22) on Reply Card

Logic, a system that puts radio station data on a ROM database in the receiver. An ID Logic radio can conduct format searches and display call letters and format titles (for AM and FM stations) in a fashion similar to RDS, with no requirement for radio stations to broadcast such data. Naturally, any such on-board database will soon be outdated, so a modified system called *ID Logic B* was suggested, which allows over-the-air updating of a receiver's data files, via one station's RDS subcarrier in each market.

Such a hybrid RDS+ID Logic B system



solves another problem that has worried some receiver manufacturers regarding RDS: Suppose a consumer purchases and installs a standard RDS radio, and then starts playing around with it. Unbeknownst to the consumer, his favorite country music station is not yet RDS-equipped, so when he activates a format search for "country," the radio doesn't stop at that station. When he tunes the station in manually, no format or call letter display comes up. The listener might assume that the receiver is defective, and attempt to return it to the place of purchase for exchange or refund.

On the other hand, if an updatable ID Logic system were incorporated in these radios, the tuner would default to the on-board database for stations where no RDS subcarrier is detected. This would allow essentially full "smart radio" operation immediately (during the phase-in period for RDS encoder installation at FM stations), and provide AM stations with roughly equivalent service. FM stations would still be motivated to install RDS encoding, because it would allow them full and up-to-the-minute control of the displayed data.

The Digital Audio Cart Machine

People like the sound of Digital Audio. It's revolutionized the way listeners respond to radio. Today, 360 Systems' DigiCart brings consistently great sound to spots and ID's too.

DigiCart delivers the production values of an expensive workstation in a cart-sized format. Seamless back-to-back cuts. Smooth fades. Fast and precise editing.

Your production people will appreciate its ease of operation the first time they use it.

But the best reason to go digital is for quality, and DigiCart delivers on every count. Rugged Bernoulli cartridges with a ten-year field track record. Dolby AC-2 data compression that puts six times more audio on every

disk. Optional hard disks by Hewlett-Packard, with a 250,000 hour MTBF figure. And premium audio specs that leave every other cart machine in the dust.

At \$3,995 DigiCart is the most cost effective record-play stereo cart machine on the market today. And it's also the best sounding one ever made. Call us today for a brochure on how DigiCart can bring an even better on-air sound to your station.



DigiCart™

by 360 Systems

18740 Oxnard Street, Tarzana, California 91356 U.S.A.
Telephone (818) 342-3127 • Fax (818) 342-4372

Bernoulli is a trademark of Iomega Corp. Dolby and Hewlett-Packard are trademarks of the respective companies.
© Copyright 1992 by 360 Systems. DigiCart is made in the U.S.A.

Circle (60) on Reply Card

Receiver manufacturers are anxious to start producing RDS radios for the American market.

including the ability to dynamically vary the receiver display as their programming varied with dayparts.

RDS would also include potential revenue-producing elements for these stations, such as paging functions. Some impressive new RDS pagers were displayed this year, and existing RDS emergency alerting systems were also described. Conferees expressed hope that a final U.S. RDS standard could be reached later this year. Further discussion of RDS as a possible future EBS replacement also took place at the conference.

TV issues

Advanced television was again the focus of a whole separate track of the conference (*HDTV World*), with its own set of *Proceedings*. (NAB has announced that starting at the 1993 conference, yet another separate track will be devoted to multimedia issues.)

Among the primary themes in HDTV discussions was the growing worldwide trend toward all-digital systems, progress and results in HDTV testing, improved audio and ancillary services, alternative delivery systems, new production hard-

**This Is No Time To Take Your
Studio Lens For Granted...**

WEATHER FORECAST



For instant
spec sheets and
product information
via FAX, dial
1-800-553-6611

Fujinon's A20 x 7 F1.4 wide angle CCD studio zoom lens catches every drop. Fujinon does it again with the fastest wide angle CCD studio lens in the industry. It features the unparalleled performance, quality and reliability needed for the most demanding video productions.

Fujinon's A20 x 7 studio zoom lens, the forecast for a shining performance is always excellent.

FUJINON INC. 10 High Point Dr., Wayne, NJ 07470-7434 (201) 633-5600
Southern 2001 Midway, Ste. 114, Carrollton, TX 75006-4916 (214) 385-8902
Midwestern 3 N. 125 Springvale, West Chicago, IL 60185-1560 (708) 231-7888
Western 129 E. Savarona Way, Carson, CA 90746-1406 (310) 532-2861
FUJI PHOTO OPTICAL CO., LTD. 1-324 Uetake, Omiya City, Saitama 330 Japan;
Phone: 048-668-2152, FAX: 048-651-8517, TELEX: J22885

Circle (24) on Reply Card



**Focused on
the Future.**

ware and techniques and the strengths of various HDTV broadcast formats. Several new HDTV productions were screened, and a successful on-air demonstration of General Instrument's Digicipher system was presented.

Other TV issues of interest included progress toward interactive TV systems, and the significant results of ghost-canceling tests. NAB reported that among five ghost-canceling systems recently tested, the Philips system was superior.

On the satellite front, a DBS system pro-

Distribution of digital video signals within the broadcast facility received increased attention.

posal using spot beams isolated to each U.S. TV market was outlined, along with Japanese plans for a versatile digital DBS-TV system.

Also reported was a new on-screen TV program ID and scheduling format developed under EIA auspices, which can be transmitted in the vertical blanking interval (line 21, field 2), and displayed via the closed-captioning decoder hardware mandated into all 13-inch and larger TV receivers produced after July 1, 1993.

Digital TV integration, video compression and TV automation systems were covered in detail from multiple perspectives. This indicated a growth in the sophistication and maturity of these systems, and their ever-widening applications in the industry. Distribution of digital video signals within the broadcast facility also received increased attention.

Continued evolution of high-power UHF transmission was a popular subject.

Surprisingly, the strong presence of desktop video applications observed on the exhibition floor was not proportionally reflected in the conference sessions. Only one paper dealt exclusively with PC-based post-production, and the subject's few other appearances during conference presentations seemed to cast it as a minor issue. This was not the case on the floor, however, where a half dozen companies showed PC-based switching solutions, and as many more showed PC systems for art creation or rotoscoping. Many of the conventional video equipment (i.e., dedicated hardware) manufacturers even offered desktop applications in the quieter corners of their booths. Unlike in previous years, where such systems lurked mostly in the niches of off-line editing and



Desktop video was a hot item on the exhibition floor, but it was hardly mentioned in conference sessions.

edit decision list (EDL) generation, at this year's show they leapt into the mainstream. Their relative non-appearance on the conference program may have been a case of "see what we do, not what we say."

RF and other topics

Continued evolution of high-power UHF transmission was a popular subject at the conference, with several reports on multistage depressed collector (MSDC), inductive output tube (IOT) and tetrode amplifier systems. Improved efficiency and reliability were primary concerns here, with transmission lines, antennas and AM radio transmission considered along these lines by other papers.

The emphasis on greater cost-effectiveness seemed pervasive at NAB '92. One entire session was devoted exclusively to the subject of reducing operating expenses at the broadcast facility. Another dealt with maximizing broadcast signal coverage.

The conference also placed substantial emphasis on international subjects. Among these, Canadian work with digital audio and radio, European experience with advanced television, and Japanese developments with DBS delivery all stirred in-

terest. The importance of the decisions made earlier this year at the 1992 World Administrative Radio Conference (WARC-92) was also stressed and interpreted (see "re: Radio," pg. 12). One significant WARC issue of indirect interest to the broadcast industry was the allocation of spectrum to non-geosynchronous, low earth-orbit satellites (LEOsats), such as the proposed

NAB '92 placed substantial emphasis on international subjects.

Iridium system from Motorola. These satellites will permit wireless communication with a broadcaster's facility from virtually anywhere on earth, using extremely small hardware.

These and other subjects covered at the 1992 broadcast engineering conference made it a wide-ranging and enriching experience. For those who could not attend or who missed a session of special interest, many of the presentations are included in the conference *Proceedings*. Most sessions were also recorded and are available on audiocassette via NAB. Such a course of study and learning, from the wisdom of experts and the experience of peers, is essential for success in today's broadcast environment.

As Tom Lewis, author of *Empire of the Air*, reminded his audience at the NAB '92 Engineering luncheon, "Each of us, no matter how tall, stands on the shoulders of giants."

■ *For more information on the NAB '92 session tapes or Engineering Conference Proceedings, circle Reader Service Number 322.*

Free Catalog & Audio/Video Applications
 Mic, EQ, Line, Tape, Phone, Osc, Trans, Video, ACN, Pwr. Supp.
 Press Boxes 1-in/16-out Video/Audio 2-In/24-out Audio
 Video & Audio Dist. Amps. RGB-Sync Dist. Amps.
 OPAMP LABS INC (213) 934-3566
 1033 N Sycamore Av LOS ANGELES CA, 90038

Circle (84) on Reply Card

The Inside Story



J14ax8.5B IRS

THE FIRST AND ONLY - The J14ax8.5 is celebrating its first year anniversary in the field. Since its introduction, the J14 has grown in acceptance to unilaterally dominate the standard zoom lens category. Designed to best utilize the excellent properties of CCD cameras, the J14 is still the first and only standard ENG zoom lens featuring an Internal Focus System.

INTERNAL FOCUS LENSES - The focusing group is mounted separately from the front lens. In essence, the focusing elements "float" within the lens, leaving the front element and mechanical barrel absolutely stationary.

ADVANTAGES

- Improved Focusing Operation** - Because only a small portion of the Internal Focus Lens actually moves, the focusing is much better than traditional lenses.
- Optional Mattebox** - A special matte box allows video shooting that is more closely aligned to film shooting.

- Square Hood for Optimal Results** - A square hood, that has more cut at the upper and lower edges, has been added to the lens. The square shade matches the aspect ratio and offers better protection from stray light, inclement weather, dust and the effects of the environment. It also reduces ghosts and flares.
- Flexible Use of Filters** - Because filters can be stationary at the front during focusing, the system allows better use of special effect filters like cross, snowcross, polarizer, multi-division and half neutral density. Re-indexing is now a thing of the past.
- Compactness and Ease of Use** - The weight of the accessory does not affect the actual movement of the front element and does not harm the focusing operation. Response time is greatly improved.



MATTEBOX

- New Focusing Servo** - Specifically developed for Internal Focus Lenses. Created to work in productions that require stable operations such as dramatic presentations.

- Newly Angled Slant Drive** - Provides a comfortable hold that is less tiring when in use for long periods of time. Special protein paint gives a soft, gentle feel to the grip and is an effective measure against moisture.

Canon - the #1 Lens. Rated Number One by chief engineers in quality, technology, maintenance and after sales service.

Internal Focus helps the new generation of CCD cameras reach their maximum usefulness. The lightweight nature, combined with the chromatic qualities, flexibility in filters and focusing, makes it the single most important advance in lens technology in years. Only Canon has it. And that's the inside story.

Newly Angled Slant Drive unit provides a comfortable hold which is less tiring when used for an extended period of time

Fixed Group is separate from both focusing group and variator, it remains stationary during focusing - response time is greatly improved

Square Hood protects against stray light and inclement weather

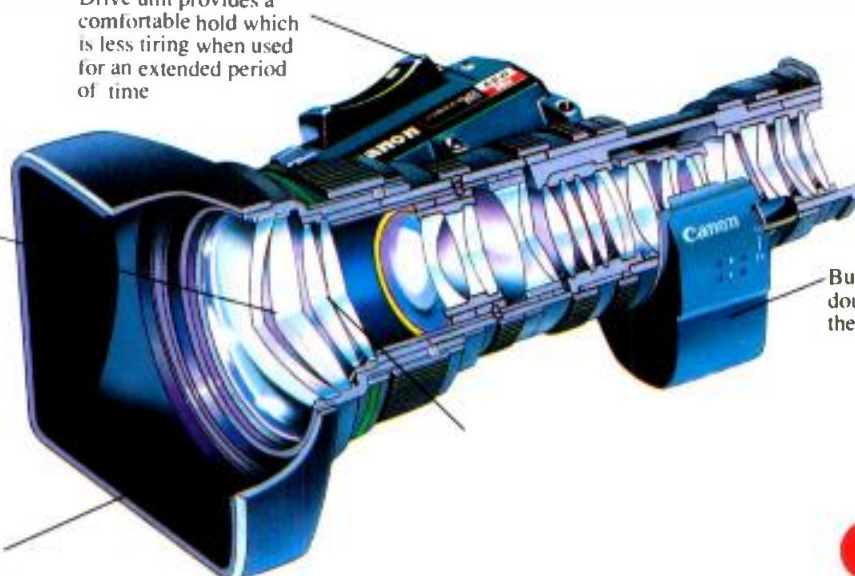

Built-in 2X extender doubles focal length at the push of a button

Canon
The Number One Lens

Circle (25) on Reply Card

CANON U.S.A., INC.
610 Palisade Avenue Englewood Cliffs NJ 07632
Telephone (201) 816-2900 Fax (201) 816-9702

Show of Shows

By Carl Bentz, editor, special projects



The NAB exhibition produced more than 1,600 new products this year. The following list identifies those new items and their manufacturers. This year's pick hits are identified in the text and are discussed with greater detail, starting on page 30. Reader service numbers assigned to each item will bring you information from the manufacturer about the product.

A

AAVS/Sencore

EVA: machine sequencer for broadcast, production; RS-422/232, ESBUS; menu screens based on Macintosh. **Circle (501)**

MOSAIC: multiplexes 16-image matrix on the screen at one time; may be used with Nexus distribution and monitoring system with signal sensing, automatic changeover features. **Circle (502)**

ONYX router: 16x8-128x128 matrices; LCD soft-key control panels. **Circle (503)**

Abekas Video Systems

A51 effects: enhanced for 4-channel operation. **Circle (504)**

A57: 10-bit frame-based digital effects system; pre-transform, background keyers; Superwarp feature for 2-sided single-channel page turn options. **Circle (505)**

A66 recorder options: SCSI/Ethernet permits transfer of computer images to A66 without digital output boards; archive files to Exabyte tape drives. **Circle (506)**

A72 titler: expanded graphic effects, shading, light sources, animation enhancements. **Circle (507)**

A82-cache: cache recorder emulates A62 disk recorder; 200s D-2 capacity with key; partitions to four 50s drives; editing between VTR and cache recorder with LINC EDIT, LINC LIST software. **Circle (508)**

A84 software: Ver 2.2 for component digital switcher; controls cache recorders, A57 effects systems, random-access audio recorders and digital routers. **Circle (509)**

Accom

ADC/DAC: 10-bit converters bridge among different signal formats; ADC analog to serial or parallel digital 601; DAC converts parallel or serial digital 601 to analog components. **Circle (510)**

Axial 2020 editor: on-line, non-linear editing system, disk recorder caching; run 48

devices in any source-to-destination configuration. **Circle (511)**

RTD 4224 disk recorder: 10-bit video, key data recorder. [See Pick Hits] **Circle (300)**

Accu-Weather

Accu-Call 900: 900 telco service; stations promote service, receive revenue based on charges paid by callers. **Circle (513)**

The Weather Show: complete weather presentations prepared by Accu-Weather, 15s and longer segments. **Circle (514)**

ULTRAGRAPHIX 386/496: high-resolution graphics access, paint, display systems; automated download and display of Accu-Weather graphics; includes ULTRAGRAPHIX ANIMATOR. **Circle (515)**

Accurate Sound Corporation

Model 1053: twin-drive microcassette recorder; tapes two copies or permits sequential recording of two cassettes; logging, time-delayed recording. **Circle (516)**

Model 1054: microcassette duplicator; copies both sides of a cassette in one pass at 8x normal speed; makes two copies simultaneously. **Circle (517)**

Model 315/925: high-speed audio duplicator electronics; channel amplifiers, bias generator; dup ratios 4:1 to 64:1; for 1/4" or cassette media. **Circle (518)**

Acoustic Systems

Series BB: voice-over booths; 3'x3'x7' to 8'x8'x7' internal dimensions; wall panel window in door. **Circle (519)**

Acoustical Solutions/Alpha Audio

Acoustical forms: Pyramid, Wedge-shaped products **Circle (520)**

Alphasorb: Fiberglass panels. **Circle (521)**

Audioseal booth: portable sound room; 4'x6'x6'8". **Circle (522)**

Sidetrack: audio recorder, editor; handheld controller; protocol similar to Sony video equipment; interface to The BOSS editor. **Circle (523)**

Sound Barrier: with absorber in blanket or vinyl barrier in rolls. **Circle (524)**

Soundtex: acoustic wall fabric. **Circle (525)**

Acrodyne Industries

LAU series: UHF TV linear amplifiers; for common amplification of visual, aural carriers (30W) or visual only (50W). **Circle (526)**

TRH/1KS: solid-state VHF transmitter; slide-out 4-module PA produces 1kW; self-contained blowers, dedicated power supplies. **Circle (527)**

TRU/10X: UHF exciter; stereo/monaural inputs; SAW IF filter; video, IF correction; retrofits high-power klystron transmitters without pulsers. **Circle (528)**

TRU/30KV: UHF transmitter with single Thomson TH 563 tetrode; 30kW visual output; 10% aural; 50kW consumption; parallel configuration for 60kW. **Circle (529)**

Adams-Smith

Q-GEN: with ADR talent cue displays; multi-format time-code generator, reader; inserts LTC, MIDI code into video. **Circle (530)**

Serial Manager: interface to products via RS-232/422 and MIDI I/O. **Circle (531)**

ADC Telecommunications

FN 6000 series: wideband, multichannel video fiber transmitters, receivers; 1 to 16 channels of video, audio, data; by American Lightwave Systems division. **Circle (532)**

LC 6000 series: single-channel video fiber transmitters, receivers; by American Lightwave Systems division. **Circle (533)**

LiteAmp CATV stations: 50-560MHz with single, multiple fiber versions. **Circle (534)**

Adelaide Works

DigiSync: reads film bar code (Keycode) at 10x play from negatives, prints, intermediates; by Research In Motion. **Circle (535)**

OSC/Rnet: LAN version of OSC/R Keycode system; supports 256 users. **Circle (536)**

TRACK/Roption: sound tracking, translating capability (available only as option to OSC/R). **Circle (537)**

ADM Systems

Post-Pro: audio console for post-production; 8/12 inputs or 8/12/16 input with optional 4x1 preselectors; 3-band EQ; VCA input control. **Circle (538)**

Adrienne Electronics

AEC 1/SCP: control AEC-1 router via dial telco network. **Circle (539)**

This is *just* an intercom system,
like a laser is *just* a light.



This is no ordinary matrix intercom system. This is a true all-digital system. It's fully programmable, user likeable, and makes interfacing a breeze. Just the way it should be! Our Matrix Plus is a field proven system with over three years experience in numerous installations; and virtually no two are alike. That's guaranteed flexibility! Matrix Plus is designed from the user's perspective. It's the kind of system you can grow with because we made it easy to program and reprogram. And we'll even *pre-program* your system to order. All it takes is a pair of wires to get connected. We call it digital matrix intercom. You'll call it incredible!

Matrix Plus

FROM CLEAR-COM SYSTEMS

See us at IBC—Amsterdam Booth #W-31

U.S./CANADIAN SALES AND SYSTEM DESIGN PHONE 510 527 6666 FAX 510 527 6699 945 CAMELIA STREET BERKELEY, CALIFORNIA USA EXPORT DIVISION FAX 510 932 2171 BOX 302 WALNUT CREEK, CALIFORNIA 94596 USA
Circle (26) on Reply Card

www.americanradiohistory.com

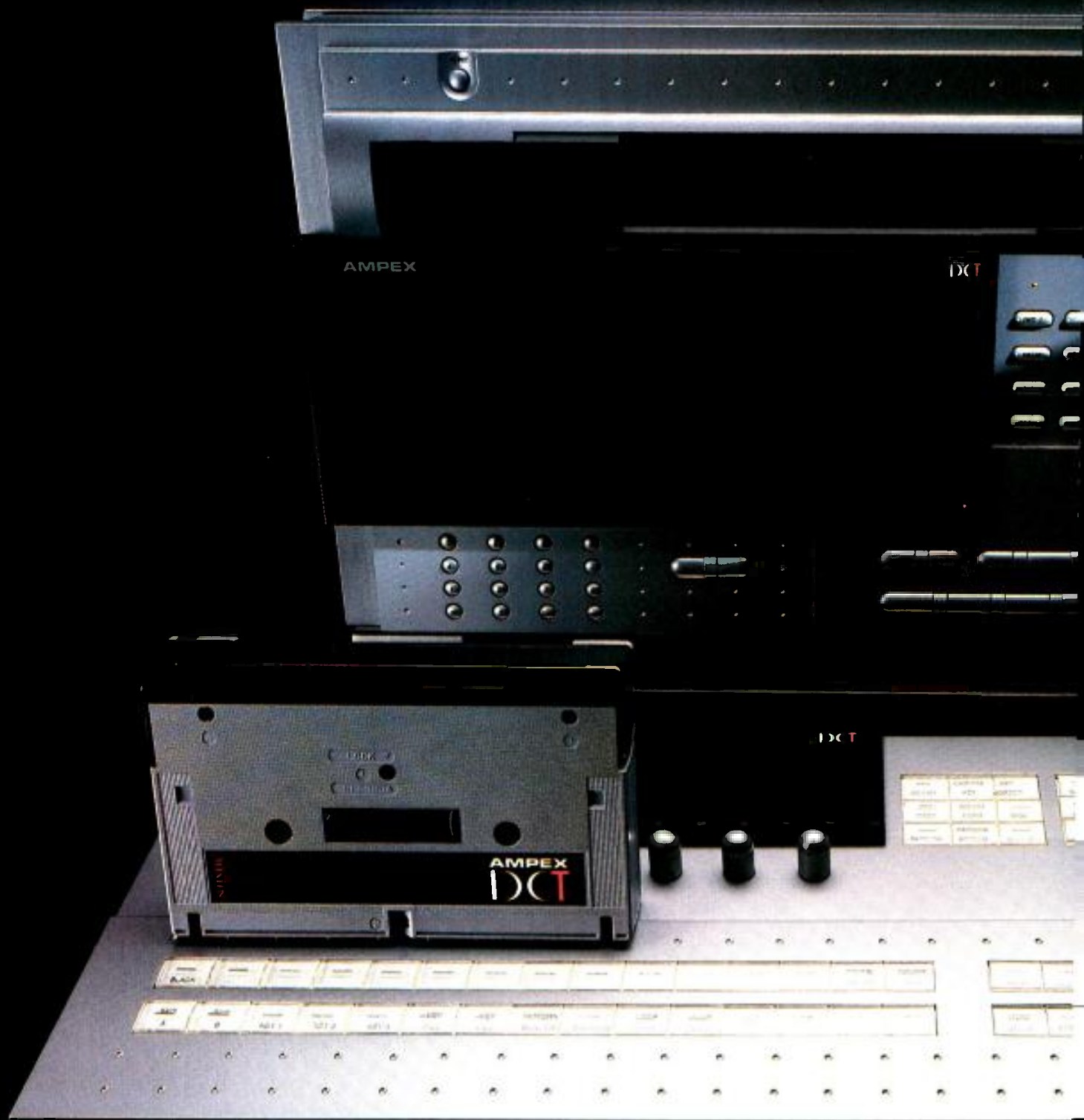

AMPEX

DCT

AMPEX
DCT

AMPEX HAS CHANGED THE POWER OF VIDEO.

It's the power to realize your dreams.

It's the impact of innovative design. It's the precision of uncompromising engineering. It's the rock-solid dependability of the Ampex commitment to quality.

It's the power to deliver video with the clarity, crispness, and multi-generational integrity available only with digital component processing.

It's called DCT™ – Digital Component Technology.

It's the world's first realistic CCIR-601 digital component system available from one manufacturer.

Tape drive, tape cartridge, switcher, editor, ADO®, character animator, and interconnect equipment.

All available now. Only from Ampex.

And DCT also gives you a clear upgrade path to the digital video technologies of the future.

So now you can have the video power you've always dreamed about. You can have it today. And you'll still have it tomorrow.

AMPEX
DCT™

Ampex Corporation 401 Broadway, MS 3A-01, Redwood City, CA 94063-3199
© 1992 Ampex Corporation

Circle (27) on Reply Card



AEC Box 2PR: LTC/VITC bar code label printing system. **Circle (540)**
AEC Box 30 update: serial LTC data inserter for Sony protocol VTRs; includes editing features. **Circle (541)**
AEC Box 32: LTC/VITC serial data inserter for Sony protocol VTRs. **Circle (542)**
AEC Box 50 update: Ampex-to-Sony serial protocol converter; interface between VPR-80, editors; supports Timeline LYNX TC audio transport Lynx adapter. **Circle (543)**
AEC Box 80P: serial adapter for Panasonic parallel remote-control VTRs. **Circle (544)**
AEC Box 95: video sampler, compressor for Sony protocol VTRs. **Circle (545)**
PC-VLTC/Gen: LTC/VITC generator card for PC/compatibles. **Circle (546)**
PC-VLTC/RG-1: LTC/VITC reader, generator card for PCs. **Circle (547)**

Advance Products

AV2C-42J PIXMobile: 42" table with cabinet; height adjusts; safety lip. **Circle (548)**
AV6-54J PIXMobile series: 54" table; optional cabinet, extra shelf, adjustable height; safety lip. **Circle (549)**
AVOH-39J, CTOH-39JS: AV tables with overhead projector well; CTOH has shelves for computer equipment. **Circle (550)**
CT-31JS: 31" height table on 4" casters; adjustable monitor shelf; for non-dedicated computer applications. **Circle (551)**
VT5CM-54J: AV table; cabinet with locking doors, adjustable shelf; 54" height, additional adjustable shelf. **Circle (552)**

Advent Communications

Communications packages: flyaway systems with CDMS, TDMA, DAMA, PAMA techniques; flyaway remote control, redundancy systems; flyaway packaged test, monitoring equipment. **Circle (553)**
Fixed earth stations: turnkey service; design, construction of any size fixed satellite communications terminal. **Circle (554)**
Lynx-MA: SNG trucks for SNG, telephony, data and radio applications. **Circle (555)**
Trailer-based: systems for all applications. **Circle (556)**

AEQ

MP-10 portable mixer: five mic/line inputs; solid-state memory holds 32s ID message; dual bidirectional 2-wire or 1-way 4-wire remote production station; full telephone operation; with touch-tone pad. **Circle (557)**
System-3000: digital telephone system for multiconferencing; touch-screen or CP-01 remote console; 8 lines may be used with simultaneous recording of all conversations. **Circle (558)**
TH-02 dual hybrid: configures in 2W mode as digital hybrid or in 4W mode for full duplex intercom. **Circle (559)**

AEV SNC di Vaccari GEC

CSPT: stereo encoder; crosstalk <-40dB; 70dB S/N, distortion >0.4%. **Circle (560)**
ECM 44: 4-mic, 4-headphone extension; one output line ties to one input of station mixer; option for talkback or other programs to headphone jacks. **Circle (561)**
On Air light: 110-220VAC; plexiglass; easily replaceable lamp. **Circle (562)**
RDSI 3800: radio identifier for RDS; transmits 10 8-character words alternately displayed on car radio display. **Circle (563)**
RDSM 3900 Midi Coder: locks to 19kHz stereo pilot carrier; DSB-suppressed carrier on 57kHz subcarrier; RAM, EPROM memory for RDS data management. **Circle (564)**
TDSS2: synthesized digital stereo generator; linear modulation approaches theoretical maximal separation. **Circle (565)**
TPI 4W: telephone line test unit; select input impedances; sine wave generator; mic, headphone amplifier. **Circle (566)**

AF Associates

ADAC 2000: 10-bit TV standards converter from AVS. **Circle (567)**
RP2: free-roaming robotic pedestal for ENG/EP cameras, lenses; full manual mode; by Radamec EPO. **Circle (569)**
See and Select: touch-screen control for Radamec EPO systems; uses video images to reference camera shots. **Circle (570)**

Afterglow

Pin-Up: alternative pin-registration system on modified Rank film gate. **Circle (571)**
Russell Square: color, brightness, spatial processor complements telecine, tape-to-tape transfers; analog component, 4:2:2, 4:4:4, 8-/10-bit digital parallel or serial inputs, outputs. **Circle (572)**

Aircraft Digital Music

American Music Series: 5-CD set covers Revolutionary period, Jazz & popular (1900-60), Civil War, Early folk (1800-1920), Fifties & Sixties music. **Circle (573)**

AKG Acoustics

Blue Line: modular microphones; Modu-Lock component assembly with bayonet coupling; TransAct capsules; CK-90 line includes cardioid, omnidirectional, figure-8, short shotgun types. **Circle (574)**
C 547 boundary mic: hypercardioid; non-reflective finish, low profile to remain visually unobtrusive. **Circle (575)**
C 647 gooseneck mic: similar to C747 with gooseneck mount; high gain before feedback, hypercardioid. **Circle (576)**
DSE 7000 Ver 2.0: extensive enhancements add speed, simplify operation of audio workstation; 16-hour capacity and >15,000 edits per project. **Circle (577)**
Quested Q108 speakers: integrated processor, amplifier; optimized transient response; compact design; each cabinet contains two 100W amplifiers, custom bi-amp circuitry. **Circle (578)**

Alamar USA

DAC-400: serial A/B switch to access Sony serial VTRs from two separate serial controllers. **Circle (579)**
Interface controller card: EBus/ESnet unit connects MC-2075 to BTS ESnet remote machine control. **Circle (580)**
MC-2075: automation system on 50MHz 486 running XENIX; interface Alamar Media

Manager Library, Traffic Manager; 32 automation channels, 256 devices. **Circle (581)**
MC-900: smaller automation system using 486 50MHz PC with XENIX; 4-channel, 64 devices; interface to Mini-Media Manager, Traffic Manager. **Circle (582)**
MC-950FX: automation with Sony Flexicart, VTRs, laser disks, master control switcher, routers, still-stores, titlers. **Circle (583)**
Media Manager IV: central library management; RISC computer and bar code track all media. **Circle (584)**
Mini-Media Manager: library management system; catalogs all media within the facility. **Circle (585)**
NDP-100SX: net delay system for automatic time shift; 1 minute to 24 hours; 486SX-20 under XENIX. **Circle (586)**
SC-2100: dual interface; general-purpose device programmable for two of various serial devices. **Circle (587)**
SPS-100SX: satellite resource management automates dish positioning, receiver frequency, audio subcarrier tuning, routing, VTR R/P functions. **Circle (588)**

Alesis

ADAT: 8-track digital recorder uses S-VHS media; synchronize 16 units to 128 tracks with SMPTE TC; proprietary timing reference; BRC controller. **Circle (589)**
AI-1 interface: ADAT to AES/EBU, S/PDIF with sample rate converter. **Circle (590)**
AI-2: EBus interface controls ADAT transports. **Circle (591)**
RMB option: 32-channel remote meter bridge for ADAT. **Circle (592)**
X-2 console: 24-channel, 24-tape monitor, 8-bus recording mixer. **Circle (593)**

Alexander Batteries

Amart Pak-14: replaces Anton/Bauer Snap-Ons; power gauge shows capacity on an mAh scale. **Circle (594)**
BP1B: 12V 2.3Ah replacement unit for Sony NP1 and NP1A. **Circle (595)**

Alias

Animator V2.0 enhancements: animation with Time Warp; 20 advanced modeling features; TextPac spline-based fonts; Rendering and Natural Phenomena w/Shader interfaces. **Circle (596)**

Allen Avionics

AVS filters: miniature packaged, LP video filters. **Circle (597)**
BAL 2873 delays: zero-loss active video delay cards; fits BAL 2800 system 3U rack; mix with VDAs, ADAs; 14 cards per rack; from 25ns to 2.54ms. **Circle (598)**

Allen Osborne

Telescopic Hilomasts: NH, NK, NL, NX, NY series pneumatically operated mobile telescoping mast products. **Circle (599)**

Alpha Image

A2128: digital serial router with 128x128 array. **Circle (600)**
A232: compact low-cost serial digital router. **Circle (601)**
A380: digital serial composite to NTSC converter. **Circle (602)**
Alpha 332, 342, 345 converters: dual parallel to serial, dual serial to parallel and serializer-deserializer. **Circle (603)**

ALTA Group

AP-30 production system: 4:2:2 analog video component switcher, effects, linear



The last thing a station needs to do is replace manual error with mindless automation.

HOW TO REPLACE "OOPS" WITH OOOPS.

If you haven't already heard, the newest buzzword in broadcast is *smart automation*. In an era of split-second timing, \$10,000 make-goods, and news rating wars, stations are having to face a new reality.

People are imperfect. On-air mistakes are expensive. Broadcast automation is behind the times. And something ought to be done about it.

Something has — OOPS. PARDON? Object-Oriented Programming is more than a breakthrough in automation, it's a boon to stations who want a smarter way to control devices.

Those days of external interface boxes? Geriatric throughput? Unfriendly software? Gone. With OOPS, devices are treated as software "objects."

So, you get a PC-based system that is faster, intuitive to use, and completely customizable to any station.

The Louth ADC-100 can control any device: Switchers, VTRs, Multiple Cart Machines, Still Stores, Satellite feeds; even custom devices and existing station software can be incorporated right into the system.

HOW MUCH FASTER? On average, the ADC-100 is ten times faster than any existing automation system. With virtually no obstacles

to throughput, you can run as many as 8 lists *simultaneously*, each with up to 1000 events.

More impressive, though, is how fast people warm up to Louth's text-based windows and pulldown menus. Everyone from Traffic to Production to News "gets it" immediately. Even a trainee can be editing full playlists within hours. So operators can be freed for more important tasks.

FUTURE PROOF. Since things change so rapidly in broadcast, Louth has designed the ADC-100 to adapt to any changes in equipment, personnel or procedures.

Advanced computer technology and client-server architecture make the system easily expandable. And with OOPS, Louth

can respond immediately to customize and support new devices.

MAKE NO MISTAKE. The best way to see how fast, easy, and powerful broadcast automation has become is to watch the ADC-100 at work. For more information or to arrange a demonstration call (415) 329-9498.

With Louth, Smart Automation has come a long way in solving the big drain in broadcast. Human error.

Louth Automation. Because air-time is money.

L O U T H
A U T O M A T I O N

Circle (28) on Reply Card

NAB '92 - Show of Shows

keyer, accessories for recording to videotape. **Circle (604)**

Centaurus SSR still-store: 179 fields, 85 frames on removable hard drive; 4-input video switcher, optional audio switching; effects; access stills by number or list files with effects to be applied; composite or Y/C switcher; tally accessories. **Circle (605)**

Altronic Research

Air-cooled loads: 6700 series 5kW to 75kW and Omegaline 6400 series 1kW to 5kW air-cooled loads. **Circle (606)**

Amber Electro Design

Amber 7000: analog, digital audio generator, analyzer; integral 386/40MHz computer; Windows-based GUI; digital signal processing with FFT analysis; AES/EBU generator analysis; offers two simultaneous measurement channels. **Circle (607)**

AMCO Engineering

Catalog 500B: 3 console styles, 19", 24" widths; black with second color; single-bay units shipped assembled. **Circle (608)**

Monitoring enclosures: single-, multibay configurations; accessories; silhouette pedestal bases, sloped front, vertical frames; standard, custom colors. **Circle (609)**

AMEK Consoles/TAC

BCIII modules: options for mixer; BC348 facility for four mono mix-minus clean feed outputs; BC344 4-into-2 monitor mixer; BC324 quad group module; TLA input amps designed by Rupert Neve. **Circle (610)**

EINSTEIN: automated mixer; compact with comprehensive metering, monitoring; 64 inputs with fader, 4-band EQ; 24 balanced group outputs and tape returns; Steinberg SUPERTRUE automation; VIRTUAL DYNAMICS option for gating, autopan, dynamics processing. **Circle (611)**

AmiWare

AmiRoute: 8x8 video switcher based on Amiga; optional audio matrix, A/V DAs, black generator. **Circle (612)**

Ampex Corporation

ACR-255 Ver 4.0: GPI triggers, Multi-Run, Remote Terminal capability. **Circle (613)**

ADO 500 digital effects: 4:2:2:4 architecture for 3-D page turn, warp, other effects; Digi-Matte key channel; 24-effect shot box to recall and run effects; 2nd channel and target framestore options for additional effects capability. **Circle (614)**

CVC-90 camera: new sensors produce 800-line resolution; f/8 2,000-lux sensitivity at 62dB S/N. **Circle (615)**

CVR-400A camcorder: Betacam SP unit features Extended Clear Scan to remove noise bar if shooting computer screen; Enhanced Vertical Definition for vertical detail; high-resolution viewfinder. **Circle (616)**

CVR-D265 studio player: with composite digital serial output for direct transfer to D-2 environment. **Circle (617)**

D-2 upgrade kits: for VPR-200, -300; Auto Edit Optimize adjusts tracking, scanner phase for clean, repeatable edits; VITC for vertical interval time code capability; chroma phase adjustment. **Circle (618)**

DCT digital component production system: new 19mm tape format; 700d transport, 700t tape cartridges, 700s switcher, 700e edit controller, 700a digital effects unit; 700i, 710i interconnect peripherals. **Circle (619)**

TrailBlazer target framestore: enhancement option for ADO 100 effects system; Trail, Sparkles, Drop Shadow, Montage processing. **Circle (620)**

Ampex Recording Media

#229 D-1 master: digital videotape with improved bit error and dropout rate; increased RF output; improves front coat frictional properties. **Circle (621)**

#329 D-2 master: digital videotape with improved bit error and dropout rate; increased RF output; better RF envelope stability; improved shell. **Circle (622)**

#398 Betacam SP: improved formulation, base film, back coat, plastics; replaces #298 product; in small and large shells; 5- to 90-minute lengths. **Circle (623)**

499 Grand Master Gold: analog mastering tape; low noise, low print through characteristics; handles operating levels of +9.0dB or greater; in 1/4" to 2". **Circle (624)**

Andrew Corporation

4-/6-port upgrades: converts C-, Ku-band only antennas to simultaneous C/Ku receive and Ku transmit. **Circle (625)**

8M series: operates Ku- or C-band, individually or simultaneously; 8M diameter has aperture efficiency near 80%. **Circle (626)**

AL-8: UHF LPTV antenna, standard 8-bay, omni; null fill; 1kW rating. **Circle (627)**

ALPS series: additional models for LPTV;



Set It Anc

INTRODUCING THE SHURE FP410; THE "HANDS OFF" MIXER THAT DELIVERS PERFECT SOUND AUTOMATICALLY.

The new Shure FP410 is not just another pretty face. It's a whole new concept in portable mixing; one that forever solves the nagging problems of multiple open microphones. By automatically keeping unused microphones turned down, the FP410 dramatically improves your audio quality.

The secret: Shure IntelliMix — the patented operational concept behind the revolutionary FP410. It thoroughly shatters existing standards for portable mixer performance and ease of operation.

Just set your levels and flip the switch to "Automatic"; Shure IntelliMix does the rest.

Its Noise Adaptive Threshold activates microphones for speech but not for constant room noise, such as air conditioning.

NAB '92 - Show of Shows

ALP-WR reduced back lobe, wide cardioid; **ALP-D**, **ALP-T** high gain cardioid; **ALP-H** peanut pattern. **Circle (628)**

DryLine dehydrator: XT or MT series; pressurizes feed line using membrane separation drying technology. **Circle (629)**

EASIAx: cable prep tool for 7/8" HELIAx coax. **Circle (630)**

MACXLine inners: replacement inner conductors for 3/8", 6 1/8" rigid line. **Circle (631)**

Model 1.2M: suitcase antenna for satellite use. **Circle (632)**

Model 9.3M: antenna for Intelsat B facilities. **Circle (633)**

SMARTRACK APC3000: satellite antenna controller; maintains correct pointing of antenna for best reception. **Circle (634)**

VHF Panel: high band; low windload; produces various patterns with 50% fewer panels than normally required; originally designed for HDTV tests. **Circle (635)**

Wiring requirement guide: illustrated booklet describes building, electrical and fire code specifications for coax, elliptical waveguide. **Circle (636)**

Angenieux Corporation

14x anamorphic lens: converts 3:4 aspect ratio to 16:9 HD format. **Circle (637)**

14x FPL series: lightweight lens for ENG/EPF; available with f/1.6 for 2/3" and f/1.4 for 1/2" cameras offering lower light capability; CCD optimized; integrated UV filter. **Circle (638)**

14x6.6: lens for 1/2" cameras. **Circle (639)**

14x8.5: ergonomic, rugged lens for 2/3" cameras. **Circle (640)**

20x8.5: 20x lens uses fluoro-phosphate glass, multilayer coatings cut chromatic aberration; 0m MOD; **Multi Range Extender** for on-air selection of five extenders; **Teleshot** focus; for 2/3" CCD cameras. **Circle (641)**

Antenna Concepts

ES44CM: improved C connector attaches Andrew LDF cable to antenna; for 1.5kW UHF, 0.75kW cellular RF. **Circle (642)**

Transmitting antennas: omnidirectional **Linear Dipole** linearly polarized FM/TV antenna; **Bull's Eye** double-V flat panel antenna for FM/TV; **Slot** directional or omni H-polarized UHF antenna. **Circle (643)**

Anthro

Technical furniture: modular computer workstations, desks, carts; adjustable PC monitor support arms. **Circle (644)**

Anton/Bauer

Automatique: accessory permits VTR record signal to control on-camera light automatically; synchronizes tape roll and light activation. **Circle (645)**

Gold Mount: quick-release battery mounting system. **Circle (646)**

Interactive battery systems: includes Logic Series Digital Magnum 14 battery; permits interconnection to viewfinder for diagnostic display. **Circle (647)**

Magnum and Compac Magnum 13/14: standard and lightweight, high capacity NiCad batteries. **Circle (648)**

UltraLight 2: on-camera light; low voltage requirement; compact size. **Circle (649)**

Aphex Systems

#400 Digidoc: FM stereo generator; HP limiting, LP filter; digital control of analog signals. **Circle (650)**

#8126: modular audio DA; no transformers; 1-in, 6 servo balanced outputs. **Circle (651)**

#9901: parametric EQ module for 9000 series enclosure; tone shaping with three overlapping filters for multiple EQ settings within a given bandwidth. **Circle (652)**

Apogee Electronics

Studio Converter: digital-analog system combines AD-500, DA-1000E stereo reference converters, PS-1000 power unit, RM-1000 rack frame. **Circle (653)**

Arrakis Systems

Digilink audio system: replaces standard cart machines, cassette/reel recorders in live or automated radio studio; 16-bit CD sound with automation. **Circle (658)**

Arriflex

ArriSoft/Fresnel: portable kit; one ArriSoft 1000, two ARRI 650 Fresnels in shipping case; ArriSoft accepts 500/750/1kW lamps; interchangeable reflector. **Circle (659)**

ART/Applied Research & Technology

DR-X 2100 Wonder: studio, live sound 24-bit dynamics processor. **Circle (660)**

Multiverb LTX: 250 multiple effects combinations; three simultaneous effects; 16-bit processing. **Circle (661)**

SGX processors: **SGX-T2** multi-effector, pitch transposer, programmable pre-amp; **SGX-LT** pre-amp, effects processor; **Multi-**



FP410 Mixer shown actual size.

Forget It.

Its MaxBus limits the number of activated microphones to one per talker.

And its Last Mic Lock-On keeps the most recently activated microphone open until a newly activated microphone takes its place.

With Shure IntelliMix, you'll get a "seamless" mix that's as close to perfect as you'll find. Providing the cleanest, clearest sound you've ever heard from a portable mixer. And freeing you from the tedious

task of turning microphones on and off.

For a closer look at the world's first portable automatic mixer, call for more information including the article "Why Use An Automatic Mixer?"

We think you'll agree: The Shure FP410 is automatically a classic.

Call 1-800-25-SHURE. The Sound Of The Professionals®..Worldwide.

SHURE®

Get a \$25 Rebate from Shure
Purchase a FP410 and VP64 mic
thru Oct. 2, 1992.
For details, call 1-800-25-SHURE

NAB '92 - Show of Shows

verb Alpha 2.0 sampler, effects system with pitch transposition. **Circle (662)**

STX-2000/SGX-Nightbass: integrated effects system; extensive effects for guitar, bass guitar players; 12AX7 duo-triode pre-amp stage. **Circle (663)**

The Phantom series: 16-, 24-input recording consoles (See Pick Hits). **Circle (310)**

ARTI

ARTI NET: local area, media synchronous network; connects various source devices, other production equipment to PC serial port. **Circle (665)**

Clark media controller: operates 16 devices simultaneously for multimedia systems. **Circle (666)**

Media Master: software to script events for multimedia system. **Circle (667)**

TapeOp: animation software for Mac II with interface to various VTRs. **Circle (668)**

Video Publisher: A/B roll edit software for Mac or PC. **Circle (669)**

ASACA ShibaSoku

AAM-200: magneto-optical audio file; records more than 60 minutes stereo per disk; rewritable technology. **Circle (670)**

ADR-6000: NTSC magneto-optical recorder; removable disk capacity of 1.2Gbytes; records full-band 4xFS composite digital format. **Circle (671)**

ADS-330: NTSC magneto-optical still-store; RC33 remote-control unit; rewritable technology; 4xFS processing for still fields, frames and 4-field color frames. **Circle (672)**

CM203: 20" hi-resolution auto setup monitor; 900-line resolution. **Circle (673)**

CP1207: 12" high-definition monitor; RGB, YPBPR/sync inputs. **Circle (674)**

RM25A: IF-band ghost signal generator creates eight ghost signals in IF output; independently adjustable level, delay, phase and modulation for each. **Circle (675)**

TD15AX: measure differential phase, gain for NTSC, PAL; noise-reduction circuit for more accuracy. **Circle (676)**

TG71BX: NTSC/PAL test source; 30 standard signals; custom pattern creation by user; composite, Y/C outputs; optional RGB, YPBPR outputs. **Circle (677)**

TZ25AX: camera measurement set; analyzes all parts of video signal generated by camera based on test patterns "on screen"; measures absolute registration from integral electronic pattern. **Circle (678)**

VB16D2: D-2 serial/parallel video to composite analog to drive standard monitors, switchers, etc. **Circle (679)**

VG922B: closed-caption encoder; produces four captioning test signals. **Circle (680)**

Associated Production Music

Broadcast 2 series: 30 CDs with updates; commercial, full length cuts. **Circle (681)**

AT&T

Skytel satellite service center: handles satellite transponder reservations for occasional video, Skytel TV service, Business television. **Circle (682)**

AT&T Graphics Software Labs

Comet/CG: character generator for Macintosh. **Circle (683)**

MacTOPAS: 3-D modeling, rendering, animation software for Macintosh. **Circle (684)**

Panorama: image-sequencing, multimedia desktop presentation software. **Circle (685)**

StudioMaster: editor for Mac. **Circle (686)**

TOPAS 4.0: upgraded 3-D modeling, rendering, animation for DOS PCs. **Circle (687)**

ATI Audio Technologies

LA-10000: modular line amp system; 10 single, dual modules with two power supplies in one rack frame; selections include metered modules. **Circle (688)**

Audio Action

FEX 01-10 Sound Effects Library: digitally mastered material; wide range of effects sounds. **Circle (689)**

Joseph Weinberger Ltd series: 10 CDs include ethnic, classic, jazz, guitar and numerous other music types. **Circle (690)**

KOKA Media: numerous CDs of music, sound effects; color-coded to simplify location of desired type. **Circle (691)**

Zzebras series: CD series; new age, jazz, pop music; *Dance/Flow* dance, rap, R&B, Funk; *Sitcom Comedy* materials. **Circle (692)**

Audio Animation

2.2 paragon-transmission: revised digital 5-band parametric EQ; setup-file management; AGC; 18dB/octave crossover slopes; stereo width enhancement; increased loudness; pre-emphasis. **Circle (693)**

Audio Developments

AD146 on-location mixer: 4-output with M-S decoding; 6-12 inputs with mic/line, mono/stereo line input modules; 9kg for 12-channel unit; operates on C, NiCad cells or 12-24VDC external source. **Circle (694)**

AD261 stereo ENG mixer: M-S decoding; four mic/line XLR inputs; 2.5kg unit operates on internal C or NiCad cells, external 10-24VDC power. **Circle (695)**

Audio Precision

FASTRIG software: enhanced FASTtest multiline test program of System One +DSP; characterizes audio channel pair for response, distortion, noise, etc. **Circle (696)**

Portable One Plus: audio system test set; portable package includes sweeps and graphs. **Circle (697)**

Audio Processing Technology

ACE 100: card for PC; 4:1 compression with apt-X 100 processors for real time stereo audio record/play from a PC. **Circle (698)**

DSM100 ISDN multiplexer: full-bandwidth audio transmission on one to three 56/64 kbps data lines; full-duplex inverse multiplexer synchronizes individual 64kbps channels; adapter to ISDN phone permits full-fidelity audio on low-capacity ISDN circuits. **Circle (700)**

Audio Services Corporation

DAT recorders: Stellavox *Stelladat* and Fostex *PD2*. **Circle (701)**

Production Sound Report: newsletter by The Journal of Production Sound Equipment & Techniques. **Circle (702)**

Audio Technica US

AT 835a: shotgun condenser mic; for long-range recording. **Circle (703)**

AT4033: studio condenser mic; direct-coupled, floating cardioid element. **Circle (704)**

AT822 OnePoint: X-Y stereo microphone for DAT recording; matched transducers optimally positioned to reproduce spatial effects of 170 arc. **Circle (705)**

AT831R: remote-powered mini cardioid condenser mic; for musical instrument, voice use. **Circle (706)**

Model DT100: digital teleconferencing system. **Circle (707)**

MT 830R: subminiature omnidirectional condenser lavalier mic; 20Hz-20kHz; *MT830CW* for use with *ATW-1031* wireless system. **Circle (708)**

PRO 88W: wireless camcorder mic; body pack transmitter with *MT830MW* or *AT-829MW* mics; 9V battery operation; one-of-eight VHF channels. **Circle (709)**

audiopak

Compact Cassette/DCC components: leader tape, graphite liners in 95 styles, configurations for Compact Cassettes, Digital Compact Cassette units. **Circle (710)**

Auditronics

850 production consoles: features of 800 series; integrated in-line processing, pre-selection features; adapts to audio sweetening or on-air operation. **Circle (711)**

Aurora Systems

Cornet: paint, animation system using 80486 processor, EISA bus under UNIX; 400Mbyte hard disk, 525Mbyte streaming tape, 1.44Mbyte floppy drives and optional SCSI optical disk; 60MHz frame buffers; Ethernet interface. **Circle (712)**

Liberty: high-resolution paint, animation; available as hardware/software system or software only; operates on S.G. Iris, Indigo, Power Series and Crimson systems as well as existing Aurora hardware. **Circle (713)**

MAC interface: software option for AU/200 series permits digital file transfer to and from Macintosh PCs. **Circle (714)**

Autogram

Mini-Mix 8: mixing console; two stereo, one mono output buses; 12 stereo inputs for balanced, high-level balanced; VCA devices; integral cue amp, speaker. **Circle (715)**

AVCOM of VA

MSG 1000B: microwave sweep generator; 100kHz-1GHz range to test microwave components, systems. **Circle (716)**

NASA 1000A: integrated network, spectrum analyzer; provides signal from 1MHz to 1GHz; for sweeping line duplexers, other microwave components. **Circle (717)**

AVID Technology

AirPlay: non-linear editing system; automated clip capture; integral title generation. **Circle (718)**

Audio PixStation: 24-track layup, editing station; syncs real time digital video playback to audio tracks. **Circle (719)**

Media Composer 2100: upgraded JPEG video compression; wipes, graphic positioning; internal color vectorscope; audio scrub, pitch change; 4-channel output; transport motion control; Apple Quadra 900 platform; audio editing. **Circle (720)**

Media Recorder series: for film, video on-location production; connects to cameras, film-to-tape equipment to digitize material directly from live feeds. **Circle (721)**

Open Media Framework: multivendor open platform to establish more extensive integration standards. **Circle (722)**

Avitel Electronics

ADA 3233, ADA 3234: audio DAs with re-

Efficient, Powerful, Fast, Analog

Are you evaluating switchers for a new suite or upgrading an existing one and finding products designed only for post production—or only digital products requiring system re-design?

At Utah Scientific, we continue to develop highly reliable new and innovative products which address a **Systems Solution** to your needs: The **PVS Series 2** family of Analog Production Switchers.

From our 12 input one ME **PVS-112** to our 24 input 2 ME with Program/Preset bus **PVS-224**, we're setting new standards in speed and flexibility of operation.

- Selective memory recall on our **HOT KEYS** enables on-air recall of certain portions of an effect
- Interface to routing switchers ensures future growth and almost unlimited flexibility
- The Electroluminescent touch screen display leads the way into the future of compact, efficient control panel design
- 100% field upgradability maximizes your investment.

Utah Scientific: We listen.

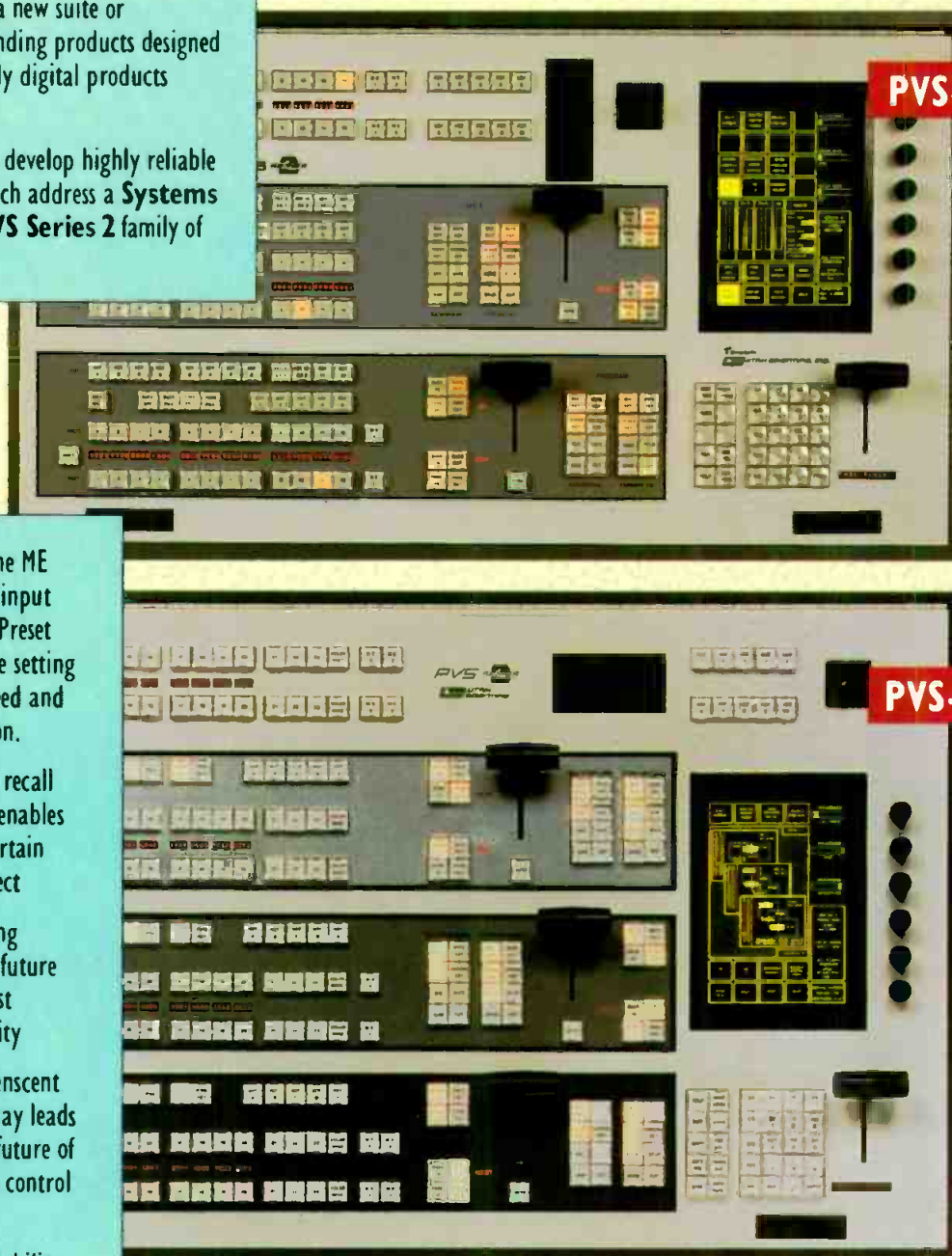

DYNATECH VIDEO GROUP

US UTAH SCIENTIFIC, INC.

V I S I O N .
V A L U E .™

To GET THE PICTURE Contact US at:
4750 Wiley Post Way, Suite 150
Salt Lake City, UT 84116
800-453-8782 or 801-575-8801
Circle (30) on Reply Card



mote gain control; 3233 single-channel, 3234 dual-channel. **Circle (723)**
TSL RMA assemblies: rack-mount cabinets for videocassette systems, monitors; by Television Systems Ltd. **Circle (724)**
VDA 3214: 3-channel component analog DA; 5 outputs/channel; 30MHz, 50MHz bandwidth EQ; clamping feature. **Circle (725)**

AVS Broadcast

601 Floating Point: free-form titler; real time manipulation in 3-D; composite, component, 601; 32-bit RISC parallel processing; on-air page update; off-line page composition; animate of elements imported from paint; logo source. **Circle (726)**
ADAC 2000: standards converter; upgrades to full motion-compensated interpolation; 10-bit processing; integrated encoding, decoding; D-1, D-2 interfaces, analog composite NTSC, PAL, SECAM and component/YC-525, 625. **Circle (727)**
Automatic Case Sensing: for Manuscript component/composite titler handles Arabic language text and supports right-to-left characteristic of Arabic, Hebrew; also supports Cyrillic language. **Circle (728)**
Cyrus: 10-bit standards converter; FIR filters produce <0.05dB ripple across 5.5MHz video spectrum; interface to all formats; full motion-vector processing. **Circle (729)**
Integra digital mixer: DVE; 4:2:2:4 processing per CCIR 601; internal routing with instant priority positioning; multiformat interfaces. **Circle (730)**
ISIS Q: standards converter; adaptive digital comb filter decoding, motion adaptive post processor; to 21dB chrominance, 17dB luminance noise reduction. **Circle (731)**
Utopia: software allows FloatingPoint system operation from PC. **Circle (732)**

B

BAF Communications

ENG/EFP-20: production vehicle on Ford E-350 cutaway chassis. **Circle (733)**

BAL

2832 VDAs: wideband with flat response to 30MHz with 3dB attenuation at 70MHz; plug-in EQ card; clamp option. **Circle (734)**

Band Pro Film/Video

Chrosziel M-5: 5" monitor for Steadicam; high intensity green CRT. **Circle (735)**
Genio PCM remote control: 12-bit 2-4 channel PCM digital remote systems operate cameras, lenses, camera support products; by Alfred Chrosziel GmbH. **Circle (736)**
Magic Dolly/Black Track: fold-up dolly supporting 275 pounds; track in 5-foot straight, curved click-on-click-off sections; from Key West. **Circle (737)**
TCS-ABI, TCS-A1: time-code sender, re-

ceiver by SM Technologies; attaches to Betacam cameras as time code and user bits source. **Circle (739)**

BARCO Industries

CVM 2137, CVM 2537: 14" monitors of CVM 2000 series; fits in OB van or monitor walls; front mounted keyboard (-2537) or soft keys on lower bezel margin (-2137). **Circle (740)**
HDM 2051, HDM 2081: 20", 32" HD multistandard unit follows CVS "intelligent monitor" philosophy; broadcast features with auto setup; for any of the five existing HDTV signals. **Circle (741)**
CVM2551, -2070: 20", 28" multistandard viewing monitors. **Circle (654)**
FSM 860: field strength monitor for CATV headends; monitors, supervises, evaluates level, modulation of all carriers on cable or in a similar RF network. **Circle (656)**
TC450: frequency agile converter for cable, satellite reception. **Circle (657)**

BASYS

D-Cart: digital audio editing, playback system; interface to newsroom system; hard disk storage; developed by Australian Broadcast Corporation. **Circle (742)**

BCD Associates

Animation controller: for operation of Sony EVO-9650 Hi8 VCR. **Circle (743)**

Beaveronics

Favag Cristalltime: master, secondary clocks for facility time keeping. **Circle (744)**
MobaTime series: programmable master and facilities clock system; by Swiss Moser-Baer. **Circle (745)**

Bec Technologies

AudioPlex/Pro-Line products: AD16 16-channel A/D transmitter, DA16D/A receiver, repeater; MP16 16-channel mic pre-amp, splitter; FB2 fiber-optic transceiver module; RPS redundant power supply module; fiber-optic snake. **Circle (746)**

Beck Associates

Series A custom consoles: welded tubular steel frames, hardwood trim, custom countertop configurations. **Circle (747)**

Beckett Electronic Eng. & Research

Equipment brokers: used video/audio; repair, installations; distributor for Digital Processing Systems, JNS. **Circle (748)**

Behringer/Samson Technologies

Audio processing systems: denoisers, compressor, noise gate, parametric equalizer, feedback suppressor, sound enhancer, expander/gate; COMPOSER compressor, expander, gate, limiter; Splitter/Mixer signal router; PROFEX double-processed expander. **Circle (749)**

Belar Electronics Lab

AMMA-1 The Wizard: precision digital AM modulation analyzer; offers many measurements, new ways of looking at modulation and processing; full remote control with PC and Wizard software. **Circle (750)**

Bencher

VP400 tabletop, Illumina: copy stand for heavier cameras to 40 lbs; available in tabletop or floor (Illumina) models; four 300W quartz sidelights; 25"x25" copy area with 16"x16" illuminated area. **Circle (751)**

BEXT

PJ 501, PJ 1002: solid-state amplifiers rated for 500W, 1kW; MOSFET devices; lightweight, low power consumption; switching power supplies. **Circle (752)**

beyerdynamic

DT 190 series: headset with microphone; high sensitivity, fast transient response, high rejection characteristics of off-axis sound; for mono, stereo or split feed headphone operation. **Circle (753)**
M 424 series: miniature supercardioid dynamic, TG-X rare earth neodymium magnets; high sensitivity, tight polar pattern, fast transient response; handles high SPL levels. **Circle (754)**
MC 833: stereo EFP mic; condenser with internal M-S, X-Y capability; three separate shock-mounted diaphragms. **Circle (755)**
Monitoring headphones: DT 911, DT 811 open, DT 901, DT 801 closed top of line; DT 411, DT 311 middle range supraural open; DT 211 and DT 211TV/Video Phone supraural open construction for cost-conscious uses. **Circle (756)**
TE 170: VHF wireless mic; DT505 earphones; miniature receiver, body pack transmitter; for lavalier, hand-held, head-worn or sound effects mics. **Circle (757)**
U 700 series: UHF wireless system; 12 channels in an 8MHz band; hand-held or body pack transmitters; enclosed RR-7000 main-frame with space for 12 EED diversity receiver units; ground plane antennas, in-line antenna amplifier. **Circle (758)**

Bi-Directional Microwave

Portable microwave: simplex, duplex systems for STL/TSL, ENG, remote/surveillance, teleconferencing. **Circle (759)**

Bio-Electronics

MCG-2: micro titler; time-of-day, date option; gen-lock to NTSC or PAL; B/W characters on B/W background. **Circle (760)**

Bogen Photo Corporation

#3066 C/V fluid head: supports weights to 22 pounds; telescoping handles; movable camera platform with 3.5" travel slot for better balance. **Circle (761)**
Avenger series: grip equipment including stands, accessories. **Circle (762)**
Pro Cine/Video Tripod: lightweight with tandem upper, single lower legs; 75mm diameter claw-ball leveller; #3181 aluminum, #3182 black anodized finish; spiked feed, spreader, mid-level spreader. **Circle (763)**

Bretford Manufacturing

1992 Product Guide: studio furniture for computer workstations, libraries, editing stations, etc. **Circle (764)**
TVCY35T-BK: ceiling yoke TV mount; for monitors to 35". **Circle (765)**
TVMP: ceiling/wall plate. **Circle (766)**
TVPW27R-BK: platform/wall TV mount with VCR bracket. **Circle (767)**
TVUM: mounting bracket. **Circle (768)**
TVWY20BK: wall/yoke TV mount for 20" monitor. **Circle (769)**

Broadcast Electronic Services

Bittree RS422 panel: patching for RS-422 serial data; self-normaling jacks; 12-24 jacks across panel in two rack spaces; 9-pin connections. **Circle (770)**
TBC/r remote control: contains presets for



Engineers and Producers Agree On The Versatility, Variety and Dependability of Maxell.

That's Why Over 2,000 Pros Nationwide Use Maxell Exclusively.

It's all on your shoulders. You have to create, enhance, preserve, make it work. So you do what you've done reach for Maxell. Rugged, reliable Maxell tapes for state-of-the-art performance ... punish it, push it to the limit, these superb video and audio tapes just won't quit. Durable Maxell tapes for the glorious sound, the brilliant image and the superior specs you *must* have when your reputation is on the line.

maxell.

Maxell Corporation of America, 22-08 Route 208, Fair Lawn, NJ 07410, 1-800-533-2836.

Circle (31) on Reply Card

©Maxell Corp. of America

www.americanradiohistory.com

NAB '92 - Show of Shows

unity gain of video, chroma, hue, setup control at distances to 150 feet. **Circle (771)**

Broadcast Electronics

Air Trak 100: configurable linear audio console. **Circle (772)**

AM series: AM transmitters using Class E amplifiers; *AM-1* 1kW, *AM-5* 5kW, *AM-10* 10kW; fully solid-state design; integral C-QUAM stereo equipment. **Circle (773)**

Disc Trak: digital cart machine; 3½" floppy disk media; 112s capacity full-band stereo per disc; 16-bit sampling; LCD displays spot name, timing data. **Circle (774)**

FM-1C: 1kW FM solid-state transmitter based on FX50 exciter. **Circle (775)**

Broadcast Software Ltd./BSL

Guardian III: transmitter management software; to 1000 sites of 50 types; supports Guardian I features, Gentner, Burk Technology, SVS Computer interface on single phone and/or computer line. **Circle (776)**

Guardian system: senses conditions at the transmitter plant; shows status on CRT with failure alarm, restoration and in-tolerance conditions. **Circle (777)**

SVS computer interface: links remote capability; 16 to 256 input status/measurement channels; 8 to 128 output control channels. **Circle (778)**

Broadcast Store/BCS

Equipment catalog #924: new, used video equipment dealer; DNF *ST60* VTR remote control; supports nearly all existing VTR products with 15 functions. **Circle (779)**

Broadcast Supply West

Equipment catalog: 1992 edition list audio, radio products. **Circle (780)**

Broadcast Video Systems/BVS

CARDKEY: linear keyer, compatible with GVG, Leitch Video DA frames. **Circle (781)**

CP-600: video proc amp; compatible with GVG, Leitch Video DA frames. **Circle (782)**

VM-400: 4x1 video switching matrix; compatible with GVG, Leitch Video DA frames; for composite or component video expandable to 4x4, 8x2 with 3 or 4 layers; remote control with single coax. **Circle (783)**

Broadcasters General Store

ST60 VTR controller: by DNF. **Circle (784)**

Brüel & Kjaer

WA0609 APE: acoustic pressure equalization attachment for microphone; spatial, spectral equalizers. **Circle (785)**

Bryston

4BNPB power amp: 250W/channel stereo; soft-start circuit; multiple filter caps per channel in power supply; proprietary input buffer circuit; clip LEDs show yellow on short peaks, red on conditions that could harm speakers. **Circle (786)**

BTS Broadcast Television Systems

400 series: serial digital distribution, signal conversion products; DAs, format conversions. **Circle (787)**

DCR 300: D1 VTR; needs external A/D, D/A converters; see DCR 500. **Circle (788)**

DCR 500: D1 VTR for post-production; requires no external A/D, D/A converters; personal setup cards include custom operation menus for each VTR operator; four units in

parallel record HDTV; flexible multiple I/O connections. **Circle (789)**

E\Clips: desktop video production system; Windows application; edit controller, switcher dissolver, titler, keyer, audio mixer and scene management system; permits access to Windows word processor, paint, graphics packages. **Circle (790)**

LDK 9 enhancements: CCIR digital output option; control panel access to numerous functions; serial remote to *Series 9000* control to robotic and station automation systems. **Circle (791)**

MARS router: 24x8 matrix; expandable I/O; 30MHz bandwidths; RAM stores configuration with battery backup. **Circle (792)**

MNR-9: noise-reduction system; 3-dimensional median filter leaves H/V bandwidth intact; motion detection avoids motion smear; dual 4:2:2 frame-stores; linear or recursive grain reduction. **Circle (793)**

Motif: character generator, titler; scalable PostScript Type 1 fonts; dynamic motion rolls, crawls; multiple attributes per character; developed with Paltex, Aston Electronics; Vector display effects; Super Vectors dynamic animation. **Circle (794)**

Pro 2000: Betacam SP VTRs, camcorders, players, peripherals. **Circle (795)**

Venus: high-density routing switcher; 2,048 crosspoints per rack unit audio, 1,024 crosspoints for video; allows an intermix of HDTV video, 400Mbit/s serial digital video, stereo analog audio and AES digital audio in one frame. **Circle (796)**

Burk Technology

LX-1: 6-input stereo audio selector. {See Pick Hits} **Circle (311)**



Cal Switch

C&K SPST: miniature power switchlock; 4A @ 125VAC/28VDC, 2A @ 250VAC. **Circle (798)**

V7S series: single-pole, double-throw device by Micro Switch. **Circle (799)**

Calaway Editing

CD-110/CE-210 upgrade: match-frame calculation into speed edit for speed-fit calculation; EDL event or event-block copy feature; 3,000-line EDL for CE-210. **Circle (800)**

CE-25/CE-75 upgrade: optional serial ESAM protocol mixer control, extended list management. **Circle (801)**

CE-400: comprehensive on-/off-line edit controller; 80486SX CPU, 4Mbyte memory; VGA color edit status display; 12 RS-422 VTR ports; 9,998-line main EDL memory; capacity of 65,000 lines in 50 EDL bins. **Circle (802)**

Switching, mixing interfaces: ALTA Group Pyxis 5.5, SP-30; Abekas A82, Ampex Century; GVG AMX-170S, Graham Patten D/SAM 800. **Circle (803)**

TBC interface: Zaxcom ZX400, MTBC 1500; Ensemble Designs TC400D. **Circle (804)**

VTR interfaces: Sony PVW Betacam SP, DVR-20/DVR-28; Panasonic AJ-D350, LQ-4000 optical disc recorder; Hitachi VL-D500; Pioneer VDR-V100 optical disc. **Circle (805)**

Calzone Case

Introduction: corrugated plastic, synthetic material for equipment cases. **Circle (806)**

Studio series: rack cases; 8 or 12 rack spaces; upper rails slanted; all rack rails of tapped steel. **Circle (807)**

Camera Platforms Int'l/Lightmaker

Lighting ballasts: ac and ac/dc HMI powering products, cover 200W to 12kW for flicker-free lighting. **Circle (808)**

Pigtail adapters: connects between Lightmaker ballasts to a variety of lighting instruments. **Circle (809)**

Canare Cable/Cables & Connectors

241U-VJ22W-C: video patchbay; 24 dual video 75Ω jacks; also baseband analog to serial digital; 1 rack unit height. **Circle (810)**

The Stripper: 15-second quick coax cable strippers; {See Pick Hits}. **Circle (301)**

Canon USA/Broadcast

HV5X: HDTV lens; 1.2m MOD; 8.5-42.5mm focal length. **Circle (812)**

J33aX: internal focus lens; -11B IAS for ⅔" -8.5B IAS for ½"; 2.2m MOD; rectangular hood cuts extraneous light. **Circle (813)**

MB-200 matte box: for J14a ⅔", PH14a ½" lenses with internal focus; accepts any 4x4 optical filter. **Circle (814)**

UV40X15B: HDTV lens; 5:1 ratio with 15-610mm focal length and 2x extender; 4m MOD. **Circle (815)**

CANOBEAM: laser beam video transmission system; 16 channels of video, 32 of audio; operates in infrared. **Circle (816)**

LX 100: Hi8 camcorder with interchangeable VL-mount lens system. **Circle (817)**

Carpel Video

Carpel-o-peel: label remover solution; odorless; causes no clouding or damage to cassette shells. **Circle (818)**

ST-3: waterproof stopwatch with countdown feature. **Circle (819)**

T-120: VHS videocassettes. **Circle (820)**

CBSI Custom Business Systems

Agency Management System: expanded, improved management of radio stations' business with agencies. **Circle (821)**

CBSI Windows: adds multitasking capability to CBSI programs. **Circle (822)**

CustomNet: multiple station consolidated traffic/billing system. **Circle (823)**

CCOR/Comlux

3083/3084: 8-channel 16-bit digital audio coder/decoder. **Circle (824)**

CED

FM-series: low-power FM transmitters; 150W, 300W, 700W systems. **Circle (825)**

TVM-series: MMDS transmitters; 2W through 100W single systems; *TVM-MX8/-MX12* 8-/12-channel transmitters each with 1W/channel output. **Circle (826)**

TVU-series: low-power UHF transmitters; 15W-1kW; GaAs FET devices; separate visual, aural amplification. **Circle (827)**

TVV-series: low-power VHF transmitters; 20W-2.5kW; separate visual, aural amplification using GaAs FET devices. **Circle (828)**

CEL Electronics

ImageCon: PC package converts among graphic standards, TV/video; supports TIF, IFF, FIR, TARGA; optimizes and converts between image standards, interfaces to graphics I/O devices. **Circle (829)**

Myriad-fx: image manipulation system; 525-line version. **Circle (830)**

PI63-RAM: upgrade to Maurice Minor hard-key controller; expands memory capacity to store effects sequences, programmed effects; external memory cards for archiving; memory for 100 sequences. **Circle (831)**



Get Auditronics' 900 audio console... for television that sounds as good as it looks

Upgrade your stereo audio to full parity with your video using the Auditronics 900 Series of audio consoles designed specifically for television news and production.

Now you can deliver seamless, glitch-free audio with source and assign switching functions controlled by the 900's built-in hard-disk computer. The console's computer remembers up to 64 set-ups and communicates with your house audio/video router via an RS232 or 422 communications bus.

Our 32-input 900 with 12 microphone and 20 line-input modules handles 48 mic and 200 stereo line inputs. And Auditronics' deft design crams all this functionality into a one-operator console that uses less than 20 square feet of precious control room space.

If you're ready for stereo audio production that makes your station sound as good as it looks, get your hands on Auditronics' computer-based 900 television console.

Call today for your information package.



auditronics, inc.

3750 Old Getwell Road
Memphis, TN 38118
901-362-1350
FAX 901-365-8629



Circle (32) on Reply Card



P184 converter: D-2/D-3 digital output from NTSC or PAL composite analog input; 8-bit processing. **Circle (832)**

P186 converter: switchable dual CCIR 601 4:2:2 digital inputs; dual YUV, Y_{CR}C_B or RGB outputs; 8-/10-bit processing; serial input option. **Circle (833)**

P272 router: signal distribution with 12 inputs by 5 dual outputs; D-1 or D-2 signals; parallel CCIR 625/601 standard; clocks regenerated. **Circle (834)**

Worldmaster P/256: television standards converter. **Circle (835)**

Century 21 Programming

GoldDisc³: CD music libraries manufactured on improved CDs; NoNOISE low-noise technology. **Circle (836)**

Century Precision Optics

WA-8XCV: 0.8x wide angle converter; attaches to front of zoom lens; 75mm, 80mm 85mm slip-on step-up rings. **Circle (837)**

Channelmatic

ADCART Plus: random access ad insertion; four VCRs shared for two channels; electronic directory editor; ROS event mode for sequential insertion without break-by-break schedule. **Circle (838)**

Adcart/D: digital local ad insertion system; replaces VCRs with digitized A/V data for analog playback; may run multiple channels for local, regional, national, satellite-delivered insertion requirements. **Circle (839)**

CompEdit: compiler-editor; auto preparation of day-part spot reels from traffic schedule with one VCR; V:base software; with Sony SVO-9600 S-VHS, PVW-2600 Betacam SP, Panasonic LQ-4000 Rewritable Laserdisc player. **Circle (840)**

Chapman Leonard Studio Equipment

Lenny Arm: camera crane arms; 4.25-29.25 feet arm lengths; greatest height achieved 56° from horizontal. **Circle (841)**

Sidewinder: camera dolly with battery-powered steering; allows a lens height range from 22 inches to 9 feet; capacity of 900 pounds. **Circle (842)**

Super Peewee II: small camera dolly with hydraulically operated arm; 23.5" pneumatic tires. **Circle (843)**

Chimera

CronieCones: for VideoPro, Daylite Jr. single lights. **Circle (844)**

Quartz, Daylite Rings: for multiple ARRI, Desisti lights to 4kW open face; second model to 10-12kW. **Circle (845)**

Chroma Technology Inc.

Chromatek 8310: 30MHz bandwidth video compensation DA for HDTV, HiRes computer graphics; EQ to 400m of 5C-2V cable; 1 RGB set input and output. **Circle (846)**

Chromatek 8340: 30MHz bandwidth video DA for HDTV, HiRes computer graphics; EQ for 200m of 5C-2V cable; 1-RGB input, 4-RGB output. **Circle (847)**

Chromatek 8355: video DA for HDTV, HiRes computer graphics; one RGB/H_s/V_s input set, three output sets on BNC or D-sub connector. **Circle (848)**

Chromatek 9100 series: scan converters with auto frequency sensing; broadcast encoder; features luminance key, 24-bit color conversion in real time; zoom function; wide input source selection. **Circle (849)**

Chyron

CODI: compact titler with external RS-232 control; anti-aliased characters with 10ns effective resolution; 16.7 million colors, shaded backgrounds; Bitstream typefaces; composite NTSC, PAL(M), S-VHS, RGB outputs with keying facility. **Circle (850)**

Computer options: single-board for iNFiNiT! using Motorola 68040 with 16Mbyte or 32Mbyte memory. **Circle (851)**

Serial CCIR 601: extended I/O capability for MAX!> graphics systems. **Circle (852)**

Software options: for iNFiNiT!, MAX!>; *Flashfont* real time sizing, italics, edge treatments; *ImageTools* graphics, drawing, paint functions; *FlipBook Animations* real time playback of 3-D animation created in Wavefont systems, transferred to iNFiNiT! or MAX!> systems. **Circle (853)**

The BUG: anti-aliased clock and logo generator; 1- to 8-color logos with <10ns effective resolution; internal linear keyer; for NTSC, PAL(M). **Circle (854)**

Triple Transform: option for iNFiNiT!; permits manipulation of 2-D graphics in 3-D space; applies different effects to individual objects simultaneously. **Circle (855)**

Cine 60

Simultaneous charger: 4-channel; charges four batteries in one hour; 12.5VDC, 60W output operates video camera. **Circle (856)**

The VAMP: volt/amp meter; allows battery characteristics to be tested during use; digital readout, low impedance. **Circle (857)**

Cinekinetics

Micro Jib Pro: arm in lightweight camera support system; 20-pound unit supports 100+ payloads; 6-foot boom travel with 55" radius pan. **Circle (858)**

Circuit Research Labs

Amigo: economy AGC, limiting and FM stereo generator in single package; sound field enhancement feature. **Circle (859)**

Real Time Event Sequencer: 200-event timer with eight contact closures for equipment control; crystal-controlled timebase, battery backup. **Circle (860)**

Clark & Associates

HDS-1000 audio storage: six simultaneous I/O channels; 8 hours of 15kHz audio; non-compressed; requires 5.25" rack space; Instacart emulation. **Circle (861)**

Clear-Com Intercoms

CS-222: 2-channel portable main station with IFB feature. **Circle (862)**

MS-222: 2-channel main station with IFB; rack-mount. **Circle (863)**

PS-22: 1-amp intercom power supply; 2-channel for 30 headset or 10 speaker stations. **Circle (864)**

PS-222: 2-channel portable intercom power supply. **Circle (865)**

PS-454: dual power supply; multifunction rack-mount unit. **Circle (866)**

CMX

OMNI500: editing controller; six equipment control parts operate switcher, 5 VTRs; *Power Pack* extension for seventh port and interfacing to control audio switching, TBCs DVEs, ATRs, etc. **Circle (867)**

Coaxial Dynamics

Model 7998, 7999: variable signal samplers cover 20MHz-1GHz, 1.5MHz-35MHz respectively; available with various in-line connector choices; provides tap from main RF line for spectrum analyzer or other RF measurement. **Circle (868)**

ColorGraphics Systems

DPenhancements: vector-based cel animation scripter *Morph Cel* software; advanced cel *Ink and Paint* software; *Mosaic 25s, 100s* digital disc caches. **Circle (869)**

DP/Animator: central device in graphics suite; provides image manipulation features with 2-D, 3-D scripting tools; optional *Mosaic* disc cache unit. **Circle (870)**

DP/MAX: D-1 video post production system; processes moving video; compositing, real-time color correction, effects, audio scratch track, warp scripter and other features. **Circle (871)**

DP/Painter: paint system generates high-quality graphics; rotoSCOPE, type, mattes; *Mosaic* disc cache option for 25s, 100s storage; upgrade capability. **Circle (872)**

LiveLine 5 enhancements: based on Motorola 68040 microprocessor; 16Mbyte system memory for expanded animation, graphics creation; doubles overlay animation capability; preload animation for instantaneous on-air access; SCSI disk control. **Circle (873)**

Real Time features: compositing, editing, layering and audio capabilities for DP/MAX video workstations; records mattes, image warp effects, chromakey, color correction features. **Circle (874)**

ColorTran

ENR 48 Rolling Rack: dimmer system includes 48 units rated for 2.4kW; 48x96 or 48x192 patch panel; 300-400A main breaker; DMX, AMX, VMX, 0-10VDC control; on 5" casters. **Circle (875)**

PRO PAK: portable lighting kits; using 100-091 Mini Pro, 104-341 Mini Broad instruments; stands, barndoor attachments, other accessories. **Circle (876)**

Columbine Systems

Master Control Automation: PC-, AS-400-based system for any size TV facility; automates airing of all scheduled events; returns as-run schedule to traffic for closed-loop reconciliation. **Circle (877)**

Sales Quadrant: sales analysis prototype, version 2; examines past, present, projected revenues. **Circle (878)**

Comark Communications (Thomson-CSF)

110kW UHF: water-cooled UHF transmitter; two EEV IOT devices; active dual exciter; with Magic Tee combiner. **Circle (879)**

High-power amplifier: for international systems; fully meets IEC-215 spec; EEV 40kW IOT device; compatible with klystron or Klystron devices. **Circle (880)**

LIFE SUPPORT FOR YOUR 3/4" SYSTEM.



INTRODUCING JVC'S 22-SERIES S-VHS EDITING RECORDER

JVC
PROFESSIONAL

Let's face it. Your 3/4" equipment is quickly becoming obsolete. But S-VHS and JVC's new BR-S822U editing recorder can help prolong the life and usefulness of your current system.

Its open architecture versatility gives you the greatest flexibility ever seen in an editing recorder. Its optional Y-688 dub output allows you to send a YC separated signal right into your 3/4" machine. There's a built-in 9 pin serial remote interface, and a plug-in TBC with component

outputs, allowing you to feed your signal directly to Betacam and MII. The 22-Series takes both standard and C-size cassettes without an adapter, and you can even equip it with a time code reader/generator -- all this while delivering the best picture quality ever produced by an S-VHS recorder.

Call 1-800-JVC-5825 for information. Or visit your nearest JVC professional products dealer. Find out how JVC and S-VHS can help you prolong the life of your present equipment.

Circle (33) on Reply Card

www.americanradiohistory.com



Comband Technologies

CT-1000 system: for multichannel, multi-mode scrambling in wireless CATV; includes encoder/IF modulator, system controller, addressable converter; compatible transmission products for MDS, MMDS, ITFS, OFS operations. **Circle (881)**

Communications Data Services

Engineering services: "Real World Propagation" coverage predictions using Sun Microsystems SPARC-based workstation; 3' digital terrain data on CD-ROM; On-line Software for RF engineering. **Circle (882)**

Comprehensive Video Supply

422 data converter: converts RS-232 control signals from PC to RS-422 format for VTR operation. **Circle (883)**

COMTEST: data communications tester; tracks wiring of RS-422 lines. **Circle (884)**

SP-1000P speech prompter: presentation prompter; two 14" VGA monitors, oak grain cabinet enclosures, 45° transparent reflecting mirrors, cables and VGA VDA; CueMaster software. **Circle (885)**

Stage Tape: adhesive-backed cloth tape; leaves no residue when removed from floor, cables. **Circle (886)**

STG-1 safe title generator: per SMPTE RP-27.3 recommendation; creates safe-action/-title markers on screen. **Circle (887)**

CK-2 chroma keyer: NTSC or Y/C input signals; -2A with full-frame synchronizer; -2B with dual frame synchronizer. **Circle (888)**

Nady wireless systems: 4-channel #301 synthesized and #401 discrete wireless mic systems. **Circle (889)**

S-VHS, Y-C breakout cables: 6-foot cables; SAP-YC-6 SAP, 7P-YV-6 RM-7P, 7J-YC-6 RM-7J to two BNC connectors. **Circle (890)**

Comprompter

ENR upgrades: software, interfacing; *GraphicMaster* links to titler; includes capability to specify screen locations; *CaptionMaster* closed-captioning software; *ArcMaster* extended archive facilities software. **Circle (891)**

Computer Assisted Technology

BCAM Ver 2.0: maintenance management software; graphic presentation of accumulated data; output in spreadsheet format; equipment tracking; "On-Line" technical databases by modem. **Circle (892)**

Computer Concepts

Editing option: for DCS digital commercial system automation. **Circle (893)**

Computer Engineering Associates

CEA newsroom system enhancements: full-function with wire capture, assignments, scripting, prompting, inventory, personnel management, machine control inter-

face; spell checking, election reporting, media library management, Chinese language script editing, UNIX. **Circle (894)**

Computer Prompting

CPC-1000D smart display: flat-screen teleprompter display; 8-pound operating weight. **Circle (895)**

CPC-2000: SmartPrompter+ with closed-caption feature; drives prompter, places caption data on line 21 with appropriate encoder/decoder; position control of 2 to 4 lines, 20-32 characters. **Circle (896)**

Comrex

Talk Console: portable talk studio; one or two phone lines, two mic channels; self-adjusting hybrids, mix-minus circuit; dial-cue feature. **Circle (897)**

COMSAT Systems

SureTrack: 3-axis mechanical tracking antenna; high-reliability communications with inclined-orbit satellites using small aperture antennas. **Circle (898)**

TMTV systems: time-multiplexed TV equipment; uses video compression to send two or three video channels through one transponder; scrambling, addressability, two stereo pairs per video channel. **Circle (899)**

COMSAT World Systems

Digital Audio Distribution: international digital service through Intelsat network; for delivery of audio from remote locations, special events; back-haul services; international spot delivery. **Circle (900)**

Intelsat-K: network services through Ku-band satellite. **Circle (901)**

TV scheduling service: short-term, occasional-use, videoconferencing services through satellite network. **Circle (902)**

ComStream

ABR200: digital audio receiver; 20kHz stereo from Ku-/C-band; multirate, multimode integrated decoder; Musicam (ISO/MPEG) compression option. **Circle (903)**

CM236: digital modulator for video networks by satellite; RS-232/-485 remote control port. **Circle (904)**

ComTek

PR-82: miniature wireless mic receiver; IFB, personal communications use. **Circle (905)**

COMWAVE/Communication Microwave

A1-S, SBB-M: low/medium power signal 31-channel boosters; offer +2dBmW, +18dBmW gains. **Circle (906)**

A50S: 50W visual wireless cable, ITFS transmitter; 2-2.7GHz for NTSC, PAL, SECAM; 15W aural output. **Circle (907)**

Concept W Systems

PowerPlex: intelligent remote power systems for cameras operating with coax; *PDC-240* 20W, *-240HP* 31W; powers camera with single coax simultaneously with other bidirectional signals. **Circle (908)**

PP-100 Plus Port Adapter: links camera control units, controllers to Complex systems, PowerPlex; for Sony, Ampex, Ikegami, Hitachi, JVC equipment. **Circle (909)**

PP-40 Plus Port Adapter: option interfaces Panasonic CCUs and digital hand controllers to Complex systems. **Circle (910)**

Connectronics

JB jackbays: construction using 1/4" A-

gauge jacks; fiber glass circuit cards to provide user-defined options; *JB44* 2-row, 22-jack; *JB16* 1-row 16-jack; *JB8000* console "insert points" system with 8 or 16 insert points. **Circle (911)**

XB modular patch panels: using XLR connectors; *XB32* 2 rows, 16 connectors; *XB16* 1 row, 16 connectors. **Circle (912)**

Continental Electronics

419G/420C: shortwave transmitters for 300kW, 500kW outputs; standard, CCM controlled carrier level modulation or SSB operation; RS-232/422 remote control; tetrode final amplifier devices. **Circle (913)**

802B FM exciter: low power transmitter or 5-50W source for high power transmitter system; PLL frequency control. **Circle (914)**

SSM series modulators: high-level digital modulation from 48-module IGBT circuit; supplies controlled DC plate current based on number of modules activated in accordance with audio input level. **Circle (915)**

T line AM: transmitters with solid-state modules; *312T* 300W; *314T* 1kW; *314T-1* 2.5kW; *315T* 5kW; broadband with synthesized frequency control. **Circle (916)**

Cool-Lux

FCR system: fast charger, recycler for NiCad batteries; operates from 120VAC to 12VDC automotive source. **Circle (917)**

Cooper Industries/Belden Div.

#8281: serial digital cable. **Circle (918)**

#9180: digital audio cable. **Circle (919)**

#9292: serial digital cable. **Circle (920)**

Covid

Cactus Cables: 3-, 4-, 5-conductor cables for R-Y/B-Y/Y or RGB use; bulk or precut lengths. **Circle (921)**

Model 650 Series 8: 8-in, 1-out switch; 30MHz bandwidth; -650 for S-VHS, Hi8, ED-BETA; -651 for composite video. **Circle (922)**

Model 913, 915: 200MHz RGB-sync DAS; *913* uses 13W3 I/O connectors; *915* has BNC connectors; 4 or 8 outputs; individual RGB gain/EQ controls. **Circle (923)**

Crouse-Kimzey Company

360 Systems Digicart: random-access digital audio recorder. **Circle (924)**

AKG Tri-Power series: stage mics for vocal, instrumental applications. **Circle (925)**

Audio Arts R-10: audio mixer. **Circle (926)**

Telos hybrids: Telos 100 Delta, One-plus-One. **Circle (927)**

Crown International

CM-230: tridundant mic; one housing, three supercardioid capsules, with individual transformer-isolated outputs. **Circle (928)**

CM31: miniature condenser mic; 30-foot cable, connects to in-line electronics interface; offers phantom power, static and RF interference protection. **Circle (929)**

LM-301, LM-300L: miniature dual gooseneck condenser microphones. **Circle (930)**

PCC-170: multifunction supercardioid boundary microphone. **Circle (931)**

SASS-P MkII: stereo ambience microphone. **Circle (932)**

SMX-6: digital 6x programmable audio mixer. **Circle (933)**

CSI Camera Support International

Daiwa dollies: positive tripod leg attachments, locks; *DL3* 25-pound, *DL30* 65-pound loads; polyurethane tires. **Circle (934)**

Daiwa systems: pan/tilt head with tripod



**When the little door opens,
a world opens with it.**

Imagine.

You can give your studio clients a CD reference of the day's work. You can compile commercial spots on compact disc. You can build your own CD-quality sound effects library.

The YPDR601 makes it all possible. It is the Yamaha Professional Compact Disc Recorder. And it lets you record onto compact disc with the ease and flexibility of recording onto cassette.

The YPDR601 lets you interrupt recording whenever you want. It's the only CD recorder that allows you to play an unfinished disc, as is, on any standard compact disc player. And the YPDR601 allows you



compact disc player. And the YPDR601 allows you

to go back and add to a partially recorded disc. Just load the disc and continue recording.

The YPDR601 can accept multiple analog and digital formats. It provides control ports that enable hands-free recording from professional R-DATs and audio sources with timecode. And you'll be pleased to learn that the YPDR601 is as affordable as it is flexible.

Call Yamaha at 1-800-395-1313, ext. 300, for more information about the exciting YPDR601 and the entire line of Yamaha Digital To Digital products.

Isn't it amazing what one little door can do.

YAMAHA®

© 1992 Yamaha Corporation of America, Professional Digital Products, P.O. Box 6600, Buena Park, California 90622-6600 (714) 522-9011

T H E Y A M A H A C O M P A C T D I S C R E C O R D E R

Circle (34) on Reply Card

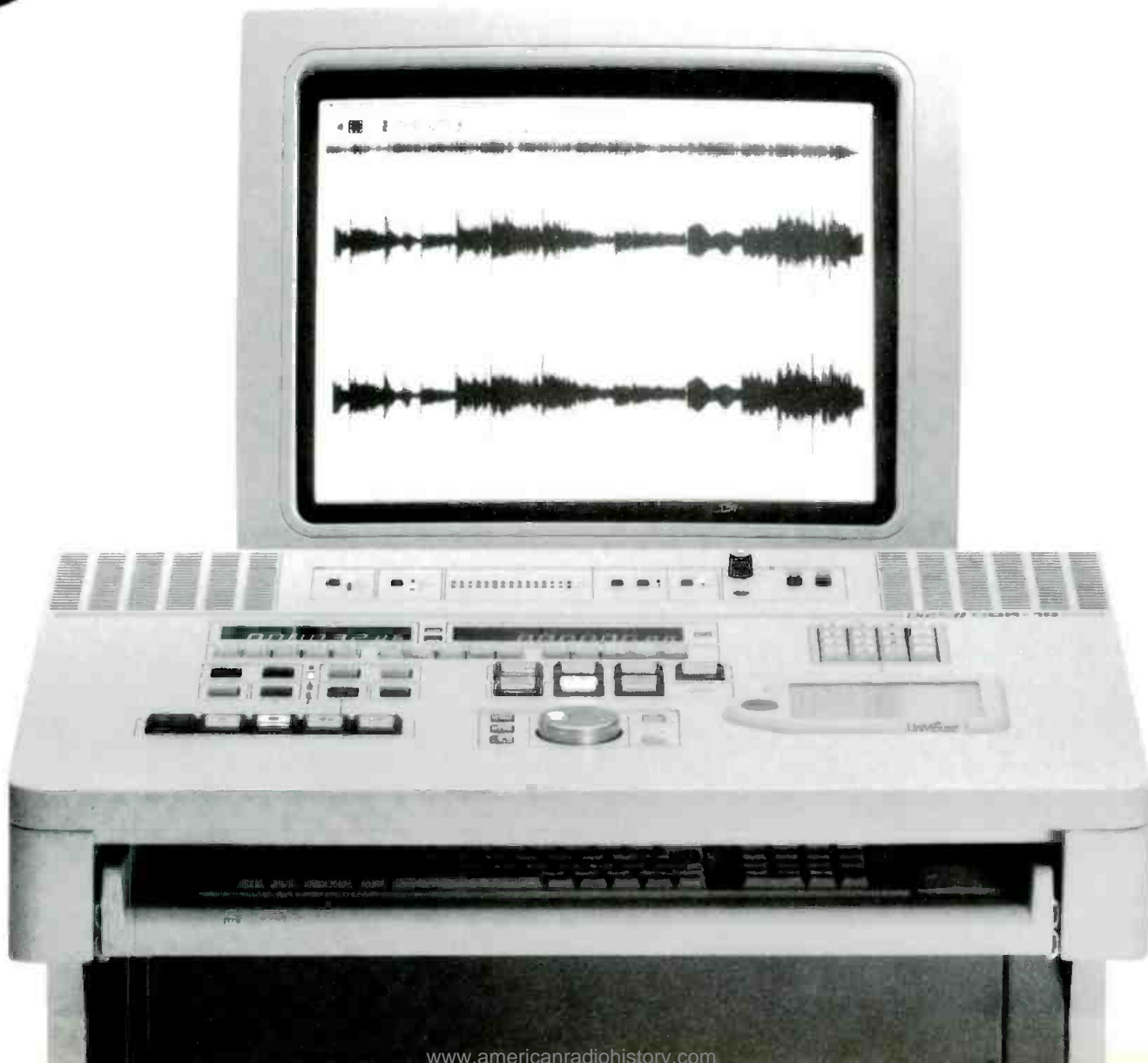

**RADIO'S TOP TEN! OTARI GIVES
YOU BETTER CHOICES.**

Otari's new audio recorders for radio give you features to fit any application or budget. This means you're not forced to make compromises when choosing a recorder, so your station sounds better to listeners, and is more efficient. And, of course, Otari's legendary reliability means less down-time.

On the forefront, there's a line of digital disk recorders including the new 2-track DDR-10, and the ProDisk 164 with up to 64 tracks for multitrack production.

Then, Otari's famous "work-horse" 5050 B11 machine, the choice of radio professionals the world over, has become the B11 – just as tough, and twice as easy to use. And it has all the things you asked for, like a Q speaker, independent left/right reel size select, dynamic braking, and much more!

A new line of 2, 4 and 8-track machines, the 5050 MKIV Series, delivers state-of-the-art performance, plus features that will make your life easier, like a built-in autolocator with 3 one-touch, cue-point memories and return-to-zero.

Don't forget the MX-5011; a professional 2-track with a price that will astound you, and the MX-55 with all the features you'll ever need today, or tomorrow. (The "5011" and the "55" both offer a Voice Editing Module for normal pitch at twice play speed.)

Then there's our multi-tracks, from 32 tracks on down, at almost every price level – 8 machines, 12 different versions! And, of course, the CTM-10, a high performance cart machine we built for perfectionists, and an automated radio station reproducer.

Before you purchase *any* audio machine, look into Otari's line-up for the broadcaster. We think you'll find exactly what you need, at a price that fits your budget. Call Otari at (415) 341-5900 for more information.



OTARI

Circle (35) on Reply Card

NAB '92 - Show of Shows

for 8 to 35 pounds; single-, double-handle options; tilt, pan locks. **Circle (935)**

CTE International

S/22 exciters: mono, stereo; meets FCC, CCIR, CIRT spec; 20W from modular, redundant design. **Circle (936)**

VL/1000: 1kW solid-state FM amplifier; four MOSFET 250W modules; diagnostic features; 25-30W RF drive. **Circle (937)**

VL/30 exciter: 30W output meets FCC, CCIR spec; programmable via RS-232 to control transmitter from a remote PC. **Circle (938)**

Cycle Sat

Automation Protocol Converter: routes 38.4kbaud data from Cyclecypher receiver for direct serial data interfaces in TV station automation system. **Circle (939)**

D

da Vinci

3/2 edit package: for da Vinci and Renaissance series; aligns telecine with recording VTR. **Circle (940)**

EDIT/2V, /3V options: VTR/telecine editing for da Vinci products; various configurations of recording VTRs with tape and telecine source transports. **Circle (941)**

Renaissance 8:8:8: color correction to CCIR-601 spec; 27MHz sampling with 16-bit video path; real time programmable processing; software-driven. **Circle (942)**

Data Security

Tape Enhancement Series: tape cleaning, diagnostics; *TapeChek* by RTI. **Circle (943)**

Datatek

D-2530: serial digital video routing switcher with 20x10 to 40x40 matrix. **Circle (944)**

D-2700DAS: AES/EBU digital audio router; transformer coupling; reclocking and regeneration feature. **Circle (945)**

D-2700DVS: serial digital video router; 64x64 to 256x256 arrays. **Circle (946)**

D-890: digital audio 1x6 DA. **Circle (947)**

D-891/D-892: digital audio A/D and D/A converter modules. **Circle (948)**

DDA/Mark IV

Interface console: 8- to 32-channel mixers; four group buses, six auxiliary buses; optional I/O transformers isolate electronically balanced XLR connections; joint project by DDA, Dynacord. **Circle (949)**

Decision, Inc.

Automation Interface: reduces log processing time and errors. **Circle (950)**

OrderCalc: electronic order calculator; eliminates many errors typical of hand-written orders. **Circle (951)**

Power-Windows: adaptation of *Broadcast System III* software to X-Windows under UNIX; package includes Sales, Broadcasting, Traffic activities. **Circle (952)**

VIEW: screen-oriented *Broadcast System III* system; improves productivity. **Circle (953)**

Dedotec USA

DP-2 projection attachment: attaches to Dedolight Gaffer instruments; integral 4-leaf framing shutters for quick setup, flexible light control. **Circle (954)**

Delta Electronics

ASE-2: high-performance AM stereo exciter; C-QUAM format. **Circle (955)**

Denny Manufacturing

Electravision electronic proofs: EV-2000 system; operates side-by-side with photographic camera to record video proofs of photo shoot. **Circle (956)**

DENON

BU-181: event controller for DN-7700R CD recorder/player system. **Circle (957)**

DN-951FA: CD part player; on-air CD playback system; *AutoTrack* selection mode; streamline profile, rugged transport with simple operation. **Circle (958)**

DN-961FA player: drawer load, unload feature; three units fit in 19" rack. **Circle (959)**

TU-680NAB: AMAX AM broadcast monitor; NRSC compatible with selectable bandwidth IF; C-QUAM stereo. **Circle (960)**

Di-Tech

#5430-I router: 16x1 stereo AFV switcher in 1 RU; 30MHz video bandwidth; RS-232/422 port; 3-level breakaway. **Circle (961)**

#5434 router: 12x4 stereo AFV routing switcher; 1RU package; 3-level breakaway; 30MHz video bandwidth; RS-232/422 control port. **Circle (962)**

Meridian routers: video 5881 and stereo audio 5882 frames with 128x160 matrix; 4:1 size, 3:1 power reductions over typical routers; expansion to 1,024x1,024 **Circle (963)**

DIC Digital

4-2.0GB: 90m, 4mm data grade cartridge medium; 2Gbyte storage. **Circle (964)**

MO-128MB: 128Mbyte rewritable magneto-optical disk; 3.5"; Microfinitivity protective coating. **Circle (965)**

Dielectric Communications

UHF FLAGPOLE: low power UHF TV antenna; flagpole design; install wherever a flagpole can be mounted; CP or HP; 1 5/8" EIA input; internal pressure seals; radome enclosure; patterns on file with FCC for quick application processing. **Circle (966)**

Digidesign

GMR ProArchive: tape backup system for Digidesign audio systems; 8mm and 4mm media units. **Circle (967)**

Pro Tools Multitrack: digital record, playback in 8, 12, 16 channels; enhanced timecode entry, fine tuning of regions; Grid mode snaps edit to selected degree of quantization. **Circle (968)**

ProSonus ProFX: CD ROM library; sound effects and ambient sounds from Sound Ideas library; formatted for ProTools and SampleCell. **Circle (969)**

Sound Tools II Ver. 2.2: records direct-to-disc; extensive editing, signal processing; playback of CD-quality audio; Motorola 56001 DSP chip; time compression, expansion, pitch shifting. **Circle (970)**

Digital Arts

RenderManager: for Iris Indigo or 386/486-chip PCs; rendering, drawing, animation, font management, geometry database features; 3-D environment; extensive "surface appearance" library. **Circle (971)**

Digital Creations

DCTV: Digital Composite TV; video display, digitizing system for Amiga; digitize, paint features. **Circle (972)**

SuperGen2000s: Y/C gen-lock, overlay card for Amiga 2000 PCs; compatible with S-VHS, ED-Beta, Hi8; RS-170A output. **Circle (973)**

Digital F/X

Composium V 4.0: upgrade expands channel, edit control capabilities for editing; *PAN F/X* second layer of motion; *Stretch, Average, 3:2 compress/expand, Snapshot, Ethernet* features. **Circle (974)**

DDR-100 control panel: operates DDR-100 disk recorder as stand-alone device with editing or telecine use. **Circle (975)**

F/Xternals demo: open architecture feature; control third-party devices from Video F/X editing system. **Circle (976)**

Paint F/X DL+ Graphics: to create multi-layer effects and animations. **Circle (977)**

TitleMan: PostScript title generator; uses PostScript fonts; bridge between Macintosh and on-line edit suite. **Circle (978)**

Video F/X Plus: improved control panel, jog/shuttle, Midi support; exports EDL in CMS, GVG, Sony protocol; Sony LVR-5000A support; effects, graphics and animation functions enhanced. **Circle (979)**

Digital Processing Systems

DPS-230: component transcoding TBC; composite, S-VHS I/O; color balance control; μ P-controlled proc amp, digital panel setup memory; compatible with Personal series products. **Circle (980)**

ES-2200 expansion system: rack-mount chassis for two Personal Series cards, frees expansion slots in the PC. **Circle (981)**

Personal TBC II Ver 2: for Amiga, includes AREXX support, controls for V-Scope monitor, access from Video Toaster; expands file storage, user source labels. **Circle (982)**

Personal VDP: plug-in card provides 1x4 video distribution. **Circle (983)**

VM-2000 Personal V-Scope: waveform, vector monitor on plug-in card for Amiga 2000, IBM PC/compatible, Video Toaster workstations. **Circle (984)**

Digital Vision

DVIS 1000: digital image stabilizer; reduces undesirable 2-D motion from camera or telecine; detects 2:3 sequence; advanced movement filters used in PHAME motion estimation technology. **Circle (985)**

Model ASC: dust, scratch, tape dropout concealment; upgrades DVNR 1000 range, available as stand-alone unit; conceals negative, positive film dust; replaces chemical, electrostatic treatment or a companion to such methods. **Circle (986)**

DN Labs

DURAPAR 4000: 4kW HMI PAR light; output equal to 12kW. **Circle (987)**

DURAPAR 6000: 6kW HMI. **Circle (988)**

SPECTRA-FLUX 1200: 21" broad; soft daylight at 5,600°K; 1.2kW with diffusion module. **Circle (989)**

SPECTRA-FLUX 200T: 100W or 200W soft light; on-camera unit uses halogen lamp; battery power. **Circle (990)**

Dolby Labs

DP5500 STL: 950MHz; for 2 audio, 2 aux channels; 250kHz bandwidth; AC-2 coding, digital RF modulation. **Circle (991)**

Model DP90: 2-channel AC-1 digital encoder; for point-to-multipoint and direct-to-consumer broadcast where low-cost decoders will be used. **Circle (992)**

SRP series: 24-track Dolby SR processor;

There are many reasons to keep using your tried and tested tube cameras. Apart from being major investments in your studio line-up, there's the high resolution, low lag and exceptional picture quality you can achieve with them.

Of course, the best tube cameras depend on the best camera tubes. So you need to be assured of their continued availability.

GOOD FOR YEARS TO COME.

Philips has made a firm commitment to keep producing the Plumbicon range of camera tubes. With a reputation earned in the world's most popular cameras, they're sure to be in demand for many years to come.

So long as there's call for the high quality images Plumbicon tubes can provide, we'll continue to provide Plumbicon tubes.

Year after year after year.

Philips Components, Discrete Products Division, 100 Providence Pike, Statersville, Rhode Island 02876, USA. Fax: +1 401 767 4493.
Philips Components, Customer Service Centre TV Camera Tubes, P.O. Box 218, 5600 MD Eindhoven, The Netherlands. Fax: +31 40 583177.

Philips Components



PHILIPS

Circle (36) on Reply Card

www.americanradiohistory.com

NAB '92 - Show of Shows

contains I/O amp/level control, 4-LED calibration display, bypass. **Circle (993)**

Doremi Laboratories

Digital Dawn: digital audio workstation nucleus; editor in Mac-based workstation; simulates multitrack recording with MIDI, SMPTE compatibility. **Circle (994)**

Duggan Manufacturing

Triopines: casters, wheels; types for light-to heavy-duty requirements. **Circle (995)**

Dwight Cavendish

CS-812: video play system for automated playback with eight VCRs. **Circle (996)**

VP-738 router: 10x10 matrix; loop-through video, balanced loop-through stereo audio; RS-422 control interface. **Circle (997)**

VS628-01: QC monitor, system controller; to 2,500 VCRs; includes defective cassette ejection. **Circle (998)**

VS628-04: QC monitoring interface; 10x1 with stereo audio. **Circle (999)**

AerosonicDOC 5001 verifier: mirror-mother verifier; dual PC-controlled 5001 units; for QC dup control. **Circle (1000)**

AerosonicVPT 9100, DOC 5001: pancake media tester; drop-out counter, signal evaluator. **Circle (1001)**

DX Communications

CATV accessories: modulators (DHM FM, DSM CATV); combiners (DHA active, DHP passive); downconverters, LNBS (DSA series). **Circle (1002)**

DIR series receivers: Ku-/C-band reception for broadcast, CATV; integral VideoCipher

II Plus descrambler; DIR-647 CATV. -657 Broadcast/CATV. **Circle (1003)**

DSA receivers: agile, synthesized satellite receivers; DSA-656 broadcast/CATV, DSA-646 CATV/private network. **Circle (1004)**

DYNAIR Electronics

DYNA MUX: stereo audio for Series 400 RS-250C short haul fiber links. **Circle (1005)**

DYNA VIEW: Series 400 video fiber link to 15km (9.3mi); permits 5Vp-p I/O amplitudes for special analog needs. **Circle (1006)**

Line Distributor: for multiple home run control of DYNASTY routers; PCA-941A 1x8 fiber, PCA-940A 1x20 coax. **Circle (1007)**

MiniStar control panel: option for MiniStar enables signal preview before take, for error-free switching; for all DYNAIR routers. **Circle (1008)**

MP9230A system controller: STARPAK 35 option; enhanced logical GUI display; 8-level control, disk storage; password, destination locks for critical signal paths. **Circle (1009)**

Dynatech NewStar

Delta Graphics: interface Quanta Delta free-form text, image generator to NewStar II automation; software, dedicated machine control device. **Circle (1010)**

LEADER election system: operates on PC2 and Zentec workstations. **Circle (1011)**

NewSearch: database processor for news archival retrieval; index-based approach scans script files. **Circle (1012)**

NewSpell Program: spell check, thesaurus on NewStar PC2 workstations. **Circle (1013)**

NewStar I EDSI drive assembly: improves reliability and data integrity in backup systems. **Circle (1014)**

NewStar II: Ver 2.0 release. **Circle (1015)**
Version 5.0: enhances speed, reliability of system; TMP board increases memory, features and functions. **Circle (1016)**

E

Echolab

dcf digital comb filter: NTSC, PAL decoder using 3-line adaptive filter; produces YPrPb components. **Circle (1017)**

PC-1, PC-2: video switchers on IBM plug-in cards. (See Pick Hits) **Circle (302)**

Editing Machines Corporation

EMC-CUTS: finishing editing system; uses analog VTR or videodiscs, instead of digitized video on disks. **Circle (1019)**

EMC-Producer: script-based non-linear video editing control system. **Circle (1020)**

EMC-TRACKS: digital non-linear audio workstation; use with EMC² or independently to play eight CD quality tracks; editing, mixing capabilities. **Circle (1021)**

Editing Technologies Corporation

422MIDI: interface editing controller to MIDI-compatible audio mixers; by Software Systems/Sierra Madre. **Circle (1022)**

Ensemble Pro: videotape edit control; PC-based for 2-, 3-, 5-VTRs; serial switcher control and GPIs; 10-lists, 2,000 events per list; auto clean, quick clean, back trace and auto assemble features. **Circle (1023)**

EDX Engineering

Engineering software: PC programs for coverage, path, contour studies of transmitted signals. **Circle (1024)**

Theft in Progress.

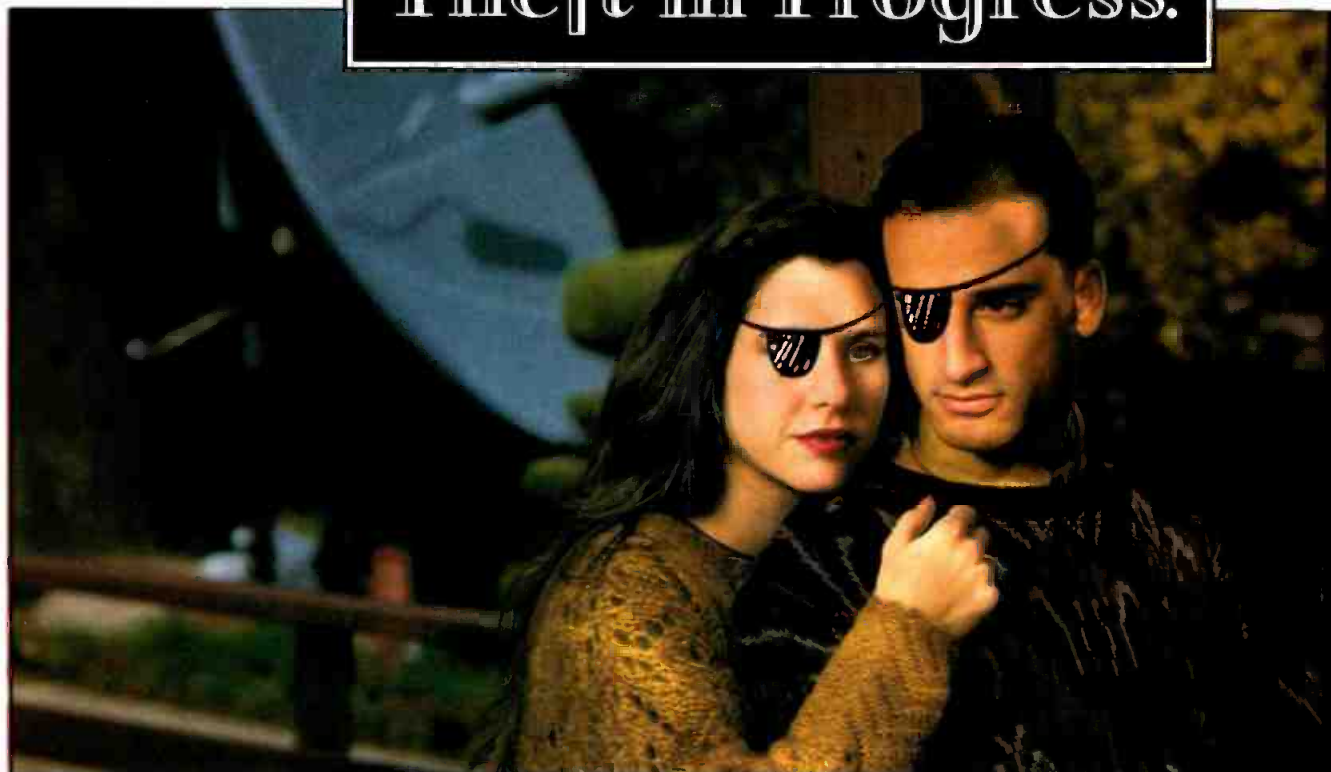

MACROVISION UK, LTD., MIDDLESEX, ENGLAND, TEL: 44-895-251602 MACROVISION JAPAN, TOKYO, TEL: 81-33-350-4050 MACROVISION, USA, MOUNTAIN VIEW, CA, TEL: 415-691-2900



POP-90: PC software for demographic analysis inside station coverage areas based on 1990 census data. **Circle (1025)**

EEV

Power tube enhancement: improved mesh filament design extends longer life; reduces noise, warm-up variations; on 4CX tetrode products. **Circle (1026)**

EG&G

FlashGuard 3000: integrated red-and-white beacons. {See Pick Hits} **Circle (312)**

equipment

The Grip Kit #208: two offset arms; male, female euro couplings; provides a variety of camera positions. **Circle (1028)**

The Sky-King crane #133/SK: supports two people to height of 21'8". load to 550 pounds. **Circle (1029)**

Electric Image

ELAS V1.5 animation: free upgrade for registered owners; shadow casting, transpar-

ency, environmental mapping, *Project Window* interface; event-based choreography in time, keyframe or frame. **Circle (1030)**

Electro-Voice/Mark IV

CS-200 back electret mic: cardioid polar characteristic for use when acoustic feedback is high. **Circle (1031)**

635A/B, RE50/B: optional black finish for ENG/EFP mics. **Circle (1032)**

CO-100 back electret mic: omni for use when feedback is minimal. **Circle (1033)**

EV 319: suspension shock mount for EV RE38N/D microphone. **Circle (1034)**

Electronics Diversified

2x2x12 Road Rack: portable dimmers in compact package; 400A disconnect; 48 2.4kW dimmers; Multi-Link selectable among DMX-512, AMX-192, RS-422 or 0-10 analog protocol. **Circle (1035)**

EnAct series: lighting control; define macros; SVGA display; edit functions; facilities for 200 or 400 control channels; to 500 cues stored on each 3.5" disk. **Circle (1036)**

Electronics Research

Series 1010: panel, directional antennas; medium power to 9kW/level and 27kW/system; for multiple class A facilities or directional antenna. **Circle (1037)**

Series 950 combiner: 30kW unit requires no assembly; suitable for use with 1010 panel antenna. **Circle (1038)**

Electrorack

EVF Electrovideo racks: 19" equipment cabinets, enclosures; full lines of accessories. **Circle (1039)**

Electrosonic Systems

Philips video displays: Procube II ESI5055 remote control; ImageMag 2 ESI 5554 2x2 processor; ImageMag 3 ESI 5559 3x3 video processing unit. **Circle (1040)**

Elenos

Compact Series power transmitters: FM RF cavity amps, 750-2000W range; based on 3CX800A7, 3CX1500A7 triodes; single- or 3-phase power; meet CCIR, FCC, ABU regs, NAB recommendations. **Circle (1041)**

T series transmitters: FM RF cavity amps; T5000 5kW to T20000 20kW use 3CX device. T30000 30kW uses 4CX20000D. **Circle (1042)**

EMCEE Broadcast Products

AM LINK: TV18 transmitters, receiver for 18.1-18.65GHz wireless cable. **Circle (1043)**

Phase Lock control system: phase locks up to 31 transmitters at a site with a stable reference oscillator; optional multisite lock with additional hardware. **Circle (1044)**

SITE LOCK control systems: maintains carrier frequency within ± 27 Hz at 2.7GHz; for local or satellite reference and distribution network to 31 transmitters. **Circle (1045)**

EMCOR/Crenlo, Inc.

Emcor Enclosure Guide: ESQ, Series 10, Emcor I enclosure systems. **Circle (1046)**

Energy-Onix

IPA-300, IPA-500: solid-state IPA units replace tube-type models; 300W, 500W ratings. **Circle (1047)**

SSA series: portable LPMF amplifiers; 100W, 300W, 500W systems. **Circle (1048)**



ou can stop video pirates

cold—with Macrovision. Our VES* transmission scrambling series is your best insurance against unauthorized viewing of *program backhauls, network feeds, live PPV events, business teleconferences, private network transmissions.*

For complete details on the VES series and a free Macrovision video demo call 415-691-2909 or fax 415-691-2999.

MACROVISION

Protecting Your Image

*Video Encryption System—Call for your free video demo, it's data you can use.

MACROVISION IS YOUR

ASSURANCE OF EXCELLENCE

IN VIDEO SECURITY

TECHNOLOGY. EACH SYSTEM

IS SIMPLE TO OPERATE.

EASY TO INSTALL, AND PORTABLE



A FULL LINE OF

NTSC/PAL SYSTEMS FOR:

TRANSMISSION SCRAMBLING

RECORDABLE SCRAMBLING

COPY PROTECTION

Circle (37) on Reply Card

NAB '92 - Show of Shows

The Legend series: solid-state FM transmitters; 1kW-10kW. **Circle (1049)**

ENG Mobile Systems

ENG/EFP, C-Vans: combined standard, optional and custom features for mobile production vehicles. **Circle (1050)**

Ensemble Designs

DP-2 processing amp: digital composite video; compatible with D-2/D-3; front panel adjustments. **Circle (1051)**

Enterprise Electronics

DWSR-90CTV enhancements: Doppler weather radar; EEC RADSYS 2000 display/control with 486 PC/DOS 5.0; 8Mbyte RAM, 40Mbyte hard drive; AT&T Vista graphics PCA, 14" VGA monitor; 19" RGB display monitor; NTSC encoder; map builder, movie-loop playback; programmable sequencer. **Circle (1052)**

ESE

ES-215P4, ES-216P4: audio level meters; LED units simulate VU meters; peak, average modes; mono, stereo/dual mono, dual stereo models. **Circle (1053)**

ES-219: 4-output RS-170A blackburst generator; PAL options. **Circle (1054)**

ES-233: fade-to-black uses digital attenuator for linear, repeatable fade rate; trigger from front panel or external momentary contact closure. **Circle (1055)**

ES-237: 1x4 120MHz video DA. **Circle (1056)**

ES-2695, -2743A: SMPTE-to-ESE, ESE-to-SMPTE companion time-code conversion system. **Circle (1057)**

ES-ACM7: encodes seven audio channels to one signal for recording on a VCR video channel. **Circle (1059)**

Euphonix

CSII console: digitally controlled analog mixer; Total Automation routing, control, processing functions; SnapShot Recall resets console to reset status. **Circle (1060)**

CSII control: digital module integrates Support Computer, Dynamics Processors; QWERTY keyboard, track ball, color LCD display. **Circle (1061)**

Visual Dynamics: for CSII mixer; multiple processors configure to compression, limiting, expansion and gating. **Circle (1062)**

Euro Tech

AXYS monitors: self-powered audio monitor products; Flex, Repra series; various component configurations. **Circle (1063)**

Eventide

H3500 Dynamic Ultra Harmonizer: 18 algorithms extend standard Harmonizer effects capabilities, including sampling, delays, pitch-shifting, etc. **Circle (1064)**

F

Fairlight ESP

Edit Decision List: for MF2 digital audio production system; compatible with DigitEyes Shotlister using captured video; no manual list writing. **Circle (1065)**

Faroudja Laboratories

LD100 line doubler: accepts NTSC, S-video inputs; high-resolution images by line doubling; available for PAL. **Circle (1066)**

FAST Electronic

Mobile Multimedia: DVI board for laptops; synchronizes DVI, VGA signals through color lookup table; drives Toshiba laptop LCD display. **Circle (1067)**

Video Machine: complete video studio for desktop use; edit, mix live video, computer graphics, animation; special effects library; for PC, Macintosh. **Circle (1068)**

Fiber Options

Series 120B: long-haul video transmission to 40,000 feet on single-/multimode fiber with 6-10MHz bandwidths. **Circle (1069)**

Series 130B: bidirectional 10MHz video system; single optical fiber may carry 18kHz audio signal. **Circle (1070)**

Series 1703V: RGB video transmission with AGC maintains signal integrity to 3km; computer graphics applications. **Circle (1071)**

Series 170B: video transmission system for runs to 1,000 feet; 10MHz video bandwidth with >54dB S/N. **Circle (1072)**

Series 240B: video, audio transmission with single fiber; 20Hz-8MHz video, 20Hz-20kHz audio; for production center, TV station applications. **Circle (1073)**

Series 242B: video, data transmission on single fiber carries RS-232/422, Manchester, TTL data, high-quality video. **Circle (1074)**

Series 245B: 2-way video, audio, data transmission on single fiber carries RS-232/422, Manchester, TTL or contact closure data types. **Circle (1075)**

Series 310B: audio transmission for routing to editing, master control operations, link to and from transmitters. **Circle (1076)**

Fidelipac

Elite series: Murphy modular furniture for the broadcast studio. **Circle (1077)**

Series VI: audio consoles for on-air by Broadcast Audio Division; 8- to 24-channel, three stereo, one mono output on 12- to 24-channel systems. **Circle (1078)**

FJ Westcott

Halo, Apollo: light reflectors; silver, gold, blue metalized interiors. **Circle (1079)**

Illuminator backgrounds: portable, collapsible units, various colors. **Circle (1080)**

Light reflective umbrellas: soft white, metalized silver, gold, blue. **Circle (1081)**

Silks, Flags: framed material providing one-to two-stop lighting control **Circle (1082)**

Flash Technology

FTS 2100 SMART: System Monitoring And Reporting Telemetry; a self-evaluating obstruction lighting system. **Circle (1083)**

Flat Antenna Ltd.

150 series: Ku-band antenna attaches to flat surface, creating minimal windload with low structural load; multisatellite reception with no moving parts. **Circle (1084)**

FloriCal Systems

AirBoss: automates TV on-air switching; analyzes incoming signals to determine times for network feeds; auto cues tapes to start of program segments; machine, switcher control; accepts traffic schedule and ShowTimer cue times. **Circle (1085)**

FM Systems

ALM 673: dual mono audio level master; maintains constant volume with 30dB range of input variance; operate as independent channels or in stereo mode. **Circle (1086)**

ATIS EATER: filter removes auto transmit

ter ID signals to avoid crosstalk in the demodulator. **Circle (1087)**

Camera Master: held-held digital meter for sync, white, iris, focus and color burst from any video source. **Circle (1088)**

Focal Press

Industry books: *Global Telecommunications; TV and Video Engineer's Reference Book; The Broadcast Century; Broadcast Technology Worktext; Art of Digital Audio; Creative Radio Production* **Circle (1090)**

FOR-A

5 Plus 1 Multi-Viewer: split screen presentation of five 1/9 non-synchronous images with sixth 1/9 picture on a standard NTSC monitor; pick any of the six for large image; freeze any or all images. **Circle (1091)**

EC-780: edit controller; 127-event memory with A/B roll for serial/parallel control VTRs. **Circle (1092)**

EC-800 edit controller: A/B/C roll editing; 256-event memory, edit list; RS-422 serial, parallel VTR interface; GVG-100, 1680, RS-422 switcher protocol. **Circle (1093)**

FA-510 Masters Series: TBC, recursive noise reduction in luminance, chrominance; color correction for red/blue, white/black balance, Y gamma control. **Circle (1094)**

FA-810: 4-field synchronizer; median noise reduction filter option; 10-bit digital encoding. **Circle (1095)**

HMC-1010: high-resolution digital camera; high speed image capture to 1,024x1,024; precision RGB registration; TGA, TIFF, PICT graphic file output; one CCD. **Circle (1096)**

HMC-1060: Multicam high-resolution still picture projection system. **Circle (1097)**

MF-3000S: Multiflex effects generator; Image-Flexor page effect shows A/B sources on opposite sides of page. **Circle (1098)**

MF-4000 Hyperflex: Multiflex digital effects generator; full 3-D features, page-turn and wraps. **Circle (1099)**

SLD-200: scan line doubler; effectively removes scan lines often visible on large screen projections or CRTs; retains field frequency. **Circle (1100)**

VPS-510S: video production system; dual TBCs, switcher, dual effects channels features with variable compression; Y/C and composite inputs; DSK uses RGB or component insert video. **Circle (1101)**

Forecast Installations

Consoles, cabinets: custom designs for video production facilities. **Circle (1102)**

Fostex

Model D-20B: upgraded D-20 digital master recorder; time-code generator, chase-lock synchronizer; time-code translation or chase without TC conversions; operates like 2-track center-track TC deck; pre/post TC stripe feature. **Circle (1103)**

Model PD-2: 4-head portable time-code DAT recorder; off-the-tape confidence monitor; internal generator; all four format; jam sync; time code loop and output jacks; video sync, work sync I/O. **Circle (1104)**

SP-32 speaker: 2-way system for commercial PAs; 30cm woofer, square horn tweeter; 250W amplifier; inputs for mics or other sources. **Circle (1105)**

Frezzolini Electronics

AR-30: μ P-controlled fast charger; 12-30V, single-channel; **AR-30/4** 4-channel system with integral sequencer. **Circle (1106)**



ZIP LOCK.

If you've ever dealt with a 2" 24-track whose synchronization was a design afterthought, you'll appreciate the speed and pinpoint accuracy of the TASCAM ATR-80. Its microprocessor-controlled transport is specifically designed for the repeatable locating you need for no-excuses, extra-fast lockup in synchronized operation. And the punch in/out precision you demand.

Built with legendary TASCAM reliability, the ATR-80 will continue to get the job done—session after session, project after project. It is also plug compatible with Dolby SR racks. Available in a higher capacity 32-track format. And, of course, accommodates 14" reels.

But, you be the judge.

To arrange for a personal demonstration of the rapid-response ATR-80, just call (213) 726-0303. Or write TASCAM, 7733 Telegraph Road, Montebello, CA 90640.

TASCAM II.



AR15: μ P-controlled fast charger for 6-15V range; 1-channel; **AR-15/4** for 4-channels with integral sequencer. **Circle (1107)**
Solar Charger: ENG battery, super-compact solar charger. **Circle (1108)**

Fujinon

A14x8.5EVM: balanced, hand-held lens for $\frac{2}{3}$ " cameras; f/1.7 to 103mm, f/2 to 119mm; MOD 2.6 feet; more comfortable hand grip and control; 2x extender. **Circle (1109)**
A18x8.5EVM, S18x6.6EVM: for $\frac{2}{3}$ ", $\frac{1}{2}$ " cameras; multiposition servo grip, multistep zoom speed; 2x extender. **Circle (1110)**
A20x8BESM, A20x6.2ESM: $\frac{2}{3}$ ", $\frac{1}{2}$ " lenses for studio production; reduced chromatic aberration, flare, reflections; improved modulation transfer function; 2x extender; 0.6m MOD. **Circle (1111)**
A24x11.5ERD: compact lens for hand-held cameras; f/2.0 11.5-207mm, f/2.7 at 276mm; MOD 1.8m; 2x extender; 6 lb. **Circle (1112)**
A8.5X5.5EVM, A8.5X4.2EVM: lenses for $\frac{2}{3}$ ", $\frac{1}{2}$ " cameras; VM series includes 5-position servo grip, user-selected zoom speeds; 1.7x extender; 0.3m MOD. **Circle (1113)**
HR22x18ES: high-definition unit with f/3.4 maximum aperture; zoom ratio selection of 10x or 22x; 2x extender. **Circle (1114)**
HR6x12ERD: HDTV lens for 1" cameras; 2x extender; f/2.2 to 72mm, f/4.4 at 144mm; 0.9m MOD. **Circle (1115)**
Tips on Optics: 20-page pocket guide to lens selection. **Circle (1116)**

Full Sail Center for Recording Arts

Technical School: instructional and production facility. **Circle (1117)**

Future Productions

AVD-10, AVD-24: audio, video DAs for duplication systems; unbalanced RCA, balanced XLR audio. **Circle (1118)**

FutureVideo

Pro MkII, Pro/TC MkII: edit controllers; reads 8mm RC time code of Hi8 camcorders for ± 3 frame accuracy; TC model also supports SMPTE/EBU LTC. **Circle (1119)**

FWT

COW tower: portable, quick-elevation towers to 80 feet; reduces twist and sway to less than 1" in 50mph wind; (Cell-site On Wheels). **Circle (1120)**



G&M Power Products

GM30B Lighting Belt: sun-gun battery with 30V 4Ah rating. **Circle (1121)**
GM4X1NP charger: simultaneously charges four NP1A batteries within one hour. **Circle (1122)**

Garner Industries

Model 682 series: 680 series degaussers; open top design; erases 850 Oe media in one pass; multiple passes ensure erasure of 1,000 Oe media. **Circle (1123)**

GE Projection Display Products

Imager: large screen projector products for presentations of video, data and computer workstation outputs. **Circle (1124)**

Gefen Systems

Filemaster: for AKAI DD1000, AMS Audiofile Plus, Lexicon Opus, Panasonic SV3900; auto transfer of sound effects from CDs to the audio/editing system. **Circle (1125)**
NSM CD 3101: 100-CD changer performs preprogrammed "concerts." **Circle (1126)**
Pioneer CVC-V3000: 300-CD changer with software for PCs, Mac. **Circle (1127)**
SFX libraries: various collections; *Sonic Boon, BBC, DigiFFelts, ...* **Circle (1128)**

Genesis Microchip

Acuity gm865x1: image resizing engine; independent height, width resizing in real time; 8-bit input to 1,024 pixels per line per chip; 64x zoom function. **Circle (1129)**

Gennum/Video-Broadcast

GB4600: unity-gain video buffer **Circle (1130)**
GX4314L: low power, wideband 4x1 video multiplexer device. **Circle (1131)**

Gentner Communications

Audisk: digital audio storage, replaces standard tape cart machines **Circle (1132)**
Digital Hybrid I: digitally processed hybrid for on-air, recording; 16-bit DSP, 2x oversampling at 10kHz rate. **Circle (1133)**

GEPCO International

G-4 Catalog: custom stage boxes, modular breakout boxes, cable reelers. **Circle (1134)**
GEP-5524 series: low capacity, 100 Ω cable for digital audio applications. **Circle (1135)**

Getris Images

ARAMIS 202: combines Sequencer with Venice Silicon Recorders (VSR); rotoscope, animation; 10-80s sequences in 4:4:4 digital domain; one VSR plays a sequence mixed with real time animation, while second records it in real time. **Circle (1136)**
Studio Venice: combines Aramis 202, Version II software; paint with animation to 11 layers; digital effects, rotoscope, compositing; multimachine control, networking; interface to 3-D software; *MACRO* generates sequences of command functions; *Cell* tool for cel-by-cel auto **Circle (1137)**

Graham-Patten Systems

D/EMEM Plus: D/ESAM 800 option; adds memory management, 20-800 storage registers; registers configure virtual machines and other advanced features; disk drive stores entire system memory. **Circle (1138)**
D/ESAM 400: digital edit suite mixer; 32 analog/digital inputs; virtual matrix routing to four analog and four program and four monitor outputs; optional parametric EQ; table-top or rack-mount. **Circle (1139)**
D/ESAM 800 Ver 2.0: EPROM replacement; manual crossfades, auto To/From for auto-assembly; other features. **Circle (1140)**

Grass Valley Group

BASYS interface: machine control between BASYS Newsroom and GVG 30K titlers, Graphics Factory; integrates BASYS auto-

mation with GVG Master-21 master control switcher. **Circle (1141)**

DDR 4400 recorder: digital video disk stores 10-bit format; 7 minutes capacity in component digital, 15 minutes composite digital formats; expandable to four extra storage modules; 4 digital audio tracks; internal generator VITC, LTC. **Circle (1142)**

Graham Patten D/ESAM 400: OEM agreement with GVG post-production editing systems. **Circle (1143)**

Model 3000: digital production switcher; accepts analog, digital inputs; all processing in digital domain; permits 9 layers in a single pass. **Circle (1144)**

PCtranslate: off-line text composition, editing software for K-series titlers; Windows 3.0 application; connects PC to titler with RS-232 cable. **Circle (1145)**

PRESTO 100: low-cost character generator; real time display effects, anti-aliased effects and high-speed operation. **Circle (1146)**

Sabre 4100 editor: linear, non-linear; displays pictures, graphics, text on display; *Dynamic Editing* software; point, click, drag or other operational configurations; controls 36 devices. **Circle (1147)**

Series 7000: signal management system; multiformat, serial digital accommodating 143-, 177-, 270-, 360-Mbit/s data; matrices from 32x32 to 128x128. **Circle (1148)**

TrailBlazer: recursive memory for DPM-100, -700 digital effects; *Wind trails, Trail defocus, Rainbow trail* features; *Drop shadow* feature; 11-bit signal path. **Circle (1149)**

videoDesigner: PC-based edit, retouch, layout; for -386, -486 PCs. **Circle (1150)**

Gray Engineering Laboratories

CC-244: code comparator; 16 contact closures, programmable to open, close or pulse, determined by input time code; for LTC or VITC with SMPTE DF/NDF, EBU, NTSC and PAL sources. **Circle (1151)**

VR-316: video reticle generators; CP-3 remote-control unit operates VR-316, VR-321 units. **Circle (1152)**

Great American Market

BEAMER: changes existing theatrical fixtures to moving lights; remote-controlled rotation; mounts to gel holder of 6" or 8" lens fixture; analog or DMX control from lighting console; mirror pan range 160 $^\circ$, tilt range 90 $^\circ$. **Circle (1153)**

RDS/Techno-Light: automated studio lighting; TACT console, 6-fixture distribution box, 1kW/2kW Fresnel fixtures; pan, tilt, focus, color change; individual barndoor leaves controlled; accommodates 48 lights; 60 cue capacity. **Circle (1154)**

Shadow Play 5: enlarged catalog of available projectable patterns. **Circle (1155)**

TwinSpin: double B pattern rotator; fits in iris slot of 6" ellipsoidal instrument; two patterns spin in opposition at variable speeds. **Circle (1156)**

Great Valley Products

Addi: digital image processing, desktop video workstation; Amiga CPU with 68030; 24-bit RGB graphics; supports YUV, Y/C, composite I/O, VGA output, analog or digital key I/O. **Circle (1157)**

Gretag Data/Image Systems

EIDOPHOR 52: video projector; high luminance output at 8,000 true white field lumens; integral decoding for current stan-

Quick Picks



Finally, a still store that's as fast
as you can see.

FlashFile™ from Pinnacle. Innovative new features.
Lightning speed. And as affordable as it is easy to use.

- **Images in an Instant**

FlashFile's one-of-a-kind FlashStore™ will access up to
12 fields in any order, in just 1/60th of a second.

- **Thousands of Stills on Demand**

Expand to 10,000 images on-line, accessible
in as little as 1/2 second.

- **On-Sight Selection**

FlashPix™ technology lets you search, sort
and browse using a picture-based graphical
user interface that is both fast and intuitive.

- **A Library System that Makes Sense**

Search by title, date, still number, key words and
categories, as well as pictures.

Image quality you won't find anywhere else, with built-in
collage capability and transitions, too. All in a compact,
three-rack unit chassis. Starting at less
than \$17,000.

Twelve images in a flash. Ten thousand
more in store. Plus Pinnacle pricing. How
accessible can you get?



See Pinnacle at IBC. Stand H15.

Pinnacle Systems, Inc.
Phone: 408-970-9787
Fax: 408-970-9798
European Phone (U.K.): 0932-848806
Circle (39) on Reply Card

PINNACLE

NAB '92 - Show of Shows

dard, HDTV, VGA, Macintosh; menu-based, hand-held remote control. **Circle (1158)**

GTE Spacenet

Global News Express: SNG service by satellite; program information uplinked by Deutsche Bundespost Telekom (Germany) and others from news sites provided the GTE downlink and network. **Circle (1159)**

Guicar Television

3-D & Normal effects: two subject groups include more than 50 1-minute broadcast-quality special effects per reel. **Circle (1160)**

Fantastic Videolibrary: includes two subject groups; 80 1-minute sequences of sky images; multiple special event cuts in 1-minute lengths. **Circle (1161)**

Videorecorder Video Test: 30-minute videocassette for checking TV/monitor and videotape equipment. **Circle (1162)**

H

Hallikainen & Friends

DRC200: programmable multisite transmitter remote control. **Circle (1163)**

ITO 177: automatic operation of Moseley TRC-15 remote control, Hallikainen TEL 171 digital telemetry adapter. **Circle (1164)**

Hamlet Video International

HVI 301: waveform, vectors combined with video on standard monitor; component, S-VHS, composite inputs; SC/H, color frame indicator; may substitute audio card for vector display; remote options. **Circle (1165)**

HVI 302 Micro Scope: hand-held in 15x10x5cm enclosure; 12VDC, for single camera use. **Circle (1166)**

HVI 303: precision composite NTSC/PAL videoscope for in-picture waveform, vector displays; accurately measures timing, phase, SC/H; full-field line select with cursors, readouts; chop mode; 3-H combined 3-input display, filter parade. **Circle (1167)**

HVI 304: precision multistandard videoscope; component, composite waveform, vector displays on standard monitor; component mode, Bow tie, overlay, parade, Y/U/V, component vectors. **Circle (1168)**

HVI 502 Stereo Scope: dual stereo input for in-picture display of left/right, sum/difference as VU or PPM and polar plot; shows information not available in a linear plot; NTSC, PAL composite, component YUV, RGB. **Circle (1169)**

MatchCam: camera alignment system; video scope unit speeds camera alignment duties; data transfer available if used with computer software for measurement and maintenance guidance. **Circle (1170)**

Harris Allied

AIRcorp Model 500TV: mic processor for TV reduces hollow room, talent crosstalk problems; 3-band EQ, compressor, downward expander, de-esser; integral phantom mic power supply. **Circle (1171)**

Audiometrics CD-10: second-generation CD cartridge system; supports INDEX 3 sub-coding to emulate secondary tone on audio carts. **Circle (1172)**

Fidelipac DCR 1000: Dynamax digital cart recorder. **Circle (1173)**

Gentner Digital Hybrid: 16-bit processing; 2x oversampling with 10kHz sampling rate. **Circle (1174)**

Marantz CDR600: CD recorder, player. [See Pick Hits] **Circle (315)**

T-Tech Pro-Audio Fiber: receiver, transmitter for 20-bit digital audio. **Circle (1176)**

TFT DMM-92: digital modem; four channels carry Left, Right, two SCA and transmitter remote control signals. **Circle (1177)**

Harris Allied Broadcast Equipment

High Power DX series: solid-state, medium-wave transmitters; 200kW to 1MW; power blocks use 100kW modules in parallel/redundant configuration; efficiencies 83-86% from 1.5kW modules driven by digital amplitude exciter. **Circle (1178)**

TVT Scepter Series: solid-state UHF transmitters; 3kW to 30kW; multiple 1kW modules operate in parallel avoids single points of failure. **Circle (1179)**

Harrison by GLW

Model MPC: Motion Picture Console; total automation of dubbing; to 256 audio channels. **Circle (1180)**

Henry Engineering

DigiStor: digital message storage [See Pick Hits]. **Circle (313)**

Hewlett-Packard

HP 3589A: time-gated spectrum, network analyzer with 1D6 option. **Circle (1182)**

Tools for Video Test/Measurement: 1992 product guide focused on oscilloscope and signal analysis instruments. **Circle (1183)**

Hitachi Denshi

SK-F200: studio camera using IT CCDs with 700-line resolution; 62dB S/N ratio; lower cost system. **Circle (1184)**

SK-H5: portable camera with Harpicon tube; 1/32, 2080 lux sensitivity; 700TVL resolution; docks to Betacam(SP); multicore, triaxial systems available. **Circle (1185)**

VL-D550 D-2 recorder: improved front-panel design, menus, machine status displays; IC memory card stores individual user setup data; digital audio crossfade; optional serial interface. **Circle (1186)**

Z-ONE-B: portable CCD camera; 2/3" 400,000-pixel array; 62dB S/N with 750 TVL resolution. **Circle (1187)**

HL Dalis

Neutrik audio connectors: various male, female type XLR receptacles. **Circle (1188)**

Sola UPS: rack-mount system protects equipment against power line inconsistencies. **Circle (1189)**

HM Electronics

Series 800: UHF wireless intercom; full-duplex mode with three interconnected RW800 base stations, 12 BH800 COMMUNICATOR belt-packs (unlimited number in push-to-talk operation). **Circle (1190)**

Holiday Industries

HI-3627: 3-axis ELF magnetic field meter; isotropic measurements for all environments. **Circle (1191)**

HI-3701: induced body current meter. [See Pick Hits] **Circle (314)**

Hoodman

HQ9 Eclipse: teleprompter hood for A-TV MVP9 display; collapsible nylon; with carry-case. **Circle (1193)**

Horita

CSG-A: optional tone generator for CSG-50 color bar, blackburst source. **Circle (1194)**

SAG-50: safe area, test pattern and line trigger generators. **Circle (1195)**

VG-50: VITC generator, LTC/VITC translator. **Circle (1196)**

Hotronic

AP41: PAL TBC/frame synchronizer; Y-C, composite I/O; frame, field/freeze feature; strobe; DOC; low cost. **Circle (1197)**

Hughey & Phillips

Lighting Guide: product catalog of solutions to hazardous air navigation problems; suggests options for obstruction lighting if applicable to FAA regulations. **Circle (1198)**

I

IBSS

Ghielmetti GKVA2x32: jackfield for audio signal routing control; applicable for analog, digital. **Circle (1199)**

I-DEN Videotronics

IVT-20: dual-channel TBC, frame synchronizer; infinite window memory; field/frame freeze; composite, Y/C, Y/R-Y/B-Y I/O; RGB in; DOC; presettable proc amp; blackburst out; remote-control feature. **Circle (1200)**

IVT-60: one to six channel transcoding TBC/synchronizer; builds on IVT-20 concept with additional modules to meet requirements. **Circle (1201)**

JAZZ Quartet: video production system; switcher, DVE, dual TBC and keying facility; 4:2:2 CCIR 601 processing. **Circle (1202)**

TBCard: plug-in TBC for Amiga, PCs; Y/C, composite 5.5MHz bandwidth; for integrating of computers and video. **Circle (1203)**

Ikegami Electronics

DMC-450 series: digital codec; multi-channel compression teleconferencing processor; carries four NTSC visual signals with eight sound signals. **Circle (1204)**

HC-240A: upgraded 3-CCD camera using 1/2" FIT devices. **Circle (1205)**

HK-355A, HK-355PA: studio/field and companion CCD cameras; RGB wideband triaxial system with base station; 2/3" FIT CCDs for 800-, 700-line images. **Circle (1206)**

HK-377: ultrawideband studio/field CCD camera; 900+ lines; 2/3" FIT CCDs with 600,000-pixel arrays; triaxial cable with base station. **Circle (1207)**

HL-55NA: extended optics camera; removable optics can be located away from camera body; three 2/3" FIT CCDs. **Circle (1208)**

HL-W40: 16:9 wide-screen or 4:3 aspect ratio portable camera; three 2/3" Plumbicons; composite outputs to dockable recorder or multicore/triax capability. **Circle (1209)**

ICD-30: 1/3" one-chip monochrome camera; on-chip microlens devices. **Circle (1210)**

TPP-1600: data, video projector; 1,300 lumen output; 15-90kHz scan range; f/1.1 glass lens aperture. **Circle (1211)**

18 series: color monitors with digital control and auto setup; TM 20-18 20", TM-14-18 14". **Circle (1212)**

HC-340: portable camera using 3 2/3" IT CCDs. **Circle (1213)**

HK-343: field, studio camera using 3 2/3" IT CCDs. **Circle (1214)**

HL-43: portable companion to HK-343 camera. **Circle (1215)**

THE ASSAULTS:

...635A thrown in the path of a Seattle Transit bus and ran over repeatedly.

"Next time have exact change, pal."

...635A entombed in a watermelon and hurled off a three-story building.

"A splattering experience."

...635A attached to a basketball, bounced, and then slam dunked.

"No harm, no foul."

...635A run over by a ten-ton steamroller.

"Major headache."

...635A blasted by a Seattle Police shotgun.

"Only a flesh wound."



Television and radio

635A

ENG crews have for years used the 635A dynamic microphone from *Electro-Voice*® because of its superb sound clarity and ability to consistently *survive* the most severe field conditions. As a result, it seems that almost every field crew has their own favorite story about the reliability and durability of the 635A, better known as the "Hammer." ¶ The

most recent story comes from

KPLZ, a top radio station in Seattle,

where morning crew *Kent & Alan* recently aired an ongoing segment dedicated to their "Incredible, Indestructible 635A." ¶ They explain: "We unleashed almost everything imaginable on our 635A – drops, slam dunks, a lawnmower, a ten-ton steamroller, a car crusher – and the only assault to

Kent – DJ from KPLZ, in Seattle.



"You Can't Keep a Good Mic Down"

...635A devoured by the jaws of a car crusher.

"Job stress."

...635A eaten by a lawnmower.

"Just a little off the top please."

...635A teed off by a wicked one wood.

"Par for the course."

...635A watched a bowling match from atop a headpin.

"Cheap seats."

Result of these heinous crimes:

THE HAMMER LIVES!

inflict 'serious damage' was a blast from a Seattle Police *shotgun*. To fix this serious damage, we had to go to the trouble of hooking up a wire. ¶ *Frustrated* by our attempts at physical damage, we decided to try a *psychological* approach. A life insurance salesman gave our 635A an hour-long presentation, but the mic emerged *unfazed*. There were no noticeable effects or damage. ¶ The microphone looks and *sounds just fine* after going through these torture tests. Of course, it's bent and twisted a bit, but then again, aren't we all? The 635A 'Hammer'

from EV is truly one incredible, indestructible microphone."



Alan – DJ from KPLZ, in Seattle.



Electro-Voice® a Mark IV company 600 Cecil Street Buchanan, MI 49107 616/695-6831

In Canada 613/382-2141

Circle (40) on Reply Card



Illbruck/SONEX Acoustical Products
ProSPEC: pyramid acoustical foam and new composite barriers. **Circle (1216)**
SONEX: ceiling tiles and materials in painted colors. **Circle (1217)**

Image Devices

Rental program: products designed for underwater (and terrestrial) production; ImagePost edit suite. **Circle (1218)**
Video Fish Book / Ocean Aquarium: two videocassettes (NTSC or PAL) featuring marine life. **Circle (1219)**

Image Logic Corp.

Autocaption: in-house closed-captioning system; for use during or following post-production; works with most existing word processors. **Circle (1220)**
Log Producer: PC-based tape logging system. **Circle (1221)**
Universal Interface: for LogProducer; enables use with M-II 505, VO-series Type 5 and many VHS machines with multipin connectors. **Circle (1222)**

Image North Technologies

I•RTX enhancement: real time titles, information display; *DPMI DOS Protected Mode Interface. Windows 3.1 drivers.* **Circle (1223)**
I•Subtitle V 2.0: companion to INSCRIBER titler; permits PC-based control for video subtitling. **Circle (1224)**
INSCRIBER V 3.1: Inscribe titler upgrade; expands titling and presentation software for PC environment; versions for ATVista, TARGA+, TARGA 16, Matrox Illuminator, VGA graphics cards. **Circle (1225)**

Image Video

RDU-1000: remote display; single line of 30 characters, dual line with 14; red, green or amber for each character. **Circle (1226)**

Imagine Products

Easy Reader: LTC time-code reader; battery-powered portable. **Circle (1227)**
TEP V1.2: The Executive Producer; logging, off-line edit, archive software; multiline text fields to 660 characters; labels; supports NTSC, SMPTE TC formats. **Circle (1228)**

IMC/International Music Corporation

S1100EX Mega Sampler: sampler expansion module. **Circle (1229)**
Version 2.0 for DD1000: time compression, expansion; RS-422 control. **Circle (1230)**
Version 2.0 for S1100: direct to disk audio recording. **Circle (1231)**

Inline

IN1222: scan doubler; 4-in, 1-out audio follow video switcher; gamma correction, freeze frame, hue, color, contrast adjustments; volume control. **Circle (1232)**
PATHFINDER: matrix switchers to 16 chan-

nels; for 120MHz video and audio routing; may be reconfigured. **Circle (1233)**

Innovative Automation Systems

MAS-5000: Windows application for Macro-mized automation on PCs via RS-232; custom drivers for numerous routers, satellite antenna/receiver controllers. **Circle (1234)**

Innovision Optics

3-axis Mini-Jib arm: table-top, portable camera support; precision horizontal, vertical, forward/backward motion; supports 100 pounds; compatible with most heavy tripods, dollies, professional fluid or geared heads. **Circle (1235)**
Mini-Mover enhancement: portable motion control tables; two joystick controllers and four axes of movement; memory in controllers repeats movement. **Circle (1236)**
Right angle Probe: features 90° angle of view for video cameras; permits camera to shoot table-top products with camera mounted over product. **Circle (1237)**

Inovonics

DAVID: stereo audio processor; includes FM stereo generator. **Circle (1238)**
The Sentinel 550: all-mode broadcast monitor receiver/evaluator. **Circle (1239)**

Intelligent Resources

Demonstration: 16:9 HDTV images from Video Explorer. **Circle (1240)**
Video Explorer DI Serial: CCIR-601 digital video card with serial I/O. **Circle (1241)**

Intelvideo

FLASHER II: video gating device; permits pictures to be taken of TV screen without visible vertical interval bars. **Circle (1242)**
IV-9R: color corrector; remote control with independent adjustment of R, G, B, chroma level and chroma phase. **Circle (1243)**
SG1 generator: blackburst, sync source; variable H, V, SC phase lock. **Circle (1244)**

International Tapetronics/ITC

DigiCenter: digital audio operating platform; hard disk record/playback; traffic system interface; live assist feature, various automation capabilities. **Circle (1245)**
DP-612: digital program repeater; stores, replays 15 mono programs, IDs, lines, effects, short messages. **Circle (1246)**
Series 2: audiotape cartridge reproducer, record/reproducer; mono, stereo models; Dolby HX Pro headroom extension, digital tape timer; balanced XLR I/O. **Circle (1247)**

Intraplex

3800 VRM: variable rate time division multiplexing of encoded voice, data, program audio into 64X kbps serial datastream; permits low fractional T1 terrestrial digital transmission. **Circle (1248)**

IRIS Technologies

IRIS Desktop Control Platform: hardware, software enhancement for Video Commander system for Windows operating system; *Routing Engine, Machine Control Engine, Mapping Engine* for specialized applications. **Circle (1249)**

IRT Electronics Pty Ltd

AA-332: digital intercom system; matrix with panels; simple to operate. **Circle (1250)**

ITS Corporation

Exciter Plus system: UHF exciter *ITS-20A;*

ITS-252A (15W), -256A (30W), -257A 50W UHF amplifiers; HEP-3 pulser; VCP-7858 variable visual coupler. **Circle (1251)**

James & Aster Music

Match Music series: CD series including *Pop History, Solo Instruments, Rock, Nature & the Elements, Feelings/Drama and The Will to Win.* **Circle (1252)**

James Grunder & Associates

C-103 Modul-Form: "build your own" TBC/synchronizer; single or multichannel; NTSC, PAL. **Circle (1253)**
C-2000 Modul-Form: "build your own" TBC/production switcher. **Circle (1254)**
Feral C-111: TBC/synchronizer, transcodes between composite or S-VHS format inputs for NTSC or PAL; proc amp level memory; auto-level fade-to-black; R-Y/B-Y component output. **Circle (1255)**
HVI 300 series: Hamlet Video combo on-screen, in-picture waveform, vector monitors. **Circle (1256)**

Jampro Antennas

JHD: low-band VHF TV dipole panel antennas. **Circle (1257)**
JLHP: series of HP TV translator antennas systems. **Circle (1258)**
JLST: series of CP TV translator antennas systems. **Circle (1259)**
JUHD: broadband UHF TV panel antennas systems. **Circle (1260)**
JY-series: YAGI antennas for VHF, UHF, FM transmission **Circle (1261)**

Jaymen Broadcast

JBSS series: UHF, VHF solid-state TV transmitters; covering 100W to 10kW; also FM/VHF/UHF series covering 6W to 55kW using solid-state technology. **Circle (1262)**

JBL Professional

M552, M553: variable crossover networks; 2-way stereo/3-way mono; 3-way stereo/4-way mono. **Circle (1263)**
M644: 4-channel noise gate. **Circle (1264)**
M712: 2-channel dynamics gating compressor/limiter **Circle (1265)**
Model 4206: 2-way 6" console-top studio monitor. **Circle (1266)**
Model 4208: 2-way 8" console-top studio monitor. **Circle (1267)**

Jefferson Pilot Data Services

SalesLine: business software package; electronic office, order processing and sales database functions. **Circle (1268)**

Jensen Tools

Fluke Model 97 scopemeter: portable DMM with storage oscilloscope. [See Pick Hits] **Circle (303)**
Rack-mount cases: 19" wide; molded high molecular weight polyethylene; six sizes; 2-space to 12-space; 15" depth. **Circle (1270)**

JLCooper Electronics

AVSIX: 6-input 2-channel mixer; interface to most popular video editing systems; manual operation mode; usable with GVG-100, RS-424, GPI, ESAM protocol. **Circle (1271)**
MLA series: MIDI line amplifiers extend lines over 1,000 feet for MIDI data; four independent bidirectional lines. **Circle (1272)**
PRO3700 upgrade: automation package for Tascam M-3700 recording console; moving

Two tubes are better than three.



Presenting the only two-tube transmitter with power levels above 100kW.

It's the first UHF-TV transmitter that delivers *over 100kW output power* using just two tubes.

This evolutionary development is the result of the marriage between IOT and common amplification technology.

That means you get the highest signal quality with the lowest energy consumption possible, with no need for a diplexer or a pulser. If your UHF-TV transmitter is 15 years old or older, that's good news.

Lowest operating cost system possible.

A high-efficiency IOT transmitter using only two tubes means fewer parts to maintain without compromising reliability. No matter how you look at it, two tubes take up less floor space, have lower operating costs, lower initial acquisition costs and lower tube replacement costs than a three-tube pulsed klystron-based system.

Now is the time to buy.

Right now is the best time to buy a new transmitter from Comark. Because right now we're offering a preferred customer program we call PERFORMANCE PLUS™ which includes:

- Low interest financing to qualified borrowers
- Extended warranty protection
- Discounts on spare parts
- Free annual engineering inspections
- Enhanced engineering support through the years

Bottom line impact.

You can acquire our *two-tube, IOT-equipped* transmitter for significantly less than the alternative, and the energy savings will continue to go to your bottom line every day.

You can trust us to stand behind your new transmitter. Comark is backed by Thomson-CSF, a \$7 billion communications giant.

Call your regional sales manager or call Comark at 1-800-688-3669 and see what a great show you can put on with just two tubes, for a lot less money than you thought.

One of the reasons we're celebrating 20 years in business is our excellent service. With PERFORMANCE PLUS we're making it even better.



1990 Emmy Award for Engineering Excellence.

© 1992 Comark Communications, Inc.

COMARK
A THOMSON-CSF COMPANY

Circle (41) on Reply Card

NAB '92 - Show of Shows

fader graphics, SMPTE display, status information. **Circle (1273)**

JNS Electronics

9000 series: audio router; 3-unit Eurocard frame with 8024 power supply; 15x16 matrix for mono, 15x8 stereo. **Circle (1274)**

Jonathan Manufacturing

Equipment mounting slides: steel, aluminum slides; specialty products; cable carriers for modular office systems. **Circle (1275)**

JVC

16:9 NTSC system: standard S-VHS recording, playback units; 36" screen; AV-36W1 multiple application receiver, HV-MC1000 MUSE/NTSC converter; 4:3, 16:9 aspect ratios; 4-channel stereo sound. **Circle (1276)**

BR-S411UB: S-VHS portable/dockable upgraded recorder; time-code option, balanced XLR audio I/O; shuttle search to 7x play speed. **Circle (1277)**

BR-S525U: S-VHS player with still, slow-motion tracking feature; Vari-Tracking heads cover -2x, +3x play speed; programmable playback time feature changes $\pm 20\%$ time range in 0.1% steps. **Circle (1278)**

BR-S605UB: S-VHS recorder connects direct to computer video output for multimedia production; video insert edit mode; SA-K27U advanced time-code system; extension slots for additional functions. **Circle (1279)**

BR-S622U: recorder, edit feeder; similar to -S822U without edit functions. **Circle (1280)**

BR-S822U: S-VHS editing recorder; uses compact and standard S-VHS cassettes; open architecture for simple system expansion; directly compatible with various formats. **Circle (1281)**

KY-17B, KY-17FIT: CCD camera upgrades; -17B uses IT MicroLens devices for high sensitivity, low vertical smear; -17FIT uses FIT devices for high resolution, negligible vertical smear. **Circle (1282)**

RM-G870U: edit controller; includes 9-pin RS-422, GPI interface; A/B-roll; 128-event EDL memory. **Circle (1283)**

TK-F7300U: single CCD camera; captures still-frame HDTV, computer images; 2,200x1,728-pixel array; AT/VISTA frame grabber by Truevision. **Circle (1284)**

K

K&H Products

Audio Organizer: large enough for a mixer, wireless mics, shotgun mic, hand mic, fishpole, filters, headphones, cables; openings to switch connectors without removing equipment from the bag. **Circle (1285)**

Computer Case: for most lap-top, notebook PCs, printer, accessories; 1,000 denier Cordura nylon with lining. **Circle (1286)**

Sling Pack: over-the-shoulder bag for batteries, tapes, mics; movable partitions; easily carried while operating a camera or camcorder. **Circle (1287)**

Kan-Tech Systems

KTS mic booms: several heavy-duty models using springless design to reduce noise to mics; accommodates instruments from 1-7 pounds; accessories. **Circle (1288)**

Kangaroo Video Products

EMIKOTE products: protection for sensitive electronic equipment, recording media

against electromagnetic radiation; plain-weave polyester with autocatalytic nickel process. **Circle (1289)**

KVP: video recorder packs; expanded for newly introduced VCRs. **Circle (1290)**

NAGRA KAP: expanded line of audio recorder carrying cases. **Circle (1291)**

Karl Heitz

#180: fluid head; quick release; 90° front-rear tilts; 360° pan; drag adjust; for loads to 7 lbs; Sport Eco tripod. **Circle (1292)**

#280: fluid head; quick release; 90° front-rear tilts; 360° pan; drag adjust; 90° side tilt feature; for loads to 10 lbs; Reporter Eco tripod. **Circle (1293)**

#380: fluid head; 90° front, 45° rear tilts; 360° pan; adjustable drag; all-metal quick release, shift plate for centering, balancing of cameras to 15 lbs; with Inter Pro Studex tripod and levelling ball 3. **Circle (1294)**

Kavouras

RADAC 2100: color weather radar system; 6-color graphics; database; access to National Weather Service or FAA radar networks; multi-image, high-resolution displays. **Circle (1295)**

TRIMETS MD workstations: 386/486-based computer under LynxOS, Ethernet controller; features auto data management through multitasking processing; allows meteorologist to concentrate on weather conditions, not computer computations. **Circle (1296)**

Keltec Florida

TWT amplifier: 2.5kW X-band high power unit. **Circle (1297)**

Keystone Communications

K2 Skylink: trans-Pacific service; KDD, Japan to Keystone, Salt Lake. **Circle (1298)**

Kings Electronics

Front load jackfields: 26-, 32-position with standard, miniature jacks; self-terminating, non-normal circuit types. **Circle (1299)**

Serial Digital video jack: two varieties; PN 7400-1, PN 7500-1; matched 75W self-normalizing, internal termination; dual video jacks. **Circle (1300)**

Kintronic Laboratories

HF Balun. **Circle (1301)**

HF feedthru panel. **Circle (1302)**

HF open-wire feedline. **Circle (1303)**

Mating network: AM/MW matching system; rapid tuning capability. **Circle (1304)**

Switch: HF open wire transmission line device. **Circle (1305)**

Kaleidoscope Camera Control

Hot Head System: three choices of heads, with or without tilt slip rings; joystick, pan bar or geared head wheel control choices; ac/dc power. **Circle (1306)**

Kline Dielectric

Design, construction services: turnkey projects, tower inspections/maintenance, HDTV feasibility studies, emergency services, project cost analyses. **Circle (1307)**

Knox Video

Mini D/A: 1x5 DA for NTSC or PAL; packaged in mini-box. **Circle (1308)**

MiniGen: gen-locking sync, black burst generator; four or six black burst outputs; RS-170A. **Circle (1309)**

PC-D/A: 1x5 DA on PC compatible plug-in card; one card handles NTSC or PAL com-

posite; two cards allow NTSC or PAL Y/C components. **Circle (1310)**

PC-Sync: gen-lock sync generator on PC card; usable with PC/XT/AT or Amiga; four (or six) black outputs; full RS-170A sync; jumper for Y/C inputs. **Circle (1311)**

RS8x8 router: 3-channel, 8MHz bandwidth; facilities for 8 audio and 8 video signals; options for NTSC or PAL without audio, NTSC or PAL with mono or stereo audio, Y/C 525 or 625 with mono audio. **Circle (1312)**

Korg USA

SoundLink: 8-track hard-disk recorder, editor; automated digital mixing, EQ, effects processing; 16-track MIDI recorder, sequencer; synchronizes to time code, digital audio. **Circle (1313)**

Koto Luminous

Di-Lites: tungsten-halogen lamps; high lumen efficiency with color index >90; single-, double-ended types. **Circle (1314)**

Kowa Company/Electronics & Optics

AF220, AF230, AF240: audio file systems using 5¼" M-O disks; two drives (AF230, -240 have single drive) with option for four; 16- to 4-bit compression; simultaneous record and playback mode possible. **Circle (1315)**

L

L. Greenberg Electronic Prompting

Telescroll International: enhanced software version with Spanish, French, Japanese character sets. **Circle (1316)**

Lakeside Associates

Design consultants: video, audio, post production and motion picture studio projects. **Circle (1318)**

LDL Communications/Larcan

TTS16M VHF: 16kW solid-state TV transmitter; in low, high VHF bands; same exciter, PA modules as 30kW system. **Circle (1319)**

L.E. Nelson Sales

1500PAR64: 1.5kW tungsten-halogen PAR64 lamp. **Circle (1320)**

ACL series: Thorn aircraft landing lamps for production effects. **Circle (1321)**

CMC GEL: gel filter and spun diffusion materials. **Circle (1322)**

CSR2500: 2.5kW single-ended daylight discharge source; compact source using rare earth elements. **Circle (1323)**

Leader Instruments

5860D: digital D-2/D-3 video waveform monitor; serial and parallel inputs, precision parallel/serial decoder. **Circle (1324)**

951: auto-ranging RF level meter; covers broadcast and cable channels; Auto-Channel Search measures and stores levels for 32 channels. **Circle (1325)**

1605: RGB video generator with 300MHz dot-clock; GUI menu with mouse control to adjust set of architecture to match the display being tested. **Circle (1326)**

3221: 2.7GHz synthesized RF generator; 10Hz resolution to 1.35GHz, 0.05ppm accuracy; numerous modulation mode settings, preset output levels. **Circle (1327)**

326 oscilloscope: 100MHz, dual-channel with alternate time base, delayed sweep; attaché size package option. **Circle (1328)**

411D: D-2/D-3 sync and test signal generator; parallel and serial digital and analog video outputs, AES/EBU serial digital audio



Nature has its own
professionals of
sound and vision.



The wonders of sound and vision found in nature are hard to reproduce. In fact, if anyone has come close it's EEV.

Whatever your broadcast requirements, you'll find EEV has the technology to match. High-efficiency UHF Television Klystrons from 5kW to 70kW for Television Transmitters. A range of Broadcast Tetrodes and Vacuum Capacitors for AM and FM transmitters, and Leddicon® camera tubes to fit virtually every broadcast color camera available today.

Our experience is the key to technological leadership. Our manufacturing know-how ensures the highest quality and reliability. Above all, our professional dedication to our customers' needs makes us the natural choice of broadcasters the world over.

® Leddicon is the Registered Trade Mark of EEV Lead Oxide Camera Tubes.



EEV

Technology for the Broadcast Industry

USA: EEV Inc, 4 Westchester Plaza, Elmsford, NY 10523. Telephone: (914) 592 6050 or 'Toll Free' 1-800-DIAL EEV Telex: 6818096 Fax: (914) 682 8922
CANADA: EEV Canada Ltd, 67 Westmore Drive, Rexdale, Ontario M9V 3Y6. Telephone: (416) 745 9494 Telex 06 989363 Fax: (416) 745 0618
UK: EEV, Waterhouse Lane, Chelmsford, Essex CM1 2QU, England. Telephone: (0245) 493493 Telex: 99103 Fax: (0245) 492492

Subsidiary of the General Electric Company plc of England. **gbc**

Circle (42) on Reply Card

www.americanradiohistory.com

YOU CAN SEE THE FUTURE BY LOOKING AT US NOW.

While industry talk invariably revolves around new technologies, it takes a very special Company to stay focused on the creative product and capital investment you've already made.

Panasonic is making significant refinements to existing technology and developing major new products such as its half-inch 4:2:2 videotape recording system currently under development. All Panasonic products share the same vision: a commitment to value, quality, and technological continuity.

Each Panasonic system, whether it's S-VHS, EnHanced MII or D-3, has cameras, dockable recorders, field portable recorders and studio VTRs; with high quality bridges between formats.

RS-232C interfaces have been added to



HALF-INCH 4:2:2 DIGITAL VTR

key VHS and S-VHS VCRs to extend their applications in edit environments. The new EnHanced Series MII has a forward-looking 16:9 video capability built-in, and includes a Studio VTR with a Digital Output for interfacing to CCIR 601 or D-3 composite digital domains. D-3 VTRs now

have a Digital Format Converter, so D-3 can work easily with component digital sources or destinations.

Thus, it should come as no surprise that when Panasonic debuts its half-inch 4:2:2 recording system in 1993, it will play back D-3 recorded tapes in composite or component.

Now, when you choose a videotape recording system, think about where you're headed and how Panasonic can help get you there.

Panasonic
Broadcast & Television Systems Company



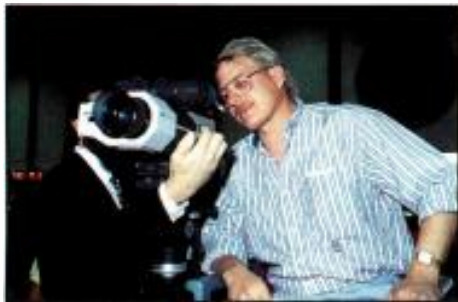

and stereo analog audio; source ID, clock, calendar signals. **Circle (1329)**

5835: stereo amplitude, phase monitor with Lissajous patterns; L+R may be oriented on a 45° or vertical locus; auto alarm triggered by accidental phase reversal. **Circle (1330)**

Lectrosonics

DR195: wideband VHF diversity receiver; dual band companding. **Circle (1331)**

T195: hand-held, wideband wireless microphone. **Circle (1332)**

Leightronix

LGX-PLAYER: video cassette playback control and switching system. **Circle (1333)**

LGX-REQUEST: classroom videotape controller and distributor system. **Circle (1334)**

TCD-PC: single channel commercial insertion controller; PC-based, with VHS/S-VHS equipment. **Circle (1335)**

Leitch Video

ADC-5100 series: analog digital clock series **Circle (1336)**

ASM-8X plus: stereo audio switching module; 8x8 matrix. **Circle (1337)**

CDC-3500: modular coder, decoder; **3500AD** converts analog component to parallel D-1; **3500DA** converts D-1 to any component analog format; **3500CE** converts parallel D-1 to composite analog video. **Circle (1338)**

FR-6010 DigiBus frame: format conversion for digital/analog video and audio; user configurable; frame synchronizer allows different input, output formats. **Circle (1339)**

HEDLINE audio series: **ADA-300, ADA-308, ADA-301** stereo distribution amplifier modules; **ATG-300** tone source. **Circle (1340)**

HEDLINE video series: distribution **VDA-301, EQ VEA-302, clamp VCA-304, switchable delay SVD-307** modules. **Circle (1341)**

PDA-308: HEDLINE pulse DA. **Circle (1342)**

UDA-680: utility DA. **Circle (1343)**

VDA-681: video DA. **Circle (1344)**

VSD-6800: serial digital DA. **Circle (1345)**

VSE-6800: auto-switching serial distribution amp; eight relocked outputs, automatic cable EQ to 1,000 feet lengths; for D1, D2 signals. **Circle (1346)**

VSM-6800: serial digital monitor; four outputs NTSC or PAL, four relocked serial outputs. **Circle (1347)**

VSM-8X plus: video switching module; 8x8 matrix; 100MHz bandwidth. **Circle (1348)**

Lenco

#3550: 8-output video DA. **Circle (1349)**

#6550: stereo audio DA. **Circle (1350)**

IEC-715: stand-alone video presence detector; includes switching for an alternate video source. **Circle (1351)**

IEC-751: Y/C video DA; individual Y and C gain controls. **Circle (1352)**

IEC-752: EQ, clamp video DA. **Circle (1353)**

PBC-111: translates blackburst signal-to-composite reference. **Circle (1354)**

PCB-120: color bar generator modules; 120N two SMPTE, one Y/C outputs; 120C RGB, MII, Beta outputs. **Circle (1355)**

PSW-816: 16-input VBI utility video routing switcher; 40MHz bandwidth. **Circle (1356)**

PVA-155: modular video DA; 32MHz bandwidth. **Circle (1357)**

Lenel Systems Int'l

MediaOrganizer PRO: multimedia object management software; cataloging, retrieval, playback of multimedia information; Windows 3.0/3.1. **Circle (1358)**

Leonetti Company

Electronic ballasts: **EB 1200** 120VAC; **EB 2500, EB 4000** 240VAC units. **Circle (1359)**

Fluorescent instrument: 4-tube, 8-tube fixtures produce high output flicker-free lighting. **Circle (1360)**

Sunray 18,000: HMI Fresnel 18kW lighting instrument. **Circle (1361)**

Sunray 2500W: HMI PAR 2.5kW lighting instrument. **Circle (1362)**

Lester Audio Laboratories

DAS 2000 D series prototype: A/D/D fiber transmission system for audio; passes AES/EBU at output stage without conversion back to analog. **Circle (1363)**

DAS 500 series: fiber-optic transmission in 8- or 16-channel formats. **Circle (1364)**

Lexicon

CP-1, CP-2, CP-3: digital audio surround sound processors. **Circle (1365)**

MIDI remote Ver 4.0: new software for bidirectional communications with LXP-1, LXP-5, LXP-15 digital audio processors; stores information from processors for future set-ups. **Circle (1366)**

Opus Software V 3.0: external machine control; **Auto.Mix** console automation; **CPEX** time compression, expansion, pitch shifting, sample rate conversion. **Circle (1367)**

Light Wave Systems

Cuemaster booms: mic support for sound stage, location, TV studio. **Circle (1368)**

Lightning Eliminators & Consultants

LEC GAF: grounding augmentation fill; low resistance material enables low resistance grounding in high resistance soil conditions; 0.8Ω-meter. **Circle (1369)**

Model CDC-1: guy charge dissipation choke; protects a system against static charges; <10Ω impedance below 60Hz, >5kΩ at 550kHz; >50kV arc-over point. **Circle (1370)**

Lightning Master Corp.

Loresco Power Fill: low-resistivity grounding backfill material; lowers contact resistance to earth by 40%. **Circle (1371)**

Linear Telecommunications

TFM1200/SG7101: FM transmitter with stereo generator; 1.2kW solid-state output; selectable pre-emphasis. **Circle (1372)**

TXU/TLU series: UHF TV transmitters, translators; 25W solid-state and 1kW with Siemens YL1057 tetrode; SAW IF filter design. **Circle (1373)**

TXV/TLV series: VHF TV transmitters, translators; 250W to 2kW; SAW filter IF design; output stage uses Siemens vacuum tube. **Circle (1374)**

Listec Video

A-4000 display: VGA resolution on-camera prompter unit. **Circle (1375)**

A-6000/100 software: stand-alone editor for look-alike preparation of scripts in PC network for import/export with A-6000 prompter software system. **Circle (1376)**

LNR Communications

DAVSAT MVC-10: mobile communications system; offers four or more digital voice channels with composite data rates from 64kbps to 2Mbps. **Circle (1377)**

LVM series: data capable video exciters for C-band **LVM6**, Ku-band **LVM14** and 17GHz DBS uplink **LVM17**. **Circle (1378)**

LocRad/LPB

Message control panel: provides an input interface between mics or other sources to Broadcast Electronics DV2A Digitalk system. **Circle (1379)**

Telephone interface: connects between standard dial-up telephone and operates MacKenzie or Broadcast Electronics digital voice recorders. **Circle (1380)**

Transmitter control panel: turns a transmitter on with presence, off with absence of audio. **Circle (1381)**

Louth Systems

ADC-10: automation for low end and cable markets. **Circle (1382)**

ADC-100: advanced automation; multi list, multichannel operation with standard sequence, random access; interface for numerous video sources. **Circle (1383)**

Lowel-Light

L-Light: second generation product line; accepts E26 base lamps; tape-up, clamp-on base, Stand-link mount; clip-on barndoor, ViP swing-in accessories. **Circle (1384)**

LPB

Citation II: radio console; three inputs per channel; P&G faders; program, audition, monitor, mono mix outputs. **Circle (1385)**

LTM Corp of America

Cinepar 1200W S/E: single-ended PAR HMI lighting fixture. **Circle (1386)**

Cinepar 4000W S/E: single-ended PAR HMI lighting unit. **Circle (1387)**

Superlite 18k: HMI Fresnel lighting system; 18kW rating; 60% more output in flood, 25% more in spot than 12kW system; full range of accessories. **Circle (1388)**

Lucasey Manufacturing

LINK X: modular security system uses interlocking components. **Circle (1389)**

Lyon Lamb Video Animation

I-VAS: animation controller; plug-in for SG Iris Indigo workstation; compatible with MiniVAS 2 with all features included; integral TC reader, generator; connections for two RS-422 VTRS, two RS-232 VTRS, two Control L/S vtrs. **Circle (1390)**

VASTools4Mac: software assists in recording Macintosh-generated graphics to videotape or disc; multimedia application supports PICT, PICS, TGA and RIB image files; requires System 7 computer. **Circle (1391)**

M

MA-COM

Product catalogs: "Master Product Index,"

The Digital STL Advantage

- CD-Quality Audio
- Higher System Gain
- Constant SNR
- No Crosstalk
- No Background Noise
- No Phase Distortion
- Degradation-Free Multiple Hops

Open Architecture

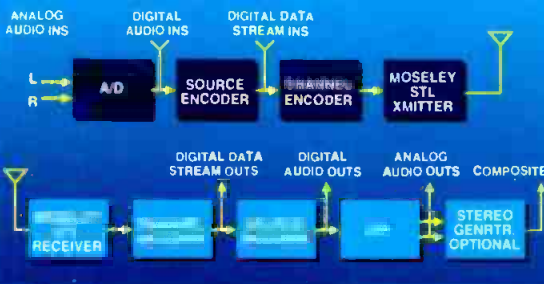

Open and optimal partition of source and channel coder. AES/EBU allows for end-to-end digital connectivity.

25 dB higher system gain translates into significant savings on antenna and transmission line costs.

A new transmission technology that has the power to deliver CD-quality audio and solve your STL problems.

The DSP 6000 can operate in existing FCC channel allocations from 100 kHz to 500 kHz with existing analog radios.

FCC Spectrum Compliant

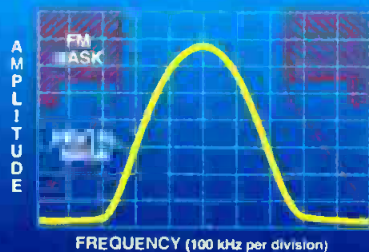

Instant Payback

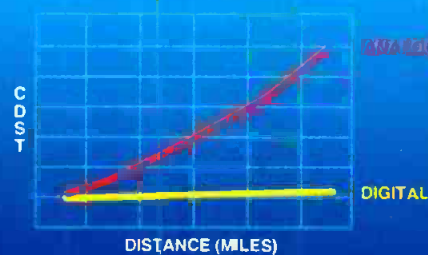

Presenting...

The Digital STL Solution.

Introducing the first spectrum efficient CD-quality digital STL system. The DSP 6000 Digital Transmission System consists of the DSP 6000E source and channel encoder and the DSP 6000D source and channel decoder, and any Moseley digital-ready transmitter and receiver. The encoder and decoder can also be easily interfaced with any existing Moseley PCL 606/C or PCL 6000 series STL. The system can convey up to four 15 kHz CD-quality audio channels and two data channels, and has a built-in V.35 modem interface for

fractional T1 applications! The DSP 6000 source coder is characterized by peak level preservation, low coding delay (3.8 ms), excellent bit-error immunity, and multiple encode/decode capability. The channel coder offers spectral efficiency, constant envelope, error detection capability and perturbation tolerance.

The DSP 6000 System offers broadcasters the digital transmission advantage, continuing the Moseley traditions of innovation, reliability, and most of all, value. Call us for a color brochure with all the facts.

Moseley

Moseley
Associates
Incorporated

111 Castillian Drive
Santa Barbara, CA
93117-3093

Phone 805-968-9621
Fax 805-685-9638
Telex 658448

a
GRC International
Company

Circle (44) on Reply Card

NAB '92 - Show of Shows

and "Products for Cellular and PCN Communications;" 1992 editions. **Circle (1392)**

Macrovision

VES-TD: video scrambler for transmission; for business, teleconference, educational programming; completely conceals audio and video. **Circle (1393)**

Magnavox CATV Systems

Vector ghost cancellation: provides 40dB echo cancellation based on ghost-cancellation pulse inserted in VBI. **Circle (1394)**

Magni Systems

MM-W/V: Magni Monitor waveform/vector overlay auto standard detector. **Circle (1395)**

SC-CSD: Signal Creator with serial 525/625 D1/D2 output. **Circle (1396)**

VGA-Pro: VGA Producer Pro, VGA-to-NTSC or PAL encoder; fits in 8-bit expansion slot for direct connection to VGA card feature connector; vertical text scroll, pan, zoom features. **Circle (1397)**

Management Graphics

8x10CP camera module: produces high quality images for Solitaire_{8xp}, Solitaire₁₆ film recorders. **Circle (1398)**

Manhattan Production Music

Audiophile Sound Effects: library contains 495 popular effects for radio, TV, film use. **Circle (1400)**

Marco

Modular rack products: standard, custom

equipment consoles, overbridge and accessory packages. **Circle (1401)**

Marconi/Eddystone Radio

B6600 series: FM radio transmitters; solid-state redundant design using 300W modules; hot pluggable; dual drive with output to 10kW in one cabinet. **Circle (1402)**

Matco Mfg & Test

MA-204A: automated playback system; 22x3 stereo audio-follow-video router; loss-of-video protection; random, sequential event list scans; programmable list per channel; parallel, serial, IR VTR control; 24 control outputs for VTRs, other devices; battery backed clock, calendar, list memory. **Circle (1403)**

Matrox Electronic Systems

Personal Producer: desktop production system; uses Illuminator-16/AT/A video-graphics/multimedia controller card; video stabilizer module; composite or Y/C inputs. **Circle (1404)**

ILLUMINATOR PRO: graphics controller; 32-bit frame buffer; all-digital encoder/decoder; 2-D video and graphics processor; alpha channel with blender. **Circle (1405)**

Matrox Studio: complete desktop editing, post-production; five boards for EISA-type PC; 8-input switcher, multilayer mix/effects unit; 3-channel digital effects; three TBCs; audio mixer; titling generator; VTR machine control; true color graphics. **Circle (1406)**

Matthews

Bates cables: Y-cable connects two 60A

units to one 100A source; 100A cables in 25' incremental lengths to 100'. **Circle (1407)**

Classic C-stand: 40" riser, grip head, single extension gobo arm. **Circle (1408)**

Hollywood box: power distribution unit; 2 and 3 duplex or 3 stage plug facilities; 40A and 60A. **Circle (1409)**

Paddle plug and box: box accommodates four plugs. **Circle (1410)**

Poultry stand bracket: attaches to any pole, tree vertically or horizontally, to use as a lightstand. **Circle (1411)**

Runway bases: C-stand with wheels; choice of 20", 40" riser. **Circle (1412)**

TPD Box #387601: temporary power distribution box; cam lock to pin 3' 3-color coded cables with ground cable. **Circle (1413)**

Matthews/ITE

H80, H90: fluid heads, include quick-release mechanism, slide plate, 100mm ball, telescoping handle. **Circle (1414)**

MHC-S, MHC-L: hex cases for T/H80, T/H500, T/H48, T/H90, T/H600. **Circle (1415)**

T50/H80: tripod and fluid head with spreader. **Circle (1416)**

T50/H90: tripod and fluid head with spreader. **Circle (1417)**

T85 ENG tripod: 3-stage, adjustable spreader, 100mm bowl. **Circle (1418)**

Matthey Video Products

DDAB 280: low-cost video delay box; delay range of 36-280ns; requires 12VDC power supply. **Circle (1419)**

NV455 delays: infinitely variable delay from 310-480ns. **Circle (1420)**

SIERRA VIDEO SYSTEMS ...

When it comes to your router, you don't want to be left in the dark!



The **NEW** *Sixteen Sixteen* router from Sierra Video Systems!

Turn on the lights and ask your favorite dealer about Sierra's new *Sixteen Sixteen* series of low-cost 16x16 video and audio routers. In component or composite models, these cost-effective systems are like a beacon in a storm!

**SIERRA
VIDEO
SYSTEMS**

... you can see the difference!

SIERRA VIDEO SYSTEMS • P.O. BOX 2462 • GRASS VALLEY, CA 95945 • USA
Telephone: (916) 273-9331 Facsimile: (916) 273-9390

Circle (82) on Reply Card

In broadcasting, Image and Power are everything.

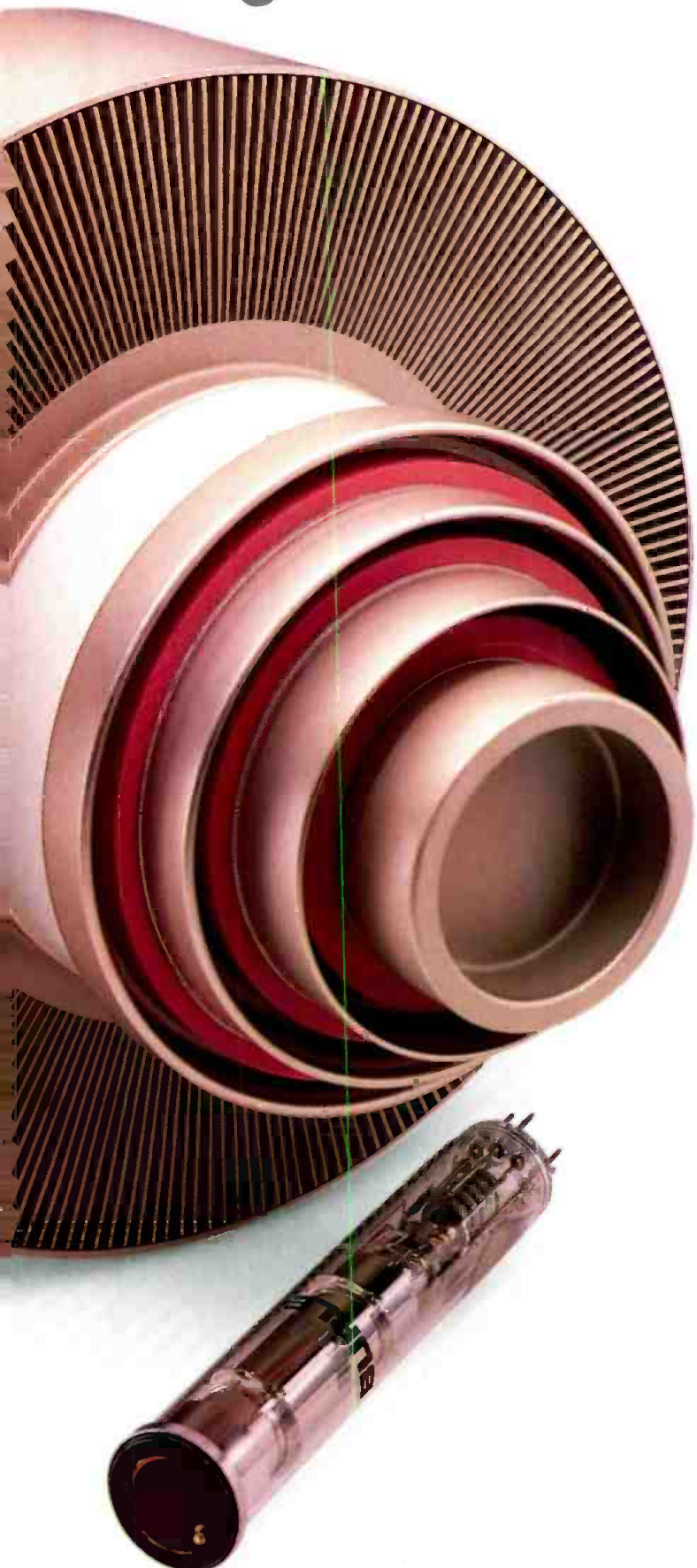

BURLE is committed to providing a full range of camera and power broadcast tubes.

As television celebrates its Golden Anniversary, BURLE continues a 50 year tradition of broadcast technology leadership. We've supplied you with Vistacon, Saticon and Vidicon camera tubes since their introduction. And our power tubes are the industry standard for VHF TV.



BURLE supplies a wide variety of camera and power tubes for the broadcast industry.

It takes a domestic source like BURLE to maintain a half century commitment to producing and supplying a full line of broadcast electron tubes. From camera to transmitter, BURLE provides the tubes that keep the broadcasting industry on the air. Count on us to keep you supplied with the full range of broadcast camera and power tubes you need. Today and tomorrow. Contact your local BURLE broadcast tube distributor, or call us at **1-800-827-8823.**

Experience counts.

BURLE Electron
Tubes

Circle (45) on Reply Card

www.americanradiohistory.com



Maxell

BQ series: media for Betacam, Betacam SP; 5- to 90-minute lengths. **Circle (1421)**

BQ Type C series: media for 1" VTRs; 5- to 180-minute lengths; epitaxial magnetic particles with gamma ferric and cobalt ferrite. **Circle (1422)**

Certified Hi8 media: 60-, 120-minute lengths; ceramic armor metal particle formulation for ENG. **Circle (1423)**

Certified S-VHS: media with magnetite core for 13% increase in remanance; improved S/N in chroma, luma. **Circle (1424)**

Digital audio mastering: media in 3/4" widths; static-free shells for low-dust, low-BER; 30-, 60-minute lengths. **Circle (1425)**

Digital videocassettes: for 1/2" ENG, EFP; small, medium, large sizes. **Circle (1426)**

HDTV media: 1/2" Hi-Vision, 1" metal products. **Circle (1427)**

MS-Studio cassettes: audio media in 20- to 90-minute lengths. **Circle (1428)**

R-120DM: DAT media; available for bulk duplicator use. **Circle (1429)**

MCL/Inc.

M/N 10541: C-band TWT; 400W output; switching mode power supply operates with incoming AC through filtered full-wave bridge; 5.85-6.425GHz. **Circle (1430)**

M/N 10886: C-band TWT; 57W or 125W; 5.85-6.426GHz; LED fault monitoring, LCD multifunction metering. **Circle (1431)**

Media Computing

pcTV-r: multimedia, equipment automation; view real-time video, control source simultaneously from PC. **Circle (1432)**

Media Touch

OmniPLAY: controls switching of digital audio sources; full automation and limited live assist functions. **Circle (1433)**

OpLOG: incorporates all features and interfacing from Media Touch for full automation with live assist to control all function at multiple stations. **Circle (1434)**

MediaTech

Duplication, delivery service: joint venture with Scientific Atlanta provides advertising duplication, distribution; uses satellite link with digitally compressed data; includes ad insertion capability. **Circle (1435)**

Michael Stevens & Partners

Artisan 120 AmpPack: 25W amplifier fits to rear of compact speaker; balanced line XLR input. **Circle (1436)**

Bel digital audio units: BDE-5000S profanity delay with auto catch-up, on-board RAM recorder; BDE-6000S lay-off recorder; BDE-7000S delay includes -7000SA auto-tracking delay; BDE-2500S sampler incorporates SMPTE trigger. **Circle (1437)**

Chromatec displays: TVD-10, -25, -35 on-screen audio level displays. **Circle (1438)**

ONYX interface monitor: visible, stereo headphone monitoring of AES/EBU and SPDIF serial digital signals. **Circle (1439)**

Shep Associates Nemesis FBS-1000: studio foldback system. **Circle (1440)**

Total Systems metering equipment: DBM-2 AES/SPDIF digital meter; PM-1A phase meter; ABM-2 single, dual analog meter; SPA-1A studio pre-amp. **Circle (1441)**

Micro Communications

#412000: constant impedance channel combiner; permits multiple channels to be fed to a common antenna. **Circle (1442)**

#41500: medium power UHF diplexer; unitized system compatible with CCIR dual sound signals. **Circle (1443)**

#42100: interdigital bandpass filters; models for FM, UHF, VHF. **Circle (1444)**

#61000: coaxial transfer switch; 7/8" EIA and 4 1/16" EIA specifications; 12VDC, 24VDC control; 120VAC, 240VAC available. **Circle (1445)**

#955000: HDTV all-band panel antenna systems. **Circle (1446)**

43200 Star-Point combiner: FM interdigital bandpass filter. **Circle (1447)**

Micron Tool & Manufacturing

CamMate System II: camera boom; 12-20' foot boom extension; remote camera head control; VTR controls; integrated battery charger; optional crab dolly, boom extension, track sections. **Circle (1448)**

Microtime

2XP, 3XP series: Xtra Patches for series 2, 3 IMPACT variable image transformer; more patches for additional 3D shapes; LSI devices for more compact system; upgrade for series 2, series 3 available. **Circle (1449)**

IMPACT ONE: variable image transformer; 3D shape manipulation in real time, then maps live video to those surfaces; also conventional effects features; shapes stored in a quick-access library. **Circle (1450)**

Microwave Networks

MVR-HPA: integrated high-power design based on MVR series. **Circle (1451)**

Miles

The Digital Striper: provides digital video, audio reference signals, 48kHz word clock; generator locks to station blackburst signal; M36 for D-1 525/625; M37 for D-2 NTSC; M38 for D-2 PAL. **Circle (1452)**

The Legaliser: signal corrector maintains legal levels through clipping in RGB or composite color signals; uses soft clipping, allows overshoot in luminance. **Circle (1453)**

Miller Fluid Heads (USA)

#700 lightweight range: single, 2-stage tripods; spreaderless with leg angle lock capability. **Circle (1454)**

Air lift assist: geared elevator column of #700 pedestal; permits air pressure assisted vertical positioning. **Circle (1455)**

Minolta

CC-100: CRT convergence meter; provides numerical measurement of CRT phosphor convergence. **Circle (1456)**

CM-2002: hand-held spectrophotometer; battery operation; 8° viewing angle with diffuse illumination. **Circle (1457)**

Master Pro 8-918: camcorder; 2 1/2" CCDs with 410,000-pixel arrays achieve 520-line

resolution; Hi8 recorder with 40mm drum; automatic operation. **Circle (1458)**

Miralite Communications

Compressed digital video system: includes SpectrumSaver encoder, integrated receiver/decoder, remote control, data expansion unit; uses Compression Labs Inc. technology. **Circle (1459)**

Educational downlink package: includes Monterey 100C receiver, VCII Plus descrambler; Miralite 40°K C-band, 1.4dB Ku-band LNBS; Corotor II C-/Ku-band feed; 3.1M commercial earth station; Thompson Saginaw 24" stroke actuator; Coaxmax SSP surge protector. **Circle (1460)**

VT261 Spaceline system: videoconferencing equipment; PC-based with data rates from 56kbps to 2.048Mbps (E1); echo suppression; high quality audio; Windows 3.1 operating system. **Circle (1461)**

Miranda Technologies

DAC-100: 4:2:2, 4:2:2:4 digital to analog converter; 10-bit processing with 2x oversampling. **Circle (1462)**

ENC-100: NTSC encoder using digital filtering. **Circle (1463)**

SDM-100: 2x oversampling, converts 4:2:2 525/625 component video to RGB analog video format. **Circle (1464)**

SMD-200: converts serial or parallel 4:2:2 525/625 video to composite or S-VHS NTSC or PAL. **Circle (1465)**

Modulation Sciences

PROceiver: receiver for PRO subcarrier; to communicate with ENG or mobile crew with the grade B contour; tune channels 2-69; balanced audio, 2,400bs RS-232 data outputs. **Circle (1466)**

Mole-Richardson

Type 4251 Big MOLE: 20kW Molequartz Solarspot; 24 3/4" Fresnel lens. **Circle (1467)**

Type 6351: 18kW HMI Fresnel Mole Solar-Arc Solarspot. **Circle (1468)**

Montage Group

Montage III Picture Processor: Models 35, 75, 100 Professional non-linear editing systems; electronic grease pencil writes notes on digitized picture labels; operates with video data compression in Windows environment; system expands to access 12 optical dists for 6 hours of "work quality" video. **Circle (1469)**

Personal Picture Processor: software for desktop PC with IBM/Intel ActionMedia II board; permits material digitized by Professional Picture Processor to be edited on a desktop system. **Circle (1470)**

Moseley Associates

CDQ 2000: digital audio equipment for video STL. **Circle (1471)**

DigiMux: synthesized digital program multiplexer; transmits of multiple feeds from satellite dish to the studio. **Circle (1472)**

PCL 6060 STL: for high RF level environments. **Circle (1473)**

TaskMaster 20: time-based control by issuing commands from a PC based on the time of day. **Circle (1474)**

Multidyne Electronics

ADA-8550: adapts screw terminals of GVG 8550 DA to XLR connectors. **Circle (1475)**

TS-12: hand-held test set; 12 RS-170A signals; multiple 32-character IDs; stereo tone source; 4 AA cells, 6-22VDC or ac power

NEW

Live Production



30 Video Inputs

Two 4-Bus Multi-level Effects Systems (MLE)

Storage & Recall of 40 complete switcher set-ups

PGM/PST Bus

12 linear keys

DOWNSTREAM Multi-KEYER!

totally integrated DVE control



On-air PRODUCTION

The RVS 630 combines the power of 30 video inputs, the flexibility of two 4-bus Multi-Level Effects Systems (MLE), totally integrated DVE control, the Ross Downstream Multi-Keyer, and complete switcher set-up storage, with the convenience of uncomplicated operation provided by the PGM/PST busses.

In addition to the power and versatility of the 630, the compact size makes it ideal for mobile installation. The 47 3/4" x 27 1/4" control panel stands a mere 4 3/4" above the desk ... and, the supportive electronics take up a minimal 10 R.U.s.

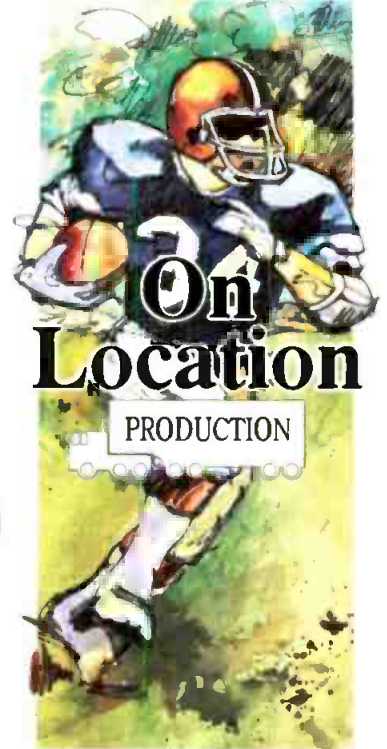

ROSS RVS 630

... handle any On-Air or On-Location production with confidence.

For a detailed Installation and Planning Guide
call us today at **(613) 652-4886**



Ross Video Inc., P.O. Box 880, Ogdensburg, New York, U.S.A. 13669 0880
Ross Video Limited, P.O. Box 220, 8 John St., Iroquois, Ont., Canada K0E 1K0

Circle (46) on Reply Card

NAB '92 - Show of Shows

supply; option provides VITS signals compatible with TEK VM700A. **Circle (1476)**
VDA-100: field video DA; cable EQ for 4,000 feet of 8281 or RG-59 in 500-ft increments; fits VVG 8500 trays; EQ networks for other video cable types. **Circle (1477)**

VDA-101: video DA card compatible with VVG 8500 systems; ac/dc feedback clamp; 1-in. 6-out. **Circle (1478)**

VEQ-200: portable video EQ DA; 8,000 ft EQ for 8281 or RG-59/U; ac/dc feedback clamping; 8-30VDC or 90-260VAC; cancels up to 70V p-p common mode hum. **Circle (1479)**

Murry Rosenblum Sound

Audio Ltd. RSM2000: hand-held wireless transmitter; may be used with Schoeps condenser mic heads. **Circle (1480)**

Audio Ltd. Dx2000: miniature diversity receiver fits in a pocket; includes multiway connector for use in custom 19" 8-channel receiver rack. **Circle (1481)**

Audio Ltd. RMS 2000MX: VHF, UHF wireless mic transmitter, receiver; attaches to camera with Velcro. **Circle (1482)**

MYAT

Series 601, 701: 50Ω, 75Ω rigid coaxial transmission line; 6 1/8" material; full line of components. **Circle (1483)**

N

N Systems

Stiletto ST6, ST8: low windload microwave antenna; asymmetrical reflector, offset feed; performs as 6', 8' parabolic with windloading reduced by 2' for each. **Circle (1484)**

Nady Systems

2000 VHF: wireless system with Hiss Mute circuitry; diversity receiver; 120dB dynamic range; hand-held mic available with Shure, Electro-Voice elements. **Circle (1485)**

351 VR: camcorder wireless mic system; receiver connects to external mic jack on the camera; hand-held and lavalier mics; single channel. **Circle (1486)**

750 VHF: dual discrete channel wireless mic system; two diversity receivers in one cabinet; filtering permits 10 channels to operate simultaneously; hand-held, lavalier, instrument mic transmitters. **Circle (1487)**

950 UHF: 10-channel wireless mic and instrument system; true diversity, companding processor; lapel, instrument or hand-held mics available. **Circle (1488)**

Nady 551 VR: 2-channel wireless video mic system; uses VHF frequencies; SMT design; 120dB dynamic range; HT-10 hand-held mic; SX/LT-30 lavalier bodypack transmitter includes mini XLR connector for use with electret condenser lavalier mic. **Circle (1489)**

RW-1 wireless receiver: true diversity reception; 120dB dynamic range; one of five channels in 170-218MHz. **Circle (1490)**

Nagra-Kudelski

Nagra-D: 4-channel digital recorder; open reel 1/4" with helical rotary heads; flexible editing, mixing; 24-bit sampling gives additional headroom for 16-bit dynamics in finished product; light weight unit for on-location recording. **Circle (1491)**

Nalpak Video Sales

Magline Kart enhancements: Quick mount shelf support brackets, Allen Wrench in-

cluded; **Mag-Bag** of Dupont cordura-plus, slips over hand grips of Magline Jr, numerous pockets for small items. **Circle (1492)**

TK-400T Travel Kart Plus: 300 lb capacity; fold-out rear wheels; soft bicycle grips on T-type handle. **Circle (1493)**

National Transcommunications

EDTV 1000: advanced television scan converters for extended, HDTV applications. **Circle (1494)**

SPECTRE project: Special Purpose Extra Channels for Terrestrial Radiocommunication Enhancements; technical tests using orthogonal frequency division multiplexing (OFDM) and digital compression to enhance transmission capabilities. **Circle (1495)**

Nautel

AMPFET FM10: 10kW solid-state, modular FM transmitter. **Circle (1496)**

AMPFET FM4: 4kW FM transmitter; modular solid-state design. **Circle (1497)**

NDG Phoenix

Mac Graphics, Mac Graphics 3-D: integrated paint software packages for 2-D and 3-D. **Circle (1498)**

OMS Operations Management Software: multi-user business system; incorporates with existing accounting software in DOS, MAC, Unix operating systems; marketing, scheduling, invoicing, labeling, equipment maintenance tasks. **Circle (1499)**

LMS 1.3: library management software; optional barcoding in several formats, tape logging module. **Circle (1500)**

NEC America

VUES Ver. 2.2: expands editing system to accept off-line EDLs from AVID non-linear editing control system. **Circle (1501)**

Nemal Electronics Int'l

EMI/RFI suppression: N, BNC, UHF, D-sub-miniature, circular connector cable assemblies with ferrite beads to reduce effects of EMI, RFI interference. **Circle (1502)**

Neotek

Esprit: production, on-air, recording audioconsole; features high quality, moderate price. **Circle (1503)**

Network Music

Primerose library: CD music library from Italy. **Circle (1504)**

Neumann USA

GFM-132: boundary layer mic. **Circle (1505)**

KMS-140: cardioid vocal mic. **Circle (1506)**

KMS-150: hypercardioid vocalist microphone. **Circle (1507)**

TLM-50: transformerless pressure microphone. **Circle (1508)**

Neutrik USA

NC3FDH6 series: 1/4" jack sockets; mounts directly to PC boards; compatible with existing mono, stereo plugs; **double jack** vertical array of two jacks with single-jack footprint. **Circle (1509)**

Neve/AMS Industries

AMS Logic 2: large format workstation with digital recording facilities; Total Dynamic Automation, Multilayer In-Line features; stand-alone system. **Circle (1510)**

AudioFile OPTICA: 4-track optical disk version; direct recording to reusable, removable MO media; use as background recorder

in video edit suite; reference to video-style EDL. **Circle (1511)**

AudioFile Plus enhancements: removable, reusable MO disk; Exabyte cartridge archiving feature. **Circle (1512)**

AudioFile Spectra: new generation digital audio editing system; MO disks, Exabyte tape; slim-design control panel, color LCD display; selectable sample rates, RS-422 record commands, etc. **Circle (1513)**

Neve Flying Fader Junior: software option with Master Touch Record, channel reassign, mix copy and backup routines; Stores writes 99 static mix structures to RAM or disc for later reset. **Circle (1514)**

System Six: integrates Neve and AMS stand-alone audio processors into turnkey package at the cost of the individual processor units. **Circle (1515)**

New England Digital

MultiArc (Rel. 3.1): Macintosh interface, includes enhanced ADR capabilities for CMS Autoconform package and for **EditView** and **TrasferMation** modules. **Circle (1516)**

PostPro, Synclavier upgrade: 4x expansion of RAM capacity using Texas Instrument ZIP modules. **Circle (1517)**

News Technology Corporation

Election Central 322: election computer based on Commodore Amiga. **Circle (1518)**

NewsMaker Systems

NewsMaker for Windows: complete newsroom automation package; compatible with MS-DOS versions; includes 100-channel tuner that fits one card slot for NTSC and PAL. **Circle (1519)**

NewTek

Video Toaster 2.0: 4-input switcher, effects, titler, still store, animation, paint, color processor; D-2 internal processing; enhanced with more soft-edge transitions, real-time sphere and cube mapping; **OrganicFX**, **ActionFX**, **KikiFX**. **Circle (1520)**

Nikon Electronic Imaging

S15x8.5B II Nikkor: enhanced version of previous S15x for 2/3" cameras; 0.8m MOD; removable servo housing for serviceability; wide zoom ratio. **Circle (1521)**

S9x5.5B TV Nikkor: ultra-wide angle; internal focusing system accepts matte boxes, filters; high MFT curve. **Circle (1522)**

S19x8B TV Nikkor: ENG lens reaching from 8mm to 152mm focal lengths; f/1.7 maximum aperture. **Circle (1523)**

Norsat International Inc.

System 60 line: satellite receive system; MC 60 controller with power supply, control modules; system includes satellite tuners, downconverters, demodulators, SMATV modulators. **Circle (1524)**

Northeastern Communication

Concepts

VLH-X, SF-X brackets: mounting devices for speakers, monitors; yoke/arm assemblies accommodate any monitor; optional vibration eliminator. **Circle (1525)**

AccuTrak NCP-1200A: message display system 2-line, 40-character vacuum fluorescent display. **Circle (1526)**

Northern Telecom

DV-45BQ video codec: for switched DS-3; 4.2MHz bandwidth includes time code, captioning data; main and video augmentation

At BTS,
big switcher technology
comes in small packages.



Finally — a routing switcher that's no space hog. The new Venus® switcher provides BTS's famed routing power, yet is packaged in the industry's most compact housing to help save valuable facility real estate. You can also mix video and audio, both analog and serial digital, in the same frame. Big things *do* come in small packages!

Let us introduce you to this new compact high-performance switcher family. Call toll-free 1-800-962-4BTS for free literature, and for a BTS representative to call.

BTS

A PHILIPS AND BOSCH COMPANY

BTS Broadcast Television Systems Inc.
94 W. Cochran St.
Simi Valley, California USA 93065

1-800-962-4BTS
Outside U.S. and Canada: (801) 977-1551

Circle (47) on Reply Card

Creative Television Technology from BTS —



channel; 4-channel digital 15kHz audio is J41 compliant; optional TBC/frame store; meets RS-250C. **Circle (1527)**

Nova Systems

4-field option: accurate color framing capability with NOVASync systems; reduces horizontal shifts in pictures caused by out-of-phase conditions; still pictures freeze without artifacts. **Circle (1528)**

NovaBlox processor: modular with PC compatible NovaCards; TBC, synchronizer, encoder, decoder, transcoder, DA, routing functions; PC plug-in, stand-alone chassis or NovaFrame modular chassis. **Circle (1529)**

NovaCoder Dcoders: composite and Y/C decoder. **Circle (1530)**

NovaCoder Ncoders: RGB, component video inputs produce composite NTSC, Y/C-3.58, Y-688 outputs; converts among RGB, Betacam, MII formats. **Circle (1531)**

NovaCoder Xcoders: RGB and component transcoder. **Circle (1532)**

NOVAMate: TBC on PC plug-in card; stand alone or NOVAFrame. **Circle (1533)**

NUCOMM

FMT, FMR series: 70MHz modulator, demodulator; AM audio subcarrier, four FM subcarriers and video. **Circle (1534)**

FT3, FR3 series: IF heterodyne transmitters, receivers; 70MHz interface; for 1.99 GHz to 13.25GHz. **Circle (1535)**

Shadow antennas: designed for ENG van and central receive applications; single or multiband models; single, dual or quad polarization; *Super-Shadow* for central receive sites. **Circle (1536)**

nVision

NV1000 terminal equipment: performs digital audio signal conversion, plant distribution and synchronization. **Circle (1537)**

NV3512 routers: for RS-422 data, AES/EBU digital audio, time code. **Circle (1538)**

NV4448 converter: digital sample rate conversion; supports current sample rates from 32kHz to 50kHz. **Circle (1539)**



O'Connor Engineering Labs

35 series: tripods with rigid spreader; air assisted column. **Circle (1540)**

55C series: tripods with air assisted columns. **Circle (1541)**

Odetics

ASI: new station automation interface product. **Circle (1542)**

CW 5500/P: cart workstation; handles the recording and playback of compiled break tapes. **Circle (1543)**

TSC90 Cart features: PVW series Betacam SP VTR added to formats usable by automation playback system; field modification for

format change; interfaced expansion converses with several station automation systems. **Circle (1544)**

O.L.E. Limited

Lightworks Digitation: prepares "rushes" for Lightworks editor by digitizing material onto various media. **Circle (1545)**

Lightworks enhancement: ultra high-speed graphics/video hardware provides interactive control in real time of dissolve, wipe, titling and time code features; removable disk packs; high-capacity disk facilities. **Circle (1546)**

OMB Sistemas Electronicos

AM 1000, AM 1000 VR: 1kW FM transmitters using 3XC800A7, 3CX1500A7. **Circle (1547)**

BMS 622: table-top audio mixer; six channels with three inputs per channel; two multiplexed telephone channels; two master output channels. **Circle (1548)**

EM FM exciters: 2-100W EM100, 20W EM-20, 30W EM-30. **Circle (1549)**

EM transmitters: solid-state FM systems; output range 250W-2000W; uses EM exciter, multiple 500W amplifiers. **Circle (1550)**

OMB-PRO TV repeater: 1-5W Band IV-V; double conversion IF system. **Circle (1551)**

TV amplifiers: Bands IV/V 100W, 200W output with solid-state circuitry; Bands III/IV/V 1.2kW, 1.6kW using Thomson TH347; NTSC, PAL, SECAM standards. **Circle (1552)**

Omicron Video

Model 887: HDTV DA. **Circle (1553)**

Omni Chroma Keyer 361/362: stand-alone unit for NTSC (361), PAL (362); three modes of operation based on use of component, encoded and standard video as foreground and background elements. **Circle (1554)**

Omni-Gen 721, 722: genlock systems for Amiga computers; composite, S-video, S-VHS/Hi8/ED-Beta, YC688, analog component in; 721 NTSC, 722 PAL. **Circle (1555)**

OpAmp Labs

A24-2ML: 2-input, 24-output audio press box; 50Hz-15kHz at -2dB; XLR, phone jack, RCA, 3.5mm jack; 18dBm output; balanced inputs switchable to 10kΩ. **Circle (1556)**

A4/2L: 2-channel 1-in/4-out DA. **Circle (1557)**

MS/8x8/VSA: 8x8 stereo audio/video matrix switcher. **Circle (1558)**

RSP-4S: stereo audio, video 4-in/1-out routing switcher. **Circle (1559)**

TCB-10K: dual 10k:10k audio transformer in enclosure. **Circle (1560)**

VA-8, VA-32: 1x8 and 1x32 mic/line video, audio press boxes. **Circle (1561)**

Opcode Systems

Studio 4: 128-channel 8-in/8-out interface for Mac; supports MIDI, SMPTE. **Circle (1562)**

Studio AV, AVx: reads and writes VITC with audio transports controlled from a Macintosh; AVx expands control of additional decks by using master/slave chase-lock feature. **Circle (1563)**

Optimum Productions

Full language services: script translations, adaptation of script to visuals; replace titles; create animation; cast necessary talent; record script in desired language(s); remix music, effects; dubbing, distribution service. **Circle (1564)**

Options International

AntiFlare & Dust CRT: removes flare effect on resolution and afterglow. **Circle (1565)**

High Speed gate lenses: for MkIII, URSA telecines; increases light output over standard lenses; color correction. **Circle (1566)**

Meta-Speed digital servo: for film transfer speeds from -30fps to +96fps with increased stability. **Circle (1567)**

Real Time Steadi System: stabilizes film-to-tape transfers on Rank telecine. **Circle (1568)**

VTK AutoShading: automatic correction of shading errors. **Circle (1569)**

Orban/AKG Acoustics

Optimod-Studio 460: level controller; 2-channel processor includes slow and fast AGC, high frequency limiting, de-essing and peak control. **Circle (1570)**

Transmission Limiter 4000: protects the transmission medium from overload without introducing discernible processing effects. **Circle (1571)**

Ortel

System 10000 FO links: TVRO transmission systems link TVRO systems and CATV headends or broadcast facilities at distances to 40km; distributed feedback laser with optical isolator achieve high performance. **Circle (1572)**

Uplink FO link: feeds an uplink system from an exciter located as far as 20km from the HPA. **Circle (1573)**

Otari

AL-662, AL-632 loading systems: audio cassette loaders; may be used for analog, upgraded for DCC digital. **Circle (1574)**

DISKMIX 2+: hard disk storage, editing system for ARMS2 and compatible console automation; runs DISKMIX 3 Ver 4.0 moving fader and VCA automation with graphic displays, pull-down menus. **Circle (1575)**

DISKMIX 3 upgrade: Ver 4.0 software; new software for front end PC, pull-down menus, on-line help features; foot/frame operation; high resolution fader display. **Circle (1576)**

LR50 series: logging recorders; three 2-speed models cover 1 1/2" to 3 3/4" 48 hours of continuous recording; VEM feature to reproduced audio at double speed with normal pitch. **Circle (1577)**

PD-464 enhancement: dedicated control hardware and software upgrade for Prodisk-464 disk-based digital audio workstation; includes new functions, optional accessories. **Circle (1578)**

R-DAT series: DTR-7 pro recorder; DTR-90N 4-head recorder, CB149 editor for non-destructive preview edit; Quickstart memory card for DTR-90N; DTR-90T includes time code synchronizer card. **Circle (1579)**

Series 54-P: modification of standard 54 series for LCRS film/video mixing; 36 dual-path input, 16 group reassign modules; 72 individual inputs with 40-channel DiskMix 3 ver 4.0 moving fader automation. **Circle (1580)**



Pacific Recorders & Engineering

ADX system: digital audio workstation; disk-based, 8-/16-/24-track recorder; 9-input automated production mixer; Macintosh platform. **Circle (1581)**

PAG Ltd.

PAG AR series: auto-ranging fast chargers; for 4.8-14.4V, 12-30VDC NiCad batteries; AR121, AR201 single channel; AR124, AR304 sequential 4-channel units. **Circle (1582)**

PAGbelt IC2: battery belt with integral

FN6000®

...WHAT YOU EXPECT FROM THE LEADER
IN HIGH QUALITY VIDEO FIBER TRANSMISSION

NOW! 4 CHANNEL SHORT-HAUL BROADCAST QUALITY OVER FIBER

1=4



Chances are, if you have needed short haul video entrance and exit links, your only choice has been single channel per fiber systems. Now, you can transmit four RS-250C short haul videos using a single laser transmitter. Today, ALS can deliver the FN6000, offering you exceptional economy, flexibility, manageability and reliability.

- **COST EFFECTIVE**
especially for TV1 tariff applications
- **FLEXIBLE**
expand your channel capacity with a single, slide-in module
- **MANAGEABLE**
options for remote diagnostics, provisioning and operation
- **RELIABLE**
availability of hot standby fiber switching, dual power supplies

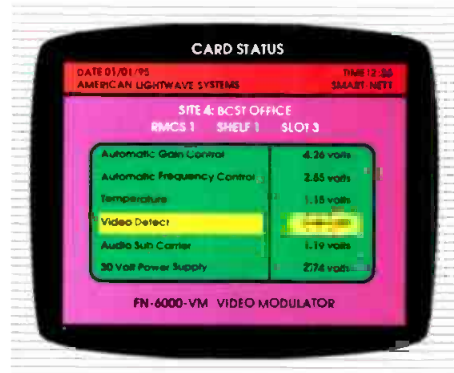

ALS

AMERICAN LIGHTWAVE SYSTEMS, INC.

a subsidiary of ADC Telecommunications, Inc.
999 Research Parkway, Meriden, CT 06450-8323
Phone (203) 630-5770; FAX (203) 630-5701

Circle (48) on Reply Card

www.americanradiohistory.com

No Assembly Required . . .



ZERO STANTRON

CALL OR WRITE TODAY FOR FREE CATALOG

Ntl. Toll Free: 1-800-821-0019 • In California (818) 890-3445
12224 Montague St. • P.O. Box 4527 • Pacolma, CA 91333-4527

Circle (49) on reply card for product information only
Circle (50) on reply card for product information and demonstration

BIRD WROTE THE BOOK ON RF POWER MEASUREMENT FOR THE BROADCAST INDUSTRY. NEED OUR LATEST EDITION?



▼ **THRULINE®**
RF Directional
Wattmeters

▼ Line Sections,
Directional Couplers
and Samplers

▼ **WATCHER®** RF Power
Monitor/Alarms

▼ Digital High-power RF
Calorimeters

▼ **TERMALINE®** RF Absorption
Wattmeters

▼ **TERMALINE®**
Coaxial Load
Resistors

▼ **MODULOAD®** and
ECONOLOAD® Coaxial
Load Resistors

▼ **TENULINE®** Attenuators

▼ All needed accessories includ-
ing carrying cases, adaptors,
connectors, cable assemblies, bat-
teries, dollies

who else but
BIRD

30303 Aurora Rd., Cleveland OH 44139 U.S.A. • (216) 248-1200 • TLX: 706898 Bird Elec UD • FAX: (216) 248-5426
WESTERN REGION OFFICE: Ojai CA • Phone: (805) 646-7255

© Copyright 1991 Bird Electronic Corp.

Circle (51) on Reply Card

switched-mode charger; 12-14.4V 4-10Ah, 24V or 30V 4-7Ah; dual output XLR4 connectors; ODP over discharge protection; 100-250VAC input. Circle (1583)

Paltex

DUOS RAM recorder: multiple I/O component digital system; records, plays key, fill and background signals. Circle (1584)

EDDi: desktop video production system operates under Windows; 8-input EDDiSwitch, EDDiView screen editor, 8-channel EDDiMix stereo mixer. EDDiText titling. *vision* video overlay and *SceneManager* key-frame database features in four versions meeting differing basic requirements. Circle (1585)

EUROPA upgrade: color-coded QWERTY keyboard, *Jogger* extension; programmable color status display. Circle (1586)

RF-Manager: transmitter remote control system. Circle (1587)

Panasonic

AG-7350R: S-VHS VCR with HiFi, linear audio channels; 34-pin parallel operation or RS-232C option to daisy-chain control for 32 VCRs; Dolby noise reduction; 2-hour record time; 17-step shuttle dial. Circle (1588)

AG-7355R: S-VHS VCR, integral frame store, HiFi audio; 34-pin parallel operation or RS-232C option. Circle (1589)

AG-A570: single-event edit control for AG-5700 S-VHS VTRs; RS-232C connections controller and transports. Circle (1590)

AG-J700: multisource switcher selects between video, audio and remote sources in edit suite; 4-input, 1-output. Circle (1591)

AJ-D320: field portable D3 VTR; 64-minute recording with two AU-BP402, Anton/Bauer Magnum 14 batteries. Circle (1592)

AJ-IA13P: digital rate format converter; interface between D-1 and D-3/D-2 format signal; integral test signal source; auto sync selection; analog output; option for embedded audio facilities and four AES audio channels. Circle (1593)

AQ-11D: digital processing camera using 3 IT CCDs; composite digital output; compatible with AQ-20D system components, including fiber-optic adaptor. Circle (1594)

AQ-20D: digital processing camera; 3-CCD system uses FIT chips for 750-line resolution; 4x Fsc composite digital output option; fiber-optic adaptor option. Circle (1595)

AQ-255: digital processing camera; 2/3" FIT CCDs; fiber-optic cable; 750-line resolution with 1/8 2,000lux sensitivity. Circle (1596)

AS-D590: serial digital video router; ASIC design reduces power, space requirement; 32x32 composite digital matrix for 143Mbit/s data rates; peripheral interface includes analog-serial and serial-analog converters. Circle (1597)

AS-D700: composite digital switcher; 4-bus, multilevel M/E; 10-input; 2 key levels; parallel digital, analog I/O boards. Circle (1598)

AU-A950: production editor controls 5 VTRs, video switcher, audio mixer; 2000-event EDL; expansion card for 8-play, 2-record VTRs. 10 GPI triggers. Circle (1599)

AU-CSFM2003 software: automatic conflict resolution and manual operation features for 2000 series software. Circle (1600)

Enhanced MII products: 7th generation; integral TBC, 2 FM/2 linear audio channels. LTC/VITC generator/reader. S-video out, NTSC 16:9 aspect capability; series includes: *AU-45H* dockable, *AU-55H* portable VTRs; *AU-62H* studio player; *AU-63H* studio player with auto tracking. Circle (1601)

S H A R P T H I N K I N G

AWARD-WINNING COPIERS THAT ARE #1 IN CUSTOMER SATISFACTION.

Today, customer satisfaction means more than productivity and reliability. It means cost-effectiveness. That's why you need Sharp Thinking.

Sharp Thinking created the high-speed, high-volume SD-2075 Master Series Copier/Duplicator. An advanced technology package that's winning industry and customer raves for excellence.

The SD-2075 does it all for less, giving you the most-wanted features as standard. It produces high-quality documents at 75 copies per minute, and masters the largest, most complex jobs — sorting, finishing, computer fanfolds, report covers and much more. That's Sharp Thinking.

It's behind every Sharp copier. So if you're looking for high value in a high-volume copier, start thinking Sharp. For more information call:

1-800-BE-SHARP



© 1992 Sharp Electronics Corporation

SHARP
FROM SHARP MINDS
COME SHARP PRODUCTS™

BANKING SYSTEMS • CALCULATORS • CASH REGISTERS • COLOR SCANNERS • COMPUTERS • COPIERS • FACSIMILE • LASER PRINTERS • TYPEWRITERS • WIZARD® ORGANIZERS

Circle (52) on Reply Card

www.americanradiohistory.com

DPS-285

Put it to the Test.

The DPS-285 is three broadcast quality systems in one. It's a Master RS-170A Genlockable Sync Generator with Composite Sync, Blanking, Subcarrier and four Black Burst/Super Black outputs. It's also an independently timed 10-bit Test Signal Generator with 32 test patterns, dedicated SMPTE Bar output and programmable 24 character I.D. Plus, it's an Audio Tone Generator with selectable frequencies throughout the audio band. It gives you three capabilities for one low price.

\$2,995

DIGITAL
PROCESSING SYSTEMS INC.

In the U.S.
Call 606-371-5533
In Canada
Call 416-754-8090

Circle (53) on Reply Card

HD fiber-optic system: digital transmission with compression, multiplexing of studio BTA format, four PCM audio channels; 8:1 compression yields 150Mbit/s signal meeting B-ISDN specifications. **Circle (1602)**

HD still store: archives 1,500 images on MO disk; JPEG compression; features include playback effects; interface to multiple MO drives, audio CD ROM drives; 2-second image access time. **Circle (1603)**

HD display: 36" receiver, 1/2" HD player, system control, message generator; auto repeat, unattended operation. **Circle (1604)**

HDTV acquisition system: portable field production equipment; AU-27000 UNIH1 recorder, 2/3" 3-CCD HD camera and 20" monitor. **Circle (1605)**

HDTV cinema projection: 6-tube rear-projection system for 110-250" screens; multiple HD VTRs play two 2-hour or longer tapes; Ramsa audio components produce 4-channel surround sound. **Circle (1606)**

M.A.R.C. D-Cart: smaller robotic automation system with two D-3 VTRs, capacity of 35 cassettes. **Circle (1607)**

M.A.R.C. Type III: automation system with 10 internal VTRs; M.A.I.F. automation interface software; operates multiple output channels, scheduled recordings; pre-compiler for breaks. **Circle (1608)**

Multi-Station software: complete management for two or more outputs using common elements or completely different material; auto cue of all segments. **Circle (1609)**

OMDR software drivers: Mac and PC drivers for optical memory disk recorders, LQ-4000 and TQ-3000 series. **Circle (1610)**

S-VHS projectors: PT-B1010U/UF for 80-120" diagonal or PT-B2010U/UF (150-250" diagonal); 700-lumen output; 800-line resolution video, 1,100-line RGB; direct optical coupling. **Circle (1611)**

WJ-MX50: audio, video switcher; 2-channel frame synchronizer for effects on A, B buses; wipe, strobe, still, posterization, trail, multi-image effects. **Circle (1612)**

WV-D5100HS: modular camera; high sensitivity to f/1.4, 3.5lux (+18dB gain) with single 2/3" CCD; four lens options; includes electronic shutter. **Circle (1613)**

WV-F250BH: 3 FIT-CCD camera; stand-alone or dock to AG-7450 S-VHS. AU-410 M-II VCRs; component or separate Y/C outputs; 750-line resolution. **Circle (1614)**

WV-F500: compact camera, digital signal processing; 3 IT CCD 700-line resolution; docks to Enhanced MII VTRs. **Circle (1615)**

Paul Olivier & Associates/POA

Products Group: distributors for Philip Drake Electronics intercoms, digital audio DAs, A/D, D/A products. **Circle (1616)**

Systems Group: systems integrators; consultant, design, turnkey jobs. **Circle (1617)**

Peerless Sales

Designer Series: ceiling and wall mount units for 20" to 27" diagonal monitors; tilt, swivel adjustment; VCR mount attaches underneath. **Circle (1618)**

Tall pedestal mount: heavy-duty column supports 20-27" monitors from 4-7' heights; other sizes by special order. **Circle (1619)**

Penny & Giles

Endless belt controller: integral bar graph display; conductive plastic device offers precise tactile interface. **Circle (1620)**

PEP

DigiSpot: digital audio system uses 3.5" disks; each disk stores 2 minutes of uncompressed stereo audio. **Circle (1621)**

Perrott

GEMINI series: combined battery with charger; 214FC, 214U 13.2V 5Ah; 28F 12V 2.8Ah. **Circle (1622)**

PS 90/u pwer supply: 12VDC 4.5Ah; operates from 80-240VAC for world wide application. **Circle (1623)**

PESA Electronica

CG4733: anti-aliased titler; 4:4:4 architecture, instant sizing; optional graphics plane; template management, multi/mini graphic pages, 16Mbyte RAM cache, removable 44Mbyte disk system. **Circle (1624)**

D-2/D-3 matrices: enhancement for System 5 routers; serial digital capability for 143Mb/s (NTSC), 177Mb/s (PAL) signals; permits creation of router with mix-and-match component, composite analog and serial digital facilities. **Circle (1625)**

RM4000: 100MHz bandwidth routing switcher; 6600EX controller board for 48-in/40-out matrix; also controlled with 16-level RC5000 system; available with serial D-2/D-3 matrix. **Circle (1626)**

Philip Drake Electronics

6000XL series: 32x32, 48x48 matrices intercoms; fit in limited space. **Circle (1627)**

PD5040: auto stereo correction; detects, indicates, corrects time delay, phase inversion, signal level errors. **Circle (1628)**

PD5050: 20-bit A/D, D/A converter; in 1-unit rack-mount package. **Circle (1629)**

PD9372: AES/EBU to SDIF-2 format converter. **Circle (1630)**

PD9375A: 20-bit A/D converter card; 44.1/48kHz; includes 16-, 18-, 20-bit dither selection. **Circle (1631)**

Philips Components

LXE18300x: microwave power transistor; 32W at 1.85GHz; for personal communications network base stations. **Circle (1632)**

PLB16030U: microwave power transistor for class C, common base stages; 30W output at 1.6GHz. **Circle (1633)**

XQ-5002: camera tube for high resolution imaging. **Circle (1634)**

Philips TV Test Equipment

PM 5686A/70: digital NICAM modulator; removes clicks or switching dropouts by temporarily storing incoming information, while regenerating frame alignment word and control bits. **Circle (1635)**

PM 5628: CAV-4:2:2 converter. **Circle (1636)**

PM 5629: 4:2:2-CAV converter. **Circle (1637)**

PM 5635: HDTV sync generator with pattern generator. **Circle (1638)**

PM 5636: 4:2:2 format video test signal generator. **Circle (1639)**

PM 5638 upgrade: color coder; redesign includes sync clippers permitting composite and non-composite inputs, integral test signal source; may be used as sync generator. **Circle (1640)**

PM 5639/00: hand-held color analyzer; filters simulate characteristics of the human eye as a standard observer; displays absolute color, luminance of a monitor and shows deviation from correct color temperature. **Circle (1641)**

PM 5640A upgrade: NTSC or PAL test pat-

Inter BEE '92

24th International Broadcast Equipment Exhibition

November 11—13, 1992

Nippon Convention Center
(Makuhari Messe)

BEE SURE TO ATTEND!

Inter BEE is the place to be. It's the one forum that gathers the world's most dramatic developments in broadcast, video and professional audio technology. Industry participants agree: last year saw 27,000 visitors and 390 exhibitors from 20 countries exhibiting their newest technologies in 1900 booths.

The impact of technological advancements is creating new opportunities, not only for hardware providers but also for operators who are looking at ways to develop new markets for news and entertainment media. So, in addition to exhibits of the latest video, broadcast and audio equipment, forums, seminars and symposiums on the state of the art run concurrent with Inter BEE '92 over the three days of the exhibition.

Building on the dynamics of previous shows, Inter BEE '92 remains the Asian forum for industry leaders where ideas on the nature of the medium are debated alongside the very technologies that are helping realize the vision of a global community.

Sponsored by the Electronic Industries Association of Japan

Planned and managed by the Japan Electronics Show Association

Tokyo Chamber of Commerce and Industry Building
3-2-2, Marunouchi, Chiyoda-ku, Tokyo 100, Japan

Circle (54) on Reply Card



Inter BEE '92



tern generator; enhanced with more than 170 signals, full VITS facilities. **Circle (1642)**

Phoenix ENG

4WD ENG: Ford 4WD Bronco; Will-Burt Sky High mast with warning system; 1kW DC converter; air system; remote pan/tilt for ENG antenna; communications antenna wiring; equipment racks. **Circle (1643)**

ENG Van: Ford E-350 van with Will-Burt Sky High mast, mwarning system; 5kW generator; air conditioning; equipment racks; remote pan/tilt control for ENG antenna; wiring for communications antenna; custom equipment per request. **Circle (1644)**

Pinnacle Systems

DVEator upgrade: animation, modeling *Sculptor 4.0*; Postscript support; doubled rendering speeds; live video mapping; Component A/B Pixel Switcher. **Circle (1645)**

FlashFile: still store; accesses 12 images within 1/60sec; random access to 10,000 in 1/2s or less; *FlashPix* search feature; standard capacity of 400 images; options for removable optical drive. **Circle (1646)**

Prizm enhancements: new control panel, CPU for vands, small studios; optional CCIR digital I/O. **Circle (1647)**

Pioneer

PLUS system: Pioneer LaserDisc Universal System; LD-V8000 player; LC-V330 autochanger; PLUS IBM AT/compatible controller; operates pay-per-view CATV, CCTV channel automation. **Circle (1648)**

VDR-V1000, -V1100: rewritable videodisc recorder. [See Pick Hits] **Circle (304)**

CAC-V3000: autochanger holds 300 CDs; dual players for undetected switching between trays. **Circle 1049**

Pipeline Digital

AutoLog V2.0: software for Macintosh; allows PICT image files to be saved as part of logging information on Mac II systems with video window card. **Circle (1650)**

PixView Inc.

Viewstore 4000: 384Mbyte RAM buffer; stores 10,000x10,000 pixel RGB image or a 15s video sequence. **Circle (1651)**

VRR Video RAM Recorder: three D-2 digital or analog channels; 108s capacity; VITC per field; slow motion; proc amp stabilizes signals not conforming to D-2; editor control port for each I/O channel. **Circle (1652)**

Plasmec Systems

ADAS-SA: stereo hard disk recorder, editor; stand-alone unit; 16-bit from 44.1/48kHz sampling; 64x oversampling stereo A-to-D converter. **Circle (1653)**

Prime Image

10 by 10 Sync: very wideband direct syn-

chronizer; 10-bit, 10MHz; 4-input, 4-field memory; D-2 output option. **Circle (1654)**

Model 2X: dual-channel time base corrector. **Circle (1655)**

Multi/TBC.Sync 10X: 3RU package with 10 plug-in TBC/synchronizer modules; any or all modules operate independently or locked; for any VCR type. **Circle (1656)**

TBC-PCB: plug-in TBC board; single-channel, 525-line window; compatible with Betacam (SP), M-II, U-matic (SP), Hi8, S-VHS, VHS and ED-Beta formats. **Circle (1657)**

Production Garden Library

Air Assault/PG CD 301: 240 elements; stingers, sweepers, lasers, promo and traffic beds; explosive effects. **Circle (1658)**

AV/Video series 200: full length themes, edits in 15 CD set. **Circle (1659)**

Broadcast Series 100: 15 volumes; :60s, :30s, production elements. **Circle (1660)**

New CDs: set includes *Idea Tracks, Energy Tracks, Cool Tracks, Off the Wall, Motivation and Journey*; **Circle (1661)**

Professional Sound Corp

M4 mixer: portable unit with four inputs; MS stereo compatibility; 20-hour operation from a battery. **Circle (1662)**

Progressive Image Technology

CP-10: cross-pulse adaptor; shows vertical interval on composite monitor. **Circle (1663)**

Kitchen Sync: synchronizes two independent sources; two TBCs on card for one IBM AT slot. **Circle (1664)**

Promusic

Digifects on CD: 3,500 sound effects on 40 CDs; 11 categories. **Circle (1665)**

Music Library Ver 3.0: library management software. **Circle (1666)**

Producers Sound Designer series: includes general sounds; cafe, crowd, festival backgrounds; rain/thunder; traffic, trains; water. **Circle (1667)**

Professional Librarian: library management from Leonardo Software. **Circle (1668)**

Sound Ideas library: selections from General, Ambiance, Hollywood, Lucas Films, Wheels series. **Circle (1669)**

Prophet Systems

Audio Wizard: radio automation system on 486/33 PC; controls 15 audio stations; DAT devices for backup, audio storage; large media hard disk stores 25,000 minutes stereo; digital audio switcher; system uses hot standby 486 PC. **Circle (1670)**



Q-TV

Executive Speech Prompter: improves speaker's eye contact at public speaking events. **Circle (1671)**

QEI

691 VPTDO: variable peak duration test for modulation monitor, 695 FM exciter; adjustable response time window from 0.1ms to 1ms; activates peak flasher if peaks in 5ms period exceed a programmed threshold range, 1-15 peaks. **Circle (1672)**

QSS-10000 transmitter: solid-state FM system rated 10kW; redundant modules with liquid cooling; 65% overall efficiency; uses Model 695 exciter with AUTOMOD modulation control. **Circle (1673)**

Quanta

Vector Logo Composer: digital graphics unit; creates logos; vector format; sizing, color, shading. **Circle (1674)**

Widescreen 16:9: Delta text and image generator with 16:9, 4:3 aspect ratios in NTSC, PAL standards. **Circle (1675)**

Quantel

Desktop Paintbox: image manipulation, photo montage feature with creative color; Mac-based; bidirectional interface to Paintbox V, Paintbox Junior. **Circle (1676)**

HAL digital compositing system: effects, graphics, key functions, high-quality audio; 75s random-access storage; Chatter disk management system; manipulate multiple layers of live video. **Circle (1677)**

Harriet upgrade: interface to Paintbox, Picturebox, shared disk storage via Picturenet; improved graphics preview, library search; timeline control. **Circle (1678)**

HENRY concurrent editor: features extensive multilayering, random access. [See Pick Hits] **Circle (305)**

Paintbox Ver 8.0: zoom feature for graphics, pasteup, effects menus; radial, parallel lines; *menu up, glue* functions; extended translation of numeric data to graphics; *Pictureport* interface to Mac. **Circle (1680)**

Picturebox enhancements: full captioning capabilities with *Headline Texts*; Serial 601 input interface; Serial 601 or RGB/YUV outputs; *Picture Mail* transport of images to outlying stations. **Circle (1681)**



R-Columbia Products

RL-100: wireless talent cue hearing aid-type headphone. **Circle (1682)**

Radiation Systems Inc.

CLI SpectrumSaver: video compression system by Compression Labs. **Circle (1683)**

Models 100, 133: antenna control; precise, multi-axis pointing, tracking for satellite antennas, radar; *Optrack* mode tracks satellites in highly inclined orbits. **Circle (1684)**

Radio Computing Services

#1000 Tracker: digital audio logging to DAT format tape with concurrent playback capability. **Circle (1685)**

Linker: integrates commercial and music logs on paper or for transfer to a radio automation system. **Circle (1686)**

Radio Design Labs

AMX-84: digital audio router; 8x4 configuration; PC control feature. **Circle (1687)**

Stick-On additions: audio problem-solving modules. [See Pick Hits] **Circle (316)**

Radio Systems

RS Master Clock: analog with drivers, slaves for broadcast facilities. **Circle (1689)**

RS-24 mixer: 24 linear faders for 48 stereo, mono sources; production, on-air; mix-minus of four discrete buses. **Circle (1690)**

RS-Squared: 24dB noise reduction system; stand-alone encode-decode unit based on Dolby S technology; may be used with cart, reel sources, STL links; single-ended stereo phase correction; **Circle (1691)**

Ramsa/Panasonic Audio

WX-RP410/RP700: 30-channel 800MHz UHF wireless mic system for ENG/EFP; synthe-

Surpassing yesterday's standards of composition, THOMSON BROADCAST is changing the creative landscape with a complete range of 4:2:2 digital component equipment, featuring the very latest technical innovations to give you the edge : Equipment such as the 4:2:2 KEYSER, a stand-alone keyer designed to fit the post-



production needs of either the small, digital "island" (be it grading station or graphics area), or as a powerful addition to an existing digital or analogue suite. Or SYNONYM, the powerful top-of-the-range digital vision mixer with serial 270 Mb/s routing and connections, offering all the advantages of flexibility with four assignable keyers and an instantly configurable mix - "MULTI-LAYER" or "DOUBLE MIX". Or COLORADO, the digital component colour processor with 4:4:4 internal processing enabling correction or manipulation of picture colour parameters - at any stage of post-production. Three modular, configurable products for a fast reaction to clients' needs. Today, THOMSON BROADCAST surpasses technical boundaries and offers the way to unequalled composition.

THOMSON BROADCAST

State of the digital art



- COLORADO**
- Digital Component Colour Processor
 - R,G,B blacks, gains, gammas and saturation
 - Shot by shot grading using time-code
 - File management system
 - Single or Multi-channel



- SYNONYM**
- Digital Component Vision Mixer
 - 270 Mb/s Serial inputs/outputs
 - Up, Mid or Downstream assignable keyers
 - Configurable mix - Multi-Layer or Double Mix



- 4:2:2 KEYSER**
- Digital Component Keyer
 - Sophisticated key control and Key-Compose
 - "Stand alone" or with Control Panel
 - Single or Multi-channel

Circle (55) on Reply Card

THOMSON BROADCAST - 17, rue du Petit-Albi - B.P. 8244 - 95801 Cergy-Saint-Christophe Cedex FRANCE - ☎ (33-1) 34.20.70.00 - Fax : (33-1) 34.20.70.47 - Télex : 616 780 F
UNITED KINGDOM - **THOMSON BROADCAST, Ltd.** - 18 Horton Road - Datchet - Berkshire SL3 9ES - ☎ (0753) 581122 - Fax : (0753) 581196
USA - **THOMSON BROADCAST, Inc.** - 49 Smith Street - P.O. Box 5266 - Englewood, New Jersey 07631 - ☎ (201) 569 16 50 - Fax : (201) 569 15 11

sized receiver; mounts on camera/recorder; 30mW RF output. **Circle (1692)**

Rank Cintel

Jumpfree: URSA telecine servo; increases vertical stability allowing real-time transfer with accurate matting; pan, zoom features in live still frame mode. **Circle (1693)**

Turbo 2 telecine: adds digital deflection to the Turbo MkIII flying spot optical system; expands adjustment range in image rotations, zoom, positioning and aspect ratio changes. **Circle (1694)**

RE Electronics

d620 digital video interface: 2-channel unit with serial I/O; CCIR 601 component converter, CCIR 656 parallel digital video processing. **Circle (1695)**

d920 interface: serial digital reference generator; conforms with AES II synchronization for digital audio equipment in studio operations. **Circle (1696)**

d930 digital audio interface: analyzes, modifies a digital audio data stream; transparent to 24-bit signals. **Circle (1697)**

d940 headphone interface: permits monitoring of digital audio data stream; performs conversion on AES/EBU and SPDIF format through 16-bit D/A device. **Circle (1698)**

RE-533 Slim Profile: RDS coder; stores 16 data records; supports Program Service name, Program Type, Traffic Announcements, Radio Text and other RDS services; **RE531** adds paging capability. **Circle (1699)**

RE8720/8730: tie line audio codec for 15kHz stereo transmission with telco lines or twisted pair conductors; optional 1.2kbaud data channel for use with RDS system; implements error concealment, muting circuits. **Circle (1700)**

RE880 sound interface: encodes, decodes four 7.5kHz speech channels to 64kbit/s; 15kHz module future option. **Circle (1701)**

Register Data Systems

DigiCorder: hard disk audio storage; 386 CPU drives from 100Mbyte to 1.2Gbyte; S-VGA monitor, 101-key keyboard; stereo, mono compatible; standard capacity 100 minutes 15kHz stereo. **Circle (1702)**

The Phantom: desk-top automation for radio using satellites program delivery; hard disk stores 100 minutes of 15kHz stereo; create logs on PC control station or import from traffic system, edit logs; export as-run logs to traffic, billing. **Circle (1703)**

Research Technology Int'l/RTI

CF3000-MK V: Lipsner-Smith ultrasonic film cleaner; submerged buffing, speeds to 200 feet per minute. **Circle (1704)**

D-11 dropout counter: analyzes videotape for dropout prior to recording, loading, editing, duplication; for Betacam SP, B, C, S-VHS, U-matic, MII formats. **Circle (1705)**

DXA-11 dropout counter: for D-1, D-2, D-3 and all analog tape formats. **Circle (1706)**

Proline 4100: Betacam(SP) videocassette recycler. **Circle (1707)**

TapeChek 490M: cleaner, evaluator for MII media. **Circle (1708)**

TapeChek 6120: evaluation unit for 1" video tape; Micro-Pulse detection system checks for flaws before re-use or inspect pre-recorded masters without erasing information; cleans, burnishes media. **Circle (1709)**

TapeChek 6120A: evaluator, cleaner for 1"

audio master tape; high speed evaluation, Micro-Pulse detection. **Circle (1710)**

TapeChek DVL: produces audible signal when a tape-based defect in the video is sensed. **Circle (1711)**

TapeChek XCL: cleaner, conditioner, rewinder for VHS. **Circle (1712)**

RF Technology

Faraday equalizers: low-pass filters, delay lines in miniaturized packages. **Circle (1713)**

RGB Computer & Video

AmiLink products: Windows 3.x versions with serial switcher, audio mixer control, Video Toaster control; AmiLink/Logger videotape logging software. **Circle (1714)**

Richardson Electronics

FM modules: by Spectrian; ratings for 150W, 300W and 700W. **Circle (1715)**

YL1057 tetrode: metal-ceramic with concentric electrode terminals; direct replacement for Siemens device in TV visual or aural final stage and translator systems; 2.3kW to 860MHz. **Circle (1716)**

Rohde & Schwarz

RDS DMDC decoder: decoder for EBU, ARD spec; retrieves, monitors, transfers RDS and VRF signals transmitted in FM multiplex system. **Circle (1717)**

RDS paging test software v1.05: use with DMC.05/09/10 encoder to create RDS radio paging transmission system for test and demonstration. **Circle (1718)**

SAF generator: multistandard video source for CCVS signals; PAL, NTSC 525-/625-line, analog component and digital component signals. **Circle (1719)**

VNA video noise meter: all TV standards, 1050-, 1125-, 1250-line HDTV, CCVS, analog component 525-/625-line systems and several non-broadcast standards. **Circle (1720)**

Roland Corporation

SRC-2 sample rate converter: dual system; two inputs, one output on XLR, coax and optical conductors may select among multiple digital formats for bidirectional conversions; permits mixing of two signals from different sampling rates into one output at any selected rate. **Circle (1721)**

Rorke Data

Mass storage systems: wide range of magnetic storage devices from major manufacturers. **Circle (1722)**

Rosco Laboratories

Cinegel system: light color modification products; diffusion, reflection, balance of different sources, reduce incidental daylight, create special effects. **Circle (1723)**

Russco Electronics

CD100: compact disc adapter. **Circle (1724)**

DA 2816: audio DA. **Circle (1725)**

HA10, HA20: headphone amps. **Circle (1726)**

MA25, MA75: 25W and 75W audio power amplifiers. **Circle (1727)**

Mark VI: phono turntable. **Circle (1728)**

Studio Master 505: mixer. **Circle (1729)**

Telemote 321: remote mixer. **Circle (1730)**

S

Sabine Musical Manufacturing

FBX-90 feedback exterminator: digital notch device senses, eliminates feedback. {See Pick Hits} **Circle (317)**

Sachtler

1800L/Video 18 III: lightweight ENG fluid head. **Circle (1732)**

2000L/Video 20 III: lightweight ENG, EFP fluid head. **Circle (1733)**

575D1/Set 575D1: lightweight, compact daylight for location use. **Circle (1734)**

6286/Tripod DA 150 HD 2: robust, greater stability than previous units. **Circle (1735)**

6400/OB1: studio support system, very good stability, weight savings. **Circle (1736)**

7080/Dolly XL: maximum stability, but weight-conscious design. **Circle (1737)**

Off-Ground spreader: snap-on locks adapt to older tripods; center lock permits different angles of the struts. **Circle (1738)**

Reporter series lights: Reporter 20H uses 20W or 75W G4 lamp; Reporter 50H uses 30W Osram, 50W or 100W GX6.35 lamp; on-board design; either unit weighs 11 oz; adjusts from spot to flood. **Circle (1739)**

Samson Technologies

UHF system: for 944-952MHz; **UR-4** receiver, **UT-4** belt-pack transmitter, **UH-4** handheld transmitter; diversity receiver; 7 crystal-controlled frequencies for simultaneous operation. **Circle (1740)**

San Francisco Satellite Center

Ku Truck: Ford E350, National Coach body; 500W uplink to SatCom 2.4m prime dish; redundant RF electronics. **Circle (1741)**

Sanken/Audio Intervisual Design

CQ-1 prototype: 4-channel *Shotgun Surround* microphone; features left, right, center and surround channels for HDTV, film production; multiple-capsule design for each mode. **Circle (1742)**

ScheduALL by VisuAll

Ver 3.20: includes enhanced library system, bidding module and project manager feature. **Circle (1743)**

Scientific Atlanta

Digital Ad Delivery system: combines D9100 VQ encoder, D9110 integrated satellite digital receiver with VQ decoder; IBM 386 PC controller; multiple 1Gbit hard disks; commercial insertion using compressed video data. **Circle (1744)**

Selco Products

Pointer Knobs: soft-touch control knobs of thermoplastic material; colored pointer; 11mm size for 6mm/18-spline shaft; custom colors for body or pointer. **Circle (1745)**

Sencore

AAVS EVA: real-time machine sequencer; broadcast or production applications with ATRs, VTRs, various peripherals, routing switchers to 64x64 matrix through RS-422/-232 or ESBUS. **Circle (1746)**

AAVS MOSAIC: real-time picture multiplexer; 16 pictures on screen simultaneously with various display modes; expansion module extends to 32 inputs and sequential switching between "pages" of images. **Circle (1747)**

AAVS NEXUS: modular switching, distribution, monitoring features; A/V signal detection; auto changeover to standby signal for each channel; 16 channels per module, expandable to 64 channel; interface to Mosaic display system. **Circle (1748)**

AAVS ONYX router: μ P-control, 16x8 to 128x matrices; control panels use "softkey" LCD buttons, LCD screens. **Circle (1749)**

Your Production Switcher Has Given You The World...

Our Multi-Layer Keyers Add The Sun, The Moon And The Stars.

Your production switcher has always been the mainstay for your television productions. However, with ongoing advances in equipment and skill levels, you may be reaching the limits of your earth-bound switcher.

Think for a minute. In post-production do you find you must make two or more passes to achieve a desired effect? Or how about your sports/entertainment coverage? Multi-camera situations may allow you a wide variety of video and key sources to optimize coverage, but when your switcher has reached its limit...so has your show.

If taking advantage of your talents, ideas and equipment resources is limited by your switcher, you should call us. Our low cost, high quality Multi-Layer Keyers add FOUR key sources to your switcher. And these keyers are incredibly easy to use with multiple remote control choices, GPI interface, fade transitions, etc.

Additionally, they operate as stand-alone units. And this opens up possibilities for an unlimited number of uses.

For your television production needs, the sky is no longer the limit. Let the keyers used in the coverage of the world's premier sporting events open up an entire universe of opportunities for you.

LairdTM
THE TELEMEDIA COMPANY

Circle (56) on Reply Card

All Laird products are made in the U.S.A. Laird Telemedia, Inc. 2424 South 2570 West, Salt Lake City, Utah 84119 (801) 972-5900

CAMERA SUPPORT EQUIPMENT: ANALOG.



AUDIO		REC TALLY	
NO.1	*ODB	Curr	New
{.35-.55}		.45	.40
*Gamma (NOR)		.45	.45
*Gamma (SHT)		98	98%
Knee Point		110	110%
White Clip		31	31
*H. DTL Level H		31	31
*V. DTL Level H		15	15
*H. DTL Level L		15	15
*V. DTL Level L		15	15

SHTR H.G BATT AUTO

EVF display of "current" and "new" settings for critical adjustments.

When you take Panasonic's WV-F700 digital processing camera into the field, you get studio quality pictures and performance without taking the studio camera support equipment with you. That's how Panasonic puts digital theory into practice—in the very practical WV-F700.

Panasonic's applied digital technology in the WV-F700 gives you control over a wide range of camera settings and set-up procedures. To adjust gamma in the field, you don't need the linearity chart, lighting kit, picture monitor or waveform monitor. Just use the "electronic tweaker"—a small on-board adjustment panel—and enter a new, numerical gamma value. Read the new setting in the electronic viewfinder (EVF).

EVF menus show you current and new settings not only for gamma, but for knee, white clip, horizontal and vertical detail, matrix masking, zebra indicator settings, shading correction and flare compensation.

*Suggested list price. Betacam SP is a trademark of the Sony Corporation.

For the Panasonic Professional Video Dealer nearest you, call: 1-800-524-0864



*WV-F700 Digital Processing Camera
pictured with AU-410, MII VTR and optional
accessories.*

DIGITAL.

You can control all this with the "electronic tweaker" or the small remote control box. Because digital circuitry is constantly comparing and adjusting the camera's performance to the settings you established in memory, you can leave your vectorscope, tweaker tool and screwdriver home too. Drift is virtually a thing of the past. Digital circuitry gives you enhancement for chroma, dark, high and low band details; cross color suppression, highlight aperture, automatic shading correction, and much more.

Digital camera technology like this should be available to everybody, so Panasonic priced the WV-F700 at just \$10,000*, and designed it to dock with MII, S-VHS and Betacam SP VTRs without need of special adaptors. Even at this price, the camera's 750-line resolution, super high sensitivity 2/3-inch 3-CCD image system (f8.0 at 2000 lux), and 62 dB signal-to-noise ratio are coupled with features like SMPTE color bars in the EVF, with time, date and camera ID.

When it's time to choose your next camera, consider Panasonic's all-digital processing WV-F700. It's a decision that will require very little additional support.

Panasonic Communications & Systems Company
Division of Matsushita Electric Corporation of America, One Panasonic Way, Secaucus, NJ 07094.

Panasonic



AAVS Series 100: signal processing, distribution modules in 3U format. **Circle (1750)**

Sennheiser

HE/HEV90: headphone with driver; two predriver tubes, four output tubes; electrostatic diaphragm with push-pull design for high linearity. **Circle (1751)**

SESCOM

Book Series: instructional publications *Audio Interfacing; Mic Splitting; Audio Transformers; Signal Processing.* **Circle (1752)**

Shereff Systems

Deputy CG: titler software operates on 386/486/586 PC with 1MByte RAM on S-VGA card; WYSIWYG editing; includes 10 fonts in 9 sizes; gradient screens, shading; shadow, transparency effects; optional Cinnamon color fonts. **Circle (1753)**

Pro Video CG II: real-time titling software for Amiga. **Circle (1754)**

Shure Brothers

FP410: portable automatic mixer; 4-input unit, *Noise-Adaptive Threshold, Max Bus Circuit, Last Mic Lock-On* features. **Circle (1755)**

ILP-1 pre-amp: for SM91/SM98 condenser mics; in-line device measures 1/2" long, 13/16" diameter; plugs directly into 3-pin XLR mixer or snake; powered by 11-52VDC phantom supply. **Circle (1756)**

L series enhancement: expanded frequency choices permits 10 L systems to be used simultaneously. **Circle (1757)**

VP64: dynamic omnidirectional hand-held microphone. **Circle (1758)**

WCM16 wireless: headworn condenser mic for no-hands operation by performers, communicators; in association with Countryman Associates; available separately with L-series wireless systems. **Circle (1759)**

Sierra Automation Systems

ANC-8: 8-character alphanumeric control panel for SAS 32000 routers. **Circle (1760)**

APC-88 control panel: console-mounted unit for SAS-32000 switcher; eight take buttons, memory, support logic in single-width module. **Circle (1761)**

DCA-8: digitally-controlled amplifier; 8 independent channels with VCA devices to control levels. **Circle (1762)**

SAS 32000C: programmable intercom for 32 users; requires 3RU; alphanumeric subscriber designations; separate talk, listen; IFB, mix-minus conferencing. **Circle (1763)**

Sierra Video Systems

Control program: DOS software control for SVS routing switchers. **Circle (1764)**

Model 20: 20x10, 20x20 video and audio routers. **Circle (1765)**

Model 32V/A: 32x V/A router. **Circle (1766)**

Model 82C: 8x2 3-channel component video router. **Circle (1767)**

Model Sixteen-Sixteen: 16x16 router for video and audio. **Circle (1768)**

Sinar Bron

ProCyc: 5' radius curved set pieces hide floor-backdrop interface; fiberglass construction. **Circle (1769)**

Sira Sistemi Radio s.r.l.

3VTV-02, -04: VHF horizontally polarized full-band panels. **Circle (1770)**

FM combining filters: high-power systems. **Circle (1771)**

FMC-03: circularly polarized FM full-band transmitting panel antenna. **Circle (1772)**

Superturnstile: full-band UHF transmitting antenna. **Circle (1773)**

Skotel

TCG-313FTK: LTC time code generator, reader, inserter. **Circle (1774)**

TCG-333FTK: VTC/LTC time code generator, reader, inserter. **Circle (1775)**

Snell & Wilcox

Alchemist: production model standards converter with phase correlation motion estimation; 24-point linear aperture CCIR-601 converter. **Circle (1776)**

DVS1000: 4:2:2 switcher; for telecine, special projects, editing environs; permits use of component signal paths throughout the facility, including switching. **Circle (1777)**

HD2100 downconverter: produces 525-/625-line material with higher picture quality than is available from conventional cameras. **Circle (1778)**

HD3100 crossconverter: converters between field rates and line rates, bidirectionally; from 1125/60 and 1250/50 to 525/60 or 625/50. **Circle (1779)**

KUDOS CVR20, CVR40: 2-field, 4-field standards converters; improved designs based on IBA DICE, BBC ACE standards converters; each on a single card. **Circle (1780)**

TPG generator: all-standard, all-format digitally encoded signal source. **Circle (1781)**

SOFTIMAGE

ACTOR software: creates complex 3-D animation and effects. **Circle (1782)**

SOFTTOUCH

CCD/PC: closed circuit decoder for IBM PC/compatibles; half-size card for ISA bus; set I/O address, IRQ; decodes any VBI line 10-21 field 1 and field 2; 120bytes per second decoded. **Circle (1783)**

CCE/PC: closed circuit encoder for PC/compatibles. {See Pick Hits} **Circle (306)**

Solid State Logic

Scenaria: digital soundtrack system; combines 38-channel mixer, 24-track audio recorder with random-access video storage in one package; compatible with ScreenSound and SoundNet systems. **Circle (1785)**

SL 8000G: multifunction audio mixer; G-series automation computer controls TV, motion picture and music recording configurations; includes capability of 3-D music production. **Circle (1786)**

SoundScreen enhancements: features include EDI, Scan CMX file import function; Autoconform loads material from external machines with timecode reference; Vari-Time compression, expansion; to eight M-C drives; Disk Store expansion packs; interface to third party additions. **Circle (1787)**

Solutec

SOL-TrafLink: software for SOL-6800 automation system operating under Windows; receives schedules through direct link with traffic computer; translates playlist data to SOL-6800 events, etc. **Circle (1788)**

Sonic Solutions

CD Printeric Station: desk-top CD recording system; double speed writing; precision track start, end times; 74-minute capacity; usable for creating CD-ROMs. **Circle (1789)**

MasterMaker: CD mastering system; interfaces to PCM-1630, DMR-4000 and other source products. **Circle (1790)**

SSP-3 card: handles loading of sound to hard disk in 16-bit resolution; 24-bit processing; 8-channel or 12-channel playback from single hard disk; seamless editing, crossfading; mixing desk with shelving, presence filters. **Circle (1791)**

Sony Communications/Broadcast

SMS-3: studio monitor; 2-way 20cm woofer, 3cm dome tweeter; 300W. **Circle (1792)**

VPH-1271Q: multistandard, multiscan projector. **Circle (1793)**

BVP-375 studio camera: with HyperHAD 1000 CCDs for 800-line horizontal resolution; f/8 at 2000 lux. **Circle (1794)**

BVP-90: EFP camera; HyperHAD 1000 sensor; 800-line horizontal resolution; vertical definition of 450 lines. **Circle (1795)**

BVW-400A enhancement: Super EVS frame integration for improved vertical resolution, perceived detail; Extended Clear Scan for flicker-free images of computer screens scanned below 60Hz. **Circle (1796)**

BVW-D265: Betacam SP player, interface to composite digital equipment. **Circle (1797)**

CKV-series: distribution monitors for board room, school room; *CKV-27EXR 27"*, *CKV-20EXR 20"*. **Circle (1798)**

DCU-372 digital CCU: adapts cameras to digital D-2 environment and RGB, Y/R-Y/B-Y analog components. **Circle (1799)**

DFS 500: combined digital effects, switching. {See Pick Hits} **Circle (307)**

DFX1201, DFX2101: bit rate converters between 4:2:2 and 4Fsc; convert digital audio and video in one process. **Circle (1801)**

DMX-E3000: 16-input digital audio mixer; 24-bit AES/EBU digital I/O and 32-bit internal signal paths. **Circle (1802)**

DPS-M7 digital sonic modulator: flexible sound effects processor; Haas effect panning, ensemble, spiral modulation; 32-bit processor. **Circle (1803)**

DVR-P20, DVR-P28: D-2 player systems; *P20* uses small and medium cassettes; *P28* uses all three cassette sizes. **Circle (1804)**

DXC-327A: dockable camera head using HyperHAD CCDs; 700-line resolution with S/N or 62dB; docks to Betacam SP and Hi8 decks. **Circle (1805)**

ECM-531: podium mic on noiseless gooseneck mount. **Circle (1806)**

EVO-9650 Hi8 animation VTR: frame-by-frame unit for use with computers creating automation; integral frame buffer; RS-232C control, optional VISCA I/O interface for computer control. **Circle (1807)**

EVW-300 camcorder: Hi8 format; 1/2" HyperHAD sensors for 700-line resolution, 60dB S/N. **Circle (1808)**

FlexiCart: scaled down multicassette library system; {See Pick Hits}. **Circle (308)**

HDC-500 camera: HDTV CCD camera; 2,000,000-pixel 1" FIT HyperHAD chips; f/8, 2,000 Lux sensitivity. **Circle (1810)**

NAB '92 - Show of Shows

LMS interface: tie to CycleSat commercial delivery system; records commercials via satellite, enters appropriate data in control computer system; requires minimal over-seeing by human operator. **Circle (1811)**

MXP-390: 12-input analog audio mixer; eight stereo channels, four mono. **Circle (1812)**

PCM-3324S: 24-track DASH, PCM recorder; prestripping at 4x normal speed. **Circle (1813)**

PHM-3400: monitor serving 1125-line HDTV and 525-NTSC signals; offers 16:9 and 4:3 aspect ratios. **Circle (1814)**

PVW-2650: Betacam SP 2000 series player; features dynamic tracking where variable speed playback is essential. **Circle (1815)**

SuperMotion system: based on Betacam products. **Circle (1816)**

SVO-9600 player/recorder: S-VHS transport; interface boards for commercial insertion, VITC board for remote control via satellite, RS-232 interface with computer controlled record/play functions; companion playback unit, SVP-9000. **Circle (1817)**

WRT-830A: hand-held mic operating on one of 74 UHF frequencies; synthesized frequency control; electret condenser capsule. **Circle (1818)**

Sony Display Products

PVM 8040 series: 8" monitors, including PVM-8040 NTSC and -8041Q, -8044Q multi-standard systems; increased sharpness; also PVM-5041Q 5". **Circle (1819)**

RVP-400Q: 40" rear projection cube; produces 1500 ft-L all white luminance output; 640x480-pixel resolution. **Circle (1820)**

Sony Recording Media

BCT-MA series: metal Betacam SP recording media. **Circle (1821)**

Enhanced D-2 Master series: cassettes for composite digital; improved lubrication; Super Cross Linked Binder; reduced dropout; 3- to 208-minutes lengths. **Circle (1822)**

HMEX series: Hi-8 metal evaporation Evaticle medium with cobalt alloy bonded directly to base film; 3,700 Gauss retentivity; new surface treatment. **Circle (1823)**

HMPX series: Hi-8 metal particle recording media. **Circle (1824)**

MDU series: digital audio U-matic material. **Circle (1825)**

MQST series: pro S-VHS tape. **Circle (1826)**

PDP series: pro DAT Plus tape. **Circle (1827)**

Shipping cases: for large-size D1, D2 cassettes. **Circle (1828)**

Sound Ideas

General 600 series: 40 CDs contains 50 hours; 6,000 new digital effects; expanded general and new categories. **Circle (1829)**

Soundcraft

VBE-100: audio-for-video mixer; 8 input modules; many features follow Delta system design. **Circle (1830)**

Vienna, Europa: live sound, reinforcement consoles. **Circle (1831)**

Soundforms

Portable recording booths: lightweight enclosures for broadcast, video, film, music industries; *SoundBooth*, *SoundRoom*, *DoubleBooth* models. **Circle (1832)**

Spaceware Graphics Ltd.

Q^{VT} animation control: software package for PC graphics studio; control for various recording products. **Circle (1833)**

Specialized Communications

Maintenance, repair services: for broadcast, professional video. **Circle (1834)**

Spectrian

FM150-C, 300-C, 700-C: DMOS-FET power amplifiers for FM band; 60% efficient units rated at 150W, 300W, 700W; 50VDC power required. **Circle (1835)**

UHF Power Blocks: a series of solid-state amplifier assemblies for UHF TV spectra; 4W, 10W, 15W, 60W, 200W models; 28V_{cc} power supply. **Circle (1836)**

VHF275L-AB, VHF275H-AB: DMOS-FET power amplifiers for VHF TV; units rated

275W, combine for greater power levels; greater than 45% efficiency. **Circle (1837)**

Sprague Magnetics

Cable assemblies: Geneva audio, video cable kits. **Circle (1838)**

Media care kits: Geneva complete care kits for videotape heads, CDs; head degaussers, tape erasers; various cleaning fluids. **Circle (1839)**

Stanton Electronics

CD-22: dual CD player in console; 10-memory program play, 99 even direct access play. **Circle (1840)**



Start Routing D2 for Less Than \$6,000, Then Grow As Far As You Like.



DYNA MITE Idea.

Don't be fooled by its compact size. DYNAIR's DYNA MITE is much more than a versatile, inexpensive, D2 broadcast and production router.

Not only is it available in serial D2 for less than \$6,000, DYNA MITE is so flexible it's also available in Hi Res, RGB, Component, HDTV, NTSC or PAL video, and wide band TC, with two level control. Built-in control panel with readout is standard.

But don't stop here. This modular little DYNA MITE system can grow from 10 x 10 to 20 or 30 x 10 video, audio, or 10 x 10 audio/video in only two rack units. Want a lot more switching power? Expand from DYNA MITE to board interchangeable DYNASTY, our top-of-the-line 1000 x 1000 switcher.

And if analog is your interest, imagine a 10 x 10 40 MHz video/audio switcher with local control standard for less than \$6,500. No one else can touch that.

We've been building our indestructible switchers for over 35 years.

Call **1-800-854-2831** to learn about DYNA MITE staying power.

DYNAIR

DYNAIR Electronics, Inc.

5275 Market St.
San Diego, CA 92114



Circle (58) on Reply Card



Stanton Video Services

Follow Focus/Zoom System: for film, video lenses; 2-position memory; AC/DC operation provides adjustable rate control of focus, zoom. **Circle (1841)**

Star Case

Custom Reference Guide: custom case designs; new literature, training aids for dealers and end users. **Circle (1842)**

Enhance Star Case line. **Circle (1843)**

The Exhibitor: convertible shipping container, organizer, table set; efficient, expeditious for trade show use. **Circle (1844)**

Steenbeck

ST-701V editing table: 6-plate system includes film-to-video transfer features; adds SMPTE time code and Keycode to videocassette transfers. **Circle (1845)**

Stellavox/Digital Audio Tech.

STELLAMODE: multistandard professional D/A converter; AES/EBU digital I/O, S/PDIF digital input; adjustable balanced analog output levels; digital domain absolute phase inversion. **Circle (1846)**

Stellaword: professional CD recorder; uses Philips CD-R technology. **Circle (1847)**

Storeil

Beta Cart Room Stretchers: setup trucks; for 280 Beta cassettes on five shelves or 300 snap-cap cassettes. **Circle (1848)**

Beta Cassette Room Stretcher: modular storage system; 10 shelves hold 200 cassettes; surface-mount tracks, overhead anti-tip track. **Circle (1849)**

Storemax, Railrider: double film/tape storage; units move on floor-mounted tracks; avoids wasted space in the tape storage room. **Circle (1850)**

Strand Lighting

CD90 dimmer: intelligent control system; 16-bit single-chip digital dimmer fade processing, 2,000 fade steps; programmable dimmer response times; 32 backup cue memory. **Circle (1851)**

Color Call Scroller: scrolling color changer with control signal, power distribution; 2-speed fan extends life of filter materials; DMX512, 0-10VDC. **Circle (1852)**

Lightboard M: mid-range lighting control desk; 768 dimmers on 96 or 144 control channels. **Circle (1853)**

Mantrix LX: manual lighting control board; 2-scene preset desk with wire-per-dimmer connections. **Circle (1854)**

mini Lightpalette 90: mid-range memory lighting controller; 1,024 dimmers on 576 control channels; 600 cues per show; permits programmed effects, channel grouping. **Circle (1855)**

Studio lighting: Reporterlights, 125W, 200W 12V/20VDC; Quattro Quasar single-

ended QuartzColor 1.2kW, 2.5kW, 4kW lamps; Daylight Special, 12kW HMI system; Sirio Fresnel, 12kW; balasts. **Circle (1856)**

Suspension Systems: self-climbing lighting hoist, motorized pantograph, pole operated pantograph. **Circle (1857)**

Strassner Editing Systems

Strassner C, D systems: single-source, 3/5-sources; uses AT PC with 2Mbyte RAM, 14" status monitor; 40Mbyte hard drive; intelligent VTR control network. **Circle (1858)**

Strassner systems Ver 4: upgrade software for all CMAX and Strassner systems; direct replacement software for CASE-1 controllers; provides variable speed editing with variable tracking VTRs; Jog-Shuttle control; ESAM II audio mixer feature; tape striping command from keyboard. **Circle (1859)**

Strassner-PRO: 6-source edit control; on-line features, programmed motion control, multi GPI triggers, split-screen EDL management, event TimeLine. **Circle (1860)**

Studer Digitec

NUMISYS: digital cart replacement; alternates steps of playlist between two channels of console; manual list editing, resequence feature; commercial insertion option; 48kHz sampling to 16 bits. **Circle (1861)**

NUMISYS REGIS: automated program editing system; uses standard PC with RS0232 link to various audio sources, including hard disk, R-DAT, CD and analog tape units; permits creation of a multi-user network and sharing of resources. **Circle (1862)**

Studer Editech

Dyaxis I: 2-channel stereo editor, production system; integrates with D740 CD recorder, D780 R-DAT; upgraded MacMix software; automated real-time EQ, level control; converses with wide range of digital I/O formats. **Circle (1863)**

Dyaxis II workstation: multichannel with real time crossfading in edit, record modes; digital mixing; signal processing; 5-band parametric EQ; event-based automation; internal time code synchronizer; Macintosh System 7, Apple Quadra computers control software. **Circle (1864)**

Dyaxis Lite: compact digital audio editor; cost-effective system combines computer-based editing with ease of conventional tape machines; compatible with and upgradable to larger systems. **Circle (1865)**

Studer ReVox

990 console: digital control in a multitrack recording, production, post production, radio/TV broadcast; 20-80 inputs through 48 buses; options for input modules, submasters, dynamic processors, metering and monitoring facilities. **Circle (1866)**

C115: pro cassette deck. **Circle (1867)**

C221: professional CD player. **Circle (1868)**

D780 R-DAT: free-standing or integrated recorder; fast spooling to 400 times play; 64x oversampling; bit-stream conversion with 8x oversampling; Quick-Start feature reads 7s of recording around desired starting point for instantaneous start. **Circle (1869)**

DS-D series: routers; analog, digital versions; matrix control panels. **Circle (1870)**

ReVox MR8: pro mixer. **Circle (1871)**

Studio Film+Tape

Evaluated tape: 1", Betacam, Betacam (SP), 3/4" KCA/KCS, D2 formats. **Circle (1872)**

Studio Technologies

IFB Plus Model 2: central controller for interrupted foldback with ENG, SNG, mobile production facilities; associated products include Model 22 access station and Model 32 talent amplifier. **Circle (1873)**

Sumitomo Electric

ViewPlex-2000: video signal multiplexer; displays to 16 different video channels on one standard monitor; or permits various configurations of 1, 3, 4, 6, 9, 10, 13, or 16 images; any type of signal may be displayed, including non-synchronous. **Circle (1874)**

Sundance Technology Group

RADIO: random-access digital in/out/off-line non-linear editing system using Sundance software. **Circle (1875)**

Swintek Enterprises

Mark Q50-200/DCT: wireless IFB; with "cover out-of-sight" receivers. **Circle (1876)**

Wireless Cypher: for boardroom systems; encryption mode for privacy; descrambled by Q2RX receivers. **Circle (1877)**

Symbolics/Graphics Div

HD XL animation: Unified Graphics system with paint, 2-D/3-D animation tools; supports multiformat input, output with NTSC, PAL, multiple HDTV types. **Circle (1878)**

Release 6.2: upgrades unified paint, 2-D, 3-D graphics software; DXF converter for CAD; networking software; direct SCSI to Solitaire film recorder; RS232 control of Abekas A66; multiple machine control. **Circle (1879)**

RenderServer 2.0: for off-loading of rendered images to Silicon Graphics Indigo, Personal Iris workstations; includes new rendering effects. **Circle (1880)**

SMIDI: software for S graphics; interface audio to queue music, voice, sound effects with animation events. **Circle (1881)**

Systems Wireless

HME 800: advanced UHF wireless intercom system. **Circle (1882)**

Vega 600: UHF wireless mic. **Circle (1883)**



Taber

McCurdy MAG7A telephone set: for private, point-to-point communications over bidirectional 2-wire circuit, unidirectional 4-wire circuit. **Circle (1884)**

McCurdy TS2200A automatic hybrid: fully automatic system; micro-processor controlled. **Circle (1885)**

#1500M degausser: for metal tape; controlled erasure for MII, Beta-SP, VHS, U-matic, 1" reels. **Circle (1886)**

#409/M: table-top eraser for metal media; erases video, audio, control tracks to 75-85dB below recorded signals. **Circle (1887)**

Tally Display Corp.

Tri-color interactive displays: system creates matrix-type characters to identify, indicate status of equipment; red, green, yellow colors show status; senses router configurations, etc, as input source. **Circle (1888)**

Tamron

Fotovix III: converts photographs, negatives, slides to video for display or recording. **Circle (1889)**

TAO/Technical Aesthetics Operations

Editizer MIDI accessories: ShuttleKnob, ShuttleKnob II VTR and transport controls; AudioMixer 8-input, stereo output; input levels adjustable through Windows software. **Circle (1890)**

Editizer V1.1: Windows-based A/B roll editing; supports Video Toaster, Lightwave 3-D animation, joystick transport functions, time code calculator; serial-parallel converter. **Circle (1891)**

Tapematic USA

Tapematic systems: audiocassette and videocassette loading systems. **Circle (1892)**

TAPSCAN

Retail Spending Power: added feature to Tapsan software package. **Circle (1893)**

Target Technology

DUAL2 management system: 2-track audio phase and channel switching; use with 2-track tape machine to correct track assignment, phase errors. **Circle (1894)**

FRED MKI: 4-in/4-out audio additive mixer, switcher; select any or all inputs to any or all outputs. **Circle (1895)**

QUAD5 management system: 4-track audio assignment, stereo monitoring; 5x4 matrix with mono-sum. **Circle (1896)**

TASCAM

202 MK II: dual record dubbing deck; makes two copies to be made from external master; twice speed, real time modes; Dolby B, C and HX Pro. **Circle (1897)**

ATS-500: synchronizer for TASCAM serial interface ATRs, parallel transports with IF-500 serial-to-parallel interface. **Circle (1898)**

CD-601/RC-601: single transport CD system with Auto Cue, End Check, Jog Wheel, Variable Pitch; digital XLR output, analog on XLR or unbalanced RCA jacks. **Circle (1899)**

M-1500 series: rack-mount 8+8, table-top 16+16 input mixers; Dual Buss for separate stereo signal path to each channel in addition to main fader signal path. **Circle (1900)**

M700-MFA: automated recording console; 24-, 32-channel, eight group buses, four assignable effects return switches, six aux sends; dual signal path effectively doubles inputs during mixdowns. **Circle (1901)**

tc. electronic A/S

M5000: digital audio delay; AES/EBU interfacing; DARC digital analog reverb co-processor technology; stereo system includes various delay-based effects programs; requires two rack spaces. **Circle (1902)**

TC8201: AES/EBU interface analyzer, test generator; Windows 3.0 driver; supports SPDIF, optical interfaces. **Circle (1903)**

Teatronics International

TV studio package: lighting, distribution, dimmer and control system designed for 30'x40' facilities. **Circle (1904)**

TechFlex

Flexo NYLON: braided nylon material; highly resistant to abrasion; for cable management. **Circle (1905)**

Flexo WRAP: braided monofilament sleeving, Velcro enclosure; for cable management. **Circle (1906)**

TechnoSystem

TRS200 transposer: 200W solid-state repeater; uses RT-10 repeater with ULS-200 amplifier in UHF band; for NTSC, PAL, SECAM standards. **Circle (1907)**

TXS200 transmitter: solid-state UHF transmitter; UL-10 modulator. ULS-200 200W amplifier; NTSC, PAL, SECAM. **Circle (1908)**

TEKNO

Fluxlite System: continuous light source with no heat output; color spectrum similar to natural daylight or tungsten; 200W unit equivalent to 1kW-2kW halogen units; dims to 10% with minimal shift in color temperature; no flicker. **Circle (1909)**

Tektronix

2711 spectrum analyzer: weighs 22 lbs; TV line, field triggers; integral C/N, occupied bandwidth, signal search, FM deviation measurement; audio demod, headphone jack. **Circle (1910)**

Educational publications: books, application notes and videotapes provide additional information about VM 700A instru-

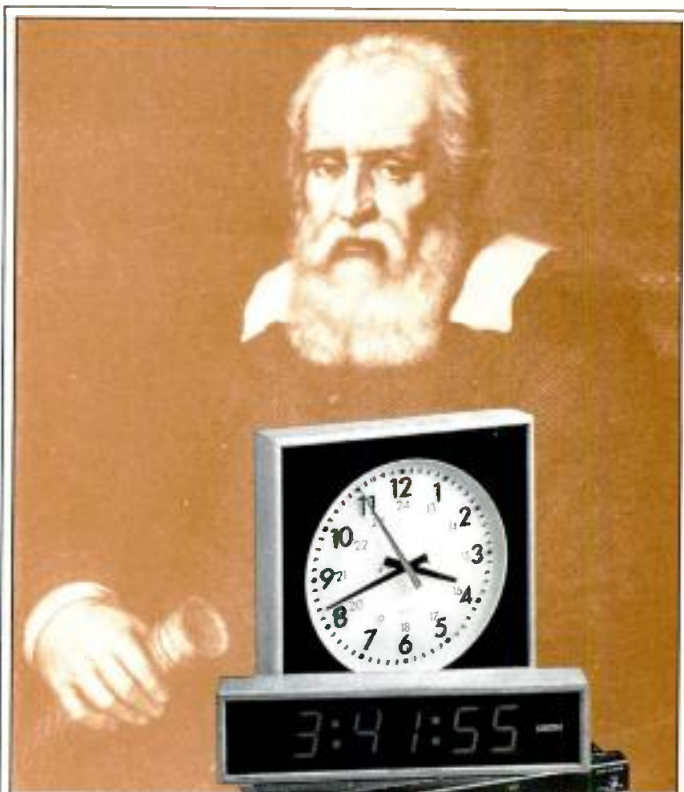

**GALILEO
WOULD HAVE
APPROVED**

When the great Galileo invented the pendulum, he opened the door for clock technology to advance to a level of accuracy undreamt of in his day. Galileo had no idea that Leitch would one day be offering superb clock technology - in the form of CSD-5300, a Master Clock System with uncompromising accuracy and trouble free operation.

This Leitch state-of-the-art time piece will drive an entire series of clocks with millisecond accuracy, across the hall or across the world. It even updates itself by automatically making a phone call. And all Leitch clocks feature precision control with remote setting. If you can set a wrist watch, you can program the Leitch CSD-5300. The Leitch system is used by some of the leading scientific organizations around the world.

If precise time synchronization and simplicity of operation is important to you, look into the Leitch series of incredible time pieces. You'll be surprised how you've managed time without them. If Galileo was around today, he would approve.

LEITCH®

Leitch Incorporated/HEDCO
920 Corporate Lane, Chesapeake, VA 23320, U.S.A.
Tel: (800) 231-9673 or (804) 548-2300
Fax: (804) 548-4088
Leitch Video International Inc.
220 Duncan Mill Rd., Suite 301, Don Mills, Ont.,
Canada M3B 3J5
Tel: (800) 387-0233 or (416) 445-9640
Fax: (416) 445-0595

Circle (59) on Reply Card

NAB '92 - Show of Shows

ment; PAL measurements; testing Y/C systems; 8-field sequence, SC/H phase; evaluation, monitoring, error detection, handling for serial digital signals. **Circle (1911)**

J17 LumaColor: handheld photometer or colorimeter; plug-in heads include *J1803* luminance head, *J1820* chromaticity head for direct measurements in CIE, CIE-UCS coordinate systems. **Circle (1912)**

PE 1000 PAL encoder: uses TSG 1001 programmable TV generator YUV outputs to produce analog PAL signal with 30MHz bandwidth. **Circle (1913)**

TDS 400 upgrade: video trigger on selected fields, lines of NTSC, PAL, non-standard signals to 75kHz line rates. **Circle (1915)**

TSG200, TSG202: compact NTSC signal generators for production, maintenance use; -200 includes six 10-bit test signals; -202 generates SMPTE bars and black burst outputs; both have audio output; half-rack width by 1 rack unit high. **Circle (1916)**

VM 700A GPIB Opt 48: graphic analysis and display of measurement instrument for GPIB environment. **Circle (1917)**

VM 700A Option 21: automated camera measurement; {See Pick Hits}. **Circle (309)**

VS210 NTSC synchronizer: transparent with four times the accuracy and resolution of 8-bit systems; analog, composite digital I/O for mixed format systems. **Circle (1919)**

Telecast Fiber Systems

Cobra: smart fiber-optic digital audio snake; 64-channel, bidirectional; mic, line inputs; lengths from 100-100,000 feet; optional 64x64 matrix switcher with Windows-based CPU. **Circle (1920)**

Viper: fiber-optic EFP video/audio snake; for audio, video, data and intercom applications. **Circle (1921)**

Telemetry

TM66095: pan/tilt control by RS-232; multi-core system operates four cameras with 16 presets. **Circle (1922)**

TM8650/AQ-20: triax adapter for Panasonic AQ-20 camera. **Circle (1923)**

Telescript

Monitor prompter: 17" display for studio use. **Circle (1924)**

Television Engineering

IFB-19A: audio controller. **Circle (1925)**

New ENG Design system: new dimensions, features and layout. **Circle (1926)**

Telex Communications

Custom frequencies: for Radiocom wireless intercoms; eight wireless systems operate on one 6MHz TV band. **Circle (1927)**

ENG-1: wireless receiver for video cameras, camcorders; compatible with any Telex belt or hand-held transmitter. **Circle (1928)**

RTS CS series enhancements: software features for E&M signalling for nonintelligent 4-wire devices; XY panel control; CSEdit intercom editor for keypad setup search; power fail recovery. **Circle (1929)**

SSA324 system interface: for transfer, conversion of 20kHz call signals between RTS-Audicom, RTS-RTS, RTS-4-wire, Audicom-Audicom intercoms. **Circle (1930)**

ACC cassette duplicator: dups both sides of original to three cassettes at 16x normal speed; as a copier, can make duplicate four cassettes. **Circle (1931)**

EGM series: electret condenser mics; 12", 19" gooseneck provided. **Circle (1932)**

ELM-33: unidirectional lapel Micro-mini mic; black matte, nonglare. **Circle (1933)**

Audiocom intercom enhancements: 2-user *US-2000* 2-channel station; *ES-4000* 4-channel expansion station; *SPS-2000* power supply, speaker; *SPK-1000* powered speaker monitor; *PS-4000* supply. **Circle (1934)**

Telos Systems

Telos 100 DELTA: digital telephone hybrid. {See Pick Hits} **Circle (318)**

Telos ONE-plus-ONE: two digital hybrids in one rack enclosure; two operate independently with mix-minus matrix, as part of multi-hybrid system; auto configuring universal power supply. **Circle (1936)**

Tentel

New gauges: designed for maintenance of D3, D2, Hi8, Betacam, M-II and U-matic transports. **Circle (1937)**

Texar

PCX 2.CX4: transmitter switcher automation; FM version uses digital control of composite baseband switcher. **Circle (1938)**

PCX 3.AX.24: full studio automation; simple to operate; for overnight, weekend satellite-feed facility. **Circle (1939)**

PCX 422.C: custom intelligent control interface using RS-422/232; distributes control of facilities including multifrequency antennas in shortwave broadcasting. **Circle (1940)**

TFT

9100S, 9107: composite aural STL transmitter, receiver; combined FM stereo generator with audio processor in transmitter; direct L/R audio, SCA injection inputs; receiver features optional stereo decoder with L/R outputs. **Circle (1941)**

DMM-92: digital STL for spectral efficiency. {See Pick Hits} **Circle (319)**

IF interface: STL system. **Circle (1943)**

Model 9200/9205: monaural field-programmable STL; VLSI design; 70dB SNR at ± 22 kHz FM deviation. **Circle (1944)**

Theatre Service & Supply

Clear-Com IF4-B4: connects intercom to cameras, 2-way radios, etc., through headset jacks or 4-wire circuits. **Circle (1945)**

Clear-Com MS-222GM: 2-channel intercom main station, speaker, power supply; to 30 headset stations. **Circle (1946)**

Clear-Com PS-22: 1A power supply for 2-channel intercoms. **Circle (1947)**

Clear-Com PS-454: multi-channel power supply, 2-, 4-channel intercom. **Circle (1948)**

Thomson Broadcast

BELLEVUE: PC 16:9 display card for 386, 486 PCs; replaces VGA allowing 24-bit color images under Windows 3.1; performs JPEG data compression. **Circle (1949)**

PIXTORE: still-store; 386 Windows-based; operates with DIANA server for any type of picture, 525/625, 4:3, 16:9; Bellevue interface card; Ethernet LAN may tie in with ISDN; uses ISO/JPEG compression to reduce disk space. **Circle (1950)**

TTV 1625: combines TTV 1647.S camera head, CA 25 multicore adaptor, CCU 1625 and control panel; for multicore EFP operation. **Circle (1951)**

TTV 7160: serial digital distribution amplifier; for D-1, D-2/D-3 signals; auto EQ to 300m cables. **Circle (1952)**

TTV 7400 DIGIPHASE: serial digital signal phasing device. **Circle (1953)**

TTV 7656: serializer, deserializer; four serial outputs from one parallel input; regenerated loop-through output of serial signals in addition to parallel signal; auto input EQ; for D-1, D-2/D-3 NTSC/PAL. **Circle (1954)**

TTV 7760 HD: Hi-Doubler image converter; produces 1050-line from 525, 1250-line from 625 inputs; processes 16:9 or 4:3 aspect ratios. **Circle (1955)**

TTV 7810: standards converter; bidirectional among analog composite NTSC, PAL, SECAM, digital composite NTSC, PAL; analog components and 270Mbit/s 4:2:2 digital component signals. **Circle (1956)**

TTV3821/3820: D-1 recorders with and without dynamic tracking; -3821 includes slow-motion; serial digital I/O; 525/60, 625/50 switchable. **Circle (1957)**

TTV7710, 7711: Double D1 splitter, combiner; splits analog HDTV signal into two 4:2:2 signals for recording and processing with standard 4:2:2 equipment; recombines finished product to component, RGB outputs with composite or tri-level sync outputs. **Circle (1958)**

Thomson Tubes Electroniques

TH 10001 modulator: screen-grid technique modifies class of operation of TV transmitter during sync; improved efficiency by 15%; adapts to all Thomson TV tube families. **Circle (1959)**

TH 343 tetrode: FM power to 30kW at 120MHz; 18dB gain; Pyrobloc grids; in TH18230G cavity circuit. **Circle (1960)**

TH3781, TH3754: Ku-band TWT devices; 55W or 160W ratings with 60% efficiency; weights of 900g. **Circle (1961)**

TH-8467 projection CRT: 9" for HDTV projectors; P53 green, P56 red, P11 blue phosphors; EM focus; 2,000 TV points per line; dispenser cathode. **Circle (1962)**

360 Systems

AC2: DigiCart data compression software; multiband frequency-domain processing; by Dolby. **Circle (1963)**

EPROM cards: 4Mbit memory cards; allows storage of six minutes of 10kHz audio per card. **Circle (1964)**

HD-1000 hard disk: 1Gbyte storage for DigiCart; 7.7-hour capacity on 7-platter, 3.5" drive. **Circle (1965)**

Mini Keyboard: controls DigiCart; standard-size keys, no keypad. **Circle (1966)**

On-Screen: playlisting software; full-color playlist generation for DigiCart using DOS PC. **Circle (1967)**

Series 1000: playback modules; self-contained system; 4-message memory, 5W output amplifier in weather resistant housing; requires speaker for use. **Circle (1968)**

3dbm

Model 802: solid-state TV transmitter; VHF or UHF to 1kW peak sync. **Circle (1969)**

3M Pro A/V Products

393, 395 magnetic film: full coat magnetic media for recording, motion picture sound track dubs; 3dB increased MOL; low wow, flutter characteristics. **Circle (1970)**

DAT hanger/shipper: container holds two DAT cassettes, track sheet, labels; for use with 3M hanger bar system. **Circle (1971)**

Enhanced 275 media: digital audio master-



ing tape; compatible for DASH, DMS, PD formats. **Circle (1972)**

Improved DSC series: D-2 media; formulated for lower headwear, low BER; total antistatic shell design. **Circle (1973)**

HXP Hi8: videocassettes for Hi8 format applications; greater than 400-line resolution, low noise; 30- to 120-minute. **Circle (1974)**

Tiffen Manufacturing

Color Grad filter line: glass optical color modification filters expanded with additional colors. **Circle (1975)**

Time Arts

Creative License: videographics and design software; for Silicon Graphics 4D series workstations and IRIS Indigo; Motif interface; VideoFramer option. **Circle (1976)**

TimeLine

Console Control Unit: optional keypad on AMS, Euphonix, Neve, Otari, SSL consoles to operate TimeLine System Supervisor multi-transport controllers interfaced to console automation computers. **Circle (1977)**

Lynx Gearbox Card: plug-in module for Lynx time code modules; V600 software for variable speed control of individual transports or synchronized groups. **Circle (1978)**

MicroLynx: low-cost machine control; synchronizes audio, video transports and MIDI; incorporates SMPTE, MIDI TC generators, two synchronizer/resolvers, MIDI-to-SMPTE synchronizer; Macintosh interface; VITC, other options. **Circle (1979)**

Toko America

TCD-1000: portable codec for multimedia teleconferencing. **Circle (1980)**

VAST-P: video, audio storage, transmission system. **Circle (1981)**

Toshiba Professional Video Systems

HDTV consumer VCR: prototype using 8mm mechanical platform; records compressed DigiCipher format on metal evaporated tape; joint venture with General Instruments. **Circle (1982)**

HC-1600A: ultra high-resolution video printer; 16.7 million colors, 256 levels of gray. **Circle (1983)**

P 6600S projector: high-resolution projection system uses six 7" CRTs with magnetic focus; front or rear screen operation; autoscans covers 15-80kHz. **Circle (1984)**

TSC-100: 3-CCD Hi8 camcorder; resolution >700 lines from 380,000 effective pixel array; multispeed shutter; 12.6-lb operating weight; S-VHS output; records SMPTE VITC TC, PCM and AFM audio. **Circle (1985)**

Toshiba Video Systems

SC-521: 3-CCD camera; 600,000-pixel; 62dB S/N ratio; 1/6.8 2000 lux. **Circle (1986)**

SC-831: portable 3-CCD camera; 400,000-pixel; 700-line resolution. **Circle (1987)**

TouchVision Systems

D/Vision V2.0: non-linear editor software; B series Intel DVI chips; near U-matic picture quality. **Circle (1988)**

TRF Production Music Libraries

CD Digital: more than 100 new releases; digitally recorded. **Circle (1989)**

Image Music Library: includes more than 50,000 selections; on-approval arrangement permits user to find if disc is applicable to projects. **Circle (1990)**

Trident Audio USA

Vector enhancements: LCRS surround sound pan module; stereo mic/line input with 4-band EQ; 3-way effects return with routing to multitrack, aux, four stereo buses. **Circle (1991)**

Tripp Communications Sales

Tape storage room design: cabinets, roll-around tape trucks. **Circle (1992)**

Trompeter Electronics

Cable stripper: hand-held, portable unit; operates from 7.2V NiCad (BCS/c24T(Δ)) or AC (ACS/c24T(Δ)); 2-, 3-level stripping for many popular coaxial cables. **Circle (1993)**

CBBJR39A bulkhead jack: 2-pin polarized right-angle device for twinax; circuit board mount. **Circle (1994)**

TrueVision

Bravado: multimedia engine; on-board VGA for ISA PC; full color video-in-a-window, audio pass-through; Windows 3.0 compatible; 8-bit entry level, 16-bit full-featured versions. **Circle (1995)**

TSM/Total Spectrum Management

Abekas A-82 switcher interface: permits control of AutoCam from A-80 switcher display screen. **Circle (1996)**

AutoCam features: Network LAN, interconnect two ACP-8000 systems via ethernet for master/slave; MCB-3 vector solving manual control allows manual operation of AutoCam system; Set Mapping provides collision avoidance through programming of fixed object locations. **Circle (1997)**

HS-310P: studio pan/tilt; safety switch disables servos, manned lens control; external adjustments for end stops. **Circle (1998)**

Sony interface: RS-422 duplex digital interface directly to each Sony CCU base station; camera RCP functions controlled from ACP-8000S. **Circle (1999)**

SP-300/X-Y: enhanced pedestal; improved accuracy, operating flexibility, wheel design, servo control software. **Circle (2000)**

TTC/Television Technology

XL-1000U: 1kW UHF translator or transmitter; uses type 347 tubes at 50% rated output for longer life; VHF, UHF, modulator input options. **Circle (2001)**

XLS-10/20U: solid-state unit with VHF, UHF or modulator input; configures for 10W or 20W output; 12VDC, 24VDC operation possible. **Circle (2002)**

XLS-1000D: 1kW solid-state transmitter, translator; auto, manual input switching; use as 2-input transmitter or translator; permits LPTV, translator programming flexibility. **Circle (2003)**

XLS-1000U: 1kW transmitter; redundant solid-state 100W modules; **XLS-2000U** 2kW,

XLS-100U 100W versions; for LPTV, translator applications. **Circle (2004)**

U

Ultimate

Memory Head software update: simulates the mechanical look of computer-generated movement. **Circle (2005)**

System 6 Transcoder 4:4: 2-channel, bidirectional transcoder; channels completely independent; permits System 6 to be used with any component recorder. **Circle (2006)**

Ultimate 45: for mid-sized production, post-production compositing; **Matte Shading** overcomes inconsistencies of blue screens; integral transcoders, flare suppression circuitry; menu drive. **Circle (2007)**

UniSet

Modular dolly storage: now in 3-foot heights. **Circle (2008)**

United Ad Label

Color tint labels: pressure sensitive labels for laser printers; white, mint green, light blue, goldenrod; for VHS, Betacam, D2, U-matic, mini U-matic. **Circle (2009)**

Status labels: log sheets, tape trackers, specs. **Circle (2010)**

UREI

LA-10, LA-12: single- and dual-channel compressor limiters. **Circle (2011)**

LA-22: dual-channel parametric compressor, "spectral agile" feature processes selected aural bandwidth for compression, expansion. **Circle (2012)**

Ushio

MR-16 REFLEKTO lamps: low-voltage halogen lamps; 12VDC, 20W, 50W; highly efficient. **Circle (2013)**

Utah Scientific

AVS-161: utility router; 16x1 video with stereo audio follow. **Circle (2014)**

DDS-2 router: digital data routing system; passes RS-422 data at 4Mbit/s to solve serial digital data requirements. **Circle (2015)**

MSC Series 2: multiple system control; distributed processing to increase number of system names, stacked group names, macros, soft keys, level combining. **Circle (2016)**

PVS 212: 12-input production switcher with two mix-effects sections. **Circle (2017)**

PVS auxiliary bus: optional eight outputs of primary matrix inputs with three re-entry crosspoints. **Circle (2018)**

Series 35: VDA-6 1x6 video DA; VDA-6eq with equalization to 1,000 feet of 8281 coax; ADA-6 1x6 audio DA. **Circle (2019)**

TAS system enhancement: total automation on Ethernet; interface to traffic, routing, switching, VTRs, etc.; facility-wide network to administer process control. **Circle (2020)**

Utility Tower

Ultra-1201: for heights to 180 feet; galvanized inside; load range between that of solid rod tower and pole mast. **Circle (2021)**

V

Vantage Lighting

PAR64 lamps: 1kW 120VAC units; **FFR** medium flood; **FFN** very narrow spot; **FFP** narrow spot; **FFS** wide flood. **Circle (2022)**

Continued on page 119

Increasing your audience through technology

New systems provide new opportunities.

The Bottom Line

Most broadcasters realize that adapting appropriate new technology can help them in their work. Usually, improvements result from lower operational costs or increased productivity. But some new technology can help satisfy broadcasters' most important priority of all — increased audience share. Many recent systems allow a broadcast facility's staff to fully realize its creative potential and thereby capture and maintain the audience's attention. When this happens, everyone wins.



As the digital revolution continues, new broadcast equipment has begun to reach an unprecedented level of maturity. Whereas earlier systems were directed at increasing the speed/capacity or otherwise lowering the cost of production, more recent devices have emphasized creative advantages.

This is a subtle, yet welcome, change. It may assuage the oft-cited fear that broadcasting is becoming an increasingly robotic exercise. It also begins to close the circle of transition that broadcasting has traversed in moving from the analog to the digital age. As with any new development, a flexing of pure technical abilities to their extremes comes first, followed by the development of a sensible aesthetic for the system's use. The latter stresses the system's value in providing communication, not its glitz.

Users are not alone in this learning process. Equipment designers are also ramping up in similar fashion, devising products today that may not pay such a high direct dividend to the bottom line as earlier systems did. But these products will nevertheless affect broadcasters' fortune in perhaps more important ways. By providing the platform for a broadcast facility's staff to do their *best* work in a cost-effective and timely manner, these systems pay off in ways that the bean counters never considered. Allowing a staff's creative powers to blossom and thrive gives the facility a distinctive edge that no competitor can duplicate.

It all adds up

The role of new technology should therefore be considered in a broader context than how much paper, time and staff it can save at the broadcast facility. Some innovations can truly improve the broadcaster's product in a direct way, thereby providing the potential for demonstrable audience increase.

On the other hand, even the systems that simply reduce a facility's operating costs can also provide a benefit in this regard. Money saved in administrative expenses can be applied to new program acquisition, for example, and help increase audience in an indirect fashion.

What follows is a look at just two of the many possibilities available today. These approaches can provide immediate improvement to program quality in a technical and an aesthetic sense. The synergy resulting from these and other systems' enhancements supplies the perfect context for improving a broadcaster's position in the increasingly competitive marketplace.

Weather radar can increase ratings

By Rick Lehtinen, technical editor

Radar has become one of the staples of weather news reporting. The station that fails to provide some type of moving storm track, cloud display or lightning strike plot is often at a competitive disadvantage. The probability is strong — especially in meteorologically active regions — that viewers will tune to the facility that can most effectively present weather information.

Recently, a spin-off of the technology that allows researchers to plot the orbits of atoms in a molecule, or the position of neural structures in the brain has been applied to the weather. It allows meteorologists to present the ebb and flow of weather phenomena in a 3-D display. This technology, called *data visualization*, can add a degree of realism and immediacy to weather coverage. It can also enhance general news coverage.

Conventional 2-D weather displays often perch the viewers in space, from where they peer down at a low-resolution representation of their areas. Using 3-D computer visualization techniques, the observer can be anywhere. Today, stations are able to present weather images as they would appear from the steps of the courthouse, the football stadium and, yes, the viewer's front door.

Such systems can produce snapshots or single frames, or animations in which the subject moves. Fly-bys, in which the observer and subject are free to move, are also possible.

High-speed/low-cost computing

The enabling technology for such 3-D weather is a new generation of high-speed, reasonably priced workstations. These powerful systems use reduced instruction set computing (RISC) architecture for high throughput.

Until recently, computers capable of intensive graphics calculations were costly. Some manufacturers have broken the price barrier by optimizing their hardware for graphics applications. This has made high graphics power available for little more than the price of a fully loaded PC. In turn, the price of 3-D weather computer systems has fallen to match the price of the 2-D systems of two or three years ago.

Weather in dataland

Weather data enters the system from a series of inputs, such as National Weather Service information, satellite imagery, the station's own Doppler radar or local observations called in from the field. Next, the computer integrates all the data. Supervisory algorithms help resolve conflicts between information sources. The computer then plots the composited data over a realistic model of the area of interest.

The base model is one of the keys to making a 3-D weather display work. (See Figure 1.) The first layer is a *base elevation map*. This consists of topographical information for every point of longitude and latitude.

Next comes *line data*. This details surface features, such as lakes, highways, borders and airports.

The line map also contains geographical information, such as the locations of towns and cities, and data, such as population size. The computer can use this information to include or exclude a city in the image, based on what the artist or operator requests.

The base model also contains cityscapes, which are the out-

Integrating digital workstations

By Russell Gentner

Understanding digital workstation technology and, specifically, how to implement it at a radio station is key in determining its impact on audience share. First, it is important to distinguish between two broad groups of workstation systems: stand-alone and network.

Stand-alone systems are designed more for use in satellite and local automation formats, primarily to reduce staff costs. These systems are usually configured for one or two workstations and cannot be expanded beyond this. Hundreds of these systems are on-air today. More than 30 manufacturers offer such systems, with prices ranging from approximately \$5,000 to more than \$20,000. Stand-alone systems comprise the majority of the current market and occupy most of the current buying interest.

More recently, however, network-type systems have entered the market. Although these also can reduce operating costs, they are principally geared toward improving the on-air product. Such systems use local area networks (LANs) to link multiple workstations together. Therefore, you can have a workstation in the master control facility, the production studio and the newsroom. Most systems also allow direct integration of traffic, billing and other software. Network systems start at approximately \$30,000.

Stand-alone systems

Stand-alone systems generally use a single computer to store, route and perform most (if not all) audio functions. Operators have control of the system via the keyboard of the master computer or via an attendant slave computer that is serially connected to the master unit. These systems typically have two audio inputs and two audio outputs.

The basic functional layout of a stand-alone system requires two workstations — one in master control and the other in production. The production workstation is used to record and edit audio files, enter scheduling information and perform other system maintenance functions. (Note that all audio files are recorded on the master unit.) The master control workstation plays audio files on-air from a schedule or log. The software of these systems is designed primarily to interface with an automation system and/or a satellite music delivery system. However, they can also be used in live-assist and manual operation.

Most of the stand-alone systems cannot be interconnected to more than one other station, and even this allows only a second *control* location (the slave unit in the previous example). This limits the flexibility and expandability of the system. Most of the systems are low in price and come without redundancy. Many systems use *bit-rate reduction* systems (often called *data compression* systems), which increase storage capacity but may result in less than optimal aural performance. (See "Digital Audio Data Compression," February 1992.)

These systems are ideal for satellite and automation formats. Many have been available for more than three years, and most of their bugs have been eliminated. Listeners enjoy smoother and tighter breaks, while station owners enjoy lower operational costs.

Gentner is chief executive officer, Gentner Communications, Salt Lake City.

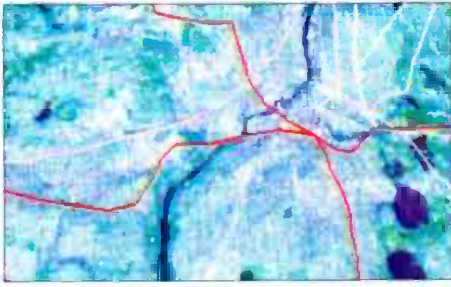

Compiling surface elevation data with line data (for roads and borders) creates a highly realistic, scalable weather map on which to plot weather activity. (Courtesy of EarthWatch, Minneapolis/St. Paul.)

Weather radar

lines of the buildings. This not only increases realism, it also gives the viewer a point of reference. Viewers have become accustomed to having north at the top of the image. Being able to roam freely increases graphic appeal, but it may lead to disorientation.

The computer colors the cityscape and surrounding landscape to match the real world. Most buildings end up a shade of gray or beige. Green spaces can be dark or light, depending on the local flora. Mountainous regions are able to adjust the

snow level to reflect the season. To keep the cityscape updated, facilities can retain a local architecture company with CAD capability.

Other news

These new systems offer related benefits to other areas of the station. With the environs in a database, the art department won't need to hunt for maps or draw them from scratch. Artists can create maps of the appropriate scale and detail by access-

Continued on page 115

Workstations

Network systems

A typical network system uses a central file server to interconnect each workstation. With these systems, the file server stores all of the audio files for each station. A redundant file server maintains a backup. The production station records and edits audio files, the master control station plays files on-air from its on-line log, news stories are compiled and aired at the newsroom workstation and so on. In essence, a network system works like a traditional cart-based system, except carts are stored on a computer cart rack in the file server.

When looking closer at network systems, it becomes clear that the fundamental infrastructure of a radio station is changing. No area of the facility will be left untouched. Every department of your station can be interconnected using the network. The station and its audience will benefit from these changes.

Technical considerations

Stand-alone and networked digital storage systems use the same basic technology. Although no two workstations are identical, the basic technical structures of most systems are similar. A workstation is generally comprised of the following standard PC-type components:

- **Frame.** The frame is the basic infrastructure of an audio workstation. It consists of the chassis, power supply and either a motherboard or a backplane, depending on the platform architecture. Most PCs use a motherboard approach, although backplane frames hold two distinct advantages. First, they allow hardware to be upgraded through card replacement as new technology becomes available. Second, and more importantly, they permit easy repair of failed components. Nevertheless, motherboard frames are less expensive, which ac-

Continued on page 116



OPAQUE TO TRANSPARENT INSERTS AT YOUR FINGERTIPS

FIVE MODELS WITH FEATURES AND CONTROL SYSTEMS FOR EVERY APPLICATION

- Downstream or stand alone
- Frame accurate mix to key, fade to black
- Serial remote control • GPI interface
- Key source input switcher • Key set memory
- Preview output • Processed black
- Key area masking



MASTERKEY 4 CONTROL PANEL

broadcast video systems ltd.

40 West Wilmot St., Richmond Hill, Ontario L4B 1H8
Telephone: (416) 764-1584 Fax: (416) 764-7438

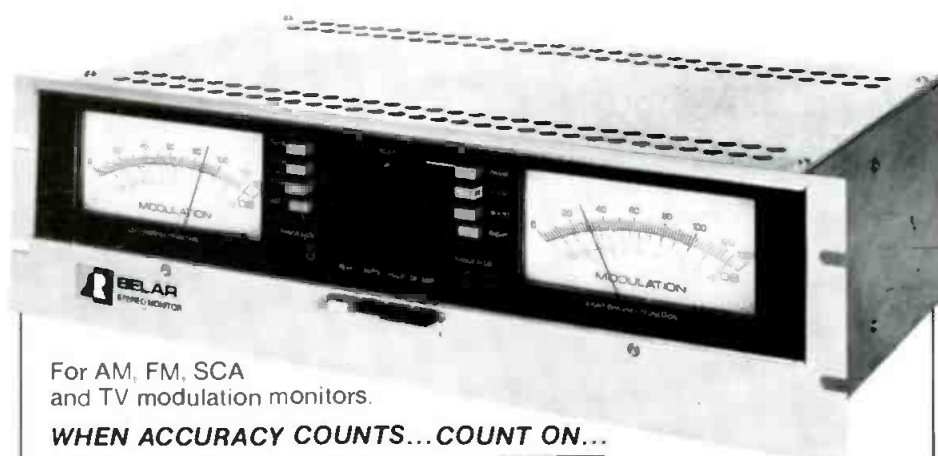

For AM, FM, SCA and TV modulation monitors.

WHEN ACCURACY COUNTS...COUNT ON...

Call (215) 687-5550 or write for more information on Belar AM, FM, Stereo, SCA and TV monitors.

BELAR
ELECTRONICS LABORATORY, INC.
LANCASTER AVE. AT DORSET DEVON, PA 19333

Continued from page 17
 the database. Elevation points are available. In addition, stories have recently been added to earth-fires). Other in-

teresting news graphic applications. Suppose an event occurs somewhere across town. The computer can begin an animation before an ENG crew can arrive. This can be aired as a supplement to the live footage when it arrives. If traffic is heavy or the weather is bad, the computer can save the story. This means the facility does not have to risk its crew.

Another use for such a system may be in stories that center on a pending event,

such as a falling piece of space material. Most likely, audience interest is high, because everyone shares in the initial risk. However, no one knows where the material will fall until the last minute. By then, there is little time to scramble crews. Visualizing the event would give facilities the ability to provide meaningful coverage until ground crews could arrive. The flexibility of 3-D systems could even allow artists to re-create the trajectory, viewing the fall from the material's point of view.

Is it live?

Someday, real and computer-generated imagery may be indistinguishable. This poses some ethical dilemmas that will have to be considered. For now, the computer is a tool with which to view the world around us without having to send out a crew. In a time when affiliate stations and networks are pinching pennies, this could be beneficial. It gives stations the ability to involve the audience and increase viewership, while containing costs.

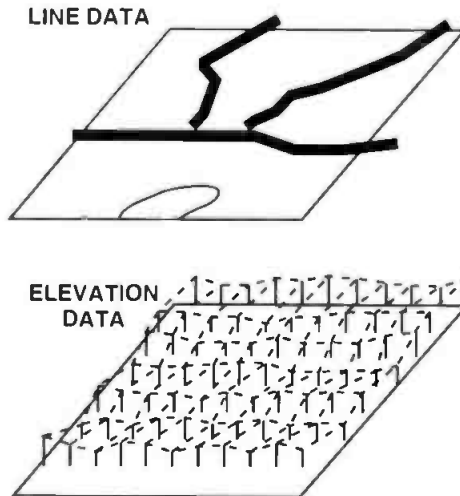

Figure 1. The base map combines topographical data, such as landscape point elevations, with line data, such as roads and borders. Cityscapes present the outlines of buildings.

For more information on 3-D weather radar systems, circle Reader Service Number 324.



SONEX audio tiles.

SONEX Acoustical Foam in 15" die-cut tiles.

- Professional look
- SONEX performance
- Easy to install

Find out how SONEX Audio Tiles can work for you.

Free Acoustical Information Packet!

illbruck

SONEX Acoustical Products Division
 3800 Washington Avenue North
 Minneapolis, MN 55412

1-800-662-0032

Circle (79) on Reply Card

ECONOMY EQUIPMENT RACKS



- Adjustable for either 19" or 23" equipment
- Available in 3', 4', 5', & 6' heights
- Made of formed 11 GA. (.120) steel
- Zinc plated with gold chromate finish
- Accessory Options:

- Wall mounting hardware
- Gated rack hardware
- Caster support hardware
- Rack caster set

Write or call for our free catalog. It's an engineering manual with helpful illustrations on installation procedures.



NEWTON

INSTRUMENT COMPANY, INC.

Manufacturers of Aux. Framing, Cable Racks, Misc. Hardware, Equipment Racks, Main Frames & Card Storage Cabinets.
 111 East "A" St. • Butner, North Carolina 27509-2426 • Phone (919) 575-6426 or FAX (919) 575-4708

Circle (80) on Reply Card

Continued from page 114
counts for their current popularity.

- **Hard disk drive.** Large-capacity hard disks are used as the storage medium for recorded audio on most systems. For linear PCM (uncompressed data), the general rule of 10Mbytes per minute of stereo audio applies. With recently developed perceptual coders that allow audio bit-rate reduction without significant audible degradation, a 1Gbyte hard drive can hold more than six hours of high-fidelity stereo audio. Meanwhile, hard disks are becoming less expensive and more reliable.

- **User interfaces.** Users make contact with the workstation via a standard video computer monitor (color or monochrome) and several types of interfaces, including a QWERTY keyboard, mouse, specialized control surface, touchscreen or a combination of these. Perhaps the most exciting interface is the specialized controller. This can be configured to meet a user's specific needs. For easing users' transition to the digital workstation environment, these surfaces often include elements of conventional audio equipment, such as faders and tape-transport button sets. Multiple control surfaces can be developed for the same networked system so that the newsroom, production studio,

master control and other facilities' staffs can each have an interface specific to its needs.

- **Audio card.** The audio card is the interface between the outside analog world and the inside digital world. The card converts analog audio to data, then stores and retrieves it from the hard disk. It also reconverts data back to analog audio for output. This component may also apply a bit-rate reduction system to the converted digital audio data to save storage space on the disk. Many types of conversion and bit-rate reduction systems exist, and both of these elements can have significant subjective effect on audio quality. This is a portion of the system to be explored carefully before making a decision. The audio card is often the only proprietary item in a workstation, so prospective purchasers should be concerned about its audio quality and its long-term availability and serviceability.

- **Network interface card.** For network systems, a network interface card is used to interconnect the individual workstations to the file server. Concerns here include the number of maximum stations and speed of data transfer or other operations on the network.

- **Other components.** Standard PC computer systems, cards, disk controllers and modems. The availability of these components is a key factor.

Putting it all together

Although it may seem like the interconnection of workstations is a fairly straightforward task, either by the station's own technicians or the manufacturer's technical staff, the technical staff must possess significant experience with PC platforms.

Experience shows that a proper installation plan allows approximately one person per workstation. However, the most important part of a successful installation involves proper training of operating staff. It is strongly recommended that you take the necessary time to teach people how to use this new technology.

Improving audience share

Consider how this new technology can improve a station's operation, and ultimately increase its audience share:

- **Production.** Recording and editing carts will be faster, more efficient, and fewer

THE NSi EQUIPMENT TRACKING SYSTEM

Eliminate duplicate acquisitions and save money.

The CBS and NBC Television Networks are tracking and archiving over 25,000 pieces of equipment and assets for the broadcast of the 1992 Olympics. To help them perform this task they chose *The NSi Equipment Tracking System*.

From Broadcasting to Healthcare, Insurance to Manufacturing—if you need inventory control and asset management, you need *The NSi Equipment Tracking System*.

KEY FEATURES

- PC-based system
- Catalogs equipment and assets and tracks location
- User defined database
- Query searches by key word, wildcard, and cross reference
- Items can be assigned to integrated groups
- Keeps maintenance records
- Custom report generator
- Creates shipping lists and labels
- Interfaces to optional bar code reader
- Generates Code 39 bar code labels
- Links to accounting systems via ASCII export
- Easy-to-use, menu-driven, on-line help
- Single-user and multi-user versions available

NSi NESBIT
SYSTEMS INC.

For more information and free self-running demo disk, call or fax:
Nesbit Systems Inc. • Phone: 609-799-5071 • Fax: 609-799-9540

Circle (81) on Reply Card

mistakes will be made. Production talent can spend their time making locally and externally produced spots sound better. Furthermore, you will not have to worry about dirty heads, cart machine alignment or other tape-related problems. Listeners (and sponsors) will enjoy digital quality for all audio sources, including commercials, jingles and IDs. More time and flexibility for staff to exercise their creativity means more listenable and ear-catching production elements on-air.

- **Master control.** Currently, a station's on-air talent spends considerable time finding, playing, replacing and logging carts from the cart rack(s). With this new technology, talent is free to work on making the on-air sequencing as good as possible. To play spots, music, IDs and jingles requires the depression of the START button on an easy-to-use keypad, touchscreen or keyboard. The system plays the cart and logs it automatically. Not only will the clutter of carts be gone, but talent will be free to do what they were primarily hired to do — attract and keep listeners.

- **News.** The news department will be able to produce a better on-air product at a lower cost. The networked newsroom will be able to edit all announce-copy text

and sound-bite audio on the workstation screen. This will make newscasts sound more polished, and it may ultimately reduce the amount of labor required to produce it. Timeliness of getting a story on the air can also be thereby improved.

- **Traffic and billing.** A station's current paper log becomes an item of the past. With network systems, logs are uploaded directly from the current traffic system. The log is used by the master control workstation to sequence and play all spots. The system automatically time-stamps each spot when it is played. At the end of the day, this list is downloaded to the billing department. The system will automatically keep track of kill dates, rotation and traffic-related spot attributes. A station can become more organized and more productive.

- **Programming flexibility.** The fully integrated network described here is a programmer's dream come true. It provides the perfect infrastructure for accommodating any kind of radio programming stream imaginable. Program directors need no longer consider whether a given type of programming can be pulled off in the facility. Format tweaks or wholesale changes are also easily instituted. Even a

requirement to optimize program-source changes with dayparts is simply satisfied (e.g., manual mornings, satellite middays, live-assist evenings, locally automated overnights).

Choosing a system

The following issues are worth considering when looking at workstation systems:

- **How does the system handle hardware failures?** Most systems are priced without redundancy. Furthermore, many levels of redundancy might be offered. Identify the level(s) of redundancy that the manufacturer offers and their respective increment(s) to the final cost.

- **Does the system allow you to load your traffic log directly from your traffic system?** If not, the staff will have to manually enter it for each day.

- **Will the system support multiple formats, including live assist, satellite, automation and manual control?** This is important because many stations run a combination of formats across a broadcast day or week.

- **Can the system accommodate external**
Continued on page 132

GOOD NEWS FOR VIDEO BATTERIES.



CASP® BATTERY CHARGER/ANALYZER/RECONDITIONER

Christie's microprocessor-based CASP® systems maintain your video batteries at peak amp-hour performance. CASP® analyzes and charges all battery makes, and electrochemically rejuvenates nickel-cadmium types, even if badly faded.

CASP®/2000 is a versatile model, programmable from its own keyboard. CASP®/1200 is a cost effective, pre-programmed, GO-NO GO model. Both models use Christie's exclusive ReFLEX® charging technique, have six channels for battery processing, indicate the process step on an LCD display, and operate unattended.

For full details contact Christie today.

CHRISTIE®

18120 So. Broadway, Gardena, CA 90248
(310) 715-1402, FAX (310) 618-8368

* CASP CHRISTIE and ReFLEX are registered trademarks of Christie Electric Corp.

Circle (61) on Reply Card

Programmable electronic TIMERS

- 2-16 independent circuits control up to 20 amps
- 8 or 16 digital inputs trigger timing sequences "on condition"
- 20 or 40 programs
- Cycle times from 2 seconds to 1 year
- Accurate to the second
- Microprocessor-based
- Battery back-up protects programs and clock
- Less than \$80 per circuit (4-circuit model)



19" rack mount

There's no need to buy 10 different timers for 10 different jobs ... one ChronTrol does it all! Now you can have precise, automatic control of all your broadcast equipment needs: tape recording, satellite feeds, equipment & signal switching — even remote control via ChronTrol's serial communications port. Field-proven and dependable, ChronTrol's easy operation simplifies your difficult timing jobs. See the latest ChronTrol catalog for full details on our various models.

CALL FOR A
FREE CATALOG TODAY—
TOLL FREE
(800) 854-1999

Outside CA

ChronTrol®

ChronTrol Corporation
9707 CANDIDA ST., SAN DIEGO, CA 92126
(619) 566-5656

Circle (62) on Reply Card

Station to Station

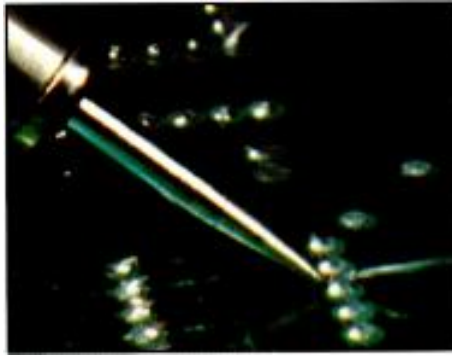

An outboard PL extender

By Ronald Pesha

Our TV facility was limited by an insufficient number of private line (PL) intercom headset terminals. Because we use the common 2-line intercom system, the simplest solution was to construct an outboard headset amplifier. The amplifier interfaces to the house system with an external plug-in adapter, and required no modifications to the cameras or CCUs.

The basic intercom unit in a camera or effects switcher typically uses two separate amplifiers with a common connection to other units at the midpoint. This ensures that each person on the PL hears everyone else and can talk with everyone. The amplifier used here employs a readily available audio IC, either an LM386 or ECG823.

ing, or fabricate a simple DC source. A regulated supply isn't needed, but a 12V 3-terminal regulator does allow use of a smaller filter capacitor.

I built four separate headset amplifiers side-by-side in a minibox with a common power supply. The box was mounted on a studio wall. The common audio feed from all four units was then connected and brought to a jack on the minibox.

This simple project surprised us with two additional benefits. First, the audio quality is better than that provided by the intercoms in our cameras. Second, the user can turn up the audio level in the earpiece considerably higher than what is available from the built-in headset driver. This feature is helpful when live musicians perform in the studio.

Troubleshooting

Troubleshooting is easy. In operation, check for a DC voltage at pin 5 of each IC of approximately half the voltage on pin 6. This means that the IC is probably functioning correctly.

The amplifier interfaces to the house system with an external plug-in adapter, and required no modifications to the cameras or CCUs.

The circuit is shown in Figure 1. The resistor combination R1-R2 forms a voltage divider with R3, to set the DC voltage to the carbon mouthpiece. Adjust R2 by trial and error during installation for maximum mouthpiece volume with minimum distortion. Once set, R2 needs no further adjustment. Resistor R6 adjusts earpiece loudness. Install it with a knob at a location convenient to the user.

Although none of the parts' values are critical, avoid making C1 much larger than the value shown, or the higher frequencies from the mouthpiece will be attenuated.

The power supply

The specified IC requires 6VDC to 12VDC. Use a plug-in power supply with high-value electrolytic for additional filter-

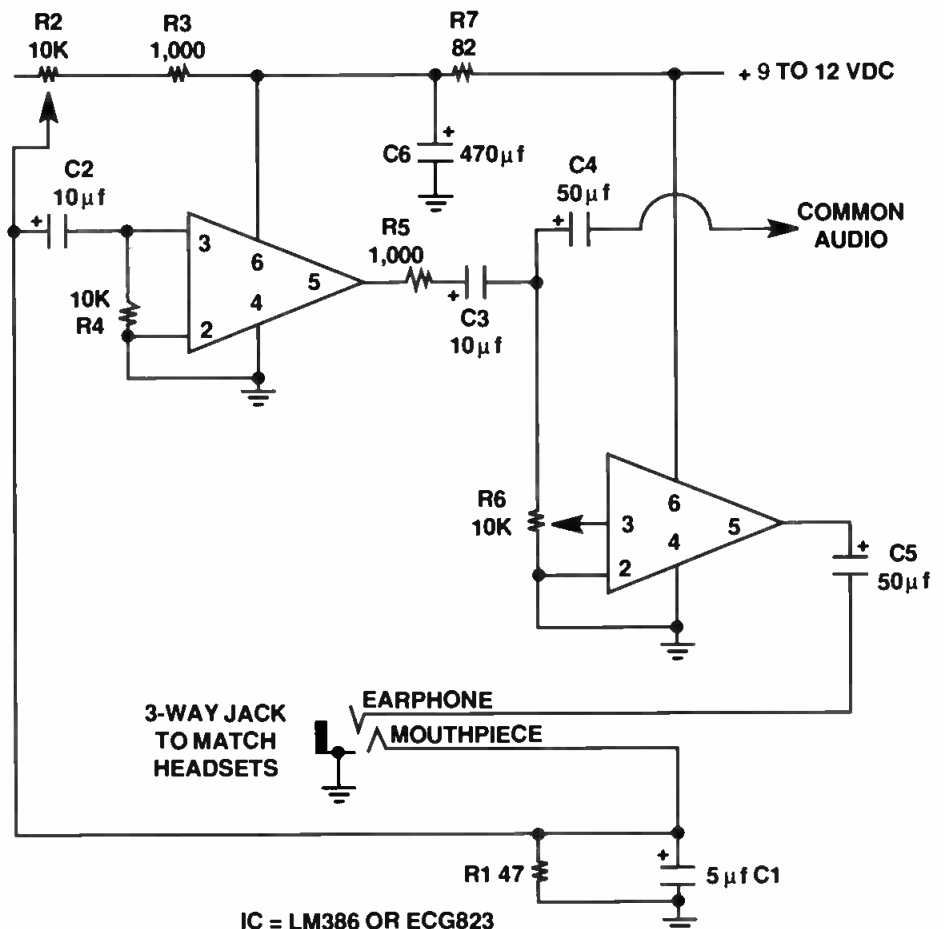

Figure 1. This outboard private line intercom extender is inexpensive and easy to build. In many cases, it can provide improved audio performance while expanding the number of headset locations available in the studio.

Pesha is assistant professor of broadcasting, Adirondack Community College, Queensbury, NY.

Varian Microwave Equipment

GEN III Klystron: high power amplifier for C-, Ku-band satellite use; 3.35kW and 2.2kW powers; microprocessor controlled, improved reliability. **Circle (2023)**

VZC-6967, VZC-6965: 4kW, 2kW TWT HPAs; single-drawer for maximum power in minimum space; 4kW in 1:1 power-combined or 1:2 redundant rack-mount configurations; 7.5kVA input per 2kW output. **Circle (2024)**

VEAM/Litton Systems

B-LOK VDS-134: sequential mating power distribution panel; series of single contact connectors permit connections to 500VAC, 3-phase, 600A service. **Circle (2025)**

Veetronix

Catalog No. 2: keyboard and panel switch products; custom projects, limited quantities. **Circle (2026)**

Vega Wireless

AX-20: professional studio wireless mic system. **Circle (2027)**

IFB-12 system: combines PL-2 2-channel miniature receivers, RMT-10 base station; two transmitters to provide talent with two independent audio sources. **Circle (2028)**

Vertigo

3D Animation System: using IRIS Indigo RISC platforms; basic, Designer and Master packages offer standard and special purpose modules. **Circle (2029)**

VGS California

Perfect Editors Chair: provides Quadracontrol with correct back support in any work position. **Circle (2030)**

Worklighting: low-voltage diffused lighting for A/V applications; fits on/under worktop or shelf. **Circle (2031)**

VGV Incorporated

DX120: composite digital production switcher with multilevel mix/effects; 4-bus, 13 primary inputs; 2-bus 10 primary key; 2-bus 5 external key inputs. **Circle (2032)**

Vicon Industries

V7000 series: desk-top, rack-mount controllers; manual, programmable models; for VectorCam pan/tilt units; for remote control of multiple "fixed" cameras. **Circle (2033)**

VCR424: 24-hour time-lapse video cassette recorder; two modes for 12- or 24-hour; continuous operation yields 2- or 6-hour operation. **Circle (2034)**

Video Accessory

VB/VDA: 4-output VDA; ultra compact design; 100MHz bandwidth. **Circle (2035)**

VDA-HN: 6-output wideband video DA; hum null adjustment. **Circle (2036)**

Video Associates Labs

AudioPort: external digital audio adapter; plugs into parallel port of DOS/Windows-based PC for record, playback; software selects sampling rates (4kHz-44.1kHz; ADPCM 3:1 compression; reads, writes .WAV files, converts uncompressed .VOC files for playback; by Antex Electronics. **Circle (2037)**

Video Central

DXC-537/PVV-1: Sony dockable CCD camera; professional Betacam VCR; PAL standard. **Circle (2038)**

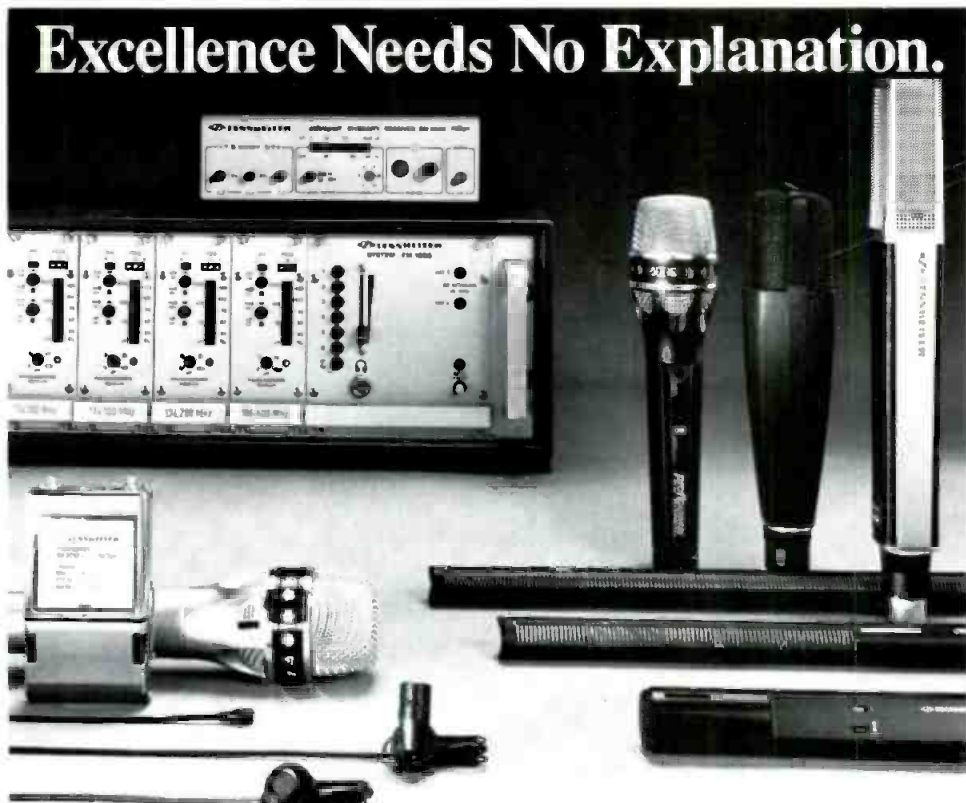

To learn more about the Sennheiser excellence in design and engineering, please call or write.

SENNHEISER

6 Vista Drive, PO Box 987
Old Lyme, CT 06371
Tel. # 203-434-9190 FAX # 203-434-1759

MICROPHONES • HEADPHONES • BOOM SETS • RF WIRELESS • INFRA-RED TECHNOLOGY
Manufacturing Plant: D-3002 Wedemark, Germany
Circle (63) on Reply Card

NEW FROM CANARE

Coaxial Cable Stripper

FOR CANARE 75Ω BNC CRIMP PLUGS

15 Second Quick

1

Insert end of cable into the stripper.

2

Rotate the stripper.

3

Press down lever and pull out cable.

4

Peel off jacket & you're ready to crimp!

MODEL SELECTION		
Model	CANARE Cable	Others
TS-4C	LV-61S	RG-59B/U
TS-5C	LV-77S	8281

511 5th ST., UNIT G SAN FERNANDO, CA 91340
PHONE: (818) 365-2446 FAX: (818) 365-0479

Circle (64) on Reply Card

PVW-2800P: Sony 2000 series professional Betacam, PAL standard. **Circle (2039)**

Video Data Systems

LAPS Laser Auto Promotion System: random-access laser disk storage; for insertion of full-motion video promos. **Circle (2040)**

System 810 titler: downstream keying facility with low-cost message display generator. **Circle (2041)**

System 900 inserter: low-cost commercial insertion; keys a 1-line crawl or a full video page sequential onto 7 independent video channels. **Circle (2042)**

Video Design Pro

VDP Pro 486/33: CAD workstation includes 486-33 PC in tower case; 8Mbyte RAM; 200Mbyte IDE drive; modem; options depend upon VidCAD software. **Circle (2043)**

Video Integrators

Consulting services: and installation of video systems. **Circle (2044)**

Video International Development

Graphics scan converter: tracks 15-100kHz horizontal, 25-120Hz vertical scans; inter/non-interlaced sampling 20-120MHz; output to any standard. **Circle (2045)**

Motion Vector standards converter: for existing standards; includes digital image enhancement, noise reduction; D-1 processing; comb-filter decoder. **Circle (2046)**

Videolab

TCR-680: time code retrofit for Sony U-matic; to record time code track on Sony V06800. **Circle (2047)**

Videomedia

Animax: V-LAN compatible animation control; includes hardware and software for use with PC desktop editing control of 31 video devices. **Circle (2048)**

Auto-Pict QT: animation, digitizing software for Macintosh, incorporates Quick-Time movies into edit lists for input and output to videotape. **Circle (2049)**

CX protocol: V-LAN command language for machine control; developed with FutureVideo in EditLink 3000 edit controllers and EDL-2000 software. **Circle (2050)**

OZ: hardware and software package for frame-accurate PC desktop video editing system; ISA compatible card includes V-LAN transmitter and two serial receiver modules. **Circle (2051)**

PC-T: V-LAN transmitter; single ISA board takes one slot of PC; use as a receiver for serial control type transport. **Circle (2052)**

Xaos nTITLE 1.3: produces high-quality text titling on Silicon Graphics PCs; 30 fonts, extensive flexibility in sizing and manipulation. **Circle (2053)**

Videoquip Research

DAVE-2000: digital audio voice editor; for news broadcast; recorded voice information can be quickly edited in digital domain; PC plug-in board, software. **Circle (2054)**

MP-2 mic preamp: 2-channel package; 2 outputs per channel with independent gain adjustments. **Circle (2055)**

SD-2 silence detector: for two independent channels of detection; adjustable silence level -40 to 0dBm. **Circle (2056)**

VP-2 VU/PM meter: 2-channel unit; separate

extended range displays cover -40 to +22 VU or PPM. **Circle (2057)**

Videotek

APM-200: stereo audio program monitor; 1-RU package; L-R, L+R, stereo, reversed stereo, L only, R only modes; stereo headphone jack. **Circle (2058)**

BTG-100P: hand-held color bar generator; PAL output. **Circle (2059)**

PDG-418: 18-input production switcher; includes multilevel effects; independent DSK feature with programmable transition rate; optional RGB, YCrCb chroma keyer; linear keyer with memory. **Circle (2060)**

TVM-730: composite video analyzer; *AutoMeasure* feature; 1/2-rack package; text readout for numerous FCC, NTC-7 tests, ICPM and other functions; printer, RS-232 output. **Circle (2061)**

WP-1: white phosphor option CRT; for any TVM-700 analyzer instrument; *WP-IP* CRT for PAL products. **Circle (2062)**

Videssence

Sustained RGB lighting: eight models from 15W to 1.6kW replace lights to 12kW incandescent rating; high-durability fixtures; dimming and control equipment. **Circle (2063)**

Vinten Broadcast

HD-1, HD-2: heavy-duty, single- and two-stage tripods; new torque-safe leg locks provides secure leg height adjustment; supports 265lb or 253lb payloads; locks cannot be overtightened. **Circle (2064)**

PRO-PED: portable 2-stage, pneumatic pedestal; modified version of existing OSPREY column; lightweight dolly on 6" castor wheels; 120lb capacity. **Circle (2065)**

Vistek Electronics

Autotran: radio/TV automation control using PC with Windows and RS-422 serial interface; 32 devices controlled through Vistek 3400 machine controller; multiple PCs can be networked for additional devices. **Circle (2066)**

Autotran Betacart emulator: permits four BetaSP decks to operate in the same way as Betacart system with Basys Newsroom computer; uses V-3400 machine control interface. **Circle (2067)**

V2000 Array series: routers for analog video V2200, analog audio V2300, digital video V2100; mix, match modules in single frame; multiple controller interface for direct control from GVG Kaleidoscope; video display of router status; tally interface, under-monitor displays for routing indications. **Circle (2068)**

V4229 decoder: digital system for analog, digital composite (D-2, D-3) to analog component format RGB or YPrPb; operates with NTSC, PAL, PAL-M inputs. **Circle (2069)**

Vector V4400 series: standards conversion between NTSC, PAL; options for PAL-M/-N, SECAM; VMC Vector Motion upgrade kit V4501/A removes nearly all artifacts caused by motion in standards conversion; VMC algorithm with three dimensional prediction. **Circle (2070)**



Walter Brewer Corporation

Lighting Systems Integrated: pre-engineering lighting packages. **Circle (2071)**

WaveFrame

WaveFrame 1000: record digital audio directly to Yamaha YPE-301 encoder and YPR-291 recorder; for creating CDs. **Circle (2072)**

WaveFrame 401: digital audio recording; includes VITC sync, digital I/O, mixing, multitrack punch recording. **Circle (2073)**

Wavefront Technologies

Hardware support: for Sony EVO 9650 Hi8 transport. **Circle (2074)**

Version 1.1: enhanced video composer feature for desktop video production system; sub-pixel cropping, panning, fitting; Mosaic effect pixellates images. **Circle (2075)**

Weather Central

Satellite imagery: for LiveLine 5 weather displays; 4-bit medium and high resolution, 8-bit high resolution. **Circle (2076)**

Wegener Communications

Series 1980: digital audio storage/playback; high-quality audio in compressed digital. **Circle (2077)**

Model 2002: digital SCPC receiver; L-band input; uses MPEG audio algorithm for decompression. **Circle (2078)**

Series 1834: digital audio demodulator for Subcarrier/FM² applications; uses IS(-)IEC MPEG compression. **Circle (2079)**

Series 1990: single-channel satellite audio receiver; addressable device for C-/Ku-band; with DBS, L-band LNB. **Circle (2080)**

Wheatstone Broadcast Group

TV-600S console: Bus-Minus multi IFB feeds; Event Computer controls channel sources from router, on-console switcher and source indicator above fader; 8-input preselector overbridge; two stereo, two mono out, SAP; mono sum. **Circle (2081)**

Whirlwind/US Audio

Presspower: active press box; two inputs distributed to 16 outputs through XLR connectors. **Circle (2082)**

Will-Burt

LPAP-12V: antenna positioner for telescoping mast; 12VDC operation; low profile, rugged, light weight; electronic control with Az/EI readout, auto stow. **Circle (2083)**

Mast extension warning kit: produces signals when telescoping mast is not fully retracted. **Circle (2084)**

Siletto: mechanical composite telescoping mast. **Circle (2085)**

Willow Peripherals

LaptopTV: portable unit converts laptop PC output to video; 640x480-pixel resolution in 24-bit color. **Circle (2086)**

Winsted Corporation

1992 catalog: video furniture. **Circle (2087)**

Cabinet Design Kit: worksheets to assist in selecting proper racks for electronic equipment. **Circle (2088)**

Locking rack shelves: 5 1/4" or 10 1/2" units with 17 3/8x14" shelf with smoked plexiglass security door; fits EIA rack. **Circle (2089)**

Wohler Technologies

TDM-1: time delay meter module; indicates delay or phase shift for a given frequency between two audio channels of stereo pair; two delay range selections. **Circle (2090)**

Worldwide Industries

BackSave chairs: special design furniture reduces fatigue. **Circle (2091)**

WSI

NEXRAD imagery: NWS Next Generation Weather Radar imagery. **Circle (2092)**

NOWrad Plus: high-definition radar composites; preparatory step toward NEXRAD program currently in development by National Weather Service. **Circle (2093)**

WEATHERspectrum 9000 1.1: enhanced weather workstation; art, animation features with advanced forecast and analysis capabilities. **Circle (2094)**

Wybron

The Coloram: color changer; supports variable length gel strings, 2-32 colors; 7.5" aperture; fits PARs, 6" ellipsoidal instruments; other options. **Circle (2095)**

The Scroller: rolling color changer; 18"x15" aperture; 0-10VDC analog, DMX-512 control; available in 7", 10" models. **Circle (2096)**

Y

Yamaha Music

PM4000: mixing console in 32-, 40-, 48-input frames (24-input special order); inputs to -70dBu nominal; 4-band parametric EQ, variable high-pass filter; eight primary mix buses plus stereo bus. **Circle (2097)**

Yamashita Engineering Mfgr/YEM

CVS-910: synchronizes computer output scans from 15kHz to 40kHz. **Circle (2098)**

CVS-970: converts high-resolution graphics to HDTV format. **Circle (2099)**

AC7000: video animation & VTR controller unit **Circle (2100)**

CVS-970A: high resolution, HDTV down converter. **Circle (2101)**

CVS-985X: advanced, wideband scan converter including HDTV format. **Circle (2102)**

EDEC-2000: digital EDTV decoder - H&V enhancement, noise reduction. **Circle (2103)**

RB-1701C: ultra stable rubidium clock-controlled dual sync generator. **Circle (2104)**

Z

Zaxcom Audio

DMX-1000: digital audio post production

mixer; integral RAM recorder, time line operation, monitor mixer, analog and digital outputs, 400-event memory. **Circle (2105)**

Zero Stantron

Duplicator racks: capacity of 16 or 24 recorders; designed for Panasonic AG6840, AG6850. **Circle (2106)**

Enclosure options: modular, wood trim, all steel cabinets; 22 colors available; pre-assembled; free tapped rails. **Circle (2107)**

Preassembled video equipment racks, consoles. **Circle (2108)**

October 14-17 - San Jose, CA

1992 SBE National Convention & Broadcast Engineering Conference

Other attractions:
Technology Center of Silicon Valley - Lick Observatory
Marine World Africa USA - San Jose Museum of Art

For details call:
317-253-1640



Sierra Automated Systems

SAS 32000 Series Switching & Mixing Systems
New CPI-80 & APC-88 console mount controls!

The 32000 System features Advanced Multi-Processor Architecture, full Unlimited Summing capability, Dual redundant Power Supplies, High Density Central Matrix, +28dBu Max. IN/OUT, PC interface, >114dB Dynamic range, and more. The new Console Control Panels provide full alpha-numeric control with "assignable "Hot Punch" buttons.

- > 8-character Alpha-numeric display
- > 8-Programmable "Hot Punch" pushbuttons
- > Rotary Encoder for Source Selection



Celebrating our 5th year of Providing High-Quality Audio Products.

For more information contact:
Sierra Automated Systems & Engineering Corp.
2112N. Glenoaks Blvd., Burbank, CA 91504
Tel: 818-840-6749 Fax: 818-840-6751

Distributed by:
RAM Broadcasting Systems Inc.
P.O. Box 3100, Barrington, IL 60011-3100
Tel: 800-779-7575 Fax: 708-382-8818

Circle (68) on Reply Card

BCAM
IBC EXPO
AMSTERDAM

MAINTENANCE MANAGEMENT SOFTWARE

Version 2.0

SEE IT AT
STAND Z-37

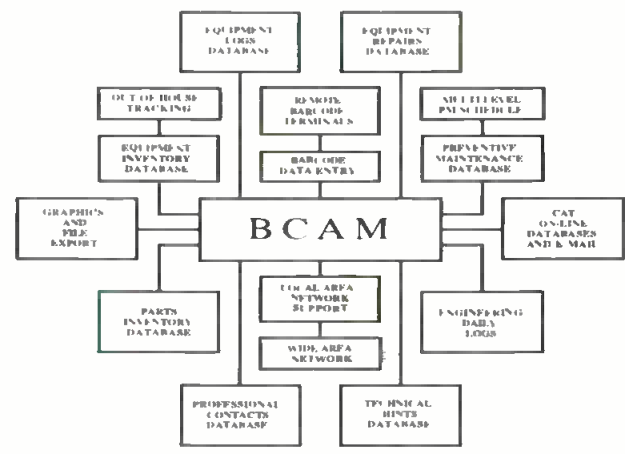



Computer Assisted Technologies
847A Second Avenue Suite 175, New York NY 10017
Tel: (212) 687-2226 Fax: (212) 922-9521 Data: (212) 922-9475

Circle (69) on Reply Card

Field Report



Avid Media Composer

By Mavis E. Arthur
and James R. Caruso

The Avid Technology Media Composer digital non-linear editing system is based on the Apple computer system. It uses graphics and mouse control to make it user-friendly. In fact, anyone who can operate an Apple computer can edit on the Media Composer.

However, this is not always an advantage. Some engineers and editors find the system too "cute" to take seriously. They seem to think that if it appears too simple to operate, it diminishes their own abilities. After all, if anyone can edit on the Avid, editors must rely on selling their creative abilities rather than their ability to operate an editing system.

**Anyone who can
operate an Apple
computer can edit on
the Media Composer.**

Bits and pieces

The Media Composer was introduced in December 1989 by Avid Technology, Burlington, MA. Today, more than 400 systems are in operation worldwide, predominantly in corporate facilities and at TV stations. They are also in place at some post-production houses, ad agencies, colleges and universities.

The capabilities of the Media Composer vary with the model. There are two series, the 200 and 2000, but the basic layout is the same. The hardware setup includes an Apple computer, either the Macintosh IIcx or Quadra 900. This is outfitted with special Media Composer boards, including a JPEG conversion board. The system also requires two CRTs, a mouse, one or more hard disks, one or more audio speakers, and a video recorder — usually 3/4-inch or Beta-SP. (See Table 1.)

One of the CRTs displays statistics of the available material (referred to as *clips* in Avid terminology). The other monitor is

Performance at a glance:

- Two hardware series include either the 200 Macintosh IIcx or the 2000 Apple Quadra 900
- Off-line editing system
- One statistical CRT
- One editing and display CRT
- System is capable of video and audio dissolves
- Graphics and titles can be imported into the system
- User-friendly

devoted to editing functions, and displays the edited material. Operators drag material from one CRT to another using the mouse.

Digitization blues

The statistical CRT includes an *edit log*. This lists all of the available digitized material. Users create this as they feed material into the system.

Digitization is a real time process that is so time consuming it is almost like doing a pre-edit before the off-line edit.

Using an accurate shot log speeds digitization considerably, because it allows operators to input only the shots that will ultimately be used. It also eliminates the need to preview. Numerous logging programs are available from several vendors.

Another problem with digitization is lack of storage capacity. If the raw material is long, a portion of it may have to be digitized, edited and then digitized some more. Users can solve this problem by adding more disk space or by fine-tuning the input list to digitize only what is absolutely needed.

Once digitized, users can call up and manipulate the log of digitized video segments, either as a written list or as a series of video clips. One frame represents each video clip. This identifying frame, called the *reference frame*, is usually the first frame in the clip, unless the editor selects otherwise. In addition, any clips created by editing can be added to this list.

On the other hand, the *edit list* is created as you edit, and is strictly a written list in the CRT. The written portion of both lists can be as simple or complex as the user makes it. It may consist of just the

time-code in and out numbers, or it may include shot descriptions, framing, notes and so on.

The biggest advantage of the CRT display is its ability to make the raw material visual. This includes the ability to view many of the clips simultaneously (up to 18 clips can be seen on the screen at once). Therefore, it is easier to find and select shots.

Editing section

The editing CRT is the working side. It has a window designated as the *play window*. Here, users can preview clips before making edits. A second window is designated as the edit window in which edited material is visually stored. Between the two windows are audio controls (on, off, volume) and an indicator of the tracks being edited. The Media Composer can edit from four to 24 tracks of audio.

**The biggest advantage
of the CRT display is
its ability to make the
raw material visual.
This makes it easier to
find and select shots.**

Users drag clips to the play window and set in and out times using arrows on a timeline below the play window. In and out points are designated in the same way on the editing window. To make the edit, users simply click the mouse on one of two graphics between the windows, one for an insert edit and one for an assemble edit. Although time-code numbers can be displayed if desired, the ability to control the video frame-by-frame generally makes them superfluous.

Below these two windows is a timeline that includes video and audio. Users may choose to represent these signals either as a line or graphically. When displayed in line format, two parallel segmented lines represent audio and video, respectively. Each segment represents one edit, and is displayed with its run time. In the graph-

Arthur and Caruso are independent producers and directors based in Sherman Oaks, CA.

ic display, the display is a series of pictures representing the first frame, or first and last frame, of every edit.

The timeline becomes a visual storyboard. This can be used for approval or reference.

Video edits are easy to move on the timeline. Users simply pick them up with the mouse and drag them to their new location. Deleting video is also easy. Users move the playing line (a line that moves up and down the timeline to indicate the current location in the edited material) to a spot within the clip to be eliminated. Then, they click on the cut button (a pair of scissors). To edit video, users mark the in and out point on the edited material and click on the cut button.

The timeline becomes a visual storyboard. This can be especially useful during the edit session and after, because some Media Composer systems are able to print a hard copy. This can be used for

approval or reference.

The audio timeline graphic display is an audio waveform readout. This makes audio editing easier. The waveform can expand, allowing operators to see and hear the sounds in critical edits.

Transitions

The system allows users to perform video and audio dissolves, and to fade up or out. Video dissolves take place almost instantly. Audio dissolves take some time. Waiting for them can be irritating.

Editors must rely on selling their creative abilities rather than their ability to operate an editing system.

Graphics and titles can be imported into the system or, in some cases, created there. Other capabilities, such as keys, freeze frames and slow motion, are avail-

able to some degree with software upgrades expanding these abilities from time to time. For the time being, the system's overall graphic capability is somewhat limited — particularly on the 200 series. This can be a source for frustration, because it means that graphic decisions must (for the most part) be made in the on-line session.



EDL output

The Media Composer is an off-line editing system. Its end product is an *edit decision list* (EDL). The EDL is output to disk in a format designed to match the on-line system that will handle the final edit. Users can use the system to auto assemble a

WHEN EVERY DETAIL COUNTS

Comprehensive Design for the Entertainment Industry

• FACILITY DESIGN

Audio Studios
Video/Motion Picture Studios
Post Production Suites
Lighting & Rigging Systems
Handicap Access

• ENGINEERING

Room Acoustics
Sound Isolation
HVAC Noise & Vibration Control
Technical Electrical Power
Signal & Control Cabling
Systems Grounding

• CONSTRUCTION

Construction Management
Turn-Key Construction
Construction Supervision

**LAKESIDE
ASSOCIATES
INC.**



9272 Jeronimo Road, Suite 123C Irvine, CA 92718 714 770-6601

Circle (66) on Reply Card

SHRUNK TO FIT!

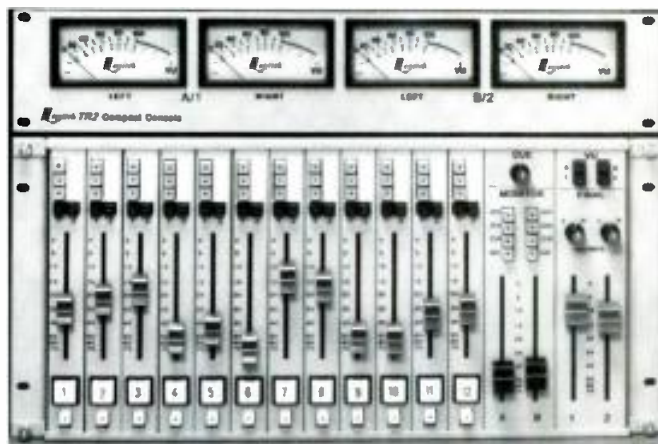

The *Logitek* TR2 Console

- A Full-size Console in a 19" Rack
- 12 Mixers with 36 Inputs
- 12 Mic Preamplifiers
- 4 Metered Outputs with DAs
- 2 Monitor Drivers plus Cue
- Machine Control & Tally Outputs
- Modular Construction

Call 1-800-231-5870 for your nearest dealer!
or write us at 3320 Bering Drive □ Houston, TX 77057

Circle (67) on Reply Card

rough cut of the EDL if they have two machines. However, this cut will not be of broadcast quality.

Pluses and deltas

The Media Composer's visual design definitely helps make it user-friendly. It is not quite as easy, however, if the user does not know how to operate an Apple. PC users in particular may find the process tedious. It seems to take forever to get into the system, to locate and call up all the storage locations and get moving on a project. Also, the number of mouse functions may be irritating to PC users who are accustomed to the keyboard, which is usually perceived to be faster.

Furthermore, the Avid terminology can be confusing at times. Avid has mixed jargon from the video and film worlds. This makes it necessary for editors from either medium to learn new terminology.

Overall, the Media Composer offers greater flexibility and creativity in the production process at a reasonable cost (\$24,500 to \$79,500).

The system has not gained wide accep-

tance in the network broadcast market. We attribute this to the professional editor's resistance to cuteness, as well as the development of non-linear editing systems by more established broadcast suppliers. Nevertheless, the system has found a place in corporate video departments and at TV stations — particularly in news departments. Users describe the system as affordable, a time saver, a great visualization

tool, and extremely flexible in terms of being able to make changes to the edited master.

The Media Composer (and other desktop systems like it) eliminates some of the mystery of editing by putting it within reach of almost everyone. Some editors may find this threatening. The advantages of these systems, however, should far outweigh this perceived threat.

Hardware base for the 200 series:

- Macintosh IIci
- 16MB RAM memory
- 80MB internal drive
- Audio co-processor board
- Video frame buffer and co-processor
- JPEG co-processor
- Panasonic optical disc drive
- Two multisync color monitors
- VLAN deck control and blackburst generator
- One or two video decks, 1-inch, 3/4-inch or 1/2-inch

Hardware base for the 2000 series:

- Apple Quadra 900
- 2MB video RAM
- 16MB RAM memory
- Audio co-processor
- VLAN and blackburst generator
- JPEG co-processor
- Audio band I/O processor
- Two multisync color monitors
- 1.5GB magnetic disk
- 2.9GB magnetic disk (for model 2500)
- One or two video decks, 1-inch, 3/4-inch or 1/2-inch

Linking your customers adds power to our sales message and to your budget.

Now you can link together readers of any of Intertec's magazines to create the most powerful network for your sales message.

And give your ad budget a power boost, too. Your network buy qualifies for our all-way combination rate. That

can result in more ad insertions for basically the same dollar investment.

Talk to any of our publishers or your Intertec marketing manager about how a custom-made network can add power to your message, and your budget.

INTERTEC
PUBLISHING

Industry Briefs

BUSINESS SCENE

Videotek, Las Vegas, has sold nine TVM-730 video analyzers to Capital Cities/ABC, New York.

National Teleconsultants' NTC Systems Division, Glendale, CA, has delivered a model APDU-100 dual-redundant, digital videotape format automatic program delay system to NBC, New York.

Solid State Logic (SSL), Oxford, England, has sold a 40-channel SL 4000 G series console to the Finnish Broadcasting Corporation, Helsinki, Finland.

SSL has also taken an order from Carlton TV, London, for an SL5000 M series console. In addition, the BBC's Maida Vale studios in West London have recently installed an SL4056 G series console.

Digital Audio Research (DAR), Surrey, England, has sold a DAR Soundstation SIGMA digital audio production system to Campus Crusade for Christ, Vancouver, Canada.

DAR has also sold an AutoConform and Multitrack Emulation package to Wild Tracks Audio Studios, London.

A.F. Associates (AFA), Northvale, NJ, has delivered the first five of 12 AVS EOS TV standards converters purchased by the Jukebox Network, Miami, to accommodate the company's expansion into the United Kingdom. Industrial Audio Video, Houston, purchased an AVS EOS converter as well.

AFA has also sold two additional AVS ISIS Q converters to CNN, Atlanta. Five Radamec EPO RP2 robotic pedestals, the Radamec EPO extended advanced robotic control system and the EPO cue computer were purchased by SKY Television, London. Furthermore, AFA has contributed robotic-controlled cameras and video systems to the Museum of Television and Radio.

Also, AFA has been awarded the contract to design, engineer, fabricate and install the New York City News Channel for Time Warner Cable.

Canon, Englewood Cliffs, NJ, has delivered an array of lenses and accessories to the Latin American marketplace. In Buenos Aires, Channel 11 has purchased a complement of lenses, including six J20X type Cs and two J8X6B wide angle internal focus lenses. Rio De Janeiro's TV Globo has added four J18X8.5B IRS lenses and a J8X6B wide angle lens. In Chile, Channel 13 has purchased eight J14aX lenses. Imagen y Sonido, a Columbian-

based production house, has purchased three J20X Super lenses. In addition, Canon has sold two J20X Super lenses and one J55X Super lens to Channel 6, Guadalajara, Mexico. The company has also sold a J45X9.5B IE to Fonovideo, Caracas, Venezuela.

BTS, Simi Valley, CA, has sold a fully equipped high-definition TV van to Videoart, Turin, Italy.

Sony Broadcast & Communications, Basingstoke, England, has delivered a 6-camera outside broadcast vehicle to Kuwait.

Basys, Yonkers, NY, has been chosen to provide NBC, New York, with an automated newsroom system to support the Summer Olympics in Barcelona, Spain.

Symbolics, Burlington, MA, has sold two Unified Graphics systems to KTRK-TV, Houston.

Dynatech NewStar, Madison, WI, has been chosen to provide comprehensive systems for Rede Brazil Sul Network, Brazil. The two NewStar PC-LAN-based systems will be installed at RBS stations in Porto Alegre, Rio Grande Dosul, Brazil and Florianopolis, Santa Caterina, Brazil.

Dynatech NewStar has also sold two NewStar II systems to TV2 Norway. One will be installed at Bergen, Norway and the other in Oslo, Norway.

National Transcommunications, Winchester, England, has extended NICAM digital stereo to the East Midlands and to East Devon for Central and TSW.

Ampex, Redwood City, CA, has sold three D-2 format VPR-300 digital videotape recorders to Northwest Teleproductions, Kansas City, MO.

Pinnacle, Santa Clara, CA, has sold a Prizm video workstation to Performance Post, Studio City, CA. The Federal Reserve Bank, San Francisco; ARC United International, Santa Fe Springs, CA; ASCR, Santa Maria, CA; and JMK, Cerritos, CA, have also purchased Prizm video workstations.

In addition, the city of Costa Mesa, CA, has purchased a 2100 series video workstation. KNXV-TV, Phoenix, has installed a Prizm video workstation as well. Furthermore, Westinghouse, Richland, WA, has purchased the Prizm and 2100 series video workstations.

Vistek's (Bucks, England) Vector standards converter has been chosen by NBC, New York, for use in standards conversion

at the Summer Olympics in Barcelona, Spain.

Columbine Systems, Golden, CO, has signed an agreement with RTL plus, Cologne, Germany, to automate RTL's master control operations with Columbine/master control automation (C/MCA).

Acrodyne Industries, Blue Bell, PA, has received an order for a 30kW tetrode VHF channel 11 TV transmitter from Flamingo Broadcasting Network, Netherlands Antilles.

Generation Technologies, Overland Park, KS, has sold a 30-workstation Generation news productivity system to WGN Radio, Chicago.

AMEK/TAC U.S. Operations, North Hollywood, has sold 20 input AMEK BCIII consoles with serial AFV interfaces to Turner Productions, Atlanta. Turner also ordered eight input TAC D-2 consoles.

In addition, Turner Network Television, Atlanta, purchased its second and third BULLET consoles with serial AFV interfaces. Another BULLET was recently installed at CNN.

WCNC-TV, Charlotte, NC, purchased a B2/AFV console. Another B2/AFV console was bought by Charlotte Cablevision, Charlotte, NC.

Apogee Electronics, Santa Monica, CA, is assisting the Massachusetts Institute of Technology (MIT) in developing an advanced TV system that may become the official U.S. standard for HDTV. The company's AD-500 and DA-1000E digital converters are being used to support the audio phase of MIT's digital-based system.

The U.S. Patent and Trademark Office has approved an exclusive patent for the technology that allows **TV Answer**, Reston, VA, to tie together its nationwide network of cell sites.

The technology covered by the patent creates a satellite-based 2-way TV system that will link consumers, local cell sites and a central data processing center into a nationwide, wireless communications network. The network will allow consumers to use their televisions to perform activities, such as playing along with TV game shows and sports events, responding to national news polls and interactive commercials, shopping, banking, bill paying and organizing viewers' programming information.

Dynapro Systems Inc. (DSI), New Westminster, British Columbia, Canada, has signed a letter of intent to acquire

Mohawk knows camera cable!

**Hitachi, Ikegami,
Panasonic and Sony
agree.**

**Get our free info kit...
and you will, too.**

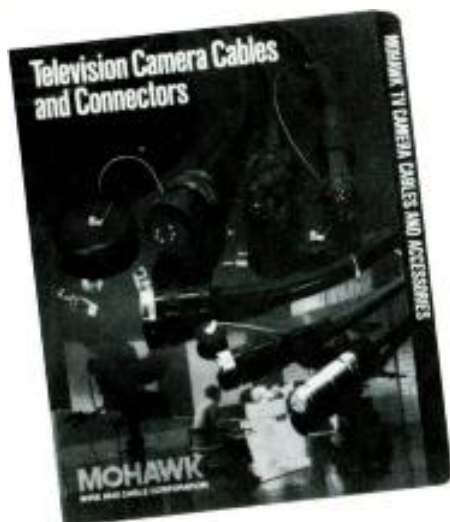

For 30 years, Mohawk has been the wire and cable resource-of-choice for major manufacturers of both radio and TV equipment. . . supplying them with audio, video and VTR cables and assemblies of proven quality and service.

This experience is available to you in our TV Camera Cables and Connectors information kit; or by calling the experts in our U.S. or U.K. customer engineering departments. It pays to know.

Our expanded product line features:

- Multi-Core and Cable Assemblies
- Triax Cables in 1/2" & 3/8"OD. in bulk or assemblies
- VTR Cable Assemblies
- Audio Cables
- Video Coax, in single and composite constructions, RGB and SEMPT miniatur cable
- Control and Snake Cables
- Fiber Optic Cables...and Connectors.

MOHAWK

WIRE AND CABLE CORPORATION

9 Mohawk Drive.

Leominster, MA 01453.USA

Tel.:+1-508-537-9961.

Fax:+1-508-537-4358

In the U.K.:

ANGLO AMERICAN CABLE COMPANY

Unit 4, Moorfield Industrial Estate

Moorfield Road, Yeadon

Leeds LS19 7BN, United Kingdom

Tele. 0532-507726 FAX 0532-506661

Circle (83) on Reply Card

John Fluke Manufacturing's touch control screen product line. DSI will acquire all equipment and technology associated with the product line, and will assume responsibility for building, selling and supporting the products to current Fluke customers, as well as new markets.

Thomson Broadcast, Englewood, NJ, has established a West Coast sales office. Six companies have been designated as company sales/service representatives for territories in the United States and Canada: Afterglow, Burbank, CA; Atlantic Video, Birmingham, AL; Dyma Engineering, Los Lomas, NM; Quad-tech Marketing, Shawnee Mission, KS; and Video Design Systems, Brampton, Ontario, Canada.

Dynatech Broadcast Group, Madison, WI, has changed its name to Dynatech Video Group.

Solid State Logic, Oxford, England, has opened Solid State Logic Audio Technik GmbH in Germany. The address is Röntgenstrasse 104, 6100 Darmstadt 12; phone 49-6151-938680; fax 49-6151-938686.

Sachtler AG, Munchen, West Germany, has received the Scientific and Engineering Award from the Academy of Motion Picture Sciences and Arts for technical achievements. The engineering department as well as the inventor of the Sachtler damping system were honored by the award.

Symetrix, Seattle, has expanded its manufacturing facilities.

Television Technology Corporation (TTC), Louisville, CO, and **Rohde & Schwarz**, Lanham, MD, have reached a preliminary agreement that exclusively authorizes TTC to include the Rohde & Schwarz modulator/exciter as a premium option in its UHF transmitter product line for the U.S. marketplace.

Signal Technology Corporation, Weymouth, MA, has acquired the business and substantially all of the assets of Keltec Florida, Fort Walton Beach, FL. Keltec is a subsidiary of Amstar Corporation. The company has been renamed ST Keltec, and will remain in Fort Walton Beach.

Vistek Americas, Palo Alto, CA, has established a technical support/service for its line of standards converters, routers, color correctors, mixers, encoders and decoders. Support will also be extended to the former A.C.E. product line, which was marketed in the United States by Midwest Communications.

Kline Towers, Columbia, SC, and **Dielectric Communications**, Raymond, ME, have announced a joint venture that will allow the companies to offer turnkey packages in the design, fabrication, construction and installation of towers, transmission equipment and antennas; complete inspection and maintenance services; HDTV feasibility studies; and structural design analysis and reinforcement requirements of existing towers for future broadcast capability.

Waldom Audio Products, Chicago, has been chosen by Australian-based Alcatel Components to market the Alcatel audio connector line in North America.

Trompeter Electronics, Westlake Village, CA, has established a toll-free number to answer questions concerning product information, sales information or technical support. In California, call 800-655-2028. The toll-free number outside of California is 800-982-COAX.

FutureVideo, Aliso Viejo, CA, has doubled the space of its headquarters.

Martin Audio Video, New York, has extended its business hours at its Manhattan location, to 9 a.m. to 6 p.m. Monday through Friday and from 10 a.m. to 2 p.m. on Saturdays.

Wavefront Technologies, Santa Barbara, CA, and **Foursome Computer Technology**, Taiwan, have entered into a joint agreement to develop software for the computer animation and multimedia industries.

Wexler Video, Burbank, CA, is the new national and international distributor, as well as the Los Angeles dealer, for the complete line of CMAX editing systems from Strassner Video Enterprises.

Leitch's master clock system driver and related clock products are on display at the National Geographic Society's Explorers Hall Museum in Washington, DC, March 5 through June 14. Admission is free. For more information, call 202-857-7588.

California Microwave, Sunnyvale, CA, has entered into an agreement to acquire 100% of Microwave Radio Corporation's stock.

Videomedia, San Jose, CA, and **RGB Computer & Video**, West Palm Beach, FL, have signed an agreement whereby RGB will produce certain V-LAN-compatible transmitters and receivers for its AmiLink line of editing systems.

BCD Associates, Oklahoma City, has relocated its headquarters within the city. The address is 128 N.W. 67 St., Oklahoma City, OK 73116; phone 405-843-4574; fax 405-840-3147.

Tektronix's TV Division, Beaverton, OR, has named TVC Horizon, San Clemente, CA, as a representative of current and future CATV and fiber-optic product lines for Alaska, Arizona, California, Colorado, Idaho, Montana, Nevada, New Mexico, Oregon, Utah, Washington and Wyoming.

Toshiba, Tokyo, and **O.L.E.**, London, have agreed to cooperate in the marketing of the Lightworks Editor for the Japanese market.

Museatex Audio Inc., Calgary, Alberta, Canada, has purchased technology rights and certain assets of the Shure consumer Home Theater Sound (HTS) business, Evanston, IL.

Moffet, Larson & Johnson, Falls Church, VA, has been acquired by WPC Telecommunications, a subsidiary of The Washington Post Company. It will continue to operate under the name Moffet, Larson & Johnson.

Chyron, Melville, NY, has entered into a joint development project with Silicon Graphics. Chyron is responsible for producing a broadcast-quality video adapter board for Silicon Graphics' IRIS Indigo RISC PC.

Television Technology Corporation (TTC), Louisville, CO, has named Nortec West as a distributor for its FM radio and low-power TV product line.

It has also added four broadcast dealers to represent its FM product line.

Vyvx, Tulsa, OK, has entered into an agreement with Fox to provide the network with digital fiber-optic TV transmission services to support Fox news activities and various other Fox programs.

Through the agreement, Fox will become the first major programming service or network to use fiber optics instead of satellites as its primary means of gathering news nationwide.

Audio Animation, Knoxville, TN, has appointed Audio Techniques, New York, and Broadcast Services, Four Oaks, NC, as retail-level dealers. They will stock and sell Audio Animation's Paragon-digital audio transmission processor.

Fluent, Natick, MA, and **HSC Software**, Santa Monica, CA, have entered into a

joint marketing agreement to provide full-motion digital video capabilities to HSC Software developers and end-users. Under the agreement, HSC Software has joined Fluent's Influence Alliance Partner program. HSC will provide support for Fluent's digital video products in its multimedia Windows product line.

ASC Audio Video, Burbank, CA, and **Norm Strassner**, author of the original CASE I Edit Controller software, have severed their alliance.

BASF Corporation Information Systems, Bedford, MA, has restructured its North American magnetic media business to improve profitability. Professional audiotape production at the Bedford, MA, plant was discontinued at the end of April. Production for that product line will be concentrated at the company's European sites.

PEOPLE

Charles P. Ginsburg, who led Ampex's development of the world's first practical videotape recorder (VTR) in 1956, died April 9 at his home in Eugene, OR. He was 71.

Memorial contributions may be made to the Juvenile Diabetes Foundation, Greater Bay Area chapter, 1806 Union Street, San Francisco 94123.

Mark Bressack has been appointed director of sales, cable TV systems, for A.F. Associates, Northvale, NJ.

Joshua Touber has been named vice president of operations for Xymox Systems, Granada Hills, CA.

James S. Kaplan has been named chief engineer for San Juan Radio, Bellingham, WA.

David W. Keller and **Larry F. Manikowski** have been appointed to positions with Dynatech Video Group, Salt Lake City. Keller is division executive for the 9-company group. Manikowski is Video Group controller.

Richard Darr has been named vice president of sales and marketing for Dynatech NewStar, Madison, WI.

Roy Moore has been appointed manager of engineering services for Bexel, Burbank, CA.

Bill Kaiser and **Brian Way** have been promoted to positions with ESE, El Segundo, CA. Kaiser is general manager, and Way is director of marketing and sales.

Peter Jostins, **Ian Lovelock** and **Christine Hale** have been appointed to positions with Soundtracs, Surrey, England. Jostins is technical sales manager. Lovelock is management accountant. Hale is purchasing manager.

Paul Gonsalves has been named sales representative for the regions of Quebec and Ontario, Canada, for Tannoy, Kitchener, Ontario, Canada.

Les Perlman, **Sylvia Sevean**, **Ron Workman**, **Larry Johnson**, **Terrie Gross** and **R.J. LaFay** have been appointed to positions with R.F. Industries, San Diego, CA. Perlman is marketing director. Sevean is marketing communications manager. Workman is director of purchasing. Johnson is chief design engineer. Gross is inventory manager, and LaFay is OEM sales representative.

Dr. Arnie Dahlke, **Bob Ofenstein**, **Michael Paganini**, **Chris Foreman** and **Thomas Combs** have been named to positions with JBL Professional, Northridge, CA. Dahlke is director of training. Ofenstein is product manager. Paganini is applications engineer. Foreman is manager of the company's operation in Kearney, NE. Combs is customer service administrator.

Jack M. Heeren has been named senior vice president of sales and marketing for Sola, Elk Grove Village, IL.

Barrie Gilbert, Analog Devices, Norwood, MA, has received the 1992 IEEE Solid-State Circuits Award for his contributions to non-linear analog signal processing.

Steven Bonica and **Alec Shapiro** have been named to positions with Panasonic Broadcast & Television Systems Company (PBTSC), Secaucus, NJ. Bonica is president of the newly formed company. Shapiro is general manager, marketing.

John F. Phelan and **Alan B. Shirley** have been appointed to positions with Shure Brothers, Evanston, IL. Phelan is general manager, international marketing and sales. Shirley is manager, technical markets and strategic planning.

Barry Epstein and **Wally Rogers** have been appointed to positions with Current Technology, Richardson, TX. Epstein is chairman of the board, and Rogers is president and chief executive officer.

Marc C. Branson has been named general manager for Optical Disc Corporation, Santa Fe Springs, CA. ■

New Products

Rewritable videodisk

By Pioneer Communications

- **VDR-V1000:** laser recording system with rewritable media; non-linear access with precision frame-by-frame editing feature; useful in commercial insertion, production, instant replay and library applications; series includes playback-only system; capacity of 57,600 frames or 32 minutes full-motion video per disk side.



Circle (395) on Reply Card

Product literature

By Simpson Electronics

- **Panel meter catalog:** 32-page publication describes analog, digital meters, meter relays, controllers; Hawk series, Wide-View, Century designer meters.

Circle (400) on Reply Card

Maintenance products

By Soder-Wick

- **Soder-Wick brochure:** focuses on Fine-Braid and Ultra-Braid desoldering products; nine widths of braided copper assist in solder removal during equipment maintenance.

Circle (401) on Reply Card

Satellite accessory

By Narda West

- **Model 60583:** Ku-band diplexer isolator; combines amplifier isolator and antenna circulator in one compact package; power rating at 1W CW maximum; 20dB isolation, 0.5dB insertion loss per junction.

Circle (391) on Reply Card

Product literature

By National Instruments

- **Data acquisition guide:** brochure outlines products for use with IBM-compatible and Macintosh NuBus PCs; plug-in boards; NI-DAQ Windows driver software; SCXI multichannel front-end chassis for data acquisition boards.

Circle (392) on Reply Card

Cable assemblies

By Nema Electronics

- **EMI/RFI suppression:** coaxial and multiconductor cables with ferrite beads; 50Ω and 75Ω with N, BNC, UHF terminations or D-subminiature and circular connectors; ferrite material, number and placement of beads determines optimum performance in desired frequency range.

Circle (393) on Reply Card

Archive software

By Nesbit Systems

- **NSi videotape library system:** database for archive and record-keeping in small to medium-sized production and broadcast facilities; PC and multi-user network versions; maintains complete record on all archived material

Circle (394) on Reply Card

Test device enhancement

By ITT Pomona

- **SMT pin adapters:** a series of spring-loaded devices permitting SMT package testing without permanent installation of the IC units; eliminates time and cost of soldering and desoldering during troubleshooting.

- **Series 5789:** spring-loaded needle point probe tips; for use on high-density circuitry; reduces chance of damage to PCB traces; easily attaches to various test equipment and cable interfaces.

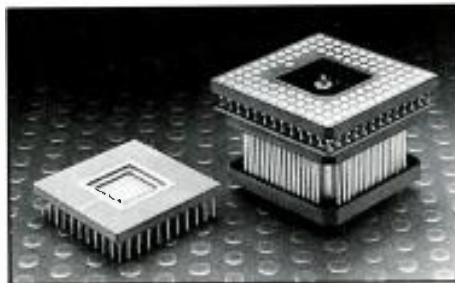

Circle (378) on Reply Card

Audio quality improvement

By Radio Systems

- **RS-SQUARED:** encode-decode system for 24dB noise reduction; stand-alone system improves cart, reel tape source or STL noise performance; incorporates Dolby S-type processing with single-ended stereo phase correction.

Circle (397) on Reply Card

Power source

By Exeltech

- **SI-500:** power inverter with true sine wave output waveform equivalent to 115VAC household current; 12A peak current capability in 12VDC, 24VDC, 36VDC and 48VDC models; overload, short and input polarity reversal protection.

Circle (368) on Reply Card

Equipment enclosure

By Winsted

- **Duplication console:** 27¹/₈-inch wide unit houses 22 compact duplicating VCRs; pull-out or stationary shelves; casters mounted to standard or anti-tip base.

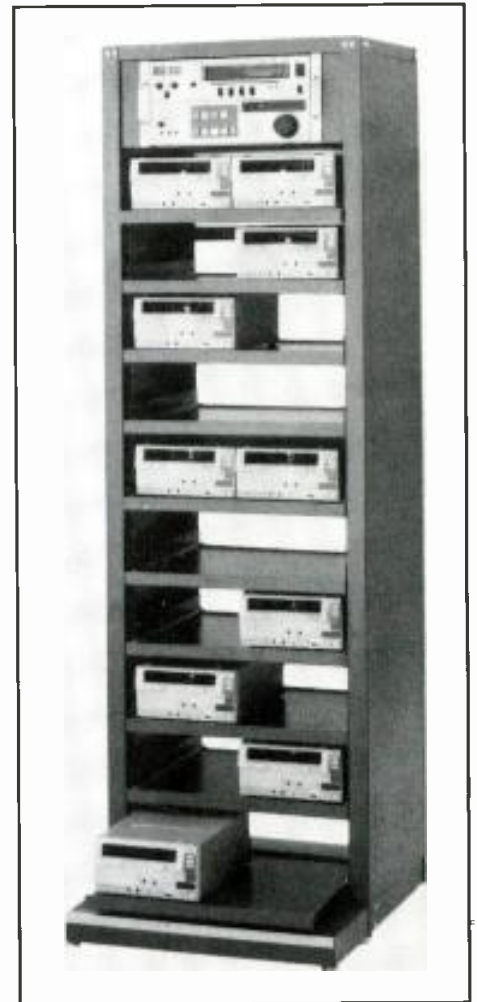

Circle (409) on Reply Card

Desktop monitoring

By Digital Processing Systems

- **DPS Personal V-Scope:** combines vector and waveform monitoring functions on a plug-in card for IBM PC-compatible or Amiga 2000-based video workstations; Personal TSG software for test patterns; analysis patterns displayed on standard video monitor.

Circle (366) on Reply Card

Intercom enhancement

By HIM Electronics

- **Intercom literature:** outlines expanded Series 8000 products; System 8110 and 8112 wireless intercom products, Communicator beltback transceivers.

Circle (374) on Reply Card

RF exposure measurement

By Holaday Industries

- **Broadband RF instrumentation:**

brochure describes products for determination of electromagnetic field measurements; covers ELF/VLF electric, magnetic fields and non-ionizing RF, microwave radiation.

Circle (375) on Reply Card

Graphics utility library

By *IMAGETECIS*

- **ImageCELS:** royalty-free graphics material for backgrounds, fills, texture mapping; floppy disk format includes .PCX for IBM, .TIFF for Macintosh; CD-ROM version supports additional file formats; requires VGA display with 16-, 24-, 36-bit displays.

Circle (376) on Reply Card

Automation software

By *Innovative Automation Systems*

- **MAS-5000:** Macromized automation system; creates event lists based on macro files that include complex equipment setups; control of an unlimited number of devices with drivers for numerous common products; Windows-based system.

Circle (377) on Reply Card

Cable tool

By *Canare Cable*

- **TS-series stripper:** three models cover Canare I-3C2VS, LV-61S, LV-77S cables, as well AS RG-59B/U, 8281; 3-step procedure requires 15 seconds to prepare a cable end for a connector.

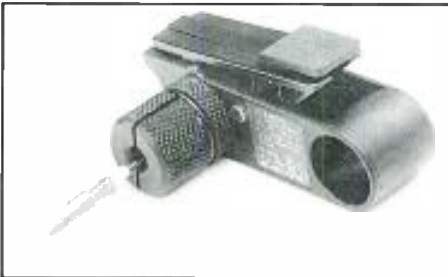

Circle (362) on Reply Card

CG enhancement

By *AVS Broadcast*

- **Arabic titling:** right-to-left function permits use of ManuScript and Floating-Point titling systems with Arabic characters; system switches functionality upon sensing of Arabic typefaces without disrupting Roman-based character sets.

Circle (360) on Reply Card

FO communications link

By *fotec*

- **FOtalk F240:** talkset for voice-over single-mode FO cable; half-duplex with talk, listen modes; network through external optical couplers; system includes two units with carrying case.

Circle (369) on Reply Card

Test probe assistant

By *J. S. Popper*

- **JP-8783 test tool:** spring-loaded test clip pierces 22-24ga wire insulation to make measurements without locating a termination; small punctures reclose when clip is removed; eliminates insulation stripping; tip designed to grip various shapes.

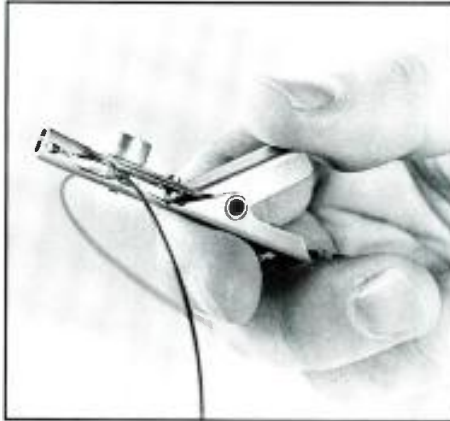

Circle (379) on Reply Card

Disk-based audio

By *Audio Follow*

- **D.D.O.2:** direct-to-disk optical digital recorder; uses removable, erasable MO or magnetic hard disk media; two independent channels for recording, editing or playback; capacity of five hours per disk; controls up to six disks; optional interfaces for various applications.

Circle (358) on Reply Card

Noise location

By *Trilithic*

- **PLI-150:** interference locator; helps find noise radiating from AC-powered equipment; measures the strength of the source with a calibrated receiver with peak-reading or weighted detectors; mobile mount and antenna, directional antenna included.

Circle (405) on Reply Card

Perfect timing

By *Truetime*

- **GPS product brochure:** series of devices includes PC plug-in cards, board-level or portable timing receivers and stand-alone reference units.

Circle (406) on Reply Card

Console automation

By *Uptown Automation Systems*

- **System 990:** moving fader position, channel mute functions automated according to time code; replacement motorized faders, control modules, 8-button control panel and 80386-based PC; MIX software includes MIDI compatibility, storage of mix information on disk or tape.

Circle (407) on Reply Card

SANIX®

INTRODUCING "Capacitive-Discharge"

PULSE GENERATION PRINCIPLE
BULK ERASERS

**FAST
COMPACT
EFFICIENT
RELIABLY ERASE
METAL TAPES**

All Models operate on 117V at 3 Amp.
24 hour continuous duty, no heat build-up.



3800
For BETACAM-SP
L-M, D3, M11,
VHS, Beta etc
METAL-OXIDE



4800
For D2(D1)M-S,
U-matic, etc.
METAL-OXIDE



5500
For D2(D1), D3
Large and M-S
all cassette
METAL-OXIDE
TABLE TOP MODEL



6000
For D2(D1), D3
Large and M-S
all cassette
Up to 1" x 14" reel
all Reel Type
METAL-OXIDE
MASTER ERASER

North American **DISTRIBUTOR**
RTI-RESEARCH TECHNOLOGY INT'L.
4700 CHASE AVENUE
LINCOLNWOOD, IL 60646 U.S.A.
PHONE: 708-677-3000
FAX : 708-677-1311

SANIX CORPORATION
TOKYO, JAPAN FAX: 81-3-3702-9654

Circle (72) on Reply Card

Patching Equipment



Audio Patching

- Panels & Jacks
- Pre-Wired Audio Panels
- Patch Cords
- Available in both 1/4 & Mini Sizes

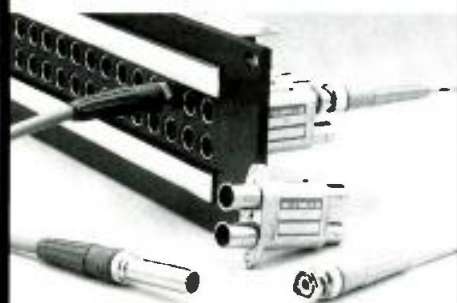

Video Patching

- Video Panels
- Video Panels & Jacks
- Patch Cords
- RGB Panels

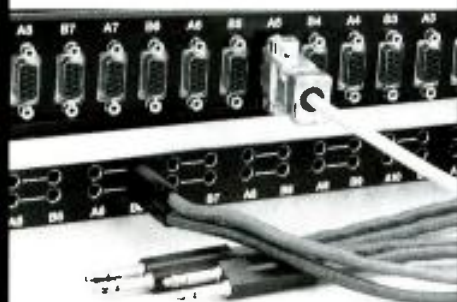

RS-422 Patching

- One Rack-Unit, 24 Port (12 in, 12 out)
- Two Rack-Unit, 48 Port (24 in, 24 out)
- Interconnect Cables

audio accessories
audio-line

Audio Accessories, Inc.
Mill Street, Marlow, NH 03456
Phone: 603/446-3335
Fax: 603/446-7543

Circle (73) on Reply Card

PCB maintenance

By *Electro Insulation Corporation*

• **Tidy Pen:** pocket-sized pen design dispenser contains industrial strength cleaning agent; applied through replaceable, wedge-shaped felt tip; effective for corrosion, solder flux, grease, label adhesives.

Circle (367) on Reply Card

Multisignal viewing

By *RGB Spectrum*

• **Watchdog:** see multiple video images on HR monitor; control for positioning and scaling of 8 video and TV tuner signals into 9 monochrome windows; accepts asynchronous signals; stand-alone display or peripheral to computer workstation.

Circle (398) on Reply Card

Product information

By *Bird Electronic*

• **50th Anniversary catalog:** 56-page publication features RF power measuring equipment and accessories, including wattmeters, calorimeters, plug-in elements.

Circle (361) on Reply Card

Instrumentation catalog

By *John Fluke Manufacturing*

• **1992 Fluke & Philips T&M reference:** 440-page book exhibits 17 product categories of test products, including oscilloscopes, DMMs, scope meters, references.

Circle (380) on Reply Card

Technical information

By *John Fluke Manufacturing*

• **"Electrical Troubleshooting with Fluke Multimeters":** techniques in maintenance procedures for electrical systems; all procedures use DMMs as basic test product.

Circle (381) on Reply Card

Signal distribution

By *Talia/Quinto Communications*

• **The Gatton:** video isolation module; opto-isolator integrates with Talia E310 video DA and E.O.S. router; 100MHz bandwidth.

• **Talia E.O.S. switcher:** virtual routing software upgrade permits one input to be assigned to several other inputs; software re-entry feature enables system to use any number of outputs as inputs; reduces timing problems typical if physical re-entry wiring is used.

Circle (403) on Reply Card

Equipment rack enhancement

By *Winsted*

• **Locking shelf:** units in 5.25-inch or 10.5-inch heights; 17.325-inch width with 14-inch depth includes smoked Plexiglas door and lock for equipment protection;

fits in any EIA console or rack.

Circle (404) on Reply Card

Portable audio equipment

By *Nady Systems*

• **MCM-400:** camcorder mic mixer; inputs for two external mics and narrator headset; slider level control pans between external mic and headset; aux input for wireless mic receiver or other level-controllable sources.



Circle (389) on Reply Card

Indicating devices

By *LEDTRONICS*

• **34PCT110 series:** tri-level LEDs in T-1 package; individual devices produce red, yellow, green; singly or arrays to 3x4 for high-density boards; 25-50 lv mcd output.

Circle (385) on Reply Card

Clock displays

By *maney-logic*

• **News-Timer-Plus:** LED displays using RS-232 drive from NTP software; slave to VITC or WWV signals; 6-digit readouts may show time of day, time out, time remaining, stopwatch or base 60 calculations for segment, back timing needs.

Circle (386) on Reply Card

EMI/RFI shielding

By *Master Bond*

• **AC83:** conductive adhesive with EMI/RFI shielding characteristics; adheres to almost any clean surface without pretreatment; various methods of application with full curing overnight; oxidation and chemically resistant polymer.

Circle (387) on Reply Card

Frequency counter upgrade

By *John Fluke Manufacturing*

• **PM 9625 prescaler:** option for Philips PM 6680 frequency counter/timer extends measurable signal frequencies to 4.5GHz; pulse width, phase and rise time measurements with frequency counting.

Circle (382) on Reply Card

Continued from page 42

Gerry Dalton

Chief engineer
K104/KKDA
Dallas, TX

John Huntley

Chief engineer
KCRW-FM
Santa Monica, CA

Television:

Leon Anglin

Vice president, engineering
WUSA-TV
Washington, DC

Marvin Born

Director of engineering
WBNS stations
Columbus, OH

Philip A. Mendelson

Vice president, engineering
Digital Magic and Transfer
Santa Monica, CA

Karl Renwanz

Vice president, engineering and
operations
WHDH-TV
Boston, MA

The rules

BE's Pick Hits judges operate anonymously. Each year they look for new products that meet the following criteria:

1. **They must be new products not shown at a previous NAB.** In some cases, distinguishing a new product from a modified old product is difficult. For our purposes, a new product is one with a new model number or new designation.

2. **They must have some positive impact on the everyday work of the user.** The judges searched for equipment that would be used on a regular basis at a station. The equipment should provide a new solution to a common problem.

3. **They must offer a substantial improvement in current technology.** The equipment does not have to include unique circuit architecture, but it should include some new ideas on applying current technology.

4. **The prices of the products must be within reach of their intended users.** The judges sought products marketed to a wide spectrum of facilities.

5. **The products must be available for purchase.** Equipment must be on display on the convention floor (not in suites) and in production (or soon to be in production). Products demonstrated in private showings do not qualify. ■



- Broadcast TV
- Cable TV • LPTV
- Educational TV
- Government TV
- Business TV
- Medical TV

Write or Fax for our Television Equipment Catalog... or call toll free for immediate over-the-phone answers to your TV automation questions.

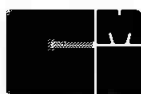

CHANNELMATIC

821 Tavern Road, Alpine, CA 91901
Telephone (619) 445-2691
FAX (619) 445-3293 • (800) 766-7171

How to cut costs and stay competitive with TV automation

- **Tape Compiling/Editing**
Exclusive V:base system... saves time, labor and tape.
- **Inserting Local Edition News or Advertising**
New ways to increase viewership and revenues.
- **Local Origination Program Playback**
Deliver high-quality output from many different inputs.
- **Custom A/V Switching, Distribution and Control**
Customized for your application, the ultimate in flexibility, quality and reliability.

Circle (74) on Reply Card

UPGRADE



- To 8 Foot Category A Performance
- 6 Foot Tower Windload
- 2, 7 and 13 GHz Frequency Bands Available
- New Dual Frequency Model 7 and 13 GHz
- Radome Available

Mark also manufactures a full line of broadcast microwave antennas including Dual Frequency 7 and 13 GHz in Standard, High and Maximum High Performance configurations.

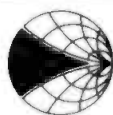

Radiation Systems, Inc.
Mark Antennas Division

1757 S. Winthrop Drive • Des Plaines, IL 60018
Tel: 708-298-9420 • Fax: 708-635-7946

Circle (75) on Reply Card

Continued from page 117

source material management, such as playing music from CD jukeboxes and RDAT? This is critical for integration to the station's existing program and spot libraries, and for versatility in the future.

- *How many workstations can you put on the system?* Although a system might start out with only production studio and master control workstations, the flexibility to add more workstations later is desirable.

- *What is the manufacturer's ability to support the system long term?* How long has the company been in business? How many employees does it have? Some manufacturers require license fees on the software to support long-term software development. Consider the long-term benefits of paying such a fee.

- *Does the manufacturer offer 24-hour-a-day support?* Many radio stations never sleep.

- *What type of hardware does this system use?* Reliability is the number one issue. Under 24-hour-a-day, 365-day-a-year conditions, consumer-grade PCs might not hold up. If the system uses proprietary hardware, repair or replacement might be problematic in the future.

- *Obtain a list of users who have the system.* It may be worthwhile to visit one or two sites and see how the system is being used and how well it works. (It's also a good idea to visit the manufacturer to see how the system is manufactured and supported.)

- *What type of bit-rate reduction system is used?* Data compression or bit-rate reduction of digital audio signals is often used to provide a cost-effective storage solution. However, there are many different methods of accomplishing this. Conduct a careful listening test of the system using several different audio sources. Be sure to try running audio samples through the system multiple times.

- *Take training seriously:* Unlike cart machines, this new technology will take some time and training to get comfortable with. Don't scrimp. Consider sending at least one person to the factory. Be sure to provide at least one month of training before putting the system on-air.

- *Do not underestimate staff resistance to change.* This new technology not only represents a change (which most people naturally resist), but it may also threaten the jobs of some staffers (or at least be per-

ceived that way). Don't be surprised if they greet the idea with less than a warm reaction. A good management response stresses the new technology's liberating effect on staff creativity.

Worth the effort?

This new technology offers risk and reward. It will take time, money and much effort to successfully implement at any station. However, current users of these systems indicate that they could not imagine going back to cart machines, paper clutter and the rest of the old ways.

After implementation, a station should begin to operate more efficiently and effectively. The on-air sound should improve because of the high-quality digital nature of all sources. Production and programming quality should increase as production and on-air talent spend more effort making the station sound better, and its product more engaging and fun to listen to. Meanwhile, the station will become simpler and more organized. With all these elements, it should come as no surprise if the station happens to attract and keep more listeners in the bargain.

■ *For more information on digital audio workstations, circle Reader Service Number 323.* ■



NEW VIDEO FURNITURE CATALOG

A newly published 1992 catalog of video furniture is now being offered by The Winsted Corporation. The full color, 108-page catalog includes complete information, specifications and pricing on Winsted's expanded line of video cabinets, consoles, racks, tape and film storage systems and accessories.

Several new products are featured in the catalog including duplication racks for compact duplicators, computer video graphics furniture, an adjustable turret for vertical racks and an expanded line of Rack Slide Kits.

Winsted's popular System 85 instant assembly frame is also included in the catalog. The company offers free design service, and promises to ship orders in 24 hours.

A valuable resource for broadcast studios, production houses and educational facilities, the new catalog is available free from:

THE WINSTED CORPORATION
10901 Hampshire Avenue So.
Minneapolis, MN 55438. (612) 944-8556



Circle (76) on Reply Card

MATCO



The New MATCO MA-204A

MATCO introduced the new MA-204A Playback System, an updated version of its predecessor, the MA-204. A New Front Panel, New Internal Routing Switcher and many New Software Features highlight the improvements of this Next Generation Playback System. The original MA-204 was available with 24VTR control and a 12x1, 24x1, 8x2 or 7x3 Internal Router. The MA-204A is available in a single version which incorporates 24 VTR control and a standard 22x3 Stereo Audio Follow Video Internal Routing Switcher. Complete control from a PC (previously a \$795.00 option) is now standard. While having the PC allows creating Event Lists Off or On Line, as well as performing all of the functions available at the MA-204A, it is not required, as all real time functions are performed by the MA-204A.

A few other interesting features are:

- Variable Event List Size by Channel (up to a total of 2800 Events).
- Complete Parameter setting, such as Preroll time, Default Input, Loss of Video Time and Routine by Channel.
- 16 week advance Event List programming.
- Loss of Video Protection on all 3 Channels.
- Automatic List updating (the 204A senses when it needs a new list and requests it automatically from the PC)
- Expanded VTR control capability to include RS422 VTRs, as well as Sony CUIS, Panasonic and JVC serial formats in addition to the standard MA-107 parallel VTR control.
- Assignable General Purpose outputs for controlling various other devices.
- Printer support for automatic logging of Events as they execute.
- All Event Data, as well as the Clock/Calendar are battery backed.

The list price of the new MA-204A, including PC software and a three year warranty, is \$4200.00. Call MATCO at (800) 225-5390 for more info.

Circle (77) on Reply Card



Louth Automation Shows ADC-100 on the Sony Stand at NAB 1992.

Louth Automation was selected by Sony to show its ADC-100 automation system on the Sony stand at NAB this year. The highlight of the Watson/Holmes Theatre Presentation was the demonstration of Louth's multi-channel capabilities. Two independent channels were run from the LMS with three decks assigned to each channel. On-the-fly editing and interface of external devices was also shown. The Louth ADC-100 can actually control a virtually unlimited number of independent playlists/channels from the system Server and many various kinds of broadcast devices can easily be integrated.



Circle (78) on Reply Card

BROADCAST ENGINEERING

PRODUCT SHOWCASE

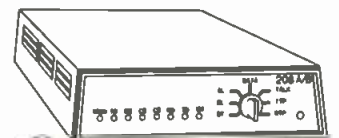

These ads are profiles of new products for your review

If you would like additional information about any of the products shown, please be sure to circle the appropriate number on the Reader Service card in this issue.

Preview

July...

AUDIO TECHNOLOGY UPDATE

• Digital Audio Production Tools

New digital audio processing equipment has opened doors to techniques and higher quality than ever before thought possible. The article will look at the advantages provided by digital processing.

• Digital Audio Processing for Transmission

Analog audio processing has reached such a high degree of sophistication that it may be unreasonable to expect further improvement. Many, therefore, are looking to the magical power of digital technology to provide even more control over production and broadcast audio.

• Replacing the Analog Cart Machine

A review of how new digital-based technology is encroaching upon the traditional stronghold of the analog cartridge machine. Although digitally based systems aren't for every application, they

have certain unique advantages that should be considered in any purchase decision.

• Using DAT in Broadcast

Digital audio recorders are making their way into the production rooms of many broadcast stations. The combination of features and digital quality make them the perfect solution to many production issues. The article will focus on the features most helpful in broadcast and production applications.

• DAB Update

The latest news on digital audio broadcast technology. The emphasis will be on the technical considerations for implementing DAB: transmitters, antennas, propagation and receivers. Also to be addressed will be the political and economic considerations for stations as they strive to implement this new technology.

August...

VIDEO TECHNOLOGY UPDATE

• HDTV: Who's On First?

An update on the HDTV standard selec-

tion process. An emphasis will be placed on those systems under test (or finished) by the ATTC. A related article on updated HDTV implementation strategy will also be included.

• Selecting and Servicing Video Effects Systems

The article will be a 2-part series. Part 1 will look at the options available, and Part 2 will look at modern servicing techniques for this equipment. Equipment discussions will emphasize 2-D and 3-D effects hardware.

• Digital Video Recorders

An examination of the digital video recorder technology. It will include D-1, D-2 and D-3 systems. This means that component and composite systems will be examined.

• Microphone Selection and Use

Faced with such a bewildering array of microphone options, it's difficult to know what's best for any application. The article will lead the reader through a decision tree selection process to help narrow the field. The second part of the article will illustrate how different microphones are best applied.

Professional Services

East Coast Video Systems
ON-LINE SERVICE

A full service company providing...

- Consultation
- Engineering & Design
- Installations
- Training

Serving...

- Cable Systems
- Corporate Facilities
- Broadcast Facilities
- Teleproduction Facilities

52 Ralph Street, Belleville, NJ 07109 (201) 751-5655

HCI INTERNATIONAL

Satellite Systems Engineering Design & Construction

T1 BUSTING • TRACKING SYSTEM • TRANSPORTABLE & FIXED UPLINKS

1-800-444-0856

PH: (805) 963-3765 FX: (805) 962-0920

425 E. Montecito St. Santa Barbara, CA USA 93101

A DIVISION OF HEMEC COMMUNICATIONS

NETCOM

STATE-OF-THE-ART ENGINEERING FOR AUDIO & VIDEO

TURN-KEY SYSTEMS
DESIGN & DOCUMENTATION
EQUIPMENT SALES
CAD SERVICES

1465 PALISADE AVE., TEANECK, NJ 07666 / (201) 837-8424

ERIC NEIL ANGEVINE, P.E.
architectural engineer

specializing in broadcast studio acoustics

1002 Greystone Street Stillwater, OK 74074
405-744-6444 405-372-3949

D. L. MARKLEY
& Associates, Inc.
CONSULTING ENGINEERS

2104 West Moss Ave.
Peoria, Illinois 61604
(309) 673-7511
Member AFCCE

JOHN H. BATTISON PE.
CONSULTING BROADCAST ENGINEER,
FCC APPLICATIONS AM, FM, TV, LPTV

Antenna Design, Proofs, Fieldwork
2684 State Route 60 RD # 1
Londonville, OH 44842
419-994-3849

For Classified Advertising
or Professional Services information
Call Renée Hambleton at (913) 967-1732

TEKNIMAX
TELECOMMUNICATIONS

DENNIS R. CIAPURA
PRESIDENT

11385 FORESTVIEW LN
SAN DIEGO, CA 92131 (619) 695-2429

Classified

HELP WANTED

RF ENGINEERS

General Atomics, a diversified high technology research company, has openings for qualified RF engineers to work on nuclear fusion programs including the design, building and operation of power supplies and components for pulsed and CW RF systems with a frequency range of 30 to 120 MHz.

Qualifications include an EE degree (advanced degree desirable) and experience in operation and maintenance of high voltage power systems and broadcast equipment. Must be capable of troubleshooting down to component level.

General Atomics offers opportunities for professional advancement along with excellent salary and benefits. Candidates should send their resume to: Dept. 92-6, General Atomics, P.O. Box 85608, San Diego, CA 92186-9784. We are an Equal Opportunity Employer. Principals only, please.



CHIEF ENGINEER NATIONAL VIDEO DUPLICATION AND DISTRIBUTION FIRM seeking candidates with BSEE or equivalent military training and at least 5 years of direct experience in video industry. Familiarity with Ampex, VPR 80's, Fiber Optic Transmission and Digital Technology. Ability to make Hardware and Procedural Recommendations to Management Essential. Please send resume and salary history to: TAT ENGINEER PO BOX 3304, Chicago, IL 60654. 6-92-11

TRANSMITTER MAINTENANCE PERSON for UHF-TV station. Technical expertise. Hi-power. Some operations. Full time position. EOE. Send resumes to Dan Nungesser, Chief Engineer, WSEE-TV, 1220 Peach Street, Erie, PA, 16501-1899. Phone (814) 455-7575. 6-92-11

WORKING CHIEF ENGINEER for 100 KW FM and DA AM in medium Southern market. Previous DA AM experience required. Will maintain transmitters, STLS, satellite receivers, all studio equipment. Must have leadership skills and ability to interact with other staff members on a daily basis. Group owned. Excellent benefits. EOE. Send resume to Broadcast Engineering, P.O. Box 12901 Dept. 731, Overland Park, KS 66282-2901. 6-92-11

SERVICES

TRANSMITTER TUBE REBUILDING SINCE 1941: 3CX2500, 4CX5000, 4CX15000 and many others. Write for details. FREELAND PRODUCTS INC., 75412 Hwy. 25, Covington, LA 70433. (504) 893-1243 or (800) 624-7626. 1-91-tfn

Broadcast
STANDARDS CONVERSIONS

VIA STATE-OF-THE-ART, 4 FIELD,
EMMY AWARD-WINNING CONVERTER

PAL BETACAM SP • PAL 1" • S-VHS
3/4" • D-2 • HI-8 • VIDEO-8 • 1/2"

VIDEO DUPLICATION
ALL FORMATS

1-800-USA-DUB1

1 8 0 0 8 7 2 3 8 2 1

USA STUDIOS

HELP WANTED

MAINTENANCE ENGINEER Fox Television, KRIV, Houston, TX is seeking a maintenance engineer. Applicants must have at least five (5) years minimum television broadcast maintenance experience. Must be familiar with small format videotape and sony betacam format. Must have FCC license or SBE certification. Interested applicants should contact: Wendell Wyborny, VP Chief Engineer, KRIV-TV, P.O. Box 22810, Houston, TX 77227 E.O.E. 5-92-21

TRANSMITTER/STUDIO MAINTENANCE: Self motivated person to be responsible for UHF Channel 32 transmitter maintenance and some studio maintenance. Send or FAX resume to WLKY-TV, P.O. Box 6205, Louisville, KY 40206. FAX 502/897-2384. E.O.E. 6-92-11

Classified advertising now available as Classified Display or By-the-word.

Classified Display: \$112 per column inch, per insertion, with frequency discounts available. 1 inch minimum, 10 inches maximum per ad. Blind ads \$40 additional. Reader Service number \$50 additional. Spot color available for \$150 (color determined by publisher).

By-The-Word: \$1.75 per word, per insertion. Initials and abbreviations count as full words. Blind ads \$40 additional. Minimum charge \$40 per insertion. No agency discounts allowed for classified ads.

Contact Renée Hambleton, at (913) 967-1732, for information on frequency and pre-payment discounts. To place your classified ad send your order and materials to Broadcast Engineering, Classified Ad Mgr., P.O. Box 12901, Overland Park, KS 66212-2215.

TRAINING

FCC GENERAL CLASS LICENSE. Cassette recorded lessons with seminars in Washington, Newark, Philadelphia. Bob Johnson Telecommunications, Phone (213) 379-4461. 5-92-11fn

FOR SALE

LINEAR CIRCUITS. Custom designed U.S. Pat. Design Award (614) 898-9120. 3-92-4t

Mobile Production Truck. 1986 Shook Electronics custom 24 ft. production truck. Rack and road ready — \$105,000. 817-238-2000 Mark or Pat. 6-92-11

HELP WANTED

THE BUREAU OF BROADCASTING A CHALLENGE IN INTERNATIONAL ENGINEERING

The Bureau of Broadcasting, Voice of America, an International Broadcasting Service of the U.S. government, is part of the U.S. Information Agency. VOA broadcast news, commentaries and features in over 45 languages to more than 130 million people worldwide daily. As we operate and expand our broadcast facilities we have a need for:

FOREIGN SERVICE OVERSEAS SPECIALISTS, Radio Engineers with knowledge and experience in management and operation of a radio broadcasting facility with HF or MW transmitters; and Technical Monitors with experience in statistical and analytical monitoring procedures. Applicants must be worldwide available, must pass medical and security clearance requirements and the Board of Examiners for the Foreign Service oral examinations.

DOMESTIC POSITIONS—Antenna Engineers (BSEE degree required) with extensive knowledge of and experience in computer modeling of wire antennas. Candidate will be expected to conduct design and analysis of complex high power HF curtain arrays and MF directional antenna systems employing computer modeling techniques; and, Electronic Technicians with experience in operation and maintenance of HF radio broadcast and telecommunications transmitters and all ancillary electronic and subsystems. VOA continually recruits Radio Broadcast and Maintenance Technicians for the Washington DC studios.

The Bureau of Broadcasting offers competitive compensation, excellent benefits, and the opportunity for foreign travel. If you would like an opportunity to be a part of America's Public Diplomacy while advancing your professional career, we invite you to send your resume or SF-171 to:

The Bureau of Broadcasting
Office of Personnel,
Room 1543, ATTN: JC-RO
330 Independence Avenue, SW
Washington DC 20547

US CITIZENSHIP IS REQUIRED
**THE BUREAU OF BROADCASTING IS
AN EQUAL OPPORTUNITY EMPLOYER**

EQUIPMENT WANTED

WANTED: USED VIDEO EQUIPMENT. Systems or components. **PRO VIDEO & FILM EQUIPMENT GROUP:** the largest USED equipment dealer in the U.S.A. (214) 869-0011. 4-91-tfn

FOR SALE

COPPER - For Construction. Strap, screen, #10 wire. 800-622-0022. 9-91-8t

MUST SELL Dorroughs Model 1200 Signal Test Set. \$1,000.00 or best offer! Hollis Halford @ 615-244-9305 or 615-646-5091 6-92-11t

Classified

FOR SALE

FOR SALE

FOR SALE

CAPACITORS OVERNIGHT

- Power Supply—computer grade: up to 450VDC
- Transmitting - MICA — Sangamo, Cornell-Dubilier
- Oil Filled — Non-PCB Oval, Rectangular

Relays • Filters • Transistors
Any Parts starting with 1N or 2N

1-800-323-0460 FAX 1-802-425-3664

Kellner Electronics, Inc., Charlotte, VT 05445

Use BE
classified ads

SUMMER SAVINGS BONANZA

In stock, late-model, used broadcast equipment to ease your budget

VIDEO

BETA & BETA-SP

SONY BVW-10 from \$5,000
SONY BVW-40 from \$9,000
SONY BVW-70 from \$18,500

C-FORMAT

SONY BVH-3100 from \$26,000

U-MATIC

SONY BVU-800 w-TC from \$3,500
SONY BVU-850 w-TC from \$6,800
SONY VO-7020 from \$900

DPM & GRAPHICS

ADO 1000 - 2 Chnl. A53 warp
HARRIS lns - still store
AURORA 220, 240, 280

MICOR VIDEO EQUIPMENT

5545 N. Clark Street, Chicago, Illinois 60640-1222
312-334-4300 Telex 910-240-9449 Fax 312-334-4385

SWITCHERS

GVG 100-N from \$8,000
AMPEX Vista 18N for \$25,000

EDITORS

SONY BVE-600 w/sxr from \$4,000
SONY BVE-900 & 910 from \$4,900
SONY BVE-9000 from \$12,000

TERMINAL

GVG 9505, 9510 & 9520
Sync. Gen.
BTS 350 Video DAs
LEITCH Video DAS & ADC
PPV 11 D-Time
TROMPETER Normal Thru
SWITCHCRAFT Audio Patch
BOSCH 40x40 Router

CHARACTER GENERATORS

CHYRON VP-2, 4100EX, 4200, Super
Scribe
CHYRON Infiniti Third Channel, Advance
Font, Create, Logo Compose, 300MB
Hard Drive, and more for \$48,000

*BETACART SP
Loaded \$135,000*

Monitors, Lighting, Audio, Plus much more!!

312-334-4300

Advertising sales offices

NEW YORK, NEW YORK

Gordon & Associates
210 President Street
Brooklyn, NY 11231
Telephone: (718) 802-0488
Telefax: (718) 522-4751

Joanne Melton

Telephone: (212) 332-0628
Telefax: (212) 332-0663

888 7th Avenue, 38th Floor
New York, NY 10106

CHICAGO, ILLINOIS

Vytas Urbonas

Telephone: (312) 435-2361

Telefax: (312) 922-1408

55 East Jackson, Suite 1100
Chicago, IL 60604

SANTA MONICA, CALIFORNIA

Herbert A. Schiff

Telephone: (310) 393-9285

Jason Perlman

Telephone: (310) 458-9987

Kelly Daugherty

Telephone: (310) 451-8695

Schiff & Associates

501 Santa Monica Blvd, Ste. 401.

Santa Monica, CA 90401

Telefax: (310) 393-2381

OXFORD, ENGLAND

Richard Woolley

Intertec Publishing Corp.

Unit 3, Farm Business Centre

Clifton Road, Deddington

Oxford OX15 4TP, England

Telephone: (0869) 38794

Telefax: (0869) 38040

Telex: 837469 BES G

TOKYO, JAPAN

Mashy Yoshikawa

Orient Echo, Inc.

1101 Grand Maison

Shimomiyabi-Cho 2-18

Shinjuku-ku, Tokyo 162, Japan

Telephone: (03) 235-5961

Fax: (03) 235-5852

Telex: J-33376 MYORIENT

FREWVILLE, SOUTH AUSTRALIA

John Williamson

Hastwell, Williamson, Rep. Pty. Ltd.

109 Conyngham Street, Frewville 5063

South Australia

Phone: 799-522 FAX: 08 79 9522

Telex: AA87113 HANDM

CLASSIFIED ADVERTISING

OVERLAND PARK, KANSAS

Renée Hambleton

P.O. Box 12901, Overland Park, KS 66282

913-967-1732

RS422 VTR REMOTE CONTROL

SONY, AMPEX, JVC
PANASONIC, HITACHI
Low Cost - Lots of Features
DNF INDUSTRIES (213) 650-5256
1032 N. Sweetzer Avenue, #212
LA, CA 90069

COMPONENT MOD KIT

For Sony 8020 and 8021. Either RGB, Y/R-Y
or B-Y monitoring in the field from a BVW
35, BVW 25 or camera. Fits inside monitor.
\$450.00 - installed price.

Please call FINER ASSOCIATES at
(617) 923-3553 for more information
or to set up an appointment.

TUBES 4CX3000A, 833A, 4-1000A, 4CX10000D, and more.
We carry large inventory, all major brands (EIMAC, AMPEX,
REX, RCA) Call Stew 1-800-842-1489. 1-91-tfn

AS A PACKAGE: SONY BVP 70 IS CAMERA, CA-3A (With
Anton Bauer goldmount bracket), Fujinon 14 x 8.5 lens,
Fujinon remote zoom control/pistol grip (SRD-52), BVW-35
VTR, CCZ-10 cable, Sachtler video 20 tripod head w/carbon
fiber medium legs, Nalpak hard case for Sachtler tripod,
Sachtler lightweight spreader, Thermodyne camera
case, all excellent condition. Best offer. (415) 243-8880.
6-92-11

CALL US

For New and Rebuilt
Radio Broadcast Equipment

HE HALL
Electronics

(804) 974-6466

1305-F Seminole Trail • Charlottesville, Va. 22901

Circle (93) on Reply Card

-NEW- COLOR BARS, BLACK SYNC \$379

The CSG-50 from HORITA generates both
SMPTF or full-field color-bars or black-burst,
and composite sync signals. Built-in timer
switches from color bars to black after 30
or 60 seconds. Full RS-170A spec. Genlock
your system, laydown color-bars and black.
Decktop and rackmount versions. UNCON-
DITIONAL GUARANTEE. Contact your local
video dealer or

HORITA - P.O. Box 3993
Mission Viejo CA 92690 (714) 489-0240

BROADCAST EQUIPMENT RESALE NETWORK

A VAST SELECTION OF ITEMS LISTED
MANUFACTURER & DEALER DEMO UNITS

MULTIPLE LIQUIDATIONS & CLEARANCES
NOW IS THE TIME TO BUY!!

BROADCAST BULLETIN BOARD SERVICE

INSTANT PRICING AND AVAILABILITY
24 HOURS A DAY!!!

CALL (708)670-7790

• 16 ft. to 33 ft. used Mobile Television Trucks
(Call St. Louis Office) • New Vehicles ranging from
14 ft. cubes to 48 ft. expandos available through
Provid Supply per customer specifications. • SP
Betacam to D2 A/B Roll system—\$172,500 • Many
Fully-Consolidated BVH-1100A's with low hours-Blow
Out! • Betacam-BVW-35—\$7,500; BVW-5—\$7,900;
BVW-10's—\$5,995 • Chyron Scribe character
generator—Loaded for \$18,000 • Sony BVH-2500—
\$24,500; BVH-2000—\$22,000 • Sony BVU-870
SP3/4" w/DT—\$12,500; VO-5850's from \$3,000 •
Hitachi FP-C10/Sony VO-8800/Miller System 20
package (New)3-CCD camera w/12x Zoom, SP U-
Matic portable (used) and (New) fluid head/tripod—
\$10,650 • Hitachi Z-one B/Sony BVW-35/Miller Sys-
tem 20 package (New) 3-CCD camera w/15x
Zoom, microphone, battery, charger, AC, SP Beta-
cam portable (used) with AC/charger & 2 batter-
ies, Portabrace case and (New) Miller fluid head,
tripod and hard case package—\$19,995 less Provid
Rebate of \$250 means you can buy this for \$19,745

Provid/Hitachi Special—\$2,800 Rebate

for your used 3-tube camera trade-in

when you buy a Z-one-B

\$2,000 Rebate for your used 3-tube camera trade-in
when you buy a FP-C10. Call for details

PROVID SUPPLY CORP.

Chicago-(708) 670-PROS

ST. LOUIS (314) 469-7297

TAMPA (813) 789-1285

GENLOCK YOUR SYSTEM BLACK-BURST, SYNC, AUDIO TONE \$289

Need to genlock your video system? The
BSG-50 from HORITA generates black-burst,
composite sync, and a 1-KHZ audio tone.
Provides 6 separate outputs of any mix of
up to 4 each of RS-170A black or sync. Also
provides subcarrier, blanking, drive. UN-
CONDITIONAL GUARANTEE. Contact your
local video dealer or

HORITA - P.O. Box 3993,
Mission Viejo CA 92690 (714) 489-0240

Ad Index

	Page Number	Reader Service Number	Advertiser Hotline		Page Number	Reader Service Number	Advertiser Hotline
Abekas Video Systems	41,43	20,23	415-369-5111	Leitch Video International	42,109	21,59	800-231-9673
ADC/American Lightwave	95	48	203-630-5771	Logitek	123	67	713-782-4592
ADC Telecommunications	35	16	800-726-4266	Louth Automation	55,132	28,78	415-329-9498
Ampex (AVSD)	52-53	27	800-25AMPEX	Macrovision	72-73	37	415-691-2909
Ampex Recording Media	19	11	415-367-3809	Matco	132	77	408-998-1655
Antenna Concepts	40	65		Maxell Corp. of America	61	31	800-533-2836
Apogee Electronics	36	19	310-399-2991	Mohawk Wire & Cable Corp.	126	83	508-537-9961
Audio Accessories, Inc.	130	73	603-446-3335	Moseley Associates, Inc.	87	44	805-968-9621
Audio Precision	13	8	800-231-7350	Nesbit Systems	116	81	609-799-5071
Auditronics, Inc.	63	32	901-362-1350	Newton Instrument Co., Inc.	115	80	919-575-6426
Barco Inc.	3	3	404-590-7900	Nikon Electronics Imaging	5	4	800-NIKONUS
Belar Electronics Laboratory	114	71	215-687-5550	Odetics, Inc.	9	6	800-243-2001
Bird Electronics Corp.	96	51	216-248-1200	Opamp Labs, Inc.	48	84	213-934-3566
Broadcast Video Systems Ltd.	114	70	416-764-1584	Orban, Div. of AKG Acoustics	7,17	5,10	510-351-3500
BTS Broadcast TV Systems	93	47	800-962-4BTS	Otari Corp.	68-69	35	415-341-5900
Burle Industries	89	45	717-295-6123	Panasonic	37,38-39,84-85,104-105	57	800-524-0864
Canare Cable, Inc.	119	64	818-365-2446	Pesa America	IFC-1	1	205-880-0795
Canon USA Broadcast Lens	49	25	201-816-2900	Philips Components	71	36	800-447-3762
Channelmatic	131	74	619-445-2691	Pinnacle Systems Inc.	77	39	408-970-9787
Christie Electric Corp.	117	61	213-715-1402	Pioneer RVR Division	BC	2	
Chronrol	117	62	619-566-5656	Radiation Systems	131	75	708-298-9420
Clear-Com Intercom Systems	51	26	510-527-6666	Ross Video Ltd.	91	46	613-652-4886
Cole Wire & Cable Co.	32	18	708-673-2210	Sanix Corporation	129	72	708-677-3000
Comark Communications, Inc.	81	41	800-688-3669	Sennheiser Electronics Corp.	119	63	203-434-9190
Computer Assisted Technology	121	69	212-687-BCAM	Sharp Copier Division	97	52	
Continental Electronics	45	22	214-381-7161	Shure	56-57	29	800-25SHURE
Datek, Inc.	23	43	800-882-9100	Sierra Automated Systems	121	68	818-840-6749
DPS	98	53	416-754-8090	Sierra Video Systems	88	82	916-273-9331
Dolby Labs Inc.	34	15	415-558-0200	Sony Business & Professional Group	31,32A-D		800-635-SONY
Dynair Electronics, Inc.	107	58	800-854-2831	Sony Pro Video Tape	28-29		800-635-SONY
EEV, Inc.	83	42	800-DIALEEV	Tascam	75	38	213-726-0303
Electro-Voice	79	40	616-695-6831	Thomson Broadcast	101	55	800-882-1824
Fujinon Inc.	47	24	201-633-5600	Total Spectrum Mfg., Inc.	21	12	914-268-0100
Hall Electronics	135	93	804-974-6466	Television Technology Corp.	15	9	303-665-8000
Harris Allied Systems	27	14	217-222-8290	Utah Scientific	59	30	800-453-8782
illbruck	115	79	800-662-0032	Videotek, Inc.	IBC		800-800-5719
Jampro Antennas, Inc.	26	13	916-383-1177	The Winsted Corporation	32,132	17,76	800-447-2257
Japan Electronics Show Assoc.	99	54		Yamaha International Corp.	67	34	800-395-1313
JVC Professional Products Co.	65	33	800-JVC-5825	Zero Stantron Enclosures	96	49,50	800-821-0019
Laird Telemedia	103	56	801-972-5900	3M Pro Audio/Video Products	11	7	612-733-1959
Lakeside Associates	123	66	714-770-6601	360 Systems	46	60	818-342-3127

Total Recall.



More Memory Is Only One Reason Our 18-Input Switcher Is So Unforgettable.

With a 100-event memory — much more than any other switcher its size — our new PDG-418 has all the features of our popular Prodigy™ Plus lots more that you told us you wanted. Like a downstream keyer that can either be linked to the multi-level effects transition system or operated separately. An optional border generator for the downstream keyer. A key loop that allows key bus cut and fill to be looped through an external effects processor. Even a clean feed/third program video output that bypasses the downstream keyer and blanking processor. All of which makes our PDG-418 the best value around in a compact, affordable switcher. Call us today to find out more about the new PDG-418. Another American-made innovation from Videotek.

 **VIDEOTEK™**
First, we listen.

243 Shoemaker Road, Pottstown, PA 19464 1 (800) 800-5719 (215) 327-2292 Fax: (215) 327-9295

Prodigy is a trademark of Prodigy Services Company.

INTRODUCING THE MOST IMPORTANT ADVANCE IN VIDEO PRODUCTION SINCE VIDEOTAPE.



THE PIONEER REWRITABLE VIDEODISC RECORDER WITH INSTANT ACCESS.

The Pioneer Rewritable Videodisc Recorder can revolutionize the way you do video production.

Through laser technology, the VDR-V1000 provides the world's fastest, most accurate broadcast-quality editing plus the greatest media reliability available.

It offers near instant non-linear

access and the most precise frame-by-frame editing in a recording device. Gone are the typical editing problems associated with shuttling, jogging, and pre-roll.

The VDR-V1000's unique, dual-

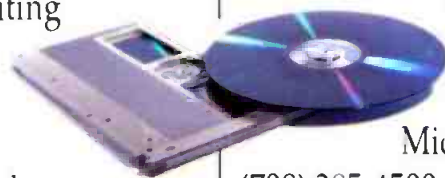

head system gives you real-time non-linear playback. You get a perfectly clean edit every time. You can erase and record simultaneously. No pre-roll or post-roll is necessary.

There's no head contact with the media. Discs can be erased and re-recorded over one million times — the quality of the millionth recording is the same as the first. Discs contain up to 57,600 still frames, or 32 minutes of full motion video.

The VDR-V1000 can record audio and video simultaneously or separately, so you can dub PCM stereo audio onto video. Control is available through RS-422A or RS-232C ports. It can read and write SMPTE time code, and transmit signals compatible with component, composite or RGB formats.

With so much going for it, the VDR-V1000 leaves only one question unanswered: What are you waiting for?

For more information or a demo, contact in the East:

Linda Toleno at (201) 327-6400, in the

Midwest: Chris Boldt at

(708) 285-4500, and in the West:

Bill Blair at (310) 492-9935.

 **PIONEER**
Pioneer Communications of America, Inc.

Circle (2) on Reply Card