

BROADCAST[®] ENGINEERING

AN INTERTEC PUBLICATION

September 1988/\$3

Audio-video control systems

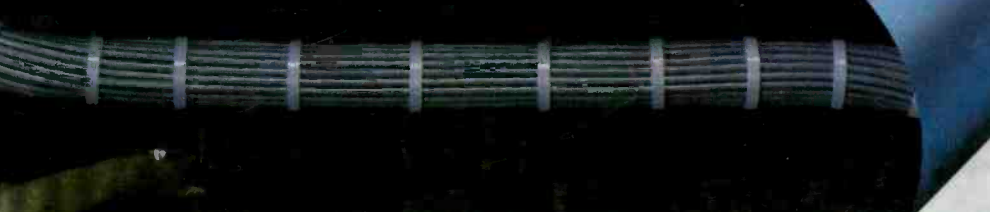
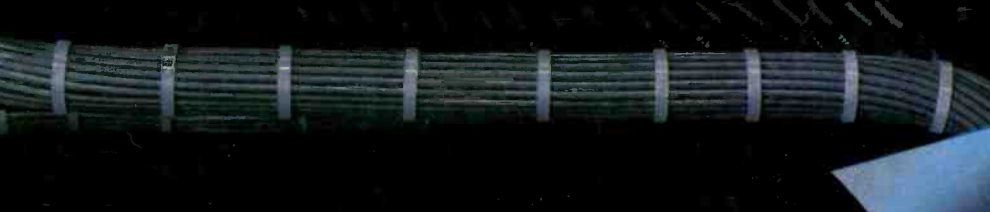
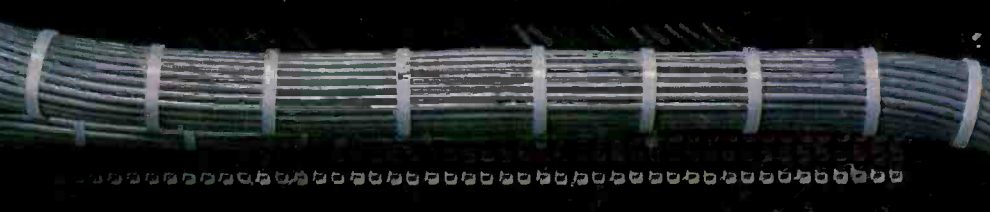
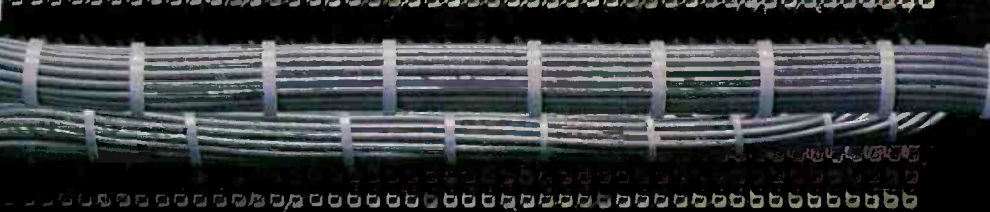
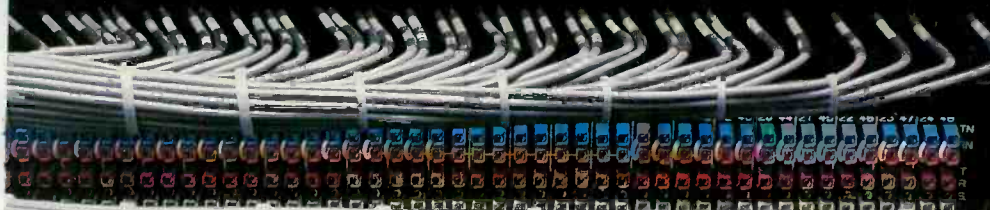

Satellite
uplinking
p. 52

Regardless of their
politics, Americans believe
in giving each candidate the
right to be heard.

So Democrats
in Atlanta and Republicans
in New Orleans agreed
on the same name.

Shure.

It's no coincidence that when the world
is listening, professionals insist on the
sound quality and reliability of Shure.

For years, Shure circuitry products and
microphones have been a key part of national
political conventions, and other major events
from the Grammy Awards... to the Olympics.

Providing reliable Shure products is impor-
tant to us, because performance on your job is so
important to you.

For a free copy of our new catalog containing
specs on our full line of professional microphones,
circuitry products and automatic microphone systems, mail the
coupon today. Or call 1-800-257-4873. (In Illinois, 1-800-624-8522).

Photo: SM57 Microphones at 1988 Democratic Convention.

Circle (1) on Reply Card



Yes, please send the new Shure Professional
Microphone/Circuitry Products Catalog.

Name _____

Title _____

Company _____

Address _____

City, State, Zip _____

Telephone (____) _____

BE 9/88

SHURE[®]

The Sound Of The Professionals... Worldwide.

222 Hartrey Avenue, Evanston, IL 60202-3696

the **SOURCE**

Midwest Links Fox Network to the World



Why did management at KTTV, flagship station for the FOX broadcasting network in L.A., go to Midwest Communications for their new S-23?

Because Midwest is number one, worldwide, in mobile satellite communications design and integration. The results were outstanding!

"With our Midwest built mobile satellite communications truck, we no longer have any limitations to our coverage area. That is very important to a news station in the L.A. market. It is also important that Midwest brought the truck in on time and in budget."

Bob Morse,
VP/General Manager KTTV

Steve Blue, KTTV News Director, continues:

"The *Spacelink* gives Fox News an advantage our competition can't top... Midwest was prompt with delivery and prompt with support."

Make Midwest the Source for all your mobile satellite communications needs. For more information on the S-23, contact your Midwest representative today.



KTTV VP/Director of Broadcast Operations, Steven H. Steinberg, sums it all up with this comment:

"This is the second S-23 that I have purchased from Midwest. It is not often I can say this, but in both cases, there were no problems."

M
MIDWEST
Communications Corp.

One Sperti Drive/Edgewood, KY USA 41017
(606) 331-8990

Circle (3) on Reply Card

Contents

September 1988 • Volume 30 • Number 9

BROADCAST engineering

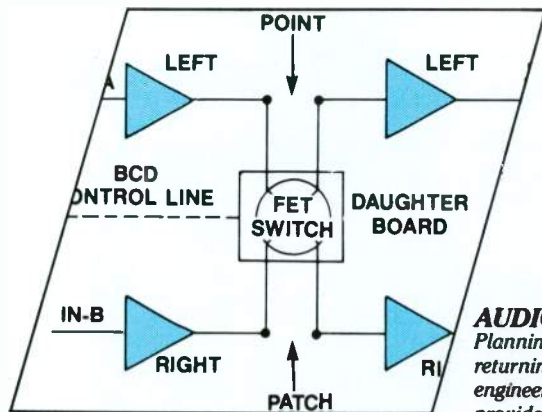

Page 40

AUDIO-VIDEO CONTROL SYSTEMS

Planning for a new radio or TV facility is not an easy task. By returning to the basics of wiring and signal distribution, engineering management can help ensure that new facility designs provide room for growth and advancements in technology. Our report on audio-video control systems examines some of the fundamentals of facility design in the following topics:

26 Wiring an Audio-Video Facility

By Tony Mitchell, Centro, Salt Lake City

Proper planning can make the difference between heyday and havoc.

40 Distributing Audio-Video Signals

By Richard Maddox, technical writer, Lynnwood, MA

Begin planning now for your future audio and video distribution system.

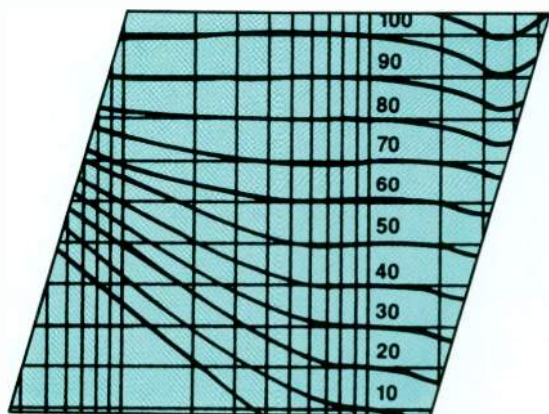

Page 46

OTHER FEATURES:

46 The Science of Close-Field Monitors

By John Eargle, JME Consulting Corporation, Los Angeles

Your product is reaching thousands of ears right now. Do you really know how it sounds?

52 Broadcast Satellites: Making Connections

By Rick Lehtinen, TV technical editor

A new era of satellite technology is on the horizon.

70 Translator System Planning and Installation

By Richard Maddox, technical writer, Lynnwood, MA

FM and TV translators and boosters may help your station regain "hidden" audiences.

90 Inside Fiber Optics

By Robert Griffiths, Telemet, Amityville, NY

People have communicated via light for centuries. Today's fiber-optic technology is sending some powerful messages.

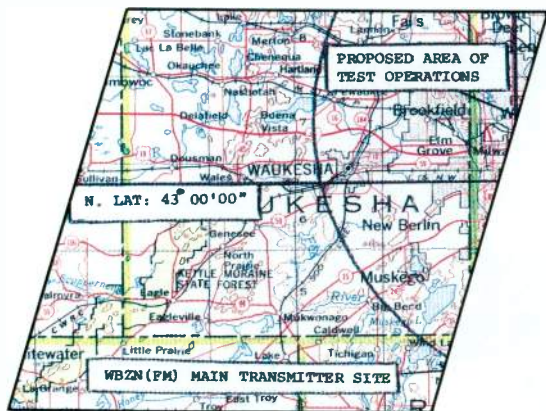

Page 70

ON THE COVER

Key to the design of any technical plant is the distribution of audio, video and control signals. Our cover this month illustrates the heart of such a distribution system, the patchbay. (Photo courtesy of Centro, Salt Lake City.)

DEPARTMENTS

4 News	104 Show Preview: SBE
6 Editorial	110 Show Preview: SMPTE
8 FCC Update	116 Applied Technology: Designing facilities for D-1/D-2
10 Strictly TV	126 Station-to-Station
12 re: Radio	130 Field Report: Etron programs
14 Satellite Technology	142 SBE Update
16 Circuits	152 People
18 Troubleshooting	154 Business
20 Management for Engineers	158 New Products

Hardtop or Convertible



C1



C2

Choose a CCD camera that's right for what you want because there's no reason to pay for more than you need.

The Hitachi FP-C1 3-chip auto set-up camera is a rugged workhorse when you need a stand-alone model with high resolution and high sensitivity that's easy to operate.

The FP-C2 dockable version gives you the added versatility of owning one camera for all formats. Our multi-standard, switchable encoder provides outputs for Beta, MII and S-VHS.

Both incorporate the latest chip technology to give you unparalleled picture performance. Call your local Hitachi dealer or the regional office nearest you for specs and a demonstration.

 **Hitachi Denshi America**

175 Crossways Park West
Woodbury, NY 11797

Circle (4) on Reply Card

New York
516-921-7200

Atlanta
404-451-9453

Chicago
312-250-8050

Dallas
214-233-7623

Los Angeles
213-328-6116

About that cover

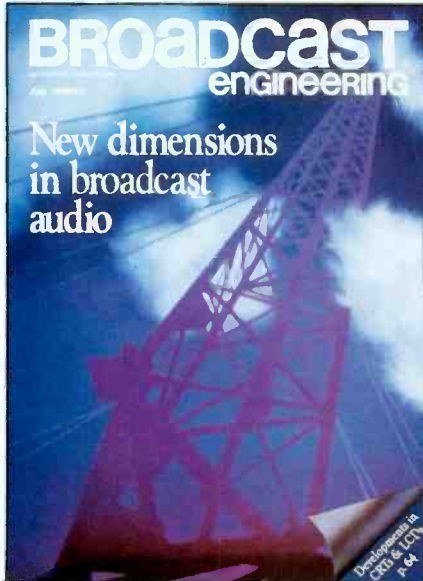

The cover illustration for the July issue

was incorrectly attributed. The design was created by Lanny Whitaker of The Weather Channel, Atlanta. He used an Aurora 280 paint system to generate the image.

Pro audio show for Asia region

The Business and Industrial Trade Fairs Group of Hong Kong has announced its intention to sponsor a new trade show aimed at the Far East/Pacific Basin pro audio marketplace. The trade show, "Pro Audio Asia '89" (the international trade exhibition for professionals in the broadcast, recording, public address, contracting, installation and duplicating industries), will take place at the Hong Kong Convention Center, July 6-8, 1989. The show aims to attract professionals from all facets of the pro audio industry. Attendees are expected to come from as far away as India, Japan, New Zealand and Australia, as well as from all of Hong Kong's neighboring

countries.

For further details, contact fax 818-709-6773 (North America) or fax 0869-38040 (England and Europe).

University of Wisconsin to sponsor seminar

The 34th annual technical conference at Madison, WI, will be held Oct. 18-20. The conference name was changed from the "FM Clinic," to better reflect the changing communication industry and converging technologies.

The 3-day seminar will host presentations covering many broadcast technologies. Current topics to be covered include an update on FMX and HDTV; analysis of FM multipath; CCD technology; technical and financial benefits of solid-state VHF transmitters; fiber optics for broadcast and CODEC applications; D-2 digital tape recording; and 14 other broadcast-related issues.

Continued on page 140

BROADCAST engineering

Editorial and advertising correspondence should be addressed to: P.O. Box 12901, Overland Park, KS 66212-9981 (a suburb of Kansas City, MO); (913) 888-4664. Telex: 42-4156 Intertec OLPK. Circulation correspondence should be sent to the above address, under P.O. Box 12937. RAPIDFAX: 913-888-7243.

EDITORIAL

Jerry Whitaker, *Editorial Director*
 Brad Dick, *Radio Technical Editor*
 Carl Bentz, *Technical and Special Products Editor*
 Rick Lehtinen, *TV Technical Editor*
 Paula Janicke, *Staff Editor*
 Dawn Hightower, *Associate Editor*
 Tom Cook, *Senior Managing Editor*
 Maura Base, *Editorial Assistant*
 Kathy Mickelson, *Editorial Assistant*
 Pat Blanton, *Directory Editor*

ART

Kristi Sherman, *Graphic Designer*

EDITORIAL CONSULTANTS

Fred Ampel, *Audio*
 Nils Conrad Persson, *Electronics*
 Ned Soseman, *Video*
 Michael Heiss, *Consulting Editor*
 Don McCroskey, *Consulting Editor*

BUSINESS

Cameron Bishop, *Group Vice President*
 Duane Hefner, *Publisher*
 Stephanie Hanaway, *Promotions Manager*
 Cynthia Sedler, *Promotions Coordinator*
 Dee Unger, *Advertising Business Manager*
 Mary Birnbaum, *Advertising Coordinator*

ADMINISTRATION

R.J. Hancock, *President*
 Doug Riemer, *Circulation Vice President*
 Jane J. Powell, *Circulation Director*
 JoAnn DeSmet, *Circulation Fulfillment*
 Barbara Clare, *Reader Correspondence*
 Kevin Callahan, *Creative Director*

TECHNICAL CONSULTANTS

Eric Neil Angevine, *Broadcast Acoustics*
 John H. Battison, *Antennas/Radiation*
 Blair Benson, *TV Technology*
 Dennis Ciapura, *Radio Technology*
 Dane E. Ericksen, *Systems Design*
 Howard T. Head, *Washington Correspondent*
 Wallace Johnson, *FCC/Bdct. Engineering*
 John Kean, *Subcarrier Technology*
 Donald L. Markley, *Transmission Facilities*
 Harry C. Martin, *Legal*
 Robert J. Nissen, *Studio/Communications*
 Hugh R. Paul, *International Engineering*
 Art Schneider, *A.C.E., Post-production*
 Elmer Smalling III, *Cable/Satellite Systems*
 Vincent Wasilewski, *Communications Law*

MEMBER ORGANIZATIONS

SUSTAINING MEMBERS OF:

- Acoustical Society of America
- Society of Broadcast Engineers
- Society of Motion Picture and TV Engineers

Member,
 Association of Business Publishers



Member,
 Business Publications
 Audit of Circulation



BROADCAST ENGINEERING is edited for corporate management, engineers/technicians and other station management personnel at commercial and educational radio and TV stations, teleproduction studios, recording studios, CATV and CCTV facilities and government agencies. Qualified persons include consulting engineers and dealers/distributors of broadcast equipment.

BROADCAST ENGINEERING (ISSN 0007-1794) is published monthly (except in the fall, when two issues are published) and mailed free to qualified persons within the United States and Canada in occupations described here by Intertec Publishing Corporation, 9221 Quivira Road, Overland Park, KS 66215. Second-class postage paid at Shawnee Mission, KS, and additional mailing offices. POSTMASTER: Send address changes to **Broadcast Engineering**, P.O. Box 12960, Overland Park, KS 66212.

SUBSCRIPTIONS: Non-qualified persons may subscribe at the following rates: United States and Canada; one year, \$25.00. Qualified and non-qualified persons in all other countries; one year, \$30.00 (surface mail); \$108.00 (air mail). Back issue rates, \$5.00, except for the Buyers' Guide/Spec Book, which is \$20.00. Rates include postage. Adjustments necessitated by subscription termination at single copy rate. Allow 6-8 weeks for new subscriptions or for change of address.

Photocopy rights: Permission to photocopy for internal or personal use is granted by Intertec Publishing Corporation for libraries and others registered with Copyright Clearance Center (CCC), provided the base fee of \$2.00 per copy of article is paid directly to CCC, 21 Congress St., Salem, MA 01970. Special requests should be addressed to Cameron Bishop, group vice president. ISSN 0007-1794 \$2.00 + \$0.00.

© 1988. All rights reserved.

Advertising offices listed on page 175.

INTERTEC
 PUBLISHING CORPORATION

LEADER

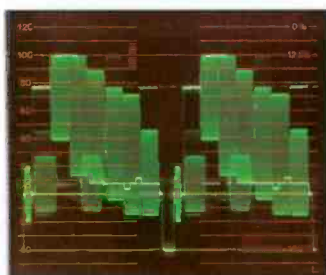

THREE.



IN ONE.

And only in the 5870 Vector/Waveform Monitor.

Only the 5870 gives you a unique numerical readout of SCH phase. And waveforms from 2 channels, plus vector information - appearing at the same time or separately. All this in one half-rack!

No compromises.

This unsurpassed unit performs like three superb instruments in one.

2-channel NTSC waveform monitor: Features simultaneous or separate display of both channels, and dual filter display, plus a CRT readout of SCH phase, full 525-line select capability with a CRT readout of the line and field selected, memory

preset and recall of nine lines. Add to this the unit's remote control capability and extra-bright CRT, and you have a terrific waveform monitor.

Full-fledged NTSC vectorscope: Boxes for error limits of $\pm 2.5^\circ$ and ± 2.5 IRE units; $\pm 1^\circ$ differential phase and $\pm 1\%$ differential gain; internal Z-axis blanking for line selection and continuous phase adjustment. The 5870 is a great vectorscope, too!

Designed to go anywhere.

Operating from any 11-20 Vdc or 85-264 Vac (48-440 Hz) power source, this 12-lb, half-rack unit is ideal anywhere that size and weight are critical.

Call toll-free
1 800 645-5104

In NY State
516 231-6900

Ask for our full-line Catalog, an evaluation unit, and the address of your nearest Leader Distributor.

Leader Instruments Corporation
380 Oser Avenue, Hauppauge, New York 11788
Regional Offices:
Chicago, Dallas, Los Angeles, Boston, Atlanta
In Canada call Omnitronix Ltd. 416 828-6221

LEADER
FOR PROFESSIONALS WHO KNOW
THE DIFFERENCE

For Product Demonstration Circle (5) on Reply Card

For Product Information Circle (6) on Reply Card

Orban Stereo Television.

Experience and Support.

Outstanding Performance.

Reasonable Price. Fast Delivery.

Orban's experience — more stations are on the air in stereo with Orban TV Stereo Generators than all other makes combined!

The Orban 8185A second-generation TV Stereo Generator has *performance* specs and features that meet or exceed those of every other generator on the market in *all* significant parameters.

And *installation and setup* can't be easier — typical setup time is less than one hour! You'll need your RF Spectrum Analyzer, composite demod, audio oscillator, and oscilloscope. Nothing else.

The Orban 8182A OPTIMOD-TV® Audio Processor — the standard of the industry for both stereo and mono. It's used by more than 80% of the stereo TV stations because it sounds better than other choices — even where another make of stereo generator is installed.

OPTIMOD-TV provides complete audio processing to give your station a natural and pleasant sound that is easy to listen to. And users tell us that our Automatic Loudness Controller eliminates viewer complaints of excessively loud commercials.

The Orban 275A Automatic Stereo Synthesizer makes your station "all stereo" when desired. Its remote control interface permits you to easily and automatically put the 275A into "bypass mode" for stereo program feeds. For operational convenience, the 275A's automatic

recognition circuit will direct the unit to synthesize mono audio and to pass stereo through unchanged. And the Auto Polarity Corrector will ensure that you'll never transmit out-of-phase stereo audio to your mono receivers.

Ready to deliver. We're ready when you are. Tell us your date. We'll meet it. We have units ready to deliver almost anytime.

A word about transmitter interfacing. In the early days of TV stereo, there was much concern about transmitter plants needing complex modification to adequately pass stereo.

Experience has proven otherwise. Most exciters can be easily modified to accept a composite input. With no further modifications, the resulting transmission usually meets BTSC stereo specifications. (You may need a more careful evaluation if you need SAP and/or PRO.) Further improvements can be implemented as time and budget permit.

Call us for brochures; ask questions — about TV Stereo or the Orban Stereo Television System, or to find out which Orban TV Broadcast Representative serves you.

Use our toll-free number: (800) 227-4498 (except Canada, CA, AK, HI).

orban

Orban Associates Inc.

645 Bryant Street, San Francisco, CA 94107 USA
 Telex 17-1480 FAX (415) 957-1070
Telephone (415) 957-1067 or (800) 227-4498

® OPTIMOD-TV is a registered trademark of Orban Associates Inc.

North American Representatives: CT, MA, ME, NH, NJ, NY, RI, VT: **DLE (508) 947-6801**; DC, DE, MD, Eastern PA: **Bradley Broadcast Sales (301) 948-0650**; NC, SC, VA, WV: **EME/Broadcast Services (919) 869-3335**; Southern MI, OH, Western PA: **Hy James (313) 471-0027**; IL, IN, MO: **International Broadcast Co. (314) 334-9443**; KS: **Midwest Communications Corp. (913) 469-6810**; KY, MS, IN, AR, LA: **Orban (800) 227-4498**; AL, FL, GA: **Midwest Communications Corp. (305) 592-5355**; IA, Northern MI, MN, NE, ND, SD, WI: **Todd Communications (612) 941-0556**; AZ, CO, NM, OK, TX, UT: **Dyma Engineering (800) 222-3962**; Southern CA, Southern NV: **Com Logic (818) 991-7506**; Northern CA, Northern NV: **Orban (415) 957-1067**; AK, HI, ID, MT, OR, WA, WY: **NORCOM (503) 632-7488**; Canada: **M.S.C. Electronics Ltd., Ontario & Atlantic (416) 731-9500, Quebec (514) 387-7348, Western (204) 885-5471.**

Circle (7) on Reply Card

Power boost proposed for Class A stations

By Harry C. Martin

The FCC is proposing to raise the power limit for Class A FM stations to 6,000W, which is double the current ceiling, and to create a new Class C3 in *Zone II*. (*Zone II* contains most of the land area in the United States, except for much of the Northeast and the Great Lakes regions, Puerto Rico and most of California.) By creating the new class, which would have an upper power limit of 25,000W and an effective antenna height of 100m, the commission hopes some Class A stations will be able to upgrade their facilities.

The increase in power to 6,000W is being considered to keep Class A competitive with the many newer, higher-powered stations that have gone on the air over the past few years. The commission is undecided about the details of implementing this program, but has suggested that a universal increase to 6,000W would not cause difficulties for co- or adjacent-channel stations.

The NAB has recommended that the commission consider a greater minimum distance separation between upgraded Class A stations before permitting a blanket power increase.

RKO permitted to sell stations

RKO General is being permitted to sell two stations among the 14 RKO licenses that have been in contest. Settlement agreements involving KHJ-TV, Los Angeles, and WHBQ-AM, Memphis, TN, were approved by the commission in July. The agreements will put the stations in the hands of qualified licensees, thereby avoiding further time-consuming litigation. RKO will receive only 70% of the fair market value of the stations.

RKO's status as a licensee has been in question for 23 years. KHJ-TV's license renewal was contested by Fidelity Television in 1965 and, since then, each RKO station has come under attack. In 1980, the commission determined that RKO was not qualified to be a licensee and stripped it of the license for its Boston TV station.

The issue of whether RKO should be allowed to retain any of its licenses has been under consideration since 1980. The



purpose of the July decision was to end these proceedings by permitting RKO to transfer the Memphis and Los Angeles stations through "distress sales" (at well below market value). The commission will continue to pursue the issue of RKO's basic qualifications in the remaining cases, but it is expected that the Memphis and Los Angeles decisions will set precedents for approval of similar settlements.

Commissioner Patricia Diaz Dennis dissented from the approval of the settlements, saying, "I fear the commission sends the wrong signal to station licensees—the way to avoid license revocation is to prolong proceedings until the commission loses its will to litigate further." Dennis said the renewal process should be reformed.

Telco-cable rules may relax

The commission has asked for comments on its recommendation that Congress modify the Cable Act of 1984 to permit local telephone companies (telcos) to provide cable TV service. The tentative conclusion is that the cable industry now is far less vulnerable to the market power of the telcos than it was at the time the act was drafted. In addition, the agency says that permitting the telcos to enter the market will provide greater availability of cable to residents of rural areas as well as heightened competition in all areas.

In light of the possibility of anti-competitive abuse, the commission recommended that relaxation of cross-ownership restrictions be accompanied by rules requiring separation between a monopoly telco and its competitive cable arm. These restrictions would place accounting barriers between telephone services that are funded by rate-payers and those that are not, such as cable TV services. This type of separation is intended to prevent monopoly operations from cross-subsidizing competitive ones, giving the telco a pricing edge over its cable competition.

The proposed legislative changes are meeting heavy resistance from the cable industry, which is a potent force on Capitol Hill. Approval by the U.S. District Court in Washington, DC, would be required before any of the seven regional Bell Operating

Companies (BOCs) could take advantage of the proposed deregulation.

Anti-lottery rules enforced

A station in Wisconsin was fined \$5,000 for broadcasting information about bingo games sponsored by a local American Indian tribal government. Although current law allows advertisements for state-sponsored lotteries, it does not permit the promotion of any other lottery or bingo game, no matter how worthy the cause.

Legislation has passed the House, and now is pending in the Senate, that would relax the restriction on lottery advertising. This legislation, which could be enacted as early as this fall, would permit advertising for any event that meets the approval of the state in which the event takes place. This would transfer control over permissible events from the federal to the state arena. Ads for casino gambling, however, would remain barred under the proposed statute.

Broadcast of telephone conversations

The commission has decided to retain and enforce its rules requiring a licensee to give prior notice to a party involved in a telephone call if the licensee intends to record or broadcast that conversation. A recent inquiry proceeding investigated the possibility of relaxing or deleting the rule, but the commission found that the added spontaneity afforded by such relaxation would not outweigh the loss of privacy.

Martin is a partner with the legal firm of Reddy, Begley & Martin, Washington, DC.

Editor's note: Additional information regarding FCC activities is available on CompuServe. IGO BPPFORUM

| = (: -) | | | | |

The right signal to the right place at the right time...



...at the right price.

"Price" and "Performance."

When it comes to choosing the right routing system for your application, these two words say it all.

That's why Grass Valley Group gives you an unparalleled choice of routing systems and options. You can match the right system to the right job, at a price that's right for your equipment budget, too.

Our full line of cost-effective systems brings you unmatched flexibility and clean performance you can rely on.

Choose from our versatile line of systems and options. From the

simple TEN-XL™ system for selecting monitor inputs, to the extremely compact and powerful TEN-20™ and 20-TEN™ products. Or, build on the virtually unlimited control and expandability of the HORIZON™ family — to as many as 128 inputs by 128 outputs.

For the best combination of "price" and "performance," there's only one name to know

... Grass Valley Group®

For complete details and ordering information on the full line of GVG routing systems and options, contact the Grass Valley Group office nearest you.

Grass Valley Group®

A TEKTRONIX COMPANY

THE GRASS VALLEY GROUP INC.

P.O. Box 1114, Grass Valley, CA 95945 USA
Telephone (916) 478-3000
TRT: 160432

OFFICES: New York (201) 845-7988; District of Columbia (301) 622-6313; Atlanta (404) 493-1255; Chicago (214) 264-0931; Minneapolis (612) 483-2594; Dallas/Fort Worth (817) 483-7447; Los Angeles (818) 999-2303; San Francisco (415) 968-6680; GVG International Ltd. (UK) +44-962-843939; Grass Valley Group Asia (HK) +852-3-7396632

Circle (8) on Reply Card

The definition of high definition

By Dennis R. Ciapura

The viewed difference between the 5:3 aspect ratio of advanced TV systems and the 16:9 HDTV aspect ratio is negligible. This means that HDTV and improved NTSC can be displayed on the same device. Another compatibility challenge is displaying 5:3 aspect ratio pictures on today's standard 4:3 displays. One practical solution is to allow 34- or 35-line bars at the screen top and bottom during HDTV broadcasts. Fortunately, the typical overscan in all current receivers minimizes the bar area. With 10% overscan, a 5:3 aspect ratio will result in bars of only about 2.5% of total raster height at the top and bottom. See Figure 1.

Viewed on wide-screen receivers, the black side bars accompanying standard 4:3 aspect ratio broadcasts would be far more noticeable, about 6% per side for 10% overscan. First-generation receivers should offer some overscan keyed to non-HDTV broadcasts to mitigate this effect.

High enough definition?

Even videophiles often are impressed by

Ciapura is vice president of technical operations for Noble Broadcast Group and president of TEKNIMAX Telecommunications, a San Diego-based technical management consulting firm.

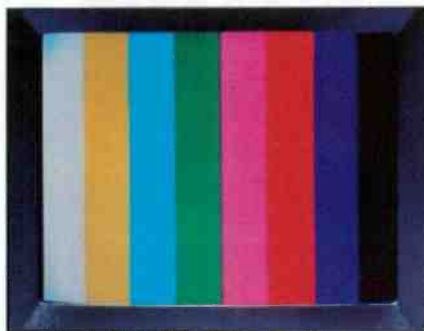

the crispness of the video seen on TV studio monitors, which is 330 lines at best. Considering Kell factor, receiver video bandwidth rolloffs and interlace inaccuracy, and assuming negligible transmission losses, few home receivers are displaying more than 250 lines. The truth is that a wide-screen version of standard NTSC displayed on a truly good NTSC receiver probably would be perceived as a major improvement by most viewers.

Is HD-NTSC the solution?

One of the most comprehensive proposals to date is the HD-NTSC system developed by CVC. Using a triple scanning process, the system triples the theoretical number of pixels generated for smart receivers able to decode the additional elements. However, because the display medium must retain the first two sets of pixels while painting the third in order to reconstruct a fully detailed image, scan time for the complete image is tripled, and temporal resolution is sacrificed. Left uncorrected, some smear appears when the image moves.

However, HD-NTSC avoids this problem by converting the parts of the image that move to a high temporal resolution format with a corresponding sacrifice of spatial

resolution. Because the eye/brain system is a poor detector of spatial resolution during motion, the HD-NTSC system optimizes its characteristics to match the scene. The HD-NTSC format is said to produce 828 pixel rows and 1,320 pixel columns. It uses digital filtering to allow full I bandwidth to improve the color resolution, and stereo digital audio along with MTS is anticipated. Overall, the video resolution provided by the system should be difficult for most viewers to distinguish from a full 1,125/60, 16:9 display, even in a side-by-side comparison.

The advanced compatible TV system (ACTV), developed by the David Sarnoff Research Center, is a similar approach in its first phase, ACTV-I. A fully NTSC-compatible signal with enhanced chroma and luminance resolution would be offered with a 5:3 aspect ratio. ACTV differs from HD-NTSC because it was designed with a second phase of improvement in mind. ACTV-II would embody a video-enhancement signal and a digital audio signal delivered on a second channel.

ACTV's approach of accommodating the 5:3 display on conventional NTSC receivers also is different from HD-NTSC. The entire screen is filled to eliminate the bars at the top and bottom, at the expense of having to transmit the extra width in side panels encoded for the side screen receivers only. If a seamless match between the main picture and the side panels could be maintained under actual operation, this method would solve many questions concerning compatibility.

Both HD-NTSC and ACTV could get wide-screen broadcast television with improved picture quality into the marketplace in time to compete with the other HDTV delivery formats. HD-NTSC appears to provide the whole spectrum of improvements in a single phase without the need for additional spectrum. However, only actual field tests will disclose whether a dynamic spatial-vs-temporal-resolution approach can provide video quality subjectively equivalent to ACTV's augmented system.

In the end, the choice of system may be far less important than the industry's ability to get behind a system and push it into reality.

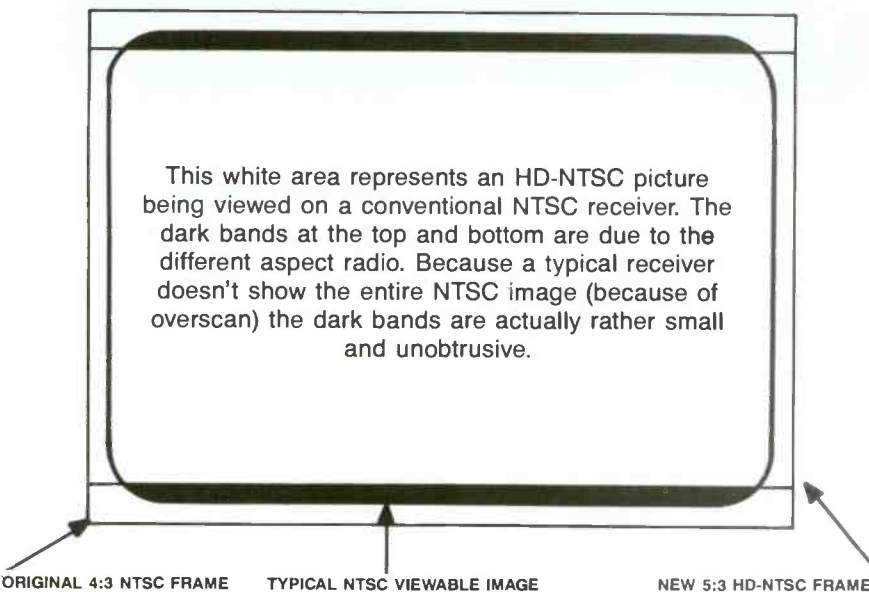

Figure 1. Typical 5:3 display on standard 4:3 NTSC receiver.



TRUTH...

OR
CONSEQUENCES.

If you haven't heard JBL's new generation of Studio Monitors, you haven't heard the "truth" about your sound.

TRUTH: A lot of monitors "color" their sound. They don't deliver truly flat response. Their technology is full of compromises. Their components are from a variety of sources, and not designed to precisely integrate with each other.

CONSEQUENCES: Bad mixes. Re-mixes. Having to "trash" an entire session. Or worst of all, no mixes because clients simply don't come back.

TRUTH: JBL eliminates these consequences by achieving a new "truth" in sound: JBL's remarkable new 4400 Series. The design, size, and materials have been specifically tailored to each monitor's function. For example, the 2-way 4406 6" Monitor is ideally designed for console or close-in listening. While the 2-way 8" 4408 is ideal for broadcast applications. The 3-way 10" 4410 Monitor captures maximum spatial detail at greater listening distances. And the 3-way 12" 4412 Monitor is mounted with a tight-cluster arrangement for close-in monitoring.

CONSEQUENCES: "Universal" monitors, those not specifically designed for a precise application or environment, invariably compromise technology, with inferior sound the result.

TRUTH: JBL's 4400 Series Studio Monitors achieve a new "truth" in sound with

an extended high frequency response that remains effortlessly smooth through the critical 3,000 to 20,000 Hz range. And even extends beyond audibility to 27 kHz, reducing phase shift within the audible band for a more open and natural sound. The 4400 Series' incomparable high end clarity is the result of JBL's use of pure titanium for its unique ribbed-dome tweeter and diamond surround, capable of withstanding forces surpassing a phenomenal 1000 G's.

CONSEQUENCES: When pushed hard, most tweeters simply fail. Transient detail blurs, and the material itself deforms and breaks down. Other materials can't take the stress, and crack under pressure.

TRUTH: The Frequency Dividing Network in each 4400 Series monitor allows optimum transitions between drivers in both amplitude and phase. The precisely calibrated reference controls let you adjust for personal preferences, room variations, and specific equalization.

CONSEQUENCES: When the interaction between drivers is not carefully orchestrated, the results can be edgy, indistinctive, or simply "false" sound.

TRUTH: All 4400 Studio Monitors feature JBL's exclusive Symmetrical Field Geometry magnetic structure, which dramatically reduces second harmonic

distortion, and is key in producing the 4400's deep, powerful, clean bass.

CONSEQUENCES: Conventional magnetic structures utilize non-symmetrical magnetic fields, which add significantly to distortion due to a nonlinear pull on the voice coil.

TRUTH: 4400 Series monitors also feature special low diffraction grill frame designs, which reduce time delay distortion. Extra-large voice coils and ultra-rigid cast frames result in both mechanical and thermal stability under heavy professional use.

CONSEQUENCES: For reasons of economics, monitors will often use stamped rather than cast frames, resulting in both mechanical distortion and power compression.

TRUTH: The JBL 4400 Studio Monitor Series captures the full dynamic range, extended high frequency, and precise character of your sound as no other monitors in the business. Experience the 4400 Series Studio Monitors at your JBL dealer's today.

CONSEQUENCES: You'll never know the "truth" until you do.



JBL Professional
8500 Balboa Boulevard
Northridge, CA 91329

Circle (9) on Reply Card

Some tips on antenna matching

By John Battison, P.E.

Many of the questions that I have been asked lately by station engineers seem to involve antenna tuning units (ATUs), or antenna matching in general. This month's column will deal with matching the antenna to the transmitter. The subject is timely because some of the newer solid-state transmitters strongly dislike even a small mismatch.

Some engineers, who have no difficulty in matching an audio load via a pad or resistance network when the loads are simply resistive, find that the inclusion of reactance (that imaginary value, j) upsets their thinking. In many cases, the mathematics associated with j values are not needed. In other cases, the imaginary component can be ignored or the application becomes much simpler than expected.

Types of networks

The principles of matching resistive loads are dealt with in many reference books, so I won't cover them here. There are three general types of matching networks: L, T and pi. The L network is so named because of its graphic resemblance to the capital letter L, when drawn either forward or reversed. The T network is probably the most useful, and the most misunderstood. The third major design is the pi network, named for its graphic resemblance to the Greek letter π .

The L networks are the workhorses of the electronics field and probably are used as much as any other type of network. An L network is simple and can easily match 5Ω to 50Ω , a 10:1 ratio. For higher ratios, say 20:1, it is necessary to use two L networks connected in series, with each doing half the transformation ratio. If you don't care about the phase shift introduced by the network, you can use a simple L to make the match and do the job satisfactorily.

Suppose you do care about the amount of phase shift. How can it be controlled? It can't. With an L network, you can control the transformation ratio, but you must accept whatever phase shift it produces.



For any transformation ratio, there is a specific amount of phase shift. Normally, you can't come up with component values that will meet both requirements.

Phase shift

Phase shift is an expression that is glibly tossed around during discussions about antenna systems. (The term also is used in other areas, but we are concerned here with RF, not that awful modulation that always messes up a nice, clean carrier.) There is nothing special about phase shift. In fact, non-directional stations normally don't care about phase shift.

In DAs, however, it is extremely important because it is the essence of the directional operation and the basis for the pattern shape. Phase shift is simply the change in angular relationship between two or more RF currents or voltages. Phase shift is not quite the same as *phase difference*. Phase shift refers to an intentionally produced change in the relative phase of a given signal to accomplish a desired electrical effect. When an antenna network is adjusted merely to effect an impedance match without concern about the phase shift, the pattern probably will be misadjusted.

Broadcast application

When a station's pattern is originally designed, the engineer makes allowances for specific phase shifts (or changes) in each portion of the antenna system. These consist of the phase change caused by the length of the coaxial transmission line, the various capacitive and inductive reactances in the phaser, the components in the ATUs and the antenna characteristics.

In a DA system, a T network with a 90° phase shift is normally used. So, once an antenna system is tuned, and the final antenna proof-of-performance is filed, maintaining each of these phase shifts is important.

As mentioned previously, L networks seldom are used for DAs because of the resulting uncontrollable phase shift. This will be discussed more fully, but it should be apparent that if an L network is used in the DA system, any changes in L or C values will change the planned phase shift and the transformation ratio and probably

will affect the DA pattern. In this context, phase shift refers to the relationships between phases, or angular displacements of the various antenna currents. These values usually are known, and included in the overall phase shift. Therefore, any change in the network may produce unexpected results in system performance.

Antenna resistance

When talking about antennas, you may refer to the antenna resistance, perhaps 37Ω for a $1/4$ -wave antenna. But if you measured the resistance between the antenna base and ground with a VOM, you would not read 37Ω . At least, you hope not. So what is this imaginary impedance of $37+j45\Omega$?

The value of 37Ω is important to the broadcast engineer. The station's efficiency depends on this *radiation* resistance. The resistance in which the transmitter's output is dissipated is the antenna resistance. This includes the radiation resistance and I^2R losses.

These I^2R losses consist of ground-system resistance produced by corroded ground connections, cables and copper straps that are too small for the current, cracked insulators or anything that causes current to flow anywhere but into the antenna. As antenna current flows through these connections, heat is produced. The engineer wants this radiation resistance to be as high as reasonably possible with low losses in heat dissipation.

The 37Ω resistance can't be measured with a VOM, but it can be measured with an RF bridge and identified as the real part of an imaginary number. The station's power becomes I^2R , where only the real part of the complex number is used.

Battison, BE's consultant on antennas and radiation, owns John H. Battison and Associates, a consulting engineering company in Columbus, OH.

The MRC-2 has PC advantages that give you total control.

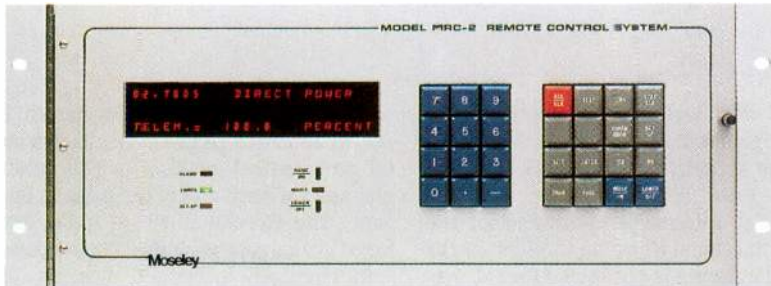

Total control means handling problems with ease and accuracy. Pre-programmed responses eliminate operator error and guesswork.

PC Control Option

Interconnecting your IBM® PC, AT or compatible PC to the MRC-2 Remote Control System gives you a smart system capable of making the right decisions during a transmission emergency.

Moseley's new PC Control Terminal software emulates the MRC-2 Control Terminal with CRT and Automatic Logging. During operation, the system monitors all important parameters and takes control when out-of-tolerance conditions exist.

The PC Control option adds feedback-oriented and time-oriented functions to the system. The multitasking software program automatically stores your logging data directly to hard disk while running other programs, such as spreadsheets and control loops. With the PC

Control option, databases can be built up for trend analysis and monthly reports automatically generated.

MRC-2 Remote Control

The MRC-2 Remote Control System can expand up to 256 command, status and telemetry channels per site. Optional CRT, Automatic Logging, Multiple Direct Command panels, and Multiple Status Display panels help run your facility with uncomplicated ease.

More and more broadcasters are taking total control of their facility with the MRC-2 Remote Control System, because no other system offers PC advantages at this level.

Moseley

111 Castilian Drive
Santa Barbara, CA 93117
805 968 9621
FAX: 805 685 9638
Circle (10) on Reply Card



Let's call it frequency sharing

By Elmer Smalling III

The term *frequency reuse* is misleading. It implies that something is used over, such as a reconditioned radio or rocket booster. Actually, the term means *frequency sharing*. When two signals can use the same frequency at the same time, it seems more appropriate to call it sharing, not reuse!

Because the usable bandwidth of a satellite transponder is valuable, allowing two signals to share one transponder would be efficient and economical. But this is not done. Frequency reuse is accomplished using differential polarization. One transponder's signal is transmitted (or received) using horizontal antenna polarization, and the adjacent transponder's signal is transmitted (or received) using vertical antenna polarization.

The simplest form of a polarized linear antenna system uses two dipoles that are rotated 90° from each other. This cross-

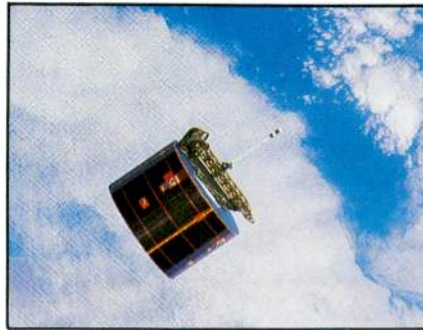

shaped array includes a horizontal and a vertical element. In order to receive either of these signals, the terrestrial antenna system must be oriented so that the horizontal antenna is optimized for the horizontal signal from the satellite, or the vertical antenna is optimized for the vertical signal. This type of cross-polar transmission can provide up to 35dB isolation between the horizontal and vertical signal or between adjacent transponders.

Because communication with a satellite is done in the microwave band, waveguides are used rather than linear (wire-type) antennas. It is easy to rotate waveguides to change polarization. However, by the same token, they may be affected by the alignment of the dish structure, the angle to the satellite and changes of the polarity due to a poor antenna-reflector surface.

way to implement cross-polarization. It is not as sensitive to the absolute horizontal and vertical position of the antenna elements at each end of the path. In linear form, the circular antenna looks like a large corkscrew mounted on a boom.

In circularly polarized systems, feed systems are excited by vertical and horizontal signals, such that the combination produces a wave that rotates circularly as the wave propagates. This rotation may be in the right-hand or left-hand direction. Phase shifters on the receiving end of a circularly polarized transmission combine the vertical and horizontal components into a single signal.

The reflectors of the transmitting and receiving antennas must not cause aberrations in the signal because of reflection angles that are too acute, or surface anomalies caused by a poorly made reflector or injuries to the surface.

Smalling, BE's consultant on cable/satellite systems, is president of Jenel Systems and Design, Dallas.

Circular polarization

Circular polarization is the preferred

Depolarization

Most of the communications satellites serving North America are linearly cross-polarized. Some circularly polarized Ku-band birds are planned. The atmosphere will distort the polarity of a wave traveling to or from the satellite, causing depolarization (polarization distortion) above 10GHz. This makes cross-polarization for frequency reuse purposes doubtful at the Ku-band or higher.

Another cause of depolarization is precipitation in the signal path. It is important that water, ice and snow be kept off the earth-station antenna system using a radome and/or heating system. Rain and ice in the atmosphere also will determine the amount of phase shift that occurs between the vertical and horizontal signal components.

The best kind of frequency sharing (up to 80dB) uses variations of time domain or x-phase shift keyed multiplexing, where digital video and audio signals are interleaved. The poor crosstalk figures of cross-polarity transmission can be improved by at least 40dB, and the signal-to-noise ratio can be improved by at least 45dB using the digital process. This type of system may appear first in HDTV satellite transmission using wideband transponders.

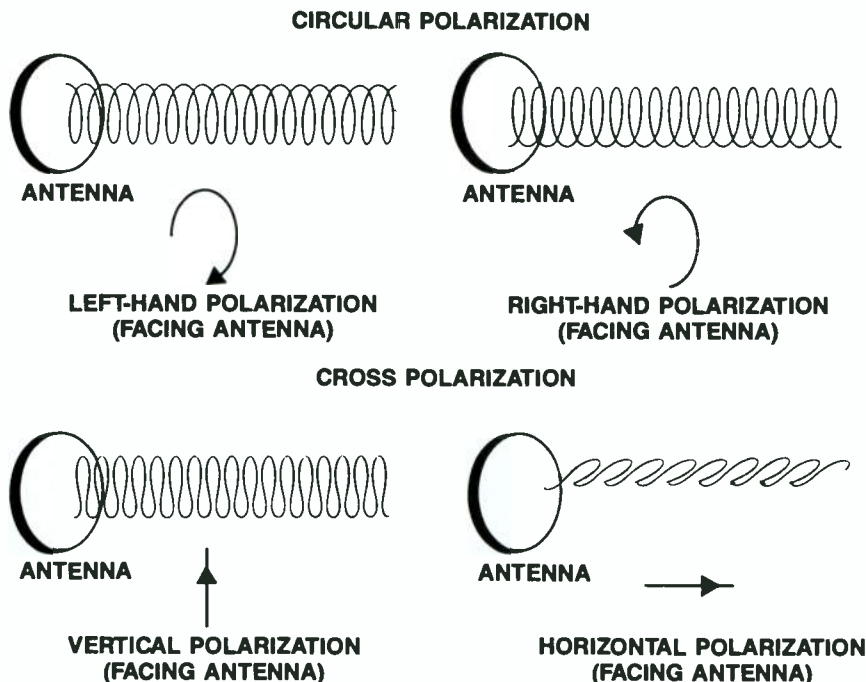

Figure 1. Four different polarizations. Polarization of receive antenna must match transmit antenna. Alternate transponders use opposite polarizations to perform "frequency reuse."

[:(-:))]]]]

FOR NEWS EDITING, ON-AIR, AND PRODUCTION



RADIO'S TOP TEN!

For news editing, on-air, or in the production studio, Otari has exactly the equipment and features to fit any application, or budget.

When you are ready for a multitrack recorder, you can choose from our BQII, MKIII/4, MKIII/8, MTR-10, or the MX-70 with 8 or 16 tracks. Need a 2-track? Choose our famous "workhorse" MX5050 BII, MKIII/2, or the brand new MX-55! Looking for top-end performance? The MTR-10 has all the features you need to stay ahead in the competitive world of broadcast. We also offer three models of our CTM-10 cart machine, and if yours is an automated radio station, our ARS-1000 reproducer is the most popular in the world.

So you see, whatever you need for today, or for the future, Otari can provide it from a complete line of high quality, ultra-reliable tape recorders. Call your nearest Otari dealer today, or contact Otari at (415) 341-5900 for "Technology You Can Trust". **OTARI**

Circle (11) on Reply Card

Looking behind the glass

By Carl Bentz, technical and special projects editor

The broadcast industry is, for better or worse, influenced by what goes on in the consumer electronics market. Consumer products provide the manufacturers of certain video products with economies of scale that allow professional products to be made at a fraction of the cost of traditional small-volume products. This trend, however, may have its downside. Consider the case of the dot-matrix, delta-gun CRT.

The bottom line

Economic theory suggests that the numbers at the bottom of a spread sheet should indicate *profit*. Company owners and investors don't just suggest a profit; they demand it. To meet that requirement, a product's sale price must rise as its manufacturing cost rises. If the price goes up too much, however, the quantity sold may be reduced. Alternately, if the price goes up because the product is in limited supply, sales also may be adversely affected.

One often-used solution to this dilemma is to cut the cost of manufacturing to allow the same selling price with little change (at least not a loss) in product profitability. Perhaps the cut can be made in labor. Perhaps it can be in components. If a cut can be made in both, so much the better. One small catch: the same quality must be maintained.

How do manufacturers decide where to make cuts? They might decide based upon the type of users of the product. In the case of video displays (encompassing professional/broadcast video monitors and home TV receivers), what is most important to profitability? There is little question that demand for home receivers will far outnumber monitors.

How can costs be cut here? One component common to both is a picture tube. The delta-gun, delta-dot type of tube has been around since the dawn of color television. Several other types of tubes use in-line guns.

The delta-gun, delta-dot is the most difficult of all CRT types to manufacture. If 100 are made, maybe 10 will meet the requirements of broadcast and the professional video market. Perhaps another 10 will meet the demands of industrial video users. That leaves 80 tubes unusable in

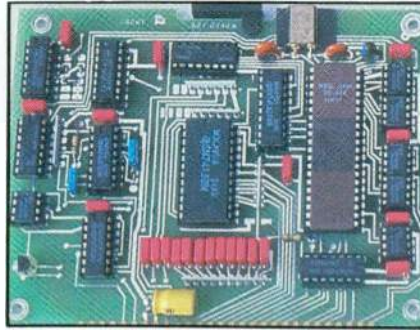

critical applications.

With 80 tubes for new consumer sets and for the replacement parts business, the tube manufacturers go to the TV receiver manufacturers. Sorry, they don't want delta-gun, delta-dot tubes. That type takes too much time for service technicians to converge, assuming they know how. If the tube or related components were replaced, the technicians would have to go through the whole process with all

the interactive adjustments. A slight movement of the yoke, and the whole thing would need to be done all over again.

Changing markets

In the '70s, the tube manufacturers received a challenge to design a picture tube that could have a yoke assembly glued into place before the tube left the factory. Engineers have come through with a design that allows picture tubes to be replaced almost like plug-in circuit modules. The new design produces brighter pictures, because instead of phosphor dot triads illuminated by electrons filtering through holes in a dot mask, the mask has larger holes, slots or even a grill. More electrons pass through the mask, creating more light on the dot-triad arrays or vertical strips of phosphors.

The circuitry necessary to converge the three electron beams is simplified. The guns that generate the streams of electrons are arranged in a linear array, not triangular as with the delta-dot. The yield of this type of tube is usually higher, because the linear array is easier to build.

The majority of viewers probably will not be able to tell the difference. In fact, because convergence is simplified and convergence drift is reduced, they may think the in-line tube picture is sharper and more defined than that of the delta-dot tube.

What happens to the excess delta-gun, delta-dot tubes, particularly when the typical yield for professional products may be just 10% to 20%? That means 80% must be disposed of. Each tube represents an investment in parts and labor. Yet, with no outlet, manufacturers must accept a loss for eight out of 10.

Profitability requires that manufacturers charge more for the tubes that do meet the standards of certain video display users. At the same time, to help cover costs, they can require that orders for the delta-gun devices be of a specified minimum number. In the end, it means that broadcasters will see an increase in the price of monitors for critical evaluation.

Invariably, someone asks, "Which tube type is really best?" We'll address that question next month. [:-:-)]

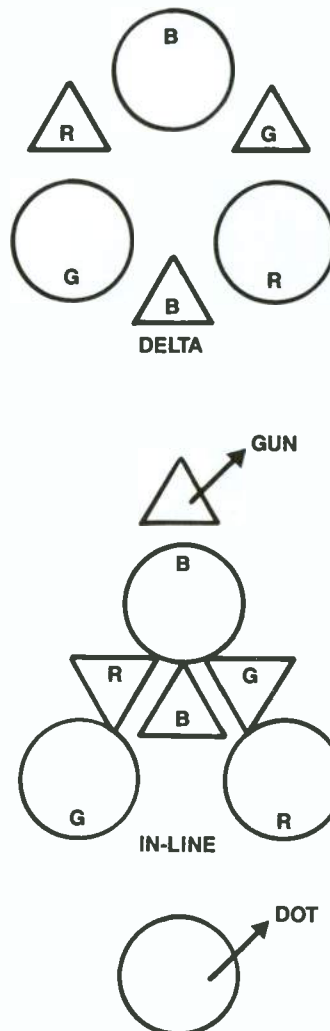

Figure 1. Geometries of the two dot-mask type CRTs.

PARAMETRIC PERFECTION



Introducing the New Orban 642B Parametric Equalizer/Notch Filter

Orban's new 642B Parametric Equalizer/Notch Filter offers unmatched versatility, superb specs, and highly musical equalization in a new generation of our famous and widely-used 622 series. The 642B represents Orban's continuing dedication to the art of creating the "most musical" parametric equalizers through the use of carefully designed, series-connected "constant Q" sections which minimize ringing and stridency.

The 642B's superiority over conventional parametric equalizers is particularly apparent at the extremes of its boost/cut parameter and at narrower bandwidths on difficult program material. In situations like these, the 642B's performance provides consistently satisfying results without complications or unpleasant surprises.

	Band 1	Band 2	Band 3	Band 4
Model 642B (Same in both channels.)	25-500Hz	80-1.6kHz	315-6.3kHz	1-20kHz

Special Application Versions

Model 642B/SP	80-1.6kHz	80-1.6kHz	315-6.3kHz	315-6.3kHz
(Same in both channels. Limited frequency range for speech processing, forensic work, notch filtering/feedback suppression, and similar applications.)				
Model 642B/SPX	Frequency ranges of 642B in channel A; 642B/SP in channel B (For combined full-frequency range broadband shaping and restricted-range narrowband notching.)			

Features include:

- Dual 4-band or mono 8-band configuration selectable by the front-panel Cascade switch
- Each band can be tuned over a 20:1 frequency range; tuning ranges of bands overlap significantly to maximize versatility; +16dB boost/-40dB cut in each band; "Q" variable from about 0.29-5.0
- Vernier frequency control to facilitate fast, precise tuning of sharp notches
- Frequency-selectable 18dB/octave high-pass filter and 12dB/octave proprietary "Automatic Sliding Besselworth"™ low-pass filter to provide full flexibility with maximum musicality
- Noise and distortion specs significantly better than 16-bit digital

Call or write today to discover more about Orban's new, ultra-quiet, 642B Parametric Equalizer/Notch Filter—a new generation of parametric excellence from the leader in parametric EQ.

Orban Associates Inc.

645 Bryant St., San Francisco, CA 94107
(415) 957-1067 Telex: 17-1480 FAX: (415) 957-1070

Circle (12) on Reply Card



CD player repair requires skill

By Brad Dick,
radio technical editor

Two CD circuits that haven't been covered in this series are the EMF decoding circuit and RF amplifier. It seems a contradiction to speak of an RF amplifier in an audio product, but CD players have them. Let's look more closely at why each of these circuits is important to the performance of a CD player. A Technics player will be used for the example circuits. Your player may be slightly different, but the principles will be the same.

RF amplifier

Servicing CD players is difficult under the best circumstances. It's hard to know what circuit to investigate first. As in many other CD circuits, failure of the RF amplifier shuts down the entire player; even the motor won't turn.

To troubleshoot the RF amplifier, you need to "fool" the microprocessor into thinking there is at least some signal coming from the photodiodes. A quick way to see whether the RF amplifier circuits are working is to "buzz" the amplifier input with your finger or test probe. Touch the input to the RF amplifier and observe the amplifier's output on a scope.

Contacting the A/C or B/D input should produce a clipped waveform at the ampli-

fier's output (RFO) and focus error (FE) test points. A similar test can be performed on the tracking amplifier by contacting the E/F inputs.

Measurable RF voltages can be obtained by substituting an RF generator for the test lead. Typical output voltages may range from approximately 2mV to 4mV peak to peak (see Figure 1).

Wave-shaping network

After the raw RF signal is recovered from the CD, it must be carefully processed to extract the audio and control data signals.

The RF signal is first processed by a wave-shaping network, then applied to an edge detector. If the dc level of the RF signal changes, a compensating voltage is added back to the wave-shaping network. The dc level correction compensates for poor optical performance or variations in disc manufacturing and ensures that the RF signal will not drift out of the operating range of the decoder circuits.

A sample of the master clock signal is divided in half and also applied to the wave-shaping circuit. This signal prevents the PLL circuits from becoming unlocked in case a sizable dropout occurs. Although the clock signal would replace the RF sig-

nal, the audio and subcode information would be lost.

Phase-locked loop

The edge detector outputs equal-width pulses to one input of the PLL phase comparator. The phase comparator output is low-pass filtered and used to drive a free-running 8.64MHz VCO. The VCO output is divided and becomes the second input to the PLL phase comparator.

Phase comparison is made between the incoming edge signal and the counted-down VCO signal. If a phase difference is detected, it causes a change in the dc value produced by the integrator. The process slaves the VCO to the frequency of the edge signal. The VCO output is then gated to produce the EFM and the playback clock (PCK) signals.

Verify the inputs

The first troubleshooting step is to verify the two primary inputs. Check the RF signal applied to the wave-shaping network. Also check for the microprocessor clock signal. If these two signals are present, the EFM and PCK signals should be available.

If the problems still exist, detailed troubleshooting will be required. Although the basic procedure is simple, remember that the lack of any of a number of status inputs may cause the microprocessor to shut down.

The service literature should tell you how to override the various status inputs as you attempt to locate the defective signal. Because the circuits are complex and interdependent, service manuals often provide troubleshooting flow charts. Use them. Otherwise, you may find yourself going in circles.

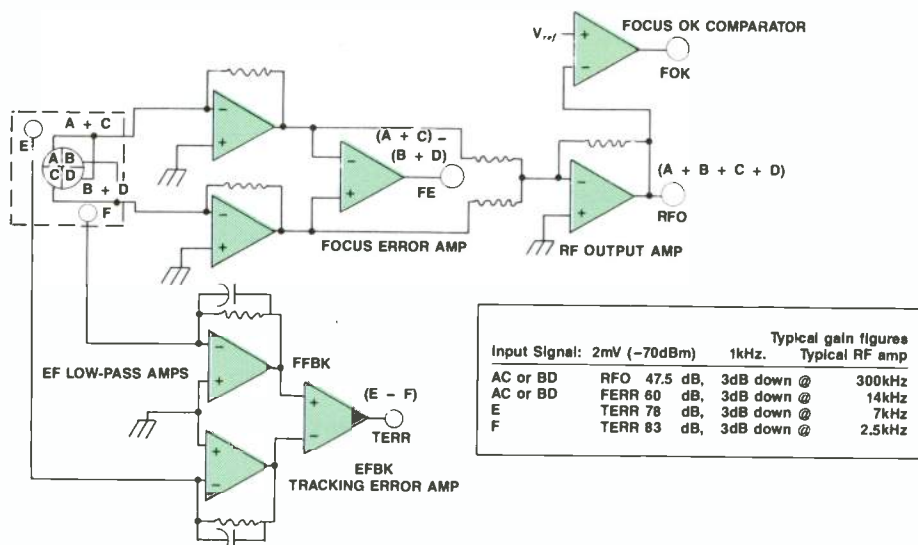

Figure 1. The RF signal is produced by the cross-connected photodiodes. The RF amplifier can be checked easily by "buzzing" the inputs.

Editor's note: Additional information on CD servicing can be obtained from "Compact Disc Troubleshooting and Repair," by Neil Heller and Thomas Bentz. Also see "Audio Corner," by Kirk Vistain, *Electronic Servicing & Technology*, April 1987.

Rigid Coaxial Transmission Lines Deliver Low Losses...High Gains.



Cablewave Systems delivers everything you need and expect from Rigid Coaxial Transmission Line performance...superior quality, plus optimum mechanical and electrical specifications.

To achieve this, Cablewave Systems fabricates high conductivity, hard-drawn copper tubing with precision machined, pin-type Teflon dielectric insulators. Standard 50 ohm transmission line is offered in sizes from $\frac{7}{8}$ " thru $9\frac{3}{16}$ "; 75 ohm in $6\frac{1}{8}$ " and $9\frac{3}{16}$ ". All utilize EIA bolt type flanges and inner connectors compatible with EIA

standards, MIL specs and international IEC recommendations. Aluminum outer conductor 50 and 75 ohm transmission lines are available on special order.

To complement our full line of Rigid Coaxial Transmission Lines and accessories, Cablewave Systems also manufactures a complete line of semi-flexible air and foam dielectric coaxial cables and connectors.

For a copy of our 48 page Rigid Coaxial Transmission Line catalog and information on other broadcast and RF communication products, contact Cablewave Systems.



Circle (14) on Reply Card

Cablewave Systems

DIVISION OF RADIO FREQUENCY SYSTEMS, INC.
60 Dodge Ave., North Haven, CT 06473 • (203) 239-3311

Techniques for dealing with problem behavior

By Brad Dick,
radio technical editor



Chris could barely restrain his anger as he returned to the engineering workshop. He tried not to show his rage, but the sound of the slamming door left little doubt that he was plenty upset.

Just minutes earlier, the program director had severely criticized Chris for failing to properly maintain one of the CD players in the air studio. The player had miscued the desired cut three times in a row. Now Rob, the PD, was fit to be tied.

Rob had jumped on him with both feet, demanding to know why Chris hadn't repaired the CD player. He didn't give Chris a chance to explain that he had tried to fix the player, and that it had worked fine for more than a week. Instead, Rob continued his tirade. If Chris couldn't fix it, he said, then it had better be replaced.

Chris is ill-equipped to deal with people such as Rob. When attacked like this, he usually nods and beats a hasty retreat. Chris knows from the feel of his churning stomach, that it isn't going to be a good day.

Case 2

"There's only one way to do things around here," Tom said. "The sooner you realize that, the better off you'll be." Bill listened, almost with disbelief, as Tom continued to describe how best to get along with Howard, the station's "star" director. It seemed that Howard was one of those people who think they know everything, and usually don't wait for you to ask them about it.

It wasn't long before Bill saw firsthand what Tom meant. During a shoot, Howard began to complain about the lighting. Just

as the lighting crew started to make changes, Howard stormed onto the floor and proceeded to tell the members of the crew how to do their jobs. If that wasn't enough, when one of the cameras developed problems, Howard was quick to tell the client that *he* knew what the problem was, but the engineers couldn't figure it out.

By the end of his first week at the station, Bill realized that Howard truly believed he knew more than everybody else. Bill also recognized that, at least part of the time, Howard was right about things. This would make it even more difficult to suggest alternatives to Howard's mandates.

Difficult behavior

These two examples dramatize the effect of problem-causing behaviors in the workplace. You may be working with a Sherman tank who tries to run over everyone, or you might be at the mercy of a staller who can't seem to make a decision. Manipulative or otherwise difficult people create problems for those who work for and with them.

Their behavior not only causes stressful working conditions, but also limits creativity and productivity. If these individuals are in supervisory positions, their behavior also can increase absenteeism, lower staff morale and even result in high employee turnover rates.

What's worse, such individuals often are immune to the usual methods of communication and persuasion. Logical arguments seldom work. Getting these people to change their ways seems almost impossible.

Fortunately, there are techniques that can help you cope with such behavior. Note that the techniques aren't meant to change the other person. Instead, the strategies we're going to examine can help adjust the power balance and minimize the impact of the other's difficult behavior.

Control yourself

Just what is a difficult person (DP)? Although you may have your own definition, let's use the following general description. Difficult people are individuals who, as a result of their personalities, attempt to control others and situations through manipulative actions. Table 1 lists some typical problem-causing behaviors. You may be able to identify others.

There are two basic approaches to coping with DPs: Attempt to change their behavior or change your response to their behavior. Forget about trying the first approach. Unless you are the DP's supervisor, you probably don't have the political power to effect any change. And, as any parent knows, trying to change someone else's behavior can be an impossible task.

The second, and more practical, approach relies on developing patterns of interaction that limit the success of the problem person's behavior. Coping methods work because they interfere with the functioning of the difficult behavior. In each case, the DP expects a particular response. If the predicted response fails to occur, the stage is set for alternative interaction. The goal is to get on with the business of doing your job.

To develop and use coping techniques, you must retain control of your own responses. You have to think about what you're going to do and say. You also have to be able to correctly identify the difficult behavior. If you use the wrong technique, you won't produce the desired results.

Your success will depend on many factors. However, if you apply the techniques we'll be discussing in future columns, you're sure to reduce your stress level and to make some improvements in the conditions at your workplace.

BEHAVIOR TYPE

Hostile/aggressive
Complainer
Unresponsive
Super agreeable
Negative
Know-it-all
Indecisive

DESCRIPTIVE TERMS

Sherman tank, bully (Rob)
Never satisfied, gripes, whines
Non-committal attitude
Mostly talk, little action
Doomsayer, contagious pessimism
Productive, but causes resentment (Howard)
Stalls, can't/won't make decisions

Table 1. Many of the problem-causing personalities can be grouped into these categories.

||:~::~)))||

NEW FROM ARRAKIS SYSTEMS

10,000 SERIES



For features, performance, price and reliability,
NOBODY BUILDS CONSOLES LIKE ARRAKIS.

Call (303) 224-2248

Circle (13) on Reply Card

ARRAKIS SYSTEMS INC. 2619 MIDPOINT DRIVE FORT COLLINS, CO 80525



Audio-video control systems

By Brad Dick, issue editor

The trouble with using experience as a guide is that the final exam comes before the lesson. A parallel exists for many engineers when it comes to building a new facility—it's often a "first experience." That is hardly the time to learn how to do it right.

Designing an audio-video system requires knowledge, planning and, perhaps, a bit of luck. Even if you are talented enough to build a good facility for today's needs, what about tomorrow's requirements? If you don't consider the demands that will be placed on your design with tomorrow's technology, the useful life of your project may be severely limited.

Back to the basics

As you plan your station's modernization, consider how the signals are transported within the facility. Wire is still the basic link between equipment. Careful attention to how devices are wired together is more important than any other single task. Even the best equipment cannot perform well if ground loops or crosstalk are present.

Likewise, distributing signals to all of the required places is a complex and demanding task. TV stations face the chore of sending a single video signal to perhaps 25 or more destinations. In addition, there may be 100 or more video signals to distribute. It doesn't take a genius to recognize that these loads cannot all be bridged across the source.

Today's radio stations find themselves in a similar situation, except that there are often more sources than destinations. Multiple, satellite-delivered signals, telephone lines, RPU and 2-way radio signals all must be distributed properly to several studios and recorders.

Look to the future

The capabilities of tomorrow's equipment may be limited if you don't build in an extra margin of quality and expandability. The four or six recorders in master control may suffice today, but will they soon be replaced by a computer-operated cartridge machine? If so, what additional demands will this place on your design?

Wiring a radio or TV station is an investment in the future. Careful attention to detail and technique can make the difference between a well-designed plant and one that has limited capacity for growth.

The engineer's responsibility is to make sure that today's technology is used properly, and that tomorrow's technology can be incorporated effectively into the station. Engineering management can help ensure that new facility designs provide room for growth and advancements in technology by returning to the basics of both wiring and signal distribution.

- Wiring an Audio-Video Facility page 26
- Distributing Audio-Video Signals 40

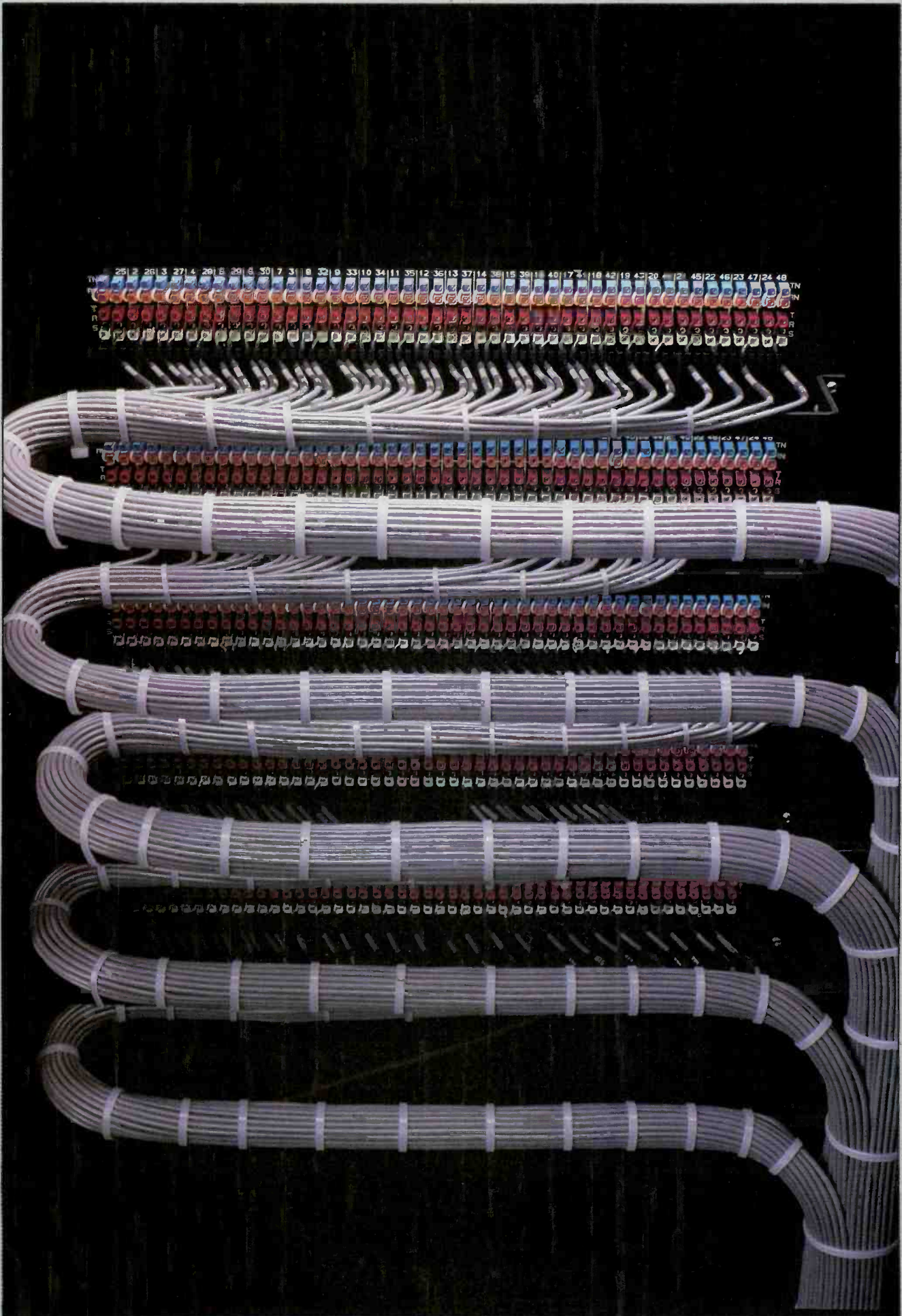

Introducing a CCD camera who are glued to



era for people the tube.

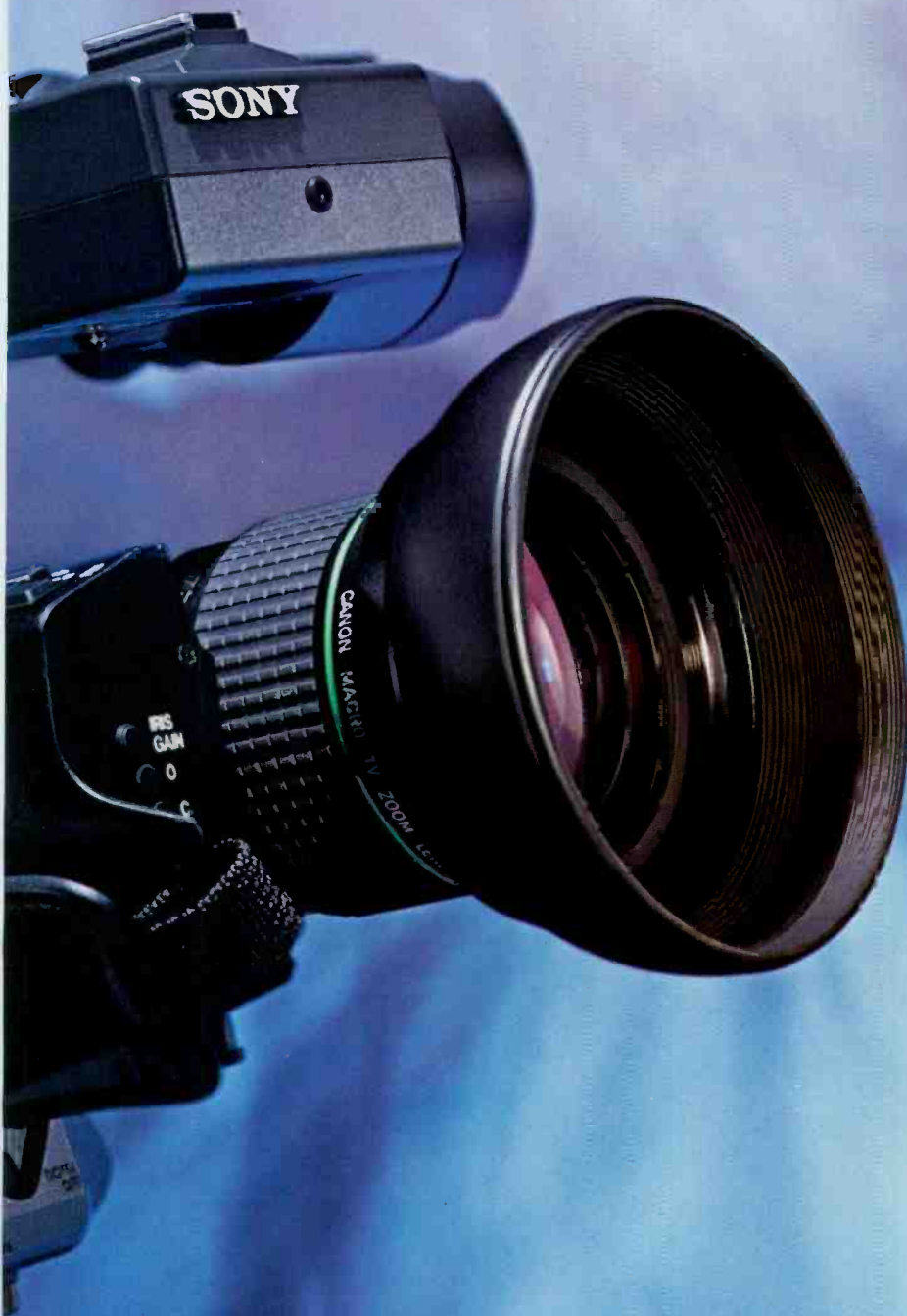

It's hard to beat the picture quality of a fine 3-tube camera. We know. We've been making award-winning tube cameras for years.

But this year we've produced a solid-state camera that will surely catch your eye.

It's the Sony DXC-M7.

What makes it so remarkable is Sony's advanced CCD technology.

Our fourth-generation chip has over 380,000 active picture elements (768H x 493V) with less than one-tenth the dark current noise of previous CCDs.

This CCD produces a picture that's cleaner, sharper, and has more accurate colorimetry. Resolution of 700 TV lines. 60 db signal-to-noise ratio. CCU function control at the camera head with viewfinder readouts. A choice of three remote controls. Composite and component outputs. Everything you've ever wished for in a video camera.

Of course, the DXC-M7's Dynamic Contrast Control and revolutionary H.A.D. sensors enable you to shoot in high contrast situations or in very low light. And its new variable electronic shutter captures fast-moving subjects in a snap.

We could go on and on about this camera, but the truth is you have to see it to believe it.

For a demonstration of the Sony DXC-M7 (or its cousins the DXC-750 and the DXC-3000A), write to Sony, Box 1006, Union, New Jersey 07083.

It will change the way you look at CCD cameras.



SONY®

Professional Video

Circle (15) on Reply Card

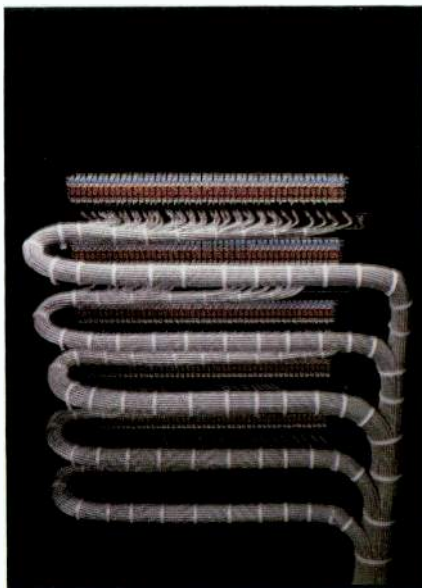

Wiring an audio-video facility

By Tony Mitchell

Proper planning can make the difference between heyday and havoc.

Blame it on progress. The technological advancements of the past decade have led to the increased complexity of fixed and mobile facilities, and have forced new and improved methods of teleproduction. In short, progress has redefined the functionality and profitability of a facility.

When planning new facilities, today's engineer must be concerned not only with the technical operational aspects, but also with the equipment and building costs. The engineer has the obligation to hold down these expenses, as well as those related to long-term operation and maintenance.

Perceptions and performance

What type of message is communicated by a facility that appears to be "thrown together" instead of designed with forethought? Most likely, the message is one that erodes the confidence of the prospective client. The client may wonder whether the staff is qualified to handle the task, whether adequate equipment is available and whether the project will be completed on time. The image of a facility is shaped during the planning stages. That's the time to consider all factors and to work to prevent mistakes that could directly affect profitability and company image.

A well-designed facility also will increase personnel efficiency, bolster morale, reduce stress-related absenteeism and enhance the system's versatility. Inadequate planning and installation techniques, on the other hand, may result in lost time related to broken wires, miswires and equipment failures.



Neatly bundled and marked cables aid in troubleshooting and create a favorable impression on prospective clients.

Design considerations

It's a mistake to try to make a facility "all-encompassing" to the audio-video industry. Consider the overall scope of the facility. What, specifically, is the facility expected to accomplish? How much area should be dedicated for growth? Will the implementation of new technology cause major reconstruction?

Provide the designers with sufficient direction so that the system will not be overdesigned, thereby costing more than is necessary to build a profitable center. Develop a list of operating goals and objectives to help determine the type of equipment required to meet the needs of the customer.

The success of designing and implementing a new facility, or upgrading an existing facility, depends on the use of competent resources. One of the first questions that arises is whether to use an outside contractor to plan and/or build the facility, or whether to have inside personnel handle all or part of the responsibility.

System integrators may have computer-aided design (CAD) systems that track all details relating to block diagrams, equipment lists, bills of materials and architectural and mechanical layout. This technique allows changes to be incorporated with ease and reliability, and it permits "what if" analysis for expenditure justification and functionality.

Mitchell is marketing assistant for Centro Corporation, Salt Lake City.

ARRAKIS SYSTEMS

5000 SERIES



.At A Down-To-Earth Price: 16 Channels, Under \$10,000.

THE FEATURES YOU WANT—

- 16 Modular Stereo Channels.
- Program, Audition and Mono Mixdown Balanced Outputs.
- Telephone Mix-Minus Buss.
- Full Monitoring Facilities.
- Remote Equipment Start/Stop.
- Remote Module Control.
- Standard Digital Clock and Timer.
- Optional EQ and Effects Modules.

THE DEPENDABILITY YOU NEED—

- DC Controlled – No Audio On Pots.
- Rugged Modular Construction.
- Penny & Giles Slice Faders.
- ITT Schadow Switches.
- NE5532 IC Module Design.
- External Regulated Power Supply.
- Superb Audio Performance Specs.
- Most Important, Arrakis Systems Designed-in Ultra Reliability!

For features, performance, price and reliability,

NOBODY BUILDS CONSOLES LIKE ARRAKIS.

Call (303) 224-2248

Circle (13) on Reply Card

ARRAKIS SYSTEMS INC. 2619 MIDPOINT DRIVE FORT COLLINS, CO 80525



These systems also are capable of providing high-quality, accurate drawings. Such documentation is critical not only to completion of the immediate project, but also to future work. Accurate, detailed documentation will prevent frustration for those who will maintain the system. Being able to identify and solve problems through accurate documentation will reduce troubleshooting time and increase profits.

The time required to plan and implement a new facility is often more than an engineer has available. After all, somebody has to be responsible for the day-to-day operation of the current facility. In addition, few broadcast engineers are sufficiently knowledgeable about all the aspects—heating and air-conditioning systems, power distribution, architectural and mechanical design, video, audio, ergonomom-

ics and business—that such a project entails.

Building blocks

Block diagrams that show the signal flow of the entire system are the foundation of any design. These diagrams represent the major elements of the system, such as switchers, VTRs, character generators and monitors. If an outside firm is used as the system integrator, block diagrams may be drawn by the client and given to the system house for suggestions and corrections.

The system sync generator should be shown with pulse direction flow, and all equipment should be identified with an alphanumeric indicating location (see Figure 1). Cables are marked to identify the signal name and cable number, such as *blk burst 4969*. More elaborate labeling schemes

can be used that specify both the signal's origin and destination.

Develop an equipment list from the system block diagram. Obtain and study equipment specifications and installation manuals of all equipment to determine unique system requirements.

Timing and control problems need to be addressed so that physical location and signal routing can be planned. Is the system going to have a single master signal generator, or are multiple slave generators going to be used at different islands within the facility? Ease of timing and the ability to move equipment while maintaining synchronization are reasons to use slave generators in rooms or bays that need to be timed to house sync.

Down to specifics

After the basic layout—how many rooms will be involved and what type of work is to be conducted in each—has been determined, the designers can look at specifics. An analysis of the overall signal flow should tell you how many distribution amplifiers (DAs) are required. Facilities that route critical signals to a switcher before going on-air still may use DAs for routing the signal into other areas.

To avoid the possibility that a distribution amplifier might fail, which would not allow the signal to reach the switcher, route critical signals through the DA's looping input before they go to the switcher. Reduce the number of monitor and DA loops from the source to the primary switcher where possible. Plan for worst-case situations by routing signals to patch panels so that if the switcher fails, you still can maintain minimal operation.

Use equalization DAs whenever cable lengths exceed 150 feet. Longer cables, such as transmitter inputs, may be a source of ground loops or hum. Use video isolation transformers when hum cannot be eliminated by other methods. Terminate all unused audio, video and pulse DA outputs.

Timing the system

Consider the timing differences between analog video sources. The most common timing procedure for analog sources is to determine the longest signal flow (the longest length of cable), and make all cables that must be timed equal to that distance.

The problem with this method is hiding the extra coils of cable. Cables typically are concealed in the false bottom of the rack, in ceilings, floors or even coiled behind racks. One of the most elegant techniques of routing cables uses raised flooring so that the cables are out of sight and not disturbed by daily traffic. Another, more expensive, method of maintaining timing, uses delay boxes to electrically

Main story continues on page 32

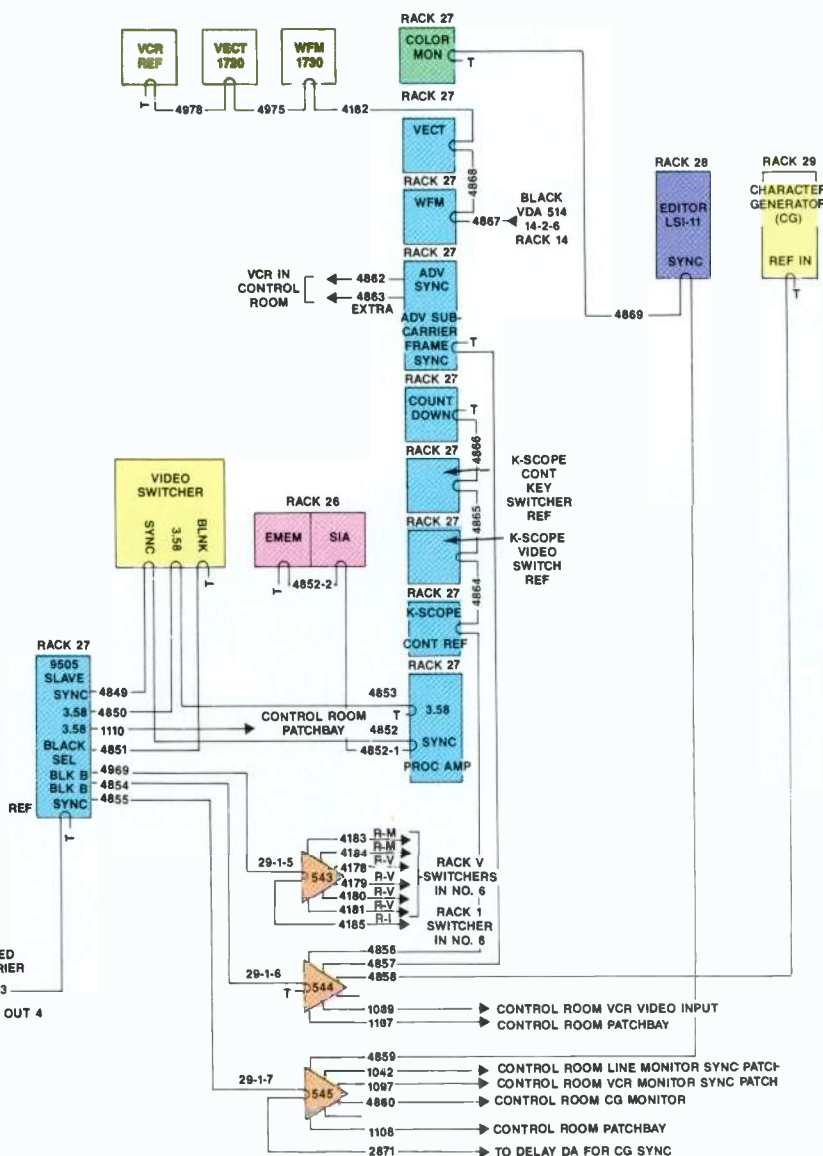

Figure 1. At the foundation of any new design or upgrade are the pulse and signal-flow diagrams. These diagrams should include cable and equipment location numbers to reduce confusion and help in equipment setup.

Standard on ours is "N/A" on theirs.



Every recorder in the C270 Series comes *loaded* with professional features it aren't available—not even as options on "comparable" machines from other manufacturers . . .

Dolby HX Pro[®] Headroom Extension and proprietary phase compensated audio electronics
Seamless and gapless punch-in and punch-out
Integral scrape-flutter filter in head assembly
Constant tape tension on both spooling motors
One-hand cueing under full servo control
Fully modular audio electronics allowing quick interchange of individual circuit elements
Front access to all audio electronics, even when rack-mounted

Plug-in record and reproduce equalizers for optimal performance and easy speed pair conversion

3 peak LED indicators: +6, +9, +12 dB (C270)
Adjustable Mute-to-Play time of audio output from 50 to 990 msec

Built-in variable speed allows -33% to +50% range

Selectable library wind and record inhibit
Optical End-of-Tape Sensor
1-year parts and labor warranty

Plus, other features *standard* on the C270 Series that are available *only* as options on other machines . . .

- Fader start circuitry
- RS 232 serial port allows full control of *all* machine functions
- Rack mount adapters

The C270, 274 and 278 all have 3 tape speeds (3 3/4, 7 1/2 & 15 ips), any pair of which can be selected and quickly changed in the field.

Low speed versions (15/32, 15/16 & 1 7/8 ips) of the C274 and C278—especially suited for logging applications—come with a built-in time and date code generator and reader with search capabilities.



All audio electronics fully accessible through front panel.

The C270 Series is designed to give you what you need, *included* on every machine . . . pro transport functions, pro audio quality and pro construction (rugged die-cast deck-plate, head assembly and chassis). Add overall value too, because that's very much what the C270 Series is about—giving the professional more for less. (Accessories and options, if you need them, *are* available—autolocators, remote controls, floor consoles and SMPTE center track time code.)

But one feature built into the C270 Series no one else has *ever* been able to offer . . . the Studer Revox 40-year reputation for reliability and unequalled performance.

Available from Studer Revox Professional Products Dealers. Or contact: Studer Revox America, Inc. 1425 Elm Hill Pike, Nashville, TN 37210. (615) 254-5651

STUDER REVOX

Acoustical problems of studio wiring

By Eric Neil Angevine, P.E.

Studio wiring presents numerous opportunities to compromise the acoustical insulation between studio spaces. Every conduit and cableway is a potential sound path into or out of the studio it serves. Even permanent wiring may jeopardize the acoustical integrity of a studio enclosure.

Acoustical principles

One of the cardinal rules of acoustics and noise control is that any enclosure that is to act as a sound barrier must be free of sound leaks. The sound transmission loss (TL) of any enclosure is limited by the approximation:

$$TL \leq 10 \log \left(\frac{\text{area of wall}}{\text{area of leaks}} \right)$$

At first, this approximation appears to be acceptable, but it can be shown that leaks amounting to 0.01% of the wall area can limit the sound attenuation to 40dB.

This means that in high-quality enclosures for broadcast studios, which may have sound transmission loss requirements of 60dB or more, leaks must be limited to 0.0001% of the wall area. For a wall with an area of 100 square feet, this is 0.0144 square inches—a 1/2-inch-long, 1/32-inch-wide crack! An opening of this size might be left around a cable penetration by a careless worker.

In addition to the problem of cracks, holes and open joints caused by poor workmanship, a second problem exists. All parts of an enclosure system that provide less than the maximum sound attenuation lead to a deterioration of the overall sound transmission loss provided by the enclosure.

This usually is kept in mind during the selection of doors and windows, which often provide sound attenuation of 10dB to 20dB less than the wall in which they are installed. It is possible to compensate for the degradation of sound transmission loss caused by doors and windows by specifying a wall construction with a sound transmission loss even greater than that required.

Speaking tubes

It is nearly impossible to provide conduits or cableways for flexible wiring that don't provide a sound leak into and out of each space they connect. Each conduit is a "speaking tube" between two spaces. The actual barrier between the two spaces is limited to the terminal box or other end condition of the conduit.

Angevine is associate professor at the School of Architecture, Oklahoma State University, Stillwater, OK.

Cable trays often are installed in such a way that they are accessible, either by being placed in the floor or above an accessible ceiling. In these cases, the acoustical barrier between adjacent spaces is limited to whatever material the cable tray is made of.

Even when studio wiring is installed permanently, it normally terminates in an electrical box with a cover of thin metal, or even plastic. Because this box replaces a portion of the wall, it creates a weakness in the enclosure.

The solution

An understanding of these phenomena suggests several rules of good practice that will minimize, but not eliminate, the effect of sound leaks inherent in studio wiring.

Although they do not provide the most attractive installation, surface-mounted conduits and cableways provide better sound control than recessed wiring, by minimizing the opportunity for sound leaks. Conduits and cableways should be made of the heaviest materials available and must not have perforations or other openings. The selection of conduits and cable trays should be made with care. Many common cable trays for general building wiring do not meet these criteria.

Cover plates for terminal boxes should be made of metal rather than plastic, and they should be as heavy as possi-

ble within the limits of practicality. Heavy materials such as steel are superior to light metals such as aluminum.

When accessibility is desired, these guidelines become even more important. Removable cover plates provide one more possibility for sound leaks.

Blocking the sound path

Even when all materials are selected carefully to provide the maximum sound transmission loss, cable trays and conduits will provide far less sound attenuation than the walls and floors of the room. A "speaking tube" still exists within the cabling system.

For this reason, it is important to plug the ends of conduits where they open into terminal boxes. Because the cables do not fill the conduit, blocking is necessary. A common practice is to fill the open area with fibrous insulation, packed to increase its density. It then should be sealed with a removable mastic material. Conduits for both permanent and temporary wiring should be plugged in this way.

Cable trays may have blocking installed where they pass through solid walls or floors. The blocking should be designed to be as solid as possible and to fill the open area of the cable tray. Again, this is important for both permanent and temporary wiring.

It should go without saying that all gaps and openings around conduits or cableways that penetrate studio walls must be filled and sealed tightly.

One final problem

An additional problem occurs in TV stations where studios share cameras. After a camera has been connected and calibrated, it may be required in another studio. Rather than disconnect cables and recalibrate, most broadcasters prefer to leave the camera connected and move it into the other studio.

Of course, to maintain acoustical insulation between studios, it is necessary to close the door through which the camera cables pass. Some provision must be made to allow a tight closure of the door without pinching the cables.

One approach is to provide a removable notch in the door frame that can be replaced by a similar block that encloses the cables.

Another method is to place an accessible cable tray in the floor, passing through the doorway. The cover of the tray must be made of heavy steel, both to provide a good sound seal and to support the floor loads that will be applied to it. In addition, provisions must be made for closing both ends of the cover, where the cables enter and leave the tray. This may be accomplished by using one cover with holes for the cables and another solid cover that completely closes the top of the cable tray.

Studio wiring creates inherent sound transmission problems. They can be controlled, however, by a studio designer who is aware of the pitfalls and who designs to compensate for them.

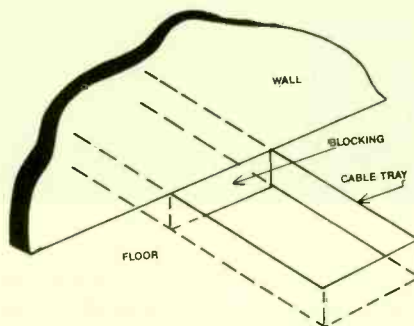

Cable trays that pass through walls or floors must be filled with a blocking material to prevent the transmission of sound.

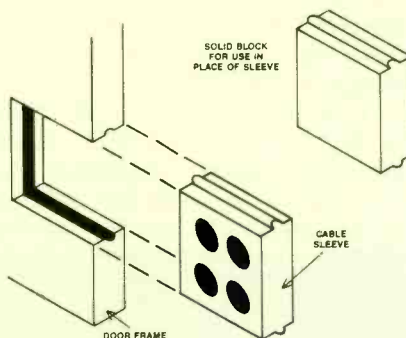

If camera cables or other movable cables must pass through a door, a removable sleeve may be used to help maintain isolation.

The good news is...



Studio camera automation has arrived... the HS-110P.

The HS-110P automated pan/tilt head provides more effective utilization and distribution of production talent... and at a surprisingly affordable price.

- Our highly repeatable servos and stiff mechanical design provide the same feel and responsiveness of a manned camera... absolutely essential for camera automation.
- Four HS-110Ps, using our software driven Multi-Controller, provide a quality production with one operator. As an alternative, the HS-110P Heads can be controlled directly by a News Room computer via MultiController's serial input.
 - These features coupled with our Multi-Controller's "shot storage" and "motion learn" capability provide the director with complete and repeatable camera moves... with less staff and improved communications... resulting in a more efficient production and a lower operating budget.
- Automate for your future... now. Call us for a demo.

HS-110P features:

- Load capacity of 250 lbs.
- Max. velocity of 90°/Sec.
- Preset return accuracy of 18 arc seconds (0.03141" from 30 ft.)
- Highly responsive servo design.

**TOTAL SPECTRUM
MANUFACTURING INC.**

709 Executive Blvd., Valley Cottage, NY 10989
914-268-0100 FAX: 914-268-0113

Main story continued from page 28
lengthen the shorter cables.

If a zero-timed facility is desired, a sync generator typically is used to time the various areas of the system. This sync generator is locked to the master generator and has the ability to advance or delay timing to gain correct synchronization.

HVAC requirements

Air conditioning is more important now than ever before. Because today's equipment contains *very large scale integration* (VLSI) components, crystal oscillators and critical timing circuits, it is far more susceptible to heat-related failures than yesterday's equipment was. One of the main causes of equipment failure is inadequate cooling within a rack enclosure. Calculations of total BTUs dissipated in all racks will help determine the amount of cooling capacity required in each area of the facility.

A detailed drawing should be generated from the system block diagram showing the placement of all racks within the architectural building plans. This will show the racks in relation to the windows, doors, heating and air-conditioning vents and electrical outlets. Such a drawing will allow analysis of spatial design. Heating and cooling considerations must be taken

into account to avoid heat-related equipment failures and to provide a workable environment for the operators.

The rack power requirements should be equal among groups of racks. The heat produced inside the rack is directly proportional to the power consumed and should be distributed evenly. Each rack's power requirements should be calculated to prevent one rack from consuming far greater power than an adjacent rack.

Determine the amount and type of cooling fans needed within a rack for adequate cooling. Space should be left between pieces of equipment within a rack to aid in cooling, allowing the hot air to rise and be expelled before going into adjacent equipment. Raised flooring may be used as a conduit for air conditioning as well as cable routing. The bottom of the racks can be left open to allow air movement from the floor through the rack.

Careful planning of air conditioning is critical to prevent hot and cold spots throughout the building. Also consider the placement of noisy equipment such as air-conditioning compressors and furnace fans. Should you use a large unit that runs at 80% to 90% capacity or several units that run at 50% to 60% capacity? If multiple units are used, the cooling can be alternated between the units by automatic con-

trols, if the outside temperature is not extremely high. Assuming they aren't designed to run at capacity when installed, multiple air-conditioning units may more easily accommodate future expansion.

System ergonomics

The importance of system ergonomics is evident to those who work with the equipment day after day. The result of poor ergonomics generally is operator fatigue, which leads to errors and loss of income. Rack elevations detailing the arrangement of all equipment should be documented, as shown in Figure 2.

Video monitors, waveform monitors, vectorscopes and other monitoring equipment should be located at eye level. Equipment requiring frequent adjustments should be placed no lower than waist level. Switchers, distribution amplifiers and other types of equipment that need little attention can be placed in the lower portion of the rack. Compromises are sometimes necessary because of thermal or electrical considerations.

Cabling considerations

Although cabling techniques vary from facility to facility, certain guidelines should be followed to avoid crosstalk problems.

Continued on page 36

Portable Partnership



When you're on the scene, you're in the air—with a cellular phone and a Comrex. Our PLXmicro converts telephone quality to program quality around town or around the world.

The PLXmicro is the tiniest extender we've ever built. Just about pocket size, it stows—and goes—almost anywhere.

Yet despite its size, it's packed with features: the Comrex frequency extender is built in, along with interface for cellular telephone or standard dial line. There are

microphone and tape inputs and automatic send level control.

A monitor decoder, hybrid circuitry and headphone output allow full duplex operation.

Call or write for a demo tape of the difference that a Comrex can make.

COMREX®

Comrex Corporation, 65 Norset Path, Acton, MA 01720.
617-263-1800 1-800-237-1776
Comrex UK, Ltd., 29 Kenilworth Road,
London W5 5PA UK 01-567-5128



**NEW
IMPROVED**

Varian EIMAC has taken the 3CX4500A7, with a proven performance record and by improving the design, developed the YU-148 hi mu triode—a 6000 W plate dissipation tube.

The YU-148 has been performance-proven and is currently in use in 10 kW FM transmitters. The YU-148 combines EIMAC's state-of-the-art technology, and cost-effective production, with a 5000-hour warranty—offering broadcasters the ultimate choice for their RF power requirements.

- Grounded Grid Triode Design
- Screen Supply Not Required
- Zero Bias
- No Need for Neutralization
- Efficient Forced Air Cooling
- Quick Warm-Up

These features, combined with EIMAC's reputation as the leader in electron tube development,

plus 50 years of serving the broadcast industry, are the reasons you should specify EIMAC.

Varian EIMAC
1678 S. Pioneer Road
Salt Lake City, UT 84104
(801) 972-5000

varian 
eimac salt lake division

**JVC's CHIP CAMERAS
LET YOU PLANT A
FOOT FIRMLY, IN ALL
THREE CONFIGURATIONS...
WITHOUT EVER
BREAKING STRIDE.**



With all their features, JVC's KY-20U and the KY-15U are steps ahead of the other chip cameras. In fact, they're a hop, skip, and a jump from studio to portable to camcorder configurations.

The easy-to-handle size and weight make them truly mobile one-man operations that walk tall in ENG/EFP environments. But handling is just part of the story. They are designed for rugged, durable use and have solid state pick-up systems that provide high levels of stability.

The KY-20U and KY-15U cameras are laced with features that give you that step in time when you need it. The KY-20U employs a $\frac{2}{3}$ " CCD to give you 380,000 pixels for a horizontal resolution of 530 lines while the KY-15U is designed with a $\frac{1}{2}$ " CCD for 360,000 pixels and a horizontal resolution of 500 lines. Both the KY-20U and the KY-15U have a signal-to-noise ratio of 58 dB. Specs which put you a giant step ahead in high quality video. When it comes to true

**FROM STUDIO
TO PORTABLE TO CAMCORDER...
JVC's 3-CCD CAMERAS, THE KY-20U
AND KY-15U...THE PERFECT FIT!**



flexibility, mobility and capability these CCD cameras far outpace the rest of the field.

The KY-15U can dock directly with the BR-S410U, S-VHS recorder. The KY-20U can dock with the KR-M260U, MII recorder (with the optional KA-M20U adapter), and in studio or portable configurations will integrate with a variety of formats.

This is only a small part of JVC's Chip Camera story. When your programming calls for a high-mobility camcorder, high-resolution portable and high-performance studio camera, plant your foot firmly in all three configurations with JVC's KY-20U or KY-15U Chip Cameras. You'll feel comfortable with JVC because providing you with your exact needs is a shoe-in.

For literature or a camera-in-use demonstration call toll free: 1-800-JVC-5825. JVC PROFESSIONAL PRODUCTS COMPANY, 41 Slater Drive, Elmwood Park, New Jersey 07407.



JVC[®]

**ALWAYS A STEP AHEAD...
TO KEEP YOU A STEP AHEAD.**

Circle (21) on Reply Card

Continued from page 32

Power lines should not be run parallel to any cable containing video, audio or control signals. When power cables need to cross signal cables, they should be perpendicular to each other to reduce pickup of ac hum.

Control lines to remote locations often run digital data at high speeds. When control lines are cabled with signal lines, crosstalk into the video can result. These "computer-type" lines should be bundled and run separately from video and audio cables. Neatly bundled cables will improve overall aesthetics and make it easier for a troubleshooter to locate individual cable.

Pull extra cables along with dedicated cables. These may be used when a new piece of equipment is installed or when an output needs to be checked by a scope in some other area of the facility. Spare cables may be dedicated to switcher inputs to provide flexibility in routing any signal to any place through use of patch panels. For obvious reasons, it is important to fully document any spare cables.

Sufficient service loops must be provided in all cables so that equipment will be accessible for replacement or repair. The service loop should be long enough to allow the unit to be pulled forward on rack slides. This permits the device's top

panel to be removed for tests while still connected to the remainder of the system.

Patchbay layout should be straightforward and logical. A good patch panel layout allows a new operator to learn the routing quickly. Start at the top of the panel, and label all rows to the bottom. Then label each connector from left to right. The patch panel should contain all input and output source signals within the room.

Grounding

Ground loops are caused mainly by equipment not being bonded to the same ground potential, resulting in hum or artifacts in the video quality. Eliminating ground loops within a facility can be a nightmare, even for the most seasoned engineer. A different ground loop occurs when equipment racks are not sufficiently grounded to each other or when one bay of equipment is not grounded back to the central ground in the same manner as another bay.

To ward off such problems, bolt racks together to ensure a good electrical contact. Remove paint where bolt and star washers secure the racks. A star method of routing ground wires from a building central ground bus to different rooms provides an equal path for return currents, reducing

the possibility of different ground potentials. Each set of racks (no more than three per set) should be tied directly to the facility's central ground bar with at least a No. 10 solid conductor wire. Daisy-chaining the ground cables from rack to rack may result in insufficient grounding, causing hum in video signals.

Before finalizing the design, monitor the ac power line for spikes and erratic voltages for at least 48 hours. This test will identify spikes and high or low voltages that may damage equipment. Only then will you know if a line conditioner or uninterruptible power supply (UPS) is necessary.

Many experts recommend that a UPS be dedicated to any equipment that may lose data in the event of a power outage, such as graphics systems. If equipment is vulnerable to line noise, a line conditioner usually is adequate to avoid system malfunction.

Future expansion

Fight the temptation to cut costs when designing the building's power-distribution system. It's easy to undersize ac power systems, thereby risking future overloads as more equipment is added to a facility. Provide adequate circuit boxes with room for future additional breakers. Use oversized



Technically speaking, the PHANTOM is a VTR Emulator that allows video editing systems control of audio transports. It accepts information from virtually any video editing system via the RS-422 interface and provides parallel information to the audio transport. Designed around a high speed microprocessor, the PHANTOM has the capability to provide control of up to four events and will even interface U-Matic type VCR's with video editing systems designed for 1" VTR's.

To get the conversation going in your editing suite, contact CIPHER Digital today!
Call (800) 331-9066

Before The Phantom

These Two Weren't Speaking

But now, the video editing system communicates beautifully with the ATR, thus eliminating the need for an expensive audio suite. And all the credit goes to the unique, new PHANTOM from CIPHER Digital.



cipher digital, inc.

P. O. BOX 170/FREDERICK, MD 21701
(301) 695-0200 TELEX: 272065

Timely today, consistent with tomorrow.

Circle (22) on Reply Card

The Abekas A53-D Special Effects with Key Channel and WARP

The acclaimed A53-D digital 3-D effects system has added an optional Key Channel to meet even the most demanding key processing needs.

The Key Channel lets you do everything under the sun. Manipulate irregular-shaped objects in 3-D and key them over other pieces of video. Position key signals horizontally and

vertically. Freeze them independent of the video. Soften their edges and change polarity. And you can even generate drop shadows of any color or transparency, and position them wherever you want.

All A53-D features can be combined with the Key Channel in the key mode as well as the drop shadow mode. WARP shapes—including page-turn, circle, cylinder, split, etc.—can now

have colorized and transparent drop shadows.

To overshadow your competition, add the A53-D Key Channel. For details, contact Abekas Video Systems, 101 Galveston Drive, Redwood City, CA 94063. (415) 369-5111.

Circle (23) on Reply Card

Abekas

Video Systems, Inc.

Now Anything is Possible.

A53-D Key Channel casts a giant shadow

See us at
SMPTE Booth 1870



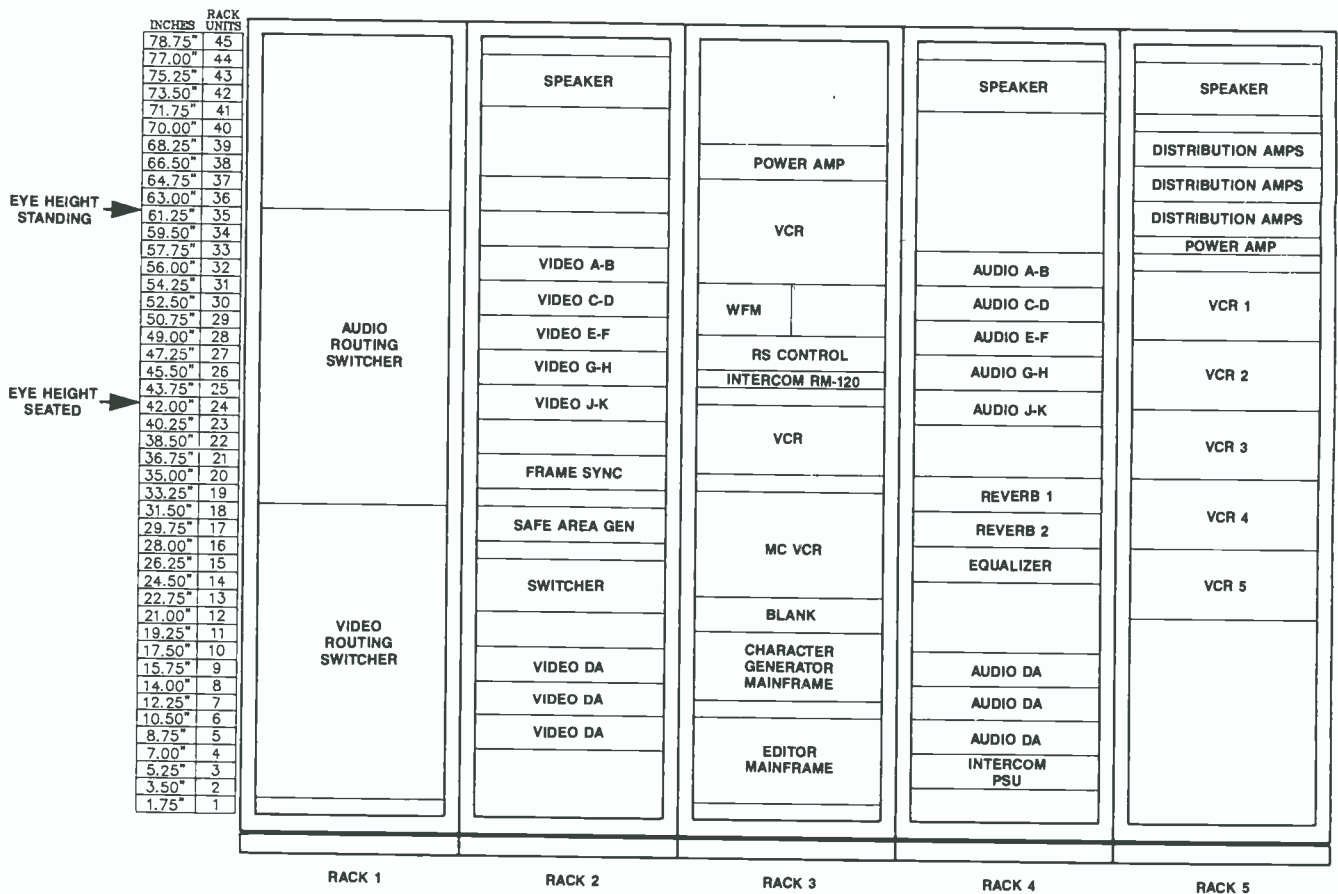

Figure 2. Rack elevations will aid in determining equipment groupings for heating and cooling calculations. Placement of equipment should reflect good ergonomic design.

conduit when possible so that more cable can be accommodated when it is needed.

A facility's intercom system is extremely important to effective communication. A common mistake is to underestimate the number of intercom stations and channels needed. A multichannel matrix system may be used to link, by application, various groups within a facility. Channel matrices allow multiple inputs to be assigned to any group where communication is not affected by other groups. Consult with professional intercom companies when a sophisticated communication system is needed.

New video standards such as D-1 and D-2 are enhancements that may not be implemented in a new facility at the outset. Even so, such future developments should be considered if expansion into digital video is a possibility.

The proposed D-2 composite digital format can be incorporated easily into an NTSC composite facility or station with current cabling. New D-2 equipment will accept the composite analog signal and supply a digital, bit-parallel signal as an output. Care should be taken to use the proper type of cable for all digital signals. A shielded, low-capacitance cable will prevent high-frequency digital signals from ra-

diating into other cables or equipment.

The D-1 digital component format presents a different problem for a facility upgrade from the analog composite realm because of the number of cables required. Along with sync, the Y, R-Y and B-Y signal components must be routed throughout the facility.

A facility planner should anticipate entry into the digital arena by allowing space for these additional cables. Cable troughs should be extra large to handle growth of not only additional machines, but also the extra cables needed for digital formats.

The quality of the coaxial cable must be addressed before installation to avert the possibility of radiation leakage caused by the high-frequency sampling rates used in digital video. The sampling rate of the D-1 Y channel is 13.5MHz, and each of the color-difference components (R-Y and B-Y) is sampled at 6.75MHz. The D-2 sampling rate is 14.318MHz.

Coaxial cables also are used to carry high-frequency digital signals operating from 100Mb/s to 270Mb/s. With the advent of digital HDTV, even higher data rates will be transmitted.

The parallel, digital cable uses low-capacitance conductors suited for high-frequency transmissions. Low capacitance is

achieved by using twisted pairs. A foil shield reduces signal leakage. Metal connector housings are connected to a drain wire within the cable, establishing sufficient grounding between two pieces of equipment.

Although cables with a loosely woven shield may work properly under NTSC standards, they allow energy to radiate at higher frequencies. To prevent energy loss, be careful to use coaxial cable with a tightly woven shield or cable that is double-shielded. Attempting to reduce costs through the use of inexpensive cables may lead to later crosstalk problems.

Another signal-distribution method to consider is fiber optics. As fiber-optic costs continue to decrease, this technology will provide a competitive means of routing and distributing video and control data in the future. Multiple signals can be transmitted simultaneously on a single fiber cable, which means fewer cables may be required.

As you plan and implement the designs, forethought will help you prevent costly mistakes. Your new or upgraded facility will be able to grow as necessary technical changes are incorporated, without unfortunate surprises to management and the corporate budget. [:-:-:-)]

Your next news story could be on any satellite, in any format.

With MAT, you'll have it in seconds.

MAT gives you unprecedented access to any satellite, at any time. So if you want to monitor an uplink from anywhere in the country, you can do it.

With MAT, once your system has been pre-programmed, all you do is punch in your chosen name for the feed—MAT takes care of the rest: antenna position, frequency, polarity, C- or Ku-band, full/half transponder, and other parameters. So whether it's a feed you receive regularly, or a new one you need to pick up with just a few minutes notice, MAT saves you valuable time.

You can schedule MAT in advance to automatically recall pre-named setups, including contact closures that activate ancillary equipment.

MAT can also be located away from your station to avoid C-band interference, and controlled remotely through a computer dumb terminal via phone line or STL link.

Meets tough broadcast specs.

MAT was designed for use in the professional broadcast environment, so it meets or exceeds all RS 250B specs. And in addition to a normal

video output, MAT provides an AGC'd output that maintains a constant level, regardless of source deviation.

There are a number of options with MAT, including terrestrial interference traps that can be programmed for use on just those channels that demand it, and your choice of a 3.66, 5, or 7 meter antenna, with either a motor-driven el/az or polar mount. And as always, we'll be happy to work with you to meet any special requirement you may have.

Turn-keyed by Microdyne.

Each MAT system is installed, calibrated, and serviced by Microdyne, so you're assured of a dependable

system that will deliver the reliability and performance we're known for, backed by one of the most responsive service departments in the industry.

Call us today for more information on the most flexible downlink system available anywhere—the only system that can guarantee access to any commercial satellite, at any time.



MAT is quickly and easily controlled through its front panel keypad or remote terminal.



Microdyne Corporation

P.O. Box 7213, Ocala, FL 32672
(904) 687-4633 • TWX: 810-858-0307

Circle (24) on Reply Card



Distributing audio-video signals

By Richard Maddox

Begin planning now for your future audio and video distribution system.

It wasn't so long ago that audio and video distribution systems in most facilities didn't warrant much attention. If a component failed, that part was simply replaced. If tape machines or audio sources were added, more distribution amplifiers may have been added. But the distribution-system philosophy at most stations was, "If the system still works, why replace it?"

With the advent of stereo TV audio, the philosophy has changed. Transmitting stereo audio means that new patchbays, wiring systems and distribution amplifiers (DAs) must be added. Many other devices, such as switchers and mixing consoles, must be replaced or modified to accommodate the need for stereo audio and SAP channels.

It is not surprising that the cost of converting to stereo has forced many stations to delay making video distribution changes for the immediate future. The delay tactic is especially significant in light of the various new video signal formats that are being proposed.

DA basics

In theory, a video or audio DA isolates

a source from one or more loads. The DA presents a constant load to the source and presents a low impedance to the switcher, tape machine, amplifier, monitor or other load connected to it.

Without a DA to isolate the source and loads from each other, the video and audio

output levels will shift as the parallel impedances loading the output are switched in and out. The resulting impedance mismatch also can cause video ringing, audio hum and distortion, degradation of signal-to-noise (S/N) ratio and frequency-response changes in both audio and video signals.

The IV P-P composite NTSC video signal is still the standard, and it probably will remain so for the near future. However, new video formats are becoming more common in production houses and newer broadcast plants. Betacam and M-II are the most widely used new formats, but the digital formats—D-1 and D-2—and several extended-definition formats also are coming.

Digital (both component and composite), analog component and extended-definition signals are either incompatible, or only marginally compatible, with today's 6MHz to 8MHz video-distribution systems. Manufacturers are aware of these factors and are now making DAs with 30MHz bandwidth. These DAs often are referred to as being ATV-, HDTV- or digital-ready.

Two design approaches

Video and audio signals can be distributed throughout a broadcast plant in two ways.

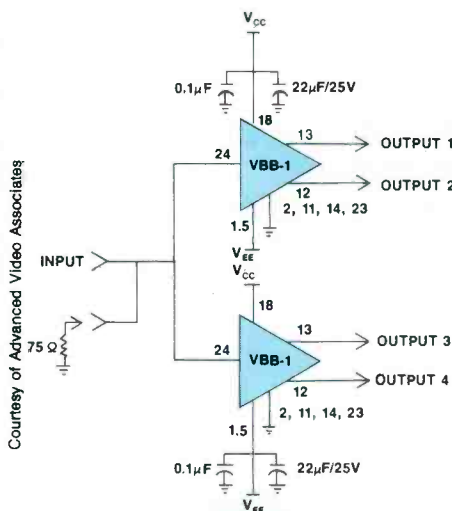

Courtesy of Advanced Video Associates

Figure 1. New integrated circuits permit up to 75MHz bandwidths on video DAs. This chip makes it possible to build a 1-in, 4-out video DA with only a handful of parts.

Maddox is a service technician and free-lance technical writer in Lynnwood, WA.

Give it your best shot with Ampex.

There are two kinds of videotape companies.

Those who commit all their efforts, resources and research to the video professional.

And those who don't.

Ampex is totally committed to the professional market. Which means we have to be dedicated to providing the best products and service in the business.

Our commitment begins with Ampex Process Management—an advanced quality program that assures you unmatched consistency. So you can count on superior picture quality. Tape after tape, year after year.

And we give you this exceptional dependability in over 100 configurations for commercial and broadcast production to electronic news gathering and corporate training.

And as hardware requirements change and new formats emerge, Ampex research and development ensures that you're always covered for the future.

Ampex's dedication to the professional also includes full technical support, immediate deliveries and the most personal service in the industry.

If Ampex sounds like your kind of videotape company, get in touch with us soon. Because anything less could be just a shot in the dark.

AMPEX

It's your best shot.

Ampex Corporation
Magnetic Tape Division
401 Broadway
Redwood City, CA 94063
(415) 367-3809

Circle (25) on Reply Card

One approach couples the source directly to a master routing switcher, which then feeds the various loads. The tape machines in this type of installation typically have short cable runs (less than 100 feet). The machines can be tied directly to the switcher without the need for any DAs. The design relies on the master switcher to provide the isolation. Sometimes, if a large number of feeds are required, multiple DAs are placed *after* the switcher.

In the second approach, facilities that have several production routing switchers in addition to a master-control switcher often use a DA on each source. The signal is then split and distributed directly from the tape machines to the various switchers and loads. This method requires a DA for each tape machine or audio source.

In either design, when the distance from the source to the switcher exceeds approximately 150 feet of standard 8281 or RG/11 cable, an equalizing DA is advisable to ensure proper high-end (color) response. Some EQ DAs can compensate for cable runs of up to 5,000 feet, but at that distance fiber-optic systems may be preferable.

If the switcher will have the same signal on two inputs—one being routed through another switcher or other effect, and the other being direct from the source—the two signals must be in phase and properly timed. A delay line is used to match the phase and to prevent timing discrepancies during switching. Some DAs provide adjustable delay times. In most cases, it is easier to calculate the delay required and insert a precision fixed delay into the signal line.

Other adjustments seldom are performed on the video signal while in the distribution chain. Occasionally, DAs with level controls are used, but because virtually every source already has an output level control, this feature is redundant.

New DA features

Equipment manufacturers continue to

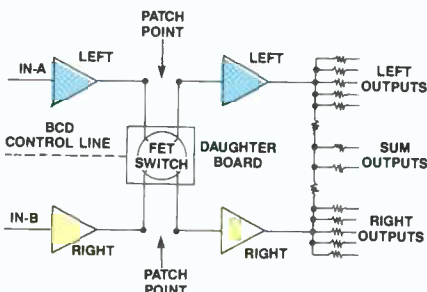

Figure 2. Stereo distribution amplifier card. Each channel's signal path is interrupted after the input buffer, but before the output line driver. An optional daughterboard, controlled via BCD signals, permits the audio to be specially configured to stereo, inverted polarity, mono sum or matrixed.

provide new DAs with more features. The question is: Do you need them? The most useful new features are the improved slew rates and wider bandwidths. Slew rates of $100V/\mu s$ for video and $13V/\mu s$ for audio DAs are now available.

Headroom also is being extended. This is especially important for audio DAs now that many tapes operate at +8dBm. Although a +24dBm maximum output level is typical for today's DAs, some devices are capable of +30dBm.

Many newer video DAs offer 25MHz to 30MHz bandwidth, in anticipation of advanced or extended-definition NTSC-compatible (ATV) signals. The 25MHz-wide bandwidth is sufficient to handle all the currently proposed ATV and HDTV formats as well as computer graphics signals. Some DAs, such as the one shown in Figure 1, are capable of even higher bandwidths—as much as 75MHz. Many of the new video DAs also can be used for data transmission rates as high as 15Mb/s.

New audio DA designs also incorporate auxiliary features. Items such as LED level, clipping and signal-present indicators, front-panel headphone jacks and higher-wattage outputs now are found on many designs. Some DAs even incorporate gated compression, which is ideal for talk shows and live audio feeds.

Space- and budget-saving combined video and stereo audio-follow DAs are available for 1/2- or 3/4-inch production and duplicating facilities. Although expensive, component digital DAs are available that distribute full 10-bit data paths meeting CCIR 601/SMPTE RP125/EBU 3246E recommendations.

Stereo audio "looks" better

Audio is finally getting the attention it has long deserved. In fact, at least one study indicates that stereo audio even

seems to improve your *picture*. In one test, viewers were asked to compare the quality of a video system operating in two different modes. The picture was not changed during the test. The only difference was that the sound was switched from mono to stereo. Most of the viewers said the *picture looked better* after the change.

Of course, viewers with monaural receivers won't perceive any difference when a station goes stereo. If, however, the station were to make a mistake and transmit the stereo signal out of phase (which can happen), monaural viewers would *hear* the difference.

Monitor carefully

TV engineers are finding that converting a room with one center-mounted speaker to one with two speakers for stereo is not quite as easy as simply adding a second speaker. The room itself becomes an important factor. Stations producing stereo studio audio also are discovering that mixing for stereo requires special consideration.

Once a TV station announces it is broadcasting in stereo, there is a great incentive to keep the receiver's MTS light on. However, because much of today's programming still is monaural, most stations have to rely on the use of stereo synthesizers.

Unfortunately, the large majority of sets still are monaural. For this reason, many stations find that monitoring in mono is essential to ensuring high-quality audio. Using a phase meter and periodically monitoring the summed signal will ensure an accurate and balanced mono signal. It is sometimes tough to maintain the extra effort, knowing most of your audience still is listening in on single 4-inch speakers.

Audio standards

Distributed audio is not as standardized

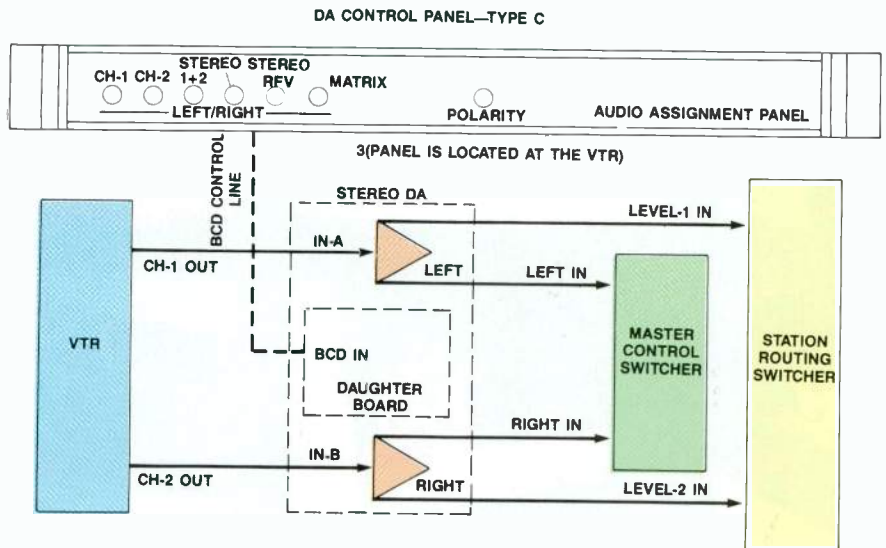

Figure 3. Signal and control flow for the stereo channels of a typical 2-channel program source.

One tape makes every production a commercial success.

You've shot 30 takes and everything has to be perfect. Including the tape.

With Ampex, you always get your best shot. You don't have to worry about dropouts, mechanical problems or other glitches that force you to settle for second best.

Because Ampex Process Management, our exclusive quality program, gives you total consistency. And total confidence.

Ampex delivers the right features, too. Like precision reels for low vibration and accurate tape winding. And ABS plastic cassettes with molded-in antistatic protection that minimizes dust, debris and other contaminants.

Of course we're saving our best shot for last. It's our service—full technical support, immediate deliveries and the personal attention of your Ampex representative.

So don't take chances. Shoot with Ampex. And make every production a success.

AMPEX

It's your best shot.

Ampex Corporation
Magnetic Tape Division
401 Broadway
Redwood City, CA 94063
(415) 367-3809



Circle (26) on Reply Card

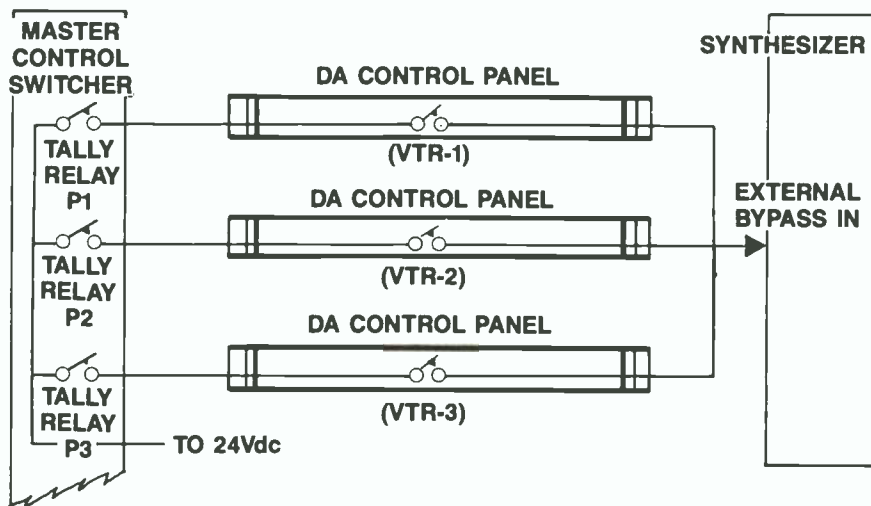

Figure 4. The stereo synthesizer is controlled from the switcher's tally signal routed through the appropriate VTR DA control panel.

as video. Today's audio DAs typically are capable of a maximum +24dBm balanced output, which provides adequate headroom for even the hottest tapes. However, many of the older DAs were designed for operation at a nominal 0dBm with a +10dBm maximum output level. Attempting to pass a nominal +8dBm tape signal through these systems can create distortion unless the audio level is attenuated substantially before it hits the DA. Doing so, unfortunately, also destroys much of the S/N ratio that the +8dBm level was designed to improve.

The one area that everyone used to agree on was the audio output impedance of professional gear—600Ω, balanced. This impedance was a carry-over from the telephone industry and from vacuum tube days.

Today's foil-shielded cable, however, exhibits a characteristic impedance of under 100Ω. Typical equipment output impedance is often quite low, perhaps 40Ω. Research shows this to be the optimum impedance to drive foil-shielded audio cabling. The lower impedance means that approximately 14dB less noise is picked up in the cabling. In addition, less power is drawn from the source, and cable runs can be up to 10 times longer than a 600Ω impedance system before high-frequency compensation is required.

Example MTS DA system

When a station decides to transmit stereo audio, there probably isn't any provision for distributing stereo audio. Two choices are available at that point. The current system can be rebuilt using a new patchbay and distribution system. Or, a second set of DAs and cable can be installed parallel to the current system.

WGN-TV, Chicago, is a good example of

a facility that has converted to stereo operation. The station's story was presented by WGN engineer, Rick Craig, at this year's NAB engineering conference. The paper outlined the seven goals set forth before the facility was redesigned:

- Easy system maintenance.
- Ability to route any stereo source to air.
- Ability to air any incoming feed (satellite, microwave or other remote feed) in stereo and/or SAP.
- Ability to place on-air any stereo playback machine.
- Flexible in-house routing of stereo signals for recording and dubbing purposes.
- Ability to generate and separately route the SAP feed.
- Ability to detect and correct routing, level and polarity errors with ease.

WGN developed several in-house conventions for both operations and equipment selection in order to accomplish these goals. The station decided to use a unity gain, 60Ω source and high-impedance load DA system.

All level adjustments are made at the source, as are decisions about the format of the stereo and SAP signals. The station decided that discrete left and right channels would be standard, with a third audio channel for SAP. A diagram of the stereo distribution card is shown in Figure 2.

Matrix distribution was not used for two primary reasons: a matrix decoder would be required at each monitoring site, and maintaining proper channel separation would be difficult because of the normal variances in the sum and difference channel levels that would occur in a distribution system.

The control panels at each program source (incoming microwave, satellite and tape machine) are used to reverse the left and right channels as well as to invert the

polarity as needed; to sum the left and right channels; and in some cases, to control the signal level via a VCA in the selected DAs. (See Figure 3.)

Like other stereo stations, WGN uses a stereo synthesizer on monaural program material. It can be switched in or bypassed by using the external control input on the synthesizer. The station's engineers found that the automatic sensing circuits on the synthesizers they evaluated were inadequate. Therefore, they decided to rely instead on manual control.

The solution, shown in Figure 4, relies on the master control switcher tally signal. The tally signal from the switcher is routed to its respective DA control panel. If the DA control panel has selected stereo operation, the voltage is routed to the synthesizer, which is then by-passed. If the DA panel is set for a monaural source, the contact is opened, and the stereo synthesizer is turned on.

The facility was wired in anticipation of future innovations. All inputs of the house routing switcher were connected, as was a separate BCD logic control system (for the control panels at each source). This advance planning will simplify future expansion.

Look to the future

Because distribution systems, historically, remain in place long after other equipment is updated, it is logical to think as far into the future as possible. A major task, such as converting to stereo, can accommodate not only the need for stereo audio, but also can lay the groundwork for possible future projects such as automation and digital audio.

Bibliography

Craig, Rick. "A Long-Term MTS System Design for the Broadcast Studio Facility." *Proceedings of the 1988 NAB engineering conference.*

[:(->)]

The best tape to pass on to future generations.

There's only one thing more important than a tape stock that gives you highly saturated colors, rich, clean sound and consistently low dropout performance.

A tape that stays that way through multiple generations of editing.

Ampex gives you both.

Our tough, crosslinked copolymer binder system delivers superior durability through hundreds of shuttles and edits. Minimizing dropout buildup and ensuring excellent picture quality. And Ampex Process Management, our exclusive quality program, guarantees exceptional consistency in every master.

You can also look forward to the most consistent service in the industry. Including full technical support, immediate deliveries and the personal attention of your Ampex representative.

So if you want the images you edit to be the best they can be, get in touch with Ampex. We'll keep your work fresh and bright. For many generations.

AMPEX

It's your best shot.

Ampex Corporation
Magnetic Tape Division
401 Broadway
Redwood City, CA 94063
(415) 367-3809



Circle (27) on Reply Card

The science of close-field monitors

By John Eargle

Your product is reaching thousands of ears right now.
Do you really know how it sounds?

Practically every recording and production studio is equipped with close-field monitoring. It allows an engineer to determine how the resultant mix will sound on domestic-style speakers and to provide a detailed analysis of the stereo balance. What are the criteria for selection of such monitors, and how should they be located in the control room?

Most studio control rooms have elaborately built-in monitor systems that are bi- or tri-amplified and carefully equalized to match a given response contour. As good as these systems are, they often are turned off in favor of a pair of small, 2-way loudspeakers, usually mounted on the console's meter bridge.

The large monitor loudspeakers may be the reference during original recording and overdubbing, but when it gets down to the fine detail of the final stereo mix, it is a good bet that the little ones will be used. The reason for this is simply that in a highly competitive music marketplace, neither producer nor engineer wants to leave any detail unchecked when it comes to the actual balances that the public will hear.

Some definitions

The practice is known by several names, including *near-field*, *close-field*, *free-field* and *direct-field* monitoring. Because the term Near Field is trademarked (by Ed Long and Associates), this article will refer to this kind of monitoring as close field. What do these terms mean in the first place, and why do engineers like to monitor a mix in this way?

Close field has a precise meaning in acoustics. Imagine any kind of acoustical source in an environment completely free of reflections. An anechoic chamber will do, or you can imagine that the source is simply located on a tall pole outdoors.

The source is approached from a suffi-

cient distance, and each time the distance is halved, the sound-pressure level increases by 6dB (thanks to the inverse square law). As you get closer to the source, however, the level does not quite double with each halving of distance. Instead, it varies unpredictably. At that point, you are in the close field of the source.

The companion term is *far field*, which describes the range over which inverse square relationships are applicable. As a practical matter, it can be said that an observer who is located at a distance of more than four times the longest transducer array dimension of a speaker system is effectively in the far field of that loudspeaker.

For a single 5-inch cone loudspeaker, then, an engineer located three feet away will be well into the far field. But if the loudspeaker is a 2-way design with an 8-inch woofer and a dome tweeter, where the longest transducer array dimension is about one foot, then the listener will be in the transition region between close fields and far fields.

With normal console distances, it is clear that the term close field may or may not apply, depending on the size of the loudspeaker in question. In some cases, the large, soffit-mounted monitors may occupy

so much surface space that an engineer seated at the console actually may be located in *their* close field.

Technically speaking, a more accurate term may be free-field monitoring because it defines a region, independent of close and far fields, in which direct sound from the loudspeaker predominates over reflective sound. This condition is probably the one that most engineers would agree is ideal. However, let's stick with close field as the operant term.

Advantages of close-field monitoring

One advantage of listening to a trial mix over a small pair of close-in loudspeakers is that the speakers probably are limited in how loud they can play. As a result, the engineer and producer are forced to monitor their product at a lower level, and certain loudness-level spectral changes may become significant. The Fletcher-Munson or Robinson-Dadson equal-loudness contours, shown in Figure 1, illustrate this concept.

The engineer and producer could just as well listen on the larger, soffit-mounted monitors, but that might not tell the whole story. Small, close-field monitors undoubtedly will be bass-shy compared with the larger ones, and that will contribute to bass imbalances too.

In any event, the producer and engineer will gain a better idea of how their product will sound over small sets and auto stereo systems in the field. This is particularly important to know, especially with regard to apparent bass and vocal balances.

Another important aspect has to do with the complexity of the mix. With today's digital recorders, superb microphones and high-resolution monitor loudspeakers, a complex mix can be produced that sounds excellent over the large monitors. When the mix is reproduced over the smaller ones, however, it might become apparent that certain details in the music have been lost, because of the lower resolution of many small loudspeakers.

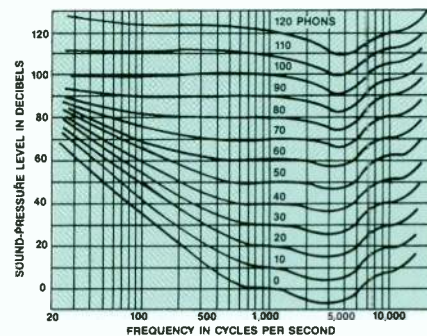
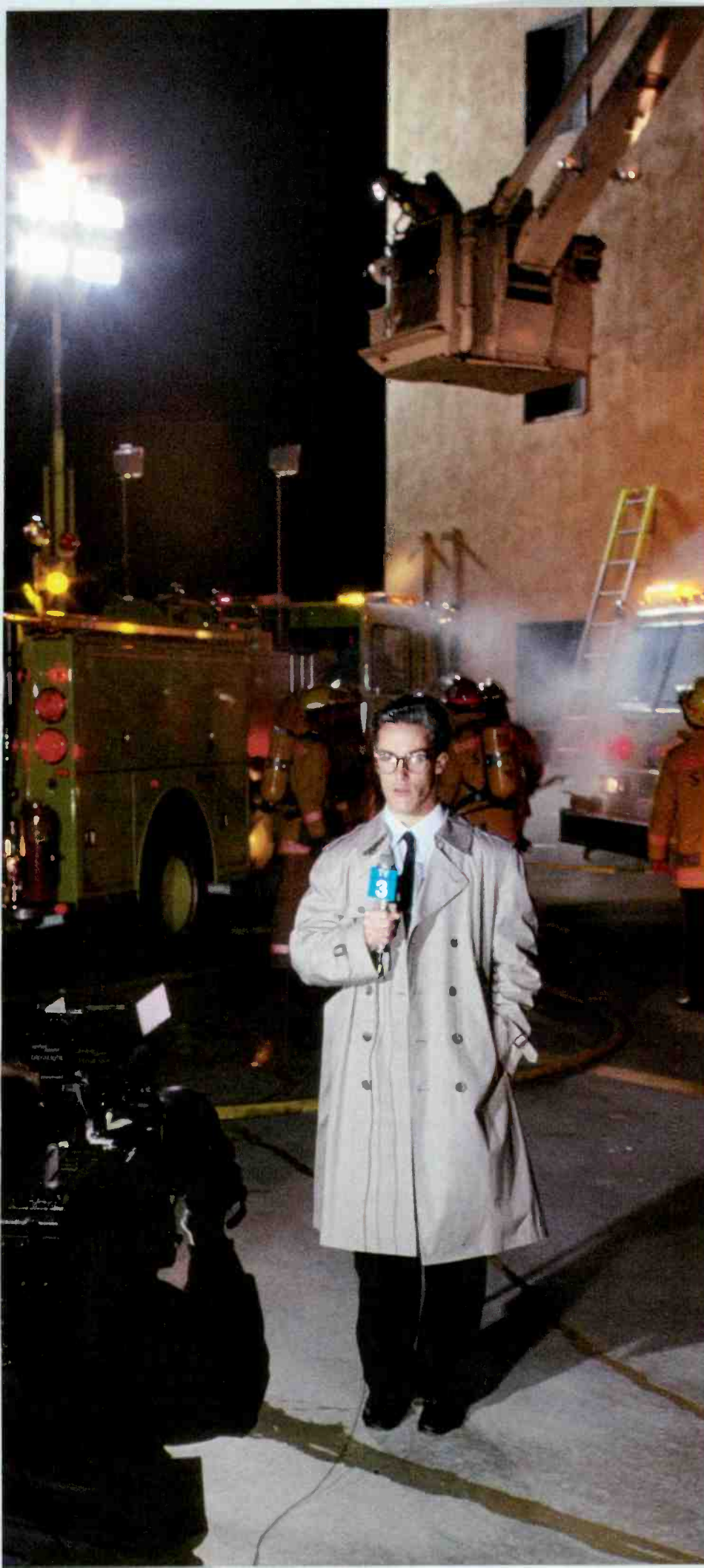

Figure 1. The Fletcher-Munson curves depict the change in the human ear's response to different frequencies as the acoustical level varies.

Eargle is president of JME Consulting Corporation, Los Angeles.



One tape consistently gets good reports.

When you've got to get the story in one take, you've got to get Ampex.

It's the tape professionals rely on to cover everything from four-alarm fires to world class sporting events.

That's because we designed it to withstand the tortures of heat, humidity and freezing cold.

And deliver fully saturated colors and rich, clean sound with minimal dropouts, tape after tape. Thanks to Ampex Process Management, our exclusive quality program.

So you can concentrate on great shots instead of worrying about your tape.

Another Ampex exclusive is our convenient labeling system which helps you keep detailed, accurate shot lists as you go.

And we always give you full technical support, immediate deliveries and the personal attention of your Ampex representative.

So when you've only got one shot at a story, cover it with Ampex. Anything less could be bad news.

AMPEX

It's your best shot.

Ampex Corporation
Magnetic Tape Division
401 Broadway
Redwood City, CA 94063
(415) 367-3809



Circle (28) on Reply Card

The engineer and producer then have the option of going back and making a mix that really is tailored to the smaller loudspeakers. All other factors being equal, it probably will sound better on the lower-resolution players used by typical consumers.

Performance parameters for close-field monitors

Close-field monitoring has been around for several years, but it has become a vital link in the production chain in only the past five years or so. Early loudspeakers used for this purpose were apt to be rather choppy in response. In time, engineers and producers demanded smoother response, and 2-way systems with 8-inch woofers were developed by many manufacturers.

Following are some guidelines for the selection of a close-field monitor.

- **Frequency response:** Look for uniformity from about 70Hz to 20kHz. The response through the midrange should be especially smooth.
- **Array size:** A 2-way vertical array is preferred because the longest array dimension can be held to about one foot if an 8-inch woofer is used. Under these conditions, the engineer will be in the transition region between the close and far fields, and will not readily perceive the sound as coming from both high- and low-frequency sources.

- **Sensitivity and power handling:** Most of the units in favor today have basic sensitivities in the range from about 87dB to 92dB, 1W at 1m. The actual sensitivity is not too important, as long as the model has enough power-handling capability and available amplifier power to reach the required levels cleanly. Tastes vary all over the place, but a pair of close-field monitors should be capable of reaching levels of 95dB at the engineer's position with no distress.

- **Dispersion:** Although controlled horizontal dispersion is an attribute in any loudspeaker, it is relatively unimportant in this application, provided the on-axis response is smooth. Because the monitoring setup usually is optimized for one listening position, the principal axis is aimed at that location.

The vertical arraying of high- and low-frequency elements is the preferred orientation, in that it produces the most accurate and stable stereo imaging. However, some engineers prefer to place the loudspeakers on their sides, with the tweeters in-board. This orientation has the disadvantage of producing response lobing in the horizontal plane, making it more difficult to position the ideal listening spot.

- **Time-domain response:** This is just as important here as in any other application. Usually, small bookshelf systems are not a problem because they normally satisfy the Blauert and Laws criteria for accept-

More on sound fields

The relationship between close and far fields is shown in the accompanying illustration. As stated in the main story, an observer who is more than about four times the longest transducer array dimension away from a loudspeaker is in the far field. That transition point is shown by the vertical dashed line to the left in the drawing.

The far field extends from that point outward, and the transition region between close and far fields is strictly a function of the dimensions of the sound source.

The upper portion of the figure shows the familiar relationships between the free (direct) field and the reverberant field. The transition region between these two fields is shown by the vertical dashed line to the right in the drawing. That region is defined by both source directivity and room absorption.

Most control rooms do not have a reverberant field, statistically speaking. However, considerable indirect sound from the big monitors at the engineer's position may come by way of side and back-wall reflections. In some control rooms, the reflected sound may be just

about equal in acoustical level to the direct sound from the big monitors. If the monitors are large enough, the listener might be in both the close field of the loudspeakers and in the reflected field of the room. Things are not always simple.

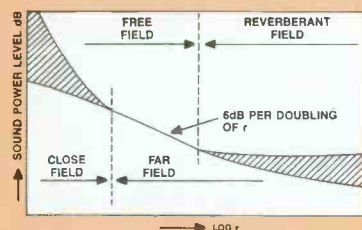

The variation of sound-pressure level in an enclosure along a radius r from a typical noise source.

Acknowledgment: Diagram courtesy of "Noise and Vibration Control," by Leo Beranek, New York, McGraw-Hill, 1971, p. 141.

able response group delay.

Control-room installations

Close-field monitors never should appear to be an accommodation or an afterthought. In fact, they are an essential part of the recording process, and they should be implemented in a professional manner.

A set of sliding platforms should be made for the console meter bridge so that the loudspeakers can be located easily for the engineer or producer. Select reasonably heavy-gauge wire to hook them up, and use professional connectors. A separate amplifier to drive the close-field monitors should be chosen to deliver the peak power for which the systems are rated. Be prepared to replace burned-out monitors quickly; have a backup pair on hand.

Different speaker models should be made available for quick changes. Always say yes when a producer suggests something you don't already have, and be ready to accommodate whatever equipment a producer or outside engineer might bring.

Electrical switching between the close-field and main monitors should be positive and easily accomplished. (Some studios have gone so far as to make sensitivity matches between the close-field and main monitors for the benefit of producers and engineers who don't want to be blown out of the room when the switch is made to the big monitors.)

An exception to the rule

On-location classical recording usually means the use of quickly installed monitoring setups in less-than-ideal spaces. The monitors usually chosen for this job are 3-way designs with 10- or 12-inch woofers, located about six or seven feet from the engineer and producer. It is essential that both engineer and producer perceive good imaging, which means that horizontal off-axis response must be uniform. This implies a vertical transducer array.

The loudspeakers should be no farther away from the engineer and producer than necessary to satisfy their mutual demands for good imaging. Otherwise, the loudspeakers should be as close as possible to maximize their direct fields, thereby minimizing room reflections.

Bandwidth should extend down to at least 35Hz for the recording of orchestral or organ music; this usually means that the systems will have sensitivities in the range of 87dB to 90dB, 1W at 1m. Generous amplifier power should be provided.

Because close-field monitoring is an important step in the production chain, it deserves more attention in implementation than engineers traditionally have given to it. Too often, it is accorded the same casual treatment that headphone monitoring receives, and you all know what kind of trouble that can be! If you've been treating close-field monitoring as an afterthought, think again. [:-)]



Beat the traffic.

M/A-COM opens up a new lane for broadcasters with our new 18GHz microwave system.

If you've been looking for an open frequency at 7 or 13GHz, you're not alone. In many areas, they simply aren't available: there's too much traffic and not enough spectrum.

M/A-COM's new 18GHz microwave system gives you another option: a wide-open band which the FCC has assigned to broadcast. It gives you 50% better link availability (or 40% longer range) than 23 GHz, and none of the congestion of the lower frequencies.

The MA-18CC is a fully-featured microwave system, designed to meet or exceed all RS-250B short-haul performance

specifications. It is field tunable, and a single gunn oscillator covers a wide selection of frequencies so spare parts can be kept to a minimum.

For over 20 years M/A-COM MAC has specialized in providing microwave radio equipment to broadcasters. Every unit with our name on it is built in our own factory, so we not only control the quality, but we know how to service it.

For more information on how you can streamline your microwave needs, contact M/A-COM MAC, Inc., 5 Omni Way, Chelmsford, MA 01824, (617) 272-3100.



Circle (29) on Reply Card

Get a sharper image...

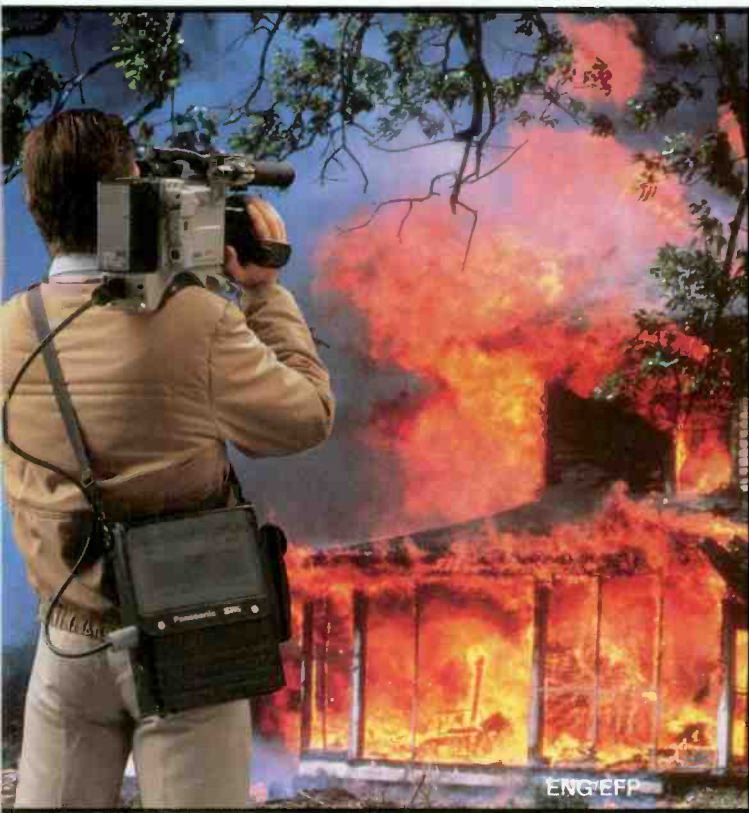

The SVHS format behind the Panasonic® Pro Series will change the way you look at half-inch recording systems. Because it delivers over 400 lines of horizontal resolution. At an affordable cost. So you can get a sharper image even as you sharpen your pencil.

In the field, the Panasonic Pro Series offers you a host of benefits existing formats fall short on. Like two hours of recording time on a single cassette with Hi-Fi audio capability. In a highly portable package. To capture more action and sound on fewer tapes. Which means you'll have less to carry in the field and on your budget. And the Pro Series easily interfaces with a variety of existing component or composite cameras and VCRs. So you can easily integrate the Pro Series in your present field operations.

For editing and post-production applications, the Pro Series takes full advantage of the SVHS format as well. With easy to use features and high performance capabilities. Such as digital framing servo circuitry to provide highly stable edits. And time code input/output facilities for frame accurate editing. The Pro Series edit-

ing VCR also features 7-pin dub capability to maintain component signal integrity throughout the system.

For studio production, Pro Series components are designed with flexible operations in mind. With VCRs and monitors outfitted for total systems application. And cameras designed for use both in the field and in the studio. To help minimize your investment without limiting your capabilities.

For duplication, Pro Series monitors and VCRs provide you with the convenience and versatility of half-inch cassettes. And the performance of SVHS. When duplicating, you can maintain excellent picture quality thru component or composite signal transfer. And dub Hi-Fi audio simultaneously with the video signal. There's even a Pro Series cassette changer to help increase the efficiency of your duplicating system.

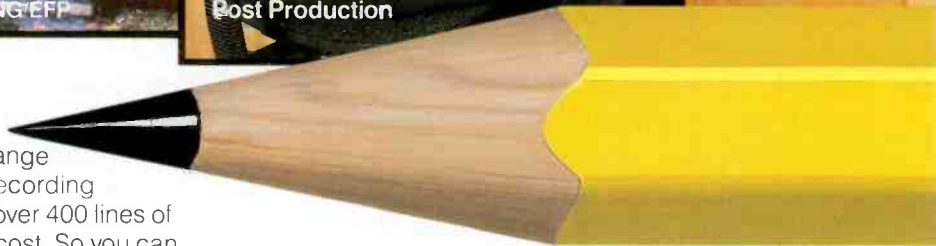

even as you sharpen your pencil.

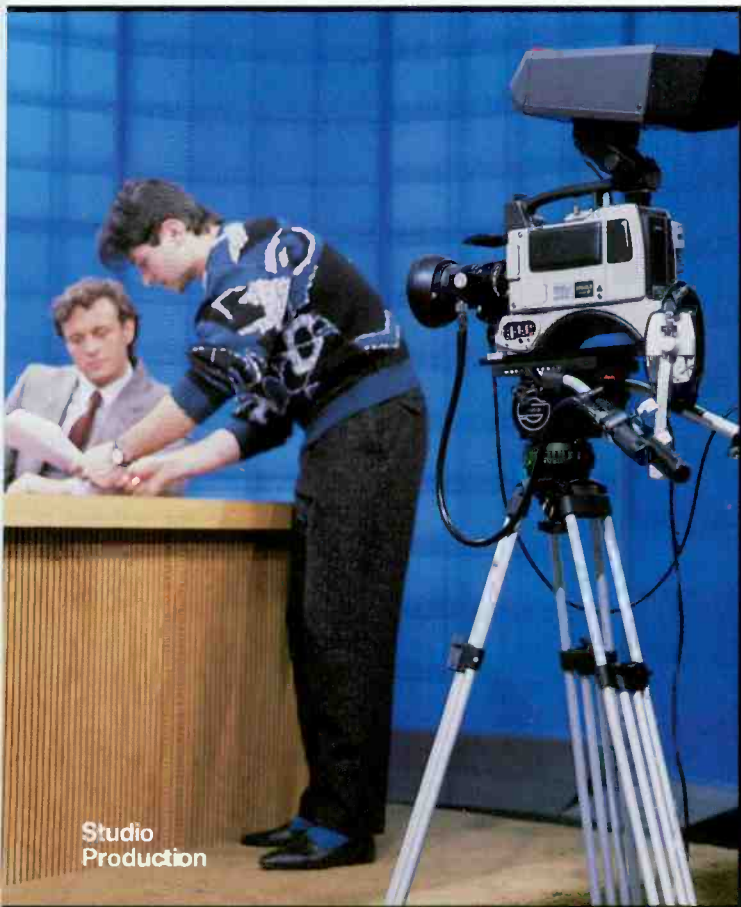

Studio
Production



Networking

Whether it be a small or large operation.

For video network applications, the Pro Series produces high quality images on both large projection systems and small screen monitors. With features like auto repeat playback for unsupervised presentations. And the system is upwardly compatible with standard VHS. So you can continue to use your existing library of recordings without any type of conversion.

Pro Series VCRs also incorporate a number of features designed for network automation. Such as video sensor recording. So you can transmit video programs to your network locations during off-peak hours. And save on both transmission and personnel cost. You can even interface Pro Series VCRs with computers for interactive training programs.

So whether you're looking for high performance field

recording, post-production, studio, duplication or networking systems. The Panasonic Pro Series can sharpen your image while you sharpen your pencil.

For more information, call Panasonic Industrial Company at 1-800-553-7222. Or contact your local Panasonic Professional/Industrial Video dealer.



Panasonic

Professional/Industrial Video

Broadcast satellites: making connections

By Rick Lehtinen, TV technical editor

A new era of satellite technology is on the horizon.

Space: the vast medium in which Earth and her sister planets whirl in their courses. But what is it really?

A vacuum, but certainly not a quiet one. The electrical noise of a million suns pounds through it. Although it has no at-

mosphere, it has solar wind, with storms of particles. Sailing chunks of long-ago planets, trapped by physics, are pushed and pulled inexorably by gravity and inertia.

So it is a vacuum with stuff in it.

Not long ago—just a blink backward in cosmic time—some of that stuff was ours. Sputnik came first. Following shortly after were SCORE, Telstar and SYNCOM, among others. Then came Early Bird, which nearly doubled the number of phone circuits across the Atlantic. Pictures could fly, too, as well as phone calls. The satellite era of broadcasting had begun.

Making the rounds

Early satellites arced over the earth at high rates of speed. Ground stations, wishing to relay signals through them, had to track them. Today, most broadcast communication relies on the fixed ring of geostationary satellites, deployed in 2° slots across the sky.¹ But the familiar geostationary orbit is not the only option. (See Figure 1.)

"Molniya" is the Russian word used to describe a family of orbits that are elliptical. Swooping to within a few hundred kilometers at the perigee (low point), the orbits soar to about 40,000km at the apogee (high point). The apogees are set above the Soviet Union. The result is that the satellites seem to hang in the Soviet sky during much of their 12-hour orbits, simplifying tracking. (Satellites move more slowly through their arcs near apogee.²)

A proposed Western variant of Molniya, the ACE (apogee at constant time-of-day equatorial) would set satellites in an elliptical orbit, somewhat more shallow than Molniya, and along the same plane, but closer in, than the geosynchronous orbit. The advantage ACE satellites would have over their geostationary counterparts is size. They would be 40% larger if launched from Cape Canaveral and 80% larger if launched from Kourou (the spaceport for the European Space Agency, located in French Guiana, just north of

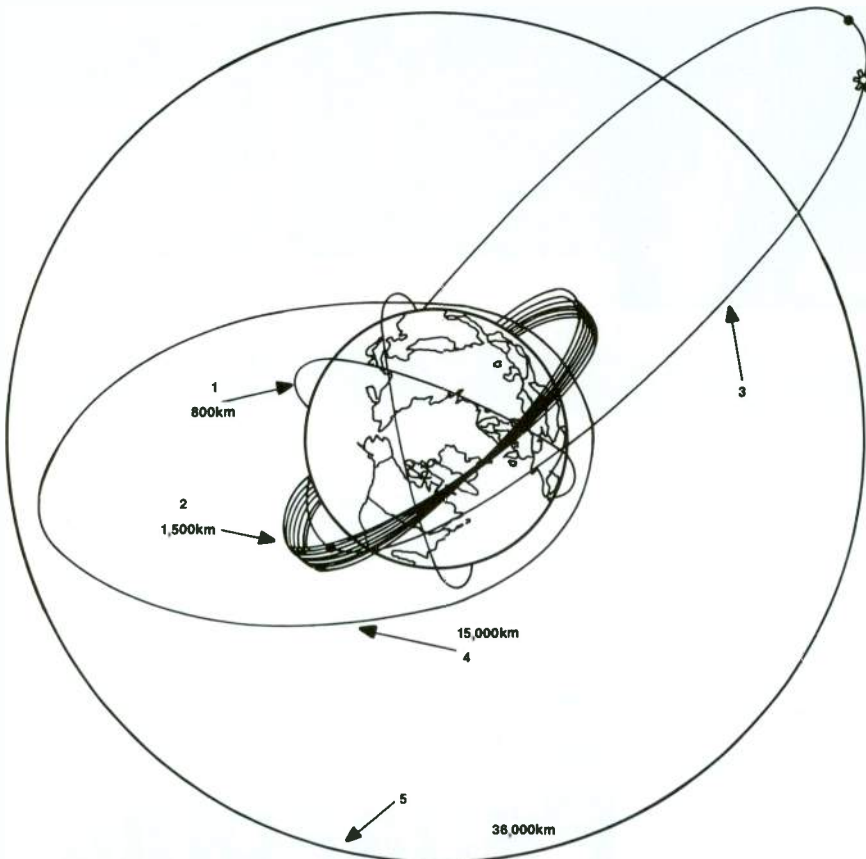

Figure 1. Various communications satellite orbits, proposed or in use today. High apogee of elliptical orbits simplifies tracking requirements because satellites seem to move slower across the sky.

Withstanding The Test of Time



Like the proud, serene monuments of another age, Neve stands alone as manufacturers of the most enduring, reliable broadcast recording consoles in the industry. It takes the same kind of ingenuity, vision and advanced technology to be the architects of a line of products that range from 8 input stereo remote consoles to 96 input, 48 bus production consoles, standard and custom designed. And all with the same pristine performance.

Unique Formant Spectrum Equalization and comprehensive Dynamics, together with the acclaimed sound of Neve, produces the facilities and benefits for the finest broadcast consoles around the world.

Neve . . . Wonder of the World of Sound

 **Neve**
Rupert Neve Inc.
A Siemens Company

RUPERT NEVE INC., BERKSHIRE INDUSTRIAL PARK, BETHEL, CONNECTICUT 06861, U.S.A.
TELEPHONE: (203) 744-6230. TELEX: 96 9683. FACSIMILE: (203) 792-7862.
NY: TEL. (212) 956-6464 • CA: TEL. (213) 374-8124 FACSIMILE: (213) 374-1406 • TN: TEL. (615) 385-2727 TELEX: 78 6569
NEVE ELECTRONICS INTERNATIONAL LIMITED, MELBOURN, ROYSTON, HERTS SG8 6AU, ENGLAND
TELEPHONE: ROYSTON (0763) 60776. TELEX: 81381. CABLES: NEVE CAMBRIDGE. FACSIMILE: (0763) 61886

Circle (31) on Reply Card

Brazil). The ACE orbit would put a satellite over the United States three hours each morning and afternoon. On the back side of its orbit, it could serve Japan and the Far East.

A host of low-altitude circular orbits fills other communications needs, most of them military. Many of them are "store and dump" in nature, meaning that a satellite picks up a message at one point in its orbit and retransmits it when it reaches the intended location.

These moving targets would be difficult for broadcast use, but they certainly wouldn't be impossible. They would be fine, however, for telecommunications, with the added attraction of lower free-space loss and less delay. Increased telecom capability here could keep geosynchronous capability free for broadcasting.

The still ones

The Earth is surrounded by a ring of celestial parking spaces. These are occupied by geosynchronous satellites, which are so far away and are moving so fast in our direction that they seem to stand still. Some are communications birds, some provide navigation signals, some perform national security functions. Some, now cold, are ghosts that have been shoved to the outfield to do nothing at all.

Geosynchronous satellites come in two types: spin-stabilized and 3-axis stabilized. (See Figure 2.) A spinner looks like a tomato juice can with a counterrotating tuna can mounted on top. A top-mounted fly swatter forms the antenna platform,

which is kept pointed toward earth. The drums rotate at about 30rpm, providing gyrolike stability. Drum surfaces are covered with row upon row of photocells that generate the few kilowatts necessary to power the craft's electronics.

The 3-axis-stabilized satellites use an inertial wheel, a 50-pound free weight twirling in the craft's center. The solar cells are deployed on sails and kept facing toward the sun.

Both systems use batteries to get them through times when they are eclipsed by the earth.

Ground control

Every satellite has a ground-control station, which consists of two organizations. One group is concerned with the health of the spacecraft, and the second is concerned with the traffic passing through it.

The spacecraft control group performs stationkeeping—keeping the satellite where it's supposed to be—and monitors the status of spacecraft systems—the health of the power, control and propulsion systems.

Orbital dynamics experts analyze the forces acting on the satellite and calculate maneuvers to keep it on station while expending the minimum amount of precious hydrazine.

Radiolocation techniques tell ground controllers exactly where the satellite is situated in its arc. Other sensors determine its attitude. Solar wind and the forces of gravity affect the satellite's orbit. The gyroscope action of the stabilization system provides some correction, because

it tends to resist change. Slightly modifying the speed of the stabilization system can bring about other changes. Three-axis stabilized satellites are sometimes wrapped with coils of wire (magnetic torquers), which push against the Earth's magnetic field to realign the spacecraft.

Then there is the hydrazine. Most of today's satellites are designed to last a decade, and many of them are almost that old. When their electronics falter, or the hydrazine runs low, some of what's left will be used to push the satellite out of orbit so that a new one can take its place.³

As a satellite drifts slowly around its intended general position, called the "box," and corrections bring it back, it passes occasionally through the center of where it is supposed to be, or the "center of the box." Each satellite operator provides "center-of-box bulletins," usually on recorded telephone tapes. Controllers also decide when and if to switch out of failing transponders, or what pattern to alternate through spares.

Cross-pol checks

Among their other functions, the access controllers ensure that every user of the satellite gets optimum performance and that no users interfere with each other. Since the early 1970s, satellites have employed frequency reuse technology that allows them to double capacity by alternating polarizations between transponders. (See this month's "Satellite Technology," page 14.) This places stringent requirements on the polarity of the incoming signal and requires that a cross-polarization test be made before each transmission. The procedure goes something like this:

An uplink that has material to transmit telephones the satellite operations center. Under the instruction of the controller, the uplink engineer slowly increases power until it is detected on a spectrum analyzer at the control center. The controller observes whether any energy is being radiated by the uplink either on the wrong transponder or, because of polarization errors, on the adjacent transponders. The controller may request that the uplink engineer jog polarity slightly to see whether off-polarity energy rejection can be improved.

If the signal is good, the uplink is cleared to transmit; if not, transmission is forbidden. The procedure usually takes less than a minute, and may be performed before the actual transmission, as long as there is no intervening movement of the dish.

If the appropriate transponder is busy, and there will be no time to perform a cross-pol before the transmission must start, the test sometimes can be performed on a different transponder of the same polarity.

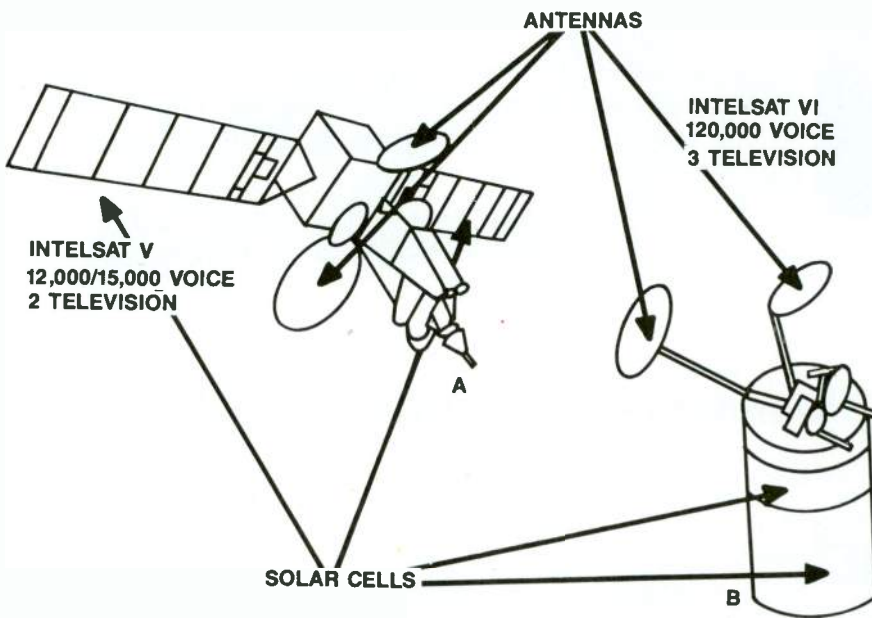
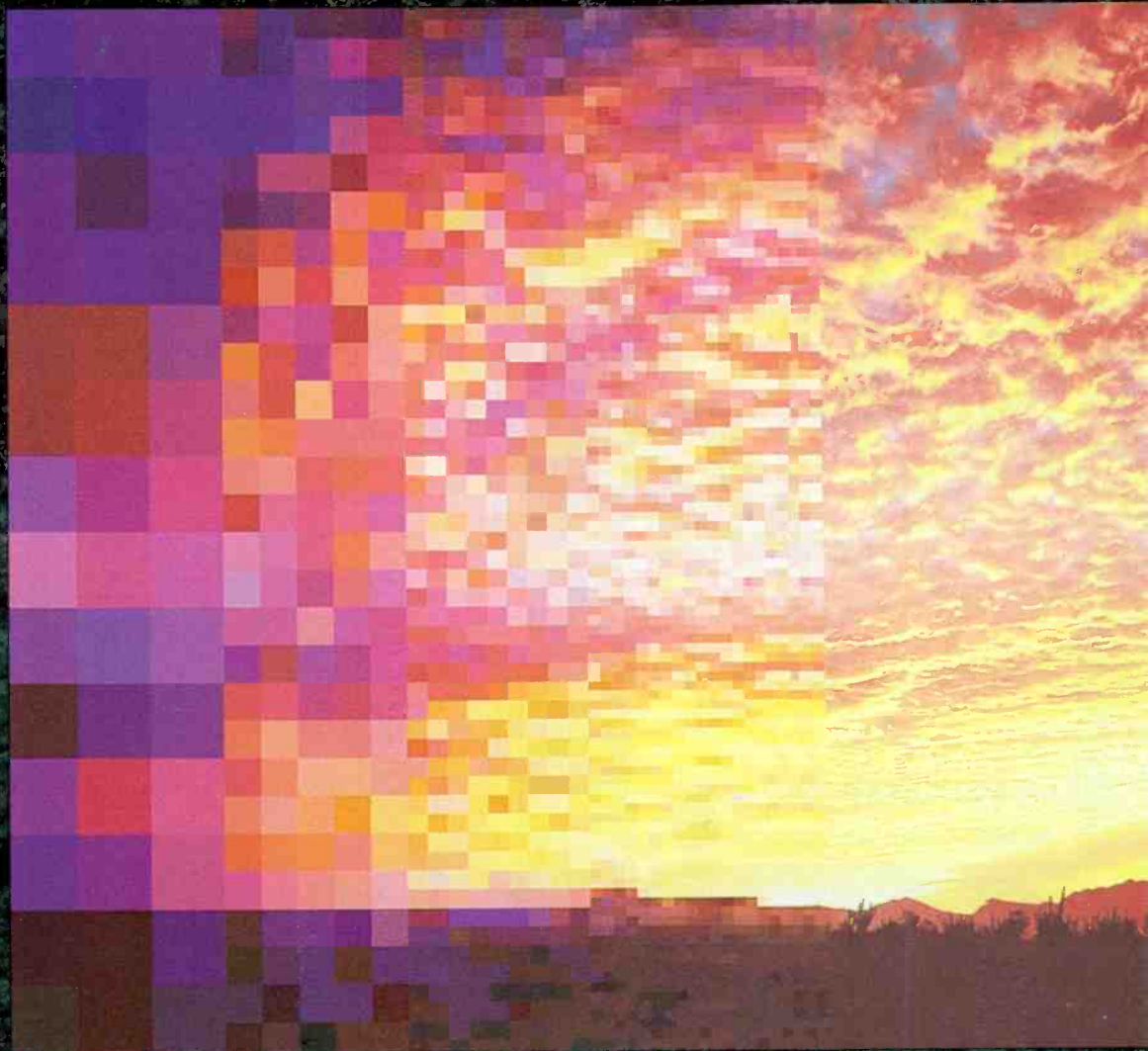

Figure 2. Satellites of Intelsat series (used for international transmission of broadcast signals, maritime and aeronautical telecommunications). Three-axis stabilized satellites have internal gyro, and spin-stabilized satellites use body as gyro.

Continued on page 63

SONY



**A progress report
on digital video
from a uniquely
qualified source.**

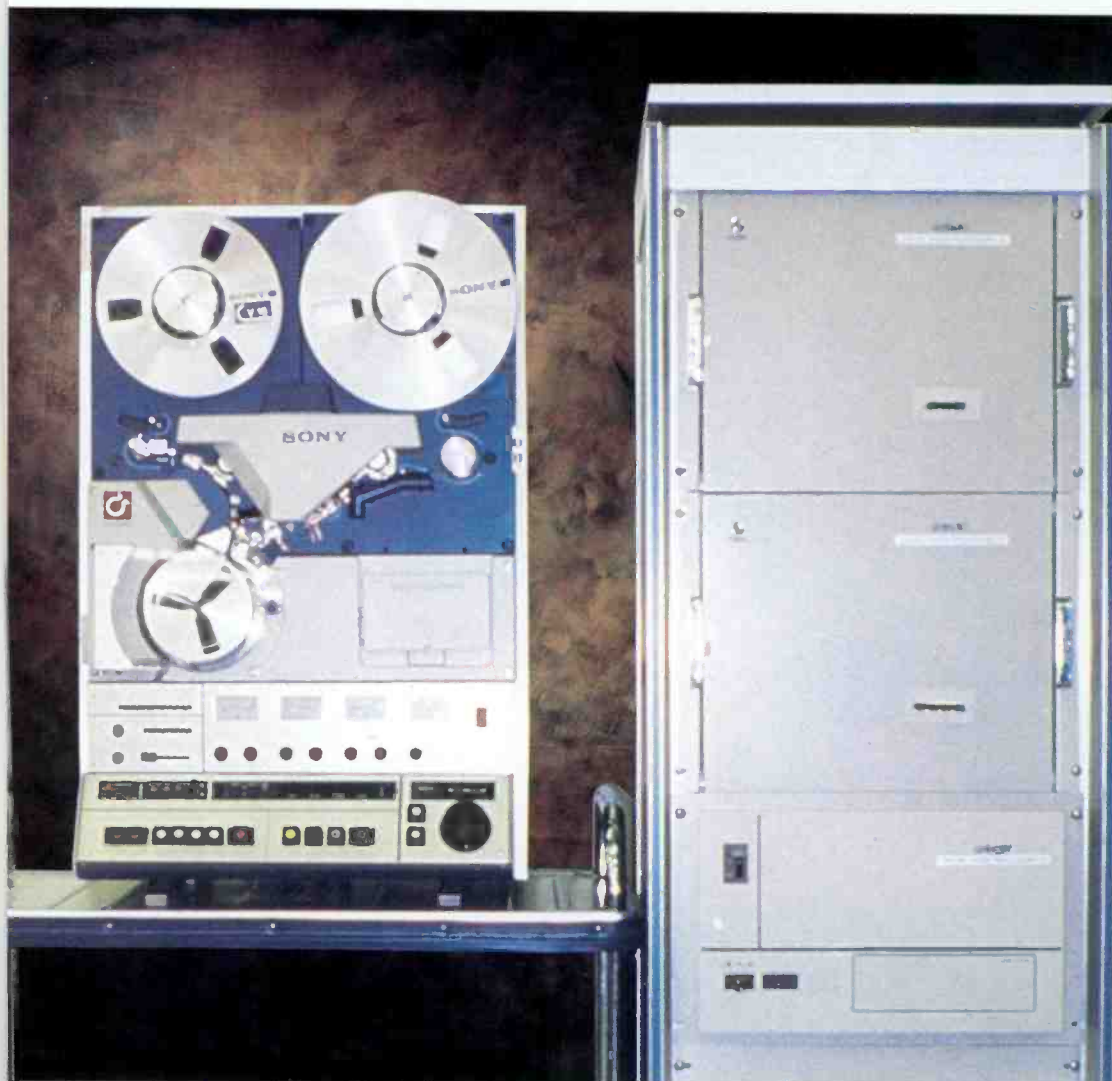

■ A landmark achievement... In 1978 a Sony experimental DTTR clearly demonstrated the tremendous advantages of digital video recording.

■ A single Sony VLSI circuit chip can replace several conventional boards of complex digital processing circuitry.

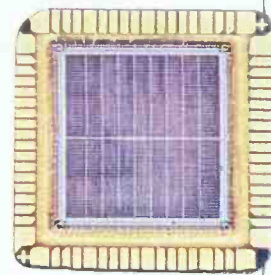

bit rate converters, peripheral Sony components and accessories. What was recently embryonic technology is now a growing product line, covering a wide range of studio applications from production to broadcast.

Sony's leadership includes all aspects of digital video recording, from signal processing, transport design, tape formulations, to cassette design and high density recording. Sony is also light years ahead because of our VLSI technology, creating chips that carry an enormous amount of information—which is critical to digital processing. **The industry looks to Sony.** Sony's groundbreaking work in digital video recording made it

T

he digital video revolution is taking shape. Gradually and inevitably, the world of video is changing.

Because it is happening step by step, many of you may not be aware of precisely where it stands. So, we've prepared this progress report on the Digital Video Revolution. And, as you'd expect, Sony is leading the way, just as it has with so many other

profound shifts in video and audio technology.

The Digital Video Era isn't new to Sony. In fact, it was back in 1978 that Sony first created an experimental digital VTR, which demonstrated the viability of digital recording. The Digital Video Era became official in 1986, when Sony introduced the DVR-1000 videotape recorder—freeing the broadcast industry from the limitations of the composite analog realm.

■ In professional audio, the Sony PCM-1610/1630 has become the recording industry's *de facto* standard digital mastering system.

Two years later, a new world exists.

Today, Sony is broadening its leadership in digital video recording. Only Sony is offering and delivering (no small distinction) an extended line of digital video products, including DTTRs (the latest terminology for "Digital Television Tape Recorders"),





■ The Compact Disc, jointly developed by Sony and Philips, has brought digital audio to the masses and changed the way the world listens to music.

inevitable that Sony would play a pivotal role in developing the technical foundation for the industry format standards. Sony's leadership in digital audio provided further resources, as digital audio is an integral component of the new digital video formats.

The cooperation was at the same high level as the technology.

The process that led to the formulation of VTR standards for digital equipment was a rare display of industry cooperation. (And that same cooperation is still going on.)

Sony is proud to have been part of that process. An effort that was supported by major manufacturers and user groups around the globe, beginning in 1979. Two separate groups, representing the EBU and the SMPTE worked closely and intensively during the years, to reach a format agreement.

As a result, format wars can be avoided and manufacturers can focus on enhancing their product technology for the benefit of all.

The promise of new technology. The reality of new technology.

Sony's efforts in realizing the

promise of digital video have been international. Sony technical leaders in Japan, North America and Europe have all contributed to the complete, expansive digital video product line that we bring you in 1988.

When you invest in Sony digital video products, you are investing in the sum total of all this expertise, in a full and rich understanding of where digital video technology is today, and where it is going tomorrow.

The Sony mastery of the craft is

unmatched in the industry.

We invite you to read on. The Sony Progress Report on the state of digital video will demonstrate how far the technology has come, what it can do for you and how Sony's product line can help you enter the new world of digital video.

■ A key contributor...Takeo Eguchi of Sony has been an active member of various working groups on DTTR standards within the SMPTE and EBU/MAGNUM.



"Outstanding Achievement In Engineering Development."

At the 40th Annual Primetime Emmy Awards, The Academy of Television Arts & Sciences awarded an Emmy to Sony in recognition of its outstanding engineering work on the D-1 Component Digital Television Tape Recorder.

DVR-1000



DVR-1000 4:2:2 Component DTRR

■ The dream comes true.

With the establishment of well-defined standards, manufacturers faced the formidable challenge of putting them into practice. The world's first production component DTRR was delivered in 1986, and, to no one's surprise, it came from Sony. The Sony DVR-1000, has since been heralded as a revolutionary and outstanding technical achievement. It fully delivers the benefits of component digital video recording and unquestionably provides the highest possible video and audio quality available today in a studio recorder, while conforming to SMPTE D-1 and EBU recommendations.

Component video has a number of demonstrable advantages over composite video. Certain artifacts are unavoidable in the composite encoding process. These are easily observed in graphics devices, telecines,

cameras, and effects units—their pictures invariably look better in component form. In composite systems, editing at points other than those defined by the color framing sequence can result in picture shifts; in component systems, editing can be performed at any frame. And with composite signals, small phase and timing errors can cause picture and color shifts.

The DVR-1000 handles the three video signal components—Y (luminance), R-Y and B-Y (color difference information)—separately from input to output. The input/output interfaces include analog Y/R-Y/B-Y, R/G/B, and Betacam® components in addition to parallel component digital video interface conforming to SMPTE and CCIR recommendations. Line level analog audio, as well as an AES/EBU digital audio interface is also provided. The DVR-1000 can

thus be connected to a wide variety of input and output devices, providing the transparent performance characteristics of digital recording without compromising the advantages of a component video system.

Ideally suited for high-quality production and post-production applications, the DVR-1000 is most effective in an environment where all devices, such as VTRs, switchers, graphics and effects units, are interfaced via the digital I/O. By maintaining signals in the digital form wherever possible throughout a facility, repeated A/D and D/A conversions can be avoided, thus maximizing long-term signal quality.

UNPRECEDENTED VIDEO QUALITY. More than 20 generations of dubbing are possible without loss of picture or sound quality. Reproduces broadcastable pictures at $\pm 1/4$ x normal speed and recognizable pictures at up to ± 40 x normal speed.

FOUR DIGITAL AUDIO CHANNELS. PCM audio channels provide in excess of 90dB dynamic range with uniform, wideband frequency response. Internal digital routing enables channel-to-channel dubbing without external patching. AES/EBU digital I/O can be configured as 4 independent channels or 2 stereo pairs. Multi-pin connector provides single cable interface for all 4 channels.

ERROR CORRECTION. Data errors, such as those caused by tape dropouts and momentary head clogs, are completely recovered by an advanced Reed-Solomon error detection and correction scheme. Large errors beyond the capacity of the correction system are handled by Sony's powerful error concealment techniques, aided by data shuffling.

SOPHISTICATED MAINTENANCE FEATURES. Built-in diagnostics, video and audio test signals, test switches, and full monitoring capabilities aid the user in maintaining optimum performance levels.

ADVANCED CONTROL PANEL WITH MENU-DRIVEN DISPLAY FOR EASY OPERATION. A large variety of tape handling, editing, setup, and maintenance functions are available via the easily mastered, logically positioned controls. A sophisticated electroluminescent panel with 12 main menu keys and 12 function keys provide rapid access to the built-in facilities.

BUILT-IN EDITING FACILITY. Two DVR-1000's can be simply interconnected via their RS-422 control ports for full editing capability. Control panel displays all necessary data, and edit data entries can be easily made through the function keys and numeric keypad.

CASSETTE OPERATION FOR HANDLING EASE AND MAXIMUM TAPE PROTECTION. The DVR-1000 accepts M cassettes (34 minutes max.) or L cassettes (96 minutes max.)

D V R · 1 0

DIGITAL VIDEO RECORDING FOR THE NTSC ENVIRONMENT. A true "plug-in" upgrade for NTSC facilities, the DVR-10 is capable of transparent dubbing through more than 20 generations and provides up to 94 minutes of record/play time. The Dynamic Tracking™ system provides broadcastable pictures anywhere from 1x through 3x normal speed. Recognizable color pictures are produced at up to ±40x normal speed for high speed search.

FOUR DIGITAL AUDIO CHANNELS. PCM audio channels provide in excess of 90dB dynamic range with uniform, wideband frequency response.

ADVANCED CONTROL PANEL WITH MENU-DRIVEN DISPLAY FOR EASY OPERATION. A large variety of tape handling, editing, setup, and maintenance functions are available via the easily mastered, logically positioned controls. A sophisticated electroluminescent panel with 12 main menu keys and 12 function keys provide rapid access to the built-in facilities.

ERROR CORRECTION. Data errors, such as those caused by tape dropouts and momentary head clogs, are completely recovered by the D2 format's Reed-Solomon code error detection and correction scheme. Large errors beyond the capacity of the correction system are handled by Sony's powerful error concealment techniques, aided by data shuffling. Even the total loss of one head during playback is virtually undetectable by the viewer.

BUILT-IN EDITING FACILITY. Two DVR-10's can be simply interconnected via their RS-422 control ports for full editing capability. Control panel displays all necessary data, and edit data entries can be easily made through the function keys and numeric keypad.

WRITE-AFTER-READ CAPABILITY. Permits video and audio signals to be played, modified, and re-recorded at the same tape location. Operations normally requiring two VTRs, such as audio sweetening, color correction, or title superimposition, can be performed with one DVR-10 connected to external processors. A-B roll editing can be performed with 2 DVR-10's instead of the usual 3 recorders.

CASSETTE OPERATION FOR HANDLING EASE AND MAXIMUM TAPE PROTECTION. The DVR-10 accepts S cassettes (32 minutes max.) or M cassettes (94 minutes max.)



DVR-10 D-2 Composite DTTR

■ A second format gives the composite world a digital alternative.

While the DVR-1000 component DTTR is ideal for state-of-the-art production facilities, it became increasingly apparent that today's television industry could benefit greatly from the application of digital recording techniques to the existing analog composite video signal format. So Sony went to work on the development and standardization of a composite DTTR.

In December, 1986, Sony and Ampex submitted the D-2 format to the SMPTE as a recommended composite DTTR standard. Today, the D-2 format for NTSC composite digital video recording is supported by a broad base of users and manufacturers.

The Sony DVR-10 fully conforms to the proposed D-2 format standard and provides

the highest level of performance currently available in a composite studio recorder. It delivers all the advantages of digital video recording, including exceptionally wide bandwidth, high S/N, and total absence of moiré. And it does so while maintaining the convenience and compatibility of the single-cable analog NTSC interface.

The DVR-10 is a full-featured VTR with numerous operational capabilities and a flexible system interface. In addition to analog composite video I/O, the DVR-10 also has a parallel input and output digital video interface. This permits direct digital-to-digital dubbing between two DVR-10's for the highest quality signal transfer. Analog and digital audio interfaces, the latter utilizing the AES/EBU standard in stereo pairs, are also provided for maximum versatility.

The DVR-10 is remarkably

compact and lightweight, considering the tremendous amount of circuitry needed for high-quality digital video and audio recording. It is only 6 rack units high—about the same size as a Betacam® studio VTR. And its power consumption is only 470 watts. A DTTR of this size and efficiency would not have been possible were it not for Sony's advanced VLSI circuit technology.

The size, features, and performance of the DVR-10 make it ideal for integration into virtually any existing NTSC environment, including production, post-production, and broadcast facilities. It can be used as a replacement for existing 1-inch and 3/4-inch VTRs. And it is the logical choice for new system installations designed to maintain maximum composite signal integrity.

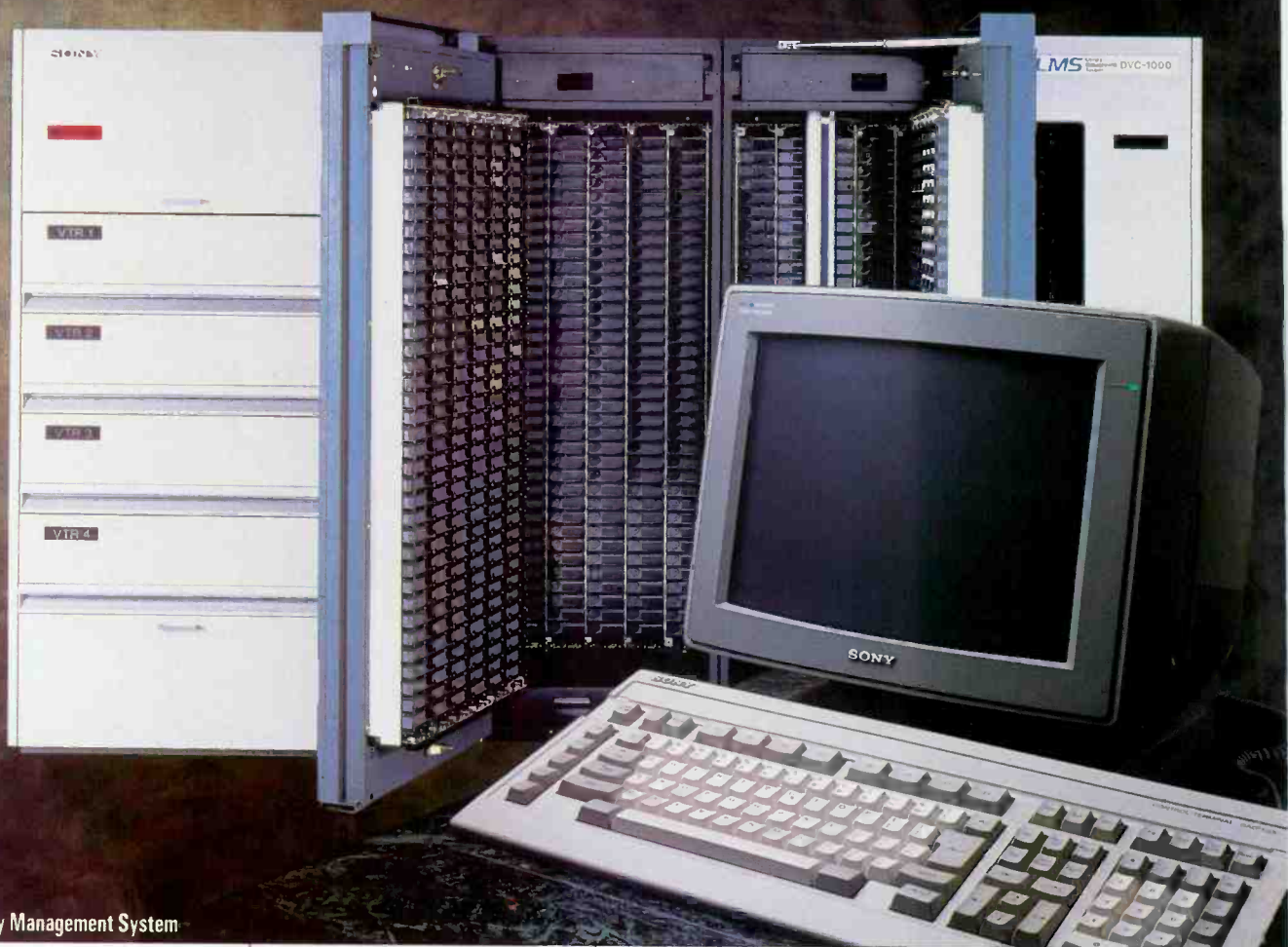

Digital Library Management System

■ **The age of broadcast automation benefits from Sony digital recording technology.**

There are, clearly, numerous applications for the D-2 DTTR in the vast television industry. One of these, in which the DTTR's extremely high signal quality and advanced monitoring capabilities are particularly advantageous, is broadcasting. The modern trend toward increasing broadcast automation and, hence, decreasing supervision has made it more difficult to keep tight reins on signal quality. Digital recording assures a high degree of confidence while reducing the need for extra care and skill in maintaining the quality of program material throughout multiple generations.

The automation trend has also resulted in the creation of ever more sophisticated multi-

cassette playback systems. When the Sony Betacart® system was first introduced in 1984, it made reliable, flexible multi-cassette video playback an operational reality. Today, Sony has combined its considerable expertise in multi-cassette presentation and digital recording to create an expanded Digital Library Management System (LMS). The Sony Digital LMS is, quite simply, the most advanced high-capacity multi-cassette playback system available, taking broadcast operations to new heights of efficiency and on-air quality.

The Digital LMS provides unparalleled flexibility, both in configuration and operation. Different models provide a range of choices in cassette sizes and capacities, so that the system can be custom tailored to individual broadcast facility requirements. Basic systems can be expanded in capacity by adding

cassette consoles. They permit broadcasters to keep an extensive library of cassettes on-line and readily accessible, thus reducing the labor involved in loading and unloading. The cassette-based operation also ensures the ultimate ease of operation, with no special skills required for library maintenance.

The Digital LMS uses 4 (expandable to 6) DVR-C10 D-2 composite DTTRs, which operate totally in the digital domain. They provide the same outstanding performance as the DVR-10 standalone DTTR. In fact, a DVR-10 can be installed in place of a DVR-C10 in an emergency. In the Digital LMS, D/A conversion is performed after the switchers to provide standard composite analog video and line level audio outputs. It can, therefore, be easily integrated into existing broadcast environments, providing the

highest level of video and audio quality possible.

Options to interface the Digital LMS with traffic and automation systems improve the flow of vital station information and reduces paperwork and time-consuming manual data entry. The LMS also provides powerful operational and management features giving broadcasters comprehensive, long-term control over their operations.

Programming flexibility is assured by the system's Multi-Segment applications software, which allows the integration of single-segment commercials and multi-segment programs. It also permits total control over program replay from the system's operator consoles. The system simultaneously supports three operator consoles, providing sophisticated multi-user, multi-tasking capabilities.

With its many sophisticated features and capabilities, the Digital LMS remains unsurpassed for reliability and ease of operation. All mechanical components are designed to deliver continuous trouble-free operation. The DVR-C10 DTTRs provide the full complement of Reed-Solomon error correction and Sony's superb error concealment circuitry to ensure the best possible on-air picture quality at all times. And the signal monitoring capability of the DVR-C10 provides operators with ample warning of tape and recorder conditions that could become on-air problems.

System dependability is further enhanced by numerous built-in safeguards and bypass capabilities that help eliminate costly on-air "down" time.

The combination of large-capacity media storage and management with state-of-the-art digital video/audio performance makes the Sony Digital LMS an ideal choice for today's highly automated, quality-conscious broadcast environments. Its flexible design permits it to be integrated into virtually any modern traffic or automation system. And because it operates reliably with a minimum of manual intervention, maintenance, and supervision, it enables broadcasters to realize considerable labor savings.

DVC·1000S DVC·300M

VERSATILE CONTROL SYSTEM INTERFACE. Host computer interface permits the LMS to be operated as a peripheral to master control automation systems. Alternately, daily playlists and library maintenance information can be downloaded directly from a station's traffic system.

DETAILED REPORTS FOR SIMPLIFIED, THOROUGH STATION AND LIBRARY MANAGEMENT. System generates as-run logs that provide detailed accounts of all on-air events. Library management software provides "required cassette" and numerous other reports to aid system operators.

TIME-PROVEN BAR CODE CASSETTE IDENTIFICATION. Originally developed for the Betacart system, the Sony bar code ID contains all relevant cassette information and eliminates the need for a separately maintained database. Multi-segment cassettes contain an on-tape directory which permits identification and location of program segments. Cassettes can be easily prepared and labeled off-line, completely independent of the on-air process.

CONTROL OF UP TO 4 EXTERNAL VTRS. Permits RS-422 control of Sony VTRs in almost any broadcast format. External VTR outputs are switched through LMS for total control. One of the external VTRs can be used to assemble and play backup spot reels.

EASY-ACCESS CASSETTE STORAGE BINS. 14 input bins and a 14-cassette output port simplify loading and unloading. 28 direct access bins are provided for short-term storage. All cassettes can be accessed for emergency manual loading without opening the console.

HIGH-RELIABILITY DESIGN WITH BUILT-IN DIAGNOSTICS. Self-aligning elevator mechanism eliminates tedious adjustments. Re-alignment after the replacement of a VTR is automatic. Maintenance is aided by an extensive array of hardware and software diagnostics. Modular system design makes replacement of mechanical assemblies fast and easy.



BVM-1910 Master Control Monitor with BKM-2080 Digital Interface

■ It takes a special color monitor to display the subtleties of the digital video signal.

The Sony BVM-1910 19" Broadcast Color Monitor has already set new industry standards for resolution, color uniformity and stability. With the addition of the BKM-2080 Digital Interface option, the BVM-1910 becomes

the ideal monitor for D-1 format environments. It is also the industry's first color monitor that permits direct connection of either parallel or serial 4:2:2 component digital video signals. Analog inputs for composite, R/G/B, SMPTE, and Betacam component signals are also provided.



Digital Matrix Switcher

■ The transition to digital is easier than you'd think.

While signal recording, processing, interfacing, and transmission will one day be entirely digital, today's production environment demands integration of analog and digital signals. Sony's digital matrix switchers and analog/digital converters meet this need.

Sony matrix switchers are highly flexible, and are configured with plug-in modules. They expand to 16 inputs and 6 outputs or, 6-in/16-out. The matrix may be configured to virtually any size within those limits, and a selection of either analog or digital input and out-

put modules provides unmatched versatility. The video and audio switchers can be controlled via their RS-422 ports.

The DSU-V210 Video Matrix Switcher handles parallel composite digital video signals. It has a built-in black burst and color bar generator.

The DSU-A210 Digital Audio Matrix Switcher handles serial digital audio signals conforming to the AES/EBU standard. It has a built-in 1 kHz tone generator.

The DAD-A210 Audio D/A and A/D converter provides a convenient analog input/output interface to the DSU-A210.

THE DIGITAL SYSTEM CONCEPT

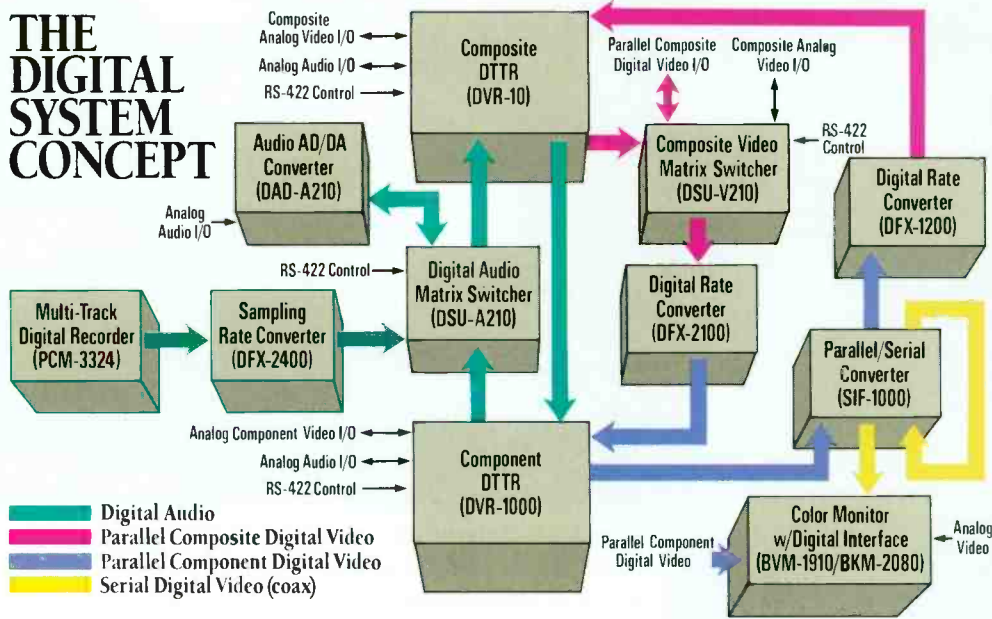

■ DTR interfacing requirements? Sony has the answers.

While Sony DTRs have been designed to provide considerable interface flexibility, the real world of studio applications poses numerous challenges and obstacles. Through the further application of advanced digital processing and VLSI circuit technologies, Sony engineers have developed a line of peripheral components that address the specialized problems of bit rate conversion and signal distribution, help avoid unnecessary A/D and D/A conversions, and enable the smooth integration of audio and video devices. These products enhance the already outstanding utility of Sony DTRs and help maintain the high-quality digital signals throughout a studio environment.

■ DFX-1200 Digital Bit Rate Converter

Converts 4:2:2 component digital video signals to 4 fsc composite digital video signals. In addition to sampling frequency conversion, the DFX-1200 encodes the separate Y, R-Y, and B-Y signals into a composite digital NTSC signal with correct I and Q bandwidths.

■ DFX-2100 Digital Bit Rate Converter

Converts 4 fsc composite digital video signals to 4:2:2 component digital video signals. Adaptive filtering is used for the Y/C separation of the NTSC signal. This assures a wideband luminance signal and a chrominance signal free from cross-luminance and cross-color distortion. Conversion from I and Q to R-Y and B-Y signal formats is also performed.

■ DFX-2400 Digital Audio Sampling Rate Converter And VSU-3310 Vari Sync Unit

The digital audio tracks on D-1 and D-2 recorders utilize a 48kHz sampling frequency. In many cases, digital audio signals come from sources with varying sampling rates—for example, the CD's 44.1kHz. Rate conversion is required in such cases.

The DFX-2400 accepts any sampling frequency between 30kHz and 50kHz, and converts it to 32kHz, 44.1kHz, 44.056kHz, or 48kHz, which represent all audio sampling frequencies in use today. It also enables format conversion between the AES/EBU standard and Sony's SDIF-2 standard. It operates totally in the digital domain, providing performance far superior to units that rely on D/A and A/D conversion.

The DFX-2400, with the VSU-3310 Vari Sync Unit, also facilitates synchronization of the digital audio signal clock to the video signal. The DFX-2400 will synchronize its internal clock to an external signal. The VSU-3310 accepts a variety of sync inputs and produces a word sync output that can be used to vary the speed of digital audio recorders. These units permit external digital audio sources to be used in video editing.

■ SIF-1000 Parallel/Serial Converter

Integrating digital equipment into an existing studio need not be complex. Serial signal distribution permits the use of existing coaxial cable to carry the digital video signals. Distributing the signal in serial form is important because parallel digital signals were intended to travel only over limited distances.

The Sony SIF-1000 is both a parallel-to-serial and serial-to-parallel converter, permitting serial signal distribution over coaxial cable up to 500 meters in length. Its signal coding is switch selectable for operation with 4:2:2 component or D-2 composite digital video signal.

Sony. We're more than pivotal to digital.

We believe this Progress Report has demonstrated that digital video could not have evolved to its current level without the ongoing contributions of Sony.

Sony is the only manufacturer providing a choice of composite and component digital formats. We are the only manufacturer providing a comprehensive line of digital video products and interfaces. Our commitment to the industry is to provide the technology necessary to lead the Broadcast and Post Production markets into the new digital era.

And as this blossoming technology yields even more, you can be sure we will be the driving force behind that, too.

Because even though digital video is new, the story behind it is an old one: Sony shows the way.

SONY

Broadcast Products

Sony Communications Products Company
Broadcast Products Division
1600 Queen Anne Road
Teaneck, New Jersey 07666
Features subject to change without notice.
Ampex is a trademark of Ampex.
Sony, Betacam, Betasart, and Dynamic Tracking
are trademarks of Sony.
©1988 Sony Corporation of America

Continued from page 54

What happens during a cross-pol if the uplink is transmitting, but the signal is not being received at the other end? The answer is simple: Stop transmitting—fast. The uplink or control center monitoring equipment may be bad or misadjusted. Even worse, the transmitter may have been set, or left, on the wrong frequency or satellite. In such a case, double illumination may occur. It is not good to be caught double-illuminating. Intentional double-illumination has resulted in prosecution. In accidental cases, authorities might not take action, but the injured party may seek redress. There is no substitute for a cautious and alert uplink engineer.

The preceding scenario assumes that the uplink has a lease on the transponder used. Otherwise, it may be necessary to obtain permission to transmit not only from the satellite operations center, but also from the "owner" of the transponder.

Space Junk

In addition to all the satellites, a cloud of space junk teems around the Earth like a swarm of angry bees. This is of great concern to satellite operators, because the junk is flying fast enough to damage equipment. In 1983, a fleck of paint,

possibly from a previous Delta rocket, chipped the outer layer of a triple-pane shuttle windshield. The repair tab was \$50,000.

Seven thousand particles 10cm or larger now orbit the Earth, with 70,000 more from 1cm up to 10cm. Although a 1cm chunk of aluminum seems tiny, calculations show that if it were orbiting at Mach 25, it would release, on impact, the energy equivalent to an exploding standard hand grenade. After investing billions of dollars, satellite operators are not at all interested in this celestial game of "kick the can."

Part of this cloud came from normal space operations: spent boosters and jet-tisoned trash. Some is said to have originated with early "star wars" target practice. The Soviets allegedly tested their anti-satellite capability by knocking out a few old ones. Anti-satellite activity today seems to produce less litter. The UPI has reported details of alleged Soviet "hosings" of U.S. reconnaissance spacecraft with high-powered lasers meant to blind the on-board optical sensors.

Already, there are tentative plans to help clean up this mess. Recovery vehicles may be launched from future shuttles to capture and de-orbit large pieces. This would be a difficult process because the trash has

random, arbitrary orbits, and changing orbits is energy-intensive. Because even little chunks can do big damage, some planners envision charged "space pillows" that would react with the magnetic field that orbiting trash develops. Losing energy, the particles would fall closer to Earth, eventually burning up in the atmosphere.

Getting up there

With the loss of Challenger, the space shuttle program has suffered nearly a 3-year setback. The military missions that should have taken place in that time span now occupy most of the upcoming slots. Many of the satellites that broadcasters use are nearing replacement age. For the next several years, good old rockets, now called ELVs (expendable launch vehicles), must handle most of the load. U.S. manufacturers have geared up production of Titans, Deltas and Atlas-Centaurs. Launch services are being offered by the European Space Agency with its Ariane, China with the Long March, the Soviet Union with Proton, Japan with H1 and H2, and others, including a whole raft of private companies. They are looking to earn their passage into the space age or keep a foot in the door.

The notion that socialist countries might

STUDIO ACOUSTICS by TUBETRAP™



Pete Townshend, The Boathouse, Eel Pie Studios

The QSF Digital Sampling Room

- QSF™ QUICK SOUND FIELD SYSTEMS
- PRE FAB, MODULAR SOUND TRAPS
- FULL BAND-WIDTH ABSORPTION
- BUILT-IN, ADJUSTABLE DIFFUSION
- FACTORY BASED DESIGN SERVICE
- ALL PRODUCTS SHIP UPS IN DAYS

1-800-ASC-TUBE, 1-503-343-9727, FAX: 343-9245

ASC ACOUSTIC SCIENCES CORPORATION
P.O. Box 1189
Eugene, OR
USA 97440

APPLIED ACOUSTICS-RESEARCH, DESIGN & DEVELOPMENT

(LICENSED MFG. ALSO IN CANADA AND ITALY, DEALER INQUIRIES WELCOME)

Circle (152) on Reply Card

SEPARATE 4.2 VIDEO from 4.5 AUDIO AND ELIMINATE "SPILLOVER"

NEW **Matthey** BRICKWALL FILTER
ELIMINATES "SPILLOVER"

FIT A
BRICKWALL
AT YOUR
SATELLITE
RECEIVER.

PASSES UP TO 4.2 MHz.
STOPS FROM 4.5 MHz.

- IT'S NEW
- IT'S 75Ω
- IT'S PHASE EQUALISED
- IT'S SHARPER THAN ANYTHING YOU'VE SEEN



11 OTHER FREQUENCIES TO CHOOSE FOR YOUR SUB CARRIER PROBLEM

CALL BILL "BRICKWALL" PEGLER:

Television Equipment Associates, Inc.

BOX 393 - SOUTH SALEM, N.Y. 105900393

Tel. 914-763-8893

In California phone 213-271-9570



Circle (34) on Reply Card

launch satellites for U.S. customers has produced somewhat of a flap. Current trade regulations, designed to prevent a loss of technology to the East, prevent sales of some high-tech items, such as graphics systems with sophisticated computers and digital signal processors. If government agencies are troubled by the sale of say, add-on cards for Macintosh computers, imagine the stir that would be caused by the delivery of a complete, working, state-of-the-art communications satellite! Negotiations are continuing.

New uses for satellites

Satellites are used for distribution of network programming, syndication programming, commercials and PSAs. There are also several ad hoc networks, particularly among users of portable Ku-band equipment. At least one radio programmer sends programming and cue signals over satellites. The cues trigger breaks and start cart machines loaded with locally tailored bumpers, which are recorded by the network announcers and sent down during off-hours. CBS affiliates can participate in one of 11 regional feeds, trading stories of regional interest. The national network also monitors and may purchase footage.

One new satellite service is data networking. A data network operator contracts to distribute information for its clients. It may be bookkeeping data, internal communications or other material. Some clients sell electronic newsletters, or make value-added contributions to other data services such as the National Weather Service or commodities market. These products generally are distributed around the country by satellite, using tiny downlinks called VSATs (very small aperture terminals).

In major markets, there may be many subscribers. Some network operators hire local broadcasters as a less expensive way to distribute their datastreams. Local FM stations often are contracted to carry the data on unused SCAs. (See Figure 3.)

Truck 54, where are you?

Another new satellite service is RDSS (radio determination satellite system). One

such system (marketed by Sony) was exhibited in an SNV unit at this year's NAB convention. The system determines its position by signals received from navigational satellites or LORAN. This data, plus a short message from the truck operator, is uplinked automatically, once each hour, from a tiny transmitter that mounts on the truck. The satellite beams the information back to Earth, where it is posted on a dial-up bulletin board. News managers periodically dial in to learn the truck's latest position and to see whether the driver has left any messages.

Designers hope to help news directors keep in touch by making it possible for them to know an SNV unit's position and its driver's intentions. If a breaking story forces a change in plans, they know where to find it. Also, if the truck experiences trouble, that message can be flashed instantly, and the station can make other plans.

Icing, de-icing, anti-icing

Snow in a satellite signal has several possible causes: off-axis alignment of the dish, feedhorn problems, TI (terrestrial interference) and sun outages. But there is another prevalent cause of snow; and that's snow. When snow and freezing rain collect in a satellite dish, it is called icing. Removing the ice and snow that have built up on a dish is called de-icing. Taking steps to prevent the accumulation of ice and snow is called anti-icing.

The dishes used to focus satellite signals provide massive gain. This gain is rapidly attenuated when a layer of snow or ice forms over the dish surface. The attenuation occurs partly because of the radio waves' inability to penetrate the obstructing layer, and partly because the layer deflects the radio waves off-axis. Also, the

weight of the snow or ice may change the shape of the dish, causing greater attenuation. The signal finally becomes so weak that snow fills the screen.

The most rudimentary form of de-icing is to remove the snow mechanically. Some stations buy telescoping squeegees; others fabricate their own tools.

After squeegeeing off the heaviest snow, some operators go over the dish again with a shop broom, perhaps one with an extended handle. This type of cleaning works best during the day when there is some sunlight. Solar heating on the exposed portions of the dish quickly melts off any remaining snow.

Another useful tool for dish cleaning is aircraft de-icing solution, available from an airport or chemical supply house. The solution (diluted according to label instructions) can be applied with a manually operated pump can. It is good to use the squeegee before the chemical, however, because a thick layer of snow can absorb a lot of the liquid. Check first to ensure that the solution will not damage the dish surface.

A snow shovel also is handy to remove the scraped-down snow that accumulates at the base of the dish. Repeated trampling can turn the snow into a slippery obstacle to subsequent de-icings.

Of course, the most elegant way to remove ice is with a heating system. Some systems duct hot air over baffles in back of the dish. Others use electric heating elements that are built into or retrofitted to the back of the dish. These usually are activated by a thermostat or snow sensor, or sometimes both.

Heating a dish unevenly may cause uneven expansion, causing it to deform and degrade the signal. Some studies have shown that it is a workable compromise to heat the top of the dish, where snow may accumulate, about one-half to two-thirds as much as the lower half, where snow definitely will accumulate. One way to achieve this is to use self-regulating heater elements that vary their heat output according to ambient temperature. The lower the temperature (from the ac-

Continued on page 68

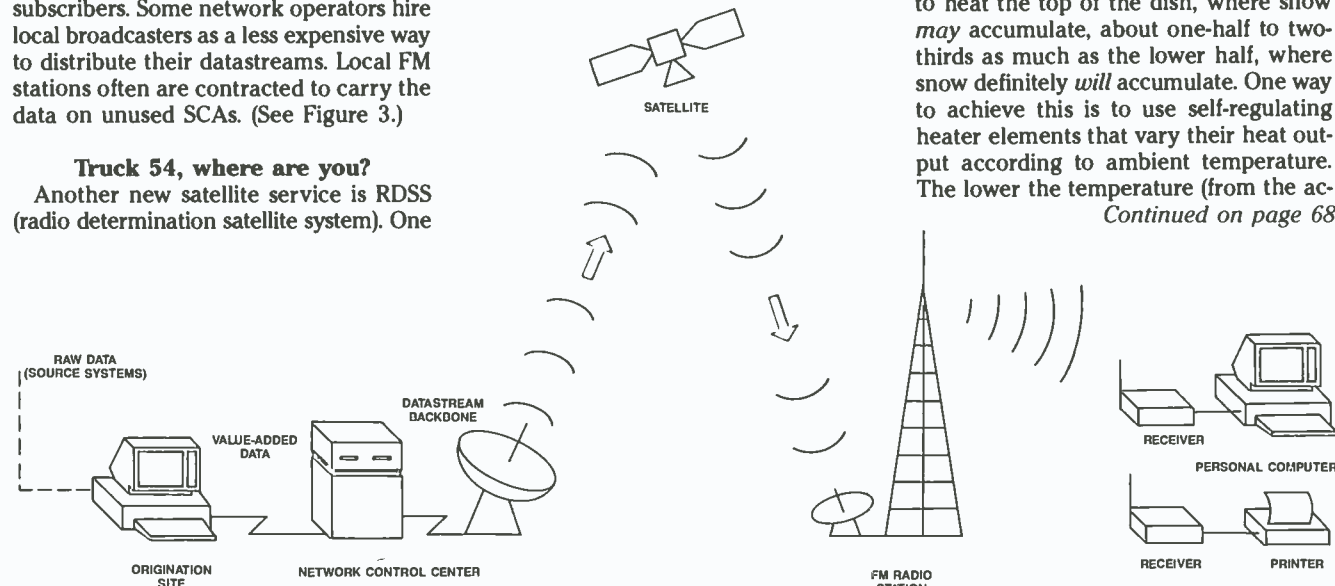

Figure 3. Data communications systems use broadcasters as "last mile" distribution system. The datastream from the network is transmitted on vacant FM subcarriers.

★ NEW ★
GRAPHIC PRINTOUT!

THE NEW ★TOP GUN★ IN AUDIO TESTING!

THE ST3100A PROGRAMMABLE AUDIO GENERATOR
AND THE ST3200B AUDIO ANALYZER



THE NEW 3000 SERIES AUDIO TEST SYSTEMS FROM SOUND TECHNOLOGY



There's a new TOP GUN in audio testing ... the Sound Technology 3000 series. The 3000 series is singularly THE most flexible audio test system available. And, with its exclusive on-board FSK automation, the 3000 series becomes THE most practical audio test system to automate! Here are a few of the features:

ULTIMATE FLEXIBILITY

- The 3000 series can be configured as a separate oscillator and analyzer for remote work OR in one main -frame as an audio test system.
- The 3000 series is portable. Use the 3000A manually for troubleshooting OR use the built-in automation for quick and comprehensive checkouts.
- Obtain tabular or graphic hardcopy directly from the Analyzer to a standard dot matrix printer!

PRACTICAL AUTOMATION

- Automate benchtop testing using the 3000's built-in automation OR use ST's IBM®/compatible bundled software with the 3000's industry standard GPIB and RS-232 interfaces!
- Automate remote tests using built-in FSK automation: no need for modems, computers or phone lines!
- Simple automated playback testing: record FSK automation on audio tracks of ATR's and VTR's. Analyzer then automatically tracks overall playback performance. Excellent for testing multiple playback-only machines!

With the ST3000 series you have ultimate flexibility with no compromises. For instance, true-floating transformerless balanced outputs allow for the world's finest squarewave output. And no one offers a greater selection of waveforms. Finally, our specifications are the finest one can encounter.

Contact us now for full technical and applications information. Learn firsthand why the ST3000 series is the TOP GUN IN AUDIO TESTING!

SOUND TECHNOLOGY

1400 Dell Avenue
Campbell, California 95008
(408) 378-6540 Telex: 357445



Put The Best
To Test!

In Canada, contact the Pringle Division
at (416) 222-2447

Circle (35) on Reply Card



GUERRIL

ENG. It's full-on warfare—brutal, competitive, and sometimes downright dangerous.

To outshoot the competition, your crew needs an advantage. Give them a big one. Give them new CVR-200 *one-piece* camcorders from Ampex.

With battery, tape and the newly-developed ultralight Nikon lens, this *camcorder* is nearly three pounds lighter than an Ike HL79E camera!

It's compact and easy to handle, too. So your crews can move fast and maintain a low profile, even in explosive situations.

Low light is no problem either. Advanced CCD sensors deliver dynamite pictures, even in adverse conditions.

And if those conditions mean hard knocks, don't worry. Its rugged design, magnesium alloy chassis and weatherproof housing

help keep the CVR-200 on the streets, and out of the shop.

But as good as it is, the CVR-200 is only part of the story. We can outfit you with a full arsenal of the most advanced Betacam equipment available:

- CVR-35—the portable VTR with the features news professionals ask for most.
- CVR-22—a low cost,



ACAM

easy-to-use office player.

□ *CVC-5, 7 and 50*—the most versatile CCD cameras in the business.

□ *Ampex Betacam 198 Tape*—rugged cassettes engineered expressly for ENG.

If you want to win the ratings war, you're going to have to arm your crew with the best equipment available—and for equip-

ment, service and support, there's no better ally than Ampex.

Give your Ampex Salesperson or your Authorized Ampex Dealer a call today. Before the competition does.

Circle (36) on Reply Card



AMPEX

Continued from page 64

accumulation of snow), the more heat.

Thermostat failure may be a cause of concern. A thermostat that is stuck "on" could damage either the dish or the heater elements, especially if it failed in summer, adding the heater output to the warmth of the day. At the least, such a failure would waste power, especially if undiscovered. This problem might be solved by turning off heater circuits in warm months and installing a remote indicator to show when the coils are energized.

Should de-icers be used on primary or protected (backup) power? It depends. Some de-icing systems draw hefty currents. Sizing a generator to accommodate an occasionally used load might not be economical. On the other hand, main power may be most likely to fail in a winter storm. De-icing would be unavailable when it was most needed. Some operators make the de-icing equipment power input switchable between the regular or backup power systems. In any case, it is probably a good idea to have equipment for manual de-icing, even if electric heat carries the burden most of the time.

With anti-icing, some of the de-icing chemicals can be applied to dry dishes to

help melt snow on contact. Also, some dishes have special coatings that discourage build-up. Some research indicates these coatings are most effective when combined with heat.

Safety habit: Do it now

Now that most studio equipment uses low-voltage circuitry, de-icing a satellite antenna may be one of the more perilous jobs station engineers must undertake.

Consider that de-icing takes place out of doors, in snowstorms, during the day or night. It is a physical activity that requires stretching and perhaps some lifting, which might pull muscles. The de-icing tools are long and unwieldy and can draw arcs from nearby power lines or break windows if the operator is not careful. And de-icing can require engineers to work on precarious, ice-caked surfaces.

Any little slip can be hazardous. Even simple injuries such as twisted ankles can keep engineers hobbling around the shop instead of being able to respond to trouble calls wherever they are needed.

The first and simplest safety precaution is to police the area. Remove all trash before it snows. Even small debris, wood scraps, leaves and twigs—the kind of stuff you'd kick aside on a summer day—

become dangerous toe-catchers when they are locked into ice. It is amazing how disorienting a good cover of snow can be. Snow might not only make it hard to find the path or catwalk, but also might make it impossible to avoid rotten boards or rusted steps.

Next, check your equipment. If your dish is high enough that it has access platforms, check and repair them now. Check your stepladder, if you use one. Repaint the "head-banging places," the "pinch points" and the "no-step" zones. If there is a catwalk out to the dish, replace any damaged boards, pound down loose nails and fix loose steps. Check the lighting at the dish (or install some). These jobs are easier to do when it's warm rather than having to grub around in the snow to do them.

Inspect the dish electronics, the dish control and actuation system and the de-icing hardware, if installed. Does it work, and is it in condition to withstand the winter? Remember that electrical repairs put off until the snow flies can be as hazardous as electrical repairs performed in the rain.

Some dishes have nooks and crannies where rodents like to curl up for the

Continued on page 148

The Dorrrough Loudness Meter



Dimensions: 8 1/4" x 2 7/8" x 6 1/2"

Model 40-A

Simultaneous Display of Peak and Average on a Single Scale

Never before has a gain riding display been able to show what is taking place acoustically and electronically. Through its unique electronics, the 40-A allows the eye to see a one-half cycle excursion at 15kHz, thus helping to keep the audio peaks within the headroom of the equipment.

This meter correlates all types of program material and has led the way to open and clean programming throughout the system.

Specifications

Scale: 40 units in 1dB steps

Input Level: -30 to +20dBm

Input Impedance: 20k bal, 10k unbal.

Power: 120V/220-240V/50-60Hz

dorrrough

Dorrrough Electronics • 5221 Collier Place • Woodland Hills, CA 91364 • (818) 999-1132

Circle (76) on Reply Card

The new SPG-1300N

proves our commitment
to setting standards
...Again!



In 1971 Jim Leitch, our founder, designed the original NTSC Sync Generator with consistent SCH! This SPG-100N was so new and exemplary that it became the forerunner to RS-170A.

We're doing it again with the all new SPG-1300N, proving our commitment to leadership with progressive concepts in television technology.

- Low cost, modular 1RU design.
- No warm-up, high stability TCXO (<1 Hz).
- RS-170A zero SCH Sync Subcarrier, Black and Test Signal outputs.
- Independent timing for pulses, black and test signals.
- Adjustable blanking widths and burst flag position.
- NTSC Digital Genlock.
- Accurate, 12-bit digital test signals (option).
- Color frame-locked stereo tone output.

LEITCH

Translator system planning and installation

By Richard Maddox

FM and TV translators and boosters may help your station regain "hidden" audiences.

Many stations are looking for ways to increase their viewer or listener base through expanded signal-coverage techniques. Today's competitive marketplace makes it mandatory that they investigate

every possible way of reaching potential audiences.

In addition to broadcasters who want to increase coverage with translators, a number of syndicates and individuals want to rebroadcast satellite-delivered programming. This application, however, may tread the fine line between being an LPTV station and being a translator installation.

As the competition heats up, FM and TV translators become viable options for many stations. Combined with recent FCC rule changes, these delivery methods offer attractive possibilities to stations that want to retain every rating point.

Maddox is a service technician and free-lance technical writer in Lynnwood, WA.

Current rules

The new FCC rules and regulations for translators and boosters are set in Volume III, Part 74, Subparts G and L. Subpart G combines low-power television (LPTV), TV translators and TV boosters. Subpart L covers FM translators and FM boosters.

The commission is accepting no new commercial FM translator applications. On March 24, the agency imposed a general freeze pending the outcome of Notice of Inquiry (NOI 88-120) on the "appropriate role of FM translators in the radio broadcasting service."

Further action on the notice is likely to take 12 to 18 months. Even then, the result may be no more than a clarification of the rules regarding the use of FM translators, rather than a technical overhaul.

This FCC action does not affect FM boosters. Since officially opening up the booster category on April 20 (with the release of the new forms), the commission has processed several applications, and is just now starting to see stations come online with newly built booster transmitters. For FM broadcasters, boosters are a hot topic now that the new rules are in effect.

The two most important differences in regard to previous limitations are that higher power now is allowed (up to 20% of the main transmitter's power output, unless the station is near the Canadian or Mexican borders), and that the booster transmitter may be fed by any common means including aural STL, cable, 24GHz, intercity relay or fiber.

Continued on page 74

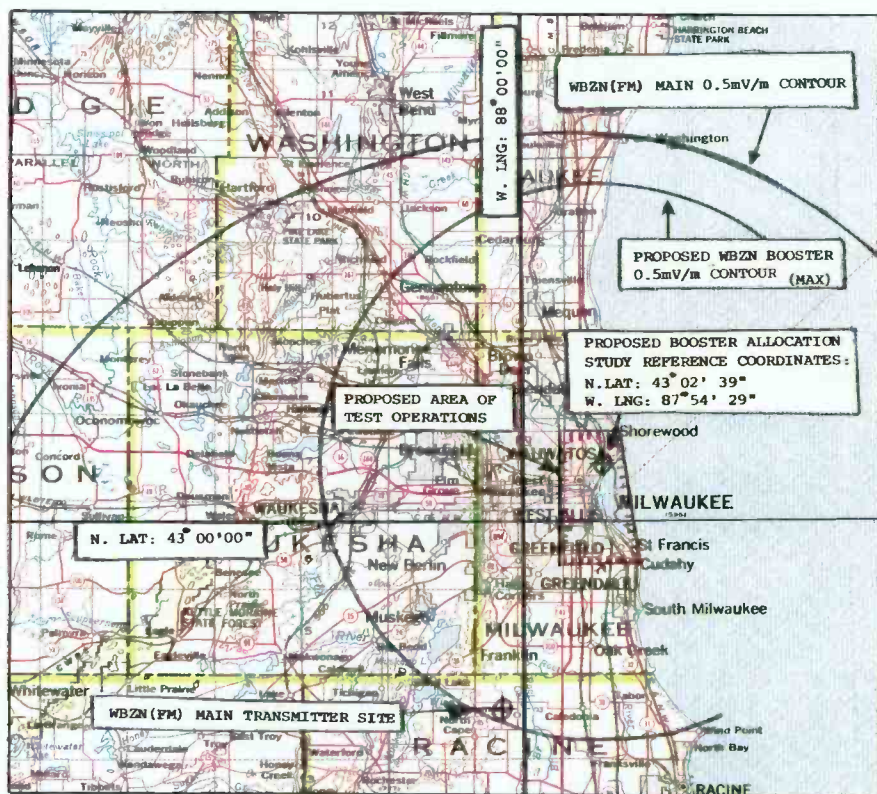
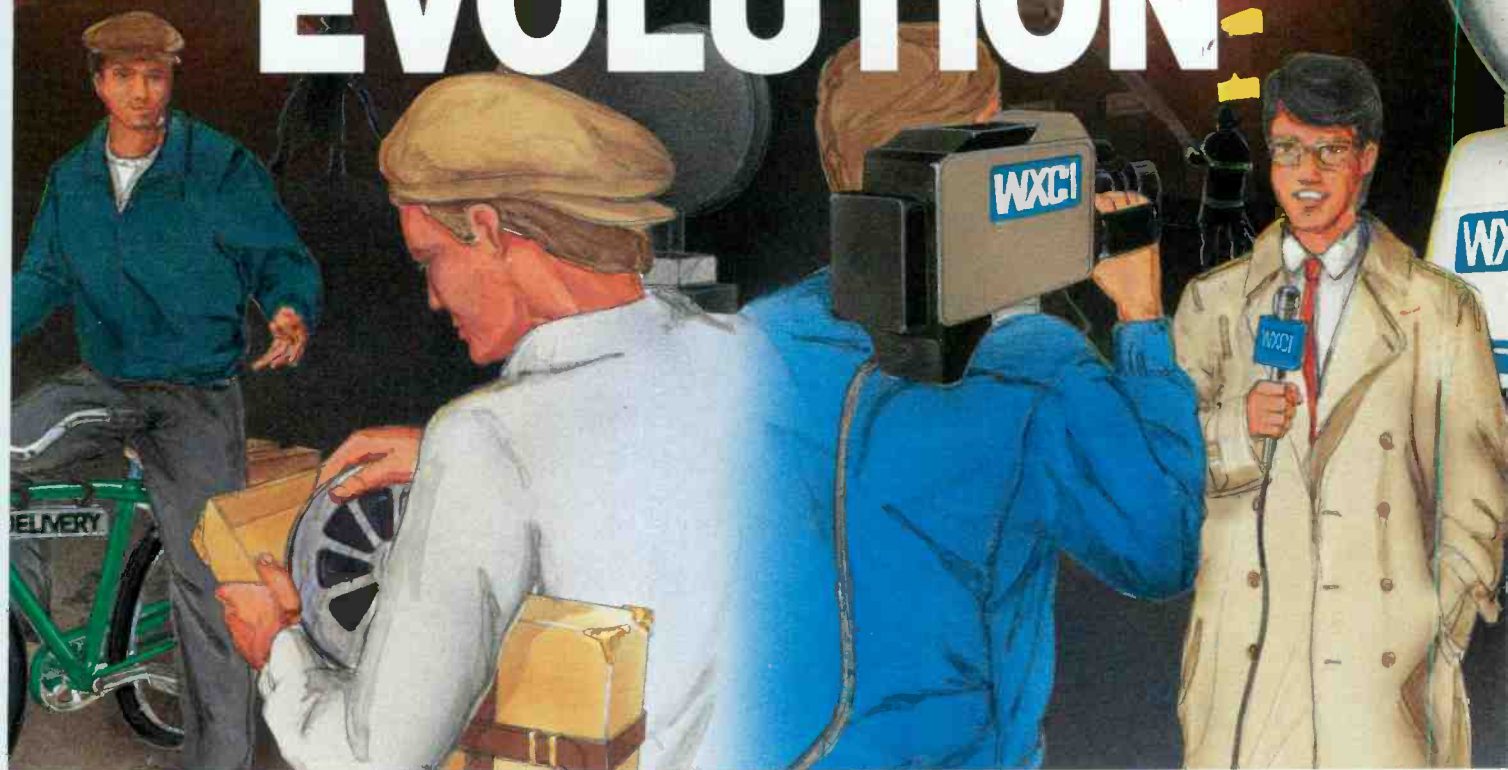

Figure 1. Supplemented coverage is provided by the booster located in downtown Milwaukee. Note that the proposed booster 0.5mV/m contour lies entirely within the station's main transmitter predicted 0.5mV/m contour.

EVOLUTION



REEL NEWS

Early newsreel makers were hungry for news. Studio cameramen were responsible for developing their own leads, and they aggressively sought exclusive footage to scoop their competition. As fast as the film was shot, it was taken to the lab, developed, and distributed to theaters. Sometimes, as in the case of a presidential election, these pioneers of the broadcasting industry would produce two endings for timely viewing. The newsreel producers' wizardry probably culminated during a parade of WWII soldiers in New York City, when audiences were able to see the event before it had ended!

Today's broadcasters still rely on speed to deliver up-to-the-minute coverage. News crews travel in sophisticated SNV's and broadcast live from the field. Their ability to communicate instantly to almost anywhere in the world has diminished the once-phenomenal feats of their earlier counterparts.

SWITCHCRAFT ARRIVES ON THE SCENE

As the broadcasting industry continues to evolve, there remains a need for reliable communications equipment. From the start, Switchcraft was there to meet that

need. For over 40 years, Switchcraft supplied broadcast engineers with quality audio components—phone jacks and plugs, patch panels, power cords, and audio adapters. Switchcraft offered the industry a product line of over 6,000 parts, to provide the right part at the right time. And Switchcraft's staff of design engineers followed through by tailoring their quality products to broadcasting engineers' custom applications.

A MARKET LEADER EVOLVES

Today, Switchcraft is the most asked-for name in audio and broadcasting components. Switchcraft is synonymous with quality,

dependability, and rugged durability. It's no wonder we're proud to broadcast our role as an industry leader and how we got there.

HERE'S THE SCOOP

You rely on your equipment to "out-scoop" your competition. Switchcraft can be counted on for delivering consistently superior performance. Specify Switchcraft—the natural selection in quality broadcasting components.

Send me information on your quality components:

- Please have a representative contact me.
 - Please send me your General Line Catalog
- My area(s) of interest is:
- Switches Connectors Power Cords
 - EAC Receptacles Jacks/Plugs
 - Molded Cable Assemblies Patch Panels
- My application is Current
- Future (date) _____

Name _____

Company _____

Title _____

Address _____

City _____ State _____ Zip _____

Telephone () _____

Mail To: Marketing Communications Dept.,
Switchcraft, Inc.,
5555 N. Elston Ave.,
Chicago, IL 60630

BE 9-88

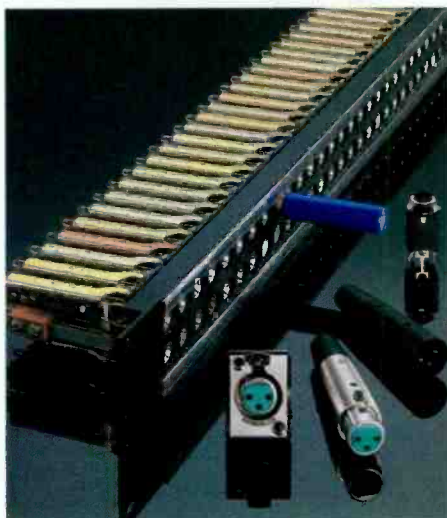

Switchcraft

A Raytheon Company

5555 N. Elston Ave.
Chicago, IL 60630
(312) 792-2700

Circle (38) on Reply Card

ROSES ARE REDDER, VIOLETS ARE BLUER.

All of the colors are richer and more vivid than you'd expect to see on video tape. That's because EASTMAN EVT-2000 Broadcast Video Tape was designed specifically for high saturation.

And with our quality assurance program for Eastman products, you can be confident the colors won't wilt. In fact, even after 300 passes, the signal degradation is less than 0.5 dB.

So next time you're looking for beautiful color, pick up an EASTMAN EVT-2000 Broadcast Video Tape.

Better yet, pick up a bunch.



Eastman
Professional Video Tape





CLOSE ▾

LOCK ▾

PRESS  TURN

OPEN ▾

 **Eastman**

EVT-2000
Broadcast Video Tape

PROGRAM: _____
 TAPE NO. _____
 CLIENT: _____
 RECORD DATE: _____ LB-NOTM: _____

<input type="checkbox"/> Camera Original	<input type="checkbox"/> NTSC	<input type="checkbox"/> 798	<input type="checkbox"/> SECAM
<input type="checkbox"/> Master	<input type="checkbox"/> Audio 1		
<input type="checkbox"/> Edited Master	<input type="checkbox"/> Audio 2		
<input type="checkbox"/> Dub Master	<input type="checkbox"/> LTC	<input type="checkbox"/> VTC	<input type="checkbox"/> DOLBY NR
<input type="checkbox"/> Dub	<input type="checkbox"/> NonDiac TC		<input type="checkbox"/> Drop TC

EASTMAN KODAK COMPANY ROCHESTER, NY 14650
 ©EASTMAN KODAK COMPANY 1987
 TB: EASTMAN PD 6033386 MADE IN JAPAN

Continued from page 70

Most of the other technical rules remain unchanged. Booster coverage may not extend beyond the 1mV/m predicted service contour for Class A, C, C1 or C2 stations, beyond the 0.7mV/m contour for a Class B1 station or beyond the 0.5mV/m contour for a Class B station. If the station is located within 199 miles of Canada, it also is limited to 50W ERP. However, if the station is located within 199 miles of Mexico, the main power is 10W TPO.

As usual, you will need to become familiar with some new forms. FCC form 349 is for new construction permits (CPs), and form 350 is for the actual license application. You can file for a CP and a license at no charge.

FM booster systems

If your station is located on a nice, flat plain, and no blocking terrain exists in your desired coverage area, then you would not need or want to install a booster. It would probably create more problems than it would solve. However, if you have a sizable audience that cannot receive a clear signal because of mountains, skyscrapers, transmitter location or other factors, then it might be to your advantage to spotlight one or more areas

with a booster.

Because the FM booster is transmitting on the same frequency as the main transmitter, there may be areas of severe multipath where the two signals converge. This can be controlled through the placement and power of the booster antenna, through phase-locking of the two transmitters and, possibly, through the use of circular polarization. Directional antenna arrays also can be used to help control the interference zones.

RF feedback may occur in some installations. When this happens, it's often necessary to physically isolate the booster receive and transmit antennas. Another technique relies on phase-locking the two transmitters. The booster is phase-locked to the main transmitter through the local oscillator, which is referenced to a divided-down signal transmitted as a subcarrier by the main station.

Booster antenna height is not as critical as main transmitter height. In fact, excessive transmitter antenna height can be undesirable because it may result in too large a coverage area, creating even larger interference zones. The same holds true for booster power. Although booster power levels as high as 20% of the main transmitter are permitted, such power

levels are often unnecessary. Typical powers are less than 5kW.

FM booster case studies

Two locations where boosters have been installed and have proved to be workable are in the Milwaukee and San Francisco Bay areas. WBZN-FM, Racine, WI, wanted to obtain better coverage in the metropolitan Milwaukee area. The station received an experimental permit last year to determine the best location and power for its booster. At this time, a 2kW booster is installed on a slight bluff north of downtown Milwaukee (see Figure 1).

Both linear and circular polarization antennas were tried. The circular antenna had a slight edge in coverage and interference zone size. (The main factor in the size of the interference zone relates to the phasing of the two carriers. Precise phase relationships must be maintained to prevent wide bands of multipath-type interference.) Final placement of the booster antenna probably will be lower on the bluff, which should result in a slightly smaller coverage area, but also decrease the interference zones.

A few miles east of San Francisco Bay is perhaps the ideal location for implementing FM and TV boosters. A fairly

The wireless system that will never leave you speechless.

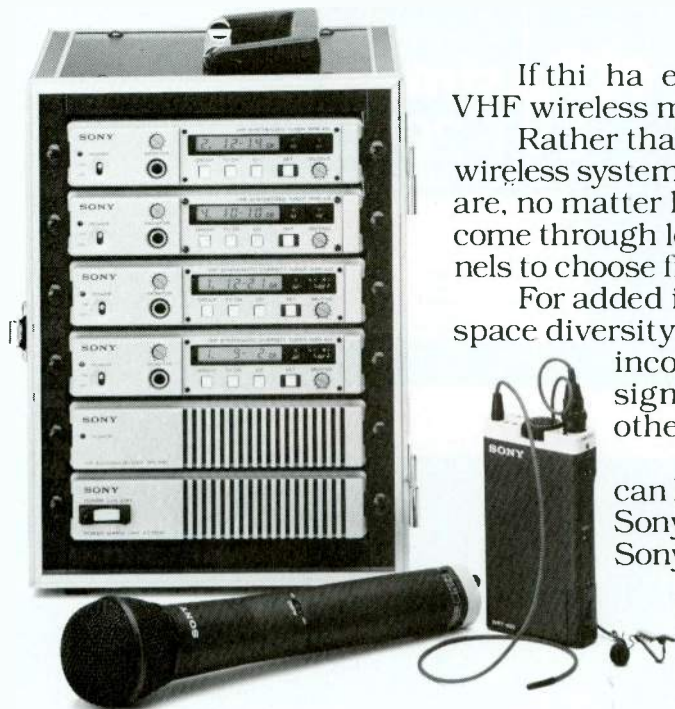

If this ever happened to you, you weren't using a Sony VHF wireless microphone.

Rather than a mere one, two or ten channels, the Sony wireless system gives you up to 168. So no matter where you are, no matter how cluttered the airwaves, the signal will come through loud and clear. And with so many open channels to choose from, multi-microphone setups are a snap.

For added insurance, Sony wireless arms you with true space diversity reception. Twin tuners constantly compare incoming signals for the strongest, clearest signal. Sparing you the echoes, dead spots and other horrors that plague lesser systems.

So, if you're looking for a wireless system you can have faith in—any time, any place—contact your Sony Professional Audio representative. Or call Sony at 800-635-SONY.

SONY.
Professional Audio

Sony Communications Products Company, Professional Audio Division, 1600 Queen Anne Rd., Teaneck, NJ 07666. © 1988 Sony Corporation of America. Sony is a registered trademark of Sony Corporation.

Circle (81) on Reply Card

"From inspiration to installation, Centro is the key."

With Centro, your next broadcast, teleproduction or post-production facility can capitalize on years of experience. Your project begins with a Centro Professional Services contract, where your needs are carefully translated into formal design and engineering plans.

With approved plans in hand, Centro can complete every aspect of systems integration, construction, fabrication, and installation. With meticulous attention to every detail, Centro can put your new or renovated facility on-line, on time and within budget.

Centro, worldwide systems integration specialists in building the finest broadcast, teleproduction and post-production facilities. In short, turning ideas and dreams into reality.

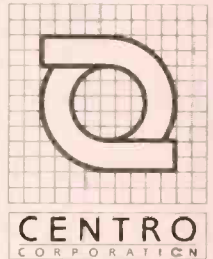

369 Billy Mitchell Road
Salt Lake City, Utah 84116
(801) 537-7779



Please call me, I'm interested. Circle (40) on Reply Card.
Please send literature. Circle (140) on Reply Card.

©1987 - Centro Corporation

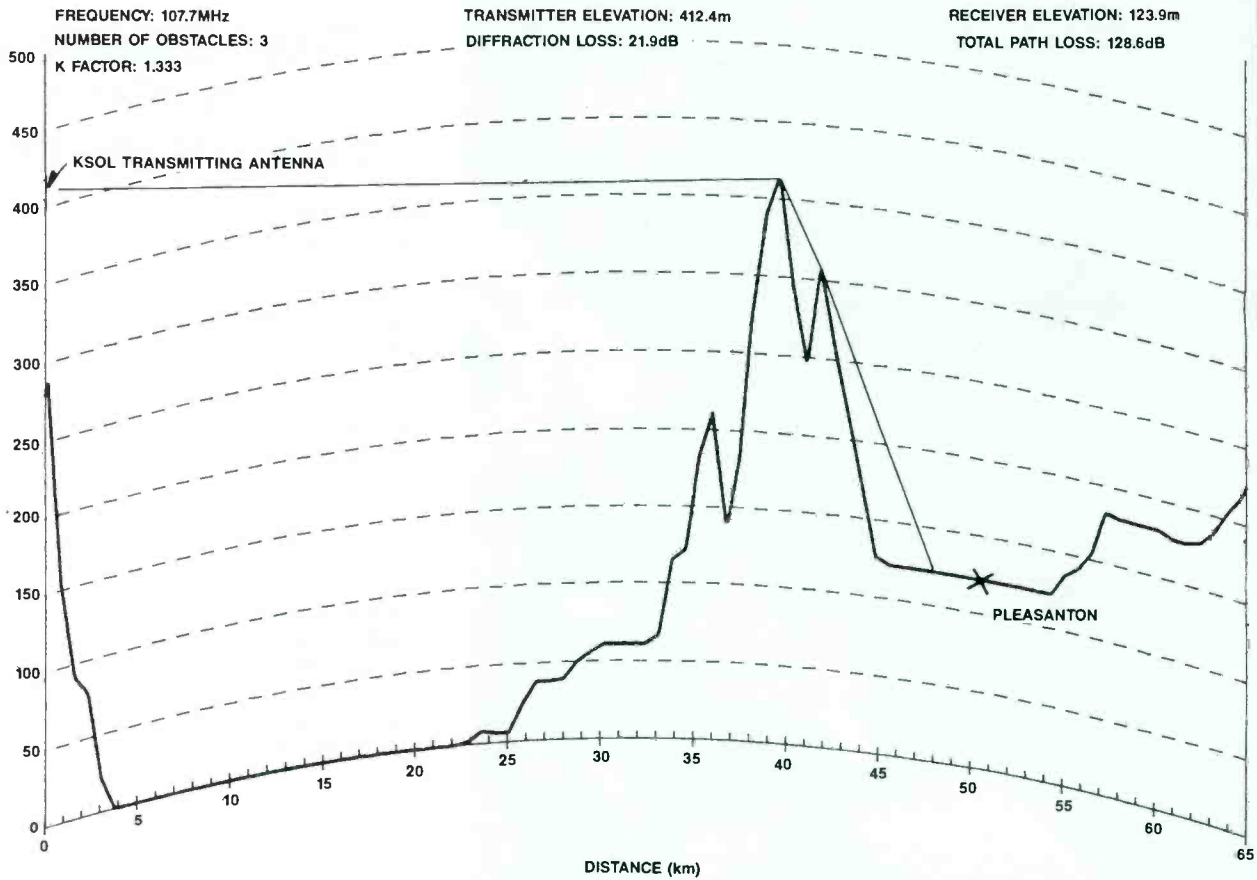

Figure 2. Elevation plot of the San Francisco Bay area showing the signal blockage suffered by KSOL-FM (and many other Bay area broadcasters). The mountain ridge effectively shields the community of Pleasanton from service, despite predicted Grade A coverage signal strength.

Your Problem Solvers

from **ATI**



- Mike
- Line
- Phono
- Mixing
- Matching
- Metering
- Monitoring
- Processing
- Distribution
- Rack Mounting

AUDIO TECHNOLOGIES, INC.

328 W. Maple Ave., Horsharr, PA 19044 • (215) 443-0330 • FAX (215) 443-0394



Circle (41) on Reply Card

If you think all cart machines are created equal...

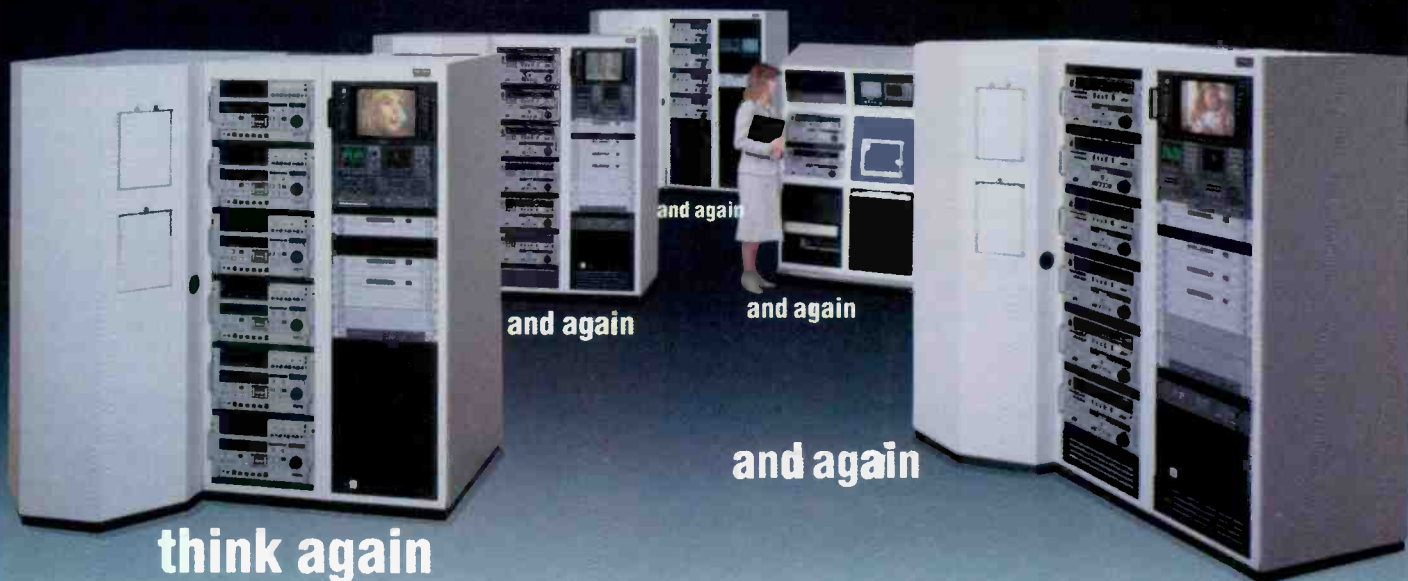

We have the industry's broadest selection of cart systems.

While our competitors deliver promises, we deliver:

- Integrated record/play cart systems
- Play-only cart systems
- Cart work stations
- Traffic interface sets
- External VTR controllers
- On-air automation cart systems
- Choice of formats including M II and SP

Odetics Broadcast

We're changing the way you think about cart machines.

1515 South Manchester Avenue, Anaheim, California 92802-2907

Phone 800-243-2001 714-774-2200

Circle (42) on Reply Card

MARKET TRENDS

The trend in audio distribution amplifiers has been limited at best. Common audio DAs never seem to have enough inputs, and fixed outputs cramp your style.



Routing Distribution Amplifier

Our uniquely flexible Routing Distribution Amplifier is turning the market around. The audio RDA gives you 8 inputs and 28 outputs. Any input, or combination of inputs, can be routed to any output. And, with the simple flip of a dip switch, you can reconfigure the RDA to meet changing needs.

GENTNER
AUDIO PRODUCTS

P.O. Box 27647 · Salt Lake City, UT 84127-0647 · (801) 975-7200 · FAX (801) 977-0087
© 1988 - Gentner Electronics Corporation
Gentner Electronics Corporation is publically traded over the counter and is listed in the "pink sheets."

Circle (43) on Reply Card

high, steep ridge runs north and south along the east side of the bay, effectively shadowing most of the rapidly developing valleys on the other side. (See Figure 2.) All the Bay area TV stations' theoretical Grade A contours and many of the area's FM station service contours easily extend beyond these hills, even if the signals don't.

Because of the enormous increase in the population of this shadowed area over the past five years, it is highly advantageous to have a good signal into the area. This holds true for FMs more than for TV stations, because cable penetration in the valleys is quite high.

The ridge dividing the bay from the valley is not highly populated. Consequently, the interference zones that are created are not a major problem. Several FM stations have boosters in place under the old FCC rules, with most planning to increase their allowed power under the new rules. One station proposed to serve the communities indicated in Figure 3. Some of the stations also are planning for other locations or new facilities in an effort to serve these areas.

Experimental permits

If you are interested in exploring the feasibility of adding a booster for your station, your best course of action may be to request an experimental permit. There is no fee and no official form to complete.

To obtain an experimental FM booster permit, simply write a letter to the commission stating when and where you'd like to try out your equipment, what equipment you'll be using, the power, the make and model, and the area that you hope to cover. This is basically the same information required to get a CP. Send this information to Tom English at the FCC's Auxiliary Services Branch, Audio Services Division, Washington, DC. Unless the proposed booster station is surrounded by complicated terrain or located in a crowded spectrum, you should get a response within five to 10 working days.

Experimental permits typically are good for three to six months, and there is no formal renewal policy. An extension request, along with information on the results obtained, seems to be the only requirement. It appears that the commission is working hard to help broadcasters get the new booster facilities up and running with the least amount of paperwork.

At this time, the only drawback to an experimental permit is that you may have to turn it in when you file for your CP. This would mean shutting down the booster until your CP and license applications are approved.

TV boosters

Because the TV booster also broadcasts on the same frequency as the main

NEW! Wireless Clear-Com

6 Beltpacks—No Wires!

FCC Approved

- ▲ Clear-Com quality audio
- ▲ Extends range of wired system with up to six wireless transceivers
- ▲ Full-duplex, high band operation
- ▲ Developed for the professional user
- ▲ Exceptional RF performance — virtually transparent from the wired system

CONTACT YOUR CLEAR-COM DEALER, OR CALL/WRITE:

Clear-Com
Intercom Systems

945 Camelia
Berkeley, CA 94710
415-527-6666
FAX 415-527-6699

Circle (44) on Reply Card

UNCOMMON STOCK

If you could solve the lion's share of your equipment needs in one place, you could spend less time running from dealer to dealer, catalog to catalog, and more time running your operation. That's why Gentner Electronics, with over 72 high performance products in stock, is an uncommon company providing innovative solutions to your common problems.

Solutions like the VRC-1000 Remote Control which has allowed countless engineers to monitor and operate their transmitters through any Touch-Tone™ phone. A preprogrammed synthesized voice gives you the parameters, you make the adjustments with the touch of a button. Nothing is simpler or more dependable.

Our Digital Hybrid™ is another example of innovation in our line of telephone interface products. It is an auto-nulling telephone hybrid with precision filtering and noise reduction. It solves your interface problems and uses advanced digital signal processing to analyze, isolate and stop leakage between receive and send signals. This greatly reduces the "hollow" sound that plagues broadcast or teleconferencing applications.

Our Audio Division, with its track record for developing unparalleled products, has taken the sting out of common audio DAs. Our unique flexible Routing Distribution Amplifier has overcome the typical DA's input and output limitations by giving you 8 inputs and 28 outputs. Any

input, or combination of inputs, can be routed to any output. And, with the simple flip of a dip switch, you can reconfigure the RDA to meet changing needs.

Gentner is setting new standards in patch panels, too. Our Versapatch, a chassis-enclosed audio patch panel, is hand-wired to your specifications and can be terminated to our Flexiblock or telco-type '66' punch block. For prewired patch panels, no one has the edge on Gentner. With a wide variety of bay fronts and terminations in stock, you're guaranteed fast delivery.

The bottom line is this—before you place a buy order for your next equipment purchase take a look at what Gentner has to offer. You'll find our uncommon stock is stable, dependable and will pay you dividends for years to come. Gentner Electronics, a sound investment in your future.



VRC 1000



Digital Hybrid



Routing Distribution Amplifier

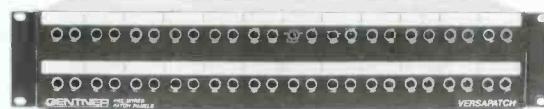

Versapatch

GENTNER
ELECTRONICS
CORPORATION

P.O. Box 27647 · Salt Lake City, UT 84127-0647
(801) 975-7200 · FAX (801) 977-0087

transmitter, there will be interference problems in areas where the main and booster signal levels are similar. Because this interference is a much greater problem in television than in FM, searching for the proper booster location is a more exacting project.

TV boosters may be used to fill in shadowed areas within a station's grade B contours, but may not extend the grade B contours. Power is limited to 10W peak visual power for VHF and 1kW for UHF. This same power limitation applies to TV

translators and LPTV transmitters.

Current wisdom says that boosters are workable only in situations where complete signal shadowing occurs. In weak signal areas, a better solution is offered by a translator.

This new category of auxiliary TV transmitters was first opened on April 20. Applications can be filed at any time. Form 346 is used for the CP (with a filing fee of \$375), and form 347 is used for the license (with a \$75 filing fee). Currently, there are no regularly operating TV

boosters in the United States.

TV translators

Unlike boosters for FM, TV translator and LPTV applications are limited to filing windows set by the FCC. The last window occurred June 15-24, 1988. The commission would like to open a window each quarter, but seems to be running more on a once-a-year schedule. Part of this is due to the large number of applications that were filed. (1,350 were filed in the June 1987 window.) A large percentage of these applications are for LPTV licenses.

Other elements make the use of TV translators more complex. The FCC reassigned UHF channels 70 through 83 to secondary status under land mobile, and decided channels 14 through 20 also would be used in some locations for land mobile stations. The existing UHF and LPTV stations and UHF translators further add to the pressures for this spectrum. These factors all combine to make the remaining space difficult to obtain.

Translator (and LPTV) applications also were limited by some of the original FCC policies. Until late last year, the commission did not consider any terrain-shielding effects when examining applications. Consequently, many applicants were turned down because of predicted interference despite the fact that, in actual usage, terrain shielding would have prevented interference.

Since early 1988, however, the commission has been granting waivers (if requested with supporting documentation at the time of application) on the basis of non-interference due to terrain shielding.

TV translator systems

Approximately 80% of the TV translator installations rely on an off-air signal. The signal is received through a single-channel reception antenna, amplified and fed to a mixer, which either heterodynes the channel directly to the desired final channel, or drops it to an IF before mixing up to the final channel. This new frequency is further amplified and coupled to a standard low-power antenna array. A typical TV translator is shown in Figure 4.

Another technique relies on the use of discrete audio-video signals received from satellite or another relayed source. These signals are then used to develop the on-air signal, just as in a standard transmitter.

Some remote installations diplex several translators into one transmit antenna or antenna array. This may be a cost-effective approach, especially if more than two stations are involved.

VHF translators are limited to a maximum output of 10W, and UHF translators can have a maximum output of 1,000W. The translator frequency can be assigned to any available VHF or UHF channel.

Continued on page 84

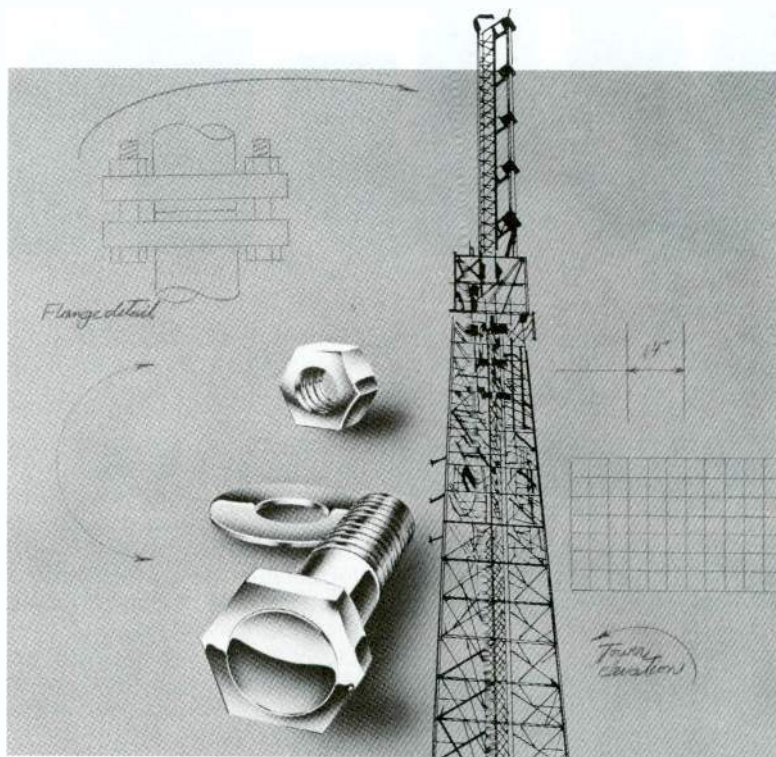

When you build major towers there are no minor details.

At Stainless, Inc., our exceptional track record has earned us the reputation of a company who specializes in detail.

Whether it's dealing with unusual equipment loading conditions or unique terrain conditions, we do whatever it takes to construct a quality Stainless tower to meet your specifications.

As a result of our high standards, we've been commissioned to design and build more than 6,500 towers of all heights and sizes worldwide. We've conquered all types of building challenges. And we've been doing it for 40 years.



Stainless, inc.

North Wales, PA • USA 19454
Phone: (215) 699-4871 Telex: 510-661-8097

STAINLESS
CONSTRUCTION COMPANY

Circle (46) on Reply Card



Getting where you want to go is a matter of selecting the right equipment.



Being prepared to face the toughest challenge is critical to success in any situation. Broadcast and Post-Production facilities are no exception,

where optimizing the quality of your production is essential to get you to the top.

Innovative, Economical Solutions

From input to output, FOR-A understands these challenges and has engineered its Professional Video Equipment to meet them head on.

Innovative solutions—TBCs, Digital Effects Generators, Production Switchers, Color Correctors, Character Generators—at every key point along the video path. Economical innovations. With an open-ended growth path so decisions you make today will keep you open to tomorrow's opportunities.

Myriad of Choices

And we give you a myriad of choices. Beginning with composite or component systems. So you can get the features you

want without paying for what you don't need plus performance that surpasses most comparably priced equipment. For example, the best "straight-up" TBC money can buy, a \$20,000 digital effects generator with performance you'd expect for twice the price, and the color correctors used by NBC for their exclusive coverage of the 1988 Summer Olympics.

Two-Year Warranty

And once you've made the decision to invest in a FOR-A

product, we're committed to helping you protect it. Our warranty says it all—two full years parts and labor. The industry's best.

So whatever your challenge—be it in broadcast, post-production or corporate TV—FOR-A will take you anywhere you want to go. FOR-A Corporation of America, Nonantum Office Park, 320 Nevada Street, Newton, MA 02160. Boston: (617) 244-3223. Chicago: (312) 250-8833. Los Angeles: (714) 894-3311.



PVM-600
Video Production Switcher

We're with you every step of the way.

FOR-A[®]
INNOVATIONS IN VIDEO
and AUDIO TECHNOLOGY

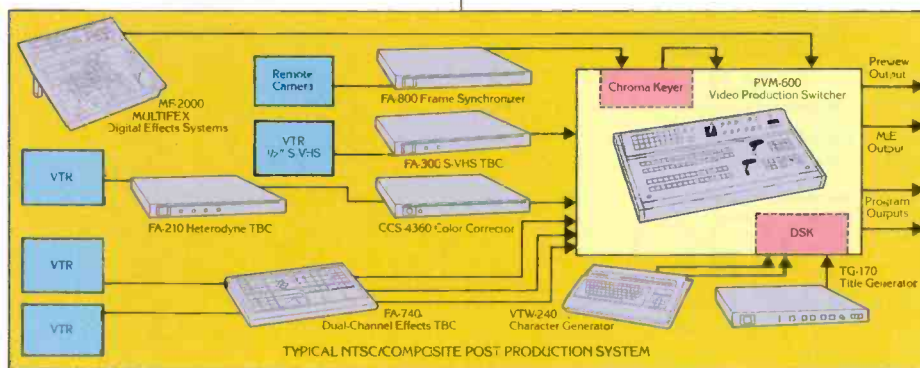

Edit your choice of to these five. MII.



The AU-660PE High-Performance VTR.
Available now.

Panasonic
MII

Official Video Equipment Of
The 1988 Olympic Games



Title 36 United States Code Section 380

studio VTR's down

AU-650



AU-640



AU-630



AU-620



With every Panasonic MII studio VTR, you get picture quality as good as, or even better than 1" or other 1/2" machines* And Panasonic's best offers you more than that. With our AU-660PE, you have more control over your editing options than ever before—from changing speeds while editing with Variable Memory Editing to memorizing and locating cue points with its 23-Key Pad Editing Control. The AU-660PE also combines these options with higher picture quality, through its 9-Bit TBC and standard edge comb filter.

Every MII studio VTR features the highest-quality components for reliability.

- Amorphous heads
- Rigid-mount reel drive motors
- Die-cast chassis
- Extensive steel gearing
- Extensive monitoring and control features

A full line for every application including broadcast, production, and post-production.

MODEL	PLAY/RECORD	PLAY ONLY	AUTO-TRACKING
AU-660PE	✓		✓
AU-650	✓		✓
AU-640	✓		
AU-630		✓	✓
AU-620		✓	

Call our field offices now:

Northeast: One Panasonic Way, Secaucus, NJ 07094; (201) 348-7671.

Washington, D.C.: (703) 759-6900.

Southeast: 1854 Shackleford Court, Suite 250, Norcross, GA 30093; (404) 925-6772.

Midwest: 425 E. Algonquin Road, Arlington Heights, IL 60005; (312) 981-7325/(317) 852-3715.

Southwest: 4500 Amon Carter Blvd., Fort Worth, TX 76155; (817) 685-1132.

Western: 6550 Katella Avenue, Cypress, CA 90630; (714) 895-7209.

Northwest: (408) 866-7974.

*Results of a recent PBSC survey.

MII Panasonic
Broadcast Systems Company

Circle (48) on Reply Card

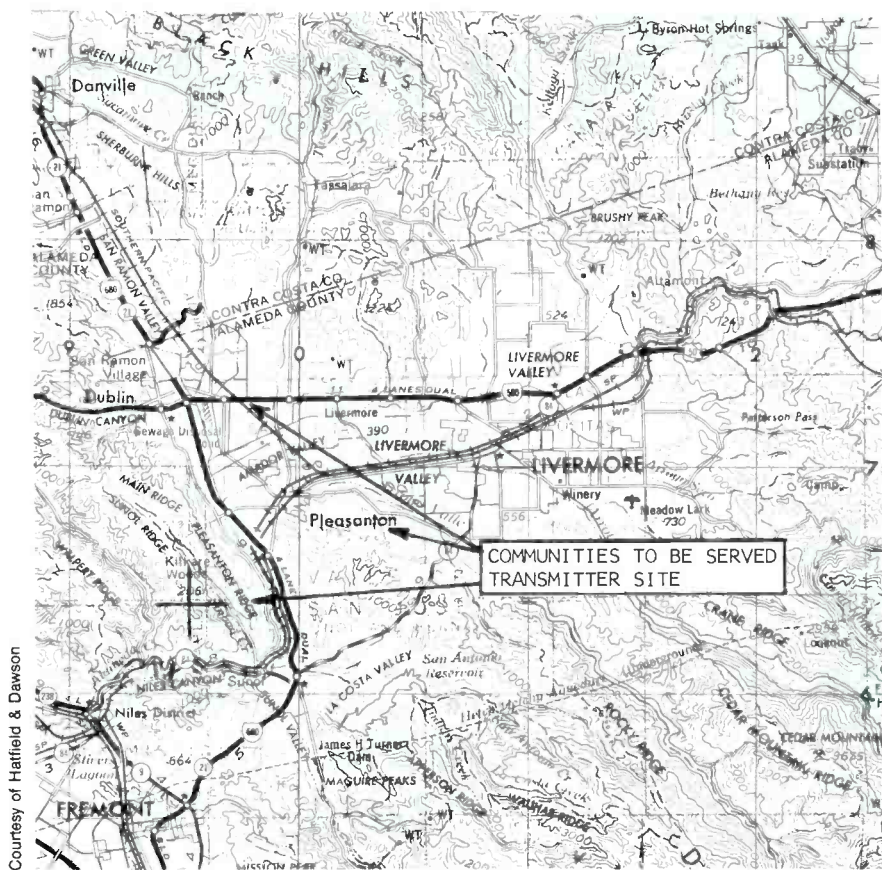

Courtesy of Hatfield & Dawson

Figure 3. Map shows the booster location and three ridges—Walpert, Sunol and Pleasanton—that prevent San Francisco stations' signals from reaching the communities.

Continued from page 80

Keep in mind that certain frequency conversions are not advisable and that UHF channels 14-20 are not usable in some areas. Also, UHF channels 70-83 are no longer available in any location.

All equipment, except the transmit and receive antennas and transmission line, must be type-accepted by the commission. The technical specifications for translator transmissions are outlined in FCC Rules & Regulations, Volume III, Subpart G, section 74.750.

TV case study

One TV station involved in the use of translators is Seattle's CBS affiliate, KIRO-TV. The station had 12 translators in 1964. The translators were located all around the Puget Sound area, not only to cover shadowed areas within the grade B contour, but also to extend coverage throughout western Washington.

Today, eight of these translators are still in operation. The other four have been sold. The extensive cabling of most area communities has reduced the need for translators in many places. Some of the remaining translators supplement coverage within the station's grade A contours that are shadowed by foothills. One, covering

10 years from now, it'll still be the standard.

The undisputed standard for broadcast cassette decks has always been the Tascam 122B. But that standard has just been surpassed.

Presenting the 3-head Tascam 122MKII. Its leadership is founded upon features such as Tascam's Cobalt Amorphous tape head technology. Plus a choice of built-in Dolby systems: not just B and C, but also HX-Pro, for virtually perfect high-end frequency response.

More than any comparable deck, it maintains constant tape speed and tension, thanks to a tape handling system that includes Tascam's Hysteresis Tension Servo Control.

And when it comes to handling, the 122MKII is the complete professional tool, with cue and review functions (manual cue), balanced XLR +4dBm inputs and outputs, and rack-mountability.

Call or write for more information about the 122MKII. Get it now, and use it for decades.

© 1987 TEAC Corporation of America, 7733 Telegraph Road, Montebello, CA 90640. (213) 726-0303. Dolby HX-Pro, Dolby B, and Dolby C are trademarks of Dolby Laboratories Licensing Corp.

TASCAM



Circle (49) on Reply Card

MORE THAN CABINETS, WE OFFER SOLUTIONS.

Everything in consoles and racks for the video professional.

We've been designing and building high quality video consoles and racks for over 35 years. So we know the ropes. This experience can save you considerable time and money.

Preassembled, modular units make it easy.

You can choose from hundreds of video consoles, cabinets, racks, desks, EMI/RFI enclosures, and accessories in a wide range of hi-tech colors and styles.

Our consoles and racks are modular for future expansion and everything is preassembled for quick, easy set up.



Modular design provides flexibility.

Quality you can count on.

When you choose Stantron video consoles and racks you're choosing the highest quality.

Our years of experience assures you the very best solution whether it's simply a VTR/VCR rack or an entire room of custom consoles.



A full range of power panels and strips.

Get all the facts.

Fill out the coupon or Reader Reply Card. Or, just give us a call. We'll rush you our new Preplanner and Video Catalog.



Professional design assistance.



Direct your inquiries to:

Stantron

Marketing Manager
6900-6918 Beck Ave.
No. Hollywood, CA 91605
Phone: (818) 841-1825 Fax: (818) 841-8892

Console and Rack Preplanner and Video Catalog!

Please rush me your Preplanner and Catalog.

Name _____
Title _____
Company _____
Address _____
City _____ State _____ Zip _____
Phone _____



FREE

Free design assistance.

If you like, our team of professional designers can help you design your own custom system.

They'll work with you so you'll get maximum aesthetics, ergonomics, efficiency, durability, and economy.

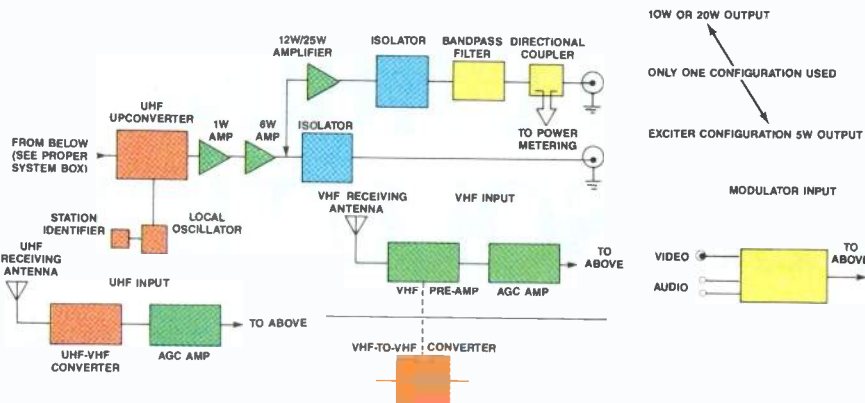

Figure 4. Block diagram of a typical UHF translator. Note that this design provides three possible inputs: VHF, UHF and discrete audio-video.

sideration accessibility, availability of power, ground conditions, surrounding topography, security and weather conditions.

Equipment selection must be completed before an experimental permit or CP is requested. In some cases, an experimental permit may be used to ascertain whether the predicted shadowing problems can be solved by using a booster. An experimental permit usually is issued for a given area (metropolitan Milwaukee, for example) so that several potential transmitter sites may be tested temporarily.

Keep in mind that even if you identify a good location through the use of an experimental license, it cannot be used for normal programming. You still have to apply for a standard license. In this case, the most frustrating part of the process may be waiting for a new filing window to open.

The steady erosion of the broadcast audience by alternate programming sources (such as cable programming and videotape rentals) has brought a renewed interest in translators. Many stations see translators and boosters as a way to cost-effectively serve outlying communities and help regain those "hidden" audiences.

[:(=))]]

the Seattle shoreline area, is on channel 2. The other translators are located in the UHF band.

System planning

Typically, the first step in planning a translator or booster installation is to complete a general coverage evaluation of your broadcast area. Using a mobile, tuned antenna and a signal-strength measuring system, record your station's signal strength. The results should indicate clearly any shadowed or weak-signal areas. Areas with strong multipath also

can be identified through the test.

From this study, potential transmitter sites can be evaluated, and a frequency-coordination study can be run to determine open channels. Factors such as channel spacing, mileage between co-channels, and interference are important criteria. Don't forget to contact your local SBE frequency coordinator for assistance. These people often can help you identify potential spectrum conflicts before it becomes expensive to make a change.

When evaluating the potential sites for a translator/booster site, take into con-

On time. On budget. On air.



The Tascam 42B makes other 2-track recorders seem downright slow.

That's due in part to an ingeniously accurate tape handling system, and in part to Tascam's unique head technology. (Its heads provide sync response fully equal to repro, so you don't waste time rewinding to make audio decisions.)

And because the 42B probably offers more features per dollar than any equivalent machine, it makes everything else seem downright expensive, too. (+4 dBm balanced inputs and outputs, plus easy-access calibration are just a few of its standard features.)

For more information, call or write about the Tascam 42B today. It's a new and vastly improved way to keep meeting your deadlines.

And your budgets.

TASCAM

roadcasting • Home Box Office • Kimball Electronics • Fox Broadcasting • JVC (Japan)
 ac • Ensoniq • Madrigal Audio • Electro-Voice • Meyer Sound Labs • Dukane • Harm
 onics • dbx • National Public Radio • Hill Audio Ltd (England) • Image Video (Canada) • Dani
 casting • High Fidelity Magazine • Crutchfield • Ford Motor Co • Clarion • Len Feldman (Auc
 ine) • Clair Bros. Sound • Swiss Broadcasting • Logitek • Cello Ltd • MA/Comm • CBS-TV
 Nations • Denon (Japan) • Carvin • National Bureau of Standards • Symetrix • Cann
 • Grass Valley Group • Calrec (England) • BTS (Bosch-Philips) • Genelec OY (Finland) • Bro
 lectronics • Datatek • British Broadcasting Corp • Continental Electronics • Bose • Fend
 Division • BGW Systems • Consumers Union • TAC (England) • Benchmark Media Systems
 audio (Holland) • Barcus Berry Electronics • Audiotronics • Lexicon • Audiotone • Dolby Labo
 • Audio-Technica U.S. • Matsushita (Japan) • Audio Technologies • UPEI Division of JBL
 atchi (Japan) • Universal Studios • Moseley Associates • Jensen Transformer • KEF (En

THANKS!

Broadcast • TVB (Hong Kong) • Ramsa/Panasonic • Modulation Sciences • Rane • A
 stics (Austria) • Rauch Precision (England) • Boeing • Sonosax (Switzerland) • Rauland Borg
 Czechoslovakia) • RCA Consumer Electronics • NBC-TV • RTBF (Belgium) • Sunkyoung Magn
 ore) • RTS Div Compact Video • SAJE (France) • NTP (Denmark) • Samsung (Korea) • O
 ian Bdcstng) • SCV Audio (France) • Capitol Records • Sescom • Oxmoor • SGS Microel
 a (Italy) • Philip Drake (England) • Showco • Plantronics • Siemens (Germany) • Air Stud
 on) • SONO Magazine (France) • ADS • Sony (Germany) • Neve Electronics (England) • Sou
 England) • Philips (Germany) • Studer-Revox (Germany) • Burr Brown Corp • Precision Mo
 • Sudddeutscher Rundfunk (Germany) • Tandberg (Norway) • U.S. Military Academy • Sony P
 cts (ex-MCI) • Viennatone (Austria) • RCF (Italy) • Voice of America • Warner Brothers • Sw
 • Waveframe • Sharp (Japan) • Westinghouse Broadcasting • Shuttlesound Ltd. (England)
 stone/Audioarts • Solid State Logic(England) • Willi Studer(Switzerland) • Norddeutsch
 unk(Germany) • Studer-Revox America • Yamaha (Japan) • Boeing • Starkey • Ensoniq
 Systems • 3M/ITC • Daimler-Benz (Germany) • Stereo Review • Georg Neumann (Germany)
 erpoint • Apogee Electronics • General Instruments • Sony (Japan) • Analog Devices • Sc
 ce) • Mitsubishi • Altec Lansing • CBS Records • ACS Communications • Beltone • W
 r (Germany) • Acoustic Research • Storer Cable • ABC-TV • NEC (Japan) • Otari (England)
 e Recorders & Engineering • Bogen • Sydney Opera House (Australia) • Allen Organ • Phil
 urch (England) • Siemens (Austria) • Leitch Video (Canada) • Pierce-Phelps • Probel Ltd. (

To these audio industry leaders (and hundreds of others) who have purchased the recognized standard in audio testing, Audio Precision System One.

Before you buy any audio test system, shouldn't you learn what our users

already know? For full information, call Audio Precision at 1-800-231-7350 (from outside the U.S., call (503) 627-0832) or write to Audio Precision, P.O. Box 2209, Beaverton, OR 97075

System One



Audio precision

P.O. Box 2209, Beaverton, OR 97075
 503/627-0832 1-800/231-7350
 FAX: 503/641-8906, TELEX: 283957 AUDIO UR

Circle (52) on Reply Card

**Wouldn't it be great
if somebody built a
fully integrated
station automation
system that could
handle all on-air
operations, with
off-the-shelf hardware,
and backed by a
ten-year warranty?**

Somebody does.

The SAS-2 from Utah Scientific—part of a growing line of integrated automation systems. Machine control, cart control, business service interface, off-line recording—complete systems from a single source. And all backed by the industry's only ten-year warranty.

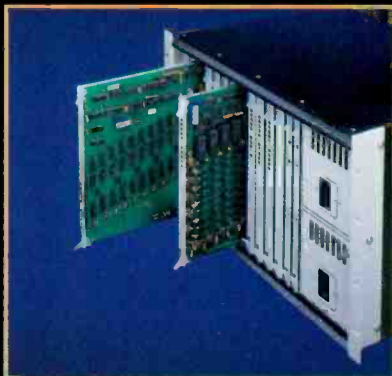
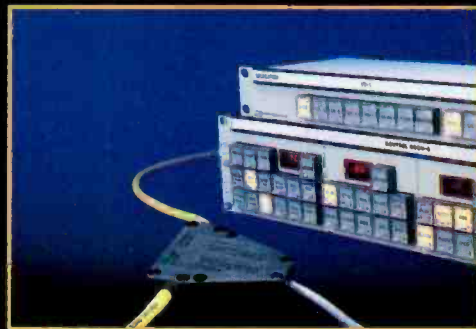
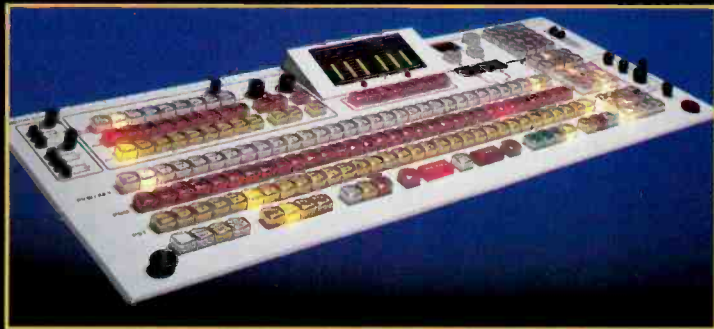

**US UTAH
SCIENTIFIC**
DYNATECH Broadcast Group

1685 West 2200 South, Salt Lake City, Utah 84119
(801) 973-6840 • Call Toll Free (800) 453-8782 • TLX: 269-916 • FAX: (301) 973-0255

Circle (53) on Reply Card

Inside fiber optics

By Robert Griffiths

People have communicated via light for centuries. Today's fiber-optic technology is sending some powerful messages.

Fiber optics is best described as transmitting light through the core of a fine, flexible-glass (or plastic) thread. Light can be sent in this manner to illuminate signs, examine interiors of the body or produce light-activated games. It can be piped around corners and through murky water without serious intensity loss or grounding problems. In fact, in the early 1950s, this technology was even used to light automobile hood ornaments and to create fender guides.

Light wave communications

Using light for communications is not a new trick. The American Indians sent messages by smoke signals and reflected the sun from mountain to valley on polished surfaces of metal or mica schist. The British used bonfires to warn of the approach of the Spanish Armada. As early as 1790, Claude Chappe constructed an optical telegraph system on hilltops throughout France that could transmit information over a distance of 200km in 15 minutes.

Seventy years later, Alexander Graham Bell invented the photophone, which transmitted speech on a ray of light. The device focused a narrow beam of sunlight onto a thin mirror. As the sound waves of human speech caused the mirror to vibrate, the amount of light energy transmitted through space to a selenium detec-

Griffiths is vice president of sales for Telemet, Amityville, N.Y.

tor at the receiving site varied correspondingly. This, in turn, operated the ear piece of a telephone receiver.

From bonfires to lasers and LEDs

Back in the days when bonfires and sunlight were used for communication, there were no tubes or guides to direct the light from point A to point B, and the losses were staggering. Today, through the use of a light guide 60 microns to 100 microns in diameter, the output of a laser or an LED (light-emitting diode) can be sent through hostile environments over several

miles to be received and used as required.

A close examination of the fiber or optical waveguide can help you to understand how this is accomplished (see Figure 1). The single fiber is comprised of a center, or core, of extremely clear, clean glass, so transparent that if sea water were as clear, you could see to the bottom of the deepest ocean. The core is surrounded by a "dirtier" or "doped" glass, referred to as the *cladding*. Most fibers are drawn to give the core a slightly higher index of refraction than the cladding. If you look into your physics textbook, you'll see that an interface between materials with different refractive indexes gives rise to reflections, making the inside of the fiber essentially a cylindrical mirror. Consequently, light rays traveling down the fiber that strike the interface between the core and cladding are reflected back into the core.

This phenomenon of *total internal reflection* is the basic principle of fiber optics. The rays bounce back and forth down the fiber until they hit a discontinuity (such as a break in the fiber), until they are attenuated by the sheer length of the glass, or until they exceed the critical angle and escape the core.

There is an angle at which light will reflect in an optical fiber. Light that is less than that angle no longer bounces, but penetrates the cladding and escapes the fiber. This critical angle is a function of

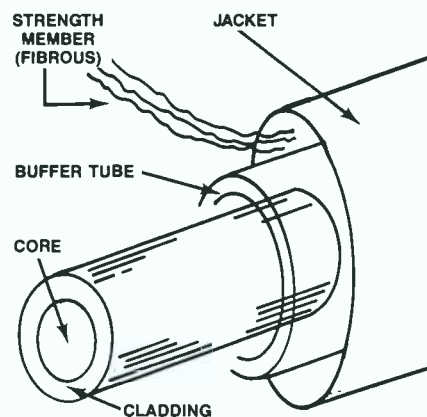

Figure 1. The interface between a clear core and a slightly doped cladding makes the inside of a fiber essentially a cylindrical mirror. Buffer tubes and strength members protect the fiber.

Main story continues on page 94

INTRODUCING THE NEW MX-55



THE NEXT "WORKHORSE."

Before you take us to task for trying to improve the BII, a design that has become the "workhorse" standard for two-channel audio machines, consider what the new MX-55 offers:

An integral autolocator; a voice editing mode that allows 2X speed playback at normal pitch; a built-in cue speaker; GSPiPO (gapless, seamless, punch-in, punch-out),* and because you told us you wanted it, *all* adjustments are available through the front panel! These, and many more improvements will help make your job easier, and the results more creative.

And for those of you who still won't forgive us, we're keeping the BII in the line. So either way, you can get exactly what you need from Otari; Technology You Can Trust. Call Otari at (415) 341-5900 for information about the new MX-55.

OTARI

Circle (54) on Reply Card



For Excellence In Antennas

- A complete line of TV and FM Broadcast Antennas
- Modern 7,000 ft. test range facilities
- Innovative Engineering Careful construction
- Two Year Warranty on Product and Workmanship

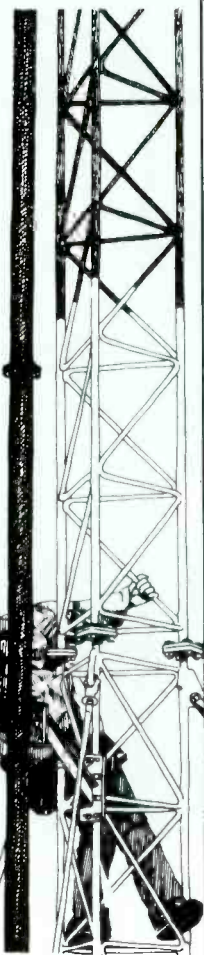

With over 1500 delivered, we've helped more stations penetrate their market.

FCC Directionals
Pattern Studies
Multi-Station Arrays
Full Scale Measurement

JAMPRO ANTENNAS, Inc.
6939 Power Inn Road
Sacramento, CA 95828

(916) 383-1177 TELEX 377321

Circle (55) on Reply Card

Modulating the fiber: information under glass

By Rick Lehtinen,
TV technical editor

The three common methods for getting information into an optical fiber are similar to those used for radio. Of the three—AM, FM and digital—the latter holds the greatest promise for exploiting fiber's extensive bandwidth. Nevertheless, applications exist for each modulation method.

Amplitude modulation

In this, the simplest of modulation schemes, the transmitting light source (an LED or laser diode) is made to vary directly with the amplitude of the input signal. Because the light source might not have completely linear response, it may be necessary to include compensation circuitry in the transmitter.

Early ENG applications attempted to use AM. Unfortunately, the technology is not appropriate in all situations. Because anything that affects the strength of the signal can distort the system's output, AM is best used in situations in which the fiber is not subject to motion, to being stepped on, or to dynamic mechanical stress (such as being suspended between two buildings). Although proper care in fiber placement can prevent these problems, at least one manufacturer's early attempt at an AM system could be completely shut down by merely wrapping the fiber around one's finger. Another drawback to AM systems is the difficulty in combining audio with video, being that some of the frequency components are similar.

In situations requiring high bandwidth, such as HDTV or high-resolution computer graphics, AM is superb because it requires no equalization and exerts minimal signal processing. Recent advances in AM units have increased bandwidth so much that it is possible to take the RF output of a microwave receiver front end or satellite dish LNA and feed it into a fiber *before* downconversion or demodulation.

The optically encoded microwave signal then can be routed without degradation to a more advantageous location for processing, such as an equipment room or other sheltered environment. This could greatly simplify future equipment designs, because less hardware would have to be protected from the elements.

Frequency modulation

In a frequency-modulation system, the frequency or phase of a "carrier frequency" is modulated according to the input signal. The advantage of an FM optical fiber is the same as an FM radio system. Recovery of information is independent of signal strength. Either there is enough power to do the job or there isn't, and changes in signal strength are less like-

ly to modulate the signal. This increases the range of applications for which fiber optics is suitable.

Audio in an FM system typically is put on subcarriers that further modulate the carrier frequency, similar to the SCA signals on an FM station. A few broadcasters have discovered that they are able to "broadband" their FM systems by removing all filtering and modulating the fiber with the baseband video output (the video plus subcarriers, all together) of a microwave or satellite receiver. The filter set that is normally attached at the microwave video output is then installed at the fiber-optic video output. In this way, these broadcasters can route a video and several audio channels (depending on how many subcarriers the microwave or satellite uses) along one fiber.

This is particularly advantageous if the microwave or satellite receive site is some distance from the studio, say a few city blocks, or on top of a tall building. The video and audio signals can travel the fiber without hum or ground loops, with no need for equalization, and without requiring a separate pair of wires for each audio. Because all the signal processing is done at the studio, troubleshooting may become more effective as well.

Digital

Fiber optics and digital technology seem to work well together. The noise immunity of FM systems is available, as is the high bandwidth of AM systems. Digital systems have other advantages as well. They usually require fewer adjustments and less alignment, especially when components are replaced, than analog systems. The signals can be run through repeaters without degradation. The modulation schemes that manufacturers use to load the fibers rely on time-division multiplexing and other telecommunications techniques. Through these techniques, better use is often made of the fiber than with analog systems.

An area of broadcasting that can benefit from the use of digital fiber systems is audio. Most analog systems treat audio as an adjunct to a video signal. To recover audio requires that the audio and video both be demodulated. In the digital domain, it is much easier to figuratively "seek out the bits" that concern a given audio channel, and decode them without worrying about the rest of the datastream.

Furthermore, most analog systems allow only a few audio carriers per signal. Digital techniques allow the carriage of many audio channels. One product introduced at this year's NAB convention was said to be capable of transmitting 64 audio signals simultaneously.

Video That Sounds as Good as it Looks.



Photographed at On Tape Productions, San Francisco, CA.

The video industry demands the same uncompromising audio quality the recording industry expects. Dolby SR signal processing and Dolby A-type noise reduction are now available on one processing board for the Sony BVH-3000/3100 VTR. Contact your Sony

representative and inquire about the BKH-3080. Find out why recording and film studios around the world rely on Dolby for cleaner, quieter audio.

 **Dolby[®] SR**
spectral recording

Sony Communications Products Co. Phone 201-833-5200, Dolby Laboratories Inc., 100 Potrero Avenue, San Francisco, CA 94103-4813, Phone 415-558-0200, Telex 34409, Facsimile 415-863-1373, 346 Clapham Road, London SW9 9AP, Phone 01-720-1111, Telex 919109, Facsimile 01-720-4118. Dolby and the Double-D symbol, are trademarks of Dolby Laboratories Licensing Corporation. © Dolby Laboratories Inc. 1988. S88/8321/8339

Circle (56) on Reply Card

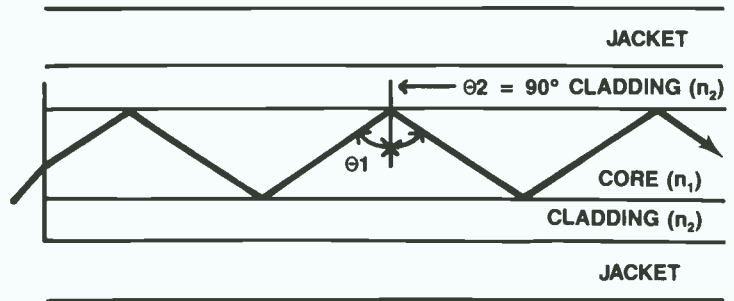
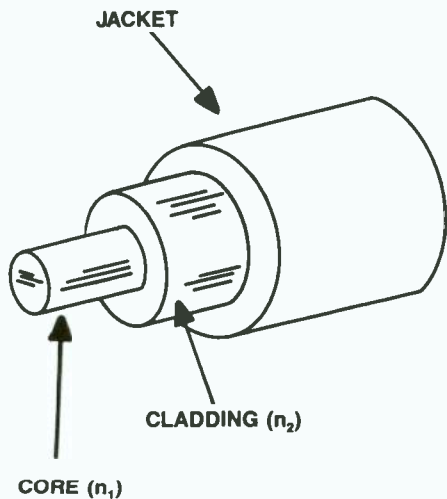

Snell's law is:

$$n_1 \sin \theta_1 = n_2 \sin \theta_2$$

where n_1 and n_2 are the refractive indices of the core and cladding, respectively.

The critical angle of incidence, θ_c (where $\theta_2 = 90^\circ$) is

$$\theta_c = \sin^{-1} \frac{n_2}{n_1}$$

At angles less than this, light escapes the fiber. At greater angles, the light is reflected. Total internal reflection is the basis of light transmission in fiber optics.

Figure 2. Snell's Law defines the relationship between the incident and refracted rays. If θ_2 is set as 90° , the critical angle at which reflection will occur can be determined. As long as the light rays are greater than that angle, total internal reflection will keep light propagating down the fiber.

Main story continued from page 90

Snell's Law and the refractive indexes of the core and cladding (see Figures 2 and 3).

Light rays that enter the core at too slight an angle (with respect to a line perpendicular to the interface) will escape, because they don't achieve the critical angle at which reflection can occur. The same thing can happen to light rays that

hit a sharp corner in a fiber-optic path. This explains why fiber routes must have gentle bends. Note that if other fibers are lying alongside this fiber or are packaged with it, escaping rays will not enter or be absorbed by the adjacent fibers. These spurious light beams will not cause interaction between the fibers nor will they result in crosstalk or interference of any kind.

Bandwidth limitations

As it travels down the core, the light in a fiber bunches together in streams of energy called *modes*. The number of modes is determined by a complex series of factors, including the refractive indexes and diameters of the glass in the cladding and the core. Some modes run straight, like an arrow. Some bounce wildly off the core-cladding interface. Others bounce, but not

This new QuantAural™ QA-100 Audio Program Analyzer gives you the advantage in competitive broadcasting

Simply put, the QA-100 quantifies what you hear. Your station sound can now be electronically monitored the way you hear it. Exactly. And, you can monitor the competition too!

Real time analysis of any audio signal. From a receiver, tape recorder, or processing equipment. You see the measurements as you hear the sound. Changes in processing or variations in system performance are immediately shown on the QA-100 panel meter or bargraph display—using program material as the signal source.

The QA-100 hears like a program director and talks like an engineer. With it you can monitor maximum peak level (relative peak modulation), overall

processing effectiveness (average level), tightness of sound and processing control (peak density), tonal balance, consistency and preemphasis (four band real time analyzer), stereo image width (L + R to L - R ratio) and "punch" (special "aural intensity" measurement).

Interested? To learn more about how the QA-100 will help your station compete, call Potomac Instruments today.

QuantAural is a registered trademark.



POTOMAC INSTRUMENTS
932 PHILADELPHIA AVE. SILVER SPRING, MD 20910
(301) 589-2662

Circle (57) on Reply Card



The Keys to your Success:

VIDIFONT.

Success is at your fingertips. Whether you're a broadcaster, production house, corporate, industrial or educational video user, Vidifont's got the features and flexibility to simply make you look good.

Distinctive character and precise detail of antialiased foundry fonts . . . real-time animation . . . third-channel windows and templates . . . multi-user access and fast text editing that eliminate production bottlenecks.

Our specialized programs are

designed to custom-fit your specific needs, including the Vidivote election package, the GraphicStore paint and library system, and the Vidicast/Vidisports weather and sports package.

Whatever your graphics, character, animation or production needs, Vidifont can simply do it better.

Considering all it does for you, Vidifont's cost will come as a very pleasant surprise. In fact, the keys to success are well within your reach.

For more information contact

BTS Inc.
P.O. Box 30816
Salt Lake City, Utah 84130-0816
Phone: (801) 972-8000.

Sales and Service Headquarters
900 Corporate Drive
Mahwah, New Jersey 07430
Phone: (201) 529-1550.

"Customer Satisfaction Is Our Satisfaction"

BTS Broadcast
Television
Systems

A joint company of Bosch and Philips

Regional Sales Offices

New York City
(201) 529-1550

Midwest
(312) 803-8060

Northeast
(207) 283-0777

Allegheny
(201) 529-1550

Mid-Atlantic
(703) 461-0188

Southeast
(904) 492-1600

Southwest
(512) 335-1481

Great Plains
(507) 334-1891

Northern California
(818) 766-8184

Southern California
(818) 766-8184

Intermountain
(801) 972-8000

Circle (58) on Reply Card

so much.

The difference in path lengths of the rays that bounce a lot and the rays that go straight is a major factor in the length of a fiber-optic run (see Figure 4). The straight rays arrive at their destination nanoseconds ahead of the bounced rays. This is called *intermodal dispersion*, or more simply, pulse broadening. For short runs of fiber-optic cable, some pulse broadening can be tolerated, and it will not distort transmission. However, for long-haul systems, intermodal dispersion

must be minimized to keep transmissions intact.

Pulse broadening can be minimized effectively in two ways. The first is to transmit over a "graded index" fiber, in which the refractive index of the core changes gradually. Rather than travel the full excursion from core to cladding to core, the light ray will, in a graded environment, gradually be bent back into the core. All modes, therefore, will travel more or less the same distance, minimizing modal dispersion.

A second and more recent solution to the problem is the use of monomode fibers. As mentioned previously, current multimode fibers support many modes of propagation, which contributes to their dispersion problem. Monomode fibers are much thinner ($5\mu\text{m}$ compared with $50\mu\text{m}$). Being purer and thinner, they will sustain fewer modes of propagation, thereby reducing dispersion dramatically.

Light sources

The two primary light sources for broadcast-quality fiber-optic systems are the laser diode and the light-emitting diode. These sources are popular because their outputs can be controlled precisely through rapid variation of their bias currents. In addition, they require low-drive voltages. They are tiny, yet extremely bright, and they emit wavelengths of light that travel efficiently down a fiber-optic cable.

At this time, certain characteristics make the LED the principle source of light for broadcast-quality fiber-optic systems. The wavelengths emitted by LEDs are directly dependent upon their base material and the kind and amount of impurities used in the doping of the device. Communication LEDs operate in the infrared range. They are of the gallium-aluminum arsenide type.

LEDs appear to be more stable, more reliable and less costly than laser diodes, but they have two major disadvantages. One drawback is their wide spectral capability. Because the speed of light through glass varies with the light's frequency, the different frequency components of light will arrive at their destination out of sync with each other. This effect, known as *material dispersion*, limits the bandwidth, distance limits and information capacity of the system. The second shortcoming of the LED is its slow operation. It normally operates with a rise time of 10^{-9}ns , which limits its use in high-frequency applications.

Laser diodes show great promise. At this time, however, a laser may become unstable because of temperature sensitivity, and it may drift by more than 20nm from its central wavelength. As temperature compensation becomes more sophisticated, the laser could become more popular in fiber-optic transmission. Because laser diodes emit coherent light on singular frequencies and do not suffer from material dispersion, they are better suited to long-haul system requirements of many kilometers. Furthermore, lasers exhibit faster rise times than LEDs (being in the 10^{-12}ps region) and are more capable of transmitting high-bandwidth information. However, control of the laser output is more difficult because of the problem of temperature sensitivity.

Main story continues on page 100

Digital Audio on Your Television STL!

We have the Solution...

Video
Audio
Multiplexing
Process

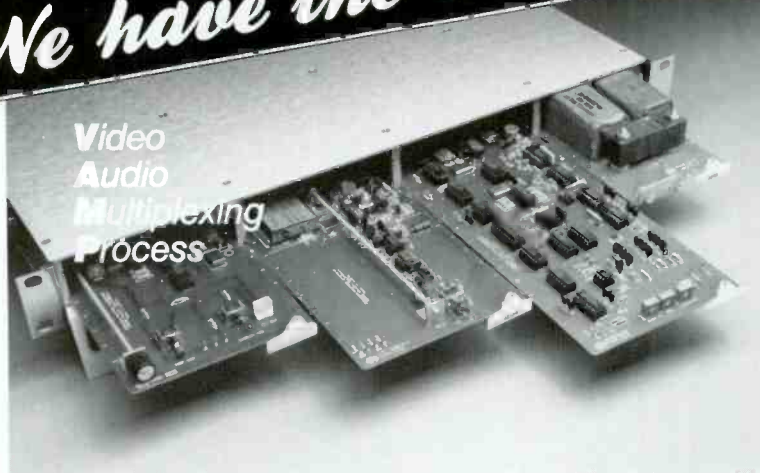

NEW - VAMP II

2 channels of PCM digital audio over video, in a single 1-rack unit package

VAMP II represents a significant breakthrough in the conversion to stereo audio for television as well as other vital communications links. By providing PCM audio coding or decoding in a rugged, single 1-rack unit package, the need for complicated and expensive systems is eliminated.

Audio/Video in . . . Audio/Video out . . . and, this is broadcast equipment, designed and manufactured to network quality standards.

- Developed specifically for **point-to-point** video transmission paths such as STLs, relays, EFP and ENG links, etc.
- Save on line costs and valuable spectrum space by using existing video paths to carry program audio.
- An additional analog subcarrier may be added in the spectrum above the VAMP II subcarrier for SAP, telemetry, voice or data transmission.

The VAMP process developed as a method of maximizing the use of spectrum within a transmission medium by combining digitized information with a video signal. There is no degradation of signal quality with the VAMP system.



GRAHAM-PATTEN SYSTEMS, INC.

P.O. Box 1960, Grass Valley, CA 95945

Inside CA: (800) 422-6662 • Outside CA: (800) 547-2489

TWX 910-333-6065 • FAX: 916-273-7458

Circle (59) on Reply Card

To get a bigger slice of your video patching business, we borrowed an idea from the experts.



Quick delivery.

Whether it's a pepperoni pizza or a patchbay, nobody likes waiting for deliveries. And when you order video products from ADC Telecommunications, you don't have to. Because unlike other manufacturers, we sell through a nationwide network of

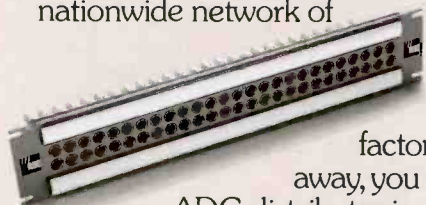

video distributors. So instead of waiting weeks for delivery from a factory a thousand miles away, you simply call the ADC distributor in your area.

We offer toppings the others can't match, too. Our video jacks come in gold or nickel finish, terminating or non-terminating and phase compensated as well.

Circle (60) on Reply Card

But you don't have to order an extra-large with everything to get fast delivery. We'll give you the same service even if you just need a few patch-cords. Because we know if we offer a broad range of quality products at fair prices, and deliver them faster than the competition, we'll get a bigger slice of your business.

We call it the "Domino Theory."

For the name of your local ADC stocking distributor, call **612-893-3126** east of the Mississippi, or call **612-893-3119** west of the Mississippi.

 **ADC Telecommunications**
® "Where Quality Runs Full Circuit."

4900 West 78th Street, Minneapolis, MN 55435

TELEPHONE JACKS

PATCH CORDS

AUDIO PATCH PANELS

STANDARD & CUSTOM-WIRED AUDIO PATCH PANELS

(603) 446-3335

ALL AVAILABLE IN LONG-FRAME (1 1/4") & MINI (.172")

audio accessories
audio line

Audio Accessories, Inc.
Marlow, NH 03456
603/446-3335

Circle (61) on Reply Card

Telco fiber: advancing on two fronts

By Rick Lehtinen,
TV technical editor

In a move to capture a portion of the program distribution work done by satellites, the telcos (notably Bellcore Labs) are testing fiber-optic networks that will provide broadcasters with program feed systems similar to those provided by satellites. On a different front, the demise of statutes designed to keep the phone companies out of the cable TV business seems probable. The result could prepare a path for HDTV and other services to enter the home without the terrestrial transmission provided by broadcasters.

Phone company video

The highly touted fiber-optic telephone systems, with their allegedly superior audio quality, form the backbone of what could be the network distribution system of the future. The calls streaming along the nation's fiber corridors are in digitized form. Reduced to ones and zeros, network programming could be sent to affiliate markets in the same manner. Research into these procedures already has led one network to link its Washington bureau to its New York studios via telco fiber.

Traditional use of fiber in broadcasting has been more or less closed-circuit. A station pulled some fiber-optic cable to where it needed to go, bought the terminal equipment to go on both ends and hooked it up. Right-of-way and routing problems required solutions.

Earlier equipment was all pretty much one signal per fiber, or a fiber for each signal carried. The proposed telco fiber is multichannel, high-quality and user-controllable.

The phone company's view of a fiber-optic network is a far cry from previous telco network distribution systems using coax. The current plan is to use DS-3-rate (45Mb/s) channels to transmit video, MTS audio, several voice or data channels, network control signals and an order wire for communication. Each of the telco's fibers can handle 12 to 24 DS-3 channels.

The embedded control signals give the proposed network its edge over previous coaxial systems, and allow it to approach the utility of satellite systems. In a satellite distribution system, providing certain time zone or regional feeds is merely a matter of directing affiliates to switch transponders. In the proposed DS-3 network, control would be nearly as easy. Instructions sent down the com-

mand channel would tell each node whether it should receive only, or transmit to other nodes in different cities. Regional feeds, such as football games, could be routed in a manner similar to today's satellite networks. The change is instantaneous, and control of the network lies with the broadcaster, not with the phone company.

In addition to nearly matching the control aspects of satellite-based transmission systems, a terrestrial network could provide immunity from Captain Midnight-style opportunists, from theft of service due to unauthorized reception and, of course, from sun outages. An 8-city test involving five networks is scheduled to begin soon.

Last-mile fiber

The shortage of geostationary orbital slots (only about 60 exist), and the current difficulty with getting a satellite into orbit to replace aging spacecraft, may make terrestrial distribution of network programming quite attractive. Subscriber loop, so-called last-mile installations, in which the fiber reaches all the way into the customer's residence, may not be so appealing. One big roadblock may be cost. It is doubtful that the phone company would want to string fiber to every house if its only use would be to order pizza and set up bowling dates. Although subscriber loop fiber has been implemented to buildings, fiber to the home has been limited to experimental installations.

Recent legislative action may increase the incentive for stringing domestic fiber. It appears that the cross-carry rules that prohibited the phone companies from being in the cable TV business soon will be stricken down. This means that a single fiber may soon carry phone, CATV and other services into the dwelling place.

Although this has great potential for broadcasters, it may be a double-edged sword. The signal delivered is likely to be of higher technical quality than what is distributed on RF CATV systems or what can be transmitted over the air using today's systems. The fiber could carry HDTV signals, for which traditional broadcasters can offer no competition. It is in the broadcaster's interest to make sure that advancing fiber technology doesn't render traditional terrestrial telecasting obsolete.

Tailor made...

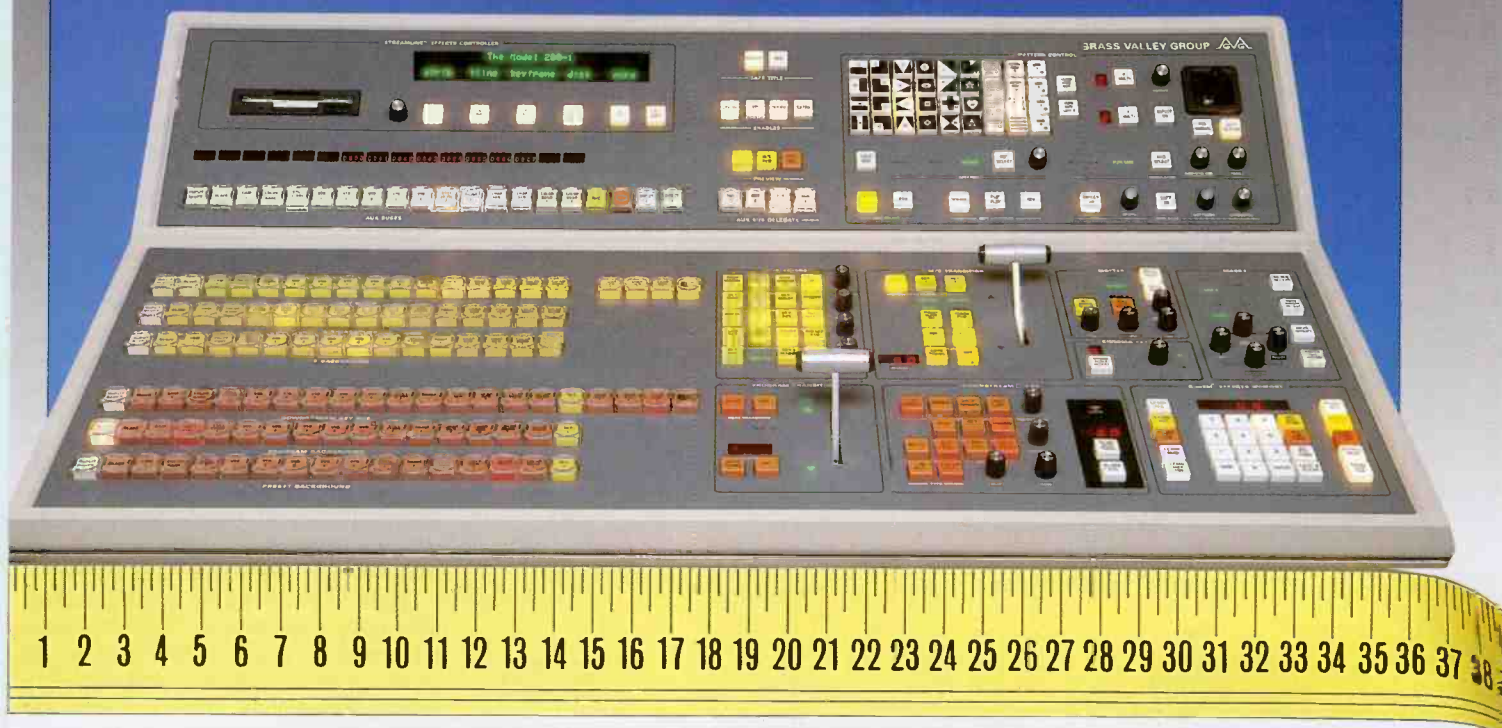

...To fit your budget

or your mobile truck or your suite.

The new Model 200-1 from Grass Valley Group.

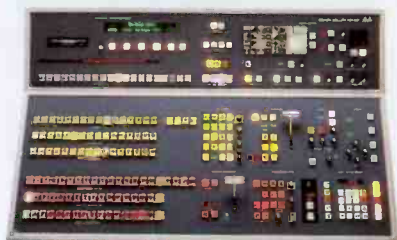

Model 200-1



Model 200-2

The compact GVG® Model 200-1 Switcher is the new single mix effect version of our popular Model 200-2. The perfect fit for your production suite or mobile van, the Model 200-1 saves you space while it saves you money. With power and features you expect from GVG:

- 1 mix effect
- Program/Preset Flip-Flop Mixer
- 20 inputs
- E-MEM® effects memory
- Downstream keyer
- Fade to black
- 3 linear keys
- Your choice of powerful options
- Control panel design: requires 5 inches less space than the Model 200-2

The Model 200-1. It fits your space, and your budget. For details and ordering information, make room in your schedule to contact the Grass Valley Group office nearest you.

Grass Valley Group®

A TEKTRONIX COMPANY

THE GRASS VALLEY GROUP INC.

P.O. Box 1114, Grass Valley, CA 95945 USA
Telephone (916) 478-3000
TRT: 160432

OFFICES: New York (201) 845-7988; District of Columbia (301) 622-6313; Atlanta (404) 493-1255; Chicago (219) 264-0931; Minneapolis (612) 483-2594; Dallas/Fort Worth (817) 483-7447; Los Angeles (818) 999-2303; San Francisco (415) 968-6680; GVG International Ltd. (U.K.) +44-962-843939; Grass Valley Group Asia (HK) +852-3-7396632

Circle (62) on Reply Card

Main story continued from page 96

Light detectors

Just as the bonfire acted as a light source in early communications, the human eye functioned as the detector or receiver. In fiber-optic technology, two types of detectors are available. One is a solid-state PIN device, similar in make-up to a solar cell. Through this device, photons of light cause an electric current to flow. The other is the avalanche photo detector, wherein

a photon of light unleashes an "avalanche" of electrons and causes current to flow.

All signal detectors suffer from background noise that increases in proportion to their operating speeds. Choose the device that is quietest in the required range of speed. The background noise in a PIN detector increases from 10^{-11} W when it is operated at 1Mb/s to 10^{-9} W at 100Mb/s. At the same operating speed, the noise in an avalanche detector is lower by a factor of 10. Noise is a serious consideration

in high-speed systems.

Transmission techniques

AM, FM or digital modulation can be used to transmit signals through fiber. Each system has its advantages.

Amplitude modulation is the simplest method, because it involves direct modulation of the signal source. It requires a light source with a linear output. Because none exists, intermodulation distortion is introduced into the system. This problem can be alleviated by creating feedback to compensate for non-linearity. Furthermore, the source range can be narrowed in intensity, making the response more linear.

Using a high-frequency RF carrier and frequency-modulating the LED solves some of the AM problems. It is not dependent on light source linearity, so it is immune to variations in the optical chain. Many FM systems use a carrier for video and use subcarriers for the transmission of accompanying audio.

Digital modulation also can be used for fiber-optic transmission. High data rates are required. Additionally, there is the need for analog-to-digital and digital-to-analog conversions. These problems are being overcome gradually, and the use of digital modulation surely will increase in

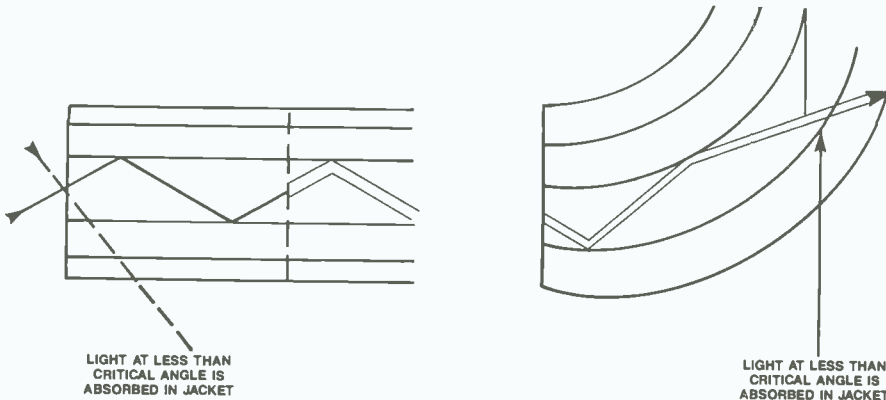

Figure 3. Light at less than the critical angle for reflection escapes the fiber and is absorbed into the jacket.

Nova

620

... and We Throw in the Sync.



Nova's 620 time base corrector gives you full frame of storage for special effects . . . a comb filter for top picture quality . . . a built-in sync generator and more . . . features that make this lightweight unit a heavyweight performer. And the Nova 620's low price produces a very special effect. Need we say more? Nova - the choice is clear.

nova
SYSTEMS, INC.

50 Albany Turnpike, Canton, Connecticut 06019 (203) 693-0238

Circle (63) on Reply Card

If your cable is doing this to your video...

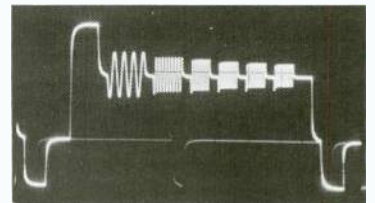

Join the rest of the industry! Restore it with a VPDA-2, the portable/rack-mounted video/pulse distribution amplifier. It equalizes up to 2,500 feet without adding any distortion.



You'll see how easy it is to make your video look like this again!

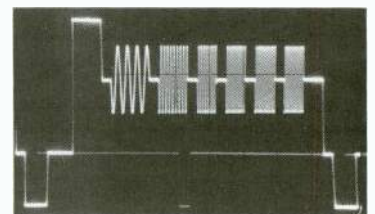

Call Multidyne now at: (800) 535-3050 or (516) 628-1495

MULTIDYNE Inc

Multidyne Electronics Inc.
P.O. Box 528
Locust Valley, N.Y. 11560

Circle (124) on Reply Card

The Critical Link

Alpha Wire delivers integrity and quality for electronic transmission.

You invest in sophisticated broadcast equipment and demand the finest in electronic interconnections, because over-the-air transmission and live feeds require the highest quality wire and cable.

Alpha is recognized worldwide for a comprehensive, rugged and dependable product line of broadcast cables that are available locally and through overnight distribution.

Extensive color varieties reduce coding problems. Excellent cable flexibility reduces set-up and storage problems. Alpha quality reduces your worries.

From the recording studio to video transmission on location, specify Alpha... the first name in wire and cable.

See Us at
SBE Booth 261



alpha

For more information, contact your local Alpha distributor, or call 1-800-52ALPHA.

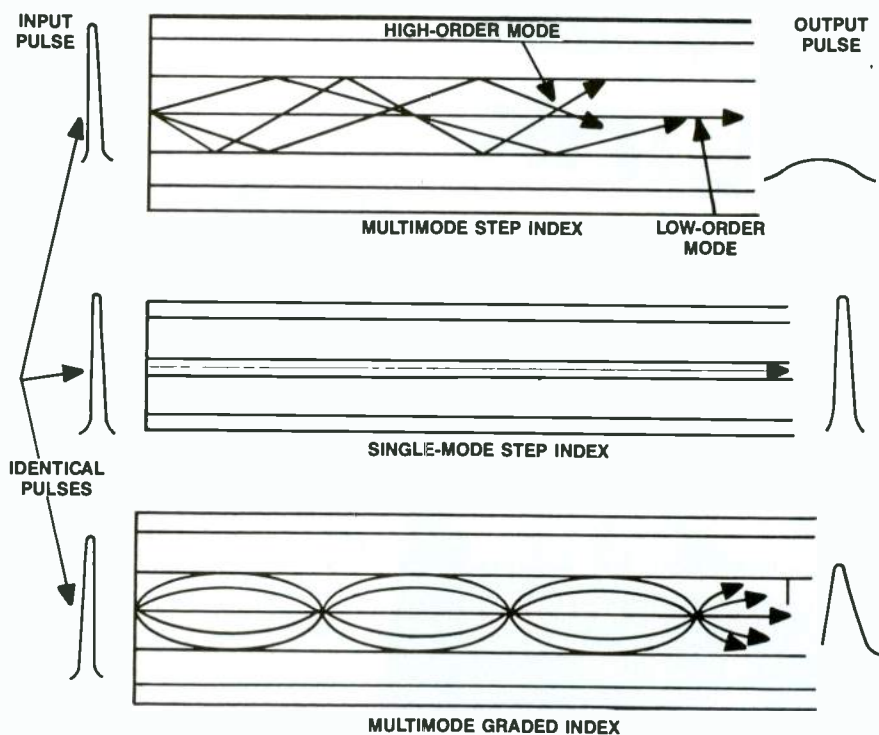

Figure 4. Pulse broadening in an optical fiber. Interaction of low-order (few bounces) modes with high-order (many bounces) modes spreads out data pulses and limits fiber's usable length. The narrow single-mode fiber conducts few modes. The graded index fiber gently curves modes in the special core, making all modes nearly the same length.

applications for which it is suited. Some systems include digital audio as part of the transmission system. Digital systems for video may eventually take on the characteristics of telecommunications circuitry, and as such, will be of a different character than the current signals.

Broadcast advantages of fiber links

A fiber-optic transmission system has at least five advantages over a hardwired system. Because it is made of glass, it will not rust or corrode, and it will weather interminably when protected in a cable sheath of PVC and kevlar. Also, because the fiber is non-conductive, it can eliminate many hum problems and ground loops. Fiber is lightweight compared with coaxial cable. It experiences no interference (electrical or radio) and is not affected by magnetic currents.

Conversely, fiber creates no EMI or RFI. It has an extremely wide bandwidth, making unrestricted transmission possible (say for HDTV or computer graphics applications). Fiber also is a "secure" method of communications, because it does not generate magnetic fields detectable by "bugging" devices. All these attributes make fiber-optic transmission a desirable broadcast system.

PROCOM INTERCOM WITH SINGLE-BUTTON SELECTION



Patents pending

DILESS ProCom is a new kind of full-duplex intercom, with convenient single-button selection. Every kind of connection is possible: station-to-station, station-to-all, all-to-all, or any combination, up to 11 simultaneous calls. You hear no unnecessary messages – only those which concern you directly.

No line can be busy, so your message will always reach the other party.

Stations are connected with standard three-core microphone cables. ProCom is also compatible with other systems currently in use, so you can upgrade your existing system by adding a central unit and keypads.

For further information, contact your local dealer, or

DILESS

DILESS Ltd.
Melkonkatu 16 A, SF-00210 HELSINKI, FINLAND
Phone: +358-0-679 271, Facsimile: +358-0-671 910
Telex: 100 1825/Attn: DILESS

Circle (65) on Reply Card

Triple Play

Videotek's new combo monitor gives you more inputs, more output and more memory for less money.

Only Videotek's TVM-620 waveform monitor/vectorscope gives you three selectable inputs for multiple viewing combinations, a roster of other winning features and the economy of a two-in-one unit.

Parade or overlay modes let you view any combination of up to three inputs simultaneously with one touch of our new membrane control panel. And ours is the only combo monitor that currently offers user-defined, one-button memory recall.

For portable monitoring of video signals during remote shoots, the TVM-620 is available with an optional internal AC/DC power supply (ADC-1). A four-pin XLR connector provides an easy interface with a variety of DC power supplies.

Engineers look to Videotek for thoughtfully-designed equipment that's built to be reliable and priced to be in your ballpark. See your Videotek dealer today about the TVM-620 plus our full line-up of test equipment.

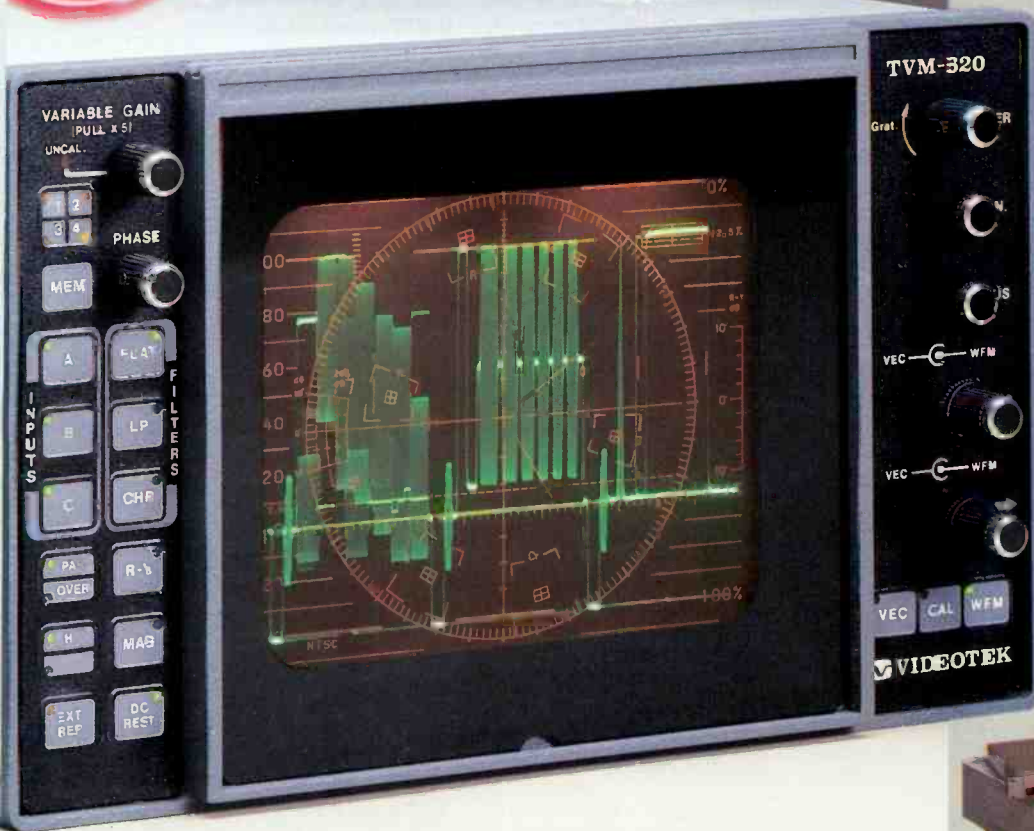

Triple Filter Parade—
1 H each of Flat, Low Pass and Chroma Filters



Triple Vector Overlay—
SMPTE Bars on A, B and C inputs delayed by 6° and 12° to demonstrate phase error



Combination Display—
Simultaneous waveform and vector displays of a single input



VIDEOTEK INC.
Designed for real needs.
Priced for real budgets.

243 Shoemaker Road
Pottstown, Pennsylvania 19464
(215) 327-2292
TWX 710-653-0125 FAX (215) 327-9295

Show preview

22 Thursday
September
1988

To
DENVER
FOR
SBE!

Thursday, September 22

A Rocky Mountain setting for SBE

By Brad Dick, radio technical editor

Head for the mountains. That's what the Society of Broadcast Engineers will be doing this month as it holds its third annual national convention Sept. 22-25 in Denver.

The Denver location is a departure; the first two conventions were hosted in St. Louis. Moving the show helps reinforce the national attention that the show is receiving. In fact, plans already have been made to relocate next year's convention to Kansas City, MO.

Outstanding program

One of the SBE convention's strong points has been the technical seminars. Building upon two years of success, this year's sessions will again be coordinated by John Battison under the auspices of **Broadcast Engineering** magazine.

A total of 31 seminars and panel discussions are planned for the 4-day event. The schedule provides a total of 25.5 hours of seminar instruction and 22 hours of exhibit time, with only six hours of overlap.

Three special evening sessions are planned, which will highlight the issues of audio processing and the NRSC, management for engineers and directional-antenna systems. Each of the sessions will feature a panel of experts. If they're anything like the evening sessions at the previous shows, they should be exciting and informational.

The seminars begin at 8 a.m. and typically continue until 4 p.m. A broad range of topics will be covered, including computers for broadcast engineering, digital video recording and transmitter security. New technical issues such as AM band expansion, FM boosters and ACTV also are scheduled.

Another critical area will be covered by Wally Johnson of Moffett, Larson & Johnson. He will update the attendees on the standards-making efforts of the Association of Broadcast Engineering Standards (ABES) committee. His group is setting the pace for future technical standards, which will affect all of us.

This year's conference has been planned in such a way as to avoid the overlapping of sessions, which is common at other conventions. With only six hours of simultaneous sessions, you can attend as many presentations as you like from each area and still have time to tour the exhibit floor.

Additional exclusive exhibit hours also have been scheduled. This means you can be assured of plenty of time to tour the exhibit hall's more than 400 booths.

The closing luncheon will feature FCC mass media bureau chief, Lex Felker. Other commission officials will provide updates on regulations and licensing.

The Rocky Mountain Video Expo is combining its efforts with SBE for the convention. The Rocky Mountain Chapter of the ITVA will hold a 2-day seminar in conjunction with the convention. Approximately 1,000 attendees are expected for the ITVA activities.

Don't be left out

The SBE convention continues to be the most cost-effective and engineering-targeted convention going. Travel and accommodations in Denver are inexpensive, especially when compared with convention costs in other cities, such as Washington, DC. Denver's hotel rates range from \$58 to \$65. Full convention registration, including seminars, proceedings and closing luncheon, is only \$90.

Additional information can be obtained from the convention headquarters in Denver at 303-989-8648. The mailing address is SBE National Convention, Box 280382, Lakewood, CO 80228.

A complete program schedule begins on this page. Plan now to attend the *engineer's show*, the SBE National Convention and **Broadcast Engineering** Conference.

SBE conference schedule

Thursday, Sept. 22 Morning session:

10:00 a.m. Welcome:
• Jack McKain, SBE president
• Brad Dick, technical editor, **Broadcast Engineering** magazine

Session coordinator: Brad Dick, technical editor, **BE** magazine

10:20 a.m. Facts About Fax:
Digital Data FM SCA Systems

• Harold Walker, Pegasus Data Systems
Transmission of high-speed facsimile over a subcarrier.

11:00 a.m. Protecting Against Power Line Disturbances
• Oral Evans, Control Concepts Corporation
Preventing damage to broadcast equipment caused by lightning and transient power line disturbances.

11:30 a.m. The Computer's Place in Broadcast Engineering
• Russell Brown, KTSF-TV

Use of computers to improve operational productivity.

12:00 p.m. The Application of Microcomputers to the Directional Antenna
• By Tom Osenkowsky, consultant
Use of a microcomputer to take the

Panasonic® Pro Series Monitors.



Designed for production quality... With an eye on your budget.



Panasonic presents two very versatile, high-grade color monitors--the BT-D1910Y and the BT-M1310Y. Built for performance, these BT-Series monitors offer you the quality and reliability you've come to expect from Panasonic. Not to mention a wide array of features at an affordable price.

Our BT-Series provides you with the controls and connections necessary for studio applications--while serving a host of industrial, educational and professional video needs.

For maximum performance and versatility, both monitors offer complete, direct compatibility with the new S-VHS format--in addition to conventional signals. And video reproduction on the BT-Series is superb. As a matter of fact, the BT-M1310Y boasts a horizontal resolution of more than 560 lines, while the BT-D1910Y offers you greater than 550 lines.

What's more, each monitor provides you with a full set of front panel controls. Like Line A/B split, S-Video input connectors, Blue single-only switch, pulse-cross circuit, preset picture off/on, comb/trap filter selectable and normal/underscan switch, just to name a few.

So when you are looking for professional quality, but still need to keep an eye on your budget, look into the Panasonic BT-Series high-grade monitors. For more information, call Panasonic Industrial Company at 1-800-553-7222. Or contact your local Panasonic Professional/Industrial Video Dealer.

Panasonic

Professional/Industrial Video

drudgery out of AM antenna DA adjustment.

Afternoon session:

Session coordinator: Brad Dick, technical editor, BE magazine

1:30 p.m. NAB Project Update
• Michael Rau, NAB
Latest news on AM improvement, FMX and HDTV.

2:00 p.m. Using the Expanded AM Band (1,605kHz-1,705kHz)
• D. R. Forde, communications authority of Canada
An assessment of various proposals to use the new AM radio spectrum channels above 1,605kHz.

2:30 p.m. Engineering Education for the Broadcast Engineer
A panel discussion featuring the following experts:
• F. David Harris, P.E., Purdue University (chair)
• Lawrence Titus, Chase Broadcasting
• Paul Young, P.E., Arizona State University
• Skip Pizzi, National Public Radio
• Roy Pritts, University of Colorado
• Harry Tompkins, Hocking Technical College
• Jim Wulliman, SBE certification chairman
Changing broadcast technology demands a new approach to engineering education.

4:00 p.m. Close of session

SBE national membership meeting

5:00 p.m. Membership meeting ends

5:00 p.m. Attendee reception in exhibit hall to 7:00 p.m.

Night owl session:

Session coordinator: Don Borchert, director of engineering, WHA-TV

7:00 p.m. Audio Processing and the NRSC
A panel discussion

coordinated by Don Borchert and featuring the following experts:

- Bill Ammons, CRL
- Andy Laird, KDAY
- Dane Ericksen, P.E., Hammett & Edison

A detailed look at the NRSC standard and what it means to your station.

9:00 p.m. Close of session

Friday, Sept. 23

Early bird session—Television:

Session coordinator: Ned Roseman, editor, Video Systems magazine

8:00 a.m. Strategies for Implementing D-1 and D-2 Recorder Formats
• By Curtis Chan, Centro Corporation
How to plan for the use of new digital formats in existing and future video facilities.

8:30 a.m. ACTV progress report
• By James Carnes, Sarnoff Research Center
Status of the proposed SRI/NBC Advanced Compatible HDTV system.

9:00 a.m. Advances in Fiber Optics for TV
• Bob Griffiths, Ph.D., Telemet
An examination of modern alternatives to coaxial cable.

9:30 a.m. Measuring Synchronous AM Noise in TV Transmitters
• Geoffrey Mendenhall, P.E., Broadcast Electronics
Minimizing synchronous AM noise for best multichannel sound performance.

10:00 a.m. Close of session

Exhibit floor opens

1:00 p.m. SBE certification exam—Radio

Afternoon session—Television:

Session coordinator: Brad Dick, technical editor, BE magazine

1:00 p.m. Computer Graphics for the Video Engineer
• Richard Lehtinen, technical editor, BE magazine
The hardware

elements of today's graphics systems.

1:30 p.m. Microprocessor Control of Switchless Combiners and RF Systems
• James Stenberg, MCI
Ways to prevent RF system problems through computerized control.

2:00 p.m. Protecting Your Station: An Overview of Security Technology
• Gerry Kaufhold, consulting engineer
Designing a security system for remote facilities.

2:30 p.m. Techniques in Narrowband Remote Pickup
• Barry Victor, the Victor Group
Making maximum use of the overcrowded RPU spectrum for TV remotes.

3:00 p.m. A Spectral Tool Box for the TV Transmitter Engineer
• Christopher E. Traficante, Townsend Broadcast Systems
Tuning TV transmitters for peak performance.

3:30 p.m. Low-Cost Transmission Line Maintenance Using a High-Power Pulse Reflectometer
• John P. Bisset, Delta Electronics
Checking transmission line using readily available equipment.

4:00 p.m. Close of session

7:00 p.m. Exhibit floor closes

Night owl session: (Mezzanine)

Session coordinator: Don Borchert, director of engineering, WHA-TV

7:00 p.m. Management for Engineers
A group discussion coordinated by Don Borchert and featuring:
• Brad Dick, BE magazine
• Neil Fink, placement specialist
• Harry Martin, Reddy, Begley and Martin
• Marvin C. Born, KRIS-TV/KGNS-TV
Good administration



25000J
FM Transmitter

300J
FM Transmitter

Model X
FM Exciter

Silverline UHF
TV Transmitter

Silverline UHF
TV Transmitter

1000W UHF
TV Transmitter

100W UHF
TV Transmitter

FOR BROADCASTING EXCELLENCE... SOLID, POWERFUL, TELEVISION AND RADIO EQUIPMENT

High Power UHF TV Transmitters

TTC's Silverline UHF TV Transmitters provide the ultimate in picture quality, reliability and efficiency. These transmitters are designed that way, without compromise.

All new state-of-the-art design utilizes CMOS logic for control functions. Silverline multiple klystron transmitters maximize reliability by offering total redundancy. Each multiple klystron transmitter includes two or more amplifier cabinets, control circuits, high voltage contactors, beam supplies, cooling systems and exciters.

Low Power Transmitters

TTC offers a full line of outstanding VHF and UHF translator-transmitters, with an ultra-stable design that assures high quality and trouble-free operation.

For both VHF and UHF TV up to the 100W level, TTC offers solid state translator-transmitters designed for worry-free unattended operation in remote and hostile environments.

The 1000 Watt TTC XL1000 has become the best selling UHF transmitter in the world. Long-term reliability, performance, advanced capabilities, and versatility for use with UHF, VHF, satellite, or video inputs provide you with assurance of lasting quality.

FM and AM Radio Transmitters

TTC has established a longstanding track record for producing highly reliable and durable FM and AM radio transmitters—combining unsurpassed value and performance.

A complete line of transmitters is manufactured including units with a power output of as low as 30 Watts and ranging upward to 50,000 Watts.

Featuring our clean, uncomplicated designs incorporating refinements developed from over twenty years of proven performance in radio stations worldwide, today's TTC radio transmitters provide unmatched price-performance value and quality.

**Put TTC, the leading manufacturer of translators,
to work for you. Call or write us with your requirements.**

TELEVISION TECHNOLOGY CORPORATION
P.O. BOX 1385 • BROOMFIELD, COLORADO 80020 USA • (303) 665-8000 • TWX: 910-938-0396 TTC COLO

Circle (68) on Reply Card

is as important as good engineering.

9:00 p.m. Close of session

Saturday, Sept. 24
Early bird session—Radio:

Session coordinator: Brad Dick, technical editor, BE magazine

8:00 a.m. FM Directional Antennas: Boon or Bane for Commercial Stations
• Ralph Evans, P.E., consulting engineer
The pros and cons of FM DAs.

8:30 a.m. Visualizing Antenna Fields
• Ron Nott, Cortana Corporation
An inside look at how directional antennas work.

9:00 a.m. FM Licensing Update
• Robert Greenberg, FCC
Is there life after Docket 80-90?

9:30 a.m. Avoiding Problems with DA Proofs

• John Sadler, FCC
How to make your directional antenna proof "FCC-proof".

10:00 a.m. Close of session

Exhibit floor opens

1:00 p.m. SBE certification exam—TV

Afternoon session—Radio:

Session coordinator: Rick Lehtinen, technical editor, BE magazine

1:00 p.m. Digital AM Technology
• Daryl Buechting
Digital audio demands digital transmission techniques.

1:30 p.m. Digital Synthesis of FM Subcarrier to Increase Available Modulation and Separation Performance
• Glen Clark, Texar
Solving some of the inherent problems of SCA generation.

2:00 p.m. FM Synchronous

Repeater Systems
• Stephen H. Broomell, P.E., Omega International
Filling holes in station coverage through use of an FM booster.

2:30 p.m. The State of Contract Radio Engineering
A panel discussion featuring the following experts:

• Mark W. Persons, M. W. Persons & Associates (chair)
• Jim Casey, Casey Engineering
• Mike Patton, Patton Circuit Systems
How to make a living as an engineer in spite of management.

4:00 p.m. Close of sessions

6:00 p.m. Exhibit floor closes

Ham radio reception

Night owl session:

Session chair: Edward Edison, Hammett & Edison

Continued on page 146

Splatter matters.

Splatter is a form of radio interference that can drive listeners away from AM radio. It creates distortion in your signal, wastes transmitter power on undesired sidebands and interferes with other stations. Even with an NRSC audio filter, misadjustment of the transmitter or audio processing equipment can still produce an RF spectrum that can exceed NRSC or FCC limitations.

That's why routine monitoring of your station's RF spectrum is a must. But it doesn't mean you'll have to bust your budget on a spectrum analyzer. It just means you need the rugged SM-1 AM Splatter Monitor from Delta Electronics.

For just \$2,150 you can now accurately measure your transmitter's spectral output, monitor transmitter IPM levels and make adjustments to improve clarity. An external audio input helps identify splatter sources.

The Splatter Monitor's unique offset feature tunes spectral segments for closer examination 10 kHz to

100 kHz away from the carrier. Unlike a spectrum analyzer, you can listen to the front panel speaker or your own headphones as you measure splatter levels on the front panel meter. The Splatter Monitor also has an alarm output to drive your remote control.

In this day and age where splatter matters, monitoring it doesn't have to cost you a fortune.

To find out more about the new Delta Splatter Monitor, call (703) 354-3350, or write Delta Electronics, Inc., 5730 General Washington Drive, P.O. Box 11268, Alexandria, VA 22312.

The Above Standard
Industry Standard.

DELTA ELECTRONICS



© 1988 Delta Electronics, Inc.

Circle (69) on Reply Card

LENCOCODER



PCE-466
Professional broadcast quality encoder.



CCE-850
Self-contained utility encoder.



PCD-473
State-of-the-art professional broadcast decoder.



EN-15
Perfect for CGA card output VCR recording. PC type encoder board.



EN-10
Designed to work with graphics boards outputting analog RGB. Requires external sync generator.



DC-20
PC type decoder board.

The word for high-performance studio and computer resident encoders and decoders. For RGB to recordable NTSC composite video...Lencode it!

The Lencoders, from Lenco. Pioneers in state-of-the-art encoding technology since 1973, and still on the cutting edge of innovation.

Lencoder. Get the word.
Write or call today for detailed information and prices.



300 N. Maryland St.
Jackson, MO 63755 U.S.A.
Phone: 314-243-3147
FAX: 314-243-7122
Telex No: 910-760-1382

Circle (70) on Reply Card

SMPTE sessions to shine in Big Apple

By Rick Lehtinen,
TV technical editor

Preparations are under way for the 130th SMPTE (Society of Motion Picture and Television Engineers) Technical Conference and Equipment Exhibit. This year, the show returns to New York, Oct. 15-19, at the Jacob K. Javits Center.

As of press time, 193 companies were signed up for booths that will cover 73,000 square feet of convention space. The exhibit floor will be open on Saturday, the first day, from 2:30 p.m. to 6 p.m.; Sunday from 10 a.m. to 6 p.m.; Monday from 10 a.m. to 6 p.m.; and Tuesday from 9 a.m. to 4 p.m.

The importance of the SMPTE exhibition may be heightened somewhat by the fact that it is soon to be the only chance each year for manufacturers of TV equipment to display their wares in the SMPTE environment. Effective next year, equipment exhibits will no longer be a part of the winter SMPTE TV conferences.

The predicted 17,000 attendees will have a full technical agenda. More than 160 papers will be presented during the 5-day conference. The theme for this year's technical program is *Innovations in Imaging and Sound*.

It might be a good idea to plan on purchasing audiotapes and copies of the proceedings. There will be so many papers that organizers have decided to hold three concurrent sessions.

The technical sessions at SMPTE are always outstanding, and this year will be no exception. In addition to the overwhelming quantity of presentations, you should expect to see high quality as well. Because the scope of the sessions will touch nearly every aspect of film and video production, there will be something informative and educational for everyone.

Of the 23 sessions, 16 will deal predominantly with television and video, including ACTV, HDTV, distribution and transmission technologies, videotape recording, automation and graphics. Five of the sessions will deal mostly with film, although some good video titles also will be featured. Two sessions split the fence. They will deal with post-production for both film and television.

New trends

Of particular note are the sessions de-

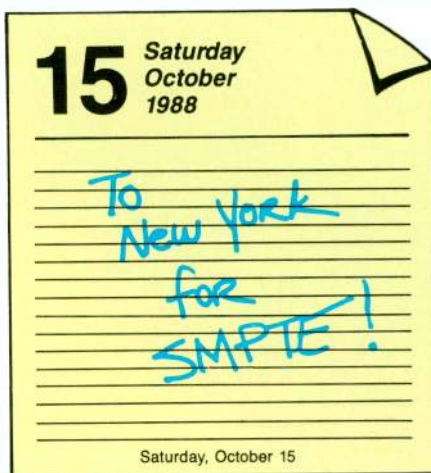

voted to emerging trends. Saturday afternoon will include a full session on digital distribution and codec technology for the proposed DS-3 rate (45Mb/s) digital signal standard. (The DS-3 rate standard addresses digitization of video for terrestrial transmission, usually via telephone fiber optics or digital radio.) The fiber-optics session on Tuesday morning will further explore the same theme and will include papers on bit reduction, packet video and digital transmission, among others.

Tuesday afternoon, in a session overviewing small-format tape machines, "A New Broadcast Digital VTR Format" will be discussed by authors from Panasonic Broadcast Systems. Also presented will be evaluations, based on field experience, of two formats. "Two Years of M-II—A Progress Report," will cover the experiences of NBC, and in "Betacam SP—The First Year," Karl Renwanz, WNEV-TV, Boston, will recount field experiences.

CCDs apparently are advancing into the HDTV world. At least three papers will treat the field of HDTV CCDs. Several other CCD papers will be presented in the "New Technology for Imaging and Display" sessions on Wednesday.

Ray Lowe, who engineered the NBC Robotic Studio, will report on the system as part of the "Automation for TV" session on Tuesday morning. Additional automation papers will discuss advances in automatic playback and record systems for TV programs and commercials. Real-time measurement and control systems also will be discussed.

Two papers in the Video Processing session, one from Central Dynamics in Montreal and one from Sony, will reveal details about new digital NTSC encoding and decoding systems.

Advanced TV transmission systems and advanced TV production systems will be covered thoroughly, with more than 30 papers being featured. Transmission topics will be dealt with on Sunday, and the topic on Monday will be production. Authors will explore HDTV, compatible HDTV, en-

hanced NTSC and MUSE. Several different compatible HDTV systems are scheduled for discussion, as well as HDTV distribution and conversion equipment.

Post-production will be covered in four sessions. One session will frame the relationship of film and television, and one session will scan the connections between film and HDTV. The other two sessions will specialize in TV post-production, with several papers focusing on the use of digital video, interactive video and optical recording media.

The topic of audio also will be discussed. Two sessions, one on sound technology and one on audio for television, will cover some of the practices in the field, as well as look into some new technologies. A paper from PBS will report on Descriptive Video Services, a program to help blind viewers gain more from television through the use of audio explanations transmitted on the SAP channel.

Several sessions will include panel discussions in which audience members can draw out experts in question-and-answer sessions. These sessions will include Advanced TV Transmission Systems (II), Fiber Optics and New Technology in Imaging and Display (I).

Honor awards

As always, SMPTE will use the conference as an opportunity to recognize individuals whose dedication and contribution to the industry has set them apart. The society will name 14 new Fellows. Once again, the prestigious Progress Medal, the society's premier award, is to be bestowed. This year's recipient is K. Powers.

The awards ceremony will take place at the luncheon on Saturday, in the convention center's special event hall, from 12:15 p.m. to 2 p.m. A pre-luncheon reception will begin at 11:30 p.m.

The SMPTE conference schedule begins on page 112.

UHF BROADCASTERS

#2 IN A SERIES ON YOUR HDTV/STEREO FUTURE

BOGNER

Subject: Competing with cable
for HDTV and Stereo

Dear UHF TV Broadcasters,

Back in March we published an article summarizing our measurements of the very large amount of beam steering displayed by many broadcast antennas, especially waveguide designs. The potential harm from this effective loss of bandwidth, chrominance, and audio was described in detail.

Since then we have been told by various waveguide antenna purchasers that certain manufacturers claim to have essentially eliminated this problem. In order to verify this, we picked two stations for which this claim was made, and concentrated our measurements on those two particular stations. We found that the beam steering exhibited by these antennas was, if anything, even worse than average for waveguide antennas, despite attempts to reduce it by such techniques as very heavy null fill-in.

The first station about which we were told that the waveguide antenna supplier had claimed to have considerably reduced the steering effect was WNEB, ch. 17 Buffalo, N.Y. We were informed that representatives of the station witnessed the antenna being tested at the manufacturer's plant, and were told that the steering problem was solved. However, we made many very precise measurements with clear line of sight to the tower within the range from 2 to 12 miles from the station, (which area includes most of the city of license) and found aural carrier levels more than 23 dB below visual in many locations, corresponding to an aural ERP of 12 Kw instead of the licensed 250 Kw.

The second station about which we were informed that the waveguide antenna supplier claimed negligible beam steering was WTOG ch. 44, Tampa, FL, just installed in June 1988. We were told that the purchaser witnessed tests at the manufacturer's plant demonstrating almost no beam steering. However, a series of line of sight measurements, very carefully made, showed aural carrier ERP 22 dB below visual (i.e. aural ERP of only 31 Kw, not the licensed 500 Kw) just in the range 5 to 12 miles from the station, proving that no reduction whatever in beam steering was achieved. Therefore the steering effect could be very severe on stereo or HDTV broadcasting, and the performance is not approaching what the station could and should get from its antenna.

There is no valid reason the broadcast industry must accept this performance deterioration caused by a broadcast antenna, and risk loss HDTV and stereo to cable. Affordable and reliable designs are available, with very high input power capability, which exhibit no steering at all. Any owner who accepts this deterioration without at least a thorough investigation of his specific situation is putting his station at considerable and unnecessary risk.

We will continue to report periodically on the specific results of our testing of additional stations which have gone on the air with waveguide antennas, or changed to waveguide antennas, since March.

Yours very truly,
Bogner Broadcast Equipment Corp.

R. Bogner
Richard D. Bogner
Technical Director

RDB/ch

See Us At SBE Booth 108

BOGNER[®]

Broadcast Equipment Corp.

603 Cantiague Rock Road, Westbury, NY 11590

Tel: (516) 997-7800 • Fax: (516) 997-7721

Circle (71) on Reply Card

Conference schedule

Saturday, Oct. 15

Opening session, welcoming address, engineering report and keynote address

Saturday, Oct. 15

Afternoon sessions:

- A. Archival and Lighting
- B. Digital Distribution/Transmission of TV Signals
- C. TV Post-Production I

Sunday, Oct. 16

Morning sessions:

- A. Film Production Technology
- B. Advanced TV Transmission Systems I

Afternoon sessions:

- A. Film Laboratory Technology
- B. Advanced TV Transmission Systems II
- C. TV Post-Production II

Monday, Oct. 17

Morning sessions:

- A. Film Presentation Technology
- B. Advanced TV Production Systems I
- C. Satellites

Afternoon sessions

- A. Sound Technology
- B. Advanced TV Production Systems II
- C. Graphics

Tuesday Oct. 18

Morning sessions:

- A. Post-Production (Film/TV)
- B. Fiber Optics
- C. Automation for TV

Afternoon sessions:

- A. Post-Production (Film and HDTV)
- B. Small-Format Video Recording

Wednesday, Oct. 19

Morning sessions:

- A. Video Processing
- B. New Technology in Imaging and Display I

Afternoon sessions:

- A. Audio for TV
- B. New Technology in Imaging and Display II

A video camera that grows with you. At Camera Mart.



Ikegami HL-95B Unicam Camera

At Camera Mart we've always had a strong preference for flexible equipment. Utilizing a unique "building-block" concept, the HL-95B is available as a standalone camera capable of accepting any on-board VCR, as well as multicore and triax.

The Ikegami HL-95B Unicam® is the only universal camera system that accepts all tape formats.

A newly developed 2/3-inch Plumbicon® tube (electrostatic focus/magnetic deflection) is incorporated into the HL-95B. Available now from Camera Mart.

The more you know about video, the more you can rely on Camera Mart.

The Camera Mart, Inc.

SALES • SERVICE • RENTAL

Headquarters/New York
456 West 55th Street, New York 10019
(212) 757-6977
Telex: 275619/FAX (212) 582-2498

Upstate/Central N.Y.
305 Vine Street, Liverpool, N.Y. 13088
(315) 457-3703 FAX (315) 457-3795

California
1900 W. Burbank Blvd., Burbank, CA 91506 (818) 843-6644

Indiana
625 Royal Avenue, Evansville, Ind. 47715 (812) 476-6327

Circle (72) on Reply Card

NEED A COMPACT INTERCOM?

The innovative CS9500 is ideal for radio and television stations, production facilities and mobile vans where a totally programmable and high performance digital intercom is required. System features include:

- Very compact: only 3 Rack Units (5 1/4") high!
- Totally field expandable up to 50 x 50 matrix
- Innovative microprocessor-based architecture
- Dual redundant switch-mode power supply

In addition to Point-to-Point communications, other capabilities include:

- Party Lines
- Fully programmable control panels
- IFB's or Program Interrupt
- 2/4-wire interface
- 2-way radio interface
- Telephone interface

The CS9500 is a high performance, space saving and cost effective solution to your intercom needs.

McCurdy Radio Industries

McCurdy

WE'RE ON YOUR WAVE LENGTH

See Us At SBE Booth 646

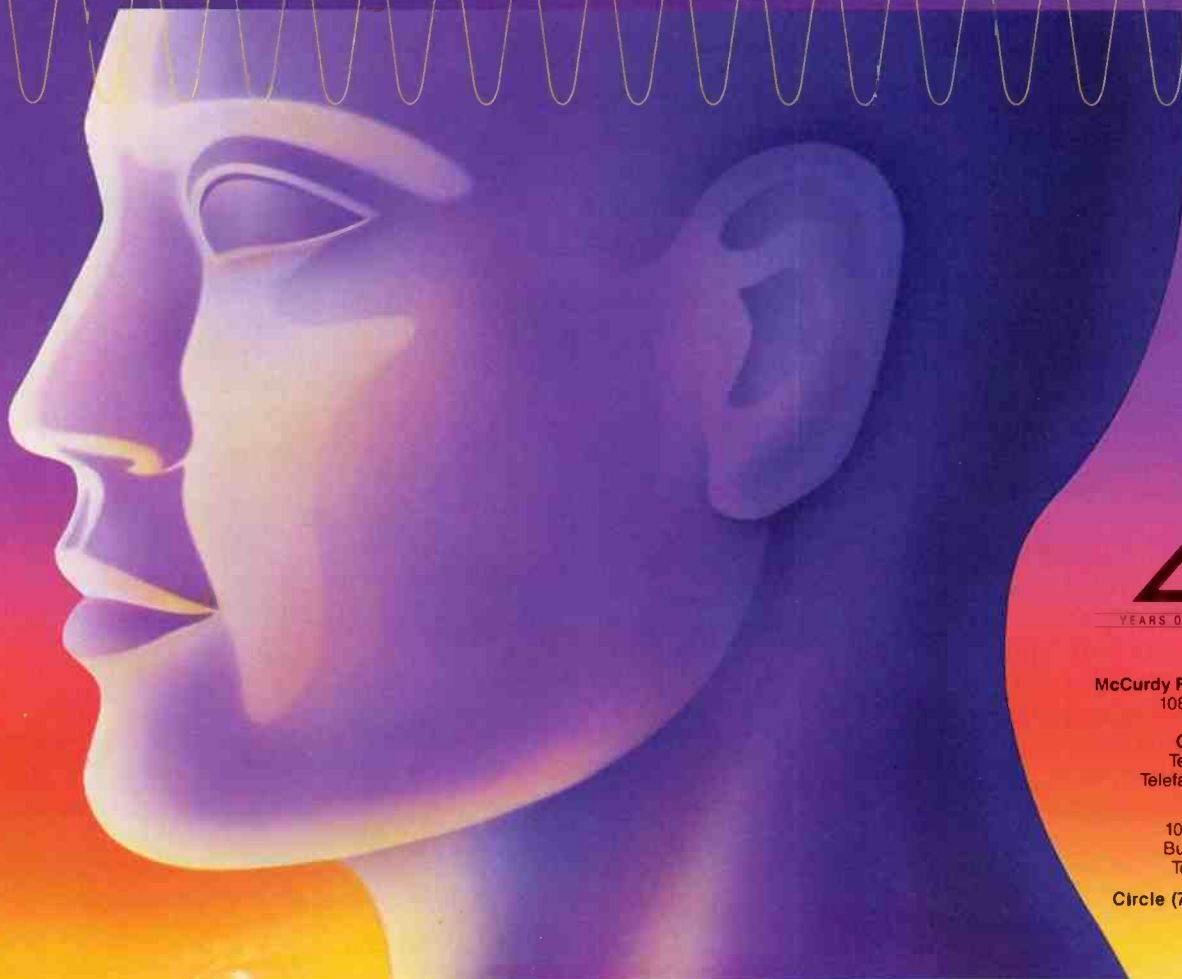
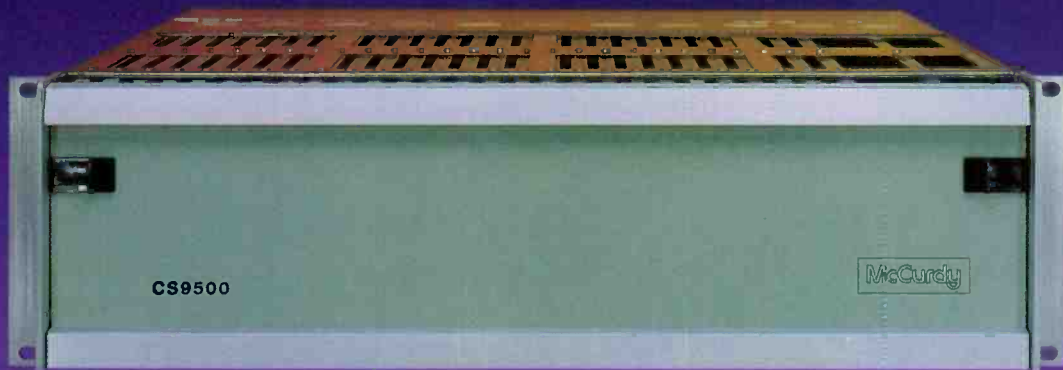

40
YEARS OF EXCELLENCE

McCurdy Radio Industries
108 Carnforth Road
Toronto, Ontario
Canada M4A 2L4
Tel. (416) 751-6262
Telefax (416) 751-6455
Telex 06-963533

1051 Clinton Street
Buffalo, N.Y. 14026
Tel. (212) 772-0719

Circle (73) on Reply Card

Why Sony cutting edge o

BVE-9000

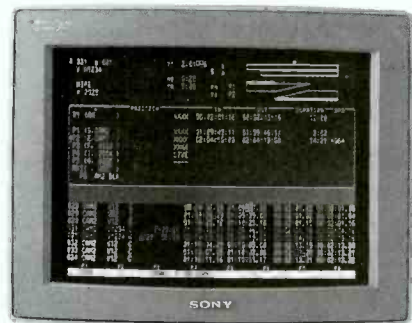

One company has consistently managed to stay at the forefront of video technology.

Sony. We've been defining and redefining editing control units for more than 12 years. Which enables us to offer a wide range of sophisticated machines that are fast, accurate, easy-to-use and offer the most features possible for the money.

With that in mind, it's easy to understand why the BVE-9000, BVE-900 and BVE-600 editors differ, yet share Sony's key operating controls and features. For instance, they all automatically detect and identify the type of Sony VTR being used and set the appropriate control parameters through RS-422 serial control

ports. Plus, they can read Control Track, Time Code and perform video/audio split edits. The list of features goes on and on, so by all means, read on.



The BVE-9000. State-Of-The-Art That's Top-Of-The-Line.

The Sony BVE-9000 is one of the most flexible and powerful editing systems in the world. It's designed to save the most precious commodity of all: time.

Among its significant innovations are multi-edit preview and full assembly look ahead. This allows you to preview an entire sequence of up to 999 events, before actually having to record a single edit. And then, with the flick of a few key strokes, you can automatically record the entire program.

Of course, there are many other incredible features that help you control your entire editing facility. For one thing, the BVE-9000 can work with 28 separate devices. It also has an optional color menu display that's user friendly and programmable for layout and color.

What's more, our Dynamic Motion Control Learn-With-Create and

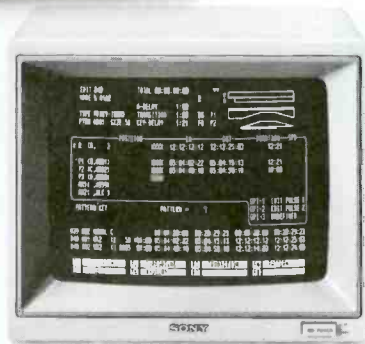

BVE-900



is on the f technology.

switcher Learn-With-Create features allow you to record a move without having to re-rehearse it. In addition, the temporary record assignment greatly speeds up multi-layering. And the most complete set of test diagnostics in the industry helps reduce system downtime. No wonder this top-of-the-line editing system can meet all your present and future needs.

The BVE-900. State-Of-The-Art Technology And State-Of-The-Art Economy.

The next best thing to editing on a BVE-9000 is editing on a BVE-900. It, too, is an easy-to-use system and economically offers technical advancements and expandability.

It controls up to four VTR's in any A/B roll edit. So you can perform sync roll and sync play. In addition, the BVE-900 gives you full control of video switchers and audio mixers, including fader selection and VCA control for split audio/video edits.

What's more, its easy-to-use menu driven display puts edit accessibility at your fingertips.

The BVE-600. State-Of-The-Art Technology Even More Economically.

The BVE-600 is our most economical unit. It allows you to control three VTRs (two players and one recorder).

Which, depending on your needs, may be more than enough. You have the power to dissolve, wipe, or superimpose editing sequences, without the need for an external video switcher. Our optional built-in component/composite video switcher offers a selection of 10 wipe patterns. That, with our built-in MXP-29 Audio Mixer interface, make A/B roll editing a reality.

Of all the benefits of using Sony editing control units, perhaps the greatest is that they form an easy-to-use system. Which means you can connect them to Sony VTRs, switchers, audio mixers and video monitors. All of which are serviced by Sony.

For more information about Sony's entire line of editors, write to: Sony Information Center, P.O. Box 6185, Union, NJ 07083. Then you'll be able to see even better why Sony is on the cutting edge of technology.

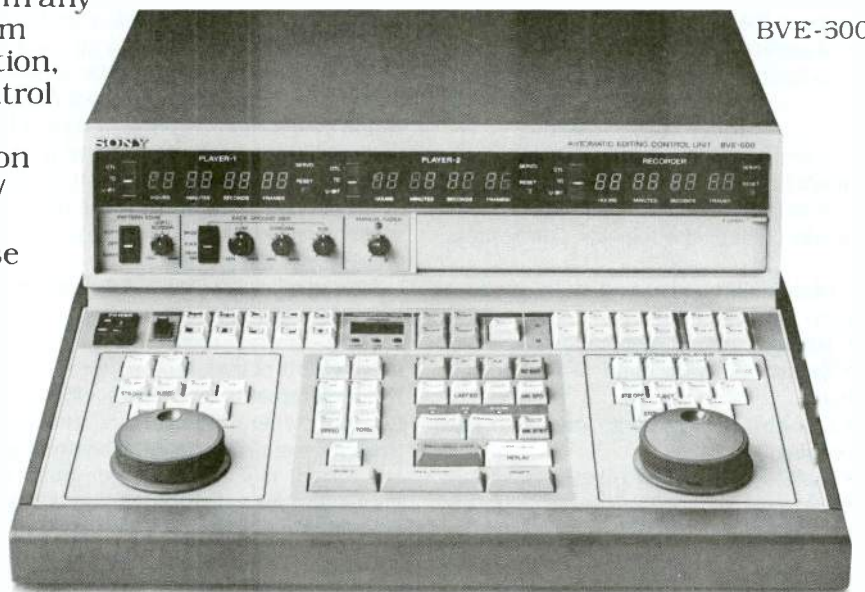

SONY

Broadcast Products

Sony Communications Products Company



Designing facilities for digital video

By Curtis J. Chan

Product implementation of the D-1 component digital format and the proposed D-2 composite digital format already has begun. End-users have used this equipment to produce commercials, music videos and documentaries. These new formats allow for the transparent recording, reproduction and distribution of video and audio signals. This article will explain some of the characteristics, considerations and applications of both formats, and discuss their importance in the marketplace.

Ideal tape format

A universal tape format that meets the needs of the broadcast and teleproduction industries would be ideal. Such a device would contain the following attributes:

- High-quality video and audio performance.
- Transparent multigeneration capability.
- Record and play time of two to four hours.
- Low-cost medium with protected tape housing.
- Built-in editing and mixing functions.
- Low cost, low-power consumption and light weight.

Chan is vice president of marketing and product development, Centro Corporation, Salt Lake City.

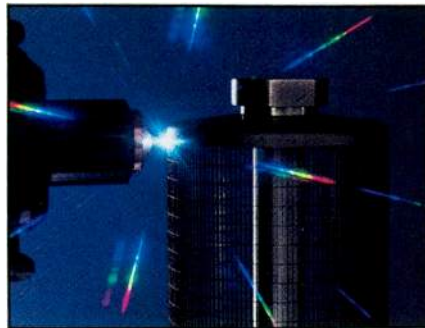

- Compatibility with present and future formats.
- High level of reliability and serviceability.

At the present, each recording device requires different attributes because of the different standards, economics and requirements for each application. End-users ultimately will have to decide whether to use a single-format device for all applications and accept the compromises in quality and performance, or match each application to a format that was designed for that particular need, and create a cost-effective interformat environment. At least at the present, a single universal tape format that meets all requirements worldwide seems impractical.

After many years of research, two digital video formats have emerged.

The D-1 format comes from the cumulative efforts of many committees to meet the requirements of CCIR recommendation 601, where performance and functionality were of concern. The proposed D-2 format is a result of user-group requirements for a digital VTR that is based on functionality and economics and is compatible with existing analog standards. See Table 1 for a short review of the rele-

vant format parameters and protocols of the two formats.

Digital processing promises to eliminate the multigeneration signal degradations of analog VTRs, to increase machine reliability and performance, and to provide increased intelligence for built-in diagnostics.

The players: D-1 and D-2

Before we look at some technical considerations for implementing the two formats, let's review their system topologies. Figure 1 diagrams a typical D-1 processing device. The D-1 device can accept various inputs, including composite analog, analog component and digital video parallel input. Analog signals are converted to a digital format before processing, and vice versa for output. With 4:2:2-based processing equipment, limitless multi-effects layering can be accomplished through bypassing the analog chain and using the digital I/O.

Figure 2 is a simplified block diagram of the proposed composite format DVTR. The main difference between the two formats is that the D-2 format doesn't need an encoder/decoder to convert the signals, and there is a 4x fsc processing block for the encoding and decoding of data. Notice also that the parallel digital video I/O is different as well. Upcoming hardware for both D-1 and D-2 will allow for the serial transmission of data.

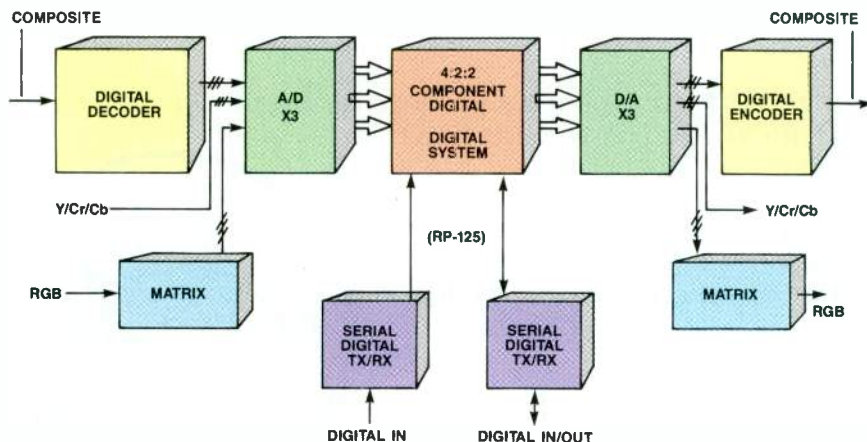

Figure 1. The component digital device accepts input and makes output in several formats, including composite video via a decoder/encoder. Internally, the device processes component video based on a 4:2:2 ratio.

Getting integrated

To properly integrate these two new formats into existing facilities, several considerations must be taken into account. These include the need for timing and reference signals in both the analog and digital domains. There is a need to overcome problems in level and phase matching, color correction, monitoring, equipment testing and adjustment. And there may be interfacing problems, both analog and digital, within the audio and video systems themselves.

Video timing and reference signals

With digital recording hardware, as with analog, there are timing and reference considerations. In the analog domain, existing reference signals, such as mixed

Limitless!

IKEGAMI'S HK-323P IS THE IDEAL PORTABLE COMPANION FOR YOUR HK-323 FIELD/STUDIO CAMERA.

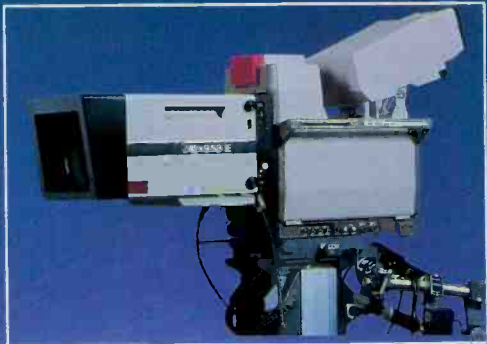

The HK-323 Field/Studio Camera

Ikegami's HK-323 1" and 2/3" field studio cameras are big news...so is the smaller HK-323P companion camera. This lightweight hand-held model provides the user with limitless potential, flexibility and performance that meets and exceeds industry standards for excellence.

Featuring a built-in micro-processor for various software based control functions and fully automatic setup, the HK-323P operates from the same base station as the HK-323 and offers high performance prism optics, auto-knee circuitry to handle high contrast, and scene files with extensive memory for the sharpest picture quality regardless of scene color content or special color lighting. This, plus selectable gamma values: 0.45, 0.4, 0.35, two motorized servo filter wheels each with four positions, a back-up memory system and various adaptors for total system flexibility.

Go the limit with the HK-323 and HK-323P and companion camera system.

For a complete demonstration of the Ikegami HK-323 and HK-323P, contact your Regional Ikegami Office.



Ikegami

Ikegami Electronics (USA), Inc. 37 Brook Avenue, Maywood, NJ 07607
East Coast: (201) 368-9171 West Coast: (213) 534-0050 Southeast: (813) 884-2046
Southwest: (214) 869-2363 Midwest: (312) 634-9774 Hawaii: (808) 946-5955

Circle (75) on Reply Card

sync and blackburst, are widely accepted. However, digital signals with inherent timing references still are being developed.

System designers must consider the timing relationships between the input reference for overall system timing and the digital interface clocks for the transfer of data.

This is because the timing for the digital interconnects between sources may not be coincident with their analog counterparts. Care must be taken in planning both the analog and digital paths.

Other delays are attributable to coax length, DAs and the equipment itself.

Automatic-delay DAs or isophasing amplifiers can correct some of the timing problems, but the best way to account for timing problems is in the design stage.

Audio

With the progression of MTS broadcasting, broadcasters are paying more attention to audio. With these formats' four digital channels and the availability of digital audio support equipment, timing and phase relationships need to be monitored closely.

Conformity to specific sampling rates will become a concern. If digital audio is to be used, it should be noted in the production stages of the shoot that the 48kHz sampling rate is recommended for recording and subsequent data transfers. The worldwide acceptance of the AES/EBU digital serial interface will play an important part in the digital facility. The standard will allow for the transfer of digital audio data between systems without any signal degradation. Pitch changes relate to variances in the sampling rate that necessitate the need for sampling rate and pitch converters.

Digital video recorder technology allows some variance in the timing of the audio edit point. An edit point can be moved in

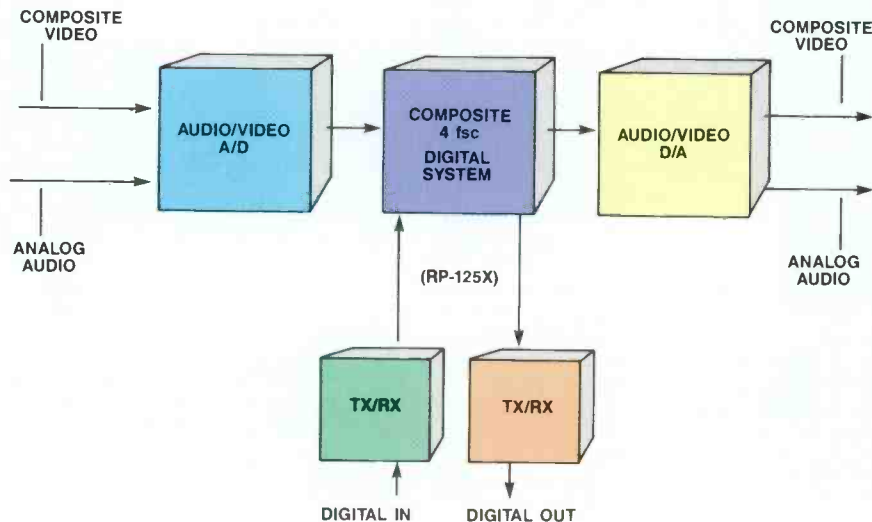
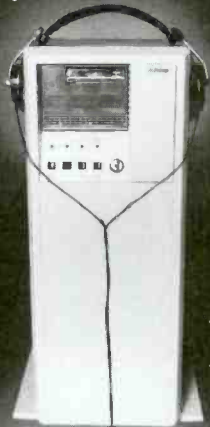

Figure 2. The composite digital device works in existing formats for easy integration into existing facilities. Processing is performed at 4x fsc.

Live Assist and more!

CABS delivers an integrated Computer Aided Broadcasting System from Library Maintenance to Analysis of Aired Events.

- Music and commercial library management
- Sophisticated programming and scheduling criteria
- Live assist with full control of audio peripherals



- Announcer information, live tags and schedule enquiry
- Analysis of formats, aired events and their relationship to station ratings.

DKW SYSTEMS INC.

#730, 9919-105 Street
Edmonton, Alberta Canada T5K 1B1
(403) 426-1551

SMALL WONDER - WE WORK 24 HOURS EVERY DAY WITHOUT A BREAK!

Circle (127) on Reply Card

OTARI

Recording Excellence

Equipment problems can ruin production schedules. That's why Otari audio machines are so widely used for news editing, broadcast, and production.

- 1/4" 2-channel half track
- Compact table-top recorder
- Recorder/reproducer
- Extra 1/4 track playback head
- Zero return
- DC-servo capstan
- Variable speed
- Balanced inputs and outputs



OTARI MARK III-2

CALL

Toll Free 50 States
800-356-5844

FULL COMPASS SYSTEMS

Wisconsin: 800-362-5445
Consultation: 608-271-1100
Fax: 608-273-6336

6729 Seybold Road • Madison • WI • 53719-1393

Circle (133) on Reply Card

See us at IBC in the Grand Hotel
and at SMPTE Booth #1668.

**THE CHYRON
SCRIBE FAMILY:
SCRIBE JR.
SCRIBE
SUPERSCRIBE
SCRIBE FOR
HIGH DEFINITION**



**High-resolution text and
graphics to fit every appli-
cation and every budget.**

The Chyron Scribe is easily the most sophisticated character and graphics generator available. With an unexcelled library of 1,500 typefaces, each so perfectly antialiased that it is as sharp and clear as printed text.

And now it's easy to find a letter-perfect Scribe to meet your specific needs. Perhaps the SuperScribe, featuring a powerful graphics engine with on-line font attribute manipulation, multi-tasking, and multi-user operations. Or the Scribe Jr, a high-quality compact version of the Scribe. All compatible.

Or when you're ready for the cutting edge, the Scribe for High Definition — with extreme resolution for HDTV applications.

The Chyron Scribe Family. The first family in character and graphic generation.

Call us: (516) 845-2020
845-2022

**THE CHYRON
SCRIBES**
Products of The Chyron Group

© Copyright 1988 Chyron Corporation.



Family portrait.

CHYRON 
A member of The Chyron Group.
The company the whole world watches.
Circle (77) on Reply Card

VIDEO	D-1 FORMAT	D-2 FORMAT
SAMPLING RATE	13.5 + 6.75 + 6.75 = 27MHz	4xfsc = 14.31818MHz
RESOLUTION	8 BITS	8 BITS
NUMBER OF TV LINES/FIELD	250 (525/60) / 300 (625/50)	255
AUDIO		
SAMPLING RATE	48kHz	48kHz
RESOLUTION	16-20 BITS	16-20 BITS
ANCILLARY DATA	DEFINED BY AES SERIAL INTERFACE	

Table 1. D-1 and D-2 sampling parameters.

Silence is Golden and less work with telcom c4 for RADIO and TV.



The NR system you just set and forget.

- A product of ANT Telecommunications, Inc.
- No overshooting.
- No wasting time with lining up — not even for tape exchanges.
- No pre or post echo.
- Up to 118dB dynamic range — the widest dynamic range available in any noise reduction system today.
- Applications: Cartridge machines, STL, RPU, Reel-to-reels, Cassettes.
- Over 15,000 channels in use worldwide.
- No breathing or pumping.

telcom c4
Silence by Design

Distributed by:

RAM BROADCAST SYSTEMS INC.

346 W. Colfax Street, Palatine, IL. 60067

New York (516) 832-8080

Chicago (312) 358-3330

Tennessee (615) 689-3030

Circle (78) on Reply Card

6.6ms intervals for higher accuracy. Also, because of extra read and write heads, sound-on-sound editing is possible to coincide with the video data.

The DVTR should have provisions for advance digital audio data to be available with adjustable delays. This will be needed if the audio is to be sent to a digital audio mixer for sweetening, or if it is to be distributed over long runs and channeled through extra processing. At the present, audio sweetening will continue to function separately, with the responsibility of sweetening and conforming the audio tracks to the final product.

Level and phase matching, color correction

In interformat systems, conversion of signals between composite and component formats may result in mismatched levels and phase discrepancies. Each recording or processing device must be adjusted properly. Care must be taken to monitor each signal before and after encoding or decoding. If the signal is to be digitally encoded, levels and timing relationships must be matched and corrected before digitizing.

If it becomes necessary to color-correct a signal after digital encoding, there are two alternatives. One is to convert back to analog, do the correction and convert to digital. The other alternative will be realized by the introduction of a digital color corrector, which would prevent degradation by the analog-to-digital and digital-to-analog chain. It should correct for black-and-white levels as well as gamma, and should operate in RGB or its digital equivalent.

Monitoring, testing, adjustment

The widespread acceptance of digital video recorders into the marketplace will take many years. As such, most of the monitoring and testing of signals will, for now, be in the analog domain. With the proliferation of 1/2-inch component formats and the introduction of the 4:2:2 component and the 4xfsc composite digital VTR, test equipment manufacturers now are offering composite- and component-based



TAKING THE SHOW ON THE ROAD?

Transmit Your Live Remote Right Back To Your Doorstep

As broadcasters, we understand the need for audio quality and system reliability—that's why we tailor our system to meet your critical needs, whether you transmit 7 days a week or once a year.

We have been able to merge fiber optics and high quality audio circuits with our SCPC technology to provide you custom links from exciting sites such as the Mardi

Gras, the Super Bowl, Hollywood, and London—at a very affordable cost!

So link up with NPR for ad hoc networking, full-time networking, transportable uplinking and SCPC audio transmission...and find out why so many broadcasters are using our services to stand out in today's competitive marketplace.

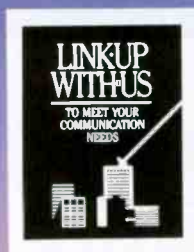

Just call (202)622-2626 for more information.

NATIONAL PUBLIC RADIO

Satellite Services

2025 M Street, NW Washington, DC 20036

Circle (79) on Reply Card

Formats and protocols

The standardization of digital formats and data-transfer protocols is essential if the digital studio is to become a reality.

The 4:2:2 component digital format is a worldwide format that is independent of the coding schemes of NTSC, PAL and SECAM composite transmission systems. The format is unique in two respects: First, it allows for the design of mechanisms and signal-processing systems to be used worldwide for any digital TV signals that conform to CCIR recommendation 601. Second, the designer of a D-1 tape-transport mechanism could use any of several different combinations of tape-scanner diameters and data-head arrangements.

The proposed composite digital format is compatible with the existing composite facilities and equipment worldwide. Facilities could reap the advantages of digital recording without having to do away with their existing equipment or buy signal-handling and routing equipment that supports the format.

Following are descriptions of some of the formats and protocols important in digital videotape technology:

- **CCIR recommendation 601**

This recommendation specifies the basic parameter values for the 4:2:2 component digital standard. The format specifies that the Y, R-Y and B-Y signal components are to be formed separately and encoded using the internationally agreed-upon sampling rates based on a 4:2:2 ratio. The Y channel is sampled at 13.5MHz, and each of the color-difference components (R-Y, B-Y) is sampled at 6.75MHz.

- **Proposed recommendation 601X**

This recommendation specifies the sampling rate and precision for the digital encoding of composite video signals. It specifies the relationship between the sampling phase and the color subcarrier as well as encoded levels of peak white, blanking and sync tip.

- **SMPTE RP-125**

This practice describes a bit-parallel, unidirectional, digital interface for component video signals, meeting the requirements of CCIR recommendation 601. The interface is applicable for 525/60 and 625/50 systems in digital TV equipment.

The video signal is transmitted in a parallel arrangement using eight conductor pairs. Each pair carries a multiplexed stream of bits of each of the Y/R-Y/B-Y signals. A ninth conductor pair carries a clock signal at 27MHz. The signals on the interface are transmitted using balanced conductor pairs for a distance of up to 50m without equalization and up to 300m with appropriate equalization.

- **SMPTE RP-125X**

This proposed practice describes a bit-parallel digital interface for composite video signals that would meet the requirements of proposed recommendation 601X (encoding parameters of composite digital television for studios). The bits of the digital words that describe the video signal are transmitted in a parallel arrangement using 10 conductor pairs. An 11th conductor pair carries a clock signal at 4xfsc.

- **EBU TECH 3246-E**

This specification for a bit-parallel, unidirectional, 9-pair interface is functionally equivalent to the SMPTE RP-125 document. However, the specification is for systems operating in the 625/50 environment and conforming to CCIR recommendation 601. The only addition is the proposal to allocate two lines explicitly for the transmission of auxiliary signals. The data signals are time-multiplexed and transferred as an NRZ code. The signals consist of video data, timing reference, ancillary and identification signals.

- **ANSI S4.40-1985**

This document describes a serial digital interface for the transmission of digital audio signals between digital audio systems. The interface is designed for the transmission of one, two or four channels of digital audio over a pair of wires or an optical fiber. In addition to digital audio channels, the interface also permits the transmission of information related to the channels, such as user-definable data, information on the interface itself, error protection and additional digital audio channels.

- **EBU TECH 3247-E**

This interface scheme allows for the serial transmission of video data between systems through coaxial cable or optical fiber. The encoding scheme is based on an 8B-9B bit-mapped block encoding technique with a transmission rate of 243Mb/s.

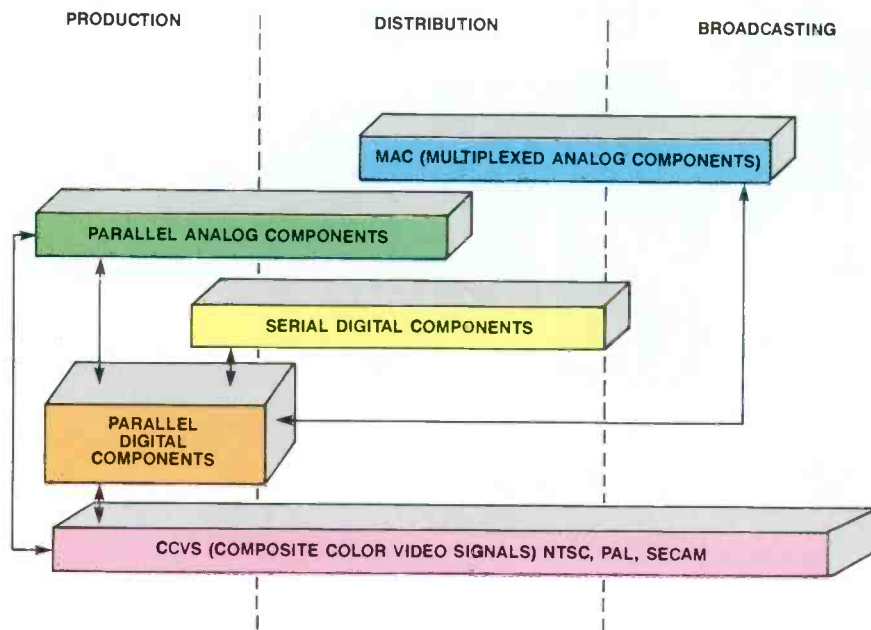

Figure 3. Options for signal formats in a production facility. Arrows show common interface paths.

test equipment. Additionally, test generators can output test signals via interfaces conforming to various digital protocols. Soon, thanks to VLSI design, it may be possible to implement digital parallel or serial inputs and outputs to high-quality monitors and test equipment.

Digital technology will bring advancements in the use of internal diagnostics to monitor and test the DVTR. These improvements may include an error-rate checker and monitor to measure a DVTR's performance; devices to check processing blocks, servo ballistics and head record/playback attributes; and circuits to monitor timing, phase and level relationships of signals. Connection to an external computer via an interface bus can minimize downtime and serve as an in-circuit emulator with expanding knowledge and adjustments. Hardware failure will be minimized by the inherent stability and advantages of digital signal processing techniques and VLSI chip integration.

Analog-to-digital interfaces

Many manufacturers now are offering

WHY YOU SHOULD PAY MORE FOR LESS.

Less phase jitter caused by poorly tracking tape, because the naturally lubricated concave guides gently position the tape and allow the cartridge machine to perform critical guidance.

Less tape noise and signal loss with our 100% laser-inspected, high output, low noise tape which delivers better frequency response and keeps signal-to-noise ratio high, harmonic distortion low.

Less wow and flutter or stop cue overshoot, because there's no rotating hub to wear out, warp or rattle.

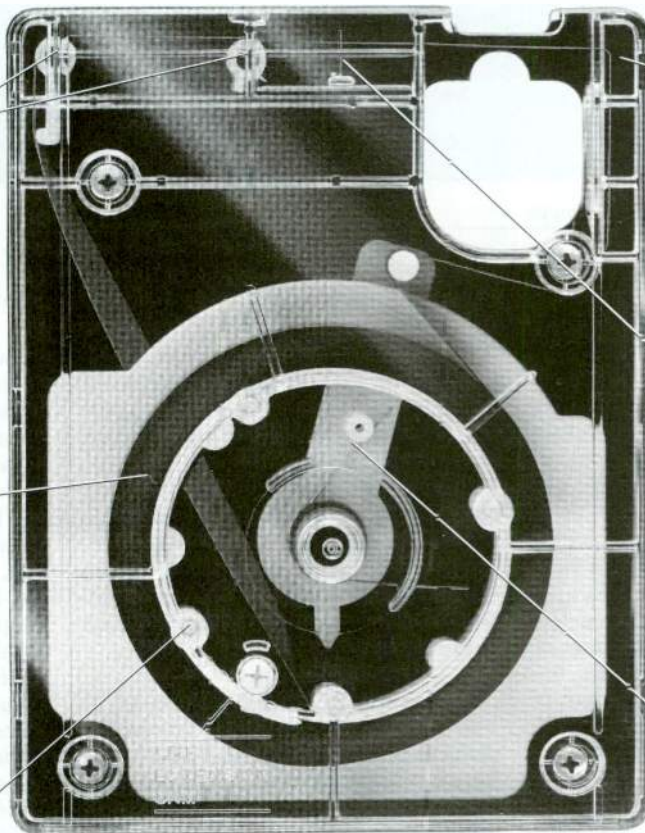

The ScotchCart® II Cartridge

Less chance of the cartridge cracking or breaking, because the tough polycarbonate cover withstands repeated use and abuse.

Less head wear, tape steering and modulation noise, because there aren't any pressure pads to add friction.

Less chance of tape destruction, because our patented tension control system ensures proper tape-to-head contact, and provides constant tension to control looping and prevent twisting.

With broadcast cartridges, like everything else, you get what you pay for. With ScotchCart® II cartridges, you get a revolutionary design that delivers trouble-free operation, superb sound quality and a life expectancy that's second to none.

You also get the benefit of 3M's extensive audio tape experience—over 40 years of successful innovation and product development.

So if you measure a cart's value by how much

uncompromising performance it provides in the long run, talk to your professional audio dealer or local 3M sales office about the advantages of the ScotchCart® II cartridge. Or for a free sample, call International Tapetronics, 3M Broadcasting and Related Products Department at 800-447-0414. (In Alaska or Illinois, call collect 309-828-1381.)

Because a cheaper cartridge may be more trouble than you can afford.

3M

Circle (80) on Reply Card

APPLICATION	D-1 FORMAT	D-2 FORMAT
	LAYERING MULTI-EFFECTS EDITING MASTERING/REPLICATION FILM TO TAPE DATA STORAGE/ARCHIVE	PRESENT TYPE C APPLICATIONS
VIDEO I/O	RGB/R-Y/B-Y/BETACAM RP-125/EBU TECH-3246-E	COMPOSITE ANALOG RP-125X
AUDIO I/O	4 CHANNEL (AES/EBU)	4 CHANNEL (AES/EBU)
CASSETTE	19mm CASSETTE—S,M,L	19mm CASSETTE—S,M,L
PLAY TIME	16 μ m	13 μ m TAPE
SMALL	11 MIN	13 MIN
MEDIUM	34 MIN	41 MIN
LARGE	76 MIN	94 MIN
		208 MIN
TAPE COATING	850 0e METAL OXIDE	1,500 0e METAL PARTICLE
TAPE SPEED	286mm/s	131.7mm/s

Table 2. Comparison of D-1 and D-2 formats.

digital video I/Os. The goal is to minimize degradation losses caused by the analog-to-digital conversion process. Nevertheless, it sometimes will be necessary to translate from one domain into the other. If, for example, an analog camera is to be used in a digital production system, an RGB to RP-125(X) converter box would be necessary. However, given the advances in technology, it's conceivable that this box may be built into the switcher or other device.

Another alternative is that, because of the DVTR's high video bandwidth, the camera can be fed into the RGB input of the DVTR initially. Paint system and DVE devices also can be fed via an RP-125 or RP-125(X) interface.

The heart of the digital studio will be a digital switcher/mixer. The digital interface between subsystems can be either the standardized parallel interface conforming to RP-125 or the serial interface specified by the EBU TECH 3247-E. With the availability of digital serializers and D-1 to D-2, D-2 to D-1 transcoders, interconnection between systems will be easily attainable.

Through bypassing the analog interfaces for equipment I/Os and using only digital interfaces, the real benefits of multilayered effects, clean chroma-keys and minimal signal degradation—using equipment such as computer graphics, paint systems, digital slide stores and effects processors—can be realized.

Video system interfaces

Figure 3 categorizes the interface options in a teleproduction environment. The arrows represent connection alterna-

tives between protocols. Because of the expense of parallel digital component hardware, this category is limited to production where cable runs of 50m or less are viable.

With the availability of serializers and deserializers, extended coax or fiber-optic signal runs will be possible. The expanded use of fiber-optic technology for the transmission of signals will increase channel capacity and reduce distribution costs in the future.

Using the D-1 and D-2 formats

As shown in Table 2, each format has distinct advantages in application. The D-1 format is ideally suited to high-end production, whereas the proposed D-2 format may find application in existing composite-based facilities.

The digital D-1 VTR, because of its ability to store and reproduce images transparently, will become a cornerstone of broadcasting and production. Various operations, such as multilayering, effects generation, recording and downstream chroma-keying off recorded material from a DVTR, can be performed without loss of quality. Digital switchers will include digital chroma-keying, color correction and picture-manipulation systems as integral features. New forms of graphics and animation outboard equipment will enhance the post-production environment. In addition, editing systems will become more user-friendly, with expanded memory capacity for the storage of programmed effects.

The proposed composite D-2 format will

allow broadcasters and production houses to gain the benefits of digital recording without giving up their existing equipment or having to purchase additional support devices. The composite DVTR will be lower in price than its component DVTR cousin. If composite digital switchers and effects processors become available, multilayered productions similar to the D-1 applications will be a reality. Coupled with the introduction of digital serializers and deserializers, D-2-based editing environments will become commonplace.

The component digital format and the proposed composite digital format will launch a new era in the recording, manipulation, reproduction and transmission of audio and video signals. The standardization of digital formats will allow manufacturers to competitively design and manufacture a new breed of production equipment. The now-standardized D-1 format and the proposed D-2 format will find many applications in the marketplace. As a result, broadcasters, production houses, manufacturers and end-users can seriously consider the implications and possibilities of the all-digital production facility.

Editor's note: For further information on this topic, read Chan's papers in the *SBE Proceedings* of the 1988 NAB Conference and the 1988 SBE Convention. []

Technical Difficulties

Please Stand By

A BELDEN® BROADCAST CABLE MEANS NEVER HAVING TO SAY YOU'RE SORRY

Signal disruption during a live broadcast is a major and costly embarrassment.

With close to 30 million seconds of air time in a year, it only takes a few seconds to realize why you need Belden quality.

That's why the broadcast industry depends on Belden cable to cover large events such as the Olympics and the Indy 500. Events where a cable has to keep working while being subjected to

extremes of weather, terrain and traffic. Events where there is no second chance.

And, because broadcasters need a cable they can install permanently without worry of failure, Belden is also relied upon for day-to-day studio operations.

The broadcast industry knows that Belden is accepted worldwide as the standard for reliable, top-quality cable. More importantly, broadcasters know Belden has earned this reputation by designing durability into cables, so users won't have reason to be sorry.

New ways to avoid apologizing.

Dependable Belden performance is now available in six new broadcast cables:

Conformable™ and Flexible Coax—9307, 9308 and 1168A are innovative conformable replacements for semi-rigid coax in applications calling for improved flexibility, high temperature rating or tight bending radii. 1163A, a flexible version of 8281, is designed to tight tolerances for excellent signal return loss.

Color Jacketed Coax—previously available in black only, Belden's 8241, 8281 and

1163A video cables are also now offered in red, yellow, green, light blue, white and orange outer jackets, making channel coding much easier.

If you've ever had to apologize for inferior cable performance, find out why *There is no equal* to Belden. For ordering information call your local Belden distributor. Or contact:

BELDEN Wire and Cable
P.O. Box 1980
Richmond, IN 47375

1-800-BELDEN-4
(in Indiana, call 317/983-5200)

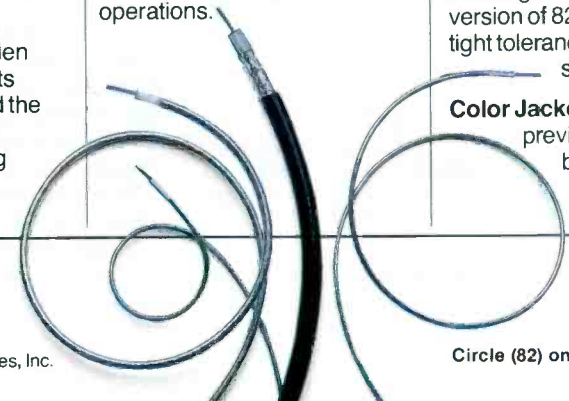
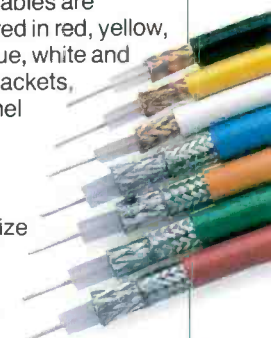

There is no equal.™



BELDEN

Videotape remote control

By Art Battram

Videotape remote controls are a challenge to install. Unfortunately, about the time you get everything hooked up and working properly, another machine or studio is added. Because VTRs and VCRs are more affordable than ever, the tape room is one of the fastest-changing areas within the station. Today, it just isn't practical to run remote-control lines from every machine to every desired location.

Universal system

At our station we wanted another way to control the VTRs. The selected method was to install a control box with four sets

Battram is engineering supervisor, VTR, with CFCN-TV, Calgary, Alberta, Canada.

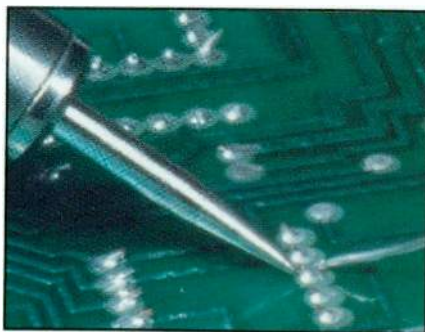

of remote-control buttons and an LED display. The control box allows the operator to control any of four videotape machines in three functions: ready, play and stop. The boxes are small enough to sit beside the switcher, which saves valuable counter space.

Although the design limits the number of machines to be controlled simultaneously to four, any of the machines in the building are accessible through the box. A patchbay is used to route the desired VTR control signals to the appropriate set of push buttons on the box. Once the patch is completed, the LED read-out displays the machine number so the operator always knows what machine is being activated.

Patchbay

The system relies on having access to all machines through a patchbay. Each remote controller connects to the patchbay through two runs of 32-conductor cable. The cable allows each controller to access four machines.

A mini-rack is installed in the tape room, along with a 5V power supply. The tape machine remote controls are terminated on the punch blocks. Two 25-pin jacks are wired to the punch blocks. Two jacks per machine are provided, which allows each machine to be controlled from two locations at once.

Our station has five locations that need access to tape machines. Five sets of four jacks are wired from the patch panel back to each of the studio control boxes. This provides five locations with access to as many as four tape machines. We recently added the Ampex ADO to our system. Zoom-in, zoom-out and freeze functions are accessible through the control box.

Each run from the control rooms to the patch blocks requires two 32-conductor cables. The cables must carry four remote-control points, external tally voltages, binary codes and ground. Although this seems like a lot of cable, it is really an efficient way to access a large number of tape machines.

A short patch cord is used to connect a tape machine to a control box. For example, if the VTR operator wants to control VTR No. 14 from production B, a patch cord is used to connect the jack for VTR No. 14 to one of the four control points for production B. Once the patch is made, the control box LED indicates "14," which tells the operator what machine is connected to that particular set of buttons. (See Figure 1.)

Control boxes

Each control box contains four sets of three push buttons and the LED read-out. The read-out indicates what machine is connected to each set of controls. A BCD decoder drives the display.

Each VTR jack contains the binary coding to drive the control-box display. When a patch cable is connected to the VTR jack, a logic high within the jack determines the binary code provided to the

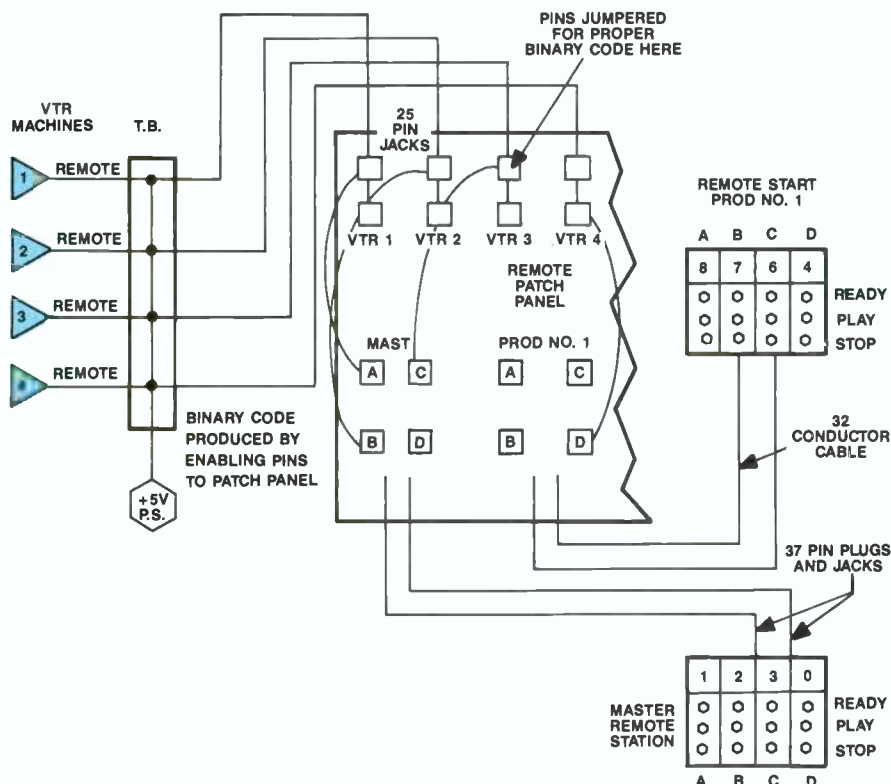
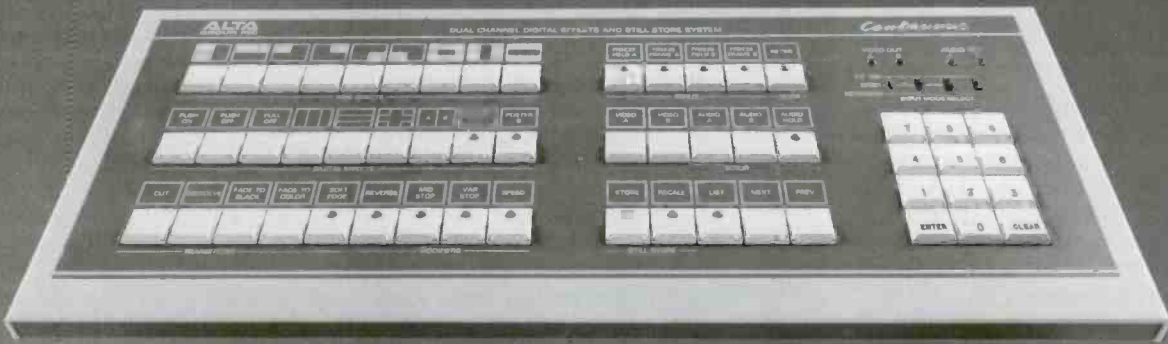

Figure 1. The VTR remote-control system relies on a patchbay arrangement, allowing any machine to be controlled from any location.



One Still Store Does More Than Just Store Pictures

Simply Storing Pictures Isn't Enough Anymore.

Your still store had better deliver absolutely pristine images and be a multitasking production center, or you're not getting your money's worth.

Can Any Still Store Really Do This?

One can. ALTA's Centaurus. Look at our bandwidth, for example. We don't just meet broadcast specs. We exceed them with high-speed component processing throughout. That means you get the sharpest image possible.

Store More For Your Money!

Now compare Centaurus' storage capacity. All on-line, for instant recall at the lowest cost per picture.

And when your storage requirements grow, we'll grow with you. With additional on-line storage, and a

digital tape cartridge for unlimited off-line storage.

No Other Options Needed!

Our dual synchronizers and TBCs are built right in. So you can work directly with images from tape, camera, microwave and satellite feeds, whatever. All without having to invest in additional equipment.

Becomes a Master of Effects in Minutes!

Put some polish on your productions. Centaurus gives you more effects to work with, on a keyboard that's simple to operate. Plus its built-in switcher and dual TBCs let this still store stand alone, so you won't tie up your entire studio.

How Can This Be?

How can we make a full-featured, dual channel still store for less than the cost of other single-channel systems? Simple. We've been doing it for years. In fact, ALTA engineers were among the pioneers of the digital still store. That's why our warranty is twice as long, and our still store gives you twice the value.

So if you're looking for a still store that does more than just store pictures, choose the one that does more for your money.

Choose Centaurus.

Specifications	ABEKAS A42	ALTA Centaurus	AMPEX ESS-5	HARRIS ESP II
Bandwidth	4.2 MHz (± 0.25 dB)	5.5 MHz (-3 dB)	5.9 MHz (± 5 dB)	5.0 MHz (± 0.5 dB)
Signal to Noise	52 dB	58 dB	?	56 dB
Storage Capacity*	200 fields 100 frames	250 fields 125 frames	207 fields 207 frames	200 fields 200 frames
Synchronizer	—	Dual	—	Dual
TBC	—	Dual	—	—
Production Effects	1 wipe dissolve —	9 wipes dissolve 7 digital	1 wipe dissolve —	3 wipes dissolve 3 digital
Warranty	1 year	2 years	1 year	1 year
Single Channel	\$19,900	—	—	\$26,333
Dual Channel	\$24,900	\$16,900	\$31,500	\$30,995

*Basic System

Based on available data as of June, 1988.

ALTA
GROUP, INC

535 Race Street, San Jose, CA 95126 • FAX 408-297-1206 • Tel. 408-297-ALTA

Circle (83) on Reply Card

BCD decoder in the control box. Therefore, every time the patch cord is moved to another machine, the correct machine's code is displayed.

Remote voltages

Be aware that not all machines can connect directly to 5Vdc logic systems. Some older quad machines use 12Vdc to drive remote-control indicators. You will have to install dropping resistors in these remote tally lines because of the LED tallies used in the control boxes.

Many imported tape machines have two characteristics that also require modification. First, the machines may not provide a "remote active" indication. We had to modify them by routing the ground contact from the remote switch back to the remote plug. Second, the remote plug voltages are seldom regulated. To protect the LED decoders, a 5Vdc zener diode was installed across the remote-plug supply voltage.

Advantages

The system has several advantages. One is that additional studios and tape machines can be added without rewiring the entire system. Adding another tape machine requires only the addition of another punch block and two jacks. Adding another control room requires another run of a pair of 32-conductor cables and a 25-pin jack in the patch area.

One technician wired the plugs and terminal area while another wired the control boxes. The five control boxes were constructed in three days. No complex parts are required, and maintenance is usually limited to replacing a switch or LED display.

The simplicity is a key advantage to the system. In our station, we have 16 tape machines, each needing three control functions. A conventional remote-control system would have required 240 switches in all five locations. That's a lot of hardware, which is expensive and takes a lot

of counter space. This system, on the other hand, is much less expensive, it's simple, and it doesn't clutter valuable work space in the control rooms.

Acknowledgment: Senior technicians Munir Virjee, Dale Coutts, Brian Gauld and Don MacDonald assisted in the project. 



NEUTRIK — PERFECT CONNECTIONS FOR AN IMPERFECT WORLD

When the going gets tough, the tough get Neutrik®. There's a good reason why top network news and sports departments specify Neutrik—superior performance under all conditions.

Just look at the flawless design and Swiss-made precision of Neutrik MX-HD and FX-HD connectors. They're water, dust and corrosion proof according to the stringent IP 65 spec when mated together. So the contacts are completely protected against any-

thing the elements might throw their way—from sun, sand and water to mud, snow and ice.

In addition to being tough, Neutrik X connectors are ready to go in 50% less time than other XLR's. The compact, screwless design is quick and easy to assemble—there are only 4 parts, with no tiny screws to lose.

You might expect to pay a premium for the higher performance of Neutrik con-

nectors, but here's the best news of all. Neutrik connectors are often less expensive than other brands that have far less to offer.

Make the perfect connection...choose Neutrik.

Neutrik USA, Inc. • 1600 Malone Street • Millville, NJ 08332
TEL: 609-327-3113 • FAX 609-825-4804



CONNECTORS • TRANSFORMERS • PLUGS • JACKS • ADAPTORS • GOOSENECKS • TEST SYSTEMS

Circle (84) on Reply Card

THE FIRST INTELLIGENT BROADCAST COLOR MONITOR



BARCO INDUSTRIES' new CVS professional broadcast monitor is microprocessor-based to make it intelligent in operation and easy to use.

It has both a digital and an analog bus for maximum flexibility. Plus four "open" slots that let you plug in today's options and those yet to come. As new features do come along, you'll be able to add them through software - no hardware changes!

All CVS functions are controlled from the front of the monitor or from a remote keyboard. An optional master remote permits control of a series of monitors.

WE PUT THE FUTURE IN THE PICTURE.

**BARCO
INDUSTRIES**

You can also store, and automatically call up, either calibrated presets or your own preferred presets.

Like our best master control monitors, the CVS has Automatic Kinescope Biasing (AKB) to maintain color and black level stability.

The CVS also generates more internal test patterns than any other monitor. They include white field, cross hatch and color bars.

The CVS is available in both 14 inch and 20 inch versions, and provides outstanding picture quality in any TV standard.

For complete specifications, contact your local BARCO INDUSTRIES Dealer or BARCO INDUSTRIES, 170 Knowles Drive, Suite 212, Los Gatos, CA 95030. Phone : (408) 370-3721.

BARCO INDUSTRIES is a member of the ACEC-group.

Circle (85) on Reply Card

Etron programs aid in circuit design

By Gerry Kaufhold II

Many broadcast engineers will admit that understanding RF circuits is a learn-by-doing endeavor. Technical books on the subject usually are written for in-class study, with an instructor available to demonstrate circuit behavior and to answer questions. One of the best ways to learn about RF circuits is through classroom instruction, but working broadcast engineers seldom have schedules that permit that luxury.

Even if the engineers at a facility have a thorough understanding of RF, solving a specific problem might take days of "crank-and-grind" mathematics. In addition to the effort required to obtain the first "workable" solution to an RF problem, several iterations are required to fit the proposed design into available circuit components.

The entire process is time-consuming, which translates into an expense for the station engineer. One alternative to the manual method of circuit design involves the use of computer programs. These programs not only provide quick answers to mathematics questions, but also allow for easily performed iterations on proposed designs.

Kaufhold is an independent consultant based in Tempe, AZ.

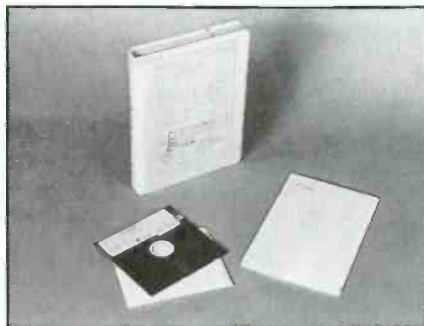

Performance at a glance

Series of six integrated computer programs for IBM-compatible PCs calculates:

- VSWR
- dB and dBm conversions
- Passive RF filters
- Impedance-matching filters
- RF attenuators
- Inductor designs
- Up to 7th-order Butterworth, Bessel and Chebyshev filters
- Ladder network analysis

The programs also make it possible to:

- Import data from other modules for network analysis
- Optimize designs using standard component values
- Analyze mixer cross-products

Cost-effective solution

The Etron Solution is a set of programs developed by consulting engineer John Simmons. Together, the programs meet a need for a cost-effective RF circuit-design computer program. They are set up to operate on IBM-compatible personal computers.

ETRON RF NOTES NO. 4
TITLE: NOTES 3, BANDPASS FOR 1,210KHZ
IMPORT FILE NAME IS: bubp1,210

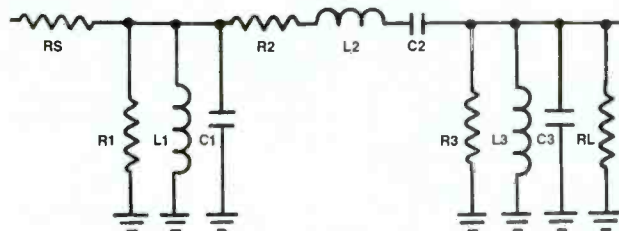

$R_S = 50\Omega$ AND $R_L = 50\Omega$

$R_1 = 100,000\Omega$
 $R_2 = 0\Omega$
 $R_3 = 100,000\Omega$
 $L_1 = 0.03\mu H$
 $L_2 = 3,183.10\mu H$
 $L_3 = 0.03\mu H$
 $C_1 = 636,619.81pF$
 $C_2 = 5.44pF$
 $C_3 = 636,619.81pF$

PLEASE SELECT (A)NALYZE, (E)DIT OR (M)ENU

Figure 1. This Butterworth filter was designed with program No. 3 and imported into program No. 4 for extended analysis.

The concept has met with international favor, too. British Telecom, the English equivalent of AT&T, has standardized on the programs. They are now available on more than 400 terminals in six countries, operating through an Ethernet communications network.

The series of programs consists of six modules. A unified user interface provides straightforward communication between the program user and the computer. The modules each can be used individually. As a useful alternative, data from design modules can be imported into the network analysis module.

The programs

The set of programs are organized so that each module covers a different area of electronic design. Following is a list of individual modules:

- Module No. 1 presents the basics of RF design and performs decibel (dB) and decibel referred to 1mW (dBm) conversions, VSWR evaluation, passive filters, resonant circuits, mixer cross-products, and even microstrip and stripline design.
- Module No. 2 develops RF attenuator pads; designs inductors (including toroids); selects capacitors at RF for resonance or bypass; and designs L, T, and broadband impedance-matching networks.
- Module No. 3 designs numerous types of Butterworth filters, including low-pass, high-pass, bandpass and band-reject.
- Module No. 4 designs the same filters as module No. 3, in a Bessel configuration.
- Module No. 5 designs the same filters as module No. 3, in the Chebyshev configuration. Design parameters include ripple specifications.
- Module No. 6 contains a ladder network analysis program. Networks and transmission-line elements with up to 17 elements and 30 sections can be designed and analyzed. Data can be input by schematic or imported from the programs.

Modular approach

Each module is packaged in its own hard plastic protective case, slightly larger than the case of a 3/4-inch videocassette. The cover of each module contains the message "Problem? Call John at



THE REASONS FOR BUYING COMARK'S KLYSTRODE® TRANSMITTER KEEP PILING UP.

**\$50,000 A YEAR IN ENERGY SAVINGS
IS JUST THE BEGINNING.**

Comark's 120 kW Klystrode transmitters can slash your energy bills up to 50%, compared to today's most advanced pulsed klystron transmitters. To learn more about Comark's Klystrode equipped transmitters with output power levels of 10 kW (air-cooled), up to 360 kW (liquid-cooled) call (215) 822-0777.

 **COMARK**

COMARK COMMUNICATIONS, INC.
A Thomson-CSF Company

Route 309 & Advance Lane • Colmar, PA 18915
Telex: 346075 Fax: (215) 822-9129

Klystrode® is a registered trademark of Varian Associates, Inc.
Circle (86) on Reply Card

714-594-8741," which indicates how seriously the company takes its commitment to customer satisfaction. Each module comes complete with diskette, program registration card and instruction booklet. Other than a standard version of BASIC, no special compilers, linkers or translating software is required.

Each module operates independently and can be purchased separately. An engineer who wants to use the series as a learning aid can purchase one part at a time so that the cost for the entire set can be spread over several months.

The programs are copy-protected, and each user is expected to use the software on only one system. The software can be installed on a personal computer with a hard disk. By using the INSTALL program, the diskettes can be transported from work to home if required.

For this field report, the most convenient way to use the programs was to operate directly from the source floppy disks and store all data files in subdirectories on the hard disk. This method made it easy to export files from program No. 1 and program No. 3 into program No. 4 for analysis. The sample data files with schematics also can be stored on separate floppy diskettes provided by the end-user. This makes the entire software package portable.

The programs run using the BASICA (advanced BASIC, GW-Basic) interpreter. The computer's DOS must be 100% compatible with Microsoft DOS 2.1 (or later version). The programs require 256kbytes of RAM and an IBM-compatible color graphics, CGA, EGA or VGA interface card. An RGB color video monitor is suggested, but not necessary. A dot-matrix printer with graphics capability is needed to obtain a graphic printout.

User interface

Once loaded, the first interface menu lists the choices available for a particular diskette. The user makes a choice by highlighting one selection, then pushing the ENTER key. The menus are presented in a hierarchical fashion. The main menu for the module lists all the categories available. Each category also has a primary menu. Once a category is activated, the program stays in that category until the user again selects the main menu.

A nice feature included in each category is called "Some Basic Information." When this option is selected, several screens of explanation describe the typical applications for the particular circuit category. The user also is informed about the required input data and available output data.

Once a category is selected, a screen prompts the user through a sequence of questions, which greatly simplifies the data-entering task. When all of the



Telex Announcers Headsets Cover Every Broadcast Need Comfortably

Each unique announcing situation can require a different headset. Is there a lot of noise in the background or are you in a quiet studio? Do you want to include or eliminate the ambient noise around the announcer? Is there a need for the announcer to be able to monitor more than one sound source? What about impedance differences, or microphone audio quality.

You could probably get by with a standard "all-around" headset, but do you really want to? Similarly, you could probably find something that would "make-do" from a headset source offering only a couple of models from which to choose. But, for a complete selection, one that offers a solution to your every broadcast need, turn to Telex.

	MICROPHONE					EARPHONE					
	TYPE			ELEMENT		TYPE		ELEM	OHMS		
	OMNI	N/C	UNI	DYN	COND	BIN	MONO	MAG	150	300	6000
Full Cushion	X		X	X	X	X		X	X	X	X
Light Weight	X	X			X	X	X	X	X	X	



Camera

The above chart indicates the wide variety of styles and specifications available in our announcers' headsets. Ask about our full line of camera and intercom headsets as well. Call or write to:
Telex Communications, Inc.,
9600 Aldrich Av. S., Minneapolis, MN 55420



Intercom

TELEX®

Circle (87) on Reply Card

200 LBS. SUPPORT WITH SACHTLER CONFIDENCE

WE'VE GOT IT.
INTRODUCING THE NEW VIDEO 80
AND OB-2 TRIPOD SYSTEM...

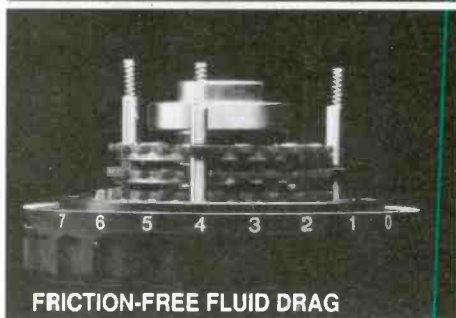
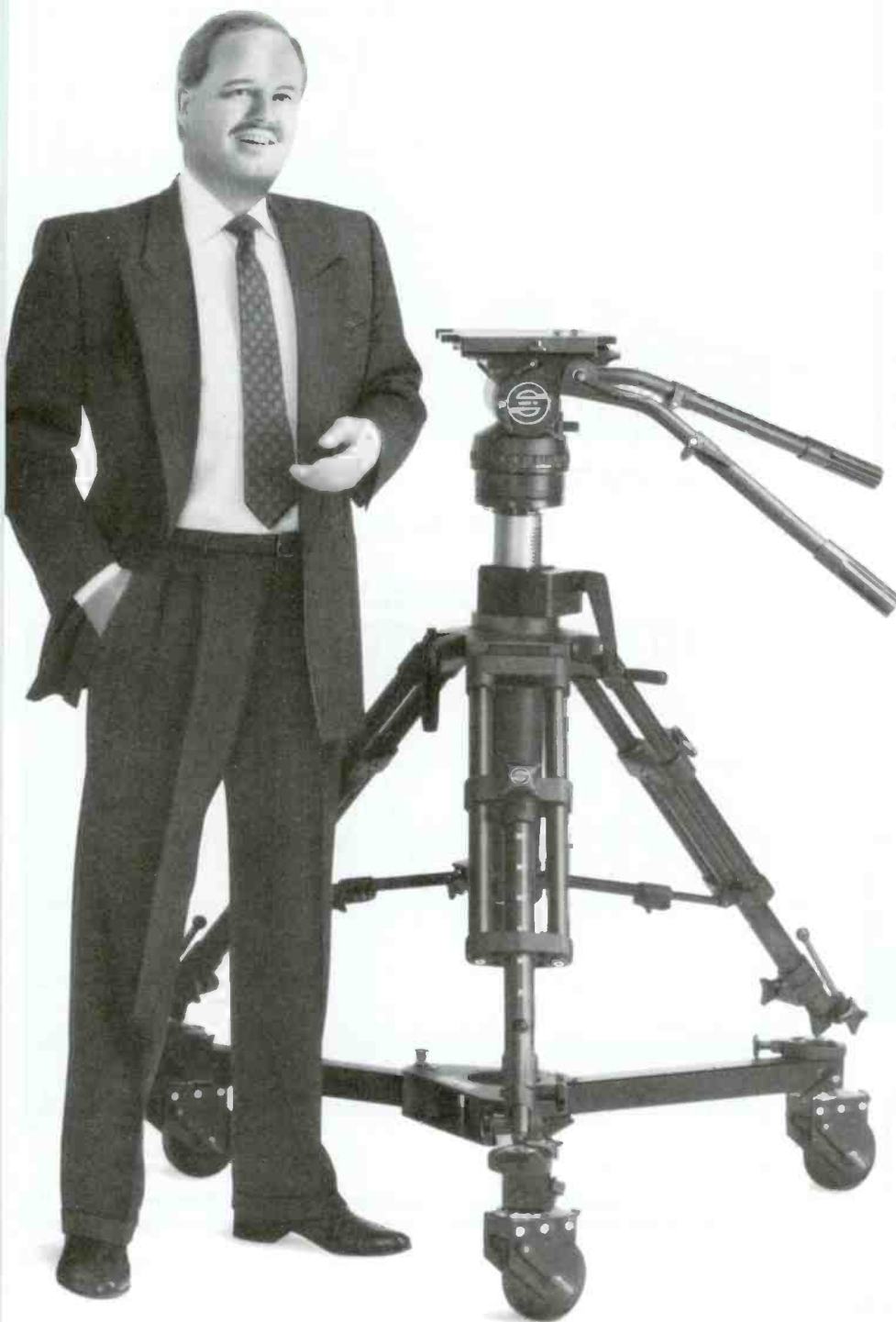

The Video 80 gives you fluid control for any camera, lens & prompter combination. With instant "dynamic" counterbalancing there are no cams to change. Our New OB-2 System gives you a range from 19" to 60" height with an optional elevation unit up to 75". The whole system is warranted for **3 years**, plus the Fluid Modules are warranted for **5 years**. The best warranty in the industry.

Eric D. Falkenberg
Executive Vice President

Call or write for information.

sachtler[®]
corporation of america



55 North Main Street
Freeport, NY 11520
Phone: (516) 867-4900
FAX: (516) 623-6844

West coast:

3316 West Victory Blvd.
Burbank, CA 91505
Phone: (818) 845-4446

Circle (103) on Reply Card

FREE!

TV CAMERA CABLE AND CONNECTORS INFORMATION KIT



Your one-stop source for broadcast-quality camera cable

- Ultra-Flex VTR Cable Assemblies for Sony, Ikegami, Hitachi, & Others
- Slimline studio camera cables
- Waterproof, three-piece high strength connector design
- Customized lengths
- Chassis Mounts
- Quick response to all assembly orders
- Quick repair turn around

Call or write today for your free order kit.

MOHAWK
WIRE & CABLE CORPORATION

9 Mohawk Drive
Leominster, MA 01453
1-800-422-9961
In Massachusetts, 1-800-642-9961

Circle (89) on Reply Card

VIDEO SUPPLIES

CABLES • CONNECTORS • CANARE • BELDEN • SWITCHCRAFT • D.A.'S • TIES • BATTERIES • NEUTRIK • 80 INTERFACE BOXES • TAPE • 500 DIFF. TAPE LABELS • GAFFERS TAPE • CASES • PATCH BAYS • LIGHTS • ACOUSTIC FOAM • FORMS • MICROPHONES • SONEX • STANDS • MOUNTS • WIND SCREENS • ZEPPELINS • FIBRE OPTICS • RACKS • DUCI • REELS • TESTERS • FILTERS • CHEMICALS • TOOLS • ON-AIR LIGHTS • DEGAUSSERS • INTERFACE DEVICES • HEADPHONES • CLIPS • SWITCHES • CAM & S VHS CABLE

MARKERTEK VIDEO SUPPLY
145 Ulster Ave., Saugerties, NY 12477 U.S.A.
TOLL FREE **1-800-522-2025**
In NY: 914-246-3036

Very Unique Professional Catalog FREE!

Circle (90) on Reply Card

Reconfirm your involvement in the broadcast industry!
Renew your subscription today.

necessary data has been entered, the equations are solved, and graphic information describes the problem's solution.

The solution might be a schematic diagram, with the component values labeled as shown in Figure 1. In other cases, the solution might be a graph showing the relationships between two variables, such as frequency vs. voltage or forward power

vs. reflected power. (See Figures 2 and 3.) The variables used in each calculation are displayed so that the user can verify that the correct method is being used. After it is calculated, the current solution can be saved to disk for use with another module.

When many iterations of the equation must be solved, module No. 6 permits the user to change component values, then

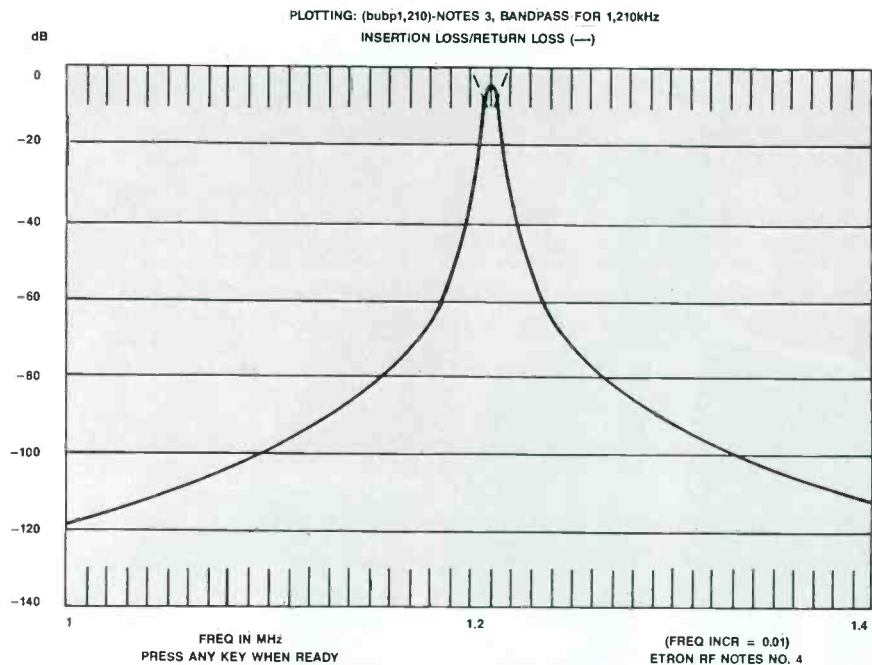

Figure 2. Previous filter's plotted insertion loss with C2 set to 5.4pF.

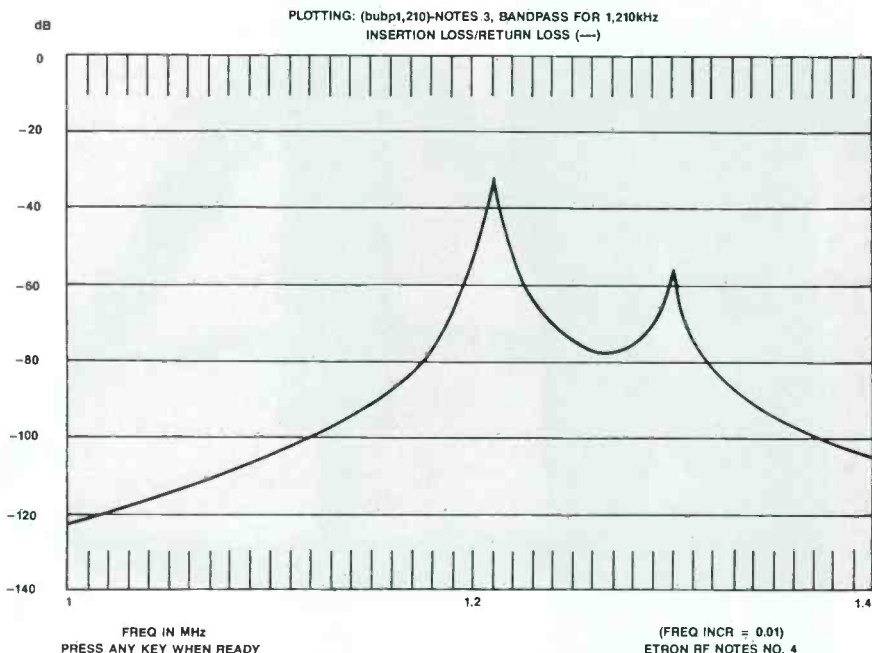

Figure 3. The graphic display illustrates the importance of plotting a filter's response. In this graph, C2 was changed to 4.7pF, which might have gone unnoticed without a frequency-response plot.

automatically recalculates the solution. This feature is a time saver because the engineer can vary the circuit component values until standard component values appear as part of the solution.

Instruction booklets are provided for each program module. Examples are specific, and can be used as step-by-step illustrated guides. The handbooks used in the series of programs are well-organized. During the field tests, two calls for help were placed to the customer service number. Both times, answers were provided immediately.

Display control and messages

The primary display screen for each module uses graphics to illustrate the topology of the circuit being analyzed, and all user-selectable components are labeled clearly. The programs provide a menu choice for selecting both the foreground and the background screen colors. Depending upon the capabilities of the graphics card and the monitor, some eye-catching displays can be created.

In addition to choosing the colors displayed, a utility program lets the user choose the length of time that temporary error messages are displayed. Error messages use complete English sentences, which is a vast improvement over the cryptic data provided by DOS. User-input errors can be corrected by changing the value of a component and re-solving the equation. To obtain a hard-copy printout of a display, use the computer's print screen function. (The DOS program GRAPHICS.COM must be loaded already for this function to work.)

Scale to fit

After a set of equations is run, the values of each variable are displayed in tabular form. A menu then displays the upper and lower "Y" values. The horizontal and vertical endpoints can be specified, thereby providing detailed graphs.

For example, if the attenuation of a filter ranges between -0.2dB and -43dB , you can specify a graph that ranges from 0dB on the top to -60dB on the bottom. In addition to choosing upper and lower endpoints, the menu also will permit adjustment of the step size and the total number of steps.

Program capabilities

The basic program (module No. 1) is contained on a single diskette. The program converts voltage and current ratios into decibels or decibels referred to 1mW and calculates VSWR.

As an aid to interference identification, the program calculates mixer cross-products. To use this feature, two frequencies are input, along with a guardband. Any cross-products that occur when the two frequencies are mixed will be

calculated and displayed. Those frequencies that occur within the guardband will be highlighted. If you've ever tried to track down interference related to mixing frequencies, you understand the potential value of this feature.

Module No. 1 also permits the development of strip designs. The thickness of the substrate and its dielectric constant must be input along with the frequency of operation and the thickness of the copper cladding. The program calculates the width of the conductor and the velocity

factor.

Module No. 2 is a general design aid for RF attenuator pads, impedance-matching networks and inductors. A total of 11 types of RF attenuator pads can be analyzed. The RF inductor program allows the design of both close- and spaced-wound, single-layer coils and toroidal coils. Wide-band, L, and T networks can be designed by simply entering known values as source reactance, load resistance and reactance and operating frequency.

The program contains a useful capacitor

HPA'S FOR SATELLITE COMMUNICATIONS

KELTEC

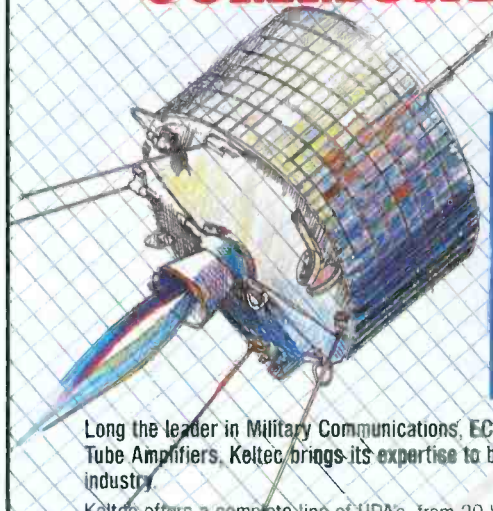

Model R90

Long the leader in Military Communications, ECM and Instrumentation Traveling Wave Tube Amplifiers, Keltec brings its expertise to bear in the satellite communications industry.

Keltec offers a complete line of HPA's, from 20 Watts single thread to 1200 Watts dual redundant, in C-Band (5.925-6.425GHz), X-Band (7.9-8.4GHz) and Ku-Band (14-14.5GHz).

Keltec can meet all of your TWT HPA requirements including fixed earth stations, transportable uplinks and remote terminals. System configurations from barebones to custom applications can be accommodated. And, at a price you can afford!

Send for your copy of our new full color, 32-page product catalog.

Sample Configurations

Model No.	Frequency (GHz)	RF Power Out (TWT)	Type
R50-75C	5.925 - 6.425	75 Watts	Single Thread
R50-125C	5.925 - 6.425	125 Watts	Single Thread
R50-20Ku	14.00 - 14.50	20 Watts	Single Thread
R60-300Ku	14.00 - 14.50	300 Watts	Single Thread
R90-600C	5.925 - 6.425	600 Watts	Single Thread
R90-500Ku	14.00 - 14.50	500 Watts	Single Thread
R91-600Ku	14.00 - 14.50	600 Watts	Phase Combined
R92-600Ku	14.00 - 14.50	600 Watts	Dual Redundant
R92-1000Ku	14.00 - 14.50	1000 Watts	Dual Redundant

An affiliate of



Amstar Electronics Group

Keltec Florida, Inc.

P.O. Box 2917 • Fort Walton Bch., FL 32549 • 904/244-0043 • TWX 510-730-7775 • FAX 904-243-0103

Circle (91) on Reply Card

Winsted

Preferred by
professionals
worldwide



WINSTED

Jerry
We're trying to do too
much in this ad. Can't
we just tell them to call
us and we'll send 'em
our 100-page catalog?
Tell them to call
800-447-2257
Charlie

SYSTEM 85 Modular Video Consoles

EDITING POST PRODUCTION CONSOLES

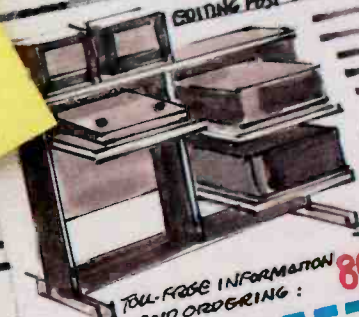

TELEPHONE INFORMATION AND ORDERING: 800-447-2257

21M/DPE
WEBE

SECURITY SUPPORT SYSTEMS

FREE DESIGN SERVICES... CALL 800-447-2257
WINSTED'S experts design video systems to meet your specific needs.

Winsted
CORPORATION

10901 Hampshire Ave. So., Minneapolis MN 55431



FREE CATALOG

FREE CATALOG features complete Winsted line in full color.

NAME _____
ADDRESS _____
COMPANY NAME _____
CITY _____ STATE _____ ZIP _____

Circle (99) on Reply Card

evaluation feature. To prevent a "paper" design from failing in the field, the program calculates the self-resonant frequency of capacitors used in the designs. This check step helps prevent a common design mistake.

The three parts of module No. 3 address the three basic types of filters: Butterworth, Bessel and Chebyshev. Each of the volumes calculates four response configurations: low-pass, high-pass, bandpass and band reject. Each is capable of designs out to the seventh order. The user simply specifies the desired filter response, and the program designs the filter.

A Chebyshev bandpass filter, designed

with module No. 5, is shown in Figure 4. The circuit's frequency response, plotted by this module, is shown in Figure 5.

Ladder network analyzer

Module No. 4, network analysis, typically is used in conjunction with the other programs. Circuit data can be entered manually, or data from the other programs can be imported for extensive analysis.

The ladder network analyzer treats a circuit like a "black box." The voltages and currents at the input to the black box are defined, and the voltages and currents at the output of the black box are de-

ETRON RF ENTERPRISES, RF NOTES 3, VOL 3
CHEBYSHEV BANDPASS, 4TH ORDER, 0.10dB RIPPLE

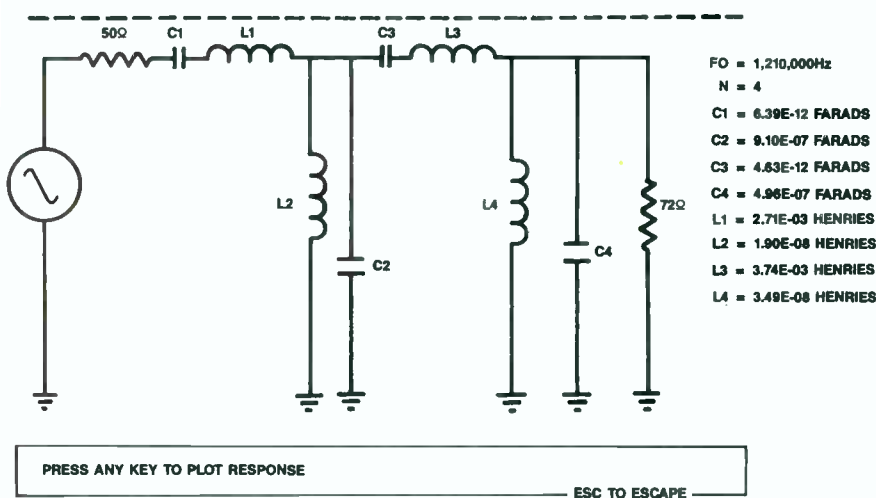
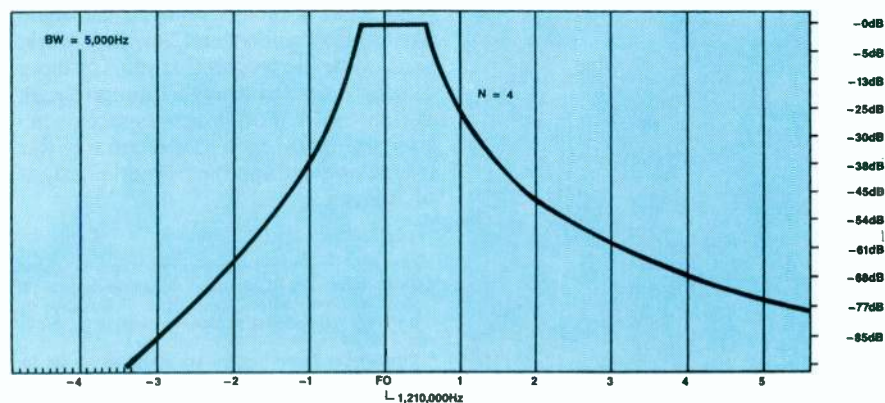

Figure 4. Selecting a Chebyshev bandpass, 4th-order filter and specifying 0.10dB ripple, the program calculates the required component values.



NO. OF BWs...CURVE IS APPROXIMATE. USE THE ETRON RF NOTES 4 FOR ANALYSIS.

Figure 5. Insertion loss for circuit calculated in Figure 4.

HIGH ENERGY CORP CERAMIC RF CAPACITORS CORNELL-DUBILIER MICA RF CAPACITORS



FL JENNINGS VACUUM CAPACITORS VACUUM RELAYS

SURCOM ASSOCIATES, INC.

2215 Faraday Avenue, Suite A
Carlsbad, California 92008
TEL (619) 438-4420
FAX (619) 438-4759

Circle (125) on Reply Card

AEC-1 10x1 V+2A Routing Switcher



Features

- Broadcast Quality
- XPT Memory
- DC Restoration
- Line 10 Switching
- 30 Year MTBF

Options

- 3 Audio Channels
- Serial Interface
- Remote Control
- RGB/Component
- Custom Work

Why pay 30-50% more?

1-800-782-2321

Adrienne Electronics Corporation

11994 MARJON DRIVE, NEVADA CITY, CA 95959
Come see us at NAB!

Circle (155) on Reply Card

Grow
Professionally!
Join &
Participate in

SMPTE

For Information -
Call: 914-761-1100

Good Reasons To Call RTS When You Need High-Performance Intercom Systems.

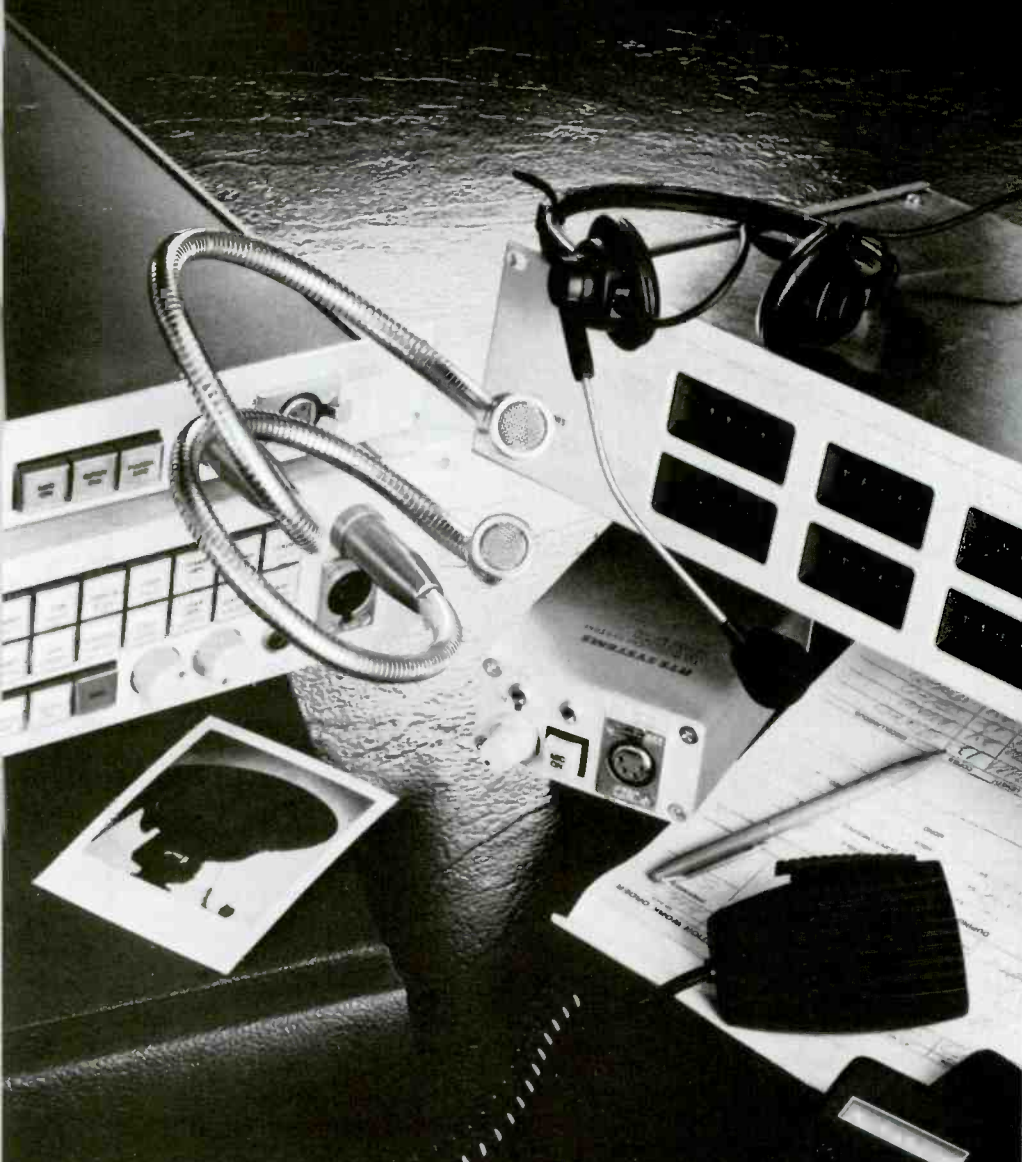

Professional intercom systems from RTS—a great way to keep in touch, no matter what the application.

Our Series 800 features multi-channel intercom products ranging from sophisticated *microprocessor-assisted* to simple and direct. And our TW Intercom offers a wide array of two-channel system components.

RTS Systems intercom—for all the right reasons. Please call or write for descriptive literature.

PROFESSIONAL INTERCOMMUNICATIONS • PROFESSIONAL AUDIO PRODUCTS

Circle (93) on Reply Card

1100 West Chestnut Street • Burbank, California 91506 • Telephone 818 840 7119 • Telex 194555 • Telefax 818 842 4921

RTS SYSTEMS
INCORPORATED

scribed. Various combinations of components are cascaded to approximate the circuit. Checks are performed so that all proposed solutions can be realized as working circuits with real parts. The data developed by this program can include:

- insertion loss.
- phase angle.
- return loss.
- voltage standing wave ratio (VSWR).
- reflection coefficient.
- real component of input impedance R_{in} .
- imaginary component of input impedance Z_{in} .

In addition, the values of individual circuit components can be changed and the network re-analyzed repeatedly to see how different component values affect circuit response. The output data can be presented in either tabular form or plotted as a graph or schematic to the screen and printer. This feature usually is available only on programs costing a lot more than this module.

Attractive solution

The program handbooks provide good insight into the operations of the programs, and no bugs were discovered. The user interface is well-designed, and the presentation of information using schematic diagrams, data tables and graphs makes the results easy to understand. Plus, the ability to transport circuit files into the ladder analyzer gives the program the kind of power usually seen in more expensive programs.

The individual modules are inexpensive enough to be purchased by someone with an interest in learning more about RF circuit design. As mentioned previously, because each of the programs is priced separately, the entire package need not be purchased at one time. However, the copy protection calls for some well-thought-out decisions on the best way to use the programs without giving up the ability to transport between your computers.

If your work requires you to design these types of circuits, or if you just would like to better understand how they work, this may be the program for you. For those of us who used to struggle through circuit design with non-programmable calculators (and even slide rules), this computer-aided approach is nothing short of fantastic.

Editor's note: The field report is an exclusive BE feature for broadcasters. Each report is prepared by the staff of a broadcast station, production facility or consulting firm.

In essence, these reports are prepared by the industry and for the industry. Manufacturer's support is limited to providing loan equipment and to aiding the author if support is requested in some area.

It is the responsibility of **Broadcast Engineering** to publish the results of any piece tested, whether positive or negative. No report should be considered an endorsement or disapproval by **Broadcast Engineering** magazine.

[:X(-)]]



AKG's K280. Listen to Reality.

Analog tape isn't the only thing made obsolete by digital recording. Headphones that used to seem fine just aren't up to reproducing the remarkable clarity and full dynamic range of live or digital sound. In the tradition of the widely-used K240 series, AKG has risen to this technical challenge with its new K280 *Parabolic* headphones. Each earcup of the K280 *Parabolic* features two perfectly matched transducers computer-positioned to focus interference-free sound at the center of the user's ear. This "acoustic lens" accurately captures the exceptionally transparent sound of a digital master tape, while the use of doubled transducers improves channel balance, increases dynamic range, and provides gain levels high enough for any kind of live or studio work. Also available is the K270, a sealed version of the K280.

AKG's K280 *Parabolic*. When you're working in the digital era, you need to listen to reality.



Focusing on new technology.
77 Selleck St. Stamford, CT 06902
(203) 348-2121

News

Continued from page 4

Registration fee for the seminar is \$135.00. For more information, contact the Wisconsin Center, 702 Langdon Street, Madison, WI 53706.

NAB, FCC differ on signal delivery

The National Association of Broadcasters (NAB) opposes an FCC proposal that would allow all non-commercial ed-

ucational FM translator stations to use alternative signal delivery technology including microwave or space satellites. The NAB said this would be a threat to the long-standing principle of broadcast localism and would limit opportunities for expansion of full-service non-commercial FM broadcasting.

The FM translator service originally was established by the FCC to enable an FM station to provide FM radio service to

unserved and under-served areas on a non-interfering, non-profit basis.

In its filing, the NAB said that "spectrum which one day could be used to add or expand local service from existing or new full-service FM stations could be gobbled up, as a practical matter forever, by other parties proposing a pure rebroadcast scheme."

The NAB said that under the FCC's proposal, the programming that these transmitters would carry will likely be from a distant market, especially where satellite technology might be used. "These translators will have no obligation whatsoever to program to the needs of the community of license," said the NAB. The major practical effect will be an increase in interference, the reduction of spectrum for issue-responsive non-commercial operation and increasing audience dilution for both commercial and non-commercial stations.

In opposing the commission's other proposal to permit FM translators to use broadcast auxiliary intercity relay microwave facilities to deliver signals, the NAB said that "these frequencies are already in limited supply in most parts of the country" and they should be reserved to provide local broadcast service by conventional non-commercial radio stations.

Changes in frequency separation await manufacturer's review

The NAB has asked the FCC to make no adjustment to the intermediate frequency (IF) distance separation regulations to provide a uniform standard without a recommendation from FM receiver manufacturers. The IF distance separation requirements are the minimum distances, by station class, that particular FM station antennas must be separated from other FM antennas. The NAB said that relaxation of the IF spacing rule now could produce significant additional interference to many receivers.

In its filing, the NAB said that recent test data indicate that no particular protected contour will assure all receivers protection from IF-induced interference. Furthermore, the test results reveal a performance degradation in a number of receivers when exposed to existing protected contours. The NAB said interference problems could be lessened, if not solved altogether, by improved receiver design.

The NAB supports a related proposal that would establish a distance separation requirement on FM channel 253 (98.4MHz) in the vicinity of an existing TV channel 6, and vice versa.

Continued on page 150

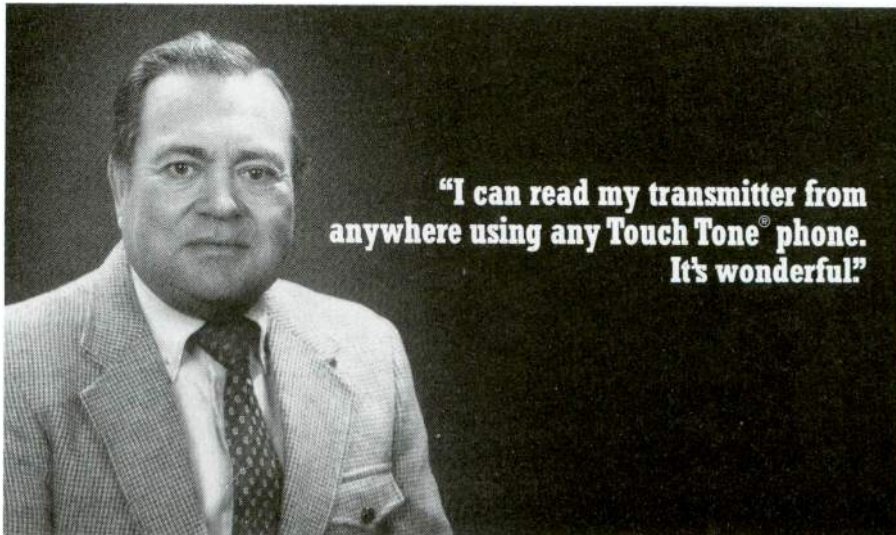

Ben Enochs - WDXL Lexington, Tennessee

"With Gentner's VRC-1000, I'm troubleshooting AM/FM, plus EBS, from my house, from the studio, from almost anywhere. Our transmitters get read at least a dozen times a night, it's the most control I've had keeping up the transmitter since 1954.

Now my transmitter can alert me to problems by phone, anywhere, any time. The preprogrammed synthesized voice gives me the parameters, I make the adjustments. All at the touch of a button.

And, I don't have to think like a microprocessor to work with the VRC-1000. Nothing could be simpler or more dependable.

**Gentner's VRC-1000
Will Put You
in Total Control.**

Stop baby-sitting your transmitter. For complete product information or specifications on the VRC-1000 Remote Control, I recommend you give Gentner a call today."

GENTNER
RF PRODUCTS DIVISION

PO Box 32550, San Jose, CA 95152 • (408) 926-3400 • FAX (408) 926-6699

© 1988 - Gentner Electronics Corporation

Circle (94) on Reply Card

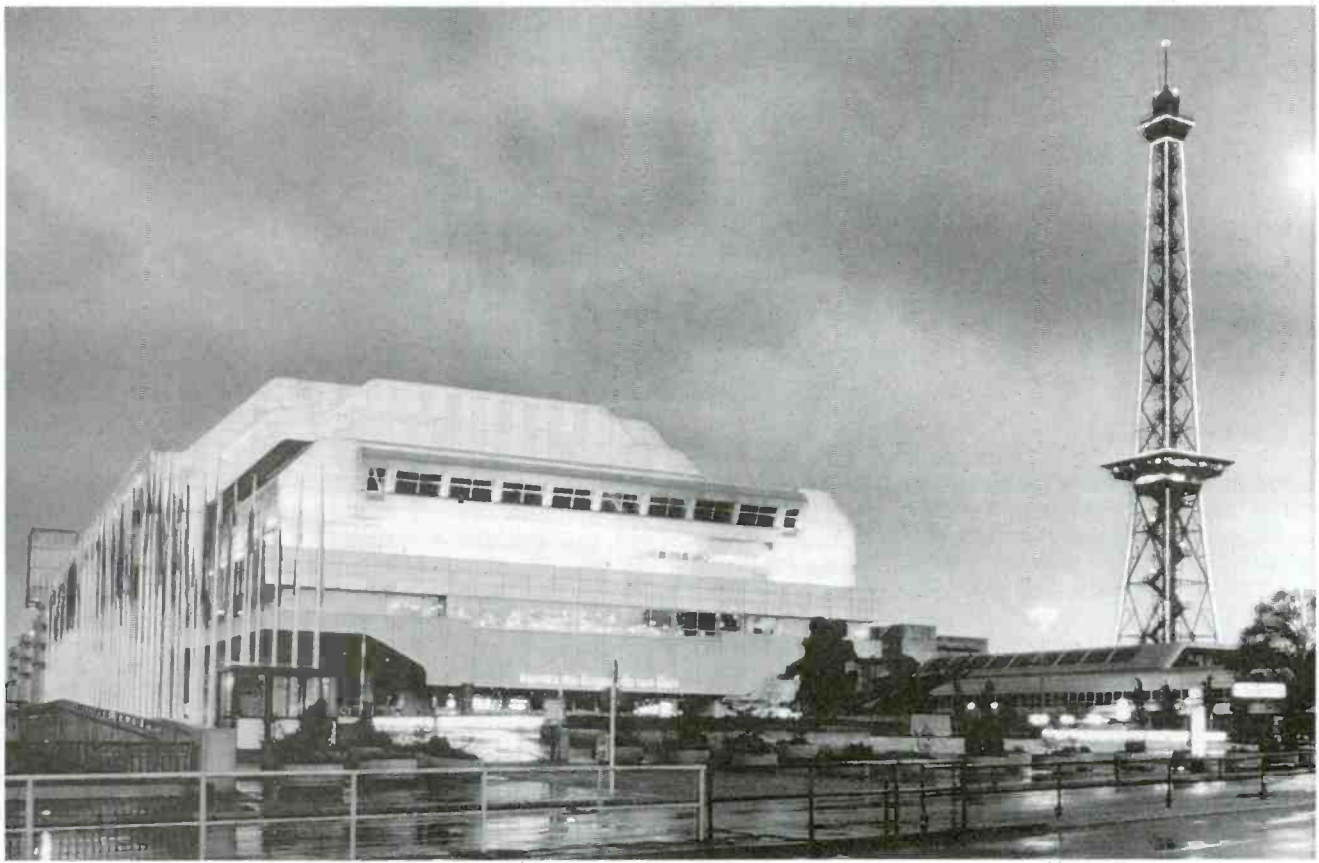

On the Air with AEG.

First-class technological achievements are a tradition at AEG. These successes are based on well-founded experience, since AEG can look back on 80 years of proven transmitter design experience. Moreover, AEG has been building broadcasting transmitters since 1923, and today it is one of the leading manufacturers offering innovative expertise in broadcasting. Modern high-power transmitters with ratings from 100 to 600 kW, a new program of long, medium and short wave broadcasting transmitters and more than 80 Pantel transmitters throughout the globe represent ultra-modern engineering perfection.



Pantel is a PDM method of modulation having high overall efficiency. Significant savings of energy are achieved by using DAM (dynamically controlled amplitude modulation) conveniently applicable to Pantel transmitters. AEG supplies on a turn-key basis complete broadcast transmitting stations that guarantee high operational reliability, economic operation and long life. Further advantages are full remote-control facilities suitable for unattended operation, and compact mechanical design.

In addition to the high-power transmitters, AEG also supplies complete broadcast transmitting stations for VHF FM and Band IV/V television including suitable antenna systems satisfying all directivity and gain requirements. Of course, maintenance and thorough technical training by experts are considered natural elements of the total AEG service.

The information and communications technology of AEG and the office automation technology of Olympia AG have united to form AEG Olympia AG – representing a new, international sphere of activity for the technology company AEG.

AEG Olympia AG
 Sickingenstrasse 20-28
 D-1000 Berlin 21
 Telephone: (0 30) 34 63-0
 Telex: 181819
 Telefax: (0 30) 34 63 24 19

Please send me further information on high-power transmitters:

Name _____

Company _____

Address _____

AO.WAK 4125 E

AEG
OLYMPIA

Circle (95) on Reply Card

Future convention dates are set

By Bob Van Buhler

The Society of Broadcast Engineers' executive committee, meeting in Washington, DC, selected the tentative dates and locations for future SBE national conventions. The 1991 convention will be held in Houston Sept. 30-Oct. 7. In 1992, the convention will move to Minneapolis Sept. 28-Oct. 5. The Nashville Convention Center will host the 1993 event Oct. 4-11. In 1994, Cincinnati is the tentative site for Oct. 4-11. The conventions generally will run Thursday through Sunday.

The 1989 convention is scheduled to be held in Kansas City, MO, and the 1990 event is to be held in St. Louis. Future conventions will rotate principally in the area defined by the cities listed. Alternates may be chosen, but the geographic area of the Central United States provides the most convenient travel for attendees. SBE's convention philosophy is to cater to the working engineer by making travel easy and inexpensive, rather than by selecting a vacation-style location with higher costs and less convenient travel connections.

SBE national conventions usually will be held during the first full week of October each year. A sensitivity to religious holidays, such as Rosh Hashanah and Yom Kippur, which occur at this time of year, is exhibited in the selection of the actual convention start and end dates.

NFCC manual

The All-Industry National Frequency Coordination Committee's Handbook has reached the formal draft stage. It was processed on a desktop publishing system by NFCC chairman Jerry Plemmons of Outlet Communications. Several local coordinating committee chairmen have been given the draft for observations and comments.

SBE contributing authors include Bob Van Buhler, Policy and Procedures; Richard Rudman, Practices of Coordination; and Gerry Dalton, Coordination Database. An active support group included representatives from the cable and broadcast industries.

The handbook is expected to be the editorial basis for the next NAB's

Van Buhler is chief engineer for WBAL-AM and WYY-FM, Baltimore.



Engineering Handbook section on frequency coordination. SBE past president Richard Rudman edited and authored much of the current edition's text on frequency coordination.

Honorary member

An early broadcast industry pioneer was presented with an honorary membership in the Society of Broadcast Engineers by membership petition and approval of the board of directors. Dr. Thomas Goldsmith was nominated for honorary membership by Chapter 86 (Greenville-Spartanburg, SC, and Asheville, NC) in recognition of his contributions to TV technology.

Goldsmith was born in Greenville, NC, in 1910, and graduated from Furman University. After earning his Ph.D. from Cornell University, he joined Allen B. Du Mont as director of research in Du Mont Laboratories, Passaic, NJ. He headed the team that pioneered the development of cathode ray tubes, experimenting with techniques to make them produce and quickly erase pictures.

Goldsmith is considered one of the three important broadcast pioneers, along with Lee de Forest and Allen B. Du Mont, who gave the world the technology to produce the TV screen and video camera, as well as computer, radar and sonar displays.

Goldsmith retired in 1966 after 30 years with Du Mont, and returned with his wife, Helen Elizabeth Wilcox Goldsmith, to Greenville. He then joined the faculty of his alma mater, Furman University. When he retired for the second time in 1975, he was named professor emeritus and continues as a consultant to the university.

For newcomers to the business, Goldsmith can even explain why the original TV spectrum began on channel 2. Originally, according to Goldsmith, there were four channels allocated for commercial television: 1, 2, 3 and 4. Channels 2, 3 and 4 went on the air in New York City, and the remaining channel was the spare. Continuous tuners followed with 12 channels and later 84 channels. But channel 1 was, from the beginning, reserved for police and fire communications on a nationwide basis.

Forty-three years ago, channel 5 in Washington, DC, went on the air, adopting

Dr. Thomas T. Goldsmith's initials as its call sign. The station is still using those letters today. This honor was a result of Goldsmith's assistance to the FCC and TV industry by the adaptation of radio rules and regulations for the fledgling TV industry.

The honorary SBE membership was presented to Goldsmith at the August meeting of Chapter 86, with the full approval and encouragement of the SBE board of directors. In his next retirement, Goldsmith plans to make his home in Olympia, WA, the area of his wife's birthplace.

SBE bylaws permit the election of people of outstanding repute and eminence in the art and science of broadcast engineering or allied professions to honorary membership by the national officers, when proposed in writing by a voting member.

Another category of membership is the Fellow, whose nomination is proposed in much the same manner as the honorary member. Fellowship is awarded to members who have rendered conspicuous service to the society, or have been recognized as having made valuable contributions to the advancement of broadcast engineering.

Upgrade your membership

Are you ready for senior membership? If you've been a member for at least three consecutive years, have participated in the broadcast industry for at least 15 years, and have demonstrated responsibility in the area of supervision, equipment design, plant layout, or projects directly related to broadcasting for a period of not less than six years, you are eligible for election as a senior member.

Members interested in upgrading their membership to senior member should make application to the admissions committee. Application forms are available from local chapters or the national office. The successful applicant will be notified of the election by the SBE secretary and will receive a new membership certificate reflecting the new status.

IF TRANSMITTER FAILURE HAS CAUSED YOU TO LOSE REVENUE, LET US INTRODUCE OUR INEXPENSIVE EMERGENCY TRANSMITTER.

What happens at your station when your FM transmitter goes down? Or your studio transmission link is disrupted? Or a power loss at the transmitter site occurs?

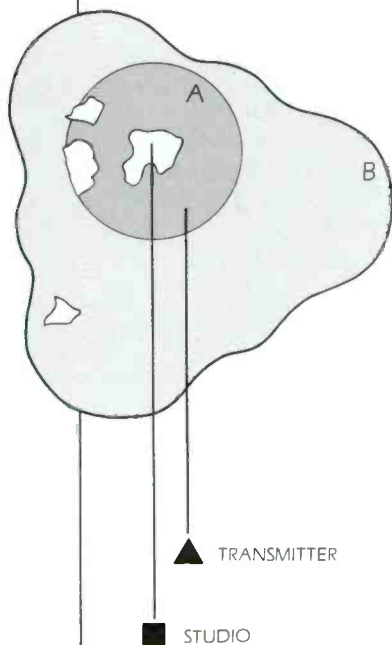

A — Coverage using QEI studio location transmitter
B — Coverage using station's primary transmitter

QEI has an inexpensive solution. Our low-power FM transmitter designed for studio operation can handle all these emergencies and keep you on the air. In many cases you'll retain the majority of your audience simply because your studio is usually located more central to your market than your transmitter site.

For a small investment your station will gain protection against lost revenues and the embarrassment of discontinued service.

QEI's low-power transmitters are all solid-state and are available in 150w, 300w or 500-watt power output levels. No warm-up is required. They are on the air in less than 10 seconds . . . and have hundreds of thousands of trouble-free hours.

Virtually silent in operation, all our transmitters are available with either our famous 675 synthesized exciter or our all-new model 695 synthesized exciter.

So cover yourself with a QEI low-power FM transmitter located at your studio site . . .

Solve the problems caused by an STL or main transmitter failure . . . and do it on a modest budget.

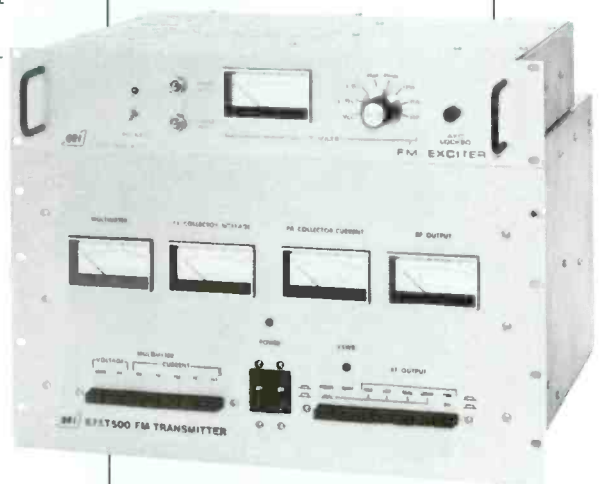

QEI CORPORATION
One Airport Drive
P.O. Box D
Williamstown, NJ 08094
Phone 609-728-2020
Toll-Free 800-334-9154

SBE Booth 322

QEI CORPORATION

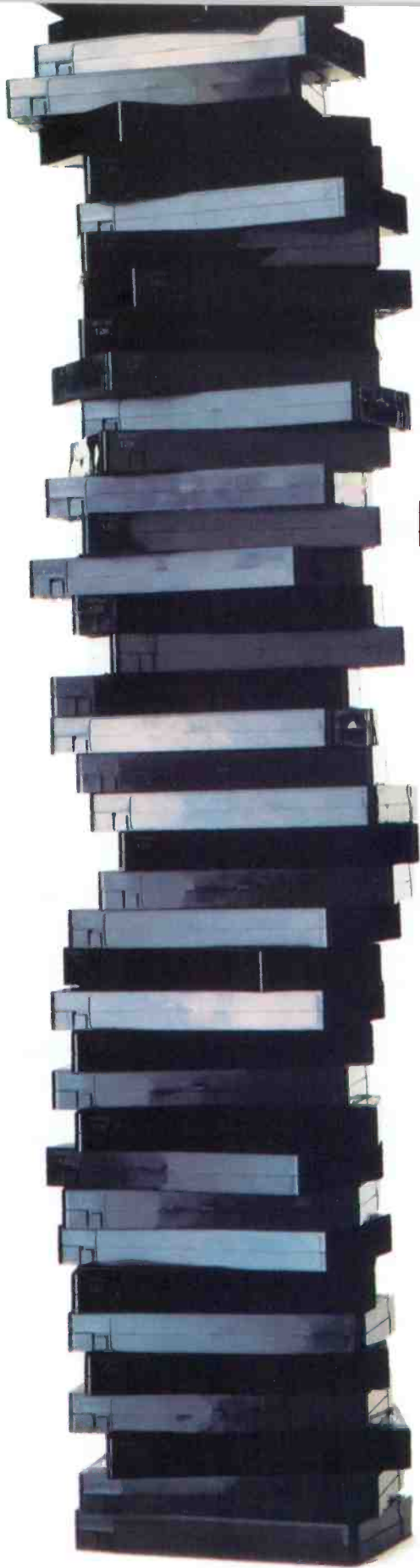

**Panasonic does it again.
Again and again.**

Again, Panasonic sets the standard: our all-new VHS Duplicator and Automatic Cassette Changer.

Here's a rugged duplicator, designed to optimize your SP recording, time after time after time.

A host of built-in self-diagnostics ensure smooth operating. Including: an auto-eject circuit with warning indicator, a tape running indicator, a record indicator that will flash a warning for any signal disruption, and an audio peak meter. And you can choose between a 34-pin parallel remote or a built-in serial remote for system control. These features, combined with 4 discrete audio channels, make the AG-6820 duplicator an ideal component for any professional duplicating system.

As for efficiency, the AG-6820 consumes only 43 watts—a 25% reduction in power consumption over previous models.

To reduce changeover time and maximize productivity, the Panasonic® AG-CL68 Cassette Changer automatically loads and unloads up to 3 tapes without manual intervention—minimizing changeover time, maximizing factory operation.

When it comes to professional duplicating, Panasonic sets the standard. Again.



Panasonic

Professional/Industrial Video

Circle (30) on Reply Card

Call Panasonic Industrial Company at 1-800-553-7222 for more information and the name of your nearest Panasonic Professional/Industrial Video Dealer.

Continued from page 108

7:00 p.m. Care and Feeding of Directional Antennas
 A panel discussion with the following experts:
 • Edward Edison, P.E., Hammett & Edison (chair)
 • Ralph Evans, consulting engineer
 • John Sadler, FCC
 Maintaining an AM DA system is 50% skill and 50% luck. This session will address both.

Sunday, Sept. 25
Early bird session:

Session coordinator: Richard Rudman, chief engineer, KFBW, Los Angeles

8:00 a.m. Frequency Coordination Update
 • Gerry Dalton, KKDA
 • Jeff Brother, KRMA-TV, Denver
 No communication without coordination.

9:00 a.m. Chapter chairman's meeting

9:00 a.m. Exhibit floor opens

12:00 p.m. Exhibit floor closes

Engineering luncheon
 • Featured speaker is Lex Felker, chief, Mass Media Bureau, FCC
 FCC policy matters of importance to broadcasters.

1:30 p.m. ABES status report
 • Wallace Johnson, Moffet, Larson & Johnson, PC
 • William Potts, Haley, Bader & Potts
 Update on the standards-making efforts of the Association of Broadcast Engineering Standards.

2:30 p.m. Making and Implementing FCC Rules
 • John Reiser, FCC
 • Dennis Carlton, FCC Denver office
 Question and answer session with FCC experts.

3:30 p.m. Good-by until next year
 • Jack McKain, SBE president

Hello, ITVA

The International Television Association (ITVA) will present the 1988 Region 8 Television Conference in conjunction with the SBE convention in Denver, Sept. 22-24. ITVA conference participants will be able to select from 35 seminars and workshops covering production, management and technical topics. The conference is open to all video professionals whether or not they are ITVA members.

The Thursday full-day seminars include: Lighting, Story Telling with a Camera, Scriptwriting and Video Department Management. Workshops begin on Friday, Sept. 23, and run through Saturday, Sept. 24.

Participants will have free access to the combined equipment exhibits of the Rocky Mountain Film and Video Expo and the SBE convention. More than 140,000 square feet of exhibits will display the latest in television, radio, audio and film equipment.

Registration and workshop information for the ITVA conference is available from Gary Hense or Paul Terry at 913-677-3151.

[:?=>]]]

A New Angle On Character Generators.

Quanta's new DELTA 1 will give your message a new slant — *character by typographically-perfect character*. We're out to corner the market with such new angles as diagonal typing in 360 degrees, unlimited planes, unlimited sizing, full 32-bit color, and digital compositing, our best angle yet!

And, if you like our angles, you'll love our curves, anti-aliased on 256 levels! What's more, DELTA 1 offers many options including camera capture.

For the most sophisticated broadcast and post-production settings, the DELTA 1 has the right angle for you!



QUANTA®

Dyestech Broadcast Group

2440 South Progress Drive, Salt Lake City, Utah 84119, (801) 974-0992

Circle 92 on Reply Card

TOO MANY OF TODAY'S MICS ARE YESTERDAY'S NEWS.

When you're in the fast-paced business of news, why use outdated microphones? Time marches on, and old habits become bad habits if you don't keep up with the times.

The M 58, on the other hand, proudly benefits from new technical developments like a unique design employing a tiny, low mass diaphragm. Highly sensitive and accurate, its contoured upper frequency response produces unprece-

dentented intelligibility, even off axis.

A sophisticated modern internal shock-mount system reduces handling noise and vibration down to new levels. The 58 is scientifically "weight balanced" for greater comfort during lengthy interviews. Its slim, elegant profile and special "on-camera" finish look exceptional—in an understated way—on camera. The mic's thoroughly rugged and reliable construction

stands out in a world of "disposable" mics

If your news microphone is old news, audition an M 58 at your authorized Beyer dealer and experience the sound of modern news mic technology. Or contact:

beyerdynamic U.S.,
5-05 Burrs Avenue,
Hicksville, New York 11801,
(516) 935-8000.
FAX (516) 935-8018.

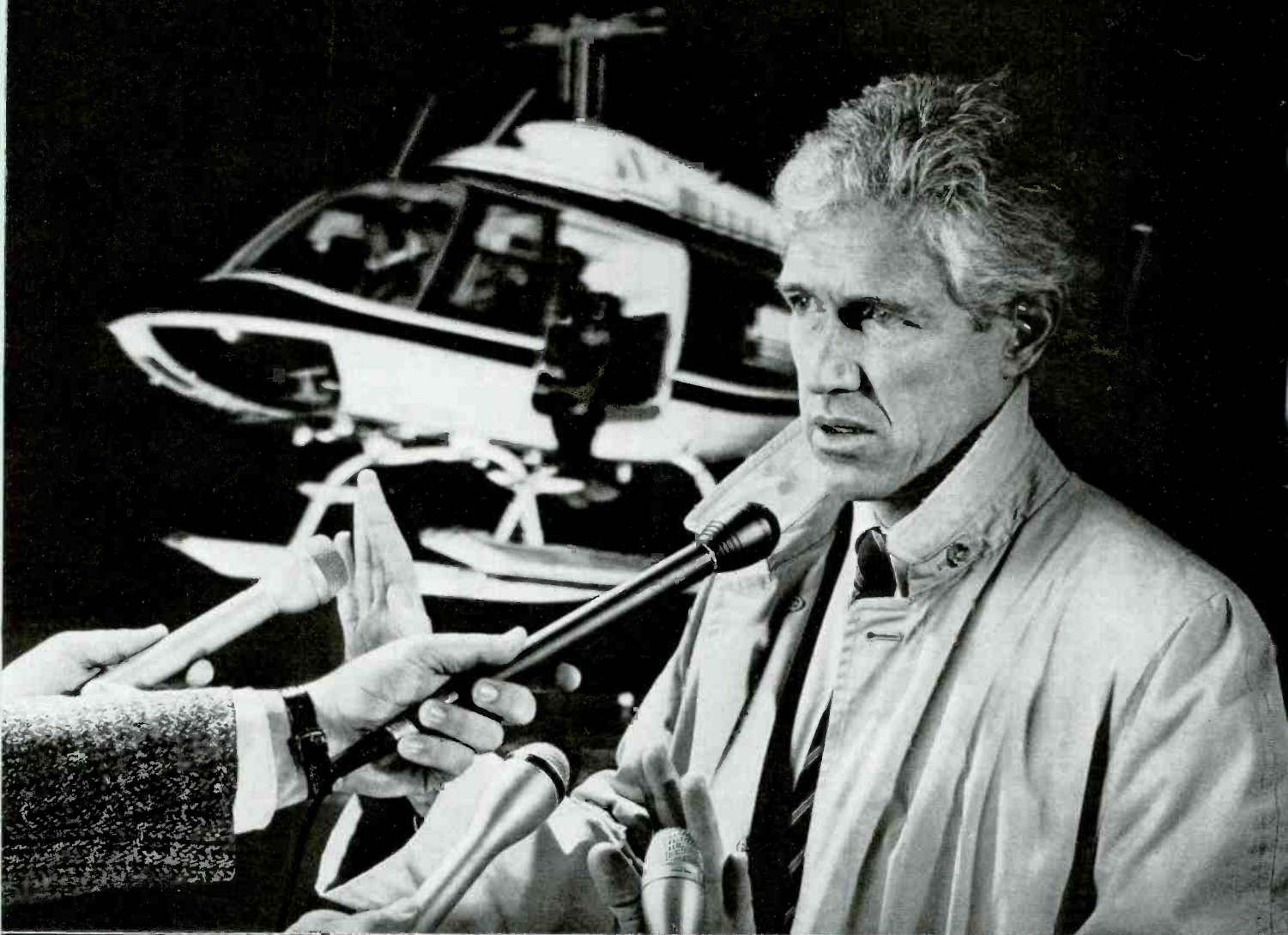

ACCURACY IN AUDIO

beyerdynamic 

Canada: ELNOVA Ltd. 4190 Rue Sere, St. Laurent, Quebec H4T 1A6
Tel. (514) 3 41 69 33 Telex 5824086

Great Britain: beyerdynamic, Ltd., Unit 14, Cliffe Industrial Estate
Lewes, Sussex BN86JL Tel. 273 479 411

Australia: Hi-Phon Distributors Pty. Ltd., 356 A-358 Eastern Valley Way
Chatswood N.S.W. 2067 Tel: (02) 417 7089

Germany: Eugen Beyer Elektrotechnische Fabrik GmbH & Co., Theresienstrasse 8,
Postfach 13 20, D-7100 Heilbronn Tel: (07131) 517-0 Telex 728771

Circle (98) on Reply Card

Continued from page 68

winter. Clear them out before they make New Year's snacks out of your wiring.

Ensure that the LNAs/LNBs/LNCs or other dish-mounted electronics are in good shape. These are frequently mounted in enclosures, which make dandy spots for rodent, bird or insect nests. If your dish accumulates bird droppings (common near shorelines), scrub it out now. It can be pretty slick, making feedhorn access hazardous. There is no guarantee the droppings will be any less slippery when half-frozen, or any more joyful to pull out of the dish when mixed with snow.

Many installations include equipment shelters. Often the rack electronics causes heat to build up, making attractive spots for insects and other small creatures. Remember that stinging insects wintering in the enclosure may not go dormant. Hang a bug zapper from the ceiling. Sweep out the enclosure, and check for openings or holes through which water or creatures could invade.

Note the location of power lines near your dish. You may consider devising something to make it harder to accidentally contact a wire with the dish-cleaning equipment. Remember that power lines

along the route to the dish from where you store the tools also can be a threat.

Because of the length of the tools, it is easy to break nearby windows, especially when you're cleaning the lower part of the dish, because the long handle will be extended behind you.

It also is good to know the toxicity and first-aid requirements for your de-icing solutions *before* you start fooling with the pump can. Inclement weather may blow the spray back into your face, or the pump can seal may fail, blowing out the solution toward you or someone nearby.

One extraordinary de-icing situation involved a 10m PBS downlink located in the Mountain West. The dish was remotely controlled, and to get there required a 15-mile drive over slick roads. At the site, a narrow aluminum ladder was propped against the lower lip of the dish and lashed in place with a piece of cotton rope someone had left dangling from the large feedhorn.

The engineers would perch on the ladder, clip their safety belts to the top rung and pull out all the snow they could reach. Next, they'd loop the rope through the D-ring on their belts and inch up toward the center of the dish. Once at the feedhorn, they'd pass their strap around

it and, half dangling, pull the snow down from the top of the dish, turn and shove it down toward the ladder. Rappelling down out of the dish, they'd clip again at the ladder, and once more pull the snow out. The engineers would then climb down, excavate the now-buried ladder and hope it wouldn't snow anymore.

Even under these unusual circumstances, simple preventive maintenance can go a long way toward making de-icing easier and safer.

References

1. The FCC has invited comments on a proposal to create a "high-power-density segment" of the arc, in which Ku-band satellites could operate at 1.5° spacing.

2. One of Kepler's laws, fundamental to orbital mechanics, is that a constantly moving point on an ellipse will trace out equal areas in equal intervals of time. Because the apogee is distant, the portion of the arc traced at each interval near the apogee is small. Prove this by placing a football on the 40-yard line (apogee), then stand in the end zone facing it (near the perigee). Send a constantly moving cheerleader out from your position, around the football and back around you to the starting point. The runner will be in your field of vision much longer than beside or behind you.

3. The "Comsat Maneuver" is a patentable attitude adjustment to extend satellite life. Basically, it consists of putting the satellite in such an attitude that North-South drift can be tolerated. Hydrazine then needs to be expended only for East-West movement, which would encroach on other spacecraft.

||-?(-))]]

STOP GROUND-LOOP HUM!

VIDEO HUM STOP COIL...HSC 1

Will ELIMINATE HUM and other INTERFERENCE in Video Lines caused by differences in Ground Potential.

- For Color and Black and White.
- FLAT-DC to 6.5 MHz.
- No Low-Freq or Hi-Freq. Roll-off.
- No Differential Phase Distortion.
- No Differential Gain Distortion.
- No Envelope Delay.
- Passive Device - Failure Free-Low Price.
- Small Compact Package 4" x 4" x 2-1/4".

ELIMINATES HUM AND INTERFERENCE:

IN STUDIO

- Between Buildings
- On long runs in Buildings
- Between Studio and Transmitter
- On Incoming Telco circuits
- On Outgoing Telco circuits

IN FIELD

- Betw. Remote Truck and Telco
- Betw. Remote Truck and Microwave
- For Intertruck Hookup
- For VTR Units
- For Monitoring Lines

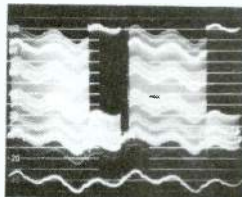

NEW!



\$190
F.O.B.
N.Y.

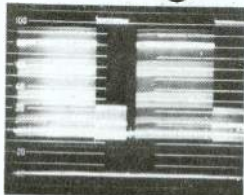

Available on
10 day free trial

AUDIO-VIDEO ENGINEERING COMPANY
65 Nancy Blvd., Merrick, N.Y. 11566
Tel. (516) 546-4239

Circle (33) on Reply Card

Looking for... DA?

Come to Us!

We make plain vanilla as well as special audio/video DA's such as component video and DC 12V powered.

- 200-1 Plain vanilla video DA, 8 outputs.
- 200-2 Cable equalizing video DA, up to 3000 ft.
- 200-3 Chroma equalizing video DA, up to +/-3dB.
- 200-4 Delayed video DA, up to 750 nS.
- 200-5* VCA video DA, remote control system DA.
- 215-1 Line driver V DA, bal/unbal in-out 75/125 ohms.
- 220* DC 12 V powered video DA, 8 outputs.
- 230* 10 outputs video/2 ch audio, dubing system DA.
- 232* 20 outputs video/2 ch audio, dubing system DA.
- 233* 50 outputs video/2 ch audio, dubing system DA.
- 240-1 Plain vanilla audio DA, 12 outputs.
- 240-2 VCA audio DA, remote control system DA.
- 273* Component video DA one gain control for 3 CH.
- 280* DC 12V powered audio DA, 8 outputs.
- 470* DC 12 V powered - V DA, A DA, 5x1 V xp A xp in one 1 RU package.

*New products -

- Other quality products from OMICRON VIDEO.
 - Model 310 4 frequency tone generator.
 - Model 410 series sync generators.
 - Model 500 series audio/video routing switchers.
 - Model 700 series data distribution equipment.

5 YEAR WARRANTY

TEL: (818) 700-0742

OMICRON VIDEO

FAX: (63)8187000313

TELEX: 910-240-1888

21822 Lassen St., Unit L, Chatsworth, CA 91311

Circle (100) on Reply Card

"FM radio has become a ratings war in which we are the casualties by being subjected to a poor excuse for clean accurate music."

Thomas J. Koch, *The Audiophile-File*

Aphex Makes You a Winner In the "No Win Modulation Wars"

K TWV-FM The Wave. WHYI Miami-Ft. Lauderdale Top 40. KKGK America's Jazz Station. WQXR New York's Premier Classical Station. All different, but all winners, because they have an overriding demand to deliver the best in audio quality. They know quality sound is essential to attract and keep loyal listeners.

That's why these premier stations have replaced their old FM processors with The Aphex Audiophile Air Chain, a combination of the Aphex Compellor™ and Dominator™, and/or Aura Exciter® to achieve *consistent high quality sound*. Once set up, this combination of Aphex products will maintain the same high quality regardless of program or who is controlling the board. Compared to other processors which need to be tuned for almost every song and achieve loudness by homogenizing or crunching to the point of pain.

AM, FM or TV... rock to Bach or talk, if you want to be a winner in the "no win modulation wars," call or write to arrange for a demo of the Aphex Audiophile Air Chain.



APHEX SYSTEMS LTD.

13340 Saticoy St.
North Hollywood, CA 91605 (818) 765-2212

All Aphex products are designed and manufactured in the U.S.A.

Hear the Aphex Audiophile Air Chain in Booth 870

News

Continued from page 140

By John Blau,
European correspondent

Murdoch expects TV expansion in Great Britain

Rupert Murdoch, chief executive of News International, predicts a dramatic expansion in the number of people in Great Britain capable of receiving new TV channels via cable and satellite. Murdoch has leased three transponders, with an option for a fourth, on the Astra satellite for February. According to Murdoch, at least six million British homes will have cable or a satellite dish within four years. About 250,000 homes currently are equipped.

Central Television pulls out

Central Television, one of 15 investors in the British satellite station Super Channel, has withdrawn its involvement in the station for financial reasons. Super Chan-

nel, a project set up by the British independent network, ITV, was launched early last year to compete with Rupert Murdoch's Sky Channel. British experts forecast heavy losses for Super Channel by the end of the year.

Satellites will be focus at WARC 1989

The next WARC conference, to be held in the summer of 1989, will focus on telecommunication satellites. American representatives are expected to argue for an extension of the current satellite bands. The situation in Europe is becoming more difficult. Talks concerning the allotment of bands have produced few results. Third World countries in Africa are blocking progress, fearing a domination of satellite distribution by a handful of European networks.

Fifth TV channel planned for Britain

The British government is determined to launch a fifth national TV channel. The

channel may go on the air by early 1992, just before present ITV franchises run out.

The government, however, dropped an idea put forward by Lord Young, trade and industry secretary, to move BBC2 and channel 4 to satellite distribution. The idea was intended to give a double boost to British Satellite Broadcasting (BSB), Britain's direct broadcasting venture. Meanwhile, BSB has suggested to the government that one of Britain's two remaining DBS channels should be used to set up a common-carrier pay-TV channel.

Mitterand calls for pan-European broadcasting

French Prime Minister Francois Mitterand, speaking at a meeting of the European Economic Community (EEC), asked community members to consider a European TV station. He suggested that a "Eureka" program, similar to the one for HDTV and digital radio, be established to explore the possibility of pan-European broadcasting.

||:~::~|||)

Broaden Your Horizons

QUALITY MANUFACTURING & PERFORMANCE



Dielectric can broaden your FM broadcasting capabilities with quality-manufactured, reliable products. Dielectric components have provided years of continuous performance with very little maintenance for FM stations around the world. That's reliability you can't ignore.

Dielectric is the single source for all your equipment needs:

- Coaxial Transmission Line, Switches and Patch Panels for maximum isolation and low VSWR
- Panel Antennas for single and multiple frequencies
- Economical, high performance DCR Series of circularly polarized FM Ring Antennas
- Rigid Coaxial Transmission Line of welded, high conductivity copper that meets critical performance criteria
- Line Hangers and Accessories
- FM Multi-Station Combiners and Switching Systems for switching any transmitter to an antenna or station dummy load

Our complete line of FM broadcasting components is also backed by reliable customer services, including quality control, installation, start-up and servicing. So, for all your broadcast needs, there's only one number to call: (800) 341-9678.

DIELECTRIC

GS

Raymond, Maine 04-071
(207) 655-4555 • (800) 341-9678
TWX: 710-229-6890

Circle (102) on Reply Card

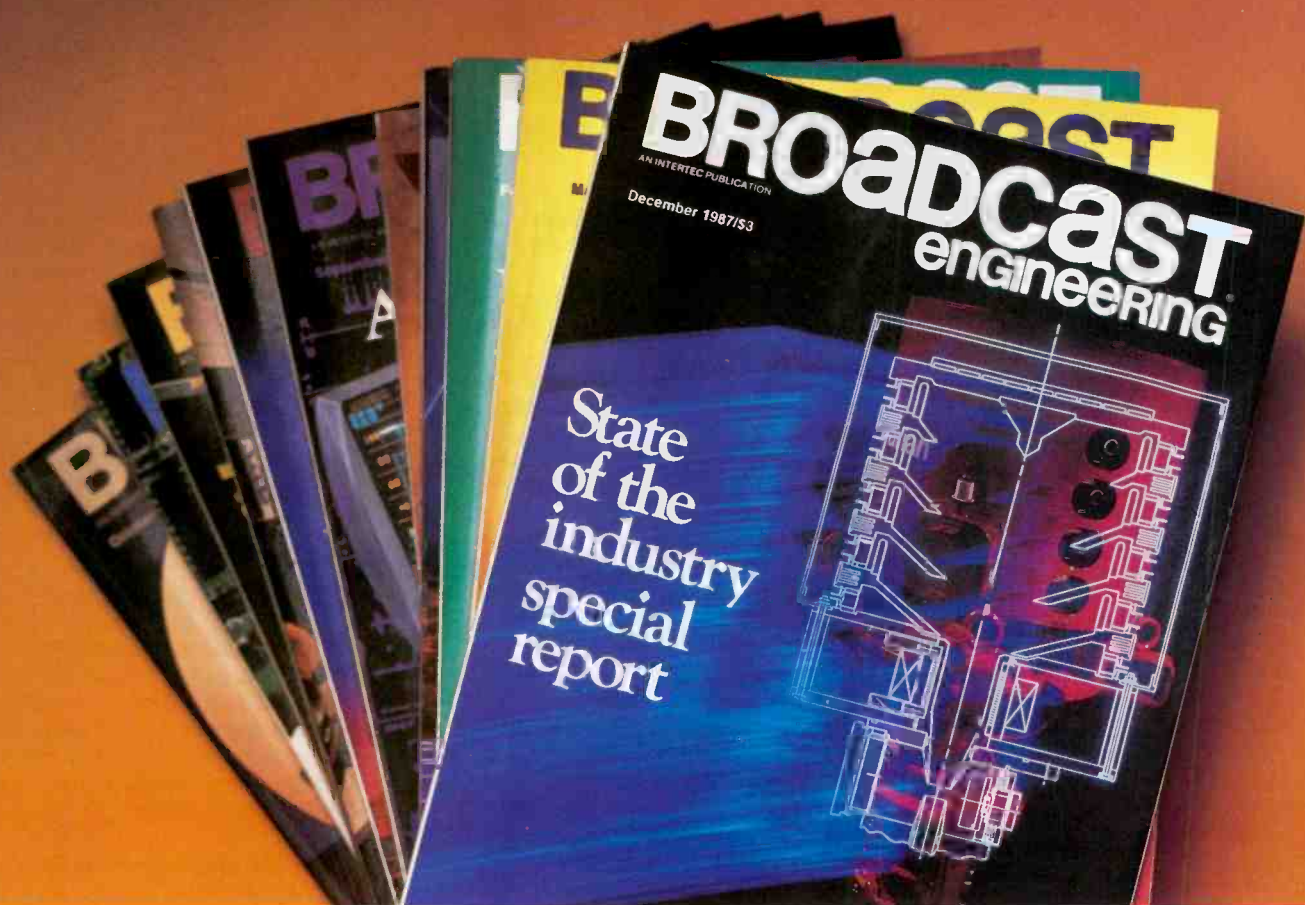

Your "monthly seminar in print"

You don't have to travel to different cities to learn new ways to do your job. Every time you read *Broadcast Engineering*, it's like attending a technical seminar in print.

For example, November's "Maintenance Special Issue" gave you the information you needed to keep your equipment running, without running into problems with the commission.

December *BE* helped you plan for your future by giving you our annual "State of the Industry Report."

You learned to plan and execute complicated remotes, and in the process give your station a key competitive edge, from reading January's "Broadcasting From the Field."

And in February, our seminar put HDTV into perspective, helping you plan your own response to this emerging technology.

What a convenient way to get the technical information that's vital to keeping your TV and radio station up and running, every minute of every day.

BE is preferred 2:1 by technical managers and engineers like you, because it's written *for* engineers *by* engineers. *BE*'s field-experienced staff knows exactly what information you need because they've been there. In the control room... on the tower... in the production van... behind the desk.

Plan to attend *your* monthly technical seminar by reading *Broadcast Engineering* magazine. If you are not already a reader, we urge you to complete the subscription form enclosed in this issue.

BROADCAST.
ENGINEERING

Richard Taylor and Sohei Takemoto have joined *Digital F/X*, Santa Clara, CA. Taylor is training manager, responsible for documentation and training programs for the DF/X 200. He also supervises the Digital F/X user hotline. Takemoto, an engineer, assists in the DF/X 200 product development program and in designing optional boards. He also works on system architecture for new product development.

Curtis Carroll has been appointed to a position with *Gentner Electronics*, Salt Lake City. As a salesman for the broadcast audio division, he will be involved in sales of all the company's products.

Louis Swift has been appointed national sales manager for the *Grass Valley Group*, Grass Valley, CA. He is responsible for overseeing the four GVG regional sales managers and the field sales force, and is responsible for order processing and support for field sales operations. He also oversees the operation of the headquarters' inside sales operation, which consists of sales engineers and sales specialists. He is located at company headquarters in Grass Valley.

Jim Smith has been appointed Western regional manager of sales and service for *Panasonic Broadcast Systems Company*, Secaucus, NJ. He is responsible for M-II equipment sales and services for the states west of the Mississippi River.

Craig Taylor has been named Northeast regional sales manager for *Sony Communications Broadcast Products Division*, Teaneck, NJ. He is responsible for the sales and marketing of broadcast products from New Jersey through Maine, including New York City and Boston. He will work out of Sony's Paramus, NJ, office.

Jeff Blackden has been promoted to the position of vice president, marketing, at *Pinnacle Systems*, Santa Clara, CA.

Jeffrey R. Detweiler has been named national sales manager for *QEI*, New York.

Lottie Morgan has been appointed to the position of vice president, sales, for *Shure Brothers*, Evanston, IL. Morgan will be responsible for the supervision of all domestic distributor sales.

Joseph Larsen has been appointed to head the sales division for *Rational Broadcast Systems*, Cherry Hill, NJ.

Robert A. Getchell has been named marketing development engineer for *Vinten Equipment*, Hauppauge, NY. He

will be working on the MicroSwift line of remote camera control systems.

Thomas Sanders has been appointed assistant broadcast sales manager for *Rank Cintel*, Valley Cottage, NY. His duties will be focused on introducing Gallery 2000 still-image management system, the ADS-2 CCD telecine and the ADS-80 digital slide scanner to the broadcast and corporate/industrial marketplaces.

Thomas E. Mintner has been appointed director of sales and marketing for the United States, at *Audio Precision*, Beaverton, OR.

Patti Carpenter has joined *Broadcast Television Systems*, Salt Lake City, as marketing assistant. She will handle a variety of marketing duties and act as public relations coordinator.

John Daniel Sessler has been named radio district sales manager for the Southeastern United States by *Harris*, Broadcast Division, Quincy, IL. He will represent the complete line of AM, FM and short-wave transmitters, antennas, audio and remote-control products, and service and training programs to broadcasters in Florida, Georgia and South Carolina.

Dave Richardson, Rick Fisher and Omar Fattah have been appointed to positions with *McCurdy Radio*, Toronto. Richardson is Western regional manager. He is responsible for developing additional sales for the audio-for-video line. Fisher is Midwest regional manager. He also is responsible for developing additional sales for the audio-for-video line. Fattah is marketing manager. He is responsible for international sales, new market development and coordination of the dealer network.

Murray Shields has been appointed director of sales for *Auditronics*, Memphis, TN.

Bob Strout, Jim Carter, Chris Genereaux, Michael Perlman and David Hart have been appointed to positions with *Centro*, Salt Lake City. Strout has assumed additional responsibilities of operations as vice president of sales and operations. He is responsible for the day-to-day operations of the engineering, design and manufacturing departments in addition to managing sales. Carter is sales manager. He oversees sales of SNGs, EFPs, ENGs, box sales and government sales in the United States. Genereaux is sales manager responsible for sales of facilities and large mobiles. Perlman and Hart are

account executives specializing in racks, consoles, custom equipment enclosures and OEM products, and in security-related and tactical operations, respectively.

Sam Spennacchio has joined *Clark-Teknik* as national sales manager. His responsibilities include overseeing the national sales rep network, coordinating all advertising and public relations activities and product planning and development for Clark-Teknik and its affiliates.

Chyron, Melville, NY, has announced personnel changes. **Isaac Hersh** has been appointed president of the telesystems and video products division, and group vice president of marketing and product planning. **Joseph L. Scheuer** has retired from his position as president and chief operation officer. His duties will be assumed by **Alfred Leubert**, chairman and chief executive officer.

Ken Barton, Bill Ganter and Les Arnold have joined the staff of *Lake Systems*, Newton, MA. Barton has joined the video equipment sales department and will serve the New England area. Ganter has joined the audio-video systems group. Arnold will help develop systems for both recording studios and audio-for-video applications as a member of the professional audio division sales staff.

Richard K. Ploss has been appointed vice president of engineering at *New England Digital*, White River Junction, VT.

Mark Hutchins has joined *Omega International*, Irvine, CA, as manager, business development. His duties will include working directly with customers to define system requirements and overseeing the efforts to sell FM synchronous repeater systems and related components.

Charles J. Motta, Jr. has been appointed vice president of marketing at *Prime Image*, Saratoga, CA. He will be responsible for working with dealers in the Eastern United States and establishing off-shore dealers.

Antony David, Chris Jenkins, Mike Kervell and Graham Longton have been appointed to the board of directors for *Solid State Logic*, Begbroke, Oxford, England.

We wish to clarify an item that ran in the "People" section of the July issue, which reported that John Richardson is with Sony Broadcast in Teaneck, NJ. Richardson is sales director with Sony Broadcast in the United Kingdom. {:-)}

Solid as a Sony.

Sony videotape has a rock-solid reputation as the toughest you can buy.

One word sums up everything we tried to achieve with VI-K videotape: durability.

From its cross-linked binder system to its adhesive base film, it was perfected for the real world of constant jogging, still frame editing, shuttling... and deadlines.

And its ultrafine Vivax™ magnetic particle formulation was made to deliver astonishing picture quality, higher stability and optimum S/N ratio with the lowest headwear rate of any major one-inch videotape.



What we did for VI-K benefitted BCT Betacam® too, resulting in trouble-free still frame editing, totally reliable repeated playback and worry-free long-term storage.

And new Sony BRS and XBR U-matic® cassettes have all of the above plus the new Sony Carbonmirror™ back coating, as well as Sony's anti-static shell, which we introduced in BCT Betacam. They deliver a new level of durability, runability and especially fewer dropouts.

So, after all, Sony professional videotape is just like any other Sony: standard-setting video and audio with a "solid as a rock" reputation. That's why it's the only videotape you can treat like a Sony.

SONY
THE ONE AND ONLY.

Circle (117) on Reply Card

Ampex audiotape selected as reference standard

Ampex Magnetic Tape Division, Redwood City, CA, has announced that after testing and evaluation by DASH and PD-format tape and hardware manufacturers, its digital mastering audiotape has been chosen by the International Electrotechnical Commission (IEC) as the worldwide primary reference tape for digital open-reel audio recorders.

The IEC digital audio primary reference tape is a reel of unrecorded tape with established, highly consistent physical and electromagnetic properties that are used to calibrate a digital open-reel audio recorder's record and playback characteristics. The reference tape will be used by manufacturers as a reference to align their machines. It also will be used by tape manufacturers to establish their products' performance characteristics to ensure they meet IEC standards.

Each reel of the IEC reference tape is manufactured to the standards used for Ampex 467 digital audiotape. Further testing also was done to ensure that each tape conforms to the electromagnetic toleranc-

es established for the IEC digital audio reference tape.

L.J. Scully forms service subsidiary

L.J. Scully Manufacturing has formed a service and parts subsidiary, the ATR Service Center, for professional reel-to-reel audiotape recorders of all makes. The company will expand its present tape equipment manufacturing operation in order to provide replacement parts for the large base of professional ATRs presently in use.

The facility has been retooled for the manufacture of pinchrollers for Scully, Ampex and MCI machines of all vintages, and will expand its line of parts. The center's telephone number is 203-366-1700.

Bosch and Philips change ownership terms

Robert Bosch, West Germany, and Philips, Netherlands, have agreed to change the terms of ownership regarding their joint venture, Broadcast Television Systems (BTS). The agreement calls for a 50-50 ownership. Philips previously owned

30% of the company. The mutual interest of Bosch and Philips to invest more in HDTV research and development was cited as a reason for the change. BTS is headquartered in Darmstadt, West Germany.

AHB changes name

AHB, Brighton, England and Orange, CT, has changed the name of the company back to Allen & Heath. Known during the years as both AHB and Allen & Heath Brenell, the company decided to revert back to the original name to alleviate confusion caused by the two previous name changes.

BTS and Alias sign joint agreement

BTS Broadcast Television Systems, Salt Lake City, and Alias Research, Toronto, Canada, have signed a joint marketing agreement. The terms of the agreement call for BTS to assume exclusive worldwide marketing and distribution responsibilities for all Alias products to the video teleproduction and broadcast markets. Alias will represent BTS products

Worried about video quality and costs?



The SWAT
Now programmable

The SWAT is perfect for:-

- Edit suite
- Studios
- VTR room
- Master control
- Off air
- Up/down links and microwave
- OB vans
- Maintenance stations
- Pro-video applications
- Automatic monitoring of the video signal to RS170A - or your own - specification

At half the cost of nearest competitor!

PESA
Grupo INISEL

Pesa America, Inc., 6073 N.W. 167 Street, Suite C-4, Miami, Florida 33015.
Telephone (305) 556-9638. Telex 6712435. Fax (305) 556 5536.

THE FIRST DESKTOP 12-INCH VIDEO DISC RECORDER.

The TEAC LV-200 Recordable Videodisc system makes producing your own videodiscs as easy as using a VCR. Everything you need for the production of high quality 12-inch videodiscs is in your control.

The LV-200A recorder allows you to make a check disc in real-time—no more waiting. Video catalog, image library, and archival data can be instantly updated as required, eliminating the time and expense of remastering an original disc at an outside source. Confidential material never needs to leave your facility.

A built-in RS232 interface allows computer control

over the videodisc recorder and a full-function wireless remote control unit is standard.

An internal real-time clock enables the recording of the year, month, day, hour, minute, and second to be displayed at playback. Each disc is encoded with its own individual ID code for easy identification. An edge search function along with a display of frames remaining makes add on recording quick and easy.

Now, with the TEAC LV-200 system, the production of interactive video programs is in your hands. For more information, call (213) 727-7675.

TEAC
Recordable Videodisc Division



COPYRIGHT 1988. TEAC CORPORATION OF AMERICA. 7733 TELEGRAPH ROAD, MONTEBELLO, CA 90640.

VISIT US AT SMPTE, BOOTH #1745

Circle (108) on Reply Card

IMPROVE YOUR FM SIGNAL

Last year, the F.C.C. created new rules which provide a practical means for many FM Broadcasters to dramatically improve their signals.

Now, OMEGA INTERNATIONAL has developed a system which allows you to take full advantage of these new rules. If your FM station suffers from multi-path, terrain shielding or other coverage problems within your licensed contours, we can help.

OMEGA INTERNATIONAL's unique solution is a proprietary FM Synchronous Repeater system. It's new, it's flexible, it's sensible, and it works.

We don't have to tell you that improving your coverage will probably bring new listeners and new sponsors. But, we should tell you that OMEGA's complete solutions probably cost less than you think. Let's talk about it. Call or write for all the details.

Call the Original... Call the Leader in Systems Engineering.

 **OMEGA INTERNATIONAL**
2691 Richter, Suite 116
Irvine, CA 92714 USA
(714) 553-0564 Telex: 678641 CORP HQ

to the industrial design, scientific visualization and automotive markets. The agreement includes a commitment to develop and maintain compatibility between Alias software products and BTS EPIC and Pixelator product lines.

Centro expands sales efforts

Centro, Salt Lake City, has opened regional offices in the Northeast, Pacific States, Central States and the Southeast. The Northeast office is in Wilmington, DE. Irvine, CA, is the location for the Pacific States office. The Southeast office is located in South Carolina. The Central States office is based in Scottsdale, AZ.

CMX moves to new headquarters

CMX has relocated its EuroService from Amsterdam to the United Kingdom. The new office is located at Dancon House, North Circular Road, Stonebridge Park, London, NW 10 755, United Kingdom; telephone 1-965-6599.

Miller Fluid Heads expands and moves

Miller Fluid Heads has expanded and relocated its main office to 410 Garibaldi Avenue, Lodi, NJ; telephone 201-473-9592. The former main office in Burbank, CA, will remain in operation as a sales office and service facility.

ODC nabs Emmy

Optical Disc Corporation, Cerritos, CA, has been awarded an Emmy for outstanding achievement in engineering development. The award is given to an individual or company for engineering developments that are either extensive improvements or innovative in nature, so that they materially affect the transmission, recording or reception of television. The recordable laser videodisc system from ODC has been used in the editing of prime time TV sitcoms, movies and specials. Non-linear, disk-based editing has substantially reduced the time it takes to edit programs and has increased creative control over the manipulation of sound and images.

R-Scan expands services

R-Scan, Minneapolis, has added two senior management executives in an expansion of the company's lightning data services. Arthur E. Morgan has been appointed president, chief executive officer and director, and will guide the expansion into new commercially focused activities. Mark S. Corona, vice president of marketing and sales, will develop the marketing activities in key target markets including major radio and TV broadcast stations, airlines, public utilities and other

Circle (109) on Reply Card

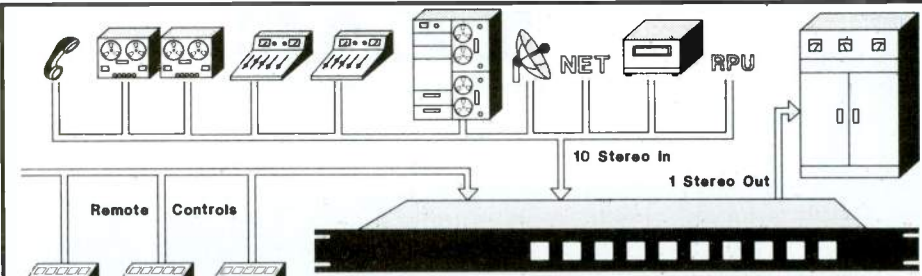

AS-101 AUDIO SWITCHER

- Illuminated and legendable control buttons
- Instant or overlap switching
- Front panel accessible level controls
- Optional RS-232 interface
- Optional relay follow switch outputs
- Plug-in screw-clamp terminals

CONEX ELECTRO SYSTEMS  P.O. Box 1342 Bellingham, WA 98227 (206) 734-4323

Circle (105) on Reply Card

PRECISION MAGNETIC TEST TAPES

STL

Standard Tape Laboratory, Inc.
26120 Eden Landing Road #5, Hayward, CA 94545
(415) 786-3546

Circle (107) on Reply Card

FREE 44pg Catalog & 80 Audio/Video Applic.

PWR SUPP. EQ. 250 PRODUCTS

PHONO, MIC, TRANS, ACN, TAPE, VIDEO, LINE, OSC

PRESS BOXES

1-in/18-out Video Audio

2-in/18-out Audio

2-in/24-out Audio

4-in/1-out Audio Mixer

Video & Audio Dist. Ampls.

RGB-Sync Dist. Ampls.

Routing Switchers

OPAMP LABS INC (213) 934-3566
1033 N Sycamore Av LOS ANGELES CA, 90038

Circle (106) on Reply Card

Want more information on advertised products? Use the Reader Service Card.

specified customer groups.

Stellar enters multiple agreements

Stellar Computer, Atlanta, has entered agreements with Wavefront Technologies, Intelligent Light, Media Logic, Paragon Imaging and the University of Lowell. The agreements call for the marketing and availability of their graphics and image processing software on Stellar's GS1000 Graphics Supercomputer.

Wavefront Technologies will work with Stellar to port Wavefront's Model, Preview and Image software modules, and will market them for use on the GS1000. Intelligent Light will make available its animation and visualization software, with its NTSC/PAL video animation subsystems and digital film recorders for use with the Stellar Graphics Supercomputer. Media Logic's Artisan software complements other animation software available on the GS1000 by allowing the development of 32-bit mattes.

The agreement with Paragon Imaging calls for the re-marketing of Paragon-IL imaging library. Stellar will sell and provide first level support for the library. The Stellar architecture was designed to support flexible image-processing as well as 3-D graphics, providing a range of visualization techniques for engineers and scientists. Under the agreement with Stellar, the Center for Productivity Enhancement at the University of Lowell will port its object-oriented Imaging Kernel System (IKS) to the GS1000 for resale by Stellar.

AKG relocates office

AKG Acoustics has moved to new headquarters. The address is Digital Products Division, 125 Walnut Street, Watertown, MA 02172. The telephone, fax and telex numbers remain the same.

Midwest and Technalogix introduce TV transmitters

Midwest Communications RF Division, has announced a joint effort with Technalogix to manufacture and market a complete line of high-power UHF TV transmitters. Various models with power ranges of 30kW, 60kW, 120kW and 240kW are available in standard and redundant configurations. Leroy Wallace Sr., Leroy Wallace Jr. and Don Adams head Technalogix and are responsible for design and manufacturing of the product line. Midwest is responsible for all marketing and sales worldwide.

"With the new Continental solid-state transmitter we have had zero down time despite inclement weather."

"At what must be the world's most hostile transmitter site, we have had zero down time despite inclement weather and antenna icing conditions. The transmitter remained on the air, with a minimum of power foldback."



W.C. Alexander
Director of Engineering
Crawford Broadcasting Company

"We are very pleased with the superior sound and performance of the solid-state 1 kW Continental transmitter."

"The new transmitter has a "cleaner" sound, better than any other stereo station on the AM band in this market by a wide margin."

"The reliability has surpassed that of its predecessor, in fact, we have installed our sixth new Continental transmitter."



A Continental 1 kW AM transmitter installation for KPBC in Dallas.

For information on any of Continental Electronics' family of reliable transmitters, contact:

varian [®]
continental electronics division

P.O. Box 270879 Dallas, Texas 75227
Telephone: 214-381-7161 FAX: 214-381-4949

!:-:))))))

New products

Delta-gun CRT monitor

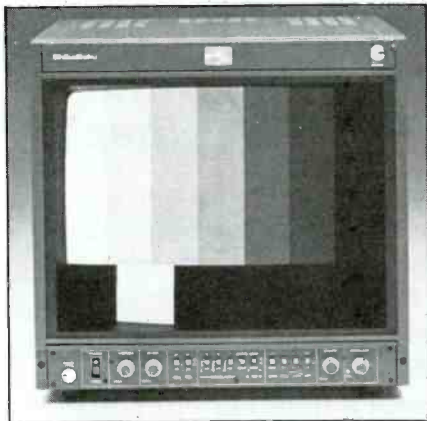

Asaca/Shibasoku has reaffirmed its commitment to supply grade one CMM20-11 20-inch delta/shadow mask monitors. The monitor features active-convergence circuitry, which permits precise alignment of the monitor, combined with the geometric structure of the delta gun. The monitor also features multiple-format operation through the addition of plug-in interface cards. Formats including

NTSC, PAL, SECAM and RGB can be switch-selected from the front panel. Optional component formats include Beta, M-II, YIQ and RGB. CRTs may be ordered with U.S., EBU or Japanese phosphors. A built-in comb-filter is standard.

Circle (350) on Reply Card

SP videotape

Ampex Magnetic Tape Division has announced 297 master broadcast-grade U-matic SP videotape, specially designed for the higher-energy requirements of the U-matic SP format. The tape delivers better electrical performance and meets the more stringent dropout standards when used with U-matic SP recorders. The videotape is available in PAL and NTSC formats. It features a red cassette shell to distinguish it from the company's line of standard-energy U-matic products, which have black shells. The U-matic SP recorder can play back standard U-matic cassettes or take advantage of the higher-energy SP cassettes. The recorder senses the bottom of the cassette by two recessed areas on opposite sides of the record lockout but-

ton, alerting the machine to the type of cassette.

The company also has introduced ALEX, a character generator. The unit is available in a 1- or 2-channel configuration, single or dual user. It consists of a keyboard with mouse, local 3½-inch floppy disk drive and a rack-mountable signal system with an internal 40Mbyte hard drive. The system does not use frame buffers, but does use 32-bit processor technology. Five typefaces are standard, with variable sizing, drop shadow, extrusion and italics capabilities.



Ampex 297 SP videotape
Circle (351) on Reply Card

Broadcast Proven Patch Panel Assemblies.



LSC VPP-26
Video patch panel
LSC WPP-300A
Audio/video patch panel
LSC WPP-26SS
Pre-wired audio patch panel

Call for Brochure
and Pricing
(617) 244-6881
1-800-848-4890

LAKE
The Systems Company

287 Grove Street
Newton, Massachusetts 02166

Circle (112) on Reply Card

SONEX CONTROLS SOUND.

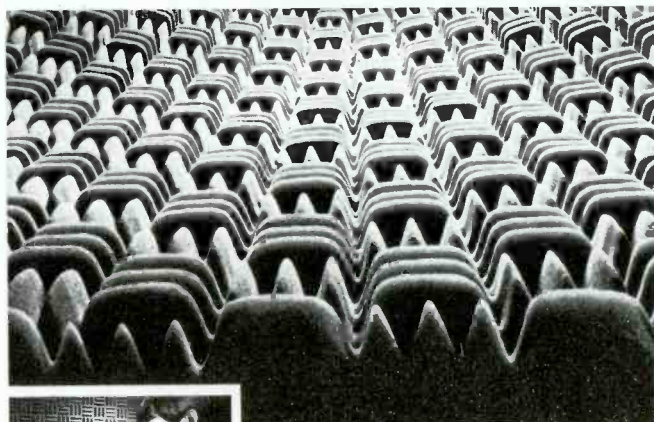

With its patented anechoic foam wedge, SONEC absorbs and diffuses unwanted sound in your studio. And it can effectively replace traditional acoustic materials at a fraction of the cost. SONEC blends with almost any pro audio decor and looks clean, sharp, professional. Check into this attractive alternative for sound control. Call or write us for all the facts and prices.

SONEX is manufactured by Illbruck and distributed exclusively to the pro sound industry by Alpha Audio.

Alpha Audio
2049 West Broad Street
Richmond, Virginia 23220 (804) 358-3852

Acoustic Products for the Audio Industry
Circle (128) on Reply Card

Console

API Audio Products has introduced the model 4032 console. It is fully automated with an Audio Kinetics master mix disk-based automation system. It has 48 inputs with 32-channel monitoring and up to 14 effect sends per channel, eight of which can be made into four separate stereo pairs. The monitor section is completely separate with two stereo cues or four mono cues. It has a 600-point ¼-inch patchbay and four separate headphone mixes.

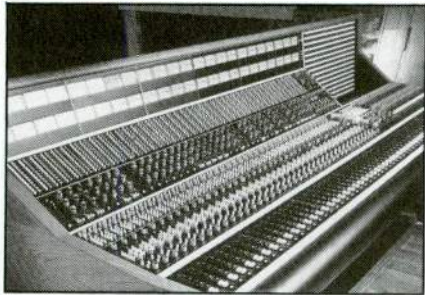

Circle (352) on Reply Card

VCR head cleaner

Allsop has introduced a line of cleaning cassettes designed for use in ¾-inch U-matic, ½-inch VHS and ½-inch Beta equipment. The cleaners use a non-abrasive cleaning ribbon together with an alcohol/Freon solution. The cassettes can be used for 25 to 50 cleanings, depending on the model. The formats are fully compatible with a variety of recorders, players and camcorders.

Circle (353) on Reply Card

Traffic management system

Alamar has introduced the Libra, a computerized traffic management system that can be either purchased or leased. It provides immediate access to current log status and availabilities reports. The system interfaces to the Alamar MC-1055 master program sequencer, making it possible for the equipment playlist to be generated and downloaded directly from the traffic department.

Circle (354) on Reply Card

Post-production system, videodisc player, multicam option and expanded EDL

CMX has introduced the following products:

- The CMX 330S post-production system combines editing and switching capabilities in a single system. It features a built-in audio-video switcher and has on-line and off-line editing, a controller with 3.5-inch disk drive interfaces for three



Al Watson

ENGINEER'S NOTEBOOK

Number 1 in a series

N/DYM™ Technology Comes to Broadcast Microphones

By Alan Watson, Director of Engineering
Electro-Voice, Inc.

Those familiar with the benefits enjoyed by musicians through the new neodymium-magnet microphones have no doubt predicted that the new technology would soon be available in broadcast microphones. And now, with the advent of the Electro-Voice RE45N/D hand-held shotgun microphone, the prediction has come true.

The advantages N/DYM™ technology brings to broadcasting are significant. Above all, it gives us a microphone with the high output previously available only from condenser mics—but without the problems of dead batteries, noises caused by poor ground connections in phantom-powering, humidity damage, static electricity, and poor rf rejection.

The Alnico magnets used in most dynamic mics yield a sensitivity of 6 dB less than would be possible if the steel parts of the magnetic structure could be completely saturated with the field. Increasing the Alnico magnet size does not work since the added size interferes with the acoustic design of the mic. Neodymium magnets, however, are so powerful that the magnet can be far smaller and still provide the "lost" 6 dB of sensitivity.

N/DYM Technology extends far beyond a mere substitution of magnetic material. To maximize the new opportunities, Electro-Voice engineers found that the ideal neodymium magnet shape is one with a thin, wafer-like configuration.

This permitted using a voice coil and attached dome of far larger diameter while reducing the surround—yielding important added advantages for broadcast engineers: a smoother, more evenly contoured pickup pattern with extended high- and low-frequency response and better rejection of unwanted noise from the sides.

For more information, please write to us for the specification sheet and brochure on the RE45N/D—the broadcast industry's first N/DYM dynamic shotgun microphone.

600 Cecil Street • Buchanan, MI 49107 • 616/695-6831
In Canada:
Electro-Voice Div., Gulton Industries (Canada) Ltd.
P.O. Box 520 • Gananoque, Ont. K7G2V1 • 613/382-2141



BROADCAST/PRODUCTION MICROPHONES

Quality-made in the U.S.A. since 1927

Advertisement

Circle (114) on Reply Card

serial VTRs, and a GPI for control of eight devices. The audio-video switcher provides cuts, dissolves and fade-to-black for A, B and C source machines, along with auxiliary and black inputs. A non-TBC mode allows for cuts and fade-to-black in the absence of time base correctors.

- A dual-headed videodisc player for the CMX 6000 laserdisc-based editing system has only two laserdiscs (one picture, one sound). Current single-headed players require four laserdiscs for the same amount of source material.

- Multi-Cam is a feature designed to permit multiple-camera random-access editing. It is available on the CMX 6000 laserdisc-based editing system. With the option, editors can view and edit "in sync," using several film cameras or videotape recorders, shot at varying angles in the same time code. Multi-Cam also offers editors the option of operating in a single-camera mode.

- The CMX 3400 computerized videotape editing system has the ability to generate the expanded CMX EDL as well as the standard CMX EDL. The option, the CMX 3400A Version 600, allows for the expand-



CMX 6000

ed EDL function through use of full alphanumeric reel names. The option also allows for the highlighting of all kinds of a featured event, including master/slave information.

- Separate audio and video crosspoints have been added to the CMX 3600 computerized editing system. The features include expanded save system with GPI configurations and switcher memory configurations; keyboard assignments of separate audio and video switcher crosspoints; keyboard selection of time code, tape

timer or user bits for each machine; and expanded learn keys with eight character titles, keystroke display count and deletion of one or all learn keys.

Circle (355) on Reply Card

Broadcast console

Broadcast Audio has introduced the System 20-VI. It features 2-inch modules that enable up to 20 mixers or optional panels to fit into the same mainframe as the System 16-IV. Four muting or control relays and 17 open collector outputs are standard. Equalized mixers and pan pots are optional. Double-sided ground plane motherboards minimize noise and crosstalk.

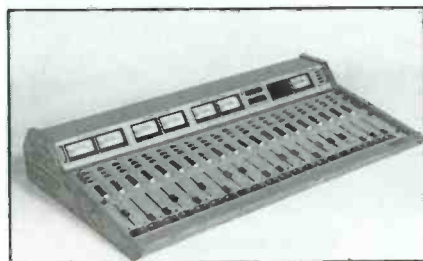

Circle (356) on Reply Card

MAP AUDIO

INSTANT AUDIO SYSTEMS

IMPAC™ SERIES

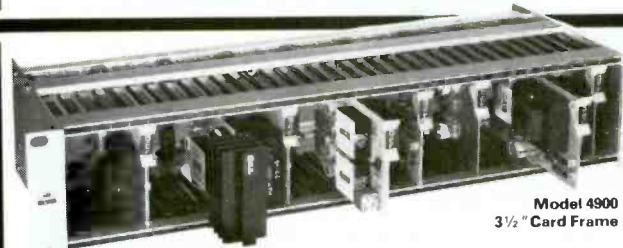

Model 4900
3 1/2" Card Frame

FOR IMPAC SERIES PLUG-IN CARDS.
FRAME WILL ACCOMMODATE WIDE
RANGE OF MODULES:

- MIC Preamps
- Line Amplifiers
- Phono & Tape Preamps
- VCA Modules
- Monitor Amplifiers
- Power Supplies
- Switcher Cards
- Distribution Amps

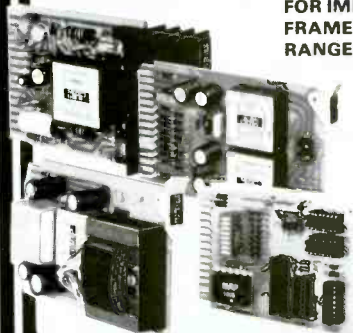

SEND FOR DATA



MODULAR AUDIO PRODUCTS

Brookhaven R&D Park • One Roned Road
Shirley, NY 11967 • (516) 345-3100 • 1-800-333-7697

Circle (115) on Reply Card

NEW

SHOULDER CASE FOR CAMCORDERS



Newly developed instant rain-top shown in place. Note small pocket for storing.



Everyday padded protection.

► This All-The-Time padded case protects against bumps, scrapes, heat and cold. Air travel carry-on. Also quick, easy, extra rainproof and dustproof protection.



K&H Products, Ltd.

Box 246
North Bennington
Vermont 05257

PHONE 802-442-8171
FAX 802-442-9118
TLX5 106005222 K AND H

Circle (116) on Reply Card

Self-contained studio program

Beacon Firmware has introduced the Studio Assistant I (version 1.20). The self-contained program cartridge plugs into the side of a Tandy Color Computer 3. The program is designed to display information as video pages and allow that information to be rapidly and easily updated.

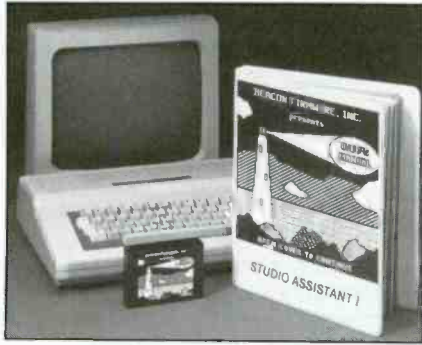

Circle (357) on Reply Card

Transmitter remote control

Advanced Micro-Dynamics has announced the ARC-16. It features 16 channels and allows the user to control one or more transmitters from the studio, by telephone, or with a combination of both. The transmitter remote-control unit includes a 32-character display for calibration and local operation. (Values are displayed with user-selected labels and units.)

The studio controller establishes a full-time studio-to-transmitter connection and displays clear-text prompts as a guide to the operator using the same 32-character LCD as the transmitter unit. The digital speech unit allows transmitter control by telephone and can be used as the only control or in addition to the studio controller. The transmitter remote control features a modular design to allow control of multiple transmitter sites from a single location, use of multiple control locations or the addition of a redundant control/metering link.



Circle (358) on Reply Card

Video monitor

Dotronix has introduced a 10-inch and 20-inch Super VHS high-resolution video monitor. The model DSV10/20 was designed for high-resolution video sources such as S-VHS, U-matic, laserdisc and ED Beta. The unit can accommodate Super VHS, Y and C, standard NTSC and analog

RGB inputs and also can accept TTL digital inputs for computer applications. The video monitor has more than 500 lines of resolution.

Circle (359) on Reply Card

Transmission system

Comlux has introduced the following products:

- The Optical Data System 2000 is a digital

fiber-optic transmission system that transports video, audio and data in a single 140Mb/s optical channel. The all-digital system has no operational adjustments or un-repeated ranges of more than 50km, and performance is unaffected by transmission distance or multiple-signal channels. The optical signals can be split, coupled, switched or repeated with no signal degradation.



30 YEARS

MANUFACTURING THE INDUSTRY STANDARD

22" Wide Broadcast Rack

20" Wide Monitor Rack

20 1/4" Wide Narrow Rack

45 Heights 4 Depths 47 Colors

GKM

Manufacturing Corporation

47 Bridgewater Street

Brooklyn, NY 11222-3890 (718) 388-4114

Call or write for catalog

Circle (96) on Reply Card

• Model 2507/2508 9-bit digital video encoder/decoder is a linear PCM video codec used with the Comlux System 2000. It provides high-quality, uncompressed digital video at RS-250B short-haul performance, plus a subchannel for audio and data.

Circle (360) on Reply Card

Character generator

For-A has introduced the VTW-240

character generator, a library-based system that allows programmable display of up to 1,600 pages in sequence. The system has four downloadable resident fonts that can be used in any combination on any page. The colors are selected from a programmable 14-chip palette, chosen from 512 color combinations, with an internal 3-zone background color generator. The character generator features include nor-

mal or drop-shadow edging; displays in cut, roll and crawl modes; page and font library on 3.5-inch floppy disk; individual flash, color, underline and upper/lower cases; and word-processing capabilities.



Circle (361) on Reply Card

ZERO LOSS VIDEO DELAY

bvs DL 705 SERIES

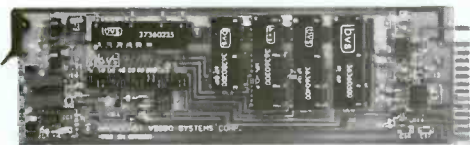

- Transparent video timing
- Delays from 10 ns to 1945 ns via jumpers and fine trim
- Up to 12 cards in 2 RU frame

- Looping input, 2 outputs per card
- Input and output return loss better than 40 db
- Flat response to 5.5 MHz
- Phase equalized
- Versions to plug directly into popular DA frames

broadcast video systems ltd.

40 West Wilmot Street, Richmond Hill, Ontario L4B 1H8
Telephone: (416) 764-1584 Telex: 06-964652 Fax: (416) 764-7438

Circle (118) on Reply Card

Lightweight headset

Controlonics has introduced the RHS-3, an ultralightweight headset that weighs 1.5 ounces. The headset features an adjustable metal boom with a noise-canceling electret microphone that produces clear communications at normal speech levels. The foam earpad allows the user to wear the headset for extended periods of time. The headset is designed to be used with the company's radio adapter.

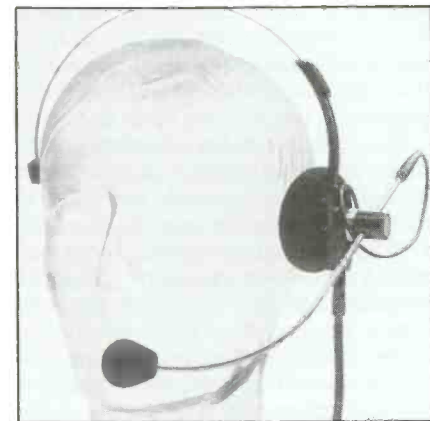

Circle (362) on Reply Card



For AM, FM, SCA and TV modulation monitors.

WHEN ACCURACY COUNTS... COUNT ON...

Call (215) 687-5550 or write for more information on Belar AM, FM, Stereo, SCA and TV monitors.



LANCASTER AVE. AT DORSET DEVON, PA 19333

Circle (119) on Reply Card

Frame synchronizer

Hotronic has introduced the AH91 TBC/frame synchronizer. It is a dual-channel video system used in A/B roll editing. The two channels are independent, each with full proc-amp control and composite or Y/C 3.58 selectable input. This allows the synchronizer to work with 1/2-inch VHS, S-VHS and 3/4-inch U-matic VTRs with or without advance sync input, and with or without 3.58 subcarrier feedback. Y/C 3.58 chroma and luminance processing is separate. The synchronizer features special effects such as wipes, tile, posterization, mosaic and negative. All the transition effects can be controlled by the editor controller.

Circle (363) on Reply Card

RS-232 interface version

Audio Precision has introduced an RS-232 interface version of System One. This version permits operation from the serial port of laptop IBM PC-compatible computers. The RS-232 version allows measurements of audio transmission links and remote facilities with no need for a PC at the distant point. Full control of the remote test system is accomplished via dial-up telephone lines and modems.



Circle (364) on Reply Card

Switcher

Crosspoint Latch has introduced a Y/C version of the 6119 switcher. The 6119YC operates in both composite and in Y/C (S-VHS). The unit has six inputs, three buses with two levels of keying with key invert on DSK and a GPI standard. The unit features 12 wipe patterns, joystick positioner, soft or variable color-bordered edges, colorizer, auto transitions with variable rate control and master fade to black. Standard features include an internal sync generator, four blackburst outputs, blanking processor and test mode. The switcher options and accessories include RGB chroma-keyer, audio-follow mixers, intercom/tally, extended wipe generator with 32 additional matrix wipes and the micro-processor controller.

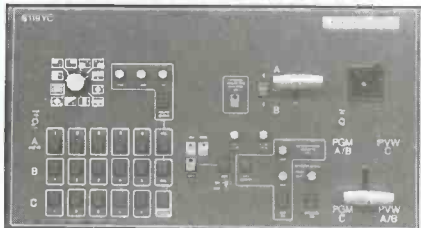

Circle (365) on Reply Card

Digital sound production system expansion

E-mu Systems has expanded the Emulator Three digital sound-production system.

• The EIII Rack packages all the features of the Emulator Three in a rack-mountable

package.

• The HD 300 is a 300Mbyte rack-mountable hard disk storage system for the EIII. It transports data over its high-speed SCSI interface and will load an entire 4Mbyte bank of 16-bit sound in less than 9s. It comes standard with 10 banks of factory EIII sounds.

• New sounds for the EIII include: stereo steel drums, stereo French horns, stereo

synth combo, flute, vintage synths and ambient dance club.

Circle (366) on Reply Card

Rotary phase converter

Kay Industries has introduced the T-series Phasemaster, a rotary phase converter for use with broadcast transmitters. It features a load range control to match the converter output to actual transmitter

Start with Stainless. Stay with Stainless.

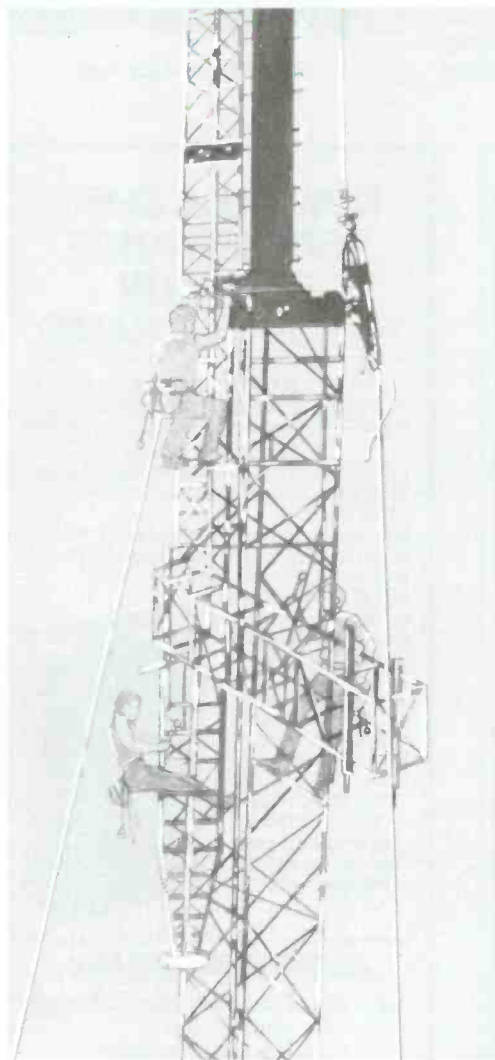

Now there's a new force--and single source--in the tower business.

Introducing Stainless Construction Company. Today, we can provide total turnkey operation for all your tower needs. Including engineering design and tower erection.

Stainless Construction also offers maintenance, inspection and modification work for towers, antennas and transmission lines.

Regardless of the tower maker you choose, count on Stainless Construction Company for complete assembly and support services. For more details, and our competitive pricing policy, give us a call. In North Wales, 215-699-4871; or Harrison, Arkansas, 501-741-9550.



**STAINLESS
CONSTRUCTION
COMPANY**

North Wales, Pennsylvania 19454
215-699-4871 • FAX: 215-699-9597
Harrison, Arkansas 72601
501-741-9550

Circle (120) on Reply Card

load. The rotary phase converter is engineered from both AM and FM radio and TV transmitters. It provides immediate power availability, improved line-voltage stability, short-term ride-through during voltage dips and transient suppression. The converter can be supplied with automatic control for high/low power switching and remote operation.

Circle (367) on Reply Card

Satellite synchronized clock



Kinemetrics/TrueTime has introduced the model 468-DC GOES Satellite Synchronized Clock. The clock is packaged in a 1.75-inch-high, rack-mountable chassis. The unit locks onto the signal provided by its compact antenna and decodes the time information on the carrier. It can provide synchronized digital time outputs to an accuracy of ± 0.5 ms of Universal Coordinated Time at NBS. Time data is available in

IRIG-B time code and RS-232, parallel BCD or IEEE-488 interfaces. Internal switches allow accurate compensation of propagation delay, choice of 12- or 24-hour format and accounting for daylight-saving time.

Circle (368) on Reply Card

Pulse generator

Leitch Video International has announced a PAL test/sync pulse generator, the SPG-1510P. The SC/H tolerances surpass the EBU requirements and simplify multiple-editing procedures. Color framing continuity is maintained from input to output, and large SC/H errors at the input are identified with a warning LED. All timing is handled by microprocessor, and presets are stored in a non-volatile memory. The pulse generator can be controlled locally from a remote-control panel or by a computer using the RS-422 interface.

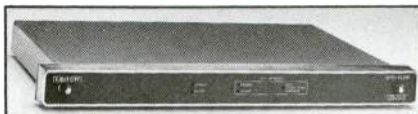

Circle (369) on Reply Card

RDS coder

RE Instruments has introduced a programmable RDS coder. The unit is to be used for inaudible insertion of paging information, clock data and program information into a VHF/FM broadcast. The data sets that define these functions are created by using a special PC-compatible software package supplied with the instrument.



Circle (370) on Reply Card

PC-compatible software

Integral Systems has announced the Organizers, two IBM PC-compatible software packages for facilities in the production and recording industries. The Tape Li-

BJM ELECTRONICS

A Great Supplier to a Great Industry

Distributor of:

- Adapters Audio/Video
- Cables Audio/Video
- Connectors Audio/Video
- Fuses & Lamps
- Multi conductor cable
- Multiple outlet strips
- Shrink tubing
- Test equipment
- Tools
- UL approved cable ties
- Video Replacement head
- Wire teflon

BJM is dedicated to the hard to find items that surround our ever expanding industry. We invite you to call for our free catalog.

1-800-DIAL-BJM

2008 Victory Blvd.
Staten Island, N.Y. 10314

OUTSIDE N.Y: (718) 442-0223
FAX: 718-442-1451

Circle (121) on Reply Card

NOW, FULL SHIFT PERFORMANCE FOR YOUR HAND-HELD RADIO

SUPER ICOM CM-7S

13.2 volts, 900 ma, double the capacity of the ICOM CM-7, 5 watt output for the IC-U2/U16/H16.

SUPER ICOM CM-8S

9.6 volts, 1200 ma, 50% more capacity than the ICOM CM-8, 3.5 watt output for the IC-U2/U16/H16/U12/H12.

Both are base charge only using CM-30, CM-35 or CM-60 chargers, and include overcharge and short circuit protection. CM-7S or CM-8S \$65.00 + \$3.00 shipping.

Call Periphex for all your battery needs. Motorola, GE, RCA, Kenwood, Icom, Johnson, Standard, etc. Also complete inventory of Gel Cells, Sealed Lead Acid, Alkaline and Nicads. All battery packs include a 1 year guarantee.

Call or write for your free catalog. Dealer inquiries invited.



PERIPHEX inc.

149 Palmer Road • Southbury, CT 06488
(800) 634-8132
in CT (203) 264-3985

Circle (123) on Reply Card

Want To Talk Broadcasting?

BPFORUM
ON
COMPUERVE

John Hoffman
Net
Administrator
76703, 1036

brary is an advanced software system used to keep track of tapes that facilities need to reference. Tape location is achieved in minutes using the title, artist, content, dates, key word index and producer. The Order Tracker software is used to keep track of rental time and tape ordering by production and recording facilities. It is used to trace production through a facility and includes dynamic data tracking sales, rental and time billing. The software runs stand alone on PC systems or PC networks. The software is user-friendly and menu-driven, bar-code- and mouse-compatible, and features pop-up HELP screens and clear instructions.

Circle (371) on Reply Card

Power-line monitors

Hub Material Company (HMC) has introduced the digital model WD121 power-line monitor and the analog model WV120C. The meters reveal bounces and fluctuations in line voltage and warn of potential brownout conditions. You can monitor line only, or install the meters between ac line and equipment. Model WD121 features a 3-digit, 0.8-inch LCD display. The

model WV120C features easy-to-read scales. Both models measure true rms ac voltage.



WD-121 and WV-120C power-line monitors

The company also has introduced the model 1010 portable oscilloscope. It contains a blue and white 1" x 1.5" display and includes a built-in calibration circuit as well as a full complement of adjustments. The portable oscilloscope offers dc to 10MHz bandwidth, 12 sensitivity ranges and 21 time base ranges. Vertical sensitivity can be selected from 10mV/div to 50V/div, and

time base can be varied from 0.1µs/div to 0.5s/div. The miniscopes include internal and external triggering with sensitivity of <math><1\text{div}</math> internal and <math><1\text{V}</math> external.

Circle (372) on Reply Card

Wire stripper

Paladin has added a wire stripper to its line of West German-made stripping tools. The PA 1101 Maxi-Stripax is designed for cutting and stripping of 10- to 22-gauge wire, flexible and solid PVC, multicore ribbon cables, hard PVC insulation, and double insulated cable or fiber-optic cable that can be stripped in two operations without any adjustment. The stripper features a built-in wire stop, insulation to 600V, front feed and a built-in wire cutter.

Circle (373) on Reply Card

Sound-effects library

New England Digital, in partnership with Sound Ideas, has developed an optical disk-based sound-effects library. The disk contains 1,462 captioned and cross-referenced sound effects. All source material on the disk was recorded digitally, then sampled into New England Digital's

MOVING?

Take us with you.

Just peel off your subscription mailing label and attach it to the address change card inside this issue. Please allow 6-8 weeks to process your address change.

New Scanner by AOR

100 Channels
800 MHz



- Includes antenna, rechargeable battery, charger/adaptor & belt clip. Full range of optional accessories available.

- Covers 27-54 MHz, 108-174 MHz, 406-512 MHz, and 800-950 MHz.

- 5 Scan Banks and 5 Search Banks.

- 25 Day Satisfaction Guarantee, Full Refund if not Satisfied.

- No Frequencies cut out.

- Size: 2' x 5 1/4" x 1 1/2" wt. 12 oz.

AR900

Total Price, Freight Prepaid
(Express Shipping Optional)

\$299.00



COMMUNICATIONS

10707 E. 106th St. Indpls., IN 46256

Toll Free 800-445-7717

Visa and MasterCard
(COD slightly higher)



In Indiana 317-849-2570 Collect FAX (317) 849-8794

Circle (122) on Reply Card



CHEMICAL SOLUTIONS

FREE CHEMTRONICS CATALOG!

Comprehensive new source for over 200 products used in electronic manufacturing and field service. Precision cleaning agents, flux removers, bulk solvents, circuit refrigerants, precision dusters, non-residual wipers, foam swabs, premoistened pads/swabs, antistatic compounds, conformal coatings, lubricants, adhesives, desoldering braids, rosin core solder and solder masking agents. Complete with technical specifications and application guide.



Chemtronics Inc.
681 0'd Willets Path
Hauppauge, N.Y. 11788
516-582-3322

Circle (126) on Reply Card

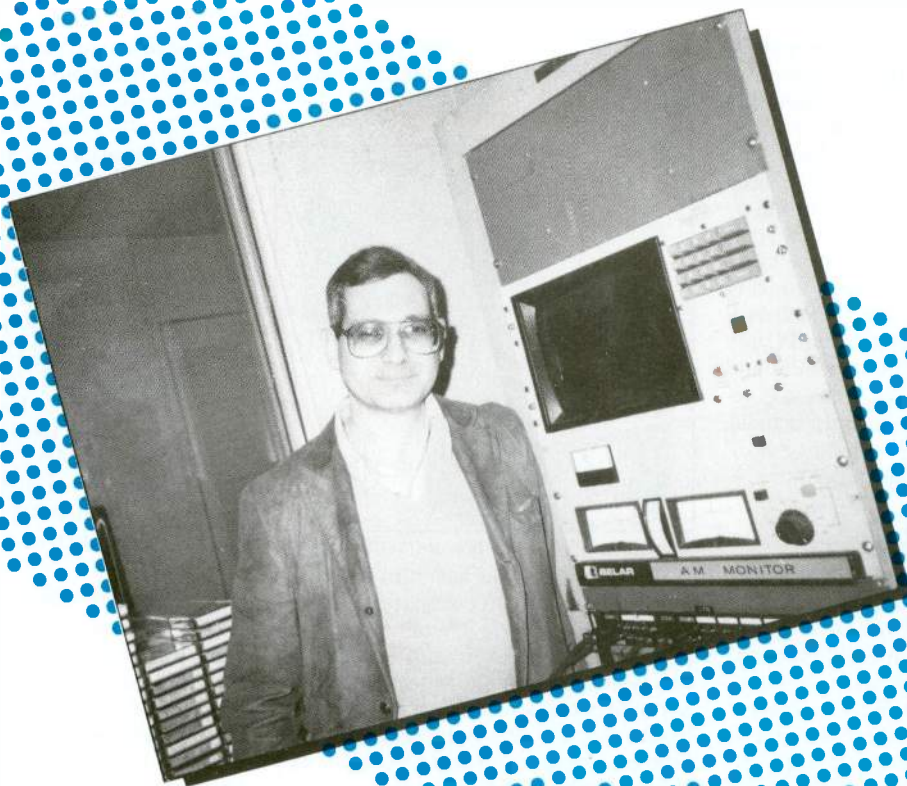

"I regularly remove technical articles from broadcast magazines and file them in my PC's database for future research and reference.

So far, the articles I have saved run three to one in favor of *Broadcast Engineering!*

Barry A. Chickini
Chief Engineer
Radio Station WTIX
New Orleans, LA

BROADCAST
ENGINEERING®

Synclavier digital audio system at rates of 50kHz or better. Most of the effects on the optical disk are in true stereo. The library comes with a manual that cross-references effects by title, file name, category, caption and volume; it lists lengths and sizes in seconds, sectors and megabytes.

Circle (374) on Reply Card

Hand-held multimeters



John Fluke Manufacturing has introduced the 80 series, a 3-model series of low-cost, high-performance, 3½-digit sealed hand-held multimeters. The Fluke 83, Fluke 85 and Fluke 87 are true rms multimeters that offer a combination of measurement functions and safety fea-

tures including frequency, duty cycle, capacitance, simultaneous minimum/maximum/average recording, minimum/maximum alert and input alert. The series is designed for use in electronic field service and plant maintenance applications, using the features of the 70 series.

Circle (375) on Reply Card

Power protector and lightning strike counter

PolyPhaser has introduced the following products:

- The IS-PM240-1P power mains protector is a shunting-type protector independent of ac current usage. It is designed for 240Vac single-phase applications. The turn-on voltage is $\pm 200V$ peak with a response time of 28ns. The circuit breakers are for added protection, because the field-replaceable protectors will, at end of life, die shorted. The relay contacts can be used for local or remote alarms.
- The LSC-2 is a lightning strike counter that plugs into a wall outlet and counts surges that exceed the $\pm 200V$ threshold with 1j of energy. The unit is circuit breaker, with internal surge protection, and

the non-resettable counter will count to 1,000,000 surges. A 20-inch-long 3-prong power cord allows the unit to sit on the floor.

Circle (376) on Reply Card

Programmable mic processor

Orban has introduced the model 787A programmable mic processor. It features a 3-band constant-Q parametric equalizer, compressor with adjustable release time, de-esser, noise gate and/or compressor gate, and effects send and return ports, integrated into a 2-rack system. Complete control setups can be stored in 99 memory registers through keystroke sequences for instantaneous recall. Bar-graph displays indicate gain reduction and peak output levels. A numeric display indicates the current setting of a selected parameter. To prevent unauthorized tampering with presets, a security code locks programming controls. A central Z-80 microprocessor with power-line monitoring capability protects memory contents. The processor offers a line-level input as standard. Remote program-stepping by external contact closure is provided.

Circle (377) on Reply Card

When there's a lot coming in



The new 7510 video processing amplifier from the Grass Valley Group is designed to process "off air" signals from satellites, microwaves and land lines.

Its unique modular design, one module — one processor, is compact and provides space for expansion. If the traffic increases . . . just add another module!

If you want real processing power today, with room for more tomorrow, call for full details now.

Grass Valley Group®

A TEKTRONIX COMPANY

THE GRASS VALLEY GROUP INC.

P.O. Box 1114, Grass Valley, CA 95945 USA
Telephone (916) 478-3000
TRT: 160432

GVG International Ltd. (U.K.) +44-962-843939
Grass Valley Group Asia (HK) +852-3-7396632

it pays to be modular.

Circle (129) on Reply Card

T1 Digital Audio

A Clear Difference
Across Town or
Around the World



Digital audio over T1 circuits consistently provides higher quality than conventional methods. Use T1 digital audio for:

- Local program circuits.
- Long-distance program circuits.
- Studio-to-transmitter links.

And you can easily configure multiple program circuits with voice and even data.

Call us to discuss how Intraplex T1 digital audio can benefit you.



Intraplex, Incorporated, 59 Porter Rd., P.O. Box 2427, Littleton, MA 01460-3427
TEL: (617) 486-3722 / FAX: (617) 486-0709

Circle (130) on Reply Card

DON'T LET THE DROUGHT KNOCK YOU OUT!

Your ground system is dry and not conductive. A scattered lightning cell appears and in the blink of an eye your equipment is down.

From mountain tops to the plains PolyPhaser's PolyRod systems can keep you communicating.

For information on this and our 400 additional Lightning Protection products, contact:

**PolyPhaser
Corporation**

P.O. Box 1237 • 1425 Industrial Way
Gardnerville, NV 89410-1237
(702) 782-2511 • (800) 325-7170
Fax: (702) 782-4476 • Telex: 272718

Circle (131) on Reply Card

Video work station upgrade

Pinnacle Systems has announced the upgrade capabilities for the Super V-1000 Video WorkStation. The 1000, originally introduced as an effects system with a limited upgrade path, is upgradable to the more powerful 2000- and 3000-series products. In addition to the background image buffer, enhanced digital effects, freeze frame, built-in digital keyer and still-store capabilities, the upgrade offers paint, 3-D modeling and animation and the PRIZM option. The PRIZM offers 3-D perspective and rotation about the X, Y and Z axes, as well as object placement in 3-D space with global location and rotation.

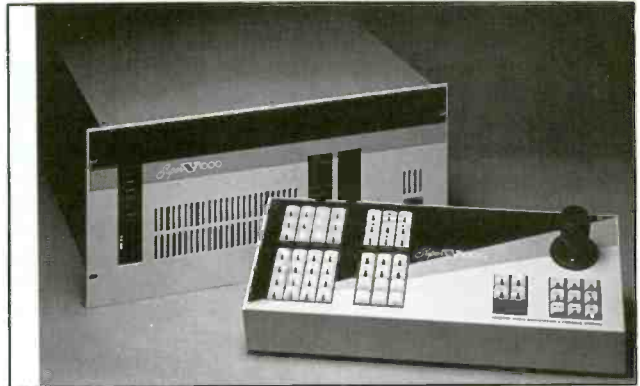

Circle (378) on Reply Card

MIDI interface

Integrated Media Systems has introduced the MIDI interface to the Dyaxis direct-to-disc digital audio recording system. The interface combines a time-code reader and generator with SMPTE-to-MIDI conversion and MIDI-to-serial conversion in a single-space, rack-mountable package that allows the Dyaxis system to record or play back under time-code control without the need for additional hardware.



Circle (379) on Reply Card

Software and manual

Solid State Logic has released the G series software and a computer operator's manual. Copies of the software and the manual automatically will be sent to existing clients who have received G series upgrade kits or complete G systems. The release of the software is a result of user feedback. It also corrects some early software bugs that were encountered in the first G software release.

Circle (500) on Reply Card

Switcher upgrade

Videotek has added the Prodigy, an upgrade standard feature, to its switcher. The feature is a user-programmable downstream keyer that has been designed into the switcher. Key in/out transitions can be from 0 to 999 frames. External key cut and key fill are provided with the upgrade's downstream keyer.

Circle (380) on Reply Card

Power-protection system

Viteq has announced the Benchmark UPS model 15A, a power-protection system that does not require the installation of a dedicated line supplying increased utility service capacity of 20A or more in order to serve a load of 12A. The on-line UPS will protect any minicomputer or other type of equipment load rated 12A or lower from all types of line disturbances. The power-protection system has circuitry incorporating a static bypass switch, providing an unlimited inrush surge capacity of up to 10 times the nominal rating. Input voltage fluctuating from 90V to 140V is accommodated.

Circle (381) on Reply Card

Film-to-tape transfer time-code generator

Skotel has introduced the model TCG-80N-FT (NTSC model) time-code generator. It identifies 16mm and 35mm film to a single frame accuracy and graphically identifies the 3/2 scan sequence within the foot and frame window. The graphic display permits the operator to identify where the film 3/2 sequence is positioned in relation to the video. This feature permits accurate conforming decisions to be made and ensures the negative is cut within the correct film frame.

Each video field is encoded with 3/2 information and displayed graphically within the foot and frames window. Using the integral character inserter, this 3/2 information and time code are keyed into the local picture monitor and displayed simultaneously. Information displayed includes reel number, footage and frame count and the 3/2 sequence number at the punch mark. Other features include 24fps or 30fps film frame rates, counts from stop to forward, reverse and shuttle speeds, and 240Hz bi-phase (10 pulses/frame) film tach reference.



Circle (382) on Reply Card

Frame synchronizer, remote control

JVC Professional Products has announced the following products:

- The KM-F250U multiformat frame synchronizer provides multi-signal standard transcoder functions and full-frame remote control. The unit allows 3/4-inch, S-VHS, M-II and composite equipment to be integrated in the editing suite. It is rack-mountable and conforms to CCIR recommendation 601 and RS-170A. The synchronizer features built-in dropout compensation and field-freeze and frame-freeze functions.
- The RM-P250U wired remote-control unit is designed to be used with the KM-F250U. It provides remote control of the synchronizer's functions and provides two special-effects features: strobe and negative/positive reversal.

Circle (383) on Reply Card

Text and graphics overlay card with videodisc control

Video Associates Labs has introduced the MicroKey/Mark 10, a modular board level NTSC/PAL product. It is an insertable, plug-in modular board to consolidate on one PC bus card (requiring only one slot), including standard EGA graphics with

Perfect Timing

CLOCKS AND TIMERS

FROM \$183



TO \$495



(213) 322-2136

142 Sierra Street, El Segundo, CA 90245

Circle (132) on Reply Card

THOMSON-CSF

POLARIS EXPANSION 5608/88

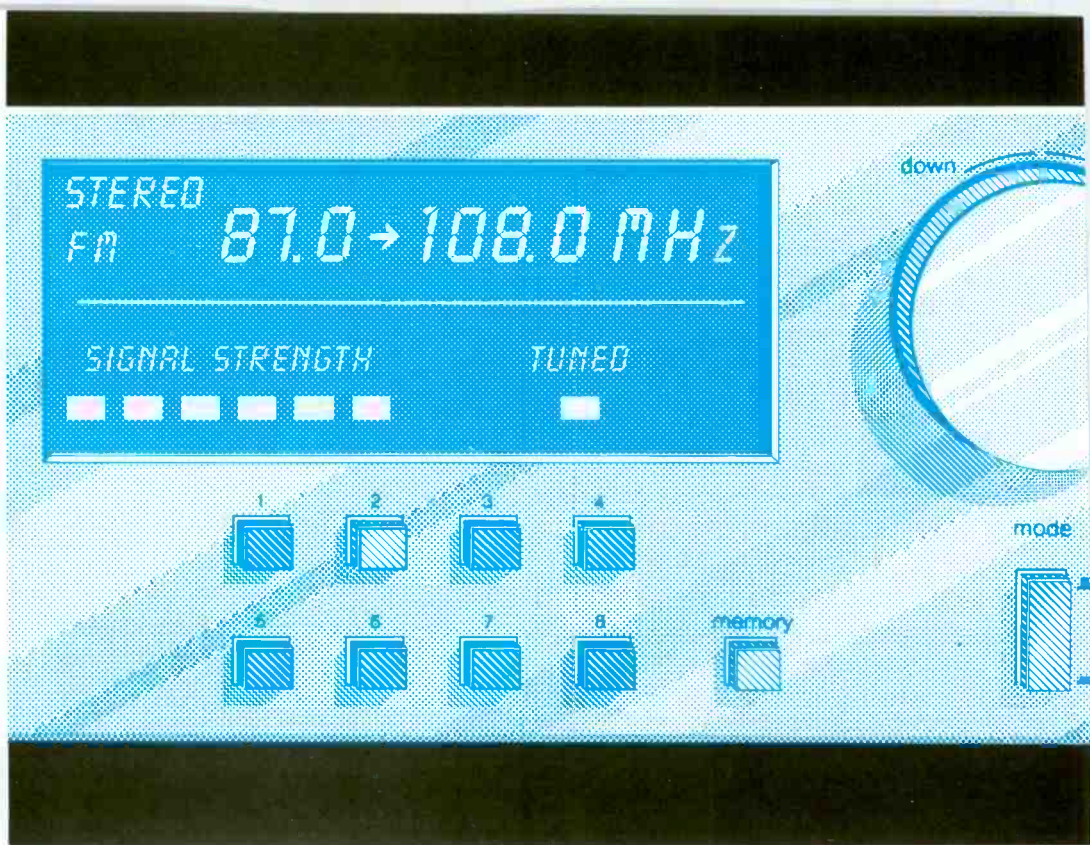

FM TUBE POWER, PLUS THE RELIABILITY YOU DEPEND ON? THOMSON-CSF IS ON YOUR FREQUENCY!

Now you can guarantee the technical and price performance of your FM station. How? With FM tetrodes from Thomson-CSF. Available in a range to perfectly meet the needs of your station.

Thomson-CSF tetrodes are the cost-effective solution for your station. That's because they offer a maximum level of reliability plus simplicity of installation, operation and maintenance that you just won't find with competing technologies.

Models range from 10 kW up to an impressive 100 kW. What's more, Thomson-CSF tetrodes benefit from all the advantages of grounded grid technology. To further

optimize their performance, each tube is available with its matched cavity easily tunable from 87 to 108 MHz.

For operational integrity under all conditions, each tetrode incorporates original Pyrobloc® technology. In addition, our 100 kW tetrode features Thomson-CSF Hypervaportm® vapor phase cooling.

FM tetrodes from Thomson-CSF. Performance and reliability that pays for itself!

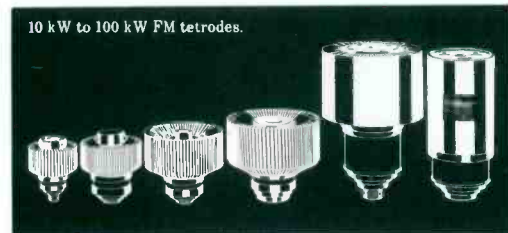

10 kW to 100 kW FM tetrodes.



THOMSON ELECTRON TUBES AND DEVICES CORPORATION
550 Mount Pleasant Avenue
P.O. Box 6500
DOVER, New Jersey 07801
Tel.: (1-201) 328-1400. TWX: 7109877901.
Fax: (1-201) 328-1747.

Circle (134) on Reply Card

Brasil: SÃO PAULO
Tel. (55-11) 5424722
Tx. (11) 24226 TCSF BR

Canada: MONTREAL
Tel. (1-514) 288 41 48
Tx. 5560248 TCSAF MTL

Deutschland: MÜNCHEN
Tel. (49-89) 78 79 0
Tx. 527916 CSF D

España: MADRID
Tel. (34-1) 405 19 15
Tx. 46033 TCCE E

France: BOULOGNE BILLANCOURT
Tel. (33-1) 49 09 26 28
Tx. THOMTUB 200772 F

Italia: ROMA
Tel. (39-6) 639 02 48
Tx. 620683 THOMIE I

Japan: TOKYO
Tel. (81-3) 264 63 46
Tx. 2324241 THCSF J

Sverige: TYRESÖ
Tel. (46-8) 742 02 10

United Kingdom: BASINGSTOKE
Tel. (44 256) 84 33 23
Tx. 858121 TECL UK G

U.S.A.: DOVER N.J.
Tel. (1-201) 328-1400
TWX 7109877901

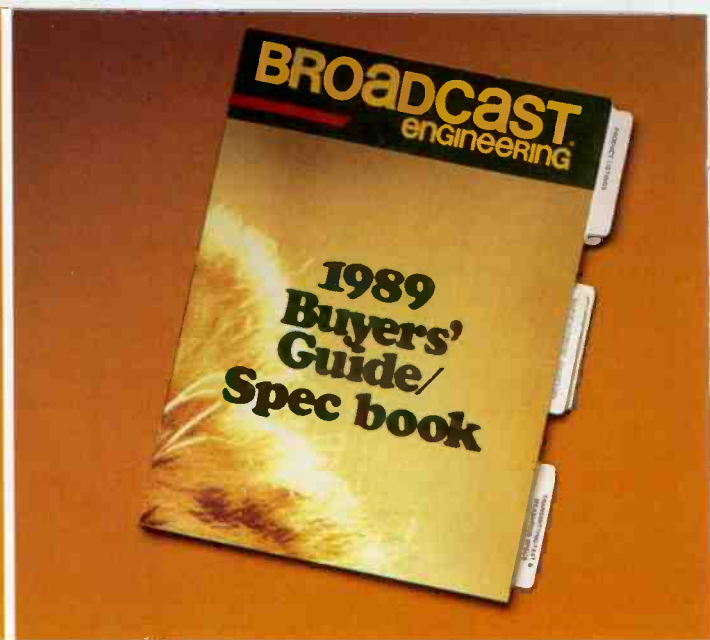
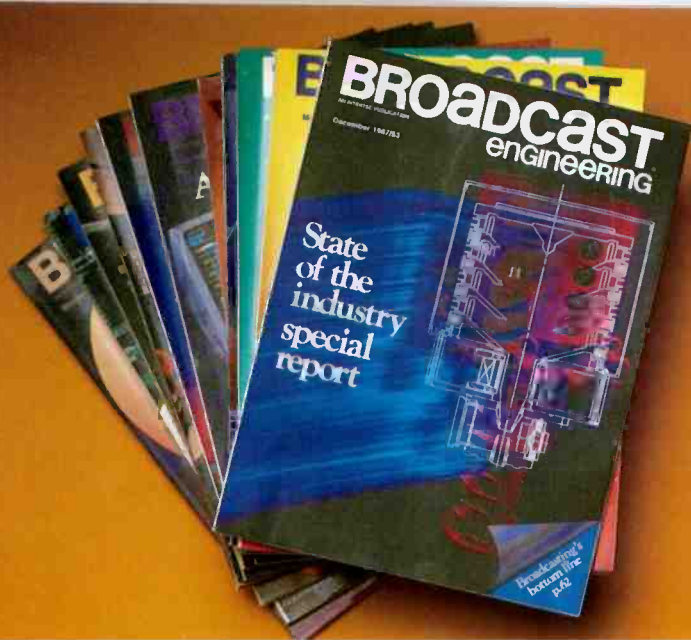

The monthly seminar

BROADCAST ENGINEERING gives you the information you need to plan your station's future. In fact, every issue is like attending a technical seminar in print.

But *BE's* seminars don't stop with our regular 12 issues. *Buyers' Guide/Spec Book* is the perfect complement to your "monthly seminar," dramatically simplifying your equipment purchases.

Past *BE* seminars have given you the technical information you needed to keep your station up and running, and to make informed purchasing decisions. Now you need the equipment to make it happen.

And that's where *Buyers' Guide/Spec Book* — your year-long reference manual — comes in.

The year-long reference manual



Over 350 types of equipment and services in the Product Listings. Over 1,000 entries in the Manufacturers' Addresses section. More than 40 categories of equipment with major specifications in a side-by-side presentation.

So many products . . . so many manufacturers . . . so many choices.

You are bombarded with so many advertising impressions and sales calls every day, it's easy to become overwhelmed. *Buyers' Guide/Spec Book* helps simplify your overwhelming purchasing

task by giving you everything you need in one neat, easy-to-use reference manual.

Equipment specs, technical data, manufacturers' addresses and phone numbers . . . and much more. Packed into the only comprehensive broadcast equipment directory of its kind.

With *Buyers' Guide/Spec Book*, you have at your fingertips everything you need to make equipment purchases your company can live with for a long time.

Make *Buyers' Guide/Spec Book* a permanent part of your reference library today. Read it. Use it. And save it.

***Buyers' Guide/Spec Book* — the year-long reference manual to *BE's* "monthly seminars in print."**

BROADCAST
engineering

P.O. Box 12901, Overland Park, KS 66212 (913) 888-4664

Professional services

VIR JAMES P.C.
CONSULTING ENGINEERS
Applications and Field Engineering
Computerized Frequency Surveys
3137 W. Kentucky Ave. - 80219
(303) 937-1900
DENVER, COLORADO
Member AFCCE & NAB

**PRO VIDEO & FILM
EQUIPMENT GROUP**
SPECIALISTS IN USED & NEW
WE BUY-SELL-TRADE-CONSIGN
FREE CATALOG ON REQUEST
(214) 869-0011 DALLAS

EVANS ASSOCIATES
CONSULTING TELECOMMUNICATIONS ENGINEERS
AM-FM-TV-CATV-ITFS-LPTV SATELLITE
216 N. Green Bay Road
Thiensville, Wisconsin 53092
Phone: (414) 242-6000 Member AFCCE

FCC ON-LINE DATABASE
dataworld[®]
Allocation/Terrain Studies
AM • FM • TV • LPTV • ITFS
P.O. Box 30730
Bethesda, MD 20814
(301) 652-8822 1-800-368-5754

D. L. MARKLEY
& Associates, Inc.
CONSULTING ENGINEERS
2401 West Moss Ave.
Peoria, Illinois 61604
(309) 673-7511
Member AFCCE

BLAIR BENSON
Engineering Consultant
TV Systems Design and Operation
23 Park Lane
Norwalk, CT 06854
203-838-9049

TEKNIMAX
TELECOMMUNICATIONS

DENNIS R. CIAPURA
PRESIDENT

11385 FORESTVIEW LN.
SAN DIEGO, CA 92131 (619) 695-2429

SMITH and POWSTENKO
Broadcasting and Telecommunications
Consultants
2033 M Street N.W., Suite 600
Washington, D. C. 20036
(202) 293-7742

Robert J. Nissen
THE NISSEN GROUP, INC.
Communications Technology Consultants
32 Ridge Drive • Port Washington, New York 11050
(516) 944-5477

DSI
COMMUNICATIONS INC.
• Radio and Television System Design
• Transmitter and Studio Installation
• Microwave and Satellite Engineering
and Installation
12 North Willow St.
Montclair, NJ 07042
201-746-9307

JOHN H. BATTISON PE.
CONSULTING BROADCAST ENGINEER,
FCC APPLICATIONS AM, FM, TV, LPTV
Antenna Design, Proofs, Fieldwork
890 Clubview Blvd. North
Columbus, Ohio 43085
614/888-3364

ERIC NEIL ANGEVINE, P.E.
consultant in acoustics
specializing in broadcast studio acoustics
910 Lakeridge Drive Stillwater, OK 74075
405-624-6043 405-372-3949

ALS AMERICAN LASER SYSTEMS, INC.
751 S. Kellogg Ave.
GULETA, CA 93117 USA

ENG • STL LINKS • SPORTING EVENTS
Solutions to LICENSE-FREE, short range
video/audio transmissions via infrared
atmospheric links

LORRAINE SHALLENBERGER 805/967-0423
MARKETING MANAGER FAX 805/683-4382

MAILING LABELS
AM, FM & TV
CALL
dataworld[®]
1-800-368-5754

PATCHPRINTS Video Tape Lines
In 1 2 Aux 1 2 Mon A B
Custom Patch Bay Labeling for the Audio/Video Industries
By
PATCH BAY DESIGNATION COMPANY
Div. of Glendale Rubber Stamp & Printing Co., Inc.
CHARLIE SCHUFER
P.O. Box 6278, Glendale, CA 91205 Telephone
4742 San Fernando Road (818) 241-5585
Glendale, CA 91204

East Coast Video Systems
ON-LINE IN-TIME

A full service company providing...
• Consultation • Engineering & Design • Installations • Training
Serving...
• Cable Systems • Corporate Facilities • Broadcast Facilities • Teleproduction Facilities

178 Casterline Road • Denville, NJ 07834 • (212) 431-7453

Consultation Services

Lightning • Power Conditioning • Grounding
Over 40 years experience, work guaranteed

Roy Carpenter
President

Lightning Eliminators and Consultants
13007 Lakel and Rd. Santa Fe Springs, CA 90670
(213) 946-6886 TWX 910-586-1381

Franklyn R. Beemish & Co.
Engineering for the Video, Motion Picture & Recording Industries

VIDEO POST, BROADCASTING, CONFERENCE CTRS, THEATERS, RECORDING

FACILITIES AND SYSTEMS DESIGN & IMPLEMENTATION
ANALOG & DIGITAL VIDEO, AUDIO, HDTV
ARCHITECTURAL ENGINEERING
ELECTRICAL, HVAC, ACOUSTICAL

574 Sunrise Highway, Baldwin, NY 11510 516/867-8510

CHUCK JONES
ANTENNA SYSTEMS
SPECIALIST
618-564-2481

SOUTHERN ILLINOIS ANTENNAS
RD 13 BOX 14
MORNING HILL 62960

UNUSED
CALL LETTERS
CALL
dataworld[®]
1-800-368-5754

**BROADCASTING CONSULTANTS
AND ENGINEERS**
• FCC Applications and Field Engineering
• Frequency Searches and Coordination
• Tower Erection and Maintenance
• Facility Design and Construction
Contact:
KENNETH W. HOEHN **Teletech, Inc.**
23400 Michigan Avenue Dearborn, MI 48124
(313) 562-6873

340 WEST 55TH ST., NEW YORK, NY 10019 (212) 769-4660



System Design
Studio Planning
Teleconferencing

**IDEO
DIMENSIONS
ORGANIZATION LTD.**

Broadcast Engineering Consultants

Hall Electronics
Broadcast Equipment & Components

• We buy and sell quality used radio broadcast equipment. 30 day warranties & economical prices.
• SEND FOR FREE FLYER
P. O. Box 7732
Charlottesville, Va. 22906
(804) 973-8697

PRO/INDUSTRIAL VIDEO REPAIR
• RAPID TURNAROUND • UPS PU/DEL DAILY
OF VO5850's AND • ON SITE PREVENTIVE
VO5800's MAINTENANCE
• GUARANTEED SERVICES IN
REPAIRS NORTHERN CA. AREA
(415) 391-2640
VIDEO TECHNICAL SERVICES
511 Sir Francis Drake Blvd., Greenbrae, CA 94904

Classified

Advertising rates in Classified Section are \$150 per word, each insertion, and must be accompanied by payment to insure publication.

Each initial or abbreviation counts a full word. Minimum classified charge, \$35.00.

For ads on which replies are sent to us for forwarding (blind ads), there is an additional charge of \$40.00 per insertion, to cover department number, processing of replies, and mailing costs.

Classified columns are not open to advertising of any products regularly produced by manufacturers unless used and no longer owned by the manufacturer or distributor.

TRAINING

FCC GENERAL RADIOTELEPHONE operators license through cassette recorded lessons at home plus one week seminar in Boston, Washington, Detroit or Philadelphia. Our twentieth year teaching FCC license courses. Bob Johnson Radio License Preparation, 1201 Ninth, Manhattan Beach, Calif. 90266. Telephone (213) 379-4461. 8-81-tfn

NAPA VALLEY COLLEGE offers a two-year maintenance telecommunications program. Emphasis in 1 inch C format, time base correctors, component and digital systems. Call or write Gary Vann, Napa Valley College, Napa, CA 94558, Ph: (707) 253-3258. 8-88-2t

SERVICES

AUDIO AUTOMATION: Computer controlled, 8-CD changers, music and commercial program software, hard disc for commercials. Complete: \$6900. BGM INTERNATIONAL, (904) 438-8054. 7-71-tfn

TRANSMITTER TUBE REBUILDING SINCE 1941: 3CX2500, 4CX5000, 4CX15000 and many others. Write for details. FREELAND PRODUCTS INC., Rt. 7, Box 628, Covington, LA 70433. (504) 893-1243 or (800) 624-7626. 6-79-tfn

FOR SALE

ORBAN OPTIMOD 9100A2 AM Stereo processors. BRAND NEW! 1987 list price \$5,995. Our price \$2,995. In original boxes with all standard accessories. May be used by C-Quam, Kahn, and mono stations. **GUARANTEED.** HALL ELECTRONICS, P.O. Box 7732, Charlottesville, Va. 22901 (804) 973-8697. 9-88-2t

MICROTIME T-220FIT FORMAT INTERCHANGE TBC. PAL/NTSC composite, component, dub signals; noise reduction, freeze frame, dynamic tracking. 1 year old with extender board and service manual. 213-462-0000. 8-88-2t

EQUIPMENT FOR SALE: 2-ACR's, plus 3,000 carts, plus Storeel storage, 1-ADDA 750 Still Store (3 Panels, plus 2 drives), 2-HL-79, 2-HL-83, CDL 480 MC Switcher, EPIC editor, CDL 480 Prod. Switcher (2 M/E). Call Don Hain, WPLG-TV, 305-325-2342. 7-88-2t

HARRIS "MICROSTAR" 2 GHz video microwave system with 2 audio sub-carriers. Full-duplex (transmit frequencies are 2.0845 GHz and 2.0335 GHz). Meets or exceeds all RS-250B short-haul specs. Rated output power is 36 dBm (4 watts). This is a NEW system which has never been installed! (Original 2 year factory warranty is still in effect.) Current list price: \$46,800—Asking \$35,200 (F.O.B. Forest City, IA). Call 800-622-1865. Ask for Lynn or Loren. 8-88-2t

1.625" HELIAX CABLE. Andrew LDF7P-50A. 1.25 dB/100 ft. at 2 GHz. 260 foot roll \$1,800 (or \$8/ft. by the foot.—20 ft. minimum). For more information please call 1-800-622-1865. Ask for Lynn or Loren. 8-88-2t

IKE 79 EAL with 14x1 Cannon zoom lens. 5 years old, excellent condition. \$25,000 or best offer. Call Videoimage at (617) 861-7171. 8-88-2t

WANTED TO BUY

HIGHEST PRICES for 112 Phase Monitors, vacuum capacitors and clean, one kw or greater powered AM and FM Transmitters. All duty and transportation paid. Surplus Equipment Sales, 2 Throncliffe Park Dr., Unit 28, Toronto, Canada M4H 1H2, 416-421-5631. 3-86-tfn

WANTED TO BUY: NEW OR USED Telemation Color Video Encoder. Call Greg McMurry, Video Image, 213-822-8872. 9-88-2t

WE PLACE ENGINEERS

ALL CATEGORIES FOR TV, PRODUCTION, VIDEO, CATV (EXCLUDING OPERATORS)

America's Leading Source for a Decade

(TV STATIONS, PRODUCTION FACILITIES, CORP. TV, MFG., CATV)

For information phone or write Mark Kornish



key systems

479 Northampton Street
Kingston, PA 18704

Employer
Paid Fees

(717) 283-1041

HELP WANTED

MAINTENANCE ENGINEER: for NBC affiliate. Need technician with experience in RCA VHF transmitters, Ampex Quads, VPR-2's, and Sony ENG equipment. Send resume, references and salary history to: KJAC, P.O. Box 3257, Port Arthur, TX 77643, Attention: Chief Engineer. EOE. 12-87-10t



BROADCAST
engineering
CONFERENCE

Don't miss it:

The third annual SBE National Convention
and
Broadcast Engineering Conference

View the latest in broadcast equipment from leading manufacturers. Attend technical sessions designed to provide practical answers for the problems faced by broadcast engineers. Building on outstanding success, the 1988 convention will provide more exclusive exhibit hours and an outstanding line-up of the industry's best technical experts.

The SBE National Convention and Broadcast Engineering Conference—the must-attend event for this fall.

Denver

September 22-25

SAVE TIME

For fast, accurate service, please remove the peel off label used to address your magazine, and attach it to the Reader Service Card, the Address Change Card or to any correspondence you send us regarding your subscription.

Classified

TRANSMITTER/STUDIO ENGINEER needed for Worcester, Massachusetts UHF television station. Strong background in UHF transmitters. Also, studio maintenance background helpful. Contact Fran Vaccari, Chief Engineer, WHLL-TV, 617-799-2727. 7-88-1fn

MAINTENANCE ENGINEER. KHJ-TV Channel 9 currently seeks the skills of a Maintenance Engineer to join our fast-paced, major market television station. The qualified individual will have 5 years broadcast equipment maintenance experience. Skills must include stand-alone maintenance and repair abilities covering high end studio cameras, video switches, digital video effects, and one inch VTR machines. General knowledge of studio equipment maintenance preferred. Candidate must be willing to work nights and weekends. If you meet our requirements, please send resume to: KHJ, 5515 Melrose Avenue, Hollywood, CA 90038; ATTN: Personnel. Equal Opportunity Employer. 9-88-1f

CHIEF ENGINEER Network Center Operations and Television Production, Smpilot/Micron Technology Center, Boise State University. Responsibilities: Operate, troubleshoot, & repair professional narrowcast studio, master control, related production receiving equipment, & satellite uplink; provide engineering support for distance learning narrowcast technologies; and serve as the principal television production technical professional for video-based statewide telecommunications activities & other live prerecorded television productions. Qualifications: Ability to install, operate, diagnose, troubleshoot & repair state-of-the-art television studio equipment; knowledge of television lighting techniques & experience in setting up lighting & microphone; experience in operations & maintenance of satellite uplink & control equipment; and knowledge & experience in managing technical facilities & personnel for television studio productions. To apply: Send letter of application; resume; and names, addresses, & phone numbers of three references by September 30, 1988 to Ben Hamblen, Director, Smpilot/Micron Technology Center, Boise State University, 1910 University Drive, Boise, ID 83725. EEO/AA Institution. 9-88-1f

RF ENGINEER SATELLITE UPLINK SYSTEMS Experienced RF Engineer for design and construction of Satellite News Vehicle RF Systems. Ku-Band exper. preferred. Live & Work in New Hampshire. Good Benefits and Leadership Role with Expanding Company. Resume & References to Charles Angelakls, President, BAF Communications Corp., 17 Everberg Rd., Woburn, MA 01801. 9-88-2t

MAINTENANCE ENGINEER. Production/Post-Production facility seeks person for repair and maintenance of post-production equipment and systems, including: CMX, ADO, Ampex VPRs and Chyron. Send resume, references and salary requirements to: American Video Factory, 4150 Glencoe Avenue, Marina Del Rey, CA, 90292, Attention: Chief Engineer. 9-88-1t

ELECTRICAL EQUIPMENT SPECIALIST, RIYADH, SAUDI ARABIA U.S. citizen sought for two-yr. position as Technical Electronic Equipment Specialist working with U.S.-Saudi Arabian Joint Commission on Economic Cooperation program in Riyadh, Saudi Arabia. This hands-on position requires expertise in maintenance of television, slide-tape, video-tape, computer graphics and other electronic equipment. Equipment includes 3/4", 1/2" BETACAM, associated switching, routing, editing suites, studio cameras and multi-image equipment. Responsible for actual maintenance and for supervision of new equipment purchases. Special emphasis on training Saudi technical staff. Req'd: Min. 5 yrs. hands-on maintenance exp. w/above equipment. College degree BSEE, prior overseas training exp., and knowledge of Arabic are pref'd. Benefits: Salary \$33,218-43,181 + up to 25%. Pls. send resume to: Dept. A-20, 1730 Rhode Island Ave., NW, Suite 910, Washington, DC 20036. EOE. 9-88-1t

MANAGER OF TELEVISION ENGINEERING OPERATIONS. Reporting to Chief Engineer. Must have associates degree in electronics or equivalent, and 5 years experience in television operations and maintenance. Supervisory experience preferred. Please send resume and salary requirements to Personnel Department, WDTN TV2, P.O. Box 741, Dayton, OH 45401. EOE. 9-88-1t

DIRECTOR OF ENGINEERING: Senior management position as the Director of Technical Applications and Planning for the Broadcasting Service of Southern Illinois University. Direct the technical operations of two public television stations, one VHF (Ch. 8) and one UHF (Ch. 16), and one 50,000 watt FM public radio station; and work with other members of the senior management team in planning for future technological growth and expansion. We offer a real professional challenge, an excellent competitive salary with outstanding fringe benefits, and mild winters in a semi-rural setting on the edge of the Shawnee National Forest, only two hours from St. Louis. Minimum requirements include an Engineering/Technology related Bachelors Degree, 5 years of technical management experience, demonstrable proficiency and experience with modern broadcast technologies and engineering practices, and well-developed leadership and management skills. Send Letter of Application, Resume & three Professional References to: Lee D. O'Brien, Executive Director, Broadcasting Service, Southern Illinois University, Carbondale, Illinois-62901. Minority members and women are encouraged to apply. Southern Illinois University is a Equal Opportunity/Affirmative Action Employer. 9-88-1t

MAINTENANCE ENGINEER FOR ORAL ROBERTS TELEVISION PRODUCTIONS needed. Experience in repair of broadcast video and audio equipment required. Satellite uplink and microwave experience a plus. Please send resumes to: Bill Lee, P.O. Box 2187, Oral Roberts TV Productions, Tulsa, OK 74171 EOE. 9-88-1t

CHIEF ENGINEER. Hands-on chief for major market independent, UHF transmitter experience mandatory. Light administrative load. Excellent salary and benefits. Resume to George Hanley, WPWR-TV, 2151 N. Elston, Ave., Chicago, IL 60614. No calls please. 9-10-1t

POSITION WANTED

SEEKING MAINTENANCE SUPERVISOR/INSTRUCTOR/CHIEF POSITION. 12 years broadcast/education maintenance and production experience. M.A. higher education administration. FCC general class. SBE certified. Contact: C.D.P., P.O. Box 6264, Surfside, FL 33154.8-8-2t

Advertising sales offices

SANTA MONICA, CALIFORNIA

Herbert A. Schiff
Telephone: (213) 393-9285
Telefax: 213/393-2381
Jason Perlman
Telephone: (213) 458-9987
Telefax: 213/393-2381
Chris Woodbury-Leonard
Telephone: (213) 451-8695
Telefax: 213/393-2381
Schiff & Associates
501 Santa Monica Blvd. Ste. 504
Santa Monica, CA 90401

OXFORD, ENGLAND

Nicholas McGeachin
Intertec Publishing Corp.
Roseleigh House
New Street
Deddington
Oxford OX5 4SP
England
Telephone: (0869) 38794
Telefax: (0869) 38040
Telex: 837469 BES G

TOKYO, JAPAN

Mashy Yoshikawa
Orient Echo, Inc.
1101 Grand Maison
Shimomiyabi-Cho, 2-18
Shinjuku-ku, Tokyo 162, Japan
Telephone: (03) 235-5961
Telex: J-33376 MYORIENT

CHICAGO, ILLINOIS

Tom Nilsen
Telephone: (312) 435-2361
Telefax: (312) 922-1408
55 East Jackson
Ste. 1100
Chicago, IL 60604

NEW YORK, NEW YORK

Diane Gottlieb-Klusner
Telephone: (212) 702-3404
Telefax: (212) 702-7802
David W. Frankel
Telephone: (212) 702-3405
Telefax: (212) 702-7802
866 Third Ave.
New York, NY 10022

FREWVILLE, AUSTRALIA

John Williamson
Hastwell, Williamson, Rep. Pty. Ltd.
109 Conyngham Street
Frewville 5063
South Australia
Phone: 799-522
FAX: 08 79 9735
Telex: AA87113 HANDM

INTERTEC
PUBLISHING CORPORATION

© 1988. All rights reserved.

34th Annual University of Wisconsin

BROADCAST ENGINEERING & TELECOMMUNICATIONS SEMINAR

OCTOBER 18 - 20, 1988
MADISON, WISCONSIN

A technical conference and equipment exhibit
for engineers involved in:



AM & FM Broadcasting
Television Broadcasting
Contract Engineering

Audio & Video Production
Cable Systems
ITFS / MDS

... and more.

For information, write: BETS, 218 Lowell Hall, 610 Langdon St.,
Madison, WI 53703, or call: (608)262-6130

Ad index

	Page Number	Reader Service Number	Advertiser Hotline		Page Number	Reader Service Number	Advertiser Hotline
Abekas Video Systems	37	23	415/571-1711	Leader Instruments Corp.	5	5,6	800/645-5104
Ace Communications	165	122	800/445-7717	Leitch Video of America, Inc.	69	37	804/424-7290
Acoustic Sciences Corp.	63	152	503/343-9727	Lenco Electronics	109	70	314/243-3147
ADC Telecommunications, Inc.	97	60	612/893-3010	3M Broadcast & Related Products	123	80	800/328-1684
Adrienne Electronics Corp.	137	155	800/782-2321	M/A-Com Mac Inc.	49	29	617/272-3100
AEG Olympia Ag	141	95	416/683-8200	Markertek Video Supply	134	90	800/522-2025
AKG Acoustics, Inc.	139		203/348-2121	McCurdy Radio Industries	113	73	416/751-6262
Alpha Audio	158	128	804-358-3852	Microdyne Corp.	39	24	904/687-4633
Alpha Wire Corp.	101	64	800/52ALPHA	Midwest Communications Corp.	1	3	800/543-1584
Alta Group Inc.	127	83	408/297-2582	Modular Audio Products	160	115	800/333-7697
Ampex Corp. (AVSD)	66-67	36	415/367-2911	Mohawk Wire & Cable	134	89	800/422-9961
Ampex Corp. (MTD)	41	25	415/367-2911	Moseley Associates Inc.	13	10	805/968-9621
Ampex Corp. (MTD)	43	26	415/367-2911	Multidyne Electronics Inc.	100	124	800/535-3050
Ampex Corp. (MTD)	45	27	415/367-2911	National Public Radio	121	79	202/822-2626
Ampex Corp. (MTD)	47	28	415/367-2911	Neutrik USA, Inc.	128	84	609/327-3113
Aphex Systems Ltd.	149	101	818/765-2212	Nova Systems, Inc.	100	63	203/693-0238
Arrakis Systems, Inc.	21	13	303/224-2248	Odetics, Inc.	77	42	800/243-2001
Arrakis Systems, Inc.	27	13	303/224-2248	Omega International	156	109	714/553-0564
Audio Accessories, Inc.	98	61	603/446-3335	Omicron Video	148	100	818/700-0742
Audio Precision	87	52	800/231-7350	Opamp Labs Inc.	156	106	213/934-3566
Audio Technologies Inc.	76	41	215/443-0330	Orban Associates Inc.	17	12	800/227-4498
Audio-Video Engineering Co.	148	33	516/546-4239	Orban Associates Inc.	7	7	800/227-4498
Barco Industries Inc.	129	85	408/370-3721	Otari Corp.	91	54	415/592-8311
Belar Electronics Laboratory Inc.	162	119	215/687-5550	Otari Corp.	15	11	415/592-8311
Belden Wire and Cable	125	82	800/BEL-DEN4	Panasonic Industrial Div.	82-83	48	201/348-7671
Beyer Dynamic Inc.	147	98	516/935-8000	Panasonic Pro Industrial Video	50-51	97	201/348-7671
BJM Electronics Ltd.	164	121	718/442-0223	Panasonic Pro Industrial Video	144-145	30	201/348-7671
Bogner Broadcast Equipment Corp.	111	71	516/997-7800	Panasonic Pro Industrial Video	105	67	201/348-7671
Broadcast Video Systems Ltd.	162	118	416/764-1584	Periphex Inc.	164	123	800/634-8132
BTS Broadcast Television Systems	95	58	801/972-8000	Pesa Electronica S.A.	154	110	800/872-7372
Cablewave	19	14	203/239-3311	Polyphaser Corp.	168	131	800/325-7170
Camera Mart, Inc.	112	72	212/757-6977	Potomac Instruments	94	57	301/589-2662
Centro Corp.	75	40,140	619/560-1578	QEI	143	104	800/334-9154
Chemtronics, Inc.	165	126	516/582-3322	Quanta Corp.	146	92	801/974-0992
Chyron Corp.	119	77	516/249-3018	Ram Broadcast Systems Inc.	120	78	516/832-8080
Cipher Digital, Inc.	36	22	301/695-0200	RTS Systems, Inc.	138	93	818/843-7022
Clear-Com Intercom Systems	78	44	415/861-6666	Rupert Neve, Inc.	53	31	203/744-6230
Comark	131	86	215/822-0777	Sachtler Corp. of America	133	103	516/867-4900
Comrex Corp.	32	19	617/443-8811	Shure Brothers Inc.	IFC	1	312/866-2553
Conex Electro Systems	156	105	206/734-4323	Sony Communications Products/ Broadcast	55-62	32	800/635-SONY
Continental Electronics, Div. of Varian	157	111	214/381-7161	Sony Communications Products/ Broadcast	114-115	74	800/635-SONY
Delta Electronics	108	69	703/354-3350	Sony Communications Products/ Pro Audio	74	81	800/662-SONY
Di-Tech Inc.	IBC	2	516/667-6300	Sony Communications Products/ Pro Video	24-25	15	201/833-5200
Dielectric	150	102	800/341-9678	Sony Corporation/Mag. Tape Div.	153	117	201/930-7669
Diless International	102	65		Sound Technology	65	35	408/378-6540
DKW Systems Inc.	118	127	403/426-1551	Stainless, Inc.	80	46	717/569-2681
Dolby Labs Inc.	93	56	415/558-0200	Stainless, Inc.	163	120	717/569-2681
Dorough Electronics	68	76	818/999-1132	Standard Tape Laboratory, Inc.	156	107	415/786-3546
Eastman Kodak Co.	72-73	39	212/930-7500	Stantron/Unit of Zero Corp.	85	150,151	800/821-0019
Electro-Voice	159	114	616/695-6831	Studer Revox America Inc.	29	17	615/254-5651
ESE	169	132	914/592-6050	Surcom Associates Inc.	137	125	619/722-6162
ESE	171	135	914/592-6050	Switchcraft Inc.	71	38	312/792-2700
For-A Corp. of America	81	47	213/402-5391	Tascam Div. Teac Corp. of America	86	51	213/726-0303
Full Compass Systems	118	133	800/356-5844	Tascam Div. Teac Corp. of America	84	49	213/726-0303
Gentner Electronics Corp.	78	43	801/268-1117	TCA Communications	155	108	213/727-7675
Gentner Electronics Corp.	79	145	801/268-1117	Television Equipment Associates, Inc.	63	34	914/763-8893
Gentner RF Products Div.	140	94	801/268-1117	Television Technology Corp.	107	68	303/665-8000
GKM Mfg. Corp.	161	96	718/388-4114	Telex Communications, Inc.	132	87	612/887-5550
Graham-Patten Systems Inc.	96	59	800/547-2489	Thomson-CSF/DTE	170	134	203/324-1320
Grass Valley Group, Inc.	9	8	916/273-8421	Total Spectrum Manufacturing, Inc.	31	18	914/268-0100
Grass Valley Group, Inc.	99	62	916/273-8421	Utah Scientific Inc.	88-89	53	800/453-8782
Grass Valley Group, Inc.	167	129	916/273-8421	Varian	33	20	415/592-1221
Hitachi Denshi America Ltd.	3	4	800/645-7510	Videotek, Inc.	103	66	602/997-7523
Ikegami Electronics Inc.	117	75	201/368-9171	Ward-Beck Systems Ltd.	BC		
Intraplex, Inc.	168	130	617/486-4072	Winsted Corp.	136	99	800/447-2257
Jampro Antennas Inc.	92	55	916/383-1177				
JBL Professional	11	9	818/893-8411				
JVC Professional Products Co.	34-35	21	800/582-5825				
K&H Products Ltd.	160	116	802/442-8171				
Keltec Florida, Inc.	135	91	904/244-0043				
Lake The Systems Company	158	112	617/244-6881				

It all adds up.

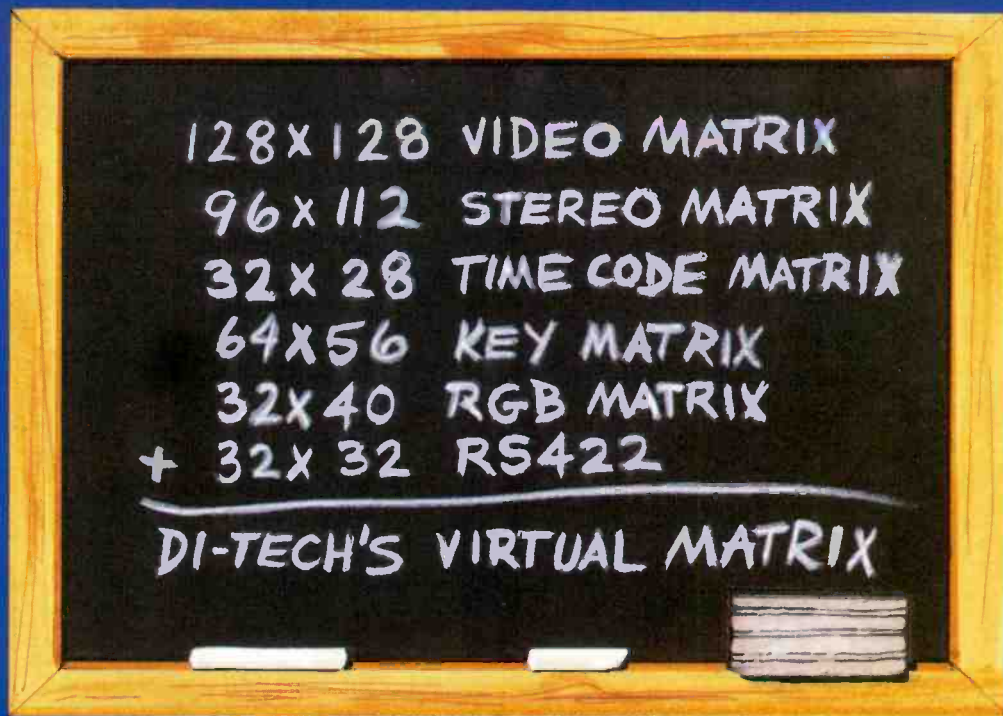

The Solution to Real World Routing Problems

Today's teleproduction techniques impose new demands on routing switcher systems. Component/RGB and key video



Model 5861
64 x 32 Video Switcher



Model 5862
64 x 32 Audio Switcher

signals are more widely used than ever. Flexible interformat editing suites may require RS422 switching systems to allocate tape machines and their time code data. Planning for growth *now* means thinking in terms of many *differently* sized routers.

Di-Tech's *virtual matrix* control system, Model 9002, allows you to name over 500 input and output devices and *automatically* select the crosspoints on up to 8 *separate* routing frames as easily as on one big system. Since our high performance routing switchers are *field expandable*, you never need to over-buy to allow for growth.

Prepare for tomorrow with the company that can do it all today... Di-Tech.



di-tech inc.

Circle (2) on Reply Card

SBE Booth #609

48 Jefryn Boulevard, Deer Park, New York 11729
(516) 667-6300, Telex No. 971806, FAX (516) 595-1012

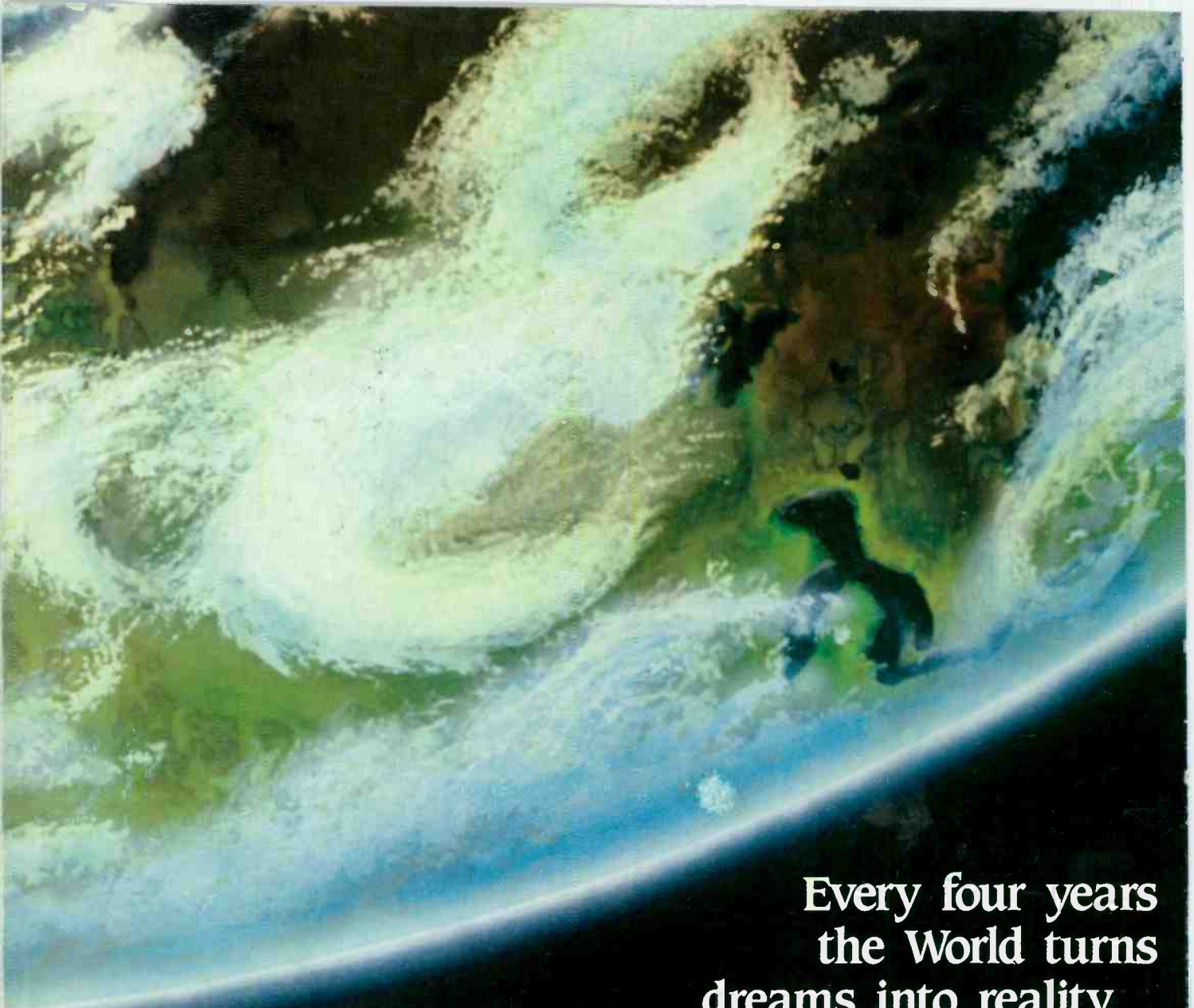

Every four years
the World turns
dreams into reality...

This is one of those years!

From every corner of the Earth thousands of Olympians assemble to put their exceptional skills to the ultimate test. Their dream is to translate selfless dedication and effort into Olympic honor!

These historic occasions also recognize our own dedication to excellence. Ward-Beck audio equipment has been chosen by broadcasters for coverage of the last three Olympics, and we are proud to have been selected again this year to appear at both Calgary and Seoul.

World Class excellence is the standard we strive to maintain throughout every single day of every year!



Ward-Beck ST Series Console - Olympics Mobile configuration.



WARD-BECK SYSTEMS

Ward-Beck Systems Ltd. 841 Progress Avenue, Scarborough, Ontario, Canada M1H 2X4.
Tel: (416) 438-6550. Fax: (416) 438-3865. Tlx: 065-25399.