

BROADCAST[®] engineering

December 1986/\$3



Designed for
the future

State
of the
industry
report



DON'T BELONG IN YOUR AUDIO!

ADM[®] POST-PRO KEEPS THEM OUT!

FUZZY AUDIO MIX WILL NOT CREATE WARM LISTENER RESPONSE

With ADM's new POST-PRO Audio Post Production Console, you can eliminate all Fuzzys, warm or otherwise, from your audio mix forever.

You would expect nothing less than outstanding Audio from ADM. With over twenty years of experience in meeting the audio needs of the video industry, ADM has become not merely the leader but the standard setter.

Now you can have full editor/switcher control, full manual control, or a combination of editor/switcher or manual control. The ADM Post-Pro provides A/B bussing with that kind of flexibility built in.

The Post-Pro is capable of direct interface with virtually any editor or switcher through a parallel GPI or our optional serial interface.

We know that in the television industry, dependability is absolutely essential. With ADM's exclusive five year warranty on parts and labor, you know that when you go "on line"...you'll stay "on line."

The Post-Pro is designed to give you audio quality comparable to video. Always an important consideration, with stereo it becomes essential. Priced from \$9,500, the Post-Pro is solid quality and solid value that means increased flexibility, productivity and profits.

LOOK WHAT WE HAVE INCLUDED IN THE NEW POST-PRO!

- Modular design with gold card edge connectors
- 8 or 12 inputs
- Line inputs with adjustable gain
- A/B control bus and parallel GPI
- Slidex[®] VCA attenuators
- Optional serial interface
- Dual monitoring with pre-selection
- Cue bus
- 4 large VU meters
- "Invert" switch on each control bus permits fingertip cross-fades
- Continuously variable 3-band EQ with HP/LP filter
- 2 master outputs



For more information, contact:

ADM[®]

Circle (1) on Reply Card
ADM Technology, Inc.
1626 E. Big Beaver Road, Troy, Michigan 48084
Phone: (313) 524-2100 TLX 23-1114

Cross-Country Communication



With the antenna
that works!

In Brownsville,
In Seattle,
In Miami,

Everywhere!

Midwest combines its mobile production unit experience with the latest antenna technology to bring you the S-23, a satellite news vehicle that enables you to uplink a story from virtually anywhere.

The S-23 incorporates a Vertex 2.6M antenna with 50db gain into a unit that is spacious enough for full production capability, yet has excellent weight distribution and a wide GVW safety margin.

An integral deployment and positioning system ensures antenna

accuracy, even in heavy weather. You can choose from a variety of equipment configurations and several domestic and foreign chassis models.

Call for specifications and antenna patterns on the S-23, S-18, S-1 Fly-away or any of our mobile satellite news systems.

The Midwest S-23. The mobile satellite news system that works. Everywhere.

- 2.6M Vertex Antenna
- >50db Gain at 14.25 GHz
 - >35db Cross Polar Isolation
 - Meets 29-25_{log} FCC 2° Spacing Curves

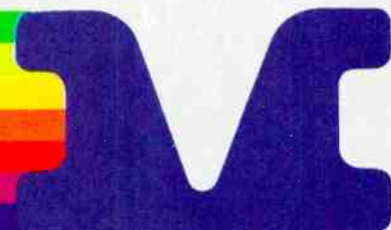

MIDWEST

Communications Corp.

One Sperti Drive
Edgewood, KY 41017
606-331-8990

Circle (3) on Reply Card

Contents

December 1986 • Volume 28 • Number 12



Page 22

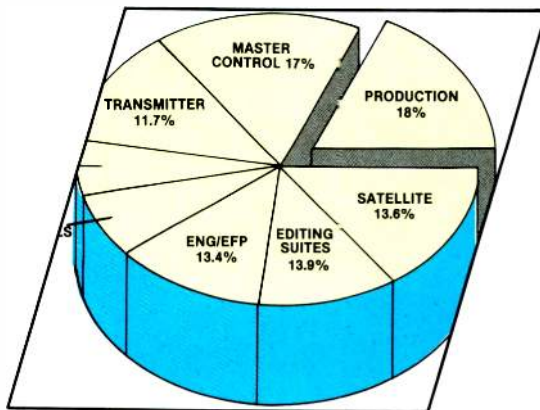

Page 82

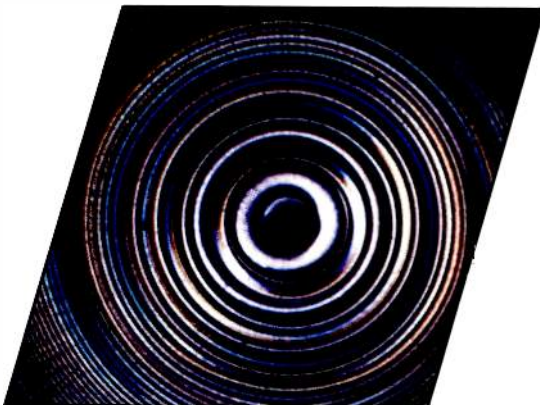

Page 106

ON THE COVER

Significant technical opportunities now exist for the broadcast industry. Stereo audio for television, component video, digital audio/video recording, fiber optics and high-definition television are just some of the technologies that hold great promise for radio and TV broadcasting. Shown on our cover this month is the audio post-production room at NBC Burbank Studio 4. (Photo courtesy of Solid State Logic.)

BROADCAST ENGINEERING

DESIGNED FOR THE FUTURE:

The renovation of a studio/control room facility is a critically important—and exciting—task. Proper planning and execution are required to produce the desired results. This special section focuses on three recently completed renovation projects:

24 Updating NBC Burbank

By Jerry Whitaker, editorial director

A look at the work under way at NBC's West Coast operations center to keep current with technology and the needs of producers.

48 Updating the AFRTS

By Peter Adamiak, National TeleConsultants

Work has just been completed on a new broadcast center for the Armed Forces Radio and TV Service in Los Angeles.

68 Updating the Voice of America

By Richard Dempsey, architect, and Michael Kelly, Hamilton Communications Consultants

The Voice of America headquarters in Washington, DC, has embarked on a multimillion-dollar facility improvement effort.

STATE OF THE INDUSTRY:

Although the world economy continues to fluctuate daily, the broadcast industry plans to maintain an even keel, and looks ahead to the technology of tomorrow.

82 State of the Industry Survey

By Brad Dick, radio technical editor

U.S. broadcasters predict 1987 will not show major changes from 1986.

96 Inside Fiber Optics

By Elmer Smalling III, Jenel Systems and Design, and Ned Soseman, TV technical editor

A tutorial that explains the basic concepts of fiber optics.

106 Distributing Video via Fiber Optics

By DeWayne Gray, National Video Network

Without interference from electromagnetic sources, glass may be a viable substitute for satellite links.

142 Annual Editorial Index

A listing of all major feature articles, columns and field reports appearing in **BE** in 1986. A cross index to topics of prime interest is included.

DEPARTMENTS

4 News	20 Management for Engineers
6 Editorial	115 IBC Replay
8 FCC Update	120 Radio '86 Replay
10 Strictly TV	122 Field Report: Shure FP16
12 re: Radio	134 SBE Update
14 Satellite Technology	136 Station-to-Station
16 Circuits	156 New Products
18 Troubleshooting	164 People
	165 Business

HITACHI INVENTS THE FIRST 1" VTR THAT WATCHES ITSELF SO YOU DON'T HAVE TO.

The revolutionary Hitachi HR-230 1" VTR has the most advanced real-time, self-diagnostic capabilities ever perfected.

In either the record or playback mode, a computer inside the HR-230 monitors 49 different performance parameters second by second. And then stores this information within the memory for recall at a later time—not just with numbers and symbols, but in words.

This means no more errors slip by when your operator is not there. And there's no more need for hit-or-miss spot checking.

The Hitachi HR-230 has a unique quick-threading tape path, incorporating retracting entrance and exit guides, main erase head, as well as a scanner air system that protects tapes.

It recues a 30-second segment in 3.5 seconds. It has a



fast/slow motion range that provides real-time reverse and field/frame still motion. Plus programmable time compression up to 20%, with 0.1% accuracy.

A unique, concealed fold-out control panel groups editing functions and separates edit controls from the main control panel.

In short, it's the ultimate 1" for networks, affiliates or teleproduction companies. Don't consider your next 1" purchase without looking into it. Contact Hitachi Denshi America, Ltd., Broadcast and Professional Division, 175 Crossways Park West, Woodbury, NY 11797. (516) 921-7200 or (800) 645-7510. Hitachi Denshi, Ltd. (Canada), 65 Melford Drive, Scarborough, Ontario M1B 2G6. (416) 299-5900.

 **Hitachi**

Tektronix makes test signals available

The television division of Tektronix is making available two proprietary test signals for general use by manufacturers of TV equipment. The company is relinquishing exclusive use of these test signals in support of international standardization efforts. Several international TV organizations plan to standardize on these Tektronix test signals.

The coring test signal is used to measure coring, the technique used in some equipment to improve apparent signal-to-noise ratio. The test signal consists of packets of low-amplitude sine waves at different frequencies tapered to zero amplitude. Each packet will have its lowest amplitudes removed where coring is applied.

The Bow Tie test signal enables the user of a component analog system to set the relative timing and gain of the component channels. This test signal, with integral time marks, is both accurate and sensitive to small changes in both gain and timing.

The signals used in the test, measurement and monitoring of component analog video signals were developed by

Tektronix and are currently available in a production test signal generator.

SSL joins UEI group

Solid State Logic Limited, Begbroke, Oxford, England, has become a member of the UEI group, a Public Limited Company in England. Other members of the group include: Quantel, Link Electronics, Link Systems and Cosworth Engineering. Colin Sanders will remain chairman and managing director of Solid State Logic and will join the board of directors of UEI.

The merger will facilitate advancement in the development of entirely digital audio and video production systems. SSL will continue to operate as an autonomous organization, but now can borrow technology and expertise from other group members.

Founded in 1969, SSL operates production and test facilities in Witney, Oxford, and Brandon, Suffolk, England. No change in Solid State Logic Inc. sales and technical support offices in New York, Los Angeles and Detroit are planned. Other overseas sales and service agents also will continue operation with little change.

NHK and Matsushita develop video head

Panasonic Broadcast Systems Company has announced the joint development by NHK and Matsushita of a high-performance amorphous video head, to be installed on all M-II format VTRs.

NHK established the principal of amorphous heads fabricated in multilaminated structures. Matsushita developed and put into practice the techniques for improved reliability and stability.

The amorphous head construction is based on a newly developed, non-magnetic substrate, NiO-MgO-TiO₂ and magnetic substrate, NiO-MgO-TiO₂, and based alloy film of Co-Nb-Ta-Zn and insulating film of SiO₂. The result is a decrease of eddy current loss and an improvement in performance in the high-frequency range.

With the incorporation of these video heads, M-II equipment shows better high-frequency performance, resulting in decreased moire and low-frequency noise. With guidance from NHK, some M-II parameters were changed in order to implement qualities suitable for use with metal tape and amorphous heads.

(-:-:-)))))

BROADCAST engineering

Editorial and advertising correspondence should be addressed to: P.O. Box 12901, Overland Park, KS 66212-9981 (a suburb of Kansas City, MO); (913) 888-4664. Telex: 42-4156 Intertec OLPK. Circulation correspondence should be sent to the above address, under P.O. Box 12937.

EDITORIAL

Jerry Whitaker, *Editorial Director*
Brad Dick, *Radio Technical Editor*
Ned Soseman, *TV Technical Editor*
Carl Bentz, *Special Projects Editor*
Paula Janicke, *Associate Editor*
Dawn Hightower, *Associate Editor*
Dan Torchia, *Group Managing Editor*
Irma Allread, *Group Associate Editor*
Alisa Carter, *Editorial Assistant*
Pat Blanton, *Directory Editor*

ART

Kristi Younger, *Graphic Designer*

EDITORIAL CONSULTANTS

Fred Ampel, *Audio*
Miguel Chivite, *International*
Nils Conrad Persson, *Electronics*
Tom Cook, *Video*
Mel Lambert, *Professional Audio*

BUSINESS

Cameron Bishop, *Group Vice President*
Duane N. Helner, *Publisher*
Stephanie Fagan, *Promotions Manager*
Cynthia Sedler, *Promotions Coordinator*
Dee Unger, *Advertising Supervisor*
Mary Birnbaum, *Advertising Coordinator*

ADMINISTRATION

R. J. Hancock, *President*
John C. Arnst, *Circulation Director*
JoAnn DeSmet, *Circulation Manager*
Kevin Callahan, *Art Director*
Dee Manies, *Reader Correspondent*

TECHNICAL CONSULTANTS

Eric Neil Angevine, *Broadcast Acoustics*
John H. Battison, *Antennas/Radiation*
Blair Benson, *TV Technology*
Dennis Ciapura, *Radio Technology*
Dane E. Ericksen, *Systems Design*
Howard T. Head, *FCC Rules*
Wallace Johnson, *FCC/Bdct. Engineering*
John Kean, *Subcarrier Technology*
Donald L. Markley, *Transmission Facilities*
Harry C. Martin, *Legal*
Robert J. Nissen, *Studio/Communications*
Hugh R. Paul, *International Engineering*
Art Schneider, *A.C.E., Post-production*
Elmer Smalling III, *Cable/Satellite Systems*
Vincent Wasilewski, *Communications Law*

MEMBER ORGANIZATIONS

Acoustical Society of America
Society of Broadcast Engineers

Member,
Association of Business Publishers
Member,
Business Publications
Audit of Circulation



SUBSCRIPTIONS: BROADCAST ENGINEERING is mailed free to qualified persons within the United States and Canada in occupations described above. Non-qualified persons may subscribe at the following rates: United States and Canada; one year, \$25.00. Qualified and non-qualified persons in all other countries; one-year, \$30.00 (surface mail); \$108.00 (air mail). Back issue rates, \$5, except for the Buyers' Guide/Spec Book, which is \$20. Rates include postage. Adjustments necessitated by subscription termination at single copy rate. Allow 6-8 weeks for new subscriptions or for change of address. Second class postage paid at Shawnee Mission, KS.

BROADCAST ENGINEERING Volume 28, No. 12 (USPS 338-130) is published monthly (except in the fall, when two issues are published) by Intertec Publishing Corporation, 9221 Quivira Road, P.O. Box 12901, Overland Park, KS 66212. Second Class Postage paid at Shawnee Mission, KS and additional mailing offices. POSTMASTER: Send address changes to BROADCAST ENGINEERING, P.O. Box 12983, Overland Park, KS 66212.

Photocopy rights: Permission to photocopy for internal or personal use is granted by Intertec Publishing Corporation for libraries and others registered with Copyright Clearance Center (CCC), provided the base fee of \$2.00 per copy of article is paid directly to CCC, 21 Congress St., Salem, MA 01970. Special requests should be addressed to Cameron Bishop, group vice president. ISSN 0007 1794 \$2.00 + \$0.00.

©1986. All rights reserved.

Advertising offices listed on page 170.

BROADCAST ENGINEERING is edited for corporate management, engineers/technicians and other station management personnel at commercial and educational radio and TV stations, teleproduction studios, recording studios, CATV and CCTV facilities and government agencies. Qualified persons include consulting engineers and dealer/distributors of broadcast equipment.



LEADER

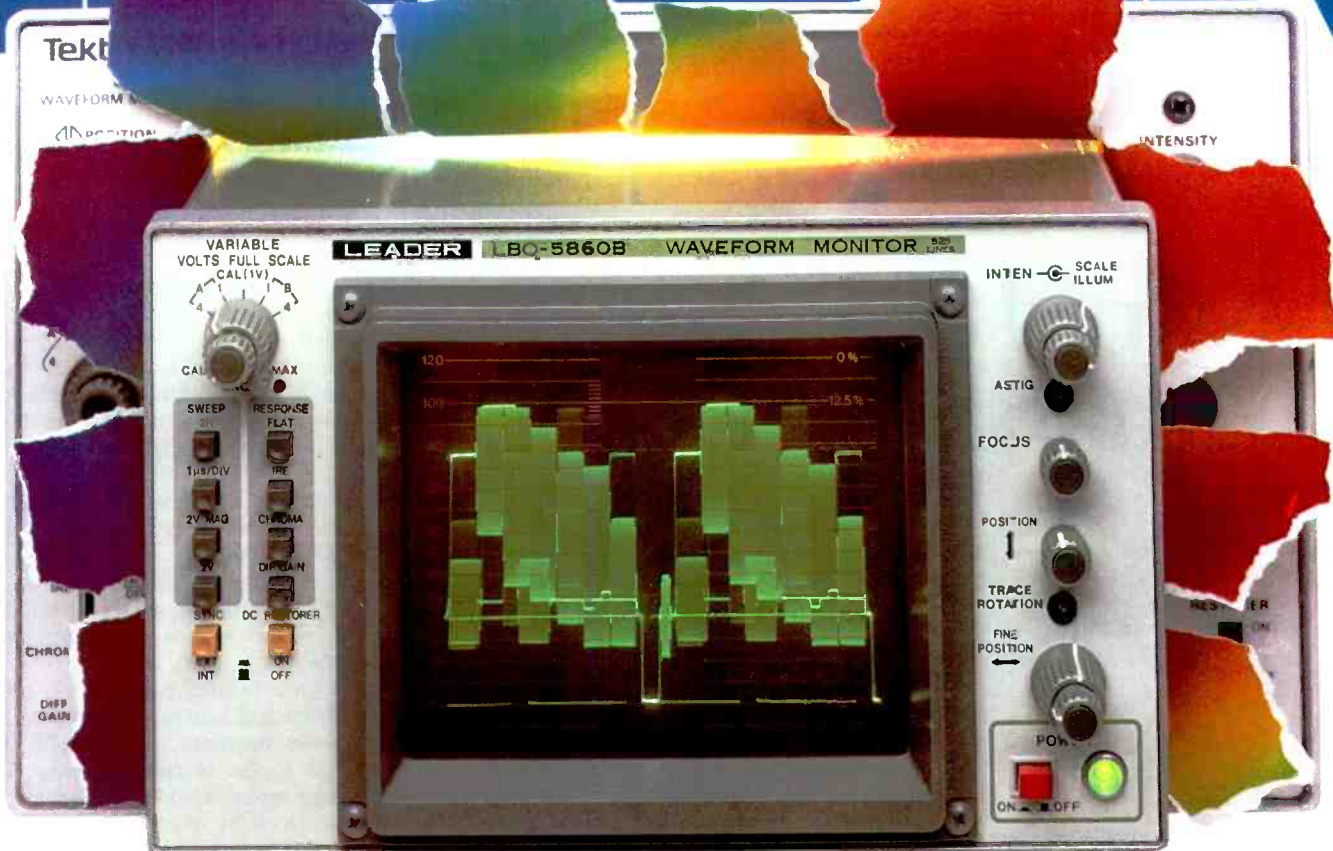

Goodbye old standard!

Leader's new LBO-5860B Half-Rack Waveform Monitor delivers all its features for \$590* less!

As good as you were, old standard, your time has passed—The Leader LBO-5860B is better because it's easier to use and delivers all your features for only \$1,740 list. In fact, among the top-quality units available today, it has the lowest cost.

The LBO-5860B sets new standards.

Compare the LBO-5860B to any other half-rack unit—be it the Tek¹ 1730 which lists for \$2250[†], or even the old standard, Tek¹ 528A, at \$2,330[†]. You'll agree the high-performance LBO-5860B has no equal in ease of use and value:

- RGB at no extra cost; optional YRGB
- Rack-mounts alongside LVS-5850B or any other half-



LBO-5860H allows selection of lines 7 to 21. LBO 5865, designed for camera and pickup device testing offers full 525-line selection with memory preset/recall of any three lines.

rack vectorscope • Bright, PDA CRT with internal, etched graticule

- 4 sweep speeds (2-line and 2-field displays, regular and expanded)
- Flat response, IEEE and chroma filters
- Switchable dc restorer clamps blanking at zero IRE
- Switchable internal/ext. sync
- Excellent stability and reliability
- PAL, SECAM and line selector (5860H) models available
- 2-year warranty.

Raise your vectorscope standards.



LVS-5850B reduced \$200 to only \$1,995.

- Easy to use
- Rack-mountable with LBO-5860B or any other half-rack waveform monitor
- Electronically generated CRT targets, and error limits
- Electronic targets eliminate parallax and readout is independent of centering controls.



Buy both for \$3,735. Less than any other high-quality, half-rack pair.

Call toll-free
(800) 645-5104

In NY State
(516) 231-6900

Ask for an evaluation unit, our latest Catalog, more information, or your nearest "Select" Leader Distributor.

For professionals

who know the difference.

LEADER
Instrument Corporation

380 Oser Avenue, Hauppauge, New York 11788
Regional Offices:
Chicago, Dallas, Los Angeles, Boston, Atlanta
In Canada call Omnitrax Ltd. (514) 337-9500

*All prices are manufacturer's suggested list prices as of 9/3/86. Actual savings may vary since prices are set by the retailer.

For Product Demonstration Circle (5) on Reply Card
For Product Information Circle (6) on Reply Card

†Trademark of Tektronix

A word of thanks

Continuing technological advancement in the broadcast industry is no accident. New products are often developed from established product knowledge. Guidelines that define a user's needs frequently include, as a strict requirement, a high degree of compatibility with existing equipment or systems. Without stipulated compatibilities, a fragmentation of the broadcast industry would occur. Fragmentation would result from inter-manufacturer competition, egos and financial considerations, rather than technological grounds.

Some years ago, such fragmentation spawned NTSC, PAL and SECAM. The variations among the systems arose from technical and ideological differences of the countries involved. Although each system has achieved an advanced stage of technology within its own boundaries, system incompatibilities remain to be solved by future advancements.

Remember a time, not so long ago, when 16mm film and a 16mm projector did not necessarily mean a motion picture presentation? Some films had two sets of sprocket holes, and others had only one, and it could have been on the right or left side. Then, if the sprocket holes did match the projector, the sound track might not. A battle was waged before 16mm was standardized, with specified locations for the sprocket holes and sound track. Other factors also were *fixed*, allowing easier use of film. The standard defined minimum requirements, but it did not stop developments in emulsions and other film innovations.

A question of magnetic or optical sound track was the next problem. Each had good and bad points. With a specified location of the track, manufacturers built projectors compatible with both types of sound, providing more flexibility.

Remember the alpha wraps, the first videotape formats smaller than 2-inch quadruplex? Some program distributors regularly shipped program copies in two different 1-inch formats. It was an additional expense, but the practice seemed justified to assure the user could air the program on schedule.

Today, types B and C cause little confusion. In the United States, type C serves program production and distribution. Some editing facilities maintain type B equipment, with certain advantages that accompany the smaller diameter scanner with its segmented head. Materials sent out-of-house are converted to type C format. In Europe, where B format is more common, type C also enjoys a wide acceptance.

In smaller formats, a single ¾-inch format has survived for more than 10 years. Research still finds means for improvements, though, which combined with the cassette convenience have assured the format will be present for several more years.

Half-inch formats proposed a significant decrease in the size and weight of equipment for remote/ENG production. Following preliminary discussions with the networks, all major tape users, two diverse systems appeared. Each answered the requests, as design engineers understood them. Was it misinterpretation or changes in the concept that produced two incompatible ½-inch systems? Several modifications later, a third ½-inch format contender appeared, hoping to find its niche in the marketplace.

Quarter-inch and 8mm formats encountered similar problems. Their existence is more than just the result of enterprising engineers hoping to prove the concept workable. Now the two small formats remain somewhat in limbo with the 8mm format delegated more to consumer video than broadcast.

Although total compatibility does not exist, the TV and film industries enjoy a high degree of consistency in equipment and products, due largely to the efforts of the Society of Motion Picture and Television Engineers (SMPTE). SMPTE, acting as an interested group for research, study and mediation, rather than a regulatory body, has been a major force in achieving the compatibilities we do enjoy. Working with consumers and manufacturers, SMPTE strives to develop agreeable methods of signal processing, monitoring, testing and control.

Today, program exchange among countries may require standards conversion. SMPTE, interacting with other similar organizations, has been a force toward establishing guidelines for a single TV medium to serve the world. It has not yet been achieved, but one day, programming from digitally encoded videotapes will require no conversions for reproduction in any playback facility.

It is comforting to know that an organization exists that suggests preferred methods, rather than dictating absolutes by which we must abide. Not every project attempted by SMPTE has been a resounding success. After all, the SMPTE approach requires agreement from diverse segments of the industry, including multiple manufacturers and a multitude of users.

SMPTE deserves the thanks of the broadcast industry for its long history of work toward developing standards and recommended practices. The society also deserves our support. Only through cooperation can the TV industry continue moving forward on a unified path toward excellence.

!:-?~))]]

ANNOUNCEMENT

Thomson-CSF And Comark Communications, Inc.

On August 1, 1986 Comark Communications Inc., was acquired by Thomson-CSF. The management of both organizations believe that the marriage of these two innovative companies will foster significant new technologies for the U.S. Broadcast equipment industry.

Technological strength, long term commitment and the ability to provide product support means the rebirth of state-of-the-art transmission equipment and systems.

Administrative and Marketing Offices
Rt. 309 and Advance Lane
Colmar, PA 18915

Engineering and Manufacturing Headquarters
Rt. 57, Feeding Hills Road
Southwick, MA 01077

New rules for broadcast auxiliary stations

By Harry C. Martin

The FCC is considering a relaxation of its rules governing remote pickup stations, TV and aural STLs, TV and aural intercity relays, TV pickup, low-power auxiliary and CARS stations. Through a notice of inquiry adopted Oct. 16, the agency is seeking comments on the feasibility of blanket frequency authorizations for mobile or portable operation on any frequency in the bands auxiliary stations are permitted to use on an exclusive basis.

Although not specifically mentioned in the inquiry, the commission also will consider granting blanket authorizations to STL and other fixed auxiliary stations. Under current rules, licenses are issued only for specific frequencies.

In announcing its proposal, the commission pointed out that existing voluntary frequency coordination programs have generally been successful.

In a related action, the commission denied a proposal to require auxiliary applicants to certify they have coordinated use of their requested frequencies with local area users or frequency coordination committees. The current rules require frequency selection and operations scheduling so as to avoid interference to other stations. On this basis, the agency ruled that mandatory coordination is unnecessarily burdensome.

Main studio and program origination rules under study

The commission is proposing to modify or eliminate its main studio and program origination rules for both radio and TV stations. These rules currently require a broadcast station to locate its main studio within its community of license, and to originate more than 50% of its non-network programming from within that community.

The commission would either eliminate both rules or amend the main studio rule to allow a station to locate within its service area or, alternatively, within its city-grade contour (3.16mV/m for FM; 5mV/m for AM; 74dBu for TV channels 2-6; 77dBu for channels 7-13; and 80dBu for channels 14-69).

In justifying its proposal, the commission said the continued relevance of the studio and local origination rules is questionable in light of current policies and broadcast technology. It noted that the



role of a main studio as an origination point for local programming has been eroded as remote facilities and satellite transmissions now permit program origination from anywhere. Furthermore, the proposals would give licensees greater discretion in locating their main studios and in choosing programming, thus reducing overall operating costs.

In recent years, the commission has granted "Arizona" waivers of its 50% local origination rule. This rule allows radio stations to base their operations at studios outside their communities of license as long as they originate more than 50% of their non-entertainment programming from a nominal main studio within the community of license. Also under the current rules, many jointly owned AM and FM stations with facilities licensed to different communities have had to operate two separate studio facilities. The new rules will eliminate the need for such dual-studio operations.

Minority preference to receive further legal scrutiny

The commission's long-standing policy of awarding special preferences to minority and female applicants in comparative hearing cases is being re-evaluated. The re-evaluation comes as a result of a remand from the U.S. Court of Appeals in Washington of a comparative case where the commission's original award was based on the gender of an applicant.

After the Court of Appeals reversed the commission's original decision, the female applicant asked the court to reconsider its decision. During reconsideration proceedings, the commission filed a brief in which it asked for an opportunity to re-evaluate the basis for its preference system. In a policy shift that has stirred considerable controversy, the commission told the court its preference system not only may exceed the agency's statutory authority but also may violate equal protection guarantees. An inquiry proceeding on the issue is to be initiated within the near future.

In the meantime, minority and female preferences remain in effect, at least in a

technical sense, because the court decision rejecting the female preference system has been vacated. However, it is unlikely the commission will decide any comparative cases on the basis of female or minority preferences until a final decision on the legality of the system is rendered.

Deregulation of sampling system and partial proof specs affirmed

The commission has denied two petitions for reconsideration of its Report and Order eliminating rules requiring directional AM stations to perform partial proofs of performance at regular intervals and prescribing design and construction guidelines for antenna monitor sampling systems.

Regarding partial proofs, the AFCCE had asked the commission to amend its rules so as to specifically sanction the use of non-directional antenna measurement data. The commission refused to do this, saying it has a long-standing policy of recognizing the use of non-directional measurements in partial proofs, thus obviating the need for a special authorizing rule. The commission noted that it does not require non-directional measurements in partial proofs, but licensees are free to submit whatever auxiliary data they believe supports their positions. The commission also declined to adopt rules prescribing a specific method of directional antenna data analysis referencing non-directional measurements.

The commission refused to reconsider its decision to remove from its rules design and construction guidelines for sampling systems. The argument was made that elimination of the guidelines creates confusion because AM licensees employing directional antennas will have to rely on FCC public notices, which may be difficult to obtain, instead of the rules to determine acceptable sampling system design.

Although the commission decided to include a reference to the appropriate public notice in its rules, it declined to reinstate specific design and construction guidelines. The agency prefers the notice method of establishing standards because it permits maximum flexibility in terms of updating sampling system standards to match the development of new technology. It would be too cumbersome to amend the rules every time there is a need to change the standards.

[:(~)]

Martin is a partner with the legal firm of Reddy, Begley & Martin, Washington, DC.

On it. In it. Behind it.

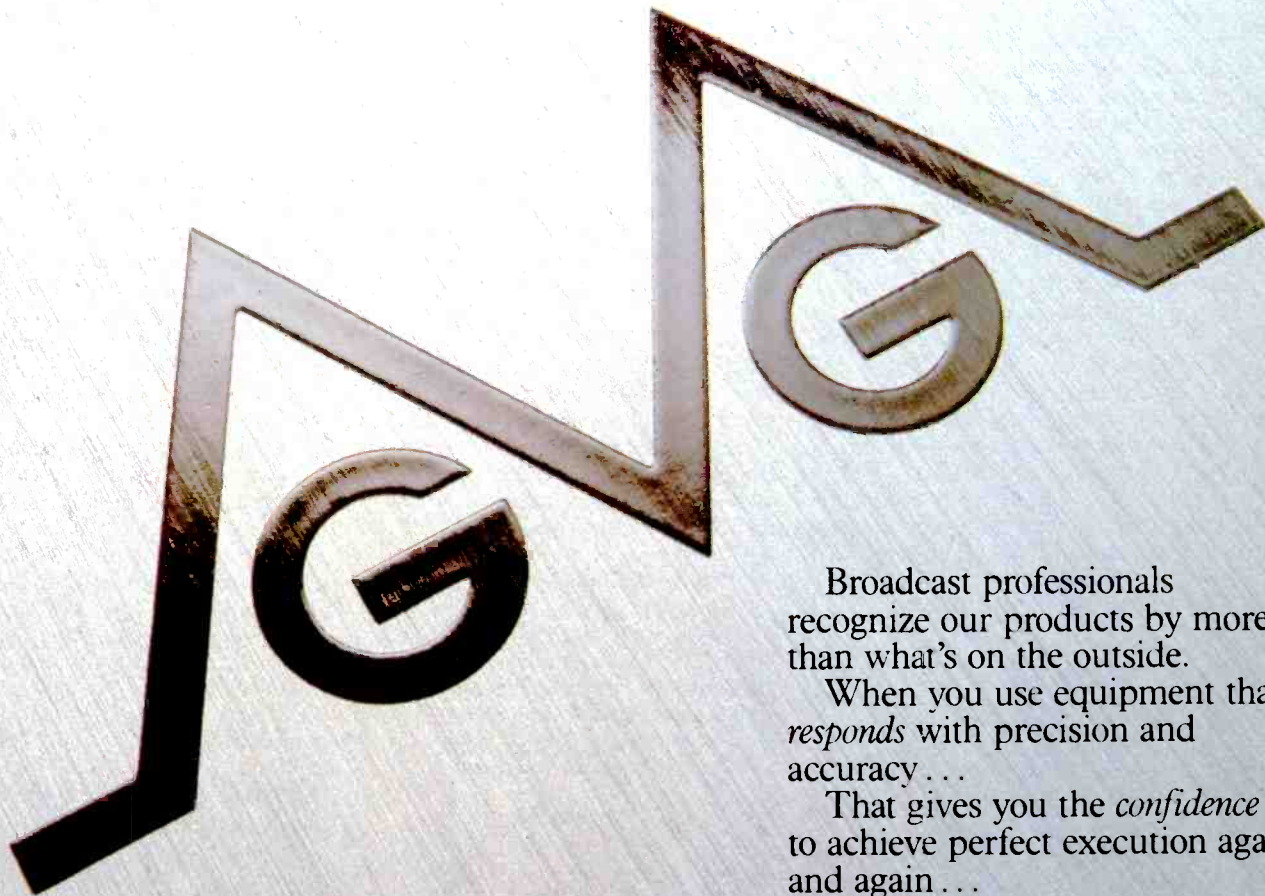

Broadcast professionals recognize our products by more than what's on the outside.

When you use equipment that *responds* with precision and accuracy . . .

That gives you the *confidence* to achieve perfect execution again and again . . .

That's backed by a world-famous *commitment* to innovation and customer support . . .

You know it's from Grass Valley Group.

Grass Valley Group®

STRENGTH YOU CAN RELY ON

PRODUCTION SWITCHERS EDITORS DIGITAL EFFECTS GRAPHICS SYSTEMS ROUTING SWITCHERS
MASTER CONTROL/AUTOMATION SIGNAL PROCESSING/DISTRIBUTION/TIMING EQUIPMENT FIBER OPTICS

THE GRASS VALLEY GROUP, INC.® P.O. Box 1114, Grass Valley, CA 95945 USA (916) 273-8421 TRT 160432
OFFICES: New York (201) 845-7988; District of Columbia (301) 622-6313; Atlanta (404) 493-1255; Chicago (219) 264-0931; Minneapolis (612) 483-2594;
Dallas/Fort Worth (817) 483-7447; Los Angeles (818) 999-2303; San Francisco (415) 968-6680. A Tektronix Company.

Circle (8) on Reply Card

Δt vs. Δf

By Carl Bentz, special projects editor

Our lives are controlled by time. Our technical efforts are no exception. Either you are working against the clock in the production studio, or you are trying to get equipment back on-line for the next commercial break. Yet, when everything operates correctly, time as a program schedule remains king.

Waveform monitors or oscilloscopes give time-base signal displays. You measure intervals of the signals in cm/sec or other submultiples of time. In essence, the instrument draws a graph for you, plotting signal amplitude (y) against time (t). For most video measurements, this time-base approach to signal analysis is adequate.

When you move to RF measurements, a reliance on time is insufficient to tell the entire story. The bandwidth of a modulated signal, for example, cannot be found easily with an oscilloscope. In recording and transmission system maintenance, measurement of bandwidth plays an important role in equipment adjustment. The instrument that most easily helps to determine bandwidth is the *spectrum analyzer*.

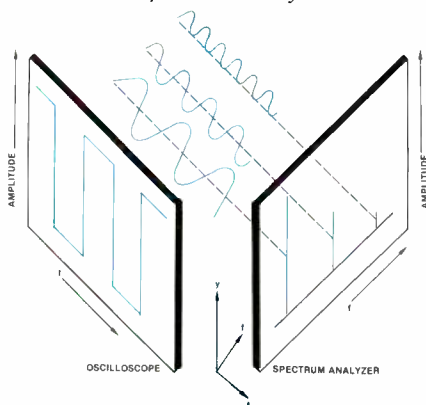

Figure 1. A comparison of oscilloscope (y-t) and spectrum analyzer (y-f) displays. A square wave consists of a fundamental and odd harmonics. Amplitudes of the harmonics are the reciprocal of the harmonic number.

Although oscilloscopes function in the time domain, spectrum analyzers operate in the frequency domain. The instrument plots the signal amplitude (y) as a function of frequency (f). There is an adjustment that determines the amount of time required for a sweep of the trace across the CRT. However, the signal on the screen involves signal amplitude



(dB/div) and the frequency (kHz-MHz/div), referred to the instrument graticule.

The diagram shows a square wave and its composition in amplitude (y) vs. time (t) drawings. The same signal, observed on a spectrum analyzer, takes on a different appearance in a y-f display. The y-f trace shows the square wave consisting of odd harmonics with a decreasing amplitude as frequency increases.

In AM

Amplitude modulation of a carrier by a tone creates two distinct sidebands. A spectrum analyzer graphs the sidebands at carrier \pm tone. With program audio, a complex mixture of sidebands occurs, always with pairs existing at carrier \pm the instantaneous frequencies of the modulation.

When the AM broadcast service began, rule makers deemed a 10kHz audio bandwidth sufficient. With AM stations limited to 10kHz modulating frequencies, assigned carrier channels can be on 20kHz centers. Audio in excess of 10kHz creates interference for a station on a neighboring channel assignment.

On-air RF

The TV visual carrier also is amplitude modulated, and like a radio carrier with program audio, presents a highly complex signal. A spectrum analyzer display of the TV signal shows the visual and aural carriers with their modulation components. (See Figure 2.)

Luminance spreads from the carrier toward higher frequencies, cutting off as it reaches carrier +4.2MHz. Chroma includes I and Q quadrature components interspersed with luminance and lying between the luminance sidebands. Chroma sidebands are offset by the relationship between horizontal scan and subcarrier frequencies. Aural information shows as an FM carrier.

If the spectrum analyzer sweep width is expanded enough, harmonics of horizontal and vertical scan frequencies appear on the CRT. Other periodic transitions in the image may also appear with some harmonic content.

A spectrum analyzer is used to measure the overall RF envelope of the transmitted TV signal. If transmitter tuning is correct, the display will coincide with the description in FCC rule 73.687. Of particular interest is the level of the color subcarrier in the lower, vestigial sideband. If large deviations from the FCC description exist, or if the 3.58MHz subcarrier is not more than -42dB below the visual carrier, the transmitter needs attention to tuning.

VTR RF

Transmission systems are not the only area of television where RF energy is used. Recording the wide frequency range of video signals requires an RF modulation approach to writing on tape (compare this to the bias signal in audio recording).

Spectrum analyzers simplify setting the modulation level of the VTR record amplifier. The recording carrier at rest (with no video input) must be set to a specific value. The VTR instruction manual will list additional frequencies for black, sync tip and maximum white. With the record amplifier output connected to a spectrum analyzer, it is relatively simple to make the adjustments for the correct recording modulation levels.

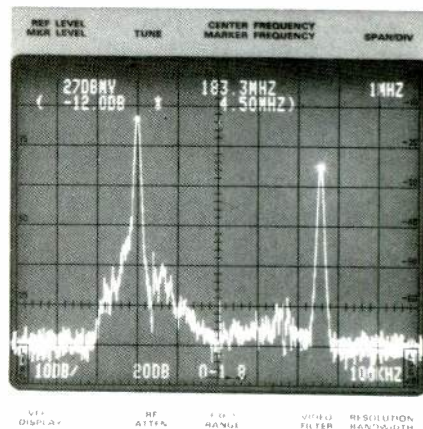

Figure 2. A spectrum analyzer display shows TV channel 8 visual and aural carriers. Photo courtesy of Tektronix.

As long as your life revolves around video adjustments, a time-base outlook will suffice. If you also deal with RF, the concept of the frequency domain adds a new dimension.

Dynamic Performer

The FOR-A PVM-500 Production Video Mixer delivers a powerful combination of performance and value for professional production and post-production video systems.

At just \$8,950, this compact switcher performs a series of dynamic functions typically found in products costing considerably more:

- 6 separate program inputs plus black and color backgrounds
- 24 programmable wipe patterns
- 4 independent automatic transition rates for effects, program, downstream keying and fade to black
- Generation of borderline edge, drop shadow and outline for downstream keying
- 3 independent colorizers for background, effects border and downstream keying
- Built-in gen-lock sync generator
- 6 independently adjustable black burst outputs
- Two program and preview output lines
- Serial and parallel editor interfaces

An optional EXKEY Component Chroma Keyer (CCK-500) and EXTROL Effects Memory (FXM-500) that can store up to 40 effects commands further extend its capabilities.

For a fast moving demonstration of the PVM-500 Switcher, call your FOR-A dealer today.



FOR-A[®]
INNOVATIONS IN VIDEO
and AUDIO TECHNOLOGY

FOR-A CORPORATION OF AMERICA • Nonantum Office Park • 320 Nevada Street • Newton, MA 02160
Boston (617) 244-3223 • Chicago (312) 250-8833 • Los Angeles (213) 4C2-5391

Circle (9) on Reply Card

Learning the basics

By John Battison, P.E.

Last month's column discussed field-strength measurement and briefly mentioned the problems that can arise when parasitic radiators are located in the field of another antenna. This month, we'll take a look at pattern contours and at parasitic radiators located near non-directional antenna systems.

Pattern contours

There are probably a number of AM engineers who think their current signal patterns are circular because the original application showed concentric circles on the coverage maps. Unless there was a conductivity change within the contours, these contour circles are probably correct. However, if the conductivity within the bounded area changes, then a non-circular pattern can develop.

You should remember that although a carefully calculated and plotted contour map may show a somewhat abrupt change in contour shape, there will not normally be a vast and sudden change in field strength at such points in the field. One notable exception exists at the junction of land and sea (salt water), where conductivities may jump from 1mmho to 5,000mmhos. A sudden change in field strength often will be noted at river crossings.

Parasitic radiation

Changes in station coverage patterns also can be caused by parasitic radiation. A station sometimes will construct a new FM tower at its AM antenna site. This practice helps to minimize the investment necessary to get the FM on the air by doubling up on land use. Unfortunately, without adequate planning, the process can be detrimental to the AM signal pattern.

FM towers are typically too tall to be effectively used at AM frequencies. A tower more than 0.625 of an AM wavelength becomes less efficient as the height increases. If a tall FM tower is located near an AM radiator, the tall tower must be *detuned* to prevent parasitic radiation. A detuning skirt is typically used to decouple the FM tower from the AM signal.

For purposes of discussion, assume that a new 400-foot FM tower with a detuning skirt is built near a 260-foot AM tower. The detuning skirt on a 400-foot FM

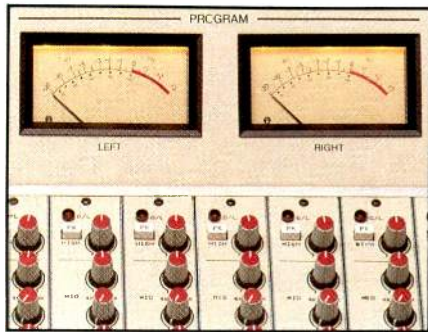

tower might be 131 feet long (about 1/8th wavelength). The skirt usually consists of three wires running parallel to and insulated from the tower. The wires form a wire tube or coaxial cylinder with the grounded tower as the center element. The three wires are joined together at the top and bottom through metal rings, also insulated from the tower. The lower ring is then coupled to ground through a tuning arrangement. (See Figure 1.) The tuning controls are used to minimize the FM tower's effect

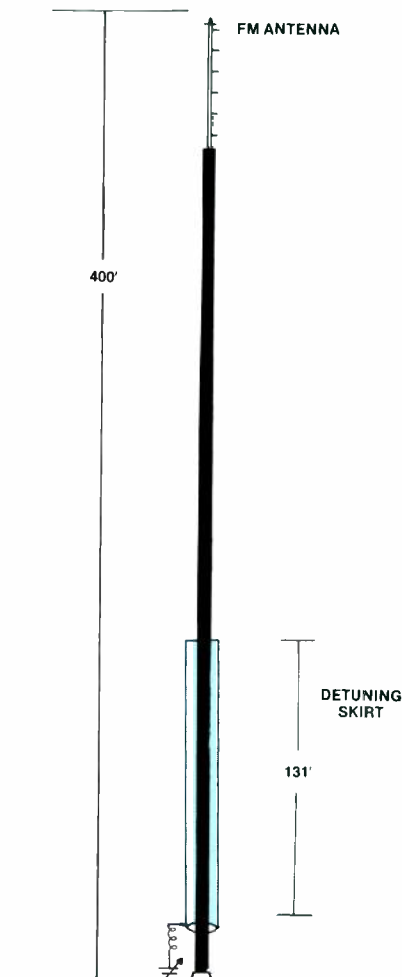

Figure 1. Detuning skirt for a tall FM tower located close to an AM radiator.

on the AM signal.

In addition to detuning the tower, the guy wires also must be prevented from reradiating the AM signal. One common method uses fiberglass cable instead of steel for portions of the guys. The non-metallic cable is as strong as steel guys but does not reradiate or disturb a radiation pattern.

Identify the source

If you suspect parasitic radiation is affecting your station's signal, it will be necessary to perform some detective work. One common method requires a standard field-intensity meter (FIM).

It's important to select a measurement location where the FIM antenna plane is at a right angle to the AM tower and pointed toward the suspected radiator. Figure 2 shows one method of identifying that location.

Draw a circle intersecting both the AM tower and the suspect tower (or object), placing each at opposite sides of the circle. If possible, draw the circle on a 7½° topographic map. Using the map as a guide, move the plotted circle around while recording the radiation from the suspected problem tower. The signal from the AM tower should produce a

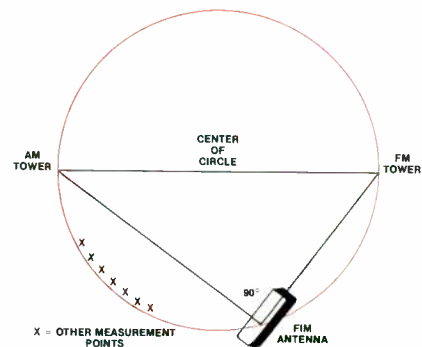

Figure 2. Measuring parasitic radiation with a field-intensity meter.

minimum reading because the figure-eight antenna pattern of the FIM is sideways to the AM tower.

Continue to take a series of field-intensity readings around the circle and plot them just like any other field-strength readings. Examine the results to see if the suspected source of reradiation is really the problem. Armed with this information you will be able to correlate reports of poor coverage with the suspected tower. [:(-)]

Battison, BE's consultant on antennas and radiation, owns a radio engineering consulting company in Columbus, OH.

THREE WAYS TO STEREO TV

the Superior Generator and More

A Stand-alone System

- Digitally synthesized signal generation
- Factory dbx encoding
- Improved noise reduction
- Full range, gated gain riding AGC
- Exclusive program-controlled stereo enhancement
- Multiband pre-emphasis limiting
- On-board Bessel tone calibrator
- Independent balanced and unbalanced output
- Selectable L/R or L + R/L - R inputs



TVS-3002

the Ultimate MTS System

Add the TVS 3001 Audio Controller to the TVS 3002 to complete the system.

- Control of entire audio transmission path
- Loudness control that works well on voice and music
- Gated linearized multiband gain reduction
- Automatic stereo phase reversal correction
- Audio asymmetry controller
- Input sync suppression filtering
- Built-in pink noise generator



TVS-3001

the Unequaled Processing Upgrade

Improve your current system with the latest in processing. Incorporates all of the features of the TVS 3001 plus:

- Extended-range AGC capability
- Exclusive program-controlled stereo enhancement
- Multiband pre-emphasis limiting
- Complete metering system for easy setup
- Loudness control that works well on voice and music
- Selectable L/R or L + R/L - R outputs
- Full remote control capability
- Compatible with any MTS generator



TVS-3002

TVS-3010

**A
GENERATION
AHEAD**



CRL Systems

2522 West Geneva Drive
Tempe, Arizona 85282
(800) 535-7648 (602) 438-0888
TELEX: 350464 CRL TMPE. UD.

More MSN units mean more interference

By Elmer Smalling III

Industry forecasts predict 300 to 400 MSN (mobile satellite news) units in the field by the end of 1987, with most of these units operating on the Ku-band. Because of this increase in the number of mobile and portable uplinks, unintentional interference to Ku-band satellite communications is destined to increase as well. The Ku-band is full of satellites and transponders carrying active network programming, news organization feeds and local station feeds, so the possibility of interrupting a live, on-the-air feed must be carefully avoided. Trial and error, even once, could result in major problems and embarrassment.

In addition to learning the functions of knobs and switches, MSN uplink operators should become as familiar with the satellite arc, and typical spectrum analyzer signatures of each satellite, as the back of their hand. Committing this information to memory will not only reduce the probability of serious unintentional interruptions, but also will save time in locating the correct satellite in those last-minute setup situations.

MSN setup

In setting up MSN units, the following guidelines should be followed:

1) The MSN unit must be parked, powered and stabilized with jacks to eliminate wind/shock absorber movement. If time permits, the van should be leveled, particularly if polarization adjustments are difficult.

2) Make certain there are no blockages such as trees, signs or buildings in the boresight path. Before raising the antenna, double-check for overhead power lines and wires, or any other obstructions that may contact the antenna at its maximum height.

3) Check the antenna surface and horn for debris. Any leaves, trash, snow or ice will affect the beam of your transmitted signal.

4) Determine true south using a compass and a magnetic variation compensation table for your location.

5) Using a chart such as the one shown to the right, determine the arc position of the satellite you wish to access, and the satellite that is closest to true south, depending on your longitude.

6) If you have spent time with your spectrum analyzer, you should readily recognize the signature of the satellite

Smalling, BE's consultant on cable/satellite systems, is president of Jenel Systems and Design, Dallas.

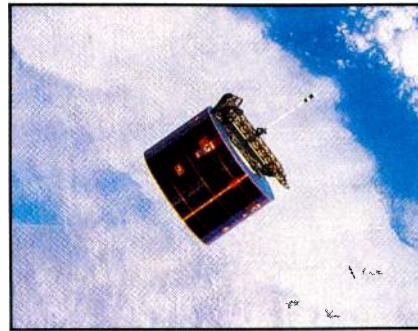

that is your true south reference. Using a picture monitor may seem practical. However, as scrambling increases, recognizable programs may be hard to see. The spectrum analyzer will provide the best method of seeing satellite

the edge of a transponder channel, and may be used to establish communications with the satellite operations center, and your own station. Be sure to log the time you established contact via SCPC, and the time you disconnected, because your station may be responsible for paying for the time used.

10) Once permission from the satellite operations center has been granted, begin transmission with video that identifies who you are. If a character generator is on board, use it to identify

DEG. WEST LONG.	NAME	OWNER
69	Spacenet II	GTE Spacenet
81	Satcom K2	RCA Americom
85	Satcom K1	RCA Americom
95	SBS3	Sat. Bus. Systems
97	SBS2	Sat. Bus. Systems
99	SBS3	Sat. Bus. Systems
103	GStar1	GTE Satellite
105	GStar2	GTE Satellite
107.5	ANIK C1	Telesat Canada
109	ANIK B	Telesat Canada
110	ANIK C2	Telesat Canada
113.5	MORELOS1	Mexico
116.5	MORELOS2	Mexico
117.5	ANIK C3	Telesat Canada
120	SPACENET 1	GTE Spacenet
128	ASC1	American Satellite

signatures before any picture will appear on your monitor.

7) Once you have determined where the arc lies in respect to your reference satellite, move your antenna to the east or west by an amount that is the difference between the reference and the desired satellite.

8) When the desired satellite has been identified, and the antenna aligned for peak signal strength and polarization, contact the satellite technical operations center. Stand by for instructions regarding a test transmission for cross-polarization and saturation.

9) You may be authorized to use the SCPC (single-channel per carrier) telephone. The SCPC uses frequencies at

the transponder you are on. This will facilitate your home station in confirming the signal they're seeing is actually you. Be sure to log your time on.

11) When the feed is completed, announce a "good night" both verbally and visually, if possible, and power the transmitter down immediately. Be sure to log your off time.

Proper training in MSN equipment use and strict adherence to good engineering practices and procedures will greatly reduce the amount of interference caused by inadvertent transmission to vulnerable satellite links. [:-?-)]]]]

Acknowledgment: Thanks to Wayne White, WDAF-TV, Kansas City, MO, for assisting with the setup guide.

CTM-10 CARTRIDGE RECORDER

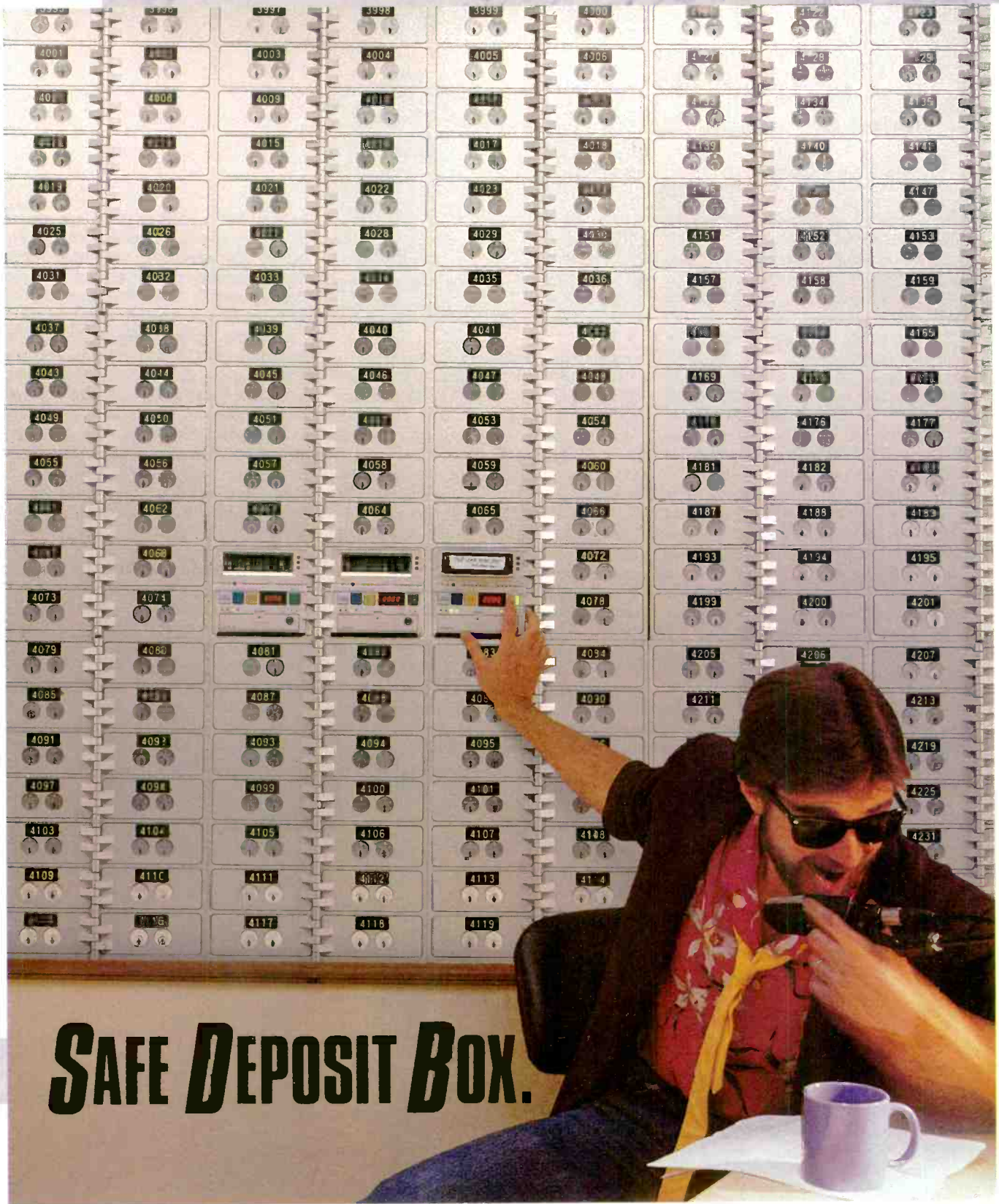

SAFE DEPOSIT BOX.

Finally, a cart machine you can bank on. ■ No jams, no repeats and no make goods. ■ Our new CTM-10 cart machine has the same famous reliability that is built into our 5050 BII, ■ plus many new features like Hx-Pro,* ■ so 7.5 ips sounds like 15 ips and your listeners don't tune-out when you shift from CD to cart.

So call us for Technology You Can Trust. ■ Otari Corporation, 2 Davis Drive, Belmont, CA 94002 (415) 592-8311 TWX 9103764890. **OTARI**

*Trademark Dolby Laboratories Licensing Corporation

Circle (11) on Reply Card

Inside digital technology

By Gerry Kaufhold II

According to the BE Salary Survey, "a typical broadcast engineer with SBE certification will be more successful than other engineers. If John Doe is SBE certified, then he will be more successful than other engineers."

This statement illustrates a basic concept of deductive logic. Like the AND gate, when all inputs are true (HI or 1), the output is true. Whenever the input is false (LOW or 0), the output will be false.

Digital circuits are designed to make decisions similar to deductive logic. The digital gates mentioned in previous "Circuits" columns (AND, OR, NAND, NOR and INVERTER) are used to help a digital circuit make decisions. How do you remember the result of a complicated series of digital pulses?

Digital memory

The up/down circuits of a transmitter remote control, shown in Figure 1 for example, should not be active until after the correct channel has been selected, and its position stabilized. A circuit is needed that will keep the up/down circuits locked out during the time when a channel is being selected. One circuit that will store information is the flip-flop.

For convenience, digital designers usually call the outputs of flip-flops Q, for the active HI output, and Q-BAR for the active LOW output. Transistors also are

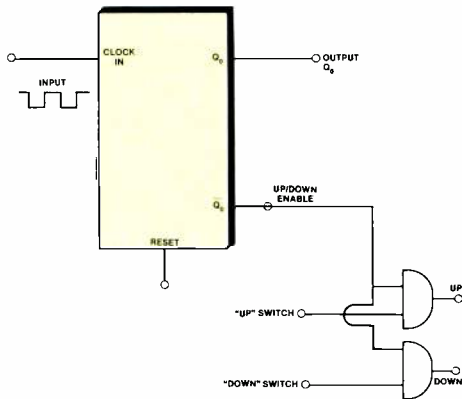
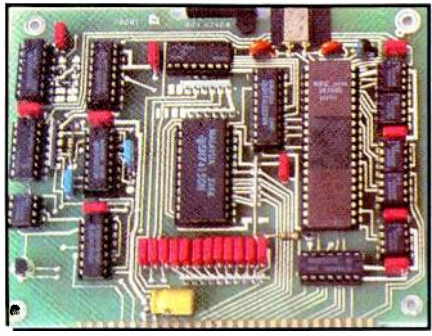

Figure 1. Logic symbol for a bi-stable flip-flop used in a transmitter remote-control circuit.

typically identified as Q. A typical simple storage circuit is the bi-stable multivibrator. (See Figure 2.) This circuit changes its output state for every other negative-going transition. Flip-flops are used for divide-by-two



counters and for time-delay circuits.

When power is first applied, or when a RESET circuit is activated, the base of transistor Q1 is forced LOW. This turns off Q1, and current flows through resistors R1 and R3a to the base of Q2. Q2 turns on and saturates, so the output signal Q0 goes LOW and stays LOW. Q2 is saturated, and R3b ties the base of Q1 LOW causing Q1 to cut off. The output signal Q0 (Q BAR or NOT-Q) goes HI and remains HI. Diode D1 is slightly reverse-biased and diode D2 is severely reverse-biased. The input is normally HI (active LOW).

When the input transitions from HI to LOW, a low-going pulse of short duration appears at point P1. Diode D1 becomes forward biased, and conducts long enough to interrupt the current through R3a. With no current flowing through

back to HI, a positive pulse appears at point P1, and the circuit does not respond. The next time the input transitions from HI to LOW, the outputs of the flip-flop switch. Thus the name flip-flop best describes the action of the circuit.

Referring again to Figure 1, the flip-flop must go LOW (Q-BAR output) at the beginning of a channel select command. It must remain LOW until the channel select command is complete. Referring to the truth table of the AND gate (see November "Circuits" column), as long as the signal named up/down enable is LOW, the up/down switches of the remote control will be locked out and inactive.

Bi-stable multivibrators

For an actual integrated circuit flip-flop, the values of the resistors will be chosen to provide for non-destructive base currents that are sufficient to saturate the transistors. Capacitors C2a and C2b help to speed up the transition time of the circuit. The input capacitor C1 must be small enough to discharge within the time required by the design.

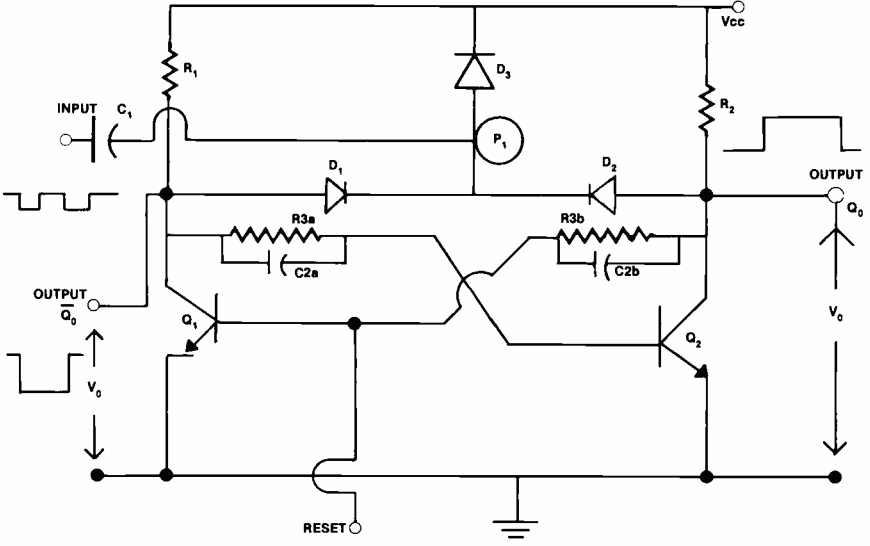

Figure 2. Bi-stable multivibrator typically used as a binary counter, by dividing the input frequency by 2.

Q2's base, transistor Q2 cuts off. Current flows through R2 and R3b through the base of transistor Q1. Transistor Q1 saturates, and the output signal Q0 (Q BAR) goes LOW. Output signal Q0 goes HI. Diode D2 is slightly reverse-biased, and diode D1 is severely reverse-biased.

When the input transitions from LOW

Besides flip-flops, some types of digital storage circuits are designated as latches. A latch is a flip-flop that has some additional control circuits added. Latches can be used to hold bits on an address bus while data is read from a memory, or for other applications that require a digital circuit to remember. [:-)]]

Kaufhold is staff engineer for KAET-TV, Tempe, AZ.

QUALITY CONTROLLER.

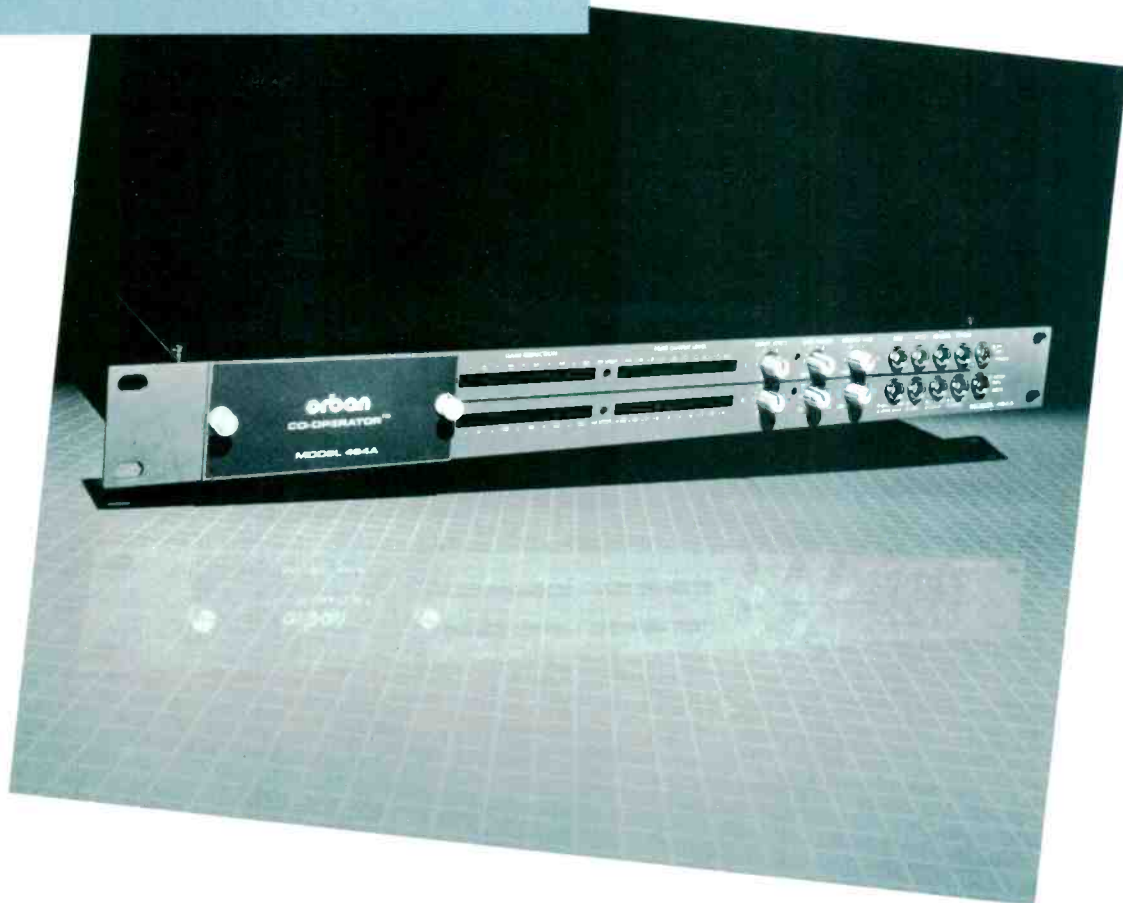

THE NEW ORBAN CO-OPERATOR™ AGC SYSTEM

Introducing the *Co-Operator*: an integrated, easy-to-use Gated Stereo Leveler/Compressor/HF Limiter/Peak Clipper in a powerful and economical dual-channel package. The *Co-Operator* automatically rides gain, controls excessive high frequency levels, and limits peaks while protecting audio and video tape recorders, broadcast cart machines, mic channels, STL microwave links, and SCA's.

Its simplified controls ensure top results—even from non-technical operators. Yet there is sufficient versatility so that you are never locked into a single "sound".

The *Co-Operator* rides gain subtly and intelligently—the way *you* would—to preserve the dynamic "feel" of the program material while effectively controlling levels. Or, if gain-riding is not desired, use it as a transparent, no-compromise safety limiter. Either way, it's always alert to safeguard audio quality. It contains a:

- Smooth leveler for transparent gain riding—without long-term distortion-producing overshoots
- Fast compressor and/or peak clipper can be activated to protect against short-term transients. Adjustable release time and release shape let you optimize processing for music or voice
- "Silence Gate" and compressor/leveler crosscoupling team up to prevent pumping and noise breathing
- HF Limiter with six switchable pre-emphasis curves from 25 to 150 us allow you to match the medium being protected and guard against sibilance overload

Ask your Dealer about Orban's new Model 464A *Co-Operator*—your subtle, automatic quality controller.

Orban Associates Inc.

645 Bryant St., San Francisco, CA 94107 (415) 957-1067 Telex: 17-1480

Circle (13) on Reply Card



A logic analyzer can give you the edge

By Ned Soseman,
TV technical editor

Repairing today's broadcast equipment is a little like trying to fix a new automobile. Several years ago, cars and broadcast gear were fairly straightforward; now they are so complex they require trained technicians equipped with dedicated test equipment to be used with the new technology. Digital circuitry and microprocessors are now the heart of autos and most new broadcast electronics.

A VOM (or DVM) and an oscilloscope might get you by if it's your lucky day and you have a plentiful supply of spare ICs and time. Most broadcasters, however, can afford neither. The ever-increasing inclusion of microprocessors and digital circuitry in new products demands a new approach to repairing broken equipment. As with any service trade, skill and the right tools are primary requisites for doing the job right the first time.

The old and the new

Digital circuits, compared with the analog varying-voltage circuits you're accustomed to, operate at only one of two voltage levels—HI or LO—and are usually clocked at a specified rate. Because the dual trace oscilloscope can display only two events at once, in real time, digital circuits require a tool that can monitor many channels of parallel data simultaneously, and that can recognize the logic levels of the circuits viewed. The logic analyzer is specifically designed to perform these tasks.

Just as the oscilloscope gives better visibility of an analog circuit than a voltmeter does, the logic analyzer makes a digital circuit more visible than an oscilloscope can. The logic analyzer enhances the vision of the maintenance engineer, and contributes to understanding the operation of a circuit.

What is a logic analyzer?

A logic analyzer is a CRT display instrument that is actually two analyzers in one package: a timing analyzer and a state analyzer.

The timing analyzer portion is analogous to an oscilloscope because its horizontal axis represents time, and the vertical axis shows voltage. Because it recognizes only voltage threshold, you

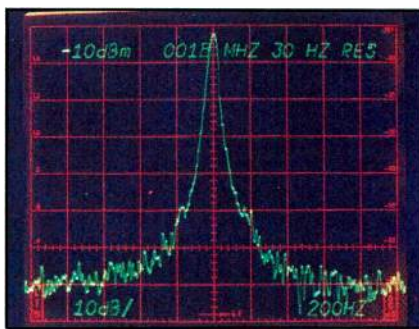

can consider it to be a multichannel digital oscilloscope with 1-bit resolution. Voltages above the threshold are displayed as HI; voltages below are displayed as LO. A sine wave applied to an input will be displayed as a square wave, with a pulse width proportional to the threshold setting.

The logic analyzer provides at least eight inputs, all of which may be simultaneously displayed on the CRT, as shown in Figure 1. The timing analyzer is used to verify timing relationships among several inputs.

The state analyzer portion is most often used to trace the execution of instructions through a processor system. Each memory cycle's data, address and status codes are captured and displayed

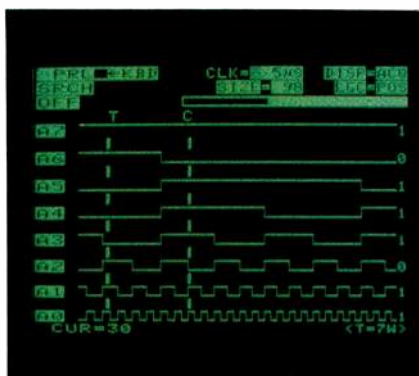

Figure 1. A typical logic analyzer screen in timing mode.



Figure 2. A logic analyzer will display data in a list format when used in the state mode.

on the CRT as they occur on the microprocessor's buses (see Figure 2).

When data are captured, the timing analyzer displays the data in a waveform format, similar to what the digital devices see. The state analyzer displays the data in a list format, typically in hexadecimal, binary, octal or assembly language. Depending on your application, each of these functions is highly useful, and unattainable with traditional test equipment.

How does it work?

Logic levels are sampled at a rate determined by an internal clock. Each sample stores one data word in the analyzer's memory. The sample points are determined by the user, based on the width of the shortest pulse expected. As the memory is limited to the number of points it can store faster sampling rates will fill the memory sooner.

During data collection, the analyzer continually fills its internal memory buffer with new samples. When the memory is full, it returns to the beginning. The memory continues to fill with new data until a trigger occurs. At the trigger point, a counter starts tallying the desired number of samples to be collected. This provides a means of viewing and analyzing stored data before and after a trigger.

Trigger events consist of a HI or LO on a single point, or one or more predefined patterns of bits detected on input channels. Logic analyzers may also recognize a glitch, any transition that crosses the logic threshold more than once between samples.

Choosing the right logic analyzer

There are many logic analyzers on the market today, designed for service (as opposed to design) use. Some use personal computers as an integral part of the system. Shop wisely, and "test-drive" a few analyzers on your own bench before deciding which model to purchase.

Editor's note: This article was adapted, with permission, from the following: "Logic Analyzers," by Kenneth H. King, *Microservice Management* magazine (an Intertec publication), July 1985; and "Feeling Comfortable with Logic Analyzers," Hewlett-Packard, Colorado Springs, CO.

TTV 2710, the first digital CCD slide scanner: for rapid, efficient and economic processing with top professional quality.



THOMSON 

ttv 2710

TAILORED FOR IT

Thomson Video Equipment, digital image pioneer and world leader in image processing, presents the exclusive TTV 2710, CCD digital slide scanner featuring:

- digital processing of video signal, conforming to international standards (CCIR 601).
- great operational flexibility: 80 slide "Kodak® carousel" for fast search: programmable color corrections, memory capacity for full carousel, 2 frame stores, preview and on-air channel, fade or cut, inversions, 2 X' 5 magnification without loss of resolution; positive or negative slides.

THOMSON VIDEO EQUIPEMENT

Because the best need the best

Circle (14) on Reply Card

FRANCE (HEAD OFFICE)
THOMSON VIDÉO ÉQUIPEMENT
17, rue du Petit Albi - CERGY-SAINT-CRISTOPHE
BP 8244 - 95801 CERGY-PONTOISE CEDEX
Phone (1) 34.20.70.00 - Telex 204 780 F
Fax (1) 34.20.70.47

U.S.A.
THOMSON CSF BROADCAST Inc.
37 Brawnhouse Road - STAMFORD
CT 06902 - U.S.A.
Phone (1203) 965.7000 - Telex 6819035 TCS FB.
Fax (1203) 327.6175.

* Carousel is a registered trade mark of Kodak.

If it's goodbye, make it good

By Brad Dick, radio technical editor

You're fired. These words strike terror in the hearts of employees and managers alike. In fact, there may be more trepidation on the part of the manager who has to say them than the employee at whom they're directed. Have you ever had to fire an employee?

Terminating a worker is never an easy task. It is heart-wrenching for both parties. Even in situations in which the person's continued employment would be a threat to company morale or in some other way detrimental to the station, most supervisors don't like the idea of having to take a job away from someone.

With today's emphasis on equal employment opportunity, there is a heightened potential for problems associated with terminating an employee. This is even more likely if the terminated person is a female or a member of a minority.

Few managers receive training on how to terminate an employee. Some managers are so inept at it that they go to great lengths to avoid it altogether. Have you ever watched an employee take advantage of a weak manager to retain a job? When this happens, the morale within a department can be lowered dramatically. An ineffective employee who gets by with inferior performance can create many serious problems for the manager or supervisor. The only solution is an effective termination procedure that protects the rights of the employee and the station.

Case studies

One effective way to learn new leadership and supervisory skills is by examining case studies. In the next few issues, this column will contain sample problems that you might encounter as a technical manager. There is seldom one correct answer to these problems. Instead, the examples are intended to start you thinking about the kinds of problems that can occur within a station. Then, you can develop your own solutions.

Case background

Kate was a 32-year-old single parent who worked as a videotape operator. Her work was satisfactory and Jim, her supervisor, had no complaints—until now. Over the past three months, Kate had been showing up for work late. Usually she was only a few minutes late, five minutes or so, but still late enough that another operator had to stay over to



cover for her until she arrived.

Finally, one of the other operators complained to Jim about Kate's tardiness. Now that Jim was officially aware of the problem, he decided to discuss it with Kate. When questioned about her tardiness, Kate said that she had two children to take care of and that she really was doing her best to be on time. She promised to try harder and the matter was dropped.

Kate tried to get to work on time, and for a couple of weeks, she was successful. However, within a month, her old habits had returned. She was again showing up late for work. Now the 10 minutes had turned into 15 and, one day, she was 20 minutes late. When approached about it, Kate replied that she had overslept and was sorry. Jim reprimanded her and warned her to be on time for her shift.

On Friday of that week, he went on a 2-week vacation. When he returned, two videotape operators demanded a meeting with Jim to discuss Kate's tardiness. Jim had no choice but to listen to their complaints. After the meeting, he scheduled a meeting with Kate.

At the meeting, Jim outlined to Kate the complaints about her performance during his vacation. He reminded her of their previous discussions about being on time and she agreed that she had broken her promise to get to work on time. Jim warned Kate that additional complaints could result in her termination.

Three months later

The next month or so went along well. Kate was on time or no more than a couple of minutes late. Her work was satisfactory in other regards, so the problem seemed resolved.

One week, Fred, another videotape operator, arrived late for work three days in a row. Someone complained to Jim and he approached Fred for an answer. When queried about being late, Fred exploded. "How can you complain about me being late when Kate does it all the time?" Jim dropped the matter.

Jim completed employee performance reviews for his staff in late March. Because he was aware of some personal problems Kate was having, he gave her a

favorable review. He didn't want to force the issue until it was absolutely necessary. Kate continued to arrive late on a regular basis. In April, Jim decided to terminate Kate.

Termination

When Jim requested to meet with her, Kate asked for a witness to be present. Jim refused, saying that they were only going to discuss her performance. Jim and Kate discussed her tardiness. Kate offered excuses for being late. After all, she was a single parent with the responsibility of two children.

At the conclusion of the discussion, Jim told Kate she could either resign or be fired. Kate elected to resign. Before leaving the building, she informed her friends of her termination.

Later that day, Jim hired a 35-year-old male (the most-qualified applicant) to replace her. In an effort to help Kate, Jim then placed a favorable reference letter in her file. In May, Jim's station was served with a lawsuit alleging:

- Sex discrimination;
 - Age discrimination;
 - Intentional infliction of mental distress; and
 - Failure to discharge for just causes.
- In addition, Kate applied for unemployment compensation, saying that she was forced to resign.

Ask yourself

This type of thing happens more often than you might realize. Some stations are fortunate enough that the terminated person doesn't pursue the matter. Other stations become embroiled in expensive legal battles that could have been prevented.

What do you think? Was the supervisor justified in forcing Kate to resign? Will the station have any problems defending the termination? What could Jim have done differently to avoid having to terminate Kate? Could he have done anything differently to avoid having to defend his actions in court?

If you would like to offer any suggestions to this problem, write the technical editor at **BE**. Reader's comments may be presented in a later column.

Editor's note: Background information on this subject was obtained from "Electronic Media Management," by William E. McCavitt and Peter K. Pringle, Focal Press, Boston and London.

[:?>]]]]

NEW FROM ARRAKIS SYSTEMS

5000 SERIES

The First No-Compromise
Modular Radio Console...



...At A Down-To-Earth Price: 16 Channels, Under \$10,000.

THE FEATURES YOU WANT —

- 16 Modular Stereo Channels.
- Program, Audition and Mono Mixdown Balanced Outputs.
- Telephone Mix-Minus Buss.
- Full Monitoring Facilities.
- Remote Equipment Start/Stop.
- Remote Module Control.
- Standard Digital Clock and Timer.
- Optional EQ and Effects Modules.

THE DEPENDABILITY YOU NEED —

- DC Controlled — No Audio On Pots.
- Rugged Modular Construction.
- Penny & Giles Slide Faders.
- ITT Shadow Switches.
- NE5532 IC Module Design.
- External Regulated Power Supply.
- Superb Audio Performance Specs.
- Most Important, Arrakis Systems Designed-in Ultra Reliability!

For features, performance, price and reliability,

NOBODY BUILDS CONSOLES LIKE ARRAKIS.

Call (303) 224-2248

Circle (15) on Reply Card

ARRAKIS SYSTEMS INC. 2609 RIVERBEND COURT FORT COLLINS, CO 80525



Designed for the future

The decision to build a new studio facility or to renovate an existing plant is like Christmas morning to technical managers and their engineering staffs. A major project such as studio/control room equipment improvements brings the opportunity to purchase lots of new hardware that you've been wanting to buy for years. It also gives you a chance to build the facility from the ground up, the way you want it. No longer will you be saddled with a design drawn up by somebody who has a different set of goals and ideas.

Although it might feel like Christmas when you begin the facility renovation, it might seem more like Halloween during the actual construction phase. Rebuilding a plant is never an easy job, and it is usually made more difficult by time and budget restrictions, labor problems and unforeseen technical details that must be worked out. Despite the potential pitfalls of plant renovation, however, most of us would jump at the chance to become involved in it.

In this special report on "Designed for the Future," we focus on three examples of studio/control room facility renovation at large-scale network operations: NBC-TV in Burbank, CA; the Armed Forces Radio and Television Systems headquarters in Los Angeles; and the Voice of America in Washington, DC.

- Updating NBC Burbank Page 24
- Updating the AFRTS Page 48
- Updating the
Voice of America Page 68

This is the audio mixing center for Studio 4 at NBC-TV in Burbank. The newly completed facility is one of several that have undergone renovation at the network. Studio 4 is currently used to produce shows such as "Wheel of Fortune" and "Sale of the Century." The audio console (built by Solid State Logic) features 40 mono and eight stereo I/O modules; stand-alone 22-channel, four stereo group submixers; three stereo mix groups; one stereo, four mono aux sends; 32 mono groups for additional sends or IFB clean feeds; and the total recall feature with Auto-Scan for console setups. The console was shaped into an "L" configuration to keep the faders and other controls near the operator. The pie-shaped area is used for NBC control and communications panels. (Photo courtesy of Solid State Logic.)



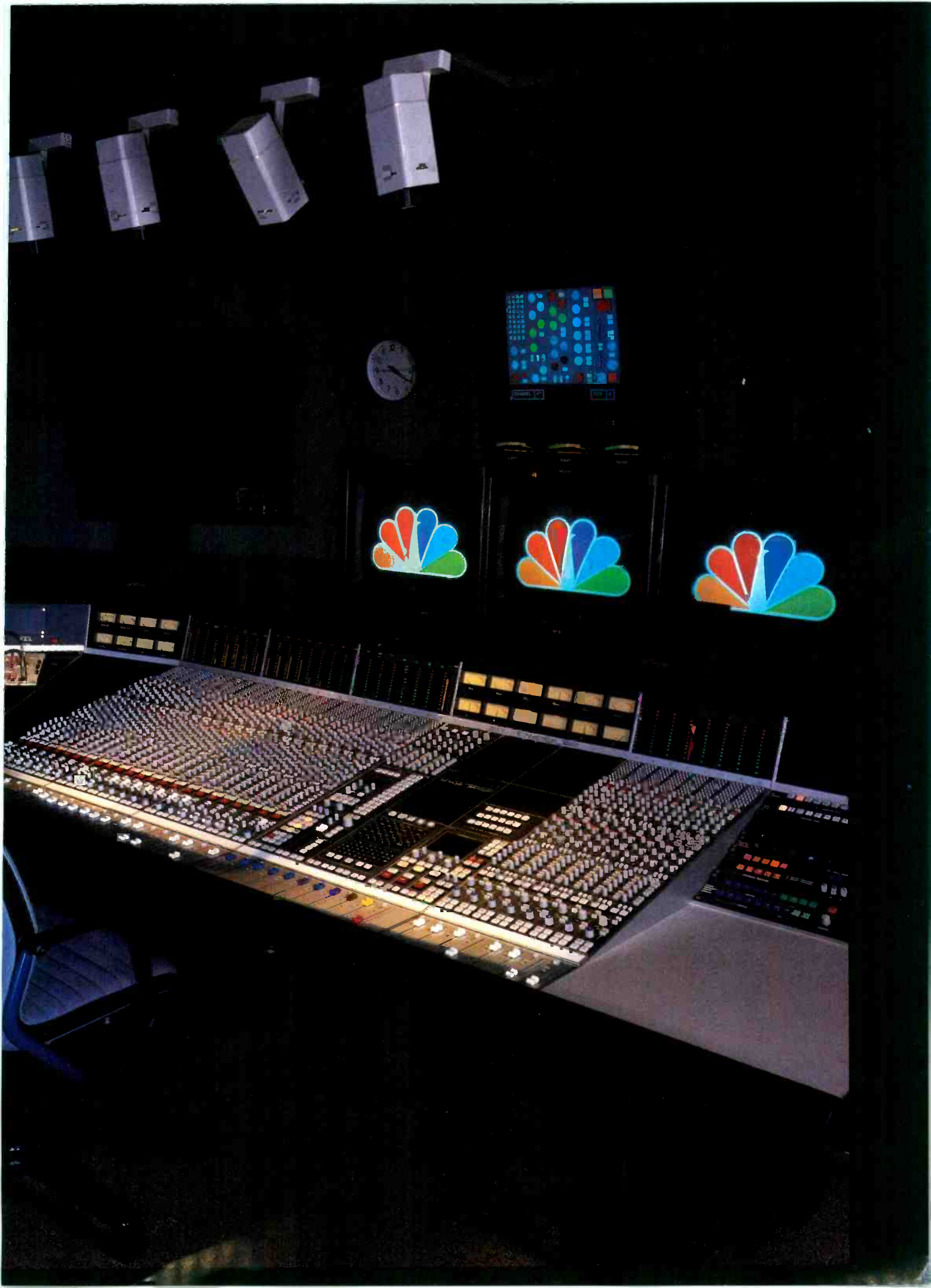

Designed
for
the
future

Updating NBC Burbank

By Jerry Whitaker, editorial director

The renovation of a studio facility is one of the most exciting and difficult tasks a technical manager faces.

What's your image of technical utopia? To most TV engineers, the ultimate in technical sophistication is assumed to reside at the major TV networks. The perception is that the net can afford anything it wants, and we suspect it updates equipment about as often as the rest of us change camera tubes. Why bother to repair a VTR? Just replace it! Major facility improvements are assumed to be continually in progress at all steps in the system.

This perception, however, is only wishful thinking. The networks have to deal with many of the same restraints—financial and technical—as the rest of the TV industry. The capital resources at the network are no different, proportionately, than at an independent station. Technology at the network level works exactly the same way it does in market 25 or in market 183.

The broadcast production and operation centers of the three major networks are different in the scope of the functions they perform. And although it is vitally important for each facility to be technically up to date, *minimum downtime* is the overriding concern. The familiar phrase "time is money" is the watchword of the networks. The need for minimum downtime requires that the equipment used in each plant be reliable and that studio/control room facilities be designed for long-term expandability.

Once a facility is put into service, it will not be taken off-line for equipment updates unless absolutely necessary.

NBC Burbank

Generally speaking, the types of network facilities found in New York differ from those in the Los Angeles area. The New York plants usually center on the production of news and sports programs, switching and transmission functions. Los Angeles operations typically concentrate on the production of entertainment programming. The requirements of studio/control room facilities differ greatly for these two applications.

Sports and news studios tend to be smaller, using a large number of remote pickups. New York operations form the center of switching and control for the network, but not for the generation of entertainment programming. That comes from the West Coast, and that business is *user-driven*.

The West Coast production/operations center for NBC is located in Burbank. Entertainment programming is produced for use on NBC and other networks, plus syndicated distribution to independent stations. The competition among studio operations for program production is tough. The more impressive the list of benefits, features, support and hardware that a facility can offer a potential client, the more likely it will be to capture a



The technical director console under construction in the control room of Studio 4. Video monitors can be seen in the background. A total of 28 black-and-white continuity monitors are used, plus three color monitors (program, preset and preview).

WHETHER IT'S NEW CONSTRUCTION OR RENOVATION...

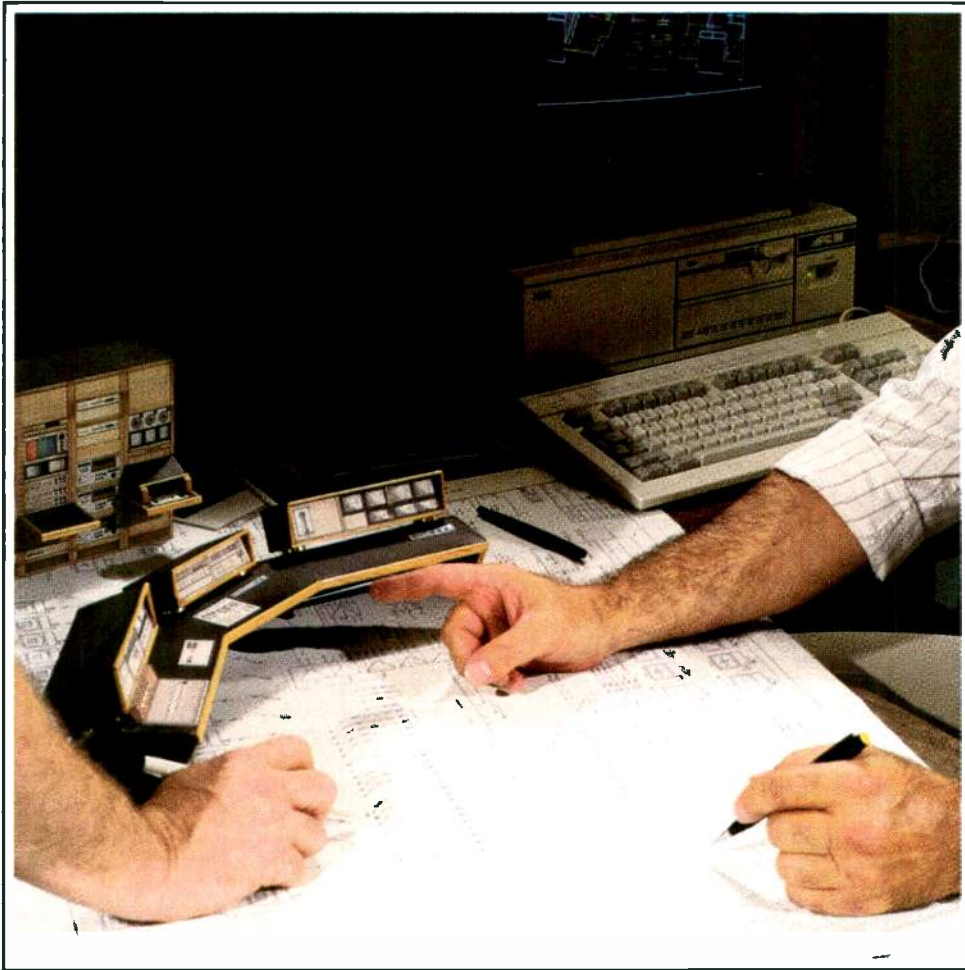

Your goal is to be the best in your market by building a facility that will produce operating efficiencies and a superior on-air look. Lerro Corporation can help you bring together all the pieces of the technology puzzle to create the most cost-effective physical plant you need to sell your services.

Lerro uses the interactive team approach, with you providing inputs on your marketing strategy, both short and long range sales goals and cost constraints. We offer technological solutions using our broad equipment lines, product knowledge, and advanced engineering tools.

A Lerro designed and constructed facility along with our follow-up training, maintenance program and warranties will create an environment for you to market your product with quality, efficiency, comfort, and profitability.

Call the Lerro half of your design team today!

THE
LERRO
CORPORATION

3125 N. Broad St., Philadelphia, Pa. 19132
215 - 223-8200



The music room adjacent to the audio mixing room of Studio 4. The music room includes 15 stereo cart machines, a mixer, nearfield monitors and cart storage racks.

good share of the available business. And with studio time booked months in advance, technical managers could not consider renovation work on a facility that would pull it off-line. It would be far too expensive for the network.

In order to remain competitive with other operators in the short- and long-term future, the Burbank center has been undergoing an extensive renovation effort. The center includes six large production studios (numbers 1, 2, 3, 4, 9 and 11). The largest, Studio 11, measures 100' x 180'. The network broke ground for Studio 11 in November 1984 and was on the air from the facility six and a half months later. This *fast-track* approach was necessary to meet production deadlines for the afternoon soap opera "Santa Barbara." The program was set to air on a specific date, and the equipment had to be in place to produce it.

How do you construct a major studio and production facility in such a short period of time? Identify your exact requirements and build to them.

Plant designers first examined the available alternatives. They didn't have the time or money to install equipment that wasn't needed immediately. A soap opera does not need a 4-channel digital video effects system, so it was not included. It also does not need a sophisticated character generator system. What Studio 11 required was a configuration that accommodated four cameras, a video switcher, audio mixer, monitoring/control equipment and audio- and videotape recorders. That was it.

A 42-input audio console was selected for the studio control room, but the budget permitted filling only 32 of the possible number of input slots. Budget restraints affect every broadcast operation—even the networks! Upward expandability was a basic design criterion.

The latest work at Burbank involved Studio 2 and Studio 4. The renovation

project included everything from the cameras and microphones to the monitoring system and tape recorders. Complicating the effort was the requirement to keep studios 2 and 4 up and running during the renovation work. That meant constructing entirely new control rooms and installing new equipment and cables.

The average life of a network production studio/control room combination is 10 to 20 years. Studios 2 and 4 were last updated during the 1960s. The only major improvements since then were the addition of new cameras and an improved lighting control system. The audio and video switching and monitoring equipment was unchanged. In fact, the audio consoles used in the control rooms were designed and built at NBC Burbank in the '60s because systems of the required sophistication were not available from audio console makers.

Inside studios 2 and 4

A facility such as NBC Burbank serves the needs of not only the network and the local *O & O* (KNBC), but of outside producers as well. It is impossible to design a studio that will do everything for any potential client, but the goal of full flexibility is generally the best approach to the planning stage.

The structural shells of studios 2 and 4 were left alone. The ceiling height of 42 feet from grid to floor allows *flying* sets if needed. The studio floor area, 127' x 73' in each studio, was adequate for most productions. Acoustically, the rooms were satisfactory. Lighting, recently updated, was in good shape. The bulk of the work involved construction of a new control room, production operating space, and replacing the audio, video and control wiring to each studio floor.

Pulling cable

Rewiring the studio floor was more difficult than it might seem, especially

AMPEX

Information about ADO and other Ampex products is available from the following Ampex video systems dealers:

AF Associates, Inc.
100 Stonehurst Court
Northvale, NJ 07647
201-767-1000

Alpha Video & Electronics
28 E. Mall Plaza
Carnegie, PA 15106
412-923-2070

Landy Associates, Inc.
330 Bear Hill Rd.
Waltham, MA 02154
617-890-6325

Lerro Electrical
3125 N. Broad St.
Philadelphia, PA 19123
215-223-8200

Midwest Communications Corp.
1 Sperti Drive
Edgewood, KY 41017
606-331-8990

MZB & Associates
4203 Beltway Dr.
Dallas, TX 75244
214-233-5535

Roscor Corp.
1061 Feehanville Rd.
Mt. Prospect, IL 60057
312-539-7700

Todd Communications, Inc.
6545 Cecilia Circle
Minneapolis, MN 55435
612-941-0556

Turner Engineering, Inc.
325 Division St.
Boonton, NJ 07005
201-263-0023

Introducing the ADO 1000 Digital Optics system: The full array of ADO effects. Single button access to 30 on-line effects. Multi-channel capability. All as standard equipment, and all with the picture quality that made the ADO family the industry standard for digital effects.

Even when you add perspective and rotation, for effects like the famous *ADO page turn*, the price is

still only \$67,000.

When you need even more power, options like Digi-Matte™, a key processing channel, and RGB input/output are available. And for the ultimate in convenience, you can integrate your ADO system with an Ampex AVC switcher and run effects right from the switcher control panel.

So call your nearest Ampex representative for a demo of the

ADO system's amazing effects. From Ampex, with product support and service, worldwide.

Atlanta (404) 491-7112 Chicago (312) 593-6000
 Dallas (214) 960-1162 Los Angeles (818) 365-8627
 New Jersey (201) 825-9600
 (In New York (212) 947-8633)
 San Francisco (415) 367-2296
 Washington, D.C. (301) 530-8800
 Canada (416) 821-8840

AMPEX

Circle (16) on Reply Card

Now There's an ADO™ System for \$39,500!



when you realize that plans called for installation of eight drops per studio. Each was to provide connection points for communications, camera, video trunks (eight lines), audio inputs (24 mic-level inputs), control and tally circuits, foldback, PA, boom drops and audience microphones.

The video tie trunks link each control room to its respective studio and allow distribution of signals where needed. Selection of feeds is accomplished with a patchbay in each control room. In-house cable video signals also come down to the studio floor for roll-around video monitors. Monitors (suspended from

pipes) are provided for audience areas.

Selection of video and audio cable is of prime importance to long-term performance. Some of the old cable pulled out of the facility dates back to when studios 2 and 4 were built (1954 and 1956, respectively). Some of the audio cable was, in fact, lead shielded. This type of cable was installed during initial construction of the Burbank plant.

Wiring was a particular concern because of the number of interference sources that exist around the Burbank center. In-house interference threats include studio-lighting circuits (particularly SCR-type dimmers), ac power-distribu-

tion circuits and intraplant data lines. Outside interference sources include RF broadcast signals and occasional-use microwave links.

Audio requirements

Audio specifications for the Burbank facility are stringent. Audio levels are standardized at 1.23V rms (+4VU or +10dBm) at 150Ω. The plant headroom is +26dBm. When audio signals go between buildings or floors, transformer isolation is used. Burbank engineers have found this procedure the best method of ensuring the required common-mode rejection ratio in the presence of RF and ac fields.

The dawn of stereo for television has led to a re-awakening of interest in high-quality audio. The sound often took a back seat to the video in years past. The conventional wisdom was: *If you can hear something, the audio must be OK.*

With stereo production, micing and phasing become extremely important. By building a new control room facility from the ground up, you know that all of the cables are of equal length and that color codes are maintained throughout the system. This measure of insurance was one major benefit of renovation work on studios 2 and 4.

The Burbank facility uses *discrete* left and right audio signal distribution. The relative benefits of using discrete vs. *matrix* (L+R and L-R) distribution were examined by network engineers.

The addition of another channel to the audio system of the Burbank plant has been a major ongoing project. Everything had been set up for only mono and time code. Adding stereo required two audio program feeds throughout the plant—left, right or mono sum—in addition to time code. Control and distribution of stereo audio was accomplished with installation of the master grid switching system designed for use at the 1980 Olympics. The grid system is capable of handling four channels of 12-bit serial digital audio.

Control room design

Planning the layout of a control room is, or at least should be, a group decision. The general parameters of the room (location and size) are usually set. Each department or user group must then identify its particular requirements for the new facility. A rough design is generated based on the wish lists developed by the group. A series of give-and-take sessions follows, resulting in a workable compromise based on the needs and preferences of engineering, operations and management personnel.

The first decision in any control room design project is whether to build a new room or renovate existing space in the plant. Perhaps the control room could be built in an area previously used for other functions, such as office work or visitor reception. A second and important con-

COST EFFECTIVE

System One is COST EFFECTIVE.

System One plus PC

(if you don't already own one)

sells for \$7,000 to \$10,000—less than slower, lower-performance IEEE-488 automated audio test systems.

Even more important, you'll have automated procedures running with minutes-to-hours of non-programmer setup time, compared to weeks- to-months of software effort required by conventional programmable instruments.

Audio precision

P.O. Box 2209
Beaverton, Oregon 97075
503/297-4837, 1-800/231-7350
TELEX: 283957 AUDIO UR

Now, that's the way
to test audio!

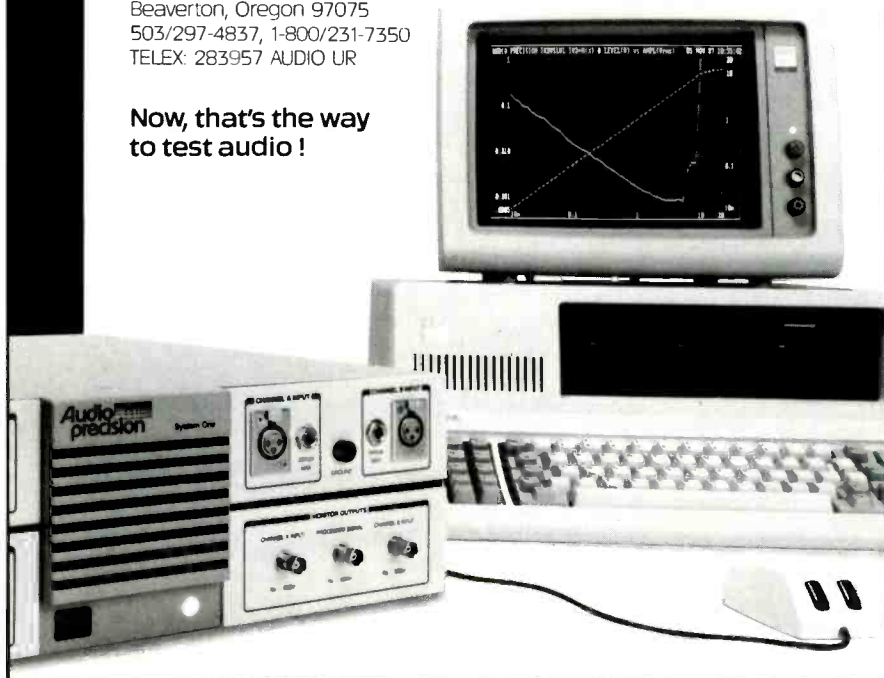

Circle (17) on Reply Card

The Pro CD Alliance

Philips and Studer have joined forces. Working together, Europe's technology "superpowers" are designing the CD systems of the future.

Studer and Philips have formed a joint venture company to develop new professional CD systems. Philips provides the venture with pioneering leadership in basic CD technology, while Studer contributes broad-based expertise in professional audio systems. And, as part of the overall agreement, Studer Revox America will represent Philips professional CD products in the USA.

So now, whether you choose a Philips or a Studer product, you will benefit from the high level of technical and service expertise provided by Studer Revox America and the network of Studer Revox professional products dealers.

If you're looking for a multi-player system with sophisticated production functions, the Philips LH 2000 has what you need—and likely a bit more. The system is modular and expandable. You can start with a basic one-player system, then plug in additional players and command modules. Naturally, the LHH 2000 is loaded with features: a three-speed search/cue wheel for precise cueing, balanced outputs, fader start, player status indication, and automatic sequential play from one player to the next. Sophisticated, yes, but also delightfully easy to use.



If you're looking for the best in a basic CD unit, look closely at the Studer A725. It's solidly built to take years of heavy use. Pro features include balanced and unbalanced outputs, precise cueing with multiple cue modes, BIG control buttons, fader start option, and a multi-mode display to show elapsed and remaining time for disc and track. Nearly every conceivable function is programmable (by track, time, or index) up to 19 steps. Finally, the sound of the A725 has won praise from audio critics and broadcasters worldwide.

For programming and production, the CD is likely to be your future source for music and SFX. And the source for CD products from the new Swiss-Dutch alliance is your Studer Revox dealer. For more information and dealer references, please call or write today.

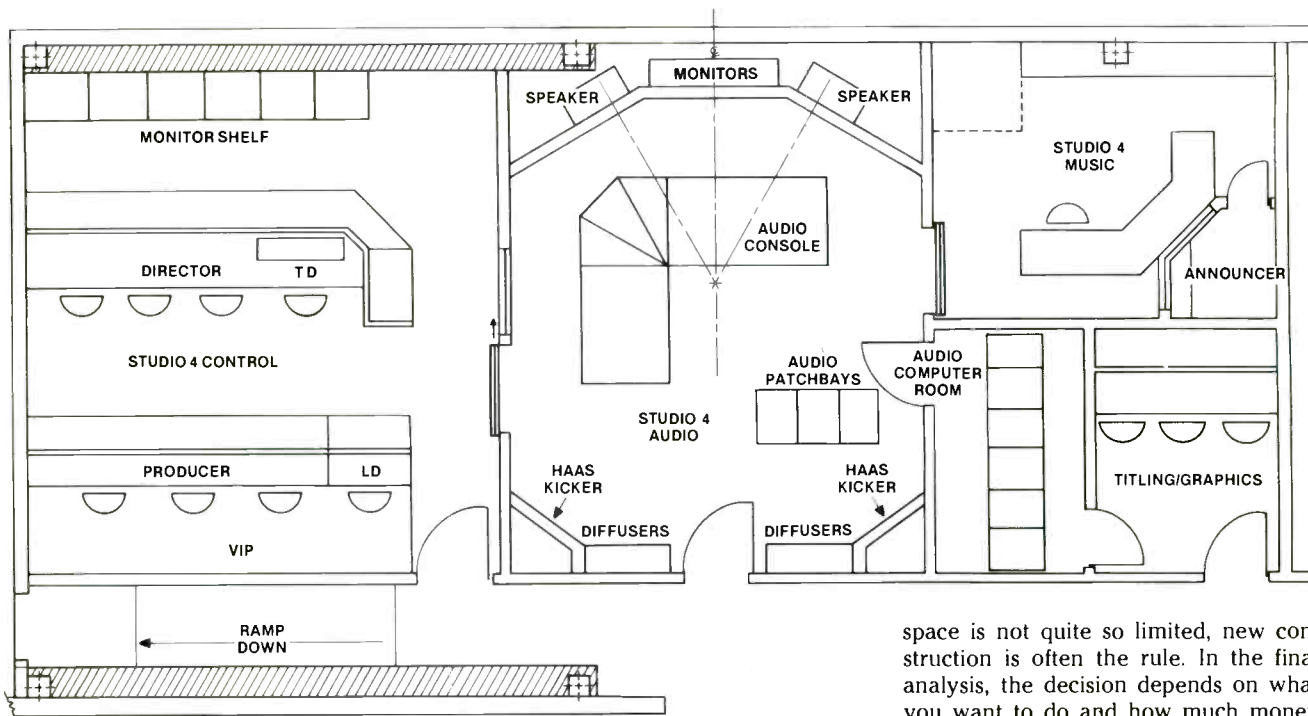

Figure 1. Basic floor plan for the control room area of Studio 4 at NBC's Burbank facility.

cern is whether you can take the room out of service while renovation work is under way.

In facilities in which space is tight, such

as the New York network headquarters, renovation of existing space is by far the most prevalent method used for improving TV facilities. In Burbank, where

space is not quite so limited, new construction is often the rule. In the final analysis, the decision depends on what you want to do and how much money and time you can devote to it.

Rebuilding or modifying a studio/control room complex while it is on-line requires a great deal of ingenuity. You usually have to beg, borrow or steal time during rehearsal or load-in/setup. Work cannot be performed, however, when

Main story continues on page 36

Showstopper!

Digital Picture Freeze & "Infinite Window" TBC/Synchronizer

4x1 Audio & Video Switcher... Built In!

H & V Image Enhancement

D.O.C.

Meets Broadcast RS170 Video Specifications



Digital Video Effects

- Mosaic
- Freeze
- Posterization
- Colorization
- Picture Strobe

Cygnus

Video Production System

\$4990. List Price

Phone or write for full particulars

The ALTA Group, Inc. 535 Race Street, Suite 230 San Jose, CA 95126 (408) 297-2582

ALTA
GROUP, INC

Circle (103) on Reply Card

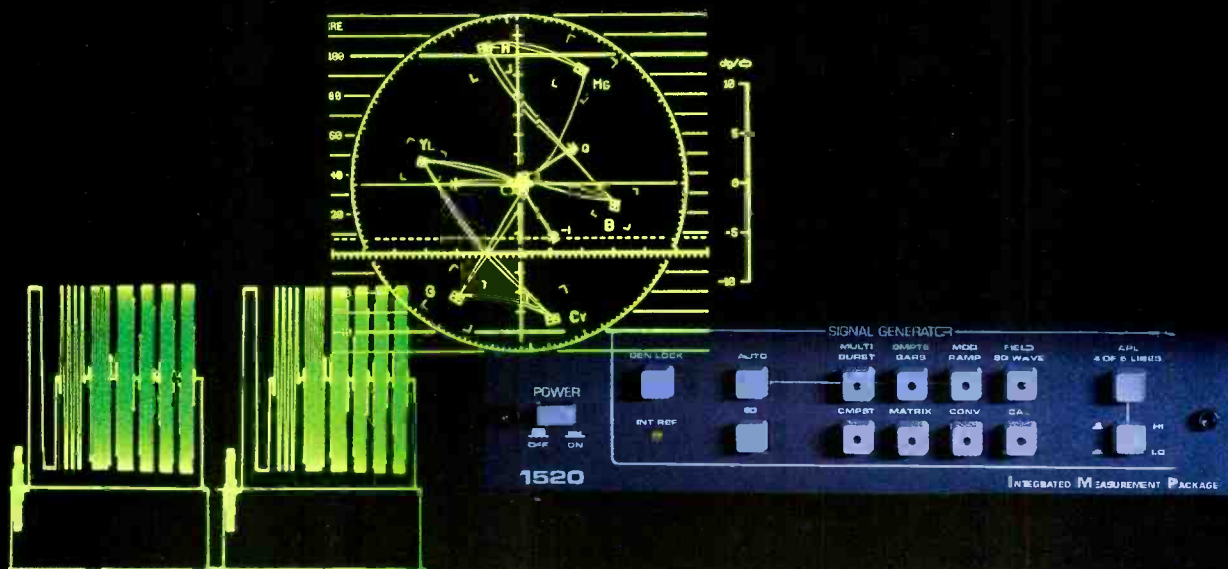

WINNING COMBINATION.



Up until now if you needed a signal generator, vectorscope and waveform monitor, you had to buy three different instruments, or at the very least, two.

Not any more. With the Magni 1520/25 you get all three in one easy to use package, with the same quality and performance you'd expect from the best in the industry. All for only \$6250.*

And that's not all. Since we set out to put as much functionality as possible into one small package, we've also included a character generator overlay and differential phase and differential gain measurement, at no additional cost.

*FOR Beaverton, Oregon USA

Circle (20) on Reply Card

We also offer the Magni 1527/25 which includes all of the above, plus the first SCH phase measurement that can look at DEMOD out. of a video tape recorder.

At Magni Systems we think it's time your test and measurement equipment was designed and packaged to do the job. So if you're tired of buying a piece here and a piece there, call us. We've put it all together.

MAGNI
Video Measurement

Magni Systems, Inc.
9500 S.W. Gemini Drive Beaverton, OR 97005 503/626-8400
Telex: 650-2769743 MCI

The concept of the live-end, dead-end (LEDE) control room was developed by Don Davis (Synergetic Audio Concepts, San Juan Capistrano, CA), who holds the trademark, and Chips Davis (Las Vegas Recording, Las Vegas, NV). The first LEDE room was finished in 1978 and it took the professional audio industry by surprise. The concept is basically opposite that of all other control rooms; the front half of the room is acoustically as absorptive as possible, while the back half is hard and reflective.

Basic principles

The design criteria involve a multi-dimensional view of the control room enclosure. LEDE incorporates the science of physics and the psychoacoustics of the world in which we live.

Music and other programming, particularly stereo programming, should be mixed and equalized without artificial coloring from the listening environment. A common problem in many mixing rooms is the tendency for the mix to sound different depending on where you are sitting. The operator hears one thing, but the producer at the back of the room hears another. The LEDE concept seeks to create a zone of reference listening in which the audio mix is consistent, allowing

The LEDE principles applied to the audio mixing room of Studio 2 at NBC Burbank.

LEDE: How it works

accurate and repeatable quality judgments.

In an uncorrected mixing room, early reflections can cause deep broadband anomalies in frequency response because of phase addition and cancellation. These variations in response can range from -30dB to $+6\text{dB}$. The LEDE goal is to effectively eliminate the back wall acoustically so that all the mixer hears is sound coming from the front speakers. The primary principle involved is the Haas effect.

The Haas effect states that the brain discriminates against (masks) echoes and delays that arrive approximately 10ms to 30ms after the original (direct) sound. This acoustic energy is still present, but it is not perceived psychoacoustically. In theory, the Haas effect/fusion zone can be extended out to 50ms by tight control of energy return from the back walls.

The goal of effectively eliminating the back wall is accomplished through the use of acoustic treatment and diffusers that achieve a dense and diffuse sound spectrum. The overall result of this treatment is a smooth spectrum without broadband anomalies. The effect simulates the diffusion characteristics of a much larger space than ac-

tually exists.

The goal of an LEDE control room is to ensure that the first significant reflection is at least 11ms behind and 12dB or more below the direct sound. Given these conditions, the direct sound level will arrive at the mixer's ears unmarred by control room surfaces because it has passed through essentially anechoic space.

The initial time delay (ITD) gap of a control room can be adjusted over a relatively wide range depending on the size of the room. Delays of 5ms to 40ms are generally practical.

The desirable LEDE features of a control room include: the control of ITD; psychoacoustic removal of directional cues belonging to the control room; and control of early reflected soundfield density and spacing in time and acoustic level. The product is a neutral acoustic environment that allows development of a soundfield at the mixer's ears that correlates well with the soundfield appearing at the microphones in the studio.

Implementing LEDE

As pointed out in the main article, construction of a room to LEDE specifications is no easy task. It requires detailed planning and frequent checks for adherence to specified tolerances throughout the construction process. Among the primary design criteria are:

- A symmetrical inner shell for the control room;
- Creation of an effectively anechoic path between the speakers and the mixing position;
- Installation of time-aligned or phase-coherent speakers;
- Proper mounting of the monitor speakers to ensure that no early sound (EES) is present (EES is sound that arrives before the direct sound through vibration of a solid structure);
- Placement of the back wall and back side walls to provide interwoven comb filter patterns that become a diffused high-density early soundfield, fall within the Haas zone, and do not cause measurable anomalies;
- Correct modal design with regard to height, width and length ratios of the room;
- Accurate control of the decaying soundfield;
- Correct placement of the speaker convergence point;
- Optimized angular incidence of the speaker plane; and
- Careful adherence to the design and installation of all electronics in the audio system from the microphones to the speakers.

In an LEDE design, there are no insignificant elements. All are required to work together to produce a controlled environment that imparts no coloration to the audio signals. Operators who use the control rooms in studios 2 and 4 at Burbank say it was well worth the effort.

Acknowledgments: Background information on the LEDE principle was provided by Chips Davis and Jerry Jacob of Chips Davis LEDE Designs, Las Vegas, NV.

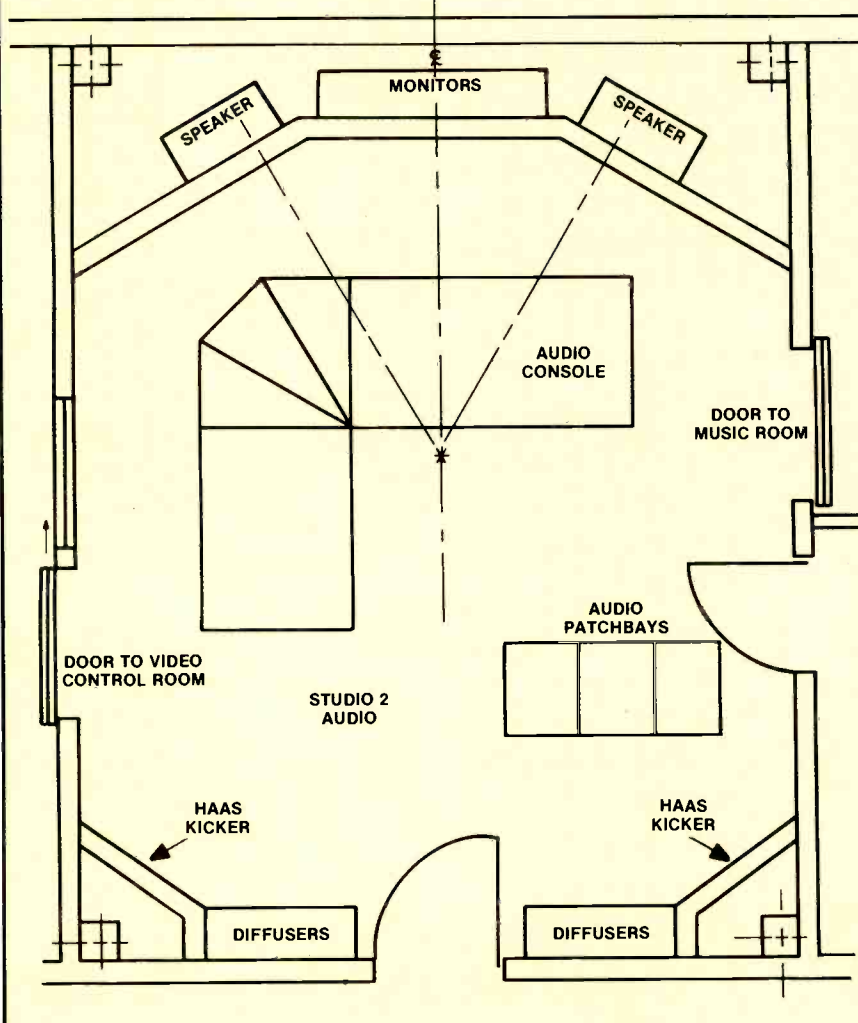



David Peters, Assistant Engineer KGLT Radio Station, Bozeman, Montana.

THE EIMAC 5CX1500B FOR LONG LIFE, QUALITY AND ECONOMY

Varian EIMAC has been in the business of broadcasting for over 50 years, producing durable, reliable and long-lasting tubes that a non-profit radio station like KGLT in Bozeman, Montana, can afford.

Longevity

KGLT engineers use the EIMAC 5CX1500B tube in their transmitter, reporting a life span of 18-19 months—approximately 13,000 hours of service!

Quality and Savings

This would be impressive under ideal conditions, but KGLT operates under rugged and adverse mountain-top conditions. Just as important is the 40% cost

savings attributable to the 5CX1500B's extended life.

In FM broadcasting, EIMAC tubes are customer-proven.



EIMAC's 5CX1500B broadcasting tube in KGLT radio station's transmitter.

Varian EIMAC offers a 5,000-hour warranty on 5CX1500B tubes.

For more information, contact:

Varian EIMAC
1678 South Pioneer Road
Salt Lake City, Utah 84104
Telephone: 801-972-5000



Circle (21) on Reply Card

**Tough as
Sony.**



What we wanted.

One word sums up everything we tried to achieve in the production of VI-K videotape: durability.

Why? Because for us, and you, it's not enough for a videotape to deliver the prettiest picture. It has to be able to do it over and over and over again.

Because the real world for professional videotape is constant jogging, shuttling, still frame editing...and deadlines. So rugged dependability counts every bit as much as dazzling picture quality.

How we got it.

Sony VI-K one-inch videotape was built to be uniquely durable, from the base film up. We developed a truly tough cross-linked binder system and coupled it with the strongest adhesive base film available.

This durable foundation protects an ultra-fine Vivax™ magnetic particle formulation, which delivers astonishing picture quality, higher stability and optimum S/N ratio.

The finishing touch is our carbon black anti-static back coating, which dramatically minimizes dropouts.

What you gained.

Amazingly enough, despite being so durable, VI-K has the lowest headwear rate of any major one-inch tape you can buy.

It also has smoother runability and better winding properties. And, oh yes, it delivers an extraordinary picture, too.

What else got better.

Our efforts to provide you with the most durable videotape have also benefitted BCT Betacam® and BRK U-matic® videocassettes. They both provide you with trouble-free still frame editing, totally reliable repeated playback and worry-free long-term storage.

We made the cassette shells and components tough, too, through precision engineering to quality control standards as tough as our tape.

Treat it like a Sony.

Sony professional videotape has the same properties as any Sony: standard-setting video and audio with a "tough as nails" reputation. That's why it's the only videotape you can treat like a Sony.

And we think that hits the nail right on the head.

SONY
THE ONE AND ONLY.

**Pound for pound,
Sony videotape
is the toughest
you can buy.**





For Excellence In Antennas

- A complete line of TV and FM Broadcast Antennas
- Modern 7,000 ft. test range facilities
- Innovative Engineering Careful construction
- Two Year Warranty on Product and Workmanship



With over 1500 delivered, we've helped more stations penetrate their market.

FCC Directionals
 Pattern Studies
 Multi-Station Arrays
 Full Scale Measurement

JAMPRO ANTENNAS, Inc.
 6939 Power Inn Road
 Sacramento, CA 95828
 (916) 383-1177 TELEX 377321

Circle (23) on Reply Card



The Studio 4 audio mixing room under construction. Note the sloping ceiling and three layers of overlapping drywall. The studs are 14-gauge steel.

Continued from page 30

taping is under way. In large productions, such as those performed at Burbank, you don't even want to walk near equipment being used for a show that is taping or on-air. If a problem results from rewiring or other renovation work while a production is in progress, the client will surely complain loudly about it.

The control room work for studios 2 and 4 involved a combination of new construction and major changes to existing areas of the building. Figure 1 shows a basic floor plan.

Acoustic considerations

Acoustic design for studio and control room facilities has come a long way in the past decade. Acoustics in the "old

days" was, all too often, a rather inexact science. It often took a back seat to everything else. Many people professed to be "acoustic experts," with their own opinions on how a room should sound. You've probably seen someone walk into an audio mixing suite, and with a clap of hands, conclude that the room is *good* or *bad*. We have progressed far beyond that point today.

Stereo for television was the driving force behind improved acoustics for the audio mixing rooms at Burbank studios 2 and 4. The sound the mixing engineer and producer usually hear in a poorly designed room will vary depending on where you are in the room, especially when stereo is being produced. For accurate stereo mixing, therefore, a better

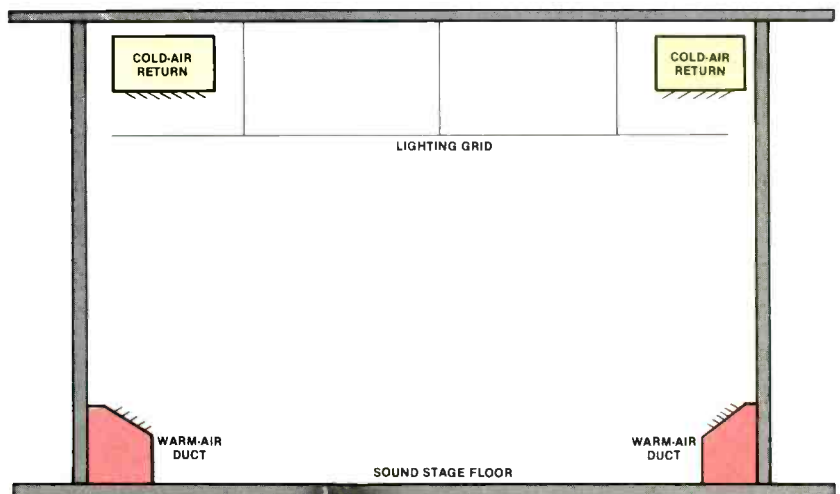
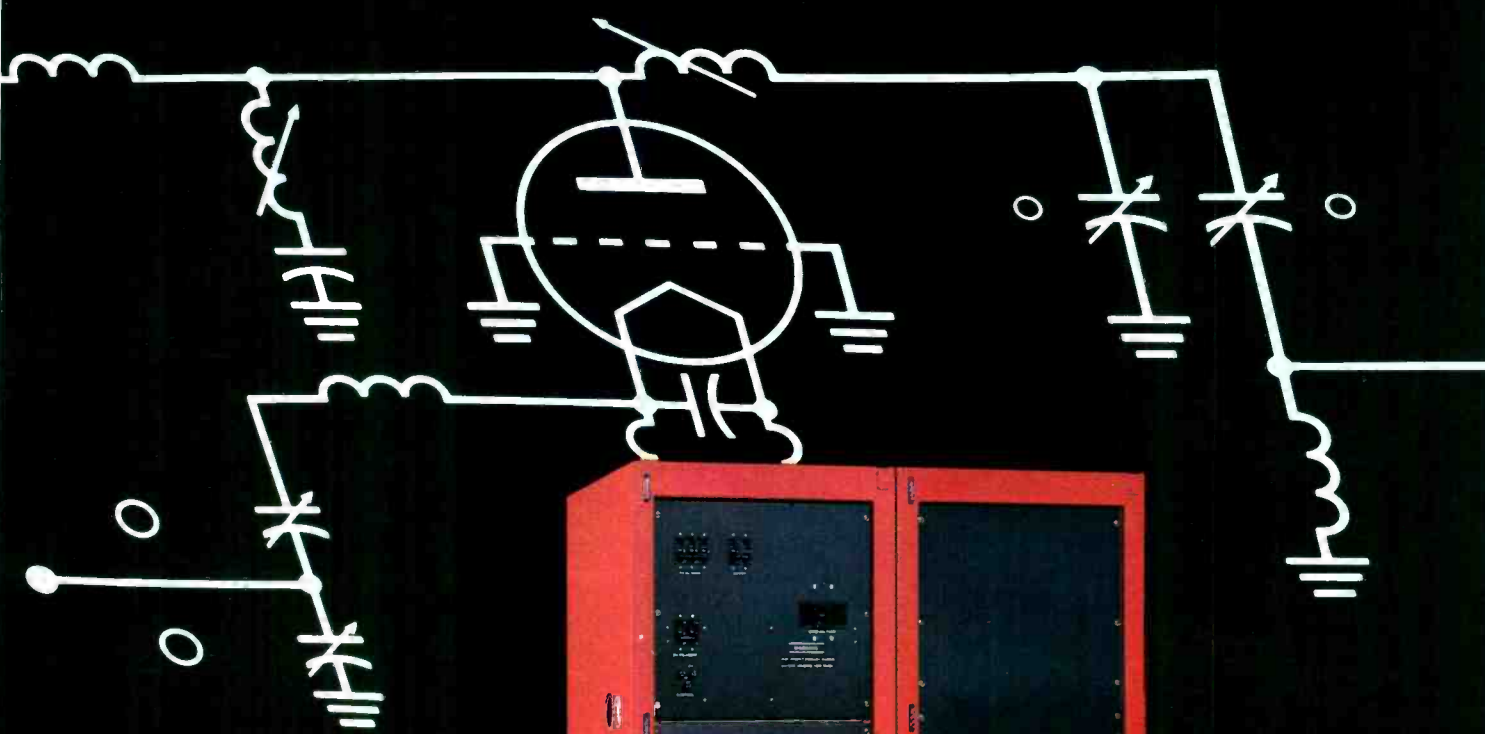

Figure 2. HVAC system layout for the sound stage of Studio 2.



Introducing our new 10-15KW FM Transmitter.
 Efficient—Single tube with solid state driver
 Reliable—No blocker, no sliding contacts
 Stable—Grounded grid triode design

Harmonic filter, directional coupler and a 100% semi-conductor spares kit included with every transmitter. ARC-27 remote control system, and power levels of 20KW and 30KW are also available. Backed by years of experience with FM transmitters and QEI's exclusive 15,000-hour tube warranty.



CORPORATION
 One Airport Drive • Box D
 Williamstown, NJ 08094
 1-800-334-9154
 Circle (24) on Reply Card

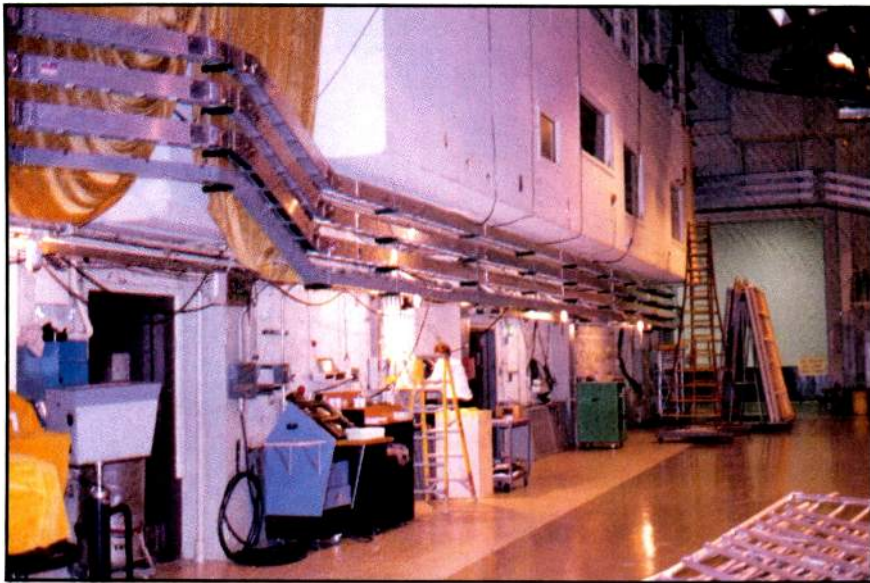

The Studio 4 sound stage floor showing the cable ladder tracks. A 4-layer cabling configuration is used. The trays (from top to bottom) carry low-level microphone lines; video and high-level audio; camera and communications; and regulated ac (technical) power.

control room design was required.

The *live-end, dead-end* (LEDE) concept of studio construction was used for the new control rooms at Burbank. (See the related article, "LEDE: How it Works," page 32.) An acoustical engineer was given the task of implementing the LEDE principles in the two audio mixing

rooms. Although the basic room dimensions and equipment requirements were fixed, the consultant was able to adjust room layout and construction details to meet the needed specifications. Freedom from a large number of set parameters is a major benefit of renovation involving new construction.

Stringent specifications were outlined by the acoustical engineer for the rooms. Included in the list of specs were the installation of high-frequency sound reflectors of specified shape and material, and walls constructed of four inches of acoustical insulation behind three layers of overlapping, sealed and taped drywall. Room dimensions were critical, with tolerances of $\pm 1/32$ nd to $1/64$ th of an inch. Project engineers had to use laser measuring equipment to lay out the angles and confirm adherence to specs.

Acoustic isolation of the rooms extended to the conduit used to carry cables in and out of equipment areas. The openings had to be acoustically sealed to prevent sound leaks. The rooms were designed to be isolated units that would provide predictable performance and could be controlled to meet the needs of the application.

Placement of monitor speakers in each room was a major concern. They were required to be mounted at a particular angle and in a specified position to give the desired coverage area effect. The speakers were also specified to be isolated from the room so they would not acoustically vibrate the structure. To meet this requirement, rubber attachments were used around each unit and a special speaker suspension arrangement was devised.

Continued on page 42

SOLUTIONS

MODULA, MINI MODULA, AND SUPPORT EQUIPMENT from BSM Broadcast Systems

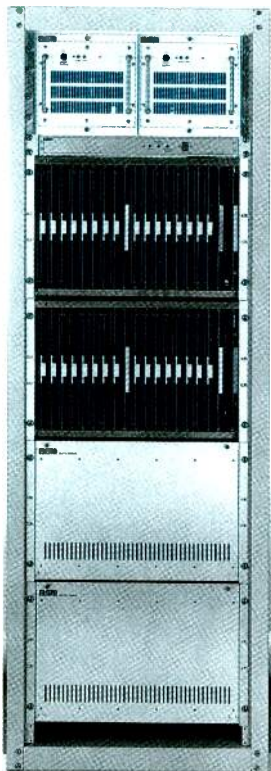

MODULA

PROBLEMS:

1. Expandability
2. Programming
3. Cost

1. BSM Broadcast Systems solves your expansion planning problems for video and audio signal routing with **MINI MODULA**, in matrix sizes from 8 x 8 to 24 x 32, and **MODULA**, for matrices as large as 256 x 256. Both products use the same circuit cards to preserve your initial investment in an expandable system.

2. Both **MODULA** and **MINI MODULA** solve your custom programming needs because the systems are software driven. You re-program to the matrix without sending equipment back to the manufacturer.

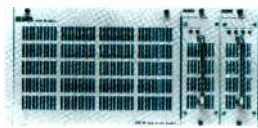

MINI MODULA

3. You can see that BSM system costs are highly competitive—user programming, no hybrids, virtually maintenance free. **MODULA** and **MINI MODULA** expandability enhances your initial investment through growth phases of your development.

BSM also offers a complete line of distribution amplifiers and smaller video or audio switchers to complete your system.

Phone BSM today and discuss the SOLUTIONS for your signal handling requirements. Our engineers and managers want to work with you from the start.



BROADCAST SYSTEMS, INC.

SOLUTIONS:
(509) 838-0110
 P.O. Box 19007
 Spokane, WA 99219

A video camera that grows with you. At Camera Mart.



Ikegami HL-95 Unicam Camera

At Camera Mart we've always had a strong preference for flexible equipment—and the Ikegami HL-95 Unicam® is as good an example of versatility as we've seen.

Utilizing a unique "building-block" concept, the HL-95 is available as a standalone camera capable of accepting any on-board VCR, as well as multicore and triax.

If you're concerned about the many tape formats, Ikegami's new HL-95 Unicam® is the only universal camera system that accepts *all* formats.

A newly developed 2/3-inch Plumbicon® tube (electrostatic focus/magnetic deflection) is incorporated into the HL-95. The tube's photoconductor size combined with diode gun electron tube technology results in high sensitivity and excellent resolution.

The HL-95 sets higher standards in color camera performance, size, weight, power consumption and flexibility than anything available before... and is typical of the Ikegami tradition of excellence.

It's new, and, as you'd expect, it's available right now from Camera Mart.

***The more you know about video, the more you can
rely on Camera Mart.***



The Camera Mart, Inc.

456 West 55th Street, New York 10019 • (212) 757-6977

Telex: 275619 / FAX (212) 582-2498

305 Vine St., Liverpool, NY 13088 • (315) 457-3703

Sales • Service • Rental

***Panasonic® brings you M-II.
The broadcast recording system our
competition can't seem to duplicate.***



Now you can shoot, edit and broadcast with 1" quality—on 1/2" cassettes.

When it comes to broadcast systems, it appears our competition has been erased. Because no other format can match the spectacular performance of M-II from Panasonic.

With M-II's metal particle tape system, you can use the same compact 90- or pocket-size 20-minute cassette from ENG/EFP right through editing to on-air broadcast. With 4.5MHz bandwidth (-3dB), 50dB S/N and burst signal insertion for phase alignment and jitter correction, M-II is the single solution to all your broadcast needs.

In fact, each unit in the M-II line offers some pretty uncommon common features like four audio tracks (two linear and two FM), an integral longitudinal and vertical interval time code/time date generator with presettable user bits and Dolby*-C noise reduction. And M-II products utilize a standard edit control interface, so you can upgrade gradually if you like.

AU-650 Studio VCR. This compact, rack-mountable VCR has all the advantages and functions of conventional recorders with

the benefit of the M-II format. The AU-650 provides video and audio performance as good as—if not better than—that of 1" VTRs. In a 1/2" cassette format that lends itself to station automation. It records and plays either 90- or 20-minute cassettes, and provides smooth action, variable slow motion as well as freeze frame. And the AU-650 can perform frame-accurate automatic editing with multi-generation transparency. There's also an internal TBC to assure on-air quality playback.

AU-500 Field Recorder. The AU-500 offers the portability and functions demanded by ENG/EFP users, while providing picture quality comparable to 1"—all on either a 90- or 20-minute cassette. This small, ruggedly designed unit is equipped with confidence field color playback, automatic backspace editing, TBC/DOC connection, search function and warning indicators that alert the operator should recording problems arise and the AU-500 accommodates NTSC composite or various component input signals.

The AU-400 Camera Recorder. This lightweight, compact camera recorder provides ENG users with more than 20 minutes of recording, and a picture quality that rivals that of 1" VTRs. The AU-400 also features B/W video confidence playback through the camera's viewfinder, a chroma confidence indicator and audio confidence output through a speaker.

There's even an automatic backspace editing function and warning indicators. And the AU-400's rugged construction provides excellent resistance to dust and moisture.

M-II, it's the only broadcast system of its type in the industry. And it's available now. Two of the best reasons to go with M-II from Panasonic.

To get the complete picture, call or write Panasonic Broadcast Systems Company, One Panasonic Way, Secaucus, NJ 07094. (201) 348-7671.

MII

THE NEW STANDARD
FOR BROADCAST.

Circle (26) on Reply Card

Panasonic

Broadcast Systems

Continued from page 38

The requirements for construction were tight, but the results were impressive. You can walk around in the room within a wide operating area and the stereo sounds the same. The improvement over a standard control room is significant enough to be perceived by the untrained ear. That's the ultimate test of an LEDE room.

Studio design

Although modifications to the sound stages associated with studios 2 and 4 were not significant (with the exception of cabling), engineers carefully evaluated the rooms to determine whether any improvements were necessary.

The construction method used in a sound stage depends primarily on how much money and space is available for the project. In New York, poured-in-place construction methods are generally used. In Burbank, tilt-up concrete walls with soundproofed roofs are typical.

Television studios, by their nature, are difficult to design from an acoustic standpoint. They need to be large to accommodate scenery, lighting and audience seating. In audio recording studios, movable walls are used to create the necessary acoustical environment for the application. Such features are not practical, however, in a video studio. The need also exists for large *elephant doors* to facilitate movement of scenery and heavy equipment.

HVAC

An improperly designed heating, ventilation and air-conditioning (HVAC) system can destroy an otherwise perfect studio/control room complex. HVAC design is a specialized science that requires a qualified consultant at every stage in the process.

The volume of air movement is critical in HVAC systems for broadcast facilities. In general, the farther you are from the HVAC outlets, the better off you will be from the standpoint of noise. The area of the return ducts should be equal to the area of the supply ducts. Otherwise, noise will result on one end of the system or the other.

At the Burbank studios of NBC, for example, return-air ducts are placed along each side of the longest walls in the studio, as illustrated in Figure 2. In Studio 11 (the largest sound stage on the lot), the ducts measure 8' x 10' and are tapered at the ends. Alongside the floor of each studio, return-air ducts of equal dimensions collect the heated air and return it to the chiller. All ducts are lined with acoustical absorbing material to prevent the transmission of noise from one area of the plant to another. The ducts also are sealed at all joints to prevent air leakage and the whistling that could result.

Cooling of equipment in machine areas



\$2900

How can Grass Valley Group sync so low?

By building application-specific models centered around the revolutionary SPG Gate Array integrated circuit, that's how.

The 9510 Reference Synchronizing Generator is a compact master featuring protected video genlock. With the phase preset option, it can even store genlock phase settings. Add an optional test signal generator and source ID, and you've got a full-featured master or source sync generator.

The 9510 is only one of our landmark 9500 Series Sync Generators.

Grass Valley Group®
A TEKTRONIX COMPANY

STRENGTH YOU CAN RELY ON

The Grass Valley Group, Inc., P.O. Box 1114, Grass Valley, CA 95945 (916) 273-8421 OFFICES: New York (201) 845-7988; District of Columbia (301) 622-6313; Atlanta (404) 493-1255; Chicago (219) 264-0931; Minneapolis (612) 483-2594; Dallas/Fort Worth (817) 483-7447; Los Angeles (818) 999-2303; San Francisco (415) 968-6680.

Circle (27) on Reply Card

Comprehensive...



Contemporary audio testing practices demand that audio measurement equipment offer a comprehensive range of capabilities. The multitude of world measurement standards, diversity of industry practice and the flexibility required in the lab can overtax most audio analyzers. Add to this the higher performance demands of the new digital audio techniques and you clearly need a lot of horsepower.

The Amber 5500 Programmable Audio Measurement System answers the call. With the most comprehensive facilities, state-of-the-art performance, computer interface and ATE speed, the 5500 meets the challenge. Whether you test communication receivers, studio broadcast equipment, Hi-Fi pre-amplifiers or telephone channels, the Amber 5500 is a winner.

The 5500 measures absolute and relative level, three kinds of distortion, weighted and unweighted noise, frequency and crosstalk - and 3 to 10 times faster than other systems. Distortion below 0.001% and noise lower than 1uV are typical of its performance capabilities.

Ask for our "comprehensive" technical brochure and meet the challenge.

Amber also makes one of the most popular portable high performance audio measurement systems - the 3501. Half the weight and size of comparable instruments, the 3501 has one of the best reliability records in the industry.

amber

Amber Electro Design Inc.
4810 Jean Talon West
Montreal Canada H4P 2N5
Telephone (514) 735 4105
Telex 05-827598
US Toll free 800-361 3697

Circle (28) on Reply Card

Five!

~~FOUR~~ ARBITRONS IN A ROW.* THE #1 MARKET... THE TOP THREE FM STATIONS.



Step up to digital control! The digitally-controlled TEXAR AUDIO PRISM™ breaks the old quality-versus-loudness tradeoff of analog audio processors. The AUDIO PRISM delivers unsurpassed modulation power for maximum cumes but with a

clarity that keeps listeners quarter-hour after quarter-hour.

Digital control delivers ratings and revenues. The AUDIO PRISM has been the audio processor of choice for the top 3 rated FM stations in America's

largest market, New York City...for five Arbitrons in a row.*

Step into the future. Put the power and clarity of digital control to work for you today! Call Barry Honel at (412) 85-MICRO to arrange for a 10-day demo in your station.

TEXAR

616 Beatty Road • Monroeville, PA 15146-1502 • 412/856-4276 • 412/85-MICRO

*Summer & Fall '85, Winter & Spring '86 and Summer & Fall '86 ARBITRON Ratings. Total Persons 12+ Share. Mon-Sun, EA-12M. (Used with permission.)

Circle (29) on Reply Card

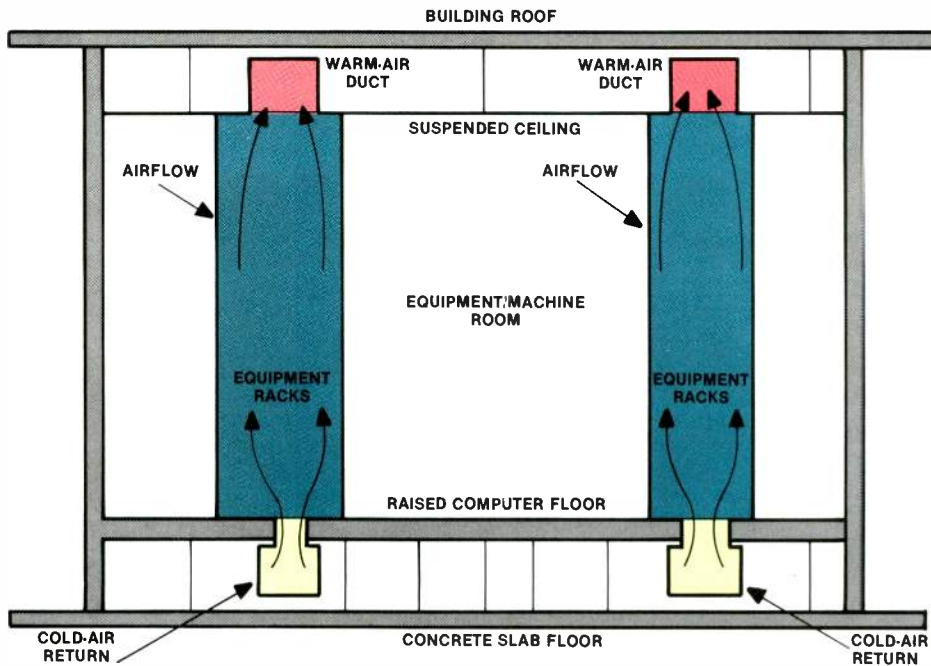

Figure 3. Air-conditioning airflow for cooling equipment racks in the control rooms of studios 2 and 4.

represents a continual challenge because of the density of hardware in a typical control room environment. The concept used in studios 2 and 4 at Burbank involves cold-air discharge in front and

back of the racks, with the top of the rack open for return air. (See Figure 3.) In this way, cold air is drawn through the rack and pulled up from the top of the rack. Equipment is arranged in the racks

so that heat-generating chassis are spread out through the available space in the control rooms.

Maintenance

The design of a facility for long-term maintenance is an important requirement for any updating project. One way of building in maintenance capability is to involve current maintenance personnel in the planning process for the new plant. The job of maintaining the equipment may be simplified if, for example, patch panels are installed at critical points in the system. Engineering or operations personnel not regularly involved in maintenance might not recognize the importance of such features until a problem occurs.

Documentation of a facility is also of critical importance. The documentation must be accurate and detailed, down to connector pin numbers and wire colors. Cable routing considerations must be carefully evaluated and planned to provide for the shortest practical runs and to allow for future expansion or modification. These requirements are generally met with computer flooring and/or cable ladder trays. Never underestimate the amount of space that cabling will require. Changes to wall or floor access points can be extremely expensive after the concrete has been poured.

The logical division of maintenance

Talk Shows Aren't Tough Anymore!

1 Cleanest, Fastest Catch-up Ever . . .

Automatically builds up delay quickly and inaudibly. Uses exclusive Eventide patented technology for catch-up quality light-years ahead of earlier designs.

2 BD980 Comes Fully Loaded.

Stereo operation, 20kHz. bandwidth and 10 seconds of delay are standard. And BD980 is priced to be a great value.

3 Stereo Audio So Clean . . .

You'll want to keep the BD980 in-line at all times. BD980 features 16 bit linear PCM design and 50kHz digital sampling rate.

4 4, 6, 8, or 10 Seconds Of Stereo Delay.

All of BD980's automatic modes can be set to give you 4, 6, 8 or 10 seconds of on-air stereo delay.



New Eventide BD980 Broadcast Delay

Takes The Hassles Out Of Talk Show Production

... Sounds Better, Too

Available Now! See how easy talk shows can be — Call your Eventide dealer to arrange for a demo. Or call Eventide direct at 1 (800) 446-7878.

Eventide
the next step

5 It's A Stereo Time Compressor, Too.

Instantly shortens (or lengthens) audio spots up to ten seconds. Better stereo/mono phase compatibility than megabuck single purpose time compressors. Works with ANY cart or tape machine — variable speed NOT required.

6 When It's Time To Get OUT Of Delay . . .

Just push the RAMP TO ZERO button and go on with the show. It's that simple. Delay inaudibly "catches-down" to zero. Frantic switching or monitoring hassles? Forget 'em!

7 Switch To A Helicopter Traffic Report . . .

Or other "live cued" event, with no timing or monitoring hassles. Just push the WAIT & EXIT button. The Eventide BD980 makes the "impossible" switch easy!

8 As A Production Tool . . .

BD980's Manual mode lets you set delay in one millisecond steps, from zero to 10 seconds. Ideal for vocal doubling, echo, and other effects.

9 Large Alphanumeric Display.

Shows amount of delay, "safe" reading and operating mode at a glance. BD980 operating functions are fully remoteable and plug-compatible with our BD955.

Eventide Inc. • One Alsan Way • Little Ferry, New Jersey 07643 • (201) 641-1200
Circle (48) on Reply Card

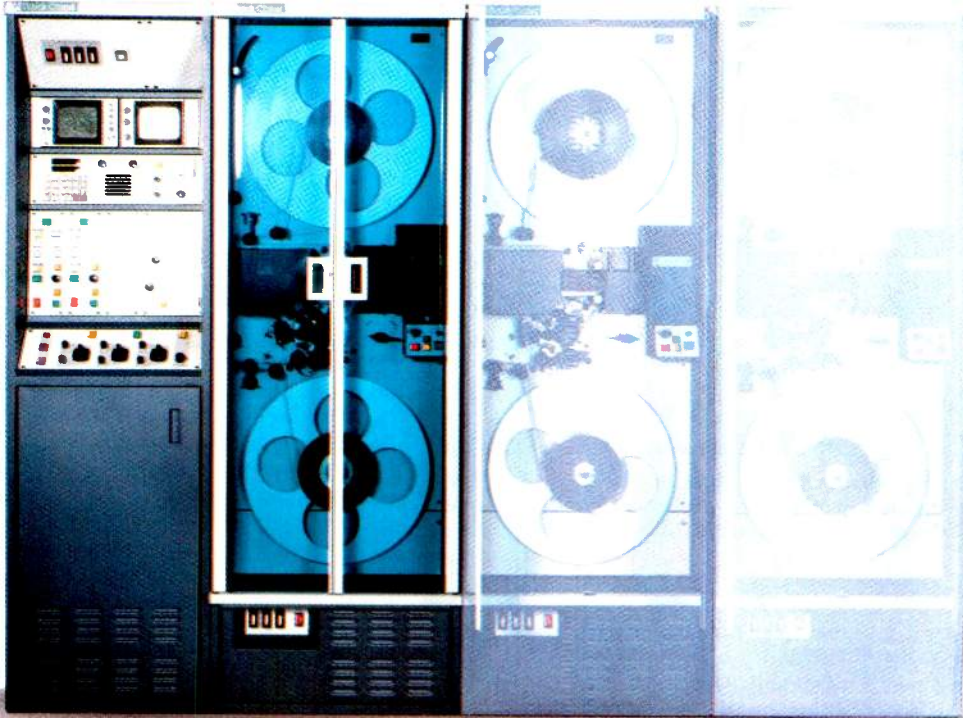

The no hassle broadcast telecine

ADS 1 Advanced Digital Scanner

With ADS 1, Rank Cintel has applied its unique film-scanning experience to the specific needs of the broadcaster.

Developed in close co-operation with the British Broadcasting Corporation (BBC), this CCD multiplexed broadcast-telecine is designed for easy 'on-air' operation and transfer of film to tape prior to transmission.

The incorporation of solid-state imaging technology is an example of Cintel's continuing development philosophy.

Latest component technology, cost-conscious design and modern manufacturing techniques have been

exploited, without compromising performance and reliability. The result is a telecine system which is technically advanced while at the same time being economical to operate. That is not all, ADS 1 also features a unique electronic dirt and scratch concealment system. Add all this together and you have the ideal broadcast-telecine package.

Take the hassle out of film broadcasting — call us at 914-353-1914.



Rank Cintel Inc. East Coast
New York 10994, U.S.A.
260 North Route 303, West Nyack,
Tel: 914-353 1914 Telex: 726441



Rank Cintel

Rank Precision Industries Inc. 411 East Jarvis Avenue, Des Plaines, Chicago, Illinois 60018, U.S.A. Tel: 312-297 7720 Telex: 646998 Fax: 312-6990581

Circle (30) on Reply Card

West Coast
13340 Saticoy Street, North Hollywood,
California 91605, U.S.A.
Tel: 818-765 7265 Telex: 182694 RPI LSA
Fax: 818-765 3315

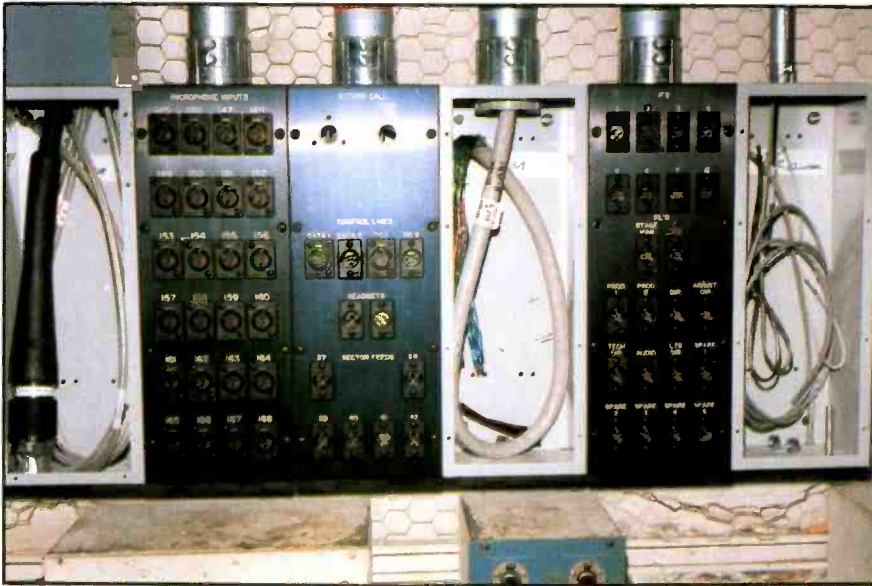

One of the eight drops installed on each sound stage floor during construction. The panels (left to right) provide connection points for camera and video tie trunks (unfinished panel); microphone inputs; actors' call lines; headsets/sector feeds (unfinished); PA lines; and IFB/com-munications (unfinished).

spare circuit boards and systems. When a client is waiting to use your facility, it makes little sense to try to repair a faulty unit on-site. Instead, substitute the faulty subsystem or even the entire chassis with a spare and troubleshoot the defective system in the shop. This technique is used extensively at Burbank because of the time restraints under which production work is performed, and the production costs that could be incurred because of a relatively minor equipment failure.

Looking toward the future

A major renovation effort such as NBC's studios 2 and 4 in Burbank is a long-term project that the designers will have to live with for years—perhaps decades—to come. For this reason, the facilities were planned with an eye toward future incremental updates.

The renovation points the way for additional improvements at the network, and serves as a reference point against which others can judge their improvement plans. The watchwords for studios 2 and 4 were long-term reliability and flexibility, appropriate goals for any facility.

responsibilities and continuity in maintenance assignments can be a big plus when maximum uptime and performance are a necessity. If staffing permits, try to have one or more maintenance technicians assigned to a particular studio complex. The concept of

dedicated maintenance personnel aids in familiarity with the peculiarities of the plant and gives the maintenance staff additional pride in keeping the equipment up and running.

A crucial part of any maintenance effort involves the stocking of sufficient

Acknowledgment: Assistance in the preparation of this article was provided by Raymond Fritzky, manager of project implementation, NBC Operations and Technical Services, Burbank, CA. [=:;-))]]]]

This new QuantAural™ QA-100 Audio Program Analyzer gives you the advantage in competitive broadcasting

Simply put, the QA-100 quantifies what you hear. Your station sound can now be electronically monitored the way you hear it. Exactly. And, you can monitor the competition too!

Real time analysis of any audio signal. From a receiver, tape recorder, or processing equipment. You see the measurements as you hear the sound. Changes in processing or variations in system performance are immediately shown on the QA-100 panel meter or bargraph display—using program material as the signal source.

The QA-100 hears like a program director and talks like an engineer. With it you can monitor maximum peak level (relative peak modulation), overall

processing effectiveness (average level), tightness of sound and processing control (peak density), tonal balance, consistency and preemphasis (four band real time analyzer), stereo image width (L + R to L - R ratio) and "punch" (special "aural intensity" measurement).

Interested? To learn more about how the QA-100 will help your station compete, call Potomac Instruments today.

QuantAural is a registered trademark.



POTOMAC INSTRUMENTS

932 PHILADELPHIA AVE. SILVER SPRING, MD 20910
(301) 589-2662

Circle (31) on Reply Card

ON AIR

Graphics . . . instantly

Slide File/Art File gives the broadcaster's old slides a new adaptability. Instantaneous retouching and graphic work allows miraculous changes and beautiful presentation, and most importantly, time is saved. Accuracy is inevitable and, very importantly, time is saved.

Slide File grants you instant access of up to 400 digitally stored stills and the ability to grab a frame from any live video source. Images are stored on Winchester-disk to CCIR 601 standard.

The Rank Cintel Slide File/Art File can also be used in conjunction with Logica's Galley 2000 system, giving you a storage capacity of up to half a million frames.

Graphics

The addition of comprehensive software and a graphics tablet brings to Slide File the capabilities of a full graphics workstation.

Art File

This graphics-enhanced system allows the artist/operator to paint and draw on existing stills, to manipulate the whole, or part of the picture, to compose using cut-and-paste techniques . . . or even to create entire pictures on a blank screen. So now you can rapidly compose or retouch in seconds before going On Air. Rank Cintel's Art File/Slide File provides On Air Graphics Instantly.



**4:2:2
System**

Rank Cintel Inc. East Coast
New York 10994, U.S.A.
260 North Route 303, West Nyack,
Tel: 914-353 1914 Telex: 726441



Rank Cintel

Rank Precision Industries Inc. 411 East Jarvis Avenue, Des Plaines, Chicago, Illinois 60018, U.S.A. Tel: 312-297 7720 Telex: 646998 Fax: 312-6990581

Circle (32) on Reply Card

West Coast
13340 Saticoy Street, North Hollywood,
California 91605, U.S.A.
Tel: 818-765 7265 Telex: 182694 RPI LSA
Fax: 818-765 3315

Designed
for
the
future



Updating the AFRTS

By Peter Adamiak

The new AFRTS facility had to meet stringent acoustical and operational specs to satisfy unique requirements.

Although the Armed Forces Radio and Television Service (AFRTS) uses an up-to-date distribution system, until recently, the studios represented more historical than modern technology. Unlike most other networks, AFRTS owns all of its outlets or stations. These outlets are closed-circuit feed systems, AM, FM, and TV stations operating in countries throughout the world and such off-the-road places as ships and submarines.

The AFRTS network relies on satellites, standard AM and FM broadcast stations, closed-circuit feeds, audiotapes and videocassettes for program distribution. To serve its audience, the network distributes 92 hours of TV programming on videocassettes and 86 hours of radio programming on audiotape every week. It also transmits or relays 1,200 real time radio programs per week, including 700 network newscasts via satellite and microwave systems.

AFRTS has the unique responsibility of serving a worldwide audience with U.S.-based programming. The audience is primarily made up of military and Department of Defense civilians and family members located in 44 countries and 15 territories and possessions. Most of the viewers and listeners are 18- to 25-year-olds with high school educations. Many of them are a literally "captive audience," given their locations on ships, submarines and remote military bases.

Unique network

Although it operates similar to other networks in most respects, there are two significant differences in the AFRTS network. First, the network produces little of its own programming. Most of it originates from other networks and program suppliers and is provided on tape or disc. Even though the network operates a worldwide system of AM and FM stations, the fact that much of the audience is located far from land-based transmitters calls for a high-volume tape

distribution network. The taped programming is supplied primarily to ships operating at sea and submarines, which cannot surface just to catch this week's "The Cosby Show" or the NFL game.

Second, AFRTS programming is commercial-free. Even though programming from commercial networks is used, the network feeds are constantly monitored, and authorized announcements are inserted in place of the commercials prior to broadcast. In fact, AFRTS and the VOA (Voice of America) may be the only truly non-commercial networks in the United States.

AFRTS originated during World War II to distribute entertainment programming to U.S. troops around the world. The original production and broadcast facility was located in Hollywood, CA. At that time, programming was distributed on audio transcription discs. Video was, of course, not yet available.

As sometimes happens with government agencies, the network was underfunded for many years. Consequently, much of the network's equipment and studios dated back to the early days of broadcasting. Serving a worldwide audience today with both audio and video programming requires sophisticated equipment. The challenge to AFRTS was to modernize the network by providing better acoustic and electronic facilities. In addition, because of the uncertainty of future governmental funding, a long-range view of the facility's needs was critical to the final design.

New location

After a careful analysis of the current facility, it quickly became obvious that the optimum solution was a new building. Not only was the current facility too small, but renovating the already cramped quarters while maintaining the demanding broadcast schedule was deemed impossible.

To keep construction costs as low as possible, the project planners decided to first look at the possibility of renovating

Adamiak is vice president of engineering for National TeleConsultants, Glendale, CA.

Continued on page 52

AM stereo and C-QUAM[®]: Superior performance is the Delta difference

Like more than 40 dB of channel separation for a purer, cleaner sound your listeners can hear. But we didn't stop there. We engineered our improved C-QUAM[®] system for all around excellence:

The Delta Difference is applied technology:

- More than 45 dB* channel separation for a purer stereo sound, guaranteed 43 dB* at 1 kHz and 40 dB* at 5 kHz.
- Transformer-less, active balanced input/output circuits for excellent frequency response, distortion, and modulation peak control characteristics.
- Dual high level RF adjustable and dual logic level (TTL) circuits and dual L + R audio circuits for faster installation and versatility in transmitter interfacing.
- Day/night and stereo/mono capability remotely controllable.
- Dual transmitter interlock protection circuits.

The Delta Difference is longer life:

- Chassis mounted heat sinks at critical points.
- Improved high-efficiency power transformer for cooler operation.
- Multi-board construction for simplified maintenance and trouble-shooting.
- Zero insertion force card edge connectors assure longer contact life.

The Delta Difference is economy:

- Day/night or main/auxiliary audio equalization is a no-cost option.

The Delta Difference is experience and commitment to your industry:

- More than 23 years serving the broadcast industry.
- More than 60 operating installations of Delta C-QUAM AM stereo systems in the U.S., Canada, Australia and Africa. (And the number continues to grow.)

- A highly experienced installation team ready to serve your needs.

When you're ready to bring AM stereo to your listeners, check on the Delta Difference.

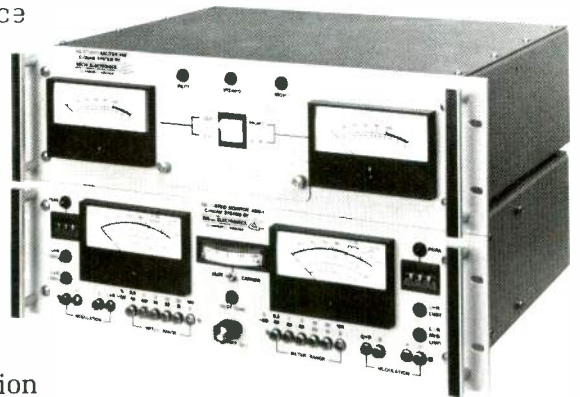

For complete information on ASE-1 AM Stereo Exciters and ASM-1 AM Stereo Modulation Monitors, contact Delta at (703) 354-3350.

Delta Electronics, Inc.
5730 General Washington Drive
P.O. Box 11268
Alexandria, Virginia 22312
(703) 354-3350
Telex: 90-1963

* C-QUAM is a registered trademark of Motorola, Inc. Manufactured under license from Motorola, Inc.

* 50% single channel, closed loop exciter monitor

DELTA ELECTRONICS

Circle (33) on Reply Card

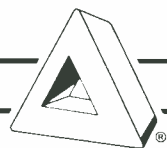



Freeze.

Introducing the fastest, easiest way to get quality prints and slides from video.

Now you can capture the moment, freeze it, and frame it. All with the touch of a button.

With the new FreezeFrame Video Image Recorder from Polaroid.

FreezeFrame produces sharp, instant color prints and color or black and white 35mm slides from virtually any video source. And it delivers a finished picture that is far superior in quality and resolu-

tion to direct screen photography or thermal video image recorders.

If you use video, you need FreezeFrame.

FreezeFrame has hundreds of uses for anyone who uses video in their profession. It can be used in broadcast, production and advertising to proof, edit, storyboard or reference. It can be used to pull a

print off a just-breaking news story, or for color correcting a proof. It can even help in film-to-video transferring. Medical professionals can use FreezeFrame for diagnostic

recording, patient referral or teaching. And it's the easiest way to get slides or prints for presentations or training.

FreezeFrame can improve your image.

FreezeFrame



System includes Video Image Recorder, control console, and print film camera/adaptor. 35mm camera/adaptor optional.



Frame.

connects easily to video cameras, professional VCR's, laser disc players and computer graphics systems.

You can preview and even improve the video image because FreezeFrame has a full range of image enhancing controls including tint, contrast, color, sharpness, brightness and raster fill. And if you're shooting prints, FreezeFrame uses a new color print film specially developed for use with video imaging.

New FreezeFrame from

Polaroid. It's fast, easy, and at \$1,899*, very affordable.

To find out how FreezeFrame can help you, call toll-free 800-225-1618, 9 a.m. to 6 p.m. Eastern Time.

Or fill out and return the coupon. We'll give you the full picture and show you just how easy it can be to capture the moment on FreezeFrame.

For more information, mail this coupon to Polaroid Corp., Dept. 671, P.O. Box 5011, Clifton, NJ 07015.

Please send more information.

I'd like a demonstration. BE12/1

Name _____

Title _____

Organization _____

Address _____

City _____

State _____ Zip _____

Telephone _____

Video Source _____

Application _____

*Suggested list price. "Polaroid"® "FreezeFrame"™ © 1986 Polaroid Corporation

Circle (34) on Reply Card

Continued from page 48

an existing building. If a suitable building could be cost-effectively renovated, then more funds would be available to equip the facility. This approach turned out to be an effective one.

A 60,000-square-foot building was found in suburban Los Angeles. The building, which had once housed a major bank's computer center, provided several attractive elements. The building featured large expanses of space and raised computer-access flooring. Together with the favorable location, these factors made the building an ideal candidate.

The initial architectural plan divided the available space into two general areas: administrative and broadcast. After a great deal of planning, it was determined that some of the existing administrative space could remain relatively unchanged, helping to lower costs and speed up the project.

The broadcast portion of the building consists of four main areas: TV broadcast center, radio broadcast center, general broadcast areas (maintenance and central equipment racks) and the ad-

ministrative area. A simplified system block diagram is shown in Figure 1.

TV broadcast center

The TV broadcast center consists of six 1-inch videotape editing suites, five film-editing rooms, telecine facilities, quality assurance rooms, satellite network control (SATNET) and the TV central operations/machine room.

The facility is unusual in that it receives satellite and telco program feeds from all national networks and major cable broadcasting sources. These feeds terminate in the TV central operations area. This is a minimally staffed and partially automated area. The incoming programs are broadcast worldwide live on the SATNET satellite channels and recorded for later use.

The SATNET control room is capable of 24-hour operation. The material broadcast comes from either the live incoming network feeds or taped programs. An operator interrupts the network feeds and inserts government-sponsored announcements and PSAs. A full-time operator monitors the live

broadcasts and eliminates the commercials by making real-time decisions.

A second, functionally equivalent, auxiliary control room is also available. Through this alternate control location, daily operations proceed without interruption or inconvenience even during major maintenance or expansion work.

Some programs are recorded and inventoried for later integration into the network feeds. The recorded programs are sent to one of the six videotape suites for final editing and commercial removal. The edited programs are then distributed on the SATNET channels or on 1/2-inch and 3/4-inch videocassettes.

Radio broadcast center

The radio operations center is similar to that used for television except that more program sources are involved. The radio network area also simultaneously originates several network feeds. Incoming programs are switched live to one of several outgoing networks operated from radio master control.

Also, the incoming programs are automatically recorded on computer-

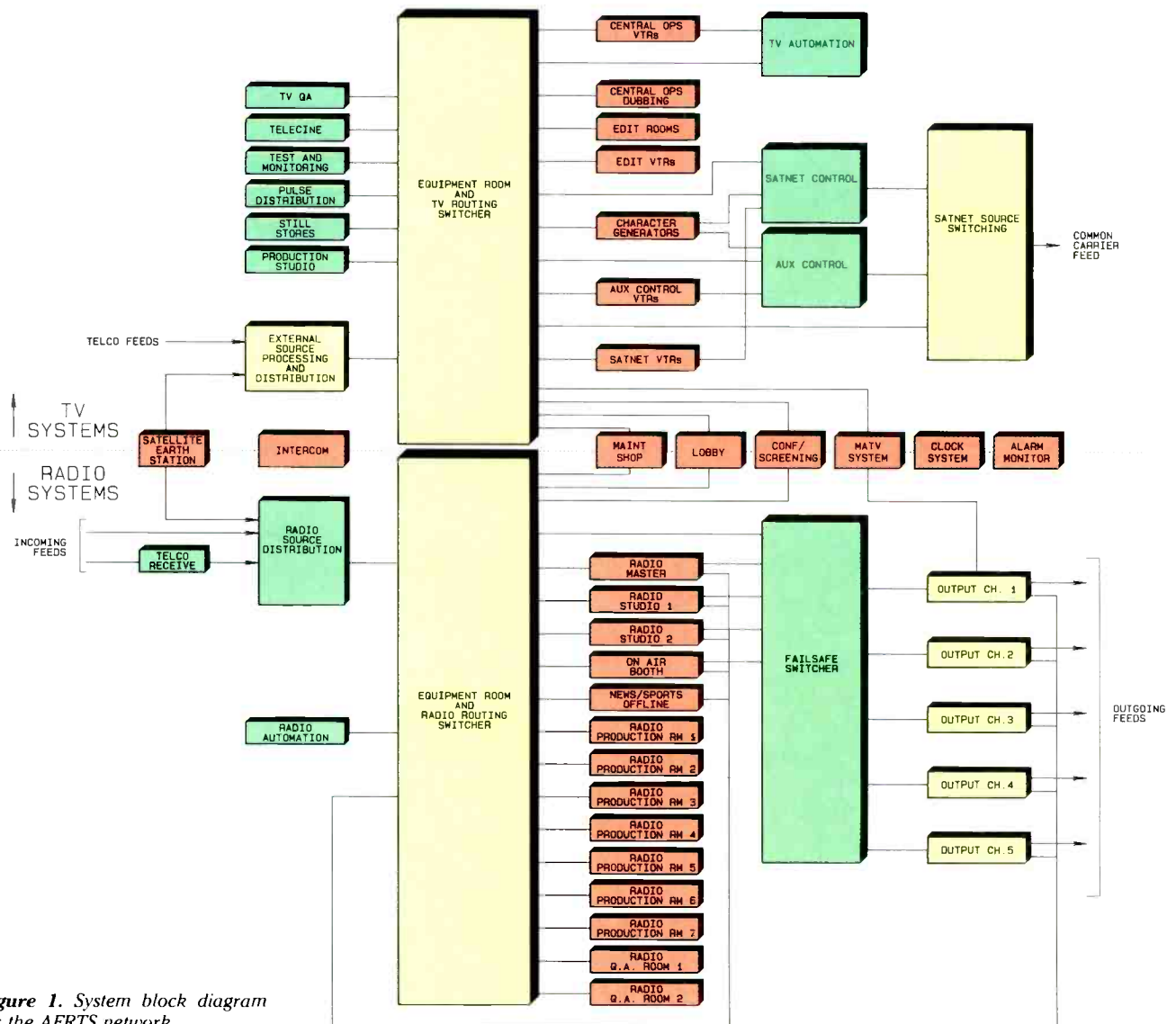

Figure 1. System block diagram for the AFRTS network.



UNWANTED FRAME GRABBING STOPS HERE



DFS-3000N Digital Frame Synchronizer

If your video synchronizer lets you
down on a noisy feed, you need the
new Leitch DFS-3000N. This digital
frame synchronizer incorporates input
processing circuitry that uses the latest
in digital auto-correlation techniques to
prevent intermittent frame grabbing or
switching to black. Only Leitch offers
this capability.

Now you know one of the features of the
Leitch DFS-3000N. But the advantages
don't stop there. Neither should you.
Write or call (toll free) for further
information.

In U.S.A. 1-800-231-9673
In Canada 1-800-387-0233

LEITCH

Progressive Concepts in Television Technology

Leitch Video of America, Inc.
825k Greenbrier Circle
Chesapeake, VA 23320
(804) 424-7920

Leitch Video International Inc.
10 Dyas Road, Don Mills
Ontario, Canada M3B 1V5
(416) 445-9640

Circle (36) on Reply Card

The beginning

AFRTS began as an unauthorized transmitter erected on Kodiak Island, AK, in 1941. A group of American soldiers assigned to the island assembled a low-power AM transmitter in late 1941 and began broadcasting to the forces located there. Using their own phonograph records, local voices and unreliable short-wave signals, these servicemen operated the radio station for many months until it came to the attention of Army officials.

In the spring of 1942, a special morale branch, later known as a special services branch, was created by the old War Department. Armed Forces Radio was born.

Branching out

For the next few years, the network developed and expanded as program production began. During the Korean War, the Air Force established the first Armed Forces TV station in Limestone, ME. Using kinescope copies of network programming and films, the station provided television to a previously unserved area.

The next major change occurred in the late 1950s. The TV operation was transferred to the radio services facility, which had been located in Los Angeles. Accompanying this change was the requirement that all commercials be deleted from both radio and TV programming.

In the late '60s, more live radio programming was produced. The "Herman Griffith Show" introduced soul music to American overseas outlets and more disc jockey programs were added. In 1969, FM stations were added to the network. The first 96-hour stereo tape library was developed and programmed in Saigon. This new service provided an alternative to the programming available on the AM band. FM stations made it possible to change the AM station's programming to more effectively address the younger listeners' needs.

Wolfman Jack was a big hit in the early '70s. Other personality packages were developed to help parallel the programming with which service personnel would be familiar.

TV broadcasts began in early 1976 with 15 hours of programming per week to eight Alaska outlets. With the success of this venture, a separate TV feed was soon added for Europe. More TV circuits were added in the mid-'70s, which allowed separate programming to be fed to different areas of the world. The Iranian crisis forced the establishment of a ninth ship's circuit for personnel operating in the Indian Ocean. Because of the crisis, a special news service was developed, which provided daily half-hour taped network newscasts. The tapes were delivered daily so the crews could be kept

abreast of world developments.

On to satellite

Satellite transmission began in January 1979, from studios located at Elmendorf Air Force Base, Alaska. Using satellite facilities acquired from the Armed Forces Information Service, the satellite network telecast 12 hours a day. The programming was carried by automatic receiving and retransmission stations located in the Alaskan cities of Galena, King Salmon, Shemya and Adak. Other outlets were established in Panama and Guantanamo Bay, Cuba. The worldwide network began 24-hour operation in 1980.

Since its inception in 1942, AFRTS has undergone many changes. In almost four and a half decades, the distribution network has seen the addition of television, stereo FM and satellite services. Source material has improved, changing from 16-inch audiodiscs to CD players. Film and kinescopes gave way to color VTRs and VCRs. The new broadcast facility in Los Angeles, completed in 1985, now provides up-to-date facilities that serve a worldwide audience of more than 1.2 million. The network is now capable of providing service personnel with the look and sound of home, no matter how far away from home they may be.

controlled automated tape recorders and an array of 36 audio cart machines. The cart machines record small segments of network material from up to 20 different networks. Later, these recorded segments are automatically integrated into an outgoing AFRTS network feed.

As with the TV programming, commercials must be removed from the radio programming. Because there are no visual cues, the audio is digitally delayed by seven seconds before broadcast. This gives the operator time to dump the network feed and insert the appropriate substitute program material.

The radio operation is more automated than television. All recording, playback and erasing tasks are prescheduled and controlled by an automation system. Two radio studios with separate control rooms provide equipment for major program productions. Smaller, combo operations provide disc jockeys with space to record their programs for later broadcast. Live DJ shows are not usually broadcast.

Design considerations

After the general operational requirements were determined, the detailed aspects of the facility were developed. When renovating existing space, it is sometimes difficult to mold the desired

work spaces from the available space. Just as difficult is the process of making the needs of the new facility match the structural limitations and configurations of the existing building. This usually requires the assistance of an outside expert. When a station staff attempts to sort out these details, personal prejudices can result in configurations that may not be optimum for the station.

The broadcast portion was intentionally situated on existing computer-access flooring. Although uncommon for radio studios, this type of construction is often used in TV facilities. Because of the acoustic requirements, the walls within this area of the building were removed. New acoustic walls were constructed from the concrete subfloor to the concrete ceiling. The raised computer-access flooring was then replaced.

The wall is a double acoustical partition appropriate for the noise-level specification of the broadcast area involved. The major components of the existing floor—channels and panels—were reused, resulting in considerable cost savings. See Figure 2.

The existing computer flooring yielded several major design advantages for the new studios. The most significant was that the concrete subfloor was depressed in these areas, eliminating the need to

raise the floor for cable runs. This allowed the hallway floors to be on the same level as the control and production rooms. Without the depressed subfloor, it would have been necessary to construct space-consuming and costly ramps at many passageways to create handicapped access. The only area that did require some access accommodation was the conference/screening room.

In order to keep the renovation costs as low as possible, the administrative area used the existing walls, floors and rooms as much as possible. This also helped maximize the funds available for use on the broadcast space.

One out-of-the-ordinary structural requirement for the renovation dealt with earthquakes. Most newly constructed buildings or extensively modified buildings must meet specific structural requirements. Because the building itself was already in compliance, however, it was necessary only that the modifications not change any of the original specifications.

Special rack base platforms were designed and installed, allowing the heavy equipment racks to be supported directly from the foundation slab, independent of the computer flooring. (See Figure 3.)

Continued on page 58

BROADCAST 87



International Trade Fair for Film, Radio, Television.

"BROADCAST

hit the predicted market gap,
spot on. We couldn't be more
satisfied." "Frankfurt is the

EDDY DELCOURT IKEGAMI

best place for a media fair.
It is ideal here." "For us, the

ADRIAN SCOTT EUROPEAN OPERATIONS BASYS

fair was a complete success.
We'll be back again next time."

HANS O. KÖFERL VIDEO DIGITAL STUDIOTECHNIK

Please note the dates:

Frankfurt, 14th – 17th October, 87

Circle (126) on Reply Card

1987 will also be a good BROADCAST year. With the latest from film, radio and television, as well as an international congress, workshops, co-production exchange and "live" media technology. Highly qualified trade visitors. Top contacts. Ideal conditions: modern fair ground, easy road, rail and air connections, large hotel capacity, a wide range of cultural and leisure facilities. Welcome to BROADCAST 87.

 Messe
Frankfurt

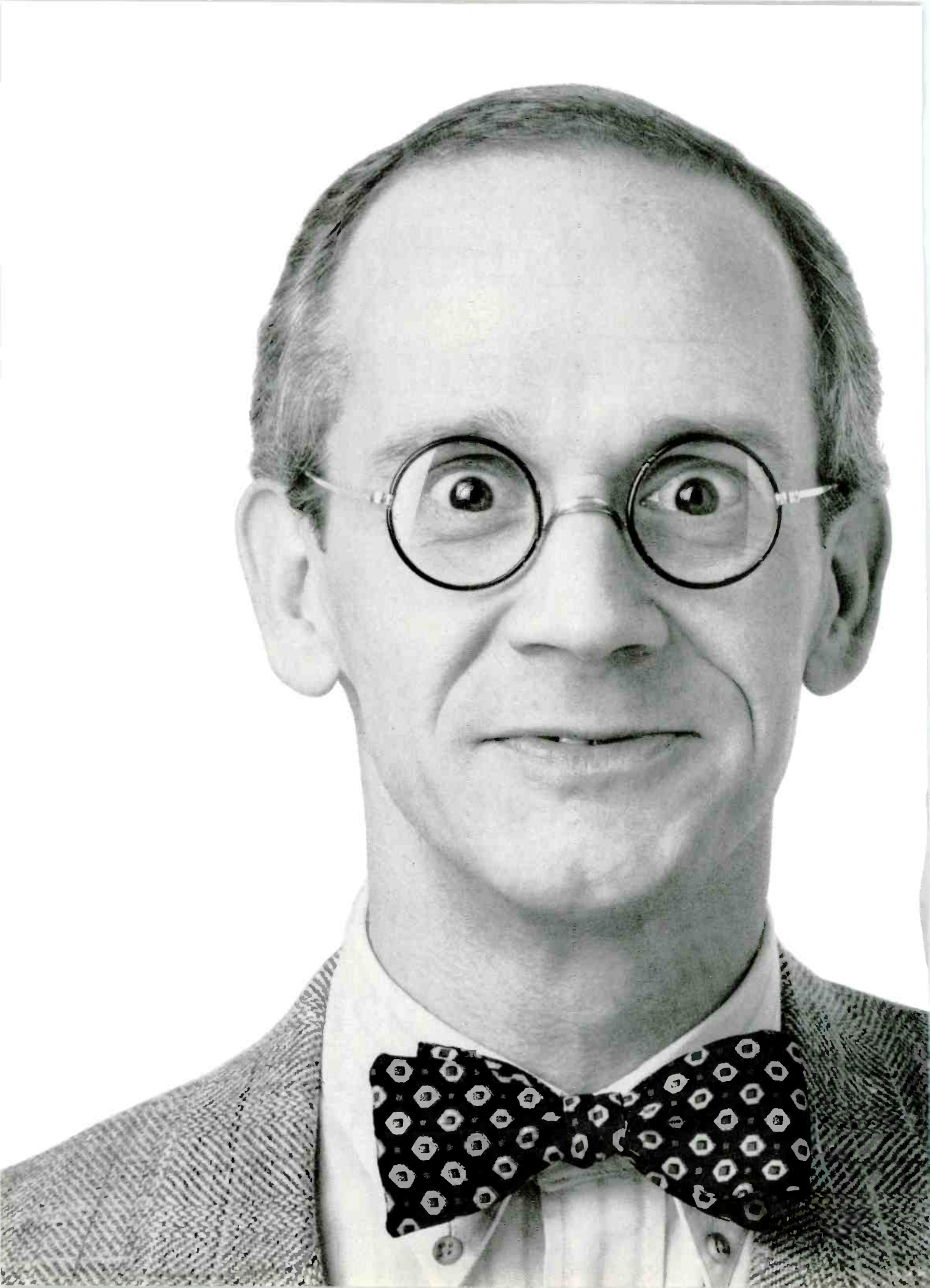

“Unu gradigi taŭgi ĉio!”

The quote above is Esperanto for “one size fits all.” But Esperanto, which was created to be a universal language, failed.

Its problem, which also applies to “universal” video formats, was simple. One size does not fit all; a truth that we at Sony have great respect for.

Our customers have different needs, so we offer a variety of solutions.

There's Betacam® for anyone who needs a compact, high quality ENG/EFP format. And Betacam SP for even higher quality with full compatibility and four audio tracks. One-inch type “C” provides unbeatable multiple generation performance; Broadcast U-Matic®, unbeatable price/performance. And for anyone who requires a digital component format, 4:2:2 digital will be available shortly.

So the next time you hear the words *universal format*, it might be wise to remember these words from the *universal language*: “Kliento atentu!” (Buyer beware!).

For more information on the complete line of Sony Broadcast products, contact your local representative. Or call Sony Broadcast at (201) 833-5231. **SONY**
BROADCAST

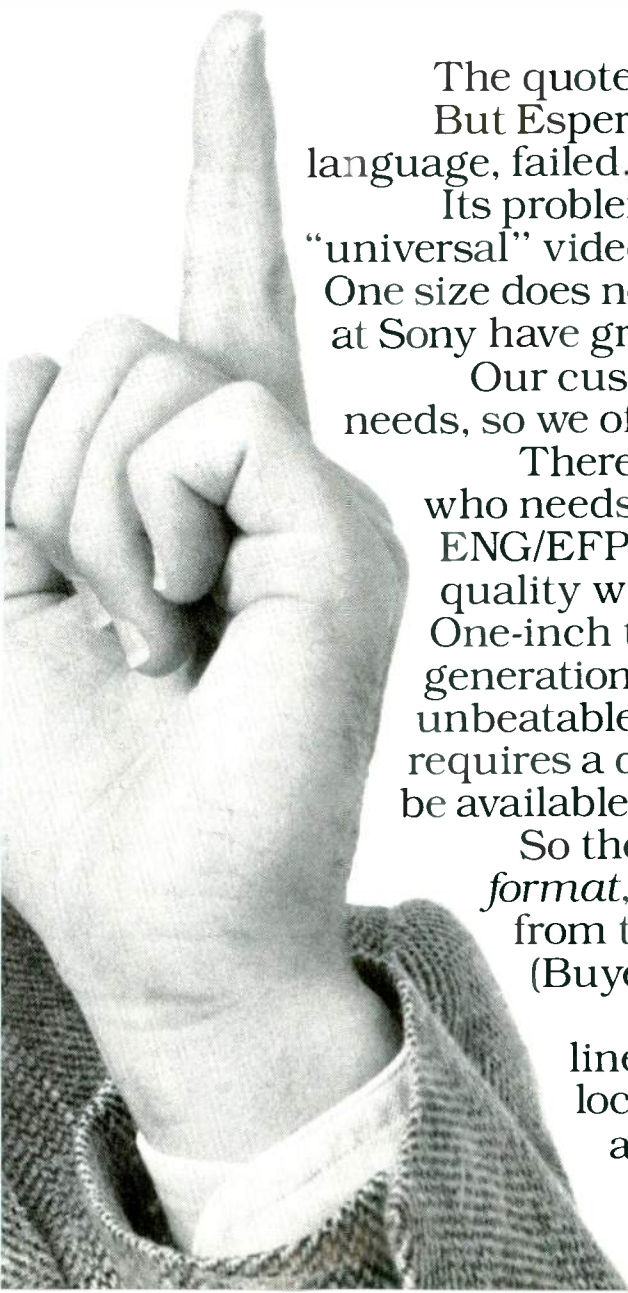

Otari's compact EC-201 SMPTE/EBU time-code reader is a natural for field or studio operation, and it costs only \$495. It offers 1/20 to 60X playspeed reading, 40 hour continuous use on battery power, and re-shaping circuitry on the loop output.

This advanced reader features a full hexidecimal user bits display (with a hold-button for edit logging), a -10 to +10 dBV input range, balanced XLR inputs/outputs, and includes an AC adapter, belt clip and batteries. It measures 1.5" x 4.2" x 5" and weighs 18 oz.

Contact Otari at (415) 592-8311 for your nearest dealer. From Otari: Technology You Can Trust. Otari Corporation, 2 Davis Drive, Belmont, CA 94002.

OTARI

TIME OUT!



©Otari 1986

Circle (38) on Reply Card

HVAC

The heating, ventilation and air-conditioning (HVAC) system is one of the most critical elements in a broadcast building. The HVAC system must provide the necessary environment for rooms that may be stuffed with heat-producing equipment. If these heat sources are correctly identified in the planning stage, the system can be designed to handle it. What sometimes happens, though, is a failure to take into account the heat that may be produced by equipment to be added later.

It's important to allow for extra tape recorders, amplifiers or other heat-producing devices. Although modern solid-state electronic equipment does not produce as much heat as old tube equipment, the motors and solenoids used in tape equipment do produce significant amounts of heat. Be sure you account for these devices when planning a facility.

Another important HVAC aspect is the effect the system may have on the facility's overall acoustic performance. HVAC systems are probably the most noise-offensive elements within a facility. If improperly designed and installed, they are quite expensive to modify.

In the AFRTS facility, the HVAC system is zoned and provides interzone cross-coupling. Failure of any single portion of the HVAC system would not prevent the facility from continuing operation. Vital portions of the facility are protected from outage by backup through a cross-connected parallel feed system.

Lighting

Lighting is another crucial element within the broadcast facility. Like other broadcast installations, AFRTS has areas with specialized lighting requirements. Because of this, it was not possible to design one lighting level to accommodate all of the various technical, operational and administrative tasks.

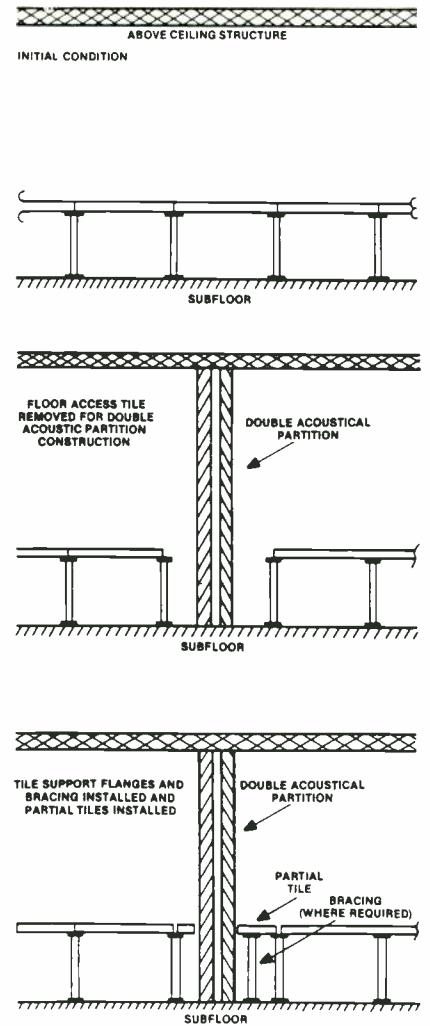

Figure 2. The existing computer-access flooring had to be specially modified to permit the construction of double acoustical partitions.

Also, despite the rising cost of electricity, significant operational savings can be realized through efficient lighting.

The AFRTS facility uses a switched, 3-stage lighting system. This scheme not only provides optimum general and task illumination, but achieves it economical-

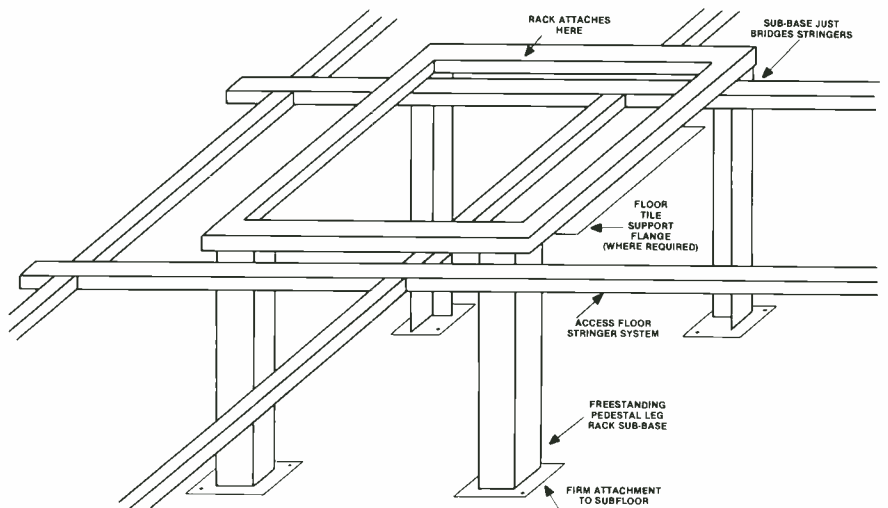

Figure 3. Special rack supports attach directly to the subfloor, keeping the racks independent of the computer-access flooring.

The Abekas A53-D Digital Special Effects System

The innovative tradition of Abekas continues with the A53-D—the most cost-effective, high-quality three-dimensional effects system available today.

In single or dual channel configuration, the A53-D gives you a full array of three-dimensional features. This includes: perspective and 3D rotation, variable rotation axes and 3D locate, field/frame freeze and full manipulation of frozen pictures, variable border and background, crop and aspect change, A/B switch-

ing and GPI control, and smooth linear motion and trajectory with variable tension.

The A53-D makes good sense for both live broadcast and post-production applications. For broadcasting, the A53-D offers a simple-to-use control panel with fast access to 24 on-line effects. For post-production, the system's extensive programming features and precise control let you create intricate effects limited only by your imagination.

You can digitally interface the A53-D to the highly acclaimed Abekas A62 digital disk recorder.

This unique duo gives you the ability to composite unlimited layers of manipulated video without generation loss.

Let the A53-D add a whole new dimension to your bottom line, with unmatched price and performance. For details, contact: Abekas Video Systems, Inc., 101 Galveston Drive, Redwood City, CA 94063. (415) 369-5111.

Abekas
Video Systems, Inc.

Now Anything is Possible

ADD NEW DIMENSION TO YOUR BOTTOM LINE



Circle (39) on Reply Card

AREA TYPE	INTENSITY LEVEL		
	TASK SURFACE INCAN. (DIMMED)	FLUORESCENT OPERATIONAL	AREA FILL (MULTILEVEL) SERVICE
VIDEO CONTROL	20fc MAX	N/A	50fc
AUDIO CONTROL	20fc MAX	N/A	50fc
VIDEO EQUIPMENT	N/A	30fc	60fc
AUDIO EQUIPMENT	N/A	30fc	60fc
MAINTENANCE	N/A	50fc	100fc

Table 1. The work areas required different lighting levels and types of lighting fixtures.

SPACE TYPE	BKGRND. NOISE CRITERIA	ADJACENT SPACE ISOLATION	REVERB. TIME	FLOOR TYPE	FLOOR SURFACE
OPERATIONAL	NC-20	STC-65	0.2 SEC	I.F.	CARPET
EVALUATION	NC-25	STC-50	0.3 SEC	R.T.	CARPET
MACHINE	NC-30	STC-45	R.T.	VINYL
GENERAL	NC-35	STC-45	R.T.	VINYL
ADMINISTR.	NC-35	STC-40	N/A	CARPET
STORAGE	NC-40	STC-35	N/A	R.T.	VINYL

NOTES:
 I.F. = ISOLATED FLOORING
 R.T. = ACCESS FLOORING
 N/A = NOT APPLICABLE TO SPACE
 STC = SOUND TRANSMISSION CLASS

Table 2. Each studio, control room and other work area had different acoustical requirements. The table summarizes the aspects to be considered for each area.

ly. The design also allows the building to comply with California and Los Angeles energy and conservation regulations.

General-fill lighting is provided in the video, audio and maintenance areas. These areas require only a basic

minimum lighting level. The video and audio control rooms require less general-fill lighting and instead, rely on task-surface incandescent lights with dimmers. This design allows the individual operators to adjust the light level as desired. The specific lighting levels for the various areas are listed in Table 1.

In addition to the general room lighting, separately switched, area-fill lighting is provided at the back of all full-height equipment racks. Retractable incandescent trouble lamps also are available at the back of each rack. These lamps greatly aid troubleshooting and eliminate criss-crossing the floor with extension cords.

All incandescent dimmers and fluorescent lights meet stringent RFI-suppression requirements. Special dimmers with protective filters and shielding keep the noise below levels at which it could become a problem.

Acoustic criteria

The acoustic criteria were critically important to the building's total design. At the earliest planning stage, each broadcast space was classified into one of six categories:

- *Operational* areas—where the sound recording or live broadcasting is performed. In these spaces, low background

Main story continues on page 64

PHASE CHASER

From

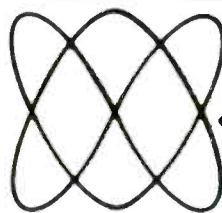

*Howe
audio*

... a Sound investment

The Smart Audio Time Base Corrector ... Definitely Discriminating!



Full **THREE YEAR WARRANTY**

Stereo is everywhere ... except in the listener's ears. Less than 50% of all radio receivers are stereo; most televisions are mono. So mono compatibility along with high quality stereo is extremely important to your success in the marketplace.

The Howe 2300 Phase Chaser **GUARANTEES MONO COMPATIBILITY AND STEREO INTEGRITY** everywhere in your audio chain, simply*.

FEATURES:

- Corrects time delay errors up to ± 150 microseconds
- Original stereo information remains unchanged
- Active balanced I/O; XLR connectors
- Programmable missing channel sensing and correction
- Channel polarity error detection and correction



2300 Central Ave., Suite E
 Boulder, Colorado 80301
 Call Bill Laletin at 1-800-525-7520
 to place your order.

*No pilot tone or prior encoding required.

Circle (35) on Reply Card

REALWARE

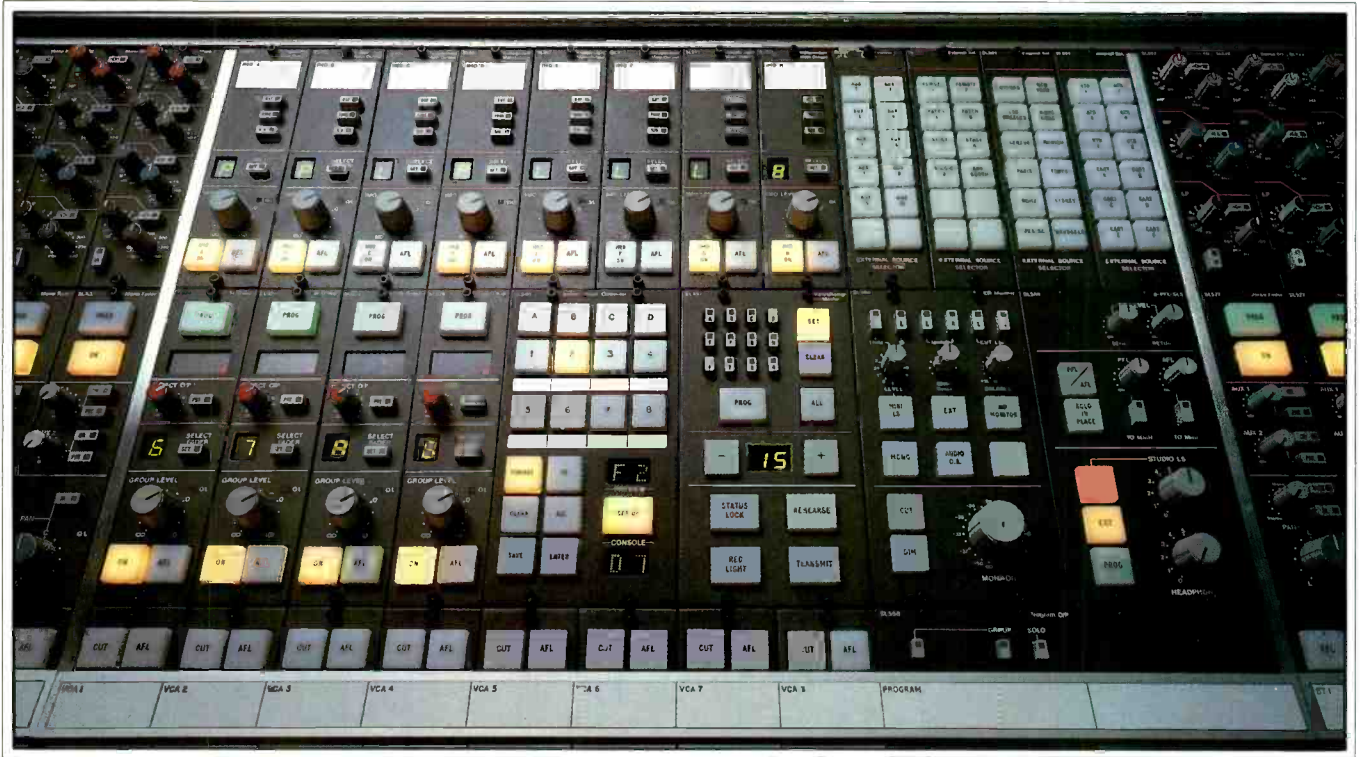

SL 5000 M Series Central Controls

Vital broadcast production facilities cannot be equipped with promises, prototypes or possibilities. Critical technical decisions cannot be based on imagination alone. Major capital planning cannot depend on guesswork and clever turns of phrase.

The facts are simple. Broadcast audio management is faced with pressing technical and creative problems that require practical, long-term solutions. And one company, Solid State Logic, is prepared for your future. Today. With real hardware, proven software, and a world of experience in advanced radio and television sound.

If you are holding out for computerised Instant Reset™, advanced centralised assignment, sensible human engineering, incredible custom flexibility, superior audio performance, simplified multichannel facilities, rational engineering and realistic prices . . . you could find your next trade show visit very frustrating.

Or you could visit the Solid State Logic stand where we'll be happy to show you the SL 5000 M Series, which features all of the above and more.

Solid State Logic Realware. It's more than a concept — it's an accomplishment!

Solid State Logic

Oxford · New York · Los Angeles

Begbroke, Oxford, England OX5 1RU · (08675) 4353
200 West 57th Street · New York, New York 10019 · (212) 315-1111
6255 Sunset Boulevard · Los Angeles, California 90028 · (213) 463-4444

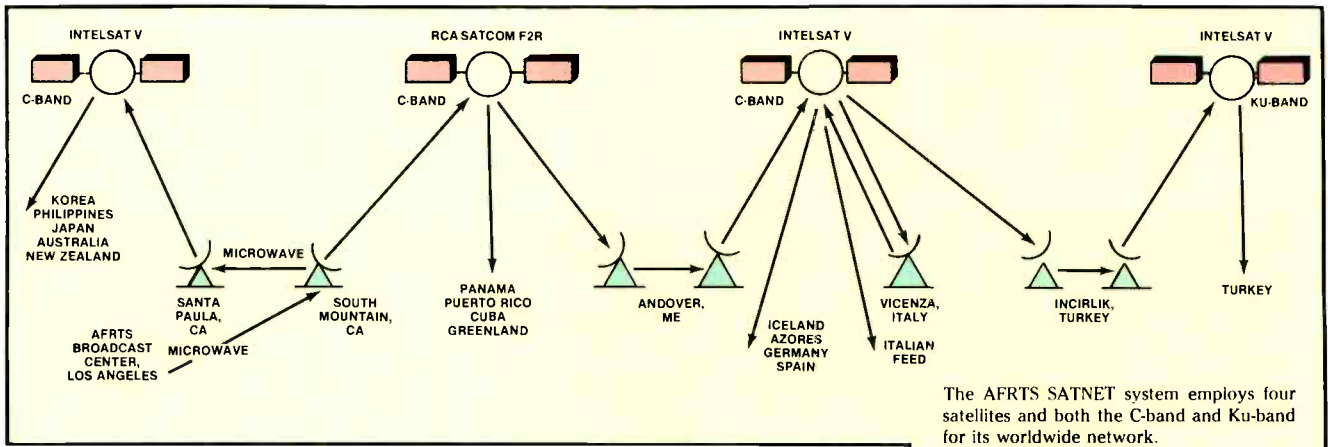

The AFRTS SATNET system employs four satellites and both the C-band and Ku-band for its worldwide network.

The AFRTS SATNET system

The AFRTS SATNET is a complex system of microwave feeds and satellite uplinks and downlinks. From the studios in Los Angeles, the network's programming is microwaved to a South Mountain, CA, uplink. There, the microwave feed splits and continues on to Santa Paula, CA, for uplinking to an Intelsat V satellite parked at 150°, which serves the Pacific.

This satellite provides programming for U.S. installations in Korea, the Philippines and Japan. Additional downlinks are planned for Australia and New Zealand.

The South Mountain uplink feeds a domestic RCA Satcom satellite, which relays programming to Panama, Puerto Rico, Cuba and Greenland. The feed is also downlinked in Andover, ME, for retransmission to an Intelsat V satellite located at 359°.

This Intelsat V satellite serves Iceland, the Azores, Germany, Spain, Turkey and Italy. The Los Angeles feed is downlinked in Vicenza, Italy, for local programming insertion. The Italian program feed is then uplinked again to a different transponder on the same satellite, allowing the Italian downlinks to receive both the international feed from Los Angeles, and local programming from Vicenza.

The 359° Intelsat V C-band satellite signal is treated much the same way in Turkey. The C-band downlink in Incirlik, Turkey, receives the international feed relayed from Los Angeles. Local programming is then inserted and the signal uplinked to an Intelsat Ku-band satellite located at 66°. The satellite's Ku-band spot-beam transponder eventually will serve 14 locations in Turkey. All of the components for this leg of the SATNET are not yet in place.

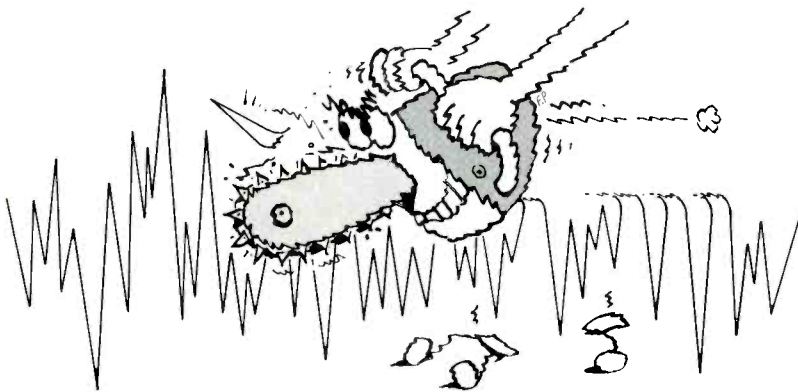

DOES YOUR LIMITER MASSACRE YOUR SOUND?

The Aphex Dominator™ is the perfect solution!

Unlike dumb, over-threshold devices, the Dominator is an intelligent 3-band limiter with a proprietary circuit which varies the threshold for limiting. The result is an *absolute* peak ceiling while retaining a transparent sound. You can run hotter levels to maximize signal-to-noise without fear of overloading.

The Dominator provides total transparency below processing threshold... increased loudness... freedom from spectral gain intermodulation... maintenance of transient feel... high density capability... and can be used for multiple applications. It's flexible and easy to use.

Ask your audio professional for a free demonstration. Once you've heard it, you'll never be satisfied with your old limiters.

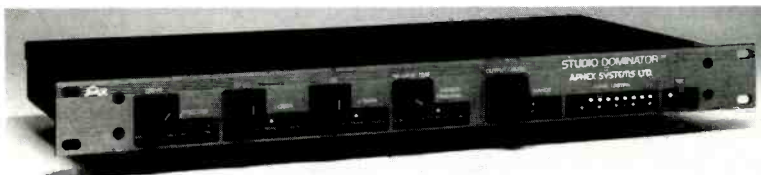

Aphex Systems Ltd.
13340 Saticoy Street • North Hollywood, Ca 91605
(818) 765-2212 • TWX: 910-321-5762

© 1986

Dominator is a trademark of Aphex Systems Ltd. and manufactured in the U.S.A.

Circle (68) on Reply Card



**Hector Munoz,
Distribution Services
Manager**

“Our purpose is to keep you on the air.”

Our extensive inventory of broadcast tubes, RF transistors and related components ensures delivery of the product to you on time—even if I have to run the package to the airport myself. Last year our company made over 7500 overnight deliveries, so we take emergencies seriously!”



**\$30 Million Inventory—
98% Same Day Shipment**



**Technical knowledge to
help you save time and
money by choosing the
right component.**



PRODUCTS: Cathode Ray Tubes ■ Diodes ■ Klystrons ■ Monitor Tubes ■ Plumbicon® Tubes ■ Receiving Tubes ■ RF Ceramic Capacitors ■ RF Transistors ■ Saticons ■ Solid State Replacements ■ Transmitter/Power Tubes ■ Tube Sockets ■ Accessories ■ TV Linear Devices ■ Vacuum Capacitors ■ Vidicons ■ Vistacons

MANUFACTURERS: Acrian ■ Amperex ■ Cetron ■ EEV ■ Eimac ■ GE ■ Hitachi ■ ITT ■ Jennings ■ Machlett ■ National ■ Philips ■ RCA ■ Raytheon ■ Thomson CSF ■ Varian ■ Westinghouse



800-323-1770

Circle (42) on Reply Card

Richardson Electronics, Ltd.

Broadcast Division — Calvert Electronics, Inc

Convenient Sales Offices: Franklin Park, IL ■ Woodland Hills, CA ■ Belmont, CA ■ Dallas, TX ■ Norwell, MA ■ Rockville Centre, NY ■ East Rutherford, NJ ■ Winter Park, FL ■ Brampton, Ontario, Canada ■ Lincoln, England ■ Gennevilliers, France

New 35 kW FM Power From A Proven Winner

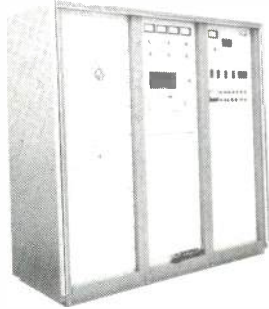

Continental's New Type 816R-5 is a high performance FM transmitter that uses the Type 802A exciter to deliver a crisp, clean signal.

The power amplifier uses an EIMAC 9019/YC130 Tetrode specially designed for Continental, to meet stringent FM service requirements at 35kW.

- SCR Power Control
- Automatic RF Power Output Control
- Automatic SWR Circuit Protection
- SWR Output Power Foldback
- Remote Control Interface
- AC Power Failure Recycle
- Grounded Screen Amplifier
- Internal Diagnostics

The 816R-5 is an outgrowth of Continental's popular 816R Series of 10, 20, 25 and 27.5 kW FM transmitters. It uses husky components and is built to give many years of reliable, dependable service.

For brochure and operating data, call (214) 381-7161. Continental Electronics, a Division of Varian Assoc., Inc. PO Box 270879 Dallas, Texas 75227.

Transmitters 1 to 50 kW AM and to 60 kW FM FM antennas studio & RF equipment • 1986 Continental Electronics 6210



Continental Electronics
a DIVISION OF VARIAN



Circle (43) on Reply Card

Continued from page 60

sound levels are required and the reverberation times must be predictable.

- **Evaluation areas**—where sound-quality evaluation and control is performed. Again, low background noise and predictable reverberation times are required.

- **Machine areas**—where operating personnel co-exist with broadcast equipment, which produces appreciable noise levels. The operating personnel monitor equipment and respond to intercom instructions, so sound levels must be absorbed and isolated. The overall sound level must be sufficiently low to permit reliable operation in comfort over an extended time period.

- **General areas**—where various administrative and non-operations technical functions are performed. These areas include the maintenance shops.

- **Administrative areas**—standard office areas that experience the accompanying office equipment and personnel noise.

- **Storage areas**—these areas require no special sound treatment.

In order to achieve the desired acoustical properties for each type of area, separate criteria were developed. (See Table 2.) Each of the areas required different isolation, reverberation and other acoustic specifications. To meet the developed specifications, different door types, surface absorption materials, mechanical system isolation and localized baffling were developed for each type of area.

Room background noise levels include contributions from the mechanical and electrical systems and structural transmission. Noise generated from the broadcast equipment within each space or from adjacent spaces is not included in the background noise levels. However, absorption of equipment-generated noise within the space is included. Because much of the noise generated by the equipment is wideband, the specified sound-absorption material had to be effective over a wide frequency range.

Adjacent space isolation pertains to all sources of undesired sound transmission, including sound from partitions, doors, windows, floors, underfloor areas (such as cable troughs), ceilings and mechanical system ductwork. The final design required the use of gaskets and caulking around partitions where they connected to other surfaces.

Success

The keys to the effective design and implementation of the AFRTS facility were planning and expertise. The network, staffed by broadcast professionals, worked with outside experts in developing a modern technical center. The challenge to the planners was to incorporate the technical requirements of live radio and TV broadcast and a large-scale duplication operation into a single efficient facility.

ⓧ

The Proven Lightning Deterrent!

Prevention is the only protection
Lightning rods attract lightning—that's their function. The only sure protection is to prevent the lightning from striking the structure and damaging the installations inside. That's what the VERDA Lightning Deterrent does—it gives you protection from all lightning-associated problems by deflecting lightning. A positive corona is formed which deters positive lightning energy. The VERDA Lightning Deterrent can be applied in all situations requiring lightning protection—

- communications systems—microwaves—two-way radio
- TV—FM—Nurad antennas
- boats—police and fire stations—ambulances—telephones—trucks—

It's round-the-clock protection against lightning. This system has been storm-tested on the highest structure in the world.

Lightning Deterrent Corp.
5321 South Kedzie Avenue
Chicago, Illinois 60632
(312) 434-7912 or
1-800-241-2360 ext. 532

Circle (44) on Reply Card

IT'S AN ITC



Low Cost Performance

OMEGA cartridge machines embody ITC quality at an affordable price with features to delight everyone ... *including low-cost stereo performance.*

OMEGA cartridge machines have simple, clean electronics for clear, accurate audio reproduction with the features you need. Microprocessor technology brings you many operational flexibilities with easy, economical maintainability. A crystal referenced DC servo motor provides audibly less wow and flutter, reduced heat and selectable speed operation.

OMEGA mono reproducers are field upgradeable to stereo while OMEGA mono recorders

have a selectable 1 kHz cue tone defeat and include a built-in microphone preamp. With direct microphone input and ITC's "FB-1" telephone answering interface, your facility can offer automatic dial-in information or perform a wide variety of news-room and research functions.

CALL US TODAY to discuss financial options on ITC's complete line of cartridge machines.

99B Cartridge Machines,
"The Best"

DELTA Cartridge Machines,
"Today's Most Popular Cartridge
Machines"

OMEGA Cartridge Machines,

"Affordable Performance You
Can Trust"

When newer technology emerges, it will come from International Tapetronics Corporation/3M, "The Leader in Reliability and Service."

In the U.S., call toll-free **800-447-0414**, or collect from Alaska or Illinois **309-828-1381**. In Canada, call Maruno Electronics, Ltd. **416-255-9108**. In most countries outside the United States and Canada, information on ITC equipment can be obtained through local distributors.

International Tapetronics Corporation/3M

2425 South Main Street
PO Box 241
Bloomington, Illinois 61702-0241

Circle (50) on Reply Card

3M

Designed for the future



Updating the Voice of America

By Richard Dempsey
and Michael Kelly

Adding new studios to the existing VOA facility while remaining on the air presented an awesome challenge.

If you think your station has a difficult time keeping track of its programming, consider this: What if you were in charge of coordinating and broadcasting more than 1,300 hours of programming each week, to a worldwide audience of more than 120 million listeners, in 42 languages? This is the task faced by the Voice of America.

Today, VOA is one of the largest broadcast organizations in the world. Its audience is constantly shifting, growing and changing in its need to know. Political realities and rapidly unfolding world events all impact on the VOA's task. The network's multilingual programming consists of fast-breaking news, music, interviews, sports, specialized features and commentary. In addition to the wide-ranging programming mix, the fact that it is carried in 42 languages only makes more apparent the staggering complexity of designing and building any new facilities.

Until recently, VOA handled this heavy traffic load with 1950s vintage broadcast equipment. The current studios were constructed in 1952 and have seen little improvement. Some of the network's broadcast facilities are so antiquated that each relay station has a maintenance shop that specializes in fabricating obsolete parts. In Germany,

for instance, VOA is still using a confiscated Nazi transmitter for regular broadcasts.

Three years ago, Congress approved a multiyear, \$1.3 billion facilities modernization program. The funds provide for much-needed studio renovation, remote broadcast vans and high-powered transmitters. The first element in the modernization program was the addition of six new studios, control rooms and news studios in the VOA's Washington, DC, facility.

The building

The network is located on the second floor of a 1938 Works Project Administration building that was originally built to house the Social Security system. Later, the old Department of Health, Education and Welfare occupied the building. Originally located in New York, the VOA moved to the building in Washington in 1952.

The intricate tasks of studio space allocation, design and construction, as well as interfacing with the network's existing systems, were scheduled for completion in 10 months. The project involved a total of nearly 1,900 square feet and was divided into two subprojects: the news department facility and the East European facility. Two studio/control room complexes were built for the East European section, which broadcasts in Albanian, Bulgarian, Czechoslovakian, Estonian, Hungarian, Latvian, Lithua-

Dempsey is a New York architect and Kelly is executive vice president for Hamilton Communications Consultants, Orange, N.J.

Photos courtesy of VOA, Joann Donnellan and Rosemary Stroer



The old VOA master control, shown here, was built in the early 1950s.

The ITC "Component System" Listeners Will Love It!



Provide impressive on-air sound for even the most discriminating listener at an unbelievable price/performance relationship.

The Best of Both Worlds

The ITC "Component System" combines the quality of digital source material with *all* the operational flexibilities of an all-cart format. Simply record from a compact disc onto a ScotchCart®II broadcast cartridge using a 99B master recorder with ELSA, then play back on a DELTA reproducer!

Separately, These ITC Components are Impressive, Together They're Awesome!

Cartridge, tape and machines have been designed by a single manufacturer to compliment each other like never before and produce uncompromising audio quality.

1. 99B Master Recorder—Loaded with features
2. ELSA—A patented automatic cartridge preparation system
3. DELTA Reproducer—Outstanding audio performance in a reliable, mid-priced cartridge machine

4. ScotchCart®II Broadcast Cartridge—Capable of frequency response equalling professional reel-to-reel performance

Allow ITC's "Component System" to provide your facility with the operational flexibilities of an all-cart format while you offer your listeners impressive on-air sound they are sure to love.

When newer technology emerges, it will come from International Tapetronics Corporation/3M, "The Leader in Reliability and Service."

Call today to discuss financial options and the unbelievable price/performance benefits of the ITC "Component System." In the U.S., call toll-free **800-447-0414**, or collect from Alaska or Illinois **309-828-1381**. In Canada, call Maruno Electronics, Ltd. **416-255-9108**. In most countries outside the U.S. and Canada, information on ITC equipment can be obtained through local distributors.

International Tapetronics Corporation/3M

2425 South Main Street
P.O. Box 241
Bloomington, Illinois 61702-0241

3M

Circle (52) on Reply Card

Give me the name of my nearest Maxell Distributor.

Give me a sales call so I can see for myself.

Maxell Corporation of America
60 Oxford Drive, Moonachie, NJ 07074
(201) 641-8600

Company _____
Address _____
City _____ State _____ Zip _____
Tel. () _____

nian, Polish, Rumanian and Yugoslavian. One of the major problems faced in renovating the current facilities was the need to maintain the 24-hour operation. The network's 26 studios could not be

The news facility uses similar but smaller studio/control room complexes than does the European facility. The news studios work in concert with an attached, but separate, announce booth

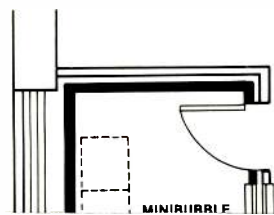

Dolby spectral recording

Original master tapes recorded with Dolby SR sound exactly like line-in. That is a strong statement, but one easily proven in a studio. The purity of Dolby SR is not surpassed by any other method of recording, even at the extremes of dynamic range, where earlier analog and digital systems have audible deficiencies.

At high signal levels... Dolby SR offers significantly greater headroom than conventional analog recording. At extreme high and low frequencies the increase in headroom is spectacular, providing uniform recording capability across the entire audio spectrum. In addition, because analog overload is gradual, there is no danger of accidental hard clipping of unexpected transient peaks. In fact, Dolby SR master tapes have greater usable dynamic range than any other method of recording (significantly more than 16-bit linear PCM, for example). The recording level can be set quickly and easily for program material with very high- and low-level passages. Because of the large dynamic range capability of Dolby SR, mixdowns from multi-track tapes remain exceptionally clean and quiet.

At low signal levels... Even the quietest signals are heard with remarkable clarity. Continuous dynamic and spectral analyses are used to assign optimal recording levels to all components of the signal, so that none of the tape hiss or modulation noise of conventional analog recording can be heard. The noise and non-linearities of low-level digital recording are simply not present.

And at every level in between... Dolby SR is not only superior at the extremes of dynamic range—a signal of exceptional purity is obtained at all signal levels. There is no tape modulation noise to be heard and no noise from the system itself. There are no staircase conversion inaccuracies, transient side effects, or phase anomalies due to steep low-pass filters, because Dolby SR does not employ digital conversion.



Listening comparison of line-in to line-out on a simultaneous basis is the ultimate test of any recording process. Dolby SR consistently passes this test.

Engineers, producers and performers all over the world are already using Dolby SR to create master recordings that match the line-in signal every time. They can freely record and edit Dolby SR tapes with any professional recorder. They have also discovered the simple, efficient and rational setup, alignment and maintenance that are possible with Dolby SR. Most important, they have confirmed the superiority of the sound of Dolby SR.

*Dolby spectral recording.
The sound of line-in.*

The new
master
recording
process

Dolby Laboratories Inc., 100 Potrero Avenue, San Francisco, CA 94103-4813, Telephone 415 558-0200, Telex 34409
346 Clapham Road, London SW9 9AP, Telephone 01 720-1111, Telex 919149
"Dolby" and the double-D symbol are trademarks of Dolby Laboratories Licensing Corporation. 586/7162

DD Dolby[®] SR



The pentagon-shaped tables provide each announcer or guest with access to several audio monitor signals and visual access to the control rooms.



The VOA newsroom, pictured here, is a part of the world's largest multilingual word processing system.



The news bubble is the heart of the news-gathering operation, with access to hundreds of reporters and news services throughout the world.

Continued from page 72
of those working in the building.

Special requirements

Among the most important specifications for the project were those dealing with the studios' acoustics. The studios and control rooms required noise criteria of 20 and 25, respectively. Because of the tight specs, a *room-within-a-room* construction process was used.

To meet these stringent requirements, the new studios and control rooms were built with prefabricated steel-panel acoustic modules for the walls, floors and ceilings. The panels were assembled on site, forming a tightly controlled acoustically isolated environment, or a room within a room. To help isolate the new rooms from the building structure, the floors were raised almost seven inches and outer walls were constructed.

These walls consist of three layers of material, as shown in Figure 2. The first layer is ½-inch gypsum board. One and one-half inches of acoustical insulation is fastened to one layer of the gypsum board. A second layer of gypsum board is fastened to the metal studs, forming the partition. This process is repeated for each studio's outer walls. The total completed partition is approximately 12 inches thick and acts as two separate free-floating walls.

Another complication was the need to conceal the cabling and electronic/electrical wiring. The detailed process of installing the walls required that the wiring proceed simultaneously with the construction of the acoustic modules. This required all of the construction trades to work together to properly assemble the panels. Because the completed acoustic panels weigh 200 pounds per foot, mistakes would be difficult to remedy.

Because of VOA's unique programming, good visual communications are required between the studio and control rooms. Large windows, unfortunately, can create significant sound leakage. To accommodate the visual needs, yet maintain sufficient isolation, special windows were constructed in the 12-inch-thick double-wall acoustic modules.

Studies determined that, to maintain acoustic properties provided by this modular construction, four panels of ¼-inch polished glass were needed. In addition, the glass had to be tilted so that disturbing multiple reflections would be minimized. A simplified drawing of a typical window is shown in Figure 3.

The design plan was to provide an 8-foot ceiling. Because of the building's height limitations, this goal proved to be difficult to meet. The 4-inch-thick floors are isolated from the building on 4-inch-high vibration shock absorbers and neoprene insulators. The ceiling panels are four inches thick as well. Thus, of the total available ceiling height of 10'2", 9'4" was already accounted for and the ductwork still needed to be installed.

MASTER CONTROL

Over sixty of our new MC-500 series **MASTER CONTROL** Switchers are in operation at television stations throughout the country, many with full *station automation* also supplied by Utah Scientific. These customers include some of the country's most prestigious broadcasters. Call or write for our 100% Users List to learn firsthand the many advantages offered by this state-of-the-art product.



US UTAH SCIENTIFIC, INC.
DYNATECH Broadcast Group

1685 West 2200 South, Salt Lake City, Utah 84119
Phone: (800) 453-8782 (Toll Free) or (801) 973-6840 • TWX: 910-925-4037
Circle (57) on Reply Card



Some studios are equipped with three TV monitors, allowing an announcer to translate a live event while viewing three different network feeds.

remote operation from within the studio complex. It is equipped with audio-processing equipment, eight channel mixers, tape recorders and cart decks. To complete the installation, teleconferencing hybrids and a monitor switcher are provided. The minibubble can act as a stand-alone or on-the-air studio or operate in conjunction with any

of the other control rooms.

The minibubble is an offspring of the existing news bubble. VOA has used the news bubble concept for many years. The news bubble acts as the nerve center for all incoming worldwide news feeds. All networks, the AP, UPI and other agencies, as well as VOA international correspondents, process their audio cir-

cuits back through the news bubble. The facility either records the program, redistributes it for recording elsewhere, or goes on the air as needed.

Because much of the audio programming coming from VOA originates from U.S. networks, visual aids are sometimes needed. Three large video monitors are mounted near the ceiling of each large studio. The monitors are each connected to a different network feed. This allows an announcer translating a major event to simultaneously view it on three different networks. The 3-network configuration helps the VOA to identify nuances and events that might be lost if only one feed were available.

Second stage

The completion of these studios is only the first stage of the renovation process. The second stage is just now beginning. In this phase, 19 more studios will be renovated, bringing the VOA into the world of modern broadcast facilities. The project may take as long as three years.

The modernized VOA facilities have been in operation for more than two years. According to the staff, the key to the successful improvement was careful planning. Renovating a facility while continuing operations is difficult under any circumstances. The VOA proved it could be done in the most complex situation. [:-:~)]]]

Portable diversity wireless.

Cetec Vega's Model 67A PRO portable diversity receiver provides improved effective operating range and virtually eliminates signal dropouts caused by multipath conditions.

Features include:

- True dual-receiver diversity.
- Low power consumption; operates from four internal 9-V batteries.
- DYNEX® II audio processing for over 100 dB dynamic range and high signal-to-noise ratio.
- True helical-resonator front-end filter and multiple-pole crystal IF filter for superb selectivity.
- External power capability for field and portable use, from a 12-V camera belt pack or other +10.5 to +18 Vdc source.

- Lightweight and compact (6.95 x 1.4 x 7 in.).
- Write or call for further information and location of your nearest dealer:
Cetec Vega, 9900 Baldwin Place,
El Monte, CA 91731. (818) 442-0782.

 **Cetec Vega**
... the professional's wireless



67A PRO

Circle (155) on Reply Card

IF GOOD IS O.K. - YOU DON'T NEED RAKS!

-but if you need a duplicator tape with a specially formulated backing that exceeds anything in the industry, with a virtually zero rejection rate...

-if you need a tape preferred by the pros that is completely designed and manufactured with uncompromising quality control in the most modern, hi-tech facility in the world...

-if you need high recording density, low chroma noise levels and a tape that practically eliminates dropouts and sustains original clarity...

-if you need a precision engineered shell, with special anti-static resin for extra toughness and heat resistance...

-if you need the BEST...
you need RAKS.. **PERIOD!**

RAKS[®]

ENGINEERED FIRST TO LAST!



THE FURTHER WE GO, THE

The world's most powerful tubes for radio and TV broadcasting.

Belgique : BRUXELLES
Tel. (32-2) 648 64 85
Tx 23 113 THXL B

Brazil : SAO PAULO
Tel. (55-11) 542 47 22
Tx (011) 24 226 TCSF BR

Canada : MONTREAL-QUEBEC
Tel. (1-514) 288 41 48
Tx 5 560 248 TESAFI MTL

Deutschland : MÜNCHEN
Tel. (49-89) 78 79 0
Tx 522 916 CSF D

España : MADRID
Tel. (34-1) 405 16 15
Tx 46 033 TCCE E

France : BOULOGNE-BILLANCOURT
Tel. (33-1) 46 04 81 75
Tx THDMTUB 200 772 F

FURTHER YOU GO.

At Thomson-CSF we've been pioneers in developing the use of high-power tetrodes in transmitters for more than 70 years.

Over the years we've stayed ahead with such developments as Pyrobloc® grids and the Hypervapotron® cooling system.

We offer: a complete line of tubes for radio broadcasting applications from FM to the most powerful SW and LW transmitters - the quality of our 500-600 kW tubes has been amply demonstrated in 15 years of service in over forty transmitters worldwide.

A complete line of power grid tubes and their associated cavities for UHF/VHF TV transmitters. Thanks to their efficiency, reliability and tight tolerances, systems makers can offer their customers substantially more cost-effective products.

A complete line of klystrons and TWTs for ground stations and space TWTs for direct broadcasting satellites (DBS) designed to last for at least a decade.

And we also produce high-resolution image pick-up tubes and devices (CCDs), and high-luminosity CRTs for top range professional applications.

In radio and television, telecommunications, military and civil aviation, as well as in a wide range of scientific and medical applications, Thomson-CSF know-how gets your systems moving. Fast.

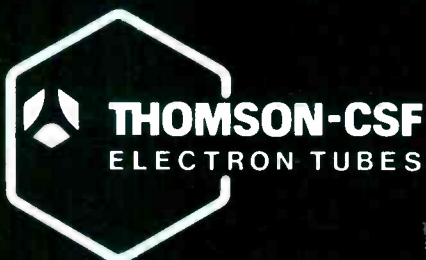

THOMSON ELECTRON TUBES AND DEVICES CORPORATION
550 Mount Pleasant Avenue
DOVER, NEW JERSEY 07801.
Tel.: (201) 328-1400. TWX: 710987 7901.

Circle (62) on Reply Card

UHF and VHF tetrodes up to 50 kW.

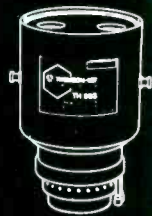

Matched cavities for best results.

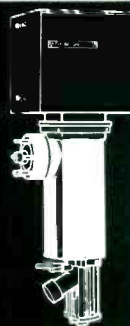

High power radio broadcasting tetrodes up to 1.2 MW (including the famous SW/LW tetrode delivering 500 kW/600 kW).



Earth station tubes up to 18 GHz (1.5 kW) or to 3.35 kW (6 GHz).

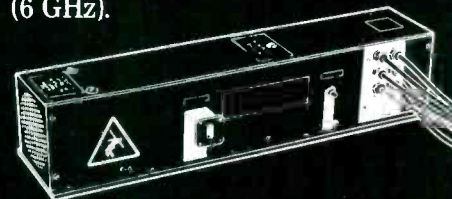

High efficiency space TWTs (including 40 W/50 W Ku-band for next generation DBS Satellites).



Primicon high-resolution, no-lag TV camera pick-up tube.



	ALL MARKETS	TELEVISION				RADIO			
	Total %	TV %	Top 50 %	Top 100 %	Below Top 100 %	Radio %	Top 50 %	Top 100 %	Below Top 100 %
Considering Upgrading Facilities	81.5*	87.9*	90.4*	80.8*	89.9*	77.5*	84.1*	83.1*	71.1*
Areas									
Production	46.7	51.0	53.2	39.7	58.0	44.0	48.3	55.4	37.1
Master control	39.9	48.0	50.0	49.3	42.0	29.8	37.1	32.5	24.1
Transmitter	37.2	33.2	28.2	28.8	49.3	39.7	41.7	47.0	35.8
Editing suites	18.1	39.3	44.2	32.9	34.8	4.5	4.6	6.0	3.9
ENG/RENG production	18.7	37.9	44.9	30.1	30.4	6.4	7.3	8.4	5.2
Antenna system	24.7	14.1	13.5	9.6	20.3	31.6	35.1	38.6	26.7
Remote controls	20.9	20.8	23.1	15.1	21.7	21.0	23.2	27.7	17.2
Satellite (MSN)	20.0	38.3	47.4	35.6	20.3	8.4	10.6	8.4	6.9
Planning Studio Improvements									
Redesigning studios	31.2	27.2	26.9	28.8	26.1	33.7	39.1	43.4	26.7
Expanding studio space	17.0	17.5	21.8	12.3	13.0	16.7	15.2	19.3	16.8
Relocating to new facilities	14.7	14.1	16.0	11.0	14.5	15.0	12.1	12.1	13.4
Base =	764	298	156	73	69	466	151	83	232

* Adds to more than total due to multiple responses.

Table 1. The percentages of TV and radio stations that plan to upgrade their facilities and make studio improvements.

Continued from page 82

1986, 1,962 questionnaires were mailed to recipients of **BE** on an "nth name" basis. On Oct. 14, 1986, 764 questionnaires had been returned, providing a response rate of 38.9%. The data contained in this report are based on these

responses. The results are broken down into the categories of *top 50*, *top 100* and *below top 100* markets.

A majority of survey respondents indicated plans to upgrade some portion of their facilities. Over all markets, 77.5% of the radio stations and 87.9% of the TV

stations planned facility improvements. This year's survey showed approximately the same number of stations as last year were planning improvements. The results are summarized in Table 1.

About one-third of the radio and TV stations plan on redesigning their

Introducing a better way to put leader tones on tape — Model 927 Programmable Reference Tone Generator.

400 Hz Will Never be the Same

■ **A Unique Product** RTS Systems' Model 927 is designed for use in making master and/or duplicate audio or video tapes. Operating in a *stereo* mode, it offers a significant improvement in record/playback audio *quality assurance*. In addition to discrete tones, white noise, pink noise, noise reduction tones, and stereo channel I.D. are available.

■ **Software Programmable** The Model 927 is user programmable; with 9 separate registers for up to 27 different tone events per sequence. Frequency, output level, duration and channel routing can be programmed with each tone event.

Please call or write for literature.

RTS SYSTEMS

1100 West Chestnut Street • Burbank, CA 91506 • Telephone 818 840-7119

Circle (63) on Reply Card

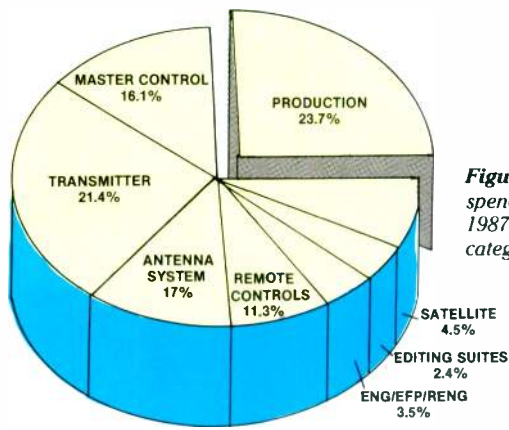

Figure 2. At left, the relative spending plans of radio stations for 1987, broken down by equipment category.

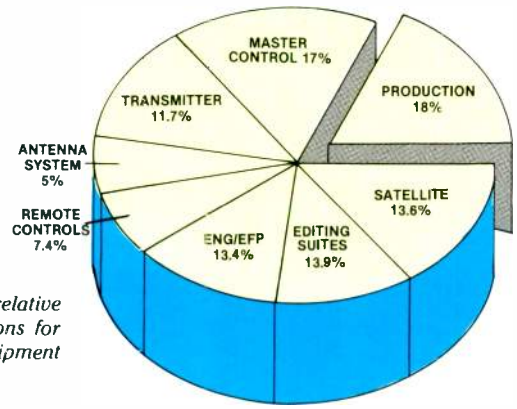

Figure 4. At right, the relative spending plans of TV stations for 1987, broken down by equipment category.

studios. A closer look at the data reveals that fewer TV stations plan studio redesign than do radio stations. Across all three market categories, approximately 25% of the TV stations plan on studio redesign.

In the *top 50* markets, almost 40% of the radio stations plan studio work. The figure rises to more than 43% in the *top 100* markets. In the *below top 100* markets, 26% of the radio stations plan studio redesign. Compared with FM stations, 20% fewer AM stations plan this work. This information tends to substantiate the projected equipment budgets for AM stations, to be discussed later.

Radio equipment

Radio stations are planning to purchase the same type of equipment as they purchased last year. Across all markets, radio stations selected produc-

tion equipment and transmitters as their first and second priorities—just as they did in the 1986 survey. The third most-often-mentioned category was that of antenna systems. The various spending categories and total survey responses are represented in Figure 1. Figure 2 illustrates purchases by category and is based on replies from respondents planning upgrades.

The survey shows a significant change in the purchasing plans for radio stations in the *below top 100* markets. The number of stations planning to purchase equipment from the listed categories is lower than last year in all categories except editing suites. The number of stations planning to upgrade equipment in this market has declined by almost 8%. The survey shows a 10% to 37% reduction in the number of stations planning to purchase equipment from the various categories.

There is a bright spot for this market.

Of this year's respondents, 39% more than last year indicated plans to purchase editing suite equipment. This large increase is somewhat misleading because only 4% of the total respondents indicated any plans to purchase editing equipment.

TV equipment

In general, more TV stations than radio stations plan to make equipment purchases in 1987. The number of TV respondents planning facility upgrading ranged from a low of 81% to a high of 90%. These planned purchases, broken down by market size, are shown in Figure 3. Figure 4 breaks down the proposed spending by category.

As in the radio segment, TV purchases planned for this year closely mirror those made last year. The No. 1 and No. 2

Continued on page 90

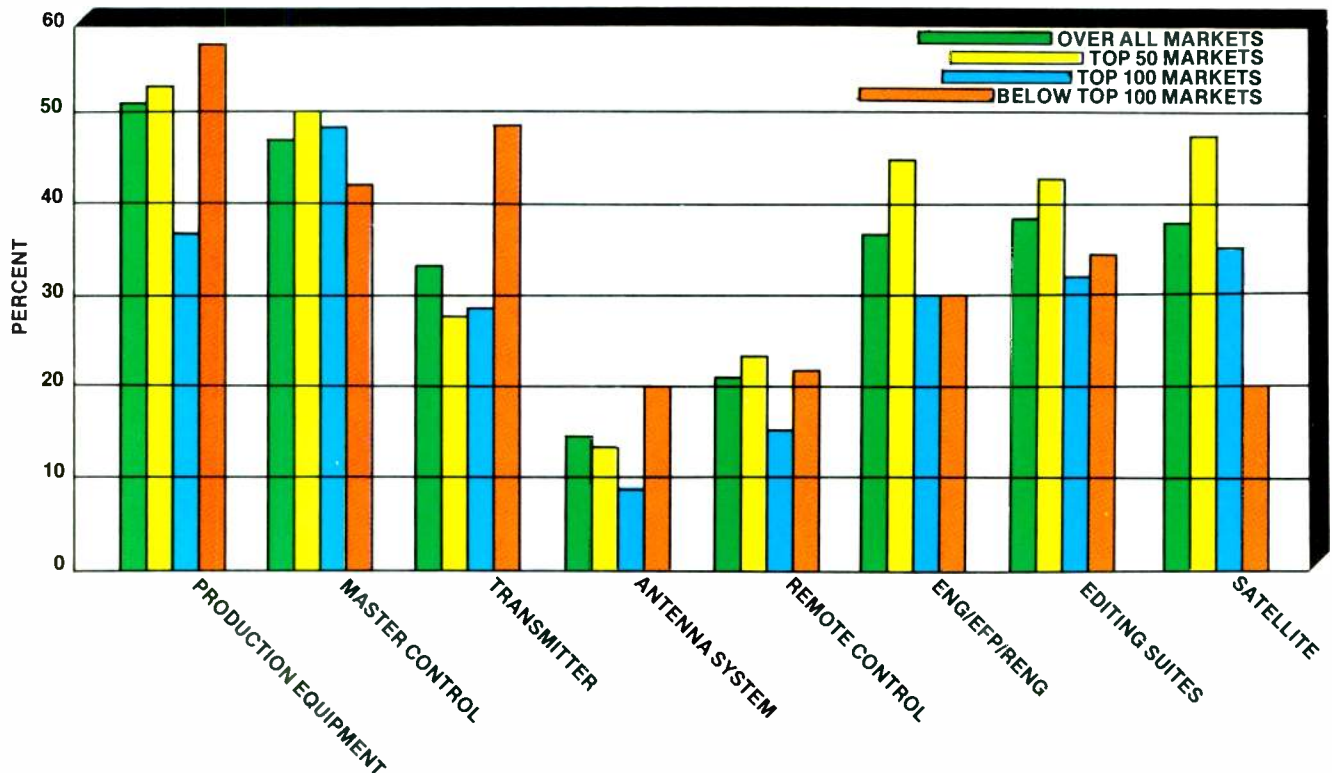

Figure 3. Planned spending by TV stations, broken down into product category and market size.

Canon Broadcast

Designed to meet all your



PV40x13.5BIE for 30mm and 25mm cameras. The Olympian—proven at the 1984 Olympic Games, its 40X reach is perfect for sports and all outdoor broadcast operations.

Focal length: 13.5-540mm (27-1080mm w/built-in extender)

Max. Relative Aperture*: 1:1.7 through 270mm
*25mm format 1:2.8 at 540mm



P18x15BIE for 30mm and 25mm cameras.

The Widest—a very wide 60° angle of view plus incredible edge-to-edge sharpness, fidelity and sensitivity. Supplied with 1.5X and 2X built-in extenders plus pattern projector.

Focal length: 15-270mm (30-540mm w/2X extender)

Max. Relative Aperture*: 1:2.1 through 218mm
*25mm format 1:2.7 at 270mm



PV14x12.5BIE High Resolution Lens for 30mm and 25mm cameras.

A Unique Design—featuring extensive use of Fluorite lens elements, this lightweight, compact 14X studio lens provides high sensitivity and critical sharpness at all focal lengths.

Focal length: 12.5-175mm (1.5X and 2X extenders built-in)

Max. Relative Aperture*: 1:1.6 at all focal lengths
*25mm format



J15x8.5BIE for 2/3" cameras.

2/3" Economy—full utility for all studio situations, combining a 15X zoom ratio with an M.O.D. of under two feet, a 54° angle of view and high sensitivity throughout the range.

Focal length: 8.5-128mm (17-256mm w/built-in extender)

Max. Relative Aperture: 1:1.6 at all focal lengths



J18x9BIE for 2/3" cameras.

Greater Reach. Lighter Weight—nothing matches the 18X zoom power of this lens—and it weighs less than 4 lbs.! It increases the flexibility of any portable camera.

Focal length: 9-162mm (18-324mm w/2X extender)

Max. Relative Aperture: 1:1.7 through 116mm
1:2.4 at 162mm



J14x8 BIE High Resolution Lens for 2/3" cameras.

Super wide (60°) and super sharp from corner-to-corner. This compact lens also provides a 14X zoom ratio and built-in 2X extender.

Focal length: 8-112mm (16-224mm w/built-in extender)

Max. Relative Aperture: 1:1.7 through 91mm
1:2.2 at 112mm

Television Lenses.

needs. Now and in the future.



J45x9.5 BIE for 2/3" cameras.
Incredible 45X reach with your 2/3" cameras!
Perfect for sports and all outdoor E.F.P.
applications.

Focal length: 9.5-430mm (19-860mm w/built-in
extender)
Max. Relative Aperture: 1:1.7 through 201mm
1:3.0 at 430mm



J25x11.5BIE for 2/3" cameras.
Greater Reach—a 25X zoom lens designed
specifically for 2/3" cameras. The power and
scope of 1" systems, the economy and
efficiency of your 2/3" cameras.

Focal length: 11.5-288mm (23-576mm w/2X extender)
Max. Relative Aperture: 1:1.6 through 220mm
1:2.1 at 288mm



J20x8.5BIE for 2/3" cameras.
Two Assignments—use a 13X zoom for ENG,
use the J20x8.5BIE for studio or outdoor
broadcast assignments—with the same 2/3"
camera!

Focal length: 8.5-170mm (17-340mm w/2X extender)
Max. Relative Aperture: 1:1.6 through 130mm
1:2.1 at 170mm



J13x9BIE for 2/3" cameras.
The Portable Standard—used by cameramen
around the world under all conditions,
the J13x9BIE is a proven performer with
superior sharpness and sensitivity.

Focal length: 9-118mm (18-236mm w/2X extender)
Max. Relative Aperture: 1:1.6 through 99mm
1:1.9 at 118mm



J15x9.5 for 2/3" cameras.
Quality plus Economy—you can't buy more lens
for less money. Lightweight and sensitive, it meets
the needs of both cameramen and accountants
yet lives up to its Canon name.

Focal length: 9.5-143mm
Max. Relative Aperture: 1:1.8 through 112mm
1:2.3 at 143mm



**J8x6 B Ultra Wide-Angle Lens for 2/3"
cameras.**
The widest of the ultra-wide zooms at 72.5°
this incredible 8X lens also has a M.O.D. on
only 11"—it's great for interviews!

Focal length: 6-48mm
Max. Relative Aperture: 1:1.7 through 33mm
1:1.9 at 48mm

Canon[®]

Optics Division

Canon USA, Inc., Head Office: One Canon Plaza, Lake Success, NY 11042 (516) 488-6700
Dallas Office: 3200 Regent Blvd., Irving, TX 75063 (214) 830-9600. Chicago Office: 100 Park Blvd., Itasca, IL 60143 (312) 250-6200
West Coast Office: 123 Paularino Avenue East, Costa Mesa, CA 92626 (714) 979-6000
Canon Canada, Inc., 6390 Dixie Road, Mississauga, Ontario L5T1P7, Canada (416) 678-2730

© 1985 Canon U.S.A., Inc.

Circle (64) on Reply Card

Continued from page 87

priorities are, respectively, production and master control equipment. In only two cases are the equipment category numerical rankings different from the 1986 survey.

In the *top 100* markets, the categories are the reverse of the 1986 results, with master control being the first preference and production equipment being the second. In the *below top 100* market category, the No. 2 planned purchase is transmitters.

In radio, expectations of purchases in the *below top 100* markets are somewhat lower than last year, but the opposite is true in the corresponding TV markets. Without exception, more TV stations than last year indicated plans to purchase equipment from the listed categories. In this market, 1987 purchase plans for production equipment are up 45%; antenna systems, up 35%; and editing equipment, up 20% over last year.

New master control equipment was scheduled for upgrading by many stations. This trend might be a result of the many new switchers, processors and automation equipment currently available. Also, it might have a direct connection to the reduction in engineering staff size, which will be discussed later.

Expenditures

As expected, television continues to spend far more money than radio does on equipment. Typical TV expenditures are 10 times greater than radio stations in similar markets. Equipment budgets for both radio and television are shown in Figures 5 and 6. The graphs illustrate data from both the 1986 and 1987 surveys to help identify overall trends.

The typical TV station has budgeted \$304,000 for equipment this year. This represents a modest 3% increase compared with last year. The *top 50* TV markets indicate the largest increase in planned spending—\$464,000, or 11% more than last year. The *top 100* market stations plan on spending \$200,000, which is down 2% from 1986. The *below top 100* stations have also decreased their planned expenditures, from \$132,000 in 1986 to \$100,000 in 1987.

In a comparison across all markets, the typical radio station equipment budget shows a 6% decrease, down from \$16,400 in 1986 to \$15,400 in 1987. The *top 50* radio markets showed a whopping 62% planned increase in spending over 1986. This appears to be attributable to heavy planned spending by FM and AM/FM combinations. The *top 100* markets show an 11% increase in planned spending. The *below top 100* markets show a 9% drop in equipment

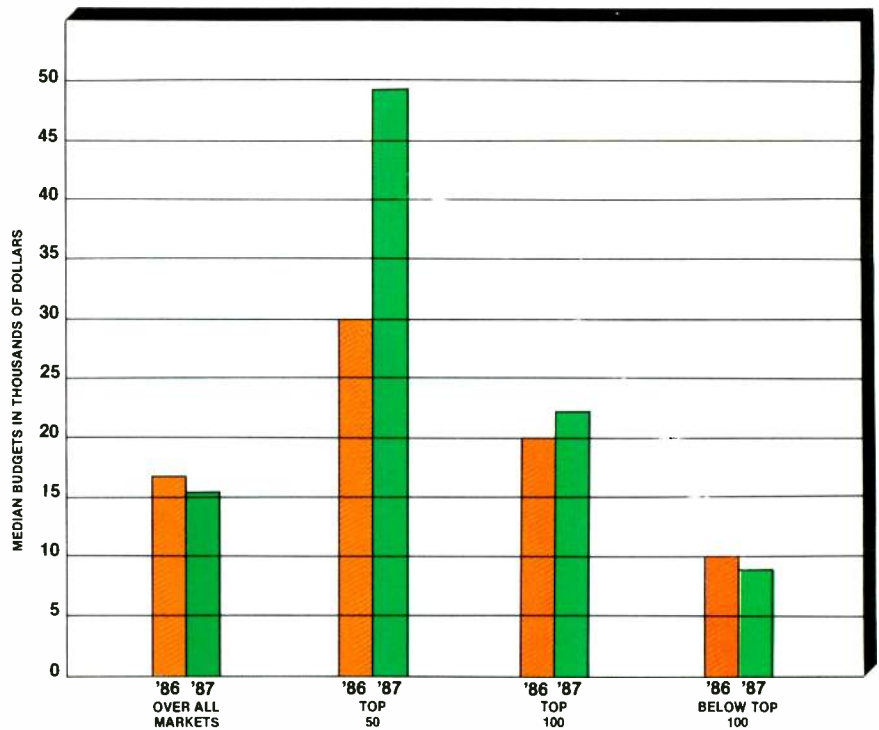

Figure 5. Radio station equipment budgets for 1986 and 1987.

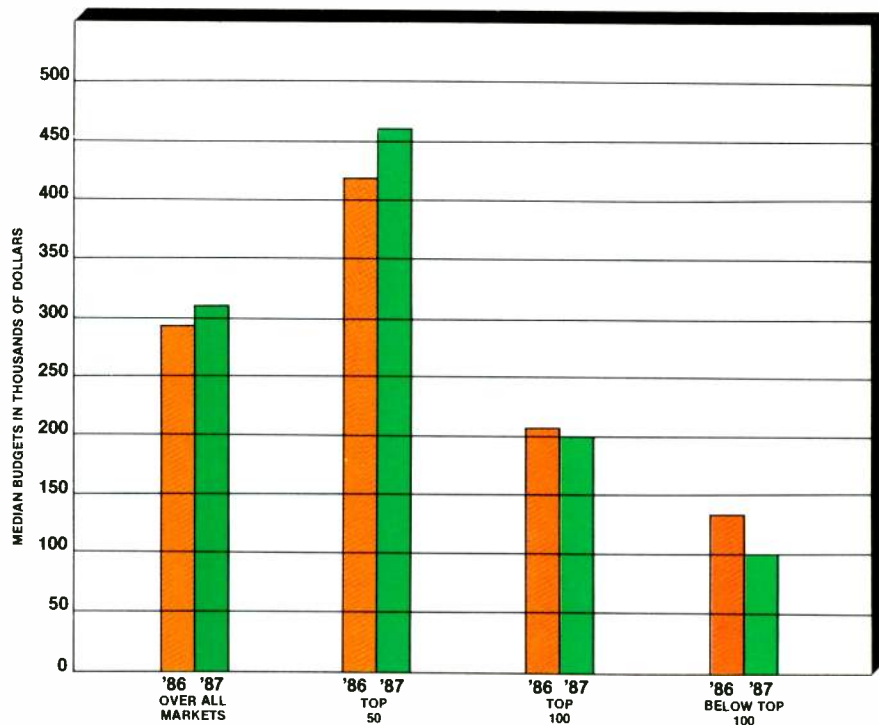

Figure 6. TV station equipment budgets for 1986 and 1987.

budgets, which correlates with the reductions already mentioned.

Of those facilities planning upgrades, 30% of the TV stations and 38% of the radio stations plan on spending more in 1987 than in 1986. (See Figure 7.) It was indicated by 42% of the TV stations and 39% of the radio stations that they would spend the same as last year. Smaller percentages—17% of the TV stations and

18% of the radio stations—said they would spend less than last year.

Despite the greatly needed AM improvements, AM stations show little incentive to spend money on technical facilities. When measured over all markets, the median AM station equipment budget for 1987 is only \$8,500. In the *below top 100* markets, the numbers are even lower, with a median equip-



Point Source Monitors for Point Blank Truth.



FOSTEX RP TECHNOLOGY

When it comes to sound, some people get a little funny about the point blank truth, in that they don't want to hear it.

They've come to expect that low end bump around 200 Hz because it makes the kick drum punchier, or they like the phase irregularities of the typical tweeter because the highs are all tst-tst.

At Fostex, we believe that truth is stronger than fiction. That's why we made the RM-Series. Point Source. Phase Coherent. Near Field.

They are reference monitors. They tell you exactly what you have and let you hear precisely what you're doing. Period. With neither apologies nor pamperings. Just the point blank truth.

What's more, when you mix with RM-765s or 780s, tape playback remains relatively the same from studio mains, to home stereo to car.

How many times have you heard just the right sound on a mix, only to find a completely different sound when you hear the tape on other monitors?

When you work with sound, you need a truthful reference. One that lets you hear the misses as well as the hits.

We encourage you to audition these Fostex reference monitors with a known source. Because we're confident that you'll know the truth when you hear it.

Point Blank.

Circle (104) on Reply Card



RM-765/780

Fostex

Pro Sound Division
15431 Blackburn Ave.
Norwalk, CA 90650
(213) 921-1112

ment budget of only \$4,280. Not until you look at the *top 50* markets will you see a sizable equipment budget, of \$26,750.

New owners

Stations that were sold or purchased saw little change in equipment purchases. According to the survey, 21% of the TV stations and 13% of the radio stations were sold. Of those sold, 8% saw an increase in new equipment. About the same number saw either no increase or less new equipment than before the sale.

More than three times as many AM stations (21%) as FMs were sold. Of those, 13% saw an increase in new equipment. This translates that an AM station is almost four times more likely to acquire new equipment after being sold than an FM station. Given the meager equipment budgets in AM stations, being sold may be the only way for these stations to get new equipment.

Maintenance budgets

Last year, 70% of the respondents replied that their stations' equipment

maintenance budgets were sufficient. In this year's survey, 9% fewer gave that reply. Over all markets, 61% of the AM respondents said their maintenance budgets were sufficient. However, in the *top 100* markets, this figure dropped to 43%.

The AM stations' funding plight is reflected in the other areas. Last year, 69% of the TV respondents indicated a sufficient maintenance budget. This year, that figure dropped to 61%. In a comparison of all markets, for both radio and TV stations, those satisfied with their maintenance budgets dropped from 70% last year to 61% this year. In general, more TV engineers are satisfied with their maintenance budgets than are radio engineers.

It is expected that there will always be a certain number of engineers who complain about a lack of maintenance funds. What is surprising, however, is that there are more and more who are dissatisfied with their budgets. Still, with 60% of the respondents saying their budgets are sufficient, complete disaster is probably not lurking around the corner. We will continue to track this trend next year.

Engineering staffs

The survey verifies what many engineers have known for some time: that station engineering staffs are being reduced or realigned. According to the 1986 survey, the median TV engineering staff was comprised of 18.8 people and radio engineering staff, 2.7 people. This year, the median TV engineering staff has 16 members and radio, 1.8. This change represents a 15% staff reduction for television and 33% for radio.

This change does not necessarily mean that engineering staffers have lost their jobs. Research shows that, in many cases, engineers have been transferred to different departments or given different titles. In these cases, they seldom continue to report to an engineering director or manager. Their new supervisors may be news or program directors, operation managers or others in non-technical positions.

There is a belief that the reliance on automation equipment helps account for the reduction in engineering staff size. That may be true, but sophisticated automation systems still require main-

Gentner Engineering - your source for broadcast telephone equipment!

- **Microtel™** - portable telephone interface for field reporters, sportscasts, IFB
- **TC-100™** - auto-answer, auto-disconnect telephone system for tape playing/recording, on-air use
- **SPH-3A™** - telephone system for on-air use, talk shows, news interviews
- **SPH-4™** - full-featured telephone system for on-air use, talk shows, news interviews

- **EFT-900™** - duplex "frequency extension" system for high-quality remotes, interviews
- **EFT-1000™** - fully automatic, duplex "frequency extension" system for remotes, interviews, teleconferencing
- **Teleprocessor™** - telephone audio processor with high/low EQ adjustments, Aphex® enhancing - use with any telephone system to maximize telephone audio

The Clear Choice.™

GENTNER™
ENGINEERING COMPANY, INC.

540 West 3560 South • Salt Lake City, Utah 84115
(801) 268-1117

Circle (66) on Reply Card

Stations looking to automate, look to IGM.

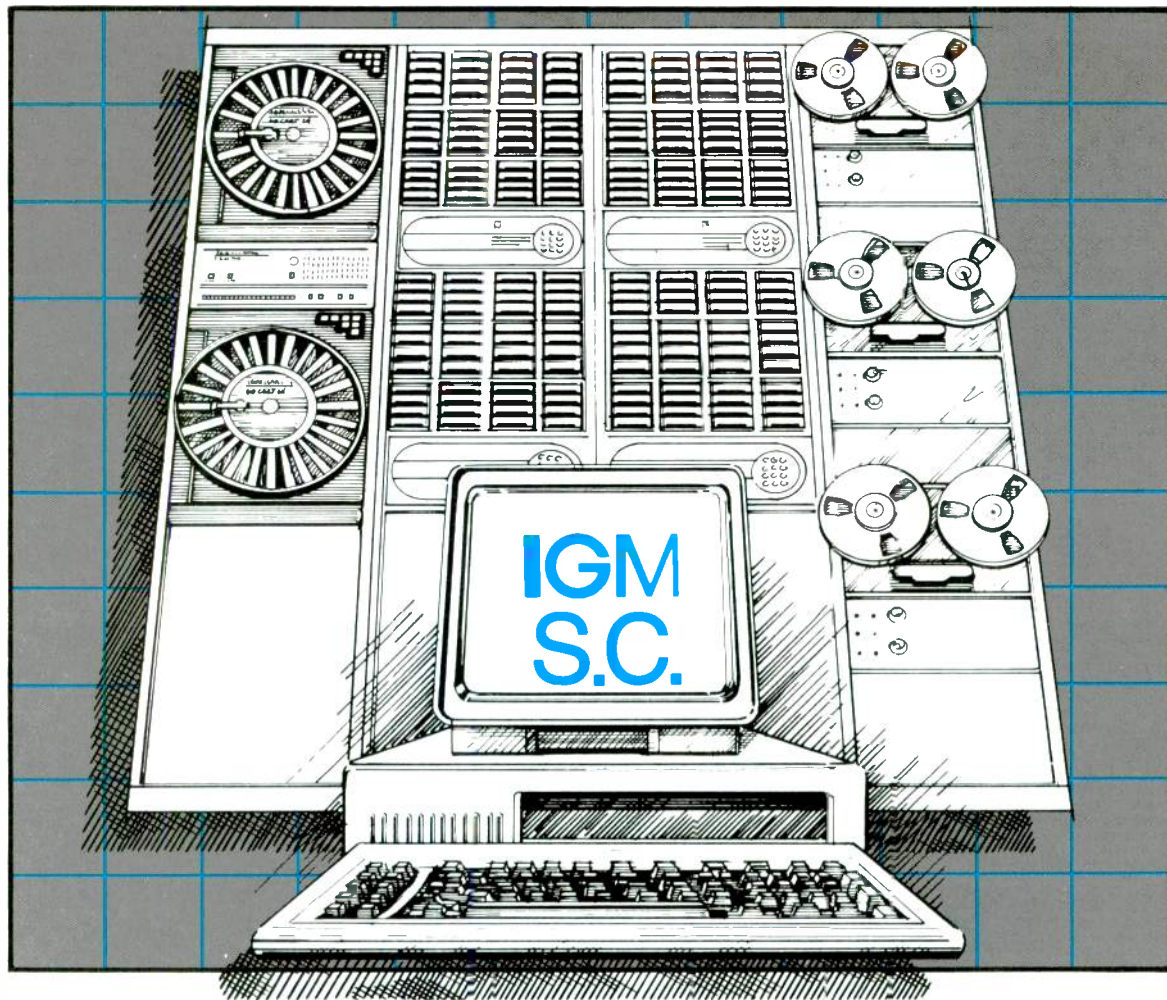

When you are thinking of using a program automation system, a number of questions come to mind. How do I handle network news? How many events of memory do I need to handle any format? How will this work with my billing system? With over 20 years of experience, IGM can help you determine how best to add automation to your operation. The broadcast industry has counted on IGM to build automation systems for all kinds of operations, from small radio stations to network operations.

We can build a program automation system for your station using an IBM-PC or compatible as the brain to

control the IGM-SC or IGM-EC automation controllers. Depending on your specific application, you can add the IGM GoCart and Instacart to handle your commercials and announcements or, if you need reel-to-reel machines or other cart machines, we can include the Studer-Revox PR-99 and Fidelipac cart machines in your system.

For information on how you can use automation successfully, call

800-628-2828 Ext. 578

IGM COMMUNICATIONS

282 West Kellogg Road

Bellingham, Washington 98226

(206) 733-4567

Circle (67) on Reply Card

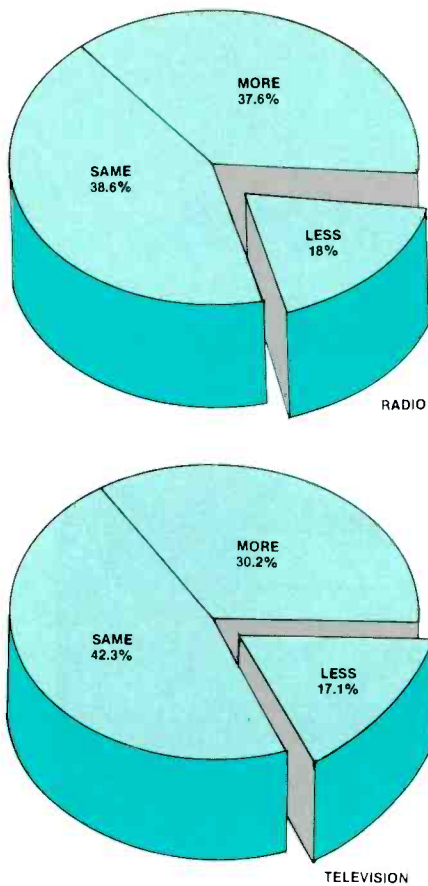

Figure 7. How stations see their equipment budgets for 1987, compared with 1986.

tenance. The employee responsible for maintaining this advanced equipment needs more training than one who services less complex equipment.

Just adding a cart machine won't, for example, replace several engineers. Those "engineers," who were really operators, may now report to an operations director and continue in their jobs. The technical staff can now concentrate on the design and maintenance of the more complex equipment found in today's stations.

Shows and conventions

Stations still consider trade show attendance important. More than 62% of the TV engineers plan on attending at least one trade show, but only 47% of the radio engineers plan to do so.

The annual NAB convention continues to be the major trade show for both radio and TV engineers. As shown in Figure 8, of the radio and TV engineers planning to attend at least one trade show, 61% will go to NAB.

For TV engineers who attend conventions, their second most-attended trade

show is SMPTE, with 18% planning to go. The TV engineers pointed to the new SBE convention as third choice, with a favorable 14% response rate. The TV engineers showed little interest in the Radio '87, AES, IBC and Montreux conventions.

Radio engineers who indicated travel plans picked the SBE national convention as the second most popular trade show. With a 26% rating, the SBE convention proved to be much more popular than Radio '87, SMPTE or AES among the radio engineers who plan to attend a trade show in 1987.

Tracking trends

The crystal ball is a bit clouded, so it's not possible to predict exactly what's ahead. However, from the results obtained over the past couple of years, certain trends seem apparent.

The rapid growth seen in past years for equipment purchases has tapered off. Instead, slow but steady growth will be seen in equipment purchases. Although it's still a driving force in the industry, new technology does not seem to be

Get in Sync with Videotek Value



The new VSG-200 Sync Generator offers you an unmatched combination of standard features:

- 6 isolated Blackburst Outputs
- SMPTE Color Bars
- 1 KHz Audio Tone Output
- RS-170A specifications
- Color Field I.D. Pulse Output
- Front panel adjustments for H Phase and SC Phase
- Adjustable Vertical Blanking Width (lines 16-21)
- Gen Lock Input with SC and Sync Indicators

© Videotek - 1985

A DECADE OF PROGRESS



A DESIGN FOR THE FUTURE

243 Shoemaker Road, Pottstown, PA 19464
(215) 327-2292, TWX 710-653-0125

VIDEOTEK Inc.

9625 North 21st Drive, Phoenix, AZ 85021
(602) 997-7523, TWX 910-951-0621

Circle (41) on Reply Card

perceived as the cure-all it was once thought to be. Stations seem hesitant to jump on a new-technology bandwagon without evidence of marketplace acceptance. Without strong evidence that any particular product (technology) will see widespread approval, broadcasters are keeping their checkbooks in their pockets.

Broadcasters have learned from AM stereo, and a myriad of here-today-gone-tomorrow video products, that waiting on the sidelines until a winner is declared can be advantageous. When competing technologies are marketed, broadcasters generally prefer that the battle not be fought in their stations.

Because the majority of stations are owned and managed by non-broadcasters, another change in the approach to new technology is evident. These owners and managers expect new technology to be cost-effective in addition to providing new features or higher quality. Although programming demands continue to drive technology, that alone will not ensure its survival. The key to the survival of many new

products will be their ability to reduce station operating costs.

Even without industry standards, new products will still see some marketplace acceptance. However, this acceptance may be painfully slow in coming.

The days of large engineering staffs, many of which included members who were actually operators, are gone. The large staffs are being broken down into smaller, more concentrated groups. It is not uncommon to find a news department with its own equipment, repair technicians and technical budget. Deregulation has allowed station managers to eliminate unproductive employees and to streamline operations. It's no longer possible to hold down a broadcast position just because you have a "license."

For those engineers who enjoy challenge, the future offers tremendous opportunity. New assignments, promotions and the chance to work with new high-technology equipment are all possible. For the person who simply wants to collect a paycheck, well, that's a different story. [:-{=)}]]]

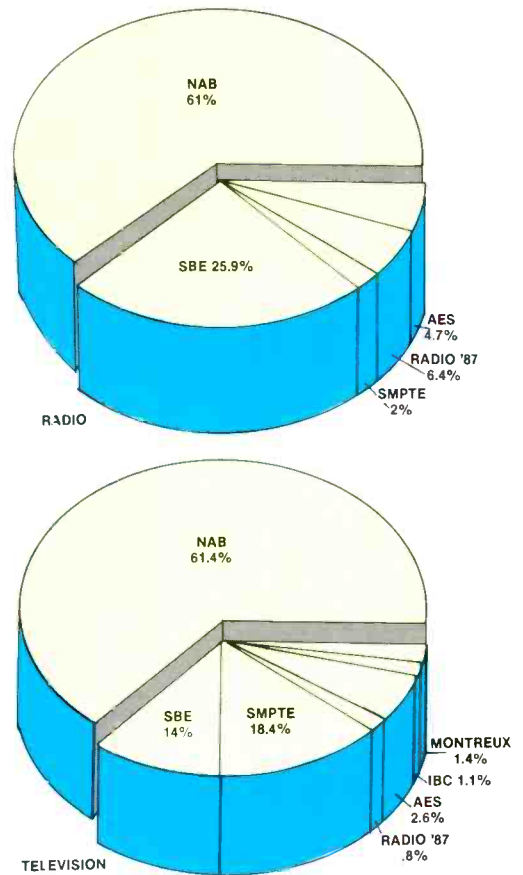
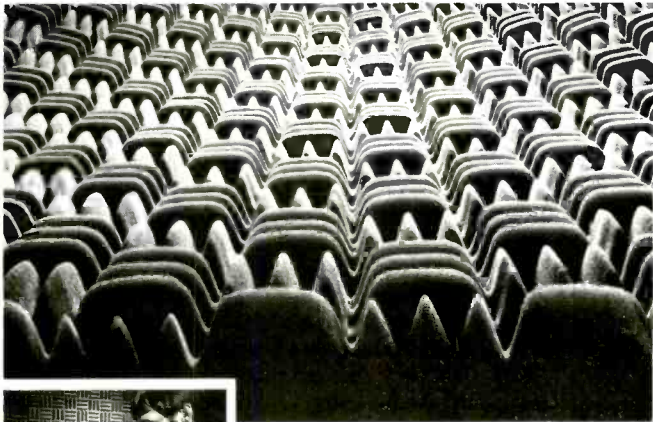

Figure 8. Convention attendance plans for radio and TV station engineers.

SONEX CONTROLS SOUND.



With its patented anechoic foam wedge, SONEX absorbs and diffuses unwanted sound in your studio. And it can effectively replace traditional acoustic materials at a fraction of the cost. SONEX blends with almost any pro audio decor and looks

clean, sharp, professional. Check into this attractive alternative for sound control. Call or write us for all the facts and prices.

SONEX is manufactured by Illbruck and distributed exclusively to the pro sound industry by Alpha Audio.

Alpha Audio
2049 West Broad Street
Richmond, Virginia 23220 (804) 358-3852

Acoustic Products for the Audio Industry

Circle (69) on Reply Card

SIERRA VIDEO SYSTEMS COMPONENT VIDEO

NEW

CIK-1

COMPONENT (RGB or Y/R-Y/B-Y)

KEYER/MIXER

- KEY SOURCE SELECTOR
 - STABLE LINEAR CLOSED LOOP MULTIPLIERS
 - WIDEBAND (HDTV OPT.)
 - KEY SIGNAL OUTPUT
 - RACK OR CONSOLE MOUNT PANELS
 - REMOTE KEY GAIN
 - GPI INTERFACE
- \$2490.00

ALSO

- ROUTERS
- CONVERTERS
- COLOR BAR GENERATORS
- DISTRIBUTION
- BETACAM™ & MI™ PRODUCTS

P.O. BOX 2462 GRASS VALLEY CA 95945 (916) 273-9331

Circle (70) on Reply Card

Inside fiber optics

By Elmer Smalling III and
Ned Soseman, TV technical editor

Getting acquainted with optical technology is an important step toward understanding forthcoming technologies.

Question: When was light first used to transmit news from point to point?

If the date you answered occurred any time during this century, you missed it by about 25 centuries. The first recorded point-to-point transmission of news using light as a carrier was in the 6th century B.C., when a chain of relay stations passed the news of Troy's downfall, using fire as the light source, from Asia Minor to Argos. Paul Revere used light signals. In 1880, Alexander Graham Bell patented the photophone, which used modulated sunlight to carry speech.

What goes around seems to come around. With telecommunications, light transmission has come around again—this time to stay—using *fiber optics*. The term was coined in 1956 by N.S. Kapany, who invented the glass-coated glass rod.

As the RF and microwave spectrum becomes more and more saturated, and cable runs are stuffed with active wire cables, the use of fiber-optic technology is rapidly becoming the only viable alternative to get a closed-circuit signal from point A to point B.

What is fiber optics?

Simply stated, fiber optics (FO) is the

Smalling, BE's consultant on cable/satellite systems, is president of Jenel Systems and Design, Dallas.



transfer of information by photons (light) through an enclosed medium such as glass or plastic fiber. The fundamental process is somewhat analogous to electrons passing through a metallic conductor such as wire. However, the analogy ends there. The components most common to a fiber-optic system are the transmitter, which converts electrical energy to light energy; the fiber, which is the conduit of that energy; and the receiver, which converts the light energy back to electrical energy.

Fiber-optic communications offer many advantages compared with metallic or RF systems. Transmitted FO signals are not distorted by any form of external electromagnetic or radio fre-

quency interference, and are immune to lightning. Fibers emit no usable radiation, and because they are non-metallic, they will not "short" or exhibit ground loop problems. They are smaller than cable wires and can carry an exponential amount of information, compared with wire. Furthermore, they are secure; transmissions cannot be "tapped," and are not susceptible to interference by unauthorized transmissions.

Fiber cable

The basic element of FO communications is the fiber itself, often referred to as the optical wave-guide. The fiber is manufactured by pulling and treating silica (glass) under high temperatures. While still molten, the fiber blank is pulled like taffy into a hair-thin strand called the core. The diameter of the core may be a few microns thick to more than 400 microns thick (.0001 inch to .016 inch), depending on the desired transmission characteristics. The glass used is so pure, according to Bell Laboratory scientists, that if sea water were as clear, you could see the bottom of the deepest ocean from the surface.

The tensile strength of an optical glass fiber is equal to that of a stainless steel wire of the same diameter, and about twice that of a copper wire of equal

Our World Of Audio DAs Is Growing...

NEW!

Dual Channel/Stereo Audio DA In A Single Module!

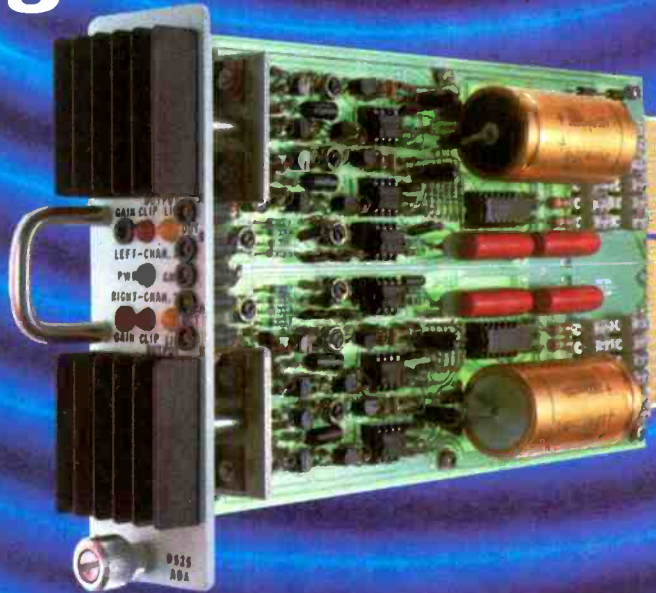

DATATEK

- 1 Input, 6 Outputs Per Channel
- Designed For 150 or 600 Ohm Systems
- +27 dBm Output Capability
- 0.05% (or Less) Distortion
- Front Panel LED's Indicate Overloads
- DF-609 Rack Frame Accommodates 10 Modules, A Total Of 120 Outputs

THE D-525 JOINS OUR FAMILY OF COMPATIBLE MODULES:

- D-523 — Maximum Headroom D.A., Wide Dynamic Range

- D-524 — Mic/Line Amplifier, Adjusts and Standardizes Incoming Signal Levels
- D-526 — 8 Output Single Channel D.A.
- D-522 — D.A., Designed For Wide Band SMPTE Time Code Application

*Write for
details on
the complete
line of DAs
from.*

DATATEK
CORP.

1121 Bristol Road, Mountainside, NJ 07092 • 1-800-882-9100
• 201-654-8100 • TELEX 833 541 DATATEK MTSD •

Circle (71) on Reply Card

diameter. Experimenters at Bell Labs have successfully stretched glass fibers as much as 6% that will still spring back to their original length when tension is released.

It is important that the core is manufactured with a minimum of metal ion impurities such as iron, copper and manganese. These metals absorb light waves and cause attenuation in the fiber. Imperfections such as small bubbles, cracks and opaque regions will cause scattering losses and reduce the tensile strength of the cable.

While the core is still molten, it is covered by the *cladding*, which is applied as an oxide layer. The cladding is the element that keeps the light within the core (see Figure 1).

The properties of light

In free space (ideally, a perfect vacuum), all light waves travel at a uniform velocity of approximately 300 million (3×10^8) meters/second, regardless of their frequency. The air in the earth's atmosphere slows light infinitesimally. In other materials that conduct light, such as glass and water, the velocity is slower and not equal for all wavelengths.

This effect can be demonstrated by a beam of white light as it passes through a prism, as illustrated in Figure 2. Because



Optical fibers may be bundled in any configuration. There is no crosstalk between adjacent fiber conductors.

the speed of light is slower in glass than air, all light is refracted (bent). At higher frequencies, the speed is slower, resulting in a spreading of the light beam at the output of the prism, and creating the familiar rainbow effect.

The relationship between the velocity of light in a vacuum and its velocity in a

particular medium is called the *refractive index* of that medium. For example, the refractive index of air is 1.0003. This refraction causes stars to seem to twinkle. Other materials are considerably higher. For example, the refractive index of water is 1.33, and glass is 1.5. Although the refractive index varies for different frequencies of light, it is small enough to be ignored when determining the refractive indexes of optical fibers.

Properties of an optical fiber

The basic optical fiber is coaxial; that is, it consists of two concentric layers of material, the core and the cladding. The cladding that surrounds the core takes advantage of an effect known as Snell's Law. This law states that when a beam of light travels through one medium to another with a different refractive index, it will be bent, or refracted, if its entrance angle is not perpendicular to the surface of the material. The cladding of a fiber-optic cable is made to have a lower refractive index than the core. This causes light waves that strike the cladding to be refracted or reflected back into the core, as shown in Figure 3. This refraction that occurs within the fiber causes light pulses to arrive at the other end of the fiber later in time than light pulses that remain on axis (see Figure 4).



COMREX EXTENDER—\$495!

Finally there's a frequency extender that's really affordable. And, it's a Comrex.

Frequency extension is a way to send broadcast-quality program over a standard telephone line. It's an encode/decode system that restores the lower frequencies that the phone can't handle.

We've been building these systems for years, but a lot of people who should have been using them simply couldn't afford them. That's why we developed the Basic extender. Each component (encoder and decoder) sells for \$495, so your complete system is less than \$1,000.

The Comrex Basic may not offer some of the "extras" available on our other models. What it does offer is a distinct improvement in program quality sent over telephone lines.

Call Comrex for a demo tape, at 1-800-237-1776. Or write Comrex Corporation, 65 Nonset Path, Acton, MA 01720. Tel. (617) 263-1800. TWX 710-347-1049.

COMREX

BUILT FOR BROADCAST

Circle (72) on Reply Card

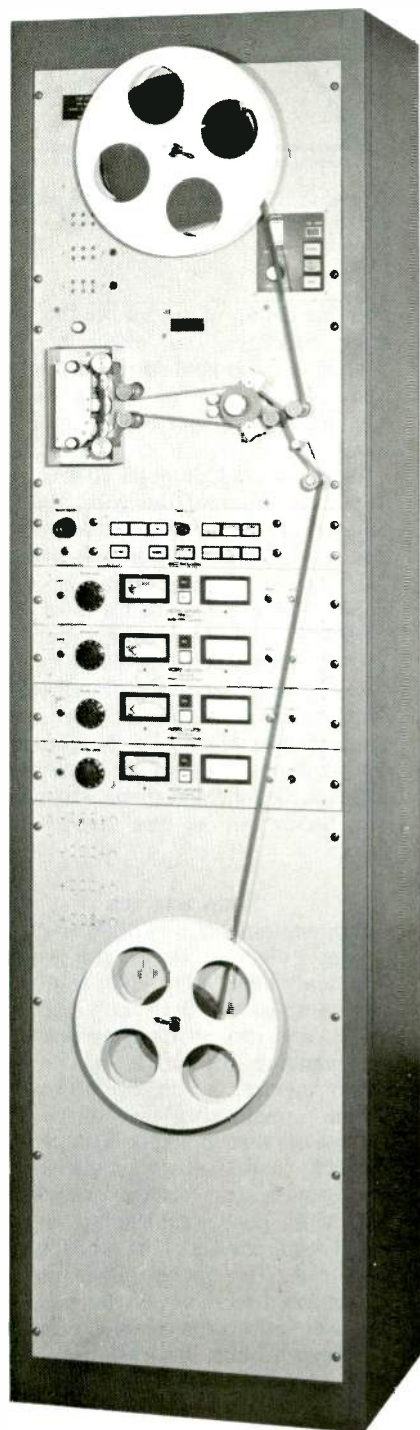

MAGNA-TECH

THE SOUND HEARD AROUND THE WORLD

Magnetic Film
Recorders and Reproducers
for Television and Film
Sound Post-Production

HIGH SPEED

Telecine Magnetic Followers
Video Tape-Film Interlock
Electronic Looping
Dubbing Systems
16 and 35mm Electronic Projectors
Total Facility Engineering

WORLDWIDE SALES OFFICES

Paris
Hi-Fidelity Services
4 Rue Semard
75009 Paris, France

Sydney
Magna-Techtronics (Aust.)
PO Box 150
Crows Nest NSW 2064
Australia — Telex 24655

Johannesburg
General Optical Co., Ltd.
15 Hulbert Road
Johannesburg 2001,
South Africa

Rome
Alberto Sciarretta
Via Siria 24
Rome 00179
Telephone 7943618

Brussels
A.R.C.
Rue de Boisdre Linthout 45
1200 Brussels Belgium

Hong Kong
Paul Yang and Associates
901 Star House
3 Salisbury Road
Kowloon, Hong Kong

Bombay
Capt. P.K. Vishwanath
234/4 Rama Baug,
Deodhar Road
Bombay 400 019, India

Kehl West Germany
Zenon GMBH
Postfach 1743
Hauptstrasse 128
Kehl am Rhein
Tel: 07851/2991
Telex: 753537

London
Branch & Appleby
42 High Street
Harrow-on-the-Hill
Middlesex HA1 3LL,
England

Kuala Lumpur
Kinematronika Sdn. Bhd.
2852, Jalan Selangor/
Persekutuan,
Federal Hill
Kuala Lumpur, Malaysia

Caracas
Cine Materiales srl
Apartado Postal 61.098
Caracas 106 Venezuela

MAGNA-TECH ELECTRONIC CO., INC.

630 Ninth Avenue, New York, N.Y. 10036

Telephone (212) 586-7240

Telex 126191

Cables "Magtech"

Circle (73) on Reply Card

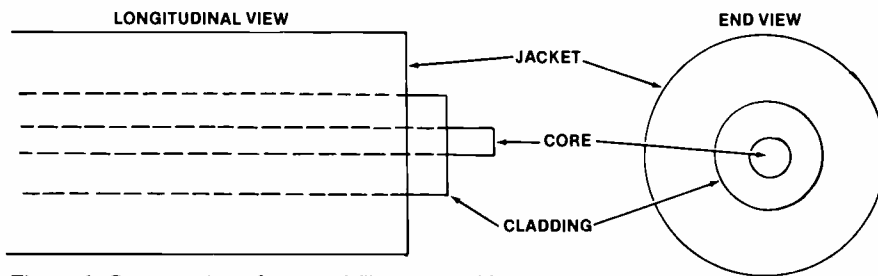

Figure 1. Cutaway view of a typical fiber-optic cable.

The angle at which the light signal is fed (or launched) into the core is called the acceptance angle or the angle of inciture. This angle must be shallow enough (on, or near, the axis of the fiber) to cause total refraction of light from the cladding. Figure 5 shows the acceptance angle (or cone, if considered 3-dimensionally) of a fiber. Inside the acceptance angle or cone, light will be accepted. Light outside the cone will be lost through total refraction, creating what are known as *skew waves*. Skew waves are complex, and are generally ignored in fiber-optic discussions. (See page 104.)

The numerical aperture (NA) is a measure of the amount of light a fiber can collect. The larger the NA number, the greater amount of light the fiber is capable of collecting. The larger the diameter and the NA, the easier it is to couple a light source to the core of the cable. As the NA increases, however, loss due to attenuation increases and the fiber's bandwidth decreases. Therefore, a large-diameter core (greater than 400 microns) often defeats the purpose.

Fiber attenuation is sensitive to the wavelength of the transmitted light source. Most fibers exhibit a low-attenuation "window" in the 800nm to 900nm band, and usually attenuate greatest in the 900nm to 1,000nm band. From 1,100nm to 1,500nm, many fibers display their lowest attenuation. However, each fiber varies and more detailed information should be obtained from the manufacturer. A typical curve is shown in Figure 5, page 104.

Dispersion

The downside of fiber optics, when compared with metallic wire transmission of information, might seem to be dispersion. Dispersion is the condition created when pulses within an optical fiber become distorted due to refraction (called *modal*, *intermodal* or *multimodal dispersion*), or because of the various speeds of different frequencies of light within the fiber (called *chromatic*, *material* or *spectral dispersion*).

As mentioned previously, light bouncing along the cladding will arrive later in time than light traveling down the axis. This effect results in a blurring of pulses at the output of the fiber, as illustrated in Figure 4.

Chromatic dispersion occurs when the light source contains more than an ex-

remely narrow frequency band of light. With a true monochromatic light source, chromatic dispersion will not occur. Light sources that are commercially available today may approach narrow bands, but do not achieve a true single frequency.

Both types of dispersion may seem to present a problem at this point, but there are a number of different ways to deal with dispersion.

Enter engineering genius

Three types of fibers, each with a different approach to resolving modal dispersion, have been developed. All three are commonly used in various applications today.

Mode refers to a possible light path that a photon may take along a fiber. Each fiber can be identified by the modes it offers photons within its core.

The most straightforward approach to reducing the effects of modal dispersion is to use a fiber core so small that the delay will be negligible. This is called the single-mode step index fiber. Its core is typically five or six microns in diameter, and it is capable of a bandwidth approaching 50GHz/km. It can easily handle 15 channels of video over a distance of 15 miles without a repeater. Single-mode step index fibers are used with laser light sources due to their low NA and their sensitivity to spectral purity. Precision connectors and splicing techniques are required.

Two types of fibers are multimode (multiple pathway) fibers: step index multimode, and graded index. The multimode step index fiber is similar to the single-mode step index fiber, except the core is much larger, offering photons more available pathways. The term *step index* refers to the large step between the refractive indexes of the core and the cladding. The diameter of the core of the multimode step index fiber typically may be 100, 200 or 300 microns. It is the least expensive fiber and is well suited for short-haul applications containing frequencies lower than 20MHz. Because the NA of multimode step index fibers is high, the amount of power (light) that can be launched into the fiber may be much greater than other fibers.

Another multimode fiber commonly used today is the graded index multimode fiber. This fiber uses many layers of core and cladding materials, which decrease in refractivity gradually

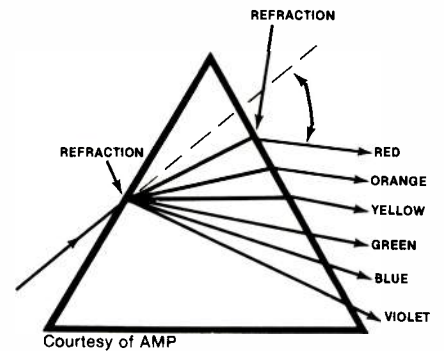

Figure 2. The refraction of light increases with frequency when passed through a prism.

from the center of the core to the outermost cladding. The effect of these graduated or graded refraction indexes uses Snell's Law to its advantage, creating a fiber that tends to be self-equalizing.

As photons of light enter an area away from the center of the core, they encounter a lower refractive index that, in turn, speeds up the photon's velocity. The farther photons stray from the center of the core into areas of lower refractivity, the faster they speed up. Graded index multimode fibers typically are capable of bandwidths ranging from 200MHz/km to 2GHz/km. The optical attenuation exhibited by the graded index multimode fibers may be as low as 1dB/km, depending on the wavelength and bandwidth of the signal's light source.

Light sources

Light-emitting diodes (LEDs) and injection laser diodes (ILDs) are the two most commonly used optical light sources for FO transmission. Both are small and bright, and can be intensity-modulated by changing the drive current with either analog or digital information. When considering a source, the parameters that should be included with reliability and cost are bandwidth, optical power and optical wavelength. Bandwidth must be sufficient to meet the speed requirements of the modulation or pulse rate. The optical power must be great enough to achieve a desired signal-to-noise ratio or bit-error rate. The wavelength must be matched to the characteristics of the fiber of choice.

Light-emitting diodes

The LED is simply a p-n junction, typically using gallium-aluminum-arsenide (GaAlAs) for lower (near visible red to infrared) frequency emissions (800nm to 900nm), or indium-gallium-arsenide-phosphide (InGaAsP) for far infrared radiation (1,000nm to 1,300nm). When doped properly, the LED's p-n junction, under forward bias, will cause electrons to jump across the junction and recombine with holes. A photon of light is created each time an electron recom-

We Make Eight Different Satellite Antennas So You Won't Have To Pay For What You Don't Need



3-meter

One simple fact governs the cost of your satellite communications antenna, whether it's for television and radio broadcasting, cable television, or private communications.

The fact is this: The bigger the antenna, the bigger the price tag.

That's why we make eight different antennas ranging from 1.2 to 7 meters. Plus a unique conical horn antenna designed for areas of high terrestrial microwave interference.



1.8-meter

High surface accuracy, great strength

Just like you, we're concerned about price. But since we're in the business of providing broadcast-quality communications systems, we can't afford to skimp—and neither can you. Our advanced construction methods provide precise surface tolerances that insure optimum performance even at Ku-



OS-4 Offset-fed (meets 2" spacing)

C-or Ku-band fixed or transportable

In addition to having the right size antenna for the job, we offer a host of options, including C-or Ku-band

antennas for uplink and down link, motorized or hand-cranked mounts, a programmable position controller that stores the position and polarization of up to 16 satellites, a multiple satellite feed system, and transportable versions of our 3-, 3.66-, and 5-meter antennas.

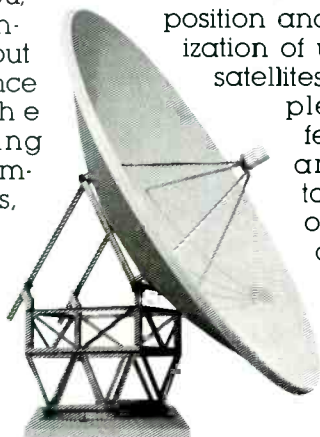

7-meter

Supervised installation and electronic alignment

When you buy a Microdyne



3.66-meter & motorized polar mount

loadings in excess of 125 mph.

antenna, we don't leave you with a box of parts and a bag

of bolts.

Our optional delivery pack—CH-14 conical horn antenna installation and electronic alignment to the satellite of your choice. So when the truck that brings your antenna leaves, you'll know the system works.

Call or write for more information

Let us show you how easy it is to save money by not buying what you don't need. Call our Sales Department at (904) 687-4633, or write to us. We'll send complete specs on our full line of fiberglass antennas for satellite communications.



5-meter & motorized polar mount



1.2-meter

Microdyne Corp. P.O. Box 7213, Ocala, FL 32672 • (904) 687-4633 TWX: 310-858-0307

Microdyne Corporation

Circle (74) on Reply Card

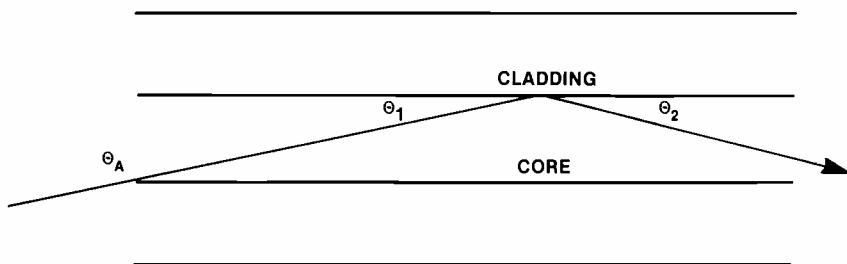

Figure 3. Snell's Law: $N_1 \sin \theta_2 = N_2 \sin \theta_1$, where N_1 = Refractive index of the core
 N_2 = Refractive index of the cladding
 θ_A = Acceptance angle.

bines with a hole. The photon radiation is incoherent, because it is random, so it is not necessarily in phase with the excitation current.

In FO transmitters, LED light sources have the greatest amplitude stability, and are less expensive than ILDs. However, LEDs emit a band of light approximately 24nm to 40nm wide, which can contribute to spectral dispersion. LEDs are relatively slow, with the fastest available rise times in the 3ns range. Most LEDs exhibit rise times between 10ns and 100ns. This can greatly limit the bandwidth of the modulating signal.

LEDs also emit light in many directions, which lowers their overall efficiency when coupling to a fiber. They provide a relatively linear relationship between input current and light output, which makes them suitable for transmission of analog signals of less than 50MHz bandwidth.

Injection laser diodes

ILDs are more expensive than LEDs, and ILD-based transmitters are usually about twice the price of LED transmitters. The ILD itself operates similar to an LED, and is made of the same InGaAs material, or of neodymium doped yttrium-aluminum-garnet (Nd:YAG). When operated below a particular threshold current, the ILD emits broadband light. When the bias is raised above the specified threshold, the light resonates in an optical cavity within the ILD. Because the light is trapped in an active region with mirrorlike walls, photons reflecting back and forth can persuade a free electron to recombine with a hole. The result is a new photon. Because the first photon has stimulated the emission of a second photon, gain

has occurred.

This area, called the *Fabry-Perot cavity*, is formed by cleaving opposite ends of a chip to create two highly polished surfaces. When lasing is achieved, light output is nearly coherent (in phase with the drive current), and its bandwidth is typically between 1nm and 6nm. As with any laser, light output is highly directional, which makes the ILD an ideal light source for single-mode step index fibers.

The InGaAsP ILD emits light in the 1,200nm to 1,600nm band depending on the phosphide doping, which is one of the most efficient frequency bands for many glass fibers. ILDs achieve rise times in the subnanosecond range, which renders the ILD transmitter most efficient when used for high-speed, long-distance fiber-optic transmission. In general, however, ILD devices degrade much more rapidly than LEDs.

LED transmitters generally are used for short-haul applications of less than 50MHz bandwidth, such as local area networks and in-plant TV signal runs.

Optical receivers

Once the light wave has traveled through a fiber, it must be received and detected. Light-wave receivers use photodetectors to convert photons of light into electrons.

As photons are absorbed by the depletion layer of the photodetector, they induce a photodiode current. Detection is accomplished by employing one of three basic types of semiconductors: photodiodes, positive-intrinsic-negative (PIN) diodes or avalanche photodiodes (APDs).

Phototransistors detect and amplify the light signal. Their sensitivity is good, but

their response time proportional to the frequency of the modulated information is rather slow because of a high-input capacitance. Because it is a transistor, it exhibits a relatively high gain, but the usable bandwidth is typically less than 150kHz.

The simplest photodiode is a p-n junction. A photodiode can be used in two modes: voltage or current. When operated in the voltage mode, incident light creates a voltage across the terminals. The voltage mode is slow, and not suited for FO circuits. In the current mode, a reverse-bias voltage is applied, and incident light creates current.

Photodiodes come in two basic types: depletion layer and avalanche. The depletion-layer diode is called a PIN diode because the p and n layers are heavily doped, and are separated by a lightly doped intrinsic material. The semiconductor region, which is doped with certain atomic metallic impurities that are added during the manufacturing process, enhances the operation of the PIN diode.

PIN diodes are lower in sensitivity than the phototransistor, and offer no gain. However, they respond relatively fast, with typical rise times in the low nanoseconds. PIN diodes are generally found in wideband FO receivers used in data systems.

Avalanche photodiodes cost about 10 times more than PINs to manufacture, and require about 10 times the operating voltage. In return, they offer approximately 10dB to 20dB gain, and a usable bandwidth approaching 3GHz.

APDs are sensitive to thermal changes and require special feedback circuits for stability. APDs operate as each photon in the impinging light wave causes internal multiple ionizations within the diode. A few photons may cause an *avalanche* of electron-hole pairs, giving APDs their high-gain characteristics. APD receivers are most commonly found in high-speed, long-distance, single-mode applications.

Choosing a photodetector receiver is an important stage in fiber-optic system design, because its bandwidth and sensitivity are often the determining factors in the limits of the total system.

The fiber connection

Transmitters, receivers and system passive devices such as couplers must be packaged for easy connection to the fiber cable. Most light sources and detectors are built within a small metal case and are preconnected to a short pigtail of fiber. The most common circuit level package is the standard TO transistor case, with a light-wave pigtail that may be PC-board mounted. Most commercially available components are sold with an attached pigtail, or built-on connectors.

The negative reputation sometimes associated with fiber-optic systems stems from the difficulty in making a good connection. Not so long ago, a microscope, a

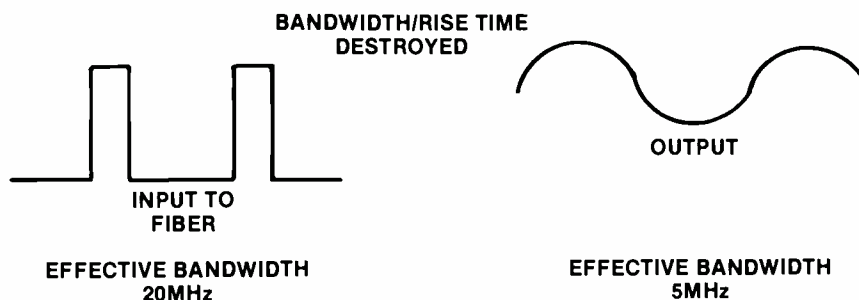
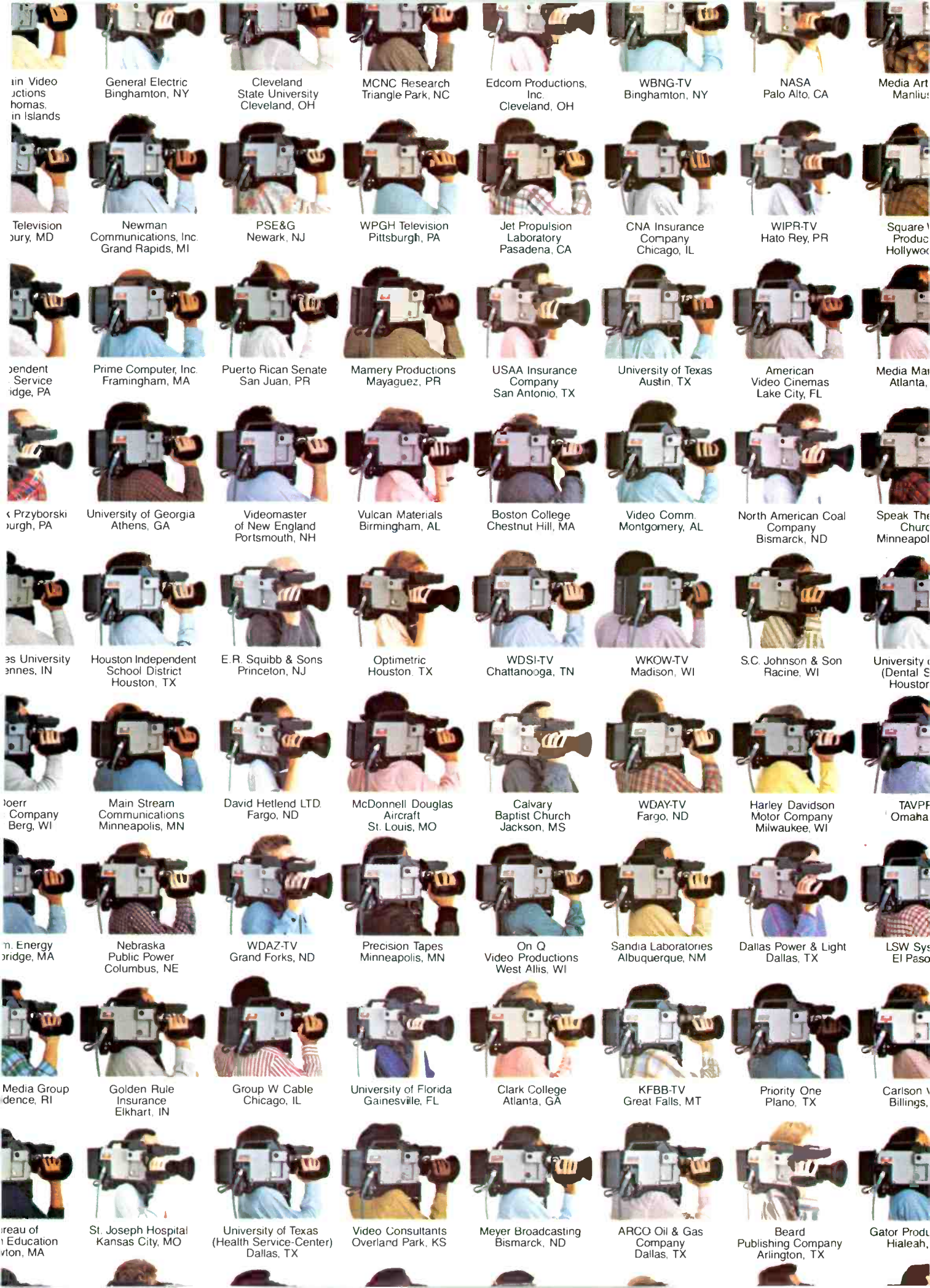

Figure 4. Effective bandwidth limitations created by modal dispersion.



in Video
ctions
omas,
in Islands

General Electric
Binghamton, NY

Cleveland
State University
Cleveland, OH

MCNC Research
Triangle Park, NC

Edcom Productions,
Inc.
Cleveland, OH

WBNG-TV
Binghamton, NY

NASA
Palo Alto, CA

Media Art
Manlius

Television
Bury, MD

Newman
Communications, Inc.
Grand Rapids, MI

PSE&G
Newark, NJ

WPGH Television
Pittsburgh, PA

Jet Propulsion
Laboratory
Pasadena, CA

CNA Insurance
Company
Chicago, IL

WIPR-TV
Hato Rey, PR

Square 1
Producs
Hollywo

pendent
Service
idge, PA

Prime Computer, Inc.
Frammingham, MA

Puerto Rican Senate
San Juan, PR

Mamery Productions
Mayaguez, PR

USAA Insurance
Company
San Antonio, TX

University of Texas
Austin, TX

American
Video Cinemas
Lake City, FL

Media Mar
Atlanta,

Przyborski
burgh, PA

University of Georgia
Athens, GA

Videomaster
of New England
Portsmouth, NH

Vulcan Materials
Birmingham, AL

Boston College
Chestnut Hill, MA

Video Comm.
Montgomery, AL

North American Coal
Company
Bismarck, ND

Speak The
Church
Minneapol

es University
annes, IN

Houston Independent
School District
Houston, TX

E.R. Squibb & Sons
Princeton, NJ

Optimetric
Houston, TX

WDSI-TV
Chattanooga, TN

WKOW-TV
Madison, WI

S.C. Johnson & Son
Racine, WI

University of
(Dental S
Houston

oerr
Company
Berg, WI

Main Stream
Communications
Minneapolis, MN

David Hettlend LTD.
Fargo, ND

McDonnell Douglas
Aircraft
St. Louis, MO

Calvary
Baptist Church
Jackson, MS

WDAY-TV
Fargo, ND

Harley Davidson
Motor Company
Milwaukee, WI

TAVPF
Omaha

n Energy
ridge, MA

Nebraska
Public Power
Columbus, NE

WDAZ-TV
Grand Forks, ND

Precision Tapes
Minneapolis, MN

On Q
Video Productions
West Allis, WI

Sandia Laboratories
Albuquerque, NM

Dallas Power & Light
Dallas, TX

LSW Sys
El Paso

Media Group
dence, RI

Golden Rule
Insurance
Elkhart, IN

Group W Cable
Chicago, IL

University of Florida
Gainesville, FL

Clark College
Atlanta, GA

KFBB-TV
Great Falls, MT

Priority One
Plano, TX

Carlson V
Billings,

ureau of
Education
vton, MA

St. Joseph Hospital
Kansas City, MO

University of Texas
(Health Service-Center)
Dallas, TX

Video Consultants
Overland Park, KS

Meyer Broadcasting
Bismarck, ND

ARCO Oil & Gas
Company
Dallas, TX

Beard
Publishing Company
Arlington, TX

Gator Produ
Hialeah,

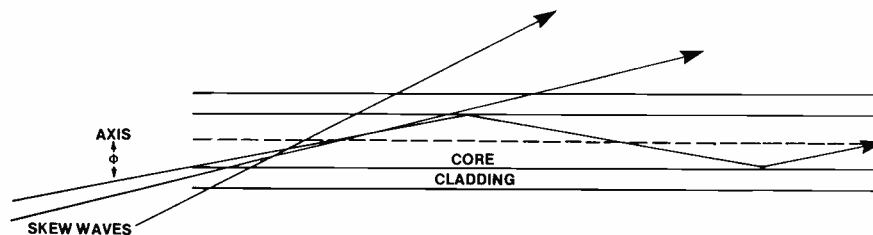

Figure 5. The acceptance angle of a fiber ($NA = \sin\theta$).

scalpel-sharp cutting tool, a fiber buffer and special heated cement were needed to make a simple connection. Today, many manufacturers have made quick connection easier by inventing simple-to-install, quick-mount connectors that exhibit low attenuation. Of course, the type of fiber and its NA are functions of the ease and speed of installing connectors.

In any FO connection, the cables must match as closely as possible so that the joint is transparent to the system. The junction of two cable ends must be as nearly perfect as possible so that new NAs will not be introduced by the splice or the connector. Launch NAs of 0.2 to 0.4 are often quoted in the specifications for quick-crimp connectors.

The variation in the core diameter of one batch of cable to the next is important, and it is specified as a percentage of signal loss that a possible mismatch will cause. This loss is usually from 0.5dB to 1dB. Any fiber connector has the potential to exhibit a throughput loss of 1dB to 4dB with the best field assembly, and many more decibels if not installed correctly. Each type of connector has its own positive and negative aspects.

The precision required for installation of connectors is also a function of the application. For example, short runs in a local area network with many nodes do not require the close tolerances of long-distance data fibers. Simple crimping may take from one to 10 minutes with a little practice; more sophisticated connections may require 15 to 30 minutes or more for each connection. Quick-crimp

connectors are rapidly becoming as popular in FO communications as they are in the world of coaxial cable.

An instrument that can make troubleshooting a fiber-optic system quite simple, compared with a wire system, is the optical time-domain reflectometer (OTDR). The OTDR displays attenuation losses and the distance to loss-producing incongruities in the fiber link. A typical OTDR looks like a general-purpose oscilloscope, and is easy to use.

Accessories

There are many fiber component accessories available today. In their absence a few years ago, however, the use of FO communications was limited to simple point-to-point links and basic local area networks. Items such as switchers, pads, multiplexers and couplers are now available from many sources.

Fiber switches are available in many configurations, including the most popular SP2T and SP3T. These switches employ a lens to collimate the incoming light (making the light waves parallel) so that it may be switched to any number of output fibers using a prism or mirror. They may be controlled mechanically by direct control, or remotely by electromagnets.

Pads (attenuators) are available in simple in-line, single-value configurations, or variable configurations that, again, may be controlled either locally or remotely. FO attenuators work using filters between the ends of two fibers, or by using physical spacing between the

ends of two fibers. The different on-axis refractive indexes will cause linear attenuation.

Multiplexers/demultiplexers combine or separate two or more light-wave signals according to wavelength. These devices are actually optical filters, and allow the transmission of signals on many discrete wavelengths. The process is called wavelength division multiplexing (WDM).

Optical couplers are 1-in, 2-out devices that can split the incoming light-wave signal at any factory preset ratio (such as 50:50, 30:70 or 10:90). Optical couplers are small passive devices that employ carefully prepared internal reflective surfaces to divide the input signal and are similar to cable TV splitters in their use.

The TV plant of the future

Although FO communications are beginning to make inroads into many broadcast facilities, full use of the capabilities of fiber optics inside a TV plant may be cost-prohibitive today. As the price of FO systems decreases as market demand increases, however, the idea of the fiber-optic-based TV plant is not beyond reality.

The TV plant interconnected with FO cable would consist of a few, small-diameter fiber multicables that carry all of the audio, video and control signals through the facility on a single fiber, in digital form. Each video recorder, camera, mixer and effects unit would require a single FO connection the size of a miniature audio plug to interconnect all signal and control data with all other equipment.

Off-bus systems such as multiple studios and remotes can be switched by a central computer or smart node controller that interfaces directly with the FO system.

Problems with grounding, RF and EMI shielding will disappear because fiber is non-conductive and immune to electrical and magnetic fields. Signal-to-noise ratios of -60dBmV can be realized.

Making preparations

If you are not yet experienced with FO communications, you may want to purchase an inexpensive experimenter kit, available from several manufacturers. These kits will allow you to try various connectors, diodes and couplers, and build simple circuits without obligating yourself to a complete system at this stage of the learning curve.

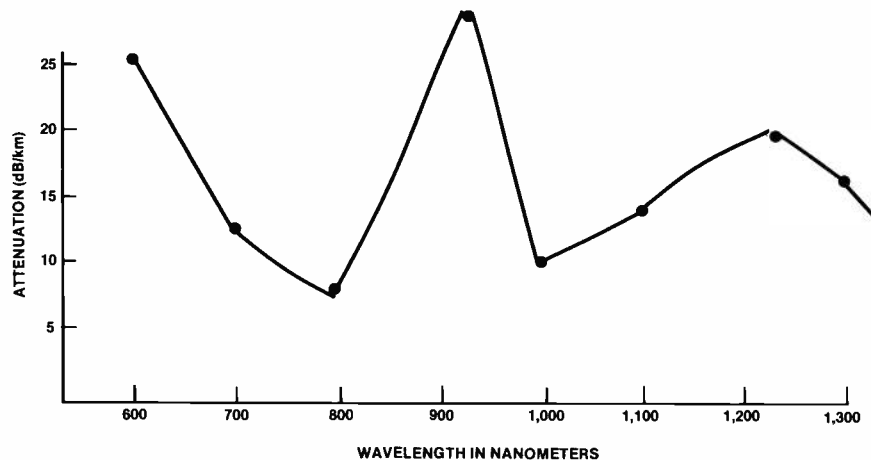

Figure 6. Typical attenuation curve of polymer-clad, glass fiber. Note the ideal operating windows at about 750nm to 850nm and 1,000nm upward.

Bibliography

- Belden Electronic Wire and Cable. "A Guide To Fiber Optics System Design." Richmond, IN, 1985.
 Grass Valley Group, "Fiber Optics in Broadband Communications: A Technical Overview." Grass Valley, CA, 1984.
 Lacy, Edward A. "Fiber Optics," pp. 12, 15, 28, 29, 30-33, 40, 41, 53. Adapted by permission of Prentice-Hall, Englewood Cliffs, NJ, 1982.
 Sterling, Donald. "Designers Guide to Fiber Optics." AMP, Harrisburg, PA, 1982.



University of Mexico Albuquerque, NM
 Laird Telemedia Salt Lake City, UT
 Coastal Video Productions Norfolk, VA
 Valcas Video Production, Inc. River Edge, NJ
 VideoAds Kennebunkport, ME
 Searle's Video News Service Richmond, MA
 Reliance Electric Visual Systems Eastlake, OH
 Rochester Institute of Technology Rochester, NY
 Lakeshore School District Miami, FL
 Harris Corporation Palm Bay, FL
 WXEL-TV Boynton Beach, FL
 Florida News Service Tallahassee, FL
 Tampa General Hospital Tampa, FL
 WTVT-TV Tampa, FL
 WINK-TV Ft. Myers, FL
 Paradise Video Miami, FL

PROCAM[®]

The choice of hundreds in high-end teleproduction.

High-end users are closing ranks solidly and fast behind PROCAMS as THE choice... for the industry's BEST performance and sheer overall value.

The KY-950B. The KY-320B. The PROCAMS. A crowning achievement even for JVC, long identified with ultra-reliable performance in compact, affordable, 3-tube cameras.

Plumbicon* tubes, of course, for high sensitivity, low lag, and minimized image retention, yet always with the highest possible resolution for each image format. They prevent the build-up of microphonic vibrations at high audio levels, too, and help maintain a high S/N ratio.

PROCAMS have Triaxial capability permitting extension to almost a full mile! And JVC's is the ONLY Triaxial System in its price range to offer chroma key.

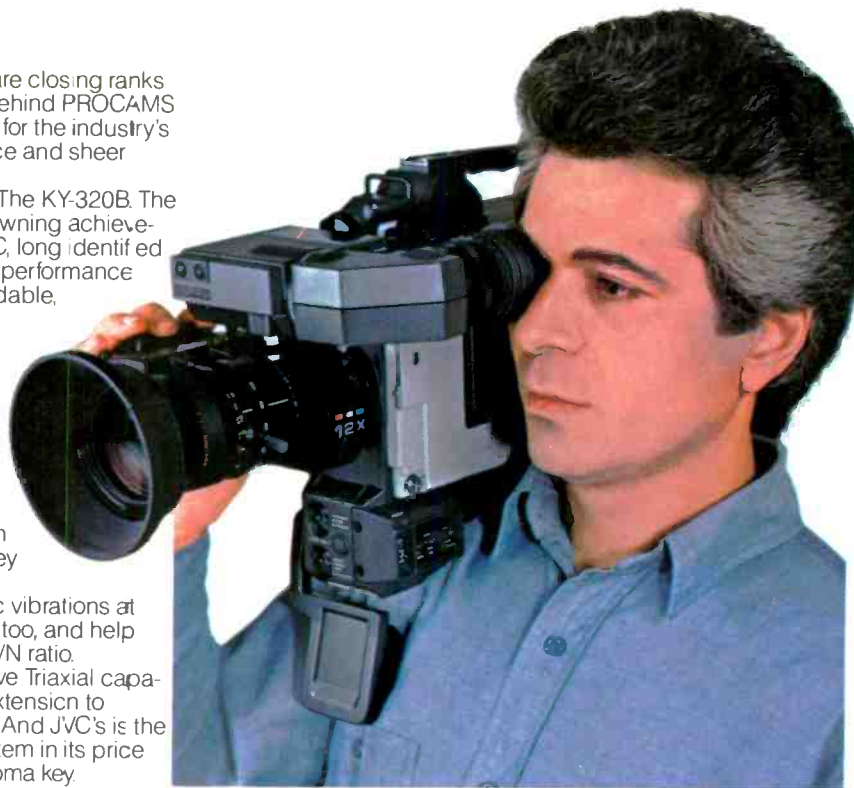

Component Video? Of course. JVC's KA-3 Component Adaptor makes you compatible with the increasingly popular M-II format as well as all other 1/2" component formats, and lets you record color signals in component form.

The PROCAMS. KY-950B. KY-320B. Penetrating dozens of new markets. Out-performing the competition in scores of imaginative applications in the hands of demanding professional users.

For a demo, call us toll-free for the name of your PROCAM Rep.

1-800-JVC-5825

JVC COMPANY OF AMERICA
 Professional Video Communications
 Division, 41 Slater Drive,
 Elmwood Park, NJ 07407
 JVC CANADA, Scarborough, Ontario

©1986 JVC COMPANY OF AMERICA



*Plumbicon is a registered trademark of North American Philips Corp.

Circle (76) on Reply Card



D-L Images Indianapolis, IN
 George A. Hornel Company Austin, MN
 Video Genesis, Inc. Beachwood, OH
 I Shoot Video Tulsa, OK
 KAIT-TV Jonesboro, AR
 Boeing Aircraft Company Wichita, KS
 Southwest Missouri State Springfield, MO
 Dyna-Mark Oklahoma City, OK
 United Telecom Inc. Shawnee Mission, KS
 Mitre Bedford, MA
 Syracuse Fire Department Syracuse, NY
 BF Goodrich Cleveland, OH
 WNSC-TV Rock Hill, SC
 Mark III Miami, FL

Distributing video via fiber optics

By DeWayne Gray

A shift in technology and regulation sent broadcast networks to space. This shift could take them underground.

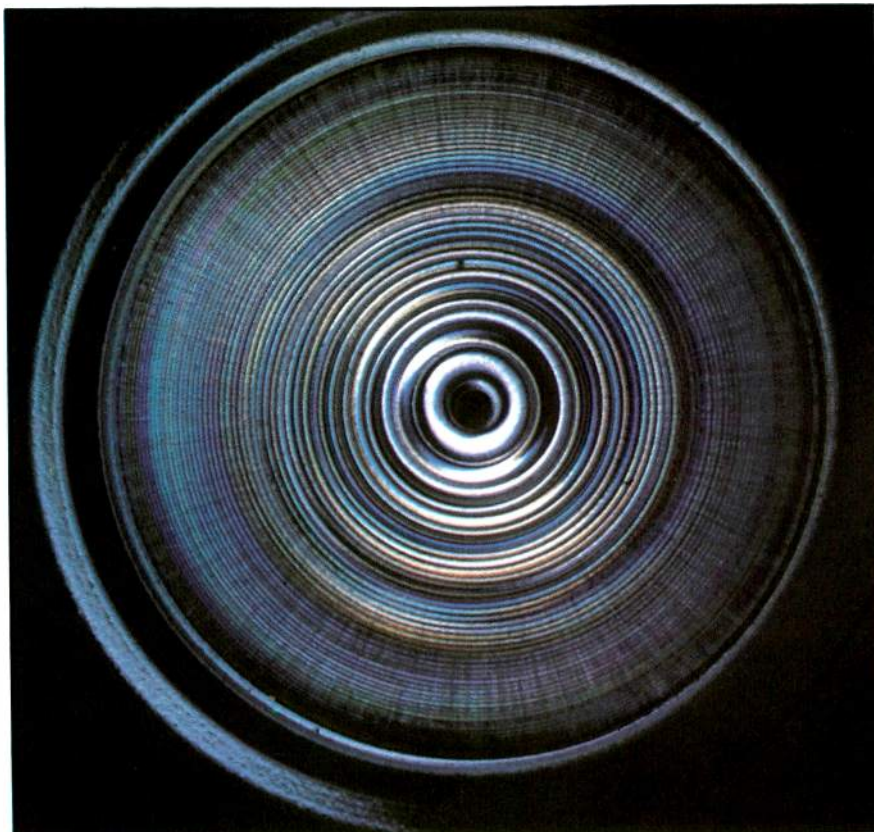

A photomicrograph showing layers in an optical fiber. Actual diameter is .005 of an inch.

The term *fiber optics* is the buzzword of the communications industry today. At broadcast stations, fiber optics has been accepted as a coming attraction, from the boardroom to the shop bench. Even at the consumer level, common carriers are advertising their fiber-optic systems, touting the benefits over other systems in use.

Meanwhile, back at the laboratory, design engineers have been drastically improving the bandwidth capabilities of fiber-optic receivers and transmitters. These improvements mean that fibers can carry substantially more information than originally anticipated.

During the past 24 months in the field there has been an enormous fiber-optic construction effort by the new telephone operating companies vying for business relinquished by AT&T divestiture.

These new common carriers predict that by the end of 1987 they will be providing coast-to-coast, high-capacity fiber-only networks. (See Figure 1.) These networks will reach approximately 95% of the population and should, in the not-too-distant future, have a significant impact on the distribution of network-quality video, and possibly, high-definition television. A major reason for this is the lower cost expected for fiber-optic network capacity, which is due to the rapid evolution of fiber-optic network technology.

It is predicted that there will be a glut of fiber capacity in the near future. Common carriers installed many more fibers than were required on speculation. They did not realize that the capacity per fiber would increase dramatically in a few years because of rapid advances in fiber-optic transmitter and receiver technology. This capacity glut, along with some of the advantages that fiber-optic (FO) networks have over existing distribution facilities, will enable the broadcast industry to take a serious look at changing from satellite-only distribution to a combination of fiber and satellite transmission that uses each capability to its full potential.

Why fiber optics?

The fact that FO networks have high capacity will not be reason enough for broadcasters to switch from the existing satellite systems to FO networks. There must be other economic and quality advantages before they will switch. Some of the advantages of a fiber network are:

- Ever-increasing bandwidth;
- Resistance to interference/tampering;
- Reliability;
- Transmission that is not affected by weather conditions;
- Redundancy based on networking and equipment;

Gray is vice president of operations for National Video Network, Plano, TX.

- Uniform performance over varying distances; and
- Lower noise level.

Some of the disadvantages are that:

- The total network is not presently in place;
- "Last mile" cost is potentially high;
- No TV broadcasting standards are set; and
- Video *codecs* (CODE DECode) are not field proven.

Currently, the vast majority of all video feeds are by satellite. Those not by satellite are being gradually replaced because of the point-to-multipoint economic advantage satellites have over line-of-sight microwave or coaxial cable. A satellite system works quite well for a network that distributes from one or two locations to many locations. Good examples of this point-to-multipoint transmission are the successful movie channels that serve the cable industry.

However, for a network that requires many live feeds (such as news and sports) from remote locations to a central location for processing and redistribution, a satellite communications system can be cumbersome and expensive. This is because of the limited number of transponders on any one satellite that can be used for video traffic. An example is the current requirement of Ku-band transponders between 5 and 6 p.m., when hundreds of TV broadcasters across the country try to cover live stories during their local news shows with only a few available transponders. These limitations can be overcome with a multipoint-to-multipoint FO network.

FO vs. current techniques

Although FO will never replace satellites for many applications, such as the use of mobile satellite news vehicles from remote locations, most of the current feeds from one city to another could be handled effectively by fiber. This is because it is possible to reuse the same channel several times in different parts of the country by "drop and insert" techniques. A news feed can originate in Houston and be received in Atlanta, where that station inserts a sporting event on the same channel and transmits to Chicago. Chicago can then insert a feed on the same channel to Pittsburgh and so on, as illustrated in Figure 2.

A broadcast network with four nationwide duplex channels could handle more than 30 feeds simultaneously from various locations to others throughout the country while still maintaining its primary program feeds to affiliates. This capability is not expected to cost much more than the major networks spend currently for this service.

Another advantage of FO distribution networks over satellites is that once a fiber network is in place, any affiliate receiving programming by fiber will also be capable of transmitting a feed to any

Exclusive, triple patented dynamic cap and coil analyzing . . . guaranteed to pinpoint your problem every time or your money back

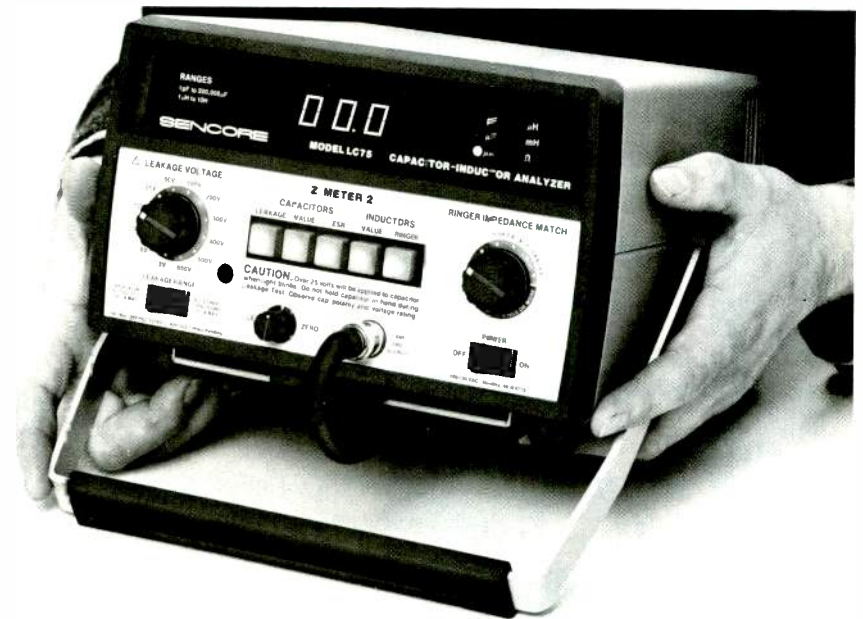

with the all new LC75 "Z METER 2"
Capacitor Inductor Analyzer
Patented \$995

The "Z METER" is the only LC tester that enables you to test all capacitors and coils dynamically — plus, it's now faster, more accurate, and checks Equivalent Series Resistance (ESR) plus small wire high resistance coils.

Eliminate expensive part substitution and time-consuming shotgunning with patented tests that give you results you can trust every time. Test capacitor value, leakage, dielectric absorption, and ESR dynamically; with up to 600 volts applied for guaranteed 100% reliable results — it's exclusive — it's triple patented.

Save time and money with the only 100% reliable, in- or out-of-circuit inductor tester available. Dynamically test inductors for value, shorts, and opens, automatically under "dynamic" circuit conditions.

Reduce costly parts inventory with patented tests you can trust. No more need to stock a large inventory of caps and coils. The "Z METER" eliminates time-consuming and expensive parts substituting with 100% reliable LC analyzing.

Turn chaos into cash by quickly locating transmission line distance to opens and shorts to within feet, in any transmission line or cable.

Test troublesome SCRs & TRIACs easily and automatically without investing in an expensive second tester. The patented "Z METER 2" even tests SCRs, TRIACs, and High-Voltage Diodes dynamically with up to 600 volts applied by adding the new SCR250 SCR and TRIAC Test Accessory for only \$148 or FREE OF CHARGE on Kick Off promotion.

To try the world's only Dynamic LC Tester for yourself, CALL TODAY, WATS Free, 1-800-843-3338, for a FREE 15 day Self Demo.



Call Today Wats Free 1-800-843-3338

SENCORE
3200 Sencore Drive
Sioux Falls, SD 57107
605-339-0100 In SD Only

*innovatively designed
with your time in mind.*

Circle (77) on Reply Card

QUIKSET



415 East St. Elmo Rd. • P.O. Box 3610 • Austin, Texas 78764 • 512-444-1961 • 800-531-5412 • TELEX 767119

ACOUSTIC SYSTEMS



MODULAR STUDIOS
for broadcast control,
production,
recording,
on-air

Circle (78) on Reply Card

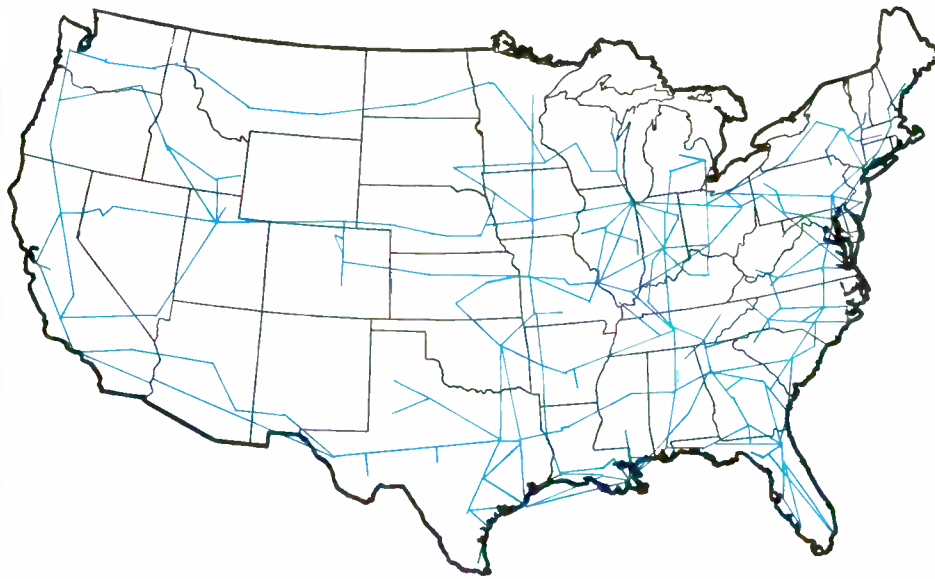

Figure 1. High-capacity fiber-only networks scheduled for completion by the end of 1987.

other affiliate. In essence, every affiliate will become an "uplink." Because FO networks will be duplex, an affiliate can transmit and receive simultaneously. This will enhance the quality of the regional networking news feeds that have recently been implemented, by ensuring that some of the smaller affiliates can feed to their regions if necessary.

It should be pointed out that some of

the smaller and more remote cities will not be served by fiber optics for several years. These cities will still be required to receive their network programming by satellite. For a network of 200 affiliates, it is estimated that 20 to 25 will not be served by fiber within three years.

Fiber-optic distribution

Long-distance FO transmissions are

NOW, ONE MICROPHONE CAPTURES IT ALL.



All components available separately.

The Sennheiser Telemike Electret Microphone System.

Its unique modular design provides all the flexibility and precision of a collection of separates—from omni to super cardioid, spot to shotgun, telescopic boom to tie-clip lavalier.

All, at a fraction of the price of comparable separates.

And all, with the most advanced electret technology available: our unique back-electret.

See your Sennheiser dealer for details. And capture it all.

SENNHEISER[®]
Sennheiser Electronic Corporation (N.Y.)
48 West 38th Street • New York, NY 10018 • (212) 944-9440
Manufacturing Plant: D-3002 Wedermark, West Germany

© 1982, Sennheiser Electronic Corporation (N.Y.)

Circle (79) on Reply Card

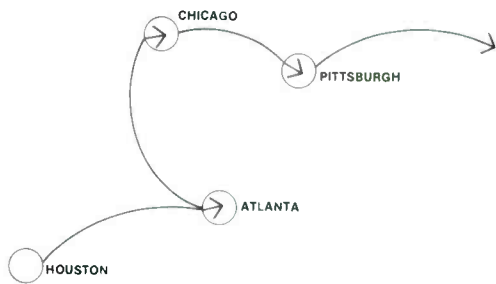

Figure 2. Drop-and-insert techniques may use the same fiber channel for multiple feeds.

digital and not as susceptible to noise and distortion as are analog systems. A digital video signal can be sent from the East Coast to the West Coast and back several times without degradation of the signal quality. In order to use a fiber system, the video signal must be converted from analog to digital. Pulse code modulation (PCM) converting techniques at a sampling rate of 10.7MHz are typically used.

Once the video and audio channels have been converted to a Bell standard DS-3 (44.736Mb/s), they may be transmitted over the fiber network to the affiliates. Redundancy will be provided by route diversity. This means that if a cable heading west is cut, an alternate path to the north or south would automatically be chosen and switched, as shown in Figure 3.

A nationwide FO network for video broadcasters will use state-of-the-art fiber equipment to interconnect broadcast operations centers to as many as 200-plus affiliate stations. It is expected that a minimum of 175 of the affiliate stations could be interconnected via FO by the end of 1988. The FO network will consist of five basic subsystems, including fiber cables, transmission equipment, TV codec, switching and control systems and "last mile" equipment.

The FO cable required for a long-distance network is single-mode step index. Fibers are paired to form a duplex channel. Each fiber is approximately as thick as a human hair. The single-mode fiber has a wide bandwidth capacity. Current in-place equipment can transmit at 560Mb/s over a single-mode fiber. Equipment available within the next year will double that rate to 1.2Gb/s. Lab experiments have been run at 20Gb/s over similar type of fiber. At 560Gb/s, a broadcast network could have as many as 24 duplex video channels.

The transmissions equipment consists of the terminal equipment and the regenerators. The terminals are located at the fiber point-of-presence (POP) in each city. The POP is usually located near the local telephone operating company switching center. Receiver terminals convert the digitized light signals from the fiber to electrical data. This data is demultiplexed into 135Mb/s circuits, and the 135Mb/s circuits are demultiplexed to 44.7Mb/s. This 44.7Mb/s

MCL

THE SOURCE

For GLOBAL/SPACE COMMUNICATIONS C-Band, Ku-Band HIGH POWER TWT AMPLIFIERS

This TWTA equipment series, truly the finest, of the state-of-the-art in engineering concepts is ideal for earth satellite communications. Units operate in C-Band (5.925-6.425 GHz) at 50-3000 watt power levels and Ku-Band (14.0-14.5 GHz) at 200-600 watt power levels, with many options for customized applications.

Units or system, meet or exceed varying ON-SITE/ON-AIR demands for maximum signal purity, efficiency and continuous reliability in transmitting diversified program material and/or complex communications data. Have self-sustaining performance capability under virtually all conditions — including those encountered in remote, unattended locations.

Resolve the most extreme conditions: interference (EMI-radiation/RFI-susceptibility), electrical (power source), mechanical stress; environmental-temperature/humidity, general maintenance and transportation.

Similarity in design simplifies manufacturing, maintenance and installation resulting in:

- Shorter manufacturing cycles.
- Efficient module inventory availability.
- Extensive, field-tested evaluation of major module performance life.

WRITE for your complimentary copy of Reference booklet #6006 TODAY.

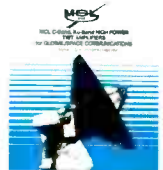

MCL, INC. Ten North Beach
La Grange, Illinois 60525
(312) 354-4350 TWX 910-683-1899

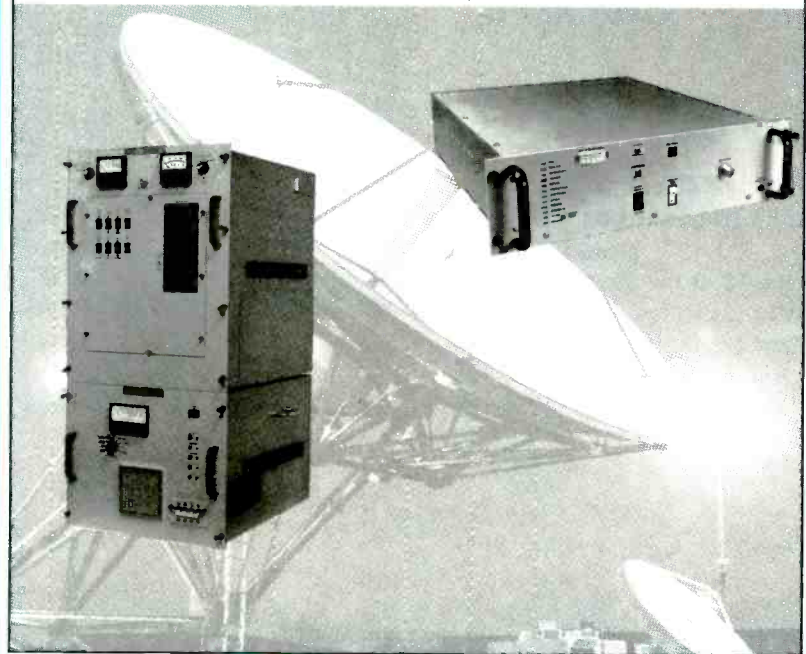

Circle (80) on Reply Card

signal will be sent either from the POP to the studio, as in PCM DS-3 form, or converted at the POP to an analog signal and then transmitted to the studio, as shown in Figure 4.

Regenerators are required every 30km to 40km along the fiber. These regenerators detect the digitized light signals and repeat the signal with a new pulsed beam of light. The most commonly used detector is the avalanche photodiode (APD). This detector provides high sensitivity and can detect wide bandwidths. Once the signal is received, it is converted to "electrical" PCM data. Next, the signal is amplified, and converted back to a pulsed light beam for transmission into the next fiber, as illustrated in Figure 5.

Fiber optics for broadcast

One of the most essential elements in the transmission path is the video codec. (See Figure 6.) The video codec converts the analog video to a digital 44.7Mb/s signal. At present, there are only a few manufacturers who meet the RS-250b specification. These video codecs digitize and compress the analog input using algorithms. Because all the manufacturers currently use different algorithms to convert the signal from analog to digital and back again, there is no compatibility among manufacturers. It is im-

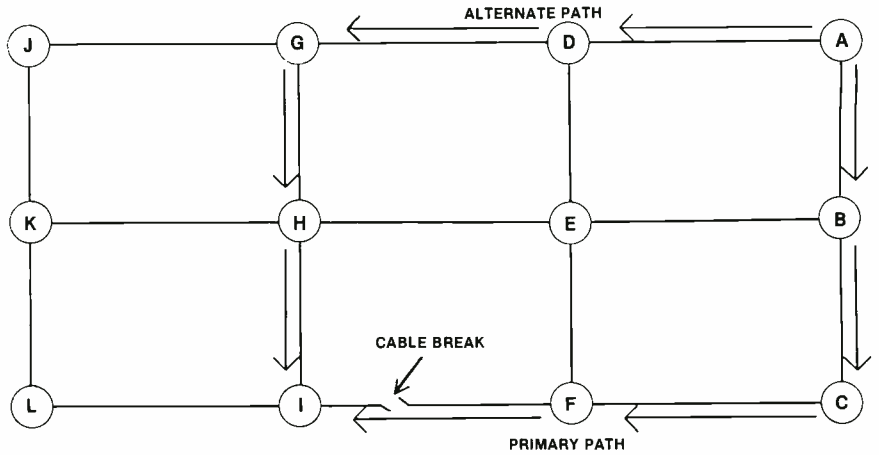

Figure 3. Route diversity provides for system redundancy.

portant for the broadcasting industry to push toward a standard so it will not be limited to a few vendors.

The control and monitoring of the fiber-optic network will be essential for a broadcasting company to get the maximum use of the available channel capacity. The fiber-optic transmission equipment was originally designed to work in the telco environment, in which switching paths and reporting faults are standard operating procedure. A master controller for the main distribution system of a video network is now being

developed. This network controller must be capable of handling feeds from the primary origination point to all the affiliates, all feeds back from the affiliates, and all feeds from one affiliate to another. With a properly designed controller and four fiber channels throughout the country, one network could distribute 40 video feeds simultaneously.

The last mile

The infamous last mile presents a major problem on the transmission path.

THE FINEST 16 INPUT COMPACT SWITCHER NOW OFFERS EVEN MORE

NOW OFFERING

Encoded Chroma Key
Pulse Regenerator with
Genlock
Wipe to Downstream Key
Pattern Limits
Wide or narrow drop
shadow widths on DSK

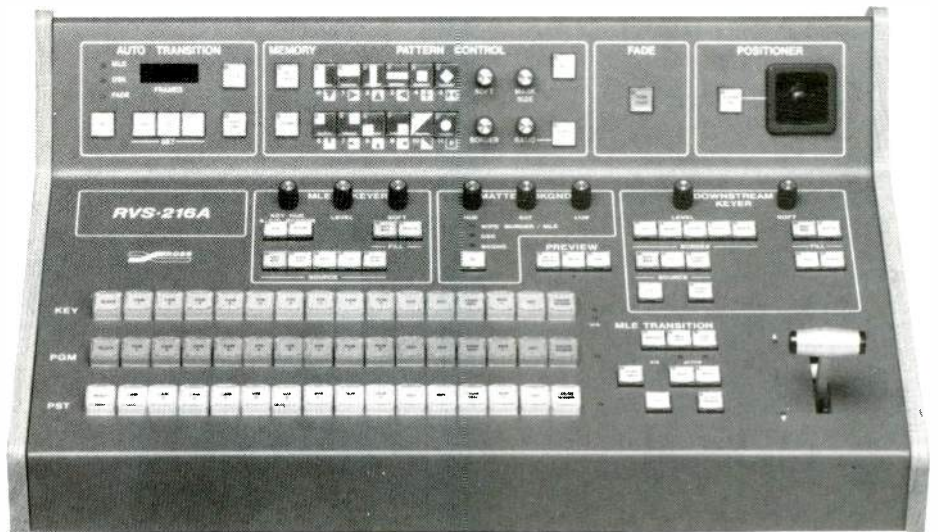

RVS 216A



Ross Video Limited, P.O. Box 220, 500 John St. Iroquois, Ont. Canada, KOE 1K0. Phone 613 652-4886 Telex 05-811579
Ross Video Inc. P.O. Box 880, Ogdensburg, N.Y. 13669-0880

Circle (81) on Reply Card

EEV KLYSTRONS

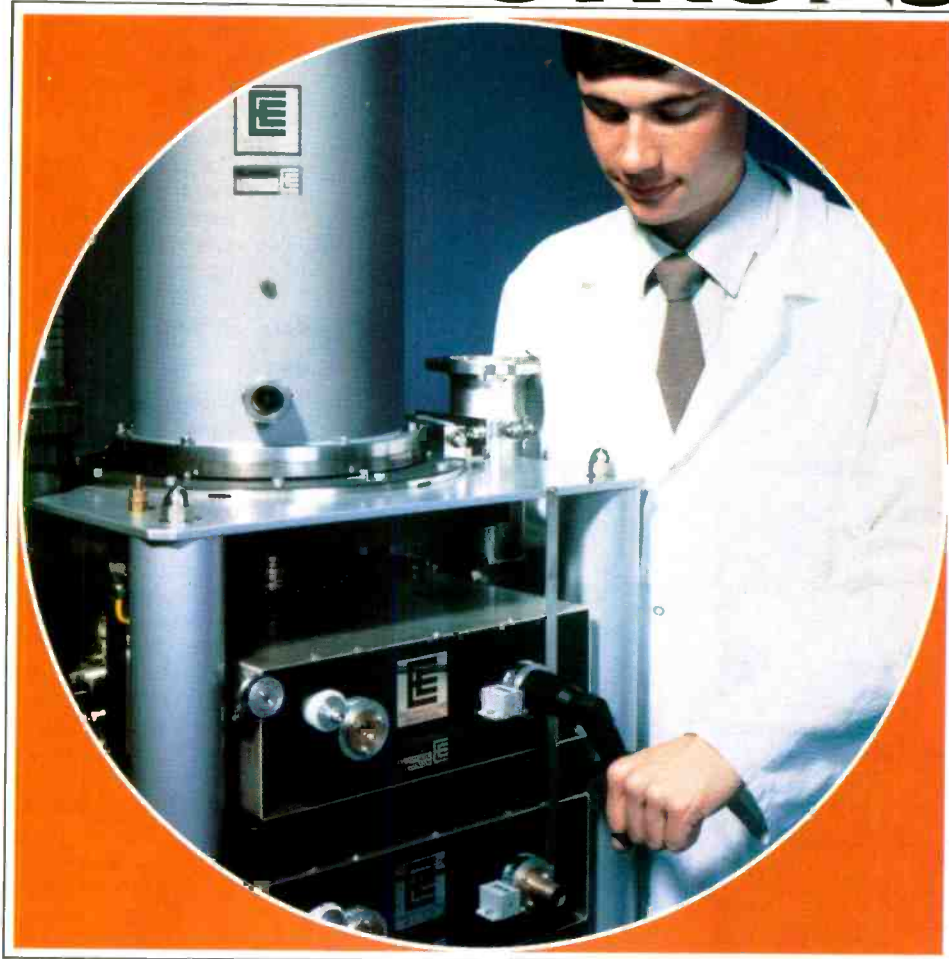

**have so much more to offer
at 60kW**

EEV Klystrons

*Dependable
EEV Technology*

**EEV klystrons and circuit assemblies
are continuously tunable
throughout their frequency range.**

The frequency setting of the cavity is uniquely identified by the numerical indication. Once the settings corresponding to vision and sound tuning on any channel are known the klystrons can be retuned within seconds. All tuning adjustments on the EEV klystrons can be carried out from the front of the circuit, enabling the transmitter to be tested on any channel without having to withdraw them from the cabinet.

*Get all the facts and figures on compact
high efficiency wideband klystrons from
10 to 60 kW by contacting us TODAY.*



USA:

EEV Inc, 7 Westchester Plaza, Elmsford,
NY 10523, USA
Telephone: 914 592 6050
Telex: 6818096 Fax: 914 592 8342

CANADA:

EEV Canada Ltd, 67 Westmore Drive, Rexdale,
Ontario M9V 3Y6
Telephone: 416 745 9494
Telex: 06 989363 Fax: 416 745 0618

UK:

EEV, Waterhouse Lane, Chelmsford,
Essex CM1 2QU, England
Telephone: (0245) 261777
Telex: 99103 Fax: (0245) 50424

Circle (152) on Reply Card

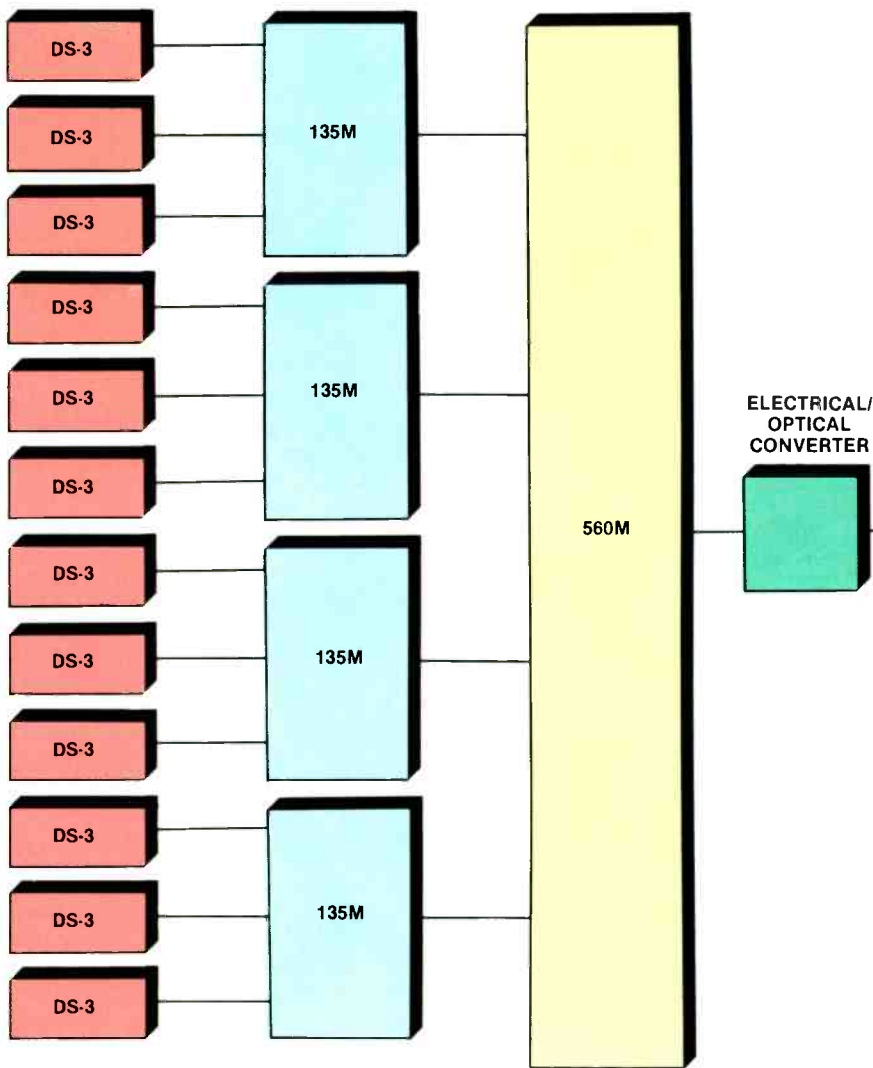

Figure 4. Block diagram of terminals located at the point-of-presence (POP) in each city.

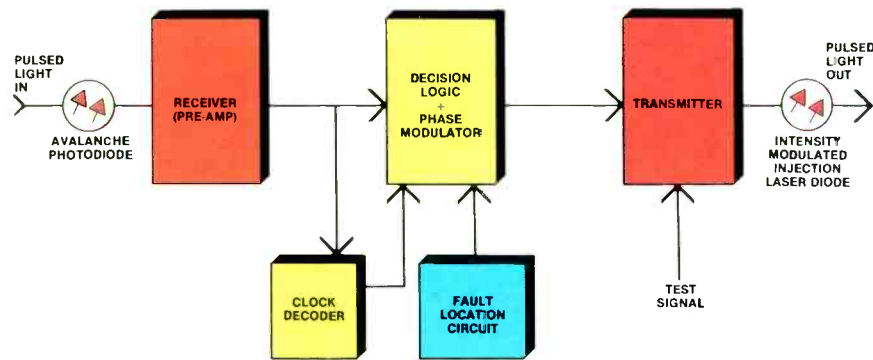

Figure 5. Functional diagram of a typical fiber-optic repeater.

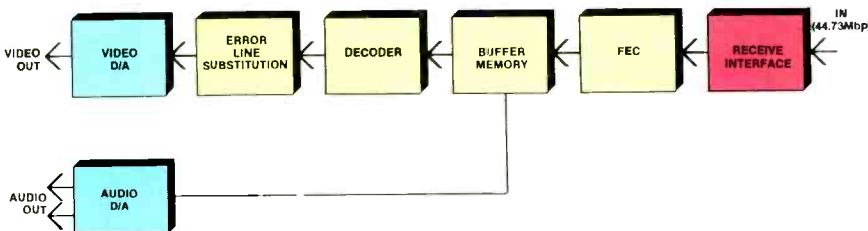

Figure 6. Block diagram of a typical video codec, used to convert TV signals from analog to digital, or digital to analog.

There is insufficient information available about the amount of fiber under the streets of the affiliate cities vs. the locations of the studios. If fiber is available to an affiliate's location it should be used, but if the fiber does not exist, an affiliate can be connected to the fiber network by microwave or coax. Present satellite transmission systems are faced with a similar problem, with some earth stations located in the suburbs and interconnected to the studio via line-of-sight microwave. Once a city has been wired for fiber, the affiliate can be economically linked by fiber.

Other FO benefits

When a fiber-optic network is in place, other benefits will be realized. With the available bandwidth, a network could handle all the headquarter-to-affiliate data and telecommunications traffic. This same system could also handle the communications between affiliates. FO technology may be used by the broadcasting industry for distribution in the near future. Once the industry has reviewed the requirements and techniques for TV transmission using FO, it may conclude that a fiber network is the optimum way of transmitting television on a nationwide basis. This postulate is based on the following criteria:

- Total network security;
- Favorable cost per channel;
- High system reliability;
- High video quality and performance;
- Expandability;
- Ease of maintenance; and
- High capacity.

Fiber optics and high-speed data transmission are technologies whose time has come. They have been tested for years by common carriers and are now a part of every major system. With the advent of integrated services digital network (ISDN), retaining wideband analog TV transmission will become more expensive and require that common carriers own specialized custom analog equipment that will cost the network user increasingly more. In the not-too-distant future, there may be no remaining analog transmission equipment.

The issue

One major issue is at stake here. Currently, the telecommunications industry sets the standards that are used in the transmission equipment and data rates over fiber. These standards are not necessarily optimum for the broadcasters. If, in the future, high-definition television becomes a reality, the 44.7Mb/s data rate will not be sufficient. The TV broadcasting industry must look at its unique requirements today, and in the future, and define those requirements early on. Otherwise, it will end up "fitting" its product to the transmission standards. [:-(-)]

Show replay

HDTV highlights 11th IBC

By John Battison, P.E.,
and Howard Head

For a record 14,000 conventioners, the 11th International Broadcasting Convention (IBC), in Brighton, England, dealt almost exclusively with the European approach to high-definition television, including the demonstration of Philips' experimental 1,250/50 system. Signal compression techniques are similar in concept to NHK MUSE. HDTV papers dealt almost entirely with European projects.

The convention has grown with each meeting, from the first meeting in 1967 to the present. The attendees viewed international products from nearly 200 companies (an increase of 50 compared with the 1984 event) in a vastly expanded exhibit space. The convention also celebrated the 50th anniversary of modern broadcasting and the 30th anniversary of videotape recording.

For Aleksandar Todorovic, this IBC will be long remembered. Todorovic, assistant general manager, JRT Televizija Beograd, Yugoslavia, was the second recipient of the IBC award. The award recognized his activity as head of the European standards committee on digital-tape recording in the 4:2:2 format.

HDTV

Technologically, HDTV garnered the greatest attention. The European HDTV proponents want improved imaging, but only with an orderly move from multiplexed-analog component transmissions (MAC) to an HD-MAC format. Compatibility of future signals with existing MAC and pre-MAC receivers is a requirement. A European timetable calls for an April 1987 preliminary, but working, MAC-compatible HDTV system.

A de-emphasis of 1,125/60 technology in the exhibits moved demonstrations of applications for other non-broadcast use to other venues. A better understanding of the defeat of the U.S.-backed system at the Dubrovnik CCIR meeting came from French and Japanese presentations, representing the opposition and pro camps, respectively.

Also, in the area of HDTV, the BBC exhibited DATV or digitally assisted TV. DATV is a motion-adaptive system using an analog signal augmented with a digital-control signal. The ratio of bandwidth compression varies with the



amount and direction of motion in the screen. Up to 4:1 compression is practical with a resulting halving of horizontal resolution. It also was noted that DATV also would be workable with sequential-scanned video cameras.

DBS

DBS continued to draw attention with MAC encoding for compatible and incompatible HDTV formats. Digital encoding of audio and data channels into packets for transmission with an analog FM visual signal received much of the attention. Australia has already instituted a DBS service based upon B-MAC to cover its large, thinly populated areas. DBS services for more densely populated countries are scheduled for implementation in Europe during 1987, but some concern was expressed about signal management. Papers presented proposed a management system to deal with MAC format flexibility and automatic MAC receiving equipment, as well as steerable space-segment antennas for improved control of the DBS footprint.

The U.S. and French satellite launching

setbacks have delayed some DBS activities, but research continues for TV and sound services. One suggestion given for consideration was a national sound service for Great Britain to operate at 500MHz. The system would provide wide area coverage, including automotive and portable/personal receivers. FM modulation would be practical, but possible digital methods were discussed. Satellite facilities for the low latitudes could include typical synchronous satellites, but coverage to higher latitudes might require a highly elliptical orbit, as used by the Russian Molniya. If such an implementation was made, three such satellites might be more suitable for continuous service.

DBS transmissions are especially important to areas of Australia. With a population of 13 million, much of the land area (roughly the size of the United States) is sparsely populated. With operations beginning in 1985, about 2,500 TVROs capture programming from HACBSS (The Homestead and Community Broadcasting Satellite Service), many of them in the outback. The B-MAC Australian System, its program relays and computer-control functions are carried on the AUSSAT 12GHz satellite. The initial service came through an IN-TELSAT 4GHz system, requiring a transfer of service. The problems and solutions of the switch between satellites presented interesting listening.

In the more geographically complex Western European arena, DBS services are scheduled to begin in 1987. Political-



Available for close inspection, satellite systems and OB production vehicles lined the quay in front of the Brighton Centre, Metropole and Grand Hotel convention facilities.

Battison is BE's consultant on antennas and radiation, and Head is BE's consultant on European broadcasting.

Classic beauty is unmistakable. You know it when you see it.

Like the beauty you get with Ampex 196. Clean, clear pictures that capture every sparkling moment of your production.

No other video tape delivers such consistent low-dropout performance. Or such dynamic picture quality.

By focusing on critical dropouts, especially in the area not compensated for by your VTR, we developed a video tape you can rely on for all your applications.

The secret behind our success is Ampex Process Management. APM is a unique manufacturing concept enabling us to control the consistency of the entire production process. From raw materials to finished products.

So you always get the cleanest, sharpest pictures time after time, reel after reel, carton after carton. That's why top professionals around the world specify Ampex 196.

If you'd like to know more about how APM contributes to beautiful pictures, call or write Ampex today for a free brochure.

B E



A U T Y

AMPEX

Circle (E2) on Reply Card

ly, however, there are still concerns about the unavoidable spilling of signals from one country into another. Disputes are lessening between most Western European nations at this time.

C-MAC, a 27MHz-wide signal at 12.7GHz, combines FM and PSK modulation. Although it is not suitable for CATV distribution, C-MAC holds promise for wideband TV signal distribution. New work with a modified D-MAC and more recently E-MAC systems have shown successful experimental applications for cable delivery on UHF and VHF frequencies with 12MHz and 14MHz bandwidths respectively. E-MAC offers increased resolution and a 5:3 image ratio.

Auxiliary services

Broadcast information systems—such as non-standard and non-broadcast communications services, the variations of teletext and radio data systems—have been available for about 10 years. Receivers, however, remain limited to about 4 million worldwide. Discussions of TV vertical interval and FM subcarrier systems suggested applications for standard frequency/time, switching and weather services in addition to other programming more universally desired by the public.

German broadcasters described a data service already operating on FM subcarriers, while the BBC explained the

Datacast system, an addressable data packet approach. Formatted for transmission of each packet at once, instead of with some delays typically found in teletext systems, the system can direct packets to individual subscribers. The security necessary for electronic funds transfer applications remains to be developed.

Transmission systems

Most conventions include discussions of reduced operating costs of transmitting equipment. For AM radio, dynamic carrier control (DCC) reduces the carrier level at higher modulation indices. One

path leads to an AGC amplifier before actual modulation. The second path provides dc rectification of the audio for a control signal to the AGC amplifier and to control the output carrier level. For a 50kW transmitter, costs savings have been estimated at about \$6,500 a year. The drawback to the method is a slight impairment to speech, but little other subjective audio quality degradation.

Shortwave stations are being converted to single-sideband (SSB) in a cost-cutting move. Most SSB systems use Class A final amplification. Conversions now in progress use compatible SSB. The modulation envelope is asymmetrical

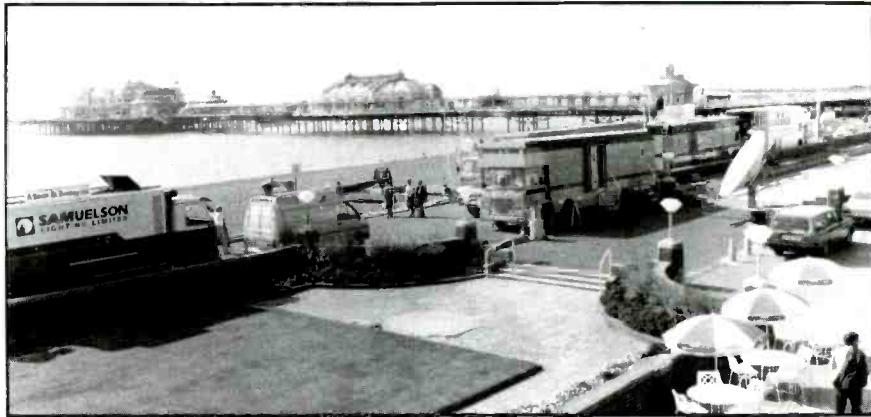

Satellite receivers and cameras located on the beach provided live feeds into the indoor convention area.

AT LAST! STEREO FIELD MIXING COMES OF AGE!



Until you try the new AT4462, you'll never fully realize what other mixers put you through, just to get a stereo signal on tape, on film, or on the air. Because simply adding pan pots or another output to a mono mixer is not enough for today's stereo.

Field Tested and Refined

We went to network and independent broadcast engineers, and leading film and A/V audio people to learn your problems and needs first-hand. And we returned again and again to test our solutions. These tough critics agree that the new AT4462 sets up far faster, provides better signal control, and results in better audio...even in the hands of inexperienced personnel.

**NEW AT4462
STEREO FIELD MIXER
WITH EXCLUSIVE
MODU-COMM™**

Introducing Modu-Comm™

The AT4462 is designed for the real world. For instance, let's assume you're doing a simple sports remote. You set up microphones for the sportscaster and the color announcer, plus a stereo mike for the ambient crowd noise. Normally you would also have to run a

with phase modulation of the carrier. By separating the two signals at low levels and maintaining them through the final amplifier, more efficient Class C modulation can be used. Linearity of both signals must be maintained through a decoupled audio modulation path.

FM broadcast has not achieved the popularity in Britain that it enjoys in the United States. From the technical standpoint, service availability differs little from the United States. With additional transmitters being installed and dual polarization increasing, almost 85% of car listeners rated the FM service as acceptable.

Windmills and television do mix, producing undesirable interference, according to reports from both Ohio and Britain. Wind-powered turbine generators located between TV transmitting and receiving sites have been pinpointed as sources of signal interference. In Britain, low-power translators are being considered as an alternative for better signals. Investigation of new windmill configurations also is under way.

Non-ionizing radiation has received much attention in the United States, but not in Saudi Arabia during the construction of a sports arena. The construction site was located next to two huge transmission plants: a 1.2MW medium-wave installation at 585kHz, with a 3dB gain directed toward the arena; and a

20MW short-wave station. When monitored, a medium-wave signal level of 4V/m was found at the site and RF burns were suffered by construction workers.

Careful attention to contact with metallic objects allowed construction to continue. Special shielding was designed into the structure to allow computer equipment to operate without undue effects from the radio energy. Careful bonding and isolation was necessary throughout the facility, rendering the final results satisfactory.

Although no report was given as to effects of the stadium complex and its metallic content on the radio patterns, you might wonder about the effects on people going to and from the stadium.

Digital tape recorders

IBC '86 marked the official European introduction of digital component and composite video recorders. Questions continued regarding the introduction of a composite system following so closely on the heels of the D1 standard. Composite proponents indicate that economics of implementation are more favorable than the component form. In addition, continued research has found problems in implementing the interface proposed for the digital VTR. Questions about the interface have been referred back to SMPTE and EBU for further con-

sideration and resolution. The questions hinge on what appear to be less complex methods of signal interfacing than stated in the standard documents.

Satellites

Improved performance of satellite-gathered news signals was reported by Independent Television News and Independent Broadcasting Authority through a newly developed threshold extension demodulator design. Operating with a small elliptical, transportable receiving antenna at the London Teleport, the demodulator provides video waveform redundancy through line and field storage. The antenna system was introduced several years ago and was one of the factors that made news relays via satellite more attractive to British users.

Next year

In 1987, the major European broadcast conference will be the 15th International Television Symposium and Technical Exhibition in Montreux, Switzerland. The general technical program is scheduled for June 11 to 17. Equipment will be on display from June 12 to 16.

Contact International Television Symposium and Technical Exhibition, P.O. Box 97, CH-1820 Montreux, Switzerland; telephone (+41) 21/633220 or 21/731212; telex 453 283 itvs. (:-?=:)))))

wired or wireless feed to the sportscaster for his cue phone.

But with the AT4462 and Modu-Comm, cue is fed through the announcer's mike cable already in place. Add a small accessory decoder to the end and plug both the cue phone and the microphone into the same cable. Cue can be program, an outside line, or "talk over" from the mixer. No extra wires, no crosstalk, and no change in audio quality! Nothing could be simpler or more efficient.

Now, No-Fuss Stereo

Actual stereo mixing is equally straightforward. The sportscaster and the color announcer in our example appear on separate pannable inputs so they can be centered as desired in the sound field. The stereo crowd pickup goes to a stereo input, with clutch-ganged controls for one-hand level control. And there's a second stereo input for another mike or line level source

(a second field mike perhaps, or for pre-show interviews on tape).

True Stereo Limiting Plus LEV-ALERT™

Adjustable limiters can operate in tandem, or individually as you prefer. And our Lev-Alert system can give you peak level audible tone warnings in your headphones when you can't watch the VU meters. Trust Lev-Alert to keep your standards high...even when it isn't easy!

Take A Close Look

When you examine the new AT4462



audio-technica®

1221 Commerce Drive, Stow, OH 44224 • (216) 686-2600

you'll see a host of other features to help you do your job: Cue on every channel...Separate headphone amplifier...Phantom power for all types of mikes...Three-frequency tone oscillators...Slate mike...Supplied carrying strap and protective case...Powered either by internal 9-volt batteries or any external 12-18 VDC supply, any polarity.

A New Era in Stereo Begins

We've made the new AT4462 a working tool that helps you and your staff take full advantage of the production values stereo has to offer. And a hands-on test will quickly prove it. To learn how the AT4462 can help you create better audio every day, call or write us now.

True 600Ω Stereo/Mono Outputs Mic/Line Level Out Mic/Line Switch on All Inputs 20 dB Pad on All Inputs MODU-COMM™ Line Level Adjust Limiter Level Adjust External 12-18VDC Either Polarity Cue on Each Input Two Mono Inputs with Pan Controls Slate Mic with Frequency-Selectable Tone

Phantom 12V Power for All Inputs All Inputs and Outputs Transformer-Coupled Flat/Lo Cut Filter on All Inputs 9V Internal Batteries (3) Strap Bracket Protects Face Headphone Outputs (2) MODU-COMM™ External Mic/Line Inputs Bus In/Out Two Stereo Inputs with Dual-Clutch Controls LEV-ALERT™ for Audible or Visual Peak Level or Limiting Warning Stereo Limiter Switchable to Dual Mono MODU-COMM™ Full Duplex Communication over Existing Mic Lines

Circle (83) on Reply Card

Shure Brothers FP16 audio DA

By Gerry Kaufhold II



At 6 p.m. on Nov. 2, 1920, KDKA radio signed on in Pittsburgh by broadcasting the presidential election returns. The presidential election was between Warren G. Harding and James M. Cox, two Ohioans. Within months after this historic event, radio stations were springing up all over America. The new stations brought music, news and sports information to an eagerly awaiting public. It seemed that everyone wanted to hear the magic of broadcasting.

In the early stations' search for broadcast material, remote broadcasts were tried. The first radio-remote broadcast took place on KDKA with a broadcast from Pittsburgh's Calvary Episcopal Church. The engineers on that remote dressed in choir robes and operated primitive microphone amplifiers while sitting among the choir. You can just imagine how exciting that must have

been for those engineers. Remote broadcasting today remains an exciting and fast-paced event. In most cases, it also is good programming.

Typical remote broadcasts include

Performance at a glance

- 0.4% THD, 30Hz - 20kHz at +15dBm
- Frequency response, 30Hz - 20kHz, ± 2 dB
- Transformer-coupled microphone or line input levels
- Six transformer-coupled microphone or line-level outputs
- Front-panel overload and normal indicator LEDs
- 90dB of gain available
- +15dBm of output available
- Link-in/out jacks for daisy-chaining or external equipment
- Individually controlled channels

church services, sports events and election coverage. Church events tend to be regularly scheduled, so the equipment is usually permanently installed at the remote location. Sports events and election coverage are mobile and the broadcast equipment is installed for that broadcast and then removed for other use.

One device that is becoming popular for remote work is a distribution amplifier. Today, it is often necessary to cover a press conference where several broadcasters or news people require an audio feed. Previously each person would set up a microphone, thereby creating an unsightly mess in front of the speaker. However, with a small, easy-to-carry, battery-powered DA, it becomes much easier to provide high-quality audio with a minimum of fuss.

Portable DA

Shure Brothers has developed a new line of audio distribution products that can help solve the problems encountered with remote broadcasts. One of these products is the FP16 audio distribution amplifier. It is small, about the size of a hardbound collegiate dictionary and weighs just over six pounds. The DA will operate from 120Vac or 240Vac. It meets both the Underwriters Laboratories and the Canadian Standards Association electrical standards. The DA also will operate from three 9V batteries.

The DA is built from medium-gauge aluminum. The top cover overhangs the switches and connectors, providing protection in the often-abusive world of field production. Individual level controls are recessed inside the front cover. They can be reached only with a tweaking tool, preventing accidental maladjustment.

The line cord is attached with a strain-relief so it cannot be removed. Some engineers may find this an inconvenience for portable operation. But, as anyone who has worked with novices will tell you, a cord that can be removed also can be left at the station. In any case, if you really want to remove the cord, it's not that complicated to do so.

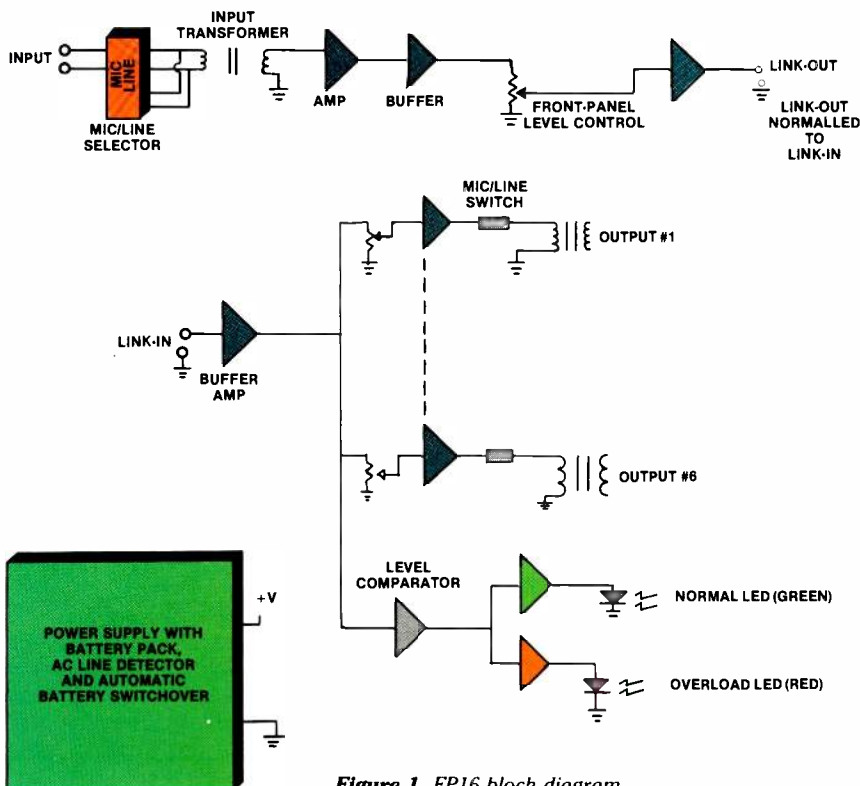

Figure 1. FP16 block diagram.

Kaufhold is an engineer at KAET-TV, Tempe, AZ.

EXCELLENCE IN THE AMERICAN TRADITION

Ikegami

GRAY

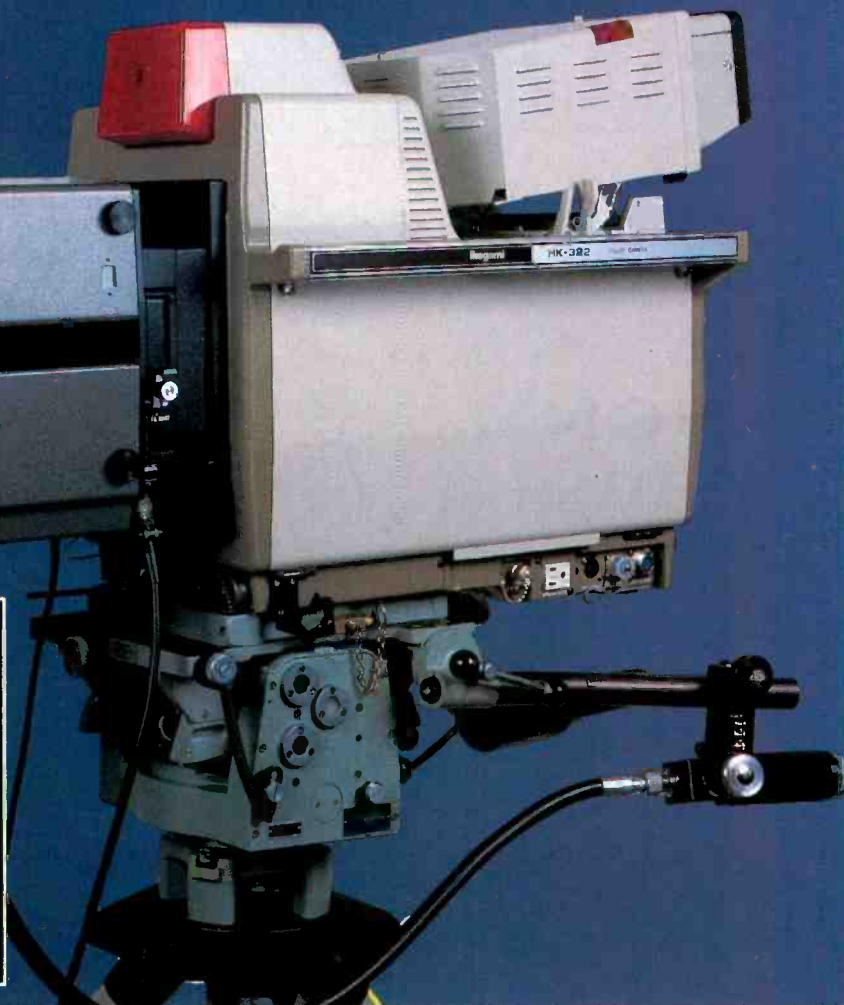

American business tradition is characterized by unsurpassed excellence in service, reliability and quality. True to this tradition, Gray does it the old-fashioned American way—we do it right the first time!

Teamed with quality cameras from Ikegami, Gray offers the finest equipment and over a decade of video engineering expertise. Call your local Gray office for excellence in service, reliability and quality.

ALBANY, GA (912) 883-2121
ATLANTA, GA (404) 956-7725
BATON ROUGE, LA (504) 928-1171
BIRMINGHAM, AL (205) 942-2824
CINCINNATI, OH (513) 896-1011

FT. WALTON BEACH, FL (904) 651-8546
FT. LAUDERDALE, FL (305) 523-3637
GAINESVILLE, FL (904) 332-2436
HUNTSVILLE, AL (205) 881-5840
KNOXVILLE, TN (615) 588-7161

N. LITTLE ROCK, AR (501) 758-3234
MEMPHIS, TN (901) 525-1135
MIAMI, FL (305) 591-3637
MOBILE, AL (205) 476-2051
NASHVILLE, TN (615) 883-9175

NEW ORLEANS, LA (504) 733-7265
(504) 733-7290
ORLANDO, FL (305) 896-7414
ST. PETERSBURG, FL (813) 823-6840
TAMPA, FL (813) 885-1411

GRAY COMMUNICATIONS

C O N S U L T A N T S · I N C

404 SANDS DR. ALBANY, GA 31705 (912) 883-2121 TWX # 810-781-5110

Circle (85) on Reply Card

December 1986 *Broadcast Engineering* 123

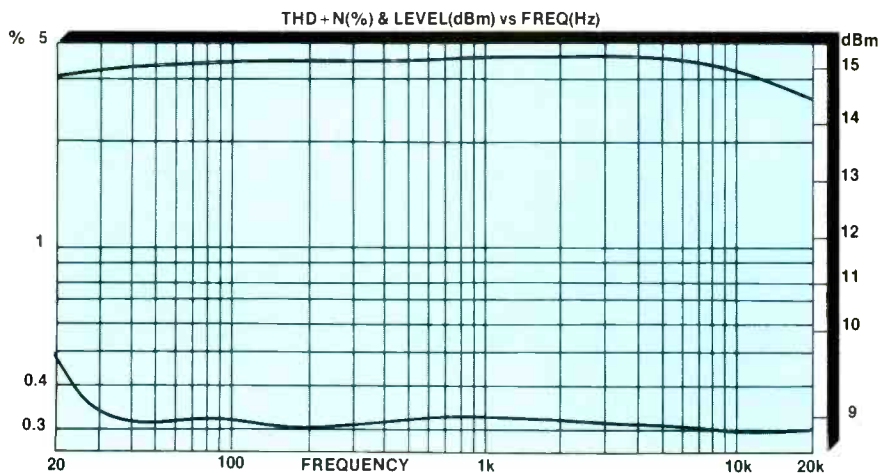

Figure 2. Microphone input frequency response (top curve). The lower curve shows the THD through the microphone input with 90dB of gain.

Features

The battery compartment is accessible from the bottom of the unit. Two spring-loaded fasteners can be removed with the edge of a dime or other similar device. Batteries can be replaced without a screwdriver, which is helpful to non-technical operators. The battery container is not keyed, so some care must be taken when inserting the 9V batteries to assure correct polarity. This might be a problem when working in a dark space or if you're in a big hurry. There is no compartment for spare batteries, so you'll have to store them elsewhere.

The input and six outputs use XLR-type connectors. The link-in and link-out connectors are 1/4-inch, single-circuit jacks. Both connectors are RFI protected with chokes and capacitors.

Electrical construction

The DA's electrical layout is clean, neat and well organized. The ac power supply and battery compartment are located on the unit's far right side. A vertical metal plate, welded inside the chassis, physically separates and electrically isolates the power supply from the audio section. The plate also provides extra ruggedness to the DA's chassis.

A green LED mounted above the on/off switch indicates when the power is on. If the batteries are installed, the power supply automatically switches to the batteries whenever ac is removed. This feature provides an innovative back-up to keep the DA on the air even if the ac goes down. However, the on/off switch must be turned off when the DA is not in use. Without ac power, the unit will drain the batteries in about 20 hours.

The main printed circuit board routes the incoming signal through a well-shielded transformer. The signal is amplified by a specially selected, low-noise op-amp. The audio is then passed through the front-panel input gain control to the link-out jack. This signal is normally to the buffer amplifier through the link-in jack if no external equipment is connected. The link-out jack is unbalanced and designed to feed either another DA (for daisy-chaining units) or to feed some off-board audio processing

SONY® 5000 Series

Model APR-5002
1/4 inch - 2 track

If you are budgeting for MTR or Studer then the all new Sony is a must consideration the latest technology, a better product and it costs less.

Ask your BSW representative for details,
1-800-426-8434.



The Ultimate
Audio Recorder



BROADCAST • SUPPLY • WEST
7012 - 27th Street West • Tacoma, Washington 98466 • 1-800-426-8434

Circle (86) on Reply Card

The digital effects.

COMPRESSOR RELEASE = 525ms	PARAMETRIC EQ. MID FRQ = 500 Hz	AUTO PAN DIRECTION= L↔R
TRIGGERED PAN PANNING = 525ms	FREEZE A REC MODE= AUTO	FREEZE B OVER DUB
PITCH CHANGE A BASE KEY = C 3	PITCH CHANGE B 1 FINE = + 8	PITCH CHANGE C L DLY = 0.1ms
PITCH CHANGE D F.B. GAIN= 10 %	ADR-NOISE GATE TRG. MSK= 5ms	SYMPHONIC MOD. DEPTH= 50 %
STEREO PHASING MOD. DLY= 3.0ms	CHORUS A DM DEPTH= 50 %	CHORUS B AM DEPTH= 10 %
REV 1 HALL REV TIME= 2.6s	REV 2 ROOM DELAY = 20.0ms	REV 3 VOCAL LPF = 8.0 kHz
REV 4 PLATE HIGH = 0.7	EARLY REF. 1 TYPE = RANDOM	EARLY REF. 2 ROOM SIZE = 2.0
STEREO FLANGE A MOD. DEPTH= 50 %	STEREO FLANGE B MOD. FRQ= 0.5 Hz	STEREO ECHO Rch F.B = +58 %
DELAY L,R Lch DLY = 100.0ms	TREMOLO MOD. FRQ= 6.0 Hz	DELAY VIBRATO VIB RISE= 1400ms
GATE REVERB LIVENESS = 5	REVERSE GATE TYPE = REVERSE	REVERB & GATE TRG. LEVEL= 65

Without the expensive side effect.

If you want highly cost-effective, extremely versatile digital sound processing, you may not need anything more than the new SPX90 Digital Multi-Effect Processor. Or want anything less.

Built into its rack-mountable chassis are 30 preset effects specifically designed to suit a wide range of studio and live performance applications.

All the preset effects have up to nine user-programmable parameters. So you can further individualize them for your particular need and store them in any of the 60 on-board RAMs for instant recall using the front panel keys, optional remote control or footswitch.

The SPX90 offers MIDI-compatibility including the ability to make program changes during live performance via MIDI. Some effects can even be actuated

\$745.

* by a change in input level during performance.

So whether you're a studio or sound reinforcement engineer, keyboard player, guitar player,

bass player, even home recording enthusiast, the SPX90 can add incredible creativity to your music. At a very credible price.

See your Yamaha Professional Products dealer. Or write: Yamaha International Corporation, Professional Products Division, P.O. Box 6600, Buena Park, CA 90622. In Canada: Yamaha Canada Music Ltd., 135 Milner Avenue, Scarborough, Ont. M1S 3R1.
*Suggested U.S.A. retail price. In Canada, \$1095 CDM.



Circle (87) on Reply Card

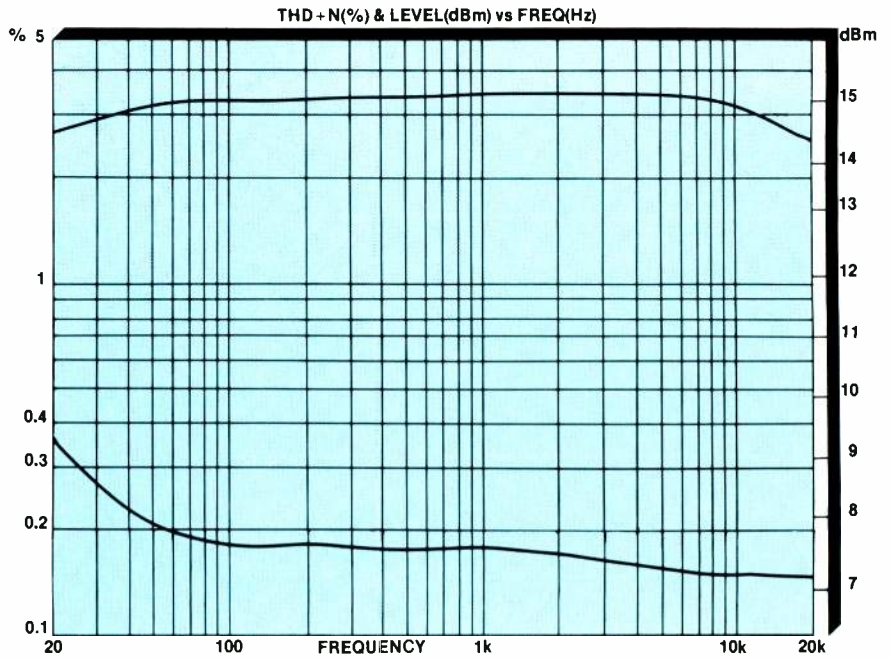

Figure 3. Line input frequency response (top curve). The lower curve shows the THD through the line input with 40dB of gain.

circuitry such as an equalizer or compressor/limiter. The link-in also is unbalanced, and feeds the buffer amplifier.

The buffered audio is fed to six independently controlled output buffer circuits and then transformer-coupled to the back-panel output connectors. A seventh buffer circuit drives the front-panel LED normal and overload condi-

tion indicators.

The outputs are transformer-coupled and balanced. Each circuit is RFI protected by inductor and capacitor circuits. As is common with other remote equipment, the inputs and outputs can be set

for either microphone or line levels through back-panel switches. Switch-selected 27V phantom power also is available from the input jack.

Input impedance for microphone-level signals is 150Ω and balanced. In the line-



space-saving tape or film MOVABLE STORAGE SYSTEMS



• HIGH CAPACITY SYSTEM



• SUPER DENSITY SYSTEM



• PULL-OUT SYSTEM

Organized, efficient storage for all types of film and videotape. Sliding cabinets move effortlessly on low-profile tracks for easy access and maximum storage capacity in limited space. Available in a variety of designs and sizes, with 5" to 36" depths, to suit your special storage needs. All steel construction.

800-447-2257

THE WINSTED CORPORATION
 *** GSA APPROVED ***
 9801 James Circle • Minneapolis, MN 55431
TELEX: 510-601-0887
 Circle (88) on Reply Card

For Free Full-color FULL LINE CATALOG
Write or call toll-free

STOP GROUND-LOOP HUM!

VIDEO HUM STOP COIL...HSC 1

Will ELIMINATE HUM and other INTERFERENCE in Video Lines caused by differences in Ground Potential.

- For Color and Black and White.
- FLAT-DC to 6.5 MHz.
- No Low-Freq or Hi-Freq. Roll-off.
- No Differential Phase Distortion.
- No Differential Gain Distortion.
- No Envelope Delay.
- Passive Device - Failure Free-Low Price.
- Small Compact Package 4" x 4" x 2-1/4".

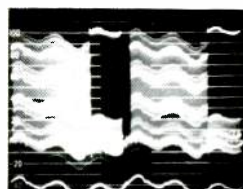

NEW!

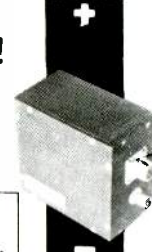

**\$190
F.O.B.
N.Y.**

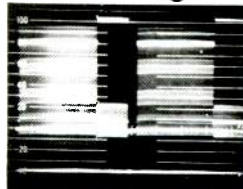

ELIMINATES HUM AND INTERFERENCE:

IN STUDIO

- Between Buildings
- On long runs in Buildings
- Between Studio and Transmitter
- On Incoming Telco circuits
- On Outgoing Telco circuits

IN FIELD

- Betw. Remote Truck and Telco
- Betw. Remote Truck and Microwave
- For Intertruck Hookup
- For VTR Units
- For Monitoring Lines

Available on
10 day free trial

AUDIO-VIDEO ENGINEERING COMPANY
 65 Nancy Blvd., Merrick, N.Y. 11566
 Tel. (516) 546-4239

Circle (89) on Reply Card

EIMAC Tubes Provide Superior Reliability at radio station KWAY — over 112,000 hours of service!



KWAY

MONTEREY, CALIFORNIA

Ken Warren, Chief Engineer at KWAY reports that their 10 kW FM transmitter went on the air in November, 1972, equipped with EIMAC power tubes. The original tubes are still in operation after over 13 years of continuous duty!

Ken says, "In spite of terrible power line regulation, we've had no problems with EIMAC tubes. In fact, in the last two years, our standby transmitter has operated less than two hours!"

Transmitter downtime means less revenue. EIMAC tube reliability gives you *more* of what you need and *less* of what you don't want. More operating time and less downtime!

EIMAC backs their proven tube

reliability with the longest and best warranty program in the business. Up to 10,000 hours for selected types.



Quality is a top priority at EIMAC, where our 50-year charter is to produce long-life products.

Send for our free Extended Warranty Brochure which covers this program in detail.

Write to:

Varian EIMAC
301 Industrial Way
San Carlos, CA 94070
Telephone: (415) 592-1221



varian

SMPTE(%) vs MEASURED LEVEL(dBm)

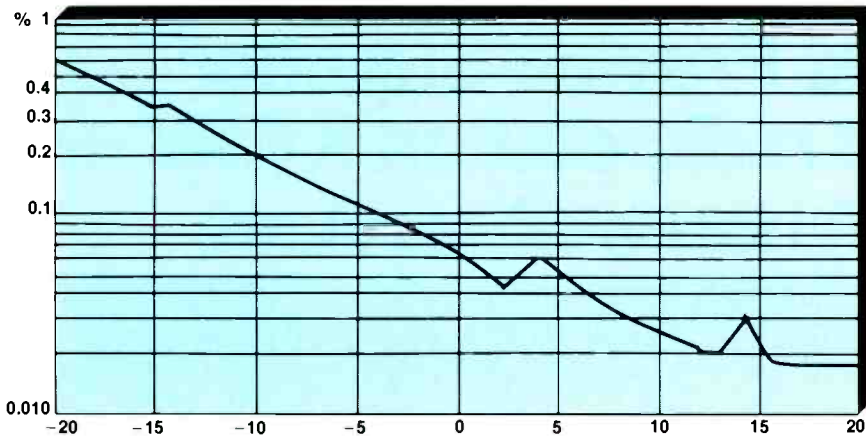

Figure 4. IMD distortion measured from -20dBm - +20dBm. The output shows less than 0.5% IMD for levels above -17dBm.

level mode, the input is balanced bridging. The output impedance is 150Ω for microphone levels and 600Ω for line levels. The DA can be used for either balanced or unbalanced audio, providing the proper conventions are observed with regard to wiring and grounding.

Performance

The microphone-level gain is rated at 90dB. When tested, the maximum gain was measured to be 93dB. This means 3dB of headroom. The frequency response and distortion for a typical out-

put channel is shown in Figure 2. The unit's specifications list the maximum distortion as 0.4% across a 30Hz-20kHz frequency range. However, the unit performed better than required by its specifications.

In one test, the input level was -75dB and the output was set for +15dBm. The frequency was swept from 20Hz-20kHz. The measured distortion did not exceed 0.4% across this range. The intermodulation distortion through the microphone channel is specified to be less than 0.5%. My tests found the IMD, in the

microphone mode, to be 0.335%.

Figure 3 presents the frequency response and distortion curves for a typical line-level configuration. The input was driven at -25dBm and the output was set for +15dBm. Once again the DA performed better than its published specification of 0.4% THD.

IMD for the line-level setup was measured with input levels ranging from -60dBm through -20dBm, with the output adjusted for 40dB gain. The graph of IMD for the line-level (-20dBm-+20dBm) setup is shown in Figure 4.

Finally, the test setup was operated in the bandpass mode, and noise levels were measured from 20Hz through

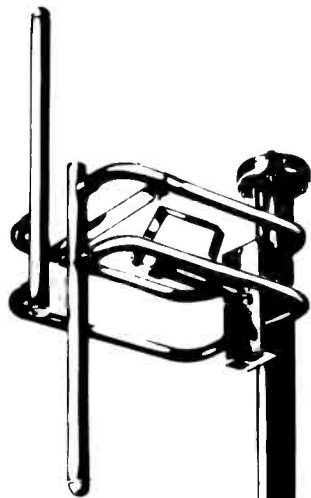

FM Antennas
 FCC Directionals • Multistations
 Rigid Transmission Line
 Pattern Studies
 Combiners

Shively Labs

a division of Howell Laboratories, Inc.

51 Harrison Rd
 Bridgton, ME 04009
 (207) 647-3327

TWX-710-223-8910 SHIVELY BRGT
 call or write for more information

Circle (91) on Reply Card

TV STEREO

BTSC AURAL MODULATION MONITORS



TVM-100 AURAL BASEBAND DEMODULATOR/MONITOR

- Mono/Stereo/Multi-Channel Capable
- Digital Peak Frequency Deviation Display
- Split-Sound and Quasi-Parallel Detection Modes



TVM-200 BTSC STEREO DECODER/MONITOR

- Full-Time Composite and L&R Metering
- Two Auto-Ranging Meters for Full Stereo Signal Test and Measurement
- Genuine dbx® Decoder Card
- Line Level Stereo Audio Outputs



BELAR ELECTRONICS LABORATORY, INC.
 119 LANCASTER AVENUE, DEVON, PA 19333
 (215) 687-5550

Where Accuracy Counts . . . Count on Belar

Circle (92) on Reply Card



TTV 1623/1624: the choice of two camera heads and seven adaptors gives a range of lightweight and high performance cameras to cover any event.

SCOOP CATCHER

The color video cameras TTV 1623/1624 make available a new generation of lightweight cameras. With 3 basic camera heads, 7 adaptors and the Betacam® VTR, they make up a complete family, covering a wide range of requirements, from news gathering to studio productions.

Integral VTR, auto-setup, comprehensive remote control, scene files: a level of possibilities and configurations never seen before. The best of Thomson's technology and quality; the know-how of a world leader in advanced electronic equipment.

Betacam® is a registered trade mark of Sony

Circle (93) on Reply Card

 **THOMSON VIDEO EQUIPEMENT**

Because the best need the best

FRANCE (HEAD OFFICE)
THOMSON VIDEO EQUIPEMENT
17, rue du Petit Albi - CERGY-SAINT-CHRISTOPHE
BP 8244 - 95801 CERGY-PONTOISE CEDEX
Phone (1) 34.20.70.00 - Telex 204.780 F
Fax (1) 34.20.70.47

U.S.A.
THOMSON-CSF BROADCAST Inc.
37 Brownhouse Road - STAMFORD
CT 06902 - U.S.A.
Phone (1203) 965.7000 - Telex 6819035 TCS FB.
Fax (1203) 327.6175.

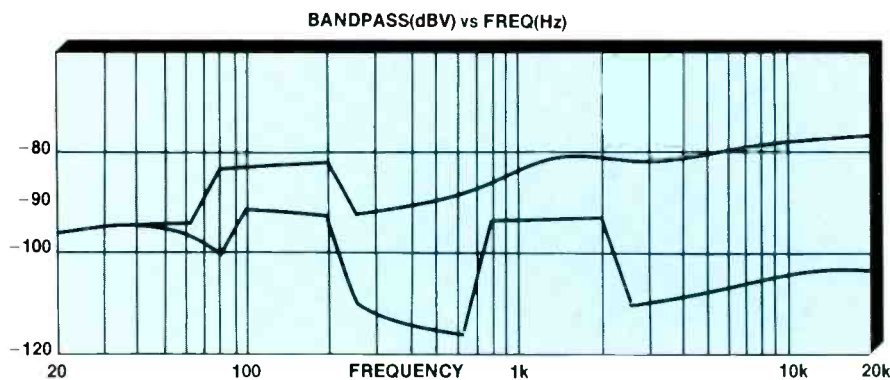
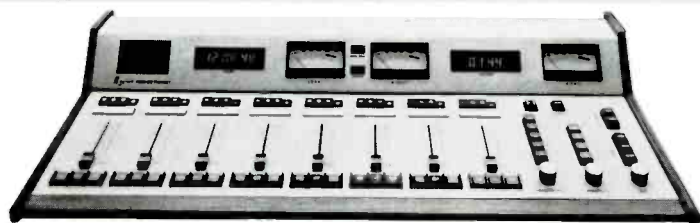

Figure 5. Noise floor sweep. Upper curve shows better than -75dBV noise with the output control fully open. Lower curve shows better than -90dBV noise with the output control fully closed.

Workhorse Reliability! Remarkable Audio Quality! Simple to Operate!



The **Logitek** PERFECTIONIST 8 and 12-Channel Broadcast Consoles

Only the Perfectionist has:

- Simple one-button operation
- Four selectable stereo inputs per fader
- S/N 88 dB, THD .008% typical
- Built-in DAs, clock, timer, machine controls
- Complete pre-wiring to punch blocks
- Exclusive *five-year* parts/labor warranty!

CALL 800-231-5870

(Texas, Alaska call 713-782-4592 collect)

for full information and the name of your
Logitek *Instant Action Dealer*.

Logitek Electronic Systems, Inc.

When it has to work right

20kHz. Figure 5 shows the results of two measurements. In one, the output control was fully open, in the other, the control was fully closed. The DA performed slightly better than specified across the bandwidth.

The output clipping level was measured to be $+21\text{dBm}$, which is 5dB higher than the company specifies. In addition, the overload LED action was checked and found to operate about 6dB below the serious clipping level. This means that the overload LED can be an effective peak indicator, while still providing sufficient headroom for most operators.

All six channels were tested and each channel met or exceeded the published specifications. Isolation between channels was verified and also met the device's specifications.

Applications

The DA will be seen in a variety of applications. Because it will accept microphone-level inputs, the unit could easily serve as a microphone-to-line converter. This configuration would be useful for church remotes, where the remote broadcast microphones could be distributed between the broadcast engineer and the in-house taping system. By eliminating the need for multiple microphones, the DA could quickly pay for itself.

Another application involves press feeds. A microphone could be connected to one or more DAs coupled through the link jacks. With this setup, many stations could receive line- or microphone-level signals without jamming a dozen microphones on the podium. A pair of microphones and two DAs will provide complete redundancy.

Routing audio in an ENG or remote truck can be a never-ending chore during live events. The battery operation feature makes the DA a candidate for such applications. When operating from batteries, the unit is as portable as a hand-held minicam. In this day of ever-increasing public awareness about quality audio, having flexible audio facilities on site becomes more important.

The FP16 portable audio distribution amplifier is designed to provide high-quality audio with a broad range of features. Contained in a rugged and easy-to-move package, the DA should find many applications in remote broadcast situations. In fact, it may be the solution to some of your problems.

Editor's note: The field report is an exclusive **BE** feature for broadcasters. Each report is prepared by the staff of a broadcast station, production facility or consulting firm.

In essence, these reports are prepared by the industry and for the industry. Manufacturer's support is limited to providing loan equipment and to aiding the author if support is requested in some area.

It is the responsibility of **Broadcast Engineering** to publish the results of any piece tested, whether positive or negative. No report should be considered an endorsement or disapproval by **Broadcast Engineering** magazine. [:-)]]

Circle (94) on Reply Card

The Newest Name In Portable Microwave Equipment Has Supplied Over 5000 Units Worldwide



MICROWAVE RADIO

**Super 2MX · 2MX · 2MR · MRC · Super 7MX · 2 + 7MR
13FA · 13CP · 40MX · 40MR · Superscan · Miniscan
Microscan · Omnipole · Skypod · Navtrack**

Microwave Radio Corporation, a new name in the portable microwave market, has purchased the entire electronic news gathering product line from M/A-COM MAC. The team of skilled production, test, and management people that brought you state-of-the-art products from M/A-COM is now an independent company focused on you and your requirements. Over the past 18 years, starting with the first solid state ENG System, we have led the industry by supplying more than 5000 high quality portable receivers and transmitters.

We will exclusively manufacture and service all portable ENG products previously supplied by M/A-COM. Our management mandate is a new "priority to service" unmatched by our competitors.

© Copyright 1986 Microwave Radio Corporation

Priority to Service
Bob

Robert Morrill
President

**Call us at (617) 459-7655.
Bob Morrissette for scheduling & spares
Al Doyle for Technical Assistance
Ed Dahn for Sales**



MICROWAVE RADIO corporation

847 Rogers Street, Lowell, MA 01852

Circle (98) on Reply Card

SBE convention is a success

By Bob Van Buhler

The first national SBE convention was a great success. Because of the high attendance and well-coordinated events, exhibitors and attendees enjoyed an air of excitement throughout the show. The convention, held Oct. 14-16 in St. Louis, hosted more than 2,200 attendees with 154 exhibitors occupying 260 booths. The convention attracted people from across the United States, South America and Australia.

The St. Louis SBE chapter, noted for its successful regional conventions, coordinated the exhibition activities. The technical sessions were coordinated by John Battison and **Broadcast Engineering** magazine.

The convention began on Tuesday with joint radio and TV sessions. The high first-day session attendance proves that engineers will travel to well-organized trade shows. The Tuesday meetings concluded with the largest ever SBE membership meeting and a well-attended ham radio reception.

The Wednesday meetings were broken down into separate radio and TV sessions. A common session characteristic was that practical and useful information was presented by industry-recognized experts. Many of the sessions emphasized subjects that the engineers could immediately apply at their own stations.

Tom Keller, vice president of engineering for NAB, made an innovative presentation Wednesday afternoon. Keller reviewed the various new broadcast-related technologies and outlined how they might affect broadcasting's future. For those engineers wanting a feel for the future, it was the perfect presentation.

Those who registered for the technical sessions received a copy of the **SBE/BE Proceedings**. The journal contains many of the papers that were presented at the convention. Because the attendance was much higher than expected, some people did not receive their copies. Additional ones are being printed and should be available soon. If you want to purchase a copy of the *Proceedings*, contact the SBE national office.

Wednesday luncheon

James B. McKinney, FCC mass media

Van Buhler is chief engineer for WBAL-AM and WIYY-FM, Baltimore.



bureau chief, was the highlighted speaker at the Wednesday joint radio-TV luncheon. McKinney addressed the well-attended gathering on the subject of deregulation and its effect on the broadcast engineer. McKinney, an SBE certified senior broadcast engineer, credited the St. Louis chapter for conducting a fine convention.

SBE meetings

Several important SBE meetings were held during the convention. Past SBE presidents held a meeting on Sunday before the convention opened. This was the second past president's committee meeting. The first also was held in St. Louis, in 1982. This meeting was called to review the society's performance and offer suggestions for the future.

During the day-long session, the committee reviewed many of the actions taken by the society over the past four years. The committee also reviewed the original suggestion list made at the 1982 meeting. After careful review, the committee offered seven new recommendations to the board of directors:

- Develop an SBE demographic database. The information will be used to better target SBE services and member needs.
- Develop a marketing plan to let more people in related fields learn the advantages of SBE membership.
- File comments with the commission on Docket 86-367. This docket suggests that a single contractor administer testing and licensing for all FCC-regulated radio services.
- SBE should establish a program to train and equip future officers to better serve the national SBE organization.
- The St. Louis Chapter was commended for its contribution to the success of the first SBE National Convention.
- SBE should immediately begin the process of hiring a full-time executive director. The SBE headquarters should be moved to Washington, DC, within a reasonable period of time.
- The goals listed in the 1983 report are still valid and should be pursued.

The board of directors met the next

day and adopted the report. Assignments were made to implement the committee's suggestions on a timely basis.

Bob Flanders was appointed hiring-committee chairman and will oversee the committee's job description development and begin the initial search process. Other committee members include: Tom Weems, Bob Van Buhler, Jim Wulliman, Mary Beth Leidman and Jeff Baker as board members. Roger Johnson, past president, and Chris Imlay, SBE counsel, also will serve on the committee.

The board voted to move the annual membership meeting in 1987 to coincide with the national SBE convention. After considering various alternatives, the board unanimously agreed to again hold the convention in St. Louis. Crediting the 1986 convention's success, in part, to the experienced and talented St. Louis SBE chapter members, the board felt holding the 1987 convention in the same location was the best option. Next year's convention will be held Nov. 10-12.

Terms extended

In order to comply with the SBE bylaws, the board voted to extend the current officers' and board members' terms to the 1987 annual meeting and convention. This action was necessary, because the current bylaws prohibit shortening an officer's term.

In order to avoid imposing any changes on the local chapters, one section of the chapter chairman's manual also was changed. Local chapter elections no longer have to be held concurrent with the annual meeting. If this section had not been changed, all local chapters would have had to change their election dates. The approved change eliminates that problem.

Membership application

The convention generated a great deal of interest in SBE membership from operators and non-broadcast personnel. The society has always welcomed participation by people working in related technology fields. If you would like to become an SBE member, complete the application in the back of the book.

SBE membership application on page 171. [:->)]))]

Anything less than a Neve is just a lot of...

Bells and whistles may be all you need for New Year's Eve... or a birthday celebration. But is a desk full of bells and whistles enough for the demanding art and science of broadcast production? You need the Neve difference.

At Neve, the first name in audio mixing control and distribution systems, we offer you all the bells and whistles your creativity demands... as well as the sonic quality, reliability, and ease of operation that sets Neve apart from the rest.

Neve's versatile 51 Series, for example, gives you the full range of advanced facilities you want, plus the virtually unlimited versatility you require... to let your creativity soar. With features that include:

- 16-to-60 inputs
- Custom configurations

Rupert Neve Incorporated
Berkshire Industrial Park
Bethel, Connecticut 06801
Telex 969638
Facsimile (203) 792-7863
(203) 744-6230

Neve Electronics Int'l Ltd.
Cambridge House, Melbourn, Royston
Hertfordshire SG8 6AU, England
ph (0763) 60776 fax (0763) 61886
telex 81381

7533 Sunset Blvd.
Hollywood, California 90046
(213) 874-8124
Facsimile (213) 874-1406

P.O. Box 40108
Nashville, Tennessee 37204
Telex 786569
(615) 385-2727

- Stereo or mono modules
- A choice of 4 standard consoles
- Up to 8 auxiliary outputs
- Multitrack recording capability
- 4-band Neve Formant Spectrum Equalization

Hear the Neve quality difference for yourself. Find out firsthand how Neve advanced engineering gives you "a touch of the future."

Circle the bingo card for a literature pack. Or call (203) 744-6230 for a demonstration of Neve sound at your location.



- Nothing sounds as good as a Neve... because nothing else is.

 **Neve**
A Siemens Company

NOISE

Circle 102 on Reply Card

NEVE 004 WLM 467

Station-to-station

Tally system solves interface problems

By Robert R. Ramsaur

The silent communications link in most TV facilities is the tally system. Tally systems are usually built by the station's engineering staff. This is the case even if new equipment is purchased. It seems there is always the need to interface a tally system to a non-standard piece of equipment.

Recently, I had the opportunity to rebuild the KBYU-TV tally system when we upgraded the station's remote production van. The old tally system consisted of a 28Vdc power supply, some 28V lamps and a punch block. Although the system worked, it required major rewiring every time we changed the numbering of cameras or the video monitor assignments. The new tally system was

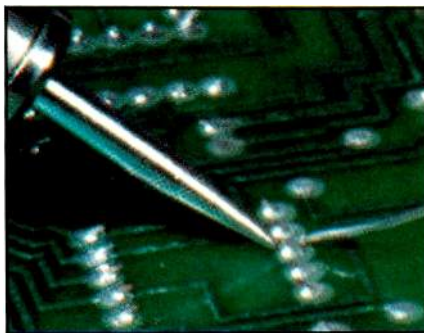

designed with the following features: reassignable equipment tallies; reassignable monitor tallies; and external tally drives; (non-powered, + common, - common and ac); and slave to another tally system.

The features allow the new tally system to easily interface with other TV remote production trucks. The system transmits tally commands to another truck, receives tally commands from another truck and runs parallel tallies. The system also allows either truck to send tally commands to any piece of equipment or monitor.

Basic circuit

A basic tally circuit, shown in Figure 1, consists of a switch closure, a power supply, visual display and a camera control unit (CCU) tally input. The elements are just repeated as many times as necessary to reach the desired sized system.

In our installation, the tally system drives 28V lamps, bidirectional LEDs and equipment with bidirectional tally inputs. It's important to use display devices that are not sensitive to tally command polarity. If your CCU requires polarized tally commands, a diode bridge similar to that shown in Figure 2 can be added. The bridge converts various tally input polarities into a constant output polarity.

Tally reassignment

There are many instances when it is desirable to reassign tallies. If there are

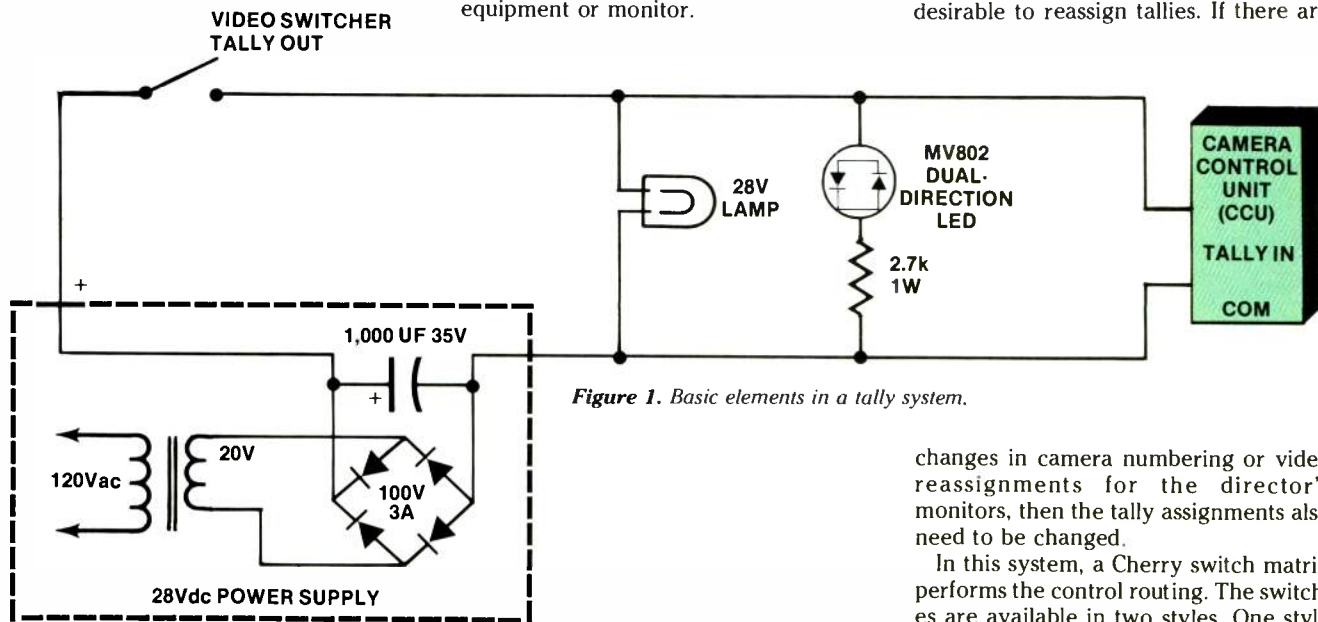

Figure 1. Basic elements in a tally system.

changes in camera numbering or video reassignments for the director's monitors, then the tally assignments also need to be changed.

In this system, a Cherry switch matrix performs the control routing. The switches are available in two styles. One style uses steering pins as the control elements. The pins are inserted at cross-point locations within the matrix. The other style uses slide switches to perform the same control routing. Banana-pin patch panels can also perform the routing function, much like the slide switch. A simplified drawing of the switch matrix is shown in Figure 3.

The pin-matrix system may be more versatile because it allows two different switcher commands to drive the same monitor tally. This feature may be need-

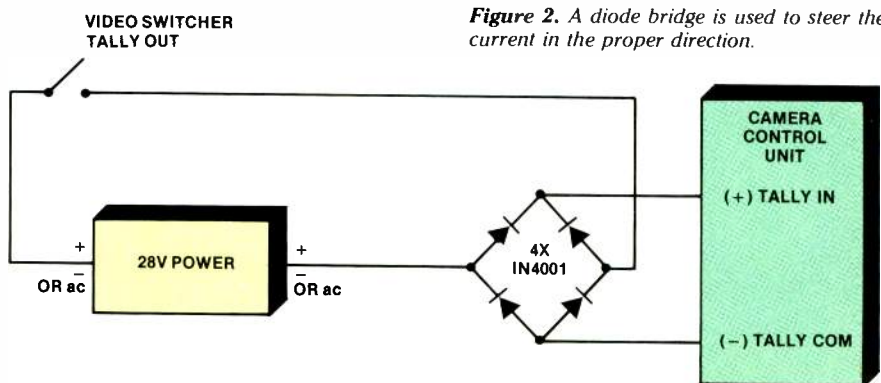

Figure 2. A diode bridge is used to steer the current in the proper direction.

Ramsaur is an engineer with the CMX Corporation, Santa Clara, CA.

Look Into Our 8000 Series Master Control Switchers

*You Can Operate It
With The Same Common Sense You Used To Buy It.*

Model 8020
(also available in 12 input rack mount version)

FIVE YEAR WARRANTY
We back our reputation for standout customer service with toll free technical assistance lines and one of the strongest warranties in the industry. Our dealers are worldwide, call for the one nearest you.

8000 Series Features

EASY TO OPERATE

Logical control layout minimizes potential for operator error.

FIELD UPGRADEABLE TO STEREO

Stereo is coming on strong. We keep you prepared so you can easily upgrade.

EXTERNAL SERIAL CONTROL

You can save now but still be prepared for the future.

MACHINE CONTROL

Intergroup's reliable machine control system interfaces with VTR's and film islands and features sophisticated time display. It's also field upgradeable.

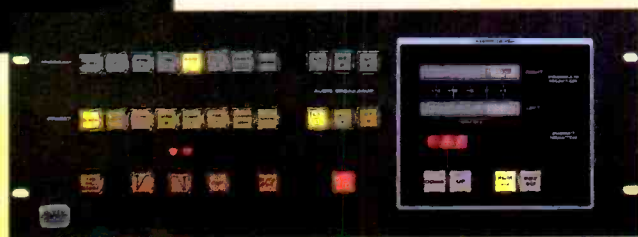

Model 8001

INTERGROUP

"Creativity You Can Depend On"



INTERGROUP VIDEO SYSTEMS, INC.

P.O. Box 1495 / Gainesville, FL 32602-9990

(800) 874-7590 / In Florida (904) 335-0901 / TWX 810-825-2307

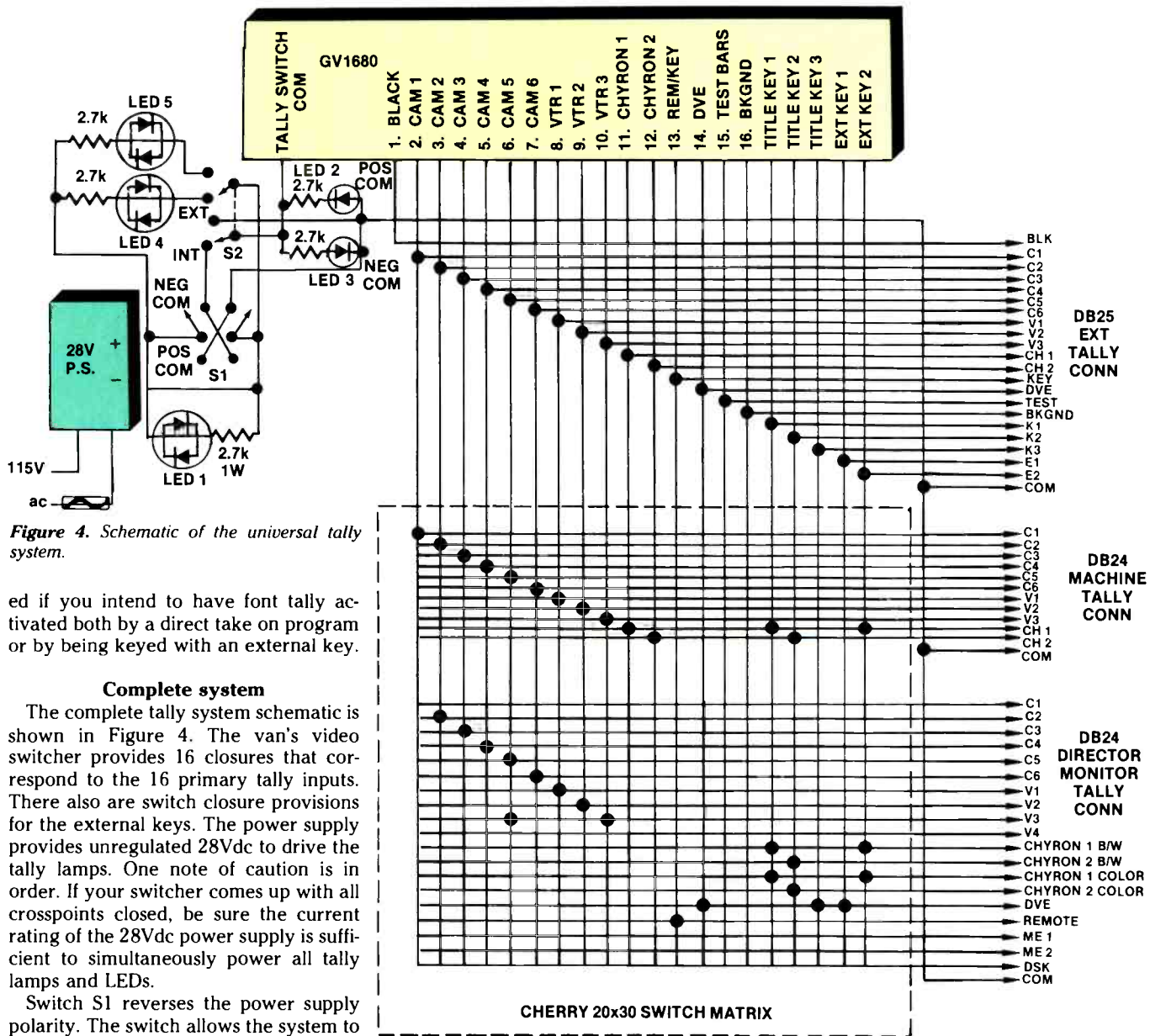

Figure 4. Schematic of the universal tally system.

ed if you intend to have font tally activated both by a direct take on program or by being keyed with an external key.

Complete system

The complete tally system schematic is shown in Figure 4. The van's video switcher provides 16 closures that correspond to the 16 primary tally inputs. There also are switch closure provisions for the external keys. The power supply provides unregulated 28Vdc to drive the tally lamps. One note of caution is in order. If your switcher comes up with all crosspoints closed, be sure the current rating of the 28Vdc power supply is sufficient to simultaneously power all tally lamps and LEDs.

Switch S1 reverses the power supply polarity. The switch allows the system to provide external tally drives with + common or - common power. Switch S2 selects powered or unpowered tallies. The switch also has a second function. When the tally system is in command of another system, S2 configures the external tally command to operate from either

powered or dry-contact switch closures. When the tally system is taking commands from another system, switch S2 configures the slaved-tally system to accept powered or unpowered tally commands.

LED 1 indicates the presence of 28Vdc power. LEDs 2 and 3 indicate + or - common tally power polarity. LEDs 4 and 5 indicate whether the system is configured for internal or external power source.

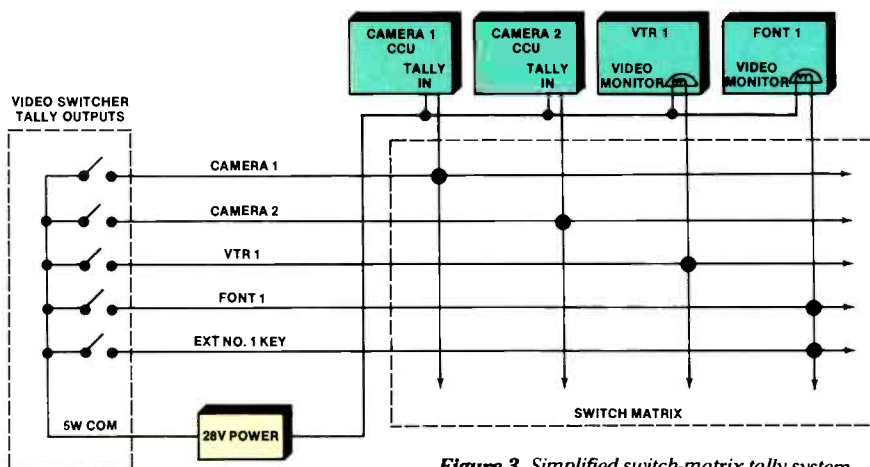

Figure 3. Simplified switch-matrix tally system.

External tally connections

For external connections to the tally system, we used a DB25 connector. It supplies the switcher primary input tally switch closures and a tally common to the outside world. This is all that is needed to provide external tally commands, accept tally commands from another system or share tallies.

Construction

The entire tally system is built on a 7-inch rack panel. The 28Vdc power supply, switch matrix, switches, LEDs and the three DB25 connectors are all mounted on the panel. (See photos on page 140.) The three DB25 connectors are mounted facing the back. One connector feeds the switcher tally into the

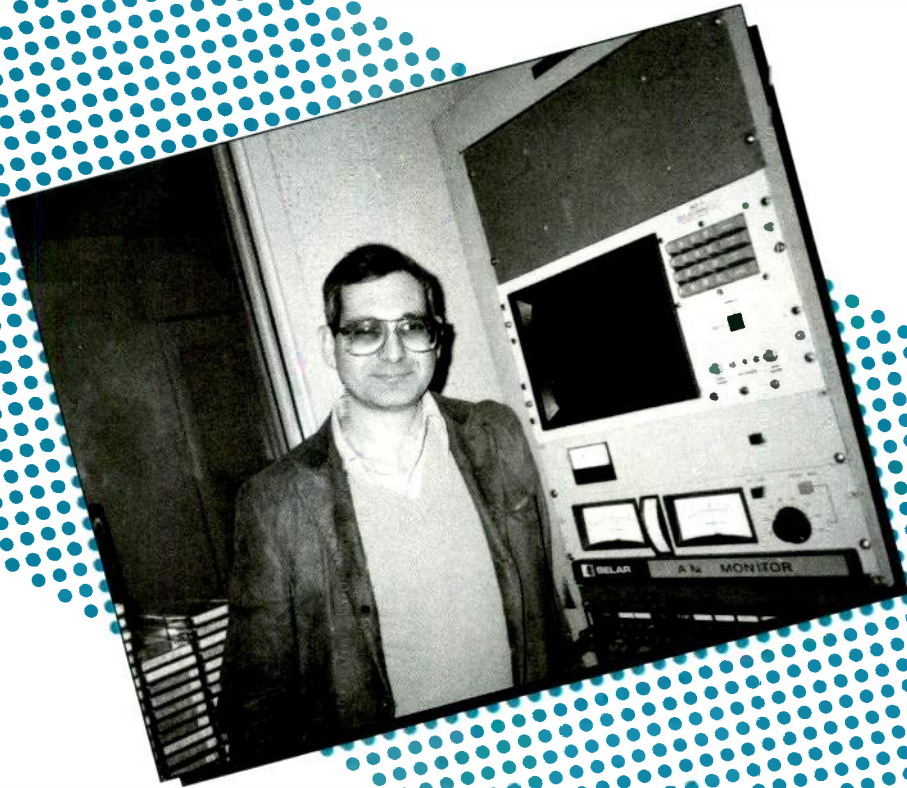

“I regularly remove technical articles from broadcast magazines and file them in my PC’s database for future research and reference.

So far, the articles I have saved run three to one in favor of *Broadcast Engineering!*

Barry A. Chickini
Chief Engineer
Radio Station WTIX
New Orleans, LA

BROADCAST
ENGINEERING

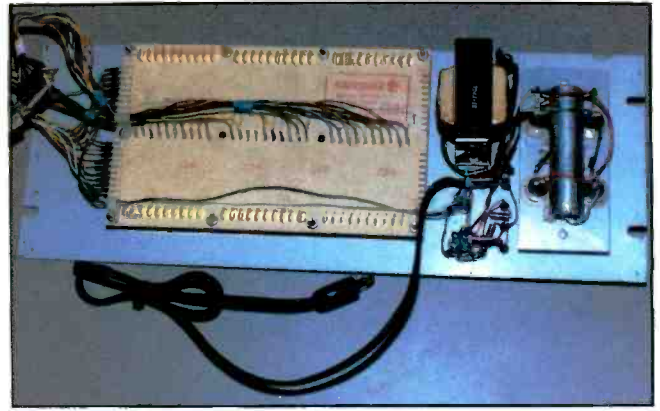
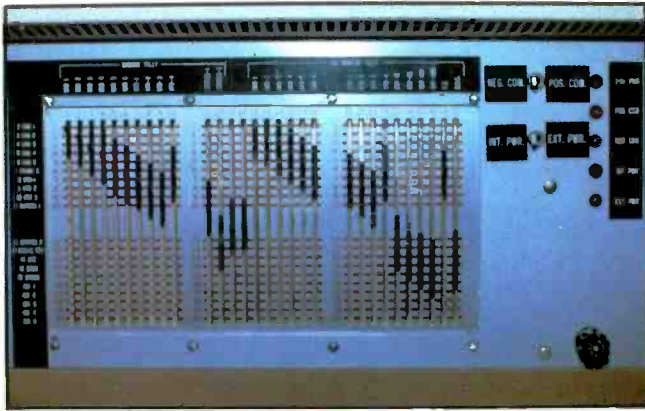

Shown above are the front and back views of the Universal Tally control panel.



The alternative to our "double isolation" headsets.

The Shure SM1 and SM2 Headsets isolate you from sound in two exclusive ways.

First, these headsets use extra-large, pillow-soft ear pads for superior noise isolation and comfort. Second, they feature a noise-reducing mic, with a precision cardioid polar pattern, to leave background noises where they belong... in the background. The mic's tailored frequency response insures outstanding voice reproduction.

Other features include: an all-metal boom and double-braced, all-metal headband for greater durability and comfort; a patented boom mount for total mic position flexibility; detachable cable; and a stylish matte chrome and black finish that looks great "on camera".

The SM2 is a dual-ear headset, the SM1 — single. For complete information, write or call Shure Brothers Inc., 222 Hartrey Avenue, Evanston, IL 60202-3696. (312) 866-2553.



SHURE
Breaking Sound Barriers™

matrix. The second sends tally commands to the equipment. The third sends tally commands to the director's video monitors. The power supply is fuse-protected with a panel-mounted socket.

Operation

After the three DB25s are connected, all you have to do is set the pins or slide switches for each switcher input. For example, switcher input No. 2 might be defined as camera No. 1. Set the matrix crosspoints so that camera No. 1 CCU receives a tally from input No. 2. Now set the director's video-monitor crosspoint so that camera No. 1 video monitor also is activated.

In a case where two different switcher tally outputs drive the same tally display, set the crosspoint so that when switcher input font No. 1 is active, tally commands are sent to Font No. 1 monitors. Now set another crosspoint on the Font No. 1 line so when the switcher tallies an EXT No. 1 key, the same monitor line is tallied. This setup will provide a tally to Font No. 1 monitor when Font No. 1 is taken direct on program or when Font No. 1 is keyed by EXT No. 1 key.

New feature

The tally system has been in operation for over a year and has enabled us to interface the remote production truck to every oddball situation that has come along. An accessory that will be added in the near future is a tally breakout box.

One end of the box will have a DB25 connector wired for the external tally connector on the remote truck. The other end will terminate in a box with binding posts for each tally function. With this scheme, simple wiring connections can be made in the box to interface with the outside van. Without this adapter, it is necessary to rewire a DB25 connector every time we interface the tally system to a different external setup.

Even without the breakout box, the tally system has made life much easier. It's a relief to know that with the universal tally system, no matter how many reassignments a director makes, the system can satisfy requests quickly and easily.

[:-(;-))]]]

Circle (19) on Reply Card



THE MOST IMPORTANT PART OF A TV STEREO GENERATOR ISN'T THE STEREO GENERATOR

Several manufacturers make a stereo generator for television, Orban among them. How do you choose the best one?

Stereo generator design, while difficult, is a task whose goals are objectively defined by BTSC specifications and the EIA Recommended Practices. Such design is well within the grasp of competent engineers, and the success or failure of the design is readily measurable by instrument.

In contrast, a TV stereo audio processor must be evaluated by *subjective listening tests*. Measured performance tells you almost nothing about the sound of a given design. This point is crucial because the audio processor, more than any other element in the system, dictates the air-sound you get.

Orban spent four years fine-tuning and perfecting OPTIMOD-TV Model 8182A until it could gracefully handle even the most difficult and diverse program material. During the development cycle, sophisticated mathematical design techniques were always complemented by exhaustive listening tests.

Part of OPTIMOD-TV's superiority stems from its architecture: its patented multiband compressor usually acts like a wideband compressor to preserve frequency balances. But unlike the oversimplified wideband compressors found in some other TV audio processors, it also prevents the pumping of midrange sounds (like dialogue) by low-frequency sounds (like sound-effects with lots of bass energy). It also has a CBS Loudness Controller

to prevent viewer complaints due to loud commercials.

Best of all, OPTIMOD-TV's adjustability makes it a processor that will serve you well now and in the future. Comprehensive setup controls determine the amount of dynamic range reduction that occurs, so you can operate OPTIMOD-TV to produce a consistent, uniform sound that is comfortably listenable on small sets, use it as a safety limiter, or split the difference. The choice is yours!

Orban's 8182A/SG stereo generator plugs into the 8182A, interleaving the stereo generator's low-pass filters with the audio processor circuitry. This *system approach* yields a brighter sound with lower distortion than would be achieved if our 8182A were merely cascaded with a non-Orban stereo generator.

When you add it all up, it becomes clear why there are more Orban OPTIMOD-TV audio processors and stereo generators in service than all other makes *combined*. To learn more, contact your favorite Orban Broadcast Products dealer. Or call us direct in San Francisco.

Orban Associates Inc.

645 Bryant Street, San Francisco, CA 94107
(800) 227-4498 or (415) 957-1067 Telex 17-1480

orban

Circle (110) on Reply Card

Annual editorial index

Compiled by Carl Bentz,
special projects editor

How often have you wanted to reread or refer to a **BE** article, but you couldn't remember the issue in which it appeared? *Where did you see it?* And how many times have you become involved in a station project that called for you to learn all the background information you could, as fast as you could? *Where do you start?*

Most of us don't have the time, or the patience, to thumb through back issues of the magazine to find the material. To help you (and the many readers who call

in search of editorial material from past issues), we bring you the first "Annual Editorial Index."

At the beginning of this 1986 index is a cross-reference listing of articles and columns, arranged alphabetically by general subject area. The subject categories selected are those we have determined to be of primary interest to **BE's** readers.

Following the listing by subject is a month-by-month compilation of all feature articles, regular columns and field reports that appeared in the

magazine during the past year. Noted at the beginning of each article review is a brief list of *key words*, words and phrases that are defined and used throughout the story, along with a reader *interest* classification. *Related* article material is indicated, when applicable, with each feature article summary.

The "Annual Editorial Index" is designed to put a year's worth of **BE** at your fingertips and to make it easier than ever for you to put the magazine to work for you—today and tomorrow.

ANTENNAS/TOWERS/TRANSMISSION SYSTEMS

<i>re:Radio</i> /Directional Antenna Field Strength	3-12
<i>Management for Engineers/Some Pros and Cons on Tower Leasing</i>	3-20
New Developments in RF Technology	5-22
Broadcast Transmission Systems	5-42
Television on Ice	5-62
Using Circular Waveguide	5-74
Complying With RF Emission Standards	5-82
New FM Blanketing Rules	6-154
<i>Satellite Technology</i> /Analyzing Antenna Types	7-14
The Folded Unipole Antenna	7-62
Integrating AM and FM Antenna Systems	7-74
<i>re:Radio</i> /Learning the Basics	10-12
Managing a Community Tower Site	10-68
Understanding Tower Loading	10-78
Controlling Ice Build-up on Towers	10-92
Maintaining an Antenna Ground System	10-102

AUDIO

Digital Delay and Reverberation	2-62
Audio Time Base Correction	2-84
Intercom System Design	3-74
Interconnecting Audio Equipment	3-148
<i>re:Radio</i> /The FMX System	4-12, 5-12, 6-12, 7-12
Selecting Speakers for TV Stereo	5-100

Stereo Audio Production Techniques	5-110
Limiters, Compressors & Expanders	8-22
Noise Gates and Expanders	8-32
Distributing Audio Signals	8-38
Inside Power Amplifiers	8-48
Perceptions of Audio Perception	8-106
Wired for Stereo	9-22
Planning for TV Stereo	9-36
The Real World of Stereo TV	9-54
Wiring an Audio-Video Production Facility	9-74
Microphones From the Inside Out	9-92
Planning Wireless Microphone Systems	9-104
Developing an FM Processing Strategy	10-60
Using Audio Patchbays	10-126

AUDIO PROCESSING

Digital Delay and Reverberation	2-62
Audio Time Base Correction	2-84
<i>re:Radio</i> /The FMX System	4-12, 5-12, 6-12, 7-12
Limiters, Compressors & Expanders	8-22
Noise Gates and Expanders	8-32
Developing an FM Processing Strategy	10-60

AUTOMATION

Automating the Newsroom	1-94
Implementing Station Automation	4-22
Managing Automation	4-40
Automating Monitor Setup	4-54
<i>Station-to-Station</i> /Remote Control System	

Operates Unattended	7-108
---------------------	-------

ENG/RENG/REMOTE BROADCASTING

<i>Satellite Technology</i> /Linking Up to SNG	1-14
Building an ENG Network	1-26
Satellite Uplink Trucks	1-44
Engineering Radio Remotes	1-64
Intercom System Design	3-74

FACILITY PLANNING/DESIGN/RENOVATION

Building for the Future	3-30
SIN: Designed to Fit	3-46
Wiring an Audio-Video Production Facility	9-74
Designed for the Future	12-22
Updating NBC Burbank	12-24
Updating the AFRTS	12-48
Updating the Voice of America	12-68

FIELD REPORTS

<i>Shure</i> FP11 mic-to-line amp	1-112
<i>Lake Systems</i> La-Kart automation system	2-98
<i>Tandberg</i> 910 cassette deck	2-104
<i>Philips</i> LDK-6 studio camera	3-186
<i>Fidelipac</i> CTR-100 cartridge system	3-322
<i>Broadcast Electronics</i> AX-10 stereo AM exciter	3-326
<i>Bosch</i> TVS/TAS-2000 routing switcher	4-88
<i>NEC</i> PCU-780KS UHF transmitter	5-124

Audio Precision System One audio test system	6-176
Modulation Sciences Sidekick SCA generator	7-84
Gentner Engineering SPH-4 telephone hybrid	7-94
Harris Phase Fixer audio TBC	8-114
JVC KY-320U TV camera	10-144
OmniLogic logic analyzer	11-130
Shure FP16 distribution amplifier	12-122

GENERAL INTEREST/MISCELLANEOUS

See FCC Update	1-8 through 12-8
Strictly TV/By the Book	1-10 through 6-10
SBE Update	1-114, 2-112, 4-108, 5-137, 6-186, 7-120, 8-120, 9-130, 10-156, 11-22, 12-134
Weather Radar Systems	1-80
VSP From A to D	2-54
Station-to-Station/Large Clock Display	2-108
Tuning In America	3-22
New Horizons for ITFS	3-56
AM Improvement Update	4-80
Applied Technology/Panasonic M-II	4-96
New Developments in RF Technology	5-22
Broadcast Transmission Systems	5-42
Television on Ice	5-62
Complying With RF Emission Standards	5-82
NAB '86: New Technologies, New Directions	6-22
Looking Toward the Future	6-24
HDTV: Where Is It Going?	6-38
Pick Hits of NAB	6-46
Show of Shows	6-62
The Birth of the VTR	6-158
Making History	6-166
Strictly TV/HDTV: What It Means	7-10
re:Radio/Learning the Basics of AM Radio, Part 1	8-12
Strictly TV/MUSE System First to be Demonstrated	8-10
Strictly TV/Advanced TV Displays the Big Screen	9-10
Circuits/Inside Digital Technology	10-16 through 12-16
1986 Salary Survey	10-22
Applied Technology/Sony CCD	10-136
Station-to-Station/Designing With CMOS	10-150
Getting a Handle on ESD	11-120
Applied Technology/Ampex Zeus	11-146
Station-to-Station/Enter the World of CAD PC Boards	11-150
Designed for the Future	12-22
Updating NBC Burbank	12-24
Updating the AFRTS	12-48
Updating the Voice of America	12-68
State of the Industry Survey	12-82
Inside Fiber Optics	12-96
Distributing Video via Fiber Optics	12-106

MANAGEMENT

See FCC Update	1-8 through 12-8
See Management for Engineers	1-22, 2-20 through 12-20
Managing Automation	4-40
Complying with RF Emission Standards	5-82
New FM Blanketing Rules	6-154
The Real World of Stereo TV	9-54
Managing a Community Tower Site	10-68
State of the Industry Survey	12-82

MEASUREMENT/MONITORING/TESTING

Station-to-Station/Analyzing Receiver Interference	4-106
Station-to-Station/VTC Simplifies Video Signal Timing	6-172
Video Waveform Monitoring	7-22
Understanding SC/H Phase	7-46

STANTRON

CENTER

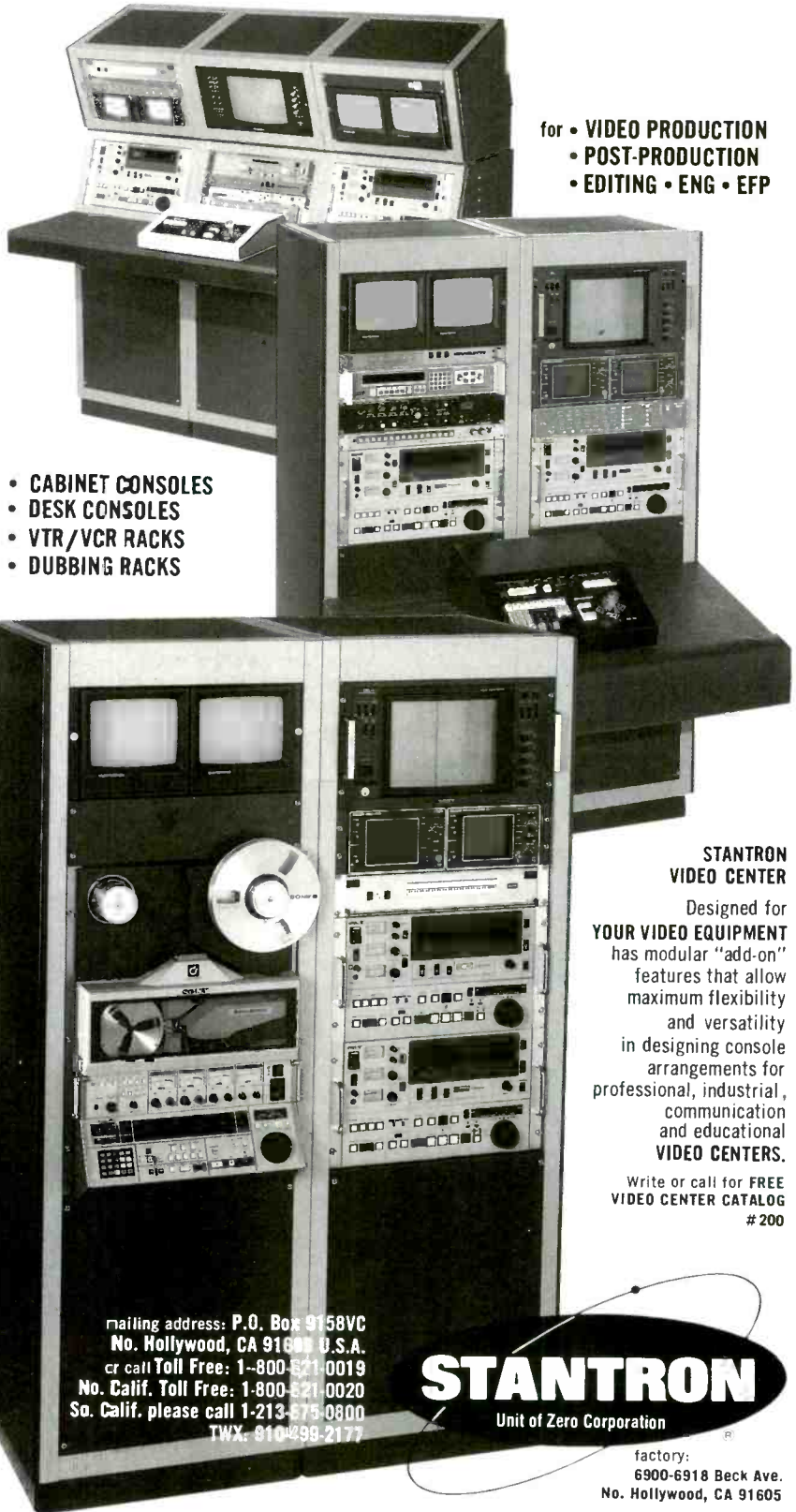

- for • VIDEO PRODUCTION
- POST-PRODUCTION
- EDITING • ENG • EFP

- CABINET CONSOLES
- DESK CONSOLES
- VTR/VCR RACKS
- DUBBING RACKS

STANTRON VIDEO CENTER

Designed for YOUR VIDEO EQUIPMENT has modular "add-on" features that allow maximum flexibility and versatility in designing console arrangements for professional, industrial, communication and educational VIDEO CENTERS.

Write or call for FREE VIDEO CENTER CATALOG #200

mailing address: P.O. Box 9158VC
 No. Hollywood, CA 91605 U.S.A.
 or call Toll Free: 1-800-821-0019
 No. Calif. Toll Free: 1-800-821-0020
 So. Calif. please call 1-213-675-0800
 TWX: 810-498-2177

STANTRON

Unit of Zero Corporation

factory:
 6900-6918 Beck Ave.
 No. Hollywood, CA 91605

<i>Station-to-Station/Testing High-Power Diodes</i>	8-122
<i>Troubleshooting/Repairing Digital Systems</i>	9-18 through 11-18
<i>Station-to-Station/Monitor Modification Eliminates Squeal</i>	9-134
<i>Strictly TV/How to Measure Bandwidth</i>	11-10
<i>Choosing a Digital Multimeter</i>	11-104
<i>Strictly TV/ΔT vs. ΔF</i>	12-10
<i>Troubleshooting/A Logic Analyzer Can Give You the Edge</i>	12-18

RF/RADIO FREQUENCY

<i>Weather Radar Systems</i>	1-80
<i>re:Radio/Antenna Field-Strength Measurements</i>	2-12
<i>New Developments in RF Technology</i>	5-22
<i>Broadcast Transmission Systems</i>	5-42
<i>Television on Ice</i>	5-62
<i>Using Circular Waveguide</i>	5-74
<i>Complying With RF Emission Standards</i>	5-82
<i>New FM Blanketing Rules</i>	6-154
<i>The Folded Unipole Antenna</i>	7-62
<i>Integrating AM and FM Antenna Systems</i>	7-74
<i>re:Radio/Learning the Basics of AM Radio</i>	8-12, 9-12, 10-12, 11-12, 12-12

SATELLITE USE

<i>Satellite Technology/Linking Up to SNG</i>	1-14
<i>Satellite Uplink Trucks</i>	1-44
<i>Engineering Radio Remotes</i>	1-64
<i>Satellite Technology/Planning for SNG</i>	2-14
<i>Satellite Technology/Transmitting Data</i>	3-14, 4-14
<i>Using Satellite Systems</i>	3-168
<i>Distributing Data Via Satellite</i>	4-66
<i>Satellite Technology/Terrestrial Interference</i>	5-14, 6-14
<i>Satellite Technology/Analyzing Antenna Types</i>	7-14
<i>Satellite Technology/Midsummer Potpourri</i>	8-14
<i>Satellite Technology/Rating Earth-Station Systems</i>	9-14
<i>Satellite Technology/The 29-25logθ dBi Envelope</i>	10-14
<i>Satellite Technology/Teleports</i>	11-14
<i>Satellite Technology/More MSN Means More Interference</i>	12-14

STEREO TV

<i>Selecting Speakers for TV Stereo</i>	5-100
<i>Stereo Audio Production Techniques</i>	5-110
<i>Wired for Stereo</i>	9-22
<i>Planning for TV Stereo</i>	9-36
<i>The Real World of Stereo TV</i>	9-54

SWITCHING SYSTEMS

<i>Solid-State Switching Systems</i>	3-109
<i>Collision Detection in Routing Switchers</i>	3-128
<i>Station-to-Station/A Tally System Solves Interface Problems</i>	12-136

TRANSMITTERS

<i>re:Radio/It's Not Too Late to Winterize</i>	1-12
<i>Circuits/Thyristor Servo Systems</i>	1-16, 2-16, 3-16
<i>Troubleshooting/Power Supply Failures</i>	1-20, 2-18, 3-18
<i>Circuits/Power Amplifier Neutralization</i>	4-16, 5-16, 6-16
<i>Troubleshooting/Using Power Tubes</i>	4-18, 5-18, 6-18, 7-18
<i>Circuits/Synchronous AM in FM</i>	

<i>Systems</i>	7-16, 8-16, 9-16
<i>Troubleshooting/Tuning for Minimum Synchronous AM</i>	8-18
<i>Strictly TV/How to Measure Bandwidth</i>	11-10
<i>Preventing Transmitter Failures</i>	11-24
<i>Routine Maintenance</i>	11-26
<i>Power Tubes</i>	11-46
<i>Preventing Failures</i>	11-64
<i>Temperature Control</i>	11-76
<i>Safety First</i>	11-88
<i>Comprehensive Preventive Maintenance</i>	11-94

VIDEO

<i>Weather Radar Systems</i>	1-80
<i>Inside Digital Graphics</i>	2-22
<i>Using Time Base Correctors</i>	2-42
<i>VSP From A to D</i>	2-54
<i>Automating Monitor Setup</i>	4-54
<i>Applied Technology/Panasonic M-II</i>	4-96
<i>The Birth of the VTR</i>	6-158
<i>Strictly TV/HDTV: What it Means</i>	7-10
<i>Video Waveform Monitoring</i>	7-22
<i>Sync Processing and Distribution</i>	7-36
<i>Understanding SC/H Phase</i>	7-48
<i>Strictly TV/MUSE System First to be Demonstrated</i>	8-10
<i>Guidelines on Camera Maintenance</i>	8-82
<i>TV Camera Optics</i>	8-90
<i>Linear Keying in Video Production</i>	9-62
<i>Strictly TV/Advanced TV Displays the Big Screen</i>	9-10
<i>Strictly TV/VBI, ATIS and More</i>	10-10
<i>Extending Videotape Life</i>	10-112
<i>Applied Technology/Sony CCD</i>	10-136
<i>Video Monitor Setup</i>	11-96
<i>Applied Technology/Ampex Zeus</i>	11-146
<i>Distributing Video via Fiber Optics</i>	12-106

VIDEO PROCESSING

<i>Using Time Base Correctors</i>	2-42
<i>VSP From A to D</i>	2-54
<i>Linear Keying in Video Production</i>	9-62
<i>Applied Technology/Ampex Zeus</i>	11-146

VIDEO RECORDING/PLAYBACK/EDITING

<i>Using Time Base Correctors</i>	2-42
<i>VSP From A to D</i>	2-54
<i>Applied Technology/Panasonic M-II</i>	4-96
<i>The Birth of the VTR</i>	6-158
<i>Special Report: Directions in Video Editing</i>	7-80
<i>Extending Videotape Life</i>	10-112
<i>Applied Technology/Ampex Zeus</i>	11-146

JANUARY 1986

ENG/RENG Special Report

FCC Update (page 8)

- Must-Carry Rules Revisited
- Non-Technical AM Acceptance Criteria Eliminated
- Field-Strength Measurement Standards Relaxed
- Auxiliary Spectrum Allocation Rules Modified

Strictly TV (page 10)

- By the Book, Part 1 (Reviewing FCC rules.)

re:Radio (page 12)

- It's Not Too Late to Winterize

(Winterizing the transmitter plant.)

Satellite Technology (page 14)

- Linking Up to SNG (Beginning SNG operation.)

Circuits (page 16)

- Thyristor Servo Systems, Part 3 (Thyristor power control in a 3-phase system.)

Troubleshooting (page 20)

- Power Supply Failures, Part 5 (Problems of single-phasing or phase loss in a 3- or 4-wire power system.)

Management for Engineers (page 22)

- Recognition Is What It's About (SBE certification.)

• Building an ENG Network (page 26)

By Karl Renwanz, WNEV-TV, Boston

Key words: ENG, microwave, cellular, 2-way, frequency coordination.

Interest: Engineering, ENG operations and planning.

Design, construction and operation of a regional ENG network is more than routine engineering. Multiple microwave links, 2-way radio, IFB and cellular radio interconnect news-oriented TV stations with remote bureaus and other network stations. Compliance with community restrictions requires compromise and ingenious design.

• Satellite Uplink Trucks (page 44)

By Brad Dick, radio technical editor

Key words: Uplink vehicles, electronics, chassis, communications.

Interest: Engineering operations, planning; producers.

Related: Satellite relay with continuously variable slope delta digital modulation.

C- and Ku-band satellite uplink trucks provide stations with vast potential for live, on-the-spot TV coverage. The satellite news vehicle design must consider the vehicle chassis and the RF equipment package. Operation involves antenna positioning, establishing a link and communication systems.

• Engineering Radio Remotes (page 64)

By Skip Pizzi, NPR, Washington, DC

Key words: Site survey, intercoms, mix-minus, telco.

Interest: Engineering operations, planning; producers.

Related: International remote origination; maritime remote origination.

Radio remotes offer programming that might not otherwise be available. Successful remote operation requires special consideration for the remote site survey, preparing a system block diagram, providing communications, the equipment setup, wireless mic usage, monitoring and telco lines.

• Weather Radar Systems (page 80)

By Carl Bentz, TV technical editor

Key words: Radar, Doppler motion, graphics.

Interest: Engineering, news producers. Weather forecasting, an inexact science at best, is more predictable with improved weather radar and digital technology. This article discusses how radar works and its application to weather, as well as how Doppler motion sensing can aid in severe storm monitoring.

• Automating the Newsroom (page 94)

By Carl Bentz, TV technical editor
Key words: News, computer, UPS, data security, redundancy.

Interest: Engineering operations, news.

The newsroom computer may involve engineering to maintain and operate technical equipment. In planning for newsroom automation, an engineering analysis should consider links to existing equipment, uninterruptible power, equipment locations, interconnections, redundancy and data security.

Field Report (page 112)

- Shure FP11 microphone-to-line amplifier

FEBRUARY 1986

Digital Technology for Audio and Video

FCC Update (page 8)

- Duplication Rules Might Be Lifted
- Construction Deadline Rules Amended
- Treatment of Character Issues Narrowed
- ATS Authorization

Strictly TV (page 10)

- By the Book, Part 2
(Reviewing FCC rules.)

re:Radio (page 12)

- Antenna Field-Strength Measurements
(Changes in station coverage or a source of interference signal a possible change in field strength.)

Satellite Technology (page 14)

- Planning for SNG
(Basic SNG system requirements.)

Circuits (page 16)

- Thyristor Servo Systems, Part 4
(Avoiding undesired thyristor triggering.)

Troubleshooting (page 18)

- Power Supply Failures, Part 6
(Problems of power control servo systems.)

Management for Engineers (page 20)

- A Professional Looks the Part
(The way you present yourself can make a difference.)

- Inside Digital Graphics (page 22)

By Carl Bentz, TV technical editor

Key words: Computer, nibbles, bites, bytes, von Neumann, pipelining, memory, array processor.

Interest: General, engineering, production.

Related: 3-D images, improved video typography, computer languages, weather displays.

Behind the flashy effects and elegant graphics and titles, computer-controlled hardware relies on a program. Without input and output facilities, the computer sits helpless, awaiting instructions. An overview of graphics equipment reveals some of the complexities.

- Using Time Base Correctors (page 42)

By Carl Bentz, TV technical editor

Key words: Digital TBC, direct/heterodyne processing, component interface, color under.

Interest: Engineering operations.

Time base correction is essential for VTR playbacks. Different correction methods are

used according to the type of VTR in use. A discussion of various methods includes the component interface.

- VSP From A to D (page 54)

By Bob Paulson, AVP Communications, Westborough, MA

Key words: Evolution, proc-amp, Amtec, Cavac, H/V-lock, Colortec.

Interest: General.

Following the 1953 demonstration of videotape recording and the 1956 introduction of a VTR product, video signal processing took an evolutionary path to digital TBC systems. A historical viewpoint notes the players and their achievements.

- Digital Delay and Reverberation (page

62)

By Richard C. Cabot, Audio Precision, Beaverton, OR

Key words: Echo/reverb, Nyquist sampling, quantizing, dither, PCM, digital audio effects.

Interest: Engineering, audio, general.

Related: Sound reverberation, echograms.

A tutorial approach to digital audio processing, delay and reverberation covers sampling, A/D and A/D conversion and various types of code modulation. Limitations existing in digital processing equipment can be overcome through architecture and software design.

- Audio Time Base Correction (page 84)

By Brad Dick, radio technical editor

Key words: Phase/time errors, cross-



You can fill in missing time code gaps with the CCI-716A's unique multi-function jam sync, which permits correction of errors produced by head offset, mistracking, and tape dropouts.

The microprocessor-based Time Code Generator is a cost effective answer to

the needs of today's video, audio, production and post production studios. It handles both SMPTE and EBU longitudinal time code formats for data, user data, status and flag bits. And, like all Cipher Digital products, it carries a 3 year warranty.



Sophisticated timing

The CDI-710A Time Code Reader offers all the latest features demanded by today's professionals.

It's completely regenerated time code output corrects incoming code for phase shift and short and long-term timing error. When used with the error bypass feature it actually eliminates

defective code. This feature is particularly important where code fed to a computer editor has been displaced in relation to the video signal, causing edit aborts.

The CDI-710A. The answer for today's sophisticated video production.

For more details on both of these fine products, contact Cipher Digital today. Call (800) 331-9066.



cipher digital, inc.
P.O. BOX 170/FREDERICK MD 21701
(301) 695-0200 TELEX 272065

Timely today, consistent with tomorrow.

Circle (106) on Reply Card

correlator.

Interest: Engineering, operations, production.

Particular attention must be paid to audio phase errors when converting the monaural plant to stereo. Audio time base correction provides a method of alleviating time and phase errors.

Field Report (page 98)

- Lake Systems LA-KART VCR automation system

Field Report (page 104)

- Tandberg 910 audiocassette recorder

Station-to-Station (page 108)

- Clock Couples Accuracy and Large Display
(Large display clock with WWV accuracy based on Heathkit unit.)

MARCH 1986

(NAB '86 Pre-Show Issue)

Updating Broadcast Facilities

FCC Update (page 8)

- AM Gets Go-Ahead for Synchronous Operation
- FCC Pre-empts Some Local Zoning Laws
- Comparative Criteria

Strictly TV (page 10)

- By the Book, Part 3
(Reviewing FCC rules.)

re:Radio (page 12)

- Directional Antenna Field Strength
(Antenna system efficiency, power measurements and pattern plotting.)

Satellite Technology (page 14)

- Transmitting Data, Part 1
(Coding data for satellite transmission, FDMA and DAMA.)

Circuits (page 16)

- Thyristor Servo Systems, Part 5
(Transient suppression.)

Troubleshooting (page 18)

- Power Supply Failures, Part 7
(Transmitter interlock systems.)

Management for Engineers (page 20)

- Some Pros and Cons on Tower Leasing
(Making decisions toward leasing.)

- Tuning in America (page 22)

By Ed Williams, NAB, Washington, DC

Interest: General.

NAB Engineering Conference schedule.

- Building for the Future (page 30)

By Ken McGowan, WOR-TV 9, Secaucus, NJ

Key words: New facilities planning, distribution switching.

Interest: Engineering operations, planning.

Whether constructing a new broadcast facility or updating one, there are similar concerns. Switching matrices play a large part for future expansion in the plans for the new WOR facility.

- SIN: Designed to Fit (page 46)

By Bebe F. McClain, B. F. McClain Productions, Asheville, NC

Key words: Site selection, equipment power-

ing, facility layout.

Interest: General.

Related: A 134-day construction program puts WYMT-TV, Hazard, KY, on the air.

To move the Spanish Information Network to a single site required an efficient facility design to combine the operations. Diagrams illustrate administrative, production and technical area layouts for the Miami-based SIN renovation project.

- New Horizons for ITFS (page 56)

By Neil Tegart, Access Network, Edmonton, Alberta, Canada

Key words: ITFS, educational/public service broadcasting, satellite networking.

Interest: Engineering, general.

Related: University of Maryland serves off-campus students via ITFS.

Educational and public service broadcasting facilities for Edmonton province combine a network of one AM and 14 FM transmitter sites with TV distribution to serve a potential audience of 2.4 million viewers. Satellite links to 107 communities with 120 specific TVRO sites carry 95 hours of weekly programming. Interlinking of sites and verification logging, studio and mobile production and additional methods for distribution of signals are discussed.

- Intercom System Design (page 74)

By Bob Tourkow, Clear-Com Intercom Systems, San Francisco

Key words: PL/party line systems, 2-, 3- and 4-wire systems, point-to-point, conference, signaling/calling, wireless, IFB/program interrupt.

Interest: Engineering, operations, production.

Related: Intercom interconnections with cameras.

Intercommunication plays an essential role in teleproduction. Planning the intercommunication system is just as essential. A tutorial on intercom systems explains the evolution and different methods of system operation.

- Solid-State Switching Systems (page 109)

By Kerry Lacanette, National Semiconductor, Santa Clara, CA

Replacing physical/mechanical switches with solid-state analog switching devices for electrical signal switching control solves some problems and introduces new possibilities. A tutorial discusses switching device characteristics, crosstalk, frequency response, isolation and transient effects. JFET voltage and current devices and low-/high-voltage CMOS switches are described.

- Collision Detection in Routing Switchers (page 128)

By Bruce Morse, BSM Broadcast Systems, Spokane, WA

Key words: Polling, token-passing, CSMA/CD, slave/remote, networking.

Interest: Engineering, general technical.

Related: Routing switcher evolution.

Increased demands on production facilities suggest new capabilities from software-controlled routing/distribution switcher matrices. Software architecture falls into three sections: matrix, security and control. Remote switcher control functions include networking and protocol for intercommunication of networked systems.

- Interconnecting Audio Equipment (page 148)

By Allen Burdick, Benchmark Media

Systems, North Syracuse, NY

Key words: S/N ratio, headroom, power systems, interconnections, RF immunity, common-mode rejection.

Interest: Engineering.

Interconnecting audio equipment means dealing with various types of input and output connections and impedances. If possible, consistency in these factors should be planned at purchase time. Information on proper power system and equipment grounding and RF interference rejection is combined with general suggestions on system parameters.

- Using Satellite Systems (page 168)

By Elmer Smalling III, Jenel Systems and Design, Dallas

Key words: Earth station equipment, signal distribution, spacecraft stabilization.

Interest: General.

Interconnection through satellites provides an efficient means to link two locations or distribute signals from one point to an entire network of receiving points. An overview of satellite technology considers spacecraft types and onboard control systems, earth station configurations and satellite networking services.

Field Report (page 186)

- Philips LDK 6 studio TV camera
Related: Triax interconnection between camera and CCU.

Field Report (page 322)

- Fidelipac CTR-100 audio cartridge machines

Field Report (page 326)

- Broadcast Electronics AX-10 AM stereo exciter

APRIL 1986

Automation Special Report

FCC Update (page 8)

- Operator Must Be on Duty at All Times
- Daytimer Preference Affirmed
- ITFS Rules Reconsidered

Strictly TV (page 10)

- By the Book, Part 4
(Reviewing FCC rules.)

re:Radio (page 12)

- The FMX System, Part 1
(A review of FMX to improve FM stereo S/N ratio and coverage.)

Satellite Technology (page 14)

- Transmitting Data, Part 2
(Data coding for satellite transmission, FDMA, TDMA, CDMA, SSMA.)

Circuits (page 16)

- Power Amplifier Neutralization, Part 1
(Requirements and methods for amplifier neutralization.)

Troubleshooting (page 18)

- Using Power Tubes, Part 1
(Operating RF tubes efficiently.)

Management for Engineers (page 20)

- Get Ahead by Learning to Delegate
(Management means working with others to get the job done.)

- Implementing Station Automation (page

**THE
NEW
MICROMAX™
RECORDER.**



**NOW
EVERY
STATION
CAN
AFFORD**

THE STATE-OF-THE-CART.™

Our new Micromax Recorder is for those who want the high performance sound of a Tomcat,™ but don't need its elaborate, exotic features - or its price.

In fact, the same performance, the most popular features and renowned reliability can be in your studios for about half the cost of the best. So, what's the catch?

NO COMPROMISES. JUST STATE-OF-THE-CART.

The Micromax is loaded with clever engineering. We integrated some of the Tomcat's best features with the latest technology into a single, compact and sleek unit.

For example, Micromax is equipped with Maxtrax™ heads, our exclusive wide-track recording format which puts more punch on today's better tapes. An innovative tape drive system with a 40 millisecond start-time helps make the Micromax Series the fastest and coolest-running machines made (only 14 watts!).

PERFORMANCE LIKE A TOMCAT

Tomcat has big meters, lighted buttons, M-S matrix operation, an instantaneous-start motor, 7.5/15 ips tape speeds, 30 ips recue and a host of logic-controlled options.

Micromax has smaller VU meters, LED tally lights and Tomcat's more popular logic features.

As far as the most important feature, performance, both machines are practically identical.

DOLLARS AND SENSE

Think of it this way: why pay for a Mercedes when a BMW will do quite nicely.

Whether equipped with NAB heads or with Maxtrax, the new Micromax Recorder is only \$2,980.* There's only two options: an attractive desktop case with a hinged service lid, \$85* and a rack-mount housing, \$105.*

Compare Micromax's performance and quality with any other machine. You'll quickly see why the new Micromax Recorder & Reproducer Series are the "digital-ready" machines ready to cart-up the best tape, vinyl and CD source material you can throw at 'em.

Contact us now for full technical information.

*Suggested Professional List Price, 9/86
Circle (107) on Reply Card

Side-by-side Micromax Reproducers in only 3½" height; with our new Recorder, a complete "State-of-the-Cart" system



Pacific Recorders & Engineering Corporation
2070 Las Palmas Drive
Carlsbad, CA 92008
(619) 438-3911 Telex: 181777

Hands Down, the #1 Choice.

22)

By Carl Bentz, TV technical editor

Key words: EBus, communications levels, real/virtual objects, feedback.

Interest: General engineering.

Related: Making automation work using a systems approach.

Automation requires a computer, appropriate software, controllable equipment and an interconnection among them into a network. The EBU/SMPTE EBus is examined at the theoretical level and described at the practical level as used at the ZDF center in West Germany.

- Managing Automation (page 40)

By Dennis Ciapura, Teknimax, San Diego, CA

Interest: Engineering, management, planning.
Related: Preparing for automation should include planning, installation, training and maintenance considerations.

Broadcast station automation promises more efficient operation with reduced costs. A decision to automate must weigh current and proposed costs against equipment expenses and other business aspects.

- Automating Monitor Setup (page 54)

By Brad Dick, radio technical editor

Key words: Objective/subjective evaluations, standards transfer, optical comparator, color analyzer.

Interest: Engineering, operations.

A consistent color presentation by all monitors in the facility improves the overall color quality of production. Monitor setup automation is possible with digital control of various monitor adjustments. Setup procedures are described.

- Distribution Data Via Satellite (page 66)

By Richard T. Cassidy, The Chesapeake Group, Chesapeake Beach, MA

Key words: DACS, NPR, PBS, FSK, SCPC, TDM, packets, network traffic.

Interest: Engineering, general.

Satellite distribution of programming has improved signal quality and reliability over other interconnections. Network-to-affiliate links can enjoy the same improvements in data transmission. Methods for data transmission now in use by networks in the United States are described.

- AM Improvement Update (page 80)

By Michael C. Rau, NAB, Washington, DC

Key words: NRSC, pre-/de-emphasis, test antennas, RF lighting, interference and signal levels.

Interest: Engineering, operations, management.

Bolstering the decline of AM radio popularity involves a number of projects. The program includes pre-/de-emphasis standards for transmitter/receiver manufacturers, AM interference sources, practical AM signal levels, new antenna prototypes and the study of RF lighting devices.

Field Report (page 88)

- Bosch TVS/TAS-2000 routing switcher

Related: Equipment-sharing between different functions in the station.

Applied Technology (page 96)

By Philip Livingston, Panasonic Industrial, Secaucus, NJ

- The M-II Format

(A description of characteristics of the 1/2-inch VCR format.)

Station-to-Station (page 106)

- Analyzing Receiver Interference (IBM PC software available to aid in deciphering sources of interference.)

MAY 1986

Transmission System Special

FCC Update (page 8)

- Deregulation Affects Business Practices
- UHF-UHF and VHF-VHF Channel Exchanges Permitted
- Forfeiture Proceedings
- Issues/Programs Lists Still Required

Strictly TV (page 10)

- By the Book, Part 5 (Reviewing FCC rules.)

re:Radio (page 12)

- The FMX System, Part 2 (Noise reduction through companding.)

Satellite Technology (page 14)

- Terrestrial Interference (How to recognize TI.)

Circuits (page 16)

- Power Amplifier Neutralization, Part 2 (Residual inductance, grounded-grid and symmetrical RF stages.)

Troubleshooting (page 18)

- Using Power Tubes, Part 2 (Cooling system design aids in achieving longer tube life.)

Management for Engineers (page 20)

- Working With Others (Working together requires cooperation between different personalities and conflict resolution.)

- New Developments in RF Technology (page 22)

By Brad Dick, radio technical editor

Keywords: Klystron, Klystrode, velocity modulation, precorrection, perveance, phased electrons, depressed collector.

Interest: Engineering, operations, management.

Related: Pictures/text trace construction of power grid tubes.

The necessity to increase broadcast plant efficiency has produced various improved amplifying products. Klystrons and power grid tubes are joined by the hybrid Klystrode for TV power amplifiers. Research of klystron operation continues, as solid-state modular amplifiers become more prevalent.

- Broadcast Transmission Systems (page 42)

By Carl Bentz, TV technical editor

Key words: Self-supported/guyed towers, statics/dynamics, torque, tension, plumb, RS-222C, turning moments, tower paint requirements, coaxial line, VSWR, burnout, waveguide propagation, RF combiners, directional couplers.

Interest: Engineering operations, management.

Related: Tower inspections; designing towers for extraordinary conditions.

How well do you understand your transmission system? This overview of the tower, transmission line and all post-transmitter plumbing discusses points for maintaining the most visible portion of your plant.

- Television on Ice (page 62)

By Robert Dean, WCSH-TV, Portland, ME; and Gary Krohe, KLDH-TV, Topeka, KS

Interest: Engineering operations, station management.

Two episodes of ice-related tower failure describe events leading to the failure and details cleanup operations afterward.

- Using Circular Waveguide (page 74)

By Gary Krohe, KLDH-TV, Topeka, KS

Key words: Waveguide vs. coax, overmoding, transverse electric mode, circular vs. rectangular, cross-polar/orthogonal.

Interest: Engineering, management.

Circular waveguide efficiently feeds UHF signals to the antenna. A comparison of circular and rectangular waveguides and coaxial feedline includes merits of each, and notes the responses of various circular materials to power and frequency of operation.

- Complying With RF Emission Standards (page 82)

By Donald Markley, D. L. Markley & Associates, Peoria, IL

Key words: Non-ionizing radiation, NEPA, ANSI, whole-body absorption, power-density limits.

Interest: Engineering, operations, management.

Related: Reducing downward radiation through antenna design, steps to analyze FM/TV power-density values.

Unknown effects of non-ionizing radiation of broadcast signals on the human body has prompted the FCC to mandate certain limitations for exposure to RF energy. Tables indicate worst-case situations for FM, AM and television.

- Selecting Speakers for TV Stereo (page 100)

By Thomas Sahara, KITV, Honolulu

Key words: Room size/acoustics.

Interest: Audio engineers.

A true representation of program audio requires speakers that match the acoustics of the listening environment. Guidelines to testing and specifying speakers aid in equipment choices.

- Stereo Audio Production Techniques (page 110)

By Todd A. Boettcher, WTMJ radio/TV, Milwaukee

Key words: Near-field sound, 3:1 rule, stereo imaging, far-field sound, near-field coincident mic techniques, X-Y mics.

Interest: Audio engineers.

Successful audio in stereo TV production depends upon mic placement and handling of audio. Various types of production, mic placement and audio theories are discussed.

Field Report (page 124)

- NEC PCU-780KS UHF transmitter

Related: Pulsed anode operation for UHF transmitters.

JUNE 1986

NAB Convention Replay

FCC Update (page 8)

- Filing Fees are Due Shortly
- FM Upgrades Made Easier
- FM Allocation Rules Under Study

The World's Best UHF TV Transmitting Antenna Just Got A Lighter Brother Easier To Install And Less Expensive

Tower legs make great supports for side mounted system components; a luxury not enjoyed by our top-mounted systems.

By removing our support pole for leg-mounted operation, Bogner's UHF TV antennas are now not only the world's best antennas but our new side mount version is a lot lighter, easier to install and costs considerably less.

Bogner's slot broadcast antennas have long been known for their outstanding performance and ability to custom tailor vertical and horizontal radiation patterns to fit the specific needs of each location. A patented director system with radiating elements is largely responsible for this impressive performance. So impressive that over 1,000 Bogner TV Broadcast antennas employing this technique are now in use.

For top-of-the-tower mounting, Bogner antennas employ a simple single row of radiating slot cavities bolted to a supporting steel pipe which also encloses the feedlines.

Now, Bogner's DUI Series antennas can be side-mounted to a tower leg without using a

support pipe at all. Instead, the slot cavities and the power divider are bolted directly to a tower leg and are interconnected with 3 1/2" pressurized semi-flexible coaxial cables. Weight, wind load, and cost are markedly reduced. But performance is virtually unchanged with power gains to 16 dB and VSWRs of under 1.08:1 over an entire channel (better than 1.05:1 at visual). In fact, the side-mounted array has precisely the same gain, VSWR and horizontal and vertical radiation patterns as our top-mounted version.

Yet the best news is that Bogner side mount antennas still offer radiation patterns that are tailored to each application and are individually guaranteed to meet or exceed Bogner's specifications.

Bogner ... always the world's best antenna.

BOGNER® 603 Cantiague Rock Road
Westbury, N.Y. 11590
(516) 997-7800
Broadcast Equipment Corp.

- Tower Leg Mounted
- No Support Pole
- Reduced Weight
- Reduced Wind Load
- Reduced Cost
- Full Bogner Performance

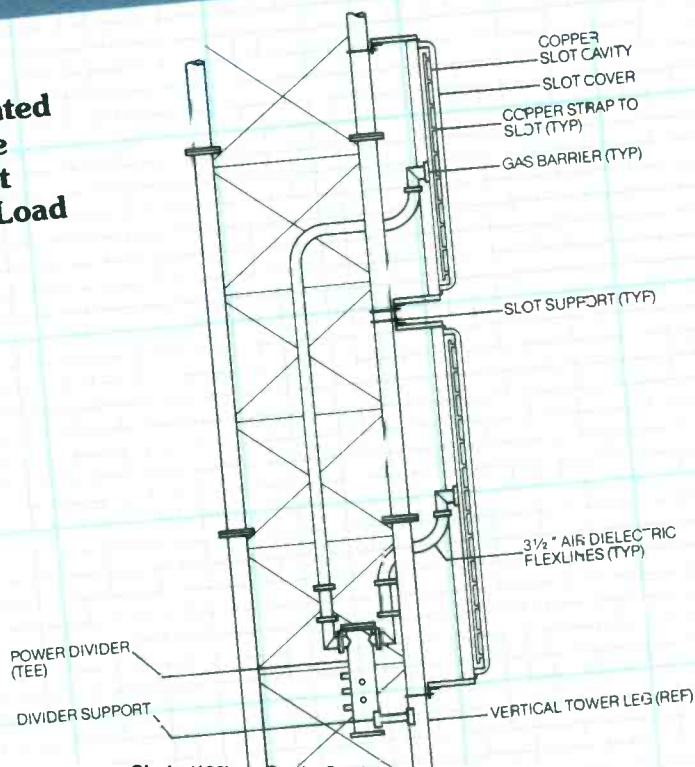

Circle (108) on Reply Card

- Table of Filing Fee Amounts

Strictly TV (page 10)

- By the Book, Part 6 (Reviewing FCC rules.)

re:Radio (page 12)

- The FMX System, Part 3 (Generating the companded S' signal.)

Satellite Technology (page 14)

- How to Cure TI (Methods to reduce terrestrial interference with earth stations.)

Circuits (page 16)

- Power Amplifier Neutralization, Part 3 (Analyzing the equivalent PA circuit eases neutralization tasks.)

Troubleshooting (page 18)

- Using Power Tubes, Part 3 (The air-handling system, PA tube sockets.)

Management for Engineers (page 20)

- Three Deadly Mistakes Plus One (Errors in judgment on promotions result in managerial headaches.)

- Looking Toward the Future (page 24) By Brad Dick, radio technical editor

Interest: General engineering.

A review of topics in NAB '86 engineering sessions includes AM radio, new AM antenna designs, FM and FMX, D-1 digital VTR format, video cart decks, klystrons/Klystrodes, tower maintenance, frequency coordination and RF radiation.

- HDTV: Where Is It Going? (page 38) By Arthur Schneider, Teledyne Camera Systems, San Diego, CA

Interest: General.

With the NHK HDTV system proposed by the United States for worldwide use, some disagreement is expressed by European countries as to the applicability of the system. The article discusses the realistic applications for HDTV in the broadcast and film industries.

- Pick Hits of NAB '86 (page 46) By Brad Dick and Carl Bentz, technical editors

Interest: Engineering, operations, production. Outstanding products for radio and TV, chosen by two panels of judges. Products selected for radio were:

- Allied/Sonomag (SMC) Audio Metrics CD player
- Aphex Studio Dominator audio processor
- Comrex basic frequency extender
- Eventide BD980 broadcast delay
- Gentner VRC-1000 remote control
- Kahn LPGA-1 Lines Plus frequency extender
- M/A COM MA-23 aural STL
- Modulation Sciences Data Sidekick SCA generator
- Sound Technology 3000 series audio test system
- Straight Wire Audio CDQue CD player

Products selected for television were:

- Apex AVSD Zeus processor
- Barco CVS color video scope/monitor
- Dielectric Communications switchless combiner
- Faroudja Labs CTE-N video encoder
- Kavouras Triton weather graphics system

- Magni Systems 2015 PCATS signal synthesizer
- Panasonic M-II format
- Tektronix 1720/1730 waveform and vector monitors
- Toshiba Microcam CCD camera
- Varian/EIMAC X-2252 Klystrode

- Show of Shows (page 62) By the **BE** staff Products introduced at NAB.

- New FM Blanketing Rules (page 154) By Don Markley, D. L. Markley & Associates, Peoria, IL

Key words: Blanketing, contours, power-density levels, joint tenants.

Interest: Engineering, management.

FM blanketing results in overloading nearby receivers, rendering them useless for other stations in the general frequency vicinity. Maintaining a power-density level contour of 115dBu can prevent or reduce the blanketing effect. Graphs and equations help in determining whether the station meets the FCC limitation.

- The Birth of the VTR (page 158) By Peter Hammar, Ampex Museum of Magnetic Recording, Redwood City, CA

Key words: Vision radio, kinescope, quadruplex, color.

Interest: General audience.

Related: Hot kines: how kinescope transcription worked.

As of NAB '86, the VTR was 30 years old. This article discusses the evolution of products that eventually led to the modern VTR.

- Making History (page 166) By John Battison, **BE's** consultant on antennas and radiation

Key words: Whirling disk TV, Kerr cell/light valve, NTSC, UHF.

Interest: General audience.

Battison, a participant in broadcasting for 40 years, tells of the coming of television and color, AM clear channels, UHF TV and other areas of communications.

Station-to-Station (page 172)

- VTC Simplifies Video Signal Timing (Construct a video timing comparator for easier signal timing monitoring.)

Field Report (page 176)

- Audio Precision System One

JULY 1986

Video Emphasis Issue

FCC Update (page 8)

- FCC Modifies Quarterly List Requirements
- Review of FM Technical Rules Terminated
- First Come, First Served (for FM applications)
- EEO Rules Not Applicable to Broadcast Networks
- Recent Forfeiture Actions
- Clarification of Report on Remote Control
- Duplication (limitations on AM/FM) Deleted

Strictly TV (page 10)

- HDTV: What It Means, Part 1 (Why high-definition TV now?)

re:Radio (page 12)

- The FMX System, Part 4 (How effective is FMX on a practical basis?)

Satellite Technology (page 14)

- Analyzing Antenna Types (Prime focus, Cassegrain and offset antennas.)

Circuits (page 16)

- Synchronous AM in FM Systems, Part 1 (Bandwidth limiting vs. synchronous AM.)

Troubleshooting (page 18)

- Using Power Tubes, Part 4 (Blower maintenance and proper warming/cooling times.)

Management for Engineers (page 20)

- Managing the Management Transition (Different management philosophies mix for best results.)

- Video Waveform Monitoring (page 22) By Margaret Feisel, Tektronix, Beaverton, OR

Key words: Waveform/vectorscope monitors, system timing, sync pulse widths, system burst phasing, linear distortions, non-linear distortions, K factor, ICPM.

Interest: General engineering, video operators.

A tutorial look at waveform and vector monitors and their use in viewing the video signal. Well illustrated, the material considers normal monitoring functions and types of distortion that can be observed with both instruments.

- Sync Processing and Distribution (page 36) By Michael Guess, Grass Valley Group, Grass Valley, CA

Key words: Sync pulses, video scanning, video delay, sync generator types, system timing.

Interest: Video engineering.

Sync, an absolute requirement in the TV facility, must be correctly timed throughout the plant for effects or mixing of signals from different sources. A discussion of the types of sync-generator systems and other delay methods shows how signals can be timed.

- Understanding SC/H Phase (page 46) By David Jurgensen, Magni Systems, Beaverton, OR.

Key words: Color frame, 4-field/8-field sequence, subcarrier-to-sync phase.

Interest: Video engineering.

To achieve editing and effects without color or horizontal image shifting, RS-170A (an as-yet unofficial TV timing specification) is essential. This tutorial explains why the subcarrier and sync phase condition exists and why phase errors occur. Monitoring equipment and methods of system timing are discussed.

- The Folded Unipole Antenna (page 62) By John H. Mullaney, Mullaney Engineering, Gaithersburg, MD

Key words: Folded unipole, series-fed/shunt-fed verticals, half-wave folded dipoles.

Interest: Radio transmission system designers/technicians.

Related: Applications of unipole antennas for AM transmission from tall towers.

The folded unipole AM antenna can serve

the station that has inefficient or deteriorating arrays and grounding systems while those problems are being corrected or when an FM antenna is to be added. The theory of this old, but unique, antenna design is discussed.

- Integrating AM and FM Antenna Systems (page 74)
By Lewis M. Owens, Radio Engineering Services, Lexington, KY

Key words: Electrical tower shortening, RF-field efficiency, 5/8-wavelength antennas, FM on an AM tower.

Interest: Radio transmission system engineers/technicians/designers.

Co-location of FM and AM antennas poses special problems if the FM antenna is to be part of an AM directional array. Interacting factors and methods to counteract them are discussed.

- Directions in Video Editing (page 80)
By Steve Smith, Ampex AVSD, Redwood City, CA

Key words: Random-access editing systems.
Interest: Video technicians, producers/editors.

Related: Hardware needed for random-access editing.

The random-access editing approach allows various program edits to be considered before a recording is made. Laser/optical disk systems, multideck tape systems and disk-based audio technologies are applicable to random-access editing. Equipment for this style of editing exists for those who are willing to try it.

Field Report (page 84)

- Modulation Sciences Sidekick SCA generator

Field Report (page 94)

- Gentner Engineering SPH-4 telephone interface
Related: How the telephone works.

Station-to-Station (page 108)

- Remote Control System Operates Unattended
(Application software for Commodore C64 PC and interfacing for remote control of FM station.)

AUGUST 1986

Audio Emphasis Issue

FCC Update (page 8)

- U.S./Mexico to Relax AM Daytime Restrictions
- AM Applicant Preferences Reconsidered
- TV Stereo Rules Clarified
- Proposed LPTV Changes
- Minimal Commission Role in Home-Dish Scrambling
- Cable Restrictions Proposed

Strictly TV (page 10)

- MUSE...Demonstrated for HDTV, Part 2 (MUSE system described.)

re:Radio (page 12)

- Learning the Basics of AM Radio (Basics for radio engineers.)

Satellite Technology (page 14)

- Midsummer Potpourri

(Vehicular direction finding, sun outage season, private TVROs.)

Circuits (page 16)

- Synchronous AM in FM Systems, Part 2 (Effects of system bandwidth.)

Troubleshooting (page 18)

- Tuning for Minimum Synchronous AM (Trade-offs in FM tuning vs. synchronous AM.)

Management for Engineers (page 20)

- Can We Talk?
(Communications with station employees is essential.)

- Limiters, Compressors & Expanders

(page 22)

By Richard C. Cabot, Audio Precision, Beaverton, OR

Key words: Dynamics, steady-state, compression, limiting, expansion, unity gain, compression ratio, threshold level, turnover point, knee, noise gate, sense input, feedforward, feedback.

Interest: General engineering, audio operators.

A tutorial approach to audio compressor, limiter and expander systems. How each type of processor operates with numerous illustrations. Included is a discussion of problems encountered with audio processing and performance specifications to be sought.

- Noise Gates and Expanders (page 32)

NEED TO EDIT AUDIO FASTER?

We have the Solution...

**With Our
Edit Suite
Audio Mixers**



Model 616



Model 612



Model 608 (New for '86)

Special y designed for television, the ESAM from Graham-Patten Systems lets you edit audio the same way you do video... operating from the edit keyboard. Only the ESAM has a proven track record in edit system integration: for Ampex ACE, CMX, Calaway, Convergence, Grass Valley Group, and other editing systems that operate a production switcher. Tailored to the needs of every facility, ESAMs are offered in 8-, 12-, and 16-input models. Additionally, an electronically controlled programmable equalizer is available for the 12- and 16-input models. Here are just a few other innovative ESAM features:

- Operates like a video switcher with preset, program & preview busses
- Manual & full edit system control of source selection, transitions, & previews
- Separate electronics & control panels for maximum flexibility & compact size
- Delivers high quality demanded by recording & post production professionals

Yet there's more! For a complete brochure, call us toll free:



GRAHAM-PATTEN SYSTEMS, INC.
P.O. Box 1960, Grass Valley, CA 95945

Inside Calif.: (800) 422-6662 • Outside Calif.: (800) 547-2489 • TWX 910-333-6065

Circle (109) on Reply Card

By Mike Morgan, U.S. Audio, Nashville
Key words: Attack/turn-on, release time, threshold, range/depth, ratio/slope, gate, keying, expansion.

Interest: Audio engineering.

Elimination of unwanted noises, ground hum, background room noise and leakage from other sources is possible with noise gates. The concept of expansion of processing signals with long sustain and decay times is explained. Adjustments for gates and expanders are discussed.

- Distributing Audio Signals (page 38)
By Scott Hochberg, Logitek Electronic Systems, Houston

Key words: Active balanced, unbalanced outputs.

Interest: Audio engineering.

An audio DA isolates the loads driven from an audio source. Different configurations of audio DAs depend upon the system they must match. Quality measurements to be considered include THD, S/N and frequency response.

- Inside Power Amplifiers (page 48)
By Cal Perkins, Fender Musical Instruments, Portland, OR

Key words: Power supply regulation, phase-controlled backslope, switching power supply, resistive/reactive loads, class B/G/H amplifiers.

Interest: Audio technicians, engineering.

Related: MOSFET technology.

Audio quality can be ascertained only if the monitoring equipment provides a true representation of the signals. An investigation of audio power amps centers on power-supply requirements and output circuit configurations. Emphasis is placed on selection of safe operating areas for transistors and audio amplifiers of class B, G and H.

- Guidelines on Camera Maintenance (page 82)
By K. Jayaraman, Robert Bosch, Salt Lake City and Bernd Poth, Robert Bosch, Darmstadt, West Germany

Key words: Camera chain maintenance.

Interest: Studio engineers, camera/maintenance technicians.

Related: Color equations for NTSC, video pre-amplifiers.

A general list of cause/effect symptoms/solutions applies to any TV camera in use today. Sections of camera chains most likely to cause difficulties are included with symptoms and probable repairs required.

- TV Camera Optics (page 90)
By Carl Bentz, TV technical editor

Key words: Light transmission, prisms, convex, concave, focus, aberrations, aperture/f-stop, depth of field, back focus, relay lens, zoom, dichroics.

Interest: Camera engineers/operators, producers.

Related: Reflections, optical media, lens types.

Tutorial material on TV lens systems begins with optical basics, focal lengths, apertures and f-stops. The laws of light control reflection, refraction, optical materials and lens types. Selection of a zoom lens depends upon the application and lens focal-length range.

- Perceptions of Audio Perception (page 106)
By Terry Pennington, Rane Corporation, Mountlake Terrace, WA

Key words: Audio equipment evaluation.

Interest: Audio engineers and technicians.

Should equipment be selected based on subjective or objective analysis? Actually, what we believe we hear is more a function of what goes on inside our heads, rather than what occurs on the outside. Equipment designs should be based on good technological grounds and common sense.

Field Report (page 114)

- Harris Phase Fixer audio TBC

Station-to-Station (page 122)

- Testing High-Power Diodes
(A test circuit simplifies analyzing high-voltage, high-power diodes easily and safely.)

SEPTEMBER 1986

Audio-Video Control Equipment

FCC Update (page 8)

- Must-Carry in Effect
- (Transmission system) Modification Rules Reviewed
- New Rules on FM Upgrades
- FM Technical Rules Reviewed

Strictly TV (page 10)

- Advanced TV Displays the Big Screen, Part 3
(Three steps beyond today's NTSC.)

re:Radio (page 12)

- Learning the Basics (of AM radio), Part 2
(What are ATUs, and how are they used?)

Satellite Technology (page 14)

- Rating Earth-Station Systems
(Figure of merit and carrier-to-noise ratio specs.)

Circuits (page 16)

- Synchronous AM in FM Systems, Part 3
(Effects of bandwidth and deviation.)

Troubleshooting (page 18)

- Repairing Digital Systems, Part 1
(Finding bad ICs with a logical comparator.)

Management for Engineers (page 20)

- Develop a Style to Call Your Own, Part 1
(Good management skills are developed, not learned in school.)

- Wired for Stereo (page 22)

By David L. Bytheway, Robert Bosch/BTS Broadcast Television Systems, Salt Lake City

Key words: Voltage-matched, impedance-matched, transformer-coupled, long line capacitance, phase response, distortion, headroom, balanced/unbalanced, floating output.

Interest: General engineering, audio operators.

The normal approach to impedance matching of audio equipment is not always the ideal method. Voltage matching offers benefits to large audio systems, particularly for TV stereo. Developing a voltage-matched system includes routing switching.

- Planning for TV Stereo (page 36)
By Douglas Dickey, Solid State Logic, Oxford, England

Key words: Acoustics, air-conditioning, am-

plance, M-S stereo, SAP, monitors, console selection, sends, groups, processing.

Interest: Audio engineering, planning.

Related: M-S/mid-side mic placement for stereo.

Upgrading for TV stereo involves more than just a new console. Acoustics and monitoring must be considered in addition to the mixer. Inputs, outputs, auxiliary sends, group control, splits, submixes, processing systems and automation computers must be selected.

- The Real World of Stereo TV (page 54)
By Dennis Ciapura, Teknimax, San Diego, CA

Key words: Synthesized stereo, companded L-R, promotions.

Interest: Audio engineering, station management, programming.

Related: Responding to viewer inquiries.

Audience response aids in evaluating the conversion to stereo TV. As a result, the decision to convert is clouded by business concerns involving how much stereo and how to achieve it. Questions of stereo synthesis and companded L-R drawbacks are noted.

- Linear Keying in Video Production (page 62)

By Tom Goldberg, Ampex Switcher Division, Wheatridge, CO

Key words: Linear/non-linear keying, key clip, gain control, self key, components, high gain vs. low gain, external key.

Interest: Video engineers, production.

Related: Requirements of component switchers, key signals, key inserts, component keys.

Many video effects that we expect in television are from linear keying in the production system. The special requirements placed on the keyer and associated equipment are discussed.

- Wiring an Audio-Video Production Facility (page 74)

By Edgar Lee Howard, WOSU-TV, Columbus, OH

Key words: Equipment interconnection, wire loss, IR drops, hot/neutral power lines, noise suppression, signal distribution, balanced circuits, inductive coupling, active circuits vs. transformer coupling.

Interest: Studio engineers, production system designers.

A broadcast facility consists of interconnected black boxes. The process of linking them together creates pitfalls and results in noise and distortion. Operational amplifiers and other solutions are suggested.

- Microphones, From the Inside Out (page 92)

By Tim Schneckloth, Shure Brothers, Evanston, IL

Key words: Condenser, dynamic/moving coil, transducer, ribbon, piezoelectric, carbon, controlled magnetics, directional patterns, frequency response.

Interest: Audio engineers, production.

Tutorial material on microphones examines the different types available, how they work and their advantages and disadvantages. Directional characteristics of microphones may be important to a production. Choose the mic type suitable for the application.

- Planning Wireless Microphone Systems (page 104)
By H. Y. Miyahira and Donald A. Kutz, HM Electronics, San Diego, CA

Key words: RF frequency allocation, free-space loss, dropouts, diversity reception, space/polarization diversity, selection combining/maximal ratio combining, companding, pumping, intermodulation.

Interest: Audio engineers, production.

Wireless microphones can provide flexibility not achievable with wired mics. The RF nature of wireless systems introduces concerns to be accounted for during production planning. Avoiding interference while achieving the best possible performance is discussed in this in-depth look at the world of wireless.

Station-to-Station (page 134)

- Monitor Modification Eliminates Squeal (Circuit mutes squeal from TFT AM modulation monitor during calibration.)

OCTOBER 1986

Annual Salary Survey

FCC Update (page 8)

- Study Will Address Signal Scrambling
- ATIS Being Explored
- Standards for (cable subscriber terminal) Devices to be Amended
- Reversal on SCA Rules

Strictly TV (page 10)

- VBI, ATIS and More (Considerations for automatic transmitter identification system.)

re:Radio (page 12)

- Learning the Basics (of AM radio), Part 3

(ATUs and network components.)

Satellite Technology (page 14)

- Antennas to Conform to Standards (Directivity, Faraday rotation and scintillation fading.)

Circuits (page 16)

- Inside Digital Technology, Part 1 (Comparison of analog and digital circuitry.)

Troubleshooting (page 18)

- Repairing Digital Systems, Part 2 (Maintenance with a digital storage oscilloscope.)

Management for Engineers (page 20)

- Develop a Style to Call Your Own, Part 2 (Good management falls between the King Kong and one-of-the-guys approaches.)

- 1986 Salary Survey (page 22)

By Brad Dick, radio technical editor

Interest: All technical and management personnel.

The results of a questionnaire to **BE** readers are analyzed. The U.S. broadcasters are broken into three general market sizes, with separate information for radio and television and various job classifications. One way to look at the health of the industry, this data allows you to compare your pay with that of others across the country.

- Managing Technology (page 44)
By Frederick Baumgartner, KWGN-TV, Denver

Interest: All technical and management personnel.

The engineering staff communicates with engineers through discrepancy/trouble reports. Many of today's engineers emulate appliance operators, a result of cost containment measures. For many positions, a hard-core technical background is not needed.

- Developing an FM Processing Strategy (page 60)
By Dennis Ciapura, Teknimax, San Diego, CA

Interest: Engineering, program directors.

Audio processing must not become a 3-ring circus. Three key components control a radio station's product: program content, promotion and technical quality. The golden ears approach must be replaced with concrete market research and a planned strategy.

- Managing a Community Tower Site (page 68)
By Don Lincoln, Sutro Tower, San Francisco

Interest: Engineering, management, general.

Every broadcasting station requires an antenna, but not every station requires its own tower. Sutro, one of several major multiple-tenant tower sites in the United States, is the focus of this look at the advantages and disadvantages of common-site operation. Working with the community is as important as working with the broadcasters.

- Understanding Tower Loading (page 78)
By Jeffrey H. Steinkamp, Broadcast Electronics, Quincy, IL

Key words: Tension, torsion, shear, bending,

REPRINTS

Interested In ordering article reprints out of this or another issue?*

Reprints can be excellent learning tools for your technical staff and great marketing tools for your sales staff. Call or write Cynthia Sedler at Intertec Publishing Corp., P.O. Box 12901, Overland Park, KS 66212; (913) 888-4664.

***Minimum order 1,000 copies**

compression, overturning moment.

Interest: Engineering.

Related: Loading and structural codes.

Tower structures are as important to the broadcast engineer as are other equipment items at the station, yet, few have studied the basics of structural loading. The tower must survive a wide range of stresses, and the engineer must help to avoid reaching its breaking point. Some vocabulary of structural engineering is included.

- Controlling Ice Build-Up on Towers (page 92)

By Karl Renwanz, WNEV-TV, Boston

Key words: Superhydrophobia.

Interest: Engineering, management.

Tower icing often results in catastrophic structural failure. The 1,067-foot WNEV tower is the focus of experiments to understanding ice formation and possible methods of controlling such formation. Vibration, mesh covers and chemical paints are discussed.

- Maintaining an Antenna Ground System (page 102)

By Bud Stuart, Susanville, CA

Key words: Ground plane, soil conductivity, directional patterns.

Interest: Engineers.

Hidden from view, the antenna grounding system is an integral part of the antenna. Any deterioration of the ground plane may result in difficulty in maintaining an AM directional pattern or a changing signal coverage by the station. Along with background information, suggestions for maintaining the grounding system are included.

- Extending Videotape Life (page 112)

By Carl Bentz, TV technical editor

Key words: Formulas, contaminants, tension, bearing effect.

Interest: Audio, video, computer magnetic media users.

Related: Cassette considerations, static electricity, magnetic formulas.

In any recording application, success (or failure) is dependent upon the medium of recording, a magnetic-oxide-coated piece of plastic. Many of the ways to extend the life of recording tape are based on common sense. Information in the article is applicable to audio, video and data recording.

- Using Audio Patchbays (page 126)

By Lonnie Pastor, ADC Telecommunications, Minneapolis

Interest: Audio and video engineers and technicians.

Although many facilities use electronic switching systems, there are still many applications in which patchbays can be effective. The types of patching equipment and their applications are discussed.

Applied Technology (page 136)

- Improved CCDs Mean Better Picture Quality

By Larry Thorpe, Sony Corporation, Teaneck, NJ

Key words: Charge-coupled device, MOS sensor diodes, frame transfer, interline transfer.

Interest: General, video engineers.

What are CCDs and how do the different types operate in video camera applications?

Field Report (page 144)

- JVC KY-320 TV camera.

Station-to-Station (page 150)

- Designing With CMOS
(Ways to use flip-flops and other CMOS IC products.)

NOVEMBER 1986

Transmitter Preventive Maintenance

FCC Update (page 8)

- U.S./Mexican Pact Implemented
- Fairness Doctrine Scrutinized
- VBI Timetable Eliminated
- Compelling Need (Standard) Relaxed

Strictly TV (page 10)

- How to Measure Bandwidth
(The Sin(X)/X test signal.)

re: Radio (page 12)

- Learning the Basics, Part 4
(Basics for radio engineers.)

Satellite Technology (page 14)

- Teleports—An Earth Station for All Reasons
(What is a teleport and how does it work?)

Circuits (page 16)

- Inside Digital Technology, Part 2
(A look at logic gates.)

Troubleshooting (page 18)

- Repairing Digital Systems, Part 3
(Some advantages and disadvantages of the DSO.)

Management for Engineers (page 20)

- Look Before You Leap Into a New Job
(Negotiating for the benefits you want.)

- PREVENTING TRANSMITTER FAILURES
(page 24)

By Jerry Whitaker, editorial director

Key words: Logging, overheating, manometer, filament voltage, VSWR, overload, transients, single-phasing, coolant conductivity, PCBs.

Interest: General engineering, transmitter engineers, engineer trainees.

No single element of the station is more important than the transmitter. And, to the engineer, no task is more important than maintaining the transmitter. Covering the complete range of radio and TV stations and ENG/RENG or SNG vehicles, this story package contains information for every aspect of transmitter system maintenance:

- Routine Maintenance (page 26)

A detailed preventive maintenance program is described. Many transmitter failures can be prevented through regular cleaning, inspection and close observation. A maintenance checklist is suggested.

- Power Tubes (page 46)

Starting with filament voltage management, the parameters that affect reliability and component life of the power amplifier are examined.

- Preventing Failures (page 64)

The more vulnerable sections of the transmitter are identified and special preventive measures are suggested. Special consideration is given to ac-dc power supplies and the

RF output stage.

• Temperature Control (page 76)
Environmental control is a key factor in transmitter reliability and determining system mean-time-between-failures.

- Safety First (page 88)

Operating voltages and currents of the transmitter can be lethal if mishandled. The importance of safety in transmitter work is emphasized and the basics of first aid outlined.

- Comprehensive Preventive Maintenance (page 94)

Planning and implementing a comprehensive preventive maintenance (CPM) program is a must for top performance of all elements in a broadcast station.

- Video Monitor Setup (page 96)

By Joseph Kane Jr., Philips Test and Measuring Instruments.

Key words: Standards transfer, optical comparator, gray scale.

Interest: Video operators, general engineering.

Because final color adjustments to cameras are often made while the picture monitor is being observed, it is logical that the reference monitor must be adjusted for the correct color temperature. A procedure for this adjustment with a color analyzer instrument is suggested.

- Choosing a Digital Multimeter (page 104)

By Patrick Chu, Beckman Industrial Corporation, Brea, CA

Interest: Engineers, maintenance technicians.

To make a technician's time most efficient, it is essential to specify and buy proper test and diagnostic equipment. The digital multimeter (DMM), is discussed and applications for various features are explored.

- Getting a Handle on ESD (page 120)

By Jess Kanarek, Wescorp, Mountain View, CA
Key words: Static electricity, non-nuclear deionizer, anti-static, static dissipative.

Interest: Operating and maintenance technicians/engineers.

Electrostatic discharge (ESD) presents more than just a potential for damage to today's electronic components. Suggestions for prevention of electrostatic potential build-up are discussed.

Field Report (page 130)

- OmniLogic Omni 4 logic analyzer

Applied Technology (page 146)

By Michael Arbutnot, Ampex AVSD, Redwood City, CA

- Extending Multigeneration Limits

Key words: Noise, velocity compensation.

Interest: Video technicians, engineers.

The number of generations possible with type C VTRs has been considered limited by certain signal degradations thought to be uncontrollable. A better understanding of the sources of degradation shows that applications of digital technology will allow many more generations in type C post-production.

Station-to-Station (page 150)

- Enter the World of CAD PC Boards
(Through computer-aided design software, you can quickly and accurately develop custom PC boards.)

Technology Forecast for 1987

FCC Update (page 8)

- New Rules for Broadcast Auxiliary Stations
- Main Studio and Program Origination Rules Under Study
- Minority Preference to Receive Further Legal Scrutiny
- Deregulation of Sampling System and Partial Proof Specs Affirmed

Strictly TV (page 10)

- ΔT vs. ΔF
(The concept of the spectrum analyzer.)

re: Radio (page 12)

- Learning the Basics, Part 5
(Pattern contours and parasitic radiation.)

Satellite Technology (page 14)

- More MSN Units Mean More Interference
(Steps to take in remote location satellite linking.)

Circuits (page 16)

- Inside Digital Technology, Part 3
(Multivibrators as memory devices.)

Troubleshooting (page 18)

- A Logic Analyzer Can Give You the Edge
(What logic analyzers are, what they do.)

Management for Engineers (page 20)

- If It's Goodbye, Make It Good
(A case study of how one manager handled the termination of an employee.)

Updating NBC Burbank (page 24)

By Jerry Whitaker, editorial director
Interest: General engineering, planning.

Renovating the TV studio is a large undertaking, especially when it involves a major network. Facility time is in great demand, making the job even more critical. Working within limited budgets and cost justification of purchasing are examined in facility planning and renovation of the NBC Burbank studios.

Updating the AFRTS (page 48)

By Peter Adamiak, National TeleConsultants, Glendale, CA

The Armed Forces Radio and Television Service has a responsibility of serving an audience located in 14 countries and 15 territories and possessions. The new facility required modern equipment and acoustic treatments.

Updating the Voice of America (page 68)

By Richard Dempsey, New York architect, and Michael Kelly, Hamilton Communications Consultants, Orange, NJ

The task was to update the VOA, a 24-hour operation that must air 1,300 hours of programming per week in 42 different languages. The challenge was to renovate existing space and add new studios without impacting the normal operating schedule.

State of the Industry Survey (page 82)

By Brad Dick, radio technical editor

Based on a survey made exclusively for this

issue, an examination of budgeting and new equipment purchases for radio and television provides a cross-industry view of the broadcast field. A comparison of the types of expenditures being planned by others allows stations to determine if they are keeping up with the pace of technology.

Inside Fiber Optics (page 96)

By Elmer Smalling III, BE's consultant on cable systems, Jenel Systems and Design, Dallas; and Ned Soseman, TV technical editor

A tutorial on fiber-optic materials and the vocabulary of the optical fiber technology provides a better understanding of transmission via glass. Free from many of the problems of transmission via wire cables, fiber optics is seeing increased application in communications. Broadcast uses are discussed.

Distributing Video via Fiber Optics (page 106)

By DeWayne Gray, National Video Network
Key Words: Codec, point-of-presence.

Interest: Facilities planning.

Fiber-optic transmission offers advantages that could make it the transportation link of the future, perhaps replacing satellite linking. FO components are discussed.

Field Report (page 122)

- Shure FP-11 audio distribution amplifier

Station-to-Station (page 136)

- A Tally System Solves Interface Problems
(Rebuilding the station's tally system.)

||:~(=))||

Ask for our
FREE CATALOG
OF PROFESSIONAL
Sound RECORDING
& DUPLICATING SUPPLIES



Polysette
Blank-Loaded
AUDIO CASSETTES

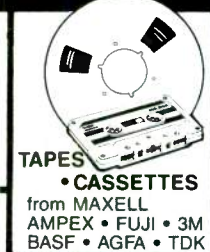

TAPES
• CASSETTES
from MAXELL
AMPEX • FUJI • 3M
BASF • AGFA • TDK



CASSETTE BOXES
LABELS • ALBUMS



ACCESSORIES
from NORTRONICS
3M • BASF • EDITALL

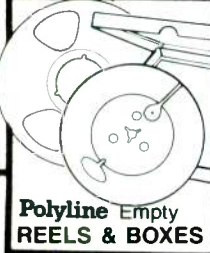

Polyline Empty
REELS & BOXES



NAB BROADCAST
CARTRIDGES

Switchcraft Connectors
Canare Microphone Cable
Connectronics Cable
Telex Cassette Copiers
Signature Prod. Music Library

Polyline Corp.
1233 Rand Rd. • Des Plaines, IL 60016
(312) 298-5300



WHATCHA-MA COLLET.

What the heck's a COLLET?
Just the best designed, most dependable and stylish general purpose knob in the world. That's what.

If you want a knob that will never break, melt, corrode, or shake loose; a knob with exquisite tactile feel; a balanced, sculptural, classic knob, then you want Selco's COLLET knobs.

Let us impress you. Our COLLET'S matte-finish, precision-molded 94V-2 nylon body is permanently bonded to a solid brass collar. This retains a machined, split-base threaded bushing, also solid brass, that slips over your control shaft and tightens from the front with a special brass nut. Finally, a nylon cap in one of seven decorator colors snaps on the front.

Simply superior. Not even a set screw mars its elegant exterior. And Selco's COLLETS come in a full range of sizes and types, with all the accessories, too.

If you're a discriminating designer who wants the respect of his most demanding customers, then furnish your equipment with Selco's COLLETS. The only thing modest about them is the price. As low as 39 cents each in OEM quantities.

Send for our full-color catalog and a sample knob today. You'll collet fantastic!



selco
PRODUCTS CO.

7580 Stage Rd. • Buena Park, CA 90621 • Phone (213) 921-0681, (800) 25-SELCO • Telex 655457.

Circle (114) on Reply Card

Circle (115) on Reply Card

Spectrum analyzer

Tektronix has introduced the TEK 2710 10kHz to 1.8GHz new generation VHF-UHF spectrum analyzer. The portable unit provides a wide 5MHz IF bandwidth filter; 10^{-5} frequency accuracy; 4-trace digital storage; full marker/delta marker control and a comprehensive time domain measurement capability; resolution bandwidth down to 3kHz; on-screen dynamic range is 80dB; and vertical scaling is selected from 10, 5 and 1dB/div with reference level units of dBm, dBmV, dBV, dB μ V, dB μ W and dB μ V/m. Sensitivity is -117dBm at 3kHz RBW. A built-in pre-amp may be switched into the conversion chain that will boost sensitivity to -129dBm.

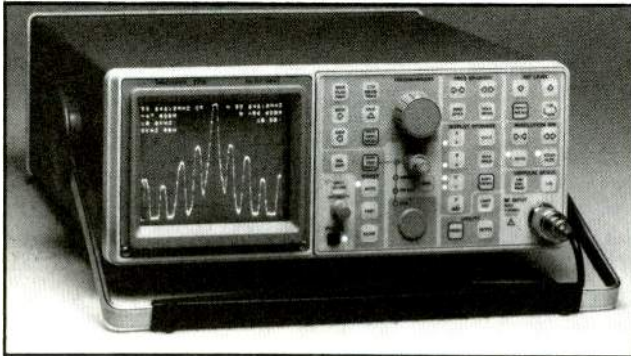

Circle (350) on Reply Card

Effects processor/reverb enhancements

Eventide has introduced enhancements to its SP2016 effects processor/reverb. A MIDI interface board puts SP2016 program selection and parameter control under MIDI command. The reverb's internal ROM program storage capacity is increased and relocated. The unit's top-mounted ROM sockets are freed for additional optional ROMs, such as the Vocoder, stereo synthesis and auto panner programs.

Circle (351) on Reply Card

Protection system

Control Concepts has introduced the IC Series of double-protection Islatrol active-tracking protection systems with both normal and common mode power-line protection in one package. The series suppresses destructive normal and common mode spurious transients present at any point on the sine wave of the ac power line. The series is designed to attenuate the IEEE 587 Category A Ringwave and Category B impulse waveform standards without failure or significant deterioration. It is available from 1A to 30A at 120Vac and 240Vac.

Circle (352) on Reply Card

Audio mastering tape/machine control system

3M has introduced the following products:

- The 3M Scotch 806, 807, 808 and 809 audio mastering tapes replace the Scotch 206, 207, 208 and 209 products. The 806 tape incorporates a 1½ mil base and combines the high-output capability (+8dB) with improved print-through characteristics and has an S/N of 74dB. The 807 has a 1 mil base. The 808 provides -60dB print level and a 3dB improvement in signal to print. The 809 incorporates a 1 mil base.
- The 422 SMPTE machine control system provides remote control of telecine-type devices. The complete system consists of one or more control panels, one or more interfaces, all con-

nected to a bi-directional, digital, serial data line. Each unit is housed in a rack-mount enclosure. It comes in an 8-button or 20-button version, with configurable software and illuminated pushbuttons. The system functions as a stand-alone machine or can be linked with 3M A-V routing switchers.

- The Series H 32 x 32 routing switcher matrix provides one video and one, two or three audio switching levels in the same enclosure. The switcher offers no internal maintenance and I/O ports for RS-232 computer terminal control. Switchers are controlled by the model 6600 microprocessor controller or a 6500 controller.

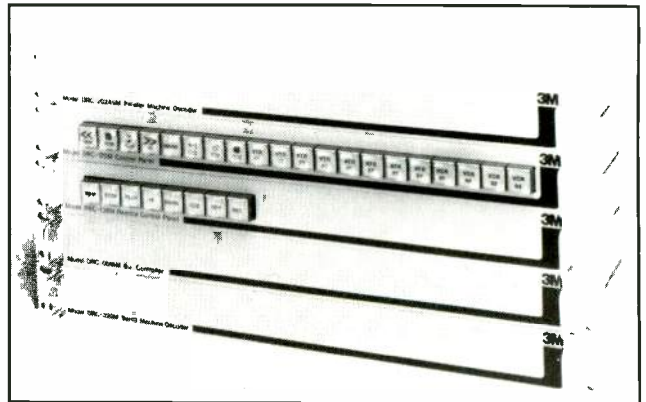

422 SMPTE machine control system
Circle (353) on Reply Card

Mirage enhancements

Quantel has introduced four major enhancements for Mirage:

- The Turbo package enhances the unit's control system, including a new curving facility, independent control of object and reference axes, and mosaic and posterization effects.
- The Starlight package adds real time light sourcing and shading.
- Contour is a new shape-creating system that enables the operator to use a touch tablet and electronic stylus to create sections through the shape required.
- The Combiner allows the unit to become part of a larger digital effects network and a part of the Quantel Digital Production Center.

Circle (354) on Reply Card

Switchers/mixers/color-bar generator

Sierra Video Systems has introduced the following products:

- The Series 8/16 computer-controlled matrix style routing switchers based on 8 input by 8 output or 16 x 4 video, audio or relay crosspoint modules. Video is wide bandwidth (-3dB at 30MHz) and is switched during the vertical interval. Audio is balanced at levels up to +24dBm. The relays are DPDT for switching data and intercom. The system can be configured for up to eight levels.
- The BetaMate CTDM dub switcher installs between the Betacam playback machines and the component video production switcher. The record machine also connects to the BetaMate. The switcher breaks out the component signals from the 12-pin cables to BNCs for connection to the switcher. When a playback machine is selected for a dub, a direct connection is made to the record machine. This allows the dub to take place in the compressed time division multiplexed mode.
- The CBG-1 component video color-bar generator is available in either RGB or Y/R-Y/B-Y. The standard color-bar signal is split field bars (RS-189). Gen-lock capability is standard and the generator is locked to horizontal rate to

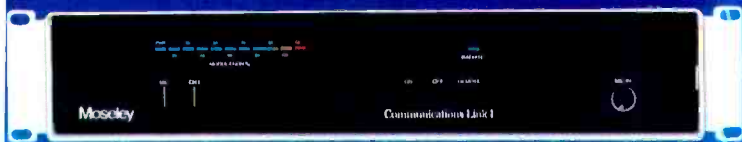

CL-100

Moseley's new CL-100 series transmitter/receiver system offers an economical alternative to aural subcarriers and dedicated telephone lines for conveying control or telemetry data between studio and transmitter locations. The CL-100 system provides for independent control or telemetry while freeing subcarrier channels for other uses.

The Cost-Effective Data Solution

Features

The voice/data communications link system, operating on a Group P channel (450-456 MHz), features a 1- or 10-watt output transmitter for varying lengths and antenna combinations; the high-sensitivity receiver has excellent adjacent channel rejection. The CL-100 system is capable of data transmission rates of up to 9600 baud with optional modems and operates on 120/240 VAC and/or 13.6 VDC.



Circle (116) on Reply Card

Moseley

Moseley
Associates
Incorporated

111 Castilian Drive
Santa Barbara, CA
93117-3093

a
Flow General
Company

Phone 805 968 9621
Telex 658448
Cable: MOSELEY
FAX 805 685 9638

eliminate audio-video crosstalk. The tone is a balanced output adjustable from -10dBm to +24dBm of either 500Hz or 1kHz.

• The CIK-1 component video keyer/mixer uses wideband linear closed loop multipliers to either mix from one component video source to another or to key one component video source over another. It also can mix to a key. There is a GPI interface for external initiation of transitions.



Series 8/16 routing switcher
Circle (355) on Reply Card

Monitor

JBL Professional has introduced the Control 1 monitor, a small monitor with a forward sound character. The response is smooth and extended but features a broad rise in the upper midrange. The monitor can be used in close proximity to a

video monitor because the high- and low-frequency transducers are magnetically shielded. Other features include a 2-way system that incorporates a 3/4-inch tweeter, a 5-inch woofer and a high-performance dividing network; impedance of 4Ω; and protection circuitry that minimizes distortion while allowing high-power handling.



Circle (356) on Reply Card

Software

Audio Kinetics has issued a free update of software to all existing customers of the Eclipse System. It allows a more comprehensive loop editing mode, recall and event listings that give more flexibility to users.

Circle (357) on Reply Card

We've taken apart half a million videocassettes and saved our customers 2 million dollars



Before we'll reload a 3/4" u-matic videocassette we take it completely apart and rebuild it inside and out. We replace wiper flaps, friction pads, tape guides and leader — everything that's needed to make the cassette test as good as new. Only then will we reload it with new 3 M videotapes or other major brands. If we can't rebuild it we won't reload it.

Coarc also loads new cassettes with broadcast quality videotape for Betacart and 3/4" cart systems.

CoarcVideo™

Custom Loaded Videocassettes (518) 672-7202
P.O. Box 2, Route 217, Mellenville, New York 12544

3/4" RELOADING □ PROFESSIONAL VHS & BETA □ 1/2" AND 3/4" CART CASSETTES

Circle (117) on Reply Card

SESCOM, INC.
"the audio source"
FOR ALL OF YOUR AUDIO NEEDS
2100 Ward Drive Henderson, NV 89015 U.S.A.
CALL TO RECEIVE A COPY OF
OUR POCKET-SIZED CATALOG
CATALOGS & ORDERS: (800)634-3457
OTHER BUSINESS: (702)565-3400
TWX(910)397-6996

Circle (118) on Reply Card

PRECISION MAGNETIC TEST TAPES



Standard Tape Laboratory, Inc.
26120 Eden Landing Road #5, Hayward, CA 94545
(415) 786-3546

Circle (122) on Reply Card

ISOLATION WITHOUT DEGRADATION
The Best Audio Transformer

- Wide bandwidth
- No overshoot or ringing
- Flat group delay
- Low hysteresis distortion

jensen transformers
INCORPORATED

10735 Burbank Blvd. • North Hollywood, CA 91601
(213) 876-0059

Visitors by appointment only. Closed Fridays

Circle (151) on Reply Card

Want more information on advertised products?
Use the Reader Service Card.

Surge-suppressing products

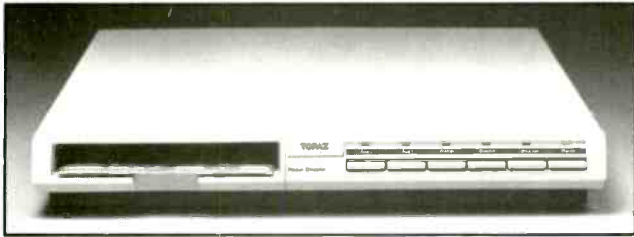

Topaz has introduced the following products:

- The Surgebuster Plus is a multi-outlet power strip that provides a central ac connection for up to six electrical devices while protecting them against voltage spikes, power surges and EMI/RFI disturbances. The strip features six fully protected and grounded outlets; reduces spikes as large as 6,000V; inter-outlet protection feature; and operates in 50Hz or 60Hz power.
- Power Directors are multi-outlet power control centers that protect personal computer systems against voltage spikes, power surges and EMI/RFI disturbances. It features outlets for up to five computer system components. Each component plugs into the back of the unit. The center reduces power-line and inter-outlet spikes; prevents surges from reaching a computer through the modem; and employs a low-pass filter. It is available in a Media Storage Slot model, Data Director model or Print Saver model.

Circle (358) on Reply Card

Cart recorder/producer; time-code reader



CTM-10 cartridge recorder/reproducer

Otari has introduced the following products:

- The CTM-10 NAB-format cartridge recorder/reproducer features a record-phase compensation and HX-Pro bias modulation. It uses both A and AA size cartridges; has transformerless balanced inputs and outputs; LED tape timer with auto-reset; and a built-in headphone amp. The unit provides mono and stereo playback "Life +" heads with replaceable crowns.

**CDE CORNELL
DUBILIER**

Mica Capacitors

LARGE

STOCK

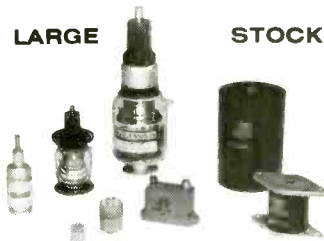

**VACUUM
CAPACITORS**

JENNINGS

SURCOM ASSOCIATES, INC.

305 Wisconsin Avenue
Oceanside, California 92054
(619) 722-6162

Circle (119) on Reply Card

THE ULTIMATE TIMING TOOLS FOR THE TELEVISION INDUSTRY

VIDEO LEVEL AUTOMATICALLY MAINTAINED AT UNITY!



ASD 2000
25-2125 ns

Infinite control throughout entire range via switches and fine trim. Ideal for remotes, matte timing. Also available in 20-1120 ns range. Rackmountable - 2 units in 1 RU frame.



ESD 500
40-540 ns

The ideal unit for timing new installations. A must for every lab. Microprocessor control: front panel pushbutton or remote, UP/DOWN, FAST/SLOW, 1 ns resolution. Precise delay indicated on LED readout. Also rackmountable.

broadcast video systems ltd.

1050 McNicoll Avenue, Agincourt, Ontario M1W 2L8
Telephone: (416) 497-1020 Telex: 065-25329

Circle (120) on Reply Card

Reconfirm your involvement
in the
broadcast industry!
Renew your subscription
today.

FREE 32pg Catalog & 50 Audio/Video Applic.

PHONO, MIC, PWR SUPP, EQ,
TRANS, ACH, TAPE, VIDEO,
LINE, OSC

Stereo/Mono Pwr Amp.

8-in/2-out, 12-in/4-out, 18-in/4-out
Video & Audio Dist. Ample. TV Audio & Recd Prod Consoles

OPAMP LABS INC (213) 934-3566
1033 N Sycamore Av LOS ANGELES CA, 90038

Circle (121) on Reply Card

THE TRUE MEASURE OF PERFORMANCE

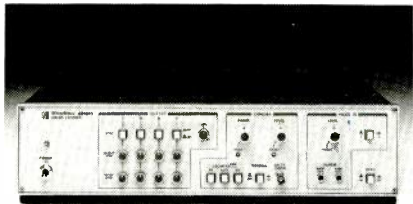

ASACA/SHIBASOKU CD10A1 Color Decoder

The CD10A1 is the New World Standard Color Decoder for use with all systems to decode a composite signal to RGB.

- Switchable Comb Filter.
- Color is demodulated on the I & Q Axes.
- 2 signal inputs selectable from the front panel.
- Alarm indication when the signal is higher or lower than the rated value.
- Sync may be independently added to R,G,B, and Y output signals.
- 10 Output signals are available: RGB, Y, I,Q,R-Y,B-Y, Blanking, Burst Flag, Sync, Sub Carrier, and Y + Sync.
- Available in NTSC, PAL, SECAM.

Measure your performance with the best.

ASACA/SHIBASOKU CD10A1.
The color decoder with character.

For complete specifications, write:

ASACA

ASACA/SHIBASOKU CORP.
OF AMERICA

12509 Beatrice Street, Los Angeles,
California 90066

Sales, Service:
(800) 423-6347 • (213) 827-7144

Circle (123) on Reply Card

- The EC-201 time-code reader features 1/20 to 60X play-speed reading, 40 hour continuous use on battery power and reshaping circuitry on the loop output. Other features include: full hexadecimal user bits display; -10dBV to +10dBV input range; balanced XLR inputs/outputs; ac adapter; belt clip and batteries.

Circle (359) on Reply Card

Consoles

Broadcast Electronics has introduced a 350A series of audio consoles for on-air or production use. Two models, the stereo 10S350A and the monaural 10M350A, are available. The consoles feature vertical faders with detent drop cues at the bottom travel of each control. Mixers No. 1 through No. 8 accept two inputs each while mixers No. 9 and No. 10 accept three inputs. Mixer outputs are fed separately or simultaneously to the dual outputs through a network of FET switches. Independent program and audition metering is centered on the front panel.

The 10S350A includes separate right and left channel meters for both the program and audition channels. The 10M350A has two meters. Both models feature modular plug-in electronics, full-system monitoring with headphone output, a cue/intercom system and multichannel muting capability.

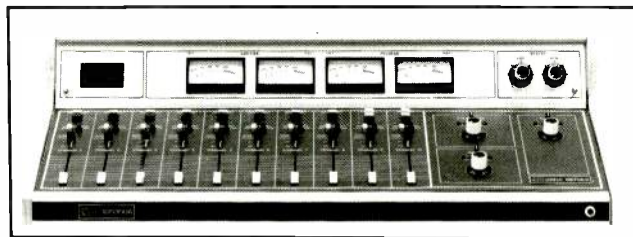

Circle (380) on Reply Card

Interface unit

Tele-Engineering has introduced the Ad-Log Auto-Mate interface, an add-on, rack-mountable unit that communicates with the Ad-Log verification unit to retrieve and store spot logs for up to six channels. Data can be retrieved locally by connecting a terminal or computer directly to the unit's RS-232C port, or remotely through the use of telephone or RF modems.

Low-power CMOS circuitry allows the unit to continue storing even if the power has failed. Battery backed-up random access memory can store up to 6,000 logs, which include the date, time, spot ID and channel number. A key-operated switch prevents the unit from accidentally being turned off.

Circle (381) on Reply Card

Graphic product enhancement

Robert Bosch Video Equipment Division has introduced an enhancement to its graphics product line. The capability to output pictures at variable resolutions up to 4,000 lines for use in film, slides and print applications is an off-line feature of the Sun 3/52 interfaced via Ethernet to the FGS-4000. Output is stored on 9-track magnetic tape for interface to various slide and print devices.

Circle (382) on Reply Card

Equipment protectors

MCG Electronics has introduced the Surge-Master Avalanche 3200A and 4200A series. Equipment damage is prevented by clamping ac line transients directly at the equipment input. The unit's backup consists of 2,000J of metal ox-

ide varistors separated by a fuse. The varistors are in standby mode ready to protect equipment from a catastrophic power surge. The unit consists of matching heavy-duty diodes to directly shunt transients around the sensitive load in less than 1ns. The unit employs a triple redundant approach and has front-panel status monitoring lights that indicate the status of all the units at all times.

Circle (363) on Reply Card

Sine wave inverters

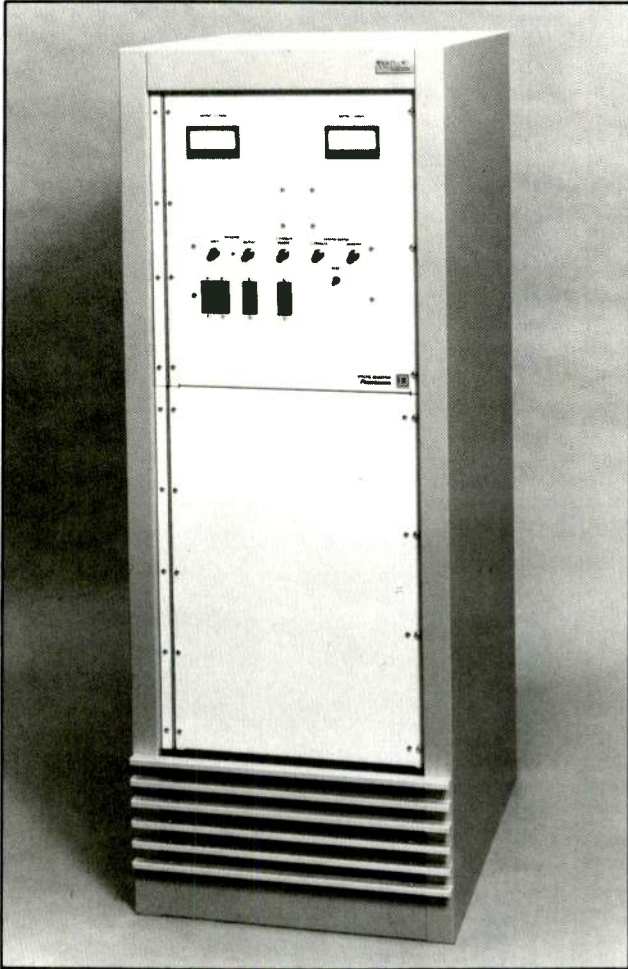

Powermark has announced the dc to ac sine wave inverters for use in providing blackout protection to broadcast systems. Equipped with static transfer switches, these inverters can be combined with batteries and battery chargers to form uninterruptible power systems that can operate off-line or on-line. The inverter is equipped with a static transfer switch that automatically transfers the critical equipment from the inverter to the ac line if the battery voltage falls below a usable level. The transfer switch also features 4ms forward transfer, enabling the inverter to operate off-line while still providing complete blackout protection. The inverter is equipped with a toggle switch that permits easy selection of either on-line or off-line operation. The inverters protect against overcurrent, reverse polarity, overvoltage and undervoltage. They provide ac power from 24Vdc or -48Vdc sources and are available in models from 2kVA to 10kVA.

Circle (364) on Reply Card

Perfect Timing

PROGRAMMABLE CLOCKS



750 E SERIES

One or Two Events,
Thumbwheel Programming
\$341-430

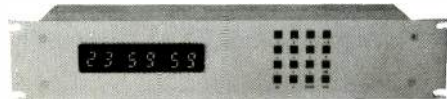

720 SERIES

10 Events,
Micro-Processor Based
\$845-1150



780 SERIES

Up to 96 Events Stored
in Random Access Memory
\$1313-1654



ES 790

1000 Events, Microprocessor-
Based, 32 Output Channels
\$2300



(213) 322-2136

142 Sierra St., El Segundo, CA 90245

Circle (124) on Reply Card

Voltage-controlled line amplifier

SCIP Electronic Systems has announced the model 1440 TGC voltage-controlled line amplifier. Features include: 120dB of dynamic range, +24dBm output at 600Ω loading, less than 0.02% maximum THD and IMD, on-card voltage regulation and supply fusing, and output short-circuit protection. The electronically balanced and servoed circuit follows a 10dB per volt control law and provides up to 12dB of gain. Differential gain tracking between cards is within 0.3dB. Each card has two audio inputs for easy stereo to mono conversion. The transparent gain control measures 2.75"x1"x9.5", and is designed for use in the optional 2RU high card cage.

Circle (365) on Reply Card

Signal processor

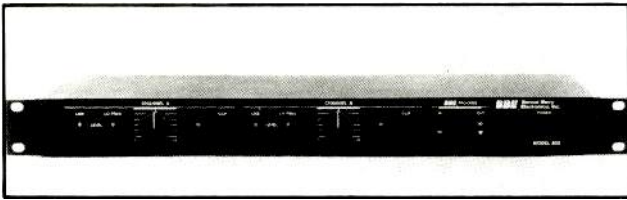

Barcus-Berry Electronics has introduced the BBE 802 multi-band, program-controlled signal processor. It uses high-speed dynamic gain-control circuitry; increases voice intelligibility by eliminating frequency-band masking. The unit is packaged in a rack-mounted chassis. Swept frequency response is essentially flat from 20Hz to 20kHz in the bypass mode. In the process mode, high-frequency response is controlled by program. Amplitude changes are developed only in direct response to application of a spectrally diverse program signal.

Circle (366) on Reply Card

Satellite video source identifier

QSI Systems has announced the Star-2400 satellite video source identifier. It uses the multiplex technique and will display 24 characters consisting of the 10-digit telephone point-of-contact, transmitter license number, user alphanumerics and a 2-digit operator number.

Circle (367) on Reply Card

Time-code slate

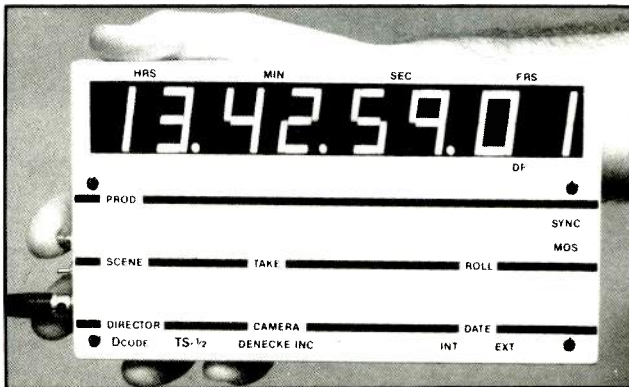

Denecke has introduced the DCODE TS-1/2 time-code slate, a modified mini version of the DCODE TS-1. It features a high-intensity 1-inch LED readout, which displays SMPTE/EBU time code, user bits, and drop-frame status with switchable high and low brightness. The unit has a button-activated display function that allows 1-handed operation. Specifica-

tions include input of -20dB to 35dB at 10k and power of 8V to 16Vdc.

Circle (368) on Reply Card

Stereo generator

Inovonics has announced the 705 FM stereo generator with provisions for FMX, the coverage-extension system. The generator features digital synthesis of subcarriers and pilots, internal peak overmodulation protection, selectable pre-emphasis, and 7-pole active/elliptic input filtering with proprietary overshoot control circuitry. The generator yields full program modulation without need for internal or add-on composite signal processing. Audio response is flat between 25Hz and 16kHz, and stereo separation exceeds 55dB over the entire range.

Circle (369) on Reply Card

Microprocessor system

Union Connector has announced computerized control of its UNITROL dimmers, made possible through the use of a Commodore 64 microcomputer and STAGEPRO hardware/software package. The package features 24 scene presetting in memory, simple sequential chasing, 100 step-light resolution in accordance to the IES square law and diskette storage of scenes programming is done in BASIC and is not copy-protected.

Circle (370) on Reply Card

Fluid head



Innovative Television Equipment has announced the ITE-H70 heavy-duty fluid action head, designed to support (with Mitchell base adapter) camera loads to 65 pounds. Weighing 19 pounds, the fluid head is equipped with a 150mm claw-ball base, adjustable quick-release camera plate, spirit level and dual-control handles. The fluid head interfaces

with the ITE-T70 tripod.

Circle (371) on Reply Card

Velcro cable ties

Seam-Tech has announced the RIP-Tie velcro cable ties for video production applications. A nylon wire tie attaches the tie to the cable. Connectors need not be removed and no soldering is required. It is available in six sizes and is designed for a variety of cable lengths and gauges. The ties prevent cable kinks and are easy to find on the cable and pull free with one hand.

Circle (372) on Reply Card

Rain/snow sensors

Environmental Technologies has introduced the CIT-5 and CIT-6 sensors that convert both snow and ambient temperature information into logic signals for snow melting and rain deviator control systems. Combining temperature and snow sensing in a single sensor improves sensing accuracy and simplifies installation.

Sensors provide logic outputs for precipitation and the operating and lock-out temperature thermostats. The solid-state thermostats have negligible hysteresis. Individually calibrated sensors improve accuracy. High sensitivity permits the detection of frost and dew under most conditions.

The CIT-5 has operating and lock-out temperatures preset at 38°F and 17°F respectively.

Circle (373) on Reply Card

Character generator

Knox Video has introduced the K100 Chromafont II high-resolution character generator. The unit features eight fonts and a video-processing section has been added to provide sharpness. The generator can be installed stand-alone, downstream of a video source or as an input to a production switcher. It automatically gen-locks to almost any NTSC or PAL signal.

Circle (374) on Reply Card

Multitrack direct-to-disc system

New England Digital has introduced the first multitrack direct-to-disc system. It is available in 4-, 8-, or 16-track configurations with either 13 or 26 minutes of recording time per track. It features 100kHz 16-bit/stereo sampling digital recording, instant random access and quiet passive filters. It is used in conjunction with the company's Synclavier digital audio system.

Circle (375) on Reply Card

Betacam cassettes

The Raks Corporation has introduced a professional quality 1/2-inch 30-minute Betacam cassette tape. Features include a precision-engineered ABS anti-static plastic shell, stainless steel pins with double-action clamper and stainless steel spool springs for tension control. A cobalt oxide makes the tape damage resistant.

||:~(-))||

Circle (376) on Reply Card

- Audio Follow Video
- Balanced Stereo Audio
- Rack Mount 19" x 1-3/4"
- BNC Connectors - Video
- Multiple Edge-Board Audio Connector
- Centralab Switches - Interlocking
- Bifurcated Silver Contacts
- Legend Strip
- Unswitched Video Terminated - 75 OHMS
- Unswitched Audio Easily Terminated
- No Signal Loss
- No Signal Degradation
- Cross Talk Better Than -60db
- No Power Required
- Simple Construction - Long Life
- Light Weight - Under 5 lbs.



THE IDEAL WAY TO SWITCH MONITOR FEEDS
IN A PROBLEM-FREE, ECONOMICAL MANNER.

10 x 1 PASSIVE SWITCHER

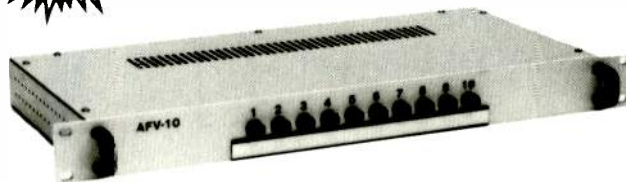

LOW COST
\$295.00

Model AFV - 10

H.M. DYER Electronics, Inc.

48647 Twelve Mile Road Novi, Michigan 48050 (313) 349-7910

Circle (111) on Reply Card

CHIPS DAVIS
LEDE DESIGNS, INC.

**Acoustics for Stereo
Facility Design
Consultation**

(415) 459-2888

Circle (112) on Reply Card

Want more information
on advertised products?
Use the
Reader Service Card.

VIDEO DISTRIBUTION AMP FEATURING:

VBB-1 Amplifier in a chip

Power 115/220 VAC

Size 4" x 4" x 2"

*Apert
Herzog*

408-225-1425

99.95*

*Quantity Price

Circle (113) on Reply Card

Pat Birch and **Paul Distefano** have been appointed to positions at Comprehensive Video Supply, Northvale, NJ. Birch is assistant sales manager in the East, a newly created position. He will continue to represent the company's product line in his current territory of New York and northern New Jersey. Distefano is sales representative, and will assist Birch.

David J. Tearle has been appointed southwest lighting consultant for LTM Corporation of America, Hollywood, CA. He will be responsible for Texas, Arizona, New Mexico, Kansas, Oklahoma and some Los Angeles accounts.

John F. Kenyon has been appointed general sales manager at Pacific Recorders & Engineering, Carlsbad, CA.

Alfred J. Menozzi has been appointed vice president of marketing and sales at dbx/ADC, Newton, MA.

Michael J. Pavlinch has been named director of graphic design at Quanta Corporation, Salt Lake City. He will assume

responsibility as the key in-house graphics/art designer.

David Ruttenberg has been appointed sales manager at NEOTEK Corporation, Chicago.

William E. Losch has been named director of marketing for ITT Cannon's commercial interconnect division, Fountain Valley, CA. He will be responsible for sales, pricing, customer service and strategic market planning.

O. J. Hanas has been appointed vice president in charge of the newly formed Advanced Telecommunication Products Division at LNR Communications, Hauppauge, NY.

Robert G. Griffiths, vice president of sales for Telemet, Amityville, NY, a division of Geotel, has been awarded a Ph.D. in business administration from California Coast University. His 82-page dissertation was an empirical study of fiber-optic applications in a broadcast studio.

Mike Kirk has been appointed

marketing manager for broadcast products at EEV, Elmsford, NY. He will be responsible for marketing and servicing klystron amplifiers for UHF TV transmitters, broadcast tetrodes for AM and FM transmitters, and the company's line of Leddicon and Vidicon camera tubes for broadcast TV cameras.

Robert B. Bonney has been named chairman of the board at EECO, Santa Ana, CA. He will fill the vacancy created by the death of Burgess Dempster.

Bill Franklin and **Fred Buehler** have been promoted to positions at Fidelipac Corporation, Moorestown, NJ. Franklin is director of engineering. Buehler is customer service manager.

Hector Martinez has been named to the new position of marketing manager at JBL Professional, Northridge, CA. Martinez will focus on the professional musician, audio and recording markets. He will work with the JBL dealer network loudspeakers, UREI electronic products and Soundcraft mixing consoles and tape machines.

!:->)))

FEEDBACK STOPPED DEAD IN ITS TRACKS

THE GSP-1000E TURNTABLE ISOLATION SYSTEM

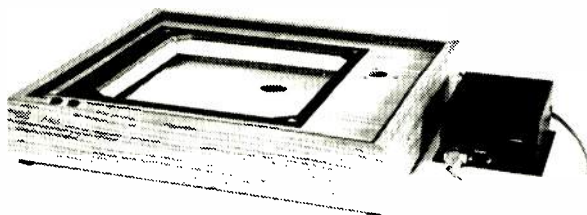

FOR TECHNICS SP-10, SP-15, SP-25

Eliminates 98% of feedback at 90db S.P.L. and significantly reduces the effects of vibration from heating and air conditioning systems including building movement from street and internal traffic.

 **SIMS VIBRATION DYNAMICS**
17724 15TH AVE. N.E. • SEATTLE, WA 98155
206 • 362-0700

Circle (125) on Reply Card

NEW!

With 300+ Page
Supplement Included

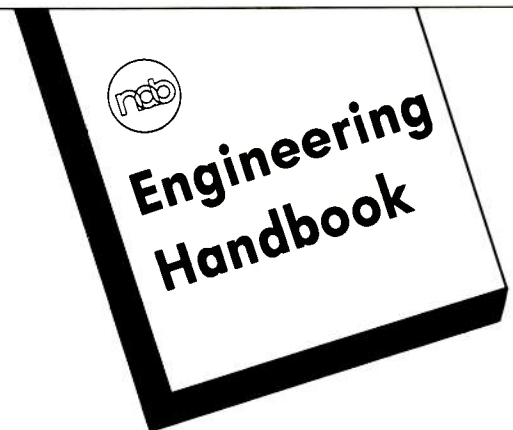

- **Latest edition** of this primary reference for radio and television engineers.
- **Relevant, practical information** on building and operating high quality production and transmission facilities.
- **Available** only from NAB.

Call our Services Department toll-free hotline:
800-368-5644

Bosch-Philips enter into joint venture

BTS Broadcast Television Systems, Mahwah, NJ, is the new joint company of Bosch and Philips. SMPTE in New York was the first U.S. exhibition in which the combined product line was displayed. The LDK-6 family of cameras with the new "A" versions was one of the exhibit highlights along with the COACH system, a remote monitoring and diagnostic maintenance surveillance system. The LDK-6 family will continue full production and be supported by a continuous program of engineering and service backup. The company will display its full range of products for broadcasters and production facilities.

Sony markets ITI products

A promotional marketing program for computer animation products has been announced by the *Sony Communications Products Company*, Teaneck, NJ, and *Integrated Technologies*, Greensboro, NC. Sony began selling ITI's line of Ani-Maker and Image-Maker 3-D computer animation products in broadcast and TV post-production applications on Sept. 1.

Sony will offer turnkey systems that include ITI's systems with the Sony 2500 frame-edit VTR.

Ampex expands switcher manufacturing capacity

Ampex Audio-Video Systems Division, Redwood City, CA, plans to expand production by relocating its Wheatridge, CO, manufacturing operation to a larger facility in Colorado Springs. The transition is expected to be complete within two to four months. The existing 40,000 square foot Wheatridge facility will house the growing Ampex design engineering and marketing staffs. Ampex will manufacture its complete switcher line in Colorado Springs including the new AVC Century series.

Microdyne supplies downlink systems

Microdyne, Ocala, FL, through its Canadian distributor, *Incospec Electronics*, has supplied two motorized satellite antenna downlink systems to the new City-TV/Muchmusic Broadcast Center, Toronto. The downlink systems, which feature C- and Ku-band 5-meter

antennas with steerable, motorized mounts, will allow access to satellites in the geosynchronous arc. The systems have been in operation since November.

Comprehensive signs rep firm

Comprehensive Video Supply, Northvale, NJ, has signed Jim Freeman Associates (JFA), Atlanta, as representative. JFA will cover North and South Carolina, Tennessee, Mississippi, Alabama, Georgia and Florida.

Nakamichi delivers cassette decks

Nakamichi, Torrance, CA, has announced the contract of more than 100 MR-2 professional cassette decks to Aapex Tape Duplication, Santa Rosa, CA. Aapex represents the largest Nakamichi real-time cassette duplication facility to date.

Shook wins Army contract

Shook Electronics USA, San Antonio, TX, has been awarded a bid from the U.S. Army for mobile TV production systems. Seven mobile systems, designed for personnel education and training,



CART 'EM UP ON AA-4!

From AOR to CHR, Country to Jazz—Whatever the format, this cart's for you. For outstanding high frequency sensitivity and headroom, compatibility with all cart machines, the multi-format AA-4 delivers the sound that audiences turn on.

AUDIO PAK AA-4. FOR STATIONS WHO CARE HOW THEY SOUND.

Capitol Magnetic Products
6902 Sunset Boulevard
Los Angeles, CA 90028
213/461-2701

Circle (150) on Reply Card

will be delivered between January and April of 1987. These include modified Ford Econoline vans for 1- or 2-camera shoots; a 4-camera cube van, designed to drive on and off air freight carriers; and a stretch system designed to support mixing, switching and editing equipment.

Soundtracs ships Dutch order

Wisseloord Studios, Hilversum, Holland, has installed a CM4400 console with CMS2 automation from *Soundtracs*, England. The console, which was packaged with an X850 Mitsubishi digital recorder, was supplied by Professional Audio Centre of Eindhoven.

Otari chooses Ampex tape

The Otari Corporation is now quality testing all of its analog and digital recorders with Ampex recording tape. Otari also will pack out every recorder it delivers in the United States, Mexico, Central and South America with Ampex Grand Master 456 analog or 467 digital mastering tape.

AEG opens headquarters

AEG has established its audio systems division headquarters in Nashville. The office includes a demonstration room equipped with M-20 and M-21 series 2-track and M-15A 32-track professional audiotape recorders, cassette duplication and loading equipment, and offers factory service and test facilities. The address is 2605 C Elm Hill Pike, Nashville, TN 37214; 615-883-0491.

Barco awarded contract

Barco Industries, Belgium, has been awarded a contract for the installation of professional studio color monitors in the Parliament House, Australia. The monitors will be used in the control rooms of the chambers and committee rooms. The order was received through Consolidated Electronics Limited, the company's Australian distributor, and will be supplied to the Australian Broadcasting Corporation, which is handling sound and vision systems.

Harris awarded VOA contract

Harris, Melbourne, FL, has been awarded a contract by the U.S. Information Agency, Washington, DC, to provide medium-wave radio broadcasting systems for six sites in the Caribbean basin. Harris will equip the six sites with 100kW, medium-wave transmitters, ancillary operating equipment and Sentinel control and operating systems, which permit each site to be operated locally or by remote control. It also automatically monitors operational conditions at each

site and relays the information to Washington.

Marconi supplies equipment

Marconi Communication Systems, England, has received its first order for the B3410 digital line array telecine featuring the Varispeed facility. The order, for one telecine with various accessories, was placed by Audio + Video International, Northvale, NJ, through AF Associates, Marconi's U.S. distributor.

Telecine Video, Switzerland, also has purchased the system, which will update its facilities and replace an earlier Marconi model.

Marconi has also been awarded a contract to supply CBS in New York with two RADETS based on the NewsHawk design. The equipment will be an addition to the RADET in service with CBS for the past 10 months.

New England Digital delivers first multitrack system

New England Digital, White River Junction, VT, has delivered its first production 16-track direct-to-disc system to Paul Hardcastle, a performer, record and music video producer.

C.A.E. manufactures cable assemblies

C.A.E., Garden Grove, CA, is manufacturing and repairing cable assemblies for Ikegami, Hitachi, Sony, Panasonic and Sharp studio cameras and camera-to-VTR systems as well as complex cable harnesses for video duplication systems. *C.A.E.* also is a supplier of components to the TV and duplicating industries.

Fidelipac marks milestone shipment of cart machines

Fidelipac, Moorestown, NJ, has announced the 3,000th shipment of the DYNAMAX cartridge machine. The company has doubled its volume over the prior 12 months with the addition of the CTR10 series as well as the ESD10 eraser/splice detector.

NewStar adopts new name

Dynatech NewStar, Madison, WI, formerly the NewStar division of ColorGraphics Systems, has become a separate company and is now a wholly owned subsidiary of Dynatech Corporation. NewStar and ColorGraphics split because of diversity of market and product lines.

The company installed its first NewStar Discovery newsroom automation system at WAJR-AM/WVAQ-FM, Morgantown, WV. Selkirk Broadcasting also has installed the system at CFAC, Calgary, Alberta.

The company also is testing a new forms generator/producer software, an update that incorporates spread-sheet format, frequently used forms, and a multiterminal capability.

Comrex relocates

Comrex Corporation has relocated to 65 Nonset Path, Acton, MA 01720; 800-237-1776 or 617-263-1800.

Delta Electronics receives Telecom Australia order

Delta Electronics, Alexandria, VA, has announced a contract to sell several Delta C-QUAM AM stereo systems to Telecom Australia. Included in the contract are 18 ASE-1 AM stereo exciters and 9 ASM-1 AM stereo monitors. Delivery is scheduled to be completed by the first of December.

Audio Kinetics delivers equipment

Audio Kinetics, England, has delivered two Mastermix console automation systems. Audio International added one system, fitted with VCA faders, to its 48-channel Cadac console. Olympic Studios added its second Mastermix, also fitted with VCA faders, to its 32-channel Trident console.

Audio Kinetics has also delivered an Eclipse Audio editor to the ITN studios in London. Other systems were delivered to CFTO, Service Audio Mixon, Pierre-Daniel Rheault and Pathe Films.

Hotronic relocates

Hotronic is moving to its own building. The address is 1875 S. Winchester Blvd., Campbell, CA 95008; 408-378-3883.

CMX supplies sweeteners

CMX, Santa Clara, CA, has selected four production facilities as beta test sites for the CASS-1 computer-aided sound sweetener. The facilities that have purchased the systems are Century III, Boston; Studio Tempo, Montreal; One Pass Productions, San Francisco; and Streeterville, Chicago.

ITFS Cooperative plans expansion

The Regional Instructional Television Cooperative, Dallas, has purchased four Instructional Television Fixed Service (ITFS) translators from Electronic, Missiles & Communications (EMCEE), White Haven, PA. Installation of the equipment will add 20 more school districts to the 33 that already receive the cooperative's direct telecasts. The 25 schools covered by the translators were equipped and receiving programs by September. [:? :>)]]

Professional services

VIR JAMES P.C.
CONSULTING ENGINEERS
Applications and Field Engineering
Computerized Frequency Surveys
3137 W. Kentucky Ave. - 80219
(303) 937-1900
DENVER, COLORADO
Member AFCCE & NAB

**STEIGER, HURRAY &
ASSOCIATES INC.**
CONSULTING ENGINEER SERVICES
6816 Westview Drive
Cleveland, OH 44141
(216) 526-7187

EVANS ASSOCIATES
CONSULTING TELECOMMUNICATIONS ENGINEERS
AM-FM-TV-CATV-ITFS-LPTV SATELLITE
216 N. Green Bay Road
Thiensville, Wisconsin 53092
Phone: (414) 242-6000 Member AFCCE

FCC ON-LINE DATABASE
dataworld®
Allocation/Terrain Studies
AM • FM • TV • LPTV • ITFS
P.O. Box 30730
Bethesda, MD 20814
(301) 652-8822 1-800-368-5754

D. L. MARKLEY
& Associates, Inc.
CONSULTING ENGINEERS
206 North Bergan
Peoria, Illinois 61604
(309) 673-7511
Member AFCCE

**CHIPS DAVIS
LEDE DESIGNS, INC.**
**Acoustics for Stereo
Facility Design
Consultation**
(415) 459-2888

TEKNIMAX
TELECOMMUNICATIONS
DENNIS R. CIAPURA
PRESIDENT
11385 FORESTVIEW LN.
SAN DIEGO, CA 92131 (619) 695-2429

SMITH and POWSTENKO
Broadcasting and Telecommunications
Consultants
2033 M Street N.W., Suite 600
Washington, D. C. 20036
(202) 293-7742

BLAIR BENSON
Engineering Consultant
TV Systems Design and Operation
23 Park Lane
Norwalk, CT 06854
203-838-9049

**LAWRENCE L. MORTON
ASSOCIATES**
21671 SUPERIOR LANE
LAKE FOREST, CALIFORNIA 92630
LAWRENCE L. MORTON, E.E.
AM • FM • TV
APPLICATIONS • FIELD ENGINEERING
ANTENNA BROADBANDING FOR AM STEREO
(714) 859-6015

**American Tower &
Communications**
1. SALES
2. Tower erection
3. Maintenance
4. World wide services
B'ham, Alabama (205) 854-9866

Robert J. Nissen
THE NISSEN GROUP, INC.
Communications Technology Consultants
32 Ridge Drive • Port Washington, New York 11050
(516) 944-5477

**BROADCASTING CONSULTANTS
AND ENGINEERS**
• FCC Applications and Field Engineering
• Frequency Searches and Coordination
• Tower Erection and Maintenance
• Facility Design and Construction
Contact:
KENNETH W. HOEHN
23400 Michigan Avenue
Dearborn, MI 48124
Teletech, Inc.
(313) 562-6873

SELLMEYER & KRAMER, INC.
CONSULTING ENGINEERS
J.S. Sellmeyer, P.E., S.M. Kramer, P.E.
AM FM TV MDS ITFS LPTV CATV
APPLICATIONS • FIELD ENGINEERING
P.O. Box 841 Mckinney, TX 75069
(214) 542-2056

ERIC NEIL ANGEVINE, P.E.
consultant in acoustics
specializing in broadcast studio acoustics
910 Lakeridge Drive Stillwater, OK 74075
405-624-6043 405-372-3949

ATT: CHIEF ENGINEERS
broadcast video maintenance
LUNAR VIDEO LTD.
FAST TURNAROUND ON ENG. EFP, EDIT
SYSTEMS, MONITORS, TEST EQUIP. SONY, JVC,
PANASONIC, TEKTRONIX - UPS & AIR FREIGHT
PU/DEL DAILY.
CALL
COLLECT
138 E. 26th St, NYC (212) 686-4802

Consultation Services
Lightning • Power Conditioning • Grounding
Over 40 years experience, work guaranteed
Roy Carpenter
President
Lightning Eliminators and Consultants
13007 Lakeland Rd. Santa Fe Springs, CA 90673
(213) 946-6886 TWX 910 586 1381

PATCHPRINTS Video Tie Lines
In 1 2 Aug 1 2 Mon A B
Custom Patch Bay Labeling for the Audio/Video Industries
By
PATCH BAY DESIGNATION COMPANY
Div. of Glendale Rubber Stamp & Printing Co., Inc.
CHARLIE SCHUFER
P.O. Box 6278, Glendale, CA 91205 Telephone
4742 San Fernando Road (818) 241-5585
Glendale, CA 91204

**MAILING LABELS FROM
YOUR COMPUTER!**
We supply: AM/FM/TV broadcasters on
computer diskettes
Mailing labels
Full direct-mail service.
STATIONBASE
Box 24092, Tempe, AZ 85282
(602) 437-3461

**UNUSED
CALL LETTERS
CALL**
dataworld®
1-800-368-5754

HOW SAFE IS YOUR TOWER?

Alpha Tower Design, Inc.
907 Waterfall Way, Richardson, Texas 75080
214-783-2578
STRUCTURAL ENGINEERS SPECIALIZING IN TOWER DESIGN
REGISTERED TO PRACTICE IN 49 STATES THREE DIMENSIONAL
COMPUTER ANALYSIS WITH LATEST DESIGN TECHNOLOGY
INSPECTION & REVIEW TOWER MODIFICATIONS

**Why not run your business
card here?**
Only \$65 per insertion.
Frequency discounts available.
Call 913/888-4664

**Why not run your business
card here?**
Only \$65 per insertion.
Frequency discounts available.
Call 913/888-4664

**Why not run your business
card here?**
Only \$65 per insertion.
Frequency discounts available.
Call 913/888-4664

Ad index

	Page Number	Reader Service Number	Advertiser Hotline		Page Number	Reader Service Number	Advertiser Hotline
Abekas Video Systems	59	39	415/571-1711	Logitek Electronic Systems	130	94	800/231-5870
Acoustic Systems	108	78	512/444-1961	Magna-Tech Electronics Co., Inc.	99	73	212/586-7240
ADM Technology, Inc.	IFC	1	313/524-2100	Magni Systems, Inc.	31	20	503/626-8400
Alpha Audio	95	69	804/358-3852	Maxell Corp. of America	71		201/641-8600
Alta Group Inc.	30	103	408/297-2582	MCL, Inc.	109	80	312/354-4350
Amber Electro Design Inc.	42	28	514/735-4105	Microdyne Corp.	101	74	904/687-4633
Ampex Corp. (AVSD)	27	16	415/367-2911	Microwave Filter Co., Inc.	113,114		800/448-1666
Ampex Corp. (AVSD)	26		415/367-2911	Microwave Radio Corp.	131	98	617/459-7655
Ampex Corp (MTD)	116-117	82	415/367-2911	Midwest Communications Corp.	1	3	800/543-1584
Apert Herzog	163	113	408/225-1425	Moseley Associates Inc.	157	116	806/968-9621
Aphex Systems Ltd.	62	68	818/765-2212	Neve, Inc.	135	102	203/744-6230
Arrakis Systems, Inc.	21	15	303/224-2248	Opamp Labs Inc.	159	121	213/934-3566
Asaca/Shibasoku Corp.				Orban Associates Inc.	17	13	800/227-4498
America	160	123	800/423-6347	Orban Associates Inc.	141	110	800/227-4498
Audio Precision	28	17	800/231-7350	Otari Corp.	15	11	415/592-8311
Audio-Technica U.S., Inc.	118-119	83	216/686-2600	Otari Corp.	58	38	415/592-8311
Audio-Video Engineering Co.	126	89	516/546-4239	Pacific Recorders & Engineering Corp.	147	107	619/438-3911
BSM Broadcast Systems Inc.	38	45	509/448-0697	Panasonic	40-41	26	201/348-7336
Belar Electronics Laboratory Inc.	128	92	215/687-5550	Pariod Corp.	50-51	34	800/225-1618
Bogner Broadcast Equipment Corp.	149	108	516/997-7800	Polyline Corp.	155	114	312/297-0955
Boonton Electronics Corp.	121	84	201/584-1077	Potomac Instruments	46	31	301/589-2662
Broadcast Supply West	124	86	800/426-8434	QEI	37	24	800/334-9154
Broadcast Video Systems Ltd.	159	120	416/697-1020	Quantel	83	61	415/856-6226
Broadcast 87	55	126		RAKS	81	60	201/438-0119
C.O.A.R.C.	158	117	518/672-7202	Rank Cintel	47	32	
Camera Mart, Inc.	39	25	212/757-6977	Rank Cintel	45	30	
Canon USA Inc., Broadcast Lens	88-89	64	516/488-6700	Richardson Electronics Inc.	63	42	800/323-1770
Capitol Magnetics, Inc.	165	150	213/461-2701	Ross Video Ltd.	110	81	613/652-4886
Cetec Vega	80	155	818/442-0782	RTS Systems, Inc.	86	63	818/843-7022
Cipher Digital Corp.	145	106	301/695-0200	Schwem Technology	78	58	415/935-1226
Circuit Research Labs, Inc.	13	10	800/535-7648	Selco Products Co.	155	115	213/921-0681
Comark	7	7	215/822-0777	Sencore	107	77	800/843-3338
Comrex Corp.	98	72	617/443-8811	Sennheiser Electronic Corp.	108	79	212/944-9440
Continental Electronics, Div. of Varian	64	43	214/381-7161	Sescom, Inc.	158	118	800/634-3457
Datatek, Inc.	97	71	201/654-8100	Sharp Electronics Corp.	66-67	51	201/529-8731
Chips Davis Lede Designs, Inc.	163	112	415/459-2888	Shively Labs	128	91	207/747-3327
Delta Electronics	49	33	703/354-3350	Shure Brothers Inc.	140	19	312/866-2553
Dolby Labs Inc.	74-75	56	415/558-0200	Sierra Video Systems	95	70	916/273-9331
EEV, Inc.	111	152	914/592-6050	Sims Vibration Engineering	164	125	206/362-0700
ESE	161	124	213/322-2136	Solid State Logic	61		212/315-1111
Eventide	44	46	800/446-7878	Sony Corp of America (A/V & Pro Aud)	132-133	99	
For-A Corp. of America	11	9	213/402-5391	Sony Corp of America (Broadcast)	56-57		
Fostex Corp. of America	91	104	213/921-1112	Sony Mag. Tape Div.	34-35	22	
Gentner Engineering Co., Inc.	92	66	801/268-1117	Standard Tape Laboratory, Inc.	158	122	415/786-3546
Graham-Patten Systems Inc.	151	109	916/273-8412	Stanton Magnetics	70	53	212/445-0063
Grass Valley Group, Inc.	9	8	916/273-8421	Stantron/Unit of Zero Corp.	143	105	800/821-0019
Grass Valley Group, Inc.	42	27	916/273-8421	Studer Revox America Inc.	29	18	615/254-5651
Gray Communications Consultants, Inc.	123	85	912/883-2121	Surcom Associates Inc.	159	119	619/722-6162
H.M. Dyer Electronics, Inc.	163	111	313/349-7910	TASCAM Div. Teac Corp. of America	73	55	213/726-0303
Hitachi Denshi America Ltd.	3	4	800/645-7510	Tex AR	43	29	412/856-4276
Howe Audio	60	35	800/525-7520	TFT, Inc.	79	59	408/727-7272
IGM Communications	93	67	405/232-5808	Thomson Video Equipment	129	93	
Intergroup Video Systems Inc.	137	101	800/874-7590	Thomson-CSF Broadcast	19	14	203/965-7000
Intl. Tapetronics Corp./3M	65	50	800/447-0414	Thomson-CSF/DTE	84-85	62	
Int. Tapetronics Corp./3M	69	52	800/447-0414	Thomson-CSF/LGT	IBC	2	
JamPro Antennas Inc.	36	23	916/383-1177	Trompeter Electronics, Inc.	113,114	95	818/707-2020
Jensen Transformers Inc.	158	151	213/876-0059	Utah Scientific Inc.	77	57	800/453-8782
JVC Company of America	105	76	800/582-5825	Varian	127	90	415/592-1221
JVC Company of America	103	75	800/582-5825	Varian	33	21	415/592-1221
Leader Instruments Corp.	5	5,6	800/645-5104	Videotek, Inc.	94	41	602/997-7523
Leader Instruments Corp.	113,114		800/645-5104	Ward-Beck Systems Ltd.	BC		416/438-6550
Leitch Video of America, Inc.	53	36	804/424-7290	Winsted Corp.	126	88	800/328-2962
Lerro Electrical Corp.	25		215/223-8200	Yamaha International Corp.	125	87	
Lightning Deterrent Corp.	64	44	800/241-2360				

Classified

Advertising rates in Classified Section are \$1.50 per word, each insertion, and must be accompanied by payment to insure publication.

Each initial or abbreviation counts a full word. Minimum classified charge, \$35.00.

For ads on which replies are sent to us for forwarding (blind ads), there is an additional charge of \$35.00 per insertion, to cover department number, processing of replies, and mailing costs.

Classified columns are not open to advertising of any products regularly produced by manufacturers unless used and no longer owned by the manufacturer or distributor.

TRAINING

ELECTRONICS DEGREE by correspondence. Earn Associate, then Bachelor's. NHSC accredited. Free catalog. Write Grantham College of Engineering, Dept. EE-5, 10570 Humbolt St., Los Alamitos, CA 90720. 8-82-tfn

FCC GENERAL RADIOTELEPHONE operators license through cassette recorded lessons at home plus one week seminar in Boston, Washington, Detroit or Philadelphia. Our twentieth year teaching FCC license courses. Bob Johnson Radio License Preparation, 1201 Ninth, Manhattan Beach, Calif. 90266, Telephone (213) 379-4461. 8-81-tfn

SERVICES

ONE STOP FOR ALL YOUR PROFESSIONAL AUDIO REQUIREMENTS. Bottom line oriented. F.T.C. Brewer Company, P.O. Box 8057, Pensacola, Florida 32506. 7-71-tf

VACUUM TUBE REMANUFACTURING—Save 60. Longer life. Better performance. We specialize in Transmitting Tubes, Vacuum Capacitors, Power Tubes. All major types. Write or call: FARADIX ELECTRONICS COMPANY, 150 Main Street, Port Washington, New York 11050, (516) 775-7838. 8-86-6t

3-D TELEVISION,—true stereographic NEW! LeaVision tm over/under (not red/blue). Viewers, consulting, lens rental. Info-SASE. DEMO (VHS/BETA)*photo* viewers-\$29.95 * \$2 S&H. TVLI-BE, CS3030 Lindenhurst, NY 11757 (516) 957-4393 (212) 245-6119. 9-86-tfn

TRANSMITTER TUBE REBUILDING SINCE 1941: 3CX2500, 4CX5000, 4CX15000 and many others. Write for details. FREELAND PRODUCTS CO., Rt. 7, Box 628, Covington, LA 70433. (504) 893-1243 or (800) 624-7626. 6-79-tfn

FOR SALE

RCA COLOR TELESCINE SYSTEM, New/unused. To include: TK-66, color camera, TP-66, 16mm telecine projector, TP-7, 35mm slide projector, TP-55B, camera multiplexer. Write to: P.O. Box 23555-273, San Diego, CA 92123. 1-86-tfn

FOR SALE: VIDEO EQUIPMENT—Ditech 40x60 three level routing switcher, Convergence 204 editing system, two Phillips LDK-25 cameras with Angenieux 14x1 lenses, Sony BVP-330 camera with Fujinon 14x1 lens, Quantum Q-8P audio console. Call Mark Piechan at (313) 548-2500. 10-86-3t

FOR SALE: R.C.A., BRAND NEW from factory. 16mm Telecine Projectors, TP-66 with R/C and lens. Call Mr. Frank N. Bovino, S.B. Video, 201-489-6358. 10-86-tfn

RCA TT-30FL dual VHF television transmitter. Excellent condition. Contact C. Whitlatch, KJRH-TV, 918-743-2222. 10-86-3t

AMPEX ACR-25 VIDEO CART reproducer/sequencer. Excellent condition. Includes several headwheel panels and numerous video tape carts. Full documentation, well maintained. Contact C. Whitlatch, KJRH-TV, 918-743-2222. 10-86-3t

CONSOLE. MCI 528B with all options; 28 inputs, 32 busses, plasma display, automation, 8 returns, send meters, phase meter. Large producers desk. Asking price \$30,000. Call 305-940-7971. 10-86-tfn

COPPER! For all your broadcast needs. #10 ground radials; 2, 4, 6, 8" strap, flyscreen, counter poise mesh. 317-962-8596. Ask for copper sales. 7-86-6t

FOR SALE—Editing system—Microtime 2020 TBC, JVC KM 2000 SEG, JVC 5550, 8250, 88U controller. 212/807-8504. 11-86-2t

M-FORMAT CLEARINGHOUSE: New, DEMO, & Used Panasonic/RCA VCR's, Adapters, Editors, TBC's, Cameras, Accessories, at surplus clearance prices. Package discounts, Trade-ins considered. WIEGAND AUDIO VIDEO, 7758 Lafayette N.W., Newark, Oh. 43055, 614-967-0059. 11-86-2t

90' TOWER. ROHN S.S.V. Self-supporting with O.B. Light package. Available in Jan. 1987. Contact: John Gebhard, Chief Engineer, Telemation Productions, 3210 W. Westlake Ave., Glenview, IL 60025. 312/729-5215. 11-86-2t

BRAND NEW CONRAC MONITOR 5725/C13 \$2,700.00. Brand new Wavetek model 1080 sweep generator \$2,400.00. Brand new Wavetek model 190 20MHz function generator \$750.00. Brand new RCA heads 2 each 431474 \$750.00 each—1 each 431473 \$750.00—plus lots of Eimac tubes all new. Contact: Amex Electronics, 501 New York Avenue, Union City, N.J. 07087, Telex: 132853, Phone (201) 348-3363. 9-86-3t

FOR SALE: 1 12 Bay Channel 7 Super Turnstyle Antenna. Completely reharnessed 5 years ago. In full operation until station built new transmission plant. 1000' plus of 3 1/2" transmission line that is 5 years old. Channel 7 hybrid diplexer also available. All for \$45,000 or best offer. Call Mark Bedgood at 214/581-2121. 12-86-1t

COLOR STUDIO CAMERAS. Two Hitachi FP-60's. Full Studio Package. Recently aligned/retubed. Great Condition. All reasonable offers considered. Emory University Medical Television. (404) 589-3556. 12-86-1t

ITE P-6. Counterbalanced pedestals and heads. Excellent condition. Emory Medical Television. All offers considered. (404) 589-3556. 12-86-1t

SURPLUS EQUIPMENT: 4 RCA 781 cameras with CCU's and 2 lenses. 2 Vital 114 switchers, tangent 32 input audio board. Quantel 2 channel DVE with or without dimension Quantel 6030 stillstore, 4 Ampex VPR-2 bridge consoles and more. Call Thom at Northwest Mobile Television (206) 251-0560. 12-86-1t

EQUIPMENT FOR SALE—Television, good condition. Quanta Q-7B character generator, JVC CR4700U 3/4" portable video recorder. Call (404) 458-1168. 12-86-2t

FOR SALE

TRANSMITTING TUBES	CAMERA TUBES
4CX1500B 8890	XQ1020 Series
4CX5000A 8916	XQ1070 Series
4CX15000A 8984	XQ1427 Series
6166A/7007 9007	H8398A Series
892R VAB91H	H8397A Series
833A	

ALL UNDER WARRANTY
PARTIAL LISTINGS ONLY
VARIAN, EIMAC, RCA, ETC.
ALSO, STAGE/STUDIO
LAMPS—LARGE STOCKS!

Electronics Ltd.
Nemtron

15 Main St.
East Rockaway, NY 11518
(800) 645-2300 (516) 599-6400

12-86-1t

EMPLOYMENT OPPORTUNITIES

WE PLACE ENGINEERS

ALL CATEGORIES FOR TV & VIDEO
(EXCLUDING OPERATORS)
America's Leading Source for a Decade
TV STATIONS, PRODUCTION FACILITIES, CORP. TV, MFG., CATV

For information phone or write Alan Kornish



key systems

479 Northampton Street
Kingston, PA 18704

Employer
Paid Fees

(717) 283-1041

WANTED TO BUY

HIGHEST PRICES for 112 Phase Monitors, vacuum capacitors and clean, one kw or greater powered AM and FM Transmitters. All duty and transportation paid. Surplus Equipment Sales, 2 Throncliffe Park Dr., Unit 28, Toronto, Canada M4H 1H2, 416-421-5631. 3-86-tfn

WANTED: WW-II German and Japanese radio equipment. Unused US Navy and Signal Corps radio equipment before 1943. Pre-1923 radio equipment and tubes. August J. Link, Surcom Associates Inc., 305 Wisconsin Ave., Oceanside, CA 92054, (619) 722-6162. 7-86-tf

POSITION WANTED

NEW OPPORTUNITY WANTED: Experienced Broadcast Engineer looking for permanent employment in Western U.S. Experienced in AM/FM transmitter/studio installation and maintenance. Excellent communication and administrative abilities. Design and managerial experience. Reply to P.O. Box 432, Sweet Home, OR 97386. 12-86-2t

HELP WANTED

MAINTENANCE ENGINEER. Top Ten Market, PBS Station: Excellent opportunity. Applicant should have a minimum three years maintenance experience. SBE Certification, FCC General Class; College degree preferred. Good benefits, competitive salary. Resumes to: Gilda Jones, KERA TV/FM, 3000 Harry Hines Blvd., Dallas, Texas 75201. 9-86-4t

TV MAINTENANCE ENGINEER: Maintain latest state-of-the-art video broadcast equipment, including Sony one-inch machines. Experience in RCA TK-47's and TCR-100 cart machines desirable. Salary commensurate with experience. Send resume to Chief Engineer, P.O. Box 400, Hampton, VA 23669. A Belo Broadcasting Company. An Equal Opportunity Employer. 11-86-2t

ASSISTANT CHIEF ENGINEER wanted for an aggressive PBS station in the Sunbelt. Must be a "hands on" person with excellent maintenance and interpersonal skills. An understanding of Broadcast systems a must. Will be responsible for overall station broadcasting and production in accordance with FCC Rules and Regulations, and good engineering practice. A great challenge for an upcoming maintenance supervisor looking for a move in Management. REQUIREMENTS: 5 to 8 years in Broadcast Engineering, minimum 2 years in a supervisory position. FCC license or SBE certification required. APPLY: Director of Finance. WYES-TV, P.O. Box 24026, New Orleans, LA 70184. 12-86-1t

GENERAL MANAGER/SALES MANAGER for a growing AM/FM station in East Texas. Programming and sales experience needed. Salary plus a percentage of sales. Call 318-226-8946 or write RADIO STATION, P.O. Box 1351, Shreveport, LA 71164. 12-86-1t

CHIEF ENGINEER: Excellent opportunity for hands-on chief. New RCA full power UHF transmitter and state-of-the-art studio and production facilities. Growing independent with aggressive production schedule. Send resume and salary requirements to Dave Miller, General Manager, WRGT-TV, 45 Broadcast Plaza, Dayton, Ohio 45408. E.O.E. 12-86-1t

HELP WANTED (CONT.)



Put Your Future In Your Hands

BTS (A joint Company of Bosch and Philips) announces the beginning of a visual Arts Training Institute. The Institute will offer courses using the Bosch FGS 4000, the new Modeler, and the 3D Illustrator paint system as tools for the artist. In addition, you will utilize other Bosch equipment including cameras, Film-to-Tape Transfer equipment, editors and production switchers. Classes are limited and fill up very fast. Now is your chance to open the door to your career in computer graphics!

For more information, call today (801) 972-8000, or write to us at P.O. Box 31816, Salt Lake City, Utah 84131, Attn: Annette Wise.

BTS

MAINTENANCE TECHNICIAN — KRIV-TV, Fox Television, Houston, is seeking a qualified studio Maintenance Technician. Must have minimum of three years experience and an FCC license, SBE certified, Betacam and VPR formats a plus. Send resume to: KRIV-TV, P.O. Box 22810, Houston, Tx. 77227. Attn: Wendell Wyborny, VP/ICE E.O.E. 12-86-21

SENIOR VIDEO/AUDIO SYSTEMS ENGINEERS

If you have at least 5 years experience in video / audio systems engineering and are a creative person, WE WANT YOU! We are expanding our operations into new modern facilities in scenic Salt Lake City. These immediate openings come with a compensation package that includes excellent benefits.

Centro

Setting new standards in the design and integration of teleproduction facilities and remote production vehicles.

WRITE TO:

Gene DeSantis
Centro Corporation
369 Billy Mitchell Road
Salt Lake City, Utah 84116
No phone inquiries accepted.

ASSISTANT CHIEF ENGINEER. Immediate opening at Chicago UHF TV station. Familiarity with studio equipment and UHF transmitter necessary. Excellent salary and benefits. Send resume to: Bernie Hoelting, WCIU-TV Channel 26, 141 W. Jackson - Suite 3200, Chicago, Illinois 60604. EOE. 12-86-21

BROADCAST ENGINEERING TECHNOLOGY INSTRUCTOR — For two year Associate Degree program training technicians in maintenance of broadcast equipment and facilities. Excellent opportunity for the person who likes to work with young people. Hocking Technical College is the second largest technical college in the State of Ohio. The college has its own television facility. Experience in the broadcast engineering field and First Class FCC License or SBE Certification required. Formal teaching experience desired but not required. Salary commensurate with experience and education. Affirmative action, equal opportunity employer. Send resume or call Personnel Office, Hocking Technical College, Nelsonville, OH 45764 (614) 753-3591. 12-86-11

RF SALES ENGINEER: This will be a rewarding position for an individual with experience in all areas of radio broadcast equipment with emphasis on FM RF Systems. The position involves field travel and is based in the Philadelphia area. Contact: Radio Systems, Box 356, Edgemont, PA 19028, (215) 356-4700. 12-86-11

AM FM ENGINEER for three station group. Studio and transmitter experience required. \$18,000 to \$24,000 depending on experience. Send resume to KBAS, 2332 Hwy. 95, Bullhead City, AZ 86442. 12-86-11

MIDWEST COMMUNICATIONS CORPORATION is seeking qualified video engineers to join our growing Miami, Florida office. Minimum 3 years experience on professional/industrial video equipment. Systems experience a plus. Send resume to 8875 N.W. 23rd Street, Miami, Florida 33172. ATTN: BOB SELL or call (305) 592-5355. 12-86-11

CHIEF ENGINEER — Small market VHF network affiliate. Sunbelt. Must replace retiring chief. Must be people oriented and technically qualified. Excellent compensation package. Send resume to: KTEN-TV, P.O. Box 1425, Durant, OK 74702. 12-86-11

VIDEO TECHNICIAN — ¼" Production/Post-Production company. 3-5 years experience required. Ability to maintain Sony and Panasonic equipment. Good audio/video theory required plus ability to work with chief engineer. Some design and installation. Production skills a plus. Send resume with salary requirements to: Communications Plus Video, 360 Park Avenue South, New York, NY 10010. No calls. 12-86-11

CHIEF MAINTENANCE ENGINEER: Bright creative engineer sought for fast growing post production and duplication facility. Digital & analog experience. Ampex, Sony, CMX, Rank, etc. Call 1-800-237-4259 or 212-279-6026. 12-86-11

Advertising sales offices

CHICAGO, ILLINOIS

Tom Nilsen
Phone: (312) 887-0677
(312) 887-0684
15 Spinning Wheel Rd.
Ste. 430
Hinsdale, IL 60521

NEW YORK, NEW YORK

Diane Gottlieb-Klusner
Phone: (212) 682-6630
(212) 682-6631
Josh Gordon
Phone: (212) 687-5076
(212) 687-5077
630 Third Ave., Eighth Floor
New York, NY 10017

SANTA MONICA, CALIFORNIA

Herbert A. Schiff
Phone (213) 393-9285
Jason Perlman
Phone (213) 458-9987
Chris Woodbury
Phone (213) 451-8695
Schiff & Associates
501 Santa Monica Blvd., Ste. 504
Santa Monica, CA 90401

NORWOOD, AUSTRALIA

Hastwell, Williamson, Rouse Pty. Ltd.
P.O. Box 419
Norwood 5067, Australia
Phone: 332-3322
Telex: AA87113

LONDON, ENGLAND

Nicholas McGeachin
Suite 460, Southbank House
Black Prince Rd.
London SE1 7SJ
Telex: 295555LSPG
Telephones: 01-582-7522
01-587-1578

TOKYO, JAPAN

Haruki Hirayama
EMS, Inc.
Sagami Bldg., 4-2-21, Shinjuku
Shinjuku-ku, Tokyo 160, Japan
(03) 350-5666
Cable: EMSINCPERIOD
Telex: 2322520 EMSINCJ

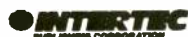

©1986. All rights reserved.

SAVE TIME

For fast, accurate service, please remove the peel off label used to address your magazine, and attach it to the Reader Service Card, the Address Change Card or to any correspondence you send us regarding your subscription.

**THE
SOLUTION
OF THE
FUTURE.**

NOW

10 kW fully solid state VHF TV transmitter EVHF 30 000s.*



- High efficiency
- Low operating cost
- Easy to maintain
- Built-in redundancy
- Built-in input voltage regulator
- Rapid pay-back

*Not yet approved by F.C.C.



THOMSON-LGT

Laboratoire Général des Télécommunications

51, boulevard de la République / BP 51 / 78401 Chatou Cedex / France / Tél.: 30.71.92.6C.

Circle (2) on Reply Card



Nobody does it better!

Ward-Beck's all-new D8212 Audio Distribution System is totally transparent! Absolutely nothing else on the market today can compare for precision, performance, packaging or price!

Check these features:

- Twelve high-performance modular DAs each with 8 outputs.
 - Dual switch-mode power supplies.
 - 3 1/2" rack mounting frame.
- Unique hinged/quick-release front panel.
 - Gold-plated terminals throughout.
 - Integral typewriter designation strip.
- Unmatched overall performance specifications.
- Renowned Ward-Beck Reliability and Quality.
 - Priced right.



First by Design.

The Ward-Beck D8212 System – An Investment in Quality!

