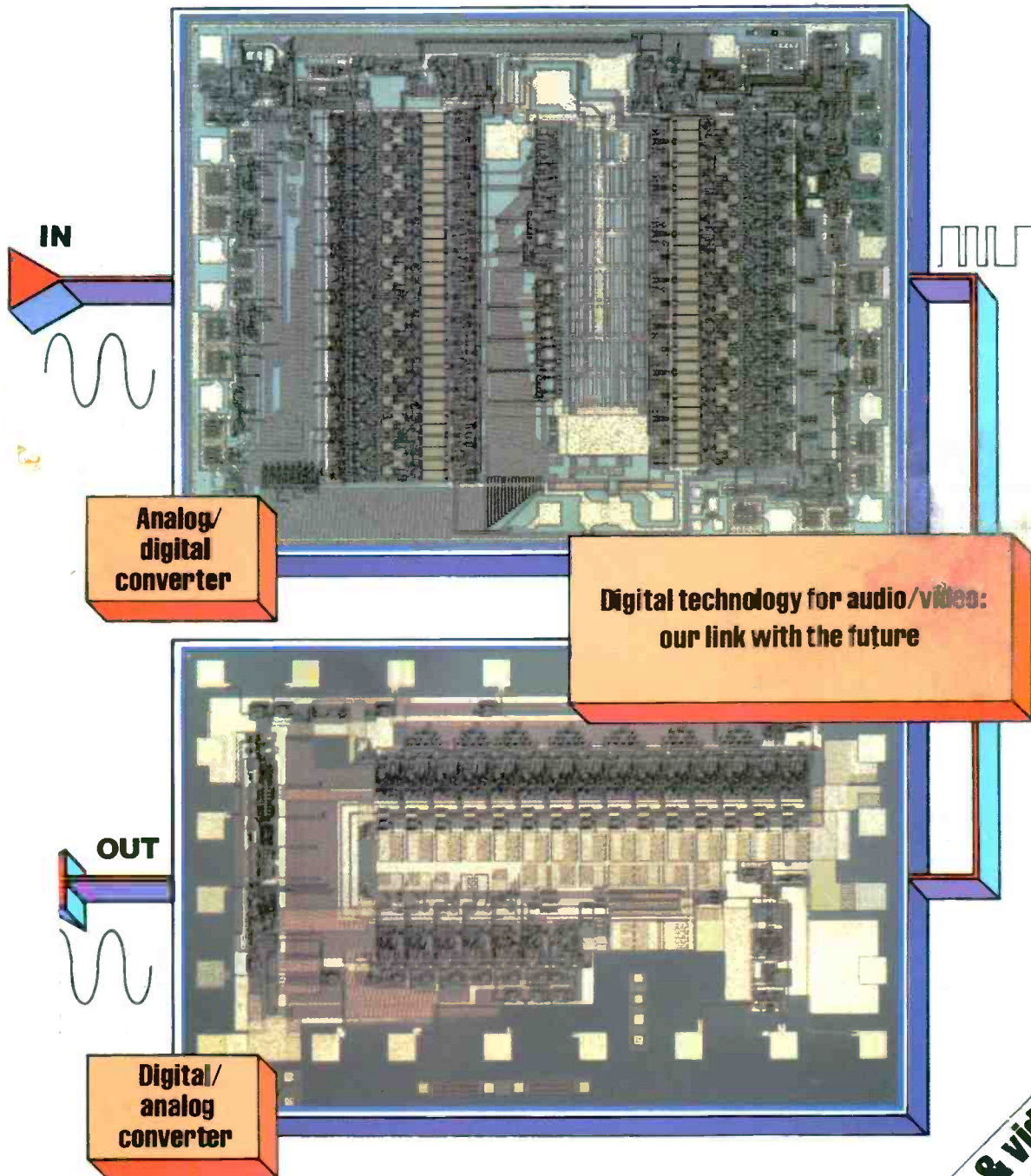


# BROADCAST<sup>®</sup> ENGINEERING

February 1985/\$3



**Audio & video  
special effects**

# Worth Its Wait In Gold.

## For Harrison Reliability

Sure, Harrison has waited to enter the U.S. broadcast market. When you're a stickler for precise engineering and a perfectionist when it comes to quality performance – you've got to take your time to get it right. *Get it just right for you.*

## No Compromises

It can be tough getting the right console to match your specifications. About as easy as fitting a square peg in a round hole, right? Harrison Systems has anticipated your need for versatility. A good deal of time and research goes into our consoles in order to bring you the smartest, most efficient technology and service. We've got the system that fits the size and scope of your needs, whether it be:

- Teleproduction
- Video Sweetening and Post-Production
- Video Edit Suite
- Film Sound Post-Production
- On-Air Broadcasting
- Broadcast Production
- Live Sound Reinforcement
- Music Recording and Scoring

At Harrison Systems, we give you choices – not excuses or unnecessary fluff. Our systems are designed to bring you long-lasting, clean performance and reliability.

## Harrison Puts You In Good Company

Organizations like Swiss Broadcasting and Belgian Radio and Television have believed in the superior quality of Harrison Stereo Broadcast Audio Consoles for years and have chosen Harrison for multiple broadcast installations. Swedish Television has selected 8 TV-3 consoles and has committed to several more. This year's Winter Olympics in Yugoslavia received the main audio feed from a TV-3.

## At Last

At Harrison, we take the time to listen to your needs. We design our consoles with the flexibility to fit your operation. And although our standards may be high for our consoles – our prices are very, very reasonable. We think you'll find it's been worth the wait – in golden, Harrison-true performance. Call us for a demonstration and see for yourself.

## For Harrison Innovation

Introducing Harrison's TV-3, PRO-7 and TV-4, the broadcast consoles you've been waiting for:

**TV-3** For large scale TV audio, remote production, studio production, post-production and sweetening ■ Adapts to wide range of tasks ■ Available in a variety of configurations for customization ■ Plus many options.



Now Available  
**AIR-7** For on-air stereo radio broadcasting, combining sophisticated technology with simple operation.

**PRO-7** Designed for comprehensive use in broadcast, live sound, motion picture teleproduction ■ Two major configurations ■ Simple to operate ■ Cost-effective ■ Independent mix decision capability ■ Long-term performance achieved through thick-film laser-trimmed resistor networks ■ Plus many options.

**TV-4** For medium scale on-air production, remote production, studio production, sweetening and post-production ■ Three major, simplified configurations ■ Easy to install ■ High-speed, low noise, low distortion amplifiers allow for best possible electronic performance ■ Plus many options.

*Harrison's new VSI Fader Section, which allows for simultaneous interface with automation and video editor/switcher, is available for TV-4 and PRO-7 consoles.*



Why wait any longer? Call or write Harrison Systems, Inc., P.O. Box 22964, Nashville, TN 37202; (615) 834-1184, Telex 555133.

**Harrison**



Midwest and Ikegami  
give you super  
performance  
on the road



To cover those on-the-road events that mean big ratings, you need a mobile unit that delivers a top-quality performance everytime. So, at Midwest we equip our M-1, M-20 and M-24 Mobile Units with tough, dependable Ikegami ITC-730A and ITC-730AP Color Cameras.

Every feature of the ITC-730 Series meets Ikegami's high standards of quality and reliability. These professional 3-tube cameras have excellent ENG and EFP capability and the performance of these economical, easy to handle cameras surpasses that of many studio cameras that cost a lot more.

The ITC-730A and ITC-730AP Color Cameras use the same lens mount as the ITC-350, SC-500, HL-83, HL-95, and HL-79, making lens interchangeability possible. Your choice of pickup tubes - Plum-

bicons® in the ITC-730AP or Saticon IIs® in the ITC-730A - make these rugged yet lightweight color cameras the perfect choice for the budget-minded professional.

And 1985 marks Midwest's 25th year in integrating superior equipment like Ikegami Cameras into comprehensive systems like the M-1, M-20, and M-24 Mobile Units. So, we have the expertise to custom design a unit that fits your needs perfectly. In addition, as one of the largest distributors in the nation, we can deliver a fully equipped mobile teleproduction unit on time and on budget.

If you want to improve your ratings by covering on location events, contact the company that specializes in giving super performances on the road. Call 800-543-1584 and order a Midwest Mobile Unit with Ikegami Cameras.



Communications Corp.

**One Sperti Drive  
Edgewood, KY 41017  
606-331-8990**

Cincinnati, OH 606-331-8990	Grand Rapids, MI 616-796-5238	Atlanta, GA 404-875-3753
Columbus, OH 614-846-5552	Louisville, KY 502-491-2888	Virginia Beach, VA 804-464-6256
Dayton, OH 513-435-3246	Lexington, KY 606-277-4994	Charlotte, NC 704-399-6336
Cleveland, OH 216-447-9745	Charleston, WV 304-768-1252	Richmond, VA 804-262-5788
Pittsburgh, PA 412-364-6780	Nashville, TN 615-331-5791	Washington, DC 301-577-4903
Indianapolis, IN 317-872-2327	Bristol, TN 615-968-2289	Miami, FL 305-592-5355
Detroit, MI 313-689-9730	St. Louis, MO 314-225-4655	Tampa, FL 813-885-9308

# BROADCAST engineering

The journal of broadcast technology

February 1985 • Volume 27 • No. 2

## DIGITAL TECHNOLOGY FOR AUDIO AND VIDEO

Much of broadcasting's rapid change is being driven by new developments in digital technology. This month we examine how this equipment works and how broadcasters use it.

### 22 The Roots of Digital Audio

By Leonard Sherman, MOS analog applications, National Semiconductor, and Jerry Whitaker, editor

Digital technology has made a significant impact on the way audio signals are generated, modified and transmitted. The methods used to make the transition between the analog and digital domains are discussed, with the following specialized areas:

- **Creating Special Effects**
- **The History of Special Effects**
- **Delta Modulation: Another Approach**
- **DASH: Where it is, Where it's Going**

### 42 Digital Processing for Effects and Graphics

By Blair Benson, TV technology consultant

The basics of digital video systems in use today. Related articles:

- **Just for Effects**
- **Faces and Fonts**

### 60 Speaking of TV, Digitally

By Elmer Smalling III, cable systems consultant

An explanation of terms commonly used in discussing digital equipment. Related articles examine:

- **Binary and Beyond**
- **The Gist of Nyquist**

### 69 Color-Mapped vs. Full Color

By David Fabian, product manager, Ampex

The inside story on the processing methods used with two types of graphics systems.

### 80 Avoid a Glitch in Time: Inside TBCs

By Carl Bentz, technical editor

What TBCs are used for and how they work. Also discussed:

- **How Many Samples per Line?**
- **Piezoelectric?**

### 90 Audio Time Base Correction

By John Pate, staff engineer, WSM Radio, Nashville, TN

A TBC for audio applications can solve the phase stability problems inherent—to some extent—in tape cartridge systems.

## OTHER FEATURES

### 112 Standby Power Systems: Reducing the Threat

By Jerry Whitaker, editor

Your station doesn't have to fail when the power does.

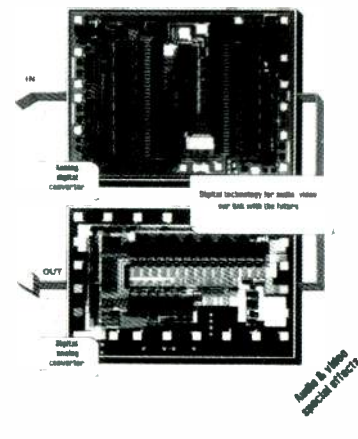
©Copyright 1985, by Intertec Publishing Corporation. All rights reserved. Photocopy rights: Permission to photocopy for internal or personal use is granted by Intertec Publishing Corporation, for libraries and others registered with Copyright Clearance Center (CCC), provided the base fee of \$2.00 per copy of article is paid directly to CCC, 21 Congress St., Salem, MA 01970. Special requests should be addressed to Cameron Bishop, publisher.

ISSN 0007-1994. \$2.00 + 0.00.

**BROADCAST ENGINEERING** (USPS 338-130) is published monthly (except in December, when two issues are published) by Intertec Publishing Corporation, 9221 Quivira Road, P.O. Box 12901, Overland Park, KS 66212-9981. Postmaster, return form 3579 to P.O. Box 12938 at the above address.

# BROADCAST engineering

February 1985



**THE COVER** this month shows the main weapons in broadcasting's digital revolution—*analog-to-digital* (A/D) and *digital-to-analog* (D/A) converter chips. The A/D die photo at the top is of a National Semiconductor ADC0820 converter, featuring 8-bit resolution and a built-in *track-and-hold* input stage. The die photo beneath it shows a TRW TDC1018 8-bit D/A converter. (Photos courtesy of National Semiconductor and TRW.)

## DEPARTMENTS

- 4 Associations
- 6 FCC Update
- 8 AM Stereo Update
- 10 Strictly TV
- 14 Satellite Update
- 20 Editorial
- 96 Troubleshooting
- 118 People
- 120 Business
- 122 New Products

## Coming events

**March 5-8**

AES,  
Hamburg, West Germany

**April 14-17**

NAB '85,  
Convention Center,  
Las Vegas, NV

## NEXT MONTH

**NAB Preview**

- Exhibitor roundup
- Equipment listings
- Booth listings
- Exhibit guide map



# HITACHI INVENTS THE FIRST 1" VTR THAT WATCHES ITSELF SO YOU DON'T HAVE TO.

The revolutionary Hitachi HR-230 1" VTR has the most advanced real-time, self-diagnostic capabilities ever perfected.

In either the record or playback mode, a computer inside the HR-230 monitors 49 different performance parameters second by second. And then stores this information within the memory for recall at a later time—not just with numbers and symbols, but in words.

This means no more errors slip by when your operator is not there. And there's no more need for hit-or-miss spot checking.

The Hitachi HR-230 has a unique quick-threading tape path, incorporating retracting entrance and exit guides, main erase head, as well as a scanner air system that protects tapes.

It recues a 30-second segment in 3.5 seconds. It has a



fast/slow motion range that provides real-time reverse and field/frame still motion. Plus programmable time compression up to 20%, with 0.1% accuracy.

A unique, concealed fold-out control panel groups editing functions and separates edit controls from the main control panel.

In short, it's the ultimate 1" for networks, affiliates or teleproduction companies. Don't consider your next 1" purchase without looking into it. Contact Hitachi Denshi America, Ltd., Broadcast and Professional Division, 175 Crossways Park West, Woodbury, NY 11797. (516) 921-7200 or (800) 645-7510. Hitachi Denshi, Ltd. (Canada), 65 Melford Drive, Scarborough, Ontario M1B 2G6. (416) 299-5900.

 **Hitachi**

# associations

## NRBA

**National Radio Broadcasters' Association**  
1705 De Sales Street, NW  
Washington, DC 20036  
1-202-466-2030

### Radio '85 convention set

The steering committee of the Radio '85 Management and Programming Convention met in Dallas in January to discuss possible speakers and entertainment, plan sessions and pinpoint the focus of this year's convention.

Sponsored by the NRBA and NAB, the convention will be Sept. 11-14 at Loews Anatole, Dallas.

All hospitality suites and entertainment will be at the Anatole, and all exhibits, panel sessions and luncheons will be at the nearby Dallas Convention Center. This will allow for easier access to all sessions and for more exhibit space.

More than 75 sessions will be held on management, programming, sales, engineering and allied radio topics.

A new feature of the convention is

that it will be held Wednesday through Saturday, which will allow for an added day of panel sessions and events.

The first convention, held in Los Angeles in September, had more than 135 manufacturer exhibits (BE, December). Attendance was estimated at 5080.



**National Association of Broadcasters**

1771 N Street, NW  
Washington, DC 20036  
1-202-293-3570

### DBA joins NAB

The Daytime Broadcasters Association was merged into the NAB on Jan. 4. The agreement was signed in December by Edward O. Fritts, NAB president, and James Wychor, DBA president.

The agreement became effective after ratification by the DBA board of directors.

Under the agreement's terms, the DBA will disband operations and will

encourage members to join NAB. The new Daytime Broadcaster Committee will represent interests formerly covered by the association.



**Society of Broadcast Engineers**

P.O. Box 50844  
Indianapolis, IN 46250  
1-317-842-0836

### Frequency coordination update

The SBE National Frequency Coordinating Committee has released an updated list of contact persons in 74 U.S. locations. The list includes several additions and changes to previously published coordinator lists.

Any user of radio or TV remote transmitting equipment is requested to check with the frequency coordination contact person in a given area before using RF equipment. These local coordinators do not assign channels. They, instead, make possible the licensee-to-licensor contact asked for in Part 74.24 of the FCC rules.

||-?=>)))

## BROADCAST engineering

Editorial and advertising correspondence should be addressed to: P.O. Box 12901, Overland Park, KS 66212-9981 (a suburb of Kansas City, MO); (913) 888-4664. Telex: 42-4156 Intertec OLPK. Circulation correspondence should be sent to the above address, under P.O. Box 12937.

### EDITORIAL

Jerry Whitaker, *Editor*  
Carl Bentz, *Technical Editor*  
Nils Conrad Persson, *Electronics Editor*  
David Hodes, *Video Editor*  
Miguel Chivite, *International Editor*  
Fred Ampel, *Audio Editor*  
Rhonda L. Wickham, *Managing Editor*  
Dan Torchia, *Associate Editor*  
Tom Cook, *Editorial Assistant*  
Joy Culver, *Editorial Assistant*  
Darryll Fortune, *Editorial Assistant*  
Pat Blanton, *Directory Editor*

### ART

Kevin Callahan, *Art Director*  
James Sen Clark, *Senior Graphic Designer*  
Darla Buckley, *Graphic Designer*

### TECHNICAL CONSULTANTS

Eric Neil Angevine, *Broadcast Acoustics*  
John H. Battison, *Antennas/Radiation*  
Blair Benson, *TV Technology*  
Dennis Ciapura, *Technology*  
Dane E. Erickson, *Systems Design*  
Howard T. Head, *FCC Rules*  
Wallace Johnson, *FCC/Bdct. Engineering*  
Donald L. Markley, *Facilities*  
Harry C. Martin, *Legal*  
Robert J. Nissen, *Studio/Communications*  
Hugh R. Paul, *International Engineering*  
Richard Rudman, *Spectrum Management*  
Art Schneider, *A.C.E., Post-production*  
Elmer Smaling, III, *Cable Systems*  
Vincent Wasilewski, *Communications Law*

### CORRESPONDING ASSOCIATIONS

American Society of TV Cameramen  
Assn. for Bdct. Engr. Standards  
National Association of Broadcasters  
National Radio Broadcasters Assn.

### MEMBER ORGANIZATIONS

Acoustical Society of America  
Society of Broadcast Engineers

### CIRCULATION

John C. Arnst, *Director*  
Evelyn Rogers, *Manager*  
Dee Manies, *Reader Correspondent*

### ADMINISTRATION

R. J. Hancock, *President*  
Cameron Bishop, *Publisher*  
Eric Jacobson, *Associate Publisher*

### ADVERTISING

Dee Unger, *Advertising Supervisor*  
Mary Birnbaum, *Production Manager*

### MARKETING

Stephanie Fagan, *Promotions Manager*  
Kelly Hawthorne, *Marketing Assistant*

Member,  
American Business Press

Member,  
Business Publications  
Audit of Circulation



**BROADCAST ENGINEERING** (USPS 338-130) is published monthly (except in December, when two issues are published) by Intertec Publishing Corporation, 9221 Quivira Road, P.O. Box 12901, Overland Park, KS 66212-9981. Postmaster, return form 3579 to P.O. Box 12938 at the above address.

**BROADCAST ENGINEERING** is edited for corporate management, engineers/technicians and other station management personnel at commercial and educational radio and TV stations, teleproduction studios, recording studios, CATV and CCTV facilities and government agencies. Qualified persons also include consulting engineers and dealer/distributors of broadcast equipment.

**SUBSCRIPTIONS: BROADCAST ENGINEERING** is mailed free to qualified persons in occupations described above. Non-qualified persons may subscribe at the following rates: United States, one year, \$25; all other countries, one year, \$30. Back issue rates, \$5, except for the September Buyers' Guide/Spec Book, which is \$20. Rates include postage. Adjustments necessitated by subscription termination at single copy rate. Allow 6-8 weeks for new subscriptions or for change of address. Second class postage paid at Shawnee Mission, KS.

### ADVERTISING SALES OFFICES

**NEW YORK, NEW YORK**  
Joe Coneri,  
Phone: (212) 682-6630  
Ann Pearce,  
Phone: (212) 697-7050  
630 Third Ave., Eighth Floor  
New York, NY 10017

### SANTA MONICA, CALIFORNIA

Herbert A. Schiff,  
Phone (213) 393-9285  
Jason Perlman,  
Phone (213) 458-9987  
Schiff & Associates  
1408 Santa Monica Mall, Suite 200  
Santa Monica, CA 90401

### KANSAS CITY, MISSOURI

Jan Winters,  
P.O. Box 12901, Overland Park, KS 66212  
Phone: (913) 888-4664

### NORWOOD, AUSTRALIA

Hastwell, Williamson, Rouse Pty. Ltd.  
P.O. Box 419  
Norwood 5067, Australia  
Phone: 332-3322  
Telex: AA87113

### LONDON, ENGLAND

Nicholas McGeachin,  
Suite 460, Southbank House,  
Black Prince Rd.  
London SE1 7SJ  
Telex: 295555LSPG  
Telephones: 01-582-7522  
01-587-1578

### TOKYO, JAPAN

Haruki Hirayama  
EMS, Inc.,  
Sagami Bldg., 4-2-21, Shinjuku,  
Shinjuku-ku, Tokyo 160, Japan  
(03) 350-5666  
Cable: EMSINCERIOD  
Telex: 2322520 MPISNJC

**INTERTEC**  
PUBLISHING CORPORATION

©1985. All rights reserved.



# Ampex Video Tape Scores a Perfect Ten




To capture the excitement of 8,000 hours of the Summer Games, ABC knew they'd need a video tape that was picture perfect.

That's why ABC chose Ampex 196 1" helical video tape and 197 3/4" videocassettes as the exclusive tapes to record the biggest events in the history of sports. It was an incredible honor for Ampex. One earned through years of consis-

tently crisp, clean performance. Reel after reel. Generation after generation. Even under the pressures of heavy editing and multiple generation dubbing.

So if you're looking for a video tape with a track record for reliability and quality, look to Ampex 196 and 197. ABC did. And their perfect performance made them the biggest winners of all.

## AMPEX

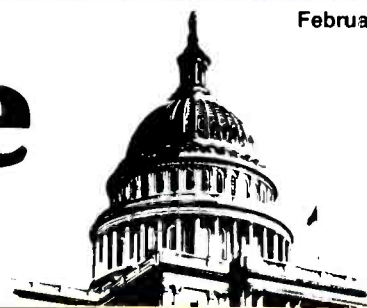
Ampex Corporation • One of The Signal Companies 

Ampex Corporation, Magnetic Tape Division, 401 Broadway, Redwood City, CA 94063, 415/367-3809

Circle (5) on Reply Card

# FCC update

By Harry C. Martin, partner, Reddy, Begley & Martin, Washington, DC



## 12-station rule modified

The FCC has affirmed its 12-station multiple ownership rule as it applies to AM, FM and TV stations.

With respect to television, however, an additional ownership limit has been adopted. Entities may not acquire ownership interests in TV stations reaching more than 25% of the national audience. Audience reach will be determined by the Arbitron ADI market rankings of the percentage of national TV households contained in each market.

However, the commission has decided to attribute only 50% of a market's ADI reach when the station involved operates on a UHF frequency.

The commission also decided to eliminate the automatic sunset provision under which all numerical limitations on station ownership would have disappeared in 1990.

Further, the commission decided to permit group owners of radio and TV stations to have cognizable interests in up to a maximum of 14 broadcast facilities in the same service if two of the stations are minority-controlled, minority ownership and control exceeding 50%. Entities having cognizable ownership interests in minority controlled TV stations will be permitted to reach 30% (as opposed to 25%) of the national audience.

These changes in the commission's multiple ownership rules will become effective on April 2.

## Power measurement amended

The FCC has adopted rules that allow more flexibility in the way AM, FM and TV stations measure operating power.

Under the new rules, AM stations may use direct reading radio frequency (RF) power meters to measure operating power. Further, if the antenna resistance of an AM station changes, the station now can resume power determination by the direct method once the new value for antenna resistance has been measured.

However, the station still must submit an application for license (FCC form 302 or 341) with the new measured value of resistance.

For FM and aural TV transmitters,

the power meter now may be calibrated by either using an external wattmeter or by using an indirect method of power determination.

In relaxing its rules, the commission emphasized that the burden of accurately measuring power and properly calibrating measuring instruments rests with the broadcaster in all cases. Stations were reminded that they must assure that operating power never exceeds 105% of that authorized for AM and FM stations and 110% for television.

## 689 new FM channels

On Dec. 20, the FCC amended its table of FM assignments by assigning 689 new FM channels to communities throughout the United States. This was the first step toward implementing the FCC's new FM station classifications and mileage separation criteria, adopted in Docket 80-90.

A second implementing order, which was expected to be released in January, is to address application filing procedures, special treatment (if any) to be afforded daytime AM stations in the application process, and procedures for filing new petitions to change the FM table of assignments.

## Cable Act rules

In a wide-ranging rulemaking proposal issued in December, the FCC proposed new rules designed to implement the Cable Communications Policy Act of 1984 (Cable Act), which was signed into law on Oct. 30.

The most significant proposals involve definitions of the terms "cable service" and "cable system" and regulation of rates for basic cable services. In response to other major portions of the Cable Act, the FCC is deleting its existing rules dealing with franchise standards and obscenity. These provisions have been superseded by the new legislation.

The proposed new definition of "cable service" takes into account Congress' distinction between programming services, which are exempt from common carrier regulation, and other types of communications services, which are not necessarily exempt. According to the Cable Act,

"cable service" is defined as the 1-way transmission to subscribers of video or other programming services together with any subscriber interaction that is required for the selection of such programming.

On the other hand, services that allow subscribers to manipulate or otherwise process information or data are not classified as cable services and could be subject to state common carrier regulation. These include at-home shopping and banking, data processing, video conferencing and all voice communications.

However, pay-per-view video programming, teletext, 1-way transmission of computer software and catalog services, none of which allow direct customer purchases, will be considered as cable services under the commission's proposed rules.

In redefining the term "cable system" to conform to the new legislation, the commission proposes to make the following additional changes in its rules:

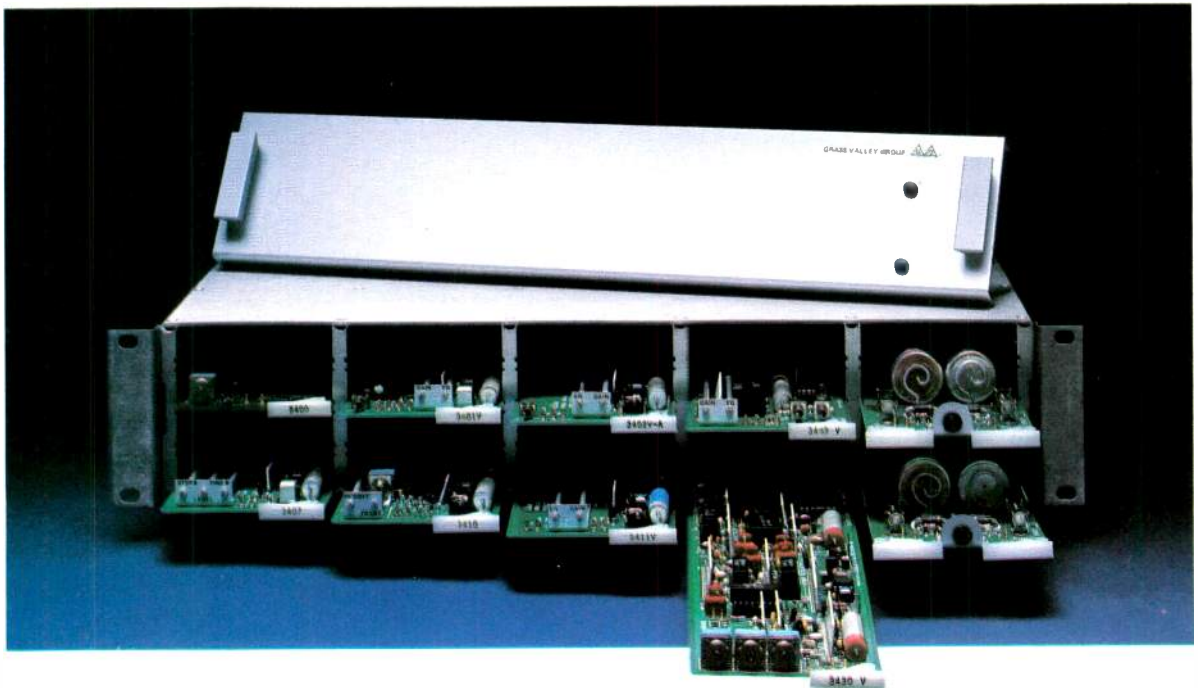
- A cable system will be defined as a facility that provides any type of video programming. Currently, a facility must distribute the signals of broadcast television stations to be considered a cable system.
- The commission will remove its exemption from regulation of systems with fewer than 50 subscribers.
- Systems that only retransmit broadcast signals will be exempt from regulation as cable systems. However, the commission is seeking comments on what regulations (if any) should apply to such newly exempt systems.
- SMATV systems that serve multiple-unit dwellings, regardless of whether they are commonly owned, controlled or managed, will be exempt from federal regulation if they do not use public rights-of-way. Currently, SMATV systems are exempt from regulation if they serve subscribers in one or more multiple unit dwellings under common ownership, control or management, regardless of whether they use public rights-of-way.

Concerning rate regulation, the new  
*Continued on page 116*



---

# Our Best Work Always Goes Unnoticed.



**I**n distribution amps, going unnoticed is the way it should be. Transparent. With distortion so low you won't even know there are DA's in the loop.

All nine of our DA's are built that way. DA's with variable cable equalization to over 3000 feet, variable delay trim and sync tip clamping. DA's for long cable runs. Regenerative DA's. DA's with 350ns to 750ns delay to help you put an end to delay lines and their EQ headaches.

No matter what your distribution

requirements are, they can be handled with our 3400 Series video and pulse distribution equipment.

Why not call the nearest Grass Valley Group regional office listed below? Tell them it's perfectly clear who has the broadest selection of DA's in the business.

---

---

**Grass Valley Group**<sup>®</sup>  
A TEKTRONIX COMPANY

P.O. Box 1114, Grass Valley, CA 95945 USA  
Telephone (916) 273-8421 TRT: 160432

---

OFFICES: Edison, NJ (201) 549-9600; Atlanta, GA (404) 321-4318; Elkhart, IN (219) 264-0931; Arden Hills, MN (612) 483-2594; Fort Worth, TX (817) 921-9411; Woodland Hills, CA (818) 999-2303; Palo Alto, CA (415) 968-6680.

Circle (6) on Reply Card

February 1985 *Broadcast Engineering* 7



The on-air performance of an AM stereo station is determined by the performance of the entire transmission chain, from the source machines to the antenna. A good on-air sound requires attention to every area of station operation. The phasing and phase stability of source, mixing and STL equipment are of critical importance and must be checked on a regular basis.

Establish a maintenance routine that includes measurement of all source equipment for proper phase coherence, frequency response, distortion, noise, wow and flutter. Be certain to use the proper test procedures when measuring the performance of source gear with active-balanced program audio outputs.

Most active-balanced (electronic transformer) output circuits should not be connected to an unbalanced test instrument. The test arrangement shown in last month's "AM Stereo Update" is appropriate for transformer-balanced or unbalanced source equipment, but it is not suitable for many active-balanced units.

The test setup in Figure 1 provides a way to accurately measure the performance of a unit with active-balanced input and output connections. Using an external transformer to make the conversion from balanced to unbalanced operation is not recommended, because the transformer may add its own phase shifts and amplitude variations to the test measurements.

Cartridge and reel-to-reel source equipment should be checked at a variety of frequencies across the audio band. Checking alignment at just one high frequency—such as 10kHz—could cause a 360° phase shift error to remain undetected.

Audio mixing and STL equipment should be checked on a regular basis for frequency response, distortion, noise and phase coherence. The test setup shown in Figure 1 can be used with an active-balanced output mixer or STL system by making the mixer or STL the unit under test.

Keep a record of the performance of each piece of equipment or link in the broadcast chain so that trends indicating a developing problem can be spotted early.

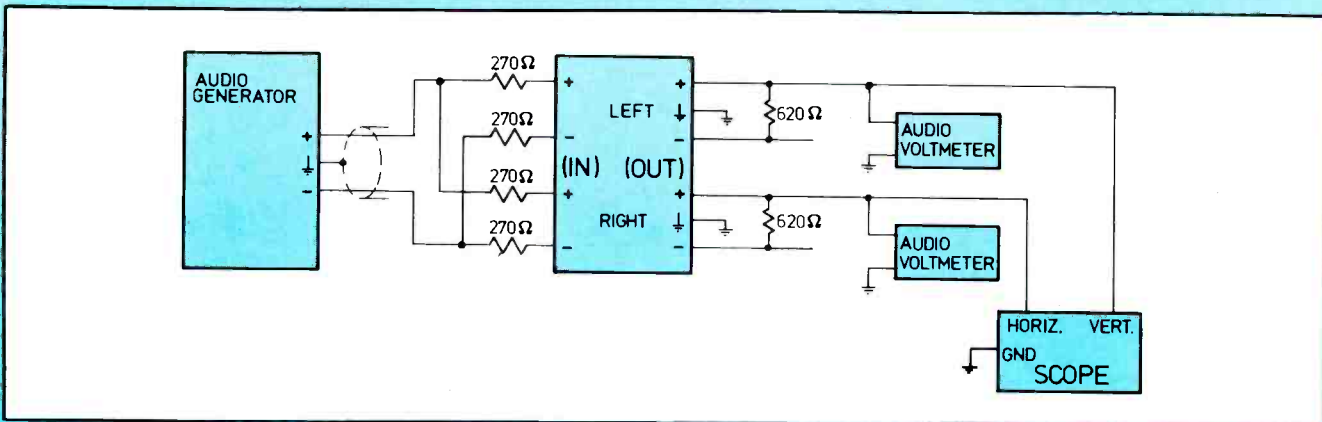


Figure 1. The recommended test setup for source equipment with an active-balanced output stage.

# Harris joins Motorola

Harris and Motorola have announced a licensing agreement under which Harris will manufacture and market AM stereo exciters and monitors using Motorola's C-QUAM AM stereo system. The move gives a giant boost to Motorola's efforts to become the de facto AM stereo standard in the United States.

William Howard, Motorola senior vice president, said the agreement "underscores the acceptance and acceleration of the C-QUAM AM stereo system as the

marketplace AM stereo standard."

Harris Broadcast Group Vice President Gene Whicker said the agreement was "in the best interest of all in making AM stereo thrive as a popular new broadcast technology and consumer medium."

Type acceptance for the Harris STX-1B C-QUAM AM stereo exciter has been filed with the FCC. Harris plans to offer users of its current system a modification kit for conversion to C-QUAM opera-

tion, once FCC-type acceptance has been received.

As expected, Leonard Kahn, president of Kahn Communications, which manufactures a competing system, has threatened legal action. In a press release, Kahn said that he had asked the government to initiate an investigation because "we believe that Motorola's conduct, including their recent agreement with Harris Corporation, raises serious antitrust problems under the Sherman and Clayton acts."



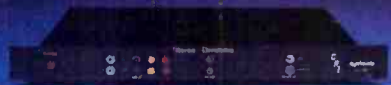
# MAXIMUM COVERAGE

CRL Audio processors are improving the fidelity and coverage of hundreds and hundreds of radio stations. From Seattle to South Africa . . . from Saipan to Rome . . . and from New York to Peru, radio stations world-wide have discovered that CRL processing gives them the best signal possible.

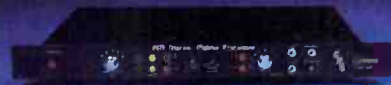
CRL has a complete line of audio processors and limiters, including unique split-band automatic gain control units; multi-band compression amplifiers that allow precise control of the on air signal; and absolute peak control units for FM and AM Stereo. The latest product is a stereo generator with unsurpassed specifications and a very modest price.

Take the time to send for complete details and user information. You will discover why America's choice should be your choice.

**SG800 Stereo Generator**  
Distortion: .01% or less  
Separation: 65 db or better  
Signal to noise: 80db or better



**SMP 900 AM Stereo Limiter**  
Provides mono compatible signal with maximum loudness. Exclusive stereo enhance control.



**SMP 80C FM Stereo Limiter**  
Patented non-overshooting filters and multiplex clipper for maximum loudness with low distortion.



**SPP 800 Stereo Preparation Processor**  
Gated split-band AGC for gentle control of console output.



**SEP 400B Spectral Energy Processor**  
CRL exclusive patented four-band compression for consistent sound.



Dealer inquiries welcome.

**CRL AUDIO**

**Circuit Research Labs, Inc.**

2522 W. Geneva Dr.

Tempe, Arizona 85282 U.S.A.

(602) 438-0888 ■ TELEX: 350464

Circle (7) on Reply Card

# Strictly TV

By Carl Bentz, technical editor

## Transmission standards, Part 2

This month's column continues a look at the three major standards in use around the world. The acronyms are defined as follows:

- NTSC-National Television Standards Committee.
- PAL-Phase Alternation each Line.
- SECAM-Sequential Colors with Memory (from the French "sequential couleurs a memoire").

### Within the PAL signal

PAL, which most closely resembles NTSC, offers a number of interesting differences, resulting from studies of NTSC and an attempt to improve upon it. For example, PAL receivers have no tint or hue control. It isn't necessary, because the system provides integral hue stability.

Five primary facts differentiate PAL transmission signals from NTSC:

- **Subcarrier.** The subcarrier frequency of 4.43361875Hz is used for

monochrome compatibility with the 50 fields and 625 lines. This is similar to NTSC, where the subcarrier is the 455 harmonic of  $\frac{1}{2}$  the line frequency.

The best compromise for the subcarrier involves a quarter-line offset. In other words, the subcarrier must be an odd multiple of  $\frac{1}{4}$  the line rate. To cancel interference patterns from frame to frame adds another restriction of a  $\frac{1}{2}$ -frame frequency offset. The line rate is 15,625Hz and the frame rate is 25Hz. Thus, the subcarrier results from the formula,  $f_{sc} = (1135/4 + 1/625)fh$ .

- **Color difference signals.** U and V have equal bandwidths that are approximate equivalents to the NTSC I component. The same gamma-corrected RGB signals are combined in a different manner. U involves B-Y, V is R-Y. In NTSC, both I and Q are derived from both the B-Y and R-Y components. Table I in January's "Strictly

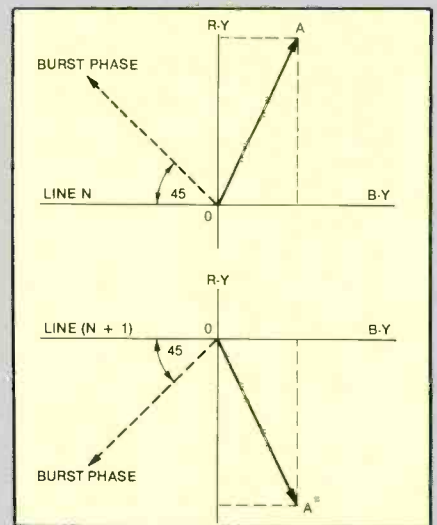


Figure 1. A swinging burst phase reference provides information on polarity of the R-Y or V component from line to line.

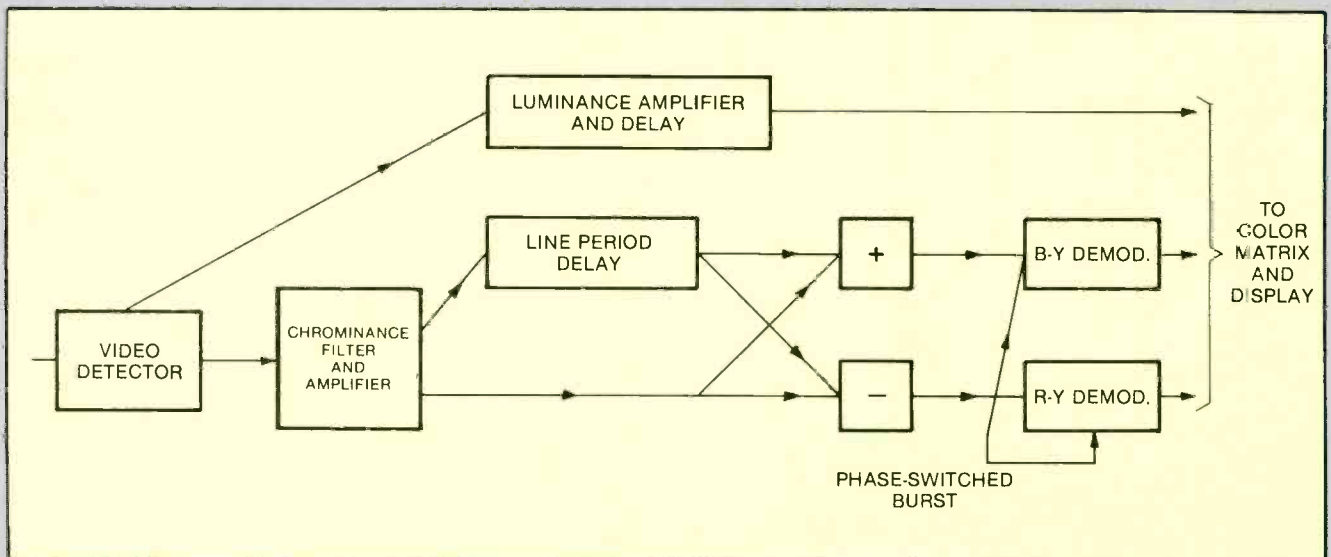
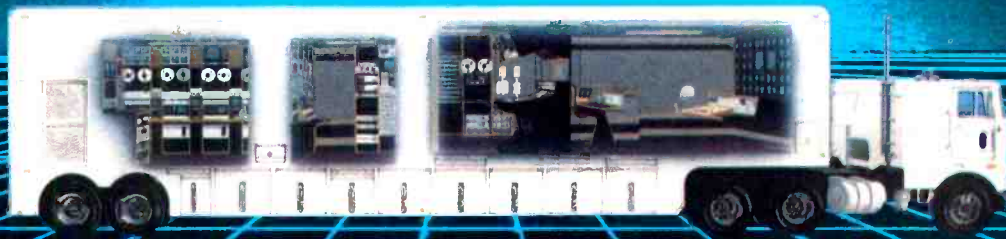


Figure 2. Color signal routing in a PAL decoder.



# FROM CONCEPT TO REALITY



We invite you to discuss with our design staff your future plans for a mobile unit. We can provide your total system...FROM CONCEPT TO REALITY.

THE  
**LERRO**  
CORPORATION

3125 N. Broad St., Philadelphia, Pa. 19132  
Contact Frank Kovary or Bob McTamney  
(215) 223-8200



TV" shows the signal compositions.

Recall that NTSC allows bandwidths of I and Q to be approximately 1.5MHz and 0.5MHz. PAL specifies an attenuation factor of less than 2dB at 1.3MHz for both U and V.

- **R-Y switching.** A phase reversal of  $180^\circ$  in the R-Y or V component occurs from line to line. The advantage of phase switching is reduced crosstalk between the color channels.

In NTSC, color fringing may occur if the Q-channel bandwidth in the receiver is insufficient for full double-sideband operation. Phase reversal creates a simulated double-sideband signal, even if high frequency components of chroma are restricted at frequencies nearing the PAL sound carrier.

- **Burst switching.** The phase of burst differs by  $90^\circ$  (actually  $\pm 45^\circ$  with respect to the B-Y signal axis) on successive lines, giving the color decoder information on the polarity of the V component. Figure 1 shows the phase relationships on two successive lines.

The purpose of this switching is to reduce level-dependent phase errors. Vector OA in the figure represents the chroma in the signal or the resultant of vectors R-Y and B-Y. A change in either component results in a much smaller change in OA. Errors as large as  $15^\circ$  will produce just noticeable effects in the picture. In NTSC, the just noticeable error is around  $6^\circ$ .

- **Phase angle vs. timing.** A sequence

of eight fields (compared to four for NTSC) occurs before exact phasing recurs. The so called "Bruch sequence" becomes very important for processing of PAL video.

#### In the PAL receiver

Additional differences occur in the PAL receiver. Beyond the missing hue control, they include a high tolerance 1-line delay with a duration exactly equal to an integral multiple of  $1/2fc$ ; addition and subtraction of delayed and nondelayed chrominance to separate U and V; line-by-line switching information developed from the shifting burst signal; and wideband equal bandwidth decoding, with the locally generated  $180^\circ$  switched subcarrier feeding the V demodulator circuit.

Of these differences, addition and subtraction of delayed and non-delayed chrominance to separate U and V is one reason why PAL appears technically superior to NTSC. The addition and subtraction of the two chroma components create an immunity to level-dependent phase errors in hue. Each line of video is sent through a delay line (Figure 2).

A video line from the chroma filter/amp feeds a precision delay line as well as sum and difference circuits. An output from the delay line also feeds the sum and difference matrix. If the line presented by the delay is represented by  $+U, +V$ , then the signal coming direct from the chroma

amp is  $+U, -V$ . The sum circuits deliver a  $+2U$  component to the B-Y demodulator. The subtractor presents a similar situation. With  $+U, +V$  and  $+U, -V$  inputs, the U signal cancels, and the value of V adds.

#### On the screen

To the U.S. observer watching PAL for the first time, there is a definite flicker to the image. It does not take long to ignore the 50Hz field rate effect. What is difficult to ignore, however, is that color in the picture appears more phase stable and more saturated than NTSC.

If observers go across the English Channel to France, they may find the picture even better. SECAM differs fundamentally from NTSC and PAL in the transmission of color information.

#### SECAM and FM color

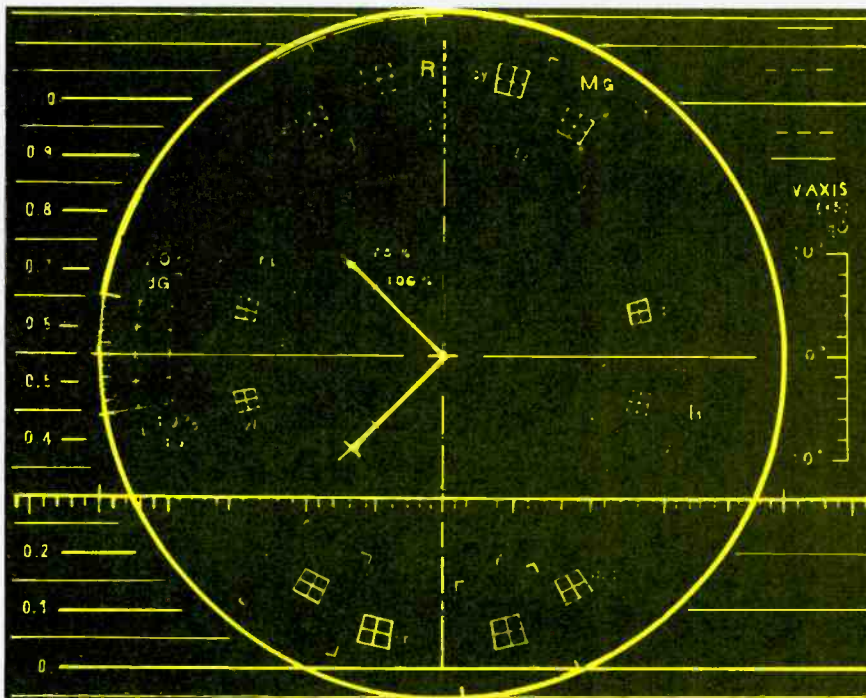
The SECAM signal is developed from typical gamma-corrected RGB inputs. R-Y and B-Y components are generated normally. Then a DR (from R-Y) and DB (from B-Y) forms modulated the 4.433MHz subcarrier. Frequency modulation is used, with DR being sent, followed by DB in a line sequential approach. The instantaneous frequency increases as DR or DB decreases.

In the receiver, a delay line and switching route the correct component to its own FM demodulator. Every displayed line will result from a B-Y component that is delayed or non-delayed, and an R-Y component that is nondelayed or delayed. Vertical resolution is somewhat reduced and a flicker along horizontal boundaries of high saturation colors may be noticed.

With only one color difference signal transmitted at any one time, SECAM receivers require no auto-phase control loops or synchronous receivers. Improved immunity from phase distortion and freedom from color crosstalk results, but some added noise appears in monochrome displays of color signals.

#### Transmission vs. studio

The comments made about NTSC and PAL generally apply to video in the studio as well as video transmitted via RF to the receiver. Fades and effects present no major difficulties. In the SECAM format, however, even simple fades become undesirable and any type of split screens and special effects become impossible. Conversion to NTSC or PAL are required before any production functions are performed.



A PAL vector display.

Courtesy of Tektronix

||:~(-))|||



# ONE LESS ALLIGATOR

The Broadcast Engineer works with time-line responsibilities few of us will ever experience. He knows that equipment problems can wreck production schedules.

That's why the Otari BII audio machine is so widely used for broadcast, news editing, and production.

Three speed operation, front panel record calibrations, a microprocessor controlled tape counter with LED display, and variable speed control, coupled with "bulletproof" reliability and high level product support all add up to one less alligator snapping at your heels. From Otari: The "Technology You Can Trust."

Contact your nearest Otari dealer for a demonstration, or call Otari Corporation, 2 Davis Drive, Belmont, CA 94002 (415) 592-8311 Telex: 910-376-4890



**OTARI**®



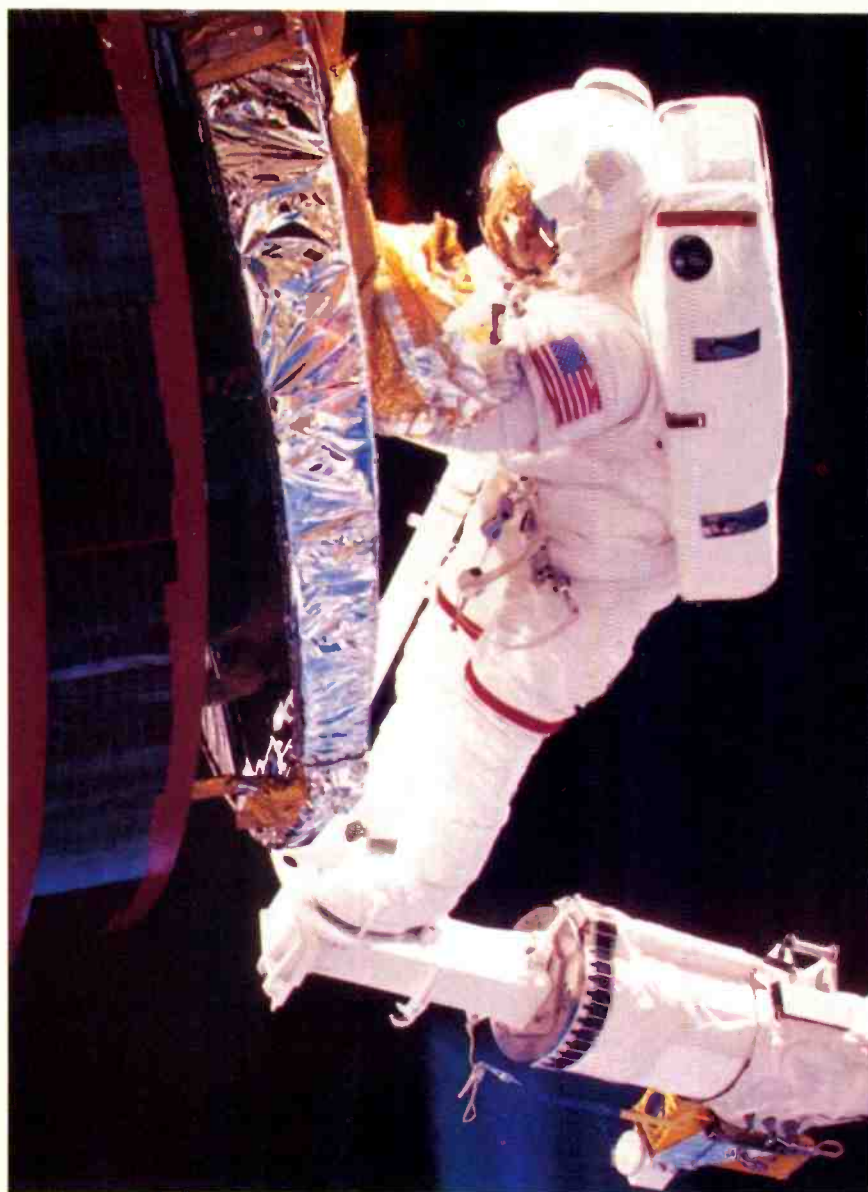
Circle (59) on Reply Card

© Otari 1984



# Satellite update

By John Kinik, satellite correspondent



Astronaut Joseph Allen secures the Westar VI satellite as he stands on a mobile foot restraint attached to the Shuttle's remote manipulator arm assembly.

---

Before the Space Shuttle crew could rescue two crippled satellites, ground crews on five continents worked for months to make the 2-day mission as easy as possible.

---

The November retrieval of the Westar 6 and Palapa B2 satellites from earth orbit by the crew of Space Shuttle Mission 51-A was dramatically portrayed in television, newspapers and magazines, giving tremendous visibility to the role of the astronauts.

But there was far more to the story than the space spectacular that the media focused on. Behind the scenes, there was an engineering spectacular going on for months prior to the actual shuttle mission. Starting in March, a team of satellite control and orbital analysis specialists performed analyses and conducted maneuvers to position the satellites in proper orbits to make the retrieval possible.

The effort involved three different phases of orbit maneuvers and the combined forces of personnel and ground facilities on five continents.

When the two satellites experienced virtually identical failure of their booster rockets after launching from the shuttle in February 1984 (see "Satellite Update," June 1984), their orbits were determined by ground tracking and radar stations.

The satellite owners, Western Union and the government of Indonesia, declared the satellites lost and collected insurance payments. The satellite manufacturer, Hughes Aircraft, called on its Orbital Operations and Analysis Team, headed by Jeremiah Salvatore, to determine whether a salvage mission was feasible, in view of the complex orbit maneuvers that were necessary. Based on the team's confidence in being able to achieve the tricky maneuvers required to bring both satellites to the shuttle for pickup, the mission was approved.



# THE RIGHT STUFF



## Lenco's New 600 System Audio Distribution Components Put All the Right Stuff Together...

Lenco's new 600 System audio components bring a new standard of performance to the field of audio/video distribution equipment. But that's not the only reason why you'll want to specify the Lenco 600 System for your next purchase.

### UNMATCHED VERSATILITY

Mix Lenco Audio and Video Distribution Equipment to suit your needs. Virtually all Lenco distribution components fit the 600 System Main Frame. And you can mix audio/video in almost any combination in the unique 9 cell frame. You're not limited to a 50/50 maximum video-audio mix. Engineers will also appreciate our innovative frame and module design which ensures ease of installation and maintenance.

### ENGINEERED FOR PERFORMANCE

Lenco 600 System components are built to the toughest standards in the industry, and engineered to assure unmatched performance with specifications such as:

**ANY  
WAY  
YOU  
WANT  
IT!**

- S/N 105 dBv
- Common Mode Rejection 70 dB
- Intermodulation Distortion < .004%
- Total Harmonic Distortion < .006% up to 24 dBm

Finally, our design engineers have taken extreme caution using grounding and shielding to minimize crosstalk.

### SUSTAINED SUPPORT SERVICE

If you should experience a problem with any Lenco component, we can supply a loan replacement from our factory ... Fast, usually within 24 hours. It's just one more reason why, when you need "the right stuff" for your audio or video operation, your first choice should be *The Professional's Choice... Lenco.*

For complete technical information on Lenco's New 600 System Components and the full line of quality Lenco distribution equipment.

**Call Toll-free: 1-800-325-8494.**



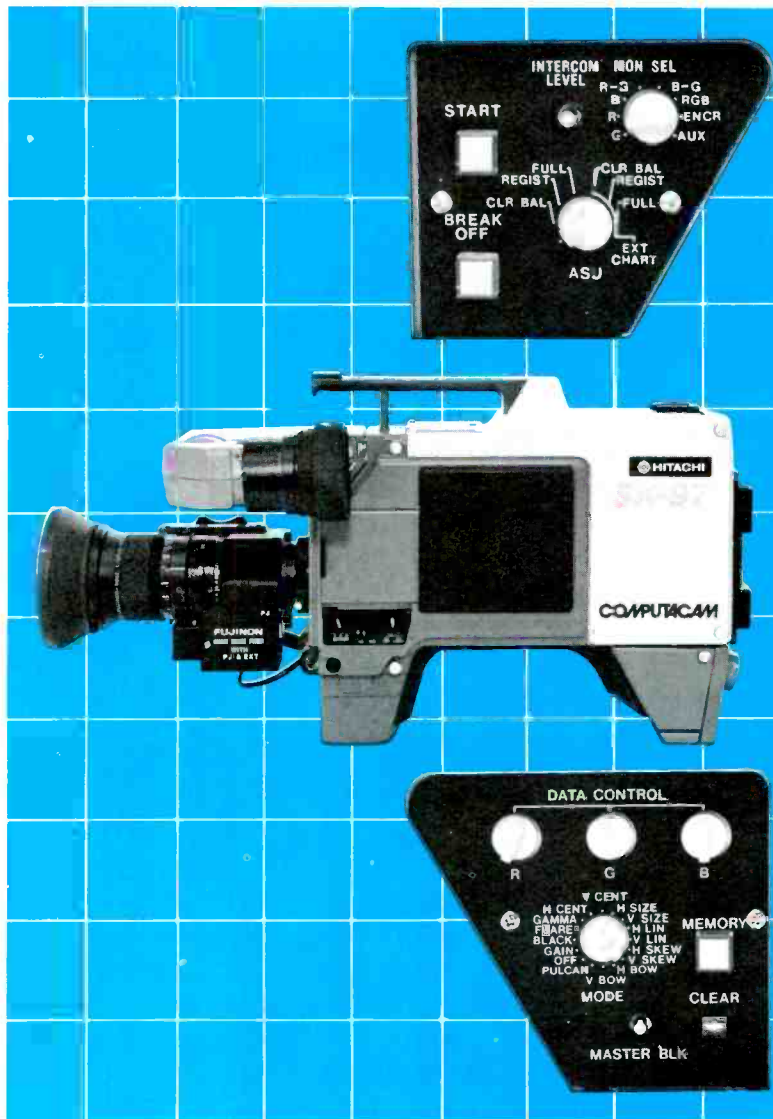
300 N. Maryland St.  
P.O. Box 348  
Jackson, MO 63755  
1-314-243-3147

Circle (8) on Reply Card





# We designed-in features the competition couldn't.



Get the competitive edge with our new family of field/studio cameras. The SK-97 and SK-970 combine on-board computers and advanced technology to provide the maximum flexibility and control available today.

No competitive video camera automatically sets up full color balance and full registration, including the green channel, in just two minutes.

No other video camera in its class has a full function, "smart" Remote Control Unit offering more capability in less space.

No other competitive video camera offers real time registration correction during lens zooming and focusing.

No other camera in its class offers automatic corner registration correction as part of its automatic registration set-up.

No other video camera has a prism heat sensor and pre-programmed ROM to ensure correct registration in real time.

Each camera contains an on-board computer that allows simultaneous set-up of up to 42 cameras within two minutes. Plus only one camera is affected in case of auto set-up failure.

## Hitachi's SK-970 and SK-97 Computacams.



Our SK-970 and SK-97 Computacams offer superior noise-free video (59 dB signal-to-noise-ratio!)

Combine all this with other advanced features such as 700 horizontal lines of resolution, high gain in 3 dB steps from 0-21 dB, completely interchangeable boards, and built-in auto diagnostics, and you can see why our SK-970 and SK-97 Computacams stand alone!

Get the features the competition couldn't design in. For descriptive literature, technical information, or a personal demonstration, contact Jack Breitenbucher, National Sales Manager, Hitachi Denshi America Ltd., Broadcast and Professional Division, 175 Crossways Park West, Woodbury, N.Y. 11797 (516) 921-7200 or (800) 645-7510.

 **HITACHI**

Circle (10) on Reply Card

# WHILE EVERYONE ELSE HAS BEEN PROMOTING A FORMAT, SONY HAS BEEN PERFECTING A SYSTEM.

Over the last three years, Sony's rivals in the combination camera/recorder arena have spent considerable time inventing wonderful things to say about their new formats. But apparently, they've overlooked inventing many wonderful new products to go along with these formats.

Sony has taken a different course.

In 1982, Sony introduced Betacam™ and the BVW-10 play-

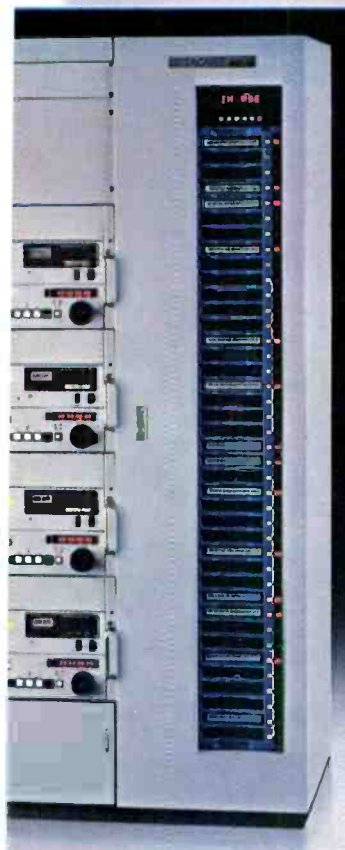
back unit. An evolutionary system that didn't force stations to abandon their existing 3/4" and 1" equipment.

Then, in 1983, Sony expanded the system with the three-tube Betacam, the BVW-40 edit/recorder, and the world's first battery-operated 1/2" field playback unit.

And this year at NAB, Sony announced a major breakthrough in cart machine technology with Betacart.™ A system

Sony Broadcast Products Company, 1600 Queen Anne Rd., Teaneck, NJ 07668. ©1984 Sony Corp. of America. Betacam, Betacart and Newsmaker are trademarks and Sony a registered trademark of Sony Corp.





that demonstrated the Betacam format's strength beyond the newsroom, beyond the studio, and beyond field production. At the same time, Sony also unveiled the world's lightest camera/recorder, the BVW-2 Newsmaker.™ And a prototype coder/decoder system that will make it possible for Betacam to be transmitted by microwave. Each of these products is the result of Sony's dedication to

the needs of the ENG and EFP industry. Work which has earned the Betacam format widespread acceptance by television stations and production companies around the world. Which only makes sense. After all, in this business you don't win sales on the merits of your arguments. You win them on the merits of your products.

**SONY**  
Broadcast

## Maintenance: The manufacturers' responsibilities

Guest editorial  
by Larry Krupa,  
maintenance supervisor,  
WPBT-TV, Miami

"This thing is great...when it works."

That phrase is being used more and more at broadcast stations across the country to describe the serviceability of some of the highly sophisticated digital equipment found at radio and television facilities.

These maintenance problems are being caused not only by inexperienced and untrained station maintenance personnel, but also by manufacturers. Whether through the childish guarding of trade secrets or the ignorance of their technical departments, the lack of factory support for new hardware is seriously affecting the operation of many facilities. With the rapid pace of technology today, manufacturers must turn this situation around.

I can document dozens of examples of equipment manufacturers that have shipped new and highly sophisticated pieces of equipment that contain schematics that bear little or no resemblance to their equipment. I've seen prototype drawings sent as operator's manuals. I've seen etched circuit cards that contain hundreds of chips and components with no labels or numbers. I've seen equipment with boards containing microprocessors and ROM chips that came with no documentation at all.

A schematic might be issued by a company for a circuit card with a suffix of "01" or "02," but you have an "05" or "06" in your system.

One section of a particular piece of new equipment that I recently installed arrived with only a hand-drawn logic flow diagram. Further, all of the component designators on the drawing were scratched out and relabeled. This created a great deal of confusion in the pinout area of the edge connector.

When I called the manufacturer to ask for a new version of the diagram, the reply was, "The fellow that designed that section quit about four years ago and no one has quite figured out the circuit."

I am not speaking of small, fledgling electronic companies. Rather, I am talking about major companies that have the necessary resources to provide proper documentation to the users of their equipment.

The lack of factory support causes needless frustration for experienced maintenance engineers, not to mention less experienced personnel who must also repair the equipment. Who on earth would ever choose a profession that required you to service an item for which the manufacturer refused to provide competent technical support or documentation?

Broadcast manufacturers, you are creating some of the havoc that exists in the engineering community today. You could ease the burden on existing maintenance personnel by providing greater technical support. This would, at the same time, pave the way for technically inclined people to become our future maintenance engineers.

Supply equipment instruction manuals that discuss the theory of operation. Print accurate block, flow and schematic diagrams. Supply users with troubleshooting information, including waveforms, voltage levels, logic test points and ROM listings. Conduct on-site training seminars for station maintenance personnel.

When a piece of equipment fails in the field, it reflects on the company that built it. Good business sense demands that manufacturers provide station engineers with adequate information and technical support to keep their products operating properly.

Poor product support is one of the easiest ways a company can create a bad reputation within the broadcast industry. When engineers get together and talk, they generally talk about problems: problems they have had with equipment, or problems they have had with factory service departments.

A poor reputation within the broadcast community will inevitably result in lost repeat business for the company. Good engineering support after the sale is good business.

[:?=:))]]




MASTERING THE MIND'S EYE

**B**ROADCAST **P**PLUS

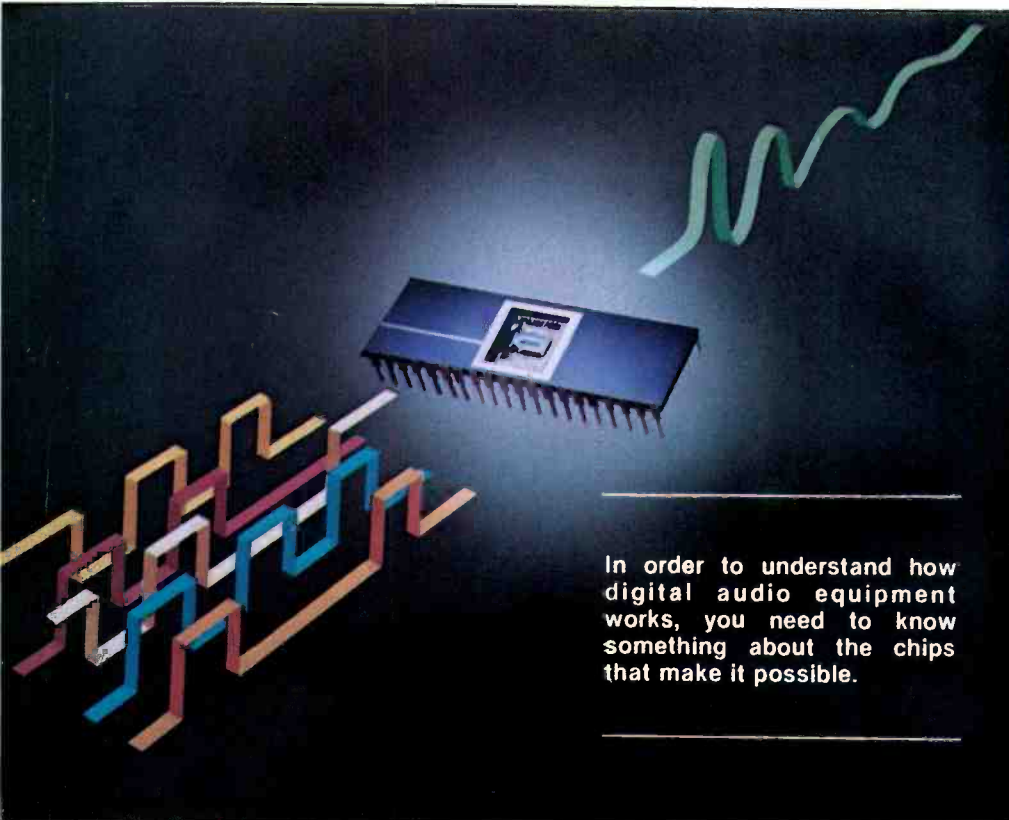
U-MATIC VIDEOCASSETTES

AGFA BP — the promise...delivered.

**AGFA**  
**VIDEO**

AGFA-GEVAERT  275 NORTH STREET, TETERBORO, N.J. 07608 (201) 288-4100

Circle (11) on Reply Card



# The roots of digital audio

Courtesy of Harris Semiconductor

In order to understand how digital audio equipment works, you need to know something about the chips that make it possible.

By Leonard Sherman, National Semiconductor, Santa Clara, CA, and Jerry Whitaker, editor

The rapid growth in digitally based audio equipment is closely linked to an even faster pace set by the computer industry for data acquisition system development. Sophisticated computers are commonplace in growing numbers of real world situations, and consequently, more uses are being found for analog-to-digital (A/D) and digital-to-analog (D/A) conversion hardware.

In certain types of broadcast equipment, digitally processing audio signals has become commonplace. Digital technology can be found in audio time delay units, special effects generators, satellite systems, tape recorders and audio consoles.

Digital audio is here. The need to understand how this new technology works cannot be overstated. There is often a tendency to treat a new discipline such as digital audio conversion as simply a *black box*, and to ignore what goes on inside the circuit.

However, to fully understand the capabilities and requirements of these chips, you should take a closer look.

The A/D converter is our bridge into the digital world. Most converters fall into one of three categories, which essentially define their basic mode of operation: *successive approximation*, *integrating* and *flash*.

## Successive approximation

Successive approximation is probably the most popular A/D conversion technique. Typical monolithic successive approximation register (SAR) converters have from 8- to 12-bit

resolution, and conversion speeds from  $10\mu\text{s}$  to  $100\mu\text{s}$ . An SAR A/D converter operates by stepping through a sequence of *educated guesses* in which the unknown input is compared to a series of binarily weighted reference

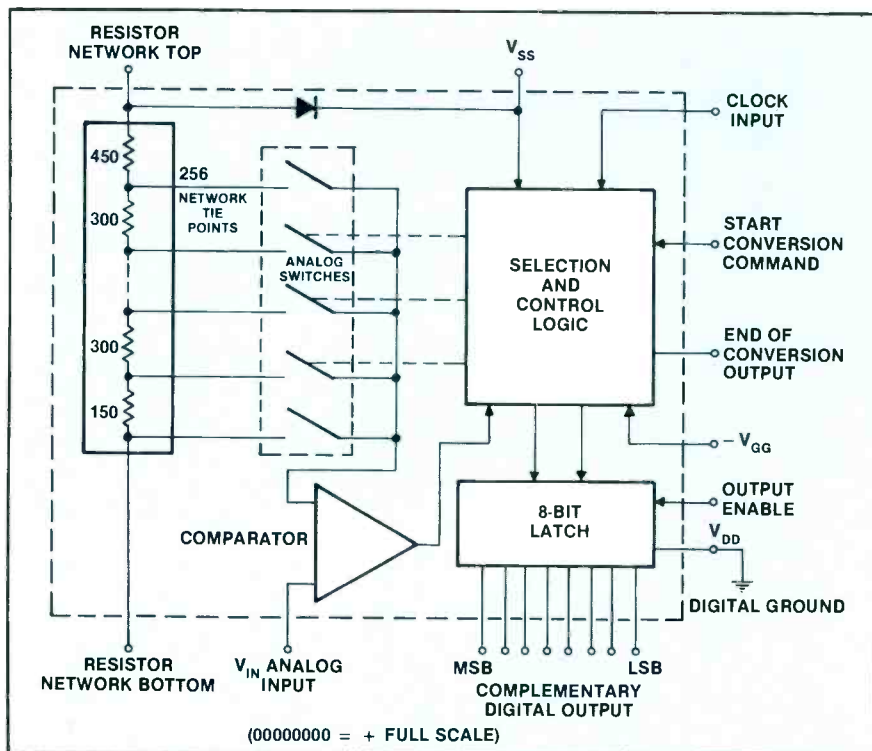


Figure 1. Block diagram of a successive approximation register (SAR) A/D converter.

Sherman is MOS analog applications engineer for National Semiconductor.



## Creating special effects

levels. The result of each successive comparison helps to determine what the next guess will be.

Figure 1 shows the block diagram of one type of SAR A/D converter. The 8-bit device contains 256 series resistors and analog switches, control logic and output latches. Conversion is performed by comparing the unknown analog voltage with the resistor tie points using analog switches. When the appropriate tie point voltage matches the unknown voltage, conversion is complete and the digital equivalent of the analog voltage is presented at the output.

The number of bits of resolution provided by the converter is equivalent to the number of comparisons that are made. There are two primary advantages of this technique: Only one comparator is needed for conversion, and higher resolution does not greatly increase the conversion time.

For example, a 10-bit A/D converter will only be 10/8ths slower than an 8-bit device of the same basic type, because only two additional comparisons are made to obtain four times the resolution. The binary nature of the SAR search also makes the converter ideal for interfacing to computers and microprocessors.

Unfortunately, the SAR converter requires a large number of steps to complete an approximation routine and is susceptible to error if the analog input changes in the middle of the SAR search. For this reason, the noise rejection performance is usually not high. For certain inputs, a *sample-and-hold* stage or filter may be needed to stabilize the input signal while A/D conversion is under way.

### Integrating converters

Integrating A/D converters, including single, dual and multislope designs, are most commonly found in digital meters and instrumentation. They are relatively slow, but this is usually not a problem because the results are used primarily for visual readout.

The strong point of an integrating A/D converter is high resolution, offering as many as 20 bits of digital data (six decimal digits). Even low-

*Continued on page 26*

Advancements in digital technology have made possible the creation of a number of new and unique special audio effects ranging from complex reverberation to comb filters.

Once an audio signal has been digitized, special effects can be generated by the application of numerical calculations to the data. For example, gain control of an input signal is accomplished by multiplying the digital word by a control constant. Audio mixing is achieved by adding together numerical samples from two or more digital signals.

Limiting is performed by multiplication of the signal by a control number derived from the signal itself. Filtering and equalization are employed in arithmetic sequences involving time delay multiplication and addition of the resulting signals to previous samples. This arithmetic processing provides the digital equivalent of reactive circuits commonly used in analog filters.

High speed digital filters, constructed of bit-slice processors and multipliers, can be used to create replicas of familiar audio processing circuits, such as shelving equalizers and second order peaking filters. Because the signal processing is under software control, the digital effects generator is not limited to specific characteristics.

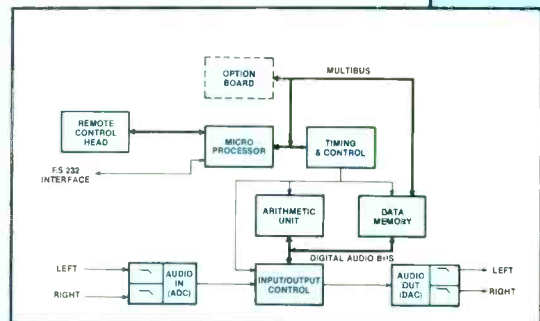
Instead, entirely new effects can be created by the user. Digital technology also allows specific effects to be stored in memory for later recall, further increasing the equipment's versatility.

### Reverbbbbbbbbb

Natural reverberation results from the combination of a sound signal with a large number of time-delayed versions of the original sound. The characteristic sound produced by the original audio signal and its reflections is determined by the intensity of each reflection, its time delay and frequency response characteristic.

Digital reverb is typically generated by feeding a digitized audio signal into a number of delay lines and then feeding back a controlled amount of the various signals to the different lines. This practice gives the user a wide variety of reverb options, all under software control, at reasonable circuit complexity.

The primary factors used to



Simplified block diagram of a new generation programmable digital reverberation system.

create specific reverb effects are the time delay of each segment, the amount of feedback used, the digital filtering applied to the feedback loops and the mixing levels of the delay channels. The creation of reverb special effects, therefore, incorporates the techniques of gain control, mixing, limiting and filtering. The software program for these parameters makes up the mathematical algorithm that simulates the characteristic sounds of the desired reverberation.

The figure above shows a block diagram of a digital reverberation system. Right- and left-channel input audio is passed through a low-pass filter and digitized in an A/D converter. A microprocessor and arithmetic unit processor operate on the digital data to produce the desired result.

The system can store data in memory, withdraw it at specific times, perform mathematical calculations on the digitally coded audio, and then mix the various signals—at various delay points—together. The resulting sum can either be presented to the output through a D/A converter and low-pass filter, or placed in the system's memory for further processing.

The complex reverb programs required for such a system are written in advance and stored in non-volatile memory. Users can recall a number of preset reverb situations (such as a particular concert hall or acoustic chamber) or create their own reverb effects. An operator can, in essence, electronically design the size and character of a room by adjusting the amplitude of each reflection, its time delay and frequency response.

Courtesy of Lexicon

**Multimedia Entertainment wanted us at Midwest to ...**

deliver all the big hits – the game winning RBI's, plus stage shows, concerts and hit specials – from any location, at any time. We designed and constructed Eagle 1, 47 feet of production capacity with more versatility than any mobile unit on the road today. What makes it the biggest hit are fine components like:

- Ikegami HK-357AT Automatic Color Cameras that set the standards for picture resolution, signal to noise ratio and registration accuracy.
- Ikegami HL-79EAL, the hand held cameras that produce higher quality images than many other manufacturers' studio models.
- Ikegami 9-Series Color Monitors, renowned for superb resolution and amazing life-like colors and high stability, unit changeability, and low power consumption.



# *Midwest and Ikegami*





This dedication to quality and versatility is evident throughout the unit. We used our 20 years of engineering experience to integrate these excellent components into complete systems that could handle any assignment.

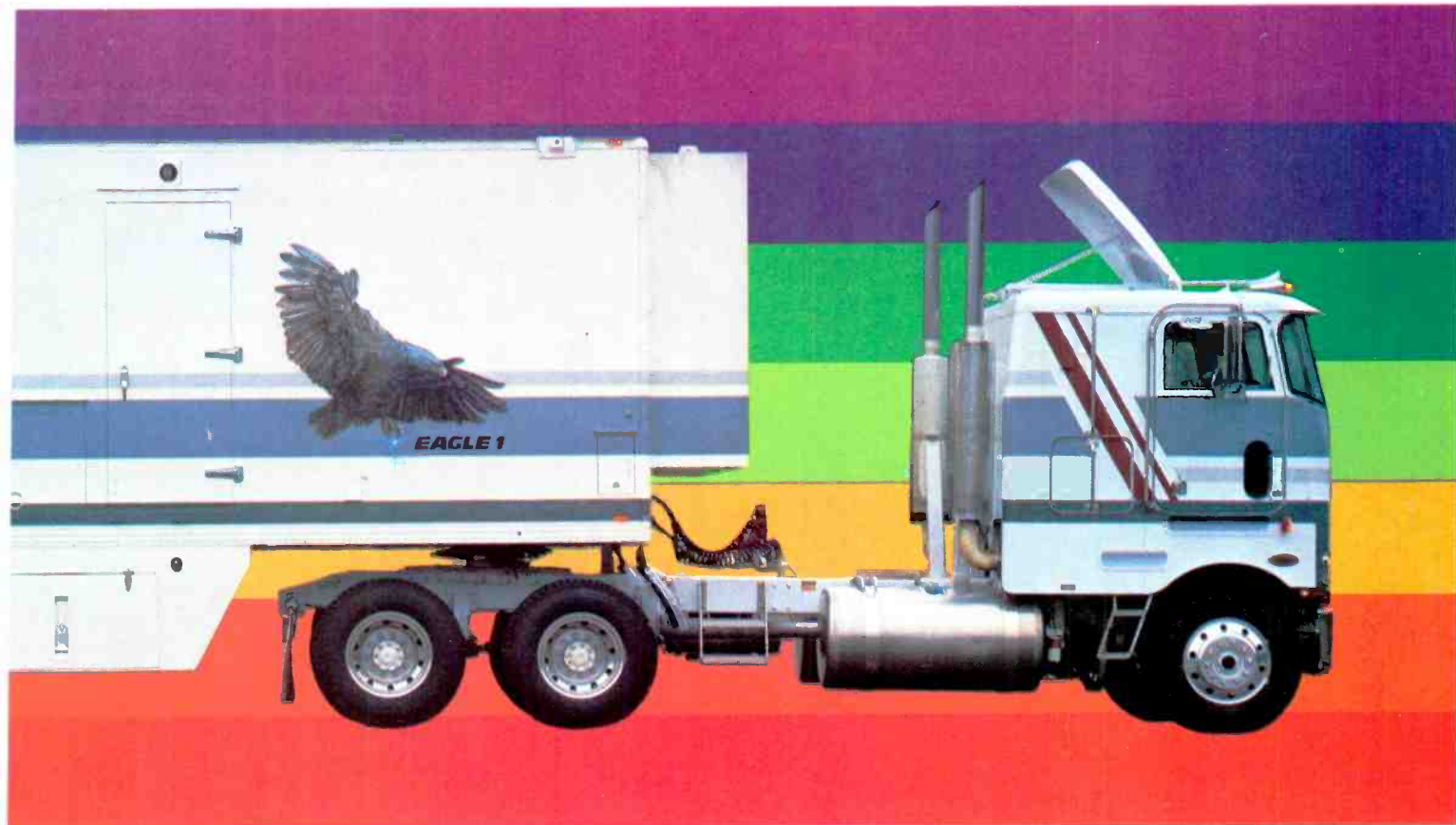
The equipment package includes:

- Five Ikegami HK-357AT Cameras with Triax and Canon 40:1 Lenses.
- Two Ikegami HL-79EAL Cameras with Canon 13:1 Lenses.
- 24-Input Grass Valley 300/3A Production Switcher.

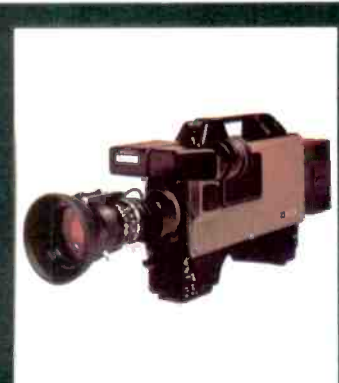
- Four Ampex VPR-2B One Inch Tape Machines with Slo-Mo.
- One Sony BVU-820 ¾" VTR with Slo-Mo.
- One Sony BVU-800 ¾" VTR.
- One Beta VTR.
- Harris HDE-200 Digital Effects System.
- Adda ESP II Still Store System.
- Audiotronics 36-Input Stereo Audio Console.
- Chyron 4100 Graphics Generator.
- Two Adda VW2 Frame Synchronizers.

Eagle I is delivering the big hits for NBC and Sports Time Cable Network. In fact, because of its diverse capabilities, other networks and companies are leasing it as well.

For the large scale teleproduction unit or any other communications system, do what Multimedia did. Call on Midwest. We'll deliver a big hit for you. For further information about leasing the Eagle I, contact Bill Spiegel at Multimedia Entertainment 513-352-5065.

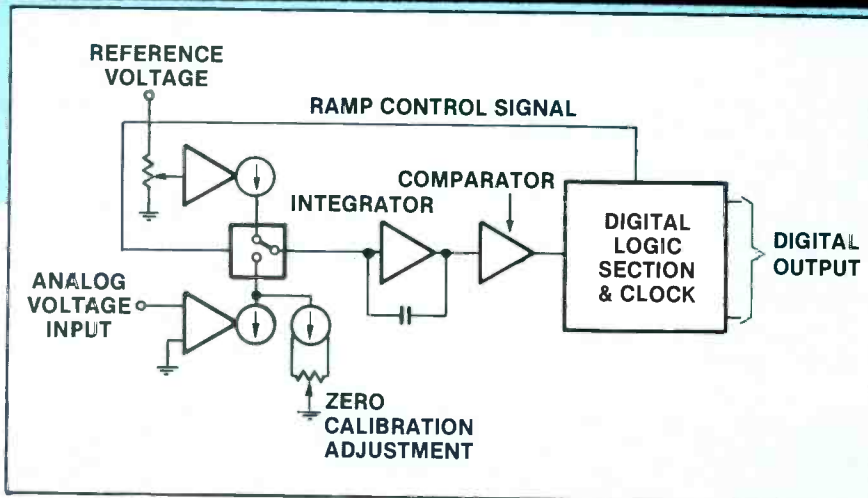


*deliver another big hit!*

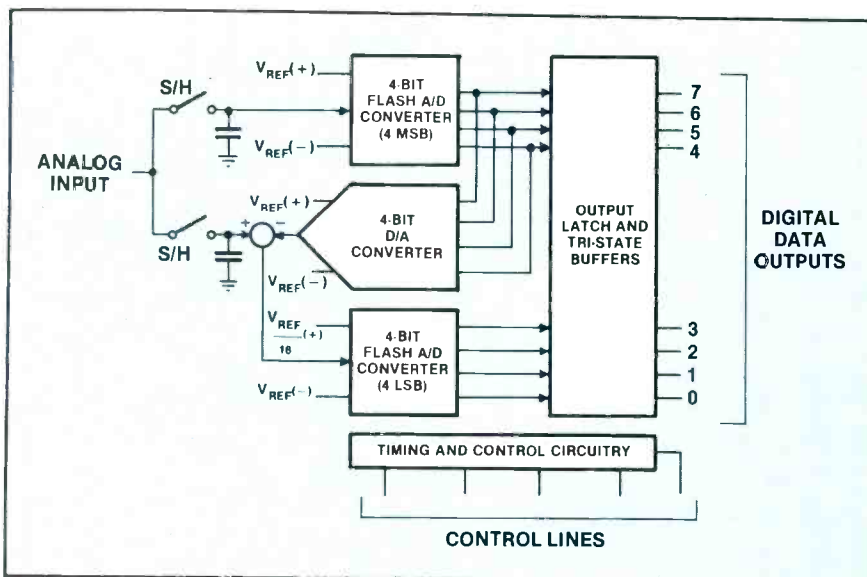



**MIDWEST**  
Communications Corp.  
Mobile Unit Group  
One Sperti Drive  
Edgewood, KY 41017  
606-331-8990

Circle (12) on Reply Card



**Figure 2.** Simplified block diagram of a dual ramp integrating A/D converter.



**Figure 3.** Block diagram of a half-flash A/D converter circuit. This 8-bit converter uses 32 comparators, a most significant 4-bit flash A/D and a least significant 4-bit flash A/D. The input signal is sampled and then held by a pair of S/H buffer stages. This converter circuit can be cascaded for greater resolution.

cost monolithic converters of this type commonly handle  $\pm 2000$  counts, which is equivalent to 12 bits.

The most popular type of integrating converter is the dual slope design, in which the unknown signal is used to ramp the input of an integrator up from 0V for a time set by a fixed number of clock cycles. A reference voltage of opposite polarity is then used to discharge the integrator and return it to zero. The discharge time, which is proportional to the input voltage, is measured by counting the number of clock pulses (Figure 2).

The dual-slope integrating A/D converter, by nature, has high noise rejection, because the output represents the average value of the input signal over the integration time. This circuit ignores changes in its integrator and clock because both are used to measure the reference, as well as the input, during each conversion cycle. This causes some of the drift and error terms to cancel.

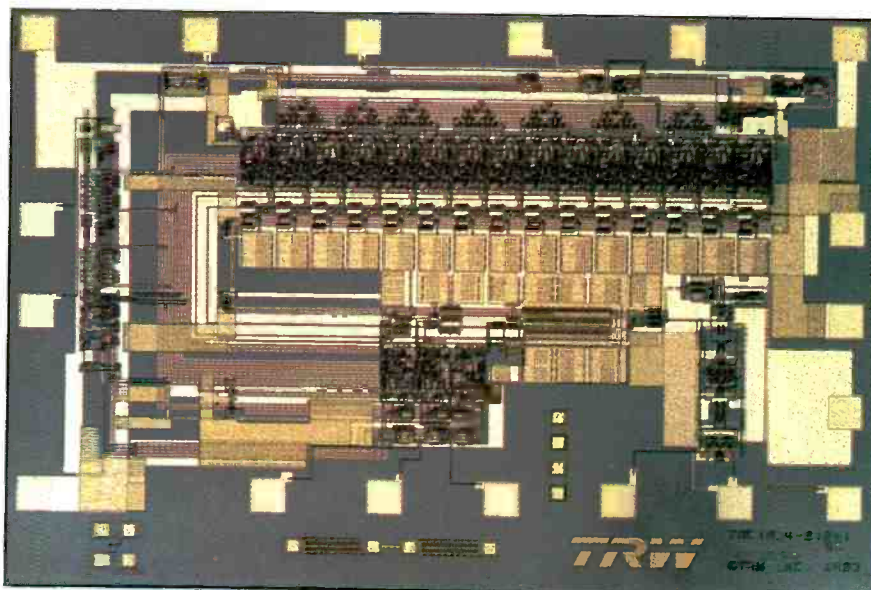
A major disadvantage of the integrating A/D converter is the difficulty often experienced in interfacing the device with a microprocessor because of the converter's slow speed and sometimes unusual output format. Obtaining higher resolution also requires longer integration times and, therefore, significantly longer conversion periods. Each additional bit of resolution will typically double the A/D conversion time.

### Flash converters

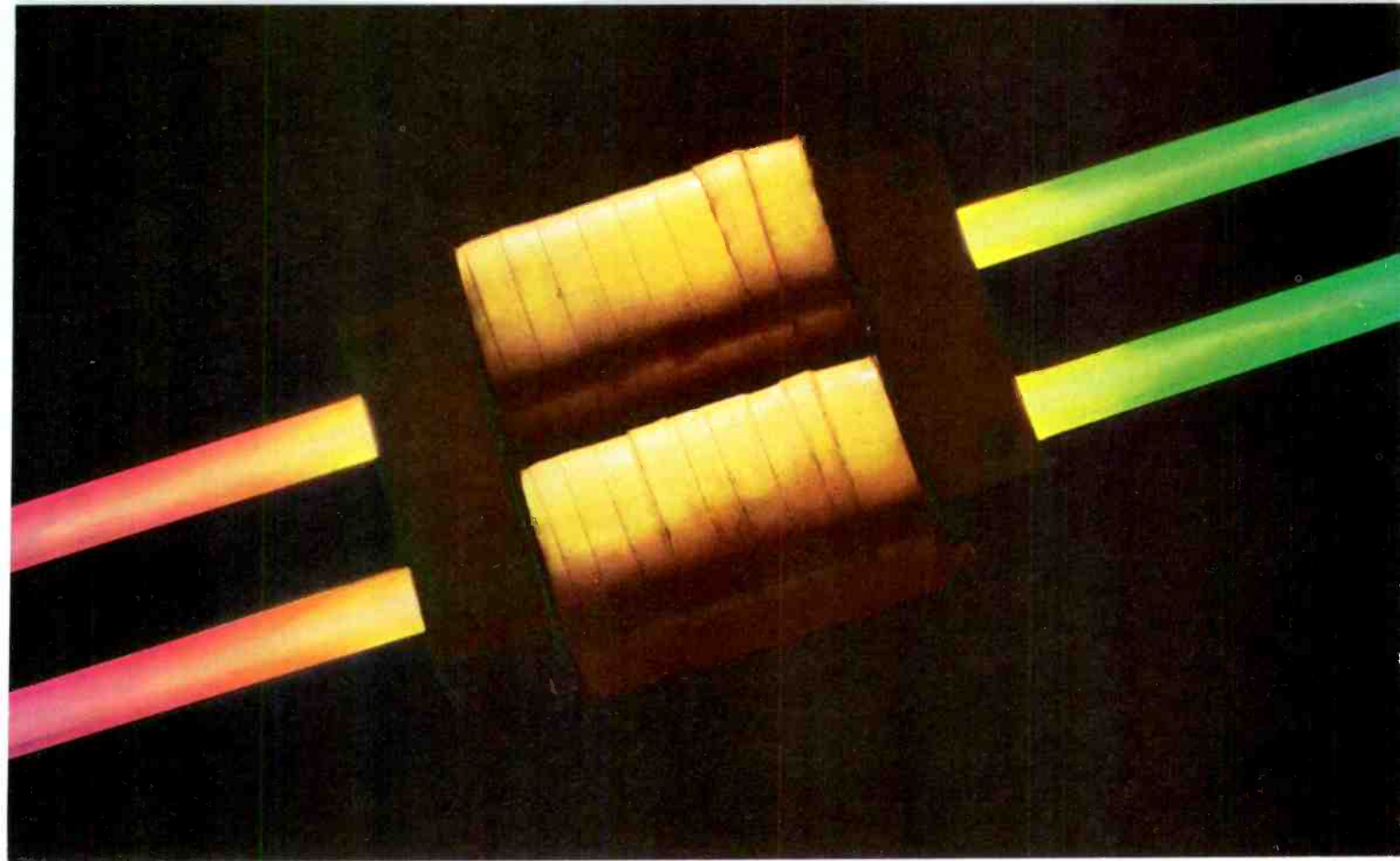
Flash A/D converters are the fastest devices presently available in either a discrete or monolithic form. The operating principle of the flash converter is in some ways opposite that of the SAR. Rather than using one comparator repeatedly to make a number of comparisons, a flash converter uses a large number of comparators to make all of the checks at once.

A consequence of this technique (besides high speed) is a relatively high cost per bit. The number of required comparators increases geometrically with greater resolution.

Die photo of the TRW TDC1034 4-bit D/A converter chip, which can operate at a maximum conversion speed of 125 million samples per second.







*Our painstaking vacuum and coil-winding technology increases efficiency and eliminates acoustical "buzz."*

## OUR SCIENTISTS HAD TO OPERATE IN A VACUUM TO GIVE YOU A NEW QUALITY OF SOUND.

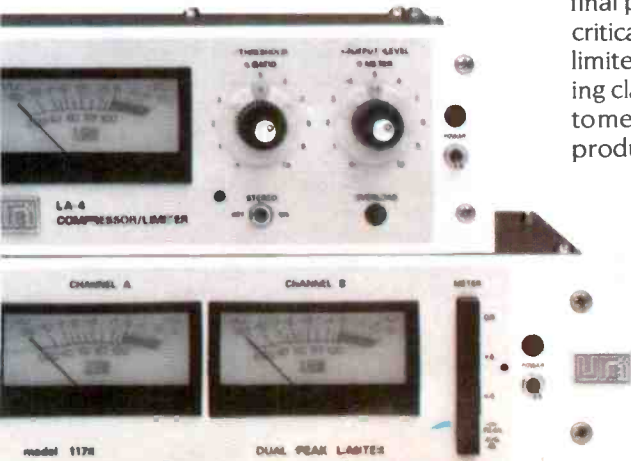
The quality of any sound system begins at its source. Precision in the power supply is vital to capturing and maintaining the fullness and subtlety of amplified sound. The need for that exactness is why we insist on operating in a vacuum rather than depending on outside sources.

A vacuum tank, to be precise. An environment in which our transformer is created with an air expulsion process. Where air pockets are purged from multi-layers of the transformer's high grade core laminations, and the core made airtight with a special impregnating sealant.

This process gives us impeccable control of transformer function and quality. Which gives you the assurance of the most efficient transfer of power possible, and an end to the acoustical "buzz" that so often fights sound purity.

To a lot of manufacturers the lowly transformer is far down on the list of priorities. For us, every element in the sound system relies on the exacting performance of every other element, and must be painstakingly attended to.

Whether you're driving your studio monitors in a demanding final production mix with our 6000 Series amplifiers, or making critical adjustments to signal quality with our peak or RMS limiter/compressors, you'll find our audio science giving outstanding clarity to your work. To find out which system is designed to meet your needs, contact your authorized JBL/UREI professional products dealer today.



JBL Incorporated,  
8500 Balboa Boulevard  
P.O. Box 2200,  
Northridge, CA 91329  
U.S.A.

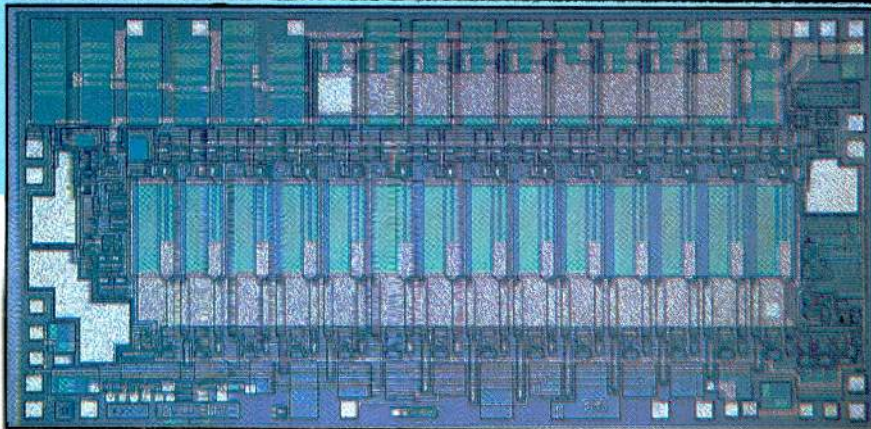


**UREI  
ELECTRONIC  
PRODUCTS**

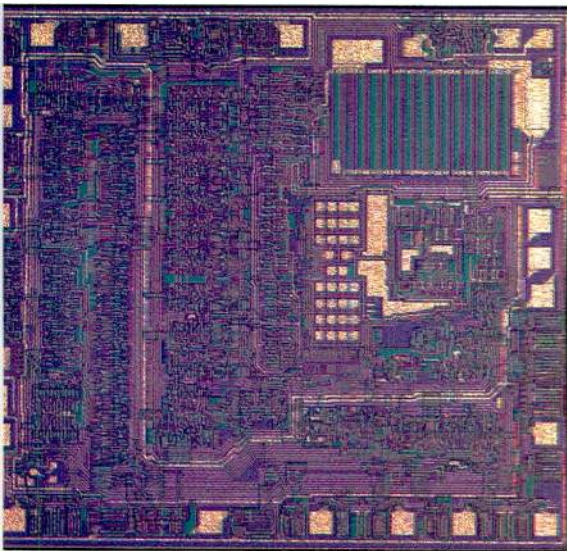
JBL/harman international ©JBL INCORPORATED 1984

Circle (13) on Reply Card

February 1985 *Broadcast Engineering* 27



A close-up of the architecture of the Harris Semiconductor HI-5618 8-bit D/A converter chip.



Die photo of the National Semiconductor ADC0811, an 8-bit serial I/O A/D converter, which features built-in sample-and-hold circuitry.

For example, a 10-bit flash converter requires 1023 comparators. For this reason, flash converters are not commonly employed for applications that demand more than 8-bit resolution. They are, however, widely used in high-speed 6- and 8-bit applications, such as video signal processing.

Some new A/D converter devices have been introduced, which combine flash and SAR techniques to provide high speeds without using huge numbers of comparators. One example of this approach is the *half-flash* A/D converter, which performs an 8-bit conversion by combining the results of two 4-bit flashes. Figure 3 shows the basic concept of the half-flash converter.

### Resolution/accuracy

Resolution is the number of discrete segments into which a data converter divides an analog signal. It is quite different from accuracy, which is a con-

verter's estimated error in deciding the absolute magnitude of an input voltage. By common definitions, data converter accuracy and resolution have no relationship to each other, although the magnitudes of the specifications may be comparable on a given device.

Assuming that a converter's accuracy will match its resolution can be a mistake. This is especially true for higher resolution (10- and 12-bit) devices where 0.1% or greater accuracies are difficult to achieve.

For example, a typical 10-bit A/D converter will be able to resolve 10V input range to within 10mV. The output, however, will generally not be accurate to specifications without trimming the device's external circuitry.

### D/A converters

From an applications standpoint, discussions of process differences between semiconductor components are often academic. But in the case of CMOS and bipolar D/A converters, there are significant operational differences related to fabrication which warrant attention.

Bipolar D/A converters are fabricated with the same process used to produce standard linear devices such as op amps and voltage regulators. The key to their performance is the IC manufacturers' ability to build precision matched current sources that can be switched at high speeds (Figure 4).

The magnitudes of these current sources are binarily weighted and each is controlled by a digital input bit. The output current of the D/A converter is the sum of the current sources that have been switched on. The full-scale output of the device is set by an internal or external reference voltage.

CMOS D/A converters are also essentially current output devices, but differ from bipolar converters in that they are passive in the analog signal path (Figure 5). The current output is controlled by using matched resistors and analog switches, rather than active current sources.

CMOS converter technology (basically the same process used for low power CMOS logic devices) permits the fabrication of resistors and switches with high precision. Because

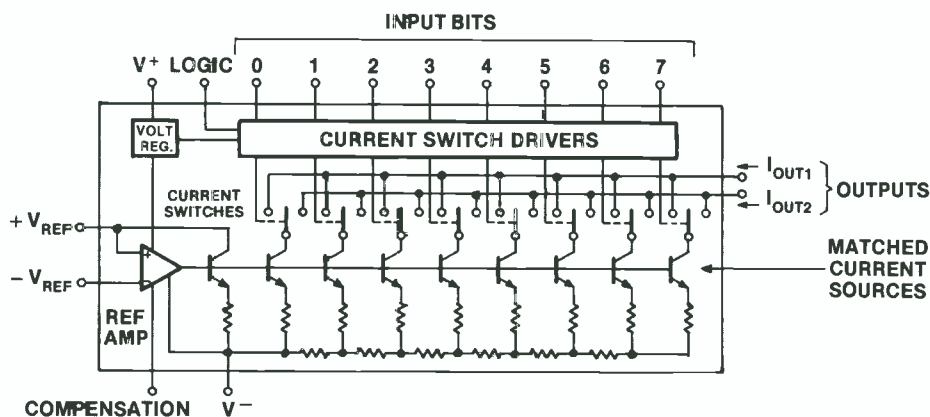


Figure 4. Functional block diagram of a basic 8-bit bipolar D/A converter. Two outputs are provided ( $I_{out1}$  and  $I_{out2}$ ) to handle various external circuit requirements.



# When You're Racing Against The Clock, Tascam Works as Hard and Fast as You Do.

At TASCAM, we know the pace demanded of you and the additional demand you're making on your audio systems. And we've built the professional equipment you need to put you out in front. We know the last thing you need with a deadline rushing at you is audio equipment that slows you down.

We designed our rugged 58 recorder/reproducer to handle rapid, high-torque tape shuttling with exacting precision and trouble-free dependability. Built to take the most rigorous production schedules, the 58 is the industry's first 1/2" 8-track with the performance capabilities and engineering depth of a 1" machine. Microprocessor 3-motor servo control moves you quickly and cleanly to the point you're after, and stops on the dime. Our unique Omega Drive ensures smooth, consistent tape

path stability, keeping tape from stretching no matter how often you start and stop. And tape to head contact is uniformly precise across all 8 tracks.

The 58 links your work to a complete TASCAM system. Our hard-working 500 Series mixers give you the speed you need with fast signal routing, logical, easy-to-use board layouts, and broad creative flexibility.

When you're ready for layback, our 2-track 52 offers you exceptional mastering capabilities. This durable deuce features the same superb control and SMPTE-interlock accuracy as the 58, with equally outstanding audio performance.

For less elaborate production needs,

our 4-track 44B keeps SMPTE up to speed for fast editing. Or integrate it as a stereo layback machine from our 48 or 58. Use our 42 for mono mastering plus code.

The best way to get the best of a relentless deadline is to get your work down to a system. A TASCAM system. Ask your dealer for full details or write TASCAM, TEAC

Professional Division, 7733 Telegraph Road, Montebello, CA 90640, (213) 726-0303.

Copyright © 1984-TEAC Corporation of America

**TASCAM**  
TEAC Professional Division

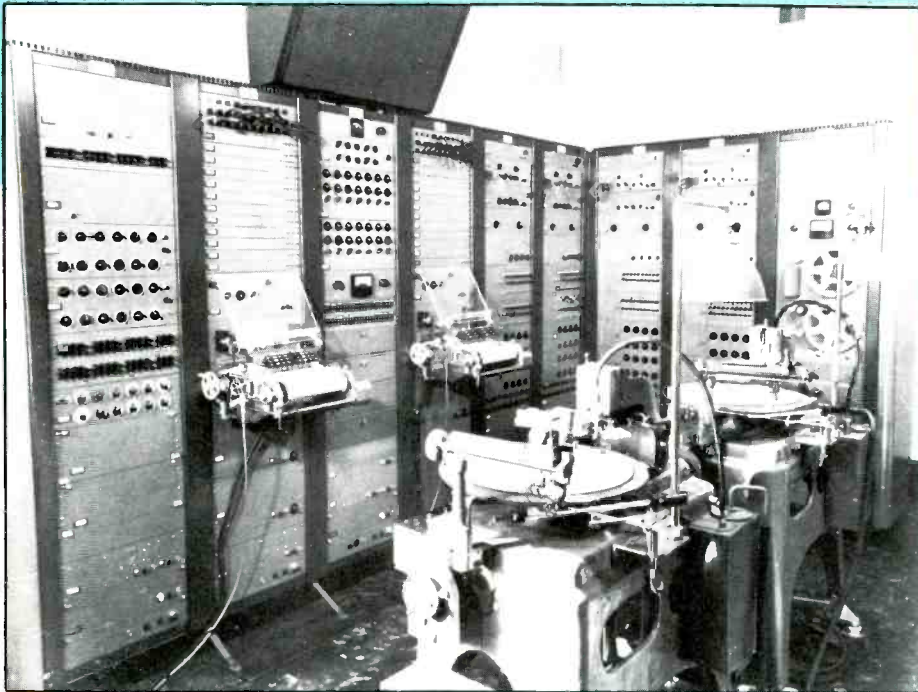


Compatible with +4 dBm systems.



TASCAM's complete SMPTE-compatible audio system puts you ahead of demanding deadlines.

Circle (14) on Reply Card



The RCA synthesizer, Mark I, special audio effects system, developed in 1955. Two Scully record cutting lathes are shown in front of the synthesizer.

Courtesy of the Electronic Arts Foundation

## The history of special effects

The creation of special audio effects by electronic means is an art form with a rich history. Most people probably think of special effects as fairly recent developments, but they have been around for decades.

The first known means for modifying electrically generated sound dates back to the late 19th century, when Thaddeus Cahill created a machine he called the *Telharmonium*. The instrument used the principle of additive tone synthesis for sound manipulation and modification. The individual tone colors were built up from fundamental and overtone signals, generated by huge dynamos. Pure sine waves were produced by tuning the individual generator coils with capacitors.

With the advent of the vacuum tube, scores of electronic and electro-mechanical musical instruments were invented with sound modification features. The Hammond organ, first developed in the 1930s, is of special interest, because it evolved from Cahill's work years earlier.

Development continued through the decade of the 1940s, producing new effects. The variable audio delay line, capacitive scanner and new frequency modulat-

ing techniques gave musicians new tools with which to work. One product from this age was the *Melochord*, developed by Harald Bode. The *Melochord* featured user control of attack and decay envelopes and vibrato.

The 1950s brought increased reliance on electronic components to generate special audio effects. The complex *RCA synthesizer* moved sound modification into a new frontier. Developed by Harry Olson, the RCA synthesizer made its debut in 1955.

The unit was controlled by pre-programmed punched tape. It offered features such as digitally controlled filters, variable attack and delay envelopes, digitally controlled pitch and waveshape, random noise generation and frequency and amplitude modulation effects.

At about the same time, Les Paul became famous with his multitrack guitar recordings, using tape speed transposition and the repetition effect. Besides being an outstanding performer, Paul was also an outstanding innovator. He introduced the multitrack recorder (eight tracks on 1-inch tape) in cooperation with Ampex. He also created *Sel Synch*.

The ring modulator was a little-known sound modification device until the mid-to-late 1950s. Before that time, the ring modulator was applied only as a switching circuit used mainly in single sideband communication systems. It was only after ring modulators were built with diodes which operated in the square law region of their transfer function (provided by certain germanium diodes), that the circuits started to perform as 4-quadrant multipliers and became musically interesting.

An important ingredient in sound modification is the addition of reverberation to program material. In the 1930s, echo chambers were used to create reverb effects. Then, in 1941, came the invention of the Hammond spring reverberation device, which was incorporated into the Hammond organ. The device also worked well in studios.

In fact, its offspring are still popular today. A different approach to the generation of reverb was taken by D. W. Martin of the Baldwin Piano Company, who used coil springs mechanically coupled to the loudspeaker cone to produce reverb effects.

A popular sound effects device that came upon the scene in the mid-1960s was the so-called *fuzz box*. The story goes that the fuzz effect was discovered by Jeff Beck while making a guitar recording and overdriving a deficient preamplifier on his tape recorder. The first successful fuzz boxes included the *VOX distortion booster* and the *Arbiter fuzz*, both introduced about 1964.

The history of electronic sound modification is as old as the history of electronic musical instruments and electronic sound transmission, recording and reproduction. The special audio effects that we take for granted today are—in large part—based upon the work of pioneers decades ago.

#### Editor's note:

This article was adapted from an article, "The History of Electronic Sound Modification," by Harald Bode of Bode Sound, North Tonawana, NY, which appeared in the October 1984 issue of the *Journal of the Audio Engineering Society* (pages 730-736).



# Over 200 broadcasters bought the Harris Medalist audio console in its very first year! Here's why.

Wide input switching flexibility. Transparent audio performance. Choice of attenuators. Adaptability to any application. Excellent cost/benefit ratio. Broadcasters across the country cite these as major reasons for choosing the new Medalist dual stereo audio console over all others.

## Switching Flexibility

Input selectors switch *after* the mic preamp, allowing intermix of mic and other types of sources on any channel. The Medalist also gives you six selector positions each for headphone and speaker monitoring.

## Superb Audio Quality

Harris engineering makes the Medalist remarkably transparent. The Signal-to-Noise ratio of 95 dB beats the competition by 10 to 20 dB, and is typical of the Medalist's outstanding performance.

## Linear Or Rotary: Take Your Pick

Harris gives you a choice—two styles of linear and two styles of rotary attenuators. Intermix rotary with linear if you like, to suit *your* station's particular needs.

## Easy To Install...Easy To Maintain

The barrel terminals on the input and output circuits connect quickly and surely. Additional preamps and program amp interconnect with plug-in ribbon cables. Also, you can change attenuator modules—even while you're on the air—in about the time it takes to cue up a record.

## Now In 8, 10 and 12 Channels

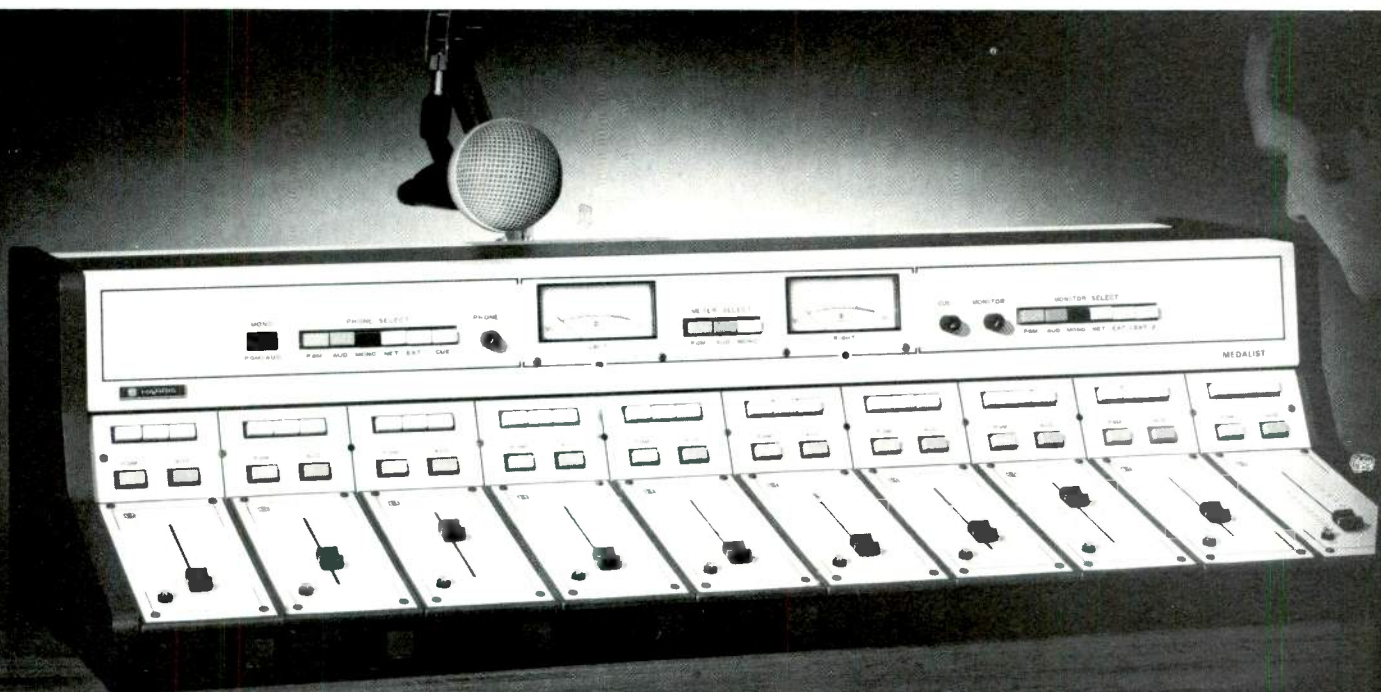
The Medalist is equally well suited for AM/FM/TV on-air and production applications. Take your choice of three models—8, 10 or 12 channels.

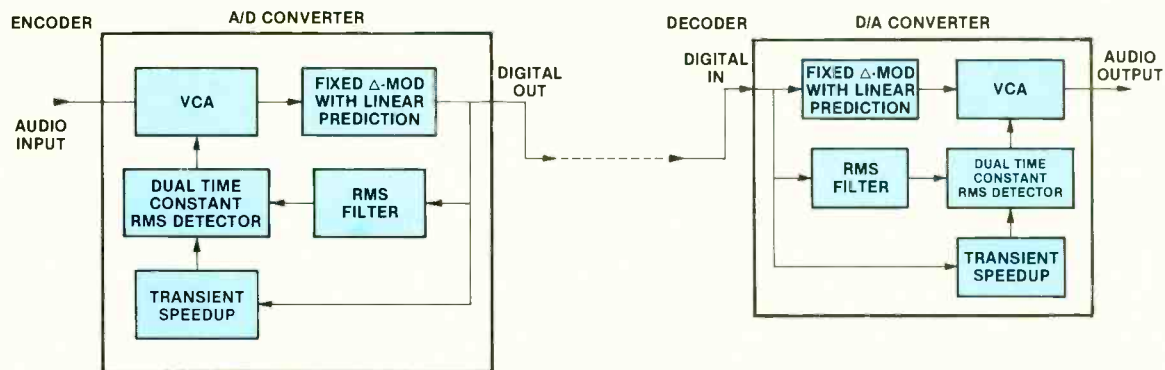
Learn more about the Harris Medalist family of audio consoles. Write Harris Corporation, Studio Division, P.O. Box 4290, Quincy, Illinois 62305-4290. 217-222-8200.



# HARRIS

Circle (15) on Reply Card





Courtesy of dbx

A companded predictive delta modulation A/D converter (a) and a companion D/A converter (b).

## Delta modulation: Another approach

The A/D conversion techniques discussed in the main article—SAR, *integrating* and *flash*—make up a family of converters using the pulse code modulation (PCM) method of digital encoding. There are, however, other methods of A/D conversion, including various types of delta modulation (DM).

The basic form of DM has been known for years to be a simple, low-cost means of A/D conversion. In this process, the data produced by the converter represents differences between successive sampled voltages, rather than the instantaneous voltage of the input signal at each point in time (the conversion method of a conventional PCM A/D system).

Delta modulation in its basic form, however, generally produces less than acceptable performance for broadcast applications, with a dynamic range of about 55dB. Although certain versions of DM can offer a 90dB dynamic range, they may suffer from noise modulation problems and noise floors

that exhibit a distinct tonal character.

In order to overcome the limitations of conventional DM conversion for broadcast audio applications, variations on the basic concept have been developed. One is the companded predictive delta modulation (CPDM) method of digital encoding, developed by dbx.

The CPDM conversion process differs from basic delta modulation in two respects. First, the CPDM converter uses a compandor circuit in which the signal itself is varied with a voltage-controlled amplifier to avoid overloading the fixed delta modulator. Second, the DM stage uses a linear prediction filter, which relies on the *history* of the audio signal to predict its *future*. The figure above shows a block diagram of a CPDM system.

### Linear prediction

One of the problems affecting DM, adaptive DM (an improved version of delta modulation) and

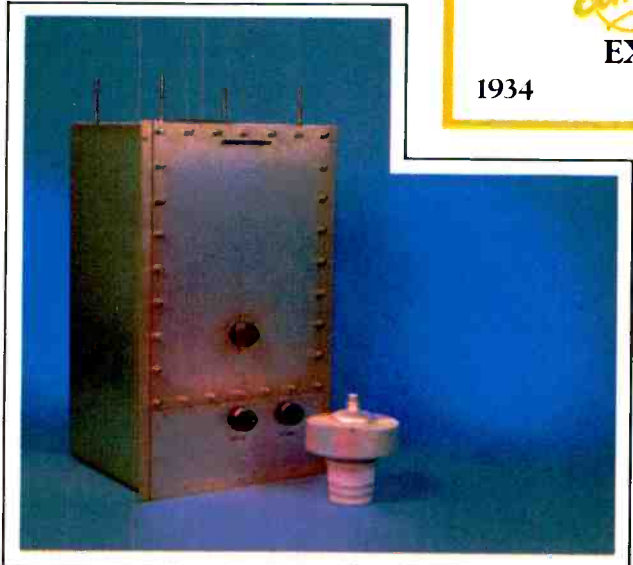
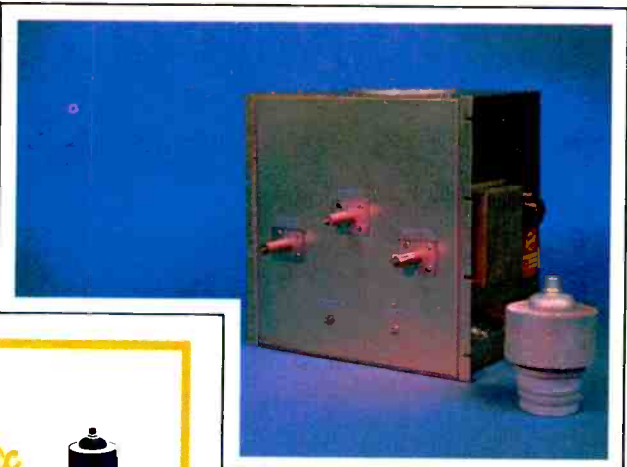
companded DM systems is that the noise floor can change with signal level. This occurs because the step size changes to follow the input, and it is the step size that determines the level of quantization noise.

As an example, assume a situation where the delta modulator has a fixed step size of 10mV. If the system's last approximation of the input signal was too high, the next will be 10mV lower. Of the last 10 approximations of the input signal voltages, seven were too low and three were too high. You might reasonably infer that the signal level was increasing, and shift the step sizes from  $\pm 10\text{mV}$  to  $+15\text{mV}/-5\text{mV}$ .

This is in line with our expectation (based on the recent history of the signal's behavior) that the signal is more likely to change in a positive direction than in a negative direction. Note that doing this does not change or lower quantization noise: The difference is still 20mV between  $+10$  and  $-10$ , or  $+15$  and  $-5$ . But it does increase the maximum slope (steepness, or slew rate) that the modulator can follow without slew rate limiting. Hence, dynamic range is increased as well.

In practice, this alteration in the balance of plus and minus step sizes is achieved by a linear prediction filter. This filter is substituted for the simpler filter (integrator) normally found in a delta modulator, and is designed for maximum dynamic range.





# EIMAC celebrates its 50th Anniversary with an extensive line of FM Broadcast Cavity Amplifiers.

Varian EIMAC celebrates 50 years of service to the broadcast industry with a spectrum of FM from a powerful 60 kW to a mini power 150 W solid state IPA.

For more information call or write Varian EIMAC or contact any Varian Electron Device Group sales office worldwide.

Varian EIMAC  
301 Industrial Way  
San Carlos, California 94070  
Telephone: 415-592-1221

Varian AG  
Steinhauserstrasse  
CH-6300 Zug, Switzerland  
Telephone: 042-23 25 75

## The cost-effective path to a modern FM transmitter.

No one knows more about broadcast tubes and cavities than EIMAC. Our strong cavity development capability reduces RF engineering problems. EIMAC cavities are inexpensive and simple to use.

### EIMAC FM BROADCAST CAVITY PRODUCT LINE

POWER	CAVITY	EIMAC TUBE
60 kW	CV-2230	4CX30,000G
30 kW	CV-2202	4CX20,000C
25 kW	CV-2200	4CX20,000A
15 kW	CV-2210	4CX12,000A
10 kW	CV-2228	4CX7500A
5 kW	CV-2225	4CX3500A
1.5 kW	CV-2220	3CX1500A7
150 W	AM-2215A	Solid State



Circle (16) on Reply Card

# Ampex Listened When You Described Your Ideal VTR.

CONSOLE WITH OVERHEAD  
PICTURE MONITOR—ONE OF  
6 CONFIGURATIONS  
AVAILABLE

HI FI SPEAKERS LET YOU  
APPRECIATE SUPERIOR AUDIO  
QUALITY OF VPR-5 WITH  
EXCELLENT STEREO PHASE  
RESPONSE.

HANDLES SPOT TO 2 HOUR  
REELS WITH EQUAL PRECISION  
AND GENTLENESS

BRUSHLESS DC SCANNER  
MOTOR AND INDIVIDUALLY  
REPLACEABLE HEADS

LOGICAL, EFFICIENT CONTROL  
PANEL—ALL OPERATOR  
CONTROLS UP FRONT

TBC-6 WITH 32 LINE MEMORY  
AND 28 LINE CORRECTION  
WINDOW; PERFORMANCE  
MATCHED TO VPR-6.

DUAL NUMERIC READOUTS—  
ONE FOR TAPE TIME/TIME  
CODE; ONE FOR CUE POINTS,  
DIAGNOSTIC CODES, TAPE  
SPEED, SETUP CODES





# Now, Here It Is. The New VPR-6.

**W**hen hundreds of users worldwide told us what they wanted in a one-inch VTR, we listened closely and then designed and built it. It's our new VPR-6, the easiest VTR to operate, service and maintain of any in its class. And it's in the price/performance ratio that most users want.

## Smart, yes. Complicated, no.

Intelligent but not intimidating, the new VPR-6 offers features that allow you to get the job done more productively. For example, virtually all machine setup procedures can be done at the highly efficient control panel. Most board-edge controls typically found in VTR's have been eliminated.

You insisted on fast but gentle tape handling... the VPR-6 shuttles tape at speeds approaching 500 ips and handles all reel sizes from spot to 2 hours with equal precision and gentleness. The servo microprocessor senses when the end of the tape is near and slows down the reels and scanner and unthreads the tape gently.

You asked for power-down memory... so we built in a long-life battery to protect setups, edit and cue points and all editor configuration parameters.

"Make it easier to troubleshoot," you said, and we built in an extensive diagnostics system that constantly monitors many system conditions and warns you if a fault occurs. You can even run from the control panel a diagnostic routine using a logic probe to test every IC in direct communication with the two microprocessors.

## A tried and true transport

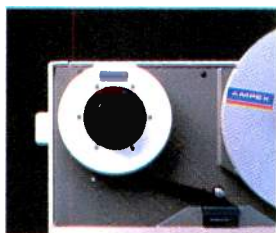
You demanded reliability. Not wanting to tamper with success, we borrowed the tape transport and mechanical

printed wiring boards and backplane connectors throughout. The modular package allows convenient access to any part of the VTR for easy maintenance.



## A TBC to Match

Because you wanted play speeds from -1 to 3X normal and picture in shuttle, we also developed the new TBC-6 digital time base corrector, performance-matched to the VPR-6. Its 32-line memory and 28-line correction window are the largest in any TBC appropriate for a VTR of this type.



## State of the art editing

So much for recording and playback, how about editing? The VPR-6 has all the capabilities you asked for, including split audio-video auto edit and auto tag. RS-422 serial communications capability lets VPR-6 function efficiently in a state-of-the-art editing system with the Ampex ACE and other edit controllers.

## First-rate audio

"Make audio better," you said, and we did. The VPR-6 has audio (as well as video) confidence playback. The audio system also offers high quality stereo phase and an optional fourth audio channel for EBU systems.



design of our reliable and proven VPR-80. We also eliminated most wire harnesses in favor of more reliable

to quote price and delivery for any model in any world standard, and watch his face light up!

## Selection of styles

Most users may agree on capabilities, but you prefer a variety of configurations to choose from. So, we offer the VPR-6/TBC-6 in four console styles as well as tabletop and rackmount versions. Many Ampex video accessories work with it, including some you may now own.

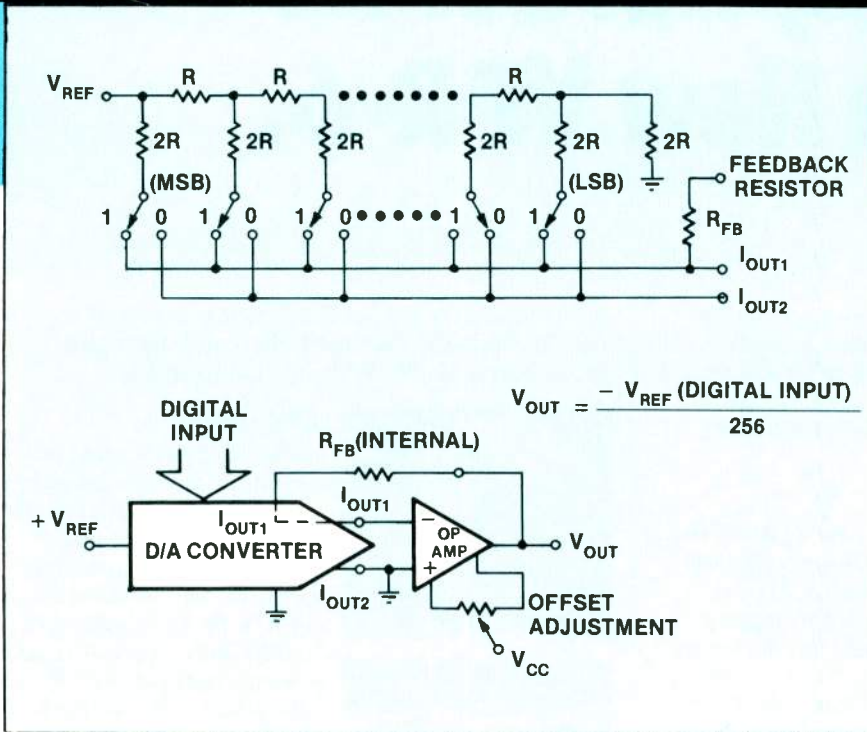
## In production now

The VPR-6 is too good to wait for, so it's already in factory production. Ask your Ampex video sales engineer

# AMPEX

Ampex Corporation • One of The Signal Companies

Atlanta 404/491-7112 • Chicago 312/593-6000 • Dallas 214/960-1162 • Dayton 513/254-6101 • Los Angeles 818/240-5000 • New York/New Jersey 201/825-9600 • Salt Lake City 801/487-8181 • San Francisco 415/367-2296 • Seattle 206/575-0156 • Washington, DC 301/530-8800  
Canada, Toronto 416/821-8840



**Figure 5.** Simplified block diagram of a typical CMOS D/A converter showing the internal resistor configuration (a) and connection of the device to an external operational amplifier (b).

a wide variety of signals can be applied to the D/A converter reference input, and therefore controlled by the digital input code, these devices are often referred to as multiplying D/A converters.

The advantages of a CMOS D/A over a bipolar converter are lower power consumption, single supply operation and the capability of handling a wide range of analog signals (at the reference input). CMOS devices also have excellent gain stability, which depends mainly on the tracking of the chip's resistors.

On the negative side, because CMOS converters are passive, they have no output compliance as current sources. This means they cannot drive their output current linearly into any load but 0V.

Although somewhat less versatile than CMOS, bipolar devices in general are faster and have improved settling characteristics. They can sometimes be used in multiplying applications, but only in a limited fashion.

### D/A output amplifier

Output amplifiers are nearly always used with CMOS D/A converters, and are often used with bipolar devices as well. The performance limits of the output op amp will have a significant impact on the output signal of the converter. The op amp must be able to change and settle accurately to a new value within a specified time. Amplifiers with a high slew rate may start quickly, but are often of little value if they are not well behaved while settling to their new level.

The dc specifications of an output op amp are important, but not for the reasons usually applied in analog circuitry. Most D/A converter amplifiers are operated with a closed-loop gain of one or lower, so that device offsets appear at the circuit's output unamplified. Therefore, the output shift because of op amp input offset is usually not a great concern.

However, with a CMOS D/A converter, this offset has a major effect in a completely different way by causing the converter's current output to be terminated at a non-zero level.

Because the passive CMOS output has no compliance as a current source, the interaction between this voltage and the converter's linearity

becomes a complex issue. The situation is further muddled because the output impedance of the D/A converter changes with the input code.

### Sample/hold circuits

The conversion of an analog audio or video signal to digital information often requires the use of a sample/hold (S/H) circuit to freeze the analog information so that it can be accurately measured. Trying to measure a signal while it is changing is like trying to photograph an object while it is in motion. A typical S/H circuit is illustrated in Figure 6.

The amount of accuracy lost during the A/D conversion process when a varying signal is present depends upon the type of converter (and conversion speed) used in the application. Systems employing a SAR converter typically use a S/H circuit at the input. Flash converters on the other hand, rarely need input holding circuitry to maintain accuracy.

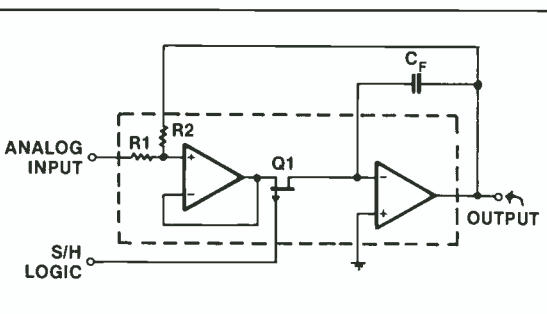
In a SAR device, the basic operating principle assumes that the input will not change by more than one-half the magnitude of the least significant bit (LSB) during an entire conversion cycle. Because each approximation in the SAR search tells the converter what its next step will be, any change in input level during the comparison sequence can disrupt the conversion process.

Input isolation of an analog source can be accomplished in a number of ways. The most direct is an isolation amplifier, usually a module or hybrid circuit (they do not as yet exist in monolithic form) incorporating a transformer or other technique to provide an electrical barrier to interfering signals.

### The future

The future holds many exciting possibilities for A/D and D/A converter technology. New device designs and chip fabrication methods promise to give users increased conversion speed, higher resolution and improved accuracy. These products will form the basis of sophisticated new equipment for broadcasters.

Digital audio, little more than a dream just a few years ago, has now established itself as an important link to the future of broadcasting.

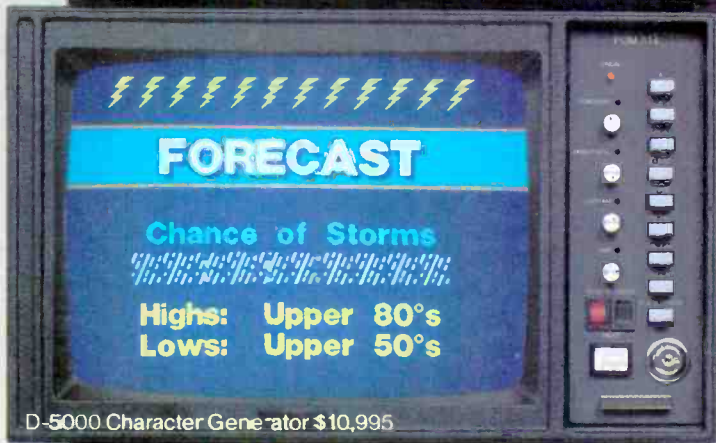


**Figure 6.** Block diagram of a sample/hold buffer amplifier. When the S/H logic line is low, Q1 conducts and the output of the device follows the analog input. When the S/H line is taken high, Q1 switches off and the output is held constant at the last input value by  $C_F$ .





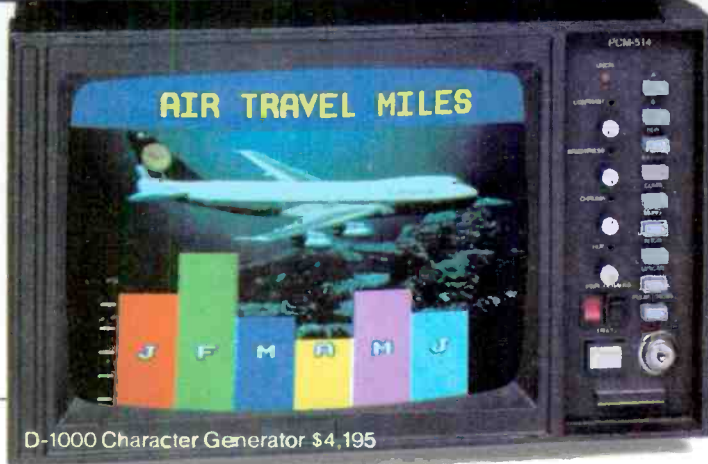
BFA Paint System \$31,995



D-5000 Character Generator \$10,995



D-1512 Character Generator \$5,995



D-1000 Character Generator \$4,195

# Dollar for dollar, our graphics stack up better.

3M offers character generators priced from \$4,195 to \$10,995. And our BFA Paint System, priced at \$31,995. In each case you can pay thousands more for comparable equipment without seeing any noticeable difference in quality.

Our D-1000 Character Generator is a self-contained, two-channel, full-featured generator with 70 nanosecond resolution.

Our D-1512 Character Generator is self-contained with two fonts, a genlock keyer and 512 color possibilities.

Our D-5000 Character Generator offers 35 nanosecond resolution for broadcast and production applications, over 150 fonts and 512 colors. It's expandable to multiple keyboards and channels.

And our BFA Paint System is a stylus-operated, menu-driven art station for broadcast news, weather and sports graphics, with 16 million color possibilities.

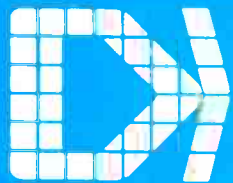
Comparable paint systems sell for three times the cost of our BFA Paint System. And the savings are similar with our three character generators.

So whether you're a small production studio or a flagship TV station, don't make a decision without looking into 3M graphics. Because the object is to look like a million, not to spend a million.

3M Broadcast and Related Products Division.

3M hears you...

Circle (17) on Reply Card



## DASH: Where it is, Where it's going

**With the new A17 × 9ERM,  
just add a camera.**

**Fujinon offers everything else.**

Field range—studio performance—Fujinon's new 17X EFP lens is smaller, lighter, "weatherized" for use anywhere, and available with the industry's most compact, built-in pattern projector. For field and studio productions, Fujinon's remote focus and servo demand units bring full control back to the pan bars. Other accessories include remote servo focus, Fujinon's exclusive multiprocessor shot box, and front-mounted wide and teleconverters.

The new 17X offers more than size, weight and range advantages (a 2X

range extender is built in). Its F1.7 maximum aperture remains absolutely flat from 9mm to 114mm. In addition, corner resolution has been increased while longitudinal chromatic aberration has been reduced. And with its weatherized features, the new 17X is the ideal lens to take into the field.

For more information about the most widely used lenses in broadcasting and the most extensive selection of accessories of any lens maker, write or phone:



**FUJINON INC.**  
672 White Plains Road  
Scarsdale, N.Y. 10583  
(914) 472-9800  
Telex 6818115

**FUJINON INC.**  
2101 Midway  
Suite 350  
Carrollton, Texas 75006  
(214) 385-8902

**FUJINON INC.**  
118 Savarona Way  
Carson, Calif. 90746  
(213) 532-2861  
Telex 194978



**FUJINON**

A key aspect of any new development in recording technology is compatibility with recording systems built by other manufacturers. Regardless of whether any material is ever shipped out of house, the ability to interface with machines in another facility is important to the user.

DASH, which stands for digital audio stationary head, represents a significant first attempt at an industry-wide standard for digital audio recording. The DASH format, now a little more than a year old, was developed by three major recording equipment manufacturers: Studer, Sony and Matsushita. The format represents a compromise between the three companies' contributions to digital technology.

The format agreement takes into account recent developments in technology, including the possible use of thin-film heads, a format for low-speed recording with increased signal processing and the recommendation of the AES Standards Committee on Digital Audio for standardization of a 48kHz sampling frequency.

The DASH specifications and features are designed to accommodate a wide variety of future technological improvements and still retain machine compatibility. A recent enhancement to the format is a revised symmetrical track geometry that is designed to make the DASH system more universally acceptable. An announcement by the DASH committee—made up of representatives of the member companies—said that this feature is being incorporated into new digital tape machines.

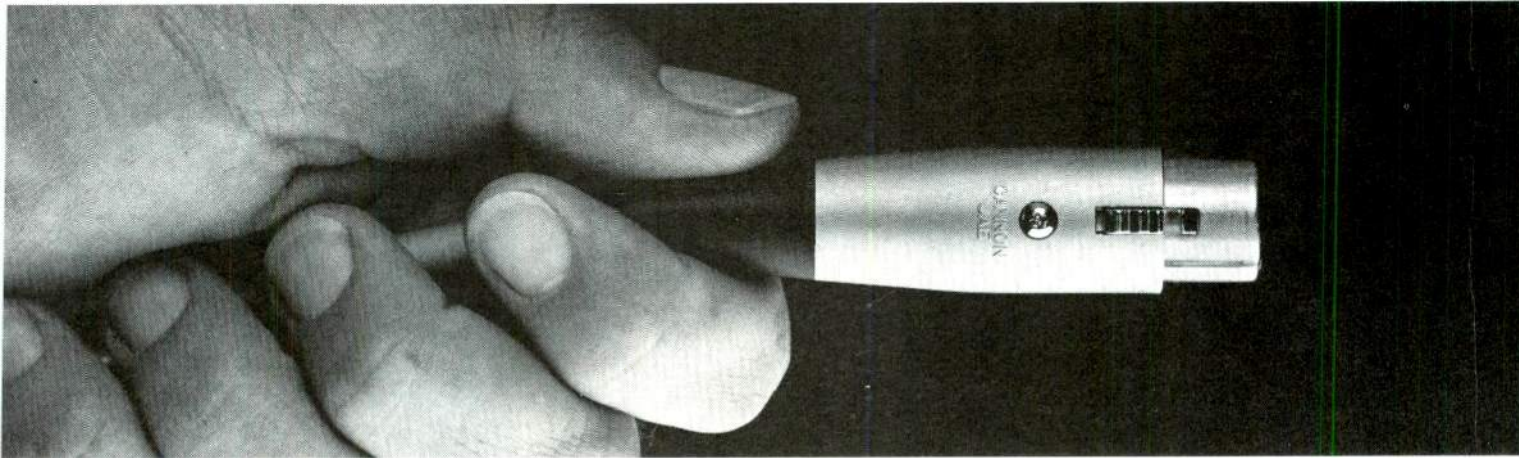
### Format details

DASH covers a wide range of applications from 2-channel recorders (using ¼-inch tape running at 7.5ips) to 48-channel recorders (using ½-inch tape running at 30ips). The format has three versions, depending on the desired tape speed: slow, medium and fast. The minimum number of

Circle (18) on Reply Card



# Protect your investment with a cannon.

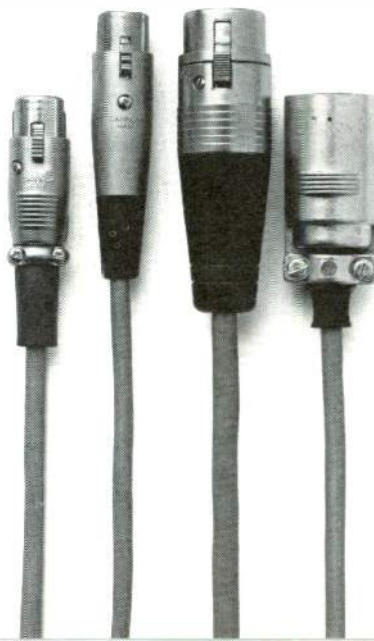
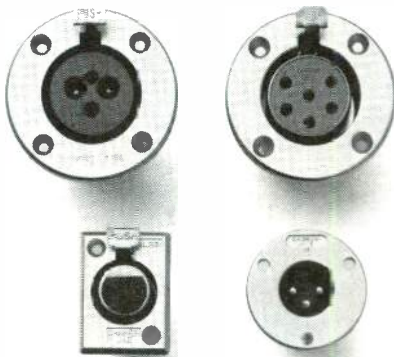


An audio connector by any other name is simply not an ITT Cannon audio connector. Which is precisely why so many audio engineers continue to specify Cannon® connectors for use with their audio equipment.

The XLR, the new XLB and XLA series are small, rugged, quick-disconnect connectors designed for use in audio/video and other low-level circuit applications where reliability, quiet operation, elimination of mechanical interference and ease of use are necessary. Four different plug styles are available.

The EP connector is ideally suited to applications where extreme ruggedness and versatility are required. The new AP connector is a popular choice for heavy-duty audio applications and is interchangeable and intermateable with the EP series. Both the EP and AP series may be used where as few as 3, or as many as 18 contacts are required.

## Audio Connectors from Cannon



The AP LNE and AX LNE are specifically designed to handle the special needs of mains and other power supply applications.

For more information, please contact Commercial/Industrial Products Marketing Manager, ITT Cannon, a Division of ITT Corporation, 10550 Talbert Avenue, Fountain Valley, CA 92708, (714) 964-7400. For the sales office nearest you, call toll-free (800) 845-7000.

Now available at the following stocking locations:

XLR/XLB at:

Time Electronics  
Ramtronix

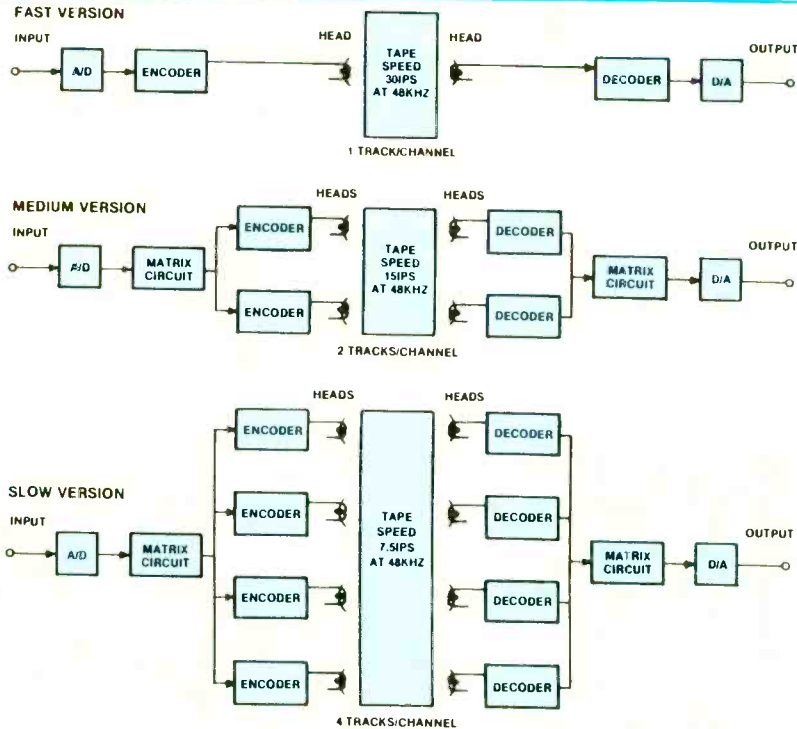
EP/AP at:

Ritchey Electronics  
Yale Electronics  
Connector Corp.  
Ramtronix

## CANNON ITT

The Global Connection

Circle (19) on Reply Card



Block diagrams of the three tape speed versions of the DASH digital audio format. The encoders and decoders in all versions of the system are identical.

tion is independent on each track in each version of the DASH system. If one track is seriously damaged, the error correction performance of the other tracks is not affected.

Editing can be accomplished in one of the three ways: punching in/out, tape slicing and electronic editing.

#### For the future

The adaption of thin-film heads will increase the number of recorders with double track density in the future, providing increased versatility and tape economy to the end-user. Manufacturers, taking advantage of new developments in large and very large scale integration ICs, will realize further improvements in system size, weight, power consumption and cost.

tracks required to record one digital channel is one for the fast version; two for the medium speed version; and four for the slow speed version. The figure above shows a block diagram of the three DASH recorder systems.

Error correction is an important

aspect of any digital recorder, and this has also been addressed in the DASH format. The encoders shown in the figure use a *cross interleave code* (CIC) correction scheme with a large amount of interleave between the even and odd input samples. Error correc-



The Sony PCM-3324 digital audio recorder.



The Studer D820 digital audio recorder.



# Essential in the trench.



# Indispensable on the bench.

SONY BVT-800



## THE SOUND TECH 1500 SERIES TEST SYSTEM

With a microprocessor-controlled Sound Tech 1500 Series test set, you can sort out the fiction from the facts—quickly and easily. Audio manufacturers the world over have come to rely on the 1500 Series. As high-tech goes higher and time seems to get shorter, the benefits of having immediate, precise and critical test data gets even greater. And that's where a Sound Tech 1510A comes in—on your bench, or in the trench.

Whether you're a design engineer or you have the technical responsibility for keeping your facilities up and running, the 1510A is designed to perform all the necessary tests for maintenance, troubleshooting and general check-out of any professional audio device like: tape recorders, film machines, mixing consoles, signal processing equipment, turntables—you name it. With the 1510A's exclusive asynchronous I/O, it's practically a mandatory piece of gear for remote location tests for satellite transmission, conventional transmitters or broadcast studio checks.

When a pro needs to know the truth, he can select from over fourteen different test programs that are stored in the 1510A. Because the instrument is modular, you can easily add options like a one-third octave spectral analysis card for noise & flutter measurements, a GPIB IEEE-488 computer communications interface, an MOL level test, and more. Much more.

With the 1510A's built-in CRT, you have easy to read and interpret alphanumeric and graphical data (on applicable tests). If you add our peripheral printer, you can have a hardcopy of anything displayed on the 1510A's CRT display—accurate, verifiable evidence.

Whether you push pencils or faders, there isn't an all-in-one audio test system around that can do everything the 1510A has been designed to do—as fast and as easy.

Contact us now for full technical and applications information. See for yourself why there are more than 1,000 users who already know something you should.

## SOUND TECHNOLOGY

1400 Dell Avenue  
Campbell, California 95008  
(408) 378-6540 Telex: 357445

*Put The Best  
To Test!*

Circle (20) on Reply Card

Facilities courtesy of Editel Corp.



# Digital processing



## for effects and graphics

Ampex

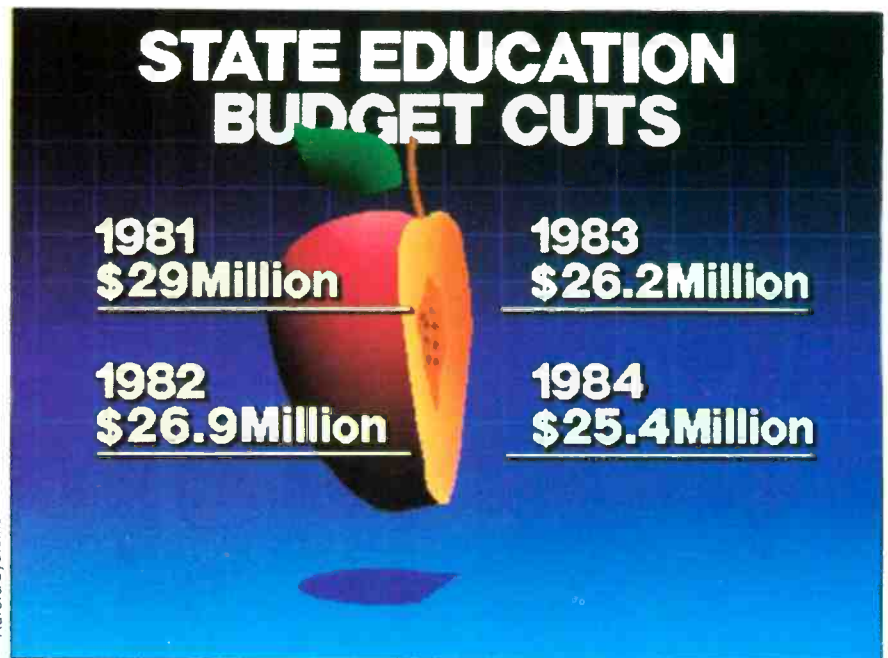
By Blair Benson, TV technology consultant

Early attempts in television to produce electronically generated graphics and effects more complex than simple dissolves and supers were restricted by constraints of analog processing. Creation of geometric forms and reproduction of discrete video signal levels were limited by bandwidths of the color-encoding system and random noise in camera signals.

Multiple steps of encoding and decoding to permit processing of timing precision. Furthermore, the imperfect scanning geometry of color cameras negated the use of more than one signal source for graphics mechanicals where overlays and image matching were required.

With the advent of digitizing and storing full frames of video signals, more complex graphics and effects, such as those in film animation, became possible. The breakthrough was the digital frame store, developed for the international exchange of TV programs with different line number and color encoding standards.<sup>1</sup> The frame store provided a basis for development of graphics as well as special effects, which duplicate even the most sophisticated film opticals and animation.<sup>2</sup>

Digital processing was aided by ad-



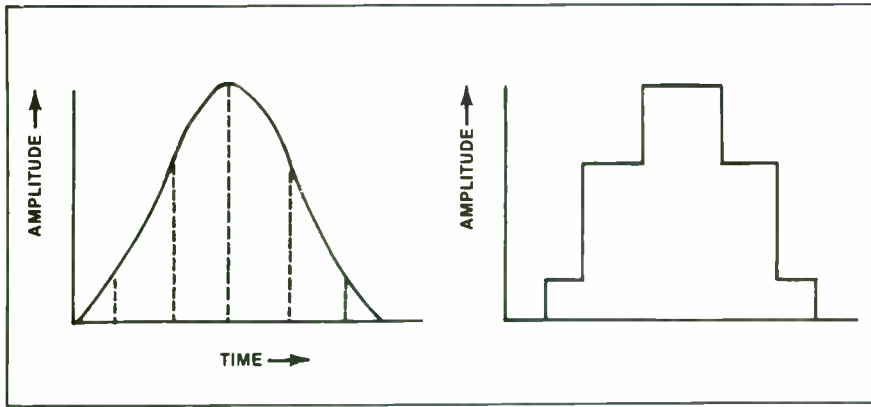
vances in computer and disc storage technology and a concurrent dramatic reduction in the cost of solid-state digital memory devices and microprocessors.<sup>3</sup> A cost reduction of nearly 10:1 in a decade has provided the designer the freedom to choose between hardware and software to provide a variety of functions.

Graphic effects may generally be broken into two classifications:

- Creation of images in a digital video signal format. The images may be generated digitally by a computer or in an analog form from a camera and converted to digital signals.

- Manipulation of digitized images. Manipulation involves processing of digital signals to create image distortions and movements with virtually infinite variety of colors. Both planar and 3-dimensional perspectives may





**Figure 1.** Sample-and-hold output is retained in a frame-store. A: An analog waveform. Dashed lines indicate amplitude samples. B: Sample-and-hold output waveform.

### Input signals

The input signal may come from an external analog source or a digital signal generator. Analog signals could be from an animator's pencil sketches, such as those used with conventional film animation, single frames from a digital still-store memory, a video recording, a character generator or a computer. The last two, which produce a digital signal directly, may be integral parts of the digital video effects or paint system.

Analog input signals are translated to a digital format for each of the three colors. This is done by sampling the analog signal voltage along each scan line at a series of repetitive decision points corresponding to picture elements, or pixels. Pixel amplitude levels from the sample-and-hold operation are retained in a framestore for subsequent digital signal coding. Sample-and-hold waveforms are illustrated in Figure 1.

The sampling rate for analog-to-digital (A/D) conversion is at least twice the high frequency cutoff of the baseband analog input video signal. This permits later analog reproduction of the signal and reduces interference between sampling-sideband components and high frequency components.

Because of imperfections in the input signal, it is usually necessary to provide digital noise reduction (DNR) even for camera signals. Some frame manipulation may be necessary to position and scale the image to match other analog sources and computer-generated patterns. This occurs after A/D conversion in conjunction with other digital manipulation processes.

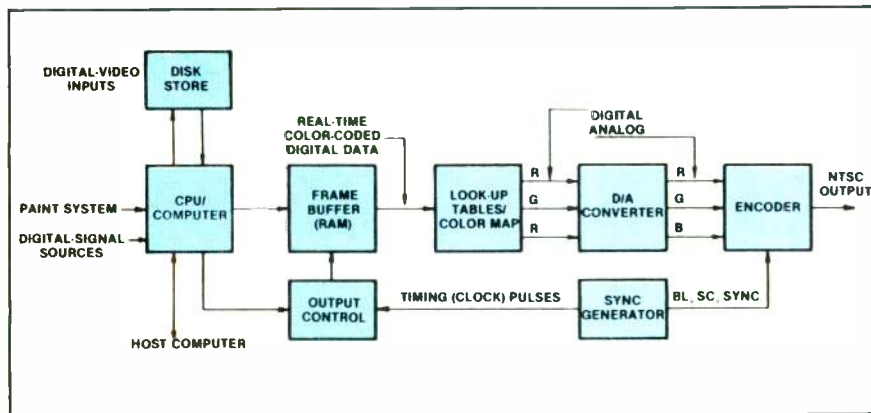
### The computer or CPU

After any necessary processing, the digital signals may be retained in a magnetic disc framestore, under central processing unit (CPU) control, or in a solid-state memory, as shown as Figure 2.

The CPU is a complex multipurpose component that provides logic, interfacing and control for the system. This includes input signal equipment, any operating or control panels and display devices. The CPU may actively generate geometric forms and patterns from its integral computers for integration with other graphic-image sources. Provisions allow expanding



Bosch



**Figure 2.** Block diagram of basic elements and functions for digital video graphics generation. The frame buffers, output control and some or all of the computer operations may be integrated into the CPU in some hardware designs.

be involved in real time or frame-by-frame under manual or programmable computer control.

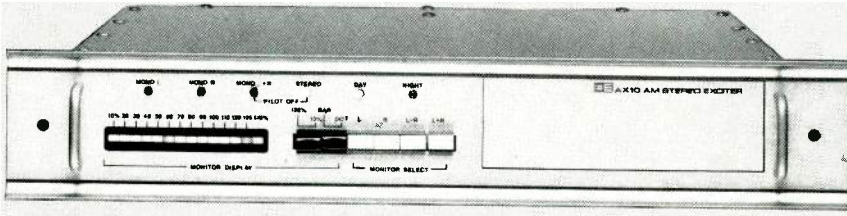
The proliferation of videographics equipment and techniques has created a lack of understanding of basic system design.

For a comprehensive view of video graphics and its technology, consider the functional aspects of the systems and their elements, rather than dwell

ing on specific hardware designs and operational programs. A knowledge of the fundamentals and the steps in signal processing and control will aid in understanding the equipment.

**FCC TYPE ACCEPTED**

# AX-10 AM Stereo Exciter.



## Second Generation C-QUAM® Digital Design.

- Independent Right and Left Channel IF Modulation Technique.
- Built-in Frequency Synthesizer.
- Peak-reading LED Modulation Display.

C-QUAM® Is a Registered Trademark of Motorola, Inc.

For Earliest 1985 Delivery,  
Place Your Order Now.

**BE BROADCAST ELECTRONICS INC.**

4100 N. 24th ST., P.O. BOX 3606, QUINCY, IL 62305-3606, (217)224-9600, TELEX: 25 0142

Circle (22) on Reply Card

## A 4 Lb. Microwave And 30-Mile Range On One Watt Of Power?

**Call NEC Toll-Free  
1-800-323-6656.**

*TVL-800-6F from NEC. A 7 Ghz microwave that needs only 10 watts of power to broadcast one watt. With advanced C-MOS and FET electronic components; 2 audio channels. Just call NEC toll-free. For big power in small packages.*

**NEC**

IMAGINE WHAT WE'LL DO FOR YOU  
NEC America, Inc., Broadcast Equipment Division  
130 Martin Lane, Elk Grove Village, IL 60007  
In Illinois 312-640-3792.

650-846

Circle (23) on Reply Card

CPU capabilities by using another computer, if need be.

### Frame buffer

Computerized data from the CPU framestores, still in separate red, green and blue components of color and 2-dimensional spatial information, is fed to the frame buffer. More complex than a framestore, this unit stores color identification information with position and amplitude data.

<b>RED</b> 15, 0, 0	<b>GREEN</b> 0, 15, 0	<b>BLUE</b> 0, 0, 15
<b>YELLOW</b> 7, 7, 0	<b>MAGENTA</b> 0, 7, 7	<b>WHITE</b> 7, 7, 7

1	3	5
2	4	

INPUT CODE	OUTPUT COLORS
1	R, 15
2	R7, G7
*	*
*	*
*	*

Figure 3. A: Pixel color and values of red, green and blue. B: Pixel coding by frame buffer. C: Look-up translation of color codes to definitions.

The data are coded as RGB percentage values for each pixel, rather than defining each primary color separately, as shown in Figure 3(a) and (b). The process may be simplified by using a unique digital number for each color.

For example, a total of 256 colors can be identified by eight bits of digital information.

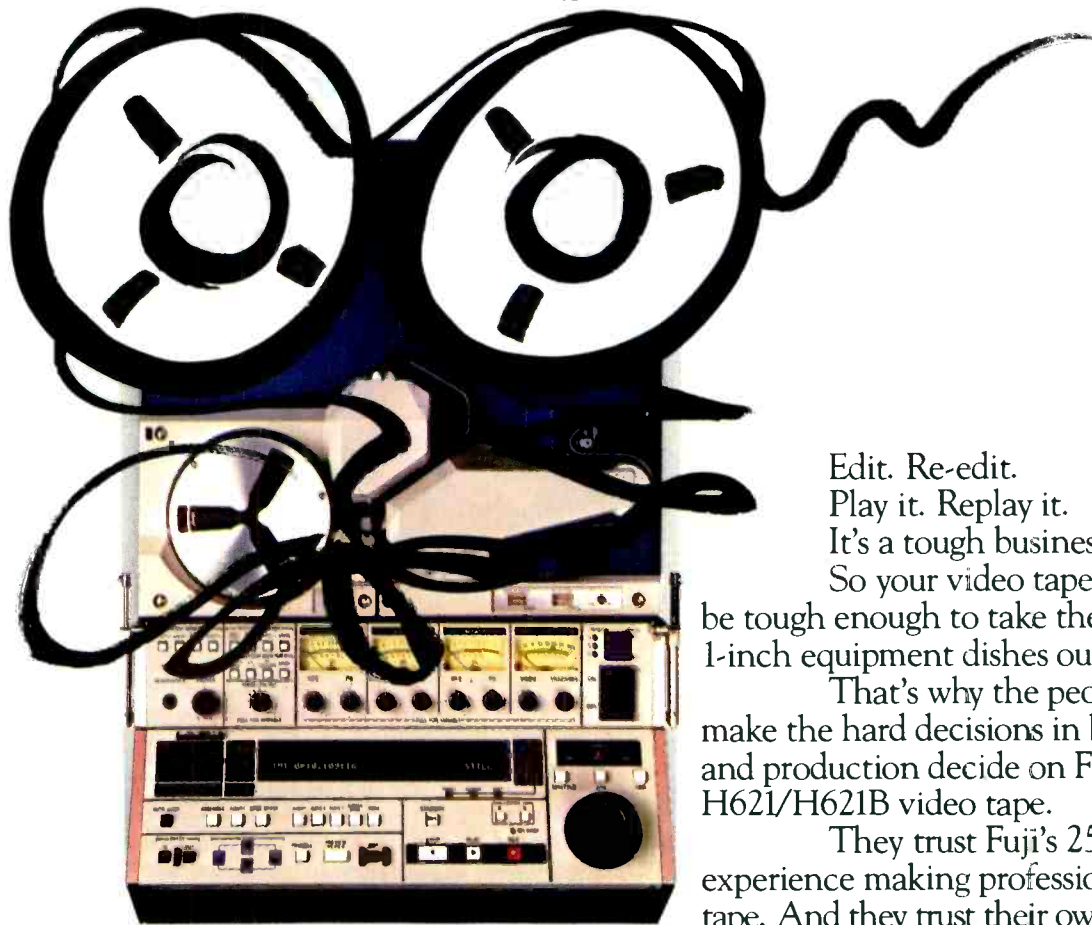
Under control of the CPU, the buffer output is modified to introduce size and position changes in images by appropriate variations in the rate of pixel readout.<sup>4</sup> By modifying the coding of pixels, the intensity and color of pixels or pixel areas can be changed.

In some instances two frame buffers may be used, one being loaded from storage while the other is being read. Dual buffering increases the operating speed materially, albeit at the expense





What good is a \$75,000 video recorder when the video tape gives a two-bit performance?



Edit. Re-edit.  
Play it. Replay it.  
It's a tough business.  
So your video tape has got to be tough enough to take the beating your 1-inch equipment dishes out.

That's why the people who make the hard decisions in broadcasting and production decide on Fuji 1-inch H621/H621B video tape.

They trust Fuji's 25 years of experience making professional video tape. And they trust their own experience.

With Fuji, they know that our high-density BERIDOX formula and special back-coating deliver picture quality that's consistently vivid, even after multiple generations. They know that dropouts drop down to a minimum. And that valuable video heads are protected to a maximum.

If you want to know more about what makes Fuji's extraordinary video tape the first choice of professionals, just do a very ordinary thing.

Run to your phone and call Fuji. And we'll show you a tape you can run and run and run and run and run and run.

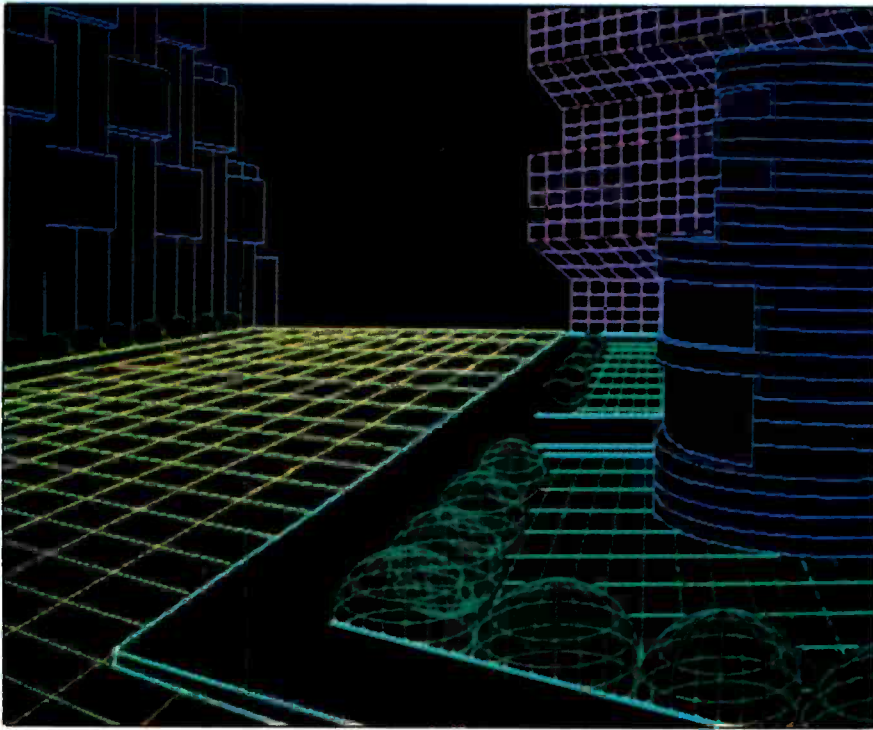


**FUJI.**

Nobody gives you better performance.

© 1984 Fuji Photo Film U.S.A., Inc., Magnetic Products Div., 350 Fifth Avenue, NY, NY 10118

Circle (21) on Reply Card



of increased cost and additional CPU output control circuitry.

**The look-up table**

The output of the frame buffer is fed to a look-up table or color map, where the identification numbers associated with each pixel are translated into color or signal values (Figure 3(c)). Look-up tables, in conjunction with frame buffer storage, were used in early character and graphic generators primarily to reduce the storage capacity requirements of the frame buffer.

Some systems use look-up tables for other signal processing such as gamma correction and color correction. More recently, they have been effective in reducing the memory requirements for frame-by-frame animation.

**Output**

The color map output signals, as red, green and blue digital video signals, are converted to conventional analog signals for monitoring and encoding into the desired transmission

# Just for effects



Chyron

Some of the most intriguing products for television are digital video effects systems. No matter how baffling these magic black boxes appear to be, there is definite logic to them—a large amount of digital logic.

**Reading, writing and RAM**

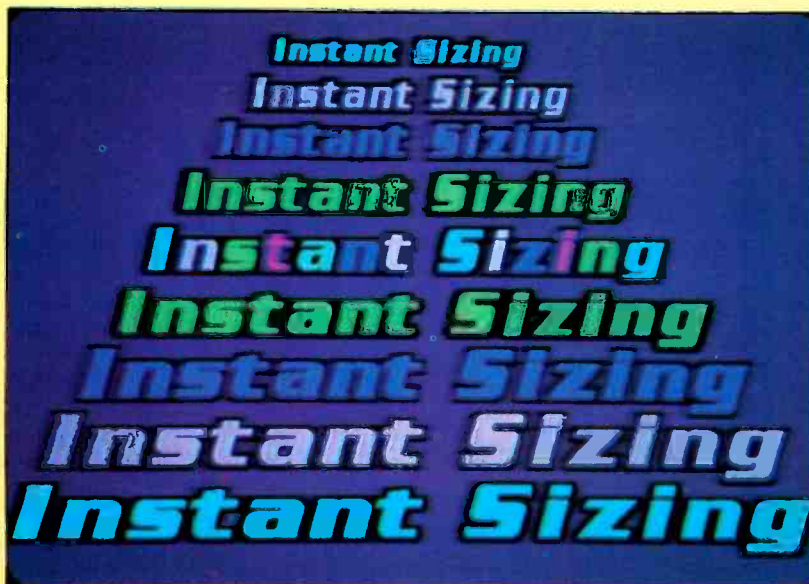
Like synchronizers and TBCs, video effects involves A/D converters to sample incoming video.

Digitized signals pass to a RAM framestore memory. Finally, a D/A converter recombines the bits to an analog output. The secret, however, is what happens in the memory.

Simple effects could result from how information is written into and read from the memory. Dropping bytes or rereading bytes alters the image size. Changing clock rates distorts perspectives. But such methods are not fast enough for video manipulation. A multistage computer control system is used instead.

One microprocessor system talks with the frame memory, either by moving bytes around or by handling read/write addressing. A second computer does complex calculations according to effects algorithms or formulas and converses with the memory controller about the results. The calculations use LSI combinations of logical AND and Or circuits called X-Y multipliers, which work with 16- and 32-bit parallel data at accelerated clock speeds.

Effects algorithm selection occurs on a keyboard or control panel through dedicated or programmed *soft* keys. Pressing one button inputs a set of parameters from ROM and RAM to the computer. The structure of the control and operating system determines the ease of using the system.



Quanta



## NTSC DIGITAL TEST GENERATOR DTG-1010N

# the multitasking machine...

Dual feeds of 40 test signals to FIVE different locations with complete remote control.

Two new test signals for chroma noise measurements and transmitter power calibration.

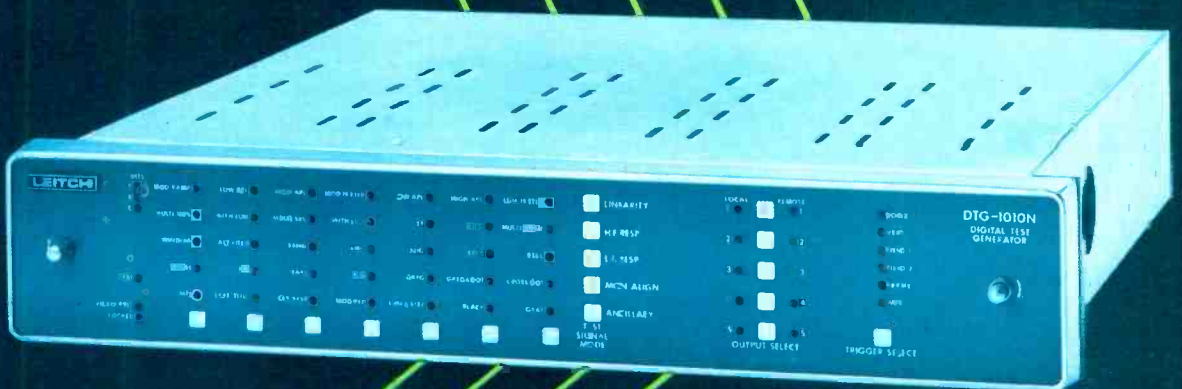
Three VITS packages.

Full range of trigger signals.

Variable H and V blanking.

Genlock.

RS170A ... of course.



STUDIO 1

STUDIO 2

VTR

MCR

MAINTENANCE

Plus  
outputs of

SYNC

BLANKING

SUBCARRIER

TRIGGERS

# LEITCH

*Progressive Concepts in Television Technology*

Leitch Video of America, Inc.  
825K Greenbrier Circle  
Chesapeake, VA 23320  
Tel.: (804) 424-7920  
Telex II: 710 882 4342

Leitch Video Limited  
10 Elys Road  
Don Mills, Ontario M3R 1V5  
Tel.: (416) 445-9540  
Telex: 06 986 241

Circle (25) on Reply Card



### Pivotal points

One approach to programmed effects uses the concept of keyframes. A keyframe is a start, stop or intermediate point of an effect. The keyframe data consists of various types of information, including flags to indicate the type of effects.

These include borders and backgrounds, H and V splits, mosaic and solarizing, image in-



One approach to effects control uses six soft keys under the effects display, which can choose one of 36 choices. After a group of six is selected, a new menu appears.



Effects sequences are stored in an electrically erasable ROM, housed in a key-shaped package.

versions of trajectories and frame or field freeze.

Which flags are set determine the subroutines (basic preprogrammed moves) to be called from an effects ROM. Default values for each keyframe flag simplifies the programming process. The operator may alter any default condition from the control panel. The computer will later use the flag status for comparisons, much like *IF-THEN* logic.

After setting flags, a group of variables with preset, but changeable, default values define: image and position; border and background colors, saturation and luminance; degrees of cropping, solarization and compression along x or y axes; and the time duration desired. These variables will be used in mathematical formulas to calculate the effect parameters when the program is invoked.

To set effects parameters, some systems require that values be entered from a keyboard. Others "read" the values of such devices as joysticks or fader bars. Some systems use both methods.

To determine the positioning of the controllers, potentiometers attached to the joystick or fader act as voltage dividers, the resulting voltage level being digitized and stored. The position could also be determined with binary switching or even by optical methods. When the positions are sensed, the parameters have been learned by the system.

With all factors selected, the operator may store the keyframe in an internal data bank for later use. Or, if the effect is not needed

for some time, the operator may elect to save the effect data in an external device. External memory choices, system dependent, include Winchester or floppy discs, bubble memories and solid-state electrically alterable ROM.

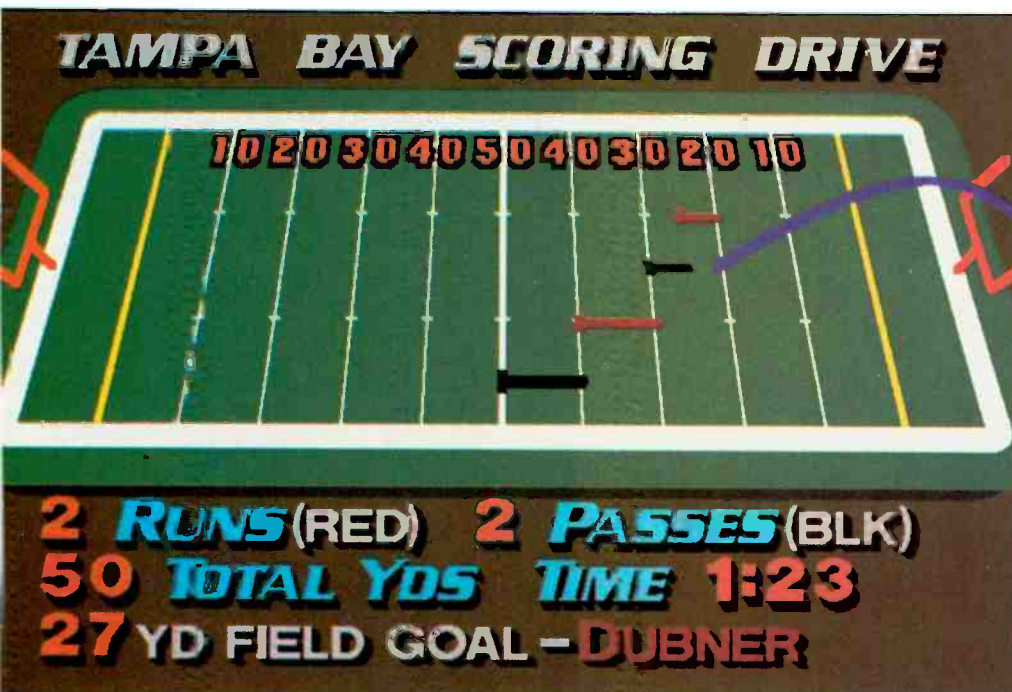
For complex effects, the operator works through a series of keyframes sequentially. Editing is possible, should a sequence need to be altered. And once a sequence is programmed, it may be saved internally or externally for later use.

### Taking control

For ease in system use, you must know the status of various parameters. Menus do that, as well as giving instructions to the operator. CRT, LED and display panel approaches are available with different systems.

Methods of operator control may vary, depending upon the application. There are differences between the on-air and production needs. On-air operators require the ability to alter effects parameters fast. You may need to access an effect from the external memory only seconds before it is needed.

In post-production, a more lenient atmosphere allows the operator to conveniently make changes. However, the investment required for digital video effects suggests that most TV stations would be using the same system for both functions. In other words, the control panel must be logically arranged and easily understood. Menu messages should be quickly readable.



standard. Because the digital outputs are a component format, the D/A conversion is a relatively simple translation of the digital values of each pixel to analog voltages.

### Image manipulation

Elementary squeeze and zoom effects require the rate of reading from frame memory be faster or slower than that at which the signals were written. This requires a simple frame-store, rather than a frame buffer with its complex color coding. By discarding every other pixel in the readout, the pictures are reduced or squeezed by a ratio of 2:1.

Conversely, by repeating pixels in the readout the image is doubled in size and cropped by the active scanning raster. The portions cropped will depend upon where the readout is started.

In both squeeze and zoom there is a loss in resolution. It is of most

Dubner

Continued on page 52



# SPACESAVERS



## NEW! Right Angle PC Connectors... for greater PC board density

Designed for mass production operations employing automated assembly and wave-soldering techniques, Switchcraft's new right angle connectors mount directly into the PC board with two self-tapping screws, totally eliminating costly hand-wiring. Flexible and versatile, these right angle connectors minimize height above the PC surface permitting greater PC board density. Escutcheons trim panel holes allowing the PC board mounted connector to be removed without unfastening it from the panel.

Available in 2 and 3 pin configurations, with detent latching, the new RAPC Series reduces production and labor costs. Optional snap-in housing protects connections and reduces PC board stress. All plastic housing also eliminates the possibility of ground loops.

Save time, money and space. Switchcraft's got the angle you've been looking for.

For further information, fill in the coupon below or call Randy Opela at (312) 792-2700.

**SWITCHCRAFT INC.**

A Raytheon Company

5555 N. Elston Ave., Chicago, Illinois 60630  
(312) 792-2700

Please send me  samples of or  literature about RAPC Series Connectors.

Name \_\_\_\_\_

Address \_\_\_\_\_

City \_\_\_\_\_ State \_\_\_\_\_ Zip \_\_\_\_\_

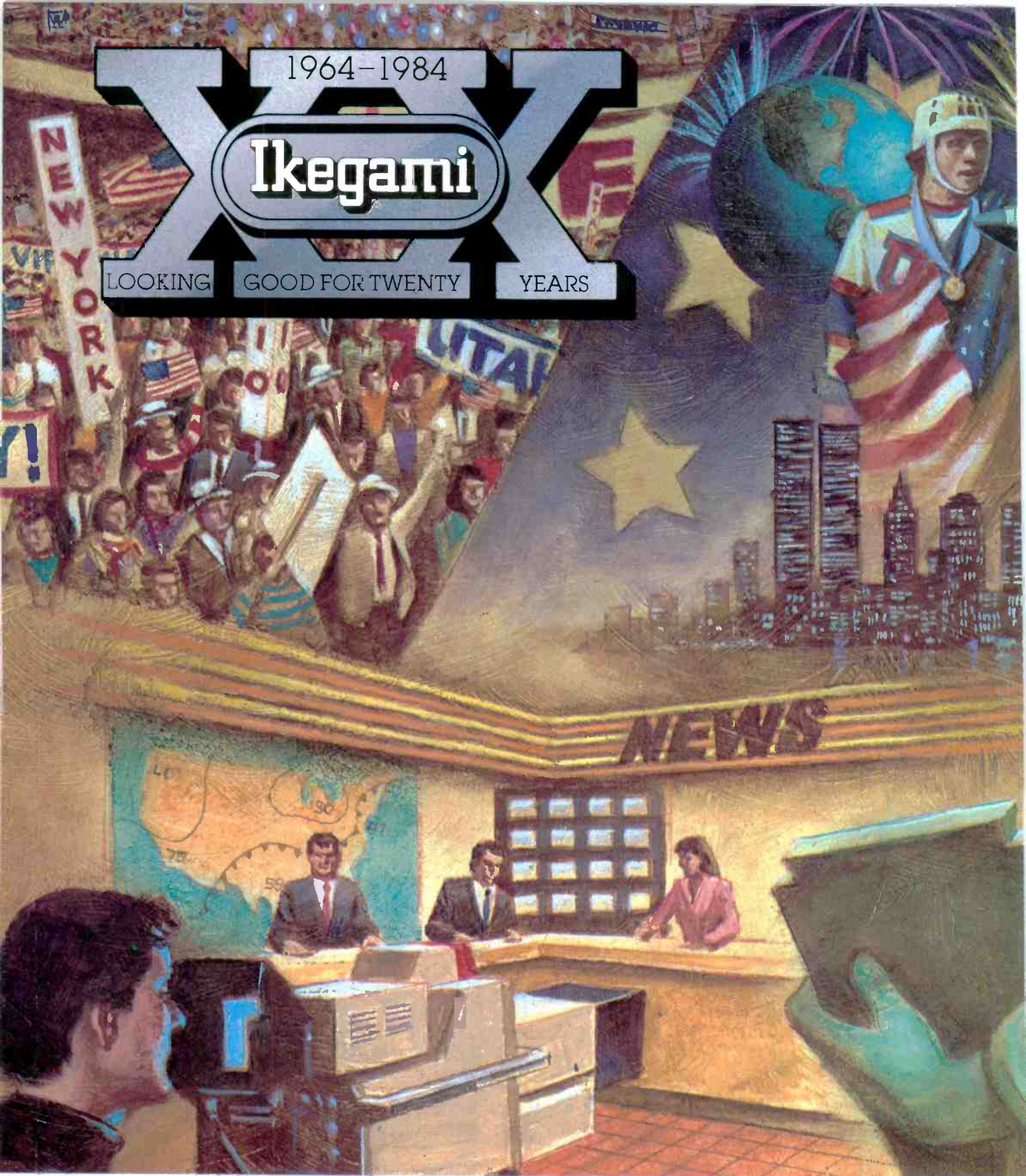
Phone \_\_\_\_\_



1964-1984

Ikegami

LOOKING GOOD FOR TWENTY YEARS



For over two decades, America has taken a good look at Ikegami—and liked what it saw. In return, we've done our best to give America a good look at itself.

In the past 20 years, Ikegami cameras have captured the excitement and emotion of nearly every major news and sports event—as well as bringing the finest entertain-

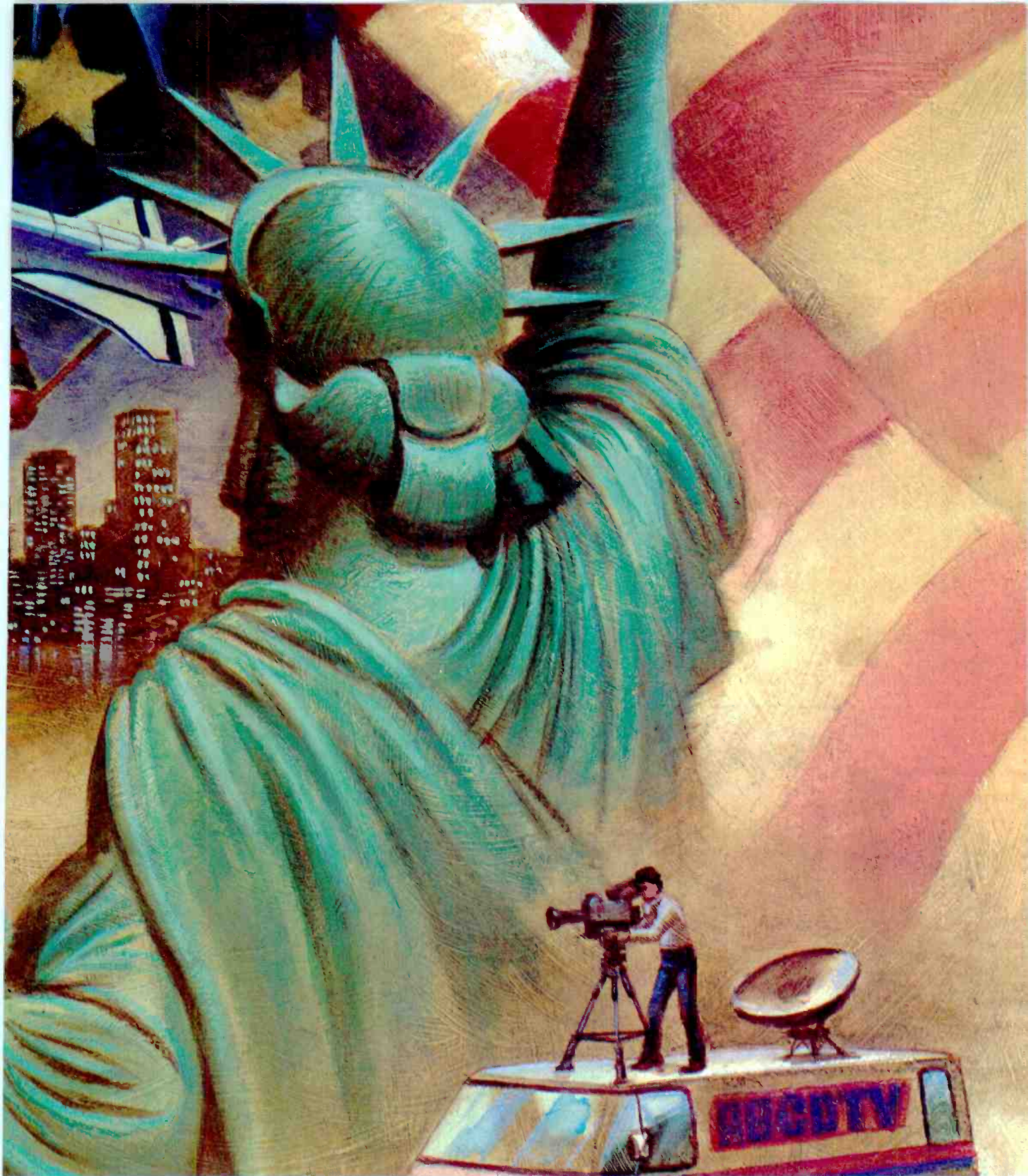
ment into American homes.

The list is a long one. It started with the Handy Looky's famous live broadcast of the Aurora 7 space flight—the first such coverage by a portable handheld camera. It continues with such successors as the HL-79E capturing news events with immediacy and spectacular imagery of on-the-spot coverage. The versatile

HL-79E has also become the standard of EFP. And the newest of Ikegami's handheld cameras, the HL-95 Unicam, made its dazzling debut covering the Summer games in Los Angeles.

In the studios and remote locations around the nation, the Ikegami HK-322 and HK-357A have conveyed the pageantry and drama of major TV programs with unrivaled reliability





and fidelity. While Ikegami monitors have helped many a director make the right decision behind the scenes.

And in industry, our high-quality ITC-730A professional camera has won the confidence of corporate production departments.

We're proud to have earned recognition from the American broadcast industry as the premier manu-

facturer of TV cameras. And to be honored with several Emmy Awards.

Join us in the celebration of our 20th Anniversary. For a free 17"x24" poster/calendar featuring the special illustration in this advertisement, please write on your letterhead to: Ikegami Electronics (U.S.A.), Inc., 37 Brook Avenue, Maywood, NJ 07607.

Circle (27) on Reply Card

# Ikegami

Northeast: (201) 368-9171  
Midwest: (312) 834-9774  
West Coast: (213) 534-0050  
Southwest: (214) 233-2844  
Southeast: (813) 884-2046



# Faces and fonts

Trends in product design seem destined to arrive at a single piece of equipment that does everything. Categorizing such products can be a problem. For example, the mention of a character generator brings several different product types immediately to mind.

What most people mean is a unit, using digital techniques to produce alphanumeric titles. Either through its own keyer or through a downstream keyer on the production switcher, the unit presents textual information within the TV picture.

A second product type places alphanumeric data on the screen as well, not intended for viewers but as an aid to editing or as source identification information.

A third type gives information about system parameters, like diagnostic displays in camera viewfinders or on oscilloscope CRTs. Technically, all three do the same thing. From a data bank of

the required shapes, the units generate characters.

TV titling falls in a general category of TV graphics. Most titling systems include free-form graphic capabilities as options. On the other hand, video art systems can produce alphanumeric characters as well. Both place informative lettering on the screen. Confusion results without some definitions.

First, the TV titler is in essence a typewriter that uses the TV screen rather than paper. As a basic unit, the TV titler places information onto the screen for the viewer. It should allow some character manipulations, such as type size, screen position, centering of lines or pages, colorizing and shading.

The data needed for formation of the characters is kept in the unit in a special memory section called a map. Some systems include the map as integral ROM

memory. In others, the data are loaded from an external storage medium, such as floppy disk.

A simple titler includes RAM memory formatted as video pages. Each of the memory cells in a page contains a value that designates the character you want to appear in that location on the screen. The value is based upon the American Standard Code for Information Interchange (ASCII) concept of 8-bit groups.

The ASCII values reference the data stores in the map, where the character is described in a rectangular matrix (for simplicity, a 5x7 matrix), as on page 54.

When a video page is presented, the 1s and 0s necessary to form each scan line through a character are called from a character memory map. The 1s appear as points of light on the screen, while 0s join the black background.

For more refined characters

# Perfect reception in long yardage situations.

Shure's new FP11 and FP12 field production units help the signal come through loud and clear. The compact size and ultra-rugged design of these units make them perfect for ENG, EFP, film and even sound reinforcement situations. Lightweight, with belt clips, they'll go

anywhere to cover all the action.

## FP12 Headphone Bridging Amp

The FP12 lets you check any audio line through headphones, without terminating the signal. The unit accepts standard  $\frac{1}{4}$ " or 3.5 mm mini-plugs. Its 96 dB of gain drives headphones even with a weak signal.

## FP11 Mic-to-Line Amplifier

The FP11 boosts mic signals to line level by up to 84 dB, giving a clear, static-free signal over long distances. It features a precision stepped gain control, a switchable limiter, and easy access to batteries for checking or replacement.

For more information on Shure's complete field production family, call or write Shure Brothers, Inc., 222 Hartrey Ave., Evanston, IL 60204, (312) 866-2553.



# SHURE

THE SOUND OF THE PROFESSIONALS®...WORLDWIDE.



**Microtime synchronizers.  
The features you want.  
The prices you can afford.**

**S-230.** A TBC that synchronizes. A synchronizer that time base corrects. In a 3½" high, 27 lb. package. The S-230 synchronizes and time base corrects external signals such as network, ENG, microwave, satellite and remote studio feeds. And because it contains an infinite window TBC, it works with all 1/2" and 3/4" heterodyne VTR formats, with or without capstan servos.

The Auto Mode switching feature samples incoming signals and automatically

selects the correct mode, TBC or synchronizer. The 8 bit, 4X subcarrier digital design and microprocessor-directed memory mean high reliability and transparent performance. Full frame memory allows manual selection of Field 1, Field 2 or Full Frame Freeze. Operator-selectable automatic freeze detectors permit controllable response to fading signals. All for only \$13,950.



**S-130.** The most full frame synchronizer for the money. Like the S-230, it features a

microprocessor subroutine that provides ease of maintenance and confidence testing. The S-130 synchronizes external signals such as network, ENG, microwave, satellite and remote studio feeds, and is ideal for the new Harmonically Related Carrier (HRC) designs in CATV applications. Only \$10,990.



**MICROTIME**

A Subsidiary of ANDERSEN GROUP  
1280 Blue Hills Ave., Bloomfield,  
CT 06002. (203) 242-4242.  
TWX 710-425-1165.

Circle (28) on Reply Card

# Savings in synch.





much larger matrices may be used, but the same principle applies. A video keyer is used to mix the characters with some type of background video, such as a solid color, colored bands or externally generated TV images.

Because of the framestore attribute of the page memory, free-form graphic options may be used with many titlers, either as software or hardware packages. The basic purpose, however, remains the presentation of textural material in a TV format.

#### Free-form graphics

The video art system is a free-form graphic unit. Its intent is to produce full or partial frame images. Those images may or may not include alphanumeric information. Characters may be drawn onto the screen through an electronic drawing pad.

Most systems also include an input for composite video to allow pictures or letters to be scanned into a portion of the memory. Again, software and hardware options may provide different sets of type, but the basic purpose of the system is for free-form artistic presentations.

#### Faces vs. fonts

Typography defines a style of lettering as a typeface. Examples include Helvetica, Old English, serif or san serif. In the true TV titler, a face is the information held in the character map.

From the data that describe a typeface, the titler creates character fonts or type sizes. Size might vary from a single pixel to a full TV screen in height, but intermediate sizes, ranging from perhaps eight points to 32 points, will provide useful size characters for easy reading by the viewer. The

0	0	1	0	0
0	1	0	1	0
1	0	0	0	1
1	0	0	0	1
1	1	1	1	1
1	0	0	0	1
1	0	0	0	1

The 5x7 matrix representing the letter A.

system should allow more than one font displayed simultaneously on the screen.

Even an italic font with controlled slant should be available from the typeface in the system's memory. That is, the italic form of the serif face should not require a separate load operation from the type face library. Mixing of italic and non-italic fonts should be possible with a single display page or even line.

For more artistic treatment of the characters, the basic titler becomes more involved. Character coloring, for example, implies additional bit storage to hold each character's color map data. Smooth characters may require anti-aliasing to get rid of jagged edges, either through hardware or software. Shadow effects are desirable to make a title stand out against a background over which the characters are keyed. Multiple colors make far more interesting titles. Reveal windows simplify captioning functions or rolls and crawls of multipage information.

Each added capability on a per-

character basis places a new requirement to both hardware and software of the system.

#### Character resolution

Characters or graphic objects are formed from pixels. The sharpness of the display is dependent upon the size and number of pixels that the system displays. But how big is a pixel?

On any NTSC TV screen there are about 485 visible lines out of the 525 lines forming a frame. About 40 are involved in the vertical blanking interval and are unusable. The smallest practical height for a pixel is one line. In time related to horizontal distances, that amounts to about 81ns.

Pixel width, however, has greater variability. With some mathematical calculations, it can be shown that for a 1:1 ratio of width to height on the 4:3 aspect ratio display, the pixel is about 80ns wide, or an 80ns resolution. A 20ns resolution would present a pixel with a width that is 1/4 the height.

Practical limits of today's TV receivers suggest that a realistic horizontal resolution for titling systems should fall in the area of 27ns. A much larger value will require greater anti-aliasing attention. A much smaller value would render unreadable titles.

#### Buying a system

What is your graphic requirement? Is it strictly to add captions and credits to a program? If that is the case, a titler is probably what you need. Let your production switcher help with keying the letters into video and you on your way. If your need is more artistic, look for a titler with art graphic options or a full-fledged art system.



MCI/Quantel

significance in the zoom, where the magnification is not accompanied by a proportional increase in fine detail. Noticeable degradation is introduced as well by the enlargement of random noise.

A 3-dimensional perspective is achieved by varying the rate of the horizontal readout. The rate varies with each successive scan line during the squeeze or zoom operation.

Inversion or mirroring requires a reversal of the readout direction. A combination of the change in rate used for squeeze and zoom, and reversal of readout can, by proper programming, produce tumbling or spinning. Rotation is more difficult, requiring a matrixed change in rate and selection of pixels on horizontal and vertical axes during the readout.



# The 2" multi-track for those with a 1 track mind. Value.

When selecting a multi-track, it's easy to get thrown off track. Why pay for technology, for technology's sake? It contributes most where you want it the least. Cost. But for professionals who value their music as much as their money, there's

stan motor delivers variable speeds in excess of 45 ips with heavy duty performance. And in video applications, external frequency or voltage controllers easily interface with the Mark III.

## Versatile Value.

The headblock is a precision milled, flat wired, self contained unit which simply plugs into place. Therefore, upgrading from 16 to 24 track recording can be accomplished without disturbing any head alignments, saving expensive time.

## Extra Value For Nothing Extra.

Another valuable feature is its durable construction and modular

configuration allowing timely and hassle-free maintenance. We've also added new audio channels with low frequency record and replay trim, adjustable phase compensation and available sync head transformer.

These features, coupled with our optional full function nine memory autolocator, makes the Mark III the ultimate in appropriate tape technology.

Soundcraft's 760 Mark III Series. It's everything the 2" professional needs to get back on the right track. At a price that really attracts attention. Under \$18,000\*.

\*Suggested retail SCM 762-16B. Other models up to \$24,950.

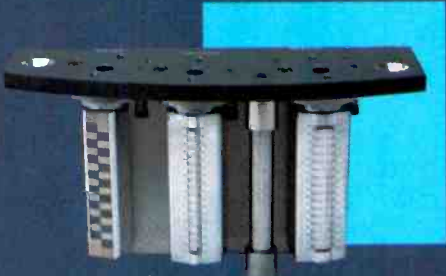
*Appropriate Technology*

# Soundcraft

Soundcraft Electronics  
1517 20th Street, Santa Monica, CA 90404  
(213) 453-4591 Telex: 664-923  
In Metropolitan N.Y. call (212) 315-0877

Soundcraft Electronics Canada, Inc.  
444 Hymus Blvd., Dorval, Quebec, H9P 1J6  
(514) 685-1610 Telex: 05-822582

Soundcraft Electronics Limited  
7-8 Great Sutton Street, London, EC1V0BX,  
England Telephone: 01-251-3631 Telex: 21198



one recorder that's second to none. The new Mark III Series from Soundcraft.

## Heavy Duty Value.

A newly developed German cap



**Nady VHF. The best sounding wireless is now also the most user friendly.**

**NADY 601 VHF RECEIVER**



**NADY 501 VHF RECEIVER—OUR NEW AFFORDABLE VHF SYSTEM**



**NADY 701 TRUE DIVERSITY RECEIVER**



**501 LT TRANSMITTER WITH LAVALIER MICROPHONE**

**DIMENSIONS:**  
2.8" x 2.6" x 1.0"  
**WEIGHT:**  
2.6 OZ.



**601/701 LT TRANSMITTER BODYPACK IS THE SMALLEST IN THE BUSINESS. INCLUDES PHANTOM POWERING FOR ANY LAVALIER MIC.**

**501 HT AUDIO-TECHNICA PR-60 ELEMENT.**

**DIMENSIONS: 8.75" x 1.44", TAPERED  
WEIGHT: 8.5 OZ.**



**601/701 HT WIDE CHOICE OF POPULAR ELEMENTS AVAILABLE.**

Virtually all of today's major touring entertainers choose Nady VHF wireless microphone systems. Why? Because Nady consistently delivers the highest quality audio and the most reliable radio transmission in the high SPL environment of the performing stage. We pioneered the use of compansion for increased dynamic range years ahead of everyone else. And Nady technology continues to set the standard in wireless system performance.

From our affordable new 501 VHF to the 701 True Diversity system, the best sounding wireless is now also in the best format for production—as well as stage—applications. Features include a versatile audio output arrangement, full LED status indicators, and the smallest, toughest transmitter bodypack in the business. Everything you need in a wireless microphone system—plus the legendary Nady sound.

Contact your sound equipment supplier and arrange for a Nady VHF demonstration. You'll see—and hear—what we mean.

**NADY SYSTEMS, INC., 1145 65th STREET, OAKLAND, CA 94608 • 415/652-2411  
CANADA: HEINL ELECTRONICS, INC. • 14 MARY STREET • UNIT 1 • AURORA, ONTARIO L4G 3W8 • 416/727-1951**



Circle (32) on Reply Card

In all of the manipulations described, there may be instances when the image extends off the screen. In these slide-on/off effects a new set of coordinates is used to permit pixel position assignment in areas of as much as three times the normal screen size.<sup>5</sup>

**Interpolation**

To maintain image quality during non-linear manipulations, such as rotating and scaling, it is necessary to interpolate or average among samples. This corrects for the variations between samples resulting from the difference between the readout sampling rate and the horizontal and vertical rates corresponding to pixel location.

The simplest example is a straight line at an angle to the horizontal scanning lines. The effect is similar, but more complex, to that encountered in TV standards conversion where the relationships are static and only on the x and y axes.

**Aliasing**

Sampling errors of one pixel per scan line or frame can occur on objects slightly larger than one full pixel. Alternatively, movement of such subject matter can cause a brightness change not related to the motion.

This distortion of reproduction is apparent as moire patterns on fine detail, or ragged edges on diagonal lines. In manipulations, the effects on diagonal lines and edges are reduced by interpolation.

On the other hand, in camera-originated material, there is no pat solution. Such interference or picture degradation effects are seen regularly in analog TV pictures where the camera scanning lines beat with fine detail patterns in the scene material.

Digitally generated material can produce more serious aliasing artifacts than analog TV, primarily because of the sampling processes. Filtering may not be possible to remove them. Filtering is also not a practical solution in the analog domain, because of the resultant loss in resolution.

One digital technique used in alias reduction is to sample the amplitude of several (say eight) pixels and to reject any values outside of a predetermined range. This is effective in memory readout of static graphic material. However, reduction of aliasing on moving objects proves quite difficult, because it involves the dimension of time, in addition to x and y.

**Fine arts graphics**

A paint system is essentially an adjunct to the basic elements of computer graphics. The paint program

**SPECIFY EXCELLENCE!**

from the company who pioneered equalization

**• ACTIVE AND PASSIVE EQUALIZERS**

18 different Models to choose from

**• REAL TIME ANALYZERS**

Octave Band, one-third and one-sixth octave

**• BI-AMP AND TRI-AMP CROSSOVERS**

Low-level at any frequency and slope

**• NARROW BANDWIDTH NOTCH FILTERS**

Control of room feedback and ring modes

**• CUSTOM FILTERS FOR AUDIO APPLICATIONS**

High-pass low-pass band-pass notch

**SEND FOR OUR COMPLETE PRODUCT CATALOG**

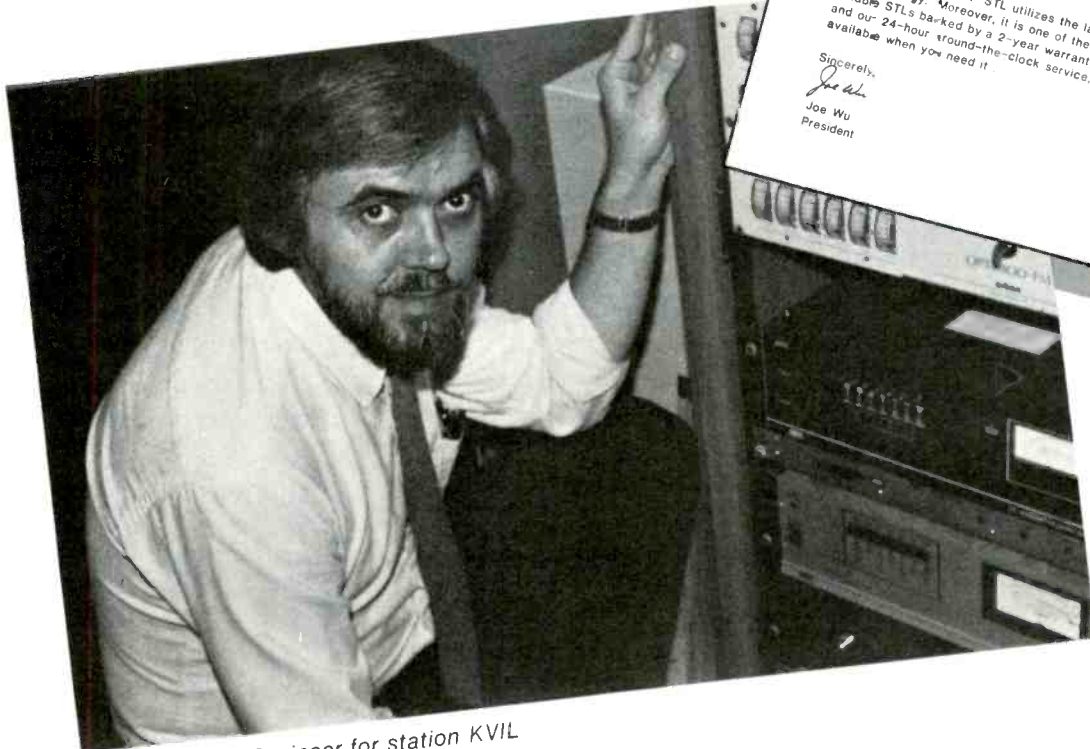


**INSTRUMENTS, INCORPORATED**  
P.O. BOX 698  
AUSTIN, TX 78767  
(512) 892-0752  
TELEX 776409 WHITE INST AUS

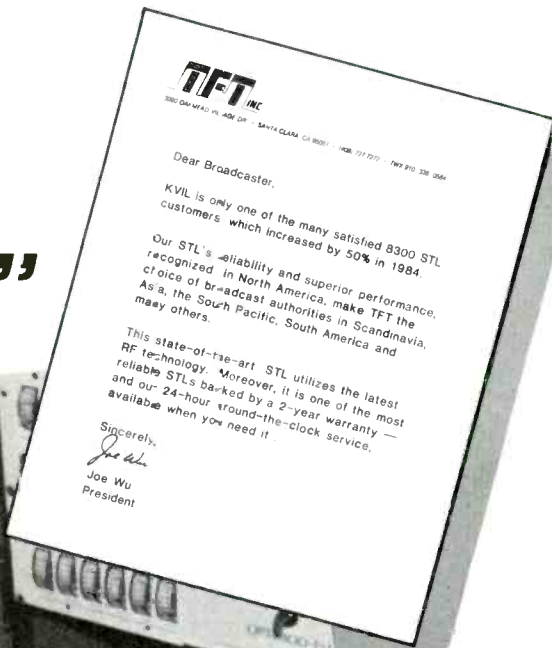
Circle (33) on Reply Card



# "TFT 8300 STL's Superior Design Made an Audible Difference on the Air"



Bill Ryan-Chief Engineer for station KVIL  
Dallas/Ft. Worth Area



Dear Broadcaster,  
KVIL is only one of the many satisfied 8300 STL customers which increased by 50% in 1984.

Our STL's reliability and superior performance, recognized in North America, make TFT the choice of broadcast authorities in Scandinavia, Asia, the South Pacific, South America and many others.

This state-of-the-art STL utilizes the latest RF technology. Moreover, it is one of the most reliable STL's backed by a 2-year warranty — and our 24-hour around-the-clock service, available when you need it.

Sincerely,  
*Joe Wu*  
Joe Wu  
President

Dallas/Ft. Worth Station KVIL has enjoyed a Number One share of the market for the past several years, and Chief Engineer Bill Ryan aims to keep it that way. That's why he turned to the TFT 8300 STL when their antenna site on Cedar Hill became overcrowded.

"We needed a superior system with enough bandwidth and selectivity to overcome the RF congestion and white noise. TFT's new 8300 system provided a 100% audio improvement at both the high end and the low end."

"Hearing is all important. You can measure a lot of things, but you can't necessarily hear all the specs. The excellent audio quality of TFT 8300 was a very pleasant surprise."

"The 8300 System is helping to keep me young. Every problem you can eliminate adds a few years to your life. The installation and operation of TFT 8300 was literally problem free. You just plug it in and turn it on."

"With TFT, it wasn't just another sale. All the way from the local rep to the president of the company, they did a great deal of groundwork. They were genuinely trying to help us solve a problem. I never have any trouble contacting TFT for help."

"I'd have no problem recommending TFT 8300 to any of our other group stations throughout the country."

These comments are from another satisfied TFT 8300 user. Call us today for full facts on the STL system with a difference you can hear!



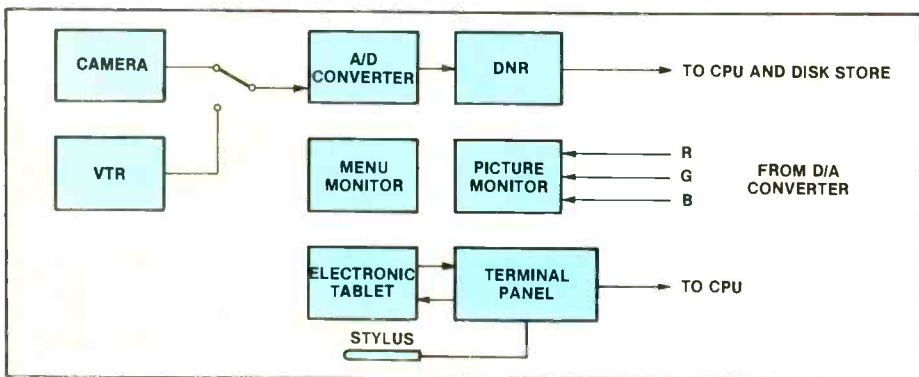
**Committed to keeping you, on the air!**

3090 Oakmead Village Dr., Santa Clara, CA 95051 ■ (408) 727-7272 ■ TWX 910-338-0584

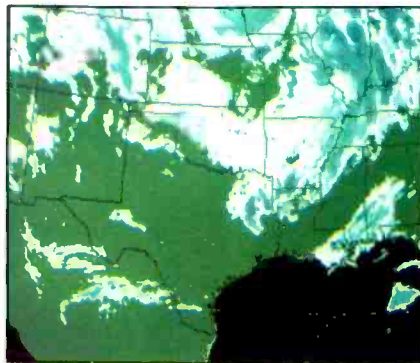
# Exploration Expenditures



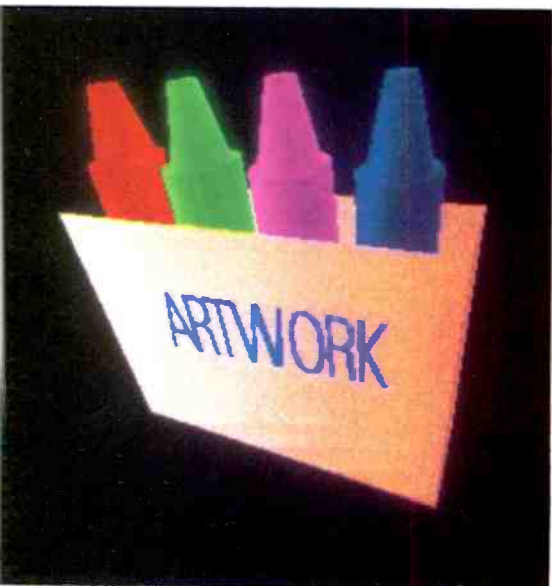
Via Video



**Figure 4.** Block diagram of typical paint system elements. Pictures can be recalled from the frame buffer and disk storage for display, and subsequent paint and manipulation operations.



Thomson/CSF



West End Artwork

allows an operator to draw on a screen using a stylus. Stylus movements are translated into electrical signals.

The sophistication of the system may range from turning individual pixels on and off to simulating the artist's tools (oil paint, water color and airbrush) and techniques (line thickness, area colors, texture, edge composition, overlays, transparency and matting).

Depending upon the talent of the artist and the level of system capability, an electronic paint program can produce outputs equivalent to images from live cameras or conventional graphics material. The elements of a typical paint system are shown in Figure 4.

Most paint systems use a manually operated input device (the graphics pad), similar to an artist's canvas, to provide two degrees of planar image creation and manipulation. The artist selects a command from the menu displayed on a monitor screen or, in some cases, from a keyboard.

With monitor menu displays, the stylus is placed on the desired command and a button on the stylus is pressed to activate the command. The same screen may provide both the drawing and command displays. More conveniently, separate monitors are used for the two functions.<sup>6</sup>

In addition to the canvas or tablet valuator, and the picture and menu displays, the paint program uses the CPU to direct and receive input data and to control the buffers and color tables for processing.

A typical paint program can be summarized as three primary tasks: to track the pointer or stylus to receive the commands for organization as digital data; to manipulate the buffer storage and color look-up table in accordance with the input data; and to store and retrieve picture information, using the system computer.

## The graphic advantage

Watching electronic graphics systems in operation creates an aura of magic. Through a logical combination of complex digital techniques, they have provided creative talent with new tools that contribute a greater artistic freedom.

At the same time, electronic effects and graphics give the producer a means to greatly reduce the time required to complete effects and animation, which in the film medium often entailed days or even weeks to bring to fruition.

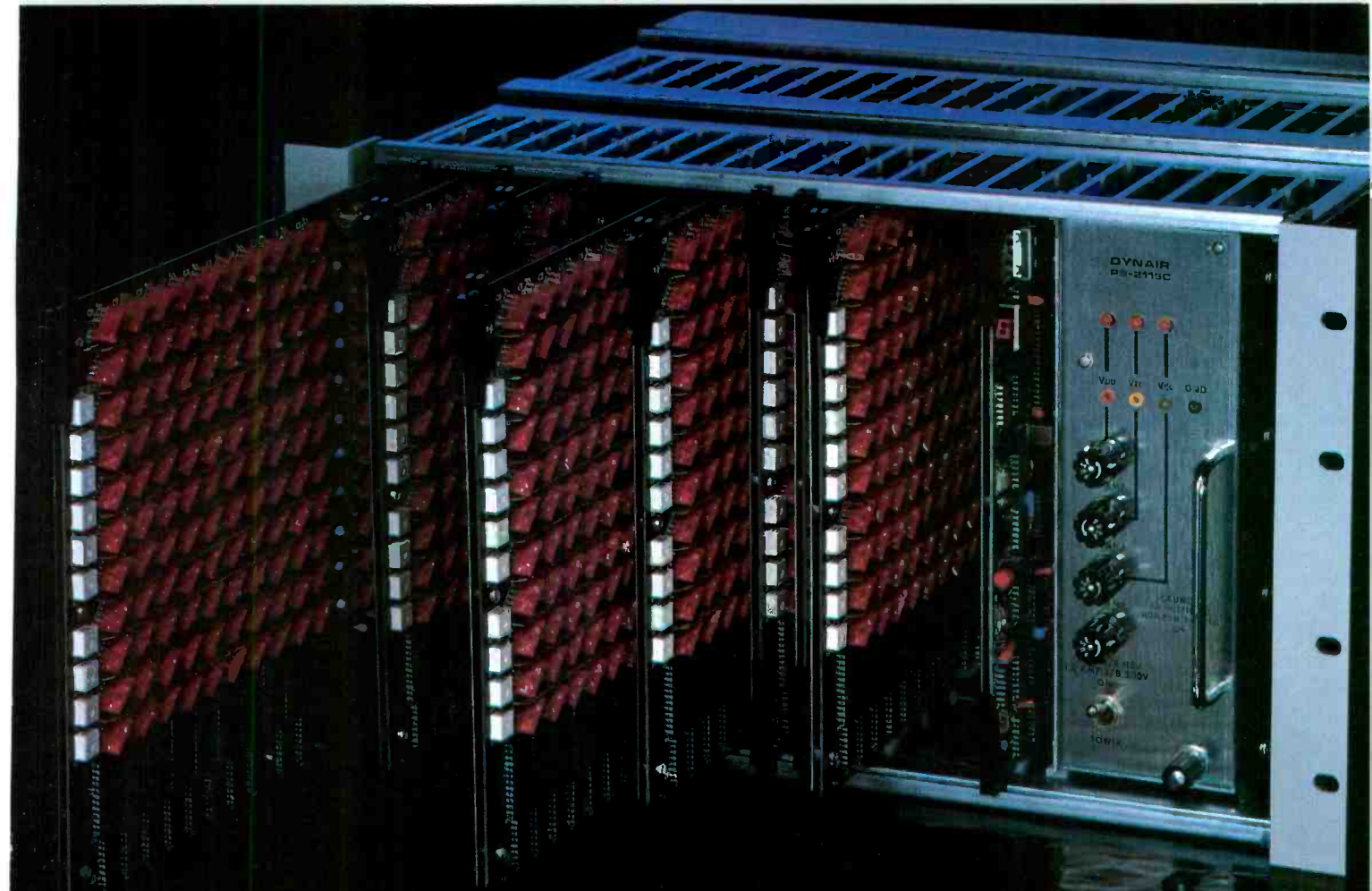
Related articles were written by Carl Bentz.

## References

1. "Television Standards Conversion." *Broadcast Engineering*, October 1982, pp. 46-50.
2. "Electronic Videographics: A Perspective." *Broadcast Engineering*, February 1983, pp. 38-48.
3. Smith, Arthur A.; Rahman, Altaf; and McMann, Renville A. "A New Dimension in Broadcast Graphics." *SMPTE Journal*, September 1982, pp. 774-779.
4. Klimek, Thomas F.; and Towles Jr., Herman E. "The Computer-controlled Frame Buffer as a Production Tool." *SMPTE Journal*, November 1983, pp. 1202-1207.
5. Blacksmith, James E. "Some Arithmetic Control Algorithms for a Digital Video Effects Unit." *SMPTE Journal*, September 1983, pp. 908-911.
6. Shoup, Richard G. "Menu-driven User Interfaces for Video Graphics." *SMPTE Journal*, November 1983, 1208-1210.

[:(-:))]]]





# Only the beginning

A thing of beauty . . . this Dynair System 21.

Begin with this single, high density frame using as few as 10 inputs and 10 outputs. Select combinations of video, audio, time code, data, tally, or machine control switch modules.

Grow sensibly, easily and cost effectively to impressive matrices of one thousand inputs and one thousand outputs of every module type by simply adding frames and modules.

Grow into high definition TV, if this possibility is in your future, without changing a thing. Bandwidth of the System 21 is already 30 MHz.

Write or phone. We would like to send you additional information. Give us a chance to begin with you as you upgrade your plant.

## DYNAIR

5275 Market Street, San Diego, CA 92114 U.S.A. Phone (619) 263-7711 TWX (910) 335-2040

Circle (34) on Reply Card

# Speaking of television, digitally

By Elmer Smalling III, cable systems consultant

For more than 40 years, television has been an analog phenomenon, as has most of the communications world.

Voices, pictures and other signal intelligence have been represented by voltages that vary in proportion to levels, frequencies and phase angles of the signals. When any device along the transmission path acts in a non-linear or abnormal fashion, the signals become distorted. Common examples include the end result of a long-distance phone call or blue faces on television.

Engineers have struggled with circuit and path non-linearities. Yet, just as technology was about to find cures for many of our analog aches, digital technology allows us to treat signals in a manner far more manageable than analog methods have allowed. Advanced systems based on applied mathematics use rather simple circuitry with word streams of 2-level bits for distortion-free transmission.

## Analog vs. digital

Analog signals are transmitted intact, without varying their complex internal relationships of amplitudes, phases and frequencies. The signals should remain similar to those generated by transducers, such as microphones or camera tubes (although in reality, mixing may be required).

Ideally, when a received and decoded signal is heard or displayed, the result retains the same internal, complex relationships. In practice, however, many of the relationships become altered and distortion results.

Digital signals are derived from their basic analog parents through analog-to-digital (A/D) conversion. The analog signal is broken into millions of discrete components, which can be represented by data words. Each word consists of four, eight, 16 or even 32 bits, depending upon the available system.

Now, instead of a complex waveform to represent our signal, we have a string of data words, a digital format that may be easily handled or transmitted as a serial flow of bits. Each bit may take on a value of 1 or 0, signifying on or off.

The time represented by each word

is called the *sampling time*. The shorter the sampling time (the greater the number of samples per unit of time), the higher resolution our signal will have. The sampling rate is determined by a system clock and the speed of *sample and hold* circuits which cause some delay while a sample is being quantized.

Once the signal is in a digital form, a simple microprocessor may handle control of processing. The signal may be stored in a memory or it may be altered. Time base correctors, frame synchronizers and digital video effects units use video that is stored or manipulated as data words.

## Signal conversion

Using an analog video signal as an example, the signal enters the A/D device and is examined and sampled at a rate at least two times that of the highest frequency component of interest within the original signal. At a rate less than two times, the sampling time is too slow to capture signal detail. The two times rate is termed the *Nyquist rate*.

Each sample could consist of three 8-bit data words. Each word may represent a number as high as 256. The first word of each sample might represent the magnitude of the video signal voltage (0 to 1V, divided into 256 steps). The second and third words might contain 256, the third a maximum of 104, giving a total angle of 360°.

Although an analog voltage can represent any number of voltage levels or degrees of phase, conceivably an infinite number, and because our 8-bit system can only represent finite levels, the signal has been *quantized* into 256 levels. (See "Binary and Beyond," page 62.) Quantized is derived from quantum, which refers to a discrete value, no matter how large or small. Quantization levels do not overlap.

## LDA, STA, BEQ

With the analog video converted to data words, you have almost complete freedom in working with the data. You can manipulate or store the signal as you would other types of data. You can transmit signals from machine to

machine or across the continent with little or no distortion from non-linear devices.

In a digital video effects unit, you can modify the data from a keyboard, using preprogrammed computer software to manipulate the video picture. The effects system allows you to use various subroutines in a computer machine language program to achieve the effects you desire.

Similar operations in the video painting system or electronic easel allow you to add color, texture or shapes to the original video image. Or you may decide to erase the stored image and draw new material with a light pen, mouse, keyboard or graphics pad. In either case, you are changing the 1 and 0 values of bits in the 8-bit words stored in memory.

## Analog animals

People require analog input. For this reason, you must reconvert any digital signals back to an analog form for listening or viewing. Eyes are stimulated by continuous and relatively smooth signals at very low data rates; low, at least, in comparison to the microsecond clocking rates of standard microcomputers. This change is accomplished with the digital-to-analog (D/A) converter, which operates in reverse of the A/D converter.

In the D/A device, the data stream of words is applied to logic gates to derive preset levels. Words, containing digital values, generate 0 to 256 parts of a 1V peak to peak or up to 360 parts of phase video signal. The level data are fed through smoothing circuits to recreate a new analog version of the original video voltage.

The digital-to-analog fabricated voltage can be no smoother than the 256 levels of quantizing you began with in the A/D converter. The resulting detail is dependent upon the number of discrete sampling levels you used, no matter what amount of smoothing or filtering is applied.

## Talking digitally

Dealing with digital processing obviously requires speaking a different language. To assist in a better understanding of digital processes,





# Stereo TV is the one to watch.

**Flash.** Stereo TV is the hot topic at the 1984 Consumer Electronics Show in Chicago.

**Flash.** Every major TV set manufacturer plans to put multichannel units on the street by 1985.

**Flash.** NBC announces *The Tonight Show* and *Friday Night Videos* will soon be recorded in stereo.

**Flash.** ABC tests bilingual broadcasts of *The Fall Guy* in Spanish markets; ratings soar.

**Flash.** NEC introduces VHF and UHF transmitters with full stereo sound.

In 1977.

## NEC

IMAGINE WHAT WE'LL DO FOR YOU

NEC America, Inc., Broadcast Equipment Division, 130 Martin Lane, Elk Grove Village, IL 60007, in Illinois 312-640-3792.

**We signed on seven years ago.**

Stereo TV may be hot, but it's nothing new at NEC.

You see, we prototyped it way back in 1969. And signed on with our first multichannel transmitter in 1977.

And since then, we've installed more than 100 stereo TV transmitters in Japan and Australia. With the same proven technology found in more than 1,400 NEC transmitters around the world.

So now, as America moves into stereo, NEC stands ready to offer you this exciting new technology.

Tested. Tenured. And fine-tuned.

**Stereo TV Transmitters. Right now. From NEC.**

Stereo TV is just a matter of when. So what can you do now?

Well, you could buy unproven technology. And pray that you don't pay for trial and error. Sooner and later.

Or, you can call NEC toll-free at 1-800-323-6656. We have a full line of multichannel transmitters, with single output powers up to 35 kW, that we'd love to show you.

You see, we're the one to watch in stereo television. Because we already have been for seven years.

the following information will serve as a partial glossary to some of the terms of digital.

•**Quantization noise**—Problems encountered when attempting to divide a signal into  $n$  equal parts (for the 8-bit case,  $n = 256$  parts). These include errors that result from defective ICs, video noise from external interference, timing jitter and the electronic noise caused by the sampling process itself.

•**Sampling noise**—The rate of sampling for digital video is commonly set at four times the color subcarrier, i.e., 14.31815MHz. Circuits that sample the input signal turn on and off at this fast rate and in the process generate switching noise. Equipment designers must attenuate this noise to avoid introducing image degradation. Most of the noise appears in the form of spurious frequencies that are non-Gaussian. In other words, the spurious products do not fall within the bell-shaped statistical Gaussian curve in terms of their amplitudes, relative to their frequencies.

•**Quantization error**—A number of samples not correct or some samples larger or smaller than others (a non-linear conversion). This error is often the result of supply voltage problems or a large amount of noise on the video signal initially.

•**False contours**—When an insufficient number of samples is taken and curves cannot be smoothly recreated. False contours will be most apparent in sizable gray areas of the picture. They will show as steps of luminance change, quanta, where no such steps existed in the original signal.

•**Tapered quantization**—Quantization steps made larger than others to define all possible detail. For example, a picture with large gray, flat areas and a great deal of fine detail in black and white areas may be sampled with different sized steps. Larger steps are used for flatter gray areas, while smaller steps cover the black and white sections. As a result, 256 levels are retained, but much greater detail is provided in the more important black and white areas than in the less detailed grays.

•**Mosaics**—The result of limited quantization levels. If you use five levels (3-bit words required), you could reproduce black, three levels of gray and white—hardly enough for an aesthetically pleasing picture. The finished product would have harsh edges with five shades of gray and resemble an overclipped video signal. This block-like, low-level quantization, called mosaic tiling, is offered in many video effects units.

•**Dither**—A low-level, random oscillation that may be added to shift

# Binary and beyond

Bits? Bytes? Confusing, perhaps, but these terms make digital technology easier to understand.

A bit, short for *binary digit*, is the smallest piece of data that can be handled. Like an electrical circuit, a bit is on or off. In digital equipment, on is represented by 1, and off is represented by 0:

By itself, one bit isn't terribly worthwhile. But combined into groups, bits are the basis of computer operation. Eight bits create a *byte*, while four bytes make a *word*. In smaller terms, four bits make a *nybble*.

Two types of processing are possible. If the eight bits of a byte are handled in order, the circuit is called *serial*. Only a single wire is used to connect one circuit to another.

Faster processing of information is possible by using a *parallel* structure, in which the eight bits of a byte are handled simultaneously. Larger systems using 16, 32 and 64 bits are common and 128-bit computers are just around the corner.

Counting in digital systems is confusing, because of how we normally think of numbers. In the decimal system, there are 10 counting digits, 0 through 9.

These digits are used in positions that have place values of units, tens, 100s, etc. Ten is written "10," meaning one ten and no units. The number 9753 is nine 1000s, seven 100s, five 10s and three units.

In binary counting, the counting digits are 0 and 1, with place values of ones, twos, fours, eights, etc., the powers of two. Decimal 63 is written as binary 111,111. Binary 10 is decimal 2.

Obviously, large numbers in binary become unwieldy on paper, but not in electronic circuitry. For people to better understand what's happening, other systems, which relate to binary numbers, have been introduced to reduce the volume of digits in a number.

Octal systems count with digits 0 and 7 and place values of ones, eights, 64s, etc., the powers of eight. Decimal 255 becomes octal 377. Octal 777 equals decimal 511.

The digital number system most used is hexadecimal, with counting 0 to 9 and A to F. In a 64k memory system, the four place values are ones, 16s, 256s and 4096s, that is, base 16. Here, A equals decimal 10 and F equals 15. Hex 10 is decimal 16, A0 is decimal 160. FFFF becomes decimal 65,535.

Decimal	Binary	Octal	Hexadecimal
0	0	0	0
1	1	1	1
2	10	2	2
3	11	3	3
4	100	4	4
5	101	5	5
6	110	6	6
7	111	7	7
8	1000	10	8
9	1001	11	9
10	1010	12	A
11	1011	13	B
12	1100	14	C
13	1101	15	D
14	1110	16	E
15	1111	17	F
16	10,000	20	10
31	10,001	37	1F
32	100,000	40	20
33	100,001	41	21
255	11,111,111	377	FF

How decimal, binary, octal and hexadecimal systems relate to one another.



**Great Effects...  
at a  
Great Price!\***

Now more exciting programming is yours with the CHYRON DIGIFEX™ Special Effects Generator. At a price that's never been lower.

Digital video manipulation of Chyron-generated graphics lets you... Create and display multiple effects instantly; spin, flip, rotate, zoom, compress, split images, etc. Manipulate background or foreground of Chyron characters and graphics. Use 15 colors at one time from Chyron's 512-color palette. Store hundreds of special effects and recall at will.

CHYRON DIGIFEX does it all.



**\*Now**

**\$19,500**

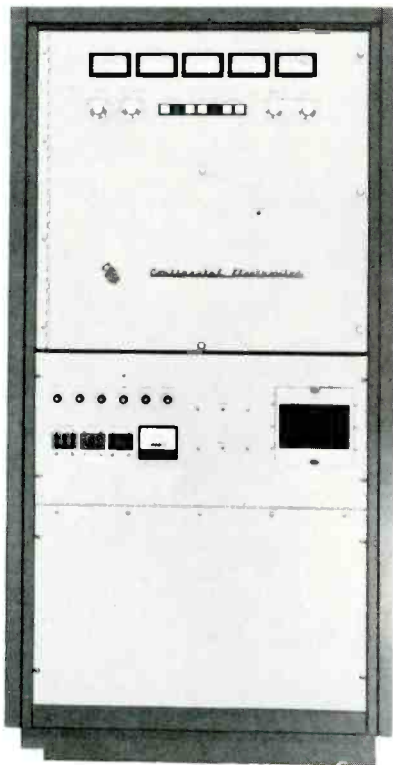
Circle (24) on Reply Card

A DIVISION OF CHYRON CORPORATION  
265 Spagnoli Road, Melville, New York 11747 • 516-249-3296 • Telex: 144522 Chyron Melv

Ampex International is exclusive distributor for Chyron Graphics Systems outside the U.S.A.  
(Price subject to change without notice)

**CHYRON**<sup>®</sup>  
TELESYSTEMS

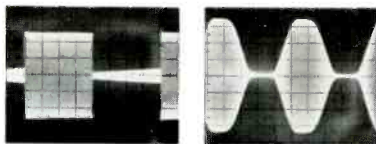




## Continental's 5 kW AM Power Rock: a sound winner that's ready for AM stereo.

The Power Rock is designed to give you the very best audio. Listen to the loud, clear signal, and you know you have a winner. The Power Rock is ready for AM Stereo and accepts sophisticated audio.

- Owners and managers like Power Rock's superior performance and outstanding on-air performance.
- Program directors like the crisp, clean signal and compatibility with the most sophisticated audio processors.
- Engineers like the proven design and conservative components: a safety margin for steady, reliable on-air performance.



Left: Photo shows excellent dynamic response of Continental's 5 kW AM transmitter at 20Hz modulation. Right: photo of modulation wave form shows effect of Instantaneous Peak Limiter

For a copy of our brochure on the 315R 5 kW AM Power Rock, call (214) 381-7161. Continental Electronics Mfg. Co. Box 270879 Dallas, TX 75227.

© 1982 Continental Electronics Mfg. Co. /5101

**Continental**  
**Electronics**

Circle (43) on Reply Card

# The gist of Nyquist

Almost every article about digital processing refers to the *Nyquist Criterion*. This rule states that in a digital system the sampling frequency must be at least two times the highest frequency component of interest in the signal to be sampled. Sampling at a slower rate will produce undesirable results.

Sampling is a form of modulation or mixing of two signals. If we modulate a carrier with a tone as in AM radio, we are actually creating two new RF signals, which we call upper and lower sidebands.

For example, if a carrier of 1000kHz is modulated with a tone of 5kHz, the result is a sum of 1005kHz and a difference of 995kHz.

Video is a complex combination of sync, luminance and chroma, which covers a bandwidth of at least 4.2MHz in a composite signal. As a result, the mixing of video with a sampling frequency results in a much more complex set of upper and lower sidebands than AM. The sampling frequency must be high enough to take all

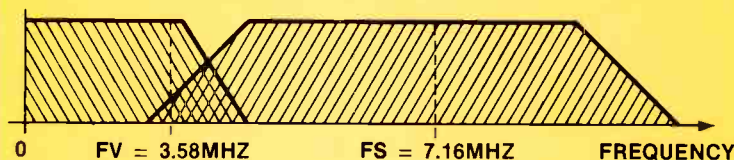
possible video frequencies into consideration.

In the figure below, the result of sampling a 4.2MHz video signal at twice the subcarrier (7.159MHz) includes an area of overlap of the mixed information with the original signal. Interference created by the overlap of signals is called *aliasing* and may be visible in pictures as moire.

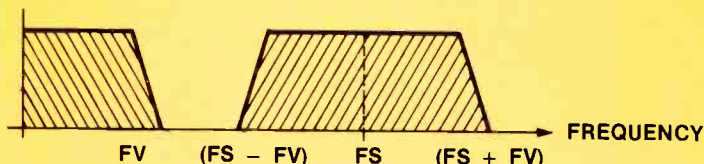
According to Nyquist, sampling for NTSC would be a minimum of 8.4MHz for a 4.2MHz bandwidth signal. The second figure illustrates sampling at a much higher rate than is required for the Nyquist criterion. Without the overlap of the signals, sampling interference is reduced.

Most digital products for NTSC are presently designed around sampling at four times subcarrier, or 14.31818MHz. If the highest frequency of interest in the video is 4.2MHz, sidebands extend from 10.1MHz to 18.5MHz.

For international digital work, a standard of 13.5MHz has been set for sampling of luminance, with chroma component sampled at 6.75MHz.



Use of 7.16MHz as a sampling frequency causes an overlap of the original and sampled signals.



A sampling frequency  $f_s$  much greater than two times  $f_v$  avoids overlap of the signals spectra.

quantizing levels up and down slightly when the number of steps of quantization is limited. This blurs the edges of the picture detail to reduce the mosaic effect.

In low-resolution systems of less than 64 quantization levels, dither is required to produce an acceptable picture. Dither (or pseudo-random noise PRN) may also be used to reduce false contouring that results from low-level quantization. False contouring would appear as exaggerated edges and outlines in the final televised picture, especially when edge enhancement circuits are used.

•**Pixel**—Video signals divided into a

large number of very small parts. Pixels are the smallest element of video that may be manipulated or quantized. Pixel size is commonly measured in nanoseconds and is determined by the sample rate, scanning beam size, image scanning rate and circuit bandwidths.

•**Smoothing**—Noise treated by use of a position invariant operation, which averages noise signals over areas adjacent to the pixel being quantized. Adjacent areas are called neighborhoods. Smoothing takes an orthogonal (at right angles) average, or mathematical integral, of the video level in pixels

Continued on page 117



**FORMAT.  
SYSTEM.  
COMPATABILITY.  
BACKED BY  
MATSUSHITA  
ELECTRIC,  
A WORLD LEADER  
IN ELECTRONICS.**

**PANASONIC® BROADCAST SYSTEMS.**



Only from Panasonic. Automatic, continuous, reliable broadcasting.

It's the MVP-100 and it will revolutionize your station. Because it lets you program in advance, and automatically air, everything from news spots to commercials to station IDs. Even complete program-length material. All with YIQ quality, time-code accuracy and computer-controlled reliability. At a lower operating cost than conventional cart machines. Its recorders, spot players, and up to 24 modular transports operate independently. So the MVP-100 can even be programmed to override a breakdown the moment broadcast continuity has been interrupted to virtually eliminate dead air.



## Panasonic Broadcast Systems.

Panasonic broadcast components can enhance any broadcast system. Not only will we make your images look better with advanced M-Format technology, we'll make it easier for you to originate, produce and broadcast them.

Panasonic Broadcast Systems. Watch us improve your broadcast quality.

Call your nearest Panasonic regional office:

Northeast: (201) 348-7336  
 Southeast: (404) 925-6835  
 Central: (214) 257-0763  
 West: (714) 895-7200  
 Canada: (416) 624-5010

**Panasonic**  
**Industrial Company**





# Color - mapped vs. full color

By David Fabian, product manager, Ampex

More and more video graphics are becoming trademarks or signatures, which identify a TV station's programming and image.

Because of this, it is important for everyone on the station staff to have a rudimentary knowledge of the graphics equipment responsible for the station's on-air look. This isn't always easy, because different types of equipment, such as still-stores, character generators, and video arts systems, may have similar graphic capabilities.

Video art systems have always seemingly been confusing. One source of confusion is the basic differences

between color-mapped and full-color systems. This article will explain some of the technical differences in the two systems.

With the color-mapped system, the video content of a pixel is assigned a number from a color palette. The number will be determined by the nearest match from the palette for the particular pixel of the incoming video. This process is analogous to a paint-by-number kit.

Imagine, for example, a low-resolution video screen consisting of 25 pixels arranged 5x5. If a picture of a blue square box on a red background were scanned into the system, the

system would assign a number to each pixel, according to the content of the picture at each location.

Now, imagine a very limited color palette, consisting of two colors, represented by 0 and 1, as shown in Figure 1.

The colors 0 and 1 are determined by assigning an 8-bit numerical value (0 is no color, 255 is fully saturated color) for each of red, green and blue to the two colors in the palette, or color map. The video observed on the screen would be determined by the amounts of red, green, and blue mixed together for each color in the map. Our color map has only two colors, so

# There's more to than meets

Producing effective multichannel sound isn't easy. Though the procedures borrow heavily from recording studio and film sound techniques, audio for video is a specialist art with a unique set of requirements.

As its early practitioners have discovered, the inherently complex process of stereo teleproduction and post-production can be made even more difficult by cobbling together a collection of modified equipment in the hope of serving these advanced needs.

While makeshift arrangements may satisfy the technical minimums of the task, they introduce tradeoffs in operational flexibility and efficiency which can ultimately affect both production quality and costs.

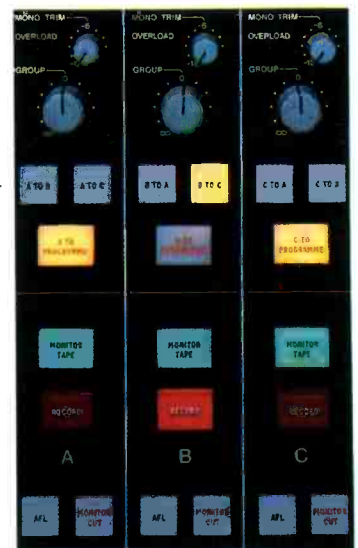
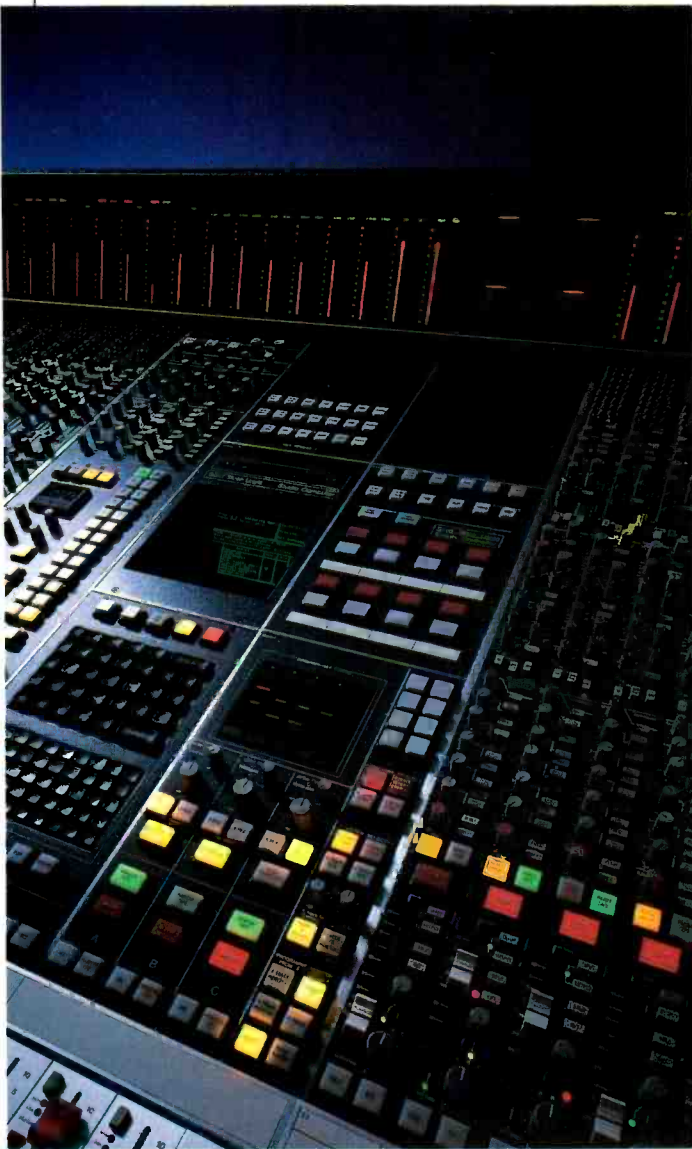
Fortunately there is an alternative, developed for the leading post-production houses and refined in collaboration with major broadcast organizations throughout the world: The SL 6000 E Series Stereo Video System from Solid State Logic.

## SSL Puts it all Together

The SL 6000 E Series is a thoroughly integrated system designed specifically for the stereo video environment. Combining the most advanced aspects of multitrack, motion picture and broadcast audio technology, it provides extensive signal processing, routing and mixing capabilities as well as comprehensive machine control and communications—all commanded by a single operator at a logical, unified control panel.

SSL's multichannel mix matrix allows separate stereo music, effects and dialogue mixes to be created at the same time as the stereo program mix. In live production, multiple stereo splits or mix-minuses can be structured at the touch of a button. Mono composites of each mix are always available, and a mono programme feed is provided. Advanced formats such as stereo plus a secondary audio programme or centre-channel dialogue are also supported.

Changeover between live and post-production modes and different output configurations is instantaneous. The rigid architecture of ordinary consoles is replaced with patchfree audio subgrouping and pushbutton signal processor routing, allowing the engineer to customise the signal flow for each project.





# Stereo Television the eye.

Meticulous electronic design creates the shortest signal path for each requested function, allowing SSL to maintain a dynamic range and bandwidth that far exceeds the performance of even the best 16-bit digital recorders, converters and routing switchers.

## Complete Machine Control



The SSL Stereo Video System also provides the operator with central control of up to five synchronised audio, video and film transports. Cue points are stored and called by timecode, foot/frames or key words.

The SSL Studio Computer provides complete list management with floppy disk storage, video display and hardcopy printouts. Distributed processors ensure rapid search and lock-up. There's even a Sync Preset function which automatically calculates offset values between reels and stores these for subsequent setups.

## Dynamic Mixing Automation

The machine control functions are integrated with SSL's audio mixing software to provide powerful, versatile and efficient assistance. Engineers can retain their existing mixing methods, or supplement them with simple yet powerful new routines that allow unlimited frame-accurate mix revisions to be performed with outstanding results and uncanny speed.

SSL's computer assisted rollback and pickup recording enables mixes to be assembled within the automation itself, using traditional techniques. Video layback can then take place in a single first-generation pass, directly from the multitrack!



Beyond fader automation, the SSL System optionally provides programmable parametric equalisation, dynamic stereo panning, and multiple Events Control of up to 32 external devices—each with its own pre-roll memory.

## Total Recall™

SSL's Total Recall computer records the settings of every control on each I/O module. A high resolution display of the stored values interacts with the console, allowing fully detailed setups to be restored to a control accuracy of a quarter dB. Total Recall greatly reduces setup time, maximising productivity and creative continuity.



## Stereo Perspectives

Not all stereo channels were designed to serve video requirements. Only SSL provides parametric stereo EQ, filters, compressors, gates and expanders on stereo inputs as standard, along with image width and stereo reverse controls. There is no easier or more effective way to match music, ambience and effects perspectives with television images.

## Get the Full Picture

As you can see, there is a lot more to producing stereo television than meets the eye. To help you get the full picture, Solid State Logic has published a forty-page colour booklet which thoroughly explains the functions, applications and operation of the SL 6000 E. If you are involved in television production, outside broadcast, video post-production or music video, we'd like to send you a copy. Just drop us a line or give us a call.

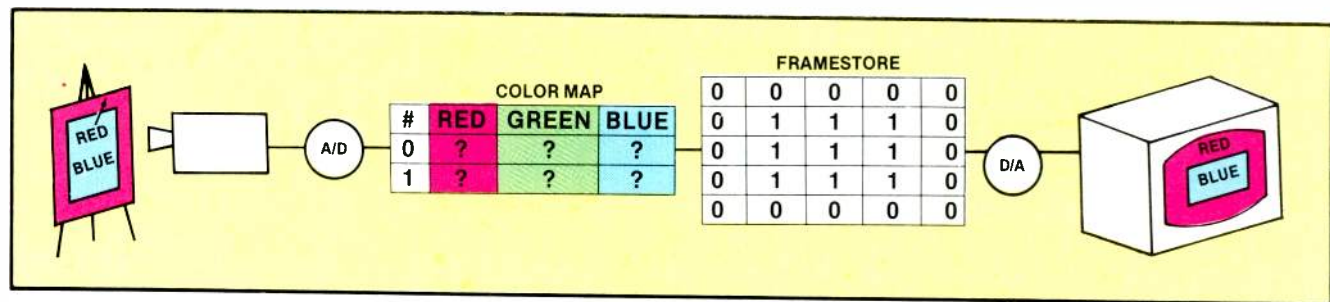
# Solid State Logic

Oxford • New York • Los Angeles

Solid State Logic Ltd  
Stonesfield • Oxford  
England • OX7 2PQ  
Tel: (099 389) 8282  
Fax: (099 389) 8227  
Tlx: 837400 SSL OXG

Solid State Logic Inc  
200 West 57th Street  
New York • NY 10019  
Tel: (212) 315-1111  
Fax: (212) 315-0251

Solid State Logic Inc  
6255 Sunset Boulevard  
Los Angeles • CA 90028  
Tel: (213) 463-4444  
Fax: (213) 463-6568



the system only displays two colors on the screen at any one time.

Because an 8-bit number can have as many as 256 different values, each color in the palette can be chosen from 256 shades each of red, green and blue, yielding 16,777,216 (256x256x256) color combinations. For the system to reproduce the picture faithfully, the color map shown in Figure 2 would have to be chosen.

Obviously a framestore has more than 25 pixel's worth of memory, and there are more than two colors displayed on art systems, but the principle is the same. Typical systems have framestore memories representing horizontal rows of 512 pixels, arranged vertically to correspond to the scan lines of standard NTSC video.

The typical framestore assigns each pixel with an 8-bit value, between 0 and 255. As a result, the system can display up to 256 colors at a time from the palette of more than 16.7 million. In a simultaneous display of 256 colors, it must attempt to emulate as many of the colors as possible.

One reason that color-mapped systems were developed was cost. Framestore memories are expensive. The color-mapped system requires only one framestore capable of assigning an 8-bit value for each pixel.

Another reason was speed. Given microprocessors available several years ago, the system taxed the computer's processing speed to the limit to

provide an acceptable response time to the artist's input.

The color-mapped system allows fair resolution, good operating speed and acceptable colorizing capability for many graphic purposes.

#### Full color

A full-color system discards the color map and stores the actual color of the pixel into the framestore's memory. Simple, right? Not quite.

For a system to scan in a true full-color image, it must reproduce all 16,777,216 of the colors available in the color-mapped palette simultaneously. This means that a full-color system framestore must allow 24 bits of digital information for each pixel, eight bits for each primary color.

Typically, the full-color video art system memory is arranged as three individual 8-bit deep framestores, one each for red, blue and green. In such a system, the scanned-in image can be realistically displayed and colorized with any color in the system.

#	RED	GREEN	BLUE
0	255	0	0
1	0	0	255

Figure 2. A 2-color map providing only fully saturated red and blue.

Figure 1. In a limited-resolution, 2-color art system, data in the framestore indicate where actual color information is held in the color map.

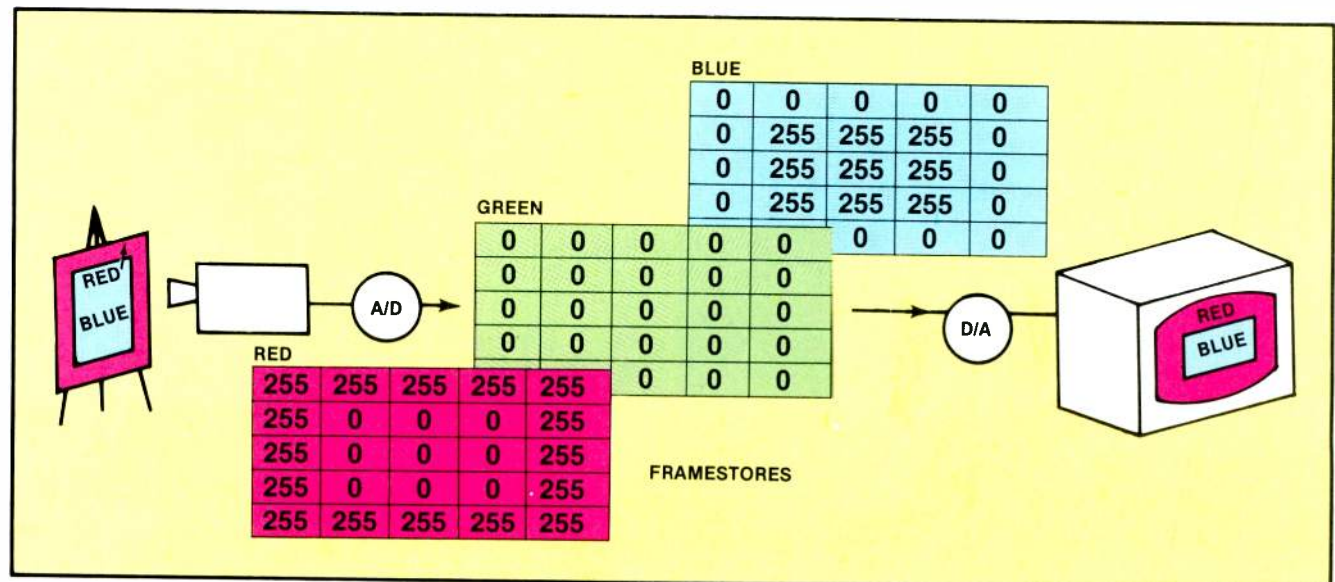
Using the previous example of the blue box on a red background, the pixels are colored in the framestore each of red, green and blue) assume their individual shades. Such a system requires three times as much framestore memory and a computer operating three times faster to respond as quickly as an 8-bit color-mapped system.

#### A matter of evolution

Three factors led to the development of the full-color system. First, a desire for a graphic system with the added color capability while allowing images to be scanned in and manipulated. Second, framestore memory devices had decreased in size and cost, while speed increased. Third, the needed microprocessors had followed the memory devices in dimension, cost and speed.

Some systems reduce the number of bits per color component to emulate

Figure 3. Three framestores, each with 8-bit capability, hold pixel color information in a full-color art system.





# IN THE BATTLE OF THE ROUTING SWITCHERS, THERE'S A NEW HEAVYWEIGHT CHAMPION.

	3M Series H 128 x 32	Ferris TVS-TAS 2000	Grass Valley GL 440	Grass Valley Horizon	Utah Scientific AVS-1
<b>VIDEO</b>					
Crosstalk Video to Video	65/4.43	60/4.43	60/5	60/5.5	60/4.4
Hum & Noise (0-4.2 MHz)	75	75	65	75	
(IRE WEIGHTING)	82				75
Frequency Response (dB to MHz)	± 1/6.5	± 1/5 E	± 1/5	1/5	± 1/5
Diff Gain (10-90%)	3.58	1%	25%	1%	1%
Diff Phase	1°	-°	25°	1°	12°
<b>AUDIO</b>					
Crosstalk (dB/kHz) Audio to Audio	88/20	85/15	80/15	80/15	75/20
Hum & Noise (dB below out) / FILTER	-122/15k	-109/°	-92/15k	-104/15k	-105/15k
Freq Resp (c) Max Out (dB/cBm)	± 1/30	± 2/24	± 1/24	± 1/24	± 2/24
Over Freq Range	20-20k	30-15k	20-20k	30-15k	30-15k
Com Mode Rej Ratio (dB)	80	75	80	65	70

<sup>a</sup>Data not available

<sup>b</sup>Data based on manufacturers specifications as of 4/83

Compare our Series H Hybrid Switching Systems to the competitors and the advantages are easy to see. If you'd like to compare a few more specs, call us toll-free at 1-300-328-1684. In Minnesota, call toll-free

1-800-792-1072. Outside the continental U.S., call International Operations collect at 1-612-736-2549. You'll be knocked out by all our advantages. Broadcast and Related Products Division.

3M hears you...

Circle (71) on Reply Card

**3M**

## The Beyer M 69 is designed for those who want studio quality in the field (and in the studio).



In this day and age, you shouldn't have to carry special microphones when you're leaving the studio to go out in the field. The Beyer M 69's wide hypercardioid pattern and high output give you the noise rejection you need with greater flexibility of mic placement in hand-held news-gathering situations. Highly versatile and rugged, the M 69 provides superior audio performance for any on-camera or mobile broadcast application as well as any video/film post-production job. The M 69 is also available with an optional Speech/Music switch.

The Dynamic Decision

beyerdynamic

Beyer Dynamic, Inc., 5-05 Burns Avenue, Hicksville, New York 11801 (516) 935-8000

Circle (37) on Reply Card

## THE SOURCE For all your equipment needs



- AKG • Ampex • Ampex
- Atlas • Audiopak
- AudioTechnica • Belden
- Broadcast Electronics
- CRL • CSI • Crown
- Cablewave Systems • DBX
- Deltalab • Electro-Voice • EXR
- Fidelipac • Inovonics
- Jampro-Cetec • JBL • Leader
- Instruments • Lexicon • 3-M
- Marti • Micro-Trak • Nortronics

Orban Associates • Otari • Phelps Dodge • Revox • Russco  
 • Shure • Sola • Staco • Stanton • Surcom • Tapco  
 • Technics • Telex • Urei • VIF and many more.

Call us for fast shipments from stock **305-651-5752**



Telex 51-4733 ELECTREX MIA

**ELECTREX COMPANY** © 1983

18620 N.E. 2nd Ave., Miami, Florida 33179

Circle (38) on Reply Card

full-color performance from a color-mapped architecture. Such systems, however, have fewer shades of red, green and blue available to recreate the subtleties of a full-color image. The result may appear as unnatural coloring.

### For the user

What are the major implications of this fundamental difference in the systems to the user? With regard to what each type of system can do and how well it can do it, several functions can be compared.

• **Image scan-in.** As mentioned earlier, full-color systems reproduce images in all colors, while color-mapped systems cannot. Close observation may show stepping rather than a smooth gradation of color on the bit-mapped unit.

• **Anti-aliasing.** Aliasing is better known as the *jaggies*, or the stair-stepping along diagonals and curves of an image. Anti-aliasing is the ability to smooth those jagged edges. Full-color systems should do a better job of smoothing.

The color-mapped systems do not simultaneously display all possible shades necessary to smooth the edges. For example, a red colored region meeting a white colored region is shown expanded in Figure 4.

To reduce the jagged appearance, pixels identified by Xs should have some mixture of red and white (i.e., pink) so that the junction would appear smoother when viewed at normal size. This is a very simplistic example of anti-aliasing.

In reality, the junction represented in Figure 4 would require several shades of pink between red and white regions to effectively smooth the jagged edges. As you can imagine, a full-color image, with hundreds of principle color regions, could require thousands of intermediate shades to smooth all diagonals and curves in the picture.

Anti-aliasing is particularly important with cut-and-paste art. How natural the cut-and-pasted image appears depends upon the quality of anti-aliasing.

• **Color mixing.** In conventional art, such as oil painting, colors are combined in differing quantities to make other colors. Full-color systems provide the artist with that capability, without affecting other colors displayed on the system.

In color-mapped systems, the flexibility is impaired if the mixed color does not exist in the color map. A desired color must be created (on some systems in a way that resembles mixing). A new color may come at the expense of losing a color already in



---

# COMPONENT QUALITY



## BETTER PICTURES FOR LESS

Until recently, the cost of component quality limited its use to high end professional teleproducers. Now, the CCD Y/C from FORTEL gives affordable component quality to all professional teleproducers. Better pictures for less.

The CCD Y/C provides outstanding picture quality from 1/2-inch and 3/4-inch VTRs. By combining component processing with the proven reliability and cost effectiveness of CCD technology, the CCD Y/C gives picture quality unmatched by its competitors. Picture quality so lifelike, you have to see it to believe it. Best of all, the CCD Y/C does it for only \$8,995.

Standard features of the CCD Y/C include full proc amp control, noise reduction, horizontal enhancement, and an internal sync generator with a full complement of sync outputs. Like all FORTEL products, the CCD Y/C is covered by a one-year warranty on parts and labor.

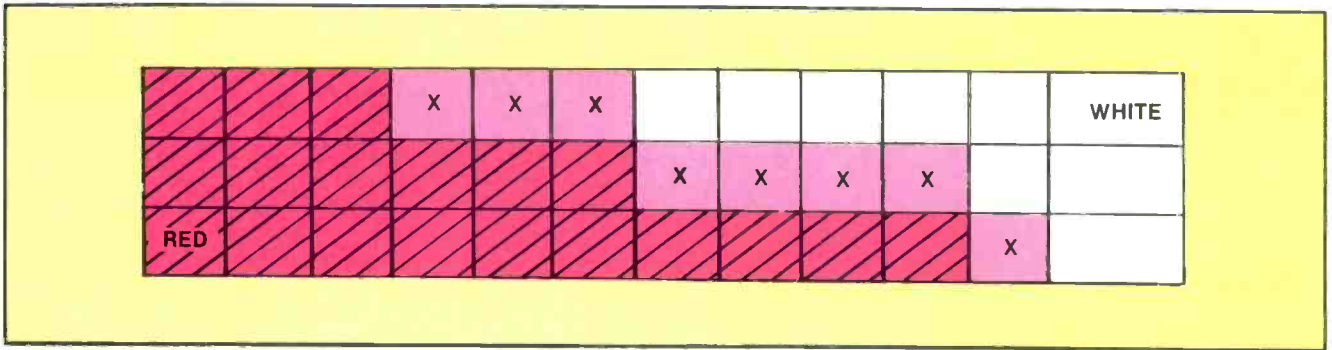
CCD Y/C... quality pictures at an affordable price. For more information or a demonstration, call or write FORTEL today.

---

**FORTEL Incorporated**  
2985 Gateway Drive  
Norcross, Georgia 30071  
404-447-4422



Circle (44) on Reply Card



**Figure 4.** At the interface between red and white regions, anti-aliasing creates various shades of pink in those boxes (pixels) marked with Xs. The result is an apparent smooth edge between the red and white.

the map, which may be important to the overall image.

•**Transparency.** Artistic requirements may need transparent colors as well as opaque ones. A transparent color can combine with existing background colors on the screen to form a completely different set of shades.

The effect is similar to placing a tinted gel over a portion of the picture. Transparent colors may be used to duplicate conventional art tools, as in shaping, air brushing and the application of washes.

System control of transparency and color mixing often uses a pressure-sensitive stylus. The degree of transparency is varied with pressure. Such flexibility with transparent colors is possible, but unlikely on a color-mapped system.

•**Changing colors.** In this area, the color-mapped system has certain advantages over the full-color approach. If, on a color-mapped system, the artist wants to change the color of an object displayed on the screen, he merely changes the color in the table. In the process, all areas of the original color in the images are also changed.

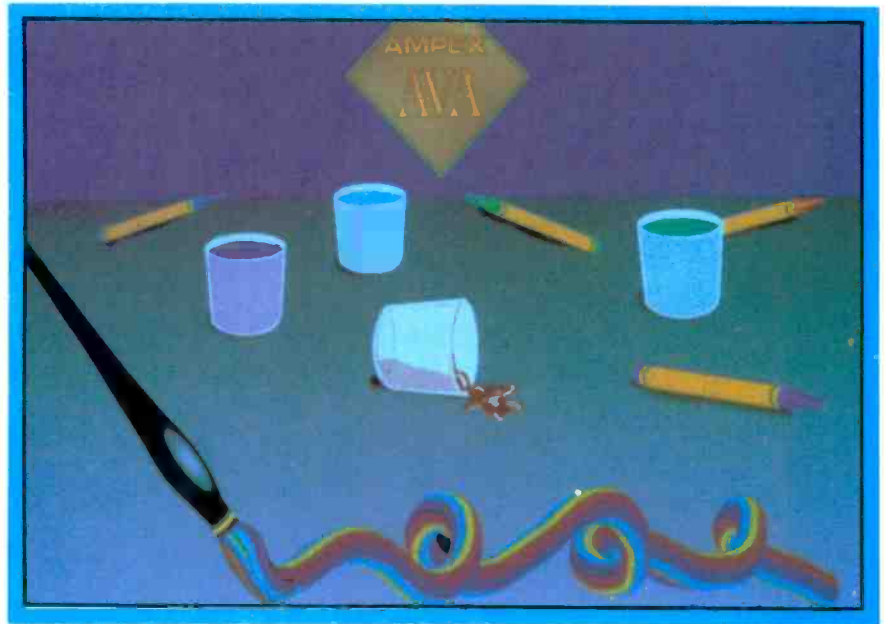
With a full-color system, an object must be exactly and completely redrawn when a change in color is desired. Other similarly colored pixels remain unchanged, as the area of interest is altered.

•**Animation functions.** Color cycling is an animation technique in which the color map is altered quickly in cycles. Colors change in all or part of the images. The effect is analogous to a theater marquee, giving the illusion of motion by turning lights on and off in a defined manner. The technique relies on a color map to function. The full-color system is incapable of this type of animation.

In *history animation*, the system memorizes the creation of an image stroke by stroke. On command, the system reconstructs the image in real time, just as it was created originally. Such animation is independent of a system's architecture, but it is most commonly found on color-mapped systems.

*Cell animation* involves at least two

framestores—one for the static background and one for the moving portions. The foreground framestore for the moving portions is reproduced in the foreground framestore as many times as there are cells.

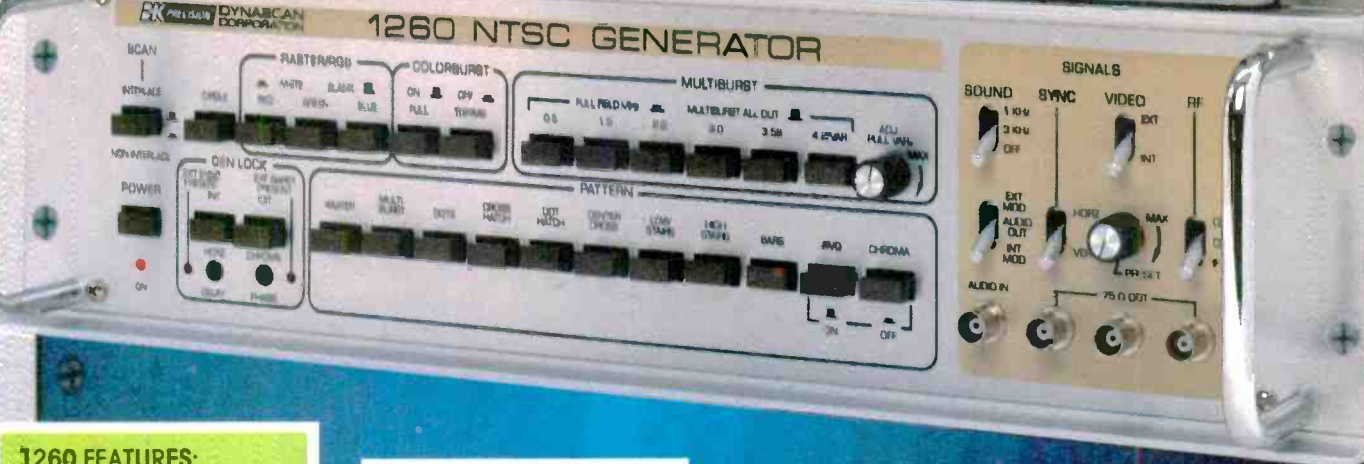




# Maintain network-quality color performance with B&K-PRECISION NTSC video test instruments

Model 1270 NTSC Vectorscope \$1995

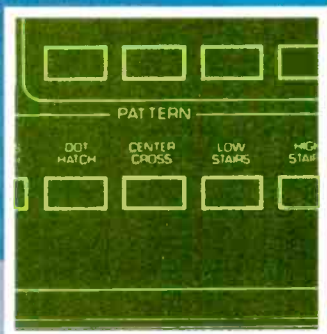
Model 1265 Waveform Monitor \$1995



Model 1260 NTSC Generator \$1695

## 1260 FEATURES:

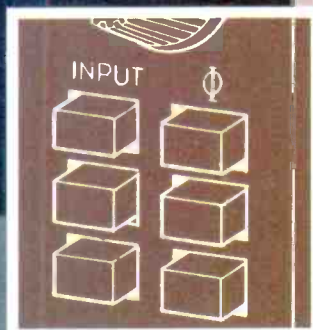
- RGB OUTPUTS
- GEN LOCK
- INTERLACED OR PROG. SCAN
- BUILT-IN MODULATOR
- MULTI-BURST TO 7.0 MHz
- TCXO STABILITY
- BLACK BURST



1260 generates 12 patterns, including circle, bar and crosshatch patterns

## 1265/1270 FEATURES:

- 12 KV ACCELERATION POTENTIAL
- ALL CONTROLS ARE FRONT-PANEL MOUNTED
- STANDARD HALF-RACK MOUNTING
- BUILT FOR CONTINUOUS DUTY OPERATION
- SPLIT FIELD VIEWING OF LINES 13-22 ON 1265



1270 offers simple set-up and selectable inputs

For the complete picture on these new video test instruments, see your local distributor or call B&K-PRECISION at 1 312 889 9087.

**B&K PRECISION** DYNASCAN CORPORATION

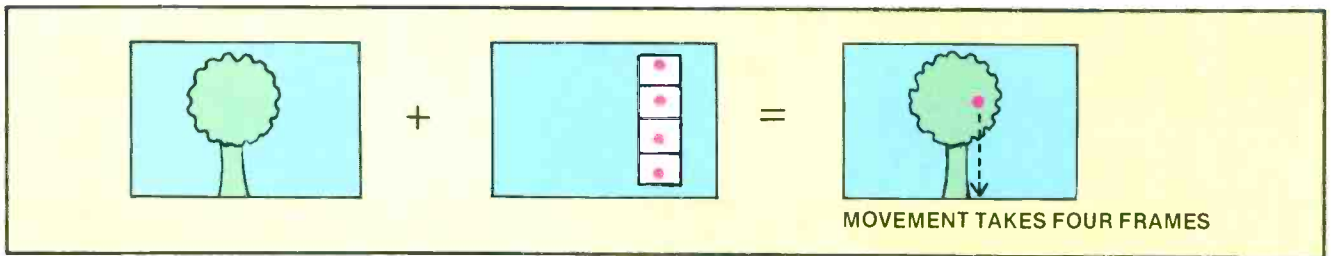
6460 West Cortland Street • Chicago, Illinois 60635 • 312/889-9087

International Sales, 6460 W. Cortland St., Chicago, IL 60635

Canadian Sales, Atlas Electronics, Ontario

South and Central American Sales, Empire Exporters, Plainview, NY 11803





In Figure 5, the apple appears in different positions in each of the four foreground cells. As the foreground framestore cells are keyed into (or mixed over) the background, apparent motion results. This kind of animation is available in both types of graphic system.

*Frame-by-frame animation* is painstaking, but versatile. Two approaches are possible. The artist may create each frame manually. Alter-

natively, the operator designates certain key frames (pivotal points in time) of the animation and instructs the system to create the frames that go between the two end points.

After the frames are generated, the animation is recreated at real-time speed by the system. Also, images may be recorded, frame-by-frame, on videotape or film for real-time playback.

Any video art system can create

Figure 5. A fixed image in the background framestore will be mixed with a moving object in the foreground framestore to produce apparent motion for animation.

frame-by-frame animation. Only more expensive computer animation/graphic systems create the in-between frames and play them back without first recording them sequentially on tape or film.

Future systems will no doubt be aided by automated control features to make this process less laborious. An example would be for the art system to control single frame VTR recording.

#### Best of both?

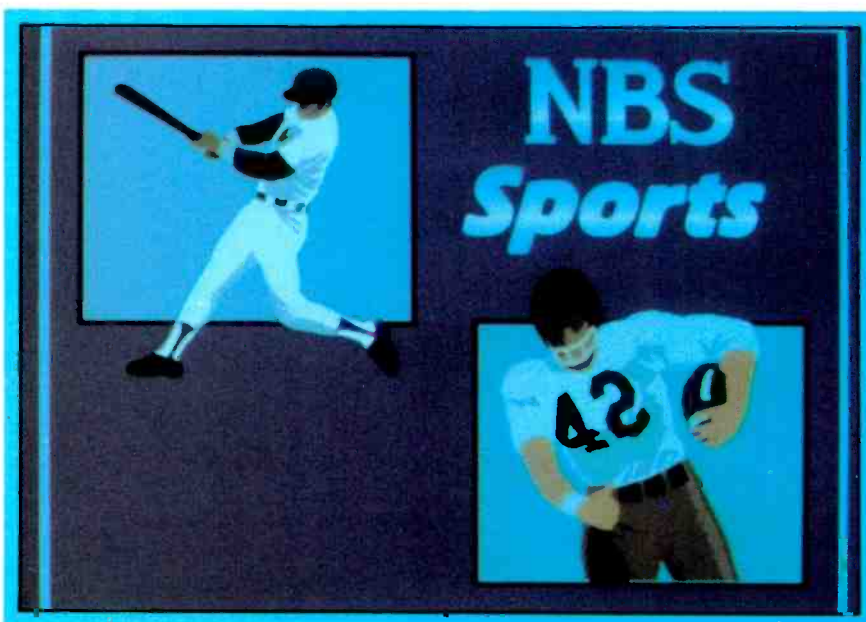
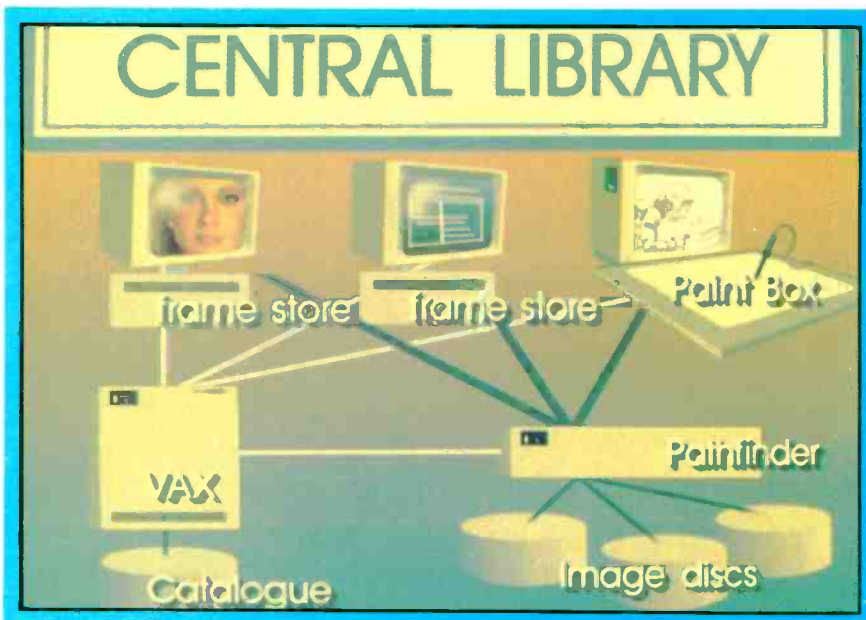
What about video art systems that combine the best of both worlds? There are color-mapped systems that can simulate many of the functions of a full-color system. Currently, no color-mapped systems can duplicate the image quality and color-mixing capability unique to full color designs.

#### Making a selection

You must assess your needs to determine which type of system best serves the purpose. To that end, the following technical artistic features should be considered:

- **Geometrics.** Can the system generate geometric figures? Are size changes and shape skewing possible?
- **Color fills.** Is fill limited to regular shapes or can boundary floods of irregular shapes be performed? Can a monochrome image, scanned into the system, be filled?
- **Brushes.** What artist's brush forms are available? Can the user create his own? Can multi-color brushes be used?
- **Auto brushes.** Can the artist designate the path a brush should follow, then allowing the system to paint the path?
- **Object manipulation.** Once an object is placed on the screen, what can be done with it? Examples include justifying, skewing, rotation, inversion, size change and foreground priority.

Obviously, there are many other specifications and features that will come into the decision. However, this discussion of some of the differences in color-mapped and full-color graphics systems will be helpful in making your video art system purchase.



Courtesy of Ampex AVA-3

||:~(=)))||





# Eastman Professional Video Cassette

U-matic

KCS  
20 min. **20**  
Broadcast Quality  
EB-930

## THE NEW NAME IN VIDEO WON'T DISTORT THE NEWS.

The new three-quarter-inch EASTMAN Professional Video Tape gives your news crews the reliability needed to deliver the story accurately every time. With high signal-to-noise ratio and the lowest of dropouts. With consistency, cassette after cassette.

This broadcast-quality video tape is designed

to work with today's state-of-the-art recording and editing equipment. It's available in all popular sizes of standard and mini cassettes.

Ask your dealer or Kodak sales and engineering representative about the complete line of EASTMAN Professional Video Tape.

Eastman Kodak Company, Motion Picture and Audiovisual Markets Division

Atlanta: 404/351-6510 • Chicago: 312/654-5300 • Dallas: 214/351-3221 • Honolulu: 808/833-1661

Hollywood: 213/464-6131 • New York: 212/930-7500 • Rochester: 716/254-1300 • San Francisco: 415/989-8434

Washington, D.C.: 703/558-9220 • Montreal: 514/761-3481 • Toronto: 416/766-8233 • Vancouver: 604/926-7411.



# Avoid a glitch in time: Inside TBCs

By Carl Bentz, technical editor

Television requires constant repetition. Each second, 29.97 complete images appear on the screen, each containing two fields of 262.5 lines, or a total of 525 lines. The lines of video occur regularly at a rate of 15,734.264/s with an error of  $\pm 0.0003\%$  allowed.

NTSC color requires a reference subcarrier of 3.57954545MHz, with a tolerance of  $\pm 10$ Hz. Subcarrier drift may not exceed 0.1Hz/s. Figure 1 illustrates the signal tolerances.

In the studio, sync drives keep the video sources in time. Precise timing

is essential for special effects or video mixing. Nonsynchronized signals produce bizarre color and luminance shifts, even within simple A-to-B fades. Studio cameras and electronic sources are driven from studio sync, so timing is relatively easy. For the complex electro-mechanical VTR, however, timing is a different story.

Today's VTRs are precise systems. Carefully machined parts and precision bearings reduce eccentric motions to a minimum. Still, mechanically induced errors plague VTR playbacks. Wow and flutter, speed variations, gyroscopic errors and physical changes of the tape produce video instabilities. These errors, all related to time, require correction before the

video playback is broadcast.

As a helical scanning video head makes one pass across the tape, the head reads an entire TV field of 262.5 horizontal lines. Ideally, each line is 63.5 $\mu$ s long, and the repetition rate is constant.

In practice, both line length and the rep rate may vary. Some lines occur early; others appear late. The image formed may exhibit a loss of horizontal and vertical hold.

In addition to time errors, off-tape sync and burst may be noisy with poor pulse shapes. A monitor will display the picture, but the signal could prove unsatisfactory for studio production functions.

Removal of the timing errors is the purpose of a time base corrector. Signal repair comes from a *proc amp* section in the TBC. Together the two forms of correction produce a stable video signal from an unstable source.

## The basic TBC

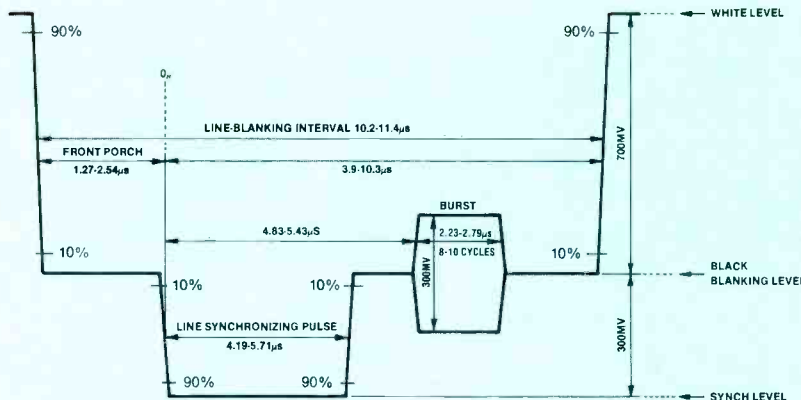
The basic time base corrector includes three major steps:

- An *input section* accepts a video signal with errors.
- The signal is digitized and the groups of bits are written to a *memory*.

When only TBC functions are required, a minimum of front panel controls is needed.

Figure 1. Tolerances allowed during the horizontal blanking interval for an NTSC signal.

Added features require added controls.









•When the time is right, an output section recalls the groups of bits and reconstitutes them into an analog form. A proc amp in the output section adds new burst and sync that coincide with local studio sync (Figure 2).

From incoming video, the input processor senses two parts of the signal, burst and sync. Off-tape burst is used to control a phase-locked oscillator (PLO). The oscillator runs nominally at 14.31818MHz, four times subcarrier, and determines the timing for sampling in the A/D converter. For

any given line of video, the exact frequency may vary slightly from 14.31818MHz.

The input section also senses the leading edge of H-sync. From this point, a precise delay determines the write start point, where the A/D converter begins breaking the signal into bytes. The converter takes four samples during each cycle of subcarrier. When exactly 768 samples have been made, sampling stops for that line.

Memory control writes each group of bits into a buffer memory, as they are formed. Although video is serial in

nature (as one line follows another one sample follows another), the eight bits of a sample move into memory in parallel (Figure 3). Each 8-bit sample goes into memory in sequence behind the previous sample, to wait until it is needed.

On the output side, when the read start point occurs, the first sample, from the write start point, is pulled from memory. Writing to memory followed the incoming video and for that reason probably happened at an uneven rate.

Reading, however, takes place every 69.8ns, precisely every 1/4 cycle of output bursts. Any remaining vestige of time error is gone.

The output D/A converter changes the bits to an analog form and filters out all remnants of sampling (i.e., evidence that it was chopped into 256 discrete levels). New sync and burst complete the correction function.

### Sync feedback

The secret of the TBC lies with the buffer memory and its capability for an uneven writing speed and a strictly regulated readout speed. But for the system to work, a sample must always be ready for readout. To assure that data are available, an advanced sync signal from the TBC drives the VTR servos. This forces the VTR to operate ahead of the TBC output.

Specifications for TBCs indicate that the memory capabilities of current models vary from two lines to 32 lines. This is the *correction window*. In theory, with the advanced sync feedback signal, the VTR keeps about half of the memory filled at all times. In other words, the time any particular sample stays in memory is approximately half of the memory capacity.

### The DOC

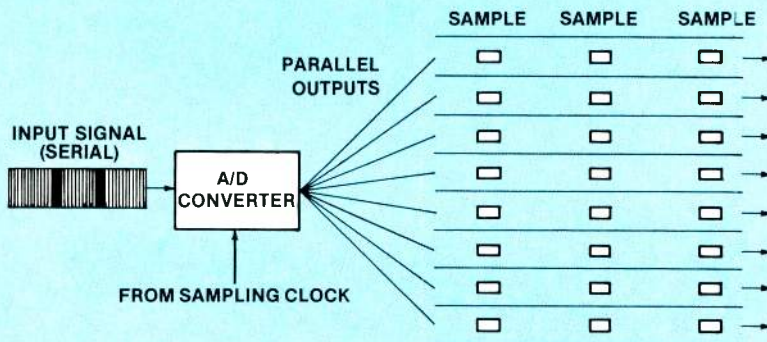
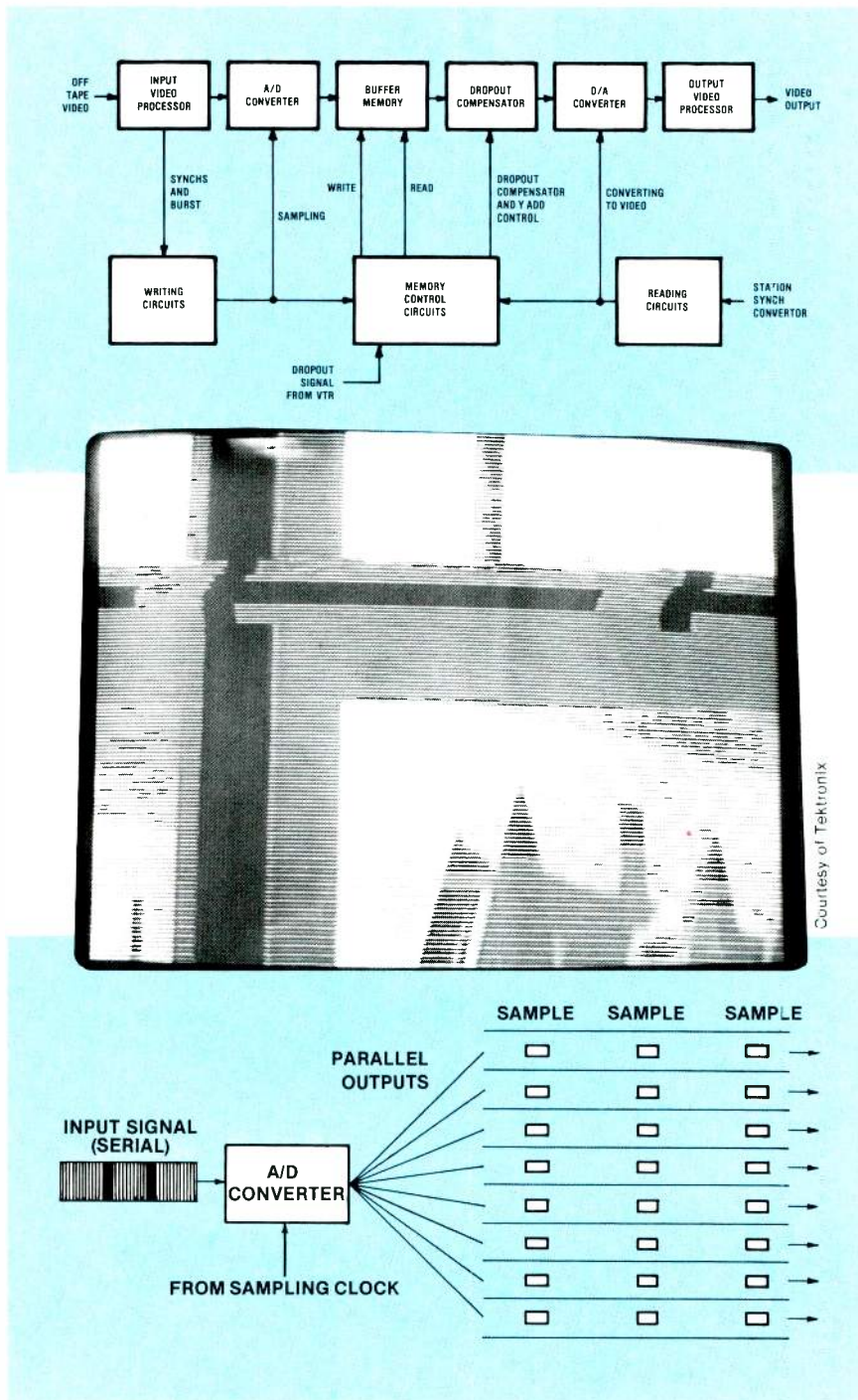
On occasion, part of a line might be missing. Defects or dirt often result in momentary periods of no video read from the tape. Specks of black in the picture indicate such defects. Drop out correction repairs the signal by replacing missing video with information from an equivalent spot on a nearby line.

If information is taken from an adjacent line, the replaced video appears to be off color. In the NTSC signal, alternate horizontal lines of each field have a 180° shift in subcarrier. Thus

**Figure 2.** A generalized block diagram of a time base corrector.

Tension error, as shown in the vertical interval, from a VCR playback, is one of the corrections provided by a TBC.

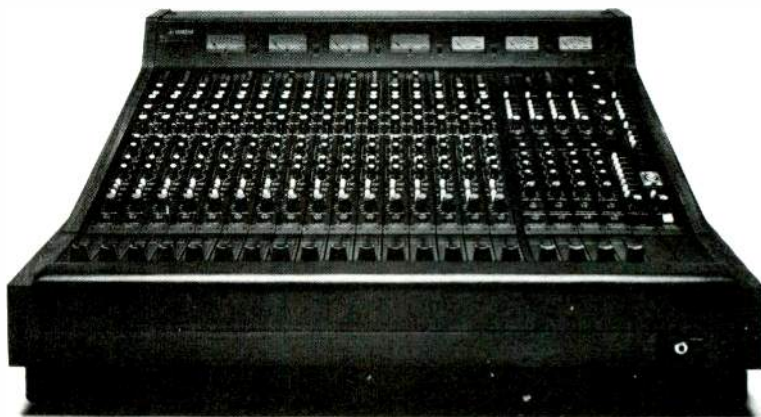
**Figure 3.** The analog signal, arriving at the A/D converter, is broken into samples. The eight bits (1s or 0s) in each sample travel in parallel to a memory location.





And  
now a message on  
Yamaha's M1500  
series  
mixing consoles.

# M1516A



## GENERAL SPECIFICATIONS

FREQUENCY RESPONSE +0, -3dB, 20Hz to 20kHz; +0, -0.5dB, 30Hz to 15kHz.

TOTAL HARMONIC DISTORTION (THD)\*

Less than 0.5% @ +10dB, 20Hz to 20kHz. Less than 0.1% @ +20dB, 50Hz to 20kHz.

HUM AND NOISE\* (20Hz to 20kHz, 150Ω source, Input Selector set at "-60")

- 128dBm Equivalent Input Noise (EIN);
- 95dB residual output noise with all Faders down.
- 73dB PROGRAM OUT (77dB S/N); Master Fader at nominal level & all Input Faders down.
- 64dB PROGRAM OUT (68dB S/N); Master Fader and one Input Fader at nominal level.
- 73dB MATRIX OUT; Matrix Mix and Master controls at maximum, one PGM Master Fader at nominal level, and all Input Faders down.
- 64dB MATRIX OUT (68dB S/N); Matrix Mix and Master controls at maximum, one PGM Master Fader and one Input Fader at nominal level.
- 70dB FB or ECHO OUT; Master level control at nominal level and all FB or ECHO mix controls at minimum level. (Pre/Post Sw. @ PRE.)
- 64dB FB or ECHO OUT (68dB S/N); Master level control and one FB or ECHO mix control at nominal level. (Pre/Post Sw. @ PRE.)

MAXIMUM VOLTAGE GAIN (Input Selectors set at "-60" where applicable)

PROGRAM & MATRIX 84dB; Channel In to the corresponding output. EFFECTS 20dB; Effects In to PGM Out.  
FB & ECHO 94dB; Channel In to FB/ECHO Out. SUB IN 10dB; Sub In to PGM Out.

EQUALIZATION (±15dB maximum)

LOW: 50, 100, 200, 350, 500Hz, shelving. HIGH MID: 1.2, 2, 3.5, 5.7kHz, peaking.  
LOW MID: 250, 350, 500, 700, 1000Hz, peaking. HIGH: 10kHz, shelving.

HIGH PASS FILTER 18dB/octave rolloff below 80Hz.

PHANTOM POWER For remote powering of condenser microphones, +40V DC can be switched on via a rear panel

Master phantom power switch. When an individual Input Phantom switch is also On, voltage is applied to pins 2 and 3 of that input's balanced XLR connector.

DIMENSIONS/WEIGHT M1516A 34" W x 36 1/2" D x 14 1/2" H 147 lbs. M1524 55 3/4" W x 36 3/4" D x 14 1/2" H 213 lbs.  
M1532 55 3/4" W x 36 3/4" D x 14 1/2" H 231 lbs.

\*Measured with a 6dB/octave filter @12.47kHz; equivalent to a 20kHz filter with infinite dB/octave attenuation.

The specs shown are for the 16-channel M1516A console. When you need the same outstanding performance but more channels, there's the 24-channel M1524 and the 32-channel M1532. All three mixers have remote rack-mounted power supplies and are ideal for just about any fixed or portable sound reinforcement or broadcast application.

Of course, all three M1500 consoles have legendary Yamaha quality, reliability and craftsmanship. Which explains why you see Yamaha mixers wherever you look. Studios. Concert halls. Clubs. Theatres. Churches. We could go on, but you get the message.

For more information, write: Yamaha International Corporation, Combo Products Division, P.O. Box 6600, Buena Park, CA 90622. In Canada, Yamaha Canada Music Ltd., 135 Milner Ave., Scarborough, Ont. M1S 3R1.





the nearest, best probable match to the missing video is on the second line after the dropout.

In an image with much vertical detail, the 2-line discrepancy could prove unacceptable. In such cases, luminance from the line after the error and chroma from the second line are used. This approach is possible only in TBCs with separated luminance and chroma.

The separation is usually done by comb filtering in the input section, and parallel paths are provided for the two components through the correction process. While the complexity is increased with extra control and memory, the operation is similar to what has been described.

### Non-standard VTR speeds

Standard play speed in Type C VTRs specifies a linear tape motion of  $9.646 \pm 0.047$  ips. Many of today's video machines may operate at other tape speeds for slow or fast motion. Locked images are possible from  $-1x$  to  $+3x$  play speed, forward as well as reverse, and still motion. This implies a new problem.

Non-standard speeds mean that the video track on the tape no longer appears at the same angle across the tape at which it was written. The normal video head cannot read the video track properly.

Attempts to do so result in dropouts as the head traces part of one track, then the guard band between tracks and finally the next track. The solution is called *automatic scan or dynamic tracking*.

Auto scan tracking requires a head that moves at right angles to the video



track. The mechanism for this places the video head chip on a piezo-electric mounting system. (See "Piezo-electric?", page 88.) In normal play, the head moves transversely only enough to keep the gap centered on the track it is reading.

As the linear tape speed varies, the head begins to move at right angles to keep the gap centered over the video track. If the linear speed is doubled, it would logically be only a short time until the entire TBC memory is filled to overflow.

For faster-than-normal operation, the dynamic tracking system causes

the playback head to skip every other video field on the tape. For slower motion, the head will be instructed to trace each video track more than once.

With a different tape speed, the time length of each line is different. Each must still be digitized at a rate of four samples/cycle of subcarrier.

However, the apparent burst frequency is not longer 3.579545MHz, because the change in tape speed means an apparent change in off-tape burst. The input circuit of the TBC phase-locks to the new frequency to drive the sampling circuit at four

times the new input burst frequency.

As with normal tape speeds, the output circuit of the TBC still clocks video out in step with the local sync generator. By skipping field on the tape, the output appears to present faster motion. If fields are read more than once, output video motion is slower.

Still-frame operation creates another condition. The head continues to read the same video field. NTSC requires that alternate fields have a half-line offset and subcarrier is reversed by  $180^\circ$  in each field.

The TBC is signaled by the VTR

## How many samples per line?

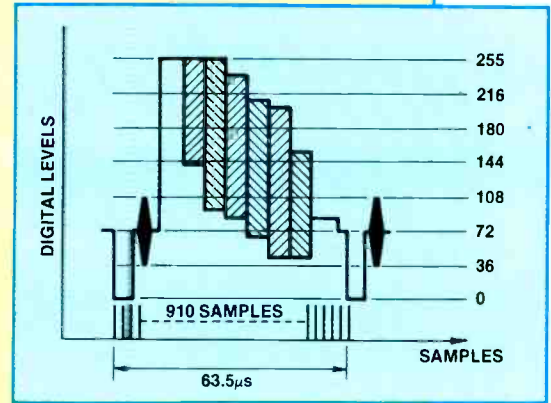
If you make a few calculations, you can determine how many samples occur along a video line. In one second, there are 3,579,545.45 cycles of color subcarrier. During the same second, 15,734.264 horizontal scan lines are traced on the screen.

The formula for the number of cycles of subcarrier in the time required for one TV line is:

- Cycles = Subcarrier (in Hz) / Line rate = 227.5Hz.

If sampling is at four times the subcarrier, 14.31818MHz, then exactly 910 samples are possible.

Actually, some of the video line is not sampled. Horizontal sync and burst intervals will be replaced at the output of the TBC by standard sync from the local generator. Of the  $63.555\mu s$  line, only about  $53.64\mu s$  carries image information. The difference of  $9.91\mu s$  is equivalent to 142 samples of 69.8ns.



Sampling a television line at 4fsc for NTSC.

Not all TBC systems use a 4x sampling clock. Some NTSC products use 3x, or 10.7386MHz. In PAL, both 3x and 4x subcarrier are used.



A trend in TBC and synchronizer products includes some production effects.



Systems may include front panel adjustments for horizontal and vertical sync timing, as well as selection of operating modes.

motion control circuit of this new condition and makes the compensation for the half-line offset in video.

### Frame synchronizers

Video from the remote truck or from a satellite relay will not be in sync with studio signals. If a news segment calls for chroma-key or split screen between remote and local video, the two signals must be locked together. A frame synchronizer is called for.

Some synchronizers include a TBC card to handle any type of incoming video. Most, however, require that the nonsynchronous signal is in a standard format, just offset by some amount of time from local sync.

Essentially, the principle is the same

as time base correction. The signal is digitized, placed in memory, delayed until timing relationships are correct and clocked from the memory as a stable video source.

The main difference between the TBC and frame synchronizer is in the size of the memory. While the TBC may have from two to 32 lines of memory, the synchronizer must be able to hold a complete frame of 525 lines. The added capacity does provide new capabilities.

To freeze a frame, for example, input sampling is stopped. The readout continues to operate with what is held in the memory. This is an advantage both for production purposes and for emergencies. If the video input should

fail, switches allow a selection of the last good frame or black.

The ability to control write and read clocks on a frame synchronizer leads to the standards converter. The input and output of the frame synchronizer are closely related, with only a fixed time offset between them. Changing from NTSC to PAL, however, introduces different parameters between the input and output. Lines of video may need to be created through interpolation of stored data. In other cases, data may need to be dropped.

### Beyond synchronizers

The capability to store a full frame of video with independent control of the writing and reading functions

## HOW DO YOU IMPROVE ON A GOOD THING?



### Peter Lisand follows a tough act...

Peter Lisand has learned from its successes. Proof of this can be seen in our two new camera support systems. Our heavy-duty camera head has a 30-50 pound capacity, while the light-duty style holds 15-30 pounds. Here are a few reasons both heads deserve your attention:

- True fluid action maintains a smooth regulated motion by a sensitive system without brake shoes, bands, or other mechanical parts to interfere with its operation. Separate positive locks and drag are featured on the pan and tilt. Tilt achieves a full 90° vertical position.
- Sealed leak-proof chamber assures long-lasting, problem-free operation.
- Adjustable quick-release will counterbalance camera and lens requirements. (optional)
- Versatile control—use right, left or dual handles.
- New reversible foot, rubber-tipped for interiors and standard metal points for outside use, can be ordered with either of the JRA tripods. (optional)
- Tripods come with various top castings to accommodate existing systems.
- Complete the light-duty system with the JRA-83M, a new light-weight tripod that weighs in at 7 lbs., with a total combined weight of 16 lbs.

These Peter Lisand products reflect our highest standards and are backed with our one-year no-nonsense guarantee.

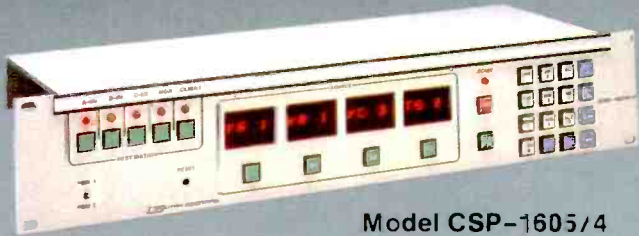
**Peter Lisand** <sup>TM</sup> <sup>®</sup>  
MACHINE  
CORP.

352 RIVER ROAD, EDGEWATER, N.J. 07020  
Phone: 943-5600 (Code 201)

Circle (47) on Reply Card



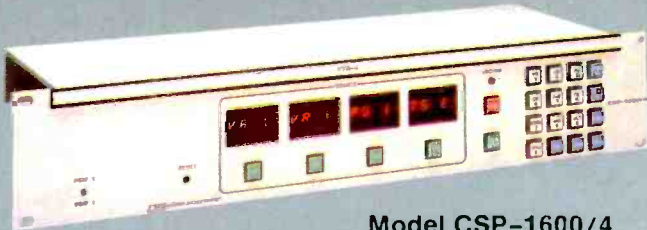
# FOUR-LEVEL ROUTER CONTROLS from UTAH SCIENTIFIC



Model CSP-1605/4  
Controls Five or Ten Busses



Model CSP-1610/4  
Controls Ten or Twenty Busses



Model CSP-1600/4  
Controls One or Two Busses



Model CSP-16160/4  
Full Matrix Controller and Diagnostic Panel

This new series of microprocessor-based panels has been designed by Utah Scientific to meet the needs of the broadcast and tele-production industries for individual control of source selection on multiple switching matrices (levels).

Each panel includes four alphanumeric displays to indicate either current *Status* (steady display) or a *Preset* source selection (flashing display) on each switching level. An alternate-action *Clear* button associated with each display plus an *All Clear* button permits toggling the displays between *Preset* and *Status* modes.

The touchpad features sixteen *group name* selections (beware of panels allowing for only ten) which, with either one or two *numeral* keystrokes, accommodates up to

1600 possible source names. Each panel can be provided with a *Program Select* switch that doubles the number of controlled busses at no extra charge.

Multi-bus panels provide instantaneous statusing of all four levels each time a new destination is identified. Instantaneous confirmation of changed status is also provided each time a new *Take Command* is entered.

The model CSP-16160/4 panel is specially programmed for maintenance/diagnostic duties as well as for full matrix control. It operates in either *alphanumeric* (source and destination names) or *numeric* (matrix input and output numbers) modes and can perform various diagnostic routines to permit rapid isolation of system faults.

**US UTAH SCIENTIFIC**  
a DYNATECH company

1685 WEST 2200 SOUTH, SALT LAKE CITY, UTAH 84119

PHONE: (801) 973-6840 TOLL FREE: (800) 453-8782

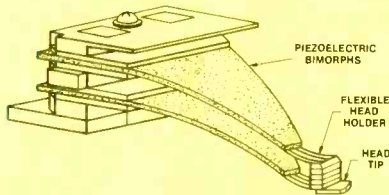
TWX: 910-925-4037

Circle (50) on Reply Card

## Piezo-electric?

Various materials exhibit an unusual coupling between elastic and dielectric energy. Crystals for frequency control are good examples. A small bias voltage placed across a carefully formed piece of quartz oscillates. The frequency of oscillation is determined by the material's dimensions and the means in which it was cut from a larger quartz crystal.

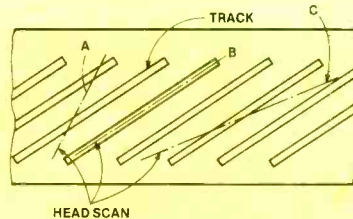
The effect is bidirectional. If a piece of quartz is placed under



A generalized structure of a VTR video head for dynamic tracking. Use of two piezo-electric parts keeps the head tip surface aligned properly with the tape surface.

stress, a voltage develops across its surfaces. This is the concept involved in a crystal or ceramic phonograph pickup. Stress created by the stylus tracking the phono grooves is translated into electrical voltages, which are then amplified for the speakers.

In a VTR designed for still-frame or slow-motion modes, the video head is mounted in a cantilevered



In normal play, the video head traces track B to reproduce the video signal. As tape motion is increased or decreased for non-standard speeds, the tracks may appear as in A or C. A voltage applied to a head mount causes the scan path to take the new direction of A or C.

arrangement that involves a piezo-electric crystal. When the machine is in standard play mode, the head traces out normal tracks across the tape. Tracking servos alter capstan and head drum speeds to keep the video head centered in the narrow band of information recorded on the tape.

When altered speeds are used, a dc control voltages, related to the speed, is developed. The voltage, when applied across the piezo-electric crystal holding the head, changes its shape (oscillates) and moves the head up and down.

By this mechanism, the head is aided in tracing out the video tracks that have essentially changed with the effective change in tape speed.

Actually, some control voltage may be applied to the crystal material even during normal play speed to aid in maintaining the best possible tracking. The primary activity of the crystal material, however, occurs when forward or reverse speeds other than normal play and stop motion are desired.

gives rise to other production tools. Digital effects systems and free-form graphics units both use some of the sample principles of frame synchronization. Both present much more complex control problems, however (Figure 4).

In the effects system, correct video is constantly clocked into and out of memory. By using more than one

memory, more than one image may be stored. By reading selectively from the multiple memory planes, parts of each image are combined in the output.

Control for such systems is handled by a computer. The computer does the high speed calculations necessary for the desired effect and talks to the memory control system. Memory control handles the rearrangement of

complete bytes of data within the frame buffer memory.

Effects systems may depend upon additional memory to store effects instructions. Designated function or soft programmable keys on the control panel allow one key access to the effects programs.

Graphics systems require a different control plan. With a frame of video held in the memory, the control computer gives the operator access to the memory. System software allows stored pixels to be duplicated, altered and replaced.

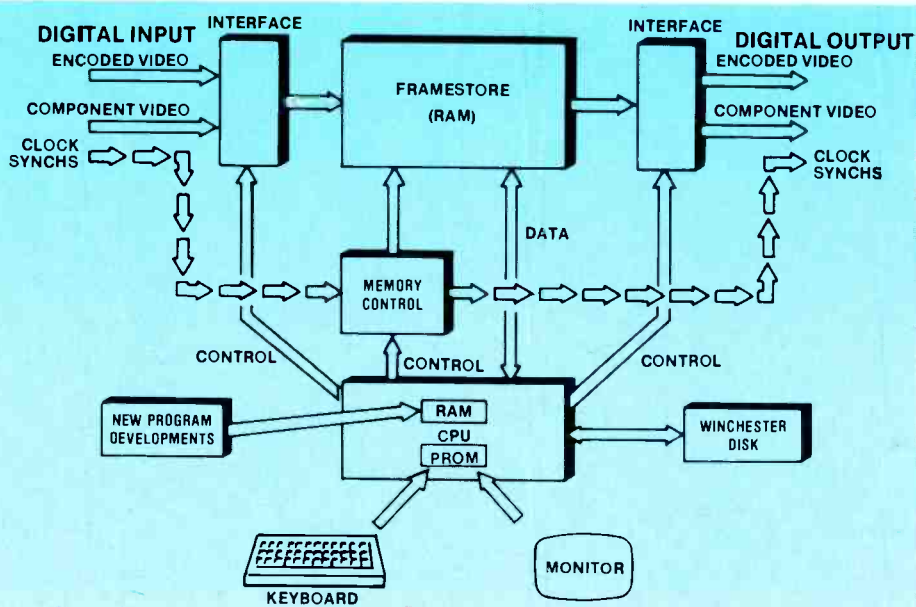
Individual bits may be changed from 1s to 0s, for example, to change the color of an individual pixel. Limitations appear to be the imagination of software engineers who program the control systems.

### Constant time

Television requires constant repetition and accurate timing. Time base correction achieves the necessary constancy through memory buffering and controlled data writing and reading.

The evolution of those principles with the marriage of computer control has produced a series of video production tools for both on-line and off-line uses. Creative use of these tools revolves around control of the time-related parameters of the video signal.

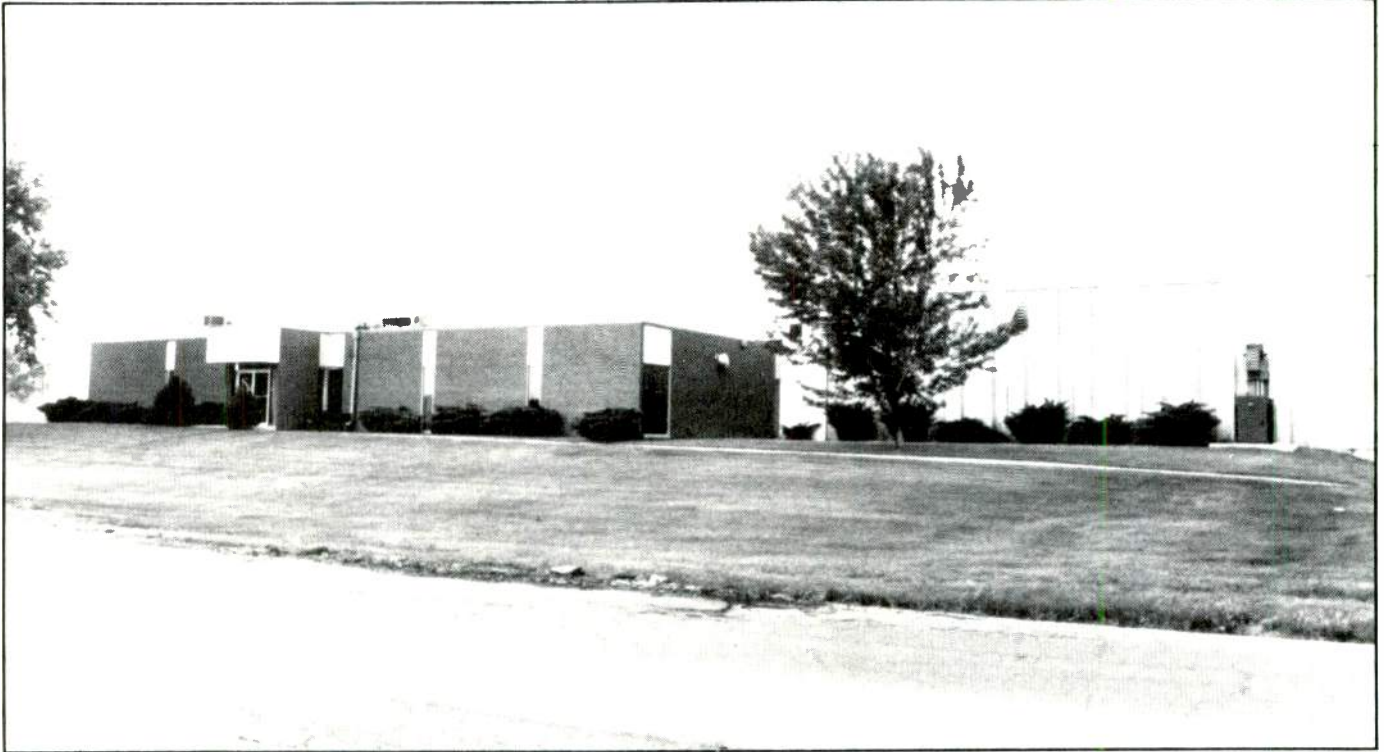
Yet one factor remains true for TV. Time must remain constant.



**Figure 4.** Centered on a large RAM storage area, the image processing system includes control of the data in memory. In this diagram, instructions for the desired effects are provided through a keyboard to the computer CPU, to the memory control and finally to the frame-store.



# TELEVISION TECHNOLOGY CORPORATION



## A good place for your **RADIO** station to look for equipment.

Television Technology has been manufacturing TV and FM Translators and Low Power Television Transmitters since 1967. In that time we have gained a reputation for simple and reliable designs that offer the highest level of performance available from existing component technology.

But, Television Technology Corporation is also a RADIO equipment company. Our Wilkinson Radio Division offers a complete line of FM Transmitters from 10 watts to 60 kilowatts, including the FM-3500J, 3.5 kilowatt FM transmitter, the first of a complete line of transmitters we think will change a lot of ideas about what's important in a broadcast transmitter. Wilkinson also offers simple, reliable AM Transmitters from 125 watts to 100 kilowatts.

Television Technology also offers a complete line of audio consoles, cartridge machines, and reel to reel decks made by our AMPRO/Scully Division.

So when you're looking at new equipment for your radio station, don't forget the television company that thinks a lot about radio, too.

TELEVISION TECHNOLOGY DIVISION – TV & FM Translators & LPTV  
WILKINSON ELECTRONICS DIVISION – AM & FM Transmitters &  
Line Surge Protectors  
AMPRO/SCULLY DIVISION – Audio Consoles & Audio Tape Equipment  
SATELLITE TECHNOLOGY DIVISION – Satellite Earth  
Terminal Systems and Transmission Systems



Wilkinson Radio Division

2360 Industrial Lane  
Broomfield, Colorado 80020  
(303) 465-4141  
TWX: 910-938-0396

Circle (51) on Reply Card

# Audio time base correction

By John Pate, staff engineer,  
WSM Radio, Nashville, TN

an ATBC pilot encoder that would generate an inaudible pilot signal, which would be inserted at a low level with the audio on the regular left and right channels of our cart machines. The pilot encoder would be located in the production room where the carts were recorded (Figure 1).

As these carts were later played back on the air, the pilot signal would travel along with the audio from the playback machines, through the air console and down the program line. Inserted in the program line before the limiter would be the ATBC.

Its function would be to make the necessary time base correction by extracting and reading the information contained in the inaudible pilot signal. When the pilot signal was not present, the ATBC would go into a non-correcting state.

This system would provide many obvious advantages. First, only one correction device would be needed for an entire system, regardless of how many tape machines or air studios were in use. The pilot encoder (one required for each production room) would be simple, inexpensive and automatic. Our existing carts and cart machines could be used without modification.

Installation of the system would be simple and its operation would be automatic. Pilot encoded carts could be phased into the system because the ATBC would automatically distinguish which carts were encoded and which ones were not.

## Building the ATBC

The first step in the project was to test our concept for the pilot signal. We had to determine whether its use would cause any undesirable side effects. Our goal was a pilot signal that could be easily recorded on any cart machine and convey the necessary time reference information to the corrector, which was to be located in the program line. The pilot also had to be inaudible, not interfere with the operation of any other equipment and not degrade the quality of the recorded audio.

After considerable testing, we

Using stereo cartridges has become widespread in FM radio stations. Because of the movement toward AM stereo and multichannel TV sound, the use of stereo carts will continue to increase. The best carts and cart machines available today are the results of more than a quarter-century of technical evolution. Their performance, in many respects, is equal to the best reel-to-reel tape machines.

If you compare the best cart equipment available and the original machines introduced at the 1959 NAB, the advances that have been made become strikingly apparent.

However, equally apparent is the similarity that still exists between the machines.

For each generation of cart machines to be compatible with the previous generation, the basic design of the tape cartridge has remained unchanged. It is still a center-pull, endless-loop, external pinch roller tape cartridge of the same basic specifications that was introduced 26 years ago.

Here lies a problem. The achievable mechanical tolerances of this tape packaging system are simply not good enough to ensure that the stereo interchannel delay error will consistently be low enough to preclude some degree of mono-sum high frequency loss.

Several years ago, WSM started a project to find a solution to the problem of stereo interchannel delay error in carts without producing objectionable side effects. The idea was to build an audio time base corrector (ATBC).

Time base correction is not new. Television has used TBCs for many years. For a time base error corrector to work, however, it must have a recorded time reference signal. In video applications, the horizontal sync pulses serve this purpose well. In audio applications, however, there is no signal. Therefore, we developed an ATBC pilot signal.

In our system, we proposed to build

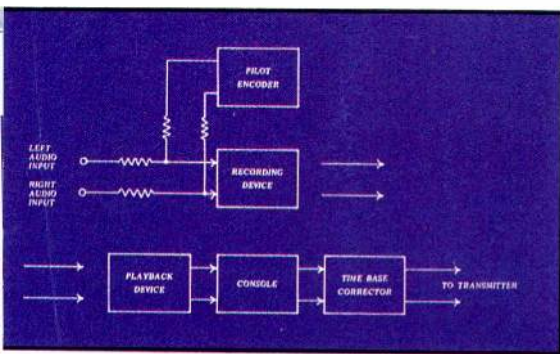


Figure 1. Block diagram of the basic ATBC pilot encoder and corrector system.

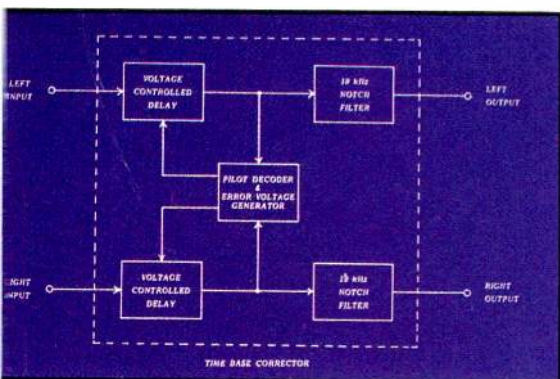


Figure 2. Block diagram of the ATBC corrector unit.





decided on the following specifications for the pilot signal: a 19kHz sine wave, 60% double sideband amplitude modulated by a 300Hz sine wave, injected into the program audio at a level 27dB below 0VU. This may sound rather complicated, but it is really quite simple to generate.

The first pilot encoder was a 1.5" x 6" module that plugged into our production console. It had two buttons labeled *pilot on* and *pilot off*, and a red LED that came on when the pilot was on.

Remote control connections were also provided for the module, which allowed the pilot to be automatically turned on when the cart machine's *record preset* button was pushed, and turned off when the record cart machine's *secondary cue* button was pushed. In this way, any number of pilot-encoded carts could be played sequentially without pilot overlap.

Performance tests on the pilot tone signal indicated that our goals had been met. We could detect no change in distortion, headroom, S/N ratio, frequency response or separation. In addition, the pilot was inaudible and did not have any detectable effect on the air console, switcher, distribution amplifiers, processing gear or FM stereo generator. Because the pilot

was injected at a low level, it didn't even show up on the VU meters.

Now that we had determined that the presence of the pilot signal didn't cause anything *bad* to happen, we began construction of the ATBC itself to learn if the pilot could cause something *good* to happen. Our concept of the ATBC was to use two short (in the millisecond range) voltage controlled delay lines, one inserted in each channel (Figure 2).

Circuits were included that extracted the pilot signal as it reached the outputs of the delay lines. The 300Hz modulation of the pilot was detected in each channel and compared. One of the voltage controlled delay lines were then either increased or decreased, as necessary, until the 300Hz AM signals were in perfect phase. In this way, all delay errors were corrected, regardless of their source.

Rather than design and construct our own delay lines, we obtained a pair of Deltalab DL-3 digital delay lines and modified them for an external clock input. The remainder of the ATBC was built in our engineering shop.

#### Ready to go

When the ATBC was completed, the

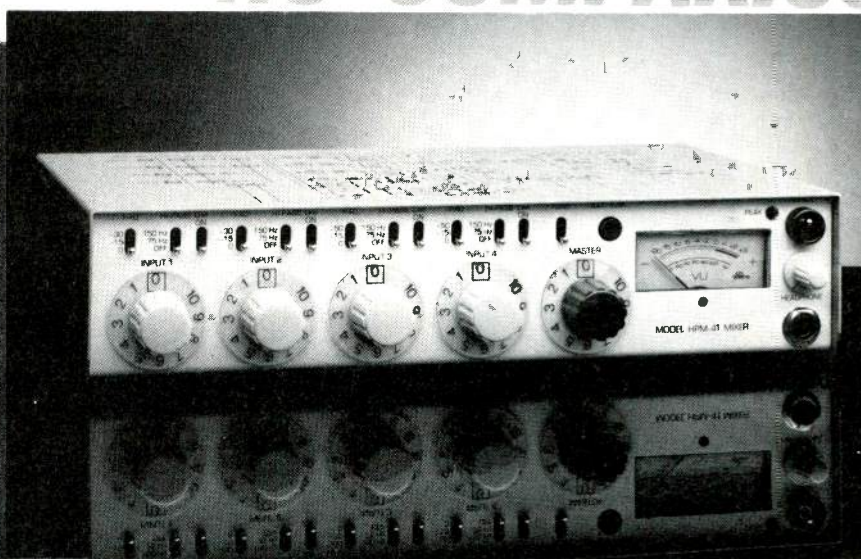
initial results were exciting. The output of a cart machine was connected to the input of the ATBC and the output of the ATBC was connected to an oscilloscope set up for a Lissajous display.

The scope showed the familiar diagonal line of an in-phase Lissajous pattern when reproducing an 8kHz tone that had been recorded along with the pilot tone. The playback azimuth screw was then moved about an eighth of a turn and the pattern instantly jumped through a full circle to a diagonal line in the opposite direction, indicating a 180° phase shift.

But then an amazing thing happened. The line gradually opened back up into a circle and then closed again to a perfect in-phase line. About two seconds after the deliberate misadjustment of the azimuth screw, the ATBC had made a complete delay correction. The delay error correction meter on the front panel was reading 62μs, which agreed with what we observed on the oscilloscope.

More tests and refinements were made on the bench, and soon the unit was put into operation on the air. By that time, a large number of carts had been encoded with the pilot. Instantly, our mono-sum problems were gone. Now, all carts sounded as bright on

## *Sure, it looks like theirs, but there's* **NO COMPARISON**



RTS SYSTEMS, INC. • PROFESSIONAL INTERCOMMUNICATIONS • PROFESSIONAL AUDIO PRODUCTS  
1100 WEST CHESTNUT STREET • BURBANK, CA 91506 • 213/843-7022 • TWX 910-498-4987 • TELEX 194855

It's what's inside that counts. And inside our HPM-41 Microphone Mixer, you'll find the most extraordinary circuitry—the kind you would expect in a major recording console. In the two years we took to develop the HPM-41, we determined every small-format mixing need. And then we condensed them into a super rugged compact package. The results? Check the specs and compare. There's nothing quite like it. On that, you can be sure. Call or write RTS for detailed information.

**RTS**  
Systems  
A COMPACT VIDEO COMPANY





FROM THE INVENTORS  
OF THE PLUMBICON™ TUBE

## Objective Color Monitor Balance

At last, a practical solution to the age-old problem of color balancing your picture monitors—the PM5539 color analyzer.

Working directly off the screen with three color-sensitive photodiodes, the PM5539 gives you quick and easy readings of the three primary colors—separately or simultaneously—referred to a previously-set white standard.

This means that in a matter of minutes every color monitor you need to watch can be set up to have the

same color temperature and intensity. Once the PM5539 matches all your monitors, you'll see all the difference in the world. The PM5539 is the quantitative way to eliminate the qualitative "calibrated eye-ball."

For nationwide sales and service information call 800-631-7172, except in Hawaii, Alaska and New Jersey. In New Jersey call collect (201) 529-3800, or write Philips Test & Measuring Instruments, Inc., 85 McKee Drive, Mahwah, NJ 07430.



*Color temperature should normally be adjusted at both high and low light levels. Balance of the three primary colors should track at the "grey" levels in between. To facilitate "grey scale tracking," the PM5539 has a wide sensitivity range (1 to 300 NIT's full scale).*

TRANS

**For Philips rental information  
call 800-527-4334**

# PHILIPS

# PHILIPS

mono receivers as they did on stereo receivers.

The most surprising thing we learned was the extent of the problem we had just solved. As the cart played through the ATBC, the amount of delay correction could be read directly on the meter. More than 2/3 of the carts we were playing exceeded 17µs delay error (3dB mono sum loss at 15kHz). Some were off as much as 100µs. This occurred in spite of the fact that WSM has always used top-quality, well-maintained cartridge equipment.

Our normal maintenance procedure had been to remove each playback machine every eight to 12 weeks and, among other things, check stereo phase against a reference cart. We would typically see a 0 to 60° (at 15.8kHz) change over this period. We had assumed, incorrectly, that the vast majority of the carts we played back on the air fell within this range.

The delay error correction meter on the ATBC revealed, however, that the problem was much worse. The difference was apparently due to the control room carts being played more

often and handled more roughly than our reference cart.

#### Flutter correction

After several weeks of testing, the ATBC was removed from service for the installation of the second portion of the time base correction circuitry. The goal of this modification was to eliminate flutter, another time base error. Because the pilot signal originates from a crystal oscillator, its carrier frequency is stable.

Circuits were added to the ATBC that measured the frequency modulated content of the 19kHz pilot carrier at the output of the delay lines. The frequency modulated component correlates to flutter and is used to generate a signal which is fed back to the control input of the delay lines.

Once this circuit was completed, we tested it on a 3-deck cart machine. At the output of the cart machine we measured 0.12% weighted flutter, but at the output of the ATBC we measured just 0.034% weighted flutter. Spectral analysis indicated that the 7.5Hz component of the flutter (induced by the capstan) was reduced by approximately 20dB.

When the ATBC was put back in the program line, the changes were immediately apparent. It was impossible to listen over the air and tell the difference between music from discs and music from carts. At the following (1981) NAB convention, I gave a paper on the subject of audio time base correction to a small but interested group of broadcasters and manufacturers.


It had been interesting to note the progress of carts and cart machines since the ATBC was developed at WSM. In 1985, the carts themselves still seem to be the greater problem in terms of phase error. Although WSM continues to use the best available carts and cart machines, a check of the delay error correction meter on the ATBC reveals that not much progress has been made in reducing long-term stereo phase error for carts in everyday use.

#### The system today

The original ATBC has now been partially re-canabalized and is in storage at our transmitter. It has been replaced by a more refined and technically sophisticated unit with delay lines using the latest 16-bit A/D technology and RAM storage. The latest version of the ATBC consumes only 5¼ inches of rack space, compared to 12¼ inches for the original unit.

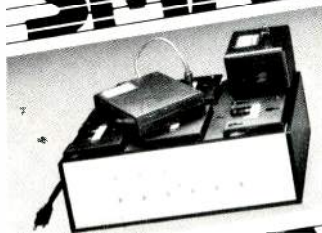
The ATBC has put in tens of thousands of hours of service. It has also been successfully tested at other stations. The audio time base corrector is an idea whose time has come. [:-:-)]!!!

# ALEXANDER If You and Your Equipment Depend on Battery Power... LET ALEXANDER HELP YOU BE FAST



Attach up to three 12-14.4 volt battery packs to the Alexander Triplex Charger. The Triplex will bring them all to full charge in less than two hours — automatically... without monitoring.

# SMART, AND



With the Alexander smart sequential charger you can charge up to six packs without buttons to push or lights to monitor. The consistent 2-amp charge means you'll get fresh packs with no worry about over-charging.

# RELIABLE!



We're so proud of the reliability of our batteries that we urge our users to analyze them on a regular basis... with the TRI-ANALYZER. The Tri-Analyzer displays remaining capacity (in MAH) in a fully automatic operation that also dememorizes the cells.

ASK FOR THE NAME OF YOUR ALEXANDER BATTERY DISTRIBUTOR



**ALEXANDER**  
1511 S. Garfield Pl/Box 1645/Mason City, IA 50401  
515-423-8955

Circle (55) on Reply Card





## GET THE PICTURE

### With the Schwem Gyrozoom 60/300™ Image Stabilizer Lens



**Now, truly stabilized optics.** The new Schwem Gyrozoom 60/300 Image Stabilizer Lens fits most  $\frac{2}{3}$ " ENG cameras and eliminates virtually all image vibration. Smooth footage is obtained when shooting from any moving vehicle—helicopter, truck, boat, motorcycle—even on foot—whether the camera is hand-held or on a tripod. The image is stabilized optically—not with braces or brackets.



**Zoom from 60mm to 300mm.** This lens enables you to shoot close-up from 1000 feet with a perfectly steady image. It is ideal for newsgathering and sports coverage.

**Compact and lightweight.** The Gyrozoom weighs in at approximately 6 lbs. Power drain is only 1 additional minute/hour.

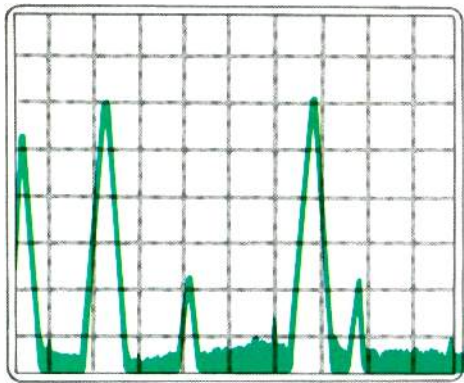
**Easy to operate.** There's no special training required. It is as easy as 1. Attach 2. Aim 3. Shoot.

**American quality backed by a full warranty.** Fully warranted for 6 months with an optional service contract after warranty period.

To get the picture, you have to see the picture. Call Schwem Technology today to arrange a free demonstration. 3305 Vincent Road, Pleasant Hill, CA 94523, Call Collect (415) 935-1226. Circle (56) on Reply Card



**SCHWEM**  
TECHNOLOGY



# Troubleshooting

## The 1/2-wavelength PA cavity

By Clarence Daugherty, senior broadcast technology instructor, Harris, Quincy, IL,  
and Jerry Whitaker, editor

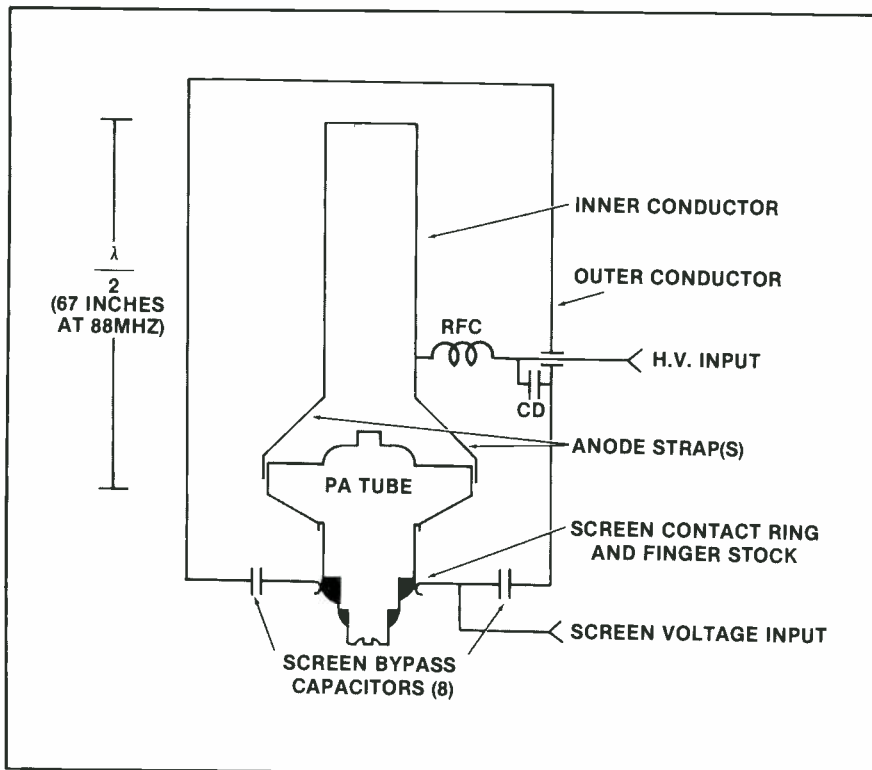


Figure 1. The 1/2-wavelength PA cavity in its basic form.

The 1/2-wavelength PA cavity has been used extensively in FM transmitting equipment. The design can take a number of forms, but the underlying theory of operation remains.

The design of a basic 1/2-wavelength PA cavity is shown in Figure 1. The tube's anode and a silver-plated brass pipe serve as the *inner conductor* of the 1/2-wave transmission line, and the cavity box serves as the *outer conductor*. The transmission line is open at the far end and repeats this condition at the plate of the tube. The line is, in effect, a parallel resonant circuit for the PA tube.

The physical height of the circuit shown in Figure 1 (67 inches) was calculated to operate at 88MHz. To allow adequate clearance at the top of the transmission line and space for input circuitry at the bottom of the assembly, the complete cavity box would have to be almost eight feet tall. This is too large for any practical transmitter.

Figure 2, page 108, shows RF voltages, current and impedance for the inner conductor of the transmission line and the anode of the tube. The load impedance at the plate is many thousands of ohms. The RF current is, therefore, extremely small and the RF voltage is extremely large. In the application of such a circuit, arcing would become a problem. The high plate impedance would also make amplifier operation inefficient.

Figure 2 also shows an area between the anode and the 1/4-wavelength location where the impedance of the circuit is 600Ω to 800Ω. This value is ideal for the anode of the PA tube. To achieve this plate impedance, the inner conductor must be less than a full 1/2-wavelength. The physically fore-

Continued on page 104

### Troubleshooting suggestions

We continue last month's discussion of transmitter plate supply overload problems. Occasional plate trip-offs (one or two a month) generally are not cause for concern. Most of these occurrences can be attributed to power line transients.

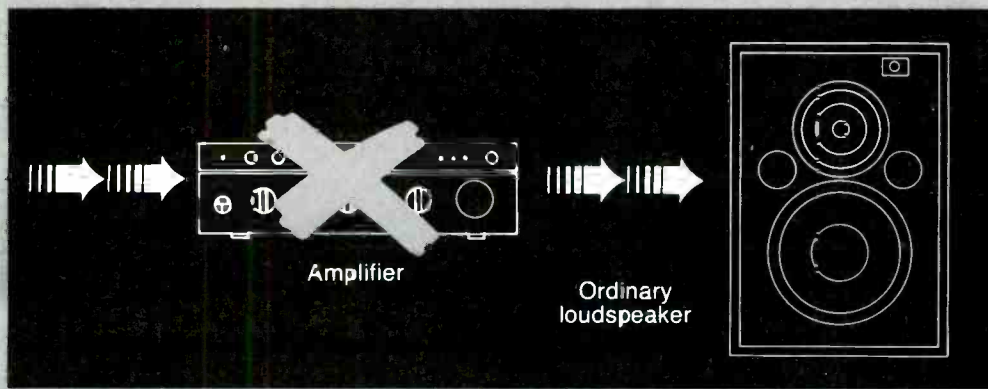
More frequent trip-offs, how-

ever, require a closer inspection of the transmission system. For discussion purposes, we assume the plate supply overload occurs frequently enough to make continued operation of the transmitter difficult.

Repair work on a transmitter that is experiencing high voltage

Continued on page 98





## Finally, a Monitor System with the Power to Make Things Easy

Imagine a monitor speaker that provides its own power. Fits in tight spaces. Simplifies setup. And reproduces sound with test-equipment accuracy.

If you can imagine all that, you've just pictured the **Sentry 100EL powered monitor system** from Electro-Voice. Designed and created for your monitoring convenience, the 100EL combines the superb audio reproduction of the Sentry 100A with an integral, 50-watt amplifier.

With speaker and amplifier in one compact, rack-mountable package, this monitor system solves problems like limited rack space, equipment transport on remotes or cramped spaces in video editing booths.

Also, by requiring less hardware—fewer cables and connectors—the 100EL keeps setup simple

and reduces potential interconnect problems. And there's no possibility of power loss caused by resistance from a lengthy speaker cable.

The on-board amplifier in the 100EL makes it ideal for single-channel monitoring. Why buy one speaker and an extra amplifier channel, when the Sentry 100EL does the job all by itself? And because amplifier power is perfectly matched to the speaker system, there's no chance of damage from inadvertent signal overload.

But convenience and trouble-free operation are only part of the package. Like all Sentry designs, the 100EL offers uncompromised accuracy. So you can be certain of quality sound.

The Sentry 100EL - with the power to make your job easier. For more information, write Greg Silsby at Electro-Voice, Inc., 600 Cecil Street, Buchanan, MI 49107.



Circle (57) on Reply Card

**EV** Electro-Voice®  
SOUND IN ACTION™

Continued from page 96

trip-off problems begins with a series of preliminary troubleshooting steps, including:

- Switch the transmitter to local control.
- Switch off the automatic recycle circuit (so that the transmitter will not restart after a fault).
- Determine the exact fault condition and failure history.
- Check all low voltage systems for proper operation.
- Inspect the internal circuitry for any obvious signs of failure.
- Check to see if the problem is

caused by an antenna or transmission line failure.

- Determine whether the overload is RF- or dc-based.
- Examine the fault sensor circuit to determine within what limits component checking will be needed.
- Substitute a spare PA tube for the original tube if tests show the possibility of tube failure.
- Check for short circuits using an ohmmeter in suspected areas of the power supply.

These preliminary steps were

discussed in previous "Troubleshooting" columns.

If the plate overload trip-off is dc-based, cannot be corrected using the previously listed procedures and occurs only at elevated voltages, it may be necessary for you to use the process of elimination to repair the system.

#### Process of elimination

This troubleshooting method involves isolating various portions of the circuit—one section at a time—until you find the defective component. However, special precautions are required:

- Never touch anything inside the transmitter without first removing all ac power and then discharging all filter capacitors with the grounding stick.
- Whenever you disconnect a wire, temporarily wrap it with electrical tape and secure it so that it will not arc-over to ground or another component when power is applied.
- Never perform this type of troubleshooting work unless another person is with you.
- Analyze each planned test before it is conducted. Every test in the troubleshooting process requires time, and so steps should be arranged to provide you with the greatest amount of information about the problem.
- Check with the transmitter manufacturer to find out what testing procedures the company recommends. Ask what special precautions should be taken.

Troubleshooting the high voltage plate supply is usually done under the following conditions: exciter off, plate and screen voltages for *all previous stages* off, PA screen voltage off. Individual transmitters may require different procedures. Check with the manufacturer first.

The figure on page 100 shows a diagram of a transmitter high voltage power supply. Begin the troubleshooting process by breaking the circuit at point A. If the overload condition persists, the failure is caused by a problem in the power supply itself, not in the PA compartment.

If, on the other hand, the overload condition disappears, a failure in the feedthrough capacitor (C1), decoupling capacitors (C2, C3) or blocking capacitor (C4) is indicated.

If a problem is indicated in the PA compartment, reconnect the high voltage supply line at point A and break the circuit at point B. A return of the overload problem would indicate a failure in one of the decoupling capacitors or feed-through capacitor.

**NEW!**

# BIG CLAIMS FROM THE SMALLEST CONTENDER

## The HME System 82 Wireless Microphone!

Smallest professional body-pac transmitter made. Weighs only 2 1/2 oz., without battery. Easy to conceal, stays in place.

High-impact resistant ABS plastic case molded-in color. Resistant to wear and tear. Keeps its new look.

Detachable, reversible belt clip — Allows antenna and microphone cables to be positioned either up or down without damage to kinking.

Dynamic Expansion II — Provides highest dynamic range of any wireless microphone today (over 115dB!).

Improved RF performance reduces multi-system interference. Over 20 systems can be used interchangeably.

Easy access battery compartment is separate from electronics enclosure. Prevents moisture and unauthorized fingers from damaging PC board.

Color identification dot matches transmitter to receiver, prevents confusion in multi-system applications.

Four pin microphone connector allows interchangeable use of dynamic, positive or negative-ground electret elements. No switching needed.



Rock-solid radio performance, sound quality that's indistinguishable from a cable and day-to-day reliability our competitors would rather not discuss. These are benefits our professional users have enjoyed for years. So how did HME improve the System 82 over the legendary System 22? We made it a delight to use. Look at the thoughtful convenience features above, starting with a transmitter package that's 9cc smaller than our closest competitor. We designed a belt clip that can quickly be added or removed, and which allows the transmitter to be mounted top-up or top-down for versatility. Color-coded dots match transmitters to receivers to prevent confusion in multiple-system applications; this is important since you can use up to twenty systems together now, thanks to advanced RF technology. Join the thousands of users who have put HME out in front in wireless microphone acceptance. The all-new HME System 82 is waiting for your evaluation . . . contact your nearest HME dealer or the factory for a demo.

HME also makes the world's most advanced wireless and cabled intercom systems.

**h m e**  
HM ELECTRONICS, INC.

9675 Business Park Ave., San Diego, CA 92131 Phone (619) 578-8300 Telex: 350-771

Circle (58) on Reply Card



# THE FIRST 3-CHIP CCD CAMERA IS ON THE STREET.

## And we just made it better.

Introducing the new SF-3A. NEC's second generation in CCD cameras. With a dramatic 30% increase in light sensitivity. And 100 time improvement in high-light handling.

And no pick-up tubes inside. So you can forget about burn-ins, retubing, sticking, comet tails, and re-registration. Forever.

Because now, NEC gives you locked-in image quality to match any conventional ENG camera. Cranking out more

than 450 lines of beautiful color resolution, for any VTR format.

And it's all neatly packaged into 5.9 lbs. (head only) of solid state power. So rugged, so reliable, you can probably drop it on a sidewalk and still get the picture.

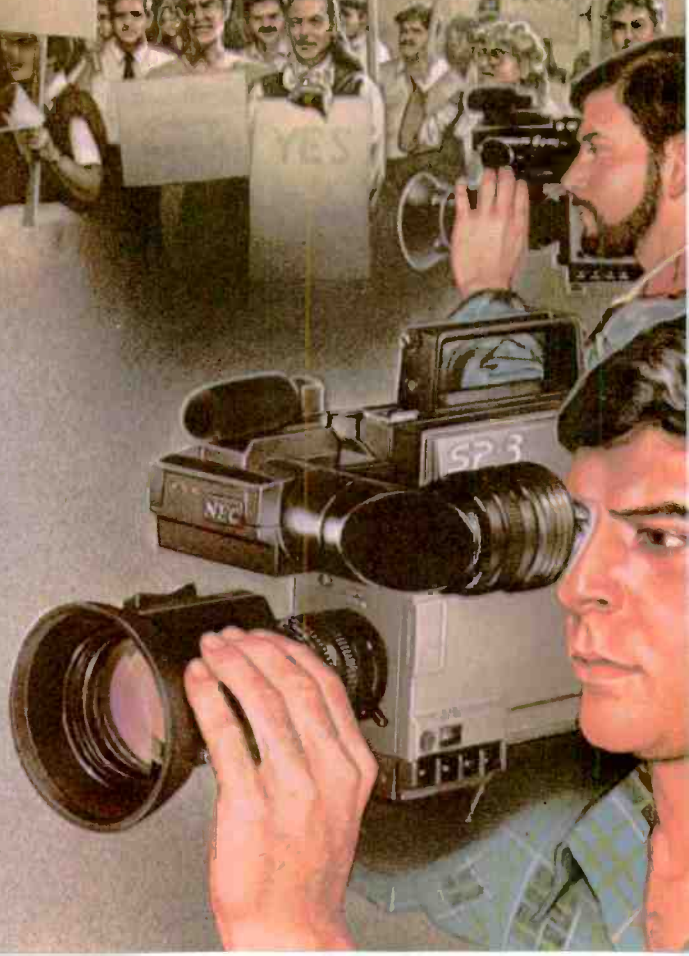
To find out more, including a very newsworthy price, just call NEC toll-free at 1-800-323-6656. And see why this CCD is making ENG video better than ever.

# NEC

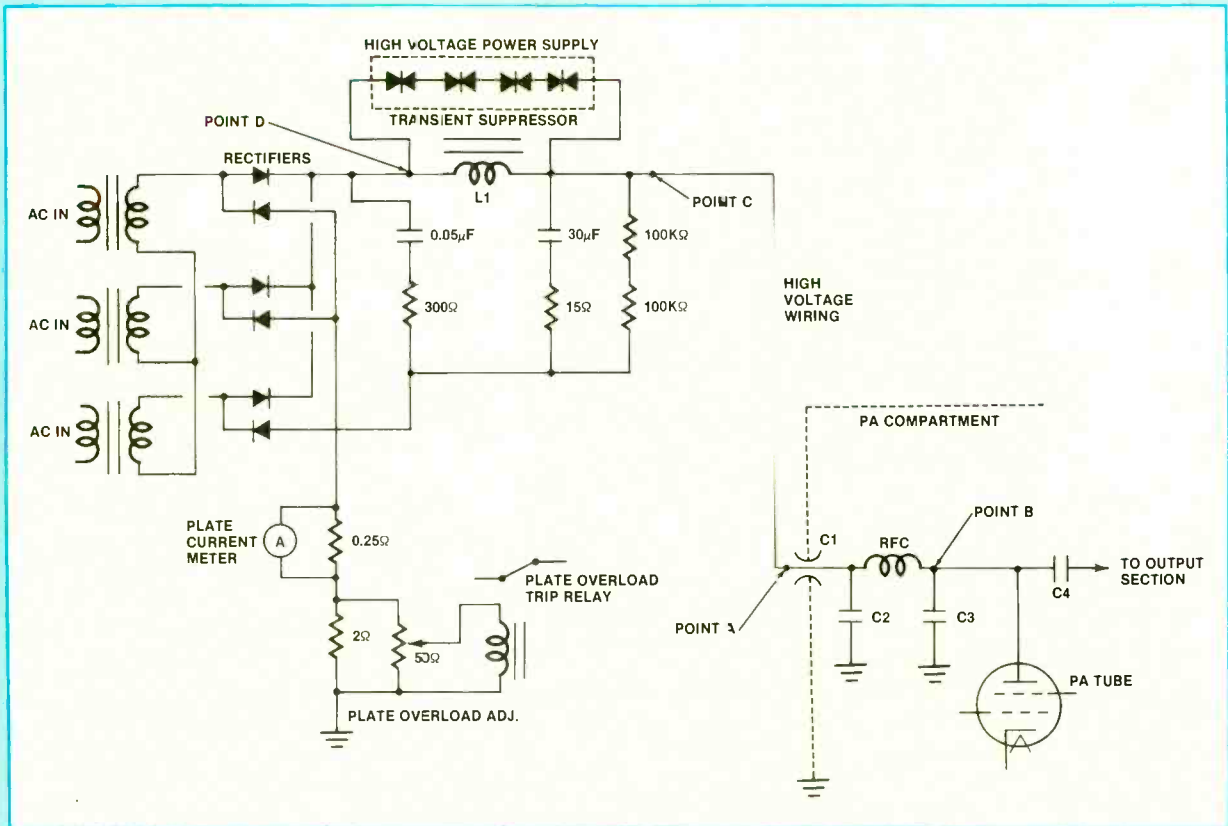
IMAGINE WHAT WE'LL DO FOR YOU

NEC America, Inc. Broadcast Equipment Division  
130 Martin Lane, Elk Grove Village, IL 60007  
In Illinois 312-640-3792

Circle (42) on Reply Card







A common broadcast transmitter high voltage 3-phase power supply circuit.

# THE VC-2500P

## AUTOMATIC VIDEO CORRECTION

The VC-2500P automatically corrects the video output of satellite receivers, VCR's, TV cameras, and other video sources. The AGC circuit will automatically hold the video level at IVP-P. The VC-2500P also completely regenerates the synchronizing and blanking signals. Problems such as jitter, bending, rolling, and satellite receiver flicker are solved in most cases.

The VC-2500P prevents over/under modulation level problems on video modulators in CATV and-MATV systems and solves downstream stability problems as well. The unit is invaluable for maintaining levels and stability in video tape duplicating systems. CCTV surveillance systems are benefitted by maintaining each camera at the same level and stability.

Available in NTSC or PAL. The NTSC price is only \$495.

Call or write for literature.

ICM VIDEO  
10 NORTH LEE • P.O. BOX 26330  
OKLAHOMA CITY, OK 73126  
(405) 232-5808



Circle (75) on Reply Card



# M/A-COM MAC, INC.

## Microwave Systems

### For Broadcasters Around the World



Over the past 25 years, Microwave Associates Communications has been installing communications links and Electronic News Gathering (ENG) equipment around the world. We are now the



leading microwave systems supplier to the broadcast industry. One stop shop for portable transmitters, receivers, and antennas to base-band and heterodyne fixed links.

#### Continuous Product Innovation

Beginning with the first solid-state portable transmitter in 1964, B-line fixed and portable equipment in 1967, G-line terrestrial radio in 1970

and up to present day with a complete line of ENG equipment, M/A-COM MAC has been the technological innovator. We have delivered the most advanced and reliable equipment spanning both local broadcasters and major networks around the world. To further our role as product innovators, we introduced a new series of portables, a new central receiver and a helicopter skypod system in 1983. In 1984, we introduced the 40 GHz portable system, multiband radios and a state-of-the-art ENG receiver.

Circle (60) on Reply Card



#### Commitment To Service

As part of our commitment to total customer satisfaction, we now have two dedicated domestic service and support centers: Eastern region - Massachusetts (800) 343-3005 and

Western region - California (714) 538-3772. Plus, for product information, write to me, Duke Brown, M/A-COM MAC, Inc., 63 Third Avenue, Burlington, MA 01803 or call (617) 272-3100, Ext. 4331.

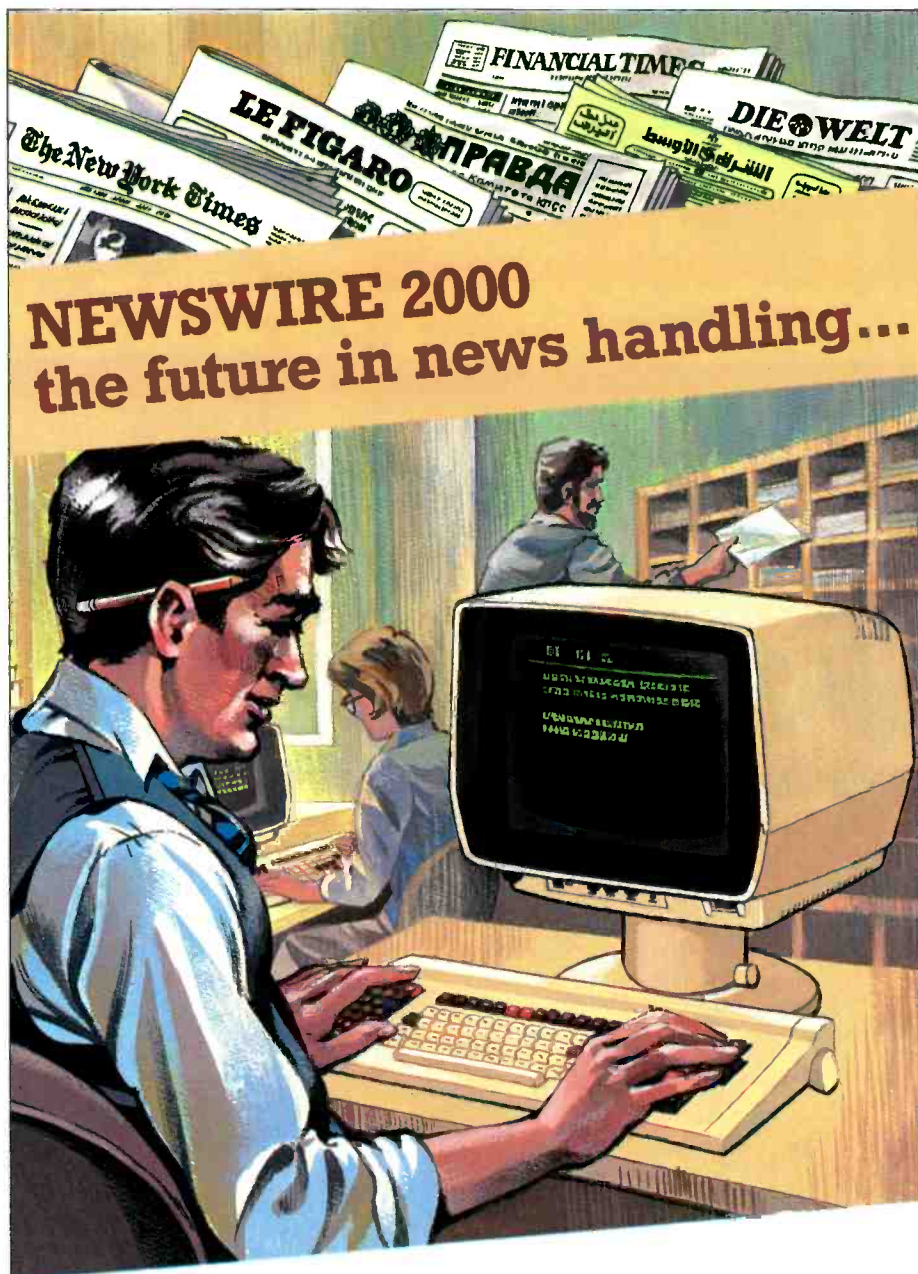
See us at the N.A.B. Show in Las Vegas, April 14 to 17, 1985 (Booth 1004)



## M/A-COM

Microwave innovations for a changing world.





## ...for press agencies and radio/TV news centres.

NEWSWIRE 2000: a computer based news handling system which fits into the press room like a hand in a glove.

- Multi-lingual split-screen editing, Arabic, Cyrillic and Latin characters
- Interfacing of wire services and transmission networks
- Library, filing and mail-box facilities
- Multiprocessor VAX cluster
- Round the clock operation, since 1983

For more interesting information contact  
Erwin Hieble, marketing manager  
phone: (49) 7191-13-33 47

or write to:  
ANT Nachrichtentechnik GmbH  
P.O. Box 1120  
D-7150 Backnang  
Federal Republic of Germany  
Teletex: 7 19132 antksav

**ANT**  
Telecommunications

In order to avoid unnecessary effort and time in troubleshooting, use the process of elimination to identify sections of the circuit to be examined. If, for example, the test at point A had indicated the problem was not in the load, but in the power supply, a logical spot to perform the next test would be at point C (for long high voltage cable runs). This test would identify or eliminate the interconnecting cable as a cause of the fault condition.

If the cable run from the high voltage supply to the PA compartment is short, point D might be the next logical point to check. Breaking the connection at the input to the power supply filter assembly allows the rectifiers and interconnecting cables to be checked.

Components protected by transient suppression devices (as shown above L1) should be considered a part of the component they are designed to protect. If a choke is removed from the circuit for testing, its protective device should also be removed. Failure to remove both connections could damage the protective device.

To avoid creating a new problem while trying to correct the original failure, break the circuit in only one point at a time. Also, study the possible adverse effects of each planned step in the process. Disconnecting certain components from the circuit may cause overvoltages or power supply ripple that may damage other components in the transmitter. Consult the manufacturer to be sure.

### Safety considerations

Perform any troubleshooting work on a transmitter with extreme care. Transmitter high voltages can be lethal. Such work should be performed only when a second engineer is with you.

Perform work inside the transmitter only after all ac power has been removed and after all capacitors have been discharged using the grounding stick provided with the transmitter. Remove primary power from the unit by tripping the appropriate power distribution circuit breakers in the transmitter building. Do not rely on internal contactors or SCRs to remove all dangerous ac.

Be familiar with first aid treatment for electrical shock and burns. Always keep a first aid kit on hand at the transmitter site.

Do not defeat protective interlock circuits. Although defeating an access panel interlock switch may save work time, the consequences can be tragic.



# IN SEARCH OF EXCELLENCE.

Long before it was a popular management theory, broadcasters were searching for excellence.

Excellence of Sound.

The search is still on, but the goal is now within the reach of every FM broadcaster.

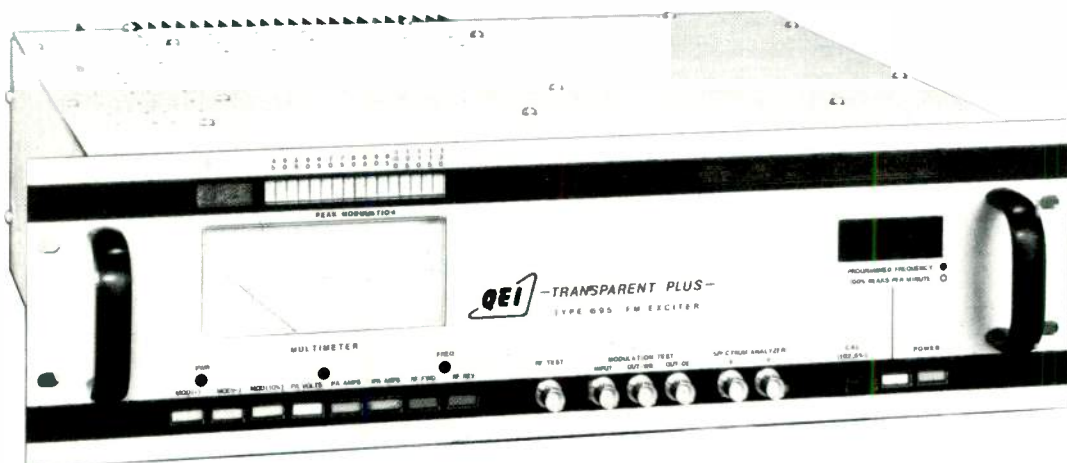
The 695 is an exciter without equal . . . in quality sound . . . in versatility . . . and in value. Any type of distortion you can name (THD, TIM, IMD) is less than .025 percent. This isn't an environmentally controlled lab figure, but rather one that is measurable over the operating temperature range of the equipment. Moreover, noise is so low that it's virtually impossible to measure.

QEI's 695 offers features that the competition has never even dreamed of. A peak counter with LED display, modulation measurements on the front panel, and a measurements grade linear demod built in. It is synthesized, has wideband circuitry, a 3-color LED bar graph for modulation display, a 10-position meter, and many other features that are best described in our new brochure.

For more information on QEI and the 695 Exciter just write or call us. You'll see why our search for excellence has produced the best value on the market today.

## QEI Corporation

One Airport Drive □ P.O. Box D  
Williamstown, NJ 08094 □ (609) 728-2020



Circle (70) on Reply Card

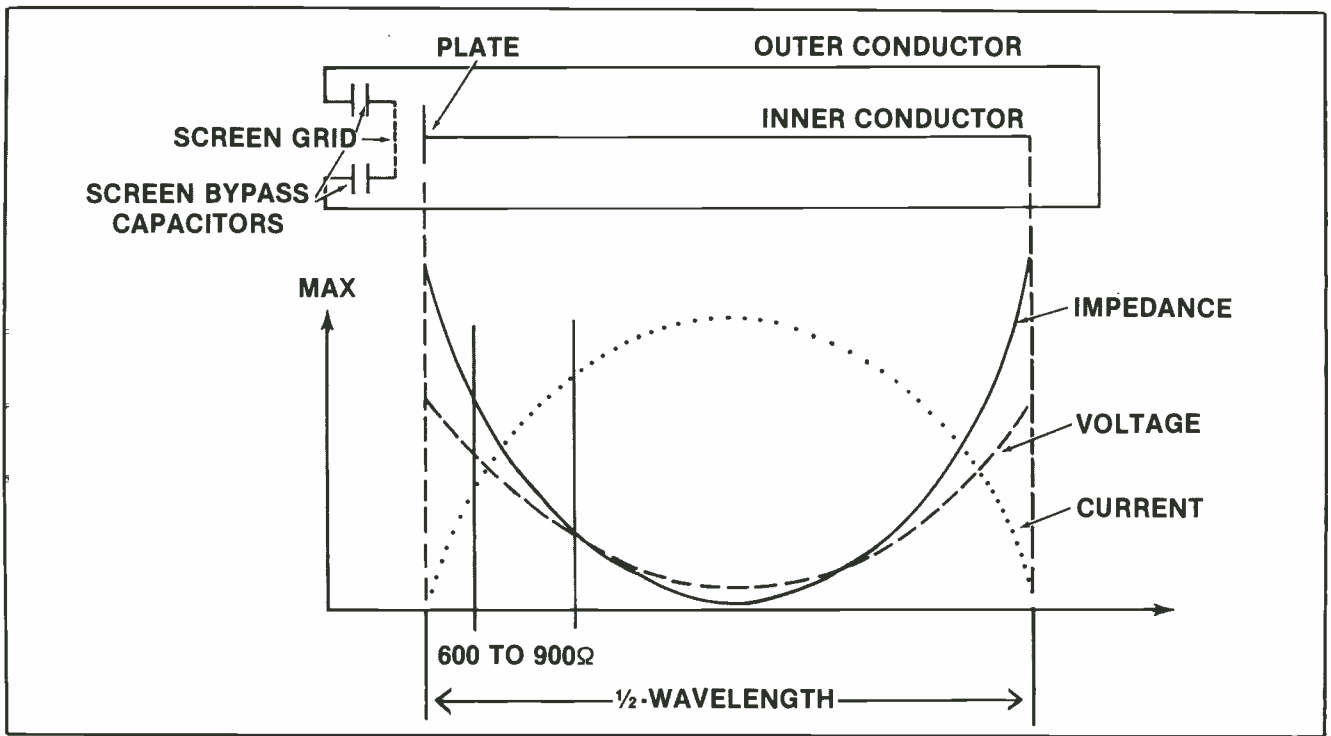


Figure 2. The distribution of RF voltage, current and impedance along the inner conductor of a  $\frac{1}{2}$ -wavelength cavity.

shortened transmission line circuit must, however, be *electrically resonated* (lengthed) to  $\frac{1}{2}$ -wavelength for proper operation.

If the line length were changed to

operate at a different frequency, the plate impedance would also change because of the new distribution of RF voltage and current on the new length of line. The problem of frequency

change, therefore, is twofold: The length of the line must be adjusted for resonance, and the plate impedance of the tube must be kept constant for good efficiency.

# A REAL TV STAR!

If you're on the air all day and night, you need a dependable digital TBC to handle various types of broadcast equipment.

Operating in the direct and heterodyne modes, the nova 510 is designed for optimum correction of non-segmented  $\frac{3}{4}$ " and  $\frac{1}{2}$ " video tape recorders.

If you aggressively cover news and sports in your community, you'll be pleased that the nova 510 is the "take anywhere TBC" at only 10 pounds and one and three quarter inches high.

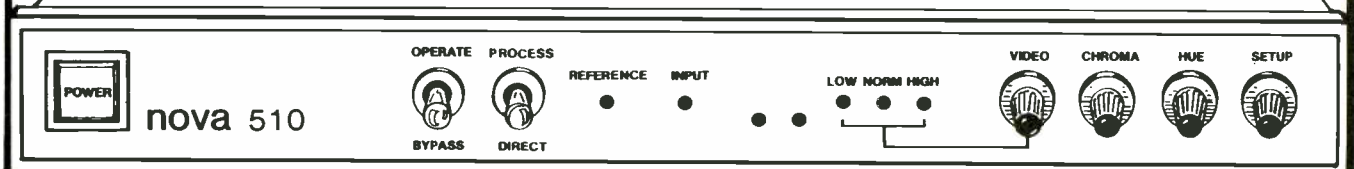
And your production staff will find it a breeze to use. Our "picture in shuttle" feature also allows you to pause the recorder for a stable color picture that can be recorded—all at no extra cost.

There's 8 bit 4x subcarrier sampling for maximum picture fidelity. And our advanced design memory provides 32 lines of video storage.

All this, for the low price of \$7,450. The nova 510 is the lowest-priced, full feature digital TBC on the market. We guarantee it.

**CATCH THE RISING STAR IN TBC'S! nova systems**

20 tower lane avon, ct 06001  
203-677-5252



Circle (72) on Reply Card



# REMARKABLE EDITING POWER. PURE AND SIMPLE.

## THE EMME™ COMPUTERIZED EDITING SYSTEM

Now there's a way of editing so simple, so powerful, it may change the mechanics of editing forever. A way of editing so flexible, it adjusts to YOUR style of editing.

### Picture and Sound Editing with the Mouse Control

EMME's revolutionary Cinemagraphic Editing Workstation makes simple work out of editing. No dials, switches or complicated command language to learn. Just a single-button mouse control that lets you make all source movement and edit sections directly from simple, on-screen menus. Finally, here's an editing system that puts all time code and computer-related functions in the background. So you can concentrate on the creative process, editing "film-style" by picture and sound.

### Time Code Editing with the Video Editing Workstation

But because the EMME computer can be used with our Video Editing Workstation, those editors who like to work with time code and edit list management can still do so with EMME. We started with a functional, easy-to-learn control panel, designed to minimize button pushing. Then arranged the most used keys in a logical triangular pattern for ease of use. All in one comfortable, familiar package.



### Time Code or Film-Style— The Choice is Yours

What makes it all possible is the heart of the system, EECO's EMME computer. Plug-compatible with either workstation, the EMME computer offers sophisticated editing features like:

- Fast, comprehensive edit decision list management
- Time-saving event clustering
- Auto assembly with full look-ahead search

And because the EMME computer works with EITHER workstation, you can choose the one most comfortable for your editing style. And that's something no other editing system can offer, at any price.

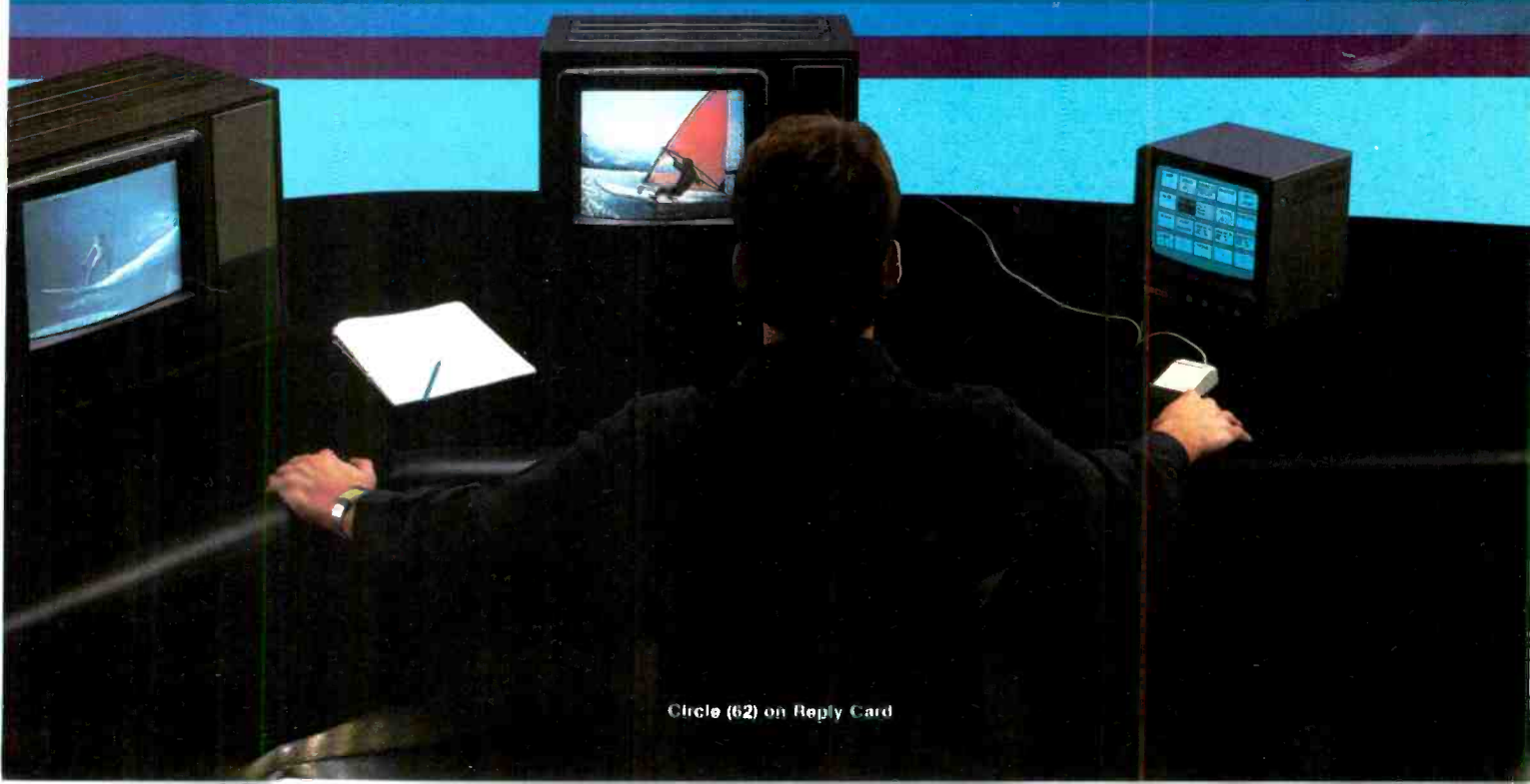
### See for Yourself

So if you've always wanted the speed and precision of time code editing with film-style ease, or if you're looking for a way to expand the market for your editing services, you owe it to yourself to take a serious look at EMME. From EECO, the people who pioneered time code editing almost 20 years ago.

For more information about EMME or about our series of one-day "Editing With Time Code" seminars for 1985, call our Video Products Customer Service Department, (714) 835-6000, ext. 2419, or write EECO Incorporated, 1601 E. Chestnut Avenue, P.O. Box 659, Santa Ana, California 92702-0659.

## EECO

Computer Controls for Video Production



### A practical cavity

To accommodate operation of the transmitter at different frequencies while keeping the plate impedance constant, two forms of coarse tuning and one form of fine tuning are built into the  $\frac{1}{2}$ -wave PA cavity.

Figure 3 shows the tube and its plate line (inner conductor). The inner conductor is U-shaped to reduce the cavity height.

With the movable section (the *plate tune control*) fully extended, the inner conductor measures 38 inches and the anode strap measures seven inches. The RF path from the anode strap to

the inside of the tube plate (along the surface because of the skin effect) is estimated to be about eight inches. This makes the inner conductor's maximum length about 53 inches.

This is too short to be a  $\frac{1}{2}$ -wavelength at any FM frequency. The full length of a  $\frac{1}{2}$ -wave line is 54.7 inches at 108MHz and 67.1 inches at 88MHz.

The coarse tuning and fine tuning provisions of the cavity, coupled with the PA tube's output capacity, resonate the plate line to the exact operating frequency. In effect, they electrically lengthen the physically foreshortened line. This process,

along with proper loading, determines the plate impedance and, therefore, the efficiency.

### Lengthening the plate line

The output capacity of the tube is the first element that electrically lengthens the plate line. A  $\frac{1}{2}$ -wave transmission line that is too short offers a high impedance that is both resistive and inductive. The tube's output capacity resonates this inductance. The detrimental effects of the tube's output capacity are eliminated.

Another element that will electrically lengthen the line is the stray capacitance between the movable section (plate tune) and the cavity box (the outer conductor).

The anode strap and the cavity inner conductor rotary section provide two methods of coarse frequency adjustment for resonance.

The anode strap (shown in Figure 3) has less of a cross-section than the inner conductor of the transmission line. It, therefore, has more inductance than an equal length of the inner conductor. The anode coupling strap acts as a series inductance and electrically lengthens the plate circuit.

At low frequencies, one narrow anode strap is used. At mid-FM frequencies, one wide strap is used. The wide strap exhibits less inductance than the narrow strap and does not electrically lengthen the plate circuit as much.

At the upper end of the FM band, two anode straps are used. The parallel arrangement lowers the total inductance of the strap connection and electrically lengthens the plate circuit only a small amount.

There are two ways to view the action of the rotary section in the plate circuit. It can—in effect—be thought of as either a variable capacitor or a variable inductor.

### Variable capacitor theory

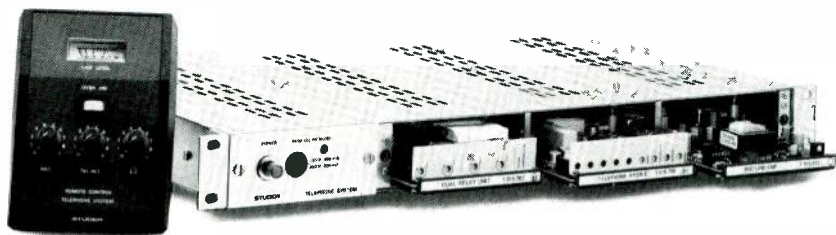
The main portion of the plate resonant line and the rotary section can be thought of as a single transmission line with an expanded conductor area, regardless of the rotor position.

The capacity of the rotary section is greatest when the assembly is closest to the cavity box (outer conductor). It is least when the assembly is furthest from the outer conductor. This shunt capacity electrically lengthens the line and lowers the resonant frequency. The amount of frequency change depends on the position of the rotary section.

### Variable inductor theory

The main section of the plate resonant line, together with the rotary section, can also be thought of as a

# Standard Setter



## The Standard-Setting Telephone Interface (Modestly Improved)

It's no secret. Studer has become the acknowledged leader in high quality telephone interfacing equipment. The Studer Telephone Hybrid—already selected by hundreds of U.S. broadcasters, including all three major networks—has been praised for its straightforward design, long-term reliability, and consistently outstanding performance.

At the heart of the Studer Telephone Hybrid is an auto-balancing hybrid circuit which automatically matches phone line impedance while isolating send and receive signals for maximum sidetone attenuation. A built-in limiter prevents sudden overloads, and bandpass filters shape the voice signals for optimum clarity and system protection. The new updated Studer Hybrid includes additional noise suppression circuitry to eliminate unwanted noise and crosstalk while still preserving true 2-way hybrid operation.

Now the Studer Telephone Hybrid is also available as part of a complete Telephone System. Designed to operate independent of the studio console, the self-contained Telephone System includes a microphone input plus a palm-sized remote module (on a 30' cable) with VU meter for line level, headphone output, and level controls for microphone, headphone, and telephone receive.

The time-tested Studer interfaces. Improved for even better performance. Expanded for more flexible operation. And built to set the quality standard for years to come. Call today for the location of your nearest Studer dealer.

## STUDER REVOX

Studer Revox America

1425 Elm Hill Pike • Nashville, TN 37210 • (615) 254-5651

Circle (63) on Reply Card



# PLAN AHEAD

**BSM**   
**BROADCAST  
SYSTEMS** INC.

## YOUR BLUEPRINT OF ADVANCED TECHNOLOGY

BSM  
provides a complete line of  
DISTRIBUTION AMPLIFIERS  
and  
ROUTING SWITCHERS  
designed to stay ahead  
of your expanding needs —  
through  
MODULARIZATION

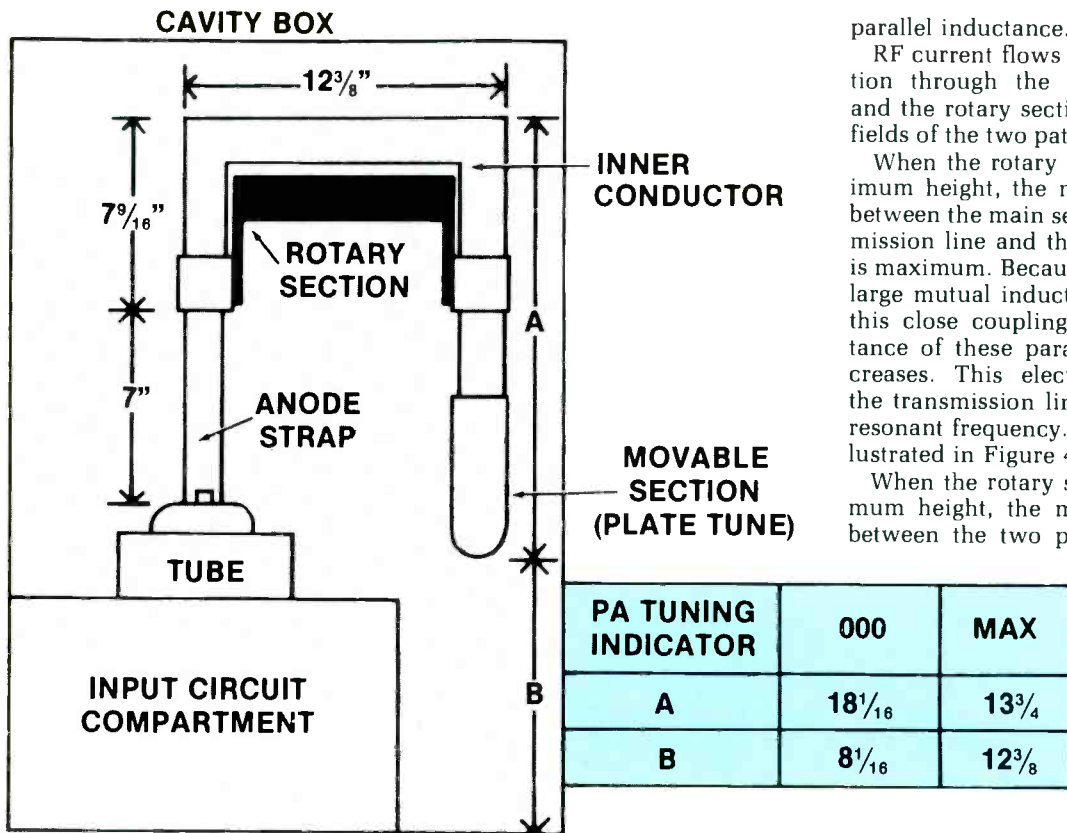


Telex #326417 Call Back: JREMOSPK

**BSM Box 8081 Spokane, WA 99203 (509) 448-0697**

Circle (68) on Reply Card

**Figure 3.** The configuration of a practical  $\frac{1}{2}$ -wavelength PA cavity.

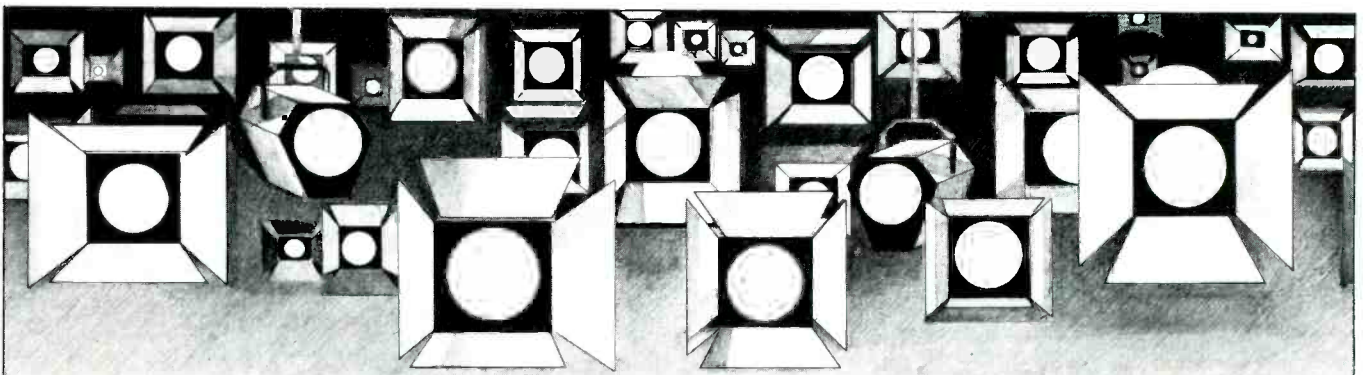


parallel inductance.

RF current flows in the same direction through the transmission line and the rotary section. The magnetic fields of the two paths, therefore, add.

When the rotary section is at minimum height, the magnetic coupling between the main section of the transmission line and the rotary assembly is maximum. Because of the relatively large mutual inductance provided by this close coupling, the total inductance of these parallel inductors increases. This electrically lengthens the transmission line and lowers the resonant frequency. The concept is illustrated in Figure 4(a).

When the rotary section is at minimum height, the magnetic coupling between the two parts of the inner



## Two concerns about studio lighting.

The first is that you can spend liberally on lighting equipment and still not get what you want. The second is that you can waste more in down-time than in the price of extra equipment if you don't have what you need.

We've already helped with more than 1,000 studio facilities all over the American continent, including all major networks. So if you're ready...

## A remedy for these concerns.

We have people who will work with you customizing your studio lighting to your particular wants by installing a designed package lighting system that meets the wide spectrum of your needs.

For further information, contact your Kliegl representative or call or write our office.

**kliegl** Kliegl Bros.  
32-32 48th Avenue  
Long Island City, NY 11101  
(718) 786-7474 Telex:960158



# THE "THIRD" TRACK

FEATURED ACTOR: A810 TC

TAPE FORMAT: 1/4"

AUDIO TRACKS: 2 (STEREO OR 2 TRACK)

CODE TRACK: THE "THIRD" TRACK

CODE FORMAT: SMPTE/EBU

CROSSTALK CODE-AUDIO: >90dB

OFFSET: ZERO

OFFSET COMPENSATION: UP-

CONTROLLED DELAY LINE

COINCIDENCE: EXTREMELY PRECISE

Take One! Or take several. Studer's new A810-TC has established a new standard for stereo audio-for-video production. By placing time code on a center track between standard stereo audio tracks on 1/4" tape, the A810 lets you synchronize high quality stereo soundtracks with your VTRs. So you don't need a 4-track recorder using costly 1/2" tape. Two separate code heads and a microprocessor delay line add up to the best center track SMPTE system on the market.

In all respects, the A810 is the most advanced analog recorder available. With microprocessor control of transport, audio functions, and audio parameter settings. Digital memory storage of audio parameters for two tape formulations. Four speeds. Advanced phase compensation circuits for superior square wave response. Plus a serial interface option for external computer control. The list goes on.

Details on the A810 could fill a 20 page booklet. So we wrote one. Call or write today for your free copy.

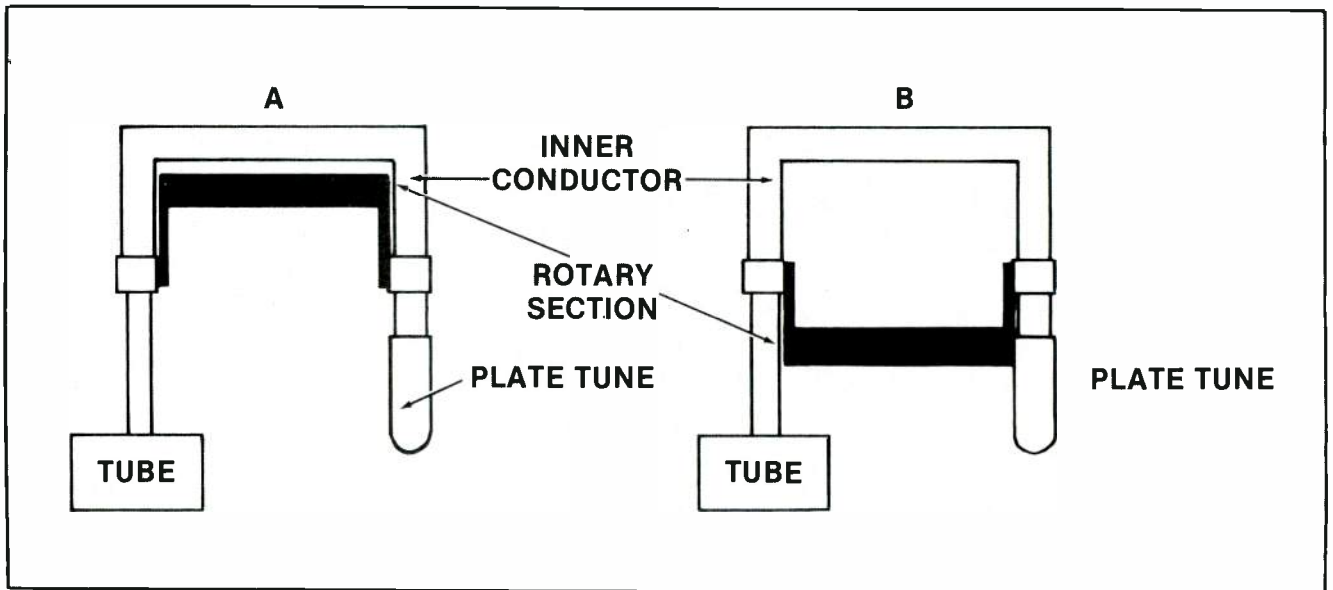


A810-TC shown with Studer TLS4000 modular synchronizing system.

**STUDER** REVOX

Studer Revox America, Inc./1425 Elm Hill Pike/Nashville, TN 37210/(615) 254-5651

Circle (65) on Reply Card



**Figure 4.** Using the cavity's movable section to adjust for resonance. Diagram (A) shows the rotary section at maximum height and (B) shows the rotary section at minimum height.

conductor is minimum. This reduced coupling lowers the mutual inductance, which lowers the total inductance of the parallel combination. The reduced inductance allows operation at a higher resonant frequency. This condition is illustrated in Figure 4(b). The rotary section provides an in-

finite number of coarse settings for the various operating frequencies.

#### Plate tuning

The movable plate tune assembly is located at the end of the inner plate transmission line. It can be moved up and down to change the physical

length of the inner conductor by about 4 11/16 inches. This assembly is linked to the front panel plate tuning knob, providing a fine adjustment for cavity resonance.

March's "Troubleshooting" will continue the discussion of the 1/2-wavelength PA cavity. [:-:-:-)]



The Monroe Model 5002 Remote Control will handle channel selection for two dual audio or voice cue modules for the Scientific Atlanta DAT-32\* and the Comtech DART-384\*. It will also provide remote transponder selection for the DART-384\*.

**THE NEW 5002 WILL SAVE YOU TIME AND MONEY AS YOU REDUCE THE NUMBER OF DEDICATED LINES AND CHANNEL CARDS.**

- Control by phone
- Access Code
- Memory
- Automatic Disconnect
- Low Priced

Write or phone today for literature. See us at the NAB. (639 & 2378)

# A NEW DAT REMOTE CONTROL FROM MONROE ELECTRONICS

**M** **MONROE ELECTRONICS, INC.**  
**E**

211 Housel Avenue, Lyndonville, NY 14098 Phone: (716) 765-2254 Telex: 756662 Easylink: 62547850

\* Registered Trade Names

Circle (66) on Reply Card



# The unique Calrec Soundfield Microphone MK IV

## THE FEATURES

- Totally steerable both vertically and horizontally in POST PRODUCTION, off tape.**
- Variable stereo capsule angle and polar pattern in POST PRODUCTION, off tape.**
- Variable zoom, both forwards and backwards, in POST PRODUCTION, off tape.**
- The only truly coincident stereo microphone in the world.**
- Very low noise performance for the digital era.**
- Separate outputs for Ambisonic surround sound.**
- Level frequency response both on- and off-axis.**
- The most accurate polar patterns in the world.**
- Maximum input for less than 0.5% THD 140 dB SPL.**

## THE FACTS

The spherical three-dimensional pick-up of the Soundfield Microphone is such that the phase errors introduced by the capsule spacing in normal microphones are effectively eliminated and the resulting stereo output of the control unit has virtually perfect image placement at all frequencies. The differing frequency responses of the pressure and gradient components of the signal are also corrected, thus giving an equally flat response to both on- and off-axis sounds. These two facts make it possible, for the first time ever, not only to generate exactly signals envisaged by A. D. Blumlein when he first proposed the M/S system, but to extend them into three dimensions.

This spherical representation of the original soundfield allows a stereo signal to be extracted pointing in any direction and of any first order polar diagram. The angle between the two microphones may be varied between 0° (mono) and 180° and the apparent proximity to the original sound sources may also be adjusted.

The control unit also provides a four-channel output signal, known as "B format," which exactly represents the first order characteristics of the soundfield. Recordings stored in "B format" allow the POST SESSION use of all the aforementioned controls. The advantage of being able to set such critical parameters as image width, direction of point and tilt, polar patterns and distance – all in the peace and quiet of the dubbing studio – cannot be over-emphasised. "B format" is also the professional signal format for Ambisonic surround sound and may be encoded directly to domestic transmission and consumption formats.

*For further information, please contact your local dealer, national distributor or:-*

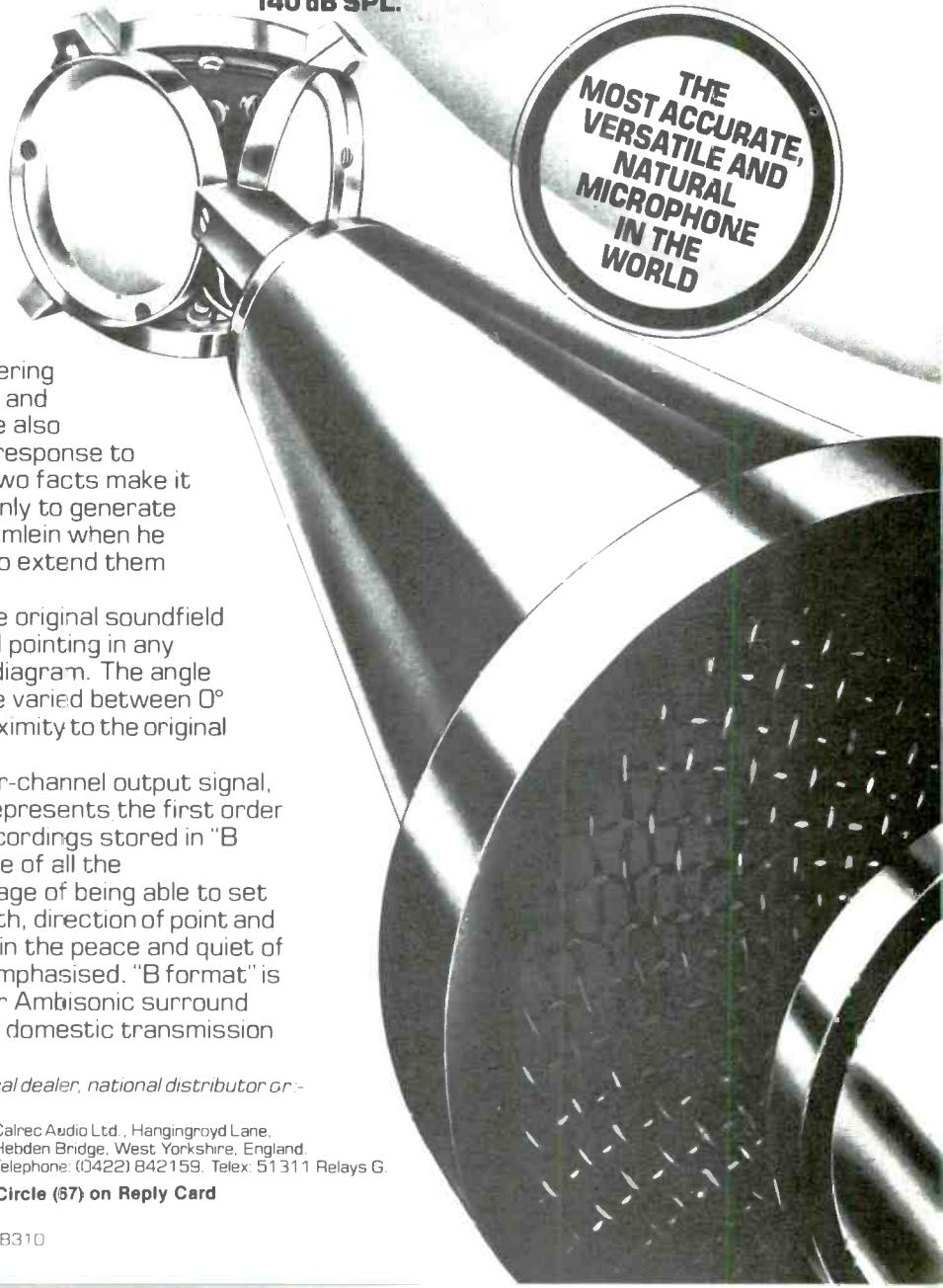


Calrec Audio Ltd., Hangingroyd Lane,  
Hebden Bridge, West Yorkshire, England.  
Telephone: (0422) 842159. Telex: 51311 Relays G.

Circle (87) on Reply Card

## U.S.A. & CANADA

Audio and Design, Inc. P.O. Box 786 Bremerton WA 98310  
Telephone: 206275 5009 Telex: 152426 ADR USA



# Standby power systems: Reducing the power failure threat

By Jerry Whitaker, editor

When most people discuss utility company power problems, they immediately think of blackouts. The lights go out and everything stops. Blackouts, however, rarely occur in most areas of the country and are generally short in duration. Studies have shown that 50% of all blackouts last six seconds or less, and another 35% are less than 11 minutes long. These power failure figures are not usually cause for concern to commercial users, except to broadcasters.

A station that is off the air for 11 minutes—or even five minutes—will suffer a drastic audience loss than can take hours (or perhaps days) to rebuild. Coupled with this threat is the possibility of extended power service loss because of storms. Many broadcast transmitting sites are located in remote, rural areas or on mountain tops. Neither of these locations are well known for their power reliability. It is not uncommon in mountainous areas for utility company service to be down for several days after a major storm. Few broadcasters are willing to take such risks with their air signal, and choose to install standby power systems at appropriate points in the transmission chain.

The cost of standby power for a broadcast facility (particularly high-

Courtesy of Topaz

## 10 ways to solve your most common microphone problems.

- Input Overload** . . . . . **A15AS** Microphone Attenuator—inserts 15, 20 or 25 dB loss to prevent overload.
- Phasing** . . . . . **A15PRS** Switchable Phase Reverser for balanced lines.
- Low-Frequency Noise** . . . **A15HP** High Pass Filter—reduces low-frequency noise and proximity effect.
- High-Frequency Noise** . . . **A15LP** Low Pass Filter—reduces objectionable high-frequency noise.
- Lack of Presence** . . . . . **A15PA** Presence Adapter—adds intelligibility and brilliance.
- Excessive Sibilance** . . . . . **A15RS** Response Shaper—sibilance filtering, plus flattened response.
- Adapting Line Level to Mic Input** . . . . . **A15LA** Line Input Adapter—converts balanced low-impedance mic input to line level input.
- Matching/Bridging/Isolating** . . . . . **A15BT** Bridging Transformer—matches balanced or unbalanced devices of different impedances.
- Troubleshooting** . . . . . **A15TG** Tone Generator—700 Hz signal helps check levels, connections, mixer inputs, and cables.
- Microphone Impedance Matching** . . . . . **A95** and **A97** Series Line Transformers—make it possible to connect low impedance lines to mid and high impedance inputs (or vice-versa).

Shure Brothers Inc., 222 Hartrey Ave., Evanston, IL 60204. (312) 866-2555.

# SHURE®

THE SOUND OF THE PROFESSIONALS®... WORLDWIDE

Circle (73) on Reply Card





power radio or TV) can be substantial, and an examination of the possible alternatives should be conducted before any decision on standby equipment is made. Management should clearly define the direct and indirect costs, and weigh them appropriately.

This cost-vs-risk analysis should include the standby power system equipment purchase and installation price, the exposure of the transmission system to utility company power failure, the alternative transmission methods available to the station and the direct and indirect costs of lost air time because of blackouts.

### Standby system options

The classic standby power system using an engine-generator is shown in Figure 1. An automatic transfer switch monitors the ac voltage coming from the utility company line for any power failure conditions. Upon detection of an outage for a predetermined period of time (generally one to 10 seconds), the standby generator starts. Once up to speed, the load is transferred from the utility to the local generator. Upon return of the utility feed, the load is switched back and the generator stops. This basic type of system is widely used in the broadcast industry and provides economical protection against pro-

longed power outages (five minutes or more).

In metropolitan centers, two utility company power drops can be brought into a facility as a means of providing a source of standby power. As shown in Figure 2, two separate utility company service drops—from separate power distribution systems—are brought into the plant and an automatic transfer switch changes the load to the back-up line in the event of a main line failure.

This dual feeder system has an advantage over the auxiliary diesel arrangement, shown in Figure 1, in that the power transfer from main to standby can be made in less than a second. Time delays are involved in

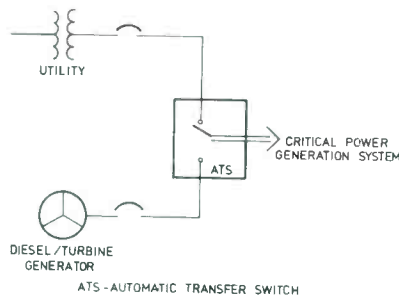
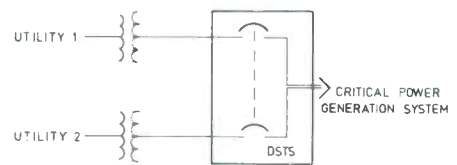


Figure 1. The classic standby power system using an engine-generator unit. This system protects a facility from prolonged utility company power failures.



DSTS DUAL SUPPLY TRANSFER SWITCH

Figure 2. The dual feeder system of ac power loss protection. An automatic monitoring system switches the load from the main utility line of the standby line during a power disruption.

the diesel generator system, which limit its usefulness to power failures lasting more than several minutes.

The dual feeder system of protection is based on the assumption that each of the service drops brought into the facility is routed via a different path. The likelihood of a failure on both power lines simultaneously is remote. The dual feed system will not, however, protect against the occasional area-wide power failure.

The dual feeder system is primarily limited to urban areas. Rural or mountainous regions are not generally equipped for redundant utility company operation. Even in urban areas, the cost of bringing a second power line into a broadcast facility can be high, particularly if special lines must be installed for the feed.

# The TSM advantage.

VS-200M... an economical Pan/Tilt System that for the first time integrates a variable speed Pan/Tilt head with motorized ENG lenses... and from a single source... TSM.

Check these lens and Pan/Tilt System features:

- TSM's exclusive motorized lens control systems for ENG bayonet mount lenses include Zoom/Focus, Focus Only and Focal Length Speed Control Feedback.
- The Focal Length control system, for zoom lenses, provides feedback to optimize the Pan/Tilt speed based on lens setting... max. speed at wide angle; min. speed at tele-angle... another TSM operating feature for a professional On-Air presentation.
- Variable speed range from 3° up to 12°/Sec.
- Precision gears and adjustable drag clutch in drive system provide a smooth, accurate On-Air operation in the pan and tilt modes.
- TSM's rugged, pedestal/ceiling mount is driven by high torque DC motors and has fully adjustable microswitch end stop protection.

Call or write for complete details on VS-200M and TSM's complete product line of Pan/Tilt heads and accessories.

Dealer inquiries are welcomed.



**TOTAL SPECTRUM MANUFACTURING INC.**  
20 Virginia Avenue  
West Nyack, NY 10994  
(914) 358-8820

THE NEW, INNOVATIVE EQUIPMENT SOURCE.

Control panel shown is for a custom console

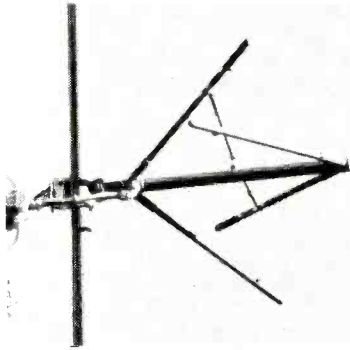


# Cetec Antennas

## WHY BUY JUST AN ANTENNA? WITH A CETEC ANTENNA YOU GET:



★ HIGH QUALITY ★  
TWO YEAR WARRANTY  
PERFORMANCE THAT'S UNEQUALLED  
RECOGNIZED SUPERIORITY



In today's competitive FM market, you have no reason to consider an antenna that's not the very best. That means a tried and proven Cetec antenna. Over one thousand JSCP Penetrators have built this reputation, and other Cetec models support higher or lower power requirements.

NOW, DON'T YOU WISH YOU HAD A CETEC? THE EDGE IN PERFORMANCE!

CALL THE FACTORY OR YOUR CETEC DEALER

Cetec Antennas  
6939 Power Inn Rd.  
Sacramento, CA 95828  
Tel: (916) 383-1177  
Telex: 377 321

Circle (74) on Reply Card

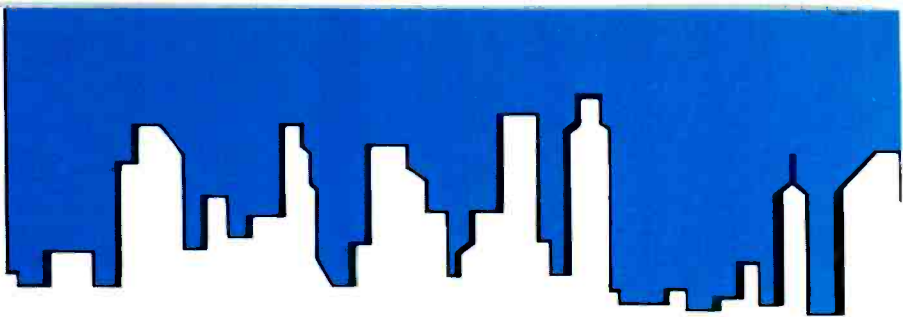
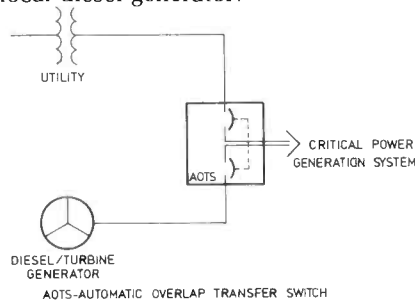


Figure 3 illustrates the use of a back-up diesel generator for both emergency power and peak power shaving applications. Commercial power customers often realize substantial savings on utility company bills by reducing their energy demand during certain hours of the day. Figure 3 shows the use of an automatic overlap transfer switch to change the load from the utility company system to the local diesel generator.



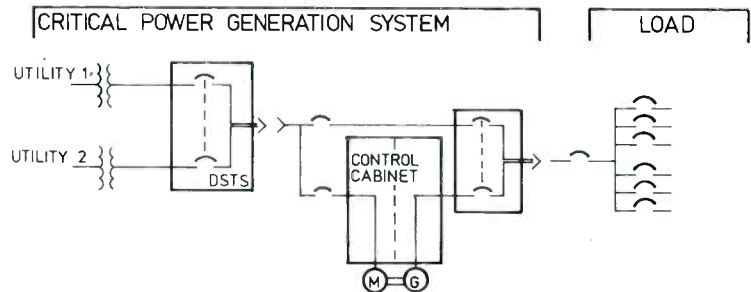
**Figure 3.** Using a diesel generator for emergency power and peak power shaving applications. The automatic overlap transfer switch changes the load from the utility feed to the generator instantly so there is no disruption of normal operation.

This changeover is accomplished by a special transfer system that does not disturb the load equipment operation. This application of a standby generator provides financial returns to the station regardless of whether the generator is ever needed to carry the load through a commercial power failure.

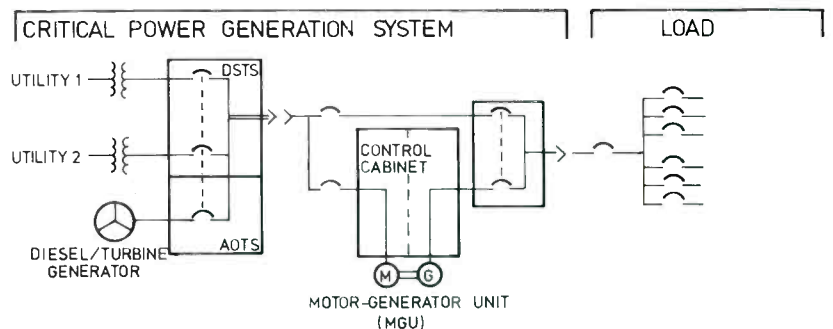
### Advanced system protection

A more sophisticated power control system is shown in Figure 4, where a dual utility supply is used to feed a motor-generator unit (MGU) to provide clean, undisturbed ac power to the load. The MGU will smooth over the transition from the main utility feed to the standby, often making a commercial power failure unnoticed by station personnel. An MGU will typically give up to 1/2 second of power-fail ride-through, more than enough time to accomplish a transfer from one utility feed to the other.

This principle is further refined in the application shown in Figure 5, where a diesel generator has been added to the ac power supply system. With the automatic overlap transfer

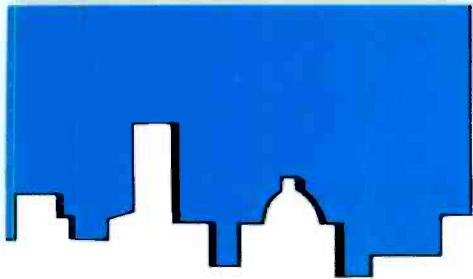


**Figure 4.** The dual feeder standby power system using a motor-generator unit to provide power-fail ride-through and transient disturbance protection. Switching circuits allow the MGU to be bypassed, if desired.



**Figure 5.** A premium power supply backup and conditioning system using dual utility company feeds, a diesel generator and a motor-generator unit. This arrangement would be used for critical loads that require a steady supply of clean ac.



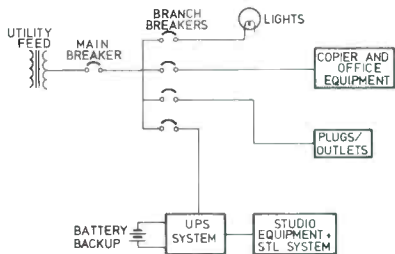


switch shown at the generator output, this system can also be used for peak demand power shaving.

#### Other considerations

The generator rating for a standby power system should be chosen carefully, keeping in mind any anticipated growth of the broadcast plant. It is good practice to install a standby power system rated for at least 25% greater output than the peak facility load. This headroom gives a margin of safety for the standby equipment and allows future expansion of the facility without worrying about overloading the system.

A station seeking standby power capabilities should also consider the possibility of protecting key pieces of equipment in an installation against power failures with small, dedicated, uninterruptible power systems (UPS). Small UPS units are available with built-in battery supplies for microcomputer systems and other hardware used by broadcasters.



**Figure 6.** An application of the "critical load" power bus concept. In the event of a power failure, all equipment necessary for continued operation would be powered by the UPS equipment. Non-critical loads would be dropped until commercial ac returned.

If economics prohibit the installation of a system-wide standby power system (using generator or solid-state UPS technology), the engineer should consider establishing a "critical load bus" that is connected to a UPS system or automatic transfer generator unit. This separate power supply would be used to provide ac to critical loads, thus keeping the protected systems up and running (Figure 6). Unnecessary loads would be dropped in the event of a power failure. A standby system built on the "critical load" principle can be a cost-effective answer to the power failure threat. | : : : : : ) ) ) ) )

### Accuracy... Dependability... Performance...

BELAR HAS PROVIDED THESE QUALITY PREREQUISITES IN OVER 11,000 BROADCAST MONITORS.

The FMM-2/FMS-2 series monitors provide an even greater degree of precision measurement and stability than ever before... Specifications, which include better than 90 dB S/N, less than .01% maximum THD and IM distortion, and 70 dB stereo separation, make Belar FM monitors the most accurate available today.

**BELAR ELECTRONICS LABORATORY, INC.**  
LANCASTER AVENUE AT DORSET, DEVON, PENNSYLVANIA 19333 • (215) 687-5550  
Call or write for more information on Belar AM, FM, Stereo, SCA and TV monitors.

Circle (82) on Reply Card

**TRIPAK™**  
Pat. Pend.

*Revolutionary New Concept  
In Tubular Case Design*

- Virtually indestructible.
- High density polyethylene.
- Octagonal shape with flat sides to prevent roll-around.
- Twin handle for instant balancing.
- 5 sizes.

1937-C Friendship Dr.,  
El Cajon, CA 92020  
(619) 258-1200

Dealer inquiries invited.

© 1984 NALPAK VIDEO SALES, INC.

Circle (83) on Reply Card

# Forever is a long time.

Lifetime guarantee on all 200-series DA's from Shintron.

Circle (84) on Reply Card



## HERE'S $\pi$ IN YOUR EYE

In any monitor, especially a near-field type, response will vary from a  $2\pi$  (wall/soffit) to a  $4\pi$  (free field/console) environment.

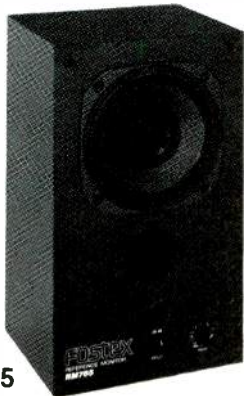
The better the performance, the more noticeable the phenomenon. In our case, with more than 20 international patents so far, this field select switch was absolutely necessary.

So that you could have the same flat response in either field or both fields.

These are Point Source reference monitors. Coaxial, and time compensation adjusted in a true concentric design. Stereo imaging the way it happens in nature.

They also take lots of power without distortion or complaint. They are stunning.

Audition the Near-Field Point Source Reference Monitors. From Fostex. RM-765 (6½" woofer) and RM-780 (8" woofer). Both with patented RP Technology. For flat response in both  $2\pi$  and  $4\pi$  environments.



RM765



RM780

**Fostex**<sup>®</sup>  
Pro Sound Division

FOSTEX CORPORATION OF AMERICA  
15431 Blackburn Avenue, Norwalk, CA 90650 (213) 921-1112

Circle (76) on Reply Card

## FCC Update

Continued from page 8

law requires the commission to promulgate regulations authorizing franchising authorities to regulate basic cable rates for systems that are not subject to "effective competition." One possible way of defining effective competition is in terms of the availability of off-air signals.

For instance, a system located in a community receiving four Grade B TV services, including three network services, could be considered to have a sufficient number of obviate the need for rate regulation.

Congress has also directed the commission to establish procedural standards for rate regulation in instances when systems do not have effective competition. The commission is proposing rules that would require formal public notice of rate proceedings, an opportunity for interested parties to make their views known, and issuance of a formal statement once a decision on rate matters is made.

With respect to the substance of rate-making decisions, the commission proposes to require that rates be set according to a "comparable rate" method. With this method, rates would be made equal to levels in comparable unregulated markets. [:(~)]]



Want  More  
information  
on advertised  
products?

Just refer to the reader service # beneath each ad. Circle the appropriate number on the Reader Service Card in the back of this issue. Complete the remaining information and mail!

**BROADCAST**  
engineering

P.O. Box 12901, Overland Park, KS 66212  
U.S.A.



## Save Money Buy AUDIO EQUIPMENT

- Lowest costs
- Quick turn around on all orders
- Fast delivery
- Complete inventory
- Unconditional Satisfaction Guaranteed

Call  
**1-800/54-RADIO**

for your copy of the famous

## GREEN LIST CATALOG

*Our ability to serve and satisfy  
has made us famous*

**david green**

broadcast consultants corporation  
Box 8782 BWI Airport, MD 21240

Circle (106) on Reply Card



### WALTER S. BREWER CO., INC.

4717-F SO. MINGO ROAD  
TULSA, OKLAHOMA • 74146  
(918) 665-6820

Lighting Consultants, Engineering &  
Sales, Television, & Motion Pictures

Circle (105) on Reply Card

Want more  
information on  
advertised  
products? Use the  
Reader Service  
Card.

Continued from page 64

above, below and on both sides of the one being quantized. The resulting level closely resembles the actual video, minus noise. Such an integration process eliminates much of the noise, which being random in nature does not come through normal averaging processes well.

•**Differentiation**—A blurred picture sharpened by enhancing the real edges in the video signal. This is the opposite of integration or averaging. Mathematical differentiation can sharpen a picture blurred from the mechanics of a quantization system. With the concept of neighborhoods, orthogonal differentiation finds a mathematical derivative that relates the greatest change in gray level near any given pixel and uses that derivative during quantization to effect more sharpness. This is superior to edge enhancement based on peaking circuits.

•**Aliasing**—The sampling process that often introduces unwanted signals as a byproduct. These spurious signals, called *aliasing* frequencies, must be removed through precise comb filters. Circuits to remove spurious frequencies are called anti-aliasing circuits.

•**Look-up table**—Pertinent data held in arrays of random access memory (RAM) or read-only memory (ROM). As a program is executed, a key is used to determine where to look up data in the array. Information for D/A processing may include special contouring, grey level treatments and color effects, in addition to words representing the video image. Such tables are typically dynamically addressed RAM, but special conditions may involve non-volatile ROM devices.

•**Digital filtering**—Signal filtering accomplished by a microcomputer. This is preferred to physical filters, which may hard limit signal bandwidths. Digital filtering, a result of recent advances in very large-scale integration (VLSI) ICs, is particularly useful when constraints or limits of a filtering circuit must change on a line-by-line or pixel-by-pixel basis, because of changing video or changing degrees of quantization with changes in picture detail.

•**Fourier analysis**—A branch of mathematics, developed by French mathematician Fourier, that applies to signal analysis. A Fourier series allows any complex waveform to be examined as a fundamental frequency plus a finite number of harmonics as sine and cosine functions. Fourier analysis is extensively used in digital video system designs where speed and limited bandwidths become critical.

||:~:~)))))

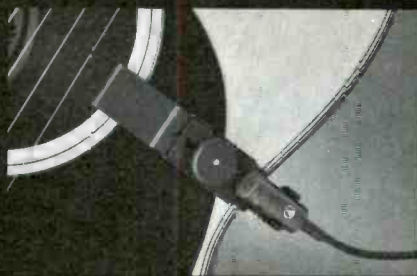
# Hang one on!

## Model AT831a

If ordinary miniature mikes are driving you to drink try the AT831a *cardioid clip-on*. Unlike *omni* miniatures the AT831a rejects noise from the back and sides, so only your talent comes through.

Operates from battery or phantom power...no rewiring needed. And the AT831a response is tailored to give you crisp articulation yet natural balance without tying up an equalizer like some others.

The low price of the AT831a means you can afford to upgrade your entire studio. See your nearby Audio-Technica sound specialist for details, prices, and clip-on performance others can't match. Or write for complete A-T catalog and dealer list today.



Adjustable musical instrument adapter offers greater versatility, better control of sound.



**audio-technica**

1221 Commerce Dr., Stow, OH 44224  
(216) 686-2600

Circle (77) on Reply Card

**Richard M. Wolfe** has been named vice president of technology for Sat-corp, New York. He will review innovations and trends in audio, video and satellite technology, with an emphasis on high-definition video applications, to determine their potential for investment or development. Wolfe is the former president of the Wolfe family radio and TV stations in Columbus, OH and Indianapolis. Also, **John Brady Jr.** has been elected vice president of finance and administration, and chief financial officer, and **David Saltman** has been named vice president of planning and development. Saltman is responsible for the development and review of new business opportunities in communications and pay television.

Gould, Rolling Meadows, IL, announces that **Michael S. Bernath** has been named president and general manager of the company's Programmable Control Division. Andover, MA, and **George M. Gordon** has been named president and general manager of the Systems Protection Division, Horsham, PA, succeeding Bernath.

**Steve Russell**, former director of operations for Walt Disney Telecommunications, has been named general plant manager of VCA Duplicating's facility in Naperville, IL. Russell will be responsible for all plant operations.

Jerry Ford, chairman of the board and chief executive officer of Lenco, Jackson, MO, announces the appointment of **Mark A. Hill** as assistant sales manager for Lenco's Electronics Division. Hill was a trust officer for Mercantile Trust Company N.A., the lead bank of Mercantile Bancorporation, St. Louis.

**Michael Crall** has joined Uniden Satellite Technology, Huntington Beach, CA, as regional sales manager. Crall will be responsible for overseeing all sales activities in the western region for Uniden's advanced line of TV receive-only satellite (TVRO) equipment. Crall was a former marketing representative with B. Eliot Suied Organization in California.

**A. Franz Witte III** has joined the Ampex Magnetic Tape division, Redwood City, CA, as manager of market

research and planning. He will create and implement division market analysis programs and develop models for future division growth.

**(Dennis) Ray Kirchhoefer** has joined Electro-Voice, Buchanan, MI, as engineering product manager/microphones, responsible for defining and developing new microphone products and product line concepts.

**Robert Dupras** has been appointed acting regional distribution manager for the Burbank, CA, regional distribution center of Agfa-Gevaert, Teterboro, NJ. He previously was office manager of the Burbank office.

Panasonic Industrial's audio-video systems group has appointed **Tom Nagai** to assistant general manager of product management. He will be responsible for product planning, line business management, training and technical support for Panasonic's professional audio-visual product line.

**Richard G. Canfield** has been named director of operations at CMX/Orox, Santa Clara, CA. [:-?>)]]]

## With our Automatic Remote Control System your transmitter – and your personnel – will operate with increased efficiency

Have you ever wondered if your night operator will remember . . . to switch patterns at sunrise? . . . to periodically check critical levels? . . . the correct transmitter restart sequence? You'll never have to worry if Potomac Instruments' RC16+ is on the job. Because it'll do all these tasks for you. Plus a lot more. Automatically.

With its microprocessor based control logic, the basic RC16+ provides 16 telemetry channels with automatic out-of-tolerance alarms and remote raise/lower controls;

plus 16 status channels. The automatic functions — pattern shift, transmitter restart, power control — are pre-programmed in accordance with station license requirements and controlled with an accurate master clock.

The RC16+ is also expandable. In 16 channel increments, up to a total of 64 channels. With the remote video display option your chief engineer can get a detailed readout of all measured parameters. It's updated every 30 seconds and connects to any standard telephone. The optional plug-in automatic logger provides a permanent record of all transmitter activity. Log intervals, sequence, and alarm flags are user-selectable.

And, best of all, the RC16+ is cost effective. No other unit on the market offers these features and capabilities at this low price.

Basic System . . . . .	\$4,995.00
Additional 16 Channels . . . . .	1,865.00
Plug-In Automatic Logger . . . . .	2,499.00
Remote Video Display Unit . . . . .	650.00



# POTOMAC INSTRUMENTS

932 PHILADELPHIA AVE. SILVER SPRING, MD 20910  
(301) 589-2662

Circle (78) on Reply Card



**Free trial  
Low prices  
Free trial  
Low prices**

## Color monitors

Discover for yourself the remarkable quality and extraordinary value for money of Philips color television monitors.

Professional users are offered a two week free trial (subject to availability) of either a 14" or 20" model for testing and evaluation. See for yourself the superbly sharp picture quality and the true color fidelity resulting from Philips high-brightness self-converging picture tube and precision in-line gun.

**20" color  
monitor  
only \$2995**

**14" color  
monitor  
only \$1995**

Both monitors are exceptionally stable and offer the kind of special features you'd expect to find on more expensive units, including two video inputs, RGB inputs, external sync., split screen and many more. Both versions have comb filter decoding as standard.

They're the perfect choice for all monitoring applications in television systems. But don't take our word for it.

See for yourself. Request a free trial on your letterhead, or return the coupon for a brochure.

For further information use the circle nos or send the coupon to:

**PHILIPS TELEVISION SYSTEMS, INC.**

900 Corporate Drive, PO Box 618 Mahwah, New Jersey 07430, USA  
Tel: 201-529-1550 Telex: 37-62558

**Free trial  
Low prices  
Free trial  
Low prices**



**PHILIPS**

Reliability through Quality

Please send me further information on

Philips color monitors 100

I would like a free trial of the

LDH6200 14" color monitor 101




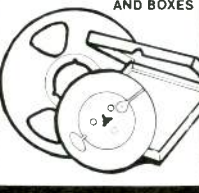



LDH6220 20" color monitor 102

Name

Status

Organization

Address

 <p>CONNECTORS AND MICROPHONE CABLES</p>	 <p>BLANK-LOADED AUDIO CASSETTES</p>
 <p>TAPES &amp; CASSETTES from AMPEX MAXELL AGFA TDK BASF 3M</p>	 <p>EMPTY REELS AND BOXES</p>
 <p>NAB BROADCAST CARTRIDGES</p>	 <p>CASSETTE BOXES, LABELS, ALBUMS</p>
 <p>ACCESSORIES</p>	

Ask for our  
**44 PAGE CATALOG**  
of  
**PROFESSIONAL  
SOUND RECORDING  
& DUPLICATING SUPPLIES**

Recording Supply Div. of Polyline Corp  
1233 Rand Road, Des Plaines IL 60016  
(312) 298 - 5300

35

Circle (80) on Reply Card

## EQUIPMENT

**Shook Electronic Enterprises**, San Antonio, TX, has delivered a new radio mobile van to the Voice of America, Washington, DC. Work began on Sept. 4, and the van was delivered on Jan. 18. The 27-foot Airstream van has lead-lined walls to block noise and is equipped to handle most broadcast applications, from interviews to live concerts. It is equipped to transmit through telephone lines, standard broadcast radio lines or by satellite.

**KMSP-TV**, Minneapolis/St. Paul, has purchased a 70kW transmitting system and a circularly polarized antenna from **RCA Broadcast Systems**, Gibbsboro, NJ. It will be the first station in that market to switch to circularly polarized broadcasting when installed this spring.

**KUSA-AM**, St. Louis, has become the first station to transmit in AM stereo using the AX-10 AM stereo exciter, from **Broadcast Electronics**, Quincy, IL. The model, developed under license from Motorola, was granted FCC-type acceptance in November.

**A.F. Associates**, a New York video systems integrator, has purchased 20 **Ampex VPR-6** VTRs. The VPR-6 also has been selected by the Swiss PTT to equip the Swiss Broadcasting Corporation. Eight VTRs with digital TBC will be shipped.

**M/A-Com**, Germantown, MD, has announced the receipt of three contracts from India. The Indian government has ordered digital speech interpolation equipment for the INSAT system and a supply of 4.8kbps burst demodulators for the Indian Meteorological Department. M/A-Com is also providing two low-cost earth stations for the Electronics Corporation of India.

**Comsat World Systems Division** has purchased an Intelsat Standard "E" satellite earth station from **Satellite Transmission Systems**, a subsidiary of **California Microwave**, Sunnyvale, CA.

**KERA-TV**, Dallas, has purchased two **Larcen 30kW** VHF TV transmitters. **KATV**, Little Rock, AK, has purchased a **TEC-IV** exciter from the company. **KHET**, Honolulu, and **KMEB**, Maui, Hawaii, have purchased 30kW and 5kW VHF TV transmitters.

**Private Satellite Networks** has ordered three transportable satellite terminals from **GEC McMichael**, Slough, England. The New York company specializes in teleconferencing via communications satellites.

**Elicon**, Brea, CA, will ship a computer-controlled camera system to Beijing Film Studios in the Peoples Republic of China. The studio will use it to film "Star Wars"-type special effects as well as live shots.

**Lake Systems**, Newton, MA, is building a stereo TV station for **WKSV-TV**, Marlboro, MA, with studios in Framingham, MA. The station is planning a 24-hour music video format with live broadcasts from the master control room.

## CORPORATE DATA

**Wiltron**, Mountain View, CA, announces the opening of its New England regional office at Woburn, MA. Tom Kilbourne, Northeastern regional sales manager, is the office manager. He is assisted by three sales engineers, Ed Macomber, Len Doiron and Dan Gabriner.

**Marconi Communications Systems**, Chelmsford, England, has announced the appointment of Comark Communications, Southwick, MA, as the sole distributor of Marconi's broadcasting transmitter products for the United States and Central and South America. Comark will also provide engineering, service and spare parts support.

**Tektronix**, Beaverton, OR, has authorized Allied Broadcast Equipment, Richmond, IN, to distribute a group of products, including the TM503, 506 and 515 mainframe power supply modules, the AA501 distortion analyzer and the SG505 audio oscillator.

**Logitek** has added two broadcast suppliers to its domestic dealer network: **Bradley Broadcast Sales**, Rockville, MD and **Keating Technical Services**, Tarzana, CA. Two new sales offices also opened by **Videomedia**, Sunnyvale, CA, will carry Logitek products. The offices are in Salt Lake City and Colorado Springs, CO.

**Acrodyne Industries**, Blue Bell, PA, has been purchased from its parent company, **Whittaker**, Los Angeles.

[:~:))]]

**CDE CORNELL-DUBILIER**

**Mica Capacitors**

LARGE

STOCK



**VACUUM CAPACITORS**

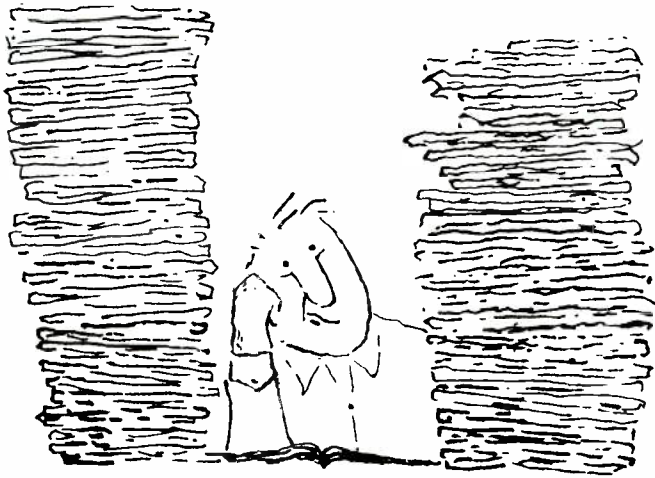
**ITT JENNINGS**

**SURCOM ASSOCIATES, INC.**

305 Wisconsin Avenue  
Oceanside, California 92054  
(619) 722-6162

Circle (81) on Reply Card





Don't wade  
through 1000 different  
product brochures...

Use BE's **Spec Book** instead!

Broadcast Engineering's 4th Annual **Spec Book** is designed to save you valuable time. And that makes it an essential tool for any broadcast equipment buyer.

#### Comprehensive Equipment Listings

**Spec Book** provides reliable specifications on nearly 1,000 different broadcast and broadcast related products, making it the industry's **only single-source equipment comparison reference encyclopedia.**

#### Spec Book is Unique

**Spec Book** is vastly different from buyers' guide directory issues, because it lists performance specifications, model numbers and special product features.

#### Easy-to-Read

**Spec Book's** convenient format developed from your feedback on past **Spec Books**, allows you to gather information quickly and efficiently. This way, you spend less time searching through product literature, and more time studying valuable equipment comparison data.

#### Spec Book Also Includes:

— **Reader service numbers** — for each listed product. So you can re-

quest additional manufacturer information quickly and easily.

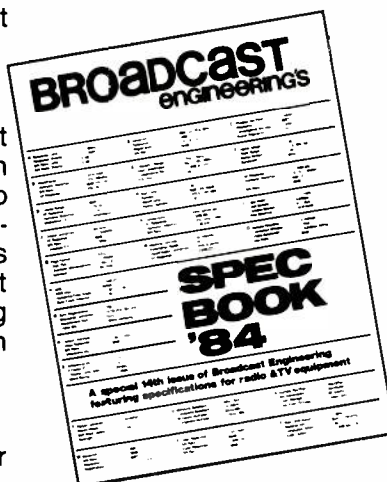
— **How-to editorial** — hands-on technical articles designed to help you stay informed on the latest technology. Expertly edited by BE's radio and television editors, both FCC-licensed engineers.

#### SPEC\*TACULAR Reader Contest

**Spec Book** is a proven winner with equipment buyers like you. And now you can be a winner, too! With the **2nd Annual SPEC\*TACULAR Reader Contest.**

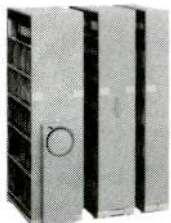
On the front cover of the forthcoming **Spec Book** you'll see 25 sections of equipment specs carefully selected from inside the issue. If you can match the cover specs with their exact location inside **Spec Book**, you can win one of two Studer ReVox B225 Compact Disc Players — valued at over \$1,000 each. The B225 is suitable for home or broadcast use and performs every programming function imaginable.

You'll find complete contest rules and an entry blank inside the **4th Annual 1984 Spec Book.** Don't miss your chance to win — enter the **Spec Book SPEC\*TACULAR Contest!**

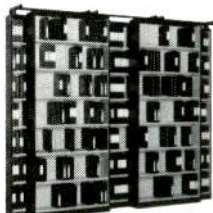


# Winsted®

## new products



• HIGH CAPACITY SYSTEM



• SUPER DENSITY SYSTEM



• PULL-OUT SYSTEM

## space-saving tape or film **MOVABLE STORAGE SYSTEMS**

Organized, efficient storage for all types of film and videotape. Sliding cabinets move effortlessly on low-profile tracks for easy access and maximum storage capacity in limited space. Available in a variety of designs and sizes, with 5" to 36" depths, to suit your special storage needs. All steel construction.

For Free Full-color FULL LINE CATALOG  
Write or call toll-free:

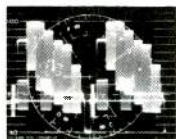
### 800-328-2962

**THE WINSTED CORPORATION**  
9801 James Circle • Minneapolis, MN 55431

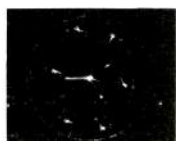
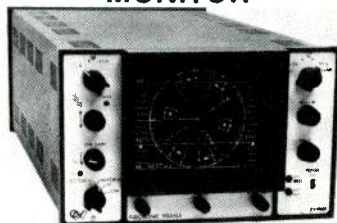
**TELEX: 910-576-2740**

Circle (85) on Reply Card

## Meet the NEW **EV4061**



### COMBINATION WAVEFORM/VECTOR MONITOR



**ALL THE FEATURES OF THE EV4060**

## **PLUS**

- 360° front panel phase control
- Looping color black external reference input
- Front panel int/ext ref switch
- Front panel DC restorer on/off switch
- Chroma filter
- 'Parade' display input

**And Still the Sharpest, Brightest Trace  
in the Industry at the Right Price**

**broadcast video systems Ltd.**

1050 McNicoll Avenue, Agincourt, Ontario M1W 2L8  
Telephone: (416) 497-1020 Telex: 065-25329

Circle (86) on Reply Card

### Wireless microphone

The T-36 wireless microphone, from Cetec Vega, uses the Electro-Voice BK-1 "Black Knight" condenser element and windscreen. It is a companion to the company's R-31/DII receiver. It operates on any crystal-controlled frequency between 150MHz and 216MHz, at a range of up to 1000 feet.

Circle (458) on Reply Card

### Camera batteries

Telecommunications Devices has video/camera replacement batteries designed for use in Sony BP90-A applications. Rechargeable, the packs come in 120- and 90-minute operating time units, providing 12V at 4A. The TD-120 and TD-90 packs come with cable and plug.

Circle (459) on Reply Card

### Coax attenuator series

A series of 33 broadband attenuators with six continuous power ratings from 2W to 75W is available from Bird Electronic. They are bidirectional and come with male/female BNC connectors.

Circle (460) on Reply Card

### Wireless intercom headphones

Two-channel FM wireless intercom headphones, by R-Columbia, provide 2-way intercommunication up to 150 yards. The TR-50/PRO has channel selection to choose between two non-interfering networks operating in the same area. Five channels are available.

Circle (461) on Reply Card

### Condenser microphone

Shure Brothers has introduced the SM91 unidirectional condenser microphone, designed for surface-mounted applications where a unidirectional pickup pattern is desirable. The half-cardioid pickup pattern (with the cardioid in the hemisphere above the mounting surface) results in less reverberation and muddiness than omnidirectional surface-mounts.

Circle (462) on Reply Card

### Signal generator

Fluke's 6060A synthesized signal generator is a general-purpose unit that tests a variety of RF receivers, filters, amplifiers and mixers. It covers a frequency range of 0.1MHz to 1050MHz, selectable with 10Hz resolution. Typical switching speed is less than 100ms.

Circle (463) on Reply Card

### Frequency counter

A frequency counter, from VIZ Test Equipment, is capable of measurements from 5Hz to 1GHz. It has eight LED displays with lead-zero blanking along with discrete LEDs as annunciators. A switchable low-pass filter allows the user to include or reject low-frequency components of high-frequency signals.

Circle (464) on Reply Card

### Belt pack

The QB-1 belt pack, from Communications-Applied Technology, is an 8.4V/1.4Ah NiCd battery pack for use with the Cetec Vega Q System. It allows the unmodified Cetec Vega system to operate from a signal master control switch, and eliminates the interconnect wire between transmitter and receiver.

Circle (465) on Reply Card



### Wire markers

Flexy Markers, from *Datak*, are wire markers that allow you to accomplish three marking tasks without letting go of the applicator tab. The first part is a terminal marker, and the two remaining pieces will mark wires as small as 0.040". The adhesive initially allows repositioning; after six hours, bonding increases.

Circle (466) on Reply Card

### Signal generators

*Marconi Instruments* has launched the 2018/2919A signal generators, which enhance the 2018/2019 units. The units combine their predecessors' features and adds full phase modulation facilities, AM, FM, variable-level AF output and auxiliary FM input. Also included is a choice of optional external-reference frequencies.

Circle (467) on Reply Card

### Industrial videodisc player

*Sony Video Communications'* LDP-180 is a laser videodisc player for the institutional and industrial markets. The front-loading, diode laser player is designed for Level I and Level III video applications. It may be used as a source player for a video editing, or for playing back images in an automatic programming sequence.

Circle (468) on Reply Card

### Character generator

*Micro-Tek* introduces the Mycro-Vision Ernie, a low-cost character generator with gen-lock and system-to-system communications. Similar to the company's Mycro-Vision Max, the new unit has several new capabilities as a titler or telecommunications device. It can operate as a stand-alone device, generating an RS-170A composite video signal.

Circle (469) on Reply Card

### Film accessory

*ARRI-VAFE* from *Arriflex* interfaces a small TV camera to the film camera to produce a videotape of the shoot. The film is imprinted with time code data that matches time code recorded on tape. After the editing decision is done with tape, time code numbers simplify cutting of original film material.

Circle (471) on Reply Card

### Still store

The *Harris Iris C* image storage system with *Iris Composition System* places a wide range of effects with still storage into a small package for the production van. Nine effects sequences may be stored in *Archive Modules* for repeated use.

Circle (472) on Reply Card

### Multichannel sound

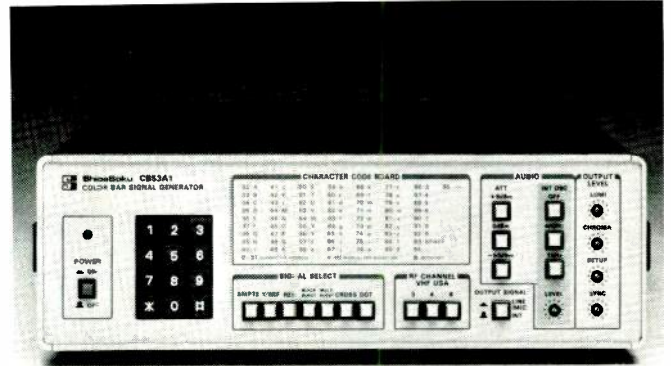
The *Tektronix 1450-1* TV demodulator is upgraded with a wide bandwidth audio section compatible with BTSC multichannel sound. For those who already have a 1450-1 demodulator, an upgrade kit called a 1450F20 will be offered in March.

Circle (473) on Reply Card

### Zoom lens

A zoom lens for 1/2-inch format cameras, from *Fujinon*, zooms 13.3X with no loss of aperture. The S14x6.6ERM,

# THE TRUE MEASURE OF PERFORMANCE



## ASACA/SHIBASOKU CB53A1 Color Bar Signal Generator

The CB5 3A1 combines a color bar generator and character generator in one versatile instrument you can take right into the field for remotes and on-location shooting. It generates SMPTE and Y/REF color bars, plus red bar, black burst, multiburst, cross-hatch and dot signals. Standard NTSC sync signals and the gen-lock function are built-in.

You can insert character information into each signal using a special keyboard with Random Access Memory that retains the signals even if your power is lost. The CB5 3A1 gives you a total of 31 character spaces on 2 lines.

- Black burst output.
- Selectable black or white color background.
- External or internal switching for video and audio signals.
- Output range of +8 dBm ~ -50 dBm for 400 Hz and 1 kHz audio signals.
- RF signal on USA channels 3, 4 and 6.
- AC-DC operation.
- Available in NTSC; PAL B, M, N; and SECAM systems.

Measure your performance with the best. **ASACA/SHIBASOKU CB5 3A1.** The color bar signal generator with character.

For complete specifications, write:

**ASACA**

ASACA/SHIBASOKU CORP OF AMERICA  
12509 Beatrice Street, Los Angeles, California 90066  
Sales, Service: (800) 423-6347 • (213) 827-7144

Circle (87) on Reply Card

# POWER PURIFIER



## IT'S THE SOLUTION TO INPUT POWER POLLUTION

We've put an end to dirty input power.

Our Kleanline Electronic Filtering Systems offer unparalleled protection against lightning, RFI, EMI, overvoltage, transients and noise... from the tiniest system to broadcast equipment or the largest main frame computer -- and everything in between.

Models are available for 115 to 600 volt applications, with AC power handling capabilities from 8 to 2,000 amperes.

And you won't find a comparable product line -- even at twice the price.

Don't wait for equipment damage. Put an end to your power pollution today. Call LEA for complete information on the Kleanline Power Purifiers and other LEA products.



**LEA Dynatech Inc.**

12516 Lakeland Road  
Santa Fe Springs, CA 90670  
(213)944-0916  
TWX:910-586-1381

Circle (88) on Reply Card

designed for ENG use, maintains an f1.4 aperture from 6.6mm to 87mm. The basic range is 6.6mm to 92mm, and is doubled with the extender. Minimum object distance is 0.08mm.

Circle (474) on Reply Card

### Metal cleaner

Cramolin, from *Caig Laboratories*, is an anti-oxidizing solution that cleans, preserves and lubricates all metal surfaces, including gold. It forms a protective layer that adheres to the metal to maintain conductivity. It can be used on switches, potentiometers, relays, PCB connectors, batteries and faders.

Circle (475) on Reply Card

### TV remote system

A microprocessor-controlled TV camera system, from *Evershed Power Optics*, has 14 control functions. The camera control processor's memory can store 500 shots and can control shot-to-shot changes, including fades.

Circle (476) on Reply Card

### M-format adapter

Panasonic's RS-422 serial interface increases the compatibility of M-format. It allows for multisource or inter-format editing by interfacing AU-300Bs with 1-inch and 3/4-inch VTRs in a single configuration. The unit can also provide 3/4-inch or 1-inch to M-format direct control.

Circle (477) on Reply Card

### Battery charger

*Christie Electric* introduces CASP, for battery charger, analyzer, sequencer and power supply. It can charge bat-

## STOP GROUND-LOOP HUM!

### VIDEO HUM STOP COIL...HSC 1

Will ELIMINATE HUM and other INTERFERENCE in Video Lines caused by differences in Ground Potential.

- For Color and Black and White.
- FLAT-DC to 6.5 MHz.
- No Low-Freq. or Hi-Freq. Roll-off.
- No Differential Phase Distortion.
- No Differential Gain Distortion.
- No Envelope Delay.
- Passive Device - Failure Free-Low Price.
- Small Compact Package 4" x 4" x 2-1/4".

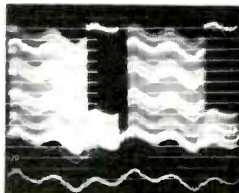
### ELIMINATES HUM AND INTERFERENCE:

#### IN STUDIO

- Between Buildings
- On long runs in Buildings
- Between Studio and Transmitter
- On Incoming Telco circuits
- On Outgoing Telco circuits

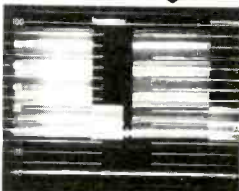
#### IN FIELD

- Betw. Remote Truck and Telco
- Betw. Remote Truck and Microwave
- For Intertruck Hookup
- For VTR Units
- For Monitoring Lines



**NEW!**

**\$190  
F.O.B.  
N.Y.**



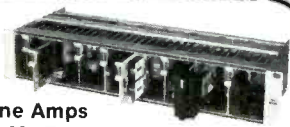
Circle (89) on Reply Card

## MAP AUDIO

### A COMPLETE LINE OF FIELD-PROVEN AUDIO COMPONENTS

#### IMPAC SERIES FRAME 4900 FOR:

- Preamps • VCA's
- Dist. Amps • Switchers • Line Amps
- Phono/Tape Preamps • And More!



#### DISTRIBUTION AMPLIFIER SYSTEM 7821-33

- Single or Dual
- With Compressor • With Mic Pre



#### NEWS ROOM SWITCHER 7301

- 10 Source taping fax • Mic Pre for intro



#### STEREO COMPRESSOR 7102

- For Master Control or TX Facilities



#### CONSOLE MODULES

- Oscillators • Equalizers • Compressor/Limiters
- Power Supplies - AND MORE!

SEND FOR DATA

**MODULAR AUDIO PRODUCTS**  
A UNIT OF MODULAR DEVICES, INC.  
50 Orville Drive ■ Airport International Plaza  
Bohemia, New York 11716 ■ 516-567-9620

Circle (104) on Reply Card



teries in 20 minutes, will analyze and recondition them and can be turned into a 0-to-50V, 350W-programmable dc power supply. It can process six intermixed batteries at once.

Circle (478) on Reply Card

#### Blower

AMCO Engineering's BRDSPM is a dual-scroll blower with variable speed control. A panel-mounted unit, it can provide from 325-425 standard cubic feet per minute. The speech interference level is 51dB at low flow and 55dB at maximum flow.

Circle (479) on Reply Card

#### ESD switch

ITT Schadow's Digitast switch protects equipment from electro static discharge, from 15kV to  $\pm 2$ kV. Pin spacing is 0.100.

Circle (480) on Reply Card

#### LED indicator

A multipurpose LED indicator card, from Modular Devices, can monitor audio signals. It allows switch selection of VU or peak reading as well as setting OVU indications from -2dB to +12dB. The unit has a 19-segment LED indicator board, balanced or unbalanced inputs and a high impedance input.

Circle (481) on Reply Card

#### PC repair kit

The CIR-KIT, from Pace, will repair or replace lifted, damaged or missing lands, plated-through holes, conductors and edge connectors on PC assemblies. Included are more than 30 sizes of eyelets, tracks plated to mil specs and in sheets of various pad diameters and track widths, abrasive stick and a setting tool.

Circle (482) on Reply Card

#### Replacement semiconductors

TRW replacement semiconductors for Gates TE3 exciters are available from Calvert Electronics. Individual semiconductors can be replaced instead of replacing the entire exciter board.

Circle (483) on Reply Card

#### Stereo processor

The MSP-126 multitap stereo processor, from Ursa Major, performs several stereo processing functions, including stereo synthesis from mono sources, image manipulation, ambience simulation and individual and cluster repeats. It can be used for music, film and video applications.

Circle (484) on Reply Card

#### Character generator

Laird Telemedia's 1500 is a TV broadcast character generator, with a character resolution of 35ns, 65,536 resident colors, 70-font library, and a dual disk drive system. It also has auto centering, italics and proportional spacing.

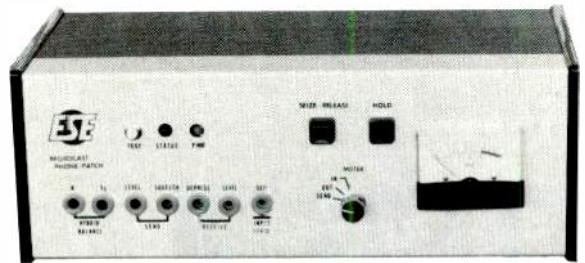
Circle (485) on Reply Card

#### Stereo generator

The FMT615 stereo generator, from Leaming Industries, is for CATV and satellite communications applications. The principle application is for use in CATV operations that incorporate the M/A-COM Linkabit Videocipher System for HBO, Cinemax, Showtime and TMC.

Circle (486) on Reply Card

# PHONE PATCH!



## ES 212

### HYBRID TELEPHONE INTERFACE

PHONE PATCH! has been evolving for the last ten years in Los Angeles area Radio Stations, Television Stations and Recording Studios. The special needs of broadcasters are met because the signal quality is unexcelled. Now ES 212 is ready for your facility.

PHONE PATCH! reproduces telephone audio cleanly and quietly—the sound is not tinny, spitting, compressed, noisy or narrow. It is as wide, clear and natural as the telephone line will permit.

PHONE PATCH! is not just another interface device. It is a quality broadcast instrument, fully compatible with the requirements of fine audio. If you depend on the quality of your audio to stay competitive, you don't need a "device."

You need a real instrument, ESE's PHONE PATCH!

# \$995



142 SIERRA ST., EL SEGUNDO, CA 90245  
(213) 322-2136

||:~(=)!!!

Circle (90) on Reply Card

# PRO SOUND

AUDIO CONNECTORS

JACK PANELS  
(Prewired available)



MULTISWITCH® SWITCHES

The one-stop source for all your electro-mechanical needs. Standard and custom assemblies. Free catalogs available.

**PRO SOUND**

13717 So Normandie Ave., Gardena, CA 90249 (213) 770-2330  
Outside CA Call Toll Free (800) 421-2471

Circle (91) on Reply Card

**G.E., Sylvania  
and Wiko  
long life lamps**

Special Prices on many numbers. Phone Toll Free.

**Sitler's** Supplies, Inc.

Box 10 Washington, Iowa 52353  
Ph: 800-426-3938 • In Iowa 800-272-6459

Circle (92) on Reply Card

FREE 32pg Catalog & 50 Audio/Video Applic.



OPAMP LABS INC (213) 934-3566  
1033 N Sycamore Av LOS ANGELES CA, 90038

Circle (93) on Reply Card

## AUDIO PATCH BAYS

- ☑ PREWIRED
  - ☑ MULTIPIN GOLD CONNECTORS
  - ☑ BROADCAST QUALITY
  - ☑ DEALER PROGRAM
  - ☑ CUSTOM WORK
- BITTREE 1337 GREENBRIAR ROAD  
GLENDALE CA 91207 213-507-0418

Circle (94) on Reply Card

## PRECISION MAGNETIC TEST TAPES

**STL**



Standard Tape Laboratory, Inc.  
26120 Eden Landing Road #5, Hayward, CA 94545  
(415) 786-3546

Circle (95) on Reply Card

## VTR AUDIO MONITOR

Self-Powered  
7" Rack Mount



Circle (96) on Reply Card



**SESCOM, INC.**  
1111 Las Vegas Blvd. North  
Las Vegas, NV 89101 U.S.A.

"the audio source" FOR ALL OF YOUR AUDIO NEEDS  
CALL OR SEND FOR A COPY OF OUR CATALOG  
CATALOG REQUESTS & ORDERS: (800)834-3457  
OTHER BUSINESS: (702)384-0993 TWX (910)397-8996

Circle (97) on Reply Card

# ad index

	Page Number	Reader Service Number	
Agfa-Gevaert Inc. ....	21	11	201/288-4100
Alexander Mfg. Co. ....	94	55	515/423-8955
Ampex Corp. (AVSD) ....	34,35		416/821-8840
Ampex Corp. (MTD) ....	5	5	415/367-3809
Anchor Audio, Inc. ....	126	96	213/533-5984
Ant-Nachrichtentechnik GMBH..	102	69	
Asaca/Shibasoku Corp. America.	123	87	800/423-6347
Audio Development . . . . .	127	99	818/843-7567
Audio Digital . . . . .	127	98	800/423-1082
Audio-Technica U.S., Inc. . . . .	117	77	216/686-2600
Audio-Video Engineering Co. . . .	124	89	516/546-4239
B & K Precision . . . . .	77	45	312/889-9087
Belar Electronic Labs . . . . .	115	82	215/687-5550
Beyer Dynamic Inc. . . . .	74	37	516/935-8000
Bittree . . . . .	126	94	213/507-0418
Brewer Co., Inc. . . . .	117	105	918/665-6820
Broadcast Electronics . . . . .	44	22	217/224-9600
Broadcast Video Systems Ltd. . . .	122	86	416/497-1020
BSM Broadcast Systems Inc. . . . .	107	68	509/448-0697
Cal Switch (Pro Sound) . . . . .	126	91	800/421-2471
Calrec/Audio . . . . .	111	67	206/275-5009
Calvert Electronics Inc. . . . .	16	9	800/526-6362
Cetec Antennas . . . . .	114	106	916/383-1177
Chyron Corp. . . . .	63	36	516/249-3296
Circuit Research Labs, Inc. . . . .	9	7	602/438-0888
Continental Electronics Mfg. Co. . . . .	64	43	214/381-7161
Crosspoint Latch Corp. . . . .	132	102	201/688-1510
Dubner Computer Systems . . . . .	IBC	2	201/592-6500
Dynair Electronics Inc. . . . .	59	34	619/263-7711
Eastman Kodak Co. . . . .	79	46	212/930-7500
EECO Inc. . . . .	105	62	714/835-6000
Electrex Company . . . . .	74	38	305/651-5752
Electro-Voice Inc. . . . .	97	57	616/695-6831
ESE . . . . .	125	90	213/322-2136
Fortel Inc. . . . .	75	44	404/447-4422
Fostex Corp. of America . . . . .	116	76	213/921-1112
Fuji Photo Film USA Inc. . . . .	45	21	212/736-3335
Fujinon Inc. . . . .	38	18	914/472-9800
Grass Valley Group, Inc. . . . .	7	6	916/273-8421
Green Broadcast Consultants Corp. . . . .	117	106	800/547-2346
Harris Corp. . . . .	31	15	217/222-8200
Harrison Systems . . . . .	IFC	1	615/834-1134
Hitachi Denshi America Ltd. . . .	3,17	4,10	800/645-7510
HM Electronics . . . . .	98	58	619/578-8300
ICM Video . . . . .	100	75	405/232-5808
Ikegami Electronics Inc. . . . .	50,51	27	201/368-9171
ITT Canon . . . . .	39	19	800/845-7000
JBL Inc. . . . .	27	13	818/893-8411
JVC Company of America . . . . .	81	48	800/582-5825
Kliegl Bros. . . . .	108	103	718/786-7474
Lang Video Systems Corp. . . . .	127	101	415/364-1287
Lea Dynatech Inc. . . . .	124	88	213/944-0916



# ad index

	Page Number	Reader Service Number	
Leitch Video Ltd.	47	25	804/424-7290
Lenco Electronics	15	8	800/325-8494
Lerro Electrical Corp.	11		215/223-8200
3M Broadcast & Related Products	37,73	17,71	800/792-1072
M/A COM MAC, Inc.	101	60	617/272-3100
Microtime, Inc.	53	28	203/242-4242
Midwest Communications Corp.	1,24,25	2,12	606/331-8990
Modular Audio Products	124	104	516/567-9620
Monroe Electronics	110	66	716/765-2254
Morrison Co.	127	100	415/525-9409
Nady Systems Inc.	56	32	415/652-2411
Nalpak Video Sales, Inc.	115	83	213/391-0491
NEC America Inc.	44,61,99	23,35,42	800/323-6656
Nova Systems, Inc.	104	72	203/677-5252
Opamp Labs Inc.	126	93	213/934-3566
Otari Corp.	13	59	415/592-8311
P.T.S.I.	119	101, 102	201/529-1550
Panasonic	65,68	39	201/348-7336
Peter-Lisand Machine Corp.	86	47	201/943-5600
Philips Test & Measuring	93	54	201/529-3800
Polyline Corp.	120	80	312/297-0955
Potomac Instruments	118	78	301/589-2662
QEI	103	70	609/728-2020
RTS Systems, Inc.	92	52	213/843-7022
Schwem Technologies	95	56	415/935-1226
Sescom, Inc.	126	97	800/634-3457
Shintron Electronics	115	105	617/441-8700
Shure Brothers Inc.	52,112	29,73	312/866-2553
Sitler's Inc.	126	92	800/426-3938
Solid State Logic	70,71	61	212/315-1111
Sony Corp. of America (Broadcast)	18,19		
Soundcraft Electronics	55		213/453-4591
Sound Technology	41	20	408/378-6540
Standard Tape Laboratory, Ind.	126	95	415/788-3546
Studer Revox America Inc.	106,109	63,65	615/254-5651
Surcom Associates Inc.	120	81	619/722-6162
Switchcraft Inc.	49	26	312/792-2700
Tascam Div. Teac Corp. of America	29	14	213/726-0303
TFT, Inc.	57	31	408/727-7272
Thomson-CSF Broadcast	91	53	203/965-7000
Total Spectrum Manufacturers, Inc.	113	79	914/358-8820
TTC/Wilkinson	89	51	303/465-4141
Utah Scientific Inc.	87	50	800/453-8782
Varian	33	16	415/592-1221
Ward-Beck Systems Ltd.	BC		416/438-6550
White Instruments Inc.	56	33	512/892-0752
Winsted Corp.	122	85	800/328-2962
Yamaha International Corp.	83,84	49	

- Film
- Video
- Live Sound
- Broadcast



## Before You Buy Digital LISTEN

### TC-2—DELAY PROCESSOR—STUDIO OR STAGE—

Clean, natural sound. Over 2 full seconds delay. Full 16kHz bandwidth.

- Simultaneous positive and negative flanging
- Pitch-controlled flanging and chorusing
- Triple tracking through use of second delay output
- Independent control of initial echo and repeat delay times
- Real-time display of delay times in all modes

### TC-3—PRE-REVERB DIGITAL PROCESSOR—

Studio enhancement of mechanical reverb or stand alone studio quality digital delay.

- Selectable delay times in one millisecond increments, up to 260 milliseconds
- 20kHz band width
- 90Db dynamic range
- Built in mixing and regeneration controls

### TC-4—BROADCAST DELAY PROCESSOR—

State-of-the-art advancement in prolatency delays.

- 6.8 seconds delay time
- 15kHz bandwidth
- 85Db dynamic range
- Optional delay build out card allows fast memory dump as well as delay time build out to allow starting in near real time.

### TC-5—INDUSTRIAL PROCESSOR—

First delay intended for permanent installation that features—

- 20kHz bandwidth
- Up to one second delay time
- Expandability for more outputs
- 90Db dynamic range

**CALL—800-423-1082**

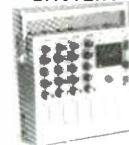
Cost/Quality/Performance



1000 S. Bertelsen Rd  
Suite #4  
Eugene, Oregon 97402

Circle (98) on Reply Card

## BATTERY POWERED MIXERS



- ✓ STEREO
- ✓ 48, 12 VOLT
- ✓ 4x2 - 6x2
- ✓ COMMUNICATIONS
- ✓ TRANS. IN AND OUT

AUDIO DEVELOPMENTS  
414 N. SPARKS ST.  
BURBANK, CA 91506

818-843-7567

Circle (99) on Reply Card

## HEAD RE-LAPPING AND NEW HEADS FOR AMPEX

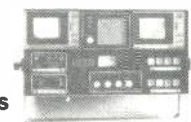
Worn cartridge and reel to reel heads re-contoured and re-lapped for original performance. Send for free brochure.

R. K. Morrison Co.  
819 Coventry Road • Kensington, CA 94707  
(415) 525-9409

Circle (100) on Reply Card

## Have "TWO-SHOT" Will Travel

- Switcher
- Mixer
- Identifier
- Color Monitors



### LANG VIDEO SYSTEMS

700 Warrington Avenue  
Redwood City, California 94063 • (415) 364-1287

Circle (101) on Reply Card

Reconfirm  
your involvement in  
the broadcast industry!  
**Renew**  
your subscription  
today.

# professional services

**VIR JAMES P.C.**  
CONSULTING ENGINEERS  
Applications and Field Engineering  
Computerized Frequency Surveys  
3137 W. Kentucky Ave. -- 80219  
(303) 937-1900  
**DENVER, COLORADO**  
Member AFCCE & NAB

**STEIGER, HURRAY & ASSOCIATES INC.**  
CONSULTING ENGINEER SERVICES  
6816 Westview Drive  
Cleveland, OH 44141  
(216) 526-7187

**EVANS ASSOCIATES**  
CONSULTING TELECOMMUNICATIONS ENGINEERS  
AM-FM-TV-CATV-ITFS-LPTV SATELLITE  
216 N. Green Bay Road  
Thiensville, Wisconsin 53092  
Phone: (414) 242-6000 Member AFCCE

**R. L. HOOVER**  
Consulting Telecommunications Engineer  
11704 Seven Locks Road  
Potomac, Maryland 20854  
301-983-0054  
Member AFCCE

**ATLANTIC RESEARCH CORPORATION**  
Jansky & Bailey  
Telecommunications Consulting  
Member AFCCE  
5390 Cherokee Avenue  
Alexandria, Virginia 22314  
(703) 642-4000

FCC DATA BASE  
**dataworld**<sup>SM</sup>  
AM • FM • TV • LPTV • MDS  
• Directories  
• Allocation Studies  
1302 18th St., N.W. Suite 502  
Washington, D.C. 20036  
(202) 296-4790 800-368-5754

**D. L. MARKLEY & Associates, Inc.**  
CONSULTING ENGINEERS  
206 North Bergan  
Peoria, Illinois 61604  
(309) 673-7511  
Member AFCCE

**ALL JAPAN RADIO & TV ENGINEERING SERVICES CO.,**  
RADIO & TELEVISION CONSULTANTS,  
BROADCASTING SYSTEM, CATV SYSTEM,  
ARCHITECTURAL ENGINEERING & DESIGN,  
EARTH STATION WORKS FOR B S  
Address: Kyodo-bldg. 41-1 Udagawa-cho,  
Shibuyaku, Tokyo, 150, JAPAN. Phone:  
Tokyo 03-464-4874 TLX: J29518 NHKINT

**Radiotechniques**  
RADIO CONSULTING ENGINEERS  
STATION DESIGN AND SERVICE  
ELECTRONIC PRODUCT DESIGN  
Edward A. Schober, P.E.  
402 Tenth Avenue, Haddon Heights, NJ 08035  
(609) 546-1841

**RADIO ENGINEERING CO. CONSULTANTS**  
NORWOOD J. PATTERSON  
BOX 420  
SANTA YNEZ CA 93460  
(805) 688-2333  
Serving Broadcasters over 35 years

**ENTERPRISE ENGINEERING P.C.**  
Consulting Engineers  
F.W. Hannel P.E.  
P.O. Box 9001  
Peoria, Illinois 61614  
(309) 691-4155 Member AFCCE

SINCE 1952 **MSI** Tel. 201-627-7400  
**MICROWAVE SERVICES INTERNATIONAL, INC.**  
SATELLITE AND TERRESTRIAL SYSTEMS  
CONSULTANTS • ENGINEERS • CONSTRUCTORS  
FREQUENCY COORDINATORS  
VICTOR J. NEXON, PE 266 W. MAIN ST.  
PRESIDENT DENVER, NJ 07834  
MEMBER AFCCE

**BROADCAST ENGINEERING SERVICE COMPANY**  
TV-FM-AM Field Engineering -  
Emergency Maintenance - Turnkey Installation -  
System Design - Survey and Critique -  
Interim Maintenance or Chief Engineer  
**B E S COMPANY**  
100 Star Trail, New Port Richey, Fla. 33553, 813-868-2969

**SMITH and POWSTENKO**  
Broadcasting and Telecommunications Consultants  
2033 M Street N.W., Suite 600  
Washington, D. C. 20036  
(202) 293-7742

**John Aalto, P.E.**  
Consulting Engineer  
TELEVISION PRODUCTION  
AND POST PRODUCTION SYSTEMS  
(213) 664-9790 4534 Van Noord Ave.  
Studio City, CA 91604

**Dr. Jeremy K. Raines, P.E.**  
Consulting Electromagnetic Engineer  
Antennas, arrays, parasitics, top loading,  
guy wires, and reradiating obstacles  
analyzed using the method of moments.  
13420 Cleveland Drive  
Potomac, Maryland 20850 (301) 279-2972  
Member AFCCE

**T & G OPTICS, INC.**  
71-01 INGRAM STREET  
FOREST HILLS, NY 11375  
COMPLETE REPAIR SERVICE FOR COLOR TELEVISION  
CAMERA BEAMSPLITTER OPTICS, LENSES, COATINGS,  
MULTIPLEXER MIRRORS, FILTERS AND PROJECTORS:  
WRITE OR CALL GERALD PINCUS (212) 544-8156 twenty  
four hour service with pleasure.

**BLAIR BENSON**  
Engineering Consultant  
TV Systems Design and Operation  
23 Park Lane  
Norwalk, CT 06854  
203-838-9049

**STARLIGHT COMMUNICATIONS, INC.**  
Satellite Down-Linking  
T.V. Satellite Terminals  
BRUCE BLUMENTHAL P.O. Box 523  
(312) 459-4122 Northbrook, IL 60062

**SELLMEYER & KRAMER, INC.**  
CONSULTING ENGINEERS  
J.S. Sellmeyer, P.E., S.M. Kramer, P.E.  
AM FM TV MDS ITFS LPTV CATV  
APPLICATIONS • FIELD ENGINEERING  
P.O. Box 841 Mckinney, TX 75069  
(214) 542-2056

**TLWI**  
The Light Work, Inc.  
Consultants  
Television  
Motion Picture  
Theatrical  
Lighting • Rigging  
Facility Design • Programming  
72 County Road • Tenafly, New Jersey 07670  
201-567-6664

CALL THE SPECIALISTS

**AUTERI Associates Inc.**  
Professional Magnetic  
Audio Head Reconditioning

9 HENARELL DRIVE  
MILLER PLACE, NY 11764

ROBERT P. AUTERI  
(516) 331-5022

**WEST SIDE STUDIO**  
For your advertising needs  
in the gulf

Complete film/video Production Editing  
facilities - Low/High band Transfer of 35mm/16mm  
to Video Audio facilities  
Tel: 226687, 215616, P.O. Box 8838 - DUBAI-UNITED  
ARAB EMIRATES Telex: 45779 IHCHOT EM 48150  
DIAL EM

**HORIZON INTERNATIONAL**  
Broadcast Implementation Engineering  
Bcast. & Video Facility Design & Installation  
Systems Evaluations & Critiques  
Emergency Service & Support  
3837 E. Wier Ave., Suite 1, Phx., AZ 85040  
602-437-3800



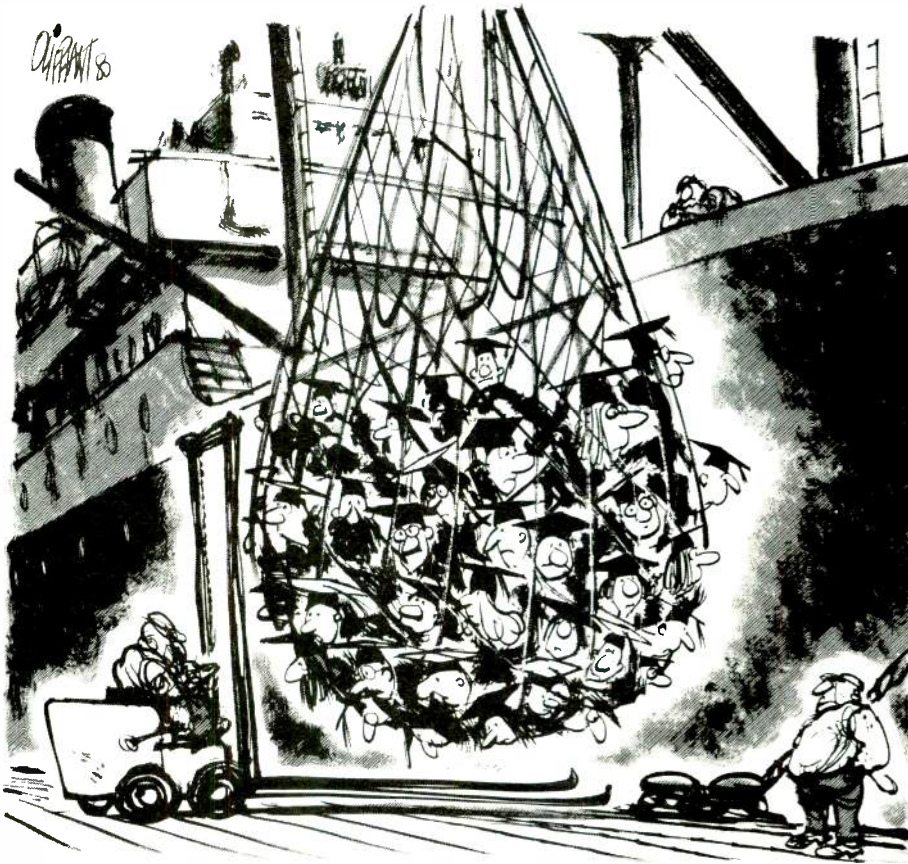
# classified

Advertising rates in Classified Section are \$1.25 per word, each insertion, and must be accompanied by cash to insure publication.

Each initial or abbreviation counts a full word. Minimum classified charge, \$30.00.

For ads on which replies are sent to us for forwarding (blind ads), there is an additional charge of \$35.00 per insertion, to cover department number, processing of replies, and mailing costs.

Classified columns are not open to advertising of any products regularly produced by manufacturers unless used and no longer owned by the manufacturer or distributor.



## WHAT WILL WE HAVE TO IMPORT NEXT, COLLEGE GRADUATES?

Ever since World War I, most of the rest of the world has come to the United States for the latest technology and for the newest in business management.

Now we're in real danger that the pendulum is swinging the other way. Our technological lead is being cut. We're importing know-how in many fields instead of exporting it.

Unfortunately this situation will get progressively worse. Unless we all make absolutely sure that our colleges and universities continue to be first-class.

For our colleges and universities supply most of the basic research upon which technological progress is built. Not to mention the trained minds that are best able to direct its uses.

But America's colleges are being hurt by inflation. Rising costs are eating away at their operations to a dangerous degree.

So, please make sure that your company is giving as much as it can, as much as it should, to the colleges of its choice. This year. Today.

If we keep the intellectual "balance of trade" in our favor, the industrial balance is bound to follow.

Send for our free booklet, "How to Develop an Effective Program of Corporate Support for Higher Education." Write CFAE, 680 Fifth Ave., New York, N.Y. 10019.

## HELP PRESERVE AMERICAN KNOW-HOW. GIVE TO THE COLLEGE OF YOUR CHOICE.

COUNCIL FOR FINANCIAL AID TO EDUCATION, INC.  A PUBLIC SERVICE OF THIS MAGAZINE  
680 FIFTH AVENUE, NEW YORK, NY 10019

## TRAINING

**ELECTRONICS DEGREE** by correspondence. Earn A.S.E.T., then B.S.E.T. Free catalog. Grantham College of Engineering, 2500 La Cienega, Los Angeles, California 90034. 7-82-tfn

**FCC GENERAL RADIOTELEPHONE** operators license through cassette recorded lessons at home plus one week seminar in Boston, Washington, Detroit or Philadelphia. Our twentieth year teaching FCC license courses. Bob Johnson Radio License Preparation, 1201 Ninth, Manhattan Beach, Calif. 90266, Telephone (213) 379-4461. 8-81-tfn

## SERVICES

**ONE STOP FOR ALL YOUR PROFESSIONAL AUDIO REQUIREMENTS.** Bottom line oriented. F.T.C. Brewer Company, P.O. Box 8057, Pensacola, Florida 32506. 7-71-tf

**HELIAX-STYROFLEX.** Large stock - bargain prices - tested and certified. Write for price and stock lists. Sierra Western Electric, Box 23872, Oakland, Calif. 94623. Telephone (415) 832-3527. 1-73-tf

**TRANSMITTER TUBES REPROCESSED** - Save 40 to 50%. 3CX2500, 4CX5000, 4CX15000 and many others. Write for details. FREELAND PRODUCTS CO., Rt. 7, Box 628, Covington, LA 70433. (504) 893-1243. 6-79-tfn

## FOR SALE

**BROADCAST CRYSTALS** for AM, FM and TV transmitters. Oven or vacuum types for Gates/Harris, RCA, Collins, CGA, G.E., ITA, etc. Good prices and service, with trade-ins taken. Over 40 years in business. EIDSON ELECTRONIC CO., Box 3751, Temple, Tx. 76501. (817) 773-3901. 8-84-eom

**C BAND SATELLITE UPLINK:** Complete Uplink Electronics with Varian dual TWT 400 W power amplifier and solid state driver. Frequency range 5.925 to 6.425GHz, includes Up/Down converter, Demod/Demux units and receiver. All equipment mounted in 19" racks. Meets all ICSC specifications. As new condition. Mfr. Calif. Microwave. Radio Research Instrument Co., Inc., 2 Lake Ave. Ext., Danbury, CT 06811, Tel: 203-792-6666. 7-84-tfn

**C BAND VIDEO BANDWIDTH MICROWAVE LINK:** Frequency: 6565-6875MHz, Transmitter Pwr: 200mw, Carrier deviation:  $\pm$  3MHz, Frequency response:  $\pm$  .5dbm from 300Hz to 3MHz. Mfr. Motorola type MR-30. In stock for immediate delivery, "As New", fully tested. Radio Research Instrument Co., Inc., 2 Lake Ave. Ext., Danbury, CT 06811, Tel: 203-792-6666. 7-84-tfn

**3 Ikegami HL-79A** color cameras, \$18,000 to \$23,000 depending on lense and accessories. Cinema Products DCU for HL-79, make offer. Contact: Bill Hughes, POB 10968, Burbank, CA 91510, (818) 845-7473. 12-84-3t

**VIDEO LAB & BROADCAST EQUIPMENT,** new and used, all types and makes, write or call for latest inventory list. Pioneer Technology Corporation, 1021 N. Lake St., Burbank, CA 91502, (818) 842-7165. 12-84-eom

**SCULLY TAPE DECKS MODEL 270,** Seeburg 200 Selectomatic players, EV-RE20 Microphones, 1/4" video cassettes, 1/4" 10 and 14" reels w/tape, Video tubes 8541ax, used power and line amplifiers, CB 1201 Turntable, and much more. Will except any reasonable offer. Call 1-617-637-5398 or write Industrial Sound Inc., P.O. Box N-5, Westport, MA 02790.

**OFF-LEASE/REPO CAMERA SYSTEMS,** including RCA TK-760, Hitachi SK-80A & SK-96, and Sony DXC-Mk3. Contact Bob Jagemann at SCIENTIFIC CLEARING HOUSE, 471 Atlas, Brea, CA 92621, 714/529-9666. 1-85-4t

## WANTED TO BUY

**WANTED:** Pre-1923 radio equipment and tubes. August J. Link, Surcom Associates, 305 Wisconsin Ave., Oceanside, CA 92054, (619) 722-6162. 3-76-1f

**HIGHEST PRICES PAID** for 112 Phase Monitors and for clean, one kw or greater powered AM and FM Transmitters. All duty and transportation paid. Surplus Equipment Sales, 2 Thorncliffe Park Dr., Unit 28, Toronto, Canada M4H 1H2, 416-421-5631. 2-79-1fn

**HIGHEST PRICES PAID** for used Dolby 334 Broadcast Units in good condition. 802-862-8881, Call Bill. 12-84-3t

## EMPLOYMENT OPPORTUNITIES

**10,000 RADIO AND TV JOBS** a year for men and women are listed in the American Radio job market weekly paper. Up to 300 every week. Engineers, DJs, Newspeople, Program Directors, Production, Sales. All markets, all formats. One week computer list, \$6.00. Special bonus 6 weeks, \$14.95. You save \$21.00. American Radio Job Market, Dept. 3, 6215 Don Gaspar, Las Vegas, Nevada 89108. 7-84-1fn

### WE PLACE TV and Video Engineers COAST TO COAST

[All Levels, But Not Operators]  
ALL FEES PAID BY EMPLOYERS

Phone/Resume

## KEY SYSTEMS

Westminster Road  
Wilkes-Barre, PA 18702

Phone Alan Kornish at  
**(717) 655-1458**

**ASSISTANT CHIEF ENGINEER:** Needed for dynamic, expanding Class C. New studios and transmitter site underway. Must have strong audio and RF experience. FCC General Class license very desirable. Some Mobile/Two-way experience helpful. Salary open. Send resume and salary history to G. Gilbreath, Director of Engineering, C&W Wireless, Inc., 5430 Fredericksburg Rd., Suite 517, San Antonio, Texas 78229. M/F EOE 2-85-1t

**TV CHIEF ENGINEER.** If you are presently Assistant Chief Engineer or Broadcast Engineer with 5 years television experience, we are looking for you to become our next Chief Engineer. Excellent career opportunity to train with retired Chief Engineer with 32 years experience. Full benefits, 100% insurance, car, moving expenses. Transmitter experience desirable. FCC license required. Equal opportunity employer. Dept. 631, Broadcast Engineering, P.O. Box 12901, Overland Park, KS 66212. 2-85-1t

**CHIEF ENGINEER:** Needed to supervise engineering and operations department. Growing Southwest Independent with excellent equipment and benefits. Strong transmitter experience a must. Contact John Grandon, Personnel Manager, KAUT-TV, P.O. Box 14843, Oklahoma City, OK 73113. 2-85-1t

**MAINTENANCE ENGINEER:** Engineer for growing sunbelt TV station. Uplink facility. 1" and 3/4" tape maintenance a must. Contact John Grandon, Personnel Manager, KAUT-TV, P.O. Box 14843, Oklahoma City, OK 73113. 2-85-1t

### VIDEO SYSTEMS SPECIALIST

Nationally known Multi-Media and Video Contractor has great opportunity for the person who is experienced in the technical system design of television studios, teleconferencing, videotape facilities, and other video systems. Knowledge of computer interfacing to video and multi-media systems is desirable. This specialist will be responsible for video system design, research, and consulting projects, with some sales contact. We offer a complete benefit package including profit sharing and pension plans. Send resume with confidence to.

Dept. 635,  
Broadcast Engineering,  
P.O. Box 12901  
Overland Park, KS 66212.

**TELEVISION MAINTENANCE ENGINEER** with chief engineering qualifications. Microwave and translator systems experience required. Reply to Weldon Paulsen, DOE, MTN—P.O. Box 2557, Billings, MT 59103. 2-85-1t

## BROADCAST ENGINEERS/TECHNICIANS

MCI/Quantel, world's leading supplier of digital video equipment and Emmy award winner for technology, has several outstanding career opportunities for engineers and technicians.

Immediate openings exist for a technical services engineer to be based in the New York metropolitan area, and test engineers, installation engineers, and technicians to be based at corporate headquarters in Palo Alto, California. Some positions require travel.

Your background ideally would include experience with digital video systems in live broadcasting or post production.

We offer an excellent starting salary, good benefits package, and plenty of room for advancement. Plus the prestige of being associated with the top company in an exciting industry.

Send your resume now to MCI/Quantel, P.O. Box 50810, Palo Alto, CA 94303. Or call George Hamilton (415) 856-6226. An equal opportunity employer.

## MCI/QUANTEL

The digital video people

**VTR FIELD ENGINEER:** A leading manufacturer of broadcast video equipment seeks to increase Field Service Team for Type C 1-in. VTR product line. Expanding operation provides opportunity for growth and advancement for those experienced with 1-in. helical scan VTRs. Competitive salary, health plan and benefits. Customer services, on-site repair and technical sales support make this a challenging position. Send resume and salary requirements to Director, VTR Engineering, Hitachi Denshi America, Ltd., 175 Crossways Park W., Woodbury, NY 11797. 1-85-3t

**CHIEF ENGINEER:** For KBVO-TV, State of Art Independent located in Austin, Texas, Capital of Texas and fastest growing city in the state. Home of high technology computer, center of the future. Applicant must have minimum two years experience in this position and hands on experience with latest equipment. Send resume to: Clyde Formby, KBVO-TV, P.O. Drawer 2728, Austin, TX 78768 EOE 2-85-2t

**KOVR-TV, SACRAMENTO,** is looking for a dynamic, self-starter to act as our primary ENG maintenance engineer. Must be familiar with ENG cameras and Sony 3/4" VTRs and be able to work well with a competitive news department in the 20th market. SBE certification a plus. Salary: \$30k plus. Contact Bob Hess, 916-927-1313, or direct correspondence to C/E, KOVR-TV, 1216 Arden Way, Sacramento, CA 95815. KOVR-TV is an equal opportunity employer, M/F. 2-85-1t

**VIDEO MAINTENANCE ENGINEER.** Minimum of 3 years of experience maintaining and repairing studio cameras, GVG switcher, master control equipment, 1" and 2" VTR's and extensive experience with 3/4" Sony VCR's. Knowledge of Digital and Analog theory a MUST. Contact Bob Martin—408-998-7344 or send resume to BAI, 1310 No. Fourth St., San Jose, CA 95111. 1-85-2t

**BROADCAST TECHNICIAN II (Engineer II)** Ref. #1233, \$1654.00-\$2117 per month. Expanding Television Station is currently recruiting a qualified Maintenance Engineer. Requires two years of full-time experience/training in television technician work to include the maintenance of 3/4" video cassette recorders and editing systems. Prefer experience with Sony BVU 200 and 800, VO2600 series and BVE 500's. Interviews will be scheduled for the second and third week of March 1985. Official University of Washington applications must be received by office closing or postmarked by Midnight, February 28, 1985. UNIV. OF WASHINGTON, Staff Employment Office, 1320 N.E. Campus Parkway, Seattle, WA 98155, (206) 543-2544, An Equal Opportunity & Affirmative Action Employer. 2-85-1t

**COME BE OUR CHIEF!** Two stations in a medium market in the Mountain West will pay \$20,000 to share an engineer. One is Class IV AM & Class C FM, the other is Class III AM DA-N. Both stations have engineering oriented management. Helpful environment and clean air. Write Dept. 633, EOE, Broadcast Engineering, P.O. Box 12901, Overland Park, KS 66212. 2-85-2t

**ENGINEER FOR NEW POSITION** at top-notch post house. Mostly daytime maintenance of our busy editing rooms and rental gear, no operations work. 1" experience required, design skills desirable. Equipment includes ADO, CMX, Paint Box, ML-79EALS. Contact Steve Beuret, Videosmith, Inc. (215) 864-0658. 2-85-1t

**ASSISTANT ENGINEERING MANAGER.** Top-notch UHF-TV and production facility. Must be well-qualified in all areas of maintenance and administration. An FCC first or general class license is required. Send resume to Dept. 634, Broadcast Engineering, P.O. Box 12901, Overland Park, KS 66212. 2-85-1t

**TRANSMITTER SUPERVISOR.** Immediate opening in Southwest's fastest growing city. 2-3 years transmitter maintenance experience required. Group owned VHF, CBS affiliate, excellent benefits. Send resumé with references to: Cason Capps, Chief Engineer, KTBC-TV, P.O. Box 2223, Austin, Texas. E.O.E. 2-85-1t

**MAINTENANCE ENGINEER** for N.Y.C. post-production company. Must have 3-5 years experience in maintaining Sony 1", GVG switcher, Quantel, CMX, Sony 3/4", RCA 2" quads and other related equipment. Experience in systems design helpful. Salary commensurate with experience. Video 44, 219 East 44th St., New York, N.Y. 10017 212/661-2727. 2-85-1fn

**TELEVISION MAINTENANCE ENGINEER:** One of the nation's leading television production centers seeks qualified Maintenance Engineer with strong electronics background. Thorough knowledge of television camera, VTR, switching, audio, digital effects, computer editing and terminal systems.

Secure future with tremendous growth potential for right candidate. Send resume to: Scene Three, Inc., 1813 8th Avenue South, Nashville, TN 37203. Attn: Mike Arnold, Chief Engineer. 2-85-1t

**CENTRAL CALIFORNIA AM/FM** seeks chief engineer. Studio, transmitter, automation experience necessary. Send resume, salary history to: P.O. Box 3730, Visalia, CA 93277. 2-85-1t

**MAINTENANCE ENGINEER:** Familiar with all studio equipment for FM Radio and LPTV station located in beautiful ski resort in the Rocky Mountains. Duties include service of JVC field cameras and tape decks for LPTV, and audio console, cart machines and turntables for radio. Knowledge of studio design and construction a plus. Transmitter and microwave servicing required. First Class license necessary. Rick Bralver, KSPN/TV-2—322 West Main Street, Aspen, CO 81612 with resume and salary requirements. 303-925-5776. Calls accepted. 2-85-1t

**RCA TK-28B lowboy filmchain** with 4 port multiplexer, 1" Saticons, 100' control cable, RCU. Good working cond. \$7000. (818) 708-2005. 2-85-1t

**MAINTENANCE ENGINEER:** CMX—Edit Suite, Sony 2000's, Ampex 4100. Chyron, Quantel. Good salary and benefits with established company. Southern Productions, 900 Division Street, Nashville, TN 37203, (615) 248-1978. 2-85-1t





Don't  
wade  
through  
1000  
different  
product  
brochures

**...Use BE's  
Spec Book  
instead!**

\$2,000 SPEC-TACULAR Contest  
Win Two Studer ReVox CD Players

**CMXORROX**

**What Separates a World Leader  
From All Others?**

**INNOVATION**

CMX received an Emmy Award for its first contribution to video tape editing technology, and has pioneered every notable advance since.

**VERSATILITY**

CMX editing equipment is used in every possible post-production application—from a ten second spot to a three hour network special.

**COMMITMENT TO THE FUTURE**

CMX has the strongest engineering and customer service organization in the industry, both to support our current products, and to produce new features and products that will link our present systems with the future. Agencies and producers have come to expect the best from CMX products, and expect their programming to be edited on CMX equipment.

**FIELD SERVICE ENGINEER SUPERVISOR**

We are looking for an experienced engineer to supervise the technical and administrative support activities in our New York City Office. Oversee field service staff, ensure that adequate records and systems are maintained. Maintain liaison with field management and specialists in resolving technical problems and train customer personnel in the operation and maintenance of CMX equipment. Qualified candidates should have a BSEE (or equiv work exp) and 7+ yrs exp, with 2+ yrs exp in managing a staff.

If you are qualified to join a winning team in the fast paced television editing equipment industry, we have a job for you.

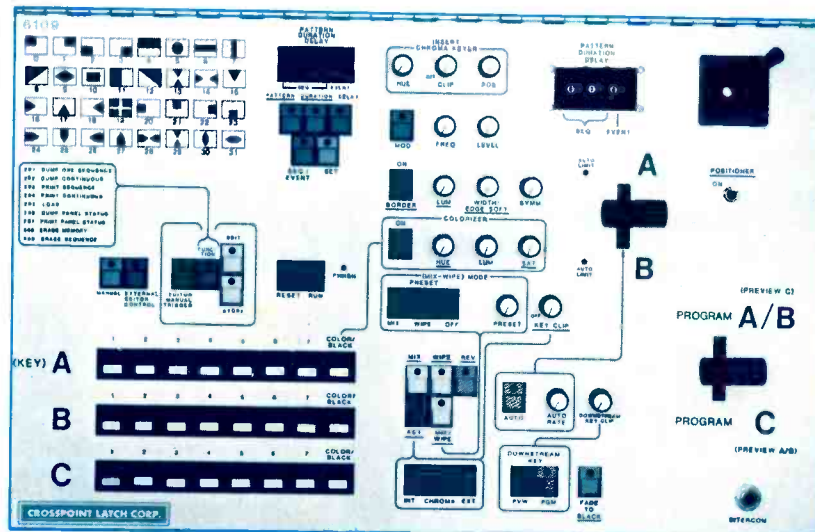
To apply, please send resume to:

Professional Staffing, Attn: C. Buchner  
3303 Scott Blvd., Santa Clara, CA 95050  
(408) 988-2000  
(800) 538-8092

**CMXORROX**

# 400 EVENT REGISTERS, 100 SEQUENCES

## 6109/7209 POST PRODUCTION SWITCHER WITH DISC OPTION



### STANDARD 6109

- 32 PATTERNS
- RGB CHROMA KEYS
- BORDERED WIPE
- DOWNSTREAM KEYS WITH EDGE
- MIX-WIPE MODE
- PATTERN MODULATOR
- COLORIZER
- MASTER FADE TO BLACK
- AUTOMATIC TRANSITIONS
- INTERNAL OR EXTERNAL KEYS
- BLANKING PROCESSOR
- TEST MODE FOR SYSTEM TIMING
- AUTOMATIC PREVIEW
- TRUE POSITIONER

### OPTIONS

- INTERNAL SYNC GENERATOR (FOUR BLACK BURST OUTPUTS)
- GENLOCK WITH TWO LEVELS OR AUTOMATIC CHANGEOVER
- SECOND CHROMA KEYS (RGB OR ENCODED) FOR INSERT KEY

## FULL EDITOR CONTROL

DISSOLVE FROM A COMBINATION OF TWO CHROMA KEYS TO A FOURTH VIDEO SIGNAL  
DISSOLVE FROM A CHROMA KEY OVER A SPLIT WIPE, TO A FOURTH VIDEO SIGNAL

6109 \$6,995.

7215 AUTO DISC<sup>T.M.</sup>

99 SEQUENCE OPTION \$1,500.

7209 \$3,000

### FULL MICROPROCESSOR CONTROL WITH THE 7209 EDITING WITH THE FOUR EVENT SEQUENCE

The FOUR EVENT SEQUENCE is a very powerful, yet simple, way of programming a switcher for editing applications. It allows for three programmable transitions (between the EVENTS) together with a programmable delay before each transition. Events can be programmed easily and rapidly. Stored EVENTS can be altered or edited by means of the unique **CROSSPOINT LATCH** "Edit" mode, which permits incremental changes to be made with ease and precision.

Programming FOUR EVENT SEQUENCES is unbelievably simple. Just set up the switcher to the required configuration and depress the STORE button. Duration and delay times can be filled in later. The operations are human engineered to the point that it is difficult to make a mistake. The switcher forgoes the next operation and sets itself up in readiness, thus reducing the number of keystrokes to an absolute minimum.

FOUR EVENT SEQUENCES can be called up and run by the editor, or they can be called up on the switcher and initiated by the editor. FOUR EVENT SEQUENCES can be dumped from the switcher, loaded into external devices, then later loaded back into the switcher for execution.

The 7209 has one FOUR EVENT SEQUENCE as standard. There is an option for an additional 99 FOUR EVENT SEQUENCES.

### AUDIO FOLLOW OR BREAKAWAY AUDIO WITH THE 6800



The 6800 has seven stereo inputs with a gain control for each of the inputs, a master gain control and the ability to cross connect tracks or combine the stereo tracks into a single audio channel. There is a built in 1 kHz tone generator. This audio unit has been specifically designed for post production. The 6800 can be controlled in three ways: from the editor, from the 6109, or manually from its own control panel.

### FULLY CONTROLLABLE BY EDITORS

The 7209 interfaces with most editing controllers or any computer. There are different modes of operations. The switcher may be either fully or partially controlled. All functions on the switcher can be accessed. Any SEQUENCE can be recalled and run.

**PERMANENT STORAGE ON AUTO DISC<sup>T.M.</sup>**

## CROSSPOINT LATCH - FOR THE MOST EFFECT-IVE APPROACH

### CROSSPOINT LATCH CORP.

95 PROGRESS STREET • UNION, NJ 07083  
(201) 688-1510 • TELEX 9104901990

Circle (102) on Reply Card



# THE WORD IS OUT

## Introducing TEXTA: a character generator with more of everything—except price.

The Emmy-winning folks at Dubner have done it again with TEXTA: a revolutionary new on-line character generator high on features and low on price.

Boasting a palette of 4C96 colors and true 37-nanosecond pixel resolution, TEXTA incorporates dedicated anti-aliasing circuitry to generate over 16 million intermediate shades, producing text and graphics of unsurpassed quality.

TEXTA features everything you'd expect in a top-of-the-line system: unlimited Border and Shadow combinations, Diagonal Typing, 3-D Shadows, Roll, Crawl, Tumble, Timed Roll, and more. Plus an optional second channel for Read Next previewing, or dual user operation.

And that's not all: complete portability; storage capacity for over 500 fonts and 20,000 pages of text; animation in real time, using built-in effects like Color Cycling, Mosaic, Fragment and Mag/Move; advanced graphic tools including Lines, Grids, Ellipses, Scale, Rotate, Area Fill; and compatibility with Dubner's CBG-1 and CBG-2.

TEXTA is the ideal high performance/low cost character generator, perfect for all broadcast, cable, corporate and education needs.

The word is out. To get the full message, call Dubner at (201) 592-6500 or write:  
Dubner Computer Systems, Inc.,  
158 Linwood Plaza, Fort Lee, NJ 07024.

Circle (2) on Reply Card

Or contact your nearest Grass Valley Group representative.



## DUBNER



# Made to Measure!

Ward-Beck extended range meters are tailor-made specifically for the broadcast industry. These instruments measure audio levels over a sensitivity range of 80 dB with one continuous detented control.

The self-powered, 3 1/2" rack mounting units include LED status readouts and offer the choice of VU only (M405F), or dual VU/PPM (M405D) scales. The unique portable M405, with rechargeable ni-cad batteries, gives additional convenience and flexibility for measuring systems levels on a totally floating basis in those hard-to-get-at places.

The M405 Series ... traditional Ward-Beck quality, carefully made-to-measure!



First by Design.

Ward-Beck Systems Ltd.

841 Progress Avenue, Scarborough,  
Ontario, Canada M1H 2X4.

Tel: (416) 438-6550.

Tlx: 065-25399.

