

January, 1977/75 cents

BROADCAST engineering

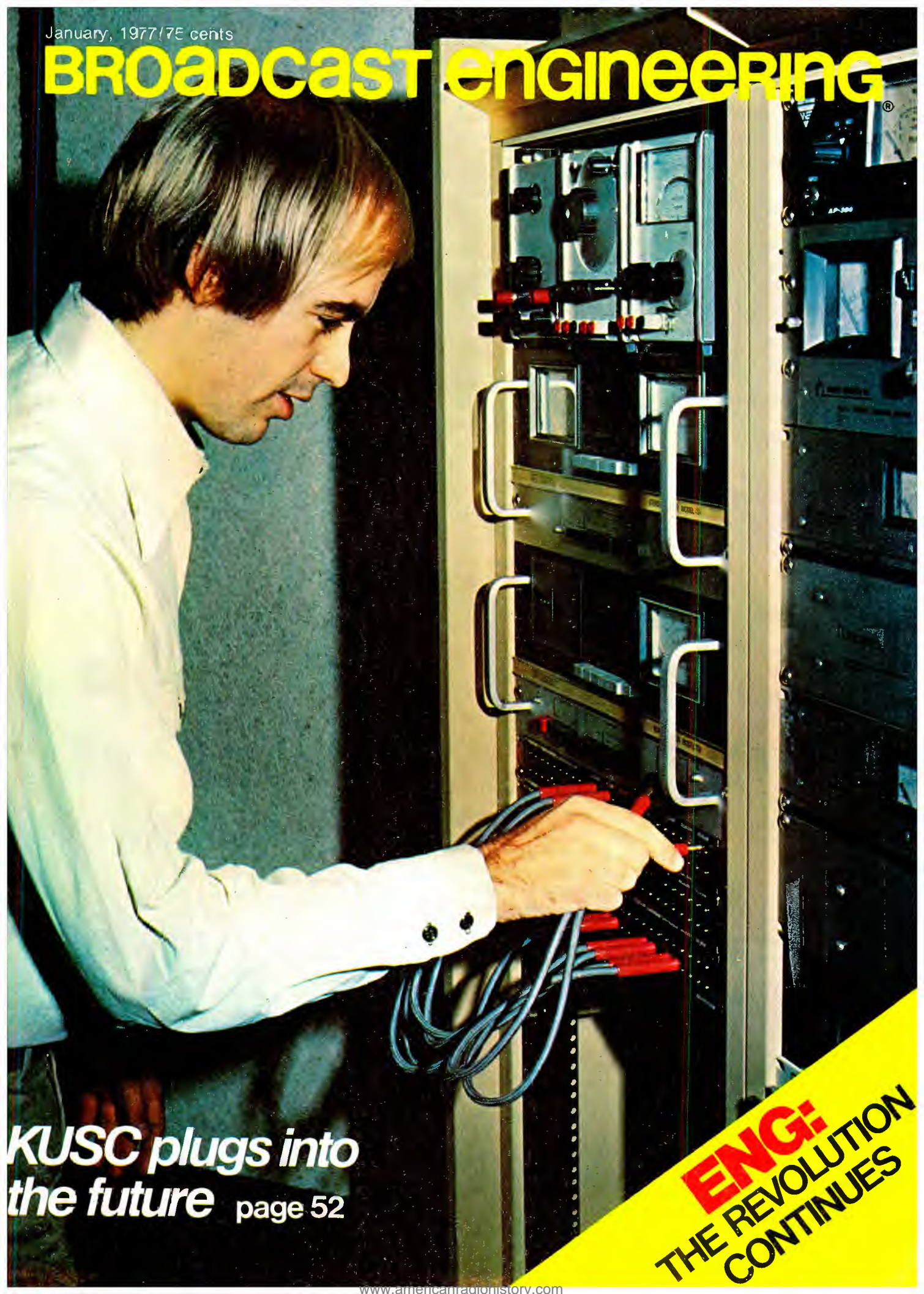

**KUSC plugs into
the future** page 52

ENG:
THE REVOLUTION
CONTINUES

Ward-Beck portables are going places.

No matter how remote the location, traditional Ward-Beck studio quality is now available from stock in the highly portable M1002 console.

The M1002 earned an enviable reputation as the great performer in the 1976 Summer and Winter Olympics. 55 units were employed by ABC and CBC for network coverage of these historic events.

The versatile M1203 offers increased input and output capability. A combination of comprehensive monitoring facilities with an integral front panel jack field make it ideal for mobile or studio installations where space is at a premium.

Available from stock, the M1002 and M1203 come in a variety of configurations designed to fit even the most modest budget.



Tomorrow's Technology Today.

Ward-Beck Systems Ltd., 841 Progress Avenue, Scarborough,
Ontario M1H 2X4. Telephone (416) 438-6550. Telex 06-23469

Ward-Beck Systems Inc., 290 Larkin Street,
Buffalo, N.Y. 14210



WBS M1002: 10 channel console.

WBS M1203: 12 channel console.

For More Details Circle (1) on Reply Card



**THERE IS A LOT MORE
TO REBUILDING A QUAD HEAD
THAN MEETS THE EYE**
(Or is visible even to the naked eye).

Every component and every step in the process is critical in providing the highest quality and longest useful head life...and that is our only business.

"If you only do
one thing,
Maxine..."

"you better be
verry good
at it."



VMX[®] videomax[®]

Videomax, An Orrox Company
3303 Scott Boulevard, Santa Clara, CA 95050
Phone: (408)983-2000 Telex: 910-368-0554

SALES & SERVICE—New York: (212)947-8031. Los Angeles: (213)983-7927. Atlanta: (404)992-4490

For More Details Circle (4) on Reply Card

- 22 **ENG: The News Will Never Be The Same Again.** An update on electronic news gathering, explaining why it continues to invade the TV marketplace. *Ron Whittaker.*
- 32 **It's The News Package That Sells, Not Just The Equipment.** A station with a widespread news territory explains how film still fills most of their needs. Points up the importance of the package. *William D. Gordon.*
- 38 **Radio Workshop.** Our Workshop editor kicks off a three-part series on RENG—Radio Electronic News Gathering. *Peter Burk.*
- 44 **ENG Makes Headway At The IBC.** BE's video editor reports on this international convention and reports on ENG's prospects on the international scene. *Joe Roizen.*
- 52 **KUSC Plugs Into The Future.** National Public Radio affiliate faces responsibility of 10 million potential listeners with new facility and equipment. Meanwhile, NPR plans network hookup via satellite. *Ron Merrell.*
- 58 **Digital Lab.** Following up on BE's Logic Illustrated series, a new monthly feature on practical troubleshooting opens with leads on courses, seminars, and experimenter kits. *Harold Ennes.*

About The Cover

Our emphasis this month is ENG and what's happening to film in the news. Three articles on ENG are included with the first beginning on page 22.

(Photo by Ron Whittaker)

Departments

Direct Current	4
Industry News	8
Zoom In	16
Blue Bananas.....	67
Book Review	68
People In The News	69
SBE Journal	70
New Products	72
Classified Ads	82
Ad Index	84

Editorial

Ronald N. Merrell, *Director*
Carl Babcoke, *Technical*
Pat Finnegan, *Maintenance*
Howard T. Head, *FCC Rules*
Robert A. Jones, *Facilities*
Walter Jung, *Solid State*
Peggy Brown, *Editorial Assistant*
Dudley Rose, *Graphic Designer*
Joe Roizen, *Video*
Peter Burk, *Radio Workshop*
Dennis Ciapura, *Audio Editor*

CIRCULATION

Greg Garrison, *Director*
Evelyn Rogers, *Manager*

ADVERTISING SALES

Gloria Parmenter, *Production*
P.O. Box 12901,
Overland Park, KS 66212
(913) 888-4664

Regional advertising sales offices

Indianapolis, Indiana—Roy Henry, 2469 E. 98th St., Indianapolis, Ind. 46280, (317) 846-7026

New York, New York—Stan Osborn, 60 E. 42nd St., Room 1227, New York, N.Y. 10017, (212) 687-7240

Mountain View, California—Dennis Triola, 2680 Bayshore Frontage Rd., Room 102, Mountain View, Ca. 94043, (415) 961-0378

London W.C. 2, England—John Ashcraft & Co., 12 Bear St., Leicester Square, Tele.: 930-0525

Badhoevedorp, Holland—John Ashcraft & Co., John J. Lucassen, Mgr., Sloterweg 303

Tokyo, Japan—International Media Representatives, Ltd., Shiba-Kotohiracho, Minatoku, Tele.: 502-0656

Editorial, advertising and circulation correspondence should be addressed to: 9221 Quivira Road, P.O. Box 12901, Overland Park, Kansas 66212, (a suburb of Kansas City, Missouri). (913) 888-4664.

BROADCAST ENGINEERING is published monthly by Intertec Publishing Corp., 9221 Quivira Road, Overland Park, Ks. 66212.

BROADCAST ENGINEERING is edited for corporate management, technicians/engineers, and other station management personnel at Commercial and Educational radio and TV stations, Teleproduction studios, recording studios, CATV and CCTV facilities, and government agencies. Qualified persons also include consulting engineers, dealer/distributors of broadcast equipment.

SUBSCRIPTIONS: BROADCAST ENGINEERING is mailed free to qualified persons in occupations described above.

Non-qualified subscriptions in the U.S. are \$6.00 one year, \$10.00 two years, \$13.00 three years. Outside the USA add \$1.00 per year to cover postage. Single copy rate 75 cents. Back issues rate \$1.00. Adjustments necessitated by subscription termination at single copy rate.

Allow 2-3 weeks for new subscriptions.

Allow 4-6 weeks delivery for change of address.

Controlled circulation postage paid at Kansas City, Missouri.



Member, American Business Press
Member, Business Publications Audit
of Circulation



George H. Seferovich, *President*
Mike Kreiter, *Publisher*

INTERTEC PUBLISHING CORP.
Subsidiary of HOWARD W. SAMS & CO., INC.

Copyright, 1977, Intertec Publishing Corp. All Rights Reserved: Material may not be reproduced or photocopied in any form without written permission of Publisher.

NEW...



GRASS VALLEY GROUP **MODEL 3257A**

AUTOMATIC CHANGE-OVER SWITCH

The 3257A is a 9-pole, 2-position switching device intended for use with television synchronizing generators. The switching action can be initiated either manually or automatically. In the automatic mode, operation is controlled by sensing circuitry which samples the output lines. If a fault is detected on any line, a transfer is made to the opposite group of inputs.

The switch is constructed in a unique manner to maximize reliability. The switching elements are sealed reeds arranged in a circular array. The latter are actuated by permanent magnets mounted on a circular rotor.

Detectors are provided for 8 of the 9 output lines and can be set to operate either with 2 volt or 4 volt pulses, as well as 1 volt or 2 volt subcarrier signals. The system will also sense a low level, steady state signal, such as color black or encoded pulse reference. Internal switches are provided to individually disable any or all of the detectors.

The system can be controlled both locally and remotely. A relay with isolated C contacts is provided for remote alarm use. The 3257A can be used on any TV standard, as well as with any type of synchronizing generator. Input voltage is 115/230V, 50-60 Hz. BNC connectors.

THE GRASS VALLEY GROUP, INC.

A TEKTRONIX COMPANY

Station Plaza East
GREAT NECK, NY 11021
(516) 487-1311

4419 Van Nuys Blvd, Ste 307
SHERMAN OAKS, CA 91403
(213) 990-6172

1644 Tullie Cir, NE
ATLANTA, GA 30329
(404) 634-0521

P.O. Box 482
MABANK, TX 75147
(214) 887-1181

810 W Bristol Street
ELKHART, IN 46514
(219) 264-0931

DIRECT CURRENT



FROM D. C.

January, 1977/By Howard T. Head and Harold L. Kassens

New Reregulation Orders Issued

Our hats are off, once again, to the Broadcast Reregulation Task Force of the FCC. In their usual rapid fashion, they have now published the 15th and 16th Reregulation Orders. Let's take the latter, first. It is an alphabetical index, 22 pages long, of all the broadcast rules and will make those "hidden" rules so much easier to find. And as great a contribution as this 16th Order is, we think the 15th Order will be applauded for years to come:

First, stations with directional antenna systems which have installed type approved antenna monitors and approved sampling systems may file for remote control authority without filing the information required by Section II of the Form 301-A. That is, the antenna resistance and reactance measurements, the 52 weeks of monitor point readings, the 30 days of parameter readings and the partial proof of performance are no longer required. The only information to be filed is the same as for non-directional operation: the location of the remote control point.

Second, a new "Special Antenna Equipment Test Authorization" is set up. This will permit the licensee of an AM station to operate with nighttime power and directional antenna pattern during daytime hours as necessary to make monitor point field strength measurements and antenna proof of performance measurements. An informal application to the Commission in Washington will result in an authorization for either a specific period or an indefinite term, whichever is requested. These authorizations are to be posted with the license.

Third, the term "carrier shift" has been replaced by "carrier-amplitude regulation" and the term defined in the rules.

Fourth, the rules are clarified to make it clear that RF power coupling, dividing and phasing networks shall be installed within protective cabinets or enclosures which are locked or provided with safety interlocks. And the antenna lead-in, transmission line and counterpoise (if used) must be installed so as not to present a hazard. Also, it is specifically noted that since operating personnel are required, on occasion, to read meters at the base of the antenna tower, management at the station must provide safe access or pathways to the location where the meters must be read subject to construction and installation safety requirements.

Continued on page 6



This is probably a terrible conversation to have during the dead of winter (Eastern style, that is), but Broadcasters who have visited our California marketing headquarters on the beautiful Santa Barbara coastline tend to identify us as the "Sea-Tek" Broadcast Group.

Curiously, we actually pronounce our name "SEA-TEK." However, when we print it, we spell it Cetec . . . with a C, and an E, and a T, and an E, and a C . . . the Cetec Broadcast Group.

The other important word in that name is group.

G-R-O-U-P.

What Group means to you, the Broadcaster, is:

A consolidation of the technological, marketing, and field service strengths of three of the most famous names in broadcast equipment manufacturing.

JAMPRO . . . finest FM antennas available, regardless of price.

SCHAFFER . . . the FIRST name in radio automation.

SPARTA . . . renowned audio products, and transmitters, including both AM and FM SOLID STATE designs!

Well, enough of this. In 1977 you'll be hearing a lot more from the good group at Cetec.



Cetec Broadcast Group

The Broadcast Divisions of Cetec Corporation

75 Castilian Drive Goleta, California 93017
Telephone: (805) 968-1561

DIRECT CURRENT FROM D. C.

Continued from page 4

Fifth, the FM and TV rules are changed so that a station is not required to have main and alternate main transmitters with identical power ratings. All that's required is that both transmitters be capable of producing the licensed output power.

Sixth, commercial and non-commercial FM stations may, by informal application, replace a stereo generator unit with a unit of another type. Likewise, an FM exciter may be replaced by a type other than that normally included in the transmitter. Modification of a type accepted transmitter with new components can be made at any time without prior authorization.

Seventh, the rule for determining operating power of an FM station is amended to provide that the efficiency factor "F" to be used for the indirect method can be determined by: (1) using the measurement data for calibration of the transmission line meter as in the direct method, (2) using the manufacturer's test data supplied to the licensee provided the measurements were made at the authorized frequency and transmitter output power, or (3) using the manufacturer's measurement data supplied to the Commission for type approval.

Short Circuits

The Commission has refused to allow a 10 Watt educational FM station into the commercial portion of the FM band...For the first time, the Commission waived its rules and accepted an application from a station to increase daytime power and add nighttime operation because it proposes to provide minority programming...In a special release, the FCC cautions CB'ers that in the last 3 years over 200 persons have been electrocuted mounting antennas on metal masts or poles that came in contact with power lines...The latest statistics show that there are now over 7 million CB licensees...The Commission has instituted rulemaking in cable TV to add frequency channeling requirements to prevent interference to over-the-air services, particularly air navigation and aeronautical emergency services...The rules have been amended to provide for the transmission captioning for the hearing impaired during the television vertical interval on line 21...The Commission has denied the petition of the National Association of Business and Educational Radio (NABER) and adopted finally the new Remote Pickup Rules...When an AM station refused to pay an FCC fine for overpower operation and was taken to court. The judge said the station was not operating over power and that the FCC power rules are inconsistent, ambiguous and unrealistic.

The big news is real-time video.

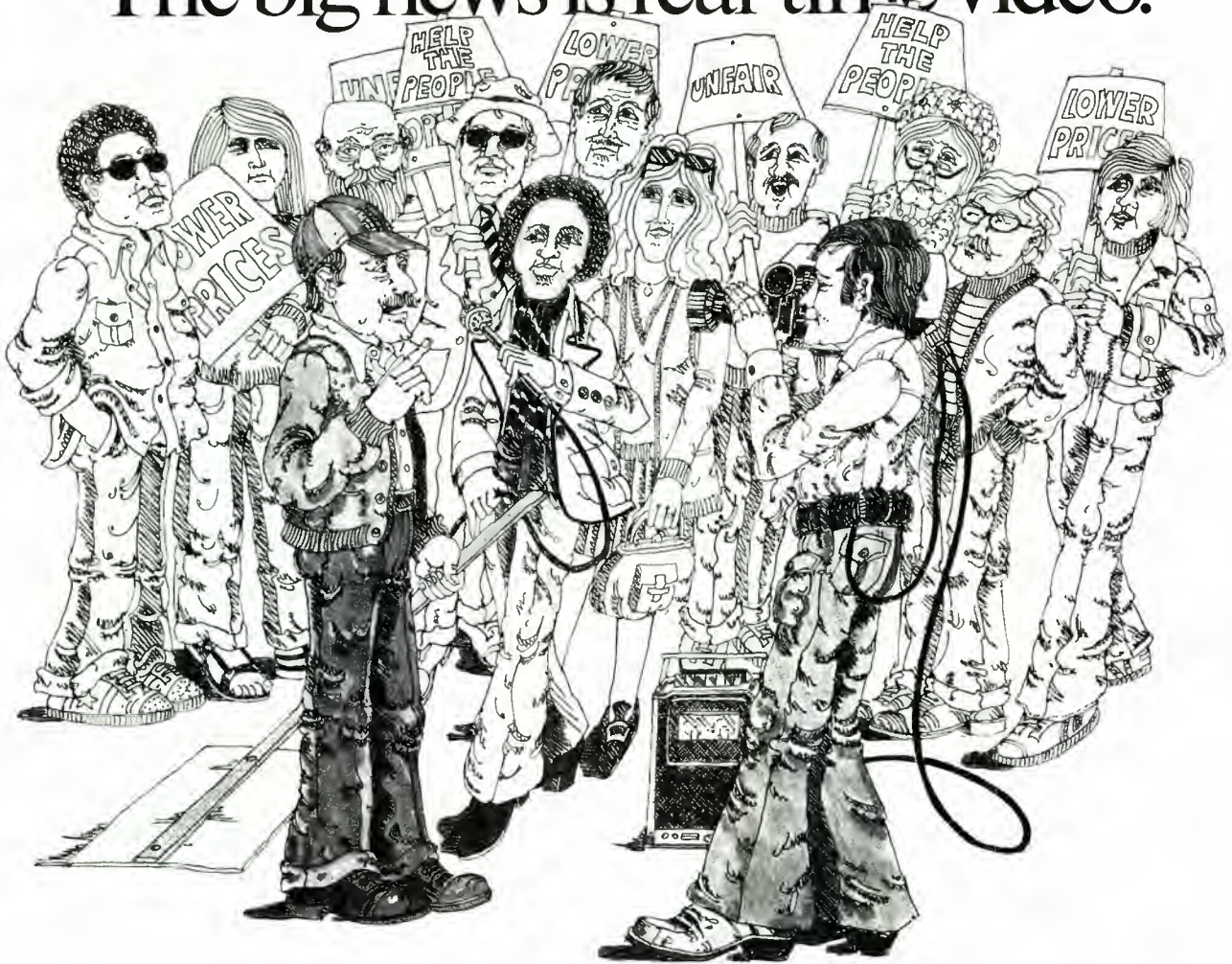

Ampex ENG is on the scene.

Ampex ENG products are best because we took the time to bring you true quality in portable equipment. With a reputation like ours to protect, we couldn't risk hanging a hundred pounds of batteries on the back of an ex-lineman and sending him into a crowd.

BCC-4, for example, is the ENG camera that feels like a film camera and shoots like a studio camera. This full-color midget is as stingy with power as it is generous with picture quality.

And the portable VPR-4400 isn't much larger than the 3/4-inch videocassette it uses. But it brings back a tape that has everything the camera saw, and everything the mic picked up.

Back at the studio, the

VPR-8300 hides on a desk corner, plays back tapes and lets you edit the segments easily, all with famous Ampex video fidelity. Route the signals through a TBC-1, and you're on the air with steady, time-corrected program material. You'll find a lot of ways to use this system.

Ampex ENG equipment is a nice match to Ampex studio equipment. A way to bring back location material that doesn't fight with your studio-originated material. Quality without a backache.

ENG Systems from Ampex. Portable video equipment for news directors who can't take chances.



AMPEX

Complete technical and performance specifications are available in a free brochure. Write us at 401 Broadway, Redwood City, California 94063, or call (415) 367-2011.



No matter how young or old the recording, the Institute of the American Musical, Inc. relies on Stanton for playback.

Speaking of problems, how would you like to be faced with the need to accurately reproduce the sound from Edison Diamond Discs, Pathés and Aeolian-Vocalions? That's just what the Institute is faced with — and that's precisely why they turned to Stanton cartridges.

The Institute collection consists of approximately 35,000 recordings, from just about every American theatre or film musical since the Berliners of the 1890's through to the latest stereo and quadraphonic recordings. They have original, historic machines to play the old recordings, but the arms are heavy and the old styli insensitive and somewhat worn. Furthermore, the acoustic playback does not permit them to filter the surface noise or tape these rare records.

Miles Kreuger, President of the Institute, discussed his problem with other famed and experienced archivists. They all agreed that the Stanton calibrated 681 Series was the answer. Naturally, it is the 681 Triple-E for critical listening and taping with more recent discs; the special 681 stylus for LP's; and, for some old 78's, a 681 cartridge, especially wired for vertical response (with a 1 mil stylus).

Today, scholars, authors and researchers, can get perfect to adequate reproduction of any of the material in the collection. The work of the Institute is important work . . . Stanton is proud to be an integral part of it.

Whether your usage involves archives, recording, broadcasting or home entertainment, your choice should be the choice of the professionals . . . the Stanton 681 Triple-E.

Write today for further information to:
Stanton Magnetics, Terminal Drive,
Plainview, N. Y. 11803.



STANTON

Hall of Fame Will Open This Spring

The National Broadcasters Hall of Fame is in its last stages of completion and will open in the Spring of 1977 in Freehold, N.J.

According to Arthur S. Schreiber, founding president of the Hall of Fame, the last stage includes construction of multi-media display units.

The idea for the non-profit project developed almost three years ago. Schreiber, a former publisher of two successful newspapers, became aware of a void in the broadcasting industry.

"As I traveled around," said Schreiber, "I realized there were various collections of broadcasting equipment on display at many locations. There were homes and laboratories of inventors open to the public. Libraries were filled with books on broadcasting. Recording companies have compiled collections of early radio programs. There were, and continue to be, many honors to those in the field distributed by a variety of professional organizations.

"But nowhere," stated Schreiber, "had the past, the present and the

future interests of the broadcasting industry been brought together in one location until we incorporated the National Broadcasters Hall of Fame as a non-profit project earlier this year."

Schreiber described the Hall of Fame as more than a museum of nostalgia. He said that while the Hall of Fame will document the past, it will also track today's achievements.

"I believe entertainers, newscasters, investors, the executives, sponsors, hobbyists and listeners will all merge their interests in broadcasting through the Hall of Fame," stated Schreiber.

When the Hall opens, visitors will find unusual displays where they will be able to hear and see broadcast history. An early radio studio is being recreated. An extensive collection of equipment—including mikes, ear phones, early radios, props, scripts and recordings have been gathered for public showing and listening.

The non-profit Hall of Fame is supported from funds donated by broadcasting enthusiasts and sponsorship from commercial broadcasting stations. The Hall of Fame address is West Main Street, Freehold, N.J. 07728, and the phone number is (201) 431-4656.

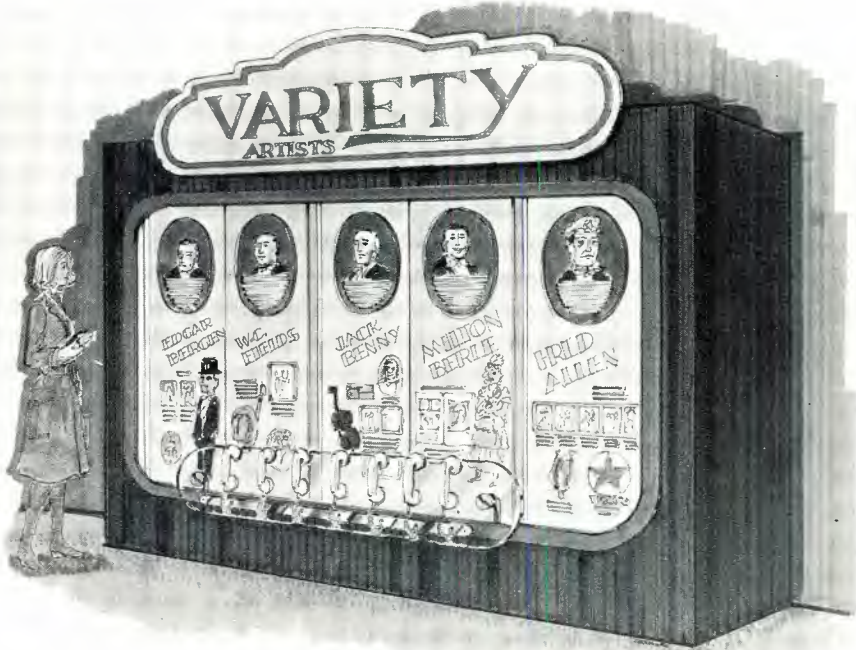

20-1000mm*

Whether you're the producer, director, cameraman or video man, field remote isn't getting any easier. Neither is big studio work.

Assignments are tougher. Production standards, higher. And schedules, shorter than ever. As you can see, we've been listening: our new PV25x20B is proof. A single, rugged 22Kg unit that packs a lot of performance into a compact 546mm-long package.

Consider: A master-lens range of 20-500mm, with built-in 1½ and 2x servo-operated extenders, to give you complete flexibility with excellent relative apertures (1.8 @ 20-297mm; 2.7 @ 30-445; 3.6 @ 40-594 and 6.0 @ 1000). A short M.O.D. of 2.5m. Zero barrel distortion and vanishingly low pincushion. Plus manual plug-in servo operation. And much, much more.

All at the kind of reasonable price that's helped make Canon the fastest-growing professional lens line in the world.

Canon

For more information, please call or write.

Canon U.S.A. Inc., Head Office, 10 Nevada Drive, Lake Success, N.Y. 11040 (516) 438-6700
140 Industrial Drive, Elmhurst, Ill. 60126 (312) 333-3070
Canon Optics & Business Machines, Canada, Ltd., 3245 American Drive, Mississauga, Ontario L4V 1B8, Can.
Canon Amsterdam N.V., Industrial Products Division, De Boelelaan 8, Amsterdam, Netherlands

*PV25x20B is 20-1000mm in 25mm format.
P25x27B is 27-1350mm in 30mm format.

TV ZOOM LENS PV25x20B 25-500mm 1:1.8

For More Details Circle (8) on Reply Card

SMPTE Geared For Digital And ENG

Beyond ENG and Digital Video are the two topics of discussion at the 11th Annual Winter Television Conference of the Society of Motion Picture and Television Engineers, it was announced by incoming SMPTE Vice President for TV Affairs, Frank L. Flemming, NBC.

The Conference is scheduled for the St. Francis Hotel, San Francisco on Friday and Saturday, January 28 and 29.

According to Conference Chairman Charles Anderson, Ampex Corp., the two-day meeting will have one full day (Friday) devoted

to "Beyond ENG." The presentations will focus on the use of high-quality portable video equipment for applications other than for newsgathering, that is for commercials and programs. A strong lineup of presentations has already been arranged. Saturday, the second day of the meeting, will feature Digital Video with presentations by the established experts in the field.

One of the major highlights of the two-day meeting will be a product specific equipment exhibit where only newsgathering and digital equipment will be shown. This is one of the few times an equipment exhibition corresponds to the material presented on the technical program.

In addition to the technical program and equipment exhibition, the meeting will have a Get-Together Luncheon on Friday. The guest speaker will be John M. Taff, Assistant Chief, Policy and Rules, FCC. On Friday evening, there will be a wine and cheese party sponsored by several of the local television stations.

Registration for the two-day meeting is \$40 for SMPTE members and \$50 for non-members. Daily registrations will be available for \$25 for SMPTE members and \$30 for non-members. The price of the luncheon is \$10. Admission to the exhibition and wine and cheese party is included in the registration fee. Registration information and pre-registration forms are available from SMPTE, 862 Scarsdale Ave., Scarsdale, NY 10583.

The papers that have so far been scheduled for the "Beyond ENG" session are: **Overview of Beyond ENG**, by Joseph A. Flaherty, CBS; **Direct Vs. Color Under**, by Robert Pfannkuch, Bell & Howell; **The Evening Show—The Use of ENG**, by Scott Gibbs, KPIX; **After ENG—What?**, by C. Robert Paulson, AVP Communications; **Beyond ENG at KOOL**, by Al Hillstrom, KOOL; and **Beyond ENG—The End Query**, by Howard Steele, IBA London. Several papers are expected to be added to the program. There will be a panel discussion following the papers. The panel will be made up of speakers from the Beyond ENG sessions.

On Saturday, the papers sched-

Continued on page 12

THE LOGICAL CHOICE the MCI JH-110

NO RELAYS • NO HEAT • NO GRIEF
JUST LOGICAL PRODUCTION:



- Three speeds
- Equalization *and* bias automatically selected for each speed
- Fast wind control "Joystick"
- DC capstan servo with built-in variable speed control
- Digital real-time tape timer (optional)
- Return to zero search (optional)
- Constant tape tension on both reels
- Plug-in head assemblies

represented by:

 PACIFIC RECORDERS AND ENGINEERING CORPORATION
1-100 ROSELLE ST., SAN DIEGO, CALIFORNIA 92121
TELEPHONE (714) 453-3255 TELEX 695008

For More Details Circle (9) on Reply Card



**From press box to announce booth,
from studio floor to once-in-a-lifetime remote...
depend on the E-V mike system
for a competitive edge in sound quality.**

Variety is more than the spice of life. It's essential for top-notch audio... for the best sound in your market area ... despite the acoustic or talent problems you might face.

Granted, most pickups can be handled with our traditional dynamic or electret condenser "basics". But when you need them, we have microphones to wear on the head, around the neck, or carry in the hand. Real problem solvers.

And E-V pioneered in the design of practical "shot gun" microphones that perform so well on overhead booms and in ENG units. We round out the line with a host of accessory windscreens,

filters, pads, and mounts... all the vital little extras you've asked for.

We call it the E-V System. Each model designed to best solve a particular problem... and all models designed to work together. To mix without abrupt quality changes. To be easily equalized because there are no power-robbing peaks. To work without fail, no matter what. And to provide the optimum signal-to-noise ratio (acoustic or electrical) that gives your signal a clean start.

Why worry about good sound? Because bad sound adds up. Fast! And considering all the dime store speakers, noise, and confusion at the listener's

Our microphone system is the place to start. Browse through our catalog. Digest our spec sheets. Try our mikes in your studio. The more you use the E-V system, the better you'll sound. Ask your E-V sound specialist for a guided tour, or write us today.



Dept. 171V, 638 Cecil Street
Buchanan, Michigan 49107
For More Details Circle (10) on Reply Card

Continued from page 10

uled for the Digital Video Sessions are: **A Review of Digital Standardization Progress in the Video Field**, by Charles Ginsburg, Ampex Corp.; **Comparison of Digital and Analog Techniques in Video Image Enhancement**, by Al Swain and Yves Faroudja, Yves Faroudja, Inc.; **Digital Techniques in Disc Recording**, by Luigi Gallo, Ampex Corp.; **Measurement of Video Sig-**

nal Transmission Parameters Using Digital Technology to Fully Automate Such Measurements, by Charles W. Rhodes, Tektronix, Inc.; **Analog to Digital Conversion for Video Applications**, by Walter A. Kester, Computer Labs, Inc.; **Digital Special Effects for Color Video**, by Stephen Beck, Consultant; **Digital Video Recording for Television Broadcasting: Part II**, by Frank Davidoff, CBS Television Network; and **Optimum Use of Frame Store Synchronizers**, by

Brian Matley, Micro Consultants, Inc.

FCC Clarifies Ascertainment Policy

The Commission has clarified its policy regarding incorporation of community leader ascertainment surveys conducted for a previously filed renewal application into an ascertainment survey filed with an assignment or transfer application.

The action was the result of a petition for clarification of the rules governing ascertainment of community problems by broadcast renewal applicants filed by the law firm of Arent, Fox, Kintner, Plotkin, and Kahn, supported by comments filed by the law firm of Dow, Lohnes, and Albertson.

The law firms asked the Commission for clarification to permit applicants for assignment or transfer of license to integrate into their community leader ascertainment surveys certain interviews conducted initially for a renewal survey.

Last September 15, the Commission adopted new procedures permitting applicants for renewal of licenses to incorporate prior ascertainment surveys they conducted for the same station or other stations within the same community if certain conditions were met. New procedures were needed because the Renewal Primer, adopted December 15, 1975, modified the ascertainment obligations of renewal applicants.

However, the Commission did not permit applicants for assignment or transfer of broadcast facilities to incorporate those surveys in their applications.

The Commission explained that applicants for assignment or transfer of license, who are governed by the 1971 Primer, must ascertain community needs and interests within six months before filing their applications. These surveys, if said, must be conducted by prospective principals or management-level personnel.

The law firms asked the Commission to rule that interviews conducted by prospective principals or

Continued on page 14

You Have a Right To Expect More from Scully's Family of Recorders.



And look what you get with Scully's 280B/284B series. One to four tracks. Plus these important features:

- Optional DC capstan servo
- Motion direction sensing logic
- Innovative low-noise electronics
- Functionally illuminated controls
- Optional 14" reel capability
- Reproduce-only version (285B)
- Variable speed accessory with L.E.D. speed read-out

For multi-channel application, Scully has the 284B-8, one inch 8-track

master recorder with DC servo and 14" reels. You'll solve a lot of recording problems at once with the versatile Scully family.

Sales, service and replacement parts are available from over 200 worldwide distributors. Get the facts, contact Scully Recording Instruments, Audio/Electronics Division of Dictaphone Corp., 475B Ellis Street Mountain View, California 94043 (415) 968-8389 TLX 34-5524

▶ Scully
Recording Instruments

Scully and Dictaphone are trademarks of Dictaphone Corporation, Inc., New York

For More Details Circle (11) on Reply Card

No-Risk High Modulation For FM Stations

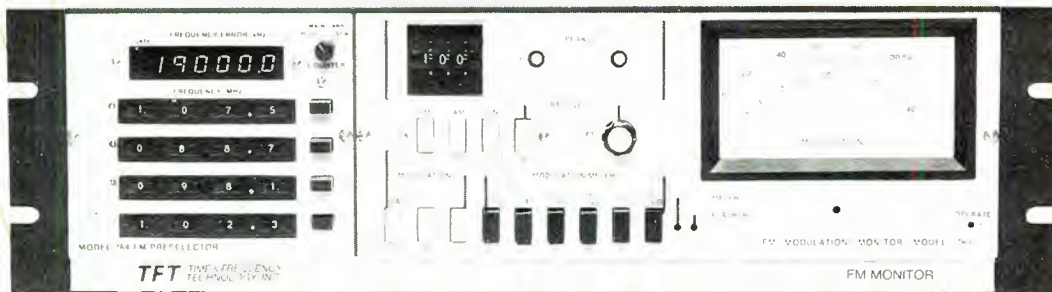

Now TFT gives you FM modulation monitoring that's so precise you can modulate your FM transmitter to the absolute legal limit—in absolute confidence. TFT monitors give you fast, unambiguous readings with an accuracy of one percent. And they can be tailored to your needs and budgets.

Our Model 763, for example, is an economical way to get precise measurement and make proof of performance measurements. It connects directly to your transmitter. Or, if you want off-the-air capability, add our optional Model 764 Preselector. It gives you frequency synthesized tuning and digital readout of carrier and sub carrier frequency errors. And, our Model 765 gives you everything the Model 764 does, except frequency readouts.

What's more, both Preselectors give you a fast, precise fix on how your modulation measures up to the competition. With either one, you can tune in other FM stations, one-at-a-time, and monitor their modulation off-the-air.

In addition, the Model 764 gives you the ability to preprogram up to four stations via thumbwheel switches. One of them can even be yours. Then, by simply pushing a button, you can monitor any one of the four off-the-air.

No matter which kind of system you choose, you'll get all the quality features that have made TFT the industry standard.

- Stereo and SCA add-on capability
- Adaptability for Automatic Transmission System (ATS) use
- 50 μ v sensitivity
- Two RF inputs for local or remote use
- Digitally settable peak flashers
- Built-in modulation meter and peak flasher calibrators
- FCC Type Approval Nos: 3-236 (FM), 3-237 (Stereo), 3-238 (SCA)

For a demonstration of how TFT can take the risk out of high modulation, ensure full FCC compliance and give you a calibration of your competitive position, call or write.

TFT

TIME AND FREQUENCY TECHNOLOGY, INC.

3000 OLCOTT STREET, SANTA CLARA, CA 95051 (408) 246-6365 TWX No. 910-338-0584

NEW!

Remote Controlled Production Switcher

Model 7400 gives you

- High Reliability
- Quality Construction & Components
- 2-Piece Design for Easier Maintenance, Greater Layout Flexibility
- Economy

and . . .

- 23 Wipe Patterns
- 12 Inputs Including Black Burst
- Computer-Compatible Control Logic
- 100% Vertical Interval Switching
- Key, Color Mat, Mix, Soft Wipe, Spotlight & Mask Key
- Program/Preview Cut Bar
- Optional Circle Pattern with Joystick Positioner
- NTSC, PAL, or PAL-M Versions

Call or write for specifications and price. Distributor inquiries solicited.

DYNASCIENCES | video products

Township Line Road, Blue Bell, PA 19422
Tel.: (215) 643-0250/Telex: 84-6358

A SUBSIDIARY OF **Whittaker** CORPORATION

For More Details Circle (13) on Reply Card

When you have to communicate, call us.



- Remote Broadcast CUE Systems
- Remote Pickup Receivers
- Remote Pickup Transmitters
- TV Aural Monitors
- Wireless Microphone Systems

Specialists in Remote Broadcast Audio Transmission/Communications/Control

60 Union Avenue/Sudbury Massachusetts 01776 (617) 443-5077

For More Details Circle (14) on Reply Card

Industry News

Continued from page 12

management-level personnel of a transfer or assignment applicant initially for the renewal application of the assignor or transferor—but in full compliance with the requirements of the 1971 Primer rather than the Renewal Primer—may be used or integrated into the assignee's or transferee's community leader survey. They said that any such contacts made within six months of the filing of an assignment or transfer application should be available for use in the applicant's surveys.

The Commission concluded that the public interest would be served by permitting prospective licensees to avoid unnecessary contacts and duplication of ascertainment efforts. Therefore, it said, applicants for assignment or transfer also may integrate into their community leader ascertainment surveys any interviews conducted initially for a renewal survey if conducted:

- in compliance with the 1971 Primer;
- by prospective principals or management-level personnel; and
- within six months prior to filing of the assignment or transfer application.

The Commission noted that these interviews should be included in the listing of community leader interviews supplied with the application, stating that a separate listing or identification of these contacts was not necessary since they must meet all requirements of the 1971 Primer.

The Commission cautioned applicants using this procedure to assure that all interviews integrated into their assignment or transfer surveys are carried out with open ended questions designed to elicit and permit a full discussion of the needs and interests which the leaders believe are important to the elements of the community they represent.

Similarly, the FCC said it would permit use of general public survey contacts, made within six months before the filing of the assignment or transfer application by prospective principals, management-level or other personnel.

Here's how useful a distortion analyzer can be

Monitor voltage, power, distortion or dB ratio.

No manual nulling controls required (the 1710A is always in auto-null, reaches a null in less than 5 seconds).

Intermodulation Distortion Analyzer optionally available.

Oscillator distortion is typically .001%.

Measure generator signal at load with the push of a button.

Selectable 18 dB per octave filters reject hum and high frequency noise.

Fast pushbutton operation lets you set level, measure voltage or power, then measure distortion.

Measure voltage or power from 10 Hz to 110 kHz.

100 k Ω Balanced Input.

View input signal on a scope.

Automatic Set Level is optionally available.

View distortion products on a scope.

Measure distortion down to .002% voltage or S/N ratios with 100 dB dynamic range.

± 1 dB Vernier adds fine level control.

Internal oscillator adjustable from +26 dBm to -89.9 dBm in 0.1 dB steps.

Turn off oscillator for quick S/N measurement.

Tuning indicators help measure distortion of an external source.

Simultaneously select oscillator and analyzer frequency with fast-to-use pushbuttons. 10 Hz to 110 kHz.

Balanced and floating 150 Ω or 600 Ω Generator output.

Two of the above features are so outstandingly valuable that we especially invite your attention to them.

One is the fast, easy measuring you get with pushbutton-selected distortion-measuring circuits (signal source and measuring circuits are simultaneously selected with the **same** pushbuttons). Pushbuttons make it so simple to measure quickly and to repeat measurements.

Secondly, you can drive virtually any type of circuit from the signal source output — whether

balanced, unbalanced, off-ground or whatever. That's because the signal source output circuit is fully **isolated and balanced**.

There is no output transformer to introduce noise or distortion.

Besides these outstanding conveniences, you can have the Sound Tech 1710A with an option that enables you to measure **intermodulation distortion**.

Call Mike Hogue/Larry Maguire to get full information on an instrument recognized everywhere as the standard of the audio field.

ST[®]

SOUND TECHNOLOGY

1400 DELL AVENUE
CAMPBELL, CALIFORNIA 95008
(408) 378-6540

For More Details Circle (15) on Reply Card

Whatever your film chain, EEV can wrap up your Vidicon needs.

We have the tubes you need, when you need them. We can send matched sets—or singles selected for appropriate color channels. Full technical back-up service available. For technical data and details of our very competitive prices, contact us now.

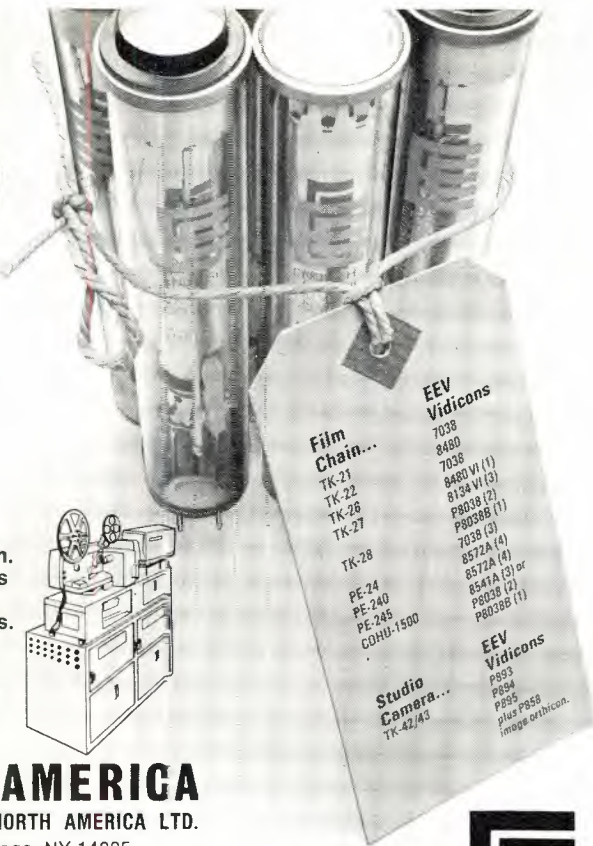
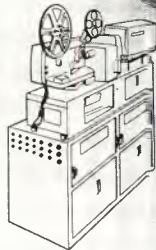

Film Chain...
TK-21
TK-22
TK-26
TK-27
TK-28
PE-24
PE-240
PE-245
COHU-1500

EEV Vidicons
7038
8480
7038
8480 VI (1)
8134 VI (3)
P8038 (2)
P8038B (1)
7038 (3)
7038 (4)
8572A (4)
8572A (3) or
P8038 (2)
P8038B (1)

EEV Vidicons
P893
P854
plus P858
image orthicon.

Studio Camera...
TK-42/43

EEV NORTH AMERICA

ENGLISH ELECTRIC VALVE NORTH AMERICA LTD.

1 American Drive • Cheektowaga, NY 14225
(716) 632-5871 • TWX: (710) 523-1862
67 Westmore Drive • Rexdale, Ontario M9V3Y6
(416) 745-9494 • Telex: 06 965864
A member of the GEC-English Electric Group of Companies



For More Details Circle (16) on Reply Card

For mono, stereo...AM, FM, TV... ONLY FIDELIPAC® GIVES YOU A CHOICE

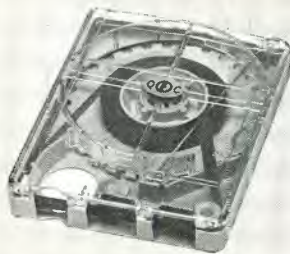

MODEL 300
The most popular NAB cartridge...performance and price make it the mono broadcaster's first choice.

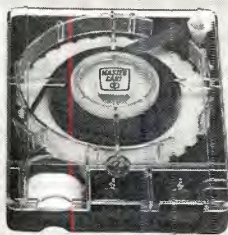

MASTER CART
For the modern stereo broadcaster satisfied with nothing less than the ultimate in performance.



MODEL 350
For use in stereo machines with inadequate tape guidance. The precision is provided by adjusting the cartridge.

AND, for extended play...Fidelipac's Models 600 and 1200.
For details, contact your Fidelipac Distributor or



FIDELIPAC®

109 Gaither Drive • Mt. Laurel, NJ 08057 • (609) 235-3511

® Trademark

For More Details Circle (17) on Reply Card

Zoom In!

Take 1!...Montage (On the effects buss)...

Good news from John Senuta at NBC's affiliate in Davenport, Iowa, WOC-TV. Our regional rep writes to say that he is no longer our regional rep...and for a very good reason. John is heading for the Big Apple with a job offer from CBS-TV...We all congratulate him...but hope that we can get a replacement of the same caliber back there in Davenport...Rest assured that we'll put him to work when he gets to New York.

Dick DeBeradinis, of Central Dynamics, tells us that his company would be happy to be one of those working with ASTVC in setting up seminars and other training sessions for the membership. Welcome aboard CD, Ltd.!...Speaking of seminars...Mike Madigan of NBC just appointed Director for Plans & Services replaces Marc Cahn who has moved over to the Membership Section...Other newcomers to the staff are John Kenny, newly appointed Director for Union Liaison and Keith Morris joining us as Associate Director for the Schools Liaison Group. Jim Schoonmaker, our regional rep down at WCIX, Miami, surprised us with an appearance on the Nightly News set...flew up from the deep south and decided to "tour" the NBC NY facilities...warn us next time, Jimmy, and we'll have a little something prepared for you.

Mary Zoller, of our San Diego chapter (and stellar SW repette) hopefully consummating some viewing arrangements with Sy Salkowitz, prexy of 20th Century-Fox TV...work on it, Mary!...Norm Kellman, up there in cool Alaska, is going to be asked to take on the regional rep duties for the big icebox...Say...How about asking "Pat" Patterson to do the same for the Houston area???...KPRC, here we come!...

Broadcast Engineering's Ron Merrell was kind enough to send us



the FUJINON WIDE-GUY with E.B.C.*

TOTAL COVERAGE for the average to small size studio. Our "wide-guy" will give you wall to wall coverage without putting your back to the wall.

P10 x 15 RW-2 f/2.8 If you light your studio for f/4 to f/5.6 you'll never need to use the full speed of this remarkable lens.

59°23' HORIZONTAL PICTURE ANGLE that makes a small studio look like Carnegie Hall. You'll cover an entire choral group or dance troupe.

13" CLOSE FOCUSING This is the only studio lens that allows such close focusing without

attachments or losing full zooming capability.

***E.B.C. (Electron Beam Coating)** This most advanced coating method provides high modulation and contrast, plus excellent transmission with extraordinary flare control. We invite you to compare it to any lens.

R10 x 11 RW-2 f/2.1 This lens is the brother of the "wide-guy" for 1 inch plumbicons. (There is no studio lens wider or closer focusing for 1" plumbicon cameras.)



FUJINON

FUJINON OPTICAL INC., 672 WHITE PLAINS ROAD, SCARSDALE, NEW YORK 10583

914-472-9800

For More Details Circle (18) on Reply Card

stacks of application forms for those of our members not yet on the mailing list. So...for those of you who have to steal the boss's copy of **BE**, here is your chance to have your very own...All you have to do is fill out the form you have been receiving from ASTVC and drop it in the mail. Be sure to mark **ASTVC** on the card. No need to stamp it...postage already on courtesy of **BE**. If, for some unexplainable reason you have not received your application form, send a letter to the complaints section for some "swift" action on

our part...

Gerry Gander, stopping by the ASTVC HQ en route from NYC back to Albany, reports plans for a big recruiting drive in the New England area. Gerry, by the way, was recently named regional director for the northeast area...

Take 2!...Meet your new board of directors...

As a result of the last membership vote, the new board of directors of ASTVC read as follows: Tom Jocelyn, Metro-Media, Washington D.C. (WTTG-TV)...Frank Melchiore, ABC...Peter Basil, NBC

...Sol Bress, CBS...These gentlemen will join Bob Zweck and Buddy Fleck as members of the board... Congratulations and best of luck, fellows!...It might be interesting to also relate for our readers just what the aforementioned board members do (when they're not working for ASTVC). Sol Bress is assigned to mini-cam ops with the CBS local news desk. As such, it is not unusual for Sol the put in twelve or more hours on some tours while out in the mobile van...Can Sol go home and look forward to a good night's sleep after all that?...Sometimes...But, more likely he'll be up on the phone "courting" his fiancée in Philadelphia...

Frank Melchiore, ABC field man, proud owner of a new home in Connecticut...Usually out of town three or four days a week...back just in time for the mowing or plowing (depending on the season) ...Same for Pete Basil...Pete's another field type...baseball, football... the whole bit...and then they throw in the Saturday Night Special... You'll find Peter "manning" (or is it **personning**) a camera in NBC's studio 8H...Now Tommy Jocelyn of MM's WTTG has it made...all he does is go out and shoot his sequences with his magic minicam, return back to the studio and edit same and...(do you really get to play them back too, Tom???)...Now that just leaves Zweck and Fleck... you don't really want to hear about them, do you?...Well...maybe in the next column...

Nobody has it like the new Spotmaster 3000 Series



Model 3100 Slim Line — the space saver for A size cartridges. Available in mono and stereo playback.

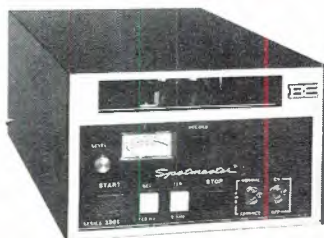

Model 3200 Compact — for A and B cartridges. Available in mono and stereo, record/playback and playback only.

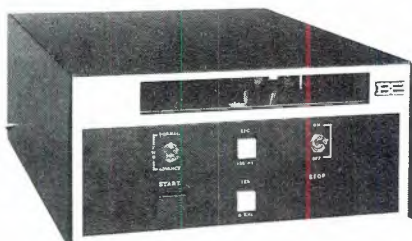

Model 3300 Standard — for A, B and C cartridges. Available in mono and stereo, record/playback and playback only.

A new family of professional cart machines with all the standard features: large air-damped solenoid, a direct drive synchronous motor, and a rugged machined deck.

PLUS the Spotmaster exclusives: Phase Lok III head bracket for optimum stereo phasing; a superior, up-to-date, modular electronic package; a unique cartridge guidance system; and a full range of options including manual/automatic fast forward, additional cue tones and microphone input. Available in desk top or rack mounting.

For details call or write Broadcast Electronics, 8810 Brookville Road, Silver Spring, Maryland 20910. Telephone: 301/588-4983.

BROADCAST ELECTRONICS, INC.
A FILMWAYS COMPANY



For More Details Circle (20) on Reply Card

Take 3!...Office of Corrections

Take note...of the correct (new) address for ASTVC...We still get forwarded mail addressed to the old Radio City box number...Remember...it is now: PO Box 296, Sparkill, NY 10976...Many members report that communications from ASTVC are late in arriving or don't arrive at all...Please help us to serve you by keeping us **posted** on your change of address and other pertinent info...such as job changes, new courses completed, etc...If you feel that you're not receiving the periodic newsletter, or other materials due you, don't hesitate to let us know ASAP. Thank you...

Wishing you all good health for the New Year...

Fade to Black...

IT'S DECADE TWO

...and the company whose innovations over the past 10 years revolutionized color television cameras in the U.S. and throughout the world, now puts its 3-Plumbicon picture and a beam-splitter prism into the most exciting new lightweight camera value on the market.

The PHILIPS LDK-11. Full broadcast quality for both ENG and commercial production!

With the LDK-11 no longer must broadcasters or production companies sacrifice picture quality or operational features for portability. Broadcasters started using the LDK-11 in January, 1976 and the reactions have been outstanding. A typical report from one of the first stations to get delivery... "the field pictures look as if they were shot in our studio!"

Battery or AC powered and with full production control either remotely or at the backpack, the LDK-11 has all the key Philips engineering features that make it like no other comparable camera in the world. These features include Philips famed 3-Plumbicon[®] tube picture, beam-split prism with bias light and Philips linear matrix for superb colorimetry. Also included are H & V contours, auto iris, auto white balance, genlock sync generator, switchable gain and gamma, built-in color bars, remote VTR and zoom controls, and two audio channels.

All this and more add up to the

utmost flexibility and economy for ENG, local remote and studio production...without compromise. And the LDK-11 is available now!

Send for more information. Or, better still, have your Philips representative set up a demo for you. But do it today before you get TKO'd into anything else. Broadcast Products, Philips Audio Video Systems Corp., 91 McKee Drive, Mahwah, New Jersey 07430. (201) 529-3800.

PHILIPS[®]

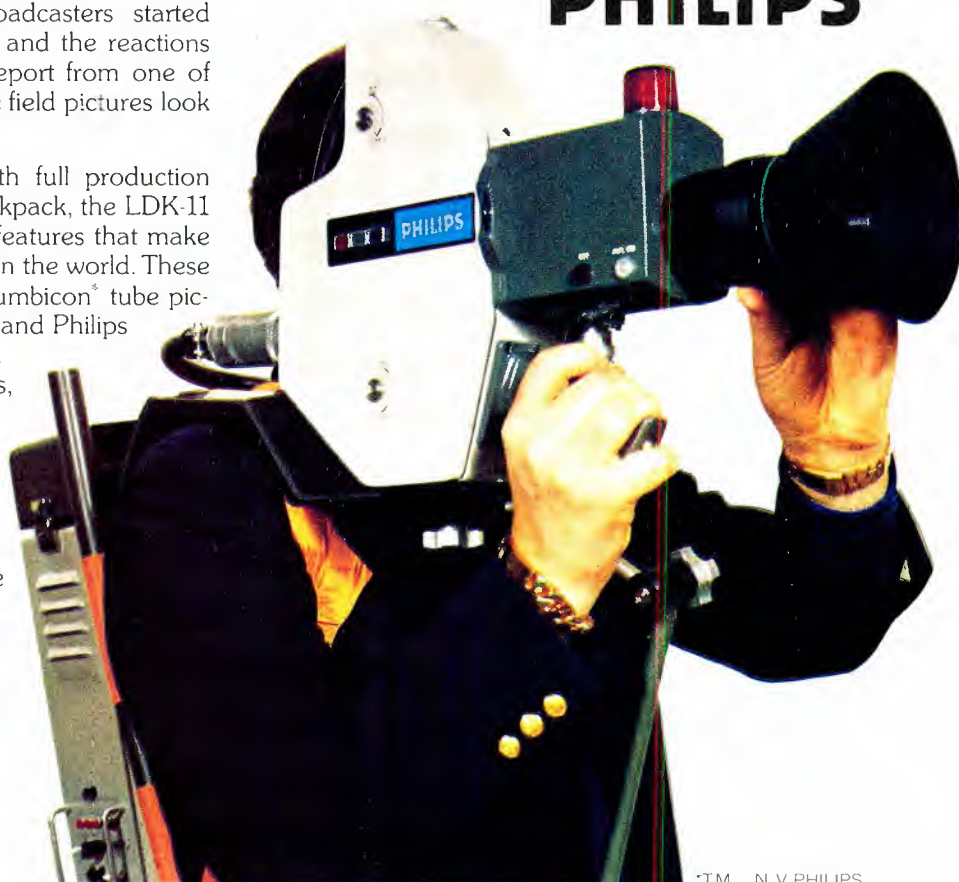

[®]TM N V PHILIPS

ENG: TV News Will Never Be The Same Again

By Ron Whittaker



"We're right in the middle of a revolution as far as TV news is concerned, and the industry will never be the same again."

These are the words of Ernie Mastroianni, news director for WJXT in Jacksonville, Florida, a station which has helped set the pace in the current electronic news gathering (ENG) revolution.

It was about two years ago that WJXT made the decision to invest heavily in ENG for their extensive news operation. Being one of the first to "go all the way with ENG" was not an easy decision to make—especially for a station which had received top ratings and awards throughout the years for news and investigative reports by film.

For a while, in the beginning, it began to look like a bad decision. Problems of all types plagued the

effort. Florida's high humidity in general, coupled with the fact that WJXT is located next to both a river and the Atlantic Ocean, presented some major problems for electronic gear which is "somewhat allergic" to moisture and condensation. Equipment broke down and stories were lost with such regularity that reporters almost rebelled against using the new ENG equipment.

And, at that time, there was really nowhere to turn to get answers for equipment problems. You will remember that in the beginning, "ENG equipment" was industrial and audio-visual equipment which was not designed for the job broadcasters had in mind. And so broadcasters were virtually on their own in modifying this equipment and pressing it into a

new and very demanding type of service. Problems were to be expected.

But equipment has changed greatly in two short years. The attitudes of reporters at WJXT has almost totally reversed. Now ENG equipment is preferred for almost all news assignments, simply because reporters realize that now more stories can be covered better, in less time, and with more production control.

All the problems have not been eliminated. Jacksonville's high humidity is still a factor to contend with. But, by and large, the major problems have faded into the background and for WJXT electronic news has definitely come of age.

In tackling part of the ENG story for **Broadcast Engineering**, it seemed appropriate to focus first of

all on the experiences of a major ENG station, and then from this to project ahead to some probable directions for ENG in the future. WJXT in Jacksonville, as one of the leading stations in the ENG revolution, seemed like a good choice for the first part of this assignment.

The WJXT Story

First, a little background. WJXT has been a leader in the Jacksonville market in news and investigative reporting since it went on the air over 25 years ago. As one of the Post-Newsweek stations, WJXT inherited a strong news and investigative reporting mandate.

It was not too many years ago, for example, that a series of WJXT investigative reports on corruption in the Jacksonville city government led to a number of city officials going to prison. You might remember that it was WJXT which was largely responsible for the investigative report on G. Harold Carswell's allegedly racist speech in Georgia. This was subsequently seen as being the major factor in his losing an appointment to the Supreme Court.

WJXT, as well as the other Florida Post-Newsweek station, WPLG in Miami, had their licenses challenged during the time Nixon was in office. Possibly not unrelated to this is the fact that the White House transcripts pay more than a passing interest in the Post-Newsweek television stations. WJXT's consistently strong policy of in-depth news and investigative pieces throughout the years—even in the face of some formidable political and economic resistance at times—has earned the station a top reputation in television news.

With this background, you can see that the decision to convert their news operation to all electronic news, or minicam, was a major one. While some stations saw an important public relations advantage in going to all electronic news operations, the motivation at WJXT was primarily one of greater speed and efficiency in news operations, according to Bill Grove, vice president of news and public affairs.

The heavy emphasis on film

actualities, for example, meant that the on-air production of the newscast was becoming impossibly complex, from a production standpoint. Film stories—possibly a dozen or so in a single newscast—often consisted of an A-roll film, a B-roll film and an audio cart, all of which had to be rolled together on the air for each film story. Now, ENG stories are sent to the video tape room for quad recording, completely assembled and ready for airing. This relieves the director and telecine area of tremendous pressures, and much of the potential for foul-ups.

The ENG Transition

According to Ernie Mastroianni, no great changes in the number of personnel were necessary for the transition to ENG. Basically, some employee job descriptions were altered, and there was some shuffling of personnel within the station. Fortunately, these changes could be made without creating significant employee problems. As many stations have found out across the country, younger personnel are generally able to adapt to the job changes that the film-to-ENG transition entail. If personnel are willing to learn new responsibilities (and union problems do not hinder redefinitions in job responsibilities), film cameramen can learn to operate ENG cameras, film editors can learn ¾-inch tape editing, etc.

According to Mastroianni, once the news department got past the rather large capital outlay for ENG equipment, there was no great change in operating expenses. It is actually very difficult to pin down comparative "before ENG" and "after ENG" expenses, due to inflation, capital investment factors, major differences in how stories are covered, shooting ratios, etc. However, some stations have concluded that they are now getting much more for their money with ENG, all things considered.

For example, more "footage" is being shot with tape than with film, and at far less cost. Instead of just trying to anticipate highlights of a talk, sporting event, or general news event—and hope you are lucky and don't miss something important—stations are "turning on the camera" and getting it **all**. By making a note of time code numbers when things of significance happen, a reporter or tape editor can go immediately to these important segments, and never have to look at, or even concern themselves with anything else. The time code numbers also enable them to add up the times of the needed segments for both pre-editing and editing decisions.

Another reason film and ENG cost comparisons are difficult is that ENG stations tend to use more actuality reports now than they did with film. Several stations have



ENG has enabled reporters to cover more stories in less time and with more production control. And since a late-breaking news story can be on in less than 30 minutes, news deadlines have been extended.

**Mix an ENG camera
with a studio camera, and
what do you get?**

A Sony.

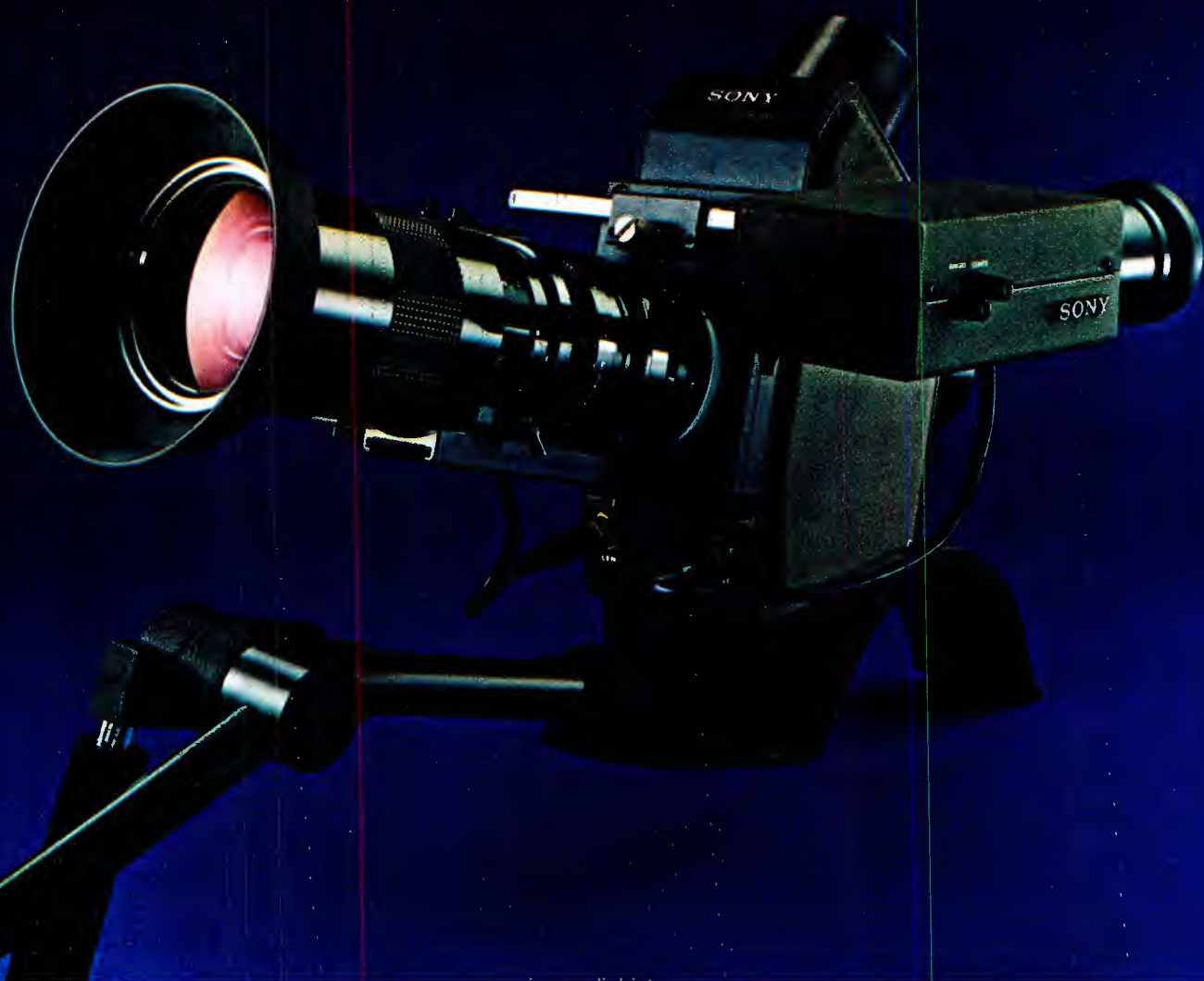

The Sony BVP-100, to be exact. A new kind of portable color video camera, from Sony Broadcast.

There have been portable ENG cameras before. Field production cameras, too. But the BVP-100 is a camera deliberately designed to give you the best of both worlds.

The BVP-100 combines the lightweight body, economy, and simple setup procedure of an ENG camera with the broadcast picture quality, manual controls, and built-in professional features of a field production camera.

It's like having two cameras in one.

In the field, the BVP-100 is fully portable, easy to handle, completely automatic. You can depend on it to cover fast-breaking news, sports events, any ENG situation you run into.

But when you're in commercial or documentary production, you need more than an automatic ENG camera. You need a camera you can control manually. A camera you can interface with other cameras. A camera like the BVP-100.

Take a look at some of the special advantages the Sony BVP-100 can offer you:

1. Beam-splitting prism optics. Three 2/3" Plumbicons* with beam-splitting prism optics provide broadcast quality signal resolution, high sensitivity, low registration error, and extremely stable operation—at a signal-to-noise ratio of better than 50db.

2. Built-in masking generator. Unlike many portable color cameras, the BVP-100 has built-in masking circuitry. This insures optimum predictable colorimetry at all times,

and of course allows matching the BVP-100's colorimetry to that of other cameras.

3. Built-in test generators. On location, you can make many necessary balance and test monitoring adjustments without accessory equipment. And the less accessory equipment you need, the faster you can move.

4. Quick adjustment to changing light. The BVP-100 special black stability circuit and automatic white balance help maintain correct color proportion levels. Even in rapidly changing lighting conditions.

5. Flare compensation. The BVP-100 has fully adjustable flare compensation circuitry to remove any annoying distortion in black balance created by an optical disturbance.

6. Recorder playback through viewfinder. For field situations, the recorded video signal is switchable to the BVP-100 viewfinder. You can monitor and review instantly.

7. Easy access to controls. The BVP-100 is designed with all setup and operating controls conveniently located for quick adjustments while the camera is in use.

And there's more. Much more. Built-in filters. Image enhancement. Easy setup. Operation with battery or AC adaptor. Plus a single 10-pin connector cable that links to the new Sony BVU-100 Portable Videocassette Recorder, or to any other Sony portable recorder.

For further information on the BVP-100 Color Video Camera, write to Sony Broadcast.

*Trademark N.V. Philips

Sony Broadcast

Sony Corporation of America, 9 West 57 Street, New York, New York 10019

Sony® is a registered trade mark of Sony Corporation of America.

For Literature Only Circle (60) on Reply Card
For Demonstration Only Circle (61) on Reply Card



With ENG, stories can be immediately checked in the field by playing the tape back through the viewfinder. Cameraman Tony Cunningham and news reporter Jan Gauss check the playback of a civil disturbance story they've just covered.

Although, admittedly, the live minicam report was at first a bit overdone by many stations, it does appear that live switches may increase in the future, due to the greater understanding of its capability and advantages by "newsmakers." It is interesting to note that many news events—especially those with political angles—are "happening" more and more during the time stations are doing local news. Ernie Mastroianni of WJXT, who has been observing this trend across the country, sees this as being anything but accidental.

In going live, these newsmakers have a much better opportunity to control their message. There can be no editing together of perceived highlights, and it may even be rather difficult to cut away from a live switch in a short time. The newsmaker can, therefore, exercise a certain amount of control over the news presentation.

The dilemma that news departments are in over these situations has not gone by unnoticed by people with political motivations. You can't exactly ignore an important news event that is happening in the middle of your newscast when you have the capability of presenting it live by ENG. Taping it and playing it back on the late night news or the next night's news reduces it to old news. And there is always the competition which knows the psychological advantage of "live switches" in an important story—a story which everyone would probably really rather carefully examine before airing.

So we may find more and more of certain kinds of news events "happening" during our local news time (with enough advance notice to make an ENG set-up possible, of course).

An ENG Era

And so, another whole chapter or era is opening up across the country in broadcast news, an era that is much more demanding for broadcast news personnel, but an era which will raise the efficiency and effectiveness of broadcast news to a new plateau. As the man said, "We are in the middle of a revolution." □

Image-Ex™

Image Processor



- Crispens video pictures**
- Reduces visual noise by 3 db**
- Corrects chroma/luminance delay**
- Operates with any TBC or VTR**
- Reduces chroma/luminance crosstalk**

*Microtime trademark. Licensed under patent pending by Yves Faroudja, Inc.

Image-Ex™ is a standalone signal processor that improves the quality of video pictures played back from U-matic and other helical VTR formats by providing the following features:

Image Processing

Better than image enhancement, the Image-Ex image processing system eliminates the soft transitions and blurriness typical of U-matic and other helical format VTR's to increase the clarity and detail of the TV picture. Image-Ex's unique design permits crispening of even multiple generation tapes without adding visual noise to the picture.

Video Noise Reduction (VNR)

The video noise reduction system of the Image-Ex device utilizes comb filtering and noise coring to improve the video signal to noise ratio. In addition, residual subcarrier and other interfering products

are eliminated from processed video to provide crisp clear pictures even from multi-generation tapes.

Chrominance Luminance Delay Compensation

Chrominance to luminance delay, or the "comic strip effect" is a displacement of the color portion of the video picture relative to its luminance image. Such delay occurs with headwear of U-matic and other format VTR's and is particularly troublesome with the playback of tapes recorded on a different VTR. This characteristic creates soft edges in the video picture and smeared transitions between different colored objects. The Image-Ex device corrects this problem with a correction range of ± 200 nanoseconds. By putting the color back where it belongs, Image-Ex provides sharp clear pictures with improved color characteristics.

Microtime, Inc.
1280 Blue Hills Avenue
Bloomfield, Ct. 06002
(203) 242-4242 TWX 710-425-2390

MICROTIME



In the news...

**IT'S THE
PACKAGE
THAT SELLS,
NOT JUST THE
EQUIPMENT**

WFMY-TV correspondent Tom Findley conducts an interview while Vander Jenkins films it. Answering the territory needs of WFMY-TV, Findley can call in a photographer when sound; otherwise, he uses his own silent movie camera to cover many stories.

By William D. Gordon

It was a run-of-the-mill feature assignment: document the return of a monster chandelier taken down for cleaning. The photography might have been just as ordinary. I could have aimed the camera at the chandelier and rolled, as it was hoisted into place. That's what I call "we were there" coverage—30-seconds of film or videotape that does little more than prove that a

TV crew showed up at the scene.

We try to avoid that type of visual reporting. So, when I shot the chandelier story, I looked for a number of dramatic angles. I took my camera, climbed a ladder 40 feet straight up the wall, and then ducked through a series of narrow passages in the hot attic above the theater to shoot down at the chandelier as it was being cautiously inched into place. The result was an artistic piece of coverage that earned some nice viewer praise.

Complete, interesting visual packages, combined with in-depth reporting, are what we strive for. Our reputation is based on this type of coverage. The February-March Arbitron ratings indicated that 106,000 sets were tuned to our 6 p.m. half-hour newscasts, while our closest competitor—a station which is now heavy in ENG in its news operation—reached only 59,000 homes. The third station had a 47,000-home share. My point is that, in this market, story selection and the way one covers a story are more important than the equipment used.

We're a medium-sized, three-city

market encompassing Greensboro, Winston-Salem, and High Point. But we also have to include the surrounding small cities, towns, and rural areas. Out of North Carolina's 100 counties, our station covers news from 21 of them. Our normal news radius is about 100 miles. Geographically, the sheer size of our reporting area is a constant headache.

Here's where the size of our staff gives us an advantage. Our 25-member news department includes eight reporters and seven photographers, giving us the largest number of people in the field. We also have full-time correspondent reporter-photographers in Winston-Salem and Raleigh, the capitol.

Though our staff is larger than the competition, we still have to conserve our resources to cover the news. Many times that means that our photographers serve as "one-man bands."

News Territory Makes A Difference

Our photography department has both ENG and film capabilities. We have two Akai video cameras

About The Author

William D. Gordon, chief photographer for WFMY-TV, joined the station 21 years ago. His ability with a camera has been recognized often by his colleagues. In 1960, Gordon was chosen "TV Photographer of the Year" in Southern Short Course competition sponsored by the Carolina's Association for Press Photographers.

He has received numerous awards for his news and documentary filming. The plaudits captured by his photography staff in recent years demonstrate that Gordon is as good at teaching camera news as he is at practicing it.

UHF-TV TRANSMITTING ANTENNA PROVIDES CUSTOM-OPTIMIZED RADIATION PATTERNS

TYPICAL ELEVATION PATTERN FOR 15.0 dBd
CARDIOID OR 12.0 dBd OMNI

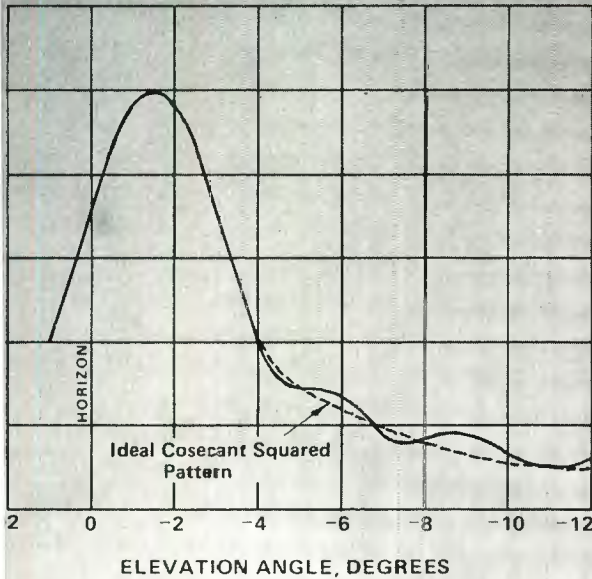

The Andrew custom-designed slotted array transmitting antenna is a new concept for UHF television broadcasting. Now it is economically feasible to optimize both azimuth and elevation radiation patterns for any given service area.

Elevation patterns are shaped by controlling the phase and amplitude of energy distributed to each slot of the array. As there are typically 20 to 40 slots, very fine control is maintained over the aperture distribution, permitting null-free pattern performance. The cosecant squared pattern, which provides relatively uniform signal strength to both near and distant locations, is very closely approximated (see graph).

An unlimited number of azimuth patterns are available. Each pattern is custom-optimized for the service area.

Other advantages include:

- High power capability: 55 – 110 kW CW, depending on requirements.
- Pressurizable radome eliminates problems caused by corrosion and ice formation. Powered radome heaters are not required.
- Antenna weight is only 1/4 to 1/3 that of other antenna types for the same gain.
- Cylindrical shape minimizes wind loading on tower.

For further information, contact your Andrew Sales Engineer.

ANDREW CORPORATION 10500 W. 153rd St., Orland Park, IL., U.S.A. 60462 Telephone: (312) 349-3300

ANDREW ANTENNA COMPANY LTD. 606 Beech St., Whitby, Ontario, Canada L1N 5S2 Tel: (416) 668-3348

ANDREW ANTENNA SYSTEMS Lochgelly, Fife, Great Britain KY5 9HG Telephone: (0592) 780561

ANDREW ANTENNAS 171 Henty St., Reservoir, Victoria, Australia 3073 Telephone: (03) 460.1544

ANDREW ANTENNAS LIMITADA Av. Brigadeiro Faria Lima, 830s/64 Caixa Postal 22.252, 01452 São Paulo, Brasil Tels: 210-2808, 211-5132

For More Details Circle (27) on Reply Card

 **ANDREW**



Reporter Susan Massengale straps on a tape recorder backpack before leaving on an assignment to cover a lengthy interview.

and Sony 3800 field backpack recorders, a Bolex Pro camera, and new CP-16A cameras. We depend on our film cameras for about 95 percent of all news work. One of the main reasons for our heavy reliance on film again relates to the size of our news territory. While we can easily send one photographer out with a CP-16A a two- or three-man crew might be needed to cover the same story on videotape. So, film gives us more mileage from each photographer.

If we were in a metropolitan area where there were a lot of spot news stories occurring in a concentrated area, ENG equipment might be more important to us. However, in the Piedmont region, if something's

happening close to a newscast, the major limiting factor in covering it and getting it on the air is travel time, not the speed of processing. So, unless we were to invest in vans with microwave capability, ENG can't be much of a timesaver for us.

Maximum News Interest

As our news director Rabun Matthews says, this market isn't well suited to "eyewitness" type reporting either. This probably relates to our market's geographic diversity. So, instead of covering car wrecks and that type of thing, we concentrate more on in-depth features, human-interest pieces, and city and county government stories.

We try to cover news that's going to be of interest to large numbers of our viewers. One day that may mean shooting out in a tobacco field where the crops are in trouble. The next day it may mean hurricane coverage or an environmental controversy on the coast. Mobility and versatility are our bylaws.

In our 14-minute news hole, we may cover only six or seven stories. We have no set length limit. Recently, for example, we ran a six and one-half minute piece on a child who remained in a coma following an automobile accident. We felt that the right-to-die-with-dignity issue merited a long and careful look. Last year, one of our stories on police corruption in High Point won the International Radio and Television News Directors' top award for investigative reporting. We also won the first place awards for general and spot news from the Radio and Television News Directors of North and South Carolina.

If you are going to concentrate on this type of news, you've got to have in-depth visual reporting to match the verbal reporting. A static stand-up interview simply won't hold the viewer's interest. Film is our primary medium, because it meets our goals best. Many of our news stories might even be classed as production packages. They are newsworthy but, nevertheless, done with production in mind.

For example, we recently did a feature story in Denton, North

Carolina, which had a Bicentennial display with a lot of historical interest. We took shots from an old plane as it landed on a grass runway as well as from an antique threshing machine. I don't think ENG equipment is ready for the ruggedness we demand in getting actuality like that. It also lacks the film camera's mobility and flexibility. With the staff we have, one person is often asked to cover a story with no back-up or second chance. In these cases, we have to stick with film because of its dependability.

Where ENG Fits

Though I don't think ENG will ever take over a market like ours, it shouldn't be ignored. It's a tool that has its place. When shooting a lengthy interview in which a reporter is digging for information videotape makes economic sense. We may only use a fraction of the material and the tape can be reused. If there's an important news event taking place just before air time and we can get a crew there and back in time, ENG can again be the answer. It also can be important for live spot news. When we upgrade our ENG system, which we hope to do next year, I think the spot and live news advantages will become more important to us.

Promotional considerations were frankly part of our reason for the timing of our purchase of video equipment. We wanted to be the first station on the air with live video news. However, I think the promotional advantages of ENG are probably overrated. Beyond those first few weeks of promotional benefit, a station's ENG capabilities will have little impact on its ratings.

When we bought our video equipment two years ago, there weren't as many choices of camera on the market as there are today. On our next go-round, I think we'll have a better defined idea of ENG's place on our market. One possibility is a mini-remote van which we could use for news and for live input to our children's morning and afternoon programming.

While all the furor over ENG has been taking place, our film quality

To make the news as visually appealing as possible, WFMY-TV photographers are constantly on the lookout for unusual photo angles, like this high shot from a fire escape.



has been steadily improving. In addition to our seven photographers, we have two lab people to handle still and movie processing. We have a Pako processor (56EK) which we converted in February to run the new Process VNF-1 for Eastman Ektachrome video news film 7240 (tungsten) and 7239 (day-light).

It took us about two weeks to fine-tune our processor for the new film, but it was worth the effort. We are processing all of the film at an exposure index (EI) of 250 (Ektachrome video news film 7240 is normally rated for an EI of 125), and it looks beautiful. The color rendition on the tube is certainly much better.

Our photographers are used to working at an EI of 80 outdoors. We still do this with the tungsten-balanced Ektachrome video news film 7240 by placing a filter over the camera lens. However, by "pushing" our processing one stop, we gain an extra camera stop indoors, where we most often need it.

By changing the process, we are also saving time and money. With

our processor, the new film has meant a reduction from 40 to 36 minutes processing time. More significant, however, is the chemical savings. By eliminating the pre-hardener and neutralizer tanks, I estimate that we will save about \$4,000 this year. We process about 75,000 feet of film a month. Though our monthly film and chemical costs run in the neighborhood of \$8,000 to \$9,000, comparable quality on ENG equipment would cost us more.

Adjusting To The Realities

Some chief photographers that I've talked with have said they've had a tough time converting to the new process for the video news film. I think the problem—and I know this isn't going to sound very scientific—is that people don't realize that processors, cameras, and light meters are going to vary. They go by the book in other words. If a film is rated at a certain EI, they'll always shoot it at that even if previous results have been disappointing. You have to go to

school on what you did yesterday and adjust to the realities. You're shooting for your processor with your cameras. Stringers know that all processors are not equal. So, if your film didn't turn out quite right, make some adjustments, experiment with chemical temperature or processing time, then adjust your shooting habits. The effort will pay off.

As I said earlier, the emphasis at WFMY-TV is on detailed, visually appealing stories. So our job doesn't end with filming. To get the most out of our raw film, we put a lot of thought and effort into editing. Much of our work is A and B rolled. Our editing equipment includes a console with a displacement recorder for dubbing sound directly onto the B roll. Many of our pieces include natural sound for effect.

From the way we select stories to the way we film and edit them, we are expressing WFMY-TV's news philosophy. How we work says a good deal about who we are and what we want to be. To prove "we were there" isn't enough. □



UNEQUALED

- **COLOR STABILITY**
- **LUMINANCE STABILITY**
- **CONVERGENCE STABILITY**

Write for detailed Catalog



Distributed in USA by

Rohde & Schwarz Sales Co. (U.S.A.) Inc.

14 Gloria Lane Fairfield, N. J. 07006
Telephone: 201-575-0750

Sync? Think of the Possibilities!

When planning or modifying a facility consider the 1410 Series of modular generators for sync generation. Using a modular approach, the 1410 Series allows you to select just the signal capability needed now. Later, as your needs change, you simply **add modules** to meet those needs. Since you buy only what you need now, your costs are reduced. Since you can add signal modules later, your investment will be protected.

A 1410 Series master sync system starts as low as \$2065. Consisting of a 1410R Generator mainframe with built-in color standard and an SPG1 Sync Generator module, this economical system produces broadcast standard subcarrier, sync, blanking, H and V drives and black burst. For a little more you can have genlock with the 1410R/SPG2 at \$2280.

A 1410 Series sync system has several special features:

- **Automatic subcarrier to horizontal sync phasing** for example, important when editing or assembling video tape.
- **Slow-lock** operation, for those situations where non-synchronous switching can cause problems.
- **Adjustable blanking widths** help maintain blanking duration within FCC limits.
- **The VIR Signal**, on line 19 of black-burst or in full-field format to record on video-tape leaders. Use of full-field VIR signal makes playback adjustment as easy as 1-2-3.

The 1410 Series can produce full-field test signals too. Modules are available now for color bars, linearity, and convergence test signals. For more information about the 1410 Series, write us at P.O. Box 500, Beaverton, OR 97077; or use the reader service numbers below.

U.S. Sales Prices F.O.B. Beaverton, Oregon 97077



TEKTRONIX®

committed to
technical excellence

For More Details Circle (39) on Reply Card

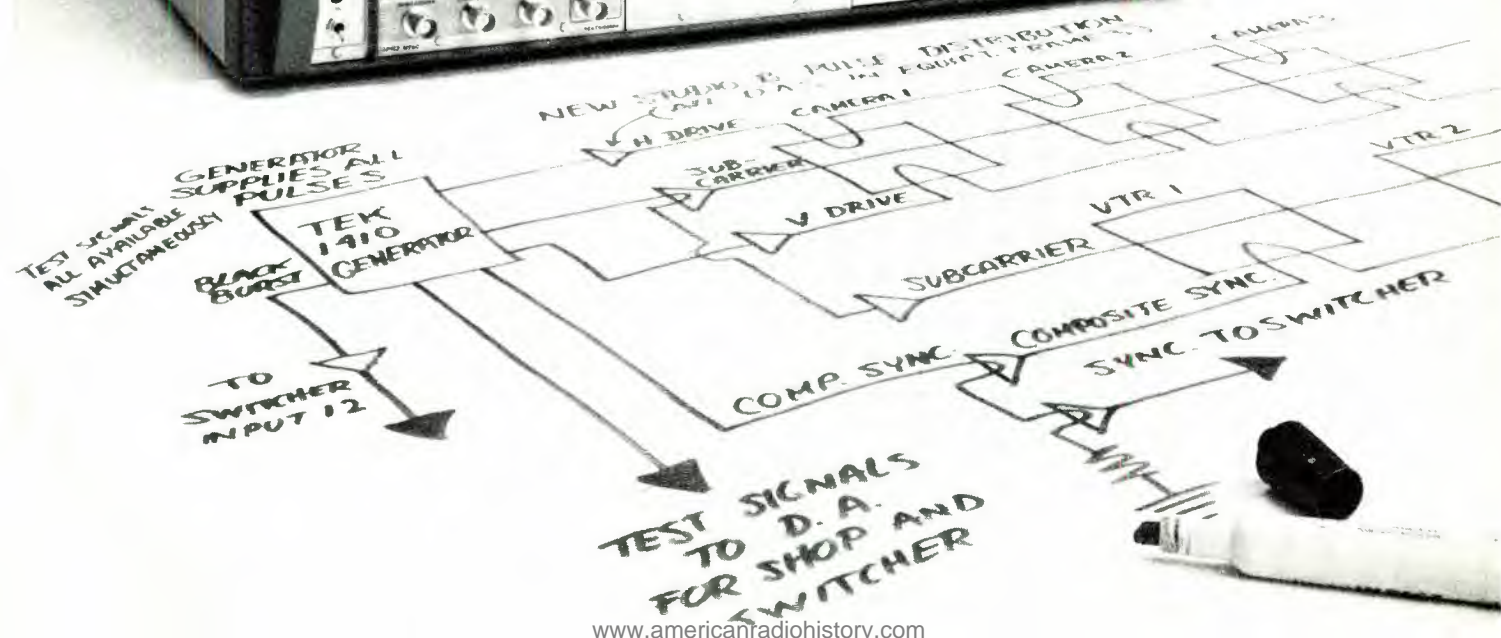

Radio ENG:

Rediscovering A Profitable Dimension

By Peter Burk

Before television beats us at our own game, we need to look at ways to put **immediacy** back into radio. Today's radio audience expects to hear what's happening **now**, and they deserve to hear reasonably good quality, even if the broadcast is originating from the local sanitary landfill!

Electric News Gathering is really a new expression for an old phase of broadcasting—remote broadcasts. The same equipment that enables your newsmen to be at the scene of a three-alarm fire can also be used to put your sports team on the

greens at the golf tournament or put your announcer high above town in a hot air balloon. The object of the exercise is to get your personalities out of the dry, sterile studio once in a while and out on the bricks where the action is taking place.

This month we'll focus on rather basic forms of remote broadcast, then next month we can deal with more sophisticated RPU setups using state of the art techniques.

The Case For Quality

It used to be that audiences

expected to hear poor line quality on anything that originated out of the studio. In fact, about ten years ago, a station in central Iowa bought a high-quality remote pickup transmitter for their news unit. Unfortunately, no one would believe that the reports from that unit were live and from the scene. To restore believability, a cheap carbon mike had to be put on the unit.

Today it isn't necessary to make field reports sound so bad. Quite the contrary! An audience that will accept high fidelity audio coming halfway around the world via satellite certainly finds it credible to listen to a nice, clean signal originating ten miles from the studio.

But, you say, most listeners don't even notice the quality of your studio sound, much less the quality of a remote broadcast. True, but as we've mentioned before in this column, we're dealing with the listeners' subconscious. No listener is obligated to provide a reason for changing the dial or turning the radio off. Unless the program is stimulating, the slightest irritation will make his fingers itchy to turn the knob. Maximizing quality even on remotes is a definite audience saver.

Telco Vs. RPU

It would be nice if we could have a 15 kHz channel for everything we do outside the studio. In the world of nasty realities, however, we frequently have to settle for less. Even if your station has a whole

Figure 1. A "quickie" 400 Hz square wave oscillator. The values are not critical, so you can use most any NPN transistor. Supply voltage can be anywhere from 3 to 24 volts. Output will have to be padded as necessary.

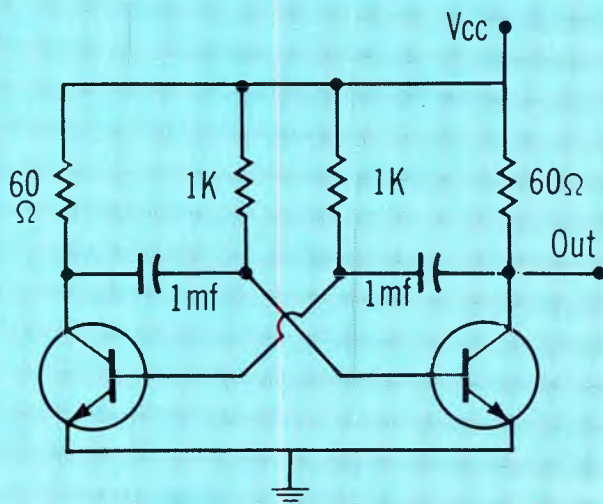

OTARI MX-5050 the original (and still the best) compact professional recorder

Just over two years ago, Otari introduced a unique new product—the first truly professional recorder in a compact package—the MX-5050. Since then, the performance and reliability of this innovative new machine have been tested and proven in over a thousand critical professional applications—by broadcasters, recording studios, A/V departments, musicians, and semipro recordists worldwide. Universal acceptance and repeat orders by these satisfied customers tell this remarkable recorder's success story better than we can.



Bias can be re-optimized in seconds.

As you compare the MX-5050 with other recorders, keep this in mind. The MX-5050 is not a hi-fi machine with a few professional features added later as an afterthought. It was designed from the ground up based on Otari's 10 year experience as Japan's leading manufacturer of professional recorders and high speed duplicators. It is a full professional machine with the performance, features, and field proven reliability that you expect to find only in the larger professional recorders.

Here are some of the key reasons why the MX-5050 is the best compact recorder available today.

Production Features: Creative production is simplified with: Front panel edit to spill tape. Lift-up head cover to mark splices and clean heads. Built-in splicing block on head cover. Adjustable cue to defeat head lifters. Selective reproduce to add new tracks in perfect time synchronization. Two speed operation, 15 and 7½ or 7½ and 3¾ ips (field changeable in dc servo versions).

Performance Features: Headroom is 19 dBm, a full 15 dBm over the switch selectable fixed output of +4 dBm. This standard reference level output can be rear panel switched to -10 dBm to drive a PA system or power amplifier. S/N ratio is NAB weighted 69 dB full track, 68 dB half track, and 65 dB quarter track. Crosstalk is greater than 60 dB half track. Outputs are 600 ohm balanced (standard on half track) or unbalanced. Line input and output connectors are XLR.



Operating Features: Bias is front-panel continuously adjustable (not limited to fixed positions). With built-in test oscillator (not available on other compact professional recorders) bias can be optimized in seconds when changing tape. Record EQ and standard reference level are also front adjustable. Straight-line tape path simplifies threading. Capstan is located on back side of tape for improved tape life. An extra reproduce head is standard on all versions to allow playback of tapes in different formats. For pitch control and freedom from power line variations, an optional dc capstan servo is available with ±10% correction range.



Easy threading; capstan on back side.

Versatility: Available in full-track (with half-track reproduce capability standard), two-track, and quarter-track versions. Walnut case (standard), rugged portable road case, rack mounting adaptor, or floor console. Universal power supply standard. Low impedance input and output transformers and remote control also optional accessories.

See your nearest Otari dealer for the full story or contact Otari. And, if it's multichannel you need, ask about the standard-setting four and eight channel versions of the MX-5050.

OTARI

Otari Corporation
981 Industrial Road
San Carlos, Calif. 94070
(415) 593-1648 TWX: 910-376-4890

Otari Electric Co., Ltd.
4-29-18 Minami Ogikubo
Suginami-ku, Tokyo 167, Japan
(03) 333-9631 Telex: J26604

For More Details Circle (28) on Reply Card

ADVANCED TECHNOLOGY MAKES RAMKO CONSOLES THE BEST BUY IN THE INDUSTRY.

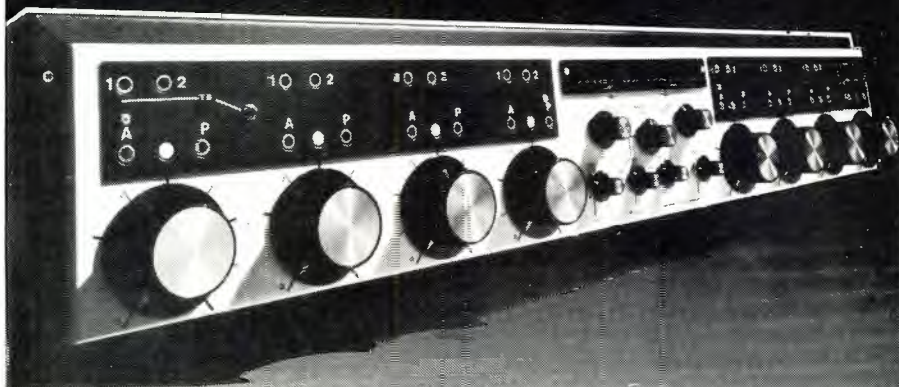

Check These Exclusive Features:

ILLUMINATED TOUCH PAD AUDIO SWITCHING. Your finger tells the audio where to go; light emitting diodes tell which function is on. Your touch gives instant command for COS/MOS audio switcher action.

SOLID STATE 'VU' METERS. Guaranteed to indicate the fastest transient and can be read 20 feet away. Eight red LED's indicate from - 21 dbm thru 0 dbm. Two yellow LED's indicate over modulation - + 1 dbm and + 2.5 dbm.

DC CONTROL OF ALL AUDIO FUNCTIONS. Hum free, noiseless audio processing with remote, mixer control and elimination of stereo pots and their tracking problems. Electronic cue switching eliminates mechanical switches on rear of mixers.

SIMUL-Q MONITORING. Permits simultaneous monitoring of other inputs, while on the air with that same channel.

MANY MORE EXCLUSIVE FEATURES. Ramko consoles also feature Plug-In I.C.'s throughout; RF Suppression through individual tuned circuits; Plug-In Amp Modules; Patch Panel Input Gain Select; Equalizer and Special Effects Interconnects and Patch Panel Monitor and Cue Mute.

NINE CONSOLE MODELS RANGE IN PRICE FROM \$695 TO \$1880. ALL CARRY A 2 YEAR WARRANTY AND 10 DAY FREE TRIAL PERIOD.

CALL COLLECT OR WIRE FOR COMPLETE SPECIFICATIONS. YOU'LL SOON KNOW WHY RAMKO CONSOLES ARE THE BEST BUY IN THE INDUSTRY!

RAMKO RESEARCH

11355 Folsom Blvd., Rancho Cordova
California 95670 • (916) 635-3600

room full of remote pickup equipment, we still have to rely on Ma Bell for some things, and as you may have already discovered, equalized loops are getting hard to come by even if you're willing to pay the freight. Out of town remotes almost have to be done with QKT circuits, using regular dial-up equipment. Hardly an ideal situation, but one we can live with by doing a little work on both ends.

The two big problems are noise and response. Most attempts to increase the high-end response only result in an increase in noise. For voice, we're more concerned with the bottom end anyway, so we'll concentrate on making voice sound natural and pleasant, and at the same time reduce noise as much as possible.

Almost all inter-exchange channels are multiplexed on carriers by the telephone company. This puts a very firm limit on bandpass. No matter what we do, we just aren't going to recover any signal below about 300 Hz or above 3500 Hz. The only thing outside this pass-band is noise! Step one, then, is to limit the bandpass at the receive end as sharply as possible. An active bandpass filter works nicely and can be made adjustable so that it can be tuned by ear after you've made the preliminary adjustments with an oscillator.

Have you been putting up with an annoying high frequency whistle on out of town QKT circuits? The tone is a pilot for the telco carrier system, and is exactly 4000 Hz. If you design your bandpass filter to notch sharply at 4000 Hz, you'll eliminate one big listener tune-out.

While we're still on the receive end, let's refine the sound just a little more with a bit of boost in the 300 to 400 Hz area. This has to be done subjectively, and will be different for each voice and each telco circuit.

The Send End

What can we do on the send end to improve the sound? For starters, level is very important. Too high, and the telco amps will clip. Too low, and the announcer's soliloquy will be masked in dial pulses and assorted other sounds provided at no extra charge by AT&T. The

For More Details Circle (29) on Reply Card

audiopak A-2
BY CAPITOL

The broadcasters' choice for reliable playback.

audiopak
A-2 BY CAPITOL
professional broadcast cartridge

The Audiopak® A-2 by Capitol® Broadcast Cartridge.

Broadcast engineers rely on Audiopak® A-2 Cartridges for good reason. All of the major components are assembled to get you from point A to point B. With efficiency and precision. For example, the constant-force, foam pressure pad assures unvarying head to tape contact over the life of the cartridge. The positive, non-slip brake mechanism locks the tape, rather than the hub, assuring accurate cueing and timing. The strong durable housing is yet another factor contributing to its reliability.

And to assure you of premium performance, each cart is individually tested — 100% — for wow and flutter, electrical output, tens on, and other properties. And because we manufacture the entire package — from tape to packaging — we can assure you of the highest possible quality control.

After all, no other tape manufacturer knows professional recording and duplicating needs better than Capitol.

AUDIOPAK® A PROFESSIONAL PRODUCT MANUFACTURED BY THE SAME PEOPLE WHO MAKE AUDIOTAPE® AUDIOFILM™ AUDIODISCS® AND TE LEARNING TAPE™ BY CAPITOL®

audiopak
BY CAPITOL



CAPITOL MAGNETIC PRODUCTS A DIVISION OF CAPITOL RECORDS, INC., 1750 NORTH VINE STREET, LOS ANGELES, CALIFORNIA 90028

For More Details Circle (30) on Reply Card

Table One

Follow these steps to set the level on each phone line:

1. Send tone from remote site.
2. Set to reference level at studio.
3. Increase send level one dB.
4. Observe one dB level increase at studio.
5. Repeat steps 3 and 4 until received level no longer increases.
6. Decrease send level by 3 dB to allow headroom.

ideal operating level will vary by a few dB from one circuit to the next, so it should be checked prior to each broadcast. A slick way to do this is outlined in Table 1. Don't exceed the telephone company's maximum permissible level of +8 dBm.

Incidentally, I prefer to use a 400 Hz square wave oscillator for several reasons. First, it's a distinctive sound that won't be mistaken for a telco tone that might be on the patch panel somewhere. Second, the high harmonic content gives you a quick clue about the response of the circuit once you've tuned your ears to hear the difference and third, it's so easy to produce a square wave with a pair of transistors in an astable multivibrator circuit.

A limiter on the send end will make even more improvement in the noise level. Ten dB of limiting will provide almost ten dB of improvement in the signal to noise ratio. Be careful that you don't limit so heavily that ambient noise from the remote location pumps up during pauses.

The voice coupler provided by the phone company QKT circuits has a coupling capacitor that is too small to pass all of the low frequency information that the line can handle. If you carry your own voice coupler, you can change the coupling capacitor to 100 mfd or so, and make some improvement in the low end response.

Take To The Air

There's little doubt that remote pickup is the way to go to maintain quality. The VHF and UHF gear being manufactured today is capa-

ble of audio performance that rivals your broadcast transmitter. One of the big obstacles is the high initial investment. If you haven't overcome this one yet, a sharp pencil will reveal some rather startling figures.

Add up what you spent last year in line charges for remotes that could have been done with an RPU and see how many years it will take to reach the break even point. You may be surprised how quickly it can pay off. As fringe benefits, throw in superb quality, instant availability and high reliability. You'll also be more likely to do sustaining remote programs, since there is no direct cost to use the gear once you have it.

Just having the gear isn't enough. Wide-band FM has to be handled carefully to get optimum performance. It takes a lot more signal to achieve usable signal-to-noise with 10 kHz audio than it does for communications quality audio.

Maximizing The Signal

The most practical place to pick up a gain in signal is at the antenna. Whether you're using VHF or UHF, height is the name of the game. Most of us are lucky enough to have a tall tower at our disposal. Even if your transmitter is not located at the studio, the height advantage may still make your broadcast tower the best location for the receive antenna. You may have to use an equalized phone loop to get back to the studio, but the cost of a permanent loop is low enough that you still retain the financial advantages of remote pickup. Besides, the loop can be connected with relays on each end so that it can double as an

emergency program loop.

Maximize the horizontal gain of the antenna by using as many bays as possible or a directional antenna on a rotor. Use good heliax for the transmission line. RG-8 just plain has too much loss for all but the shortest runs, even at VHF.

The transmit antenna is even more critical. You'll probably find that one antenna won't handle every situation, unless your market is small and flat. A single halo or 5/8 wave whip (depending on polarization of the receive antenna) is nice because it's quick to set up and will handle a good share of the remote locations.

For slightly more difficult shots, a yagi mounted on a mike stand or piece of pipe works nicely. Several manufacturers make two-meter amateur yagis that can be easily cut down to your frequency. Cut the same percentage off all elements. The seven and eleven element yagis come in several sections and can be easily collapsed for transporting.

To pull in the real toughies, you can go to a push-up mast for an additional 30 to 50 feet. They are inexpensive and light weight. A 3/16-inch nylon rope works well for guys.

Pruning the antenna is best done with SWR bridge, but observe one caution: many newer solid state transmitters are equipped with SWR protection circuits in the output. With some, you'll get an indication on the bridge of a nearly perfect match even if the antenna is way off resonance. If you have a tube-type transmitter on the same frequency, you can tune the antenna with that. If not, tune for maximum forward power instead of minimum reflected.

Your receiver should be equipped with a low pass audio filter that can be switched in at the output. Do everything you can to pull in the signal without the filter, but if you can't eliminate the hash, the filter will give you a sound that is still superior to a phone loop.

These basic techniques are just the start of what we can do with ENG for radio. In the next several months, **Radio Workshop** will focus on some of the ways you can put ENG to work for you. So you won't be confused, we'll call it RENG (Radio Electronic News Gathering). □



Introducing a Color Corrector for Electronic News Gathering.

Electronic News Gathering makes tough demands upon the broadcaster. Color imbalance and colorimetry problems are frequently encountered. Matching remote camera shots to indoor studio programs or assembling tapes from different locations or cameras is "chancy" at best. Often that fast-breaking story doesn't allow for camera rebalancing!

Thomson-CSF Laboratories now provides a solution to such difficult encoded signal color problems. With the Model 5500A Color Corrector, you'll be able to rebalance and match video signals *after* encoding. It can be used either after the play-back tape machine or following the microwave receiver during live coverage. In most cases, a noticeably improved color picture will result. For ease of operation, a Remote Control unit is included as standard equipment.

As an added feature, an optional automatic Sensor unit is also available to control the Color Corrector for telecine use.

Whether for Electronic News Gathering, tape production or telecine use, the Thomson-CSF Laboratories Color Corrector System should be working for you. Interested? Give us a call.



THOMSON-CSF LABORATORIES, INC.

37 Brownhouse Road, Stamford, Connecticut 06902
(203) 327-7700 / TWX (710) 474-3346

ENG Forges Ahead At The IBC Convention

By Joe Roizen

Expectancy about the IBC Convention did not quite materialize in the predicted manner. Rumors of major breakthroughs in recording techniques or new exotic products in the camera field remained unfounded as neither the BBC, IBA or any of the other exhibitors had any really novel

hardware to display. CEEFAX, ORACLE and DICE, the digital devices and techniques pioneered in the U.K. were on hand, but an all-digital VTR still seems to be around the corner.

However, the VTR scene was not exactly dormant. In fact, the marketing battle shaping up between

the new one-inch helical formats proposed for broadcast applications was in full swing and the introduction of ENG equipment and techniques to the seemingly reluctant European broadcasters is virtually assured.

Cameras on display were pretty much what had been seen at the



Joe Flaherty of CBS explains his views on ENG while moderator Rout makes notes and Mr. Morizono of Sony contemplates his remarks. The main question facing ENG in other countries is, will their standards drop or will new equipment meet their needs. Obviously, there is great interest in ENG in other countries. (Photos by Donna Foster Roizen)

last NAB show or ones that are being used currently by broadcasters all over the world, both in studio and mobile/portable applications.

The ornately chandeliered "Great Room", as the exhibit hall in the Grosvenor House Hotel is called, was filled to capacity and was simply not great enough. Consequently, many exhibitors chose to put their exhibits at other locations and lure potential customers over in shuttle busses or taxis. Registration was the highest ever (50 percent over the last IBC) with over 3000 delegates from more than 50 countries attending. With few exceptions, most products had been seen before, but had updating features that attracted visitors' interest. The SECAM color standard had the most new equipment being shown by manufacturers who are starting to cash in on the rapid growth of TV in the Middle East where SECAM is used. Engineers from Saudi Arabia, Iran, Iraq and Egypt were on hand in greater numbers than before.

IBC organizers have finally admitted what everyone has been saying for the last two conventions and have agreed to move the exhibition to a better location. The new Wembley Conference Center in Northwest London, with its extensive facilities, will house the next IBC in September, 1978.

Perhaps the most notable event at the IBC did not take place at the Grosvenor House at all, but at the London Hilton's Crystal Palace Suite. The ENG panel session was held there with a packed audience that overflowed to the floor and window sills. Several hundred people outside never did gain entry. An unscheduled repeat ENG session was held the next day to accommodate those who had missed the first one.

IBC had planned a mini-exhibit at the London Hilton for ENG equipment only, but could not get enough exhibitors to support this,

and it was cancelled. Those who had signed up for the space were forced at the last minute to set up in nearby hotel suites. Nevertheless, interest among the technical visitors to IBC in relation to ENG was very high, and there is not much doubt that it will increase in the near future.

The VTR Picture

Both Ampex and Bosch Fernseh added yet another overlay to their previously held positions on their one-inch helical formats. Bosch had claimed at NAB that it would be difficult to make a lightweight portable acquisition VTR out of the Ampex VPR-1 because of the large scanning assembly. Ampex had a portable, lightweight acquisition VTR on display at their U.S. Trade Center VTR exhibit. This unit, called a VPR-10, is about the size of the BCN-20 and while it was not fully operational, Ampex promised delivery in two years.

The Fernseh booth in the Great Room had a BCN with a frame store attached that gave still images on demand. As frame stores get smaller and cheaper it is conceivable that a pair of them with sequential programming could also do slow motion. BCN machines were also on display in the IVC and Philips booths, and many interested engineers were carrying tapes from one exhibit to the other testing interchangeability. IVC also announced that they will build a portable BCN with a different physical configuration than the original Bosch Fernseh model.

Ampex wisely chose not to hold their main exhibit at the Grosvenor House. Instead, they installed the 20-year-old VRX-1000 video recorder that they had borrowed from CBS for the NAB show in a booth where visitors were encouraged to take the free shuttle bus to the U.S. Trade Center. They had a very elaborate installation at the Trade Center, complete with a color

studio and all of their audio and video broadcast products on display. In particular, they were promoting the AVR-3 with super hi-band and pilot carrier for the more stringent European PAL and SECAM requirements.

Video Products

SECAM/PAL versions of a number of American products that were new to Europe were on display and attracted a lot of interest: the Television Microtime 2020 digital TBC, the Yves Faroudja CRISP-MATIC image enhancer, the Arvin/Echo Frame Store Discassette, the Thomson-CSF Labs Microcam, the Conrac 6000 monitor series, Harris Gates' TC-80 triaxial color cameras and others. Harris put their color camera on the roof of the Grosvenor and fed a picture to their stand through 5000 feet of triaxial cable.

New SECAM equipment included the Tektronix 653 precision color monitor which can be fitted with dual decoders for SECAM and PAL operation, the associated SECAM scope with a novel Cartesian display graticule that permits accurate inspection of SECAM color signal parameters in vector form and a new addition to the Tektronix line of signal generators, the 143. The 143 produces SECAM bars, test signals, convergence patterns and all the other special signals provided by the 140 series in NTSC and PAL. Tektronix TV engineering manager, Charles Rhodes, made a point of saying that their new SECAM equipment provided the most sophisticated generation and analytical tools that the SECAM process has had available to this day.

Michael Cox Electronics had a new SECAM switcher on display in addition to the SECAM encoder and calibrator they had introduced in Montreux last year. Marconi Instruments also introduced some new SECAM measuring gear to complement their PAL line.

IBC Exhibitors

Adrien de Backer S.A.
AKG Equipment Limited
Allotrope Ltd.
Ampex International
Aston Electronic Developments Limited
Audix Ltd.
Autocue Ltd.
F.W.O. Bauch Limited
Berkey Colortran
Bosch Ltd.
Boston Insulated Wire (UK) Ltd.
Brabury Electronics Ltd.
British Broadcasting Corporation
Broadcast Audio (Equipment) Limited
Canon Amsterdam N.V.
Convergence Corporation
Alexander Cole Limited
Michael Cox Electronics Ltd.
Crow of Reading Ltd.
Dynamic Technology Ltd.
Electrocraft
Electronic Visuals Ltd.
EMI Sound and Vision Equipment Limited
EMV-Elektromechanikai Vallalat
Engineering Designs and Supplies Limited
English Electric Valve Company Limited
Evershed Power-Optics Ltd.
Guild of Television Cameramen
Harris Corporation
Hayden Laboratories Ltd.
Imhof-Bedco Standard Products Limited
Independent Broadcasting Authority
International Video Corporation (UK) Ltd.
Leavers-Rich (Inc. Bias) Equipment Limited

LGT-Laboratoire General des Telecommunications
Link Electronics Limited
Marconi Communications Systems Ltd.
Marconi Instruments Limited
Matthey Printed Products Limited
Mellotronics Ltd.
Microwave Associates
Mullard Ltd.
Nippon Electric Company Limited
NTP Elektronik A/S
NV Cobar Barco Electronic Philips
Pye TVT Ltd.
Quantel Limited
Rank Cintel
Rank Film Equipment
Rank Optics Taylor Hobson
Rank Strand Electric
Richmond Hill Laboratories Ltd.
Rupert Neve & Company Ltd.
Screen Electronics Limited
Seltech Equipment Limited
System Video Limited
Tektronix Ltd., comprising Tektronix TV & Grass
Valley Group Products
TeleMation International
Television International Operations Ltd.
Thomson-CSF, Division Radiodiffusion Television
Thomson-CSF Electronic Tubes Ltd.
Thomson-CSF Electron Tube Division
Thorn Lighting Limited, Theatre Lighting Division
TMI
Velec-Sefat
VG Electronics Limited
Video Electronics Limited
W. Vinten Limited

with triggering a waveform monitor trying to see if the last vertical serration is there or not, will applaud this gadget which, according to Bill Pegler of Television Equipment Associates (the Mathey rep in the USA), was developed as an in-house aid for development work. It was never conceived as a saleable product until some marketing type noticed it in use. Another English company, Quantel, had their PAL/SECAM digital Frame Store Synchronizer showing picture compression as a useful added feature to the infinite window correction range for VTR time base stabilization. The Telemation booth not far away had equivalent CVS digital TBCs on display and the PAL versions of Telemation's own signal generating and switching gear, as well as their character generators.

The major U.K. companies such as Marconi, English Electric Valve, Rank Cintel, EMI, etc., of course had full displays of their product lines that covered the gamut of video equipment from Leddicons to large mobile vehicles with six cameras, a few of which were parked next to the Grosvenor House with a web of cables running inside. The recent popularity of the small outside broadcast vehicle was evident in the display of Marconi's new addition to this field of a modified Land Rover with over-cab space for a camera and a built-in AVR-2. Both Ampex and RCA also showed their earlier versions of these types of small TV vehicles.

IBA were celebrating their 21st birthday with a large display of their engineering achievement over this period and the BBC had a display booth with the latest CEE-FAX update and a well-documented review of BBC developments in television technology.

Away from the Grosvenor House at the London Hilton, CMX Systems and Sony had space to discuss and display products to potential clients who were invited to take the short walk down Park Lane. CMX's President, Bill Orr, and his European manager, Klaus Eichstadt (who is slated for their about-to-open Munich office), explained the new PAL and SECAM versions of the 340X and the Intelligent Interface (I²) units to groups of engineers from the BBC, IBA companies and

A few small video products from both sides of the Atlantic pulled in good booth traffic. Convergence Corporation's "Joystick" editor for non-time code VTRs and Porta-Pattern's new ENG test chart gave delegates an impression of the demands imposed by fast-paced news operations in the U.S. A unique transparency illuminator (Porta-Pattern) wherein the light

source is moved instead of varying the voltage also impressed engineering types with its direct applicability to color temperature setup on cameras.

Mathey Electronics had a neat device which gets rid of jiggling displays on line selector scopes and gives a stable view when inspecting expanded TV waveforms. Any technician or engineer who has fiddled

It takes guts to run your video through an Ikegami broadcast monitor.

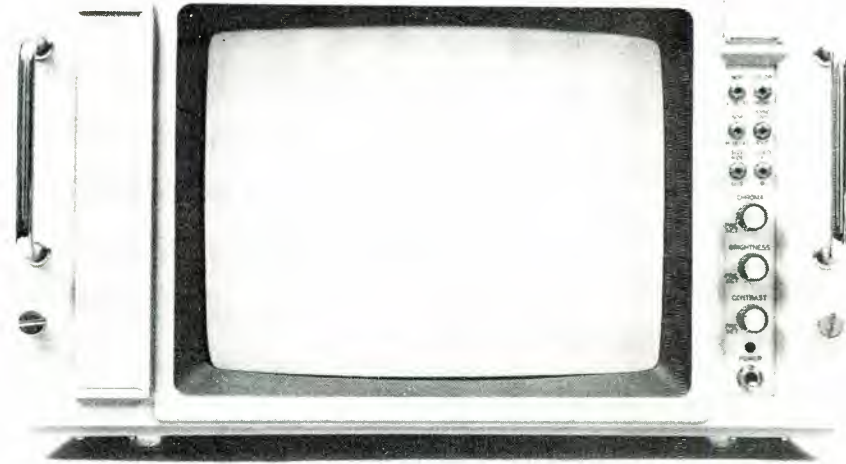

With twice as many image-making dots on its tube, an Ikegami color-tv monitor can show up in an amazingly high resolution a dozen or more things that could go wrong in your picture. Not just purple cows, but the smallest anomaly in nearity, the slightest picture distortion, the most marginal overload.

This one is our Model TM14-2RH. A comb filter helps maintain resolution to more than 600 lines. It gives you a choice of over- or under-scanned picture display.

Damage to its picture tube is prevented by power-protective circuits. Up front are all adjustments for its 14-inch CRT and inside are modular PCB boards for simple servicing and maintenance. A keyed back-porch clamp system keeps the black level constant for maximum picture stability.

There are both pre-set and adjustable controls. Video response is from +1 to -2 dB from 60 Hz to 8 MHz.

It has extremely rigid, sturdy construction and is available in a free-standing cabinet or for standard 19-inch rack mounting. Its built-in de-aussing circuit and magnetic shield to fend off external magnetic effects make it possible to move the Ikegami monitor without affecting its picture.

Also available from Ikegami are our Series Eight monitors for broadcast studios. There are four models, 25, 20, 16, and 14 inches. All use in-

tegrated circuits for high stability, long service life, and very modest appetite for power. Their picture tubes have black matrices for maximum contrast and best color fidelity. A keyed back-porch clamping circuit keeps pictures stable with proper black level. Video response is +1 to -2 dB from 60 Hz to 5 MHz.

You can get an optional remote control for brightness, contrast, and chrome.

We really shouldn't have to give you all the specs. The name Ikegami alone is enough to tell you how good they are. But if you do insist on more, ask Ikegami. Ikegami, the leading manufacturer of ENG cameras, manufacturer of the best in studio cameras, and now the best in monitors, too.



Ikegami

Ikegami Electronics (USA), Inc., 29-19 39th Ave., Long Island City, N.Y. 11101. (212) 932-2577

For More Details Circle (31) on Reply Card



Julius Barnathan of ABC makes a point during the well-attended ENG session at the London Hilton's Crystal Palace Suite. This was part of the IBC technical symposium that attracted a standing room only audience.

similar representatives from European networks.

Sony used the Wellington Room to show their line of new products catering to ENG and general broadcast applications and their top technical talent in the video field, "Morrie" Morizono, was on hand with ample assistance from their U.K. representatives.

At the Europa Hotel on Grosvenor Square and around the corner from the U.S. Embassy, the Mercury Electronics people were exhibiting the large patching bays used by the EBU and their members at major international events such as the Olympics and the World Cup. Their suite also included two new products that cater to VTR signal improvement of time base errors and color under deficiencies. The Microtime 2020 digital TBC provides a wide window correction range for PAL and SECAM signals with an added optional feature of signal enhancement that improves signal to noise ratios by 3 dB while increasing subjective sharpness of the color image coming from a cassette VTR or other low bandwidth source. The same signal enhancement features are also available in a stand alone unit known as the CRISP-MATIC which may be used with or without a digital TBC.

In their suite at the Grosvenor,

Thomson-CSF were displaying two products made in America by their recently acquired subsidiary, Thomson-CSF Labs. The one attracting most attention was their Microcam, a portable color camera weighing under 12 pounds and recently used by CBS at the Democratic and Republican National Conventions. They also showed the Vidifont Mark IV, an electronic character generator for alpha-numeric TV displays. Speaking of character generators, Chyron Telesystems, a company that has been in this field for many years, announced at IBC that they have granted worldwide distribution rights for their titling system to Ampex Corporation.

The technical sessions at IBC were generally well attended, but this year's spotlight was on the ENG session that was held away from the main conference hall at IBC.

The ENG Conference

The lucky ones got there early and staked out their seats in the Crystal Palace Suite of the London Hilton. The not so lucky ones were spread out on the floor, in the aisles and on the window sills. The most unfortunate found themselves on the outside balcony overlooking the 007 bar, waiting to get into the packed conference chamber either

at the session break or to replace any departing members. There was not much doubt that ENG was a hot topic and the panel were in for a lively discussion.

Moderated by E. R. Rout of the BBC's designs department, the panel consisted of an interesting mix of protagonistic users such as Joseph Flaherty of CBS, potential users like A. Protheroe, BBC news and ENG equipment suppliers—M. Morizono, Sony; F. Van Roessel, Philips; and J. Fielek of Microwave Associates.

The moderator injected a little opening levity by introducing each panel member with a mildly humorous title while asking him to stand up and be recognized. Flaherty was introduced as the Godfather of ENG and he demurred this title by claiming to be more like a midwife. Sony's representative, Morrie Morizono, was labelled "Mr. U-Matic" and was asked to stand. He brought the house down with the deadpan statement, "But I **am** standing!" before he actually got up.

After an opening statement by the moderator on the dichotomous views regarding ENG operations in the USA that are held by U.K. broadcasters (news departments are for—engineering against), he turned the floor over to Flaherty who gave

Refurbished video heads?

Videomagnetics has everything you need: superior product, experience and facilities, solid operational position, plus lower price.

It's a paradox, but the newest company in the refurbished video head business is also the most experienced. This comes about because the people who established Videomagnetics have been in the field for more than 20 years and have the kind of technical, manufacturing, and business know how that it takes to succeed and to meet your needs.

It all boils down to three basics: 1) a product better in all ways (including price), 2) experienced people and sophisticated facilities, and 3) a sound operational position coupled with business acumen. Videomagnetics has them all.

Want to know more about how you can improve your refurbished video head situation? Call or write Videomagnetics today.



VIDEOMAGNETICS, Inc.

VIDEOMAGNETICS, INC.
General Offices and Marketing
155 San Lazaro Avenue
Sunnyvale, CA 94086
(408) 737-8300



a detailed review of CBS use and assessment of ENG versus normal film coverage of news events.

In general, Flaherty showed that in addition to the time advantages of ENG, there are also considerable cost savings and some programming benefits to be had. Furthermore, he described a confidential audit made by CBS of one of their affiliate stations when off-air comparisons were made of their ENG equipped facility and a non-CBS station that used 16 mm film. According to Flaherty, the ENG picture quality was consistently superior, even while being faster and cheaper. The other panel members each made opening remarks relating to their topic or product, at which point a slightly audible commotion outside the door subsided as Julius Barnathan, Engineering Vice President of ABC, was admitted to the room.

Barnathan was obviously distressed at the fact that his network had not been officially invited to participate in the ENG session, even though as he put it, they had just been through the bloodbath of two Olympiads at Innsbruck and Montreal. Taking the microphone, he made his own opening statement in which he berated the IBC organizers for not anticipating the size of the audience (several hundred people were turned away) and for not having a suitable hall in which to hold the session. He claimed the 16mm news films he had seen on European TV were often so bad in quality that he thanked God for ENG.

With this controversial beginning, the ENG session was off and running. Bob Longman of the BBC deplored the quality of ENG images coming from the USA via satellite and he was strongly supported on this stand by Les Free of TCN9, Sydney, Australia. Both seemed to be reflecting general U.K. and European engineering opinion that the image quality of ENG pictures is just too poor for serious consideration as a picture origination format in non-NTSC countries.

Flaherty's explanation of the poor picture quality that ENG originated images render across the Atlantic was that it was due to reasons other than the limitation of the equipment. The U-Matic format

original tape is often copied to quad, edited further to second generation quad, and then for economy reasons, a U-Matic copy of the last quad generation is made for transmission or shipment overseas. Add NTSC to PAL or SECAM standards conversion and the end product will indeed be a poor television image. Flaherty claimed that the networks that paid the extra tariff for a quad copy got much better results.

There was lively audience participation both before and after the coffee break and the subjects of vehicle size, complexity of equipment, recording on site versus direct links, lighting and sound for ENG operations were thoroughly aired. It was evident that U.K. television news departments were pushing their reluctant technical colleagues to at least experiment with portable, light weight ENG gear to see if it could make the grade in their PAL environment.

Barnathan, who took a strong stand in the closing half of the session, stated emphatically that what ENG equipment needed was to be first, ultra reliable; for if it didn't work on site, all was lost. Second, it had to be simple to operate, as the minimal crews that go out for such coverage cannot be technical experts and third, it had to be low cost as every \$1000 added to an ENG package must be multiplied 100 times since ABC had that many or more ENG units working in the field. Barnathan reiterated that picture quality was adequate and he feared that pressure to increase it would force the price of ENG equipment out of their budgets.

A floor question on vehicle size and decor prompted the response from Flaherty that CBS tries for a minimum profile at a local news event since going in with a large, blatantly decorated vehicle and scene lighting would quickly make them the news rather than the event they were sent to cover.

The ENG session was certainly the highlight of the IBC technical symposium and both the BBC and IBA are on the verge of starting experiments with ENG equipment operating in PAL. It will, therefore, remain a subject of increasing

interest in the U.K. and Europe for the next few years.

Summary

IBC in '76 was successful in spite of the cramped exhibit space because it continued to maintain its good reputation of the technical symposium associated with it, and it provided a good forum for the display of British built TV equipment and similar displays by American, European and Japanese suppliers.

CEEFAX and ORACLE continue to be displayed by both the BBC and the IBA although it is admitted that while the systems work well technically, they have not attracted much user response and the number of sets equipped with decoders after more than two years of transmission are disappointingly small.

The larger British and TV equipment manufacturers are doing a brisk business in Eastern Europe and the developing countries in Africa, the Middle East and South America where color television is either being introduced or greatly expanded. IBC, of course, attracts TV engineering types from Commonwealth countries like Australia and Canada and from British oriented TV operations such as exist in South Africa and in Singapore.

The social functions at IBC were also well planned and well attended. The champagne receptions at London's historic Guildhall which has been a center of civic government for over 1000 years was impressive in its vaulted Gothic structure. Other receptions put on by exhibitors such as Thomson-CSF and English Electric Valve Company gave delegates a good opportunity to meet old friends and make new ones.

It is unfortunate that security checks have become a way of life and it was understandably necessary to enforce some tighter measures than were used in the past.

Exhibitors and delegates who may have felt a little cramped at IBC '76 can at least look forward to the next convention in 1978 when the newer and more spacious facilities at the Wembley Conference Center will be the site of IBC '78. □

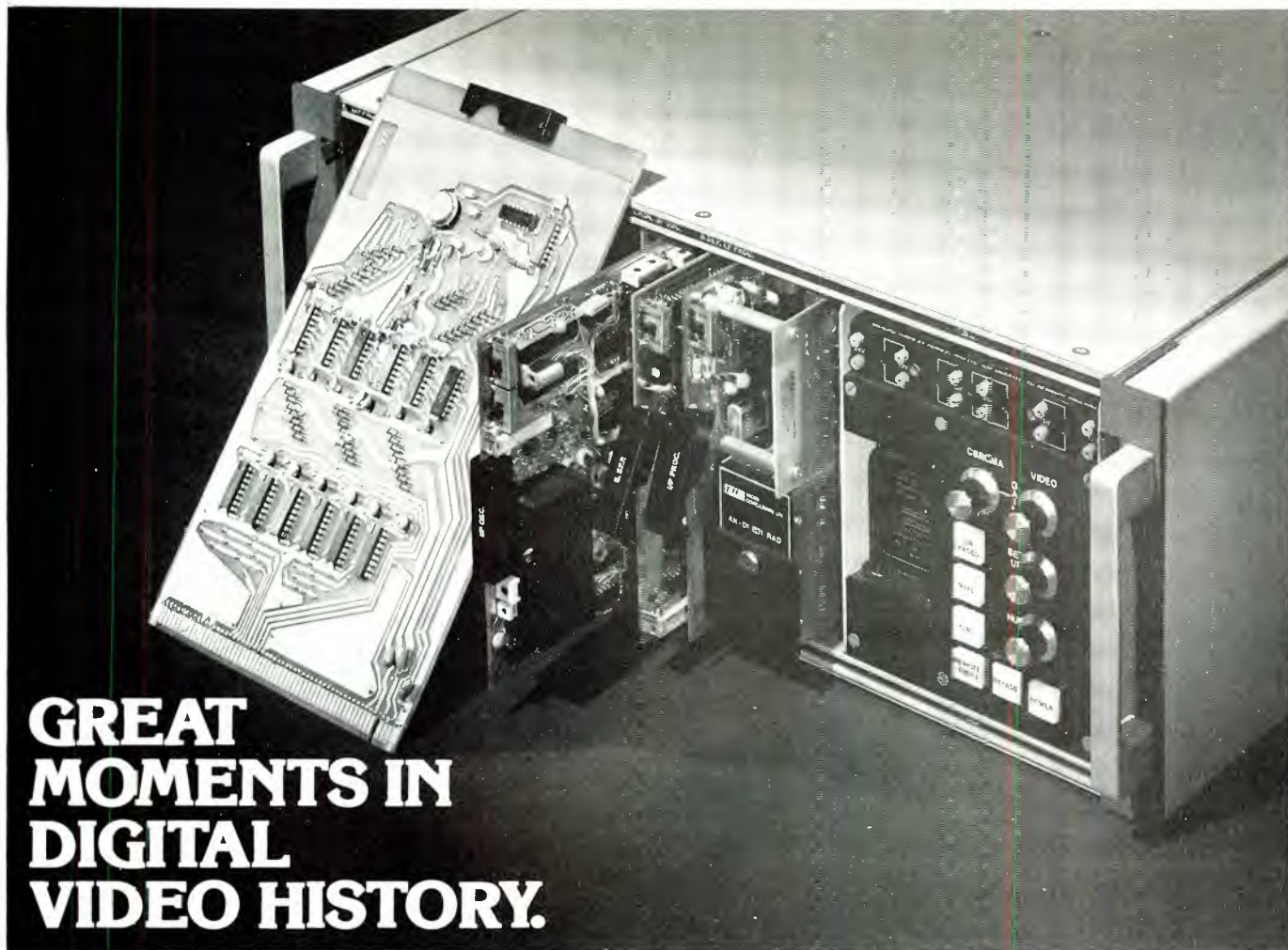

GREAT MOMENTS IN DIGITAL VIDEO HISTORY.

THE FIRST TRULY MODULAR TIME BASE CORRECTOR IS DEVELOPED

AND MICRO CONSULTANTS IS THERE WITH THE QUANTEL DTC 300.

The same people who brought you the world's most advanced digital framestore synchronizer now bring you the world's most advanced digital time base corrector—the new DTC 300. The DTC is advanced not only in its performance specifications, but also in its modularity.

Now, for the first time in digital video history, you can buy a top-of-the-line time base corrector at an attractive price, and broaden its capabilities as your needs broaden. True modularity means that upgrading is simply plugging in new boards. That's all there is to it.

The basic unit handles a variety of VTR's—helical, segmented field, etc. With plug-in options, you can also handle heterodyne and non-capstan servo units. In short, **any** VTR.

Additional plug-in options are drop-out compensator, look-ahead velocity compensator, sync generator output driver, and jittered subcarrier output to convert heterodyne VTR's to direct color VTR's. They take minutes to install.

With products like the DTC 300, Micro Consultants is creating great moments in digital video history. Shouldn't you be creating your own? Make a start. Call your local Micro Consultants representative. Or write us at P.O. Box 10057, Palo Alto, California 94303.

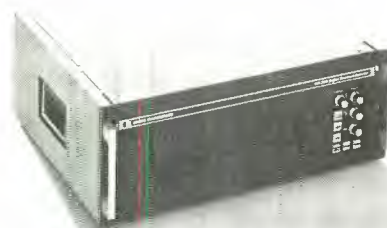

The digital video people



KUSC-FM Plugs Into The Future

By Ron Merrell

At NPR the slogan these days is: "Satellites are the ultimate hi(gh)". Relaying feeds by satellite is not exactly new, but the NPR's futuristic plans for radio may someday form the groundwork of commercial systems.

KUSC-FM, Los Angeles, inaugurated their new stereo studio and transmitter facilities early in December. Impressed?

The new station setup will enable KUSC-FM to reach about 10 million Southern California listeners. Impressed now?

KUSC-FM, the Los Angeles National Public Radio affiliate, will be delivering classical music, exclusive and original programming, and National Public Radio network material from 6 a.m. to midnight without commercial interruption.

With an ERP of 10,700 watts at 930 feet HAAT, the station reaches the Los Angeles Basin, the San Fernando Valley, the San Gabriel Valley and north Orange County.

The new transmitters were provided by the University of Southern California, licensee of KUSC, as part of its increased support of the station. KUSC is using two Sparta 610A transmitters, each capable of supplying up to 13,000 watts, remotely controlled from the studios. The site, on Lookout Mountain in the Hollywood Hills, was chosen because it provides the best location for KUSC to achieve maximum power and coverage as a Class B station.

There are two Moseley PCL505C STL's, providing dual reliability and simplified maintenance.

Plans to make KUSC—an arts, music and information station—an important force in the maturing of Los Angeles as a cultural center have been in the works for several years, according to Wallace A.



Dolby FM Ends The High-Frequency Power Shortage

Look at this graph. You wouldn't tolerate an amplifier that did this to your music. So why put up with an FM system that does this to your amplifier?

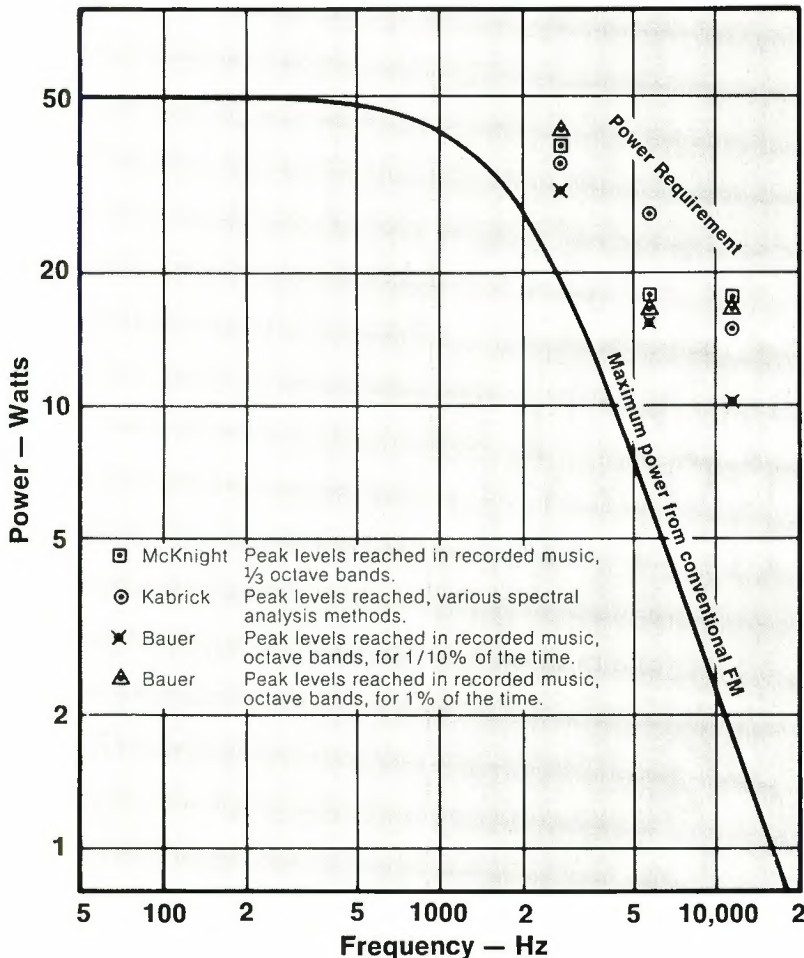

This curve shows the maximum power output of a 50-watt amplifier when fed from conventional FM. The power curve and the power requirement points are all shown with respect to full mid-frequency modulation at the transmitter and 50 watts peak power from the amplifier.

Take a typical state of the art 50-watt amplifier. It will deliver its full 50 watts over the whole audio bandwidth. Well, what would you think of a system that treated the high frequencies like the one pictured above? A droop to half-power at only 2 kHz? Or a pitiful 2 watts at 10 kHz? It sounds ridiculous. And yet this is what the conventional 75 microsecond FM broadcasting system does to the signal. It is impossible for a conventional station and a conventional receiver to do better than this.

Of course, the full 50 watts isn't needed at high frequencies. The graph

points in the high-frequency region of the drawing show how much power is actually required, according to researchers who have investigated this matter. Obviously, there is a significant difference between the requirement and what conventional FM can provide.

What does this have to do with Dolby FM? Plenty. Dolby FM provides not only lower noise but a dramatically improved power capability. In fact, the power curve of a Dolby FM receiver runs right through the power requirement points on the graph above (which is no accident). Thus Dolby FM gives you the full high-frequency power

needed for accurate reproduction of music. Brasses retain their bite. Cymbal crashes don't collapse.

If this improvement in FM broadcasting and reception interests you, then you may like to write to us for further technical details. We also invite you to consider purchasing one of the more than 30 new models of receivers with built-in Dolby FM circuits (write for receiver list and Dolby FM station list). Check with your hi-fi component dealer for details on the specific receiver models available in your area.



Dolby Laboratories Inc

'Dolby,' 'Dolbyized' and the double-D symbol are trade marks of Dolby Laboratories Inc.

731 Sansome Street
 San Francisco, CA 94111
 Telephone (415) 392-0300
 Telex 34409
 Cable Dolbylabs

346 Clapham Road
 London SW9
 Telephone 01-720 1111
 Telex 919109
 Cable Dolbylabs London

Smith, general manager. In 1976, KUSC was awarded the first-ever Major Market Radio Coverage Expansion Project Grant offered by the Corporation for Public Broadcasting for support over a five-year period. This grant is enabling KUSC to expand its facilities, staff and programming and more than double its music library.

Smith and Director of Engineering Hugh Paul approached the KUSC expansion with the idea that

quality and reliability would be key criteria for equipment design and layout of the facilities. Hugh Paul stressed the necessity for state of the art equipment and dual reliability. "Reliability is as important as quality. Radio is a service, especially public radio. When a station is off the air due to equipment failure, the service is not being provided. In addition, KUSC is offering the listener the best possible sound."

Part of KUSC's 18-hour daily on-air time is devoted to programming provided by National Public Radio. "Being a member of NPR demonstrates KUSC's desire and pledge to become the major public radio broadcasting outlet for our city, this region and the nation," Smith says. "We at KUSC-FM are dedicated to providing a program service unique in radio broadcasting. We intend to develop a community resource that will become a significant force and catalyst for cultural growth."

The equipment arrangement or the commitment to quality signals and sounds might impress you, but even if that fails, there's something about KUSC-FM that should impress you: the day is not far off when this station will join other NPR stations in a satellite-connected NPR network. It's not blue sky, and it is impressive because NPR is leading the way toward the future. And just for openers, consider 15 kHz feeds. Compare that with feed you're getting now.

We've all been exposed to signals bounced around in space. Some years ago when the Apollo missions were tinkering with TV in space and then color signals en route to the moon, I wondered if there weren't deep and far reaching implications for commercial broadcasting. So, in the space between now and then, we've grown accustomed to remotes via satellite. But the thing that interests many engineers is that radio, too, can take advantage of satellite capabilities.

Radio, in NPR's version, will be capable of network feeds in four channels of mono, two sets of stereo channels, or quad. and for that matter, any workable combination of four channel feeds.

What About Terminals?

Obviously, television signals eat up a lot more channel space than do typical radio response frequencies. And that works to the advantage of radio, because the larger TV terminal dish receiving antennas planned for NPR use are of the 10 meter variety. The requirements for radio would only be 4.5 meter dishes, easing space and expense problems.

According to NPR, about one third of NPR's radio stations are tied to CPB television operation.

What's so special about Beaucart stereo machines?

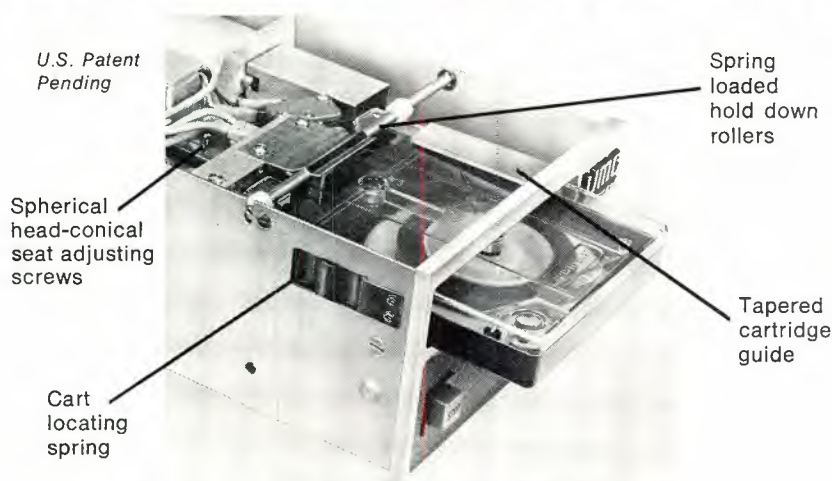

Everything.

Don't let anybody tell you that all stereo broadcast cart machines are the same. It just isn't so. Because we've built into our Beaucart stereo units proprietary cartridge locating features which enhance stereo phasing from cartridge to cartridge under long term, continuous service conditions.

Take a look at the photo. No other machine incorporates these features. Our spring-loaded rollers ensure repeatable location of each cart's left corner post. The tapered cartridge guide allows each cart to squarely contact the roller and feed smoothly into the machine. Our locating spring positions the cart against the right-hand guide every time, and our unique ad-

justing screws for which patents have been applied provide uniform, positive contact immune to movement from external forces.

Little things? Sure! There are a hundred little things that make full-featured Beaucart the stereo machine for you.

Let us tell you more. Write or call today for further details and pricing. You'll be glad you did!

UMC
BEAUCART DIVISION
UMC ELECTRONICS CO.

460 Sackett Point Rd. North Haven, CT 06473 (203) 288-7731

Since all CPB TV stations will have a dish, radio also can be accommodated. In cases where there's a CPB TV station in the same city with an NPR affiliate that is not operating out of the same facility, the feed will be accomplished by microwave. This group accounts for about one third of the NPR stations.

The remaining one third of NPR's affiliates would be using the 4.5 meter dishes to receive their feeds. (This, of course is if the FCC goes with 4.5 meter dishes.)

As it stands now, NPR finds itself committed to quality signals and sounds, but they are caught in network feeds that leave a lot of the recognizable audio spectrum missing.

In keeping with the **Broadcast Engineering** belief that there is a great need for Radio Electronic News Gathering (RENG), our position also is that there is a lot to be gained from live programming. And it's the intention of NPR to feed live programming. With satellites, NPR could feed a live concert from



NPR sees satellites as a means of feeding network signals with full audio bandwidths. And since there is a limited supply of recorded quad material, with satellites doing the feeding, they could jump over that problem and offer live quad programming.

London, or through RENG it could feed a live news event.

Over the next 10 years it is estimated that National Public Radio will grow at a rate of 10 stations per year. That's impressive, too.

Perspective

Oldtimers will recall that many of the early stations on the air were operating out of colleges and universities. Some universities still operate those vastly updated stations, others have moved over to the

Since you're already aware of RCA quality, it makes sense to find out what's inside this FM transmitter.

We believe you'll be impressed.

Because RCA quality can be seen as well as heard. Our high power 5/10/20 and 40 kW Tetrode Transmitters are full of conservatively rated components for longer life. Exclusive linear power adjust of the IPA and PA make for low distortion at all power levels. Other features such as VSWR and under-power protection, filament adjust and extensive metering—all standard.

The low power 3/5 kW grounded grid transmitters are simple to operate and include many of the features found in the higher power units, such as vacuum capacitors, a large H.V. transformer, circuit-breakers, to minimize maintenance and down time.

Of course, all RCA FM transmitters are backed by 24-hour service on technical advice and parts distribution system that's a credit to the RCA name.

And if the RCA name means long-term quality to you, an RCA FM transmitter will confirm it. Send the coupon, today.

RCA Corporation
Radio Station Equipment-Product Management
Building 2-5, Camden, New Jersey 08102

Dear RCA:
I'd like to find out what's inside this FM Transmitter. Send me complete details immediately.

Have your representative call.

Name _____

Title _____ Station _____

Address _____

City _____

State _____ Zip _____

I'm interested in:

3 kW ETF-3E1 FM transmitters

5 kW ETF-5E2 FM transmitters

5, 10, or 20 kW "expandable" FM transmitter systems

40 kW BTF-40E1 "Powerhouse" FM transmitters

RCA Broadcast Systems

For More Details Circle (33) on Reply Card

NOW! AUDIO DESIGNS' UNIQUE DA16 AUDIO DISTRIBUTION SYSTEM

... a combination
of features
no competitive
system offers

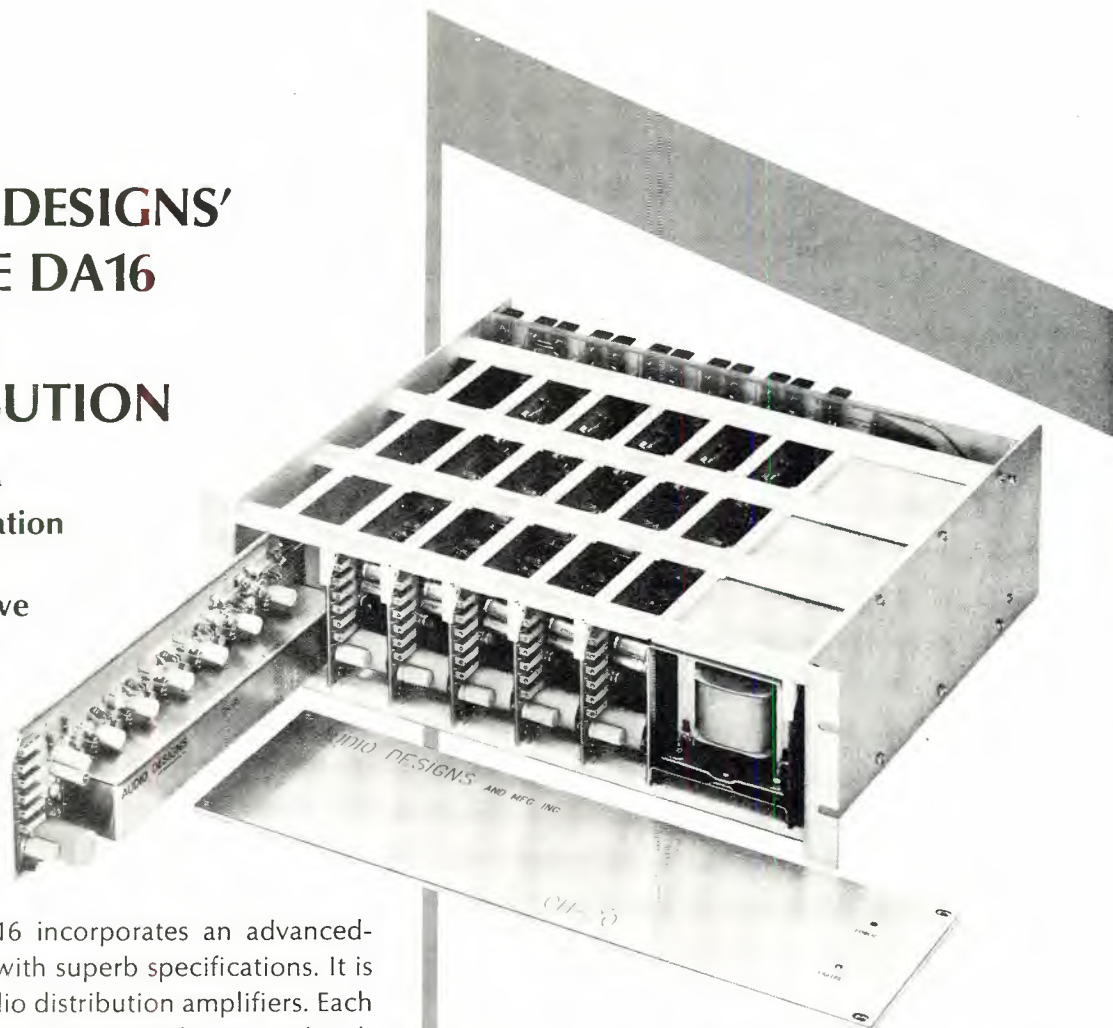

The ADM® DA16 incorporates an advanced-design approach, with superb specifications. It is the ultimate in audio distribution amplifiers. Each amplifier is a one in, six output plug-in card with +24DBM input and output capability.

The input is transformer coupled, and each of the six outputs is individually transformer isolated. Amplifiers have individual front panel gain adjustments. Noise level is ultra low, and distortion is less than .1% at +24DBM.

Up to six DA16 amplifiers can be housed in the Audio Designs® CH20 rack frame, which includes a redundant power supply with automatic changeover. Built to exacting quality standards, DA16 amplifiers offer exceptionally high reliability. Write or call for specification sheet.

OTHER HIGH-INTEGRITY ADM COMPONENTS

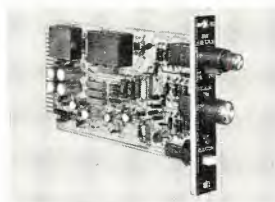

302 LIMITER—a unique, instantaneous device designed to allow constant output regardless of input level.

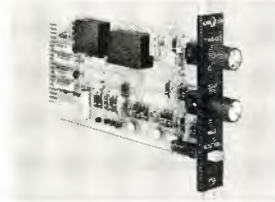

301 NOISE SUPPRESSOR—a new, fast gain expander that puts silence where there was noise.

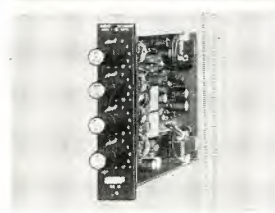

1500/1501 EQUALIZER—unity gain, four band, 14 frequency reciprocal equalizer designed to provide EQ anywhere in an audio system.



AUDIO DESIGNS AND MANUFACTURING, INC.
16005 Sturgeon, Roseville, Michigan 48066
Phone: (313) 778-8400, Cable: AUDEX TLX-23-1114

AMPEX

DISTRIBUTED OUTSIDE U.S.A.
BY AMPEX INTERNATIONAL OPERATIONS, INC.

For More Details Circle (34) on Reply Card

commercial side. But they played a vital part in our broadcast history. And now, more than 50 years later, under a much different umbrella, but still educationally oriented, NPR stations are paving the way for their own success by looking ahead. And in doing so, they will leave a target others are sure to shoot at.

We stand at that point in communications history where change is a way of life. Trouble is, we can get bogged down in trying to understand digitals and forget about fiber optics. We can boggle our minds with computer capabilities and miss the home listener or veiwier. Worse yet, we can be so caught up in our own struggle to keep up and moving forward that we lose sight of where we could be going as an industry.

Broadcast Engineering will keep you up to date on where NPR is going and how they're finding it out

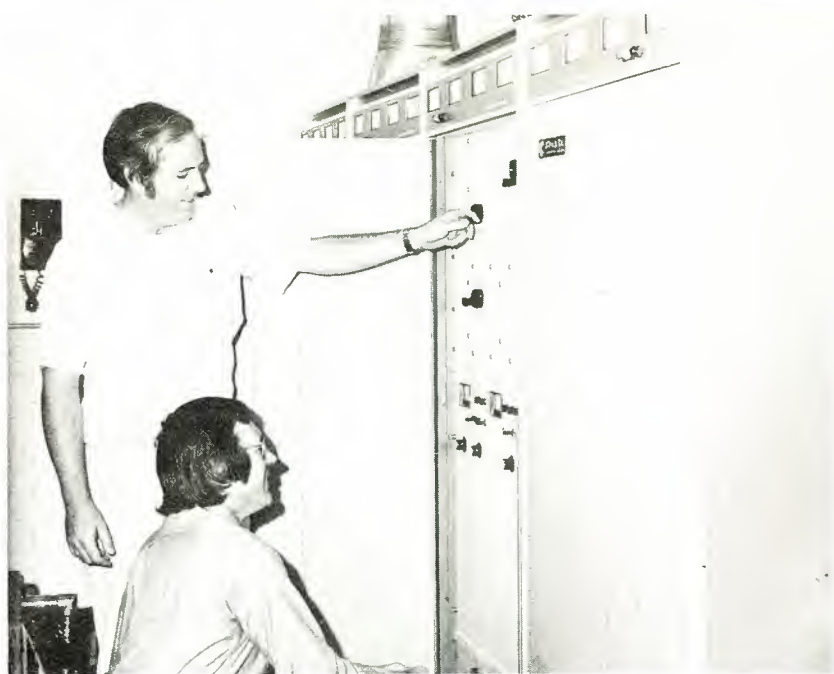

Checking out the new equipment at KUSC-FM. With 10 million potential listeners, reliability of all equipment is a big responsibility for engineering.

there in space. Of course it's lonely at the head of the pack. And we'll be telling you what that's like, too. Meanwhile, let's remember that although NPR is funded, it is committed to quality. That's a goal all of us should be reaching for. And as for KUSC-FM, I'm impressed. Satellites are the ultimate high). □

Since you're already aware of RCA quality, it makes sense to find out what's inside this Audio Processing System.

Behind those dials and light-emitting diodes is the reason for RCA quality: RCA technology. And it's pretty impressive. The system shown here, for example, is our BA-145AGC amplifier and the BA-146/147 Limiter. All tops in AM, FM and TV Audio Control. Both have our unique Program Modulated Release (PMR) with automatic reset—for the latest approach to fast attack, with inaudible AGC or limiting action. And with RCA, fast limiting without a "thump" is certain—our non-temperature sensitive insulated-gate field-effect transistor (IG/FET) controlling element simply designs the thump out. Of course, there's plenty more to see in an RCA audio processing system. And you're backed by RCA technical service, and RCA parts distribution, all the way. Send the coupon, today.

RCA Broadcast Systems
Radio Station Equipment Product Management, Building 2-5, Camden, N.J. 08102

Dear RCA: Okay. Tell me more about what's inside your audio processing systems. Send literature immediately. Have your representative call.

Name _____
Title _____ Station _____
Address _____
City _____ State _____ Zip _____

I'm interested in:
 BA-145 AGC Amplifier for AM, FM, or TV BA-146 Limiter for AM
 BA-147 Limiting Amplifier for FM or TV (use 2 for stereo)

RCA Broadcast Systems



For More Details Circle (35) on Reply Card

digital lab

With this issue of **Broadcast Engineering**, Digital Lab becomes a monthly column. It's a column that will help you find practical information on digital circuits as well as troubleshooting tips. In the past, we've printed three series dealing with the basic theory of digitals. Now it's time to consider what to do with digitals when they don't operate according to theory or "logic".

In the coming months, **Digital Lab** will demonstrate the beautiful simplicity of digitals. And the column will help you teach yourself how to troubleshoot digital circuits.

Your guide will be Harold Ennes, an engineer who has made all the transitions in technology that one could hope to encounter. With Harold's perspective, you'll see that mastering digitals is not as complicated as you might have thought. Our February column will be designed to get you started in troubleshooting.

Digital's Best Bet Is The Station Engineer

By Harold Ennes

Jack of all trades? In view of the rapid entry of the digital world into our familiar analog world, broadcasters are beginning to wonder if computer people must take over in AM-FM-TV technology. If you have such thoughts, I hope this paper will bury them forever.

The Problem

Broadcast management has always been faced with ever-changing technical requirements in engineering personnel. Up-dating and up-grading programs were required

with the introduction of stereo in FM, and color in TV. In the past, this has involved the expansion of existing analog techniques with more refined analog techniques and systems.

Most recently, digital technology has been interfaced with analog technology. Digital technology in broadcasting, while entirely different, does not replace the analog system, nor should it replace your technical staff already trained and familiar with your particular installation. This circumstance re-

quires a different approach than previous up-grading programs, and is a subject that should be given immediate but cautious attention.

First of all, computer training in itself is not particularly suitable for digital broadcast applications. While computer-type circuitry is used, applications are different. Don't send your technicians to a part-time computer school. They will feel more at home with IBM. Conversely, a person trained only in digital computers may adapt rather quickly to digital applications in broadcasting, but will have a complete lack of training and experience in the broadcast system with which digital equipment must interface.

This emphasizes the need for considerable thought and caution in selecting a training program either as an individual or for a selected portion of your staff. The following will help you decide how and where to find the best deal in digital training for your specific needs. I have had personal experience with some of these programs. Other listings are included by virtue of their excellent reputation in the electronics field.

A brief outline of coverage is given, along with length of course (where applicable), cost to user, and address of contact. While it cannot

The hands-on approach to digital training can speed up the learning process through building practical circuits. But textbooks and seminars are equally important. **BE** editor Ron Merrell is shown here doing his homework on a Heath experimenter unit. This type of unit can be used with a home study course and later for experimental designs.

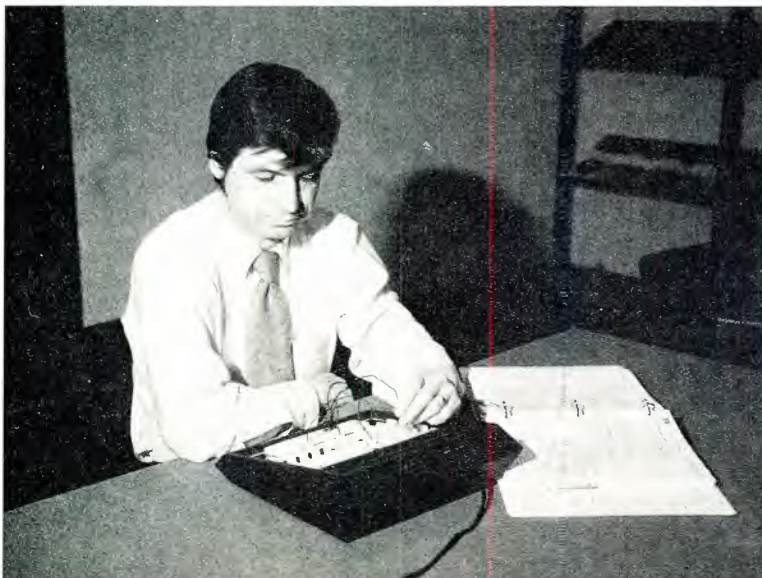

How did these broadcasters get ahead of the competition?



"The Compositor has excellent fonts-- they're clean, they are sharp-looking, and they are distinctive... we have as much memory storage as we're ever going to need. You can change directly from any page to any other page without any problem whatsoever-- you don't have to stick with the original sequence. The Compositor gives you super flexibility."—Don LaCombe, KING Production Manager

"The Compositor's on-air display is a marvel... head and shoulders superior to the competition. We've virtually discontinued using hotpress for supers."
—Galen Daily, KRON Program Manager



"We used the Compositor for the first time on election night. We were very pleased with the clarity and color. I'm sure we had the best election show in town that night." —Donald Loose, Manager WTMJ News Operations

"We used our new Compositor system during the election and were very happy with it. It seemed to me that the character edging made our display easier to read than the competitions'. We moved ahead of the other stations soon after the election results started coming in." —Terry Harrison, KTVK-TV Engineer



"...the election went like clockwork--I couldn't have asked for anything better. The Compositor display is clear and easy to read...you just glance at it and you've got it. We were ahead of the competition getting numbers on the air." —Tom Craven, KGW Production Manager

"We were well ahead of the competition election night... the reason, I feel, was in large measure due to the Compositor. It's easy to use, and prevents a great deal of possible error. Where the TM unit really shines is its computer interface with the character generator, which eliminates the extra step of manually entering the election results."
—Bill Gill, WOTV News Director



These broadcasters agree: with or without the TED election reporting option, the new Compositor I Titling/Graphics System offers a superior on-air look. With graphic-quality fonts and instant access to any page in memory at any time, the software-based Compositor I provides the fast on-air operation demanded by production personnel, the artistic quality demanded by advertisers, and the competitive edge that broadcast management is looking for. For details, please call Jack Daniels at (801) 972-8000.



Compositor I



the discovery people
P.O. Box 15068, Salt Lake City, Utah 84115

For More Details Circle (43) on Reply Card

Fig. 1 The E&L DD-1 Digi-Designer contains a power supply, six frequency clock positions normal and inverted, including logic lamps and switches. (B) is the Hewlett Packard 5035T Logic Lab.



(A)



(B)

possibly be all-inclusive, the listings should serve to get your thoughts in gear.

Hands-On Training You Can Arrange

I highly recommend this approach before attending any formal training program, whether brought into your plant via video tape, or by arrangement with a manufacturers seminar.

Solderless breadboarding socket hardware exists that enables you to insert components directly for instant circuit construction. All interconnections are made with common 22 or 24 gauge solid wire. Some manufacturers (such as the first one listed here) have made available an accompanying self-training course for individual or class use.

E&L Instruments, Inc. The E&L Digi-Designer (Figure 1) meets most design and experimental circuit requirements for digital circuit ap-

plications. It includes a 5 volt, 400 ma power supply, a six-frequency clock (with normal and inverted outputs), 2 debounced pushbutton switches, 4 SPDT slide switches to supply ground or 5 volts to circuit, and 4 LED type logic lamps. Components insert directly in the socket without adapters. IC's such as TO-5 type, 8, 14, 16, 20 or even 40 pin DIP units plug directly into the board. The Digi-Designer sells for \$70 in kit form, or is available completely assembled for \$105. The socket alone with optional plug-in outboards is also available.

An excellent starting point is "Bugbook I" and "Bugbook II" available from E&L at 17 dollars for both. These books contain over 90 Logic and Memory experiments with TTL IC's for student self-training. Starts with basic logic circuits and works up through Microprocessors, if you wish (Bigbook III). I have had personal experience

with this Course and find it highly effective. It **proves** that digital electronics is easier to grasp than analog electronics.

The E&L LT-2 Logic Probe is a low cost (\$25) unit with switchable storage (for short pulses) and suitable for TTL circuitry. I advise you to use your oscilloscope in conjunction with a logic probe until you become acquainted with logic probe characteristics. The combination of visual display on the scope with probe indicator action will give you a good feeling in learning to use such probes. There are at least three basic types of probes, with different interpretations.

E&L Instruments also offers a series of short intensive seminars encompassing two distinct areas:

1. "In House" training programs. The customer can specify the time and location. This is a "custom" service that can be tailored for the

time available, background and technical level of the personnel. Cost varies, and must be ascertained by contact.

2. Scheduled, formal, open-enrollment courses offered in various locations at pre-determined times. Length of courses in either area varies from two to five days depending on coverage.

Contact: E&L Instruments, Inc., 61 First St., Derby, Connecticut 06418.

Continental Specialties Corp. You will find some intriguing and useful hardware at CSC once you have started your training. The Proto Board 101 (Figure 2) has 10 14-pin DIP capacity. This is a fully assembled breadboard with two QT-35S breadboarding sockets plus four bus strips giving you 8 bus lines, and at low cost (\$29.95). Smaller and larger units are available, some with built-in power supplies. Also available are reasonably priced pulse and function generators.

I am most impressed with the CSD Logic Probe LP-1 (Figure 3). This probe is not tied down to a single logic family such as TTL, but has multi-family compatibility; DTL/TTL/HTL/CMOS. It detects pulses as short as 50 nanoseconds by stretching and latching for easy pulse detection. (Employs memory circuit.) It is very reasonably priced at \$44.95, which is the lowest price I have seen for a multi-family probe.

Another very useful device from CSC is the Logic Monitor 2 (Figure 4). This employs the logic clip that simultaneously indicates state of each IC pin up to 16 in number. This unit has selectable threshold control to set logic 1 level to proper voltage for each logic family. The price is \$124.95 and the logic clip alone can be obtained for \$74.95.

Contact: Continental Specialties Corp., 44 Kendall St., New Haven, Ct. 06509.

The Heath Co. This company offers a program in digital fundamentals which assumes a prior knowledge of electronics and math, but no digital training. The Heath model EE-3201 includes all texts, records (you will need a record player), and 44 parts for 24 experiments. Average completion time is 40 hours. A certificate is issued for passing an optional exam, plus 4

CEU credits. (CEU, or Continuing Education Units are a nationally recognized means of acknowledging your participation in non-credit adult education programs.)

The EE-3201 is priced at \$49.95 complete. You will need the Heath-kit Digital Design Experimenter/Trainer (a kit) which costs \$69.95 and includes three power supplies and clock. The entire package can be purchased for \$109.95.

Contact: The Heath Co., Benton Harbor, Mich. 49022.

Heath/Schlumberger. This company offers factory assembled and calibrated digital design and training units that are highly flexible and expandable by optional plug-in cards. A large variety of breadboarding systems for design, research and education are available with training texts. For example, the EU-801C (\$410) includes everything you need to start learning or teaching logic operation. You will need the complete catalog of the "800-Series" modules to grasp the scope of subjects covered.

Contact: Heath/Schlumberger In-

struments, Benton Harbor, Michigan 49022.

Hewlett-Packard. This well-known company to broadcasters puts together a 5035T Logic Lab for learning about digital circuits. The course consists of a text "Practical Digital Electronics" and 26 learning experiments that can be breadboarded on the Logic Lab. Starting with the basics of 1's and 0's and simple gates, the course logically progresses through the most complex circuits available to a discussion of communications codes (BCD, ASCII, etc.) and a comparison of the various logic families.

A unique feature is that the removable breadboard means that many students can share the same Logic Lab mainframe, but individually build their own circuits.

The cost of the complete 5035T Logic Lab is \$750. But this includes all parts, the HP Logic Probe, Logic Clip, and Logic Pulser. It provides practical "hands-on" experience in digital circuitry and troubleshooting.

Contact: Hewlett-Packard, 1501 Page Mill Road, Palo Alto, Ca.

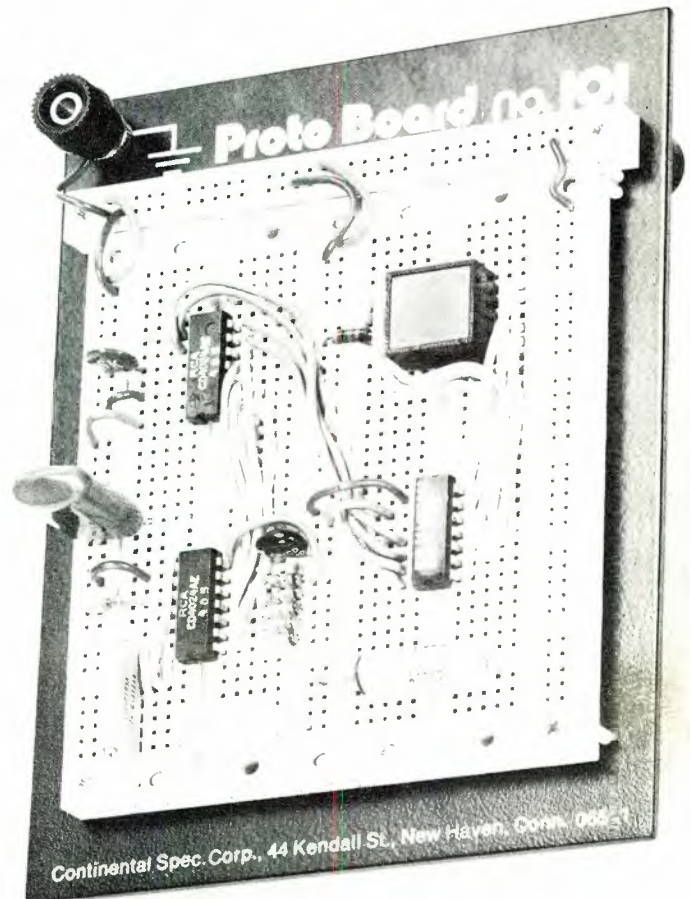

Fig. 2 This board is CSC's No. 101. Smaller and larger boards are available. (Photo courtesy Continental Specialties Corp.)



Fig. 3 There are a number of logic probes available today. This one has switch-selectable TTL/DTL - CMOS function. It also has a pulse memory switch. (Photo courtesy CSC)



Fig. 4 A logic monitor clips on IC pins to show operation of each pin simultaneously. This attached logic monitor can be used on all logic families. (Photo courtesy CSC)

94304. Or call your nearest HP office.

Live And Tape Training Programs

Listed here are some examples of available digital training programs you can have shipped to you (via video cassette), or by attendance at a "live" source.

University of Wisconsin-Extension: "Digital Technology for Broadcast Engineers" is a 24-lesson video cassette correspondence study course developed by the Electronic Media Programming Unit of this university. A half-hour 3/4-inch U-matic video tape is provided (on a "bicycle" arrangement) for each of the 24 lessons.

The course fee is \$480 for the first student at a broadcast station, and \$170 for each additional student. Two textbooks are required at an additional \$15 each. A laboratory kit (\$50) is required, but you may be able to assemble this from on-hand parts prescribed by a free list of materials. You will need to use your own oscilloscope and power supplies.

Linear amplifiers are covered in Part I, digital logic in Part II, with Part III including memory circuits and digital systems. In addition to the 24 half-hour lessons, a Study Guide is issued which includes written material, illustrations, references to specific material in the textbooks, homework (both self-graded and university graded), and lab experiments. Average course duration is expected to be 100 to 120 hours. At the time of this writing, only Part I has been produced and released, with Part II in the production stage.

I would suggest before going into any long (120 hours is certainly not a "shortie") digital training course,

On the Air®

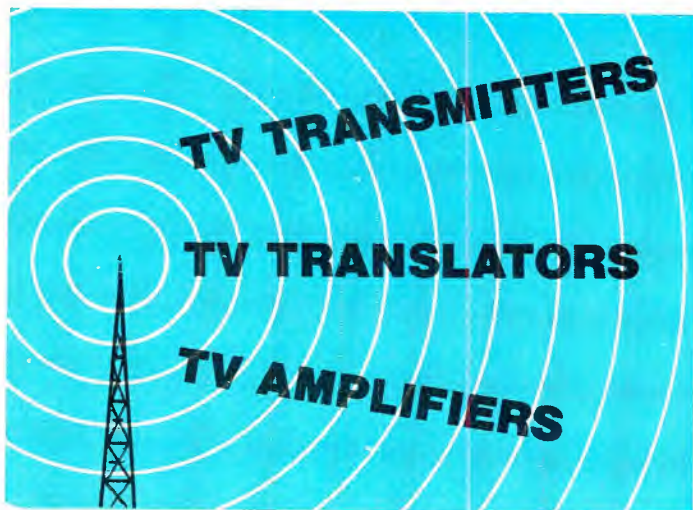

Acrodyne
industries, Inc.

21 Commerce Drive • Montgomeryville, Pa. 18936
(215) 368-2500 TWX 510-661-7265

The 55th annual convention of the National Association of Broadcasters will get underway in Washington, D.C. on March 27. By the time it ends, three days later, everyone will be saying that this was the biggest of all. And that's a mixed blessing for those who will attend.

A Washington, D.C. NAB convention has always meant getting lost in the Sheraton Park and running across the street to the Shoreham. This year there will be an added complication. A third hotel, the Washington Hilton, will be used.

Knowing all this in advance should help you devise your plan of attack, and **Broadcast Engineering's** pre-NAB March issue will be designed with that thought in mind. We will provide separate sections on the three hotels, tell you who is exhibiting in each hotel, where they are located, what's being shown, and, if we can get the information in time, we will list the sessions by hotels. What's more, we'll include a pullout exhibitor locator section that will show the exhibit floor plan for each hotel.

If you are not planning to attend this convention, **BE** will fill you in on many of the new products that will be introduced in the exhibits. After a pause to collect our thoughts, we'll return to the scene in our May issue and recap the important events and cover even more new products.

The Editor

For More Details Circle (44) on Reply Card

that you thoroughly analyze the level of instruction you or your staff can handle. I am particularly concerned with the wide gamut of technical levels that exist in the engineering departments of broadcast stations. Any course that proves too difficult will result in early loss of interest, and you will find that you have lost rather than gained ground in your program.

One of the best ways to evaluate a training schedule is to get familiar with the textbooks used. I would suggest you purchase the textbooks used in the University of Wisconsin course (you need these in your technical library anyway) and examine their contents. These textbooks are:

"Handbook of Integrated Circuit Operational Amplifiers" by George Rutkowski, Prentice-Hall, 1975. \$15.

"Digital Computer Circuits & Concepts" by Deem, Munchow, and Zeppa, Reston, 1974. \$15.

You might be able to find these at your local library. If the general level of instruction is something you can handle (or can grow into), then



Fig. 5 Seminars will continue to grow in importance. Here, RCA's John Wentworth conducts a session on the TCR-100. Seminars in the near future will assume digital training before registration.

this course will be highly beneficial.

Contact: Willis F. Long, Dept. of Engineering, University of Wisconsin-Extension, 432 N. Lake St., Madison, Wisc. 53706. A pilot tape, Study Guide, and free literature are available for exhibition at SBE Chapter meetings and interested stations.

Hewlett-Packard. In addition to the HP Logic Lab (described previously), Hewlett-Packard offers both live training sessions and video

tapes. Live seminars are generally product-orientated on HP's specific digital systems. With the HP video tapes, you can tailor your training program for individuals with different backgrounds and specific needs. You can schedule highly professional presentations anytime and anywhere, without arranging for outside instructors or juggling the detailed logistics that are often required for live training sessions.

HP video tapes of particular

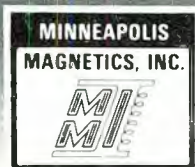

-SYMBOL OF PROFESSIONAL TAPE HEADS

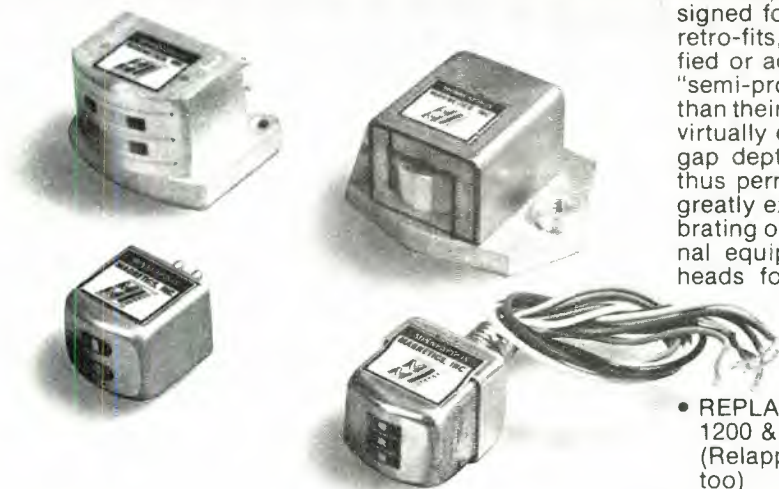

MMI Replacement Heads are professional heads — designed for the machines they will be used with — direct retro-fits, both mechanically and electrically — not modified or adapted heads originally intended for "home" or "semi-pro" recorders. But there is more to MMI Heads than their professional performance: An all-metal face that virtually eliminates oxide loading ... More than twice the gap depth-of-metal of some original equipment heads, thus permitting relapping (under normal head wear) for greatly extended head life ... Individual testing and calibrating of each head to insure meeting or exceeding original equipment specifications ... MMI has ¼-inch tape heads for Ampex, ITC, Magnecord, Revox A-77, and Scully. Professional heads for professional recorders — from MMI.

ALSO FROM MMI
(PROFESSIONALLY, OF COURSE) ...

- REPLACEMENT AUDIO HEADS FOR AMPEX VR-1100, 1200 & 2000 VIDEO RECORDERS (Relapping and refinishing of the complete columns, too)
- HEAD ASSEMBLY REFURBISHMENT AND REBUILDING (Loaner Assemblies available for only the shipping costs)
- HEAD RELAPPING AND REFINISHING (No-Charge head evaluation)



(612) 884-7393

NEW! MMI HAS HEADS FOR CART MACHINES!

For More Details Circle (36) on Reply Card

Sportscaster Headset... Color, Action, Hands-free Mobility

Combine the finest omnidirectional dynamic boom mike with an equally high performance binaural headphone and you have the superior Sportscaster headset...the Telex CS-90. For live broadcasts, from the station or on remotes, with cue and program monitoring and hands-free convenience. The audience hears every word, clearly, crisply, with crowd noise for background color and atmosphere. Circumaural ear cushions screen out noise in the immediate area so that special acoustic facilities are unnecessary. Supplied with convenient in-line, mike-muting "push-to-cough" switch. The Sportscaster headset. Color, action and hands-free mobility. For complete information please write:



PRODUCTS OF SOUND RESEARCH

TELEX[®]
COMMUNICATIONS, INC.

9600 ALDRICH AVENUE SOUTH
MINNEAPOLIS, MINN. 55420 U.S.A.

Europe: 22, rue de la Légion - d'Honneur,
93200 St. Denis, France

Canada: Telex Electronics, Ltd., Scarborough, Ontario



Fig. 6 The Ampex logic course has gained worldwide reputation. The seminar shown taking place here included students from Mexico, England, and Indonesia as well as the U.S.

interest to beginners are the Digital Tutorial Series consisting of five tapes from 18 to 29 minutes in length. These tapes are available either on 1/2-inch EIAJ-1 (suitable for Sony AV and compatible reel-to-reel video tape equipment), or 3/4-inch video cassette. Tape number 1 starts with Digital Building Blocks, and tape 5 winds up with Data Communications. The tapes are purchased outright for a cost of around \$130 each.

Contact: Your Hewlett-Packard field engineer or call the HP office nearest you. Or write: Hewlett-Packard, 1501 Page Mill Road, Palo Alto, Ca. 94304.

Movonics Company. A series of four-day seminars is being offered as an introduction to digital for electronic technicians. Titled Digital Troubleshooting, students will study all currently used IC technologies, examine basic digital gate circuits, and learn tools and techniques available to troubleshoot digital circuits.

The first day is taken up with basic IC logic families, analysis of gate circuits, and tools and techniques to troubleshoot gate circuits. The fourth and final day covers ROM's and troubleshooting, so you can see the four days are intense ones. Each day includes three hours

of hands-on lab work on the specific subject of that day. The tuition for the seminar is \$300 per student, which includes seminar material, lunches, and coffee-breaks.

The instructor for this seminar is Dick Gasperini, formerly the Instrument Service Training Manager at Hewlett-Packard, a job that entailed both coordinating training programs and presenting seminars similar to the Digital Troubleshooting seminar. Dick is considered quite an authority in the field.

Seminar dates and locations must be obtained from Movonics. For example, during September and October of 1976, seminars were held in such cities as Chicago, Paramus (New Jersey), Atlanta, and Los Angeles.

Contact: Movonics Company, P.O. Box 1223, Los Altos, Ca. 94022.

RCA. RCA customers are aware of the product-specific seminars offered on video tape and color cameras. I have attended many of these training sessions and can vouch for their helpfulness.

Usually, the first day (at least) is devoted to basic digital technology. About two-thirds of this time is used up in coverage of gates, flip-flops, registers, counters, decoders,

HITACHI SK-70

The One Camera That Can Do The Work Of Four... Inside Or Outside The Studio!

The modular SK-70 converts easily from a fully equipped, self-contained color studio camera to a modified studio camera. In the field, the studio version of the SK-70 can be connected directly to a VTR with only a co-axial cable. And for hand-held portability, the camera head features a shoulder mount, an auto-iris portable zoom lens, and a 1.5" viewfinder, along with a DC and process pack. The Digital Command Unit (DCU) with up to 3000 feet of single co-axial cable strongly enhances the capability of the SK-70. Another striking option is a 22:1 zoom lens that can be used for the studio version of the SK-70 in the field.

No matter which configuration you choose from those shown in the photo and three diagrams, the Hitachi SK-70 offers the precision and reliability of three 2/3" Saticon tubes in the camera head to insure excellent picture quality, combined with all the latest advances in broadcast camera technology.

As you can see, our outstanding Hitachi SK-70 is a sound investment for broadcasters, production studios, and universities who need broadcast quality performance in a wide variety of assignments, all for the price of a single camera. We'd be pleased to arrange a demonstration of how the SK-70 can fit the following camera requirements inside or outside your TV studio, and more:

1. Fully studio-equipped

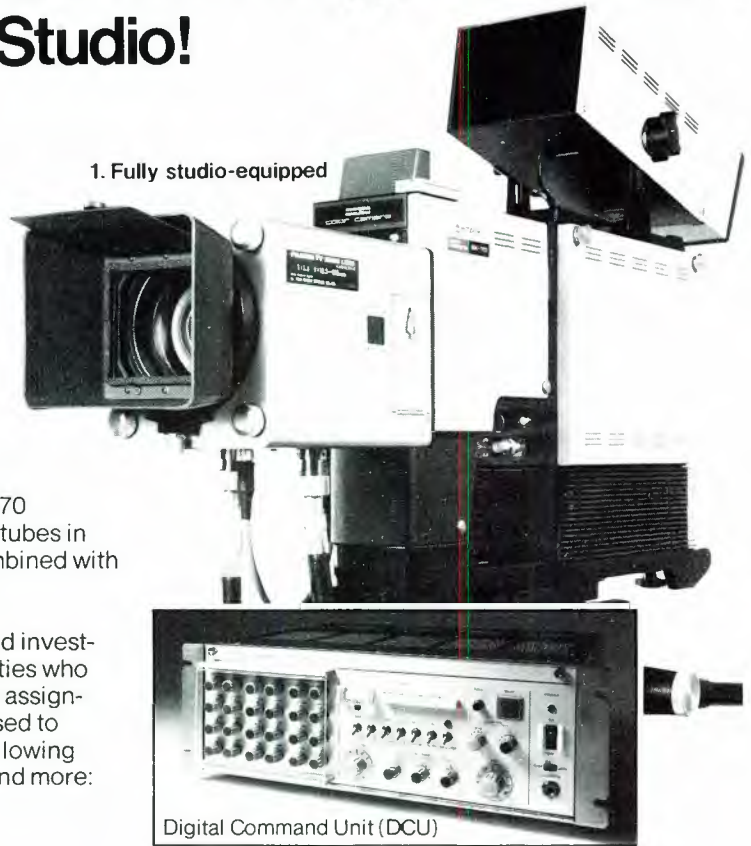

Digital Command Unit (DCU)

2. Portable Use

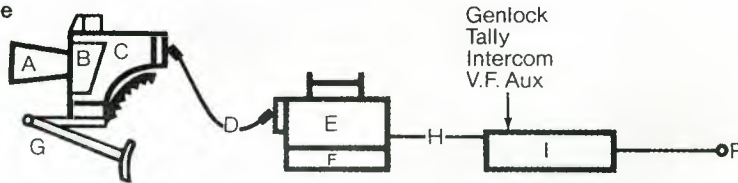

3. Field Use

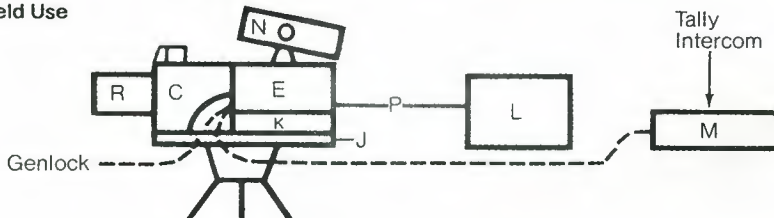

4. Modified Studio Use

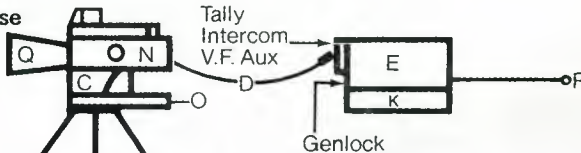

A)	Portable lens
B)	1.5" viewfinder
C)	Camera head pack
D)	Camera cable (300 ft.)
E)	Process pack
F)	D.C. pack
G)	Shoulder Mount
H)	Co-axial cable (3000 ft.)
I)	DCU
J)	Mount adapter
K)	A.C. pack
L)	VTR or FPU
M)	Operation panel
N)	5" viewfinder
O)	5" V.F. Mounting Plate
P)	Co-axial cable (video)
Q)	Portable lens w/conversion adapter
R)	Studio lens



HITACHI
Hitachi Denshi America, Ltd.
FORMERLY HITACHI SHIBADEN CORP. OF AMERICA

Executive Offices: 58-25 Brooklyn-Queens Expressway, Woodside, N.Y. 11377 (212) 898-1261
Offices in: Chicago (312) 344-4020 • Los Angeles (213) 328-2110 • Dallas (214) 233-7623 • Atlanta (404) 451-9453

For More Details Circle (45) on Reply Card

RUSSCO
gives **BIG**
performance

at
little
prices

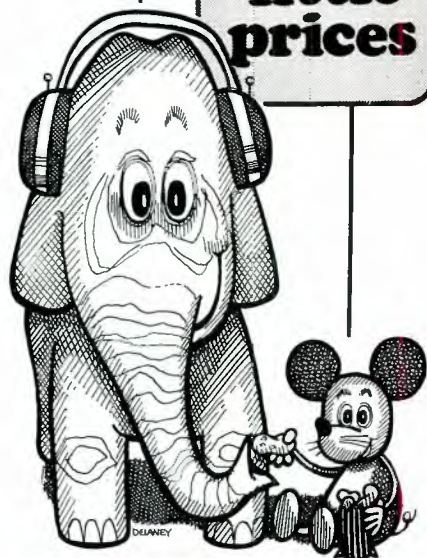

Good Looks & Great Performance are yours with the **RUSSCO STUDIO/MASTER 505** Audio-Mixers! 5 mixing channels, 4 channels each with built-in preamps, each adjustable for mic, phono or hi-level, and the 5th channel has 5 hi-level push-button inputs! The monaural version has a built-in monitor amp! Built-in cue speaker, cue on any channel! Push button key switching & LED indicators! Built-in headset amplifier, Allen-Bradley Mod Pots, FET monitor muting! Available Now in Stereo or Monaural, Cabinet or Rack Mount!



All Solid State, the New **MONITOR/MASTER 260** Audio Amplifier produces 60 Watts RMS through each of its Dual Channels. Low distortion and high damping provide you with clean sound at full output. Balanced or unbalanced bridging inputs without transformers are featured, along with overload protection. The 260 is **RUSSCO**-Rugged and Economically priced!



ELECTRONICS INCORPORATED

1070 Brookhaven, Clovis, Calif. 93612
Phone (209) 299-2167

For More Details Circle (46) on Reply Card

etc. The remaining time allotted to fundamentals reviews specific logic families; DTL for the TCR-100 and TR-70C; TTL for the TR-600; COS/MOS for camera products.

Figure 5 shows John W. Wentworth instructing a group on the theory and practice of the TCR-100 at RCA. Those of you familiar with John Wentworth's lucid technical writings get so you can spot his style even if his name is unceremoniously omitted. The same inimitable style is carried over in his plain-speaking presentations on complicated subjects in RCA seminars.

I am, therefore, happy to report that John is planning to prepare some audio-visual training programs on digital concepts for broadcasters. Some "hands-on" projects may be included, and will be oriented around applications in character generators, frame synchronizers, and advanced editing systems. This course is tentatively planned for release during the second quarter of 1977. Price structure has not jelled, but it definitely won't be a "freebie." After this, RCA seminar participants will be expected to have a basic digital background, so that valuable time can be spent on more advanced coverage of specific gear.

Robert N. Hurst, another well known instructor via his clear and concise technical papers, has recently joined the training group. This is a strong team. Watch the **RCA Broadcast News** (distributed to broadcast customers) for technical papers and further developments.

Contact: Bug your local RCA Rep to keep you posted on near-future developments. John W. Wentworth is Manager, and Robert N. Hurst is Administrator of Broadcast Technical Training at RCA, Camden, N.J. 08102.

Ampex Corporation. I had the privilege of attending one of the original VR 1000 training seminars at Ampex, and know first-hand the amount of time and effort devoted by their training group. Since then, the training department has been vastly expanded in full-time personnel, to handle the ever increasing products of the Audio-Visual Systems Division.

Of particular interest to broadcasters who need orientation in digital technology is the Ampex

seminar on "Logic." It will teach you basics and use circuit examples from the current Ampex product line as typical applications of the basic techniques. These are applicable to the field in general. The courses are conducted in Redwood City, California.

Depending upon demand from Ampex International customers, eight to ten additional Logic courses are conducted in various locations around the world over a twelve-month period.

Ampex strongly recommends that their customer students attend this course before enrolling in one of their equipment courses. Thus, it is scheduled to immediately precede sessions on those Ampex products which make heavy use of digital circuit techniques (AVR-1-2-3, ACR-25, TBC-800, etc.).

Course length is four days, and costs \$150. Several texts and reference books are used for the course, but Ampex relies mostly on its own "Handbook of Solid State Logic." This text ranks among the best I have seen, and is a good indication of the excellence of the Logic seminar.

Contact: Your Ampex Regional office or: Ampex Training Dept., Mail Stop 2-11, 2655 Bay Road, Redwood City, California 94063. Mr. James C. Lawson is Manager. You may contact the Training Dept. direct by calling (415) 367-3701/3702.

Looking Ahead

Meanwhile, the correspondence schools are not ducking the subject of digitals. Cleveland Institute of Electronics (CIE), for example, incorporates digital sections in many of their courses (including their course designed for broadcast engineers).

If you have information on other training devices, tapes, or seminars, drop a line to Digital Lab, in care of Broadcast Engineering. We'll include the vital information in future Digital Lab columns. Also, if you have logic circuit ideas or circuits that will help other broadcasters, send them to our Station-To-Station column.

No doubt about it, this is a subject we should all know more about. With help from Harold Ennes and by sharing our knowledge, the entire industry will benefit. □

From BLUE BANANAS to SAG TAILS

Hold Everything! There's A Wagon On The Line

While looking through our BE picture morgue the other day, I found the shot you see here. It reminded me that not all the strange things that happen in this business are pure Blue Bananas. But, you'll have to admit, it's certainly an unexpected and rare event indeed to find a car hanging on your telco line.



The picture was sent in back in 1972 by Norm Smith of KTLK, Denver, Colorado. If you have copies back that far, check out the August, 1972 issue, page 49.

Now, can anyone top this?

When you peel a Blue Banana for BE, keep in mind that names of other persons involved should be omitted. In some cases, it would be just as well to leave out the call sign. There are still a few people in the business who would rather not share the part(s) they have played in the humorous aspects of our broadcast history. What a different business it would be if we had never made a mistake or done anything zany!

Send your entries to: The Editor, Broadcast Engineering, 9221 Quivira Road, P.O. Box 12901, Overland Park, Kansas 66212.

All's Silent On Debate Dead Air

Before I launch into my own Blue Banana, will the person(s) involved in the "no sound snafu" on the Carter/Ford debates please write in and be counted? You're all quiet as Watergate!

It was a warm morning in late summer when I ran what I thought was a super creative sign-on at the Twin Cities former all-concert music station. In order to appeal to the widest segment for that already minority of listeners I ran uptuned versions of the Star Spangled Banner & Dixie. With great pride I started the first classical selection, flipped off the mic switch, and glanced over at the transmitter modulation meter. Zilch. I flipped the board monitor to air monitor (let that be a lesson). Zilch again. Then I remembered. It was a little after 6 a.m. and my weary brain, used to doing the sign-on by the numbers, had forgot to tell the rest of me to turn on the transmitter. I hadn't the strength to do the fancy sign-on over again so I turned the transmitter on and everybody settled for the "meat and potatoes" approach. But I ran the neater sign-on next morning!

Jim Stokes
Broadcast Consultant
Jim Stokes & Associates

**(217)
222-8200**

**This
number
puts the
Harris
service
team
at your beck
and call**

The Harris Service Department is ready to help if broadcast equipment problems should arise.

Emergency service. Field service. Technical assistance. Installation. Check-out. Parts. Repairs.

What we want to do is make your life easier. And we mean it when we say Harris takes "Pride in Service."

Remember our number—
24 hours a day—
(217) 222-8200. Harris Corporation, Broadcast Products Division, 123 Hampshire Street, Quincy, Illinois 62301.

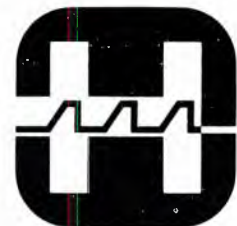

HARRIS
COMMUNICATIONS AND
INFORMATION HANDLING

STOP GROUND-LOOP HUM!

VIDEO HUM STOP COIL...HSC 1

Will ELIMINATE HUM and other INTERFERENCE in Video Lines caused by differences in Ground Potential.

- For Color and Black and White.
- FLAT-DC to 6.5 MHz.
- No Low-Freq. or Hi-Freq. Roll-off.
- No Differential Phase Distortion.
- No Differential Gain Distortion.
- No Envelope Delay.
- Passive Device - Failure Free-Low Price.
- Small Compact Package 4" x 4" x 2-1/4".

ELIMINATES HUM AND INTERFERENCE:

IN STUDIO

- Between Buildings
- On long runs in Buildings
- Between Studio and Transmitter
- On Incoming Telco circuits
- On Outgoing Telco circuits

IN FIELD

- Betw. Remote Truck and Telco
- Betw. Remote Truck and Microwave
- For Intertruck Hookup
- For VTR Units
- For Monitoring Lines

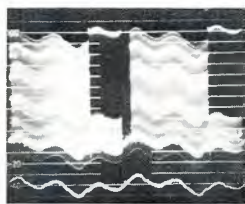

NEW!

\$140
F.O.B.
N.Y.

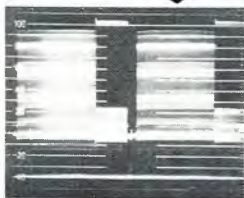

Available on
10 day free trial

AUDIO-VIDEO ENGINEERING COMPANY
65 Nancy Blvd., Merrick, N.Y. 11566
Tel. (516) 546-4239

For More Details Circle (47) on Reply Card

VIDEO PATCHING

- Self-normalling, no patchcords or plugs required for standard connections.
- Self-terminating, unused sources automatically terminated within the jacks.
- Non-interrupting, on-line monitoring of live circuits.
- Best frequency response and isolation specifications in the industry.
- Patented design in wide use by TV broadcasters, industry and government.



Patented
COTERM® 22T Jack
22 per 19" panel
1 3/4" or 3 1/2" high

DYNATECH LABORATORIES, INC.

Cooke Engineering Division

900 SLATERS LANE, ALEXANDRIA, VIRGINIA 22314
TELEPHONE: 703-548-3889 ■ TELEX: 89-9119

For More Details Circle (48) on Reply Card

bookreview

Broadcast Engineering & Maintenance Handbook, by Patrick S. Finnegan, is a 532-page reference work for all broadcast engineers, technicians, and managers—for anyone involved in the planning, construction, installation, start-up, calibration, operation, updating, maintenance, modification, and repair of commercial or educational broadcasting facilities. The book engulfs the subject of aural broadcasting, and is the sum total of the author's know-how and over 30 years of experience in broadcasting.

The book is full of timely maintenance tips, installation techniques, and measurement methods for the entire broadcast equipment chain. Finnegan views the station as a complete system, and shows how to use the same logical approach by which the system was designed to understand and troubleshoot it. The author provides practical answers to problems, rather than theoretical exercises. As he points out, when it is necessary to perform maintenance in the middle of the night, what's wanted are practical solutions to the problem. Thus the entire thrust of the book is practical—little mathematics, but a lot of "how-to-do-it" information that can be put to use immediately.

Separate chapters cover AM and FM transmitters, inspections (SWR indicators to guy tension), antennas (arc suppression to tower icing), automation (system response to the new MOS program controllers), and how to get the most out of the station's test equipment. There's a complete course in FM station transmission lines, from coax characteristics to FM station impedance sweeps. One chapter tells how all the standard electronics techniques—troubleshooting, signal tracing and measuring—are especially adapted to broadcasting. Another describes everything about installation—planning, grounding, surge protection, and construction. There's coverage of the audio chain.

The book is available from Tab Books, Blue Ridge Summit, Pennsylvania.

The Recording Studio Handbook, by John M. Woram, is an indispensable guide to the audio industry. It deals with every important aspect of recording technology.

The book is divided into eight sections. The first deals with the basics, the decibel and sound. The second section is on transducers: microphones and loudspeakers. Signal processing devices are taken up in the third section with chapters on echo and reverberation; equalizers; compressors, limiters and expanders; and phasing and flanging.

Other sections deal with magnetic recording; noise and noise reduction; recording consoles; and recording techniques. The appendices include a table of logarithms, conversion factors and NAB standard.

The book is available from Sagamore Publishing, Plainview, New York.

PEOPLE IN THE NEWS

Alan Baker, Assistant Manager of radio station WLBN in Springfield and Lebanon, Kentucky, has been named as the recipient of a state-wide Community Service Award presented by the Kentucky Broadcasters Association.

Harvie E. Schwartz, Jr. is filling the newly-created post of Director of Technical Operations at Goldmark Communications Corporation...**Harriette Silverberg** is now Director of Marketing and Sales at Imero Fiorentino Associates, Inc.

Alfred C. Lutz is moving to the position of National Service Manager for the Blaupunkt Radio Division of Robert Bosch Corporation...**Tom Kitaguchi** has joined Broadcast Electronics, Inc. as Manager, Systems Engineering...**Ray Willis**, after serving on the news assignment desk for two years at KORK-TV, Las Vegas, Nevada, is the new News Director at that station.

Lucille Larkin, Director of Consumer Affairs for Carl Byoir & Associates, has been named Vice President for Public Affairs for the National Cable Television Association...**John Brumage** is advancing to Vice President of Engineering at MPCS Video Industries, Inc.

Richard V. Warden is now heading Raytheon Marine Company as President...**E. Nevin Kather**, who formerly held that position, is returning to Raytheon's corporate staff as Vice President-Commercial Marketing.

L. R. Dongelewicz is based in Sunbury-on-Thames, Middlesex, England, in his new position as Manager, Eastern European Sales, for RCA broadcast equipment...**David S. Linick** is the new Chief Engineer for Holland Electronics, Inc., Brooklyn, New York.

Klaus Speelmanns will manage International Video Corporation's new branch office in Sao Paulo, Brazil...Scientific-Atlanta, Inc. has announced the expansion and strengthening of its Instrumentation sales organization under two newly-appointed Area Sales Managers. They are **Allen Gillingham**, Western Sales Area Manager, and **Howard B. Klippel**, Eastern Sales Area Manager.

Stan Michalski is filling the new position of Marketing Manager for Knox Ltd...**Bob Hueffed**, formerly Vice President/General Manager of Central Dynamics Corp., has formed Bob Hueffed Marketing, Rye, NY, offering advertising and marketing consulting services to the broadcast industry.

The appointment of **George H. Seferovich** as President of Intertec Publishing Corporation has been announced by Stanley S. Sills, General Manager of ITT Publishing. Intertec publishes eight magazines, including **Broadcast Engineering**.

some inventions SAVE you TIME, WORK & MONEY



THIS ONE DOES ALL THREE

Color sub-carrier burst phase requires close attention to prevent visible color faults (objectionable hue shifts) during a production or duping. Especially if you want to keep normal fleshtones when using special effects, supers and chroma key during color productions. Phase shifts greater than 5 degrees can distort normal fleshtones creating visible color faults. This can result from mis-adjusted video equipment or from various cable lengths and amplifiers which create delays and different burst angles according to their location in a color video system. Phase shifts could also result from normal aging of various components throughout the video system. You can check for phase shift the old way or the VACC way.



phase shift checked **the old way**



phase shift checked **the VACC way**

VACC's Burst Phase Meter (model BPM-1) is a \$437.50 replacement for most vectorscope applications. The unit requires only ac power, video and subcarrier inputs. An easy-to-read analog meter indicates phase shift in the video burst relative to the subcarrier over a full 180 degree range with 1/2 degree accuracy. (360 degrees phase range can be obtained with a coax delay line).

NEW! You saw it at NAB...now available for immediate delivery. **H-Phase Meter** Option 02...includes Burst Phase and H-Phase...all in one unit! \$638.00 list.



USA (303) 667-3301
Canada (Toll Free) (800) 261-4088
VIDEO AIDS corporation of colorado
327 E. 7th St.
Loveland, Colorado 80537

For More Details Circle (100) on Reply Card

THE WILKINSON AM2500B 2.5 KW AM BROADCAST TRANSMITTER

FEATURES

- Solid State Modulator Driver
- Solid State Exciter
- Only One Tube Type - (4) 4-1000A
- Variable Vacuum Capacitor Tuning
- Motorized Variable Capacitor Loading
- Low Distortion, High Level Modulation
- Accessible Drawer Construction
- Solid State Timing Circuits
- Self-Testing Silicon Power Supplies
- Automatic Recycle
- Simplified PA Tuning - Only two controls
- Double Duty Plate & Modulation Transformers
- Pretuned at Customer's Frequency
- Power Cutback (optional)
- Designed for Remote Control
- Ample, Roomy Cabinet for Ease of Service
- Completely Metered
- Uses Standard Parts with Original Maker Numbers

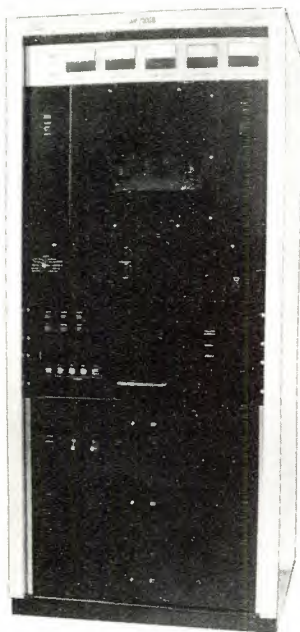

WILKINSON
ELECTRONICS, INC.

P.O. BOX 738, TRAINER, PA. 19013
TELEPHONE (215) 497-5100



Chapter 1—Binghamton, New York

Ron Dagenais of Cetec Broadcast Group gave a short presentation in which he explained that Cetec is now handling a broad spectrum of broadcasting equipment. (Gary Simon, WSYE-TV, P.O. Box 314, Elmira, NY 14902, 607/733-5536).

Chapter 2—Northeastern Pennsylvania

On September 13th Jim De Stefano of EMCEE, Inc. discussed microwave and VHF propagation and systems design. Along with De Stefano was John Saul, Vice-Chairman of the Chapter. They covered selection of site, levels, fresnel zones, clearance, dimensions, free space loss, noise figures, and transmission of signals from origin to receiver. (John Kowalchik, RCA Solid State Div., Crestwood Road, Mountaintop, PA 18707, 717/474-6761).

Chapter 3—Kansas

The October meeting was held at KAKE-TV studios in Wichita, Kansas where Mert Knold of Microwave Associates held a symposium and lecture on ENG practices and uses. After a short recess, the program was continued by John Fielch, also of Microwave Associates, who spoke on the basic criteria involved in microwave path calculations and studies. (Bill Keegan, KTSB, P.O. Box 2700, Topeka, KS 66601. 913/582-4000).

Chapter 5—Atlanta, Georgia

On September 28th Paul Karelson, ATT South-eastern manager, provided description of ATT's organization, function, future plans and conducted tours of audio-video switching facilities and also microwave installations. (Joe Abercrombie, WSB, 1601 Peachtree, Atlanta, GA 30309, 404/897-7424).

Chapter 17—Minneapolis/St. Paul

Chapter 17 met on October 20th at Nortronics Incorporated. Paul Lund, Manager of Marketing Services, and Joe Dundovic, Vice President of Market Development, presented a discussion/presentation on the areas of magnetic head relapping, magnetic head construction, and the electrical test and measurement of magnetic tape heads. (Lance Raygor, Rt. 1, Box 337, Chisago City, MN 55013, 612/373-4807).

Chapter 26—Chicago, Illinois

On October 7th William Baird of Microtime, Inc. gave a most informative review of T B C Technology and the concepts used in A-D and D-A converters and digital storage of video information. He told about the new R S I unit for remote synchronization of the TV signal, especially useful for ENG feeds. This is a lower cost substitute for frame

synchronizers and/or color loc. He demonstrated and talked about other Microtime units such as the 2020 TBC and Image-Ex. On October 27th George Picard of Magnetic Communications Inc. presented a program about tape recording with emphasis on cassettes and high-speed duplication. Future programs are planned featuring Illinois Bell, Switchcraft, Jensen, Andrew and Anixter-Mark. (Bob Churchill, SBE, 121 W. Wacker Dr., Rm. 540, Chicago, IL 60601, 312/729-5215).

Chapter 33—Southwestern Ohio

The September meeting of the Southwestern Ohio Chapter was held on September 23rd. The meeting included a tour of the new WCET-TV studio facilities and a demonstration of their new Phillips LDK-5 studio cameras by Bob Uphaus, staff engineer at WCET. (Louis A. Williams, 2092 Arrowhead Pl., Cincinnati, OH 45231, 513/851-4964).

Chapter 34—Albuquerque, New Mexico

The topic of the September 22nd meeting was grounding, bonding, shielding, isolation and decoupling. C. G. Cunningham of Dyna Engineering discussed these topics which are parts of the background behind discussions of transmitters, modulators, audio circuits, control consoles, etc. As Cunningham mentioned, "Sometimes these background items are forgotten—to our sorrow." (Mike Langner, Gaylord Broadcasting, P.O. Box 737, Albuquerque, NM 87103, 505/765-5600).

Audio Heads? Get on the Beau bandwagon.

There must be some reason why the reaction to Beau mono and stereo audio heads has been so enthusiastic and widespread. There is: Quality and price. From the maker of Beau motors and Beucart®



audio cartridge tape machines, Beau heads are equal to anything else on the market. But at \$19.00 for mono models and \$69.50 for stereo units, Beau heads are unquestionably the biggest bargain around. Heads either with no mounts or threaded studs with leads, right from stock, are available for all popular cart machines, including Ampro, ATC, Beucart, Collins, Garron, Harris/Gates, ITC, RCA, Sono-Mag, Sparta, and Spotmaster. And if you can find another quality broadcast cart machine, we'll provide heads for it, too.

For a listing of all Beau audio heads, please request our new head brochure. Call (203) 288-7731 or write today.

UMC

**BEUCART DIVISION
UMC ELECTRONICS CO.**
460 Sackett Point Rd. North Haven, CT 06473

For More Details Circle (51) on Reply Card

January, 1977

CHYRON

...most advanced

...most imitated

...most desired

and when you consider:

performance...

ease of operation...

maintainability...

customer support...

and continuing

development

of new features to

prevent obsolescence

...most economical!

CHYRON

**...SYSTEMS THAT
LET YOU GROW**

*the industry standard
for character and
graphics generators*

CHYRON

TELESYSTEMS DIVISION OF CHYRON CORPORATION

223 Newtown Road, Plainville, New York 11803

TELEPHONE: (516) 249-3296 • TELE X: 144522 CHYRON PLVW

For More Details Circle (52) on Reply Card

NEW PRODUCTS

Digital Remote Control System

A modular system for digital remote control of AM, FM and TV transmitters has been introduced by **Time & Frequency Technology**.

Called the 7600 Series, the new

system is adaptable to ATS operation, and consists of three basic instruments which can be combined to provide from 10 to 80 channels of remote control. The system uses digital, pulse-code-modulated modems and can be linked by telephone wire, STL and SCA, or sub-audible telemetry.

The basic building block of the TFT system is the Model 7610 Digital Telemetry/Control System. It is a stand-alone unit with raise/

lower functions and from 10 to 80 channels of telemetry. The 7610 can be expanded by addition of a Model 7615 Status and Direct Control System. This gives users 15 or 30 direct, on/off control functions and 15 or 30 status monitoring channels. The third system component is the Model 7640, a microprocessor-controlled Digital Data Panel. It displays up to 40 meter readings simultaneously, and includes automatic limit alarms. Automatic logging is available as an option.

Users can purchase a complete system or just the basic 7610 and add other system components in the field as needed. A complete line of accessories is available for transmitter interface.

A quick disconnect rear panel allows users to remove instruments without disturbing any of the wire connections between the system and the transmitter or sampling points. On-site calibration by one person is achieved with the digital readout at the transmitter site.

For More Details Circle (165) on Reply Card

Diversity Receiving System

Vega's new single-package dual diversity receiving system is designed to eliminate problem noise and signal dropouts that are occasionally encountered when a wireless microphone system is used on a set, in studios and in theaters. The system lets you use wireless microphones in live productions with confidence. The Model 63 Diversity receiving system works well with any VHF wireless microphone; when used with Vega's new Model 77 transmitter, the audio quality is like a hard-wired connection.

The compact Model 63 measures just 3.7 inches by 6.8 inches by 9 inches—identical to a single Vega Model 58 receiver. Inside, the Model 63 contains two low-distortion, high-sensitivity receiver sections and a combiner circuit that silently and electronically switches the audio feed to derive signal from the receiver section having the strongest input. By connecting the two receiver sections to antennas that are separated by about 1/2-

Simplicity is Reliability

The **Sintronic** **DFM-25K-B**
25Kw FM TRANSMITTER

- Grounded Grid Driver
- Grounded Grid Power Amplifier
- Direct FM Solid State Exciter
- Self-Contained: No External Power Vault
- No Neutralization
- Front Panel Power Control From 2Kw to 30Kw
- Rectifiers Engineered to Transformer Characteristics
- VSWR Protection

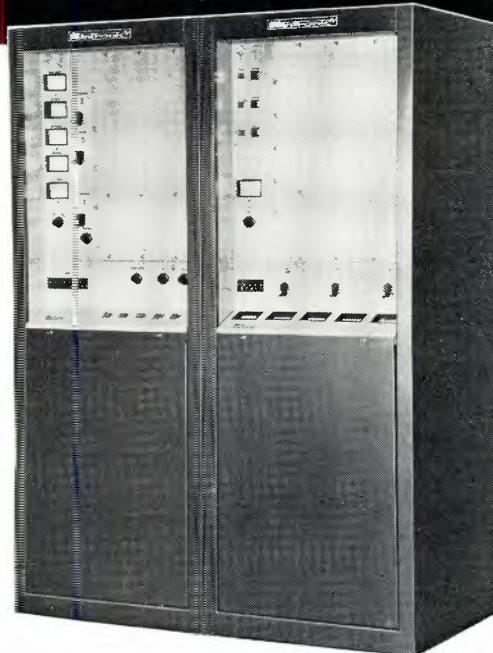

The SINTRONIC DFM-25K-B FM Transmitter offers the simplicity of "grounded grid on grounded grid" — grounded grid driver and power amplifier — resulting in a considerable reduction of components and a greater increase in stability and reliability. The driver section of the DFM-25K-B is the SINTRONIC DFM-3K-A 3500 watt FM transmitter. This driver operates at 1200 watts for full 25Kw output power but can be used as a 3500 watt emergency transmitter. The DFM-25K-B is FCC type accepted and field proven. The unit is self-contained in two cabinets normally located side-by-side. However, they can be separated according to individual spacing requirements.

SINTRONIC manufactures a complete line of AM and FM Transmitters to satisfy every broadcast requirement. Highest quality components are used throughout. All our transmitters contain design features that increase efficiency, provide greater reliability, and reduce maintenance time and costs.

CALL OR WRITE FOR DETAILED INFORMATION

Sintronic CORPORATION

Sintronic Corporation is a subsidiary of Singer Products Company, Inc.
Integrity and Dependability since 1937

Main Office and Plant: 705 Haverford Ave., Bryn Mawr, Pa. 19010 (215) 525-3700
Administrative & Export Offices: One World Trade Center, Suite 2365, N.Y., N.Y. 10048 (212) 432-1400

For More Details Circle (53) on Reply Card

wavelength, the likelihood of a dropout or fade occurring simultaneously at both receivers is all but eliminated.

The combiner has integrated-circuit switching that is designed to preserve the phase and amplitude of the audio with no annoying clicks or pops. Front panel functions include LED's that show when RF and audio is present at each receiver input, an LED for power "on," an illuminated VU meter that can be switched to display audio or RF level from either receiver section, as well as AC power, a headphone monitor jack with volume control, and a selector switch for diversity or fixed reception. The main audio output is available at a balanced, XLR connector that is switchable for mic level or line level.

For those who need simultaneous diversity receivers, and includes less microphones, Vega offers a Model 463 Mainframe. The Model 463 houses up to four Model 63 Diversity receivers, and includes

twin, active antenna splitters and a rechargeable battery/AC power supply.

For More Details Circle (166) on Reply Card

Supplementary Lenses

Canon has announced the availability of two new snap-on supplementary lenses that provide increased zoom-lens versatility without any loss of f-stop whatever. The first, a 1½X tele-converter, fits the Canon 12-120mm and 12.5-75mm zoom lenses. The second, 9mm wide-angle adapter, provides increased acceptance angles for Canon 12.5-75mm and 12-120mm professional zoom lenses only.

The 1½X tele-converter, which snaps onto the front of existing zoom lenses, increases focal lengths by 1½ times, resulting in effective maximum focal length of 180mm for 12-120mm zooms and 112.5mm for the Canon 12.5-75 zoom.

The 9mm wide-angle adapter, designed for Canon macro zoom

lenses only, is a negative-focal-length supplementary lens which decreases effective focal length of both the Canon 12.5-75mm macro lens and the 12-120mm macro zoom lens to 9mm.

For More Details Circle (167) on Reply Card

Cine/ENG Camera Fluid Heads

Four new fluid can/tilt heads each with a specified capacity—the Samson Mini (20 pound capacity), Samson Junior (30 pound capacity), Hercules Hydro (50 pound capacity) and Hercules Fluid Cam (50 pound capacity) have been introduced by **Quick-Set, Inc.** They are designed specifically for Cine/ENG cameras.

Meeting the most critical professional standards, these heads incorporate special bearings for precise, effortless, ultra-smooth pan and tilt movements. All four heads feature compact, lightweight design, independent positive pan and tilt locks, a built-in level, 360° pan

Continued on page 74

Who Has The Time?

Skotel time code readers and generators. High performance timekeeping for greater flexibility in programming and commercial production. Models feature full user data facilities, high visibility LED display, low power consumption and cool reliable operation. Skotel is



compatible with all other SMPTE code equipment and options plug in with no special tests or tools required. Our reader reads 80 bit SMPTE code from any source at speeds from hand turn to 40X. Self-contained character generator gives precise, single frame accuracy.

Like to see more? We've got the time.

skote

PO Box 310, Station Rosemont
Montreal, Canada H1X 3B8
(514) 728-2285

For More Details Circle (54) on Reply Card

Perfect Timing calculated for your pocket only \$39.95



Now you can compute Hours, Minutes and Seconds in the palm of your hand!

ESE INTRODUCES THE CANON 8T HIGH SPEED TIME CALCULATOR. Featuring one touch calculation of addition, subtraction, multiplication or division. Unique Time Keys for automatic chain calculations. "Auto" Input Switch for automatic entry of sexagesimal time data. And Conversion Keys which instantly change sexagesimal data to decimal data or vice versa!

SIZE: 2½" x 5½" x ¾"
POWER SOURCE: 2 penlite dry batteries (size AA)
AC ADAPTER AVAILABLE: \$5.00



Write, Wire or Call: (213) 674-3021
505½ CENTINELA AVENUE • INGLEWOOD, CALIFORNIA 90302

For More Details Circle (55) on Reply Card

Cameraman's Headset... Keeps the crew in touch

A professional TV Cameraman's Headset series specifically designed to interface with existing Western Electric circuits. Single side unit receives intercom only. Dual side, binaural unit receives intercom and monitors program. Carbon boom mike with optional push-to-talk switch. Designed for comfort and rugged dependability in every day use. Keeps the crew in touch—in or out of the studio. For complete information please write:



PRODUCTS OF SOUND RESEARCH

TELEX
COMMUNICATIONS, INC.

9600 ALDRICH AVENUE SOUTH
MINNEAPOLIS, MINN. 55420 U.S.A.
Europe: 22, rue de la Legion—l'Honneur,
93200 St. Denis, France
Canada: Telak Electronics, Ltd., Scarborough, Ontario

For More Details Circle (56) on Reply Card

New Products

Continued from page 73

range, and a choice of Pro. Jr., ball level, or geared column bases.

Except for the Samson Mini, each of the heads has separate pan and tilt tension controls for critical adjustments. The Hercules Hydro features a spring-loaded tilt action to counter-balance uneven loads. All feature dual handle operation. Optional accessories include a quick-on camera plate mount (included with the Hercules Fluid-Cam at no extra charge) and a second telescoping control arm.

For More Details Circle (168) on Reply Card

FM Broadcast Transmitter

CSI Electronics Inc. has introduced Model T-1-F Broadcast Transmitter. Use of a 3CX1500A7 high mu, zero bias power triode, operating in a Class C, grounded grid configuration eliminates the need for grid bias and screen voltage power supplies.

Plate efficiency of the final amplifier exceeding 70 percent provides the qualities of reliability and minimum operating cost.

All CSI FM Broadcast Transmitters are equipped with a synthesized solid state direct FM exciter with an output of 20 watts. Using this system an eight MHz crystal can be employed to cover the entire FM broadcast band.

The transmitter contains many features such as front panel circuit breakers, lighted push button switches, tune-operate switch and local-remote switch that enables the operator to disable the remote control for safety purposes. Also included are facilities for remote control.

CSI transmitters use standard components readily available from conventional sources. All parts and wire meet EIA and FCC specifications.

For More Details Circle (169) on Reply Card

AM/FM Audio Recorder

A new audio recorder that provides expanded production capabilities to professional users at

AM/FM radio and television stations and institutions has been placed on the market by Ampex Corporation.

The ATR-700 audio recorder was unveiled by Ampex at the 55th convention of the Audio Engineering Society in New York City.

The new recorder offers all the features of its two field-proven predecessors, the AG-500 and the AG-600, and now incorporates variable speed, 10½-inch reel capability, full remote controls, and a built-in 4 by 2 mixer. In addition it is rack mountable and available in an optional portable case.

The recorder has a 3-motor tape drive system with a capstan servo DC motor that provides greater torque with improved operational control and speed accuracy. A universal power supply permits operation on AC power anywhere in the world. Equalization is switchable, IEC/NAB.

The system offers three record/reproduce formats: full track (one channel), 2-track (two channel) and ¼-track (two channel) for greater versatility.

Three reel sizes, 10½-inch, 7-inch and 5-inch—can be used with the ATR-700, and the front panel reel size selector adjusts tension for both large and small reels.

Every ATR-700 is wired for 2-channel operation, including electronics. The system can be upgraded from a 1-channel to a 2-channel capability by simply plugging in the appropriate precision manufactured heads.

The ATR-700 is available in two speed pairs: 3¾-7½ and 7½-15 ips. Flexibility is increased with a built-in speed control.

Synchronous reproduce is standard, permitting the audio professional to record a second channel in sync with the sound on the first channel.

An edit system permits spilling tape in playback to simplify editing operations. Separate switches are located on the front panel for bias, equalization and level to maximize performance of different types of tape.

A pause button provides added cueing flexibility, while the pinch roller automatically swings away when in "stop" mode to allow easy

Accurate Field Strength Measurements Can Be Easy

With the Model FIM-21, electromagnetic field strengths can be measured to within 2% across the entire 535 to 1605 KHz AM band. And to intensity levels as low as $10 \mu\text{V}/\text{m}$. Its integral shielded antenna in the cover, front panel speaker, large illuminated mirrored meter, and ganged oscillator/receiver tuning, make it easy to operate in the field. An optional telescoping stand adds convenience. It's also a versatile instrument — use it as a tuned voltmeter for RF bridge measurements.

Contact us now for complete details on our line of field strength meters.



POTOMAC INSTRUMENTS

932 PHILADELPHIA AVE.
SILVER SPRING, MARYLAND 20910 (301) 589-3125

For More Details Circle (57) on Reply Card

threading. Modular design with plug-in PWAs permit ready access to electronics and simplifies maintenance.

For More Details Circle (170) on Reply Card

5300 Multi-deck

Spotmaster has announced the availability of its 5300 Multi-deck. It features a Phase Lok III head bracket for head to tape positioning, a cartridge guidance system, and rear panel LED displays. It is a total modular system with plug in PC cards, plug in transistors and IC's, and plug in transformer.

For More Details Circle (171) on Reply Card

Open Reel Video Tape

Memorex has announced a new 500-oversted video tape designed to provide superior performance on the new generation of one-inch VTRs. The new tape, designated MRX 716 Quantum, is available in one-inch and half-inch configurations for all VTRs capable of

utilizing a 500-oversted tape.

MRX 716 Quantum utilizes a new chromium dioxide formulation which provides improved overall performance and longer useful life. Specific performance features of the new tape include improved color performance, RF and signal-to-noise.

Memorex manufactures a full line of broadcast and helical scan video tape for broadcast, educational and industrial markets.

For More Detail's Circle (172) on Reply Card

Digital Multimeter

This new Model 3435A, $3\frac{1}{2}$ digit multimeter from **Hewlett-Packard** has a unique "touch-hold" probe available as an accessory. It lets the user "freeze" the reading on the display—a convenience when probing closely-packed circuit boards. Accurate enough for both bench and field use, the new digital multimeter is autoranging on AC and

Continued on page 76

THE NEW STANDARD COVERS AM BAND PLUS HARMONICS TO 5 MHz



The Model FIM-41 Field Strength Meter has many more features —

- Measures Harmonics to -80 dB
- High Adjacent Channel Rejection
- Ganged Oscillator/Receiver Tuning
- Stable Operation over wide Temperature Range
- Low Battery Drain Circuits
- Front Panel Speaker
- Large illuminated Meter and Tuning Dial
- Indicates field strength accurately down to $10 \mu \text{ volts}/\text{M}$
- RF input jack for tuned voltmeter applications

CONTACT US NOW FOR COMPLETE DETAILS
ON OUR LINE OF FIELD STRENGTH METERS

POTOMAC INSTRUMENTS

932 PHILADELPHIA AVE.
SILVER SPRING, MARYLAND 20910 (301) 589-3125

For More Details Circle (58) on Reply Card

DON'T BLOW IT...

**TRANSTECTOR
PROTECTORS STOP
TRANSIENTS-SURGES-LIGHTNING
IN LESS THAN
5 NANO-SECONDS**

Your station is too valuable to get taken off the air by power line pollution.

Transtector solid state protectors are non-arcing, non interrupting and permanent.

CALL (213) 283-9278
ASK FOR MR. SMITTER

**TRANSTECTOR
SYSTEMS**

ABSOLUTE
TRANSIENT
PROTECTION

a division of Konic International Corporation
532 MONTEREY PASS ROAD, MONTEREY PARK, CALIF. 91754

For More Details Circle (59) on Reply Card

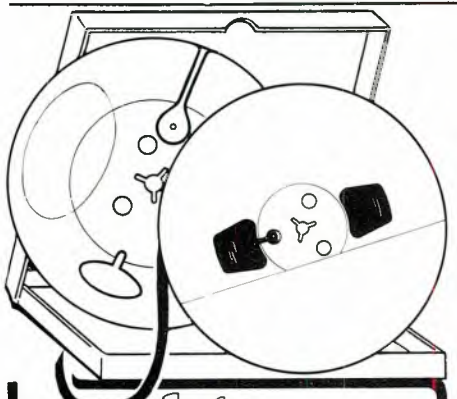

complete supplies for reel to reel audio recording

TAPE

AMPEX and Scotch
all professional grades
on reels or on hubs

EMPTY REELS

all sizes, widths
and hub types

BOXES

for all reels, in various colors

LEADER-,TIMING-& SPLICING TAPES

Top Quality Competitive Pricing
Immediate Shipment
Call or Write for Details/Prices



Recording Supply Co.

DIVISION OF POLYLINE CORP.

1233 RAND RD. • DES PLAINES, IL 60016
312/297-0955

For More Details Circle (60) on Reply Card

New Products

Continued from page 75

DC volts and resistance. AC and DC current ranges are selected manually. Lighted front panel annunciators display the function and its units.

The digital multimeter covers a DC measurement range from 200 mV full scale to 1200 V full scale with a mid-range accuracy of $\pm(0.1\%$ of reading + 1 digit). AC measurement range is 200 mV full scale to 1200 volts rms full scale with a mid-range accuracy of $\pm(0.3\%$ of reading + 3 digits) over a 30 Hz to 100 kHz bandwidth.

AC and DC current measurement range is from 200 microamps to two amps. DC current accuracy for the 200 μ A to 20 mA range is $\pm(0.3\%$ of reading + 2 digits). AC current measurements are made over a frequency band of 30 Hz to 10kHz with a mid-band accuracy of $\pm 1.7\%$ of reading + 4 digits.

Resistance range is 10 milliohms to 20 megohms with a mid-range accuracy of $\pm(.2\%$ of reading + 2 digits). Open circuit voltage on the ohms terminal when set to its lowest range does not exceed 5 volts, preventing damage to most solid-state devices.

For More Details Circle (173) on Reply Card

Record/Playback Preamplifier

Telex has announced a new tape record/playback preamplifier of unique versatility for broadcast, recording studio and industrial applications. Designed as a modular addition to their line of tape products, Telex states that the new RP-85 has wide application for single and multi-channel use in both new equipment and replacement tape systems.

The compact, monaural RP-85 will accommodate tape speeds from 1-7/8 to 15 ips in 1/8 to full track formats. A low speed RP-85L provides special equalization for use with cassette or open reel logging application (15/16 to 1-7/8 ips).

The unit has facilities for mixing and is universally matched for line and microphone inputs as well as line and monitor outputs. Independen-

dent line and cue amplifiers permit monitoring without loading the program output. Self-synchronizing bias permits multi-channel operation including stereo monitoring. Two isolated DC outputs provide continuous or record-mode controlled voltage for external relay or lamp operation. Programmable connectors accommodate various head impedances and configurations.

The RP-85 features silent FET switching, 60 dB bias rejection and full immunity to electromagnetic and radio frequency interference.

For More Details Circle (174) on Reply Card

Highpass Active Filters

A new series of resistive tunable highpass active filters featuring a 1000-1 tuning range over which the desired corner frequency (f_c) is user-determined by external connection of several easily calculated, non-critical resistors is now available from **Frequency Devices, Inc.** The 770 Series filters are finished components using a few standard, equal valued, one percent non-inductive resistors externally to achieve tuning. The basic resistor value is calculated from one simple equation, and the standard one percent value closest to the calculated value provides sufficient accuracy for most applications.

The 770 Series consists of four 2-pole models and four 4-pole models—all having a Butterworth response. A tuning range of 0.02 to 20 Hz, 0.2 to 200 Hz, 2 Hz to 2 kHz and 20 Hz to 20 kHz is available from the appropriate model for both the two- and four-pole models.

The two-pole models include simultaneous highpass and low-pass outputs with a fixed, non-inverting passband gain of 0 ± 0.2 dB. The four-pole models contain a highpass output only, but for extra versatility the non-inverting passband gain can be user-varied over a range 0 to 10 dB.

Performance features common to all models include monotonic stop-band rolloff, 100 kHz full power response, 50μ V/root-hertz voltage

noise, 20 kilohm input impedance and one ohm output impedance and an input offset voltage drift of $20\mu\text{V}/^\circ\text{C}$ over the operating temperature range of 0°C to $+70^\circ\text{C}$. The storage temperature range is -25°C to $+85^\circ\text{C}$.

For More Details Circle (175) on Reply Card

Audio Distribution Amplifier

A new rack mounting audio distribution power supply is available from **Modular Audio Products**, A Unit of Modular Devices, Inc.

Designated Model 7820, the new unit features low distortion and noise, through the use of two MAP Model 1731A Audio Op-Amps in a transformerless bridging input, differential amplifier configuration. Model 7820 provides eight balanced 600 ohm outputs, at up to +20 dBm level output, with a minimum of 80 dB of isolation between outputs, and from output to input. The amplifier is internally protected against short circuit and input overload.

All controls, including gain, On/Off switch, fuse, pilot lamp and a built-in switchable input/output VU meter, are located on the compact $1\frac{3}{4}$ inch high front panel, which is designed for standard 19 inch rack mounting. Audio connections are on barrier strip screw terminals located on the rear of the eight inch deep chassis. A three prong, grounded line cord is provided, for safe operation off 105 to 125 VAC line power.

For More Details Circle (176) on Reply Card

Video Presence Detectors

Di-Tech's Models 401 and 402 video presence detectors are designed to sense only the horizontal line rate of the composite video input. In the absence of this frequency, an on-board alarm light is illuminated and an external relay contact triggers the external alarm.

The 401 provides for four bridg-

Continued on page 78

PERFECT TIMING

Low Cost ESE Right On Timers



ES-300: Four digit incandescent display, one hundred minute timer (99:59) with six controls: Count Up, Count Down, Min-Set, Sec-Set, Stop, Reset. \$180.00

ES-301: Identical to ES-300 except with planar, gas discharge display. \$198.00

ES-302: Equivalent to ES-301 plus fast-set lever wheel programming. \$254.00

ES-400: Three digit ten minute timer (9:59) with Start, Stop, Reset. \$105.00

ES-510: Four digit sixty minute timer (59:59) with Start, Stop, Reset. \$134.00

ES-500: Six digit, twelve hour combination clock/timer with five controls: Start, Stop, Reset, Fast Advance, Slow Advance. \$160.00

STANDARD OPTIONS AVAILABLE: Kit; Slave; BCD Output; Remote Connector; 6' Remote Cable and Pushbutton Set; 220V A.C., 50Hz; 9" or 19" Front Panel $3\frac{1}{2}$ " high; 3 Wire Cord and Molded Plug. Tenths of seconds are available on all timers except the ES-500. Relay Contact Closure at Zero and/or Stop at Zero available on ES-300, 301, and 302. Crystal Timebase available for ES-500. Custom options and special orders available.



WRITE, WIRE OR CALL TODAY

505 $\frac{1}{2}$ Centinela Avenue • Inglewood, California 90302 • (213) 674-3021

For More Details Circle (61) on Reply Card



Waters MM faders mean more mixing in less space

With Waters $\frac{3}{4}$ -inch thin-line conductive plastic faders you can cram 24 channels into an 18-inch mix bay for high density recording studio applications, sound reinforcement and location mixers, and lighting control consoles.

Waters MM faders retain all the superior quality of our accepted LM series including choice of $2\frac{3}{4}$ -inch or 4-inch travel; 600 ohm or 10 k impedance; linear, audio or true log characteristic; and our famed trouble-free long service life. For more mixing in less space circle reader service number or call Bob Waters at 617-358-2777 for more information about thin-line faders.



**WATERS
MANUFACTURING, INC.**

CONGELLO CENTER, WAYLAND, MA. 01778 • (617) 358-2777

For More Details Circle (62) on Reply Card

Communications Headsets... ...for whatever the job

Telex 1320 series headsets offers you six models for all general communications requirements, indoor or out. Single or dual dynamic drivers are impervious to environmental humidity or temperature changes. With optional boom mikes, noise canceling dynamic or carbon. Designed for comfort. Dependably made for heavy duty use. Complemented by the compact Telex IC-10, amplified common talk intercom system for dynamic mike headsets. For "whatever the job," please write for free information:



PRODUCTS OF SOUND RESEARCH

TELEX
COMMUNICATIONS, INC.

9600 ALDRICH AVENUE SOUTH
MINNEAPOLIS, MINN. 55420 U.S.A.
Europe: 22, rue de la Legion-d'Honneur,
93200 St. Denis, France
Canada: Telak Electronics, Ltd., Scarborough, Ontario

For More Details Circle (63) on Reply Card

New Products

Continued from page 77

ing loop-thru inputs and one external alarm relay. Should any one of the four inputs fail, the single relay for the external alarm is triggered.

The 402 provides for four bridging loop-thru inputs and four external alarm relays. Each detector has its own external alarm relay, and is only triggered when that particular video input fails.

The 401 mounts into the Di-Tech 101 frame (up to three modules) or the 103 frame (up to ten modules).

For More Details Circle (177) on Reply Card

Master Audio Meter

MICMIX Audio Products, Inc. makes its entry into the panel meter market with the master audio meter, a dual-channel LED-bar display unit having exceptional features which should prove to be a significant step in obtaining highest performance from consoles and other recording and broadcast equipment.

The adjustable brightness display is selectable for either PEAK or RMS values on smooth, flowing bars having a 55 dB display range in 1 dB increments from +5 to -7, and in 5 dB increments from -10 to -55. In the RMS mode, the master audio meter display has the same rise and fall characteristics as a ballistic type VU meter (300 msec for 20 dB), while timing in the PEAK mode is 130 msec to capture transients and yet provide a very comfortable viewing display.

For More Details Circle (178) on Reply Card

Digital Time Base Corrector

Digital Video Systems has introduced an NTSC digital time base corrector operating at 4x sub-carrier. The super wide window eliminates the vertical jumping often encountered in other TBCs. If this window is exceeded by an ENG tape displaying gyro effects, full color lock is maintained and only a

Nickel Cadmium BATTERIES for ENG.



ALEXANDER BP-20A REPLACES SONY LEAD ACID BP-20A

FITS MODEL NO.
TAPE RECORDER VO 3800
CAMERA NO. DXC 1600

CAN BE
MODIFIED TO
FIT AKA1

NICKEL CADMIUM CONSTRUCTION OUTPERFORMS ORIGINAL with higher discharge rates, longer duty cycles and longer total life. Alexander guarantees free replacement for six months. Thermally protected against overcharge, the BP-20A will stay in service in spite of charger failures.



Write Wire or Phone

ALEXANDER manufacturing co.

Box 1645 Mason City, Iowa 50401
Phone (515) 423-8955

For More Details Circle (64) on Reply Card

Heart Transplant



Tape Recording Electronics

Modern recording capability for new or old recorders. 2-speed EQ, separate EQ for optional SYNC amp. "Linearized" record amp and phase-corrected reproduce circuitry. Fully remotable. Pin-compatible with most Ampexes, adaptable to many others.

Model 375, \$690.

iNOVONICS
INCORPORATED

1630 Dell Avenue, Campbell,
CA 95008 (408) 374-8300

For More Details Circle (65) on Reply Card

BROADCAST ENGINEERING

slight vertical movement will be displayed.

Push button controls and an LED display provide absolute repeatability of settings for any tape or scene. Programmable unity settings have a power down memory.

Decoding, chroma/luminance re-alignment, and encoding are all accomplished in the digital 4x sub-carrier format. VTR delay mismatches (envelope delay) between the Y and chroma channels are corrected up to one microsecond.

Advance is automatically adapted to each different VTR for zero system delay. Advance can also be manually controlled over ± 8 TV lines. For precision, burst and blanking are inserted as a stream of digital numbers prior to data conversion to analog video.

The standard DVL 2002 has a minimum of internal adjustments, adapts to any capstan servo VTR without modification, and every component has been burned in for at least 100 hours prior to shipment.

For More Details Circle (179) on Reply Card

Lens Adapter

The **Warren R. Smith Company** has announced the availability of a new version of ADAPTA-LENS for all electronic newsgathering cameras. ADAPTA-LENS permits the use of a wide variety of 16mm motion picture lenses without loss of light or color fidelity. ADAPTA-LENS, already in use on the one inch and 1¼ inch studio and handheld cameras, now allows the new TV newsgathering cameras to take advantage of the full range of 16mm cinematography including extreme wide angle, macro and special effects shots not possible with the normal TV zoom lenses.

ADAPTA-LENS also enables the TV camera to be interfaced with microscopes, endoscopes and other optical equipment. Professional lenses as well as specialized lenses can be used with ADAPTA-LENS. ADAPTA-LENS can double as a diascope by replacing the field lens with registration and step wedge slides. A 35mm slide attachment is available to permit integration of production titles and products. ADAPTA-LENS features non-ad-

adjustable lens and camera mounts for simplicity and rigidity. Focus for each lens in use is accomplished by a knob controlling internal optical elements. Removable field lenses facilitate cleaning. A filter slide is built in for N.D. or color compensation. Iris control and remote focus are also available. The ADAPTA-LENS unit comes with a standard "C" mount. Specialized mounts are available as an option.

For More Details Circle (180) on Reply Card

Modular Carrying System

K and H Products, Ltd., designers of video work tools, introduces a new Porta-Brace, the PB-4400 with Wheelbase WB-2, designed to carry and transport the new JVC ¾ inch portable video-cassette recording system.

The Porta-Brace PB-4400 with WB-2 is a modular carrying system, similar in design to the Porta-Brace PB-3800 with WB-2 now being used with Sony video equipment.

The PB-4400 with Wheelbase WB-2 includes two padded, canvas-type nylon cases—one for the JVC CR-4400U portable videocassette recorder, and the other for the JVC CC-4800U camera control unit. The two cases are designed to permit over-the-shoulder use, or they may be attached directly to the patented Porta-Brace frame to create a one-man, balanced, hands-free means of operating all three components of the JVC system.

In addition, the Porta-brace PB-4400 frame, when used with its Wheelbase, becomes the rolling vehicle which has become a standard tool among broadcasters.

For More Details Circle (181) on Reply Card

Compact Oscilloscope

A built-in 40MHz multiplier and comprehensive storage facilities are features of a new, lightweight, compact 50MHz oscilloscope introduced by **Philips Test & Measuring**

Continued on page 80

VIDEO RECORDER PROBLEMS GOT YOU DOWN????



Shown measuring the critical supply tension on a Sony 2850

FLAGGING? SIGNAL DROP-OUTS? INTERCHANGEABILITY?

The TENTELOMETER tape tension gage can help isolate and correct these problems and others on your reel to reel and your U-matic machines by measuring dynamic tape tension.

Send for your FREE 8 pg. TENTELOMETER instruction and application manual or call today:



50 Curtner Avenue, Campbell, CA 95008
(408) 377-6588

Prices start at \$179

For More Details Circle (66) on Reply Card



For More Details Circle (67) on Reply Card

New Products

Continued from page 79

Instruments, Inc., a division of North American Philips Corporation. The PM3243 has two channels with 5 mV sensitivities and both the product and one of the original signals can be displayed simultaneously. Variable persistence and variable storage make the PM3243 ideal for studying single shot events.

The use of a direct conversion

power supply allows operation from almost any voltage or frequency - including DC - without switching. Any AC supply between 90 and 264 V from 46 to 440Hz or any DC supply between 100 and 200 V suffice. Power consumption is 39 W, typically allowing the oscilloscope to run for 3½ hours on a rechargeable battery pack.

The built-in analog multiplier offers a full 40MHz bandwidth.

For More Details Circle (182) on Reply Card

30 KSR Printer

The GE TermiNet® 30 Keyboard Send/Receive KSR printer—a new, high-speed, 30 character per second teleprinter—is now available for leasing at low cost from **RCA Service Company**. The printer provides terminal facilities for the exchange of communications in attended or unattended mode.

Designed to meet a variety of needs, this matrix impact printer avoids having to waste computer or communication line time waiting to receive data.

The TermiNet 30 KSR printer features include: vertical format unit (for form out and vertical tabulation), telephone coupler hook-up capability, answerback, adjustable pin-feed—4 inch to 9½ inch and ribbon cartridge. If desired, a Telephone Acoustical Coupler or EIA Interface can be supplied.

Operating on the eight-level ASCII code, the TermiNet 30's print font has 64 upper case ASCII characters. The terminal prints 10 characters to the inch on an 80

When accuracy Counts...Count on Belar for AM/FM/TV MONITORS



BELAR
AM MODULATION MONITOR

BELAR CALL ARNO MEYER (215) 687-5550
ELECTRONICS LABORATORY, INC.
LANCASTER AVENUE AT DORSET, DEVON, PA. 19333 • BOX 826 • (215) 687-5550

For More Details Circle (70) on Reply Card

Electric Rain Gauge

Now you can report minute-by-minute rainfall amounts and not get wet! This new, low cost, remote-reading gauge shows announcer rainfall accumulations in 1/100 inch increments. Transmitter can be located several hundred feet away and is completely automatic—needs no service or attention. Ask for *Spec. Sheet, Model 525*. Free.

Model 525



Also, a complete line of
Texas Weather Instruments
Electronics, Inc.
P. O. Box 7225B (214) 631-2490
Dallas, Texas 75209

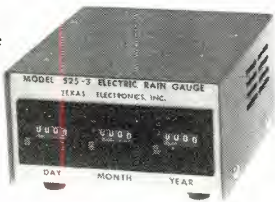

For More Details Circle (71) on Reply Card

angénieux service corporation of california
13381 BEACH AVE., VENICE, CALIF. 90291 • (213) 821-5080
FACTORY SERVICE CENTERS
REPAIRS • PARTS
ACCESSORIES
angénieux service corporation of new york
1500 OCEAN AVE., BOHEMIA, N.Y. 11716 • (516) 567-2424

For More Details Circle (68) on Reply Card

FREE CATALOG
HARD-TO-FIND PRECISION TOOLS
Lists more than 2800 items: pliers, tweezers, wire strippers, vacuum systems, relay tools, optical equipment, tool kits and cases. Also includes ten pages of useful "Tool Tips" to aid in tool selection.
JENSEN TOOLS AND ALLOYS
4117 N. 44th Street, Phoenix, Ariz. 85018

For More Details Circle (69) on Reply Card



Still the industry's MOST WANTED

VIDEO TAPE TIMER

- Bright LED display
- Optional remote display
- Available for all 2-inch VTRs
- Free evaluation to qualified buyers



RECORTEC, INC. 777 PALOMAR AVE SUNNYVALE, CA. 94086 TEL: (408) 735-8821 TWX: 910 339 9367

character line with six vertical lines per inch. Printing at selectable 10, 20 or 30 cps, this impact printer is capable of handling up to a four-part form set of fan-fold or roll, sprocket-feed paper. The ribbon cartridge employs a Mobius loop ribbon to extend ribbon life four to five times over conventional spool-type ribbons.

For More Details Circle (183) on Reply Card

Educational FM Antennas

Harris Corporation, Broadcast Products Division offers its FM-11 series. Two new additions to this series are the FM-33 and FM-44. The FM-11 series is now available in single and up to four ring elements (FM-11; FM-22; FM-33; FM-44). All use lightweight horizontally polarized ring type radiators having a horizontal plane radiation pattern that is essentially omni-directional.

A vertical spacing of one wavelength between elements is used on antennas with more than the single ring element. All are designed for mounting on a pole having an outside diameter of two to 2½ inches.

For More Details Circle (184) on Reply Card

Audio Tape Cue Locator

A tape position locator for fast, accurate cueing has been introduced by 3M Company's Minicom Division for use with its professional Series 79 multi-track recorders.

A sophisticated location and selection device, Selectake II unit is a powerful microprocessor in a com-

compact, self-contained calculator-style case to be used remotely.

Programming a cue during a session requires entering a "store" command and the digitally displayed time on a keyboard. Up to nine separate cues can be stored in the unit's memory. No information is placed on the tape.

Cue recall is accomplished by touching the recall key, number key corresponding to store position and locate key which moves the tape drive to the specified location at high speed, stopping within one count of the cue point, thus eliminating overshoot.

Control panel contains full tape control functions including rewind, forward, record, stop, play and locate.

For More Details Circle (185) on Reply Card

Studio Cueing Receiver

The Comrex Model CRA receiver is designed for broadcast field and studio cueing applications. The CRA receiver is available on any frequency from 50 MHz to 550 MHz, including all VHF TV channels (for cueing during live broadcasts) and the remote pickup broadcast frequencies in the 150-174 MHz and 450-470 MHz bands.

For More Details Circle (186) on Reply Card

Shoulder Camera Pod

Designed to fit any hand-held shoulder-mounted film or electronic camera, the new Image Devices Incorporated MiniPod is of uni-welded stainless-steel construction

with an angled rubber shoulder cushion. Unit is adjustable for individual fit. Dovetailed acceptance plate takes Cine 60 or CP snap-lock baseplate.

For More Details Circle (187) on Reply Card

FREE CATALOG & AUDIO APPLICATIONS	
	CONSOLES KITS & WIRED AMPLIFIERS MIC, EQ, ACN, LINE, TAPE, DISC, POWER OSCILLATORS AUDIO TAPE BIAS POWER SUPPLIES
	 OPAMP LABS, INC. 1033 N. SYCAMORE AVE. LOS ANGELES, CALIF. 90038 (213) 934-3566

For More Details Circle (73) on Reply Card

QUALITY TALKS FOR KIRO

Seattle, Washington



Continental's 317C is the best measure for any 50 kW AM transmitter purchase. Performance, 125% positive modulation and reserve power capabilities are unbeatable. Today's best sound in 50 kW AM is Continental.

Write for brochure: Continental Electronics
Mfg. Co., Box 270879 Dallas, Texas 75227
(214) 381-7161

Continental 
Electronics

For More Details Circle (74) on Reply Card

Still the industry's MOST DESIRED

VIDEO TAPE EVALUATOR



- Tape evaluation at 16 times speed
- World wide customer base
- Standard in the industry
- Leasing program available

RECORTEC, INC. 777 PALOMAR AVE. SUNNYVALE, CA. 94086 TEL: (408) 735-8821 TWX: 910 339 9367

advertisers' index

Acrodyne Industries, Inc.	62
Alexander Manufacturing Company	78
Ampex AVSD	7
Andrew Corporation	33
Angenieux Corp. of America	80
Audio Designs & Manufacturing	56
Audio-Video Engineering	68
Beucart Div. of UMC Electronics	54,71
Belar	80
Broadcast Electronics	18
Canon Video	9
Capitol Magnetic Products	41
Central Dynamics	21
Cetec Broadcast Group	5
Chyron Telesystems	71
Collins Radio Group—Rockwell International	Cover 3
Comrex Corp.	14
Continental Electronic Mfg. Co., Inc.	81
Cooke Engineering, Div. of Dynatech Laboratories, Inc.	68
Dolby Laboratories	53
Dynair	29
Dynasciences	14
Dynatech Laboratories, Inc., Cooke Engineering Div.	68
ES Enterprises	73,77
Electro-Voice, Inc.	11
English Electric Valve of N.A. Ltd.	16
Fidelipac	16
Fujinon Optical, Inc.	17
The Grass Valley Group, Inc.	3
Harris Corp., Broadcast Products Div.	67
Hitachi Denshi America, Ltd.	65
Ikegami Electronics	47
Inovonics	78
International Video Corp.	20
Jensen Tools & Alloys	80
Leitch Video	25
Microtime	31
Micro Consultants, Inc.	51
Minneapolis Magnetics, Inc.	63
Opamp Labs, Inc.	81
Otari	39
Pacific Recorders	10
Philips Audio/Video	19
Potomac Instruments, Inc.	75
RCA Communications Systems Div.	55,57
Ramko Research	40
Recording Supply Corporation	76
Recortec, Inc.	80,81
Rohde & Schwarz	36
Russco Electronics Mfg., Inc.	66
Scully Recording Instruments	12
Sintronic Corp.	72
Skotel	73
Sony Corp. of America	26,27
Sound Technology	15
Spotmaster	18
Stanton Magnetics, Inc.	8
Tektronix, Inc.	37
TeleMation, Inc.	59
Telex Communications Inc.	64,74,78
Tentel	79
Texas Electronics, Inc.	80
Thomson-CSF Laboratories, Inc.	43
Time & Frequency Tech., Inc.	13
Transtector Systems Div.	76
UMC Electronics—Beucart Div.	54,71
Video Aids Corp. of Colorado	69
Videomagnetics	49
Videomax Div., Orrox Corp.	1
Vital Industries, Inc.	Cover 4
Ward-Beck Systems Ltd.	Cover 2
Waters Mfg. Co.	77
Wilkinson Electronics, Inc.	70

PROFESSIONAL SERVICES

Applied Video Electronics, Inc.

STUDIO SYSTEMS DESIGN AND INSTALLATION ENGINEERING. REFURBISHING/MODIFYING COLOR CAMERAS AND QUADRUPLIX VIDEO TAPE RECORDERS.

Post Office Box 25
Brunswick, Ohio 44212
Phone (216) 225-4443

RALPH E. EVANS ASSOCIATES

Consulting TeleCommunications Engineers
AM-FM-TV-CATV-ITFS
3500 North Sherman Boulevard

MILWAUKEE, WISCONSIN 53216
PHONE: (414) 442-4210 Member AFCCE

VIR JAMES

CONSULTING RADIO ENGINEERS
Applications and Field Engineering
Computerized Frequency Surveys
345 Colorado Blvd.

Phone: (Area Code 303) 333-5562
DENVER, COLORADO 80206
Member AFCCE

Midwest Engineering Associates Consulting Engineers

F. W. Hannel, P.E.
BSEE; MSEE

7304 N. Oxford, Peoria, Illinois 61614
(309) 691-3426

W. H. BRADLEY, P.E.

Consulting Radio Engineer
Engineering Applications
& Field Engineering

Phone: 918-245-5444
300 West 41 Street,
SAND SPRINGS, OKLAHOMA, 74063

SMITH and POWSTENKO

Broadcasting and Telecommunications
Consultants

2000 N. Street, N.W.
Washington, D. C. 20036
(202) 293-7742

James Tiner, President

TINER COMMUNICATIONS SERVICE, INC.

"We Specialize in Towers"
Complete Tower and Antenna
Installation and Service

P.O. Box 3827, 15201 Hickman Road
Des Moines, Iowa 50322 (515) 278-5501

Joseph & Donna Roizen VIDEO CONSULTANTS

International TV Systems
Marketing/Technical Writing
800 Welch Rd., Suite 354
Palo Alto, Ca. 94304
Tel: (415)326-6103

CLASSIFIED

Advertising rates in Classified Section are 25 cents per word, each insertion, and must be accompanied by cash to insure publication.

Each initial or abbreviation counts a full word. Minimum classified charge, \$2.00.

For ads on which replies are sent to us for forwarding (blind ads), there is an additional charge of \$3.00 per insertion, to cover department number, processing of replies, and mailing costs.

Classified columns are not open to advertising of any products regularly produced by manufacturers unless used and no longer owned by the manufacturer or a distributor.

TRAINING

EARN YOUR ELECTRONICS DEGREE by correspondence. G. I. Bill approved. For free brochure, write Grantham School of Engineering, Information Desk, 2000 Stoner Avenue, Los Angeles, Calif. 90025. 8-72-1f

FIRST PHONE in six to twelve weeks through tape recorded lessons at home plus one week personal instruction in Boston, Philadelphia, Detroit, Atlanta, St. Louis, Seattle or Los Angeles. Our twentieth year teaching FCC license courses. Bob Johnson Radio License Preparation, 1201 Ninth, Manhattan Beach, Calif. 90266, Telephone 213-379-4461. 8-75-1f

BROADCAST ENDORSEMENT and third phone preparation on cassettes. Illustration book includes current FCC-type exams. Radio License Preparation, 1201 Ninth, Manhattan Beach, Calif. 90266. 8-75-1f

GET YOUR FIRST TO GET THERE FIRST! DON MARTIN SCHOOL OF COMMUNICATIONS/ Since 1937, training Broadcasters for Broadcasting! 1st Phone training using latest methods and completely equipped Transmitter studio. Call or write for details and start dates. Don Martin School, 7080 Hollywood Blvd., 5th floor, Hollywood, CA 90028. Call (213) 462-3281 or (213) 657-5886. 8-75-1f

PASS FCC first and second class exams with new 21-lesson, 450-page course. Starts with basic electricity. Over 600 FCC-type, multiple-choice questions and sample exams included. No previous technical knowledge required. Commercial Radio Operator Theory Course, #15-01. Only \$5.95. Ameco Publishing, 275G Hillside Ave., Williston Park, N.Y. 11596. 8-72-1f

PASS FCC EXAMS WITH Ameco books. Each book contains FCC questions plus simplified answers plus FCC-type exams and answers. 3rd class includes broadcast endorsement \$1.25. 2nd class \$2.50. 1st class \$1.60. Free catalog. Ameco Publishing, 275G Hillside Ave., Williston Park, N.Y. 11596. 8-72-1f

SERVICES

FREQUENCY MEASURING SERVICE—WE'RE #2 —MONITOR REPAIRS—MOBILE UNIT—covers Northern 2/3 Ill., Eastern Iowa, Eastern Minn., Southern 2/3 Wis., Western Mich., and Western Ind., monthly, Radio Aids, 528 Ravine Ave., Lake Bluff, Illinois 60044, (312) 234-0953. 2-74-1f

COMMERCIAL RADIO MONITORING CO. Precision frequency measurements since 1932. Local and mobile service covering entire midwest plus. Test instruments, counters, monitors repaired and certified. Lee's Summit, Mo. 64063. (816) 524-3777. 9-74-1f

ONE STOP FOR ALL YOUR PROFESSIONAL AUDIO REQUIREMENTS. Bottom line oriented. F.T.C. Brewer Company, P.O. Box 8057, Pensacola, Florida 32505. 7-71-1f

HELIAX-STYROFLEX. Large stock—bargain prices—tested and certified. Write for price and stock lists. Sierra Western Electric, Box 23872, Oakland, Calif. 94623. Telephone (415) 832-3527. 1-73-1f

SERVICES (CONT.)

CAMERA TUBES...ALL TYPES EXCEPT ORTHICONS CAN NOW BE RECONDITIONED AT AN UNBELIEVABLE PRICE. LEAD OXIDE TYPES \$300.00. VIDICONS FROM \$35 TO \$200.00. ALL RECONDITIONED TUBES COME WITH 500 HOUR WARRANTY. FOR DETAILS WRITE: RODONCO ENGINEERING, CAMERA TUBE DIV., 4020 STAPLETON DR., BLOOMINGTON, IND. 47401. 8-75-1f

USED BROADCAST EQUIPMENT sold on consignment. Catalog updated and mailed free bi-monthly. David Castellano, 3232 McNutt Ave., Walnut Creek, Calif. 94596. 11-76-6f

TRANSMITTER TUBES—Save 50 to 50%. 3CX2500, 4CX5000, 4CX10000, 4CX15000, 4CX-35000 and many others. Write for details: FREELAND PRODUCTS CO., 3233 Conti St., New Orleans, La. 70119. 504-822-9223. 11-76-12f

WANTED

WANTED: All surplus broadcast equipment especially clean A.M. & F.M. transmitters, capacitors, 112 Clark & Potomac Phase monitors, Field Strength Meters, etc. High prices. All custom duties paid. Surplus Equipment Sales at 2 Thorncliffe Pk. Dr., Unit 28, Toronto 17, Ont., Canada (416) 421-5631. 1-76-1f

WANTED: Pre-1926 radio equipment and tubes. August J. Link, Surcom Associates, 305 Wisconsin Ave., Oceanside, Ca. 92054, (714) 722-6162. 3-76-1f

GOOD COLLINS 21E transmitter. Call 408-475-0172 or write: Grant Wrathall, P.O. Box 483, Aptos, Calif. 95003. 7-76-8f

NEED 2.35 KW FM TRANSMITTER—used, also antenna Gates FMC-3A, 3 section (H&V) side mounted or equivalent tuned to 92.7 and stereo generator. Used automation minimum 3 carousels, 3 tape decks. No junk. Broadcast Engineering, Dept. 365, Box 12901, Overland Park, KS 66212. 1-77-11f

EQUIPMENT FOR SALE

FOR SALE: TR-22 High band color video tape machine, also one CEI-280 plumbicon broadcast camera. Write WXON-TV, P.O. Box 2020, Southfield, Mich. 48075 or call 313-355-2901. 5-76-1f

A FEW COMPETITIVELY PRICED used Revox A77 & A700 decks available. Completely reconditioned by Revox, virtually indistinguishable from new and have the standard Revox 90 day warranty for rebuilt machines. Satisfaction guaranteed. Write requirements to ESSI, Box 854, Hicksville, N.Y. 11802 (516) 921-2620. 5-76-1f

RAZOR BLADES—Single Edge, Tape Editing, \$24/M, \$15/5C, 25884B Highland, Cleveland, Ohio 44143. 9-76-6f

12 BAY FM ANTENNA, 3-1/8" Rigid coax, stereo cart and reel recorders, Sparta console, limiters, other audio processing equipment and more. Call Norm Laramee 918-585-5555. 12-76-3f

DON'T PAY \$150.00—\$280.00 each for VIDEO or PULSE distribution amps. You can save your organization a few thousand dollars, if you have someone who can solder and follow simple instructions. I supply ALL parts, including pre-drilled and etched epoxy card, for building a six output, BROADCAST video or pulse amp. AVAILABLE ONLY PER THIS AD. Will ship prepaid, COD or P.O. from credible CO. TELE-TEC., 8688 ROYAL DRIVE, NOBLESVILLE, INDIANA 46060. VIDEO 3601-VDA PULSE 3601-PDA, complete with instructions \$25.00 each. 12-76-3f

MICA AND VACUUM transmitting capacitors. Vacuum relays. Large stock; immediate delivery. Price lists on request. SURCOM ASSOCIATES, 305 Wisconsin Ave., Oceanside, Ca 92054, (714) 722-6162. 3-76-1f

EQUIPMENT FOR SALE (CONT.)

COLOR FILM CHAIN—IVC 90 Color Camera with CCU, 3M Broadcast Encoder, Spindler Saupee Dual Drum Slide Projector, Bell & Howell 16mm (optical & magnetic sound) Laird Base. Zolomatix Prism Optics, Low Hours, \$6900 or Offer. Contact: Doug Kanczuzewski, 2121 S. Manchester Ave., Anaheim, Ca 92802. (714) 634-2222. 1-77-11f

IVC-960CD VIDEOTAPE RECORDER, new heads, TBC, excellent condition. \$17,500 or best offer. (206) 623-3188. 1-77-11f

FOR SALE—All equipment brand new in late 1973—Wilkinson FM 1000-E Broadcast Transmitter, Wilkinson Stereo Generator, Wilkinson Stereo Peak Limiters, Wilkinson Stereo AGC, Wilkinson Turntable Preamps Stereo, McMartin TBM2000-A/SCA Monitor, McMartin TBM 4500-A Modulation, McMartin TBM 2500-C RF Amplifier, McMartin TBM 3019/Pilot Monitor, Shively Six Bay Model 6601/Horizontal, Moseley PCL/303/C STL, Moseley PBR 15/Remote. Contact: JOSEPH BAHR/WVIS/Box 487, F/dsted, St. Croix/U.S.V.I. 00840—Phones 809/772-2257 and 772-1652. 1-77-21f

DEMO EQUIPMENT FOR SALE: in like new condition. 1 Philips LDH-20/50A-VF systems camera complete with 10-1 lens, 2X extender, local control panel, \$31,600.00—list price, \$19,500.00—sale price. 1 Hitachi FPC-1000P Camera with 10-1 Zoom Lens, \$15,650.00—list price, \$11,750.00—sale price. 1 Editing system consisting of 1 Convergence ECS-1 editor, 2 Sony VO-2850A editing 3/4" VTR's, \$18,000.00—list price. \$13,500.00—sale price. 1 Akai VTS-150B + color portable camera & VTR, \$8,500.00—list price, \$4,675.00—sale price. For more information write or call Mike Barness at Wahl & Wahl, Inc., 1907 Hiawatha Ave., Mpls., Minnesota 55404. Area 612-338-6825. 1-77-11f

CLOSE OUT—3-VJB-12 Juke Boxes with 13-12-1200 Sony Cassette Player with Timer, Monitor, Graphics and Tension Control—\$6,500.00. 5 - E UMP-3 Movie Player with JVC 5000 Cassette Player—\$2,500.00. 200 - Channel "D" converters—\$20.00. 13 - Blonder Tongue Channel "D" - (2) Channel "7" AVMT Audio Video Modulators #4933—\$400.00. 15 - Jerrold-Gibraltar TV Amps #3455—\$70.00. 20 - Blonder Tongue - DAZI - \$25.00 each - DA-IV-75P—\$15.00. 1 - Blonder Tongue Field Strength Meter #FSM-3—\$300.00. PLUS—other amps, splitters, equipment. Write Gene D. Carlisle, 5575 Poplar Avenue, Suite #803, Memphis, Tennessee 38117, or call 901-683-8234. 1-77-11f

TOTAL WORKING SYSTEM, consisting of: 2-Sony Model DXC-5000BP Plumbicon Color Cameras, 1-Sony PVM-1200 Monitor, 1-Sony PVM-400 Monitor, 1-Tektronix RM-529 Waveform Monitor, 1-Sony SEG-600 Spec. Effects Gen., 1-Sony PSA-101 Color Sub-Car. Ph. Shifter, 1-Sony CG-101 Sync Gen., 1-Sony DA-101 Distr. Ampl., 1-MX-900 Micro. Mixer, 1-Grass Valley Processor, 950H, 940A, 955 & 900, 1-Portable Console/Cabinet (wired and ready to go). Makes a great small station studio or remote system. Contact: Communications Systems Co., 121 N. Front St., Marquette, Michigan 49855, 906-228-9622. 1-77-11f

BROADCAST CRYSTALS for AM, FM or TV transmitters. frequency change, repair or replacement of oven types. Also new vacuum types for RCA, Gates, Collins, etc. transmitters. Quality products, reasonable prices and better delivery! Don't be without a spare crystal. Frequency change and service for AM and FM frequency monitors. Over 30 years in the business. Eidson Electronic Co., Box 96, Temple, Texas, 76501. Phone (817) 773-3901. 12-74-1f

MOTORS FOR SPOTMASTERS

NEW Paps hysteresis synchronous motor HSZ 20.50-4-470D as used in series 400 and 500 machines. Price \$49.00 each prepaid, while they last. 90 day warranty. Terms check with order only, no COD's. Not recommended for Tapecaster series 600 or 700.

TAPECASTER TCM, INC., Box 662
Rockville, Maryland 20851

1-72-1f

RCA TP-6 TELEVISION PROJECTORS. Pair, one has Magnetic playback. Excellent operating condition. (212) 541-9295. 1-77-11f

HELP WANTED

PATENTED MATV. \$200 00 day profit possible. Preliminaries \$3.00. Box 809, Boynton Beach, Fla. 33435. 10-76-6t

BROADCAST ELECTRONICS FACULTY POSITION: To teach the final year of a Bachelor of Science program. The subjects to be taught include two-way communications, Radio Transmitters (A.M. and F.M.), CATV, and Color Television Transmitters. Bachelor of Science degree required plus significant work experience. This is a tenure track position. Apply to: M. R. Halsey, Head, Electrical and Electronics Department, Ferris State College, Big Rapids, Michigan 49307, (616) 796-9971, Ext. 208. AN EQUAL OPPORTUNITY/AFFIRMATIVE ACTION EMPLOYER. 12-76-3t

TELEVISION ENGINEER WANTED: Minimum of 3 years experience operating and maintaining studio cameras, audio and RCA video tape. Must have an excellent technical background and 1st class FCC license. Send resume to: Ted Newcomb, Chief Engineer, P.O. Box 32325, Oklahoma City, Oklahoma 73132, 405-848-3311. An Equal Opportunity Employer. 12-76-3t

TELEVISION MAINTENANCE/Supervisors, Electronic/Computer Systems Technicians/T.V. Servicepersons, for Northern New Jersey or New York Area. Send resume to: V.P.C., P.O. Box 268, New Hyde Park, N.Y. 11040. 1-77-tf

CPTV HAS OPENING for experienced Video/VTR Engineer. Minimum two years experience and FCC 1st required. Send resume: F. Abramowicz, Conn. Public TV, 24 Summit Street, Hartford, CT 06106. An Equal Opportunity Employer. 1-77-1t

HELP WANTED (CONT.)

CAMPUS SYSTEMS T.V. ENGINEER—Large medical school located in central Virginia needs top engineer to maintain and troubleshoot equipment in audio-visual department. Must have experience in color television systems. Excellent benefits. Contact: University of Virginia, Personnel Dept., Madison Hall, Charlottesville, Virginia 22903. An equal opportunity employer. 1-77-1t

ENGRG. MGMT.—Direction and administration of all engineering activities, including product development, documentation and production support. Requires strong background in broadcast and industrial video, RF, and digital control switching and distribution. Will work closely with marketing and with customers to define system requirements, and assist in generation of sales quotations. Also available, a switching and controls engineer position. Please send resume and salary history to: Personnel Manager, DYNAIR Electronics, Inc., 5275 Market Street, San Diego, CA 92114, (714) 263-7711. Equal opportunity employer, M/F. 1-77-1t

VIDEO SWITCHER SALES:

Locate L.A. area, willing to travel West Coast. Like to sell quality products. Video technical background essential. Write:

Nubar Donoyan
3700 N.E. 53rd Avenue
Gainesville, FL 32601 Tel.: 904-378-1581

BROADCAST engineering®

Regional advertising
sales offices

Indianapolis, Indiana—Roy Henry, 2469 E. 98th St., Indianapolis, Ind. 46280, (317) 846-7026

New York, New York—Stan Osborn, 60 E. 42nd St., Room 1227, New York, N.Y. 10017, (212) 687-7240

Mountain View, California—Dennis Triola, 2680 Bayshore Frontage Rd., Room 102, Mountain View, Ca. 94043, (415) 961-0378

London W.C. 2, England—John Ashcraft & Co., 12 Bear St., Leicester Square, Tele.: 930-0525

Badhoevedorp, Holland—John Ashcraft & Co., John J. Lucassen, Mgr., Sloteweg 303

Tokyo, Japan—International Media Representatives, Ltd., Shiba-Kotohiracho, Minatoku, Tele.: 502-0656

**Remember
Our New Address:**

**Broadcast Engineering
P.O. Box 12901
Overland Park, Kansas 66212**

Broadcast Products Division

RADIO FIELD SERVICE TRANSMITTER ENGINEERS

International/Domestic Opportunities with Harris

We are a steadily growing division of Harris, a corporation with a remarkably consistent record of expansion in many aspects of communications, and sales now over the half-billion mark. Broadcast Products Division is a world leader in television, radio and long range equipment.

These positions involve both domestic and international travel and offer excellent professional potential, plus exceptional financial opportunities when extended periods abroad are called for.

Requirements include technical strength in AM and FM broadcast, 3-5 years or more of directly related experience, and at least 2 year Associate's degree in Electronics. Ability to work with minimum supervision is essential.

Advantages include salary fully consistent with your qualifications, bonus plus other overseas incentives for international field expense assistance. Please send resume with salary data in confidence to Mr. Lawrence B. Carlstone, Professional Employment Supervisor, Harris Corporation Broadcast Products Division, Quincy, Illinois 62301.



HARRIS
COMMUNICATIONS AND
INFORMATION HANDLING

An Equal Opportunity Employer M/F

Help!

Anytime you have a question about your subscription to Broadcast Engineering, please include a mailing label to insure prompt service on your inquiry.

Change of Address

If you're about to move, please let us know approximately four weeks before the move comes about. Simply affix your present label here, and carefully print the updated information below.

**AFFIX
LABEL
HERE**

Please Help Us to Serve You Better

Broadcast Engineering
P.O. Box 12901
Overland Park, KS 66212

Name _____
(Please Print)

Employer _____

Address _____

City _____ State _____ Zip _____

in Switching- the Star is Vital

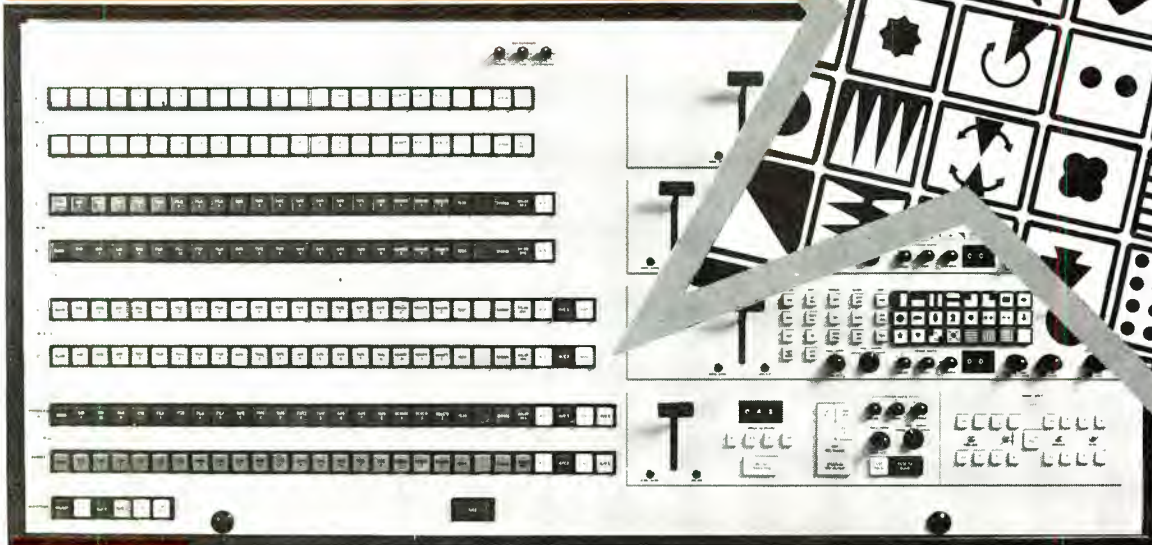

- 12, 16, 20, or 24 inputs. 4 bus, 6 bus, 8 bus or more bus systems.
- All digital waveform and quad split generators.
- Digital key edging, border, shadow and outline available on all ME's.
- Vari-key. Soft, hard, shadow, or see-thru key.
- Digital quad split. Wipe or dissolve in each quadrant.
- Electronic vignette. Adjustable soft pattern edges.
- Superb linear chroma keyer. RGB or encoded.
- Automatic transition control on each ME.
- Ready to interface for computer aided operation.
- Many more state of the art and operational features described fully in series 114 brochure.

Choice of over 80 exciting patterns such as star, heart, binoculars, keyhole, rotary clockwise and more

Vital Industries, Inc. is the first manufacturer to introduce extensive use of digital circuitry in switching techniques. In addition to superb electronics, we furnish a control panel that allows easy and frequent use of all features you buy. Example is the separate illuminated pushbutton showing pattern in use on each ME. No secret coding or delegation is used.

Automatic transition on each ME is furnished for professionally smooth transitions of wipes, keys and dissolves.

The VIX-114 is the only switcher in the world that generates the star, heart, binoculars, keyhole and many useful and creative effects.

Delivery now in ninety days.

Do not fear to discover a superior product in the VIX-114 series switchers. Ask to see the demo tape for a sample of what we can do for users of switching equipment. You'll like it.



GOOD ENGINEERING IS VITAL

VITAL INDUSTRIES, INC.

MORRELL BEAVERS Midwest 2644 North Seventh St. Terre Haute, Indiana 47804 Phone 812/466-3212

ROBERT McALL Northeast 34 Autumn Lane Hicksville, N.Y. 11801 Phone 516/735-0055

GORDON PETERS Southwest P.O. Box 912 Arlington, Texas 76010 Phone 817/261-6855

ERIC KING Fox Hill Road Lynchburg, Va. 24503 Phone 804/384-7001

BARRY HOLLAND West Coast 7960 West Beverly Blvd. Lcs Angeles, California 90048 Phone 213/653-9438

For More Details Circle (3) on Reply Card

Now. The single most powerful FM transmitter in the Collins Generation 4 line: 25 kW.

And yes, two can be joined for 50 kW. First came Generation 4[™] 9 new FM transmitters from Collins.

Now comes number 10, the new 831G-2C with 25 kilowatts of clear, clean FM power.

All 10 are called Generation 4 because they're the product of four decades of Collins broadcast experience. And all are a full generation ahead of other transmitters on the market.

Collins was the first with Generation 4 and now it's the first major to offer a 25-kW FM transmitter.

At the heart of all Generation 4 Transmitters is Collins' new, field-proven Phase 4[™] Exciter. The exciter which was selected by the Swedish government for use in every FM station in Sweden. Selected after a year of evaluating the leading FM exciters in the world. Selected by Sweden's top broadcast engineers.

Because it is the world's finest FM exciter.

And the Phase 4 Exciter is only one part of a line of transmitters designed to meet the requirements of today's new generation of radio audiophiles.

So, whether you need a 10-W transmitter, a 50-kW transmitter, or something in between, Generation 4 is the answer.

Generation 4 Transmitters are available right now at very competitive prices. All have the superior Collins quality you have come to expect. And all are backed with the same unexcelled 24-hour parts and field service.

Contact your local Collins Broadcast salesman. Or Broadcast Marketing, Collins Commercial Telecommunications Division, Rockwell International, Dallas, Texas 75207. Phone: (214) 690-5574 or 5424.



Rockwell International

...where science gets down to business

For More Detail: Circle (2) on Reply Card

