

# Broadcast Engineering

the technical journal of the broadcast-communications industry



A HOWARD W. SAMS PUBLICATION

Scope review for 1971  
page 28

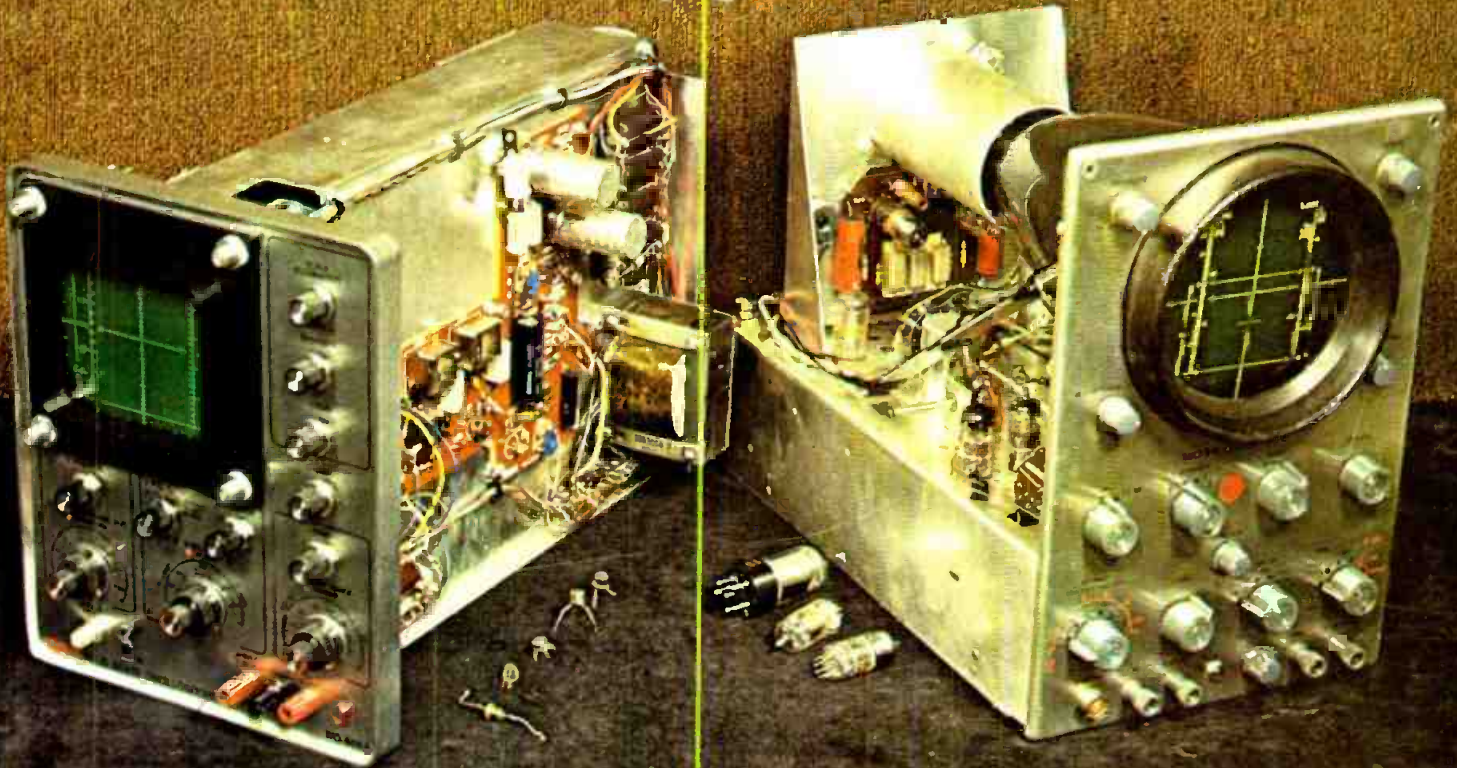

Reducing loop rates  
Training for CATV  
More on SCA birdie

Box 1193  
TOWN N Y 147

TCA-40

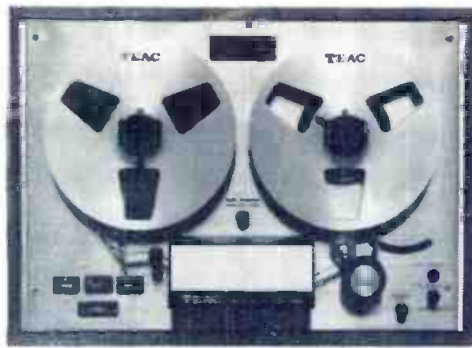

**= TCA-40**  
4-track, 4- and 2-channel playback

TCA-40

RA-41



**= TCA-41**  
4-track, 4- and 2-channel playback  
2-channel record

(record amplifier)

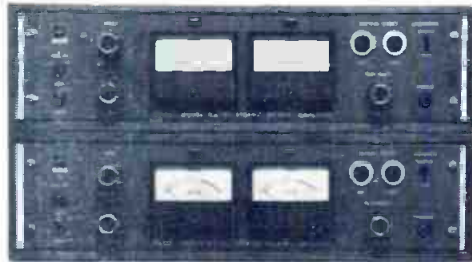

**= TCA-42**  
4-track, 4- and 2-channel playback  
4- and 2-channel record

2 RA-41's

TCA-40

(Mounting cradle and dust cover optional)

# HIGHER MATH

Three decks, three capabilities: the Simul-trak® TCA Series from TEAC.

Buy one, add onto it, and you're up to the next model. Keep going till you reach the top. Or start at the top, and get everything going for you at once.

All three units feature 4- and 2-channel playback – the only brand with auto reverse. And Models 40 and 41 can be modified to the full 4-channel capability of Model 42 as shown. Meanwhile, any one of these decks is compatible with your present 2-channel equipment without modification.

Other 4-channel tape decks may look like ours. But they either have only one motor – or they cost a king's ransom. (They don't sound as good, either.)

And any way you add them up, the TCA Series can never be obsolete. You don't even need a slide rule to show you why. Just a good pair of ears.

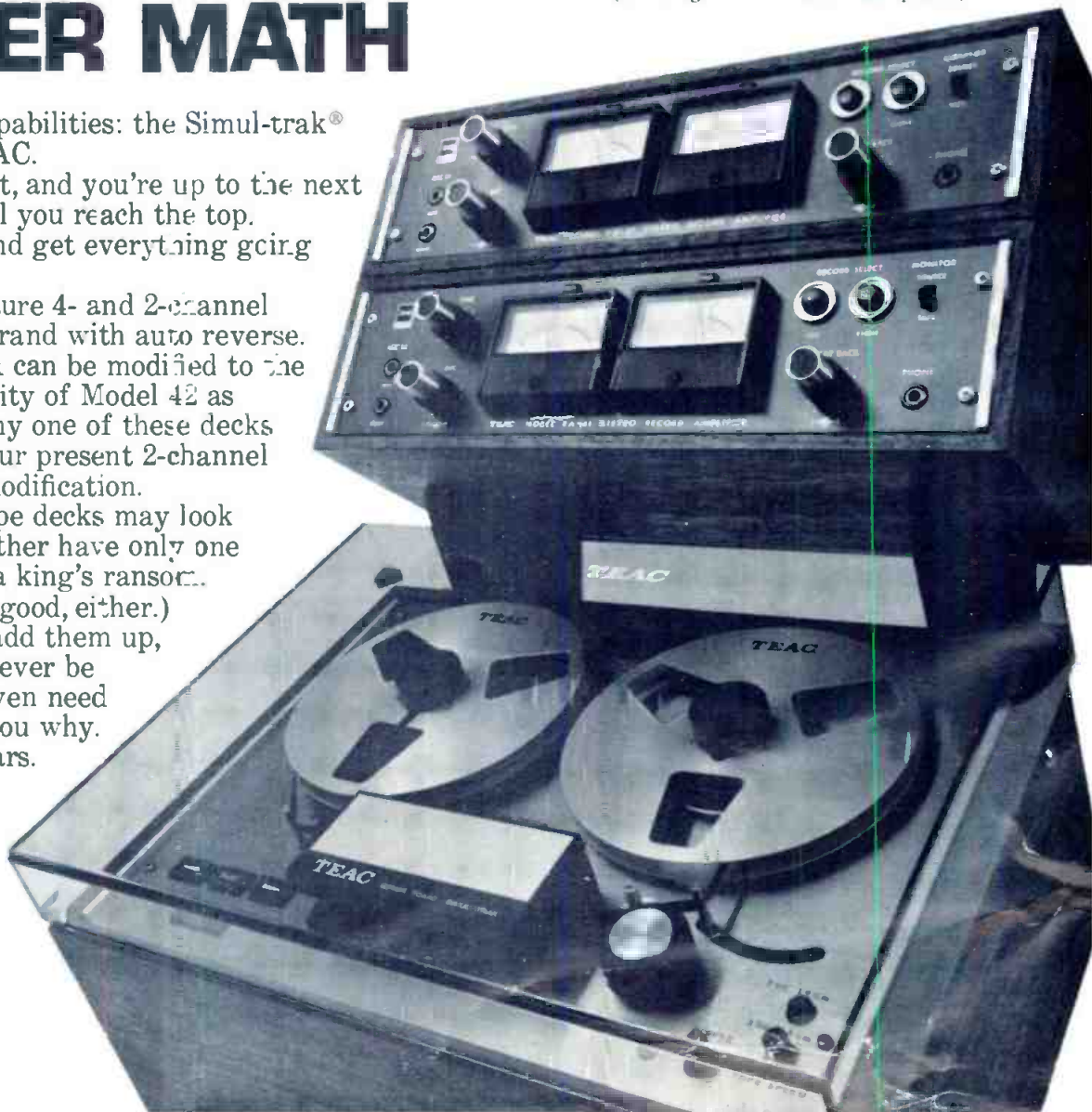

**TEAC**

TEAC Corporation of America  
2000 Colorado Avenue  
Santa Monica, California 90404

Circle Number 1 on Reader Reply Card

Now...

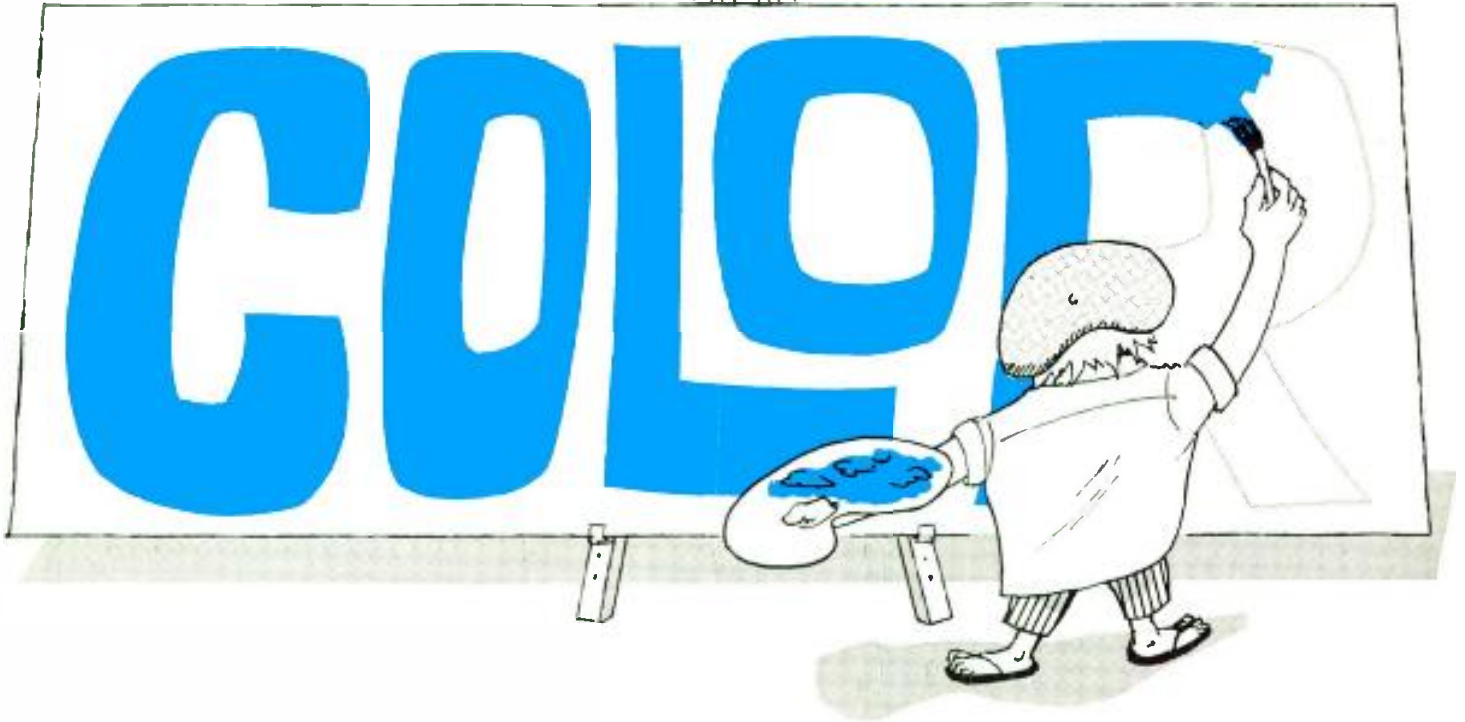

with COHU'S new solid-state  
**VIDEO ENCODER** \*

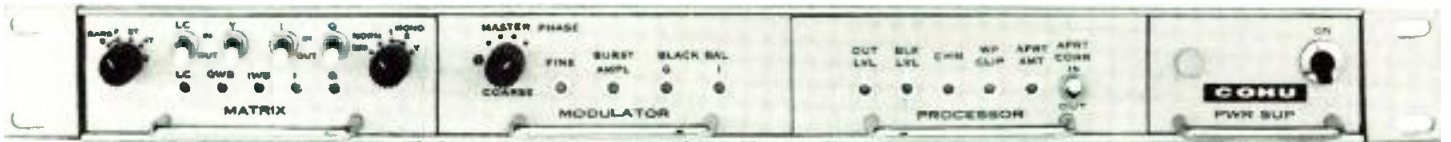

\* **EXCEEDS ALL NTSC AND FCC SPECS**

**ACCEPTS RGB OR RGBM INPUTS**

**PROVIDES THREE-LINE OUTPUTS**

**HAS RGBM-LUMINANCE CORRECTION**

**IS 1-3/4" HIGH (IN 19-INCH RACK)**

**PURCHASE ORDERS MAY BE PLACED DIRECTLY WITH THE COHU ENGINEERING REPRESENTATIVE IN YOUR AREA—OR CALL BOB BOULIO IN SAN DIEGO.**

Box 623  
San Diego, California 92112  
Phone 714-277-6700  
TWX 910-335-1244



SEE US AT NAB BOOTH 325—CONRAD HILTON HOTEL, CHICAGO—March 28-31, 1971  
Circle Number 4 on Reader Reply Card

# Broadcast Engineering

The technical journal of the broadcast-communications industry

## *in this issue...*

- 22 Putting The Oscilloscope To Work.** A brief review of scope basics and a number of examples of how to use your scope in audio circuits. **Pat Finnegan**

---

- 28 1971 Oscilloscope Survey.** Summary of data collected from 20 scope manufacturers who answered our survey questionnaire. Includes state-of-the-arts trends, spec comparison, and prices.

---

- 38 A Manufacturer's View . . . Can Stereo-SCA Be Compatible?** More on the question of how to eliminate that "birdie" so long associated with SCA and stereo. **James L. Tonne.**

---

- 40 Reduce Those Loop Rates For Remotes.** Author tells how to cut costs and maintain quality of sports remotes. Includes schematics. **Elliott Full.**

---

- 42 A Talk Show Delay System.** Engineers discuss their search for a delay system for a talk show. Gives method that will not tie up equipment. **Philip V. Blakely Jr. and T. Frank Ritter.**

---

- 46 Can We Close The Gap Between Management and Engineering?** Part two of a three-part series on the gap that has so long kept many engineers and managers at odds. Part two is a hard hitting piece that forces the engineer to look more closely at his job and his professional associations. **R. H. Coddington.**

### ABOUT THE COVER

This month's cover shows the evolution of scopes. On the left is the latest RCA service scope. At right, an older tube model still in service. In order to bring the reader up to date, we've put the scope to work on page 24, and offered a look at the trends and specs in a survey article on page 28. (Photo by Carl Babcoke).

### DEPARTMENTS

Direct Current . . . . .	4
Letters to the Editor . . .	8
Industry News . . . . .	11
CATV Scope . . . . .	18
Educational	
Broadcasting . . . . .	20
Engineer's Exchange . .	50
New Products . . . . .	53
Book Reviews . . . . .	61
Tech Data . . . . .	62
Ad Index . . . . .	65
Classified Ads . . . . .	66

### EDITORIAL

GEO. H. SEFEROVICH, Director  
 RONALD N. MERRELL, Editor  
 CARL BABCOKE, Solid State  
 MORRIS COURTRIGHT, Automation  
 PAT FINNEGAN, Maintenance  
 HOWARD T. HEAD, FCC Rules  
 ROBERT A. JONES, Facilities  
 WALTER JUNG, Education/Closed Circuit  
 ANDRA PETERSON, Editorial Assistant  
 H. G. ROESLER, Cartoonist  
 DUDLEY ROSE, Art Director  
 LEO G. SANDS, CATV

### EDITORIAL ADVISORY BOARD

LES NELSON, Chairman  
 Howard W. Sams & Co., Indianapolis

### CIRCULATION

EVELYN ROGERS, Manager

### ADVERTISING

E. P. LANGAN, Director  
 R. JACK HANCOCK, Manager  
 S. F. WILSON, Production  
 JAKE STOCKWELL, Sales

### REGIONAL ADVERTISING SALES OFFICES

Indianapolis, Indiana 46206  
 ROY HENRY  
 HOWARD W. SAM'S & CO., INC.  
 2469 E. 98th St.  
 Tele: 317/846-7026

New York, New York 10019  
 CHARLES C. HORNER  
 3 W. 75th St.  
 Tele: 212/688-6350

Los Angeles, California  
 JOHN D. GILLIES  
 3600 Wilshire Blvd., Suite 1510  
 Los Angeles, California 90005  
 Tele: 213/383-1552

London W. C. 2, England  
 JOHN ASHCRAFT & CO.  
 12 Bear Street  
 Leicester Square  
 Tele: 930-0525

Amsterdam C, Holland  
 JOHN ASHCRAFT & CO.  
 W.J.M. Sanders, Mgr.  
 for Benelux & Germany  
 Herengracht 365  
 Tele: 020-240908

Tokyo, Japan  
 INTERNATIONAL MEDIA  
 REPRESENTATIVES, LTD.  
 1, Shiba-Kotohiracho, Minato-ku  
 Tele: 502-0856



BROADCAST ENGINEERING is published monthly by Intertec Publishing Corp., 1014 Wyandotte Street, Kansas City, Missouri 64105. Telephone: 913/888-4664.

BROADCAST ENGINEERING is mailed free to qualified persons engaged in commercial and educational radio and television broadcasting. Non-qualified subscriptions in the U.S. are \$6.00 one year, \$10.00 two years, \$13.00 three years. Outside the USA add \$1.00 per year to cover postage. Single copy rate 75 cents. Back issue rate \$1.00. Adjustments necessitated by subscription termination at single copy rate.

Controlled Circulation postage paid at Indianapolis, Indiana.



Robert E. Hertel, Publisher  
 Intertec Publishing Corp.  
 Subsidiary of Howard W. Sams & Co., Inc.

# IF YOUR 1971 PLANS INCLUDE

**AUTOMATION SYSTEMS**  
 For MCR Switchers  
 For Routing Switchers  
 For Machine Control

TIME	VIDEO SRC	TR	AUDIO SC	TR	PROGRAM	MANUAL ROLL = SEC.
12:17:53 PM						
12:29:37	N1		N1		WAYSIDE DOCTOR	-12R-
NEXT						
0:30	F3A				CUNSHOKE PROMO	
0:08	F1A		FN		CRES- 02P	
0:02	F2S		C3		D	
-----						
EDIT LOG:						
0:00	4M				EVENING NEWS PR.	
0:08	F4B		FS	AI	DO HENRY'S BEAUTY	
0:02	F2S		AI		AC	
7:57:06 AM	AM				8886-	
1:52	VT3		DF		JOHNSON'S MAM	
3:08	F2M		IMF1	AI	0 LOCAL INSERT	
13:45	F1B				SPORTS SPECIAL	
0:15	VT1		DS		SPECIAL PROMO	
26:35	F1B		DS		SPORTS PART 2	

**SWITCHING SYSTEMS**  
 For Production Studios  
 For A/V Routing  
 For Pulse Delegation

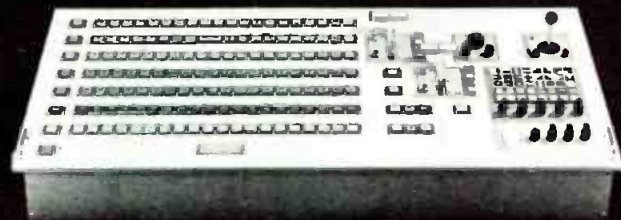

**PROCESSING SYSTEMS**  
 For Transmitters  
 For Remote Signals  
 Helical Scan VTR



**SYNC/PULSE SYSTEMS**  
 Sync Generators  
 SYNAC Systems  
 Pulse Distribution Amps.



Or Other Television Line And Terminal Equipment  
**THEN LOOK TO THE GRASS VALLEY GROUP, INC.**  
**FOR YOUR EQUIPMENT REQUIREMENTS**

**THE GRASS VALLEY GROUP, INC.** 

**FOR ADDITIONAL INFORMATION, CONTACT GRAVCO SALES, INC.**

6515 Sunset Blvd.  
 LOS ANGELES, CALIF.  
 (213) 462-6618

Station Plaza East  
 GREAT NECK, N.Y.  
 (516) 487-1311

1312 West Northwest Highway  
 ARLINGTON HEIGHTS, ILL.  
 (312) 394-1344

2626 Mockingbird Lane  
 DALLAS, TEXAS  
 (214) 352-2475

1644 Tullie Circle, N.E.  
 ATLANTA, GEORGIA  
 (404) 634-0521

Circle Number 5 on Reader Reply Card

# DIRECT CURRENT FROM D. C.

February, 1971

By Howard T. Head

## Class IV Stations In Florida Granted Power Increase

The Commission has authorized an increase in daytime power from 250 watts to 1000 watts for several Class IV stations in Florida. These approvals had previously been withheld due to interference problems with notified Cuban assignments.

The Commission's allocation policy in the past has considered protection to both operating stations and notified assignments in Cuba. In many cases, Cuban assignments were notified in one community but operated in another, thereby requiring protection from stations in the U.S. toward widely separated locations in Cuba. In some cases assignments were duly notified to certain communities in Cuba but actually did not operate on these frequencies. This procedure sometimes resulted in protection to stations that did not exist.

The Commission has been conducting listening tests to determine the actual frequency usage in Cuba and to establish protection requirements toward operating stations. The Florida grants were made based upon the data ascertained from these listening tests which showed that the calculated interference would not obtain.

## Canada Permits Private "Mini-Power" AM Station

The Canadian Radio-Television Commission (CRTC) has announced its decision to grant authority for a private "mini-power" AM operation on 1450 kHz with a power of only 40 watts. This application was approved on an experimental basis for a two-year period.

Heretofore, the Canadians have operated about 200 low-power AM stations as boosters, but only as network outlets for the Canadian Broadcasting Corporation (CBC). According to CRTC, the new authorization represents the first deviation from this policy. Each of these booster stations operates non-directionally, but the interference requirements of NARBA are scrupulously observed.

Privately owned AM broadcasting stations in Canada ordinarily operate with a minimum power of 100 watts. This is equal to the minimum power formerly permitted for AM Class IV stations in the United States (the minimum power now is 250 watts).

*(Continued on page 6)*

now . . .  
 a company  
 that has AM, FM  
 and TV frequency  
 and modulation  
 monitoring  
 systems.

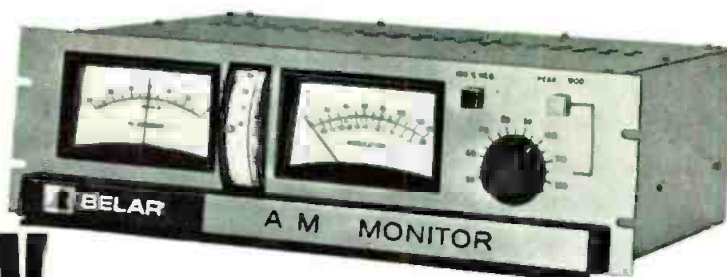

Type Approval #3-176

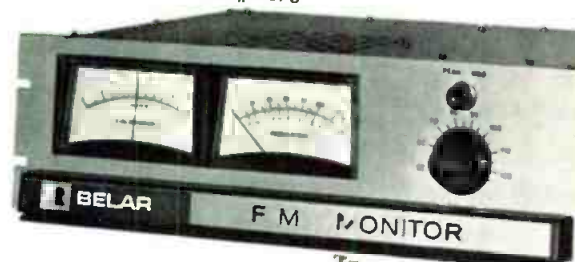

Type Approval #3-129



Type Approval #3-146



Type Approval #3-162



Type Approval #3-181

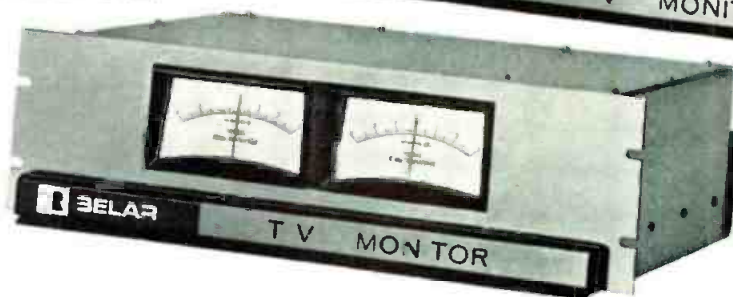

See us at the N.A.B.,  
 Booth 205,  
 West Exhibit Hall

Now . . . Belar. Belar is the only company that has the necessary type approvals on all three monitoring systems. Belar accuracy permits use of the maximum power allowable and maximum power means maximum profit. Add to this that all Belar equipment is immediately available.

Isn't it time you stopped running around and finally settled for a company that can handle *all* your frequency and modulation monitoring needs? Contact Arno Meyer . . . he'll show you the way.



BELAR ELECTRONICS LABORATORY, INC., DEPT. BE 21  
 BOX 83, UPPER DARBY, PA. 19084 • (215) 789-0550

Circle Number 6 on Reader Reply Card

There are no comparable proposals for this type of operation in the United States. However, such mini-power operations for AM could perform much the same function as television translators in isolated areas or might be applicable for local service in underserved areas or in directional antenna null regions.

#### Class IV Stations Excluded From PSA

The Commission has denied the request by a Class IV station for a Pre-Sunrise Service Authorization (PSA). The petitioner had requested permission to operate during the pre-sunrise hours with the power of 500 watts in the same manner and with the same maximum power as now permitted by Section 73.99 of the Commission's Rules for Class II and Class III stations. In denying the request of the Class IV petitioner, the Commission held that, among other things, such operation would be inconsistent with pertinent agreements with Canada and Mexico.

The North American Regional Broadcasting Agreement (NARBA) establishes 250 watts as the maximum nighttime power for Class IV stations. Therefore, an agreement with the Canadians would be required on a basis similar to that affecting operation during pre-sunrise hours by other classes of stations.

The recently ratified U.S./Mexican Treaty would permit a maximum nighttime power of 500 watts for Class IV stations located more than 93 miles from the common border. Although pre-sunrise operation at a power higher than 250 watts is not contemplated for Class IV stations in the U.S./Mexican Treaty, the maximum power requested is not inconsistent with the treaty provisions for nighttime operation.

Since domestic interference is ignored for PSA's it would appear that operation with the power of 500 watts prior to local sunrise might be feasible even on the Class IV channels if pertinent agreements could be achieved on a reciprocal basis consistent with the treatment afforded Class II and Class III stations.

#### Short Circuits

CARS operating in the Business Radio Service band between 12.2 and 12.7 GHz prior to November 22, 1965, may continue operation until February 1, 1976; the previous deadline was February 1, 1971 . . . NAB has asked the Commission to terminate its proposal for the reassignment of remote pickup broadcast channels in the 450 MHz region to land mobile operation . . . NAB has supported the proposal of a Delaware station (See July, 70 D.C.) for the elimination of the use of loss resistors by AM stations . . . The U.S. will recommend a "go-slow" position for direct satellite-to-home television broadcasting at the forthcoming ITU World Administrative Radio Conference to be held in Geneva starting June 7, 1971; such service appears unlikely on a regular basis prior to 1985 and then somewhere in the microwave region . . . The first "surprise" test of the Emergency Broadcast System (EBS) was held on January 11 (see April, 1970 Pompous Predictions); more "surprises" are scheduled for the months to come.



# EIMAC's new 8877 high-mu triode delivers over 1500 watts output at 220 MHz. (2000 watts output at 30 MHz is easy)

On your right is the new, rugged, ceramic/metal 8877 high-mu power triode by EIMAC. Another state-of-the-art tube. Only three and one-half inches high, this low-profile, heavy-duty tube has a plate dissipation rating of 1500 watts, a maximum plate voltage rating of 4000 and a maximum plate current rating of one ampere. In the HF region, typically, the 8877 coasts along at a continuous duty level of 3500 watts PEP input. A peak drive signal of only 65 watts is required. This impressive power gain is achieved with 3rd order intermodulation distortion products — 38 decibels below one tone of a two equal-tone drive signal.

This magnificent power triode is rated at full input to 250 MHz. The low impedance grid structure is terminated in a contact ring about the base of the tube, permitting very effective intrastage isolation to be achieved up to the outer frequency limit of operation. The close tolerance grid, moreover, is composed of aligned, rectangular bars to achieve maximum grid dissipation and controlled transconductance. This aligned grid, plus the

EIMAC segmented, self-focusing cathode provide low grid interception and the low grid drive requirement; both of paramount importance in the VHF region. Although primarily designed for superlative linear amplifier service demanding low intermodulation distortion, the 8877's high efficiency permits effective operation as a class C power amplifier or oscillator, or as a plate modulated amplifier. The zero bias characteristic is useful for these services, as plate dissipation is held to a safe level if drive power fails, up to an anode potential of 3 kV.

The sophisticated circuit connoisseur will appreciate the many advantages of this newly developed power tube. Write for detailed information. And remember —the 8877 is another example of EIMAC's ability to provide tomorrow's power tube today. For additional information on this or other products, contact EIMAC, 301 Industrial Way, San Carlos, California 94070. Phone (415) 592-1221 (or call the nearest Varian/EIMAC Electron Tube and Device Group Sales Office.)

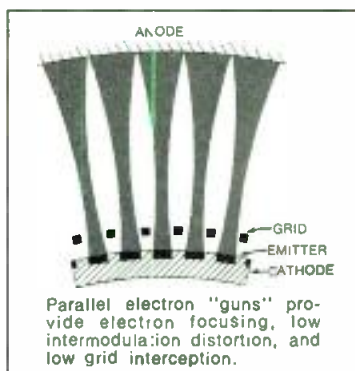
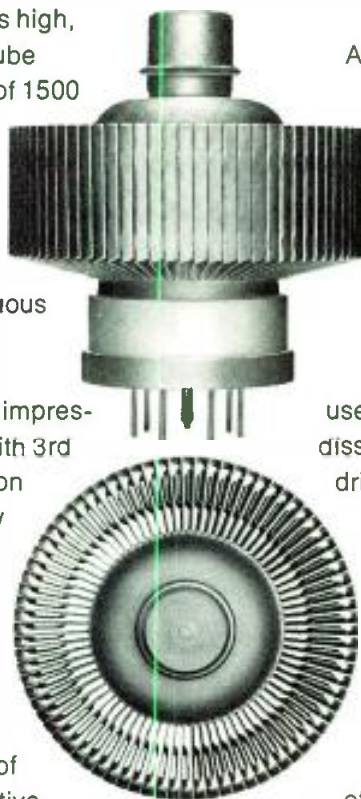

Circle Number 7 on Reader Reply Card

# REVOX

10½"  
TAPE MACHINE



STEREO  
RECORD/PLAY  
\$529.<sup>00</sup>

SOLD EXCLUSIVELY  
TO BROADCASTERS  
BY



CCA ELECTRONICS CORP.  
716 Jersey Ave., Gloucester City,  
New Jersey 08030 • (609) 456-1716

Circle Number 8 on Reader Reply Card

"INSTANT START"  
"RELIABLE"

Who can ask for  
anything more?



Outstanding for 25 yrs.



ELECTRONIC  
PRODUCTS  
FRESNO, CALIF.

A SUBSIDIARY OF  
CCA ELECTRONICS CORPORATION

Circle Number 9 on Reader Reply Card

## LETTERS TO THE EDITOR

### On Pirating Technicians

**Dear Editor:**

I think it is high time that someone called attention to a situation in the broadcast technical labor market which has been prevalent for some time and which is rapidly deteriorating.

This is the pirating of technical help from commercial stations by educational TV systems. There are many facets to the situation which place the commercial TV station at a distinct disadvantage when competing in the labor market. One of these is the fact that apparently many educational TV stations are either not operating on budgets or they have very liberal budgets. Obviously this is possible because they are not required to show a profit. Also, they are spending your money and my money (we are the taxpayers).

The net result is that they are offering salaries which are completely out of proportion with the prevailing wage scale in a given section of the country. One certainly can not blame the engineers for taking advantage of this bonanza. However, it does place the commercial station at a disadvantage. Unfortunately many government supported agencies do not worry in the slightest about good business practice. They seem to have unlimited resources in our pocket-books so why should they worry.

The ironic aspect of the whole thing is the fact that money is being poured indiscriminately into educational TV while so many of our public servants (teachers, police, etc.) are so grossly underpaid.

**George F. Sprague**  
**Chief Engineer**  
**WLOS-TV**  
**Asheville, N.C.**

**Dear George:**

For a long time now **Broadcast Engineering** has been suggesting that interested people pick up the engineering ball and run with it all the

way through conventions, station sponsored seminars and technical courses, college engineering courses, and state association monthly and annual meetings.

Some state associations have gone to considerable lengths to train and update the engineer. But this was only one major goal suggested by **BE**. Fact is, this only serves to upgrade those already in communications. Of course, it might be a positive point in recruiting new blood.

It behooves us all to look at the industry and ask ourselves, why should someone pick our medium for a life's work?

The rob from Peter to pay Paul method of grabbing off engineering talent is not even nearing its peak. Think of all the latest developments in commercial and non-commercial communications. Now, without a new supply of engineers and technicians, how will the need of growth be met?

Isn't it about time that this subject and its complexities were brought out in the open by local, state and national organizations and handled in an atmosphere that lends itself to progress. People have to be committed to it. The challenge? How will we attract new engineering talent?

**The Editor**

### FM Station Plagued By Unknown Signal

**Dear Editor:**

This is a problem we at WHCN have found occasionally, and one which has caused us much grief. Intermittently, a very strong signal completely blanks out our signal on 105.9 MHz. It consists mostly of hum, with what seems to be TV audio very faintly in the background. Upon tuning the receiver to either side of the interfering signal, the station can be picked up,

# Gates Color TV Transmitters for VHF and UHF

Featuring IF MODULATION for better hue and saturation

- FCC type approved!
- In use at commercial and government stations!
- Transmitters from 100 W to 220 kW!
- Remote control provisions built-in!
- Solid-state visual and aural exciters!
- Ceramic tetrode VHF power amplifiers!

- Five-cavity internal klystron vapor cooled UHF!
- Modulation capability to 3% with precise linearity!
- Equalization of envelope delay is continuously variable!

For additional information write Gates, Quincy, Illinois 62301.

**GATES**  
A DIVISION OF  
**HARRIS-INTERTYPE CORPORATION**

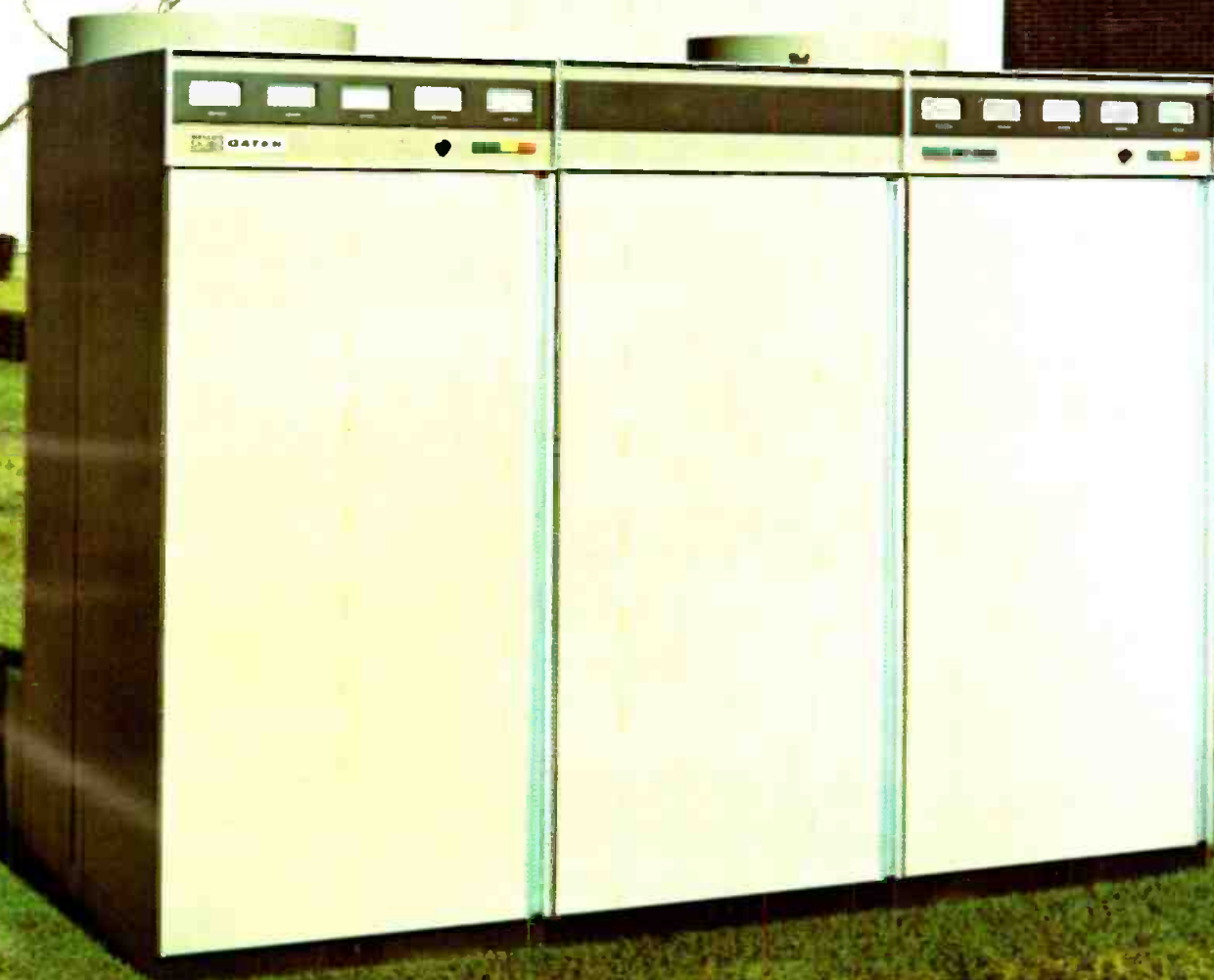

Model BT-55U provides 55 kW.

HARRIS  
INTERTYPE  
CORPORATION

**GATES**  
A DIVISION OF HARRIS-INTERTYPE

# AKG

## Where superior microphones originate.

We research and design . . . and build microphones exclusively.

Surely you will want to keep abreast of the technical developments which make AKG the leaders in microphone developments. Research and modern technology in both microphones and headphones have resulted in recent breakthroughs. Current data on products will be sent you regularly without obligation.

Register via the coupon below and receive our latest 50 pages treatise on the concept and technology of the modern cardioid dynamic microphone . . . complete with technical data. Do it today!



Yes, add my name to AKG's Professional Engineers' Mailing List. Also send me a complimentary copy of—AKG's history of the cardioid dynamic microphone.

AKG-14

NAME \_\_\_\_\_

TITLE \_\_\_\_\_

FIRM \_\_\_\_\_

ADDRESS \_\_\_\_\_

CITY \_\_\_\_\_

STATE \_\_\_\_\_ ZIP \_\_\_\_\_



**MICROPHONES • HEADPHONES**

DISTRIBUTED BY  
NORTH AMERICAN PHILIPS CORPORATION  
100 EAST 42ND STREET, NEW YORK, NEW YORK 10017

AKG CANADA • DIVISION OF DOUBLE DIAMOND ELECTRONICS • SCARBOROUGH, ONTARIO

Circle Number 11 on Reader Reply Card

but reception is very poor due to the fact that the tuner is tuned so far off frequency. Stereo, of course, is impossible under these conditions.

The first time it happened, I feared that terrible things were happening to the transmitter, and immediately called the operator to shut it down. When I arrived at the transmitter, I found that everything was in great shape, including the signal. Upon returning home, I found that the problem was: 1. confined to my locality; 2. radiating from the power lines; and 3. strongest on the power line to an apartment spotting a brand-new color TV antenna.

I've racked my brain trying to figure out what could be causing this interference. Second harmonic of the IF? No, too low. IF plus radio frequencies? No, still too low. Second harmonic of IF plus audio plus color burst? No, too high.

I'm at wit's end trying to figure this one out. If anyone has a lead on what this interference could be, I'd sure appreciate it to find out.

**Randy Mayer**  
**WHCN-FM**  
**Hartford, Conn.**

## Sightless DJ Needs Meter Reading Ideas

**Dear Editor:**

We have a sightless DJ who would like to read his own meters for remote control operation. If anyone knows of any method or equipment which would allow him to do this with an accuracy which would be acceptable to the FCC I would appreciate hearing from them.

**Jerold R. Rice**  
**WLEN-FM**  
**149½ S. Main St.**  
**Adrian, Mich. 49221**

## SCA For Cable TV: What's It Mean?

In our December, 1970 issue of **Broadcast Engineering**, the CATV editor gave some insight as to how SCA can broaden the scope of cable system services.

In the interest of keeping the record straight, it must be pointed out that the FCC definition of SCA means Subsidiary Communications Authorization. In the article (page

48), the author loosely defined SCA as "subscriber carrier authorization". There are many who use this definition, for, in fact, it does serve as a better description of what SCA actually is. However, when used in its technical sense, and in any correspondence with the FCC, the user must be aware of its strictest meaning.

Since 1950, many FM stations have found additional revenue by reaching a specialized audience. Since 1955, this technique has been known as SCA multiplexing. Without disturbing the public programming on the main channel, an SCA subchannel is additionally transmitted by the station. This SCA subchannel, which may carry background music or other special services, is then sold or leased to paying subscribers. Thus, while SCA is defined as Subsidiary Communications Authorization, it is an authorization to sell a service offered on a subchannel to subscribers.

**The Editor**

## New FCC Equipment List Is Available

The latest listing of Radio Equipment Acceptable for Licensing, dated November 16, 1970, has been issued by the Federal Communications Commission.

Copies of the list are not available from the Commission for purchase or public distribution. Copies may be bought from Keuffel & Esser Co., 1130-19th Street N. W., Washington, D.C. 20036 (Telephone FE 8-3800, area code 202). Copies are available for reference at the Commission offices at 1919 M Street N. W. in Washington, D.C. and at FCC field offices. Inquiries, other than requests for purchase of the list, may be addressed to Technical Division, Technical Standards Branch, Federal Communications Commission, Washington, D.C. 20-554 (Telephone 632-7093, area code 202).

**Buying? Looking? Selling?**  
**Try Our Classified Ads**  
**For Better Results**  
**Broadcast Engineering**

BROADCAST ENGINEERING

## Cross-Ownership

### NAB Wants CATV Ruling Deferred

The National Association of Broadcasters says radio ownership of CATV systems contributes to the public interest and the Federal Communications Commission should refrain from imposing any disruptive rules.

It said in comments filed that if the Commission feels some limitations may be needed, a decision should be deferred while the FCC considers the related question of cross-ownership of newspapers and radio stations and newspapers and CATV systems.

In any event, NAB said, a "flat prohibition" on radio-TV ownership would be inappropriate and case-by-case approach should be used in "rare instances where proscriptions might be in order."

The Association said it is "firmly opposed to prohibitions on cross-ownership of broadcast and CATV facilities in the same area," and feels any Commission moves in this direction would be "premature" before the future role of CATV is firmly established.

Noting FCC's requirement for program originations by most CATV systems as a means of providing more diversity, NAB said:

"It is clear that joint ownership of CATV-radio facilities contributes to the public interest and should not be disrupted by proscriptive rules . . .

"Radio stations which own CATV can facilitate local program origination through the shared use of studios, personnel, equipment and, most importantly, the basic programming 'know-how' which the radio operator can impart. . .

"Any move to exclude radio stations from present or potential ownership of local CATV systems would fly in the face of the Commission's aim to foster CATV originations as additional outlets for local expression and minority interest programming."

#### CATV Franchise Fee

Meanwhile the NAB has urged the Federal Communications Commission to abandon its proposal to limit local franchise fees for CATV systems to no more than two percent of gross revenues.

It said that the proposal is "an unsubstantiated intrusion" into the exclusive province of local franchising authorities and "a complete usurption of the local government's discretion to determine what is a fair and equitable franchise fee."

NAB said, in general, it favors a Commission proposal for shared regulation of CATV systems by federal and local governments with federal regulations for some aspects and

local regulations under prescribed standards in others. However, it said, local authorities should not be precluded from adopting additional standards that do not conflict with federal regulations.

"Matters such as distant signal importation," it said, "inherently require national uniformity and Commission action in such areas must be regarded as preemptive. . .

"But those areas of local concern, such as technical criteria, rates, repair services, etc., do not necessarily require national uniformity and only where there is actual conflict with federal standards should the state or local body be precluded from imposing additional requirements."

### May Is National Radio Month

The National Association of Broadcasters announced the selection of the slogan "Radio . . . The Greatest Sound On Earth!" as the 1971 National Radio Month theme, May 1-31.

Don C. Dailey, vice president and general manager, KGBX, Springfield Mo., chairman, NAB Public Relations Committee, said the theme was chosen because "it reflects the ever-widening range of radio's program fare—both AM and FM—and suggests the reason for radio's increasing popularity.

"Radio begins its sixth decade of service. It can be the beginning of a new and exciting 'golden age.' National Radio Month promotions in 1971 will reflect this enthusiasm and relate to the expanded role radio will play in American life," he said.

National Radio Month is an annual, month-long event designed to acquaint the public at local stations throughout the country with the many and varied services radio provides. The observance is sponsored jointly by NAB, its nationwide radio membership and the four national radio networks.

In announcing plans for the 1971 promotion, John M. Couric, NAB vice president for public relations, attributed radio's "consistent appeal and widespread public acceptance" to the medium's "ubiquity, convenience and personalized character."

Couric said that a special promotional packet for use by stations and networks during the observance is now being produced by NAB. Musical jingles depicting the slogan have been created by Scott-Textor Productions, New York, N.Y., and recorded earlier this month for inclusion in the kit. The jingles will be made available to NAB radio members in both monophonic and stereophonic recordings. Distribution of the kit is slated for mid-March, 1971.

Designation of May as "National Radio Month" predates World War II. Recent years have seen the event grow to broad, industry-wide proportions with participation by allied electronic industries, retailers, civic, fraternal, religious and governmental bodies joining the broadcasters in commemorating the event.

Spotmaster

## AD1B Audio Distribution Amplifier



The solid state AD1B distributes audio signals to five separate points within a studio system or to telephone lines. Output level controls are individually adjustable. Adding our AD1B-X channel extenders allows up to 25 channels to be accommodated, with input metering and audio monitoring for all 25 provided by the AD1B. Both units meet traditional SPOTMASTER standards of performance and reliability. Response is essentially flat from 40 to 20,000 Hz with low distortion and noise and 60 db channel isolation. Input transformers are standard; the user may specify either balanced output transformers or unbalanced emitter follower outputs. Write for details.

**BROADCAST ELECTRONICS, INC.**  
A Filmways Company  
8810 Brookville Rd., Silver Spring, Md. 20910

## RIGHT ON CUE



### ANNOUNCERS EARSET

Used by TV networks and stations for inconspicuous use on camera. Lets the announcer hear program cues while working with a live microphone.

The efficient, versatile Announcers Earset includes five snap-on attachments, clothing clip, and personal carrying pouch. Order to fit left or right ear. Volume controls optional. From \$12.46.



PRODUCTS OF SOUND RESEARCH  
**TELEX**  
COMMUNICATIONS DIVISION

9600 Aldrich Avenue South  
Minneapolis, Minnesota 55420

Circle Number 12 on Reader Reply Card

## Distant Signal Study

# Top Vision Given Extension

A petition by Top Vision Cable Company for a further extension of its temporary operating authority to carry distant signals on its CATV system at Owensboro, Kentucky, a community in Evansville, Indiana has been granted by the FCC.

In granting the extension (the fourth since the operation was authorized on August 13, 1969 (18 FCC 2d 1051 (1969))), the Commission authorized Top Vision to operate for another six months, unless renewed, provided that the system continues to provide status reports every sixty days concerning its efforts to obtain additional retransmission authority.

In its request for extension, Top Vision said there is still a need to gather information about the actual operations of a CATV system under the proposed rules. (Proposed Section 74.1107(b) to the CATV rules provides that CATV systems may import distant signals from the top TV markets if the originating stations grant retransmission authority (Docket 18397)).

Top Vision added that the Commission should encourage the system to continue because of the progress it has made in working within the framework of the Commission's proposal. Top Vision pointed out that it was beginning to negotiate fee payments with program distributors, that it has increased its subscribers from 325 to 515, and that it still presents no economic threat to the Evansville stations.

WFIE, Inc., (WFIE-TV, NBC, Channel 14) and Gilmore Broadcasting Corp. (WEHT, Channel 25) both Evansville, opposed the extension, claiming that the experiment has provided little relevant information and that the proposals to pay for retransmitted programs are not serious because of the small amount of money involved. (Based on the suggested payment of 0.7 percent of a system's annual subscription revenue for each distant signal carried (Second Further Notice of Proposed Rule Making in Docket 18397-A) the system would pay \$0.462 per

subscriber per year for each distant signal.)

Citing its decision of June 29, 1970 (when the Top Vision authority was first extended for a six month period), the Commission said that at that time it recognized the limited nature of the experiment but, inasmuch as Top Vision distributors, it permitted the effort to continue for whatever information might be supplied about the operation.

The Commission said there was now no reason to change its opinion because since the last authorization Top Vision has obtained additional consents and refusals and has made an effort to implement a revenue sharing with the stations and program suppliers.

## Canadian Cable Opposes Pole Rates

The Canadian Cable Television Association has formally opposed new charges for pole rates by the New Brunswick Telephone Company. Appearing before the New Brunswick Public Utilities Commission Association general council, W. Z. Estey argued that the Commission should order New Brunswick Telephone to revert to its old pole rental charges. The company had proposed a new rate of \$6 per pole. The old rate was \$3.50 per pole. Estey pointed out that the old pole rate in Canada compares favorably with current U.S. rates. The life of a pole is about 40 years. During this time, the telephone company has no maintenance cost on the pole. If the new rates are imposed, the user may well help the telephone company recoup the entire cost of each pole rented.

---

**For more details about products in this issue use free readers service card in the back of this issue.**

---

## FCC Releases UHF-VHF Tuner Rules Bulletin

In order to inform television receiver and tuner manufacturers and other interested persons of various rulings made on "comparable tuning" rules, the FCC has approved release of an information bulletin, "Interpretations of the FCC Rules on Comparability for VHF and UHF Television Receiver Tuning."

The bulletin consists of a number of inquiries submitted to the Television Tuning Panel after the release of the rules requiring television receiver manufacturers to provide comparable systems for tuning the VHF and UHF channels on sets manufactured after July 1, 1971 (FCC 70-668, 23 FCC 2d 793, June 29, 1970) and the answers given by the Panel. The Panel was set up to advise the Commission's Chief Engineer on matters relating to the rules. Edited and condensed by the Panel, the questions and rulings are listed under general subject headings for easy reference.

Each question and answer deals with a particular aspect of the comparable tuning rules and covers such subjects as effective date, percentage computations, definition of "same basic chassis," definition of "manufacturer," basic tuning mechanism, tuning aids, tuning controls and channel read-out, certification of receivers, and identification of certified receivers.

In releasing the bulletin, the Commission pointed out that the Panel's rulings apply only to the comparable tuning rules and have no bearing on other aspects of receiver regulation such as radiation limits and filing fees. The Commission invited interested persons with further questions about the comparable tuning rules to write to Upton K. Guthery, Secretary, Television Tuning Panel. Arrangements for meetings with the Panel may be discussed with Arnold G. Skrivseth, Panel Chairman, (Telephone: 202-632-7040), the Commission said.

Copies of the bulletin may be obtained from the Office of Chief Engineer, Room 756.

now.... aerospace solid state  
technology for broadcast equipment

**Acrodyne\***  
**Translators**  
**unsurpassed**  
**for reliability**  
**and low**  
**maintenance**  
**COST**

RF components or systems off the shelf  
or customized to your requirements

\* The only translators  
carrying a 3-year guarantee



Gentlemen:

Please send details of ACRODYNE translators and capabilities in design and fabrication of broadcast RF components and systems to:

Name \_\_\_\_\_

Position \_\_\_\_\_ Affiliation \_\_\_\_\_

Address \_\_\_\_\_ Zip \_\_\_\_\_

**Acrodyne Industries, Inc.,**  
21 Commerce Drive, Montgomeryville Industrial  
Center, Montgomeryville, Pa. 18936 • 215-368-2600 • TWX 510-611-7265



Circle Number 13 on Reader Reply Card

# FCC Seeks Broadcast Help For Deaf

While profit and loss statements are still in the fire—and maybe in for an even longer look in 1971, the communications industry must still be concerned with informing the public of impending local or national emergencies. In a late December Public Notice to broadcasters the FCC directed its attention to the need of deaf persons and those with impaired hearing for information concerning their safety, as well as their need for news, information and entertainment programs. The Commission estimates the number of people with these needs to be somewhere between 8.5 to 20 million. Many of these people, it appears, live alone and may not receive important news information unless advised by neighbors or friends.

As AM and FM radio are ideally suited to bring news, informational material and entertainment to the blind, so the video segment of telecasts and ideally suited to alert, assist and entertain persons with impaired hearing. Therefore, the capability of television to present visual material should be used to its fullest extent, the FCC says, while oral announcements of news bulletins, sports scores, weather conditions, etc, are being made on a telecast that the same material be presented, when feasible, visually.

The material which persons with impaired hearing need and desire to receive via telecasts falls basically into two categories: rapid receipt of emergency information which concerns the safety of life or property; and second, the receipt of news, information and entertainment.

### **Visual Announcements**

In respect to the need for all citizens including the deaf and hard of hearing for information concerning emergency situations, FCC's convinced there can be little argument. They suggest that TV broadcasters make use of visual announcements along with oral announcements when presenting bulletins of an emergency nature, such as ap-

proaching tornadoes, windstorms, hazardous driving conditions, escaped convicts, industrial accidents, health hazards and other community dangers. These visual announcements would not only provide an alert to persons with impaired hearing, but would also emphasize the importance of the announcement to all viewers.

### **Latest Suggestions**

Leaders of the deaf and hard of hearing have made the following suggestions: In respect to news programs—that visual bulletins of the matter under discussion be presented, that weather maps have descriptive phrases placed on them and that some segment of the screen be, as far as possible, continually reserved for the presentation of the face of the announcer so as to permit lip-reading. In respect of informational programs—that such programs be presented concerning the problems of the deaf and hard of hearing. At this time we note that various educational television stations have been and are presenting courses in lip-reading. In respect to entertainment—that during sports programs the scoreboard be frequently flashed on the screen, that names of players or persons being pictured be presented in written form and that broadcasts of movies be made with subtitles when films are available with subtitles. The FCC understands that some sub-captioned Hollywood films are available from the Division of Media Services and Captioned Films of the U.S. Office of Education.

One approach to this subject which the FCC believes warrants exploration is the possibility of stations presenting material in a form especially useful to the deaf on a rotating basis. If this were done, for example, by each of the various stations in a large city for a month, it might be possible for them to do more in the way of visual presentation of value to the deaf than each station would be able to do (or justified in doing) continuously. The Commission suggests that licensees

in multi-station markets explore this possibility. The Commission does not believe that discussions and joint efforts among licensees concerning programming for the deaf, without extending into other areas of programming or commercial practices, would be subject to question under the antitrust laws.

The FCC intends for this Public Notice to alert licensees to the importance of making television a truly valuable medium for the hard of hearing, and of our concern about the matter. We will observe developments in this area in the near future, and if the situation does not develop satisfactorily it may be necessary to begin rule making looking toward the adoption of minimum requirements.

While the Commission does not specifically point to cable TV for passing news of an emergency nature, the cable industry should see this interest as another means of serving the public.

## **NAB Asks FCC To Abandon 1966 Land Mobile Line**

The National Association of Broadcasters has asked the Federal Communications Commission to abandon its 1966 proposal to reallocate land mobile radio services.

NAB said FCC rulings since that time make this proposal meaningless and, if now adopted, "would seriously impede the further development of the remote pickup broadcast service," which utilizes this portion of the spectrum.

NAB said the FCC's rulings in 1970 which authorized land mobile sharing on one and possibly two of the lower seven UHF television channels in and near 10 of the 25 largest urban areas, and the reallocation of spectrum space to land mobile communications systems and private land mobile radio systems resolve the frequency congestion problems at issue.



# It makes "file copies" of your **AUDIO** correspondence



The Tape-Athon **LOGGER** is a low cost, idiot-proof, around-the-clock tape recorder for securing permanent records of vital audio communications. Police stations use it to record every incoming phone call and all radio transmission. It performs the same type of dependable service for fire stations, broadcasters, civil disaster agencies, air traffic control centers, private security services, naval and marine stations and ships, conference and meeting centers, and wherever voice transmission records must be kept.

The **LOGGER** uses the same professional quality tape deck designed for Tape-Athon's studio recorders—with

exclusive dual capstan tape drive, automatic reversing, three-motor tape activation, and fail-safe emergency braking and change over.

Handling up to 8 separate incoming channels, and capable of recording 384 hours on a single reel, the **LOGGER** is also designed for "building block" expansion. Simply adding a second, third, or more decks onto the original permits almost unlimited recording capacity.

And where does it all start? Right there with the basic **LOGGER** shown—from \$1390.00 for 1/4 inch, single channel transport and electronics. Write for detailed description before you invest in any logging system. ▾

**Tape-Athon**®

# NAB Award To Ben Wolfe

Benjamin Wolfe, vice president for engineering, Post-Newsweek Stations, Washington, D.C., has been named by the National Association of Broadcasters to receive its annual Engineering Achievement Award.

The award, NAB's top engineering honor, will be presented at an engineering luncheon on Tuesday, Mar. 30, during the 25th annual Broadcast Engineering Conference, held in conjunction with the NAB's 49th annual Convention in Chicago.

In his Post-Newsweek position, Wolfe supervises the engineering for WTOP radio and television in Washington; WJXT-TV, Jacksonville, Fla.; WPLG, Miami, and WCKY-AM, Cincinnati, Ohio.

He started in broadcasting in 1935 as station engineer for WCBM, Baltimore, Md., and was later field engineer for the Radio-Marine Corporation of America.

Wolfe has been associated with various broadcast stations, notably as chief engineer of WJZ-TV, Baltimore, in 1949; chief engineer of

WPIX, San Francisco, Calif., and vice president for engineering for Westinghouse Broadcasting Company in 1964. He served in the



Ben Wolfe (far left) has served the industry on numerous panels. He was serving here on an IEEE symposium panel.

## *High Sensitivity* AM Modulation Monitor

For Off-Air Operation  
With Total Wireless  
AM Remote Control



FCC Type Approval 3-183

Created specially for off-air operation, the Model AMR-1 AM Modulation Monitor frees the AM broadcaster from the use of a remote modulation meter or RF amplifier. Accurate monitoring can be accomplished at any site where an unaltered signal of proper level exists — main studios, satellite studios, personal residences . . . Additionally, the AMR-1 recovers subaudible telemetry information and serves as an excellent off-air audio monitor. Contact our Marketing Department for full details.



**MOSELEY ASSOCIATES, INC.**  
SANTA BARBARA RESEARCH PARK

111 CASTILIAN DRIVE  
GOLETA, CALIFORNIA 93017  
(805) 968-9621

Circle Number 15 on Reader Reply Card

Westinghouse post until joining Post-Newsweek in Dec., 1968.

In addition to being a graduate of Capitol Radio Engineering Institute, Wolfe is largely self-taught. In 1935 he decided to read the 40 most significant books on electrical engineering; the task was completed in 13 years.

Among his many inventions, Wolfe pioneered the development of the first three-antenna tower in the world. He also holds the U.S. patents in multi-channel communications systems with anti-acoustic feedback and single carrier television multiplexed. He provided the conceptual design and specifications for a new type of television transmitter that improves color signals.

Members of the Committee are: Charles Abel, manager of engineering, KFMB-TV, San Diego, Calif., chairman; Ralph F. Batt, vice president and manager of engineering, WGN Continental Broadcasting Co., Chicago, Ill.; William J. Clark, director of engineering, RKO General, Inc., New York; James H. Hoke, vice president, Southern Broadcasting Company, Winston-Salem, N.C.; Leslie S. Learned, vice president for engineering, Mutual Broadcasting System, New York; James D. Parker, staff consultant, telecommunications, CBS Television Network, New York; Royce Laverne Pointer, director, broadcast engineering, ABC, New York; Lindsey G. Riddle, vice president, engineering, WDSU-TV, New Orleans, La.; Leonard A. Spragg, vice president for engineering, Storer Broadcasting Co., Miami Beach, Fla., and William H. Trevarthen, vice president, operations and engineering, NBC, New York.

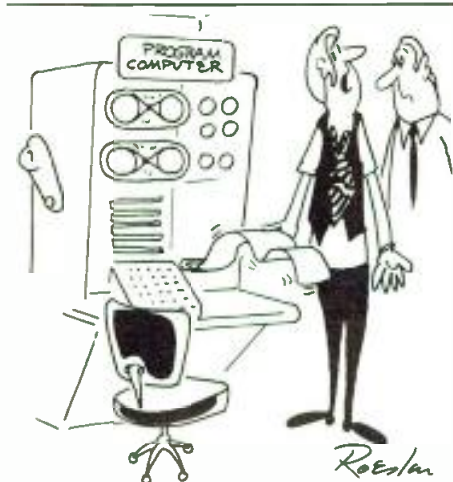

"IT CAN'T KICK THE HABIT. IT REFUSES TO WORK WITHOUT CIGARETTE COMMERCIALS!"

# If you want a tube distributor who knows your business, give it to him.



## He's your RCA Broadcast Tube Distributor. No.1 in tubes for all broadcasting applications.

What made him No. 1? Emergency service is one reason. It's like money in the bank.

For example:

You're on the air. It's late, a tube fails. You're low on replacements. Too low for comfort. So you call your RCA Broadcast Tube Distributor. To keep you on the air, he'll get out of bed to fill your order!

There are more reasons.

Experience. He talks your language, knows your needs. Some of our distributors have been in the business of supplying broadcasters for as long as we have—40 years!

Engineering service. He has a "hot line" to RCA's Field Engineers. Call him any time you need their services. Call even if you need help in servicing our competitor's equipment!

Quality. You know the story. He stocks the finest.

In power tubes, for example, brand preference studies by leading electronic publications have listed RCA as the first choice of professional designers year after year!

Inventory. The widest. Power tubes, rectifiers, vidicons, image orthicons. Think of his establishment as your tube warehouse. For all practical purposes, that's what it is!

Need more reasons? Call your local RCA Broadcast Tube Distributor. For starters, ask him for the new 1971 Guide to RCA Industrial Tube Products, or write: RCA Electronic Components, Commercial Engineering, Dept. 20B, Harrison, N. J. 07029.

P.S. Your RCA Broadcast Tube Distributor is also the man to call for RCA Starmaker Microphones.

The  
ACFOR  
Team

1971  
Guide

RCA  
Industrial Tube  
Product Guide

# RCA

## Training Programs Needed For CATV

By Leo G. Sands

BE CATV Editor And  
President of Leo G. Sands  
& Associates, New York

"Before our plane touched down, as we were returning from a CATV system turn-on, the customer had already phoned our office to say that the system was malfunctioning," the chief of a CATV installation crew said unhappily. He explained that although the customer had employed two technicians to handle maintenance, he had misgivings about their ability to keep the system operational. And apparently he was right.

The same CATV equipment manufacturer's service manager said that his company's policy was to discourage customers from attempting to make amplifier repairs. Instead, the manufacturer preferred to perform amplifier repairs at the factory and to provide an amplifier assembly exchange service.

An official of another CATV equipment manufacturer said he had two major problems—the inadequacy of customer maintenance personnel, and difficulty in finding qualified field technicians to supervise and assist customer maintenance personnel.

Obviously, the demand for qualified CATV technicians far exceeds the supply, and the demand can be expected to accelerate. Consequently, CATV operators have to settle for what's available in the way of manpower.

To cope with this problem, some equipment manufacturers operate CATV technician training schools and some also conduct on-the-road training sessions. But, to adequately train a CATV technician requires more than attendance at the usual 2-4 day roadshow session or even a

two-week course at a manufacturers plant. These sessions, however, provide indoctrination to a product line.

Homestudy courses in CATV operation and maintenance are available. Such courses can be very effective if sufficiently comprehensive and if diligently studied. But they must be accompanied or followed by on-the-job practice. Intensive classroom/laboratory training is better but more costly.

CATV operators, fortunately, can attract personnel with experience in other facets of electronics because of the glamour and growth potential of cable television. The most likely candidates include television servicemen, broadcast operators and radio amateurs, all of whom can be expected to have an understanding of electronics plus practical experience. Some can move into CATV work with a minimum of additional training. Many, however, will require considerable training.

### Who Pays The Bill

The big question is: "who pays for the training?" Many industries have been forced to establish an in-house training department and/or to contract for training of employees for new or higher-skill jobs. Some organizations encourage their employees to take homestudy courses and/or attend night schools, or to even take college courses, and

pay part or all of the tuition costs.

The CATV operator seldom employs enough personnel to warrant setting up an in-house training program. The alternative is to send technicians to a manufacturer-operated school or to roadshow training sessions, or to enroll them in a homestudy program. Another alternative is to send key technicians to a full-time school for several weeks. This is by far the most costly, but the most effective alternative.

Of course, there are people who are willing to have themselves trained, at their own expense or under the GI bill, in anticipation of being eligible for a well-paying job in a new field or advancement within the present employer's organization.

### How Much Training Is Necessary

The amount of training required to transform a person with previous electronics experience into a CATV technician depends upon the depth of his previous experience and training. It may be necessary only to provide refreshment in electronics theory and special training in CATV theory and practice. To train a recruit with no previous electronics experience could require 12-15 months full time at a technical school to become proficient as a general electronics technician, plus several weeks of specialized CATV training.

Since time is of the essence—CATV technicians are needed now—electronics technicians should be upgraded into CATV specialists as quickly as possible. This can be done by utilizing performance-oriented-training (POT) techniques. Training is concentrated on need-to-know topics and procedures.

While months could be devoted to study of relevant and irrelevant theory, (such as tube theory), results can be achieved faster by homing in on the target shown in Figure 1.

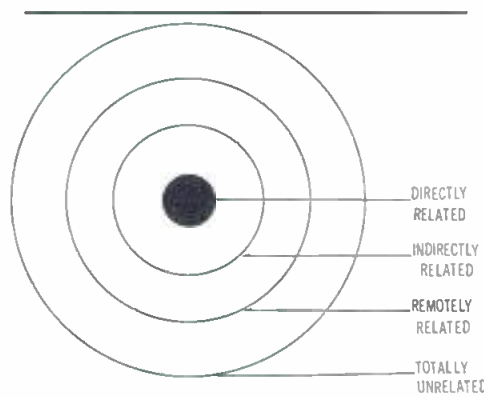

Figure 1

## All you need is a film crew of one.

Local origination is easier than you think. When you think film.

Today you can go anywhere with a light, easy-to-operate camera, a power pack, and a few rolls of film. In fact, film equipment is so portable that one person can act as a complete film crew.

Cost? Prices for 16mm cameras start under \$500. With no hidden costs like technical servicing or expensive repairs. You can start with a simple camera, and add narration after shooting. This one camera can be used for local news, commercials, and short features in black-and-white or color.

Want to know more about the possibilities of film? Talk to the people who know film best. All it takes is a call to Kodak.

### EASTMAN KODAK COMPANY

Atlanta: 404/251-6510; Chicago: 312/654-3300; Dallas: 214/351-3221;  
Hollywood: 213/464-6131; New York: 212/627-1100; San Francisco: 415/776-6055.

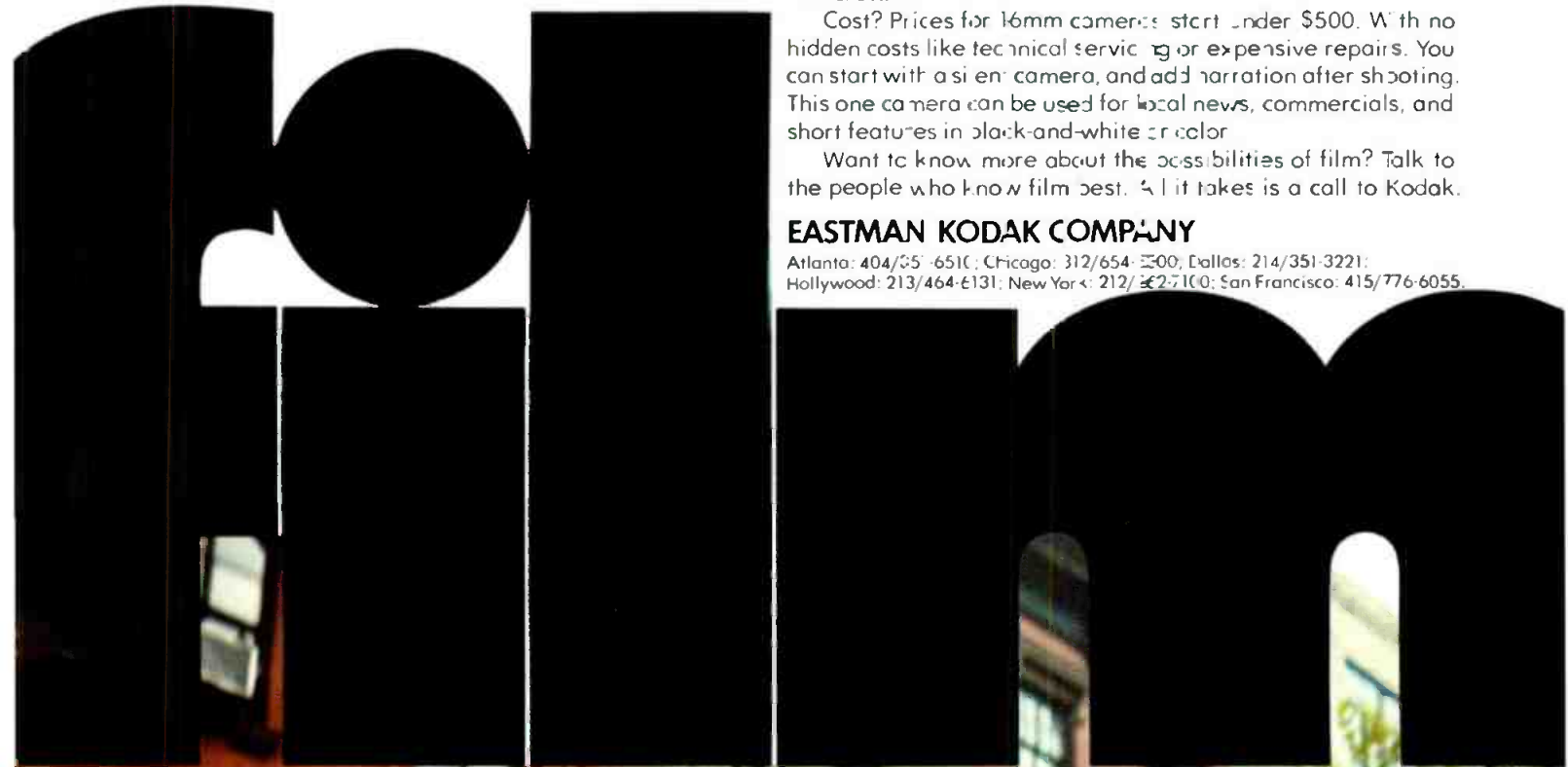

# Planned non-obsolescence.

Sylvania's CATV transmission equipment doesn't go out of date.

Its modular design makes sure of that.

You can start out with our 50-to-270 MHz wide-spectrum trunk amplifier. When required, you can add total automatic control and bridging amplifiers. An extra-service module can be added to give sub-VHF for bi-directional or long-haul low-loss transmission, band multiplexing, or fault reporting.

In addition, we've got a complete line of other distribution equipment, including a family of

line amplifiers, directional coupler multi-taps, and other outdoor passive devices.

All outdoor equipment is housed in rugged cast aluminum housings with total environmental seal and electromagnetic interference protection.

Sylvania CATV equipment has the future designed in, so you'll never have to design us out.

Sylvania Electronic Components, Seneca Falls, New York 13148.

**GTE SYLVANIA**

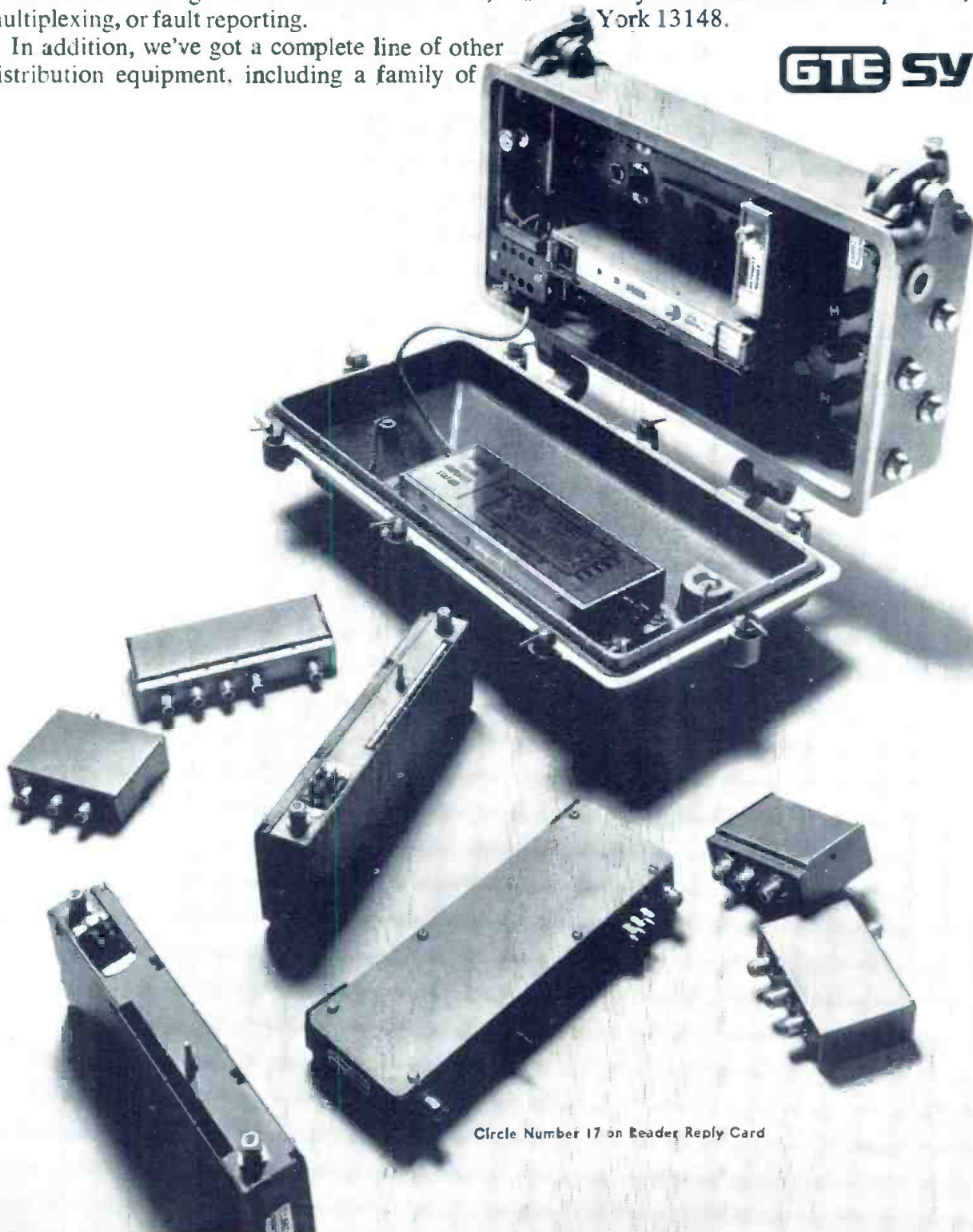

Circle Number 17 on Reader Reply Card

The training program should begin with a review of basic electronics. While some experienced technicians will scoff and say "I know it already," it has been found that the foundation must be reaffirmed. A review of basic electronics could take several weeks. But this is not necessary. The objective is not to produce a design engineer. The objective is to produce a practical CATV technician who later, on his own, may study additional theory as much as he pleases.

One of the main objectives of the review of basic electronics is to correct erroneous impressions which could lead to delay in understanding CATV equipment operation.

Except for head end equipment, most CATV equipment is designed to be almost idiot-proof. Trunk amplifiers and bridgers have test points and a minimum of controls. By following factory-prescribed procedures, adjustment and check-out should be easy. But not always. That's why adequate training is essential.

### **Training Is Essential**

Mastering the use of test equipment is mandatory. While a "wet finger voltmeter" and a tube caddy were often all that an early radio repairman required, CATV adjustment and troubleshooting requires the use of sophisticated instruments. Their use not only requires understanding of their functioning, but also extensive practice in their actual use.

While some manufacturers feel that only factory personnel should repair and tune line amplifiers, a CATV technician should know how since a replacement amplifier may not always be available. As CATV grows, the logistics of sending amplifiers to the factory and back to the system can eventually present significant problems. Also, some CATV operators may find that they have "orphan" equipment on their hands, with no factory repair service available. Then there will only be the system's technicians to repair amplifiers.

It is in the amplifier repair area that the highest skills are required, and where knowledge of the correct use of sophisticated test equipment is essential.

Training of CATV technicians

should take the future into consideration. What was standard practice a decade ago is essentially obsolete today. Training at present should cover the state of the art, but should not stop there. Additional training will be required as new equipment and techniques are adopted. Once trained in overall CATV, the knowledge of technicians can be updated by attending manufacturer-sponsored training sessions.

The basic job is now to train CATV technicians to cover all facets of their present responsibilities. This training cannot be acquired during a two-week or shorter

course.

An intensive six-week classroom/laboratory CATV course is being developed by the author and his associates for a training school in New York City. The following syllabus for a meaningful course can serve as a guide for schools and CATV operators large enough to set up their own in-house training programs. Although not indicated in the syllabus, equipment demonstrations should be conducted in the classroom, and trainees should be afforded considerable "hands-on" practice with actual CATV equipment and a working CATV system.

<b>CATV TECHNICIAN TRAINING</b>		
<b>Day</b>	<b>Morning</b>	<b>Afternoon</b>
1	Review of DC circuits	Inductance and capacitance
2	Review of AC circuits	Lab experiments with DC and AC circuits
3	Diodes and transistors	Transistor circuits and biasing
4	Power supplies	Resonance and filters
5	RF amplifiers	Oscillators and frequency converters
8	Transmission lines	VHF and UHF propagation
9	TV and FM antenna systems	Lab experiments with transmission lines
10	TV transmitters and receivers	TV transmitters and receivers
11	DC and AC measurements	Theory and use of the oscilloscope
12	RF measurements	Lab experiments with measurements
15	Sweep generators	Spectrum analyzers
16	Field strength meters	Lab experiments with RF measurements
17	CATV system principles	Head end systems
18	CATV cable plant	Line amplifiers
19	Field trip to CATV system	Field trip to CATV systems
22	Strip amplifiers	Heterodyne amplifiers
23	TV modulators	FM Modulators
24	TV demodulators	Lab experiments with head end equipment
25	Vidicon cameras	Sync generators
26	Video switchers and effects generators	Lab experiments with studio equipment
29	Trunk amplifiers	Bridgers
30	Distribution amplifiers	Line extenders and taps
31	Amplifier testing and adjustments	Lab experiments with amplifiers
32	Power supplies and inserters	Subscriber equipment
33	Logical approach to troubleshooting	Review of CATV equipment
36	CATV system alignment	Lab experiments with system alignment
37	Amplifier troubleshooting	Troubleshooting practice in lab
38	Head end troubleshooting	Troubleshooting practice in lab
39	System symptoms analysis	Lab practice in symptoms analysis
40	Cable plant maintenance	Review and examination

# EDUCATIONAL BROADCASTING

Looking Inside Non-Commercial Broadcasting

By Walter Jung

## Tracking WGBH

# Public TV Simulcasting

Some exciting things have been in progress in the audio end of the broadcasting field, happenings that are genuine technical milestones. In general what we refer to are multi-channel stereophonic audio and TV simulcasts. These have taken place on both the commercial scene and in public broadcasting, but it is right in our own backyard of public broadcasting where the more trail-blazing efforts have taken place, and continue to do so.

Historically the technical pioneer, WGBH in Boston has launched a series of large scale operatic productions for NET, as well as its own Boston Pops series. Many organizations would consider the production of such a demanding technical and artistic endeavor as an opera a large enough success in itself—WGBH produced its first NET opera in 1969. But, an opera is more of an aural experience than a visual one, and herein lay the problems. Previously used conventional recording techniques could not adequately capture the large orchestral and vocal production with adequate fidelity and the monophonic audio channel left much to be desired in the transmission process.

WGBH then literally turned its audio recording capability into a multi-channel professional studio for production of the Jack Beeson opera "My Heart's in the Highlands". The object was to record multi-track audio synchronously with the video tape recording. Subsequent editing and mixdown would result in a 2-channel stereo audio tape completely in sync with an edited video tape master. Now all of this did not come about overnight—six months of

preparation went into this opera which was presented on NET in March of last year. And the manner of presentation was another first for WGBH also—the simulcast was presented simultaneously over WGBH-TV and FM in Boston while a matched stereo pair fed WNYC-FM in New York with accompanying video fed to WNET via EEN. Since then, another opera has been presented, Mozart's "Abduction of the Seraglio" in October of 1970. Tchaikovsky's "Queen of Spades" is to be presented February 28th on NET, and the transmission should be another first if current plans mature. This one is hoped to be fed in stereo from Boston to Washington.

### Technical Highlights

Tom Keller, Director of Engineering for WGBH gave some interesting background material on what went into the first opera and what methods they continue to use in these productions.

Recording of these productions is done with a 16 track Ampex MM-1000 fed through 12 "Dolbyized" channels. An Ampex VR-2000 is used for video recording and simultaneously feeds 4 tracks of the MM-1000 sync information to be used in subsequent editing sessions. This is essential so exact frames can be matched to corresponding point in time on the audio tape during editing. From work tape to final air copy involves about a 10 to 1 reduction in time, and final tape length is a 90 minute program. So its easy to appreciate the importance of exact timing information on the master recording(s).

The final production tape is a

separate two channel audio version which must be synchronized with the video playback. The first question one might ask is why not try and put the final L & R channels on the video tape itself using the audio and cue tracks? The answer here is that neither channel offers the fidelity of performance needed, and the matching between the two (or lack of) renders them unusable for good separation at upper audio frequencies. WGBH went through a series of experiments investigating this possibility by using an L & R matrix system (L + R on audio track, L - R on cue track). Various factors led to the conclusion that it was not feasible—phase shift in the audio range above 8 KHz was intolerable even when reproduced on the same head. Since the tracks are on (or near) the edge of the tape, this also does little to help, compounding phase shift and dropout problems.

To get the performance desired, a separate "audio only" machine had to be used. This machine is slaved to the video tape by driving its capstan from the video tape control track through a resolver type phase shifter and power amplifier. This allows the audio to be phased into proper sync once the two are started, and thereafter they run synchronously, since the audio drive is derived from the video tape. This might sound a little cumbersome, but the only real problem is at start-up, and Tom Keller reports his operators have it down to less than 15 seconds, little more than a standard pre-roll.

### In The Immediate Future

Working under the support of a Ford Foundation grant, NET opera is presenting the "long haul" stereo operatic transmissions using specially ordered 15 KHz phase matched stereo audio pairs with video on the presently existing EEN TV network. The March 1970 opera was the first time this was done on an interstate basis, and future simulcasts are aimed at establishing this on a regular basis. The March broadcast utilized a stereo pair between Boston and New York as mentioned above. WGBH engineers were at both ends to ensure technical quality. This transmission also used Dolby units on both ends to boost signal to noise ratio. The resulting figures were reported to be between 60 and 70 dB,



apparently well worth the effort! A complete stereo audio transmission path could not be obtained as far south as Washington, so WETA-TV and FM used a second set of WGBH equipment on the same date to present the same simulcast in the nation's capitol.

The upcoming February 28th opera is aimed at covering all major cities on EEN in simulcast TV and FM stereo. WHYI in Philadelphia hopes to have a new FM stereo transmitter installed, enabling them to participate in the simulcast, along with WETA TV and FM. Cities where an EEN TV affiliate may not have a sister FM can carry the simulcast through a cooperative effort with a local educational FM, such as WNET-TV and WNYC-FM in New York.

#### Other Audio Activity

This NET opera series is by no means the only work going on in multi-channel audio. The rock concert "Calibration" originally presented in San Francisco via KPIX-TV and KIOI and KCBS FM will be presented over all Westinghouse owned TV stations (KPIX being the first). This is a four channel stereo audio/TV presentation. Four channel FM—only broadcasts have taken place in a number of cities involving two cooperating stations. KIOI of San Francisco has an FCC experimental authorization to conduct tests using a second subcarrier of 76 KHz during regular stereo programming to study feasibility of the 4-channel medium. It will most probably be some time before standards are evolved, but this is a healthy interest in better quality audio—more channels, both FM and TV. The above broadcasts have been well received, indicating listener interest.

Relating this to the public broadcasting field, it is most gratifying to note the contributions towards better audio which have come from the "non-commercial" broadcasters such as WGBH. There is a message here: we don't always have to be satisfied with things the way they have always been, particularly if they don't give us the quality we want. WGBH was faced with a situation of this type, and evolved a new production technique which removed previous technical limitations. A secondary message is the level of quality available to today's

broadcaster. Sixteen channel recorders and Dolby systems allow things not previously possible. In general, the audio state of the art has advanced tremendously in the last few years. Highly flexible consoles with multi-channel capability, graphic response equalizers, 80 dB S/N, distortion levels of .01 percent, noiseless non-interactive mixing—the list is quite lengthy. Techniques and equipment of 5 years ago are just not good enough in some cases today. It may be a good time to examine our systems as well as our thinking to see if they are ready for the needs of tomorrow.

#### National Public Radio

More interesting audio developments are underway as National Public Radio (NPR) readies for its April target date.

NPR is to be a hookup of approximately 100 (out of 450) educational radio stations, selected on the basis of meeting standards in technical considerations, staffing, location, etc. Quality is one of the prime goals of NPR also, both from a technical and program standpoint.

Technically, a large percentage of stereo programming is intended (over 1/2 of the stations can program stereo). Initial program service will be via tape distribution. One of the first is a 20 program series of the Los Angeles Philharmonic done by KPFF. Eventual Telco 15 KHz stereo hookups are anticipated.

The bulk of NPR will be comprised of a round-robin trunkline from the northeast through the midwest, with 28 stations along the route.

#### Standards

NAEB engineering committee chairman, F. Lee Morris, reports the formation of a standards committee concerned with the specific problems in this field. Since the specific interests within the field are varied (ITV, public TV, CCTV, etc.) initial work will be aimed at reviewing existing IEEE, SMPTE, NAB, and other standards and evaluating their relation to specific needs. Comments from professionals engaged in the above mentioned fields is solicited as necessary background to getting the program under way. Write to: F. Lee Morris, NAEB Engineering Committee Chairman, P. O. Drawer 1101, Mississippi ETV Authority, Jackson, Mississippi, 39205.

A lot of people talked about it...

We did something about it!



TOTAL ELECTRONIC TITLING CAPABILITY — TODAY

- All-around edging
- Word by word color
- Automatic centering
- Roll/crawl with pause
- Up to 800 rows of title storage
- Access time in less than 700 milliseconds
- Automatic addressing
- Automatic lower-third display

These are only a few of the many features that make the Chiron Vidiloop a total electronic titling system. The complete system is now available at the low budget price of \$16,100.00. Write for more details or call 516 249-3018 collect for a demonstration in your station.



SYSTEMS RESOURCES CORP.  
223 Newton Rd.  
Plainview, N.Y. 11803

# Putting the oscilloscope to work

By Pat Finnegan\*

The test equipment an engineer will use will often be dictated by habit as much as by the needs of required tests. Those who use a particular instrument or even a particular model, will tend to expand its use into many areas. The oscilloscope certainly falls within this cate-

\*BE Maintenance Editor and Engineering VP for WLBC, Muncie, Ind.

gory. Those who are accustomed to using the oscilloscope often (such as in video or stereo work) will tend to rely upon the scope for many areas of trouble shooting.

With a scope, one feels he can "see" into the circuit. This is not to say that many problems cannot be solved by other methods. In many cases, however, the scope will provide more definite answers. In

this article, the use of the scope in various situations will be presented, and the term "scope" will also be used instead of the full name oscilloscope.

## Waveforms

Aside from learning how to use the scope controls on a particular instrument, the most difficulty occurs in making interpretations of the waveforms displayed. Improvement here comes with practice. When in doubt, the best method to use is comparison. That is, the output waveform should appear the same as the input signal except in amplitude. For example, the output waveform of a sine wave appears to have its peaks clipped off. A quick comparison with the input signal will show that it should not be that way and severe distortion is occurring. Thus comparison can quickly point out what the waveform should appear to be when normal.

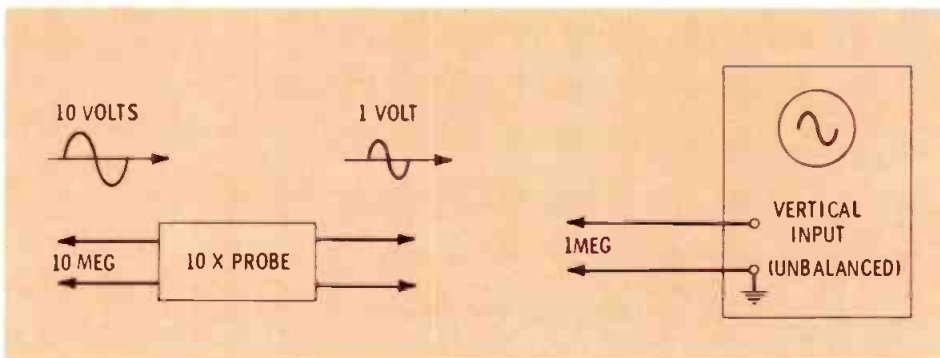

Fig. 1 The direct input impedance is 1 megohm. By the use of a 10X probe, the input impedance is 10 megohm. The input voltage to the scope is reduced by a factor of 10.

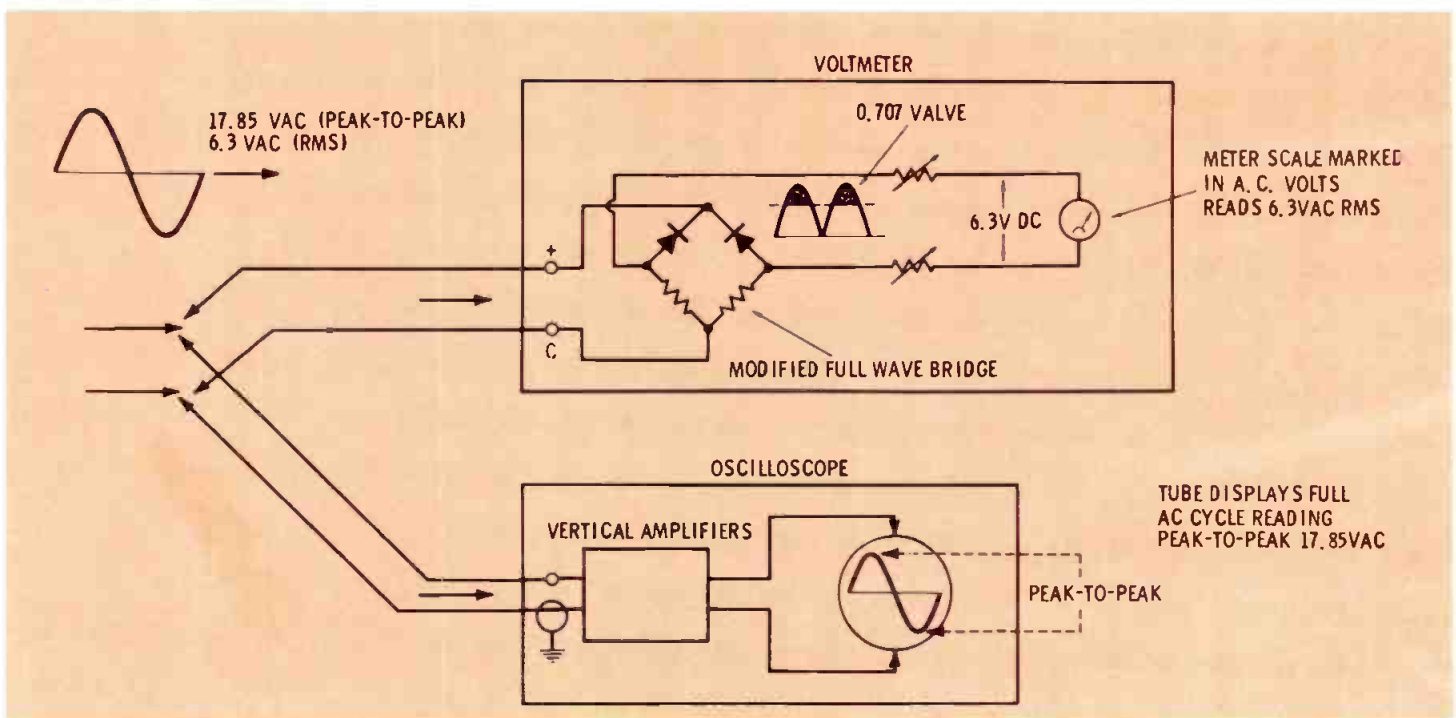

Fig. 2 The difference between reading a standard voltmeter and a scope is that the scope reads the AC voltage in peak to peak values. The voltmeter rectifies the AC voltage in a modified bridge circuit, converts it to DC equal to the RMS AC value and reads it on a DC movement meter. Of course, the scale is marked as AC.

### Scope Uses

As a signal tracer in a single unit under test, the scope is the speediest instrument available and will at the same time give many bits of useful information, such as gain or loss, waveform shape (distorted or non distorted), spurious frequencies present, hum or other noise present. As in any signal tracing technique, one must consider the circuit under test within the amplifier, as all signal voltages will not necessarily show a progressive increase from input to output. There are often stages, such as cathode or emitter followers or impedance changing devices used within the amplifier. Signal voltages at these points will be low or lower

than would be expected if conventional stages were used, so these must be considered.

The cathode or emitter follower will produce less than unity gain. Thus, if the input signal driving that stage is 5 volts, one would expect to find 4.5 to 5 volts in the output of the stage. The only time one would be concerned would be in the event the output measured only 1 volt, or a distorted waveform. Peak clipping is a common type of distortion caused by overdriven stages. The scope will quickly pinpoint the site of such clipping.

### Testing Non-Linear Circuits

Some amplifiers are designed to

especially limit the one peak, while allowing the other peak to expand in amplitude as far as it will (see Figure 3). These amplifiers are intended to prevent overmodulation of the AM carrier by the negative modulation peaks. The scope is the most accurate instrument for setting these amplifiers up.

The phasing of the wiring and especially any patchcords that may be in use following such amplifiers is most important. Improper phasing can negate the whole purpose of the amplifier by suppressing the positive modulation peak.

Besides test and set up of the audio itself, most present day scopes are capable of a vertical amplifier

### The Scope

Briefly, the scope depends on a cathode ray tube which contains a pair of vertical and a pair of horizontal electrostatic deflection plates. The signal to be displayed is fed through the appropriate amplifier stages so its voltage can be developed to a level that will give adequate deflection of the beam vertically. This is called the vertical section. So that an appropriate time base may be established, local internal oscillators and amplifiers generate a timed sweep voltage that is applied to the horizontal plates. External timing of the sweeps are also usually available. This is called the horizontal or sweep section of the scope.

### Limitations

There are limitations presented to the highest frequency that can be displayed on the tube by the bandpass of the vertical amplifiers. The bandpass of the horizontal amplifiers will limit the highest frequency of the sweep circuits. That is, the ability of the sweep circuits to strobe or stop a single cycle of the vertical input signal. Just how stationary the display will appear depends upon the stability of the sweep oscillators.

### Input Circuits

In almost every case, the input circuit of a scope is a high impedance, unbalanced input. That is, one side of the input is connected to the scope chassis. This unbalanced condition can be a contributing factor in the accuracy of the dis-

play when measuring balanced circuits (see Figure 1). Even though the input is a high impedance, there are many cases when this will still provide some circuit loading. When that happens, the 10X probe should be used to obtain a still higher impedance input, provided the measured signal is high enough and/or the scope sensitivity is adequate.

### What It Reads

The scope is a voltage measuring device. The voltage across a particular circuit is raised in the scope amplifiers to a voltage level that will provide adequate deflection of the tube beam. One must keep this in mind when investigations are conducted in high current, low voltage circuits, and especially when these circuits contain high reactive elements.

In most instances, the scope is used to observe and measure dynamic signal voltages, such as sine waves or complex audio waves (see Figure 2). The display will be indicating on a peak-to-peak basis. That is, the calibrated attenuators and the display tube is a peak-to-peak reading device. Thus, if the calibrated attenuator is set for 10 volts full scale deflection, and the display is full scale, the voltage is 10 volts peak-to-peak.

The standard voltmeter will read in RMS values of AC voltage. The peak-to-peak value is approximately 2.83 times the RMS value. Thus, if one measures the filament circuit in an amplifier with a standard voltmeter, it will indicate 6.3 volts AC

(the RMS value). Now if the scope is placed across the same circuit, it will indicate approximately 17.85 volts (peak-to-peak value). This may seem a little amazing, but look at what happens in the meter. The AC voltage is rectified so that only half of the signal is present, or a peak value of approximately 8.92 volts. The rest of the meter circuitry then reduces this to an RMS value of 6.3 volts.

Decibels can be computed from the attenuators and displays also. But, here again, the instrument is working on voltage levels and not power levels, so the voltage formula for decibels must be used. That is,  $DB = 20 \log$  base 10 of the voltage ratios. Of course, care must be exercised when comparing readings from different circuits so that the same impedance values are in use. Quite often, though, the scope is left attached to one point, perhaps the output, while adjustments are made in the amplifier or system. If the original display was set for normal level, but after equipment adjustments have been made the display is now only one half as much, the amplifier gain has dropped by 6 dB. That is, the output voltage is now only half as much as it was previously.

A standard dB meter measures power changes. In the example, while the voltage would have changed one half, the power would have changed to one fourth its original value. The regular meter would show a 6 dB change.

bandpass of at least 4.5 MHz. Standard AM RF carriers will be no higher than 1.6 MHz. Thus, the complete setup, including the RF modulation and envelope can be observed for correct action by the scope.

### Distortion and Noise Analyzers

These test instruments usually provide a scope output so that the waveforms of the signals being measured can also be observed (see Figure 4). These output circuits generally include internal amplifiers so that the voltage applied to the scope will be adequate for proper deflection. When making Proof-of-Performance measurements, the scope attached to this output can

help speed up trouble shooting of problems that might be present because it can identify what the instruments are reading.

The waveforms observed may be the harmonics remaining after the fundamental has been nulled out (hum and the character of noise that is present). As a trouble shooting device in the system when a problem is present, let's say distortion, the signal generator can be moved from point to point within the system. Once the offending unit has been passed, the distortion will disappear. When feeding the generator into various parts of the system, levels and impedances must be maintained if accurate results are to be obtained.

There is also the possibility of upsetting circuits when attempting these isolation techniques, which could be positive feedback or high hum levels. Now, if only the noise and distortion analyzer were measuring the circuit, they would indicate higher levels, but with the scope also attached, it will be quickly evident that the procedure has introduced problems which have no relationship to the original problem.

### AM Noise On FM

The usual technique for making the required Proof measurement uses a diode as a detector to rectify the FM carrier and feed its output to a precalibrated noise meter. Now, if the scope is attached to the Noise meter, the character of the measured noise can be determined easily. In most cases, this will be some type of hum originating in the various transmitter power supplies. The benefit of the scope will come into play if the measurements do not meet requirements. For example, the previous proof measured this noise level at -60 dB, but now it only measures -50 dB. While it is within legal limits, something has obviously happened to move it in the wrong direction. Observation of the scope waveform will show if the hum is 60 cycle, 120 cycle or perhaps 3 phase. Thus, it quickly points out the segment of the transmitter needing attention. Much time could be wasted checking out all the hum producing circuits in the transmitter before locating the faulty section when the specific type of hum is not known.

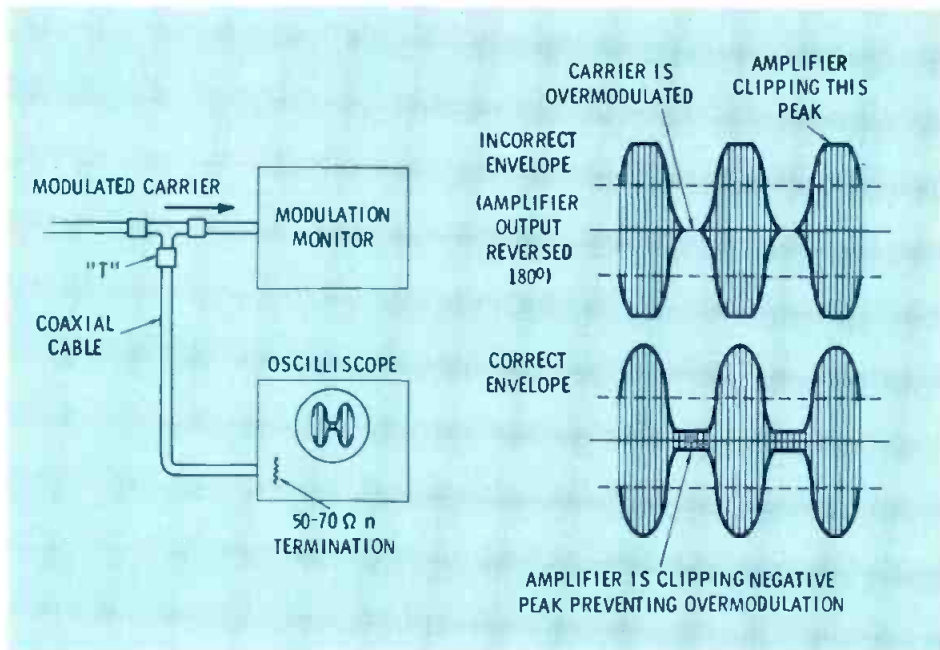

Fig. 3 Connection of the scope to check modulation envelope and correct output phasing of an amplifier designed to prevent overmodulation. Wrong output phasing can negate whole purpose of the amplifier.

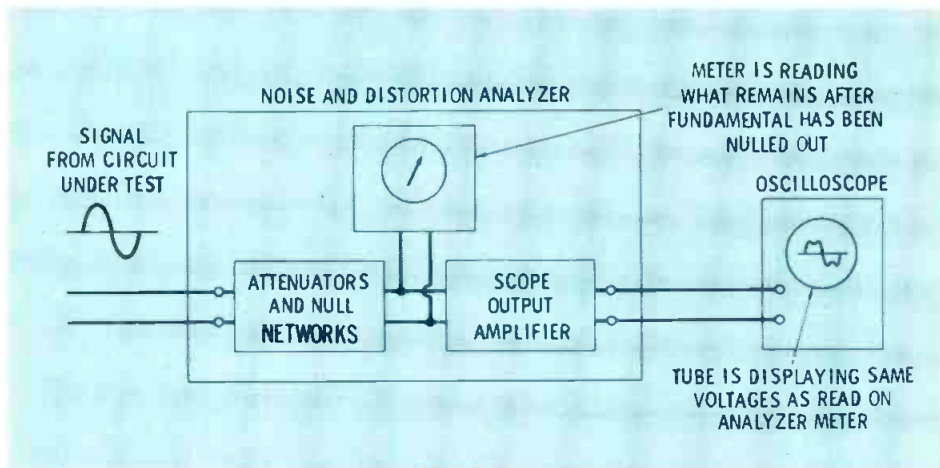

Fig. 4 Using the scope output of the noise and distortion analyzer. The same voltages being read on the meter are amplified and fed to the scope output. The scope displays the meter voltages.

### Hum & Ripple

Whether it is a power supply or other circuit under test, the scope can quickly show up hum and ripple problems on the DC buses. Being able to identify the nature of the hum is a very important aspect of scope signal tracing. On many occasions, this aspect is all that is necessary, rather than absolute signal amplitudes. That is, a go or no-go technique, is the signal present or not, is it distorted or not. The scope will quickly orient the direction the troubleshooting is to take.

Hum is a good example. An amplifier has a large level of hum in its output. Without input signal, it is observed on the scope as 60 Hz. Right away the power supply and

# HELIAX COAXIAL CABLE...

the ultimate  
in high power  
performance

3-70

The one cable that has all the advantages for transmission of high power RF. One piece connects transmitter to antenna. Eliminates the numerous flanges and bullets of rigid systems. HELIAX is easiest to plan. Easiest to install. Most reliable.

Corrugated conductors eliminate the differential expansion problems. Cable can be clamped directly to tower, buried directly in earth.

Standard types and sizes up to 8".

Communicate with Andrew.

 **ANDREW**

ANDREW CORPORATION, 10500 W. 153RD STREET, ORLAND PARK, ILLINOIS 60462, PHONE (312) 349-3300

DC Buses are eliminated as a possible source. Effort may now be made in searching for primary AC problems, such as filament to cathode leakage, pickup of primary AC from power transformer field, defective grounds, etc. Once the character of the hum has been determined, the scope probe may be moved from point to point in a signal tracing manner until the defective area is located.

### Measuring DC Voltage

Ordinarily, one does not consider setting up a scope just for the purpose of measuring DC voltages, when it is more convenient to use a regular voltmeter (see Figure 5). There are times, however, when searching a circuit with a scope, that it is desirable to know the voltage at some points in the unit. The scope will accurately measure DC voltage and in many cases, is more accurate than regular voltmeters.

The scope should be set for DC coupling. Remove the probe and short it to scope ground as a zero reference. This will provide a single dot or line if the sweeps are still running. Set this line across the bottom of the tube graticule with the vertical centering circuits. Now attach the probe to the circuit under

test. If the voltage is positive, the trace will deflect to the top of the tube. Use the vertical attenuators to keep it within the scale. Then, by the use of the deflection on the tube and the calibrated attenuators, the DC voltage can be quickly measured. When signal is present, the DC voltage can still be measured, so long as the combined AC and DC voltages do not overload the scope. Overload will produce erroneous results.

In a complex signal or sine wave, the zero axis line will be the DC level line. Use the zero axis line as was done when measuring DC without the signal present. In either case, positive voltages will deflect the trace towards the top of the tube, while negative voltages will deflect the trace towards the bottom of the tube. If it is known that the voltage will be negative, set the zero voltage line at the top of the graticule, so that the deflection towards the bottom of the scale can be measured.

Some confusion can result when the scope in use does not have enough stages in the vertical amplifier. This type scope will always invert the input signal as it is displayed. That is, if a positive pulse is applied to the input, it will dis-

play on the tube as a negative pulse. This can be very confusing, but it is quite common on many of the lower price scopes and especially in some kits.

The DC test will show up this problem if the scope in use is one that inverts the input. Measure the voltage on a regular flashlight battery. Attach the probe to the positive terminal of the battery with the negative terminal to the scope case. The trace should deflect towards the top of the tube. If it deflects towards the bottom, it is inverting the input signal. Generally, this is no problem in audio work unless one needs to check phasing in a stereo generator or other case when the phase must be known. This inversion is mostly a nuisance as the user must constantly be aware of the inversion that is taking place.

### Measuring Interference Levels

Many AM stations have their transmitter located close by. The RF carrier can find its way into low level circuits. Even high level transistor stages are not immune. In fact, many transistors become detectors when RF is present and cross talk can be introduced. The scope is capable of observing and measuring the RF signal directly. Besides RF interference, there can be spike or impulse noise generated in defective motors and similar devices. And of course, there can be plain circuit noise from defective components, such as tubes, noisy resistors and capacitors.

All these type noise problems can be measured by the scope, and the decibel value computed if the scope is sensitive enough. The amplifier or system should be set up for normal operation and a tone fed into the input of the system so that normal system peak levels can be established. The output of the system is then measured on the scope and this sets its calibration. Remove the input signal and terminate in the usual manner. Adjust the scope calibrated attenuator controls until a suitable display is present of the noise. The level of the display plus the use of the calibrated attenuator controls will give the two levels necessary for computation in the decibel formula.

### Measuring Waveforms In A High Current Circuit

Remembering that scopes are

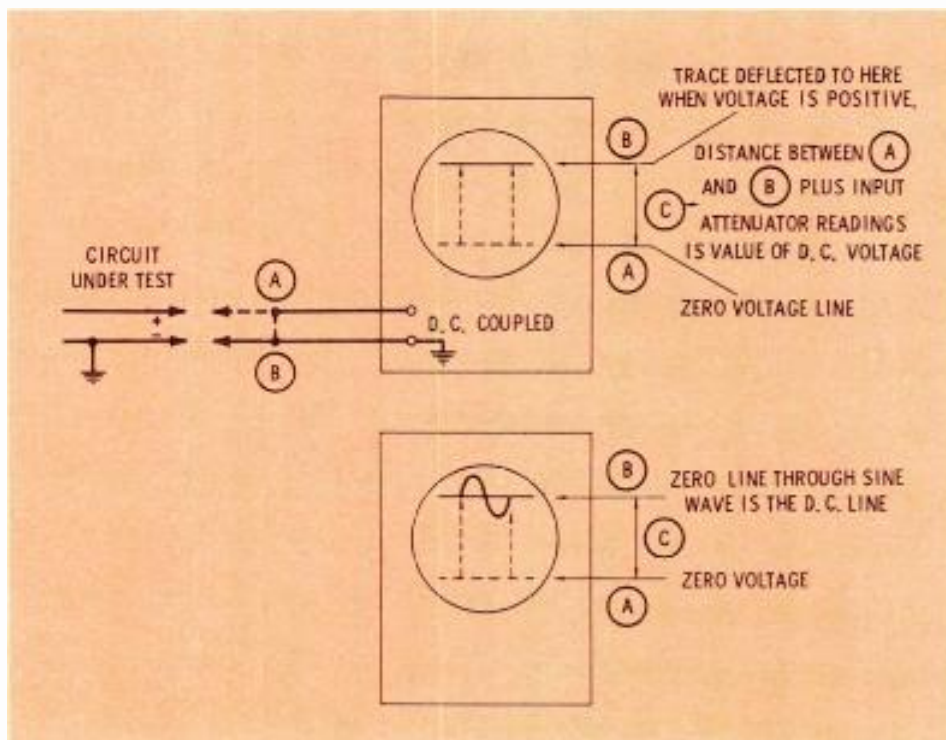

Fig. 5 Measuring DC voltage with a scope. Short the scope terminals together to give "A" the zero voltage trace. Center trace on the bottom line. Then attach scope input to circuit and trace will deflect to "B". The distance from A to B and the attenuators measure the voltage. When a signal also is present, use the zero axis through signal trace as the DC voltage line.

voltage measuring devices, it can be difficult to measure waveforms in a high current circuit, because the voltage is usually low. Such a circuit may also have highly reactive components which can give a distorted trace of the low voltage available. Quite often, the circuit can be temporarily modified slightly so that higher voltage is available for the scope to operate properly.

Add a small value resistor of one or two ohms in series with the circuit, so that all the circuit current must flow through the resistor.

Usually, a small value resistor will not upset the circuit. The voltage drop across the resistor will be in phase with the current flowing through the resistor, so there should be little voltage distortion caused by the reactive components of the circuit. The resistor, however, should be of enough power rating to carry the current or it may burn up quickly. Also, it should be a carbon or non-inductive type if reactance can upset the circuit.

There is another caution to observe. The scope is an unbalanced input, so if the circuit is balanced, care must be taken to isolate the scope chassis from the circuit ground. If the circuit is unbalanced, add the resistor in the ground return lead.

### Checking High Frequency Bias

The scope is an excellent instrument for determining the level and shape of the HF bias waveform used in audio recording. Many recorders have this signal metered, but if there is no metering available, it can be done with the scope. The bias output should be measured and adjusted for a non-distorted waveform. The 10X probe will provide the least amount of circuit loading. With the scope connected across the bias output while recording a tone, adjust the bias level control for best level of audio output and response. This figure should be preserved for future reference. It could be added to the response curve sheet when that is plotted. When later troubles develop, new measurements can be made and compared with the initial readings.

### Adjusting Bias Traps In Playback

This adjustment can be easily

made in the tape machine for maximum rejection of the bias signal that was recorded on the tape (see Figure 6). Attach the scope to the stage immediately following the bias trap and adjust for minimum bias as observed on the scope trace. A tape should be recorded without audio signal. This will cause less confusion than having two different waveforms on the scope trace at once.

### Checking Cue Tones In Cartridge Tape Equipment

Cartridge tape equipment may have up to three or more various tones recorded on the cue track. The individual tones are intended to provide switching functions inside and externally to the machine. Within the cue amplifier, these tones must be separated if they are to perform their individual functions properly. If the separation becomes inoperative, many problems can come up. For example, the tape may stop on auxiliary cue tones, and when the tape is to be played the next time, it is not cued up to its proper starting position.

The scope probe can be attached to the cue amplifier after each separating circuit and the level of tone measured there. Thus, if the 150 Hz tone is present by a large percentage in the 1 kHz cue circuit, the machine will stop when the aux. tone is present. On a normal tape, these tones are recorded only as a short burst at the place on the tape they are needed. The time may be less than one second, or so. One needs to observe the deflection on the scope quickly. Test tapes can be made up

with many bursts of the desired tones, or the recorder can be temporarily rigged so the tones will be produced continuously. A continuous tone is fine for careful observation of levels, but remember, the equipment doesn't normally operate that way. The real test comes by observing it in the normal operating manner. Sometimes, when a tone burst is recorded on the tape, a fault in the recorder may shoot a switching transient onto the tape. If this transient is large enough in amplitude and frequency, it can cause the cue circuits in the playback to operate at improper times. The scope can usually detect these transients when they occur. But the operator must observe the scope closely and quickly, as these transients are very fast and do not repeat. They flit across the scope trace and are gone. Sometimes, these transients can be much higher in amplitude than the actual cue signals.

### Summary

The scope will not solve all problems of maintenance and troubleshooting. There is still need for many other test instruments. However, when one has a good scope available and has become accustomed to its use, particularly interpreting the waveforms, he will find many other areas in which it will serve him well. The scope is unlike any other instrument. A scope user derives a certain confidence in that he feels he is not working blind. With the aid of the scope, he can "see" into the circuit under the test. ▲

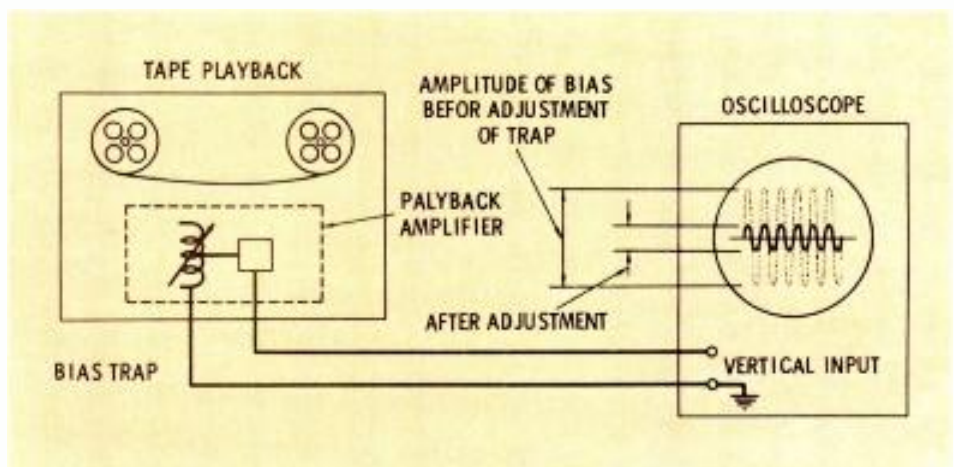
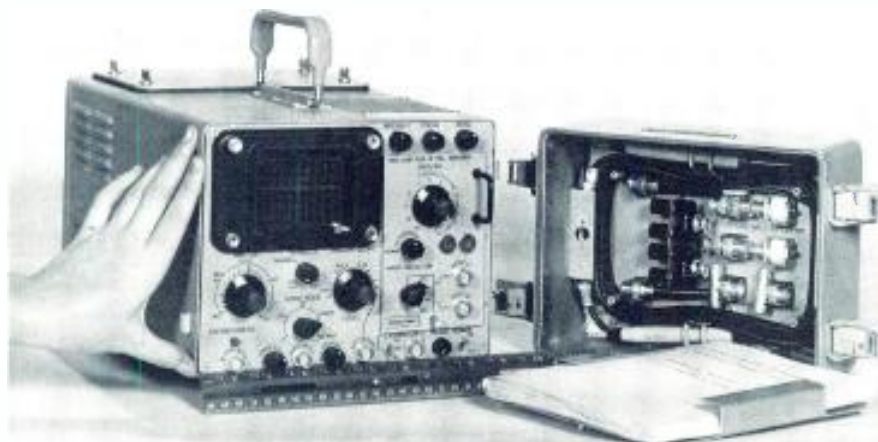

Fig. 6 Using the scope to adjust bias rejection trap in a tape playback amplifier. Scope probe should be placed as close to trap output as possible without loading. Next stage will do. The amplifier output itself can be used, but measurements will be more accurate closer to trap.

# 1971 Pro Scope Survey

A look at the trends, stats and costs of 20 scope manufacturers who answered the Broadcast Engineering survey.



General Atronics' portable, miniature scope.

Shopping for scopes today is much like shopping for a new car. There are numerous makes, a myriad of models, and a long, long list of options. And you can pay just about whatever suits your budget.

Most of us remember that our 1930 and 1940 model cars went to the junk yard when newer, fancier models with higher power and more chrome hit the show rooms. We could have driven the older cars . . . perhaps even until 1971. They were built that way. Maybe scopes will always be built that way.

Yes, the workhorse of the maintenance shop is probably one of the most dependable, long-lasting pieces of equipment at your station or operation. But you should be aware that today we have sleek models with greater range and flexibility . . . and chrome. And the multi-line scope manufacturers can offer quite a list of options that are certainly meaningful to those who need to keep pace with our "here we go again technology".

Now because the scope will last long enough to pay for itself many times over, the choice is increasingly difficult. If you make the wrong choice, you'll have to live with it a long time. The purpose of this article is to give the tech-

nician and engineer a quick survey of the latest trends and a roundup of what's available from manufacturers who answered our survey.

## Solid State

As we move more completely into solid state component usage and as we see how they affect the state-of-the-art, we will quickly realize that scopes are becoming even more important to broadcast equipment servicing. As we eliminate tubes, so the tube tester becomes less important and something, or some method, must replace it. You can't use a transistor curve tracer without a scope, and that may be one of the more important transistor testing methods of the future. What's more, the scope probably will be scheduled for even more duty when chips prevail.

As you might have guessed, the advance of solid state has marched right through the heart of scope design. Latest to join the ranks is the Heath Company, with their EU-70A. In less than a year the kit manufacturers have made major conversions to solid state within their test equipment lines.

Aside from the fact that the EN-70A is solid state . . . dual trace . . . and triggered sweep, and it includes front and rear tilt rails for

bench work or shelf installation. Then, as the options pile up, size becomes a factor.

## Case Sizes

There was a time when the case dimensions of scopes worked a hazard on bench use. They were so bulky that it was hard to move them around. Everything had to be brought right up next to the scope. And a scope that was needed for trouble shooting in some other area of the plant was tied by its sheer size and weight to the bench. Broadcasters soon learned that the best way around this problem was to mount the scope on a cart, along with a few other pieces of test gear.

The trend in solid state obviously has its implications where scope size and weight is concerned, especially in general service scopes. From Hewlett Packard and Tektronix on to the kit manufacturers, scopes may be getting a bit wider (front panel), but they also are getting shorter in case depth. This is largely due to solid state components, and the size limiting factor now becomes the CRT. Some advances have been made here, too, but not in step with circuit components.

Remember when a handle on the top of the case was sheer folly?



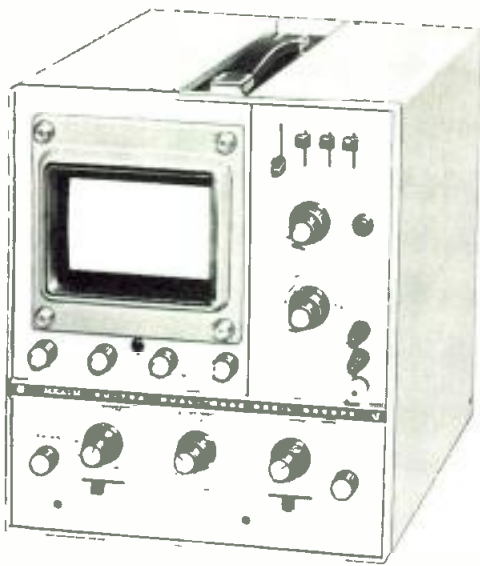

Heath's latest solid state scope features dual trace and triggered sweep.

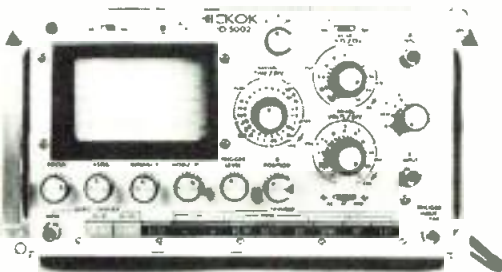

The Hickok CRO 5002 offers some new features in design.



The EICO 465 is an easy-to-build kit scope. The power supply has gone solid state, while the amplifiers are still tube-type.



The Philips PM 3250 is truly a pro scope, and note the multitude of close but easy to read controls.

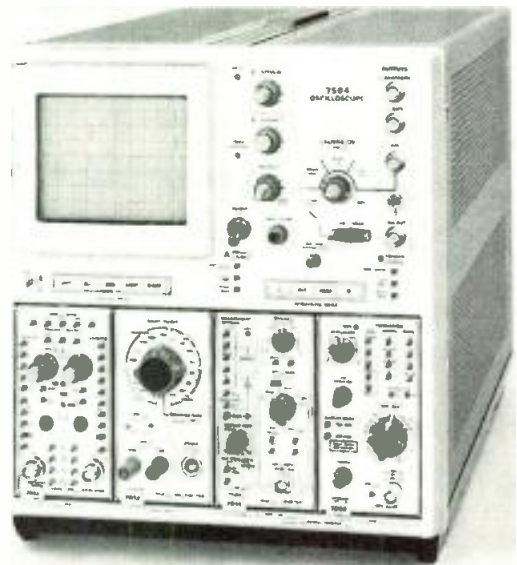

Tektronics model 7504, loaded with extras and options, just one of a long line scopes with plug-in options.

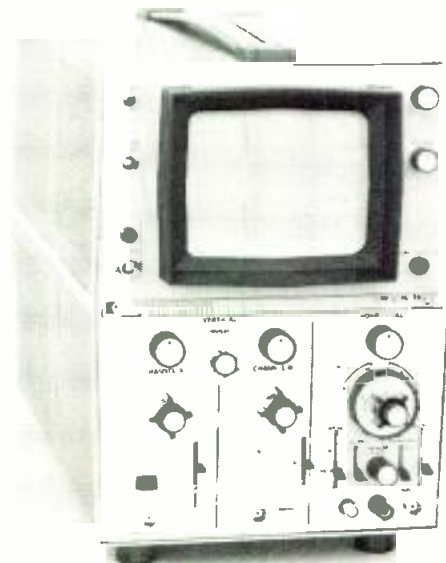

This is one of the more simple scopes by Hewlett - Packard.

Those handles were about as much use as a set of backup lights on a wheelbarrow. But not today. The solid state trend has made many models truly portable.

### Other Options

Another meaningful advance in scopes is the wider choice of dual trace models. For those who want a faster comparison of input and output signals, the dual trace scope certainly does offer an big advantage over other scopes.

Jumping into the Cadillac lines, the manufacturers are now offering an increasing list of options in plug-in modules that make the scope even more flexible. The prices are higher, but then these scopes are

precise, lab-quality units that are essential—especially where triggered sweep applications are required. At the top the options look like this: split-screen bistable storage; auto display switching; calibrated delayed sweep; designs for use in severe environments; X-Y/Y-T scopes; auto scale-factor readout; differential inputs; analog displays of analog/digital measuring systems; distributed reflection CRT; TV line and frame triggering; and even a battery powered model.

This is, by no means, the full list of options. If you're tired of fighting the limitations of your present scope, you will want to look over the scope roundup list. If one fits



Here Telequipment gets closer to the idea of a lightweight, portable pro scope.

Brand	Model #	CRT Size	Hybrid Solid State Tube	Vertical Bandwidth	Vertical Sensitivity	AC or AC-DC	Horizontal Bandwidth	Horizontal Sweep Triggered or	Frequency Range Recurrent Dual Trace	Price
B&K	1460	5"	X	DC to 10 MHz	10 mv/cm	AC/DC	DC to 800 kHz	.5 $\mu$ sec/cm to .5 sec/cm	X	389.95
EICO	427	5"	X	DC to 500 kHz	3.5 mv RMS/cm	AC	2 Hz to 450 kHz	10 Hz to 100 kHz	X	99.95 kit 139.95 wired
EICO	435	3"	X	DC to 4.5 MHz	18 mv RMS/cm	AC	1 Hz to 500 kHz	10 Hz to 100 kHz	X	119.95 kit 169.95 wired
EICO	465	5"	X	DC to 8 MHz	12 mv RMS/cm	AC	DC to 1 MHz	10 Hz to 100 kHz	X	179.95 kit 249.95 wired
EICO	460	5"	X	DC to 4.5 MHz	10 mv RMS/cm	AC	1 Hz to 400 kHz	10 Hz to 100 kHz	X	99.95 kit 149.95 wired
General Atronics	K106	4"	X	DC to 6 MHz	10 mv/cm	AC	.5 MHz	.1 $\mu$ sec to .1 sec	X	1620.00
Heathkit	IO14	5"	X	DC to 8 MHz	.05 v/cm	AC/DC	200 kHz	.2 $\mu$ sec/cm to .5 sec	X	275.00 kit
Heathkit	IO17	3"	X	DC to 5 MHz	.03 v/div	AC	300 kHz	20 Hz to 200 kHz	X	79.95 kit
Heathkit	EU70A	5"	X	DC to 15 MHz	.05 v/cm	AC/DC	100 kHz	.2 $\mu$ sec/cm to 500 $\mu$ sec/cm	X	X 595.00 wired
Hickok	5002	3"		DC to 25 MHz	10 mv/cm to 20 v/div	AC/DC	DC to 5 MHz	50 nsec to 2 sec/div	X X	995.00
Hewlett Packard	120B	5"	X	DC to 45 kHz	100 v/cm	AC/DC	DC to 450 kHz	5 $\mu$ sec/cm to .5 sec/cm	X X	585.00
Hewlett Packard	132A	5"	X	DC to 500 kHz	100 $\mu$ v/cm to 50 v/cm	AC/DC	DC to 500 kHz	1 $\mu$ sec/cm to 12.5 sec/cm	X X X	1475.00
Hewlett Packard	1200A/B	8 cm x 10 cm	X	DC to 500 kHz	100 $\mu$ v/div to 50 v/div	AC/DC	DC to 1 MHz	1 $\mu$ sec/div to 12.5 sec/div	X X X	1050.00
Hewlett Packard	1201A/B	Storage CRT	X	DC to 500 kHz	100 mv/div to 50 v/div	AC/DC	DC to 1 MHz	1 $\mu$ sec/div to 12.5 sec/div	X X X	1900.00
Hewlett Packard	1202A/B	8 cm x 10 cm	X	DC to 500 kHz	100 $\mu$ v/div to 50 v/div	AC/DC	DC to 1 MHz	1 $\mu$ sec/div to 12.5 sec/div	X X	790.00

your needs and you want further information, we suggest you write to the manufacturer at the address given at the bottom of the scope list.

Meanwhile, if you would like to read up on scopes and get more ideas on how to use them, we suggest the books listed below for selected reading:

"Know Your Oscilloscope" by Paul C. Smith, order number 20549; Howard W. Sams & Co., 4300 West 62nd St., Indianapolis, Ind. 46206.

"Scope Waveform Analysis" by

Robert G. Middleton, order number SWM-1; Howard W. Sams & Co.

"Trouble Shooting With The Oscilloscope" by R. G. Middleton, order number 20550; Howard W. Sams & Co.

"Using And Understanding Probes" by Rudolf F. Graf, order number PRG-1; Howard W. Sams & Co.

"101 Ways To Use Your Oscilloscope" by R. G. Middleton, order number 20416; Howard W. Sams & Co.



Leader's LBO-501 triggered sweep offers a large CRT and easy to use controls.

Brand	Model #	CRT Size	Hybrid Solid State Tube	Vertical Bandwidth	Vertical Sensitivity	AC or AC-DC	Horizontal Bandwidth	Horizontal Sweep Frequency Range	Triggered or Recurrent Dual Trace	Price
Hewlett Packard	1205A/B	8 cm x 10 cm	X	DC to 500 kHz	5 mv/div to 50 v/div	AC/DC	DC to 1 MHz	1 $\mu$ sec/div to 12.5 sec/div	X X X	895.00
Hewlett Packard	1206A/B	8 cm x 10 cm	X	DC to 500 kHz	5 mv/div to 50 v/div	AC/DC	DC to 1 MHz	1 $\mu$ sec/div to 12.5 sec/div	X X	715.00
Hewlett Packard	1207A/B	Storage CRT	X	DC to 500 kHz	5 mv/div to 50 v/div	AC/DC	DC to 1 MHz	1 $\mu$ sec/div to 12.5 sec/div	X X	1550.00
Hewlett Packard	1208A/B	8 cm x 10 cm x-y display	X	DC to 600 kHz	<0.1 v/div to >1 v/div	AC/DC	DC to 600 kHz	x-y display		540.00
Hewlett Packard	1208B	Storage CRT	X	DC to 600 kHz	<0.1 v/div to >1 v/div	AC/DC	DC to 600 kHz	x-y display		1450.00
Hewlett Packard	1215A/B	8 cm x 10 cm	X	DC to 7 MHz	5 mv/div to 50 v/div	AC/DC	DC to 7 MHz	1 $\mu$ sec/div to 12.5 sec/div	X X	950.00
Hewlett Packard	1217A/B	8 cm x 10 cm	X	DC to 7 MHz	5 mv/div to 50 v/div	AC/DC	DC to 7 MHz	1 $\mu$ sec/div to 12.5 sec/div	X X X	1175.00
Hewlett Packard	1300A	x-y display	X	DC to 20 MHz	0.1 v/in	AC/DC	DC to 20 MHz	x-y display		2000.00
Hewlett Packard	1331A 1331C	x-y display	X	DC to 1 MHz	1 v/8 div	DC	DC to 1 MHz	x-y display		1575.00
Hewlett Packard	1330A	x-y display	X	DC to 1 MHz	1 v/8 div	DC	DC to 1 MHz	x-y display		800.00
Jackson	CRO-3	5"	X	5 MHz	4.6 mv	AC	5Hz	5 Hz	X	254.95
Kikusui	539A	3"	X	5Hz - 700 kHz	1v/cm	AC	2 Hz to 500 kHz	10 kHz to 100 kHz	X	130.00
Kikusui	536A	3"	X	DC to 15 MHz	20 mv/cm	AC	2Hz to 500 kHz	10 kHz to 100 kHz	X	167.00
Kikusui	556A	5"	X	DC to 1.5 MHz	20 mv/cm	AC	2Hz to 400 kHz	10 kHz to 100 kHz	X	239.00
Kikusui	557A	5"	X	DC to 5 MHz	20 mv/cm	AC	2 Hz to 500 kHz	10 kHz to 100 kHz	X	249.00
Kikusui	555	5"	X	DC to 10 MHz	20 mv/cm	AC	2 Hz to 200 kHz	1 $\mu$ sec to 1 sec/cm	X	346.00

Brand	Model #	CRT Size	Hybrid Solid State Tube	Vertical Bandwidth	Vertical Sensitivity	AC or AC-DC	Horizontal Bandwidth	Horizontal Sweep Frequency Range	Triggered or Recurrent Dual Trace	Price
Kikusui	555G	5"	X	DC to 10 MHz	20 mv/cm	AC	2 Hz to 200 kHz	1 $\mu$ sec to 1 sec/cm	X	349.00
Kikusui	553	5"	X	DC to 10 MHz	10 mv/cm	AC	2 Hz to 200 kHz	1 $\mu$ sec to 1 sec/cm	X	538.00
Kikusui	572	7"	X	DC to 600 kHz	20 mv/cm	AC	DC to 600 kHz	1 Hz to 100 kHz	X	589.00
Kikusui	573	7"	X	DC to 200 kHz	1 mv/cm	AC	DC to 200 kHz		X	410.00
Kikusui	5121	12"	X	DC to 10 kHz	5 mv/cm	AC	DC to 1 kHz	Line sweep	X	580.00
Kikusui	5122	12"	X	DC to 10 kHz	5 mv/cm	AC	DC to 1 kHz	Line sweep	X	798.00
Kikusui	568	5"	X	DC to 25 MHz	5 mv/cm	AC	2 Hz to 200 kHz	0.1 $\mu$ sec to 5 sec/cm	X	1298.00
Leader	LBO-501	5"	X	DC to 10 MHz	20 mVp-p	AC	2 Hz to 200 kHz	1 $\mu$ sec/cm to 0.2 sec/cm	X	339.50
Leader	LBO-53B	5"	X	DC to 10 MHz	10 mVp-p	AC	DC to 500 kHz	1 Hz to 200 kHz	X	229.00
Leader	LBO-32B	3"	X	DC to 5 MHz	10 mVp-p	AC	DC to 400 kHz	1 Hz to 200 kHz	X	189.50
Leader	LBO-31M	3"	X	3 Hz to 1 MHz	80 mVp-p	AC	3 Hz to 400 kHz	10 Hz to 100 kHz	X	99.00
Lectrotec Inc.	TO-50	5"	X	DC to 10 MHz	.02 v/cm	AC/DC	DC to 0.5 MHz	0.1 sec to 0.02 $\mu$ sec	X	339.50
Mercury	3000	5"	X	5 MHz	4.6 mv to 10v	AC	5 Hz	5 Hz	X	199.95
Millen	90905	5"		rack scope		AC	rack scope			163.90
Millen	90905-B	5"		rack scope		AC	rack scope			204.00
Millen	90923	3 x 1 1/2"	X	DC to 275 kHz	0.43 v P-p/cm	DC	DC to 250 kHz	2 Hz to 30 kHz	X	322.00
Millen	90925	4 5/8 x 2 5/8	X	DC to 550 kHz	0.16 v P-p/cm	DC	DC to 550 kHz	2 Hz to 30 kHz	X	393.30
Millen	90954	3 1/2 x 3 1/2"	X	DC to 1 MHz	0.1 v P-p/cm	AC/DC	DC to 1 MHz	1 Hz to 30 kHz	X X	655.50
Philips	PM3200	4"	X	DC to 10 MHz	2 mv/div	AC/DC	DC to 100 kHz	100 nsec to .5 sec/div	X X	495.00
Philips	PM3230		X	DC to 10 MHz	20 mv/div	AC/DC	DC to 1 MHz	100 nsec to .5 sec/div	X X	795.00
Philips	PM3231	8 x 10 div	X	DC to 15 MHz AC 2Hz to 15 MHz	10 mv/div	AC/DC	DC to 2 MHz	40 nsec to .5 sec/div	X X	1050.00
Philips	PM3250	8 x 10 cm	X	DC to 50 MHz or 5 MHz	2 mv/div	AC/DC	DC to 5 MHz	10 nsec to 5 sec/div	X X	1995.00
Phillps	PM3370	6 x 10 cm		DC to 150 MHz	1 mv/cm	AC/DC	DC to 1 MHz	50 nsec to 1 sec/cm	X X	

Brand	Model #	CRT Size	Hybrid Solid State Tube	Vertical Bandwidth	Vertical Sensitivity	AC or AC-DC	Horizontal Bandwidth	Horizontal Sweep Frequency Range	Triggered or Recurrent Dual Trace	Price
Philips	PM3400	8 x 10 cm	X	DC to 2 GHz	1 mv/div	AC/DC	Sampling scope	10 ps to 20 $\mu$ sec/div	X X	2725.00
PSC	30	3"	X	DC to 200 kHz	10 mv p-p	AC/DC	DC to 200 kHz	20 Hz to 20 kHz	X	179.50
PSC	325	3"	X	DC to 200 kHz	10 mv p-p	AC/DC	DC to 200 kHz	20 Hz to 20 kHz	X	249.00
PSC	525	5"	X	DC to 200 kHz	10 mv p-p	AC/DC	DC to 200 kHz	20 Hz to 20 kHz	X	365.00
RCA	WO-33A	3"	X	DC to 5.5 Hz to 5.5 MHz	3 RMS mv/in	AC	DC to 3.5 Hz to 350 kHz	75 kHz	X	180.00
RCA	WO-505A	5"	X	DC to 5 MHz $\pm$ 1 dB	15 mv p-p/in	AC/DC	DC to 3.5 Hz to 2 MHz	10 Hz to 1 MHz	X	298.50
Sencore	PS148	5"	X	10 Hz to 5.2 MHz	.017 v RMS/in	AC	DC to 5 Hz to 400 kHz	5 Hz to 500 kHz	X	269.50
Tektronix	544	6 x 10 cm	X	DC to 50 MHz	depends on plug-in	AC	DC to 400 kHz	10 nsec/div to 5 sec/div	X	1625.00
Tektronix	546	6 x 10 cm	X	DC to 50 MHz	depends on plug-in	AC	DC to 400 kHz	10 nsec/div to 5 sec/div	X	1825.00
Tektronix	547	6 x 10 cm	X	DC to 50 MHz	depends on plug-in	AC	DC to 400 kHz	10 nsec/div to 5 sec/div	X	1950.00
Tektronix	545B	6 x 10 cm	X	DC to 33 MHz	depends on plug-in	AC	DC to 350 kHz	20 nsec/div to 5 sec/div	X	1700.00
Tektronix	549	6 x 10 cm	X	DC to 30 MHz	depends on plug-in	AC	DC to 350 kHz	20 nsec/div to 5 sec/div	X	2625.00
Tektronix	556	8 x 10 cm	X	DC to 50 MHz	depends on plug-in	AC	DC to 400 kHz	10 nsec/div to 5 sec/div	X X	3700.00
Tektronix	647A	6 x 10 cm	X	DC to 100 MHz	depends on plug-in	AC	depends on plug-in	10 nsec/div to 5 sec/div	X	1725.00
Tektronix	502A	8 x 10 cm	X	DC to 1 MHz	100 $\mu$ v/div @ 100 kHz	AC	DC to 100 kHz	50 nsec/div to 5 sec/div	X X	1265.00
Tektronix	503	8 x 10 cm	X	DC to 450 kHz	1 mv/div	AC	DC to 450 kHz	0.1 $\mu$ sec/div to 5 sec/div	X	695.00
Tektronix	504	8 x 10 cm	X	DC to 450 kHz	5 mv/div	AC	DC to 100 kHz	1 $\mu$ sec/div to 5 sec/div	X	595.00
Tektronix	515A	6 x 10 cm	X	DC to 15 MHz	50 mv/div	AC	DC to 500 kHz	40 nsec/div to 2 sec/div	X	1050.00
Tektronix	516	6 x 10 cm	X	DC to 1 MHz	50 mv/div	AC	DC to 500 kHz	40 nsec/div to 2 sec/div	X	1275.00
Tektronix	5030	8 x 10 div @ 1.27 cm/div	X	DC to 15 MHz	10 $\mu$ v/div or 1 ma/div	AC	DC to 1 MHz	1 $\mu$ sec/div to 5 sec/div	X	1850.00
Tektronix	5031	8 x 10 div @ 1.22 cm/div	X	DC to 1 MHz	10 $\mu$ v/div or 1 ma/div	AC	DC to 1 MHz	1 $\mu$ sec/div to 5 sec/div	X	2500.00
Tektronix	321A	6 x 10 div 0.25 in/div	X	DC to 6 MHz	10 mv/div	AC/DC	DC to 1 MHz	0.1 $\mu$ sec/div to 0.5 sec/div	X	1045.00

Brand	Model #	CRT Size	Hybrid Solid State Tube	Vertical Bandwidth	Vertical Sensitivity	AC or AC-DC	Horizontal Bandwidth	Horizontal Sweep Frequency Range	Triggered or Recurrent Dual Trace	Price
Tektronix	323	6 x 10 div @ 0.25 in/div	X	DC to 4 MHz	10 mv/div	AC/DC	DC to 10 kHz	0.5 $\mu$ sec/div to 1 sec/div	X	960.00
Tektronix	422	8 x 10 div @ 0.8 cm/div	X	DC to 15 MHz	10 mv/div	AC/DC	DC to 500 kHz	50 nsec/div to 0.5 sec/div	X X	1500.00
Tektronix	453	6 x 10 div @ 0.8 cm/div	X	DC to 50 MHz	5 mv/div	AC	DC to 5 MHz	10 nsec/div to 5 sec/div	X X	2050.00
Tektronix	454	6 x 10 div @ 0.8 cm/div	X	DC to 150 MHz	5 mv/div	AC	DC to 2 MHz	5 nsec/div to 5 sec/div	X	2925.00
Tektronix	7704	8 x 10 cm	X	DC to 150 MHz	5 mv/div	AC	DC to 3 MHz	2 nsec/div to 5 sec/div	X	2500.00
Tektronix	7514	8 x 10 cm	X	DC to 90 MHz	5 mv/div	AC	DC to 2 MHz	5 nsec/div to 5 sec/div	X	3200.00
Tektronix	7504	8 x 10 cm	X	DC to 90 MHz	5 mv/div	AC	DC to 2 MHz	5 nsec/div to 5 sec/div	X	2000.00
Tektronix	7503	8 x 10 cm	X	DC to 90 MHz	5 mv/div	AC	DC to 2 MHz	5 nsec/div to 5 sec/div	X	1375.00
Tektronix	565	10 x 10 cm	X	depends on plug-in	depends on plug-in	AC	DC to 350 kHz	50 nsec/div to 5 sec/div	X X	1675.00
Tektronix	564B	8 x 10 cm	X	depends on plug-in	depends on plug-in	AC	depends on plug-in	50 nsec/div to 5 sec/div	X	1095.00
Tektronix	561B	8 x 10 cm	X	depends on plug-in	depends on plug-in	AC	depends on plug-in	50 nsec/div to 5 sec/div	X	595.00
Tektronix	568	8 x 10 cm	X	depends on plug-in	depends on plug-in	AC	depends on plug-in	depends on plug-in	X	1025.00
Tektronix	519	2 x 6 cm	X	DC to 1 GHz	10 v/cm	AC		2 nsec/cm to 1 $\mu$ sec/cm	X	4650.00
Telequipment	S51B	8 x 10 cm	X	DC to 3 MHz	100 mv/div	AC	DC to 500 kHz	1 $\mu$ sec/div to 100 ms/div	X	245.00
Telequipment	S52	10 x 10 cm	X	DC to 3 MHz	100 mv/div @ 1 MHz	AC	DC to 3 MHz	1 $\mu$ sec/div to 0.5 sec/div	X	550.00
Telequipment	S54A	6 x 10 cm	X	DC to 10 MHz	10 mv/div	AC	DC to 1 MHz	0.2 $\mu$ sec/div to 2 sec/div	X	450.00
Telequipment	D54	6 x 10 cm	X	DC to 10 MHz	10 mv/div	AC	DC to 1 MHz	0.2 $\mu$ sec/div to 2 sec/div	X X	595.00
Telequipment	S54U	6 x 10 cm	X	DC to 10 MHz	10 mv/div	AC/DC	DC to 1 MHz	0.2 $\mu$ sec/div to 2 sec/div	X	715.00
Telequipment	D51	6 x 10 cm	X	DC to 6 MHz	10 mv/div @ 2 MHz	AC	DC to 500 kHz	1 $\mu$ sec/div to 100 ms/div	X	375.00
Telequipment	D52	6 x 10 cm	X	DC to 6 MHz	10 mv/div @ 1 MHz	AC	10 Hz to 400 kHz	1 $\mu$ sec/div to 0.5 sec/div	X X	525.00
Telequipment	S43	5x 8 cm	X	DC to 25 MHz	depends on plug-in	AC	depends on plug-in	depends on plug-in	X	350.00

# DITCH WITCH '71... THE NEW V30C "COMBO"

Revolutionary design  
performs  
five operations  
without changing  
attachments



**THE NEW DITCH WITCH V30C "COMBO"** will trench, back-fill, backhoe, do vibratory plowing and horizontal boring operations without changing attachments! You have the capability of all five operations with one basic machine. No other trencher on the market can offer all these combined features. Digging chain and vibratory plow are mounted at the rear of the machine; backhoe, backfill blade and boring unit are mounted at the front. The operator instantly can select the required job function. This 30-HP model offers all this, plus the proven Ditch Witch design advantages of hydraulic travel speed independent of mechanically-selective digging chain speeds, four-wheel drive, directional power steering and unmatched operator convenience and safety. Trench to depths of 42" at 6" widths; plow in material to diameters of 1 1/4" to depths of 24".



## The Professionals

A Division of Charles Machine Works, Inc.

100 Ash Street, Perry, Oklahoma 73077

Circle Number 20 on Reader Reply Card

Brand	Model #	CRT Size	Hybrid Solid State Tube	Vertical Bandwidth	Vertical Sensitivity	AC or AC-DC	Horizontal Bandwidth	Horizontal Sweep Frequency Range	Triggered or Recurrent Dual Trace	Price
Telequipment	D43	6 x 8 cm	X	DC to 25 MHz	depends on plug-in	AC	depends on plug-in	depends on plug-in	X X	390.00
Telequipment	D53A	8 x 10 cm	X	DC to 100 MHz	depends on plug-in	AC	DC to 1 MHz	0.5 $\mu$ sec/div to 5 sec/div	X X	850.00
TES	0.1064	5"	X	DC to 100 MHz	20 mv/cm	AC/DC	AC DC to 500 kHz	2 sec/cm to 0.01 $\mu$ sec/cm	X	775.00
TES	0.169	5"	X	DC to 12 MHz	50 mv/cm 20 mv/3 MC	AC/DC	AC to 300 kHz	50 msec/cm to 1 $\mu$ sec/cm	X	256.00
TES	0.370	5"	X	DC to 1 MHz	10 mv/cm	AC/DC	AC to 500 kHz	10 Hz to 100 kHz	X	140.00
TES	0.366	5"	X	DC to 7 MHz	50 mv/cm	AC/DC	AC to 500 kHz	10 Hz to 100 kHz	X	140.00
Xetex	0S15A	5"	X	DC to 3 MHz	100 mv/cm	AC/DC	5 Hz to 100 kHz	1 $\mu$ sec/cm to 1 sec/cm	X	200.00
Xetex	0S25A	5"	X	5 MHz	100 mv/cm	AC/DC	5 Hz to 100 kHz	1 $\mu$ sec/cm to 1 sec/cm	X X	315.00
Xetex	0S2000	10 x 6 cm	X	25 MHz	1 mv/cm or 50 $\mu$ v/cm see plug-in	AC/DC	DC to 250 kHz see plug-ins	50 nsec and 200 msec	X	525.00
Xetex	0S2100	10 x 6 cm @ 10 kv PDA	X	30 MHz	1 mv/cm or 50 $\mu$ v/cm see plug-in	AC/DC	DC to 250 kHz see plug-ins	50 nsec to 200 msec	X	695.00

## Manufacturers' Addresses And Scope Special Features

**B&K Dynascan Corporation.** Fully automatic triggered sweep scopes. 1801 W. Belle Plaine Ave., Chicago, Ill. 60613.

**EICO Electronic Instrument Company.** Automatic sync circuits, kits, flat face CRT, Zener diode calibration voltage. 283 Malta St., N.Y. 11207.

**General Atronics Corporation.** (Subsidiary of Magnavox) Portable, interchangeable plug-in amps, can be rack mounted. 1200 East Mermaid Lane, Philadelphia, Pa. 19118.

**Heath Company.** Wired or kit scopes, Solid state and hybrid, dual trace and triggered sweep, lightweight. Benton Harbor, Mich. 49022.

**Hickok Electrical Instrument Company.** Triggered sweep. 10514 DuPont Ave., Cleveland, Ohio 44108.

**Hewlett Packard.** Precision scopes, dual beam CRT's, internal graticule standard on all models, rack and bench models. 1900 Garden Of The Gods Road, Colorado Springs, Colo. 80907.

**Jackson** No Features Listed. Distributed by Mercury Electronics Corp., 315 Roslyn Road, Mineola, N.Y. 11501.

**Kikusui Electronics Corporation** Lab and shop scopes, up to 12-inch CRT, recurrent and triggered sweeps. Available through Marubeni-lida (America), Inc. 200 Park Ave., N.Y. City 10017.

**Leader Instruments.** No features listed. 37-27 27th St., Long Island City, N.Y. 11101.

**Lectrotech Incorporated.** No features listed. 4529 N. Kedzie Ave., Chicago, Ill. 60625.

**Mercury Electronics Corporation.** No features listed. 315 Ros-

lyn Road, Mineola, N.Y. 11501.

**James Millen Mfg. Company.** Features special purpose rack models. 150 Exchange Street, Malden, Mass. 02148.

**Philips Electronic Instruments.** Calibrated sweep speeds, true dual beam, solid state, jitter free delay time base sweep, simplified controls. 750 South Fulton Ave., Mount Vernon, N.Y. 10550.

**Philadelphia Scientific Controls, Inc.** No features Listed. Croydon, Pa.

**RCA Electronic Components.** Solid state, return trace blanking, highly stable. (See cover picture) 415 South 5th St. Harrison, N.J. 07029.

**Sencore Inc.** No Features Listed. 426 South Westgate Drive, Addison, Ill. 60101.

**Tektronix Inc.** Multiple plug-ins that make each scope highly versatile, auto display switching, differential inputs, dual beam, calibrated delayed sweep, analog displays of digital measuring systems, split screen bistable storage, and some models with up to 28 plug-ins. P. O. Box 500, Beaverton, Oregon 97005.

**Telequipment.** A subsidiary of Tektronix. TV line and frame triggering, FET input, battery powered model available, X-Y scope, dual trace, plug-ins available. Same address as Tektronix.

**Tecnica Electronica System (TES).** No Features listed. Via Moscova, 40/7, Milano, Italy.

**Xetex.** Marketed through Marconi Instruments. No features listed. 111 Cedar Lane. Englewood, N.J. 07631. ▲



# COLOR MONITORING FOR UNDER \$400 ...AND THE QUALITY SPEAKS FOR ITSELF!

Listen to what Otto Claus, Chief Engineer, WBAL-TV, Baltimore, says about general purpose monitoring with RCA'S low-cost commercial color receiver:

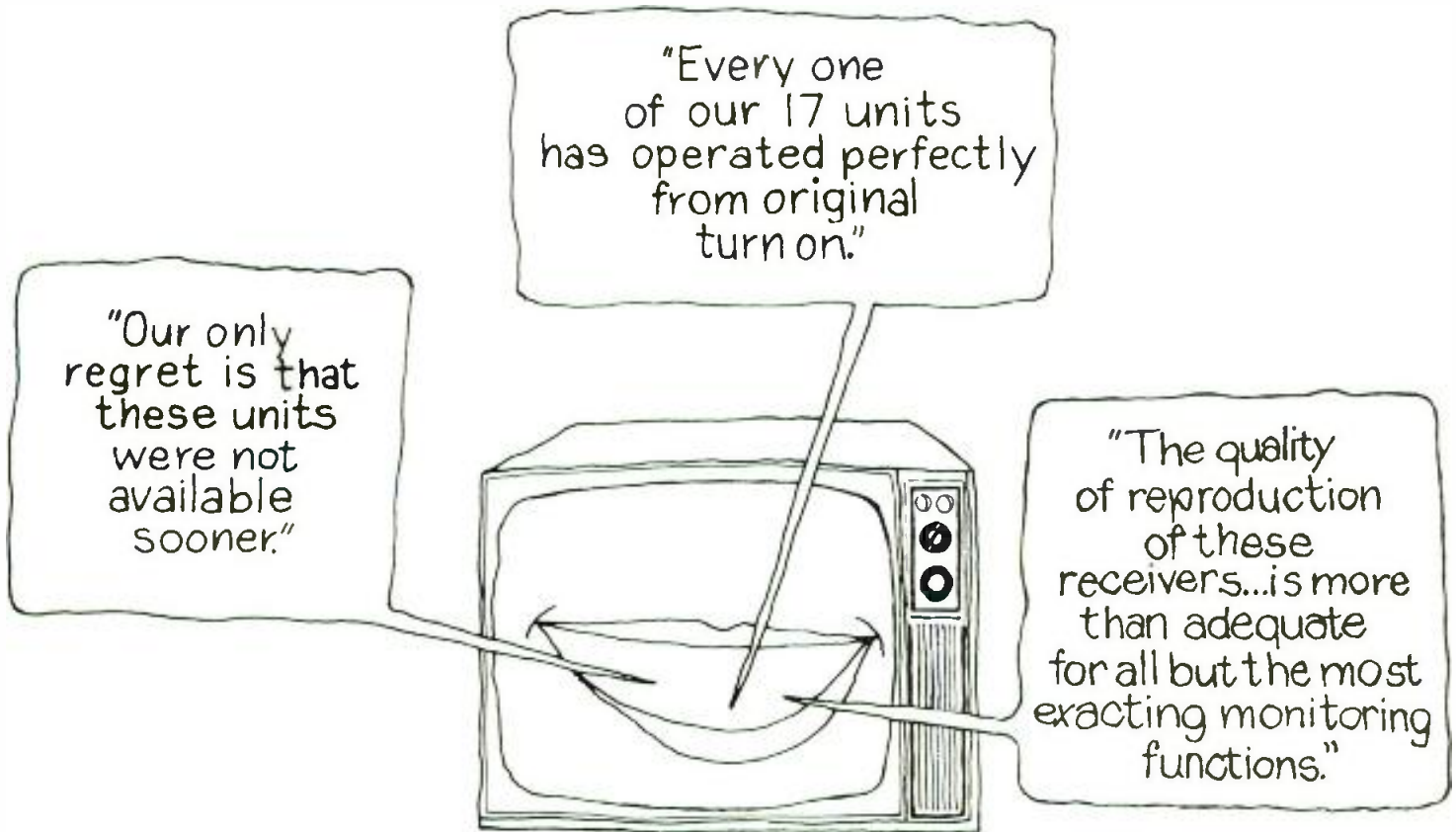

Broadcast Engineers all over the country are raving about this special model. Unlike color sets intended for home use, this receiver is equipped to accept RF or bridged direct video and audio line feed without the need for costly adaptors. *For under \$400*, you get every non-critical monitoring function you can ask for — picture, sound, live or tape, color or monochrome. It's especially suitable for monitoring needs back-stage, for the band, for the audience, and similar applications.

For complete details, send the coupon. We'll show you cold cash reasons why RCA's commercial color TV is your best answer.



**RCA Commercial Products**

Circle Number 21 on Reader Reply Card

RCA Service Company	0-141
A Division of RCA	
Commercial Products Sales, Bldg. 203-3	
Camden, N. J. 08101	
Please furnish further information about RCA commercial color sets for broadcast monitoring purposes.	
Name _____	
Title _____	
Station _____	Phone _____
Address _____	
City _____	
State _____	Zip _____

# A manufacturer's view . . . . can stereo-SCA be compatible?

---

By James L. Tonne\*

---

The subject of "whistles" when simultaneously transmitting stereo and SCA crops up frequently. The problem is not peculiar to any one station nor to any one transmitting equipment manufacturer. No method of modulation is secure and no AFC scheme is sacred. Most manufacturers are aware of the general problem, but are reluctant to discuss it. And most broadcasters assume that since they can hear a whistle in their own receivers and even their stereo monitors that they are transmitting it.

Not So! You can be transmitting a magnificent signal, clean and pure, indeed ideal, and you will probably be blessed with a whistle (also known as a birdie).

If you examine the wideband output (sometimes called the composite or baseband output) of the modulation monitor using a tuneable voltmeter, you will see the signal you are transmitting. Assuming that the monitor is working properly, the only inaccuracies introduced will be caused by the transmitting antenna and feedline. Generally their effects can be ignored (in this discussion).

If you modulate your multiplex transmitter with a 15 kHz tone in one channel only, with no SCA signal, the spectrum as observed on the wideband output of the monitor should look similar to Figure 1.

Now let's add the SCA channel. A small liberty taken will be to leave the SCA unmodulated. Our transmitted baseband spectrum now looks as in Figure 2. Notice, and this is most important, that no birdies at 9 and 10 kHz have been added. This is the signal that you are transmitting, and it is free of birdies. At

\*Moseley Associates, Inc.

least it should be, and in this article we are assuming it is as clean as shown (very achievable, believe me).

## Enter The Villain

Now let us move the tuneable voltmeter to the output of the switching-type stereo demodulator. This type of demodulator, because of its fidelity, reproducibility and simplicity, is used in all currently-available FCC-approved stereo monitors as well as the better-grade stereo receivers. Looking at the output of the demodulator before we enter the 15 kHz low-pass filters, we see the interesting spectrum of Figure 3. Logically, such a spectrum would look pretty terrifying on an oscilloscope: you can confirm this yourself.

Of special interest are the components at 9, 10 and 57 kHz. You are not transmitting any of them. They have been generated in the stereo demodulator. After this messy signal is passed through a 15 kHz low-pass filter, the 57 kHz component is removed but the 9 and 10 kHz components remain. The 57 kHz signal is generated in the demodulator by the "chopping" or decommutating action on the pilot signal itself by the locally-regenerated 38 kHz carrier. The 10 kHz signal is then a byproduct of any intermodulation between that 57 kHz signal (generated in the demodulator) and the 67 kHz SCA signal.

The 9 kHz signal, should it be present, is a result of the 38 kHz carrier having a second harmonic component. Normally, the 38 kHz waveform has no even-order harmonics, but if a second harmonic component exists (at 76 kHz), then that component will directly demodulate the 67 kHz signal and produce a birdie at the difference frequency of 9 kHz.

Other stereo demodulators, such as the "envelope" type, may have these same general problems plus possibly a few of their own (for

example a horrendous amount of 38 kHz feedthrough).

## The Case Of People VS. dB

How far down are these 9 and 10 kHz components? Typically, after de-emphasis, about 55 to 65 dB. An interesting point here is that in some cases the human ear can hear the birdies (oh so painfully!) and yet they do not even show up as a degradation of system SNR. This is evidently because our ears are quite sensitive to these mid-high frequencies, especially where the objectionable material is a single tone. The hum and hiss might very well measure greater on a voltmeter but the ear is more concerned with the high frequency whistle.

If the 38 kHz demodulating or decommutating activity is prohibited, then the 57 and 76 kHz components (generated in the receiver) will disappear, and along with them the 9 and 10 kHz whistles. Notice, if you will, that a receiver without a stereo demodulator (perhaps a small alarm-clock radio) will not have these birdies.

The amplitude of the 57 kHz signal generated in the stereo demodulator is several times that of a terribly misadjusted pilot signal. The pilot should not have more than 10 percent total harmonic distortion. Even if you did have that much distortion, and even if it were all third harmonic, at 57 kHz, it would still be small by comparison with the level of the 57 kHz signal generated in the demodulator.

In a good demodulator, the level of the 76 kHz component developed in the demodulator will be quite low, competitive with a good stereo generator.

But, remember that harmonic content of the pilot, in itself, will not cause birdie generation. You must intermodulate (mix) the 57 kHz component with the SCA signal to generate the 10 kHz beat note. A 76 kHz component in the

demodulating waveform unfortunately is capable of demodulating the 67 kHz signal on its own without the intermediate spurious-signal generation step. Fortunately, even if you did transmit the 76 kHz component, it would not pass through the 19 kHz pilot-extraction band-pass filter. Once again the transmitter escapes blame.

### The Solution

Are stereo and SCA signals compatible? My answer is yes, transmission-wise. But the receiver manufacturers have too long been playing the game of the blind following the blind in developing stereo demodulators. Reducing the level of the 67 kHz component by filtering prior to stereo demodulation will reduce the severity of the birdie by as much as perhaps 15 dB, at the usual expense of a severe loss of separation at high stereo modulating frequencies. It is simply uneconomical to reject the SCA signal and its sidebands while still passing the composite waveform to 53 kHz with a good degree of phase integrity.

It would appear that two items in particular need to be observed in the development of a birdie-resistant stereo demodulator. First, the 19 kHz pilot should not be distorted in the demodulator proper or else the demodulator should use a sinusoidal or "soft" switching waveform instead of the brutal but stable and efficient squarewave. Secondly, the 76 kHz component in the switching waveform must be eliminated. There is one professional demodulator which uses the now-commonplace bistable method of generating such a waveform but none of the FCC-approved modulation monitors (leave alone home receivers) currently use it. By not distorting the pilot, and so not generating the 57 kHz component in the waveform to be demodulated and by having no 76 kHz component in the demodulating waveform, the 67 kHz signal can be rendered harmless.

In the meantime, I propose a temporary solution. Specifically, keep the modulation level up so the receivers' gain controls are kept turned down. In this manner the lis-

teners will also turn down the level of the birdie. This will be a painful decision to make for a classical music station.

By now it should be quite clear that adding traps, filters or other magical cures to a transmitter will have no effect at all if that transmitter was operating properly in the first place. In order for these transmitter-oriented cures to be effective, the transmitter must be in a sad state of disrepair. Further, most modern transmitters have modulated oscillators operating at 12 or more megahertz, quite far removed from the 57 to 114 kHz octave of suspi-

cion. I submit that the problem lies in the stereo demodulator.

**Editor's Note:** In fairness to all, and and because we think Mr. Tonne has a point, **Broadcast Engineering** will continue coverage of this problem. James Wulliman, CE of WTMJ is currently working on an article on the subject. I'm sure he'd be happy to hear from readers who have had similar whistle or birdie problems. Other comments will be accepted for letters to the editor. Letters to the editor should be sent to: **Broadcast Engineering**, 1014 Wyandotte, Kansas City, Mo. 64105. ▲

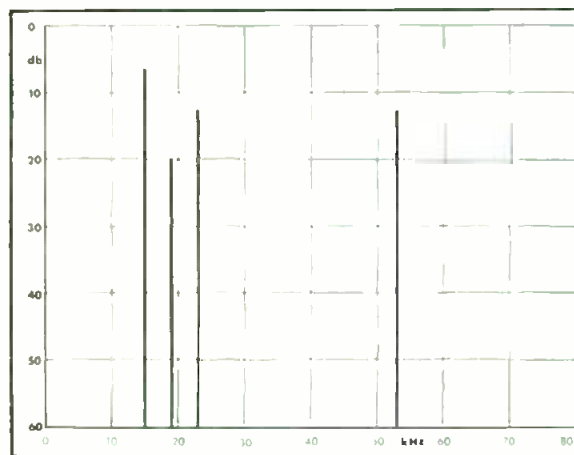

Fig. 1 Typical spectrum of baseband signal of stereo station. 100 percent modulation, one channel only, 15 kHz tone.

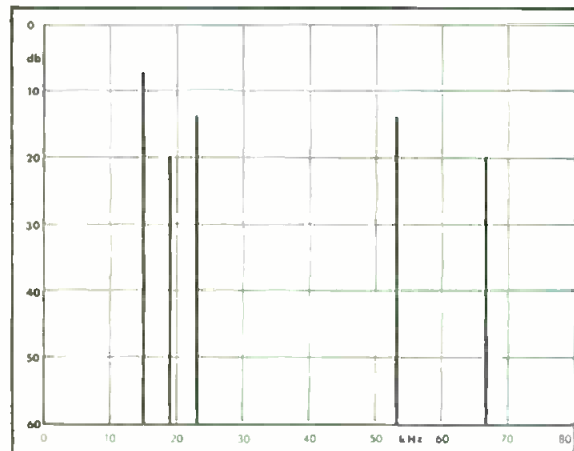

Fig. 2 Same as Fig. 1, but with added SCA signal.

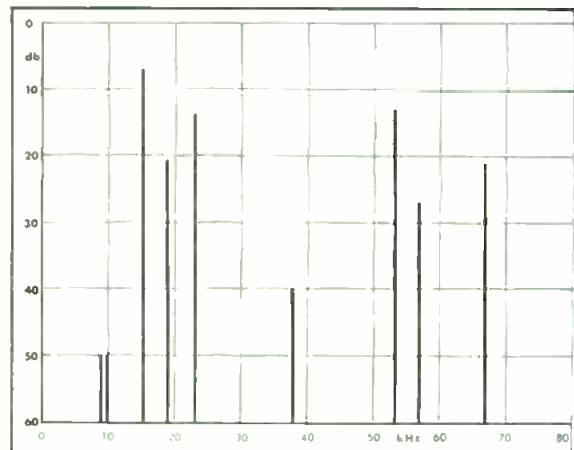

Fig. 3 Signal of Fig. 2 after passing through a stereo demodulator. Typical 9, 10, 38, 57 and 76 kHz "spurs" are indicated.

# Reduce those loop rates for sports remotes

Elliott Full\*

For years broadcasters have been paying 10 cents per hour/mile for class D & E broadcast loops. This was the bottom rate. Equalized loops cost considerably more.

Most smaller stations have to be satisfied with the non equalized loops, even though their quality often leaves something to be desired. Dialing pulses, ringing noises and low fidelity often detracted from program value because of listener "ear fatigue". Recently, loop rates have jumped to 12 cents so broadcasters have been looking for a way out. It is a rare broadcaster indeed that can carry the "local bulldogs at home and away" and make costs on the sports broadcast itself.

There is a way out now. The Carter phone decision, a landmark case before the FCC, permits equipment other than that provided by the telephone company to be used on their circuits.

Is there any reason broadcasters, who have been using D & E loops, can't just dial the station from the away stadium and broadcast on the telephone line? No, there isn't! Several provisos and qualifications however!

\*KXIC, Iowa City, Ia.

1. A coupler, as provided by the telephone company makes things easier.
2. If you can't hear the station on your radio from the booth, better have two business phones installed.
3. A 12 dB pad is needed to minimize the possibility of overloading the phone circuit.
4. Be sure to give the station your telephone number(s). If only one phone, give them the number of some other nearby phone so they can reach you in case you are cut off.
5. If you get a bad line the first time, wait several minutes and dial again.

Item 4 above needn't frighten you off. We have been broadcasting University of Iowa football for 23 years and have been cut off when using broadcast loops a number of times. Saturday afternoon is a bad time to get these interruption problems solved, so the telephone method poses no more serious problem than has always been present. In fact, with the monitoring phones

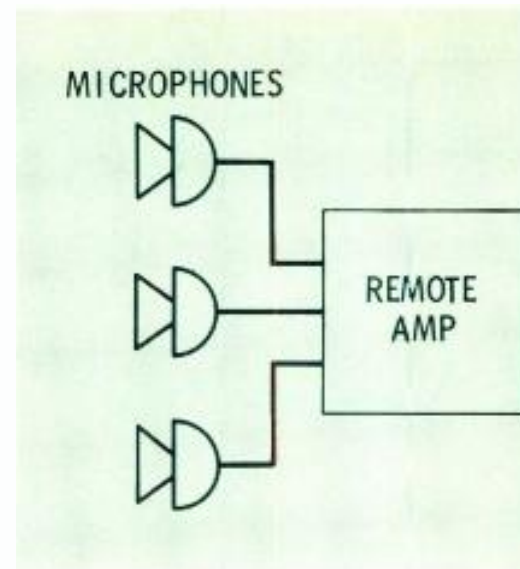

(see Figure 1) plugged in after the 12 dB pad, the broadcaster may be reached during commercials, time outs, etc. and assured that all is well. Connection is made to the coupler using a standard 2 conductor phone plug. It is possible to clip the 12 dB pads output to the telephone terminals after dialing the station. This is particularly useful around town because the pad will hold the line if the phone is hung up. Also, the pad allows enough DC through to the phone so that the phone is usable if needed.

The schematic of the station end equipment is fairly self explanatory. The 2 mf capacitor allows the phone and the audio feed to be used simultaneously. Shunting out the capacitor disables the phone and holds the loop. We installed a phone without a ringer.

The loops should be polarized in the same direction so that searching with the switch does not cause a multitude of clicks. To broadcast, we patch a small booster to the repeat coil output, then at about +8vu, we go into an equalizer. With a frequency range of 300 to 3000 Hz, you say "why equalize?". A 250 mile line last football season passed 100 Hz at only 8 dB down! We usually boost 10-12 dB at 200 Hz and 5-6 dB at 4000 Hz. We come out of the equalizer into a limiting amplifier, which helps if the engineer is asleep or nonexistent.

The equalizer gives an improvement that is rather dramatic to the ear. Our loops, this year, using only

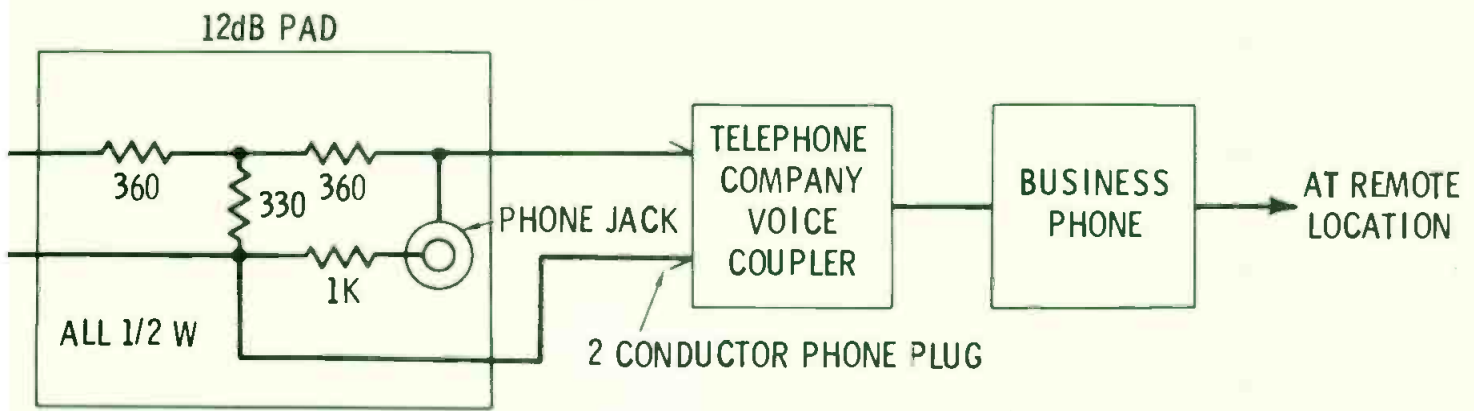

Fig. 1 Setup at remote location. Monitor phone jack at pad allows announcer to be reached during commercials.

telephone connections, sounded at least as good as the leased wires we have used in the past. After all, we could and did redial when the loop was unsatisfactory.

Telephone men and telephone offices often are not well informed on the use of the voice coupler. Your order may be the first one they have received. In figuring comparative costs, remember that telephone companies now may charge an extra \$4.50 for merely patching

in a loop to your existing tie loop. So the 20 percent rate increase is only part of the story. Tie loops and local loops have also gone up in price. Providing your own voice coupler and phone at the remote location may save some more money. We checked and found it not to be enough here to merit carrying the extra equipment. This, however, may change from one company and one state to another.

Bell's nomenclature is as follows:

OKT order designation for the 30A voice coupler; XCN "Exclusion key used with voice connecting arrangement/no charge;" CFF Transmitter cut off button. Push to talk switch also ok.

We cannot say that this method of program transmission will be the "wave of the future". We can only say that it has saved us a good deal of money, about \$1500.00 last football season alone, and that we are well satisfied. ▲

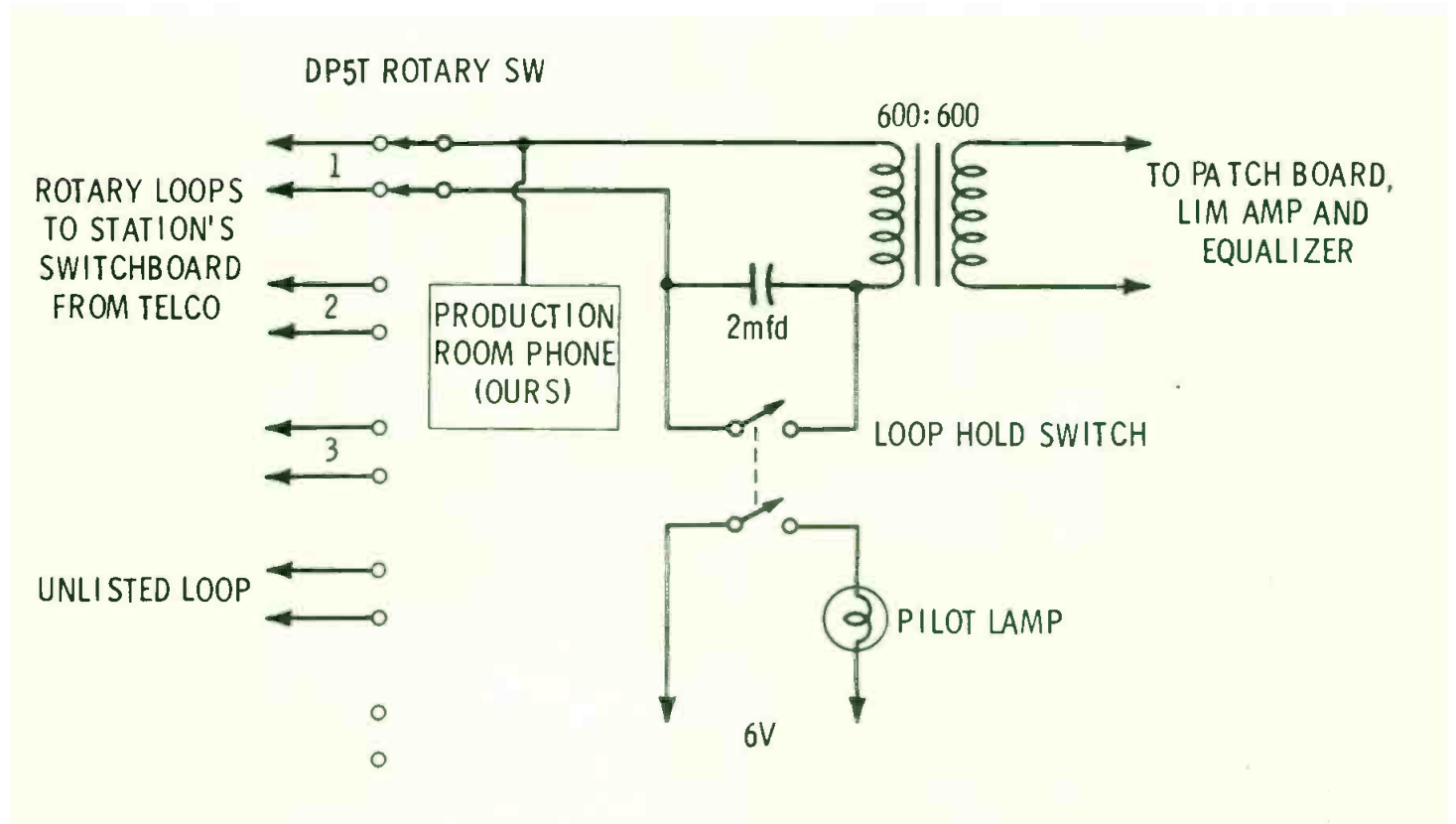

Fig. 2 Wiring at the station.

# A talk show delay system

This is a discussion of how KBAT radio modified and built gear that would help them produce a "clean" talk show.

By Philip V. Blakely Jr.,  
and T. Frank Ritter\*

In preparation for a program change on KBAT Radio, the Engineering Department was asked to design and build the electronics for a telephone "talk show." Legal advice suggested two requirements for the system: 1) a time delay device so that an operator could prevent nasty no-no's from being aired, and 2) a record of on-the-air programming during the show.

## System Philosophy

A study of previous work in this area was conducted, largely by word-of-mouth. We found that there are three types of systems in operation at stations with similar programming.

In the first system, a good quality three-head tape recorder (AmpeX AG600 or one similar) is modified by interchanging the record and playback heads so that the tape encounters first the playback, then the erase and record heads. If the tape is formed into a closed loop, a delay results from recording until that portion of tape travels the loop and encounters the playback head. In this system, the duration of the delay is easily changed (between fixed limits), but the machine has been altered and is effectively useless for any other purpose than delay. Off-

\*KBAT Engineering. San Antonio, Texas.

the-air record capability does not exist, so an additional recorder must be used.

The second system uses two large, separate tape units in which the tape is continually fed from the supply of one machine to the take-up reel of the other, passing through both sets of tape heads. The first machine is used for recording, and the tape is played back on the second machine with the duration of the delay being the length of tape between them. Naturally, one must have the two recorders (one does not purchase two high-quality units for a delay system) and, aside from setting them up each night, be willing to have them occupied for the duration of the program.

With single-channel machines, a simultaneous off-the-air record of programming is not available; the recorded tape delay contains only the audio before it is cut off, and does not indicate if a particularly damaging phrase was broadcast.

The third method for obtaining the delay involves the use of one good-quality recorder, altered for delay with extra tape guides and an additional playback head. Since this method would involve the mutilation of a fine machine with no improvement in performance over other methods, it was considered only briefly. As noted previously, off-the-air record capability is not available on a monophonic delay recorder.

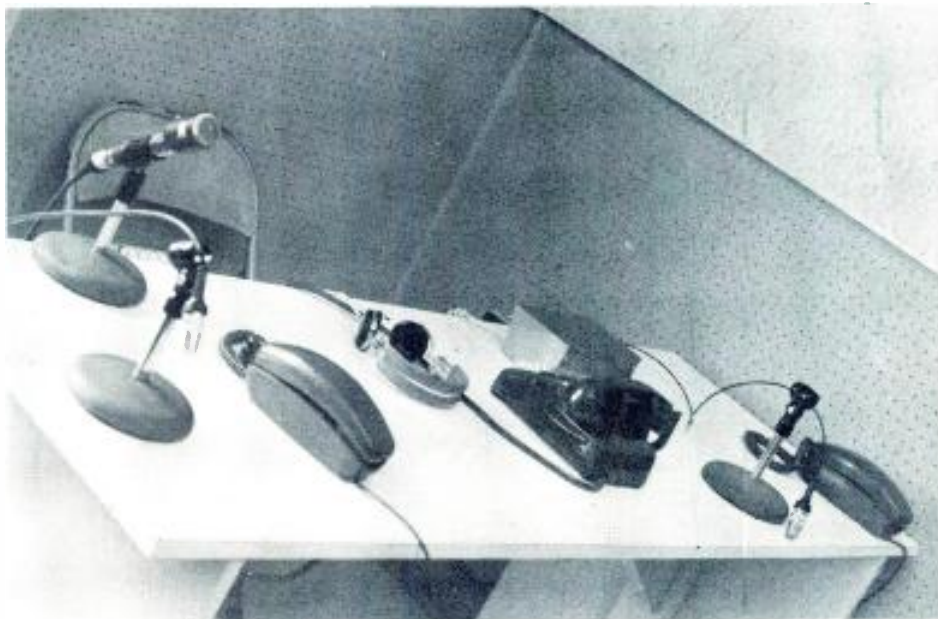

Photo #1 KBAT's talk show operating desk. The flat box unit on the back side of the table is the delay control panel.

### A New Approach

None of these delay systems satisfied us, so we decided upon a new approach. Thought on the topic suggested that we might be able to combine the delay and on-the-air record in one dual-track deck. The primary requirement of the system, the length of the delay, was a controversial specification, but we believed a 1 or 1.5 second delay would be about right, and this was later demonstrated in practice. Calculation indicated that with certain tape decks we could obtain the desired delay in the normal configuration, using very slow speeds. The slow speed would present some frequency response problems, but would definitely increase tape economy.

### Hardware

Consumer quality machines were tested for the application, but were not found suitable. We then decided to purchase a semi-professional, relay controlled, four track stereo tape deck with the slow speed option installed (1 $\frac{7}{8}$  and 3 $\frac{3}{4}$  ips) to provide a good delay.

When the machine arrived the delay was increased by moving the recording and playback heads further apart, thus lengthening the tape path between them. The erase head was removed from the first head position, tucked behind the panel, and replaced by the record head from the second head position. When the playback head was moved from the third to the fourth head position, a total displacement of 3.4 inches was achieved from recording to playback, giving 1.8 seconds delay at 1 $\frac{7}{8}$  ips. This was considered more than sufficient in which to analyze the program material and take action (to cut it off) if necessary.

The slow speed option on the Magnecord 1024 deck consists of a belt and pulley change only, and does not include tailoring of the frequency response for slow speed. Our deck provides for adjustment of system response, and with these adjustments turned to their extreme, they

give satisfactory voice reproduction without undue noise. A low-frequency rolloff was programmed into the preceding unit (Bogen MTM mixer) and a good overall sound resulted.

One idiosyncrasy of the Magnecord 1024 was noticed during operation in the form of periodic audio "dropouts." These were eliminated by increasing head penetration, and since there is no specific penetration adjustment, the heads must be moved forward separately. As supplied, the heads are held in position by a clamp assembly and glue (to prevent slippage). The heads must be broken free, re-adjusted and reglued. Elmer's glue works nicely.

Naturally since the erase head is not used, each reel of tape must be "clean" or erased before use. One side of a 1200 foot reel of tape lasts through the entire scheduled two hour program. It is then labeled and set aside to be used in the opposite direction on the following night. One reel of tape thus lasts for two nights of regular programming.

### Operating Convenience

Further plans for the talk show system called for an operating desk separate from the main control board, with places for the moderator and two guests. Three pushbutton telephones would be installed, with all three line selectors controlled by the moderator and the audio input to the system being taken from the moderator's telephone by a Telco recorder connector. Three microphones would be used for studio conversation, and levels from all four inputs would be semi-permanently adjusted on a rack-mounted Bogen MTM mixer. (Provision can also be made in this mixer for silent remote muting of each input.)

A relay-logic switching arrangement would provide the moderator with control over three distinct modes of operation: 1) Delay, 2) Off, and 3) Live. Going from Delay to Off operation would cut out 1.8

seconds of no-no's before they were aired by muting the audio output of the system, as well as disconnecting the telephone line from the input of the mixer. (The system is designed so that it can be used with an external tone source, or a "coo-coo" sound to indicate the program has been interrupted. The Live mode is used only in the event of a delay system failure, such as tape breakage.)

The three-telephone system is awkward. After a few hard nights we decided to use a speakerphone in place of the individual telephone instruments. This was a definite change for the better, for it eliminated many of the dial tone and hang-up noises associated with the program. It was also much easier for the guests to hear and participate in round table discussions between a caller and the moderator.

In an effort to eliminate distractions to the moderator, all telephone lines used for the program were terminated at the main control board where the board operator could answer the lines as they rang, and put them on hold.

A different system of phone line audio pickup while using a speakerphone has been described (Hilde-

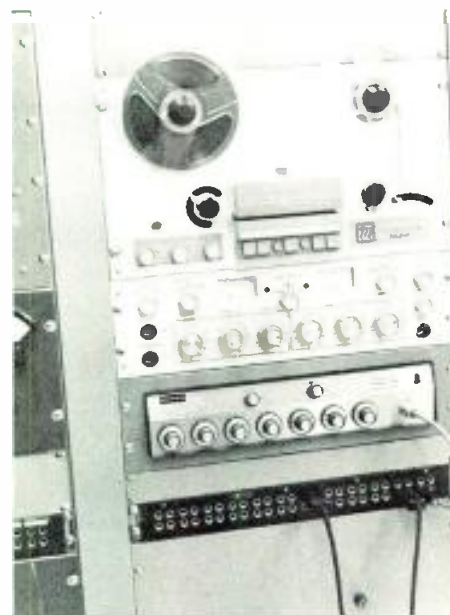

Photo #2 The main units of the delay system.

brand, **Broadcast Engineering** August, 1970, p. 32) where the speakerphone audio output is fed into a desk mike, and on into the system. Although, as noted in the article, audio quality of the phone conversation is not greatly affected with this method, the control desk is cluttered by a fixed speaker-microphone relationship, for constant phone line audio into the system.

The entire delay system is de-

signed to be inserted into the normal audio path from the control board (channel A) to the transmitter audio equipment (AVC and Limiter). This poses a problem upon going into or off of delay, but does leave the board operation relatively unchanged, with access to all normal inputs. Since the audio level into the transmitter should be controlled, the other board channel (channel B) is used for this purpose.

Placing the system before the normal board channel would make the delay system less confusing, but would require re-education of the control board operator as to which board channel was "studio-live." A switch thrown to the wrong board channel would defeat the entire system.

### System Software

Preliminary thinking on the system required going into delay from the moderator's desk only. This procedure was never used on the air as tests resulted in considerable confusion and coordination difficulty between the moderator and the control board operator during the time changes. Since no music was to be aired on the show, the entire studio was put on continuous delay. In this system, the control board operation is generally unchanged: all studio-live ("before time") inputs go into channel A, the channel normally used for live programming,



Photo #3 Delay system control panel.

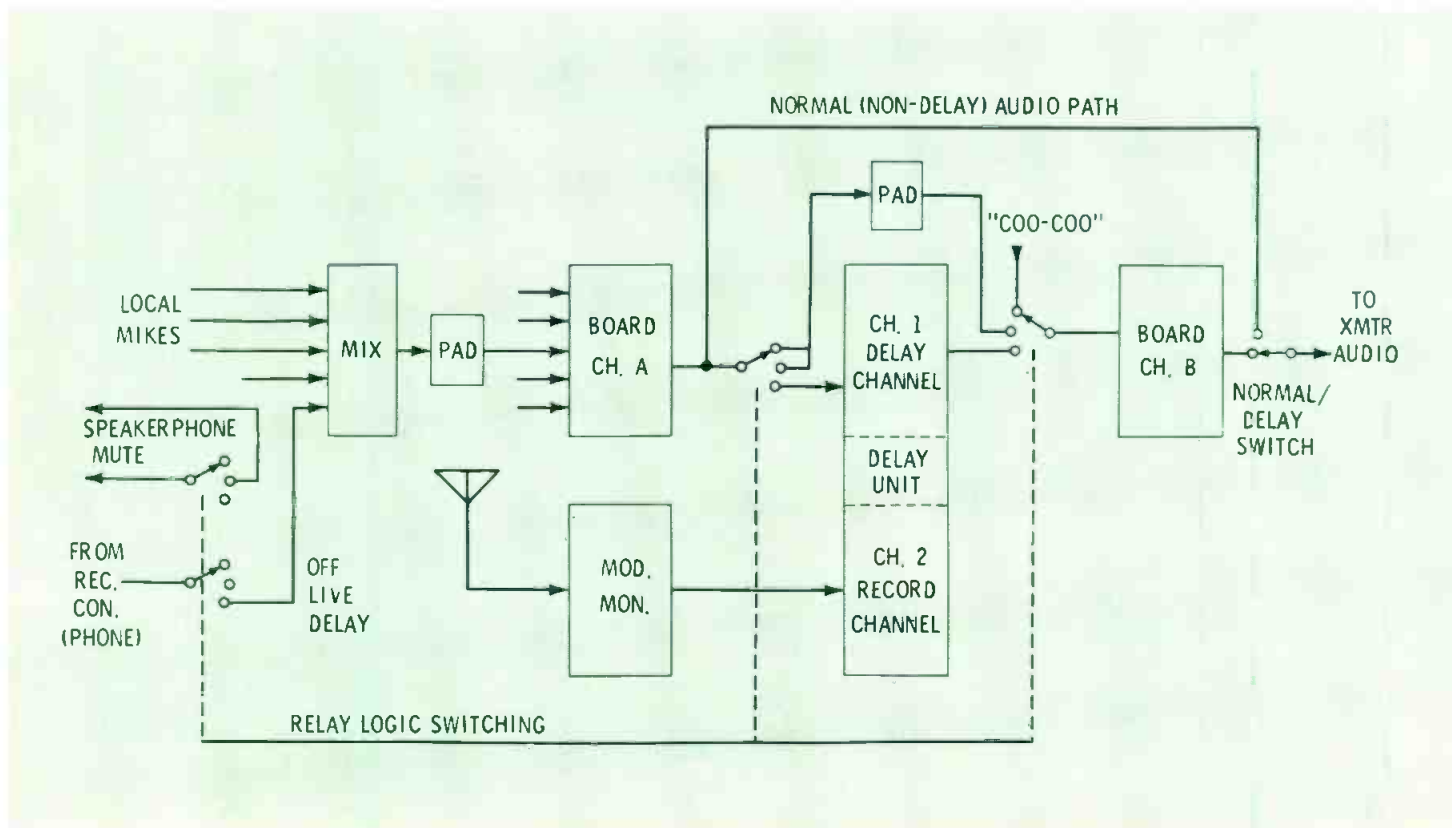

Fig. 1 The KBAT Delay System.



which gives the operator program-live access to the cartridge machines, newsroom, and other board inputs. Delayed ("real time") programming appears on channel B of the control board to allow the operator control over transmitter input levels, and access to the transmitted audio in case of breakdown.

Headphone monitoring at the control board is studio live, or "before time," for control of the program. The moderator is not provided with an off-the-air monitor, as this would defeat the purpose of the system: the moderator must listen to "before time" programming in order to exercise control over the delay. All programming during the show is run

through the delay, including commercials, news and weather, so if the news is coming from another studio, that studio must also be equipped with "before time" monitoring, or a 1.8 second discontinuity will occur upon entry into the news.

The major objection immediately voiced by all concerned to our system of delay was that of delay span. Our system critics insisted that 1.8 seconds was just not enough time. In practice it turned out that any more than 1.8 or 2 seconds would have been too much. In our system, the moderator has full control over the delay system. If he wishes to cut something out he merely flips the switch to Off, waits two seconds.

flips back to normal, and continues. If a longer delay is used, an additional person is necessary to operate the system. Not only does this increase the budget of the program, but it takes the complete program content control out of the hands of the only man that should have control.

We have thus obtained the desired results of a talk show delay system at a minimal capital expenditure consistent with a quality system. Further, the tape unit is standard, with no permanent modifications, and could be used for other purposes when not being used for delay. Tape use is also minimized, due to the slow speed. ▲

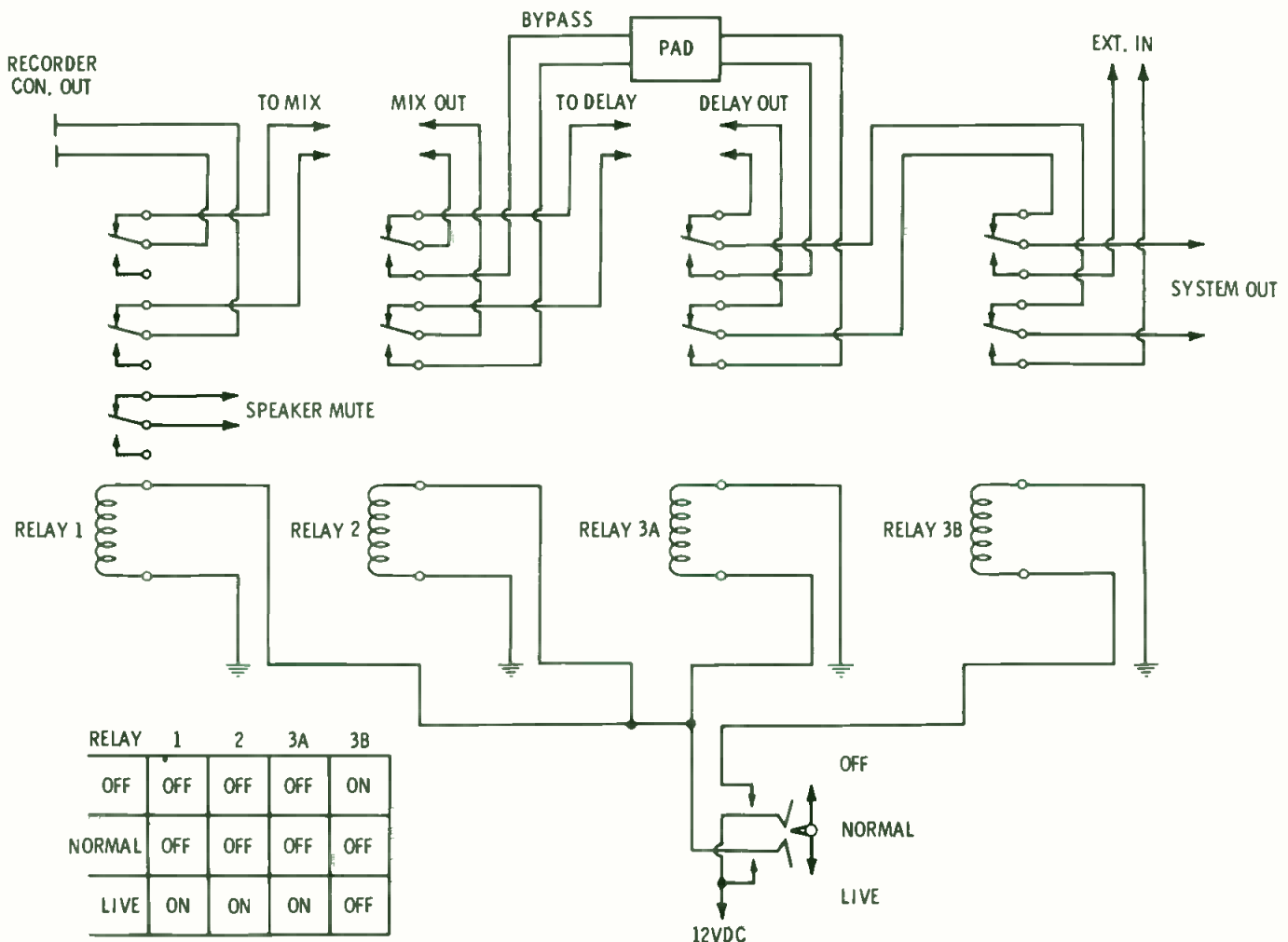

Fig. 2 Delay system relay detail.

# Can we close the gap between management and engineering?

Second part of a series exploring the need for closing the communications gap within the radio station.

By R. H. Coddington

The radio engineer needs to step out of his frame of reference long enough to view his job with a managerial eye. Is his time **really** productive, or is he riding on outmoded regulations that require little more than his unproductive presence? Is his salary mainly expensive insurance against the prolongation of a rare breakdown?

It's more probable, though, that the engineer's productivity is partially hidden from management. The front office is fairly oblivious to an engineer's **preventive** labors. It is when an operational failure occurs that he becomes most visible. In this regard, it is to the engineer's disadvantage that the more reliable operation reflects the more productive technical talent.

The engineer who is hidden by his competence might tactfully call his productivity to management's attention. One simple, businesslike approach is to make daily or weekly reports. There are numerous instances in every operation where the engineer on the premises detects the symptoms of some impending trouble and corrects it before the point of failure is reached. Management should know of these occasions.

(It's safe to say that perhaps 90 percent of potential equipment failures are telegraphed in advance to an engineer who is familiar through every-day operation. He becomes aware of a small deterioration in performance long before the non-technical individual notices anything wrong. This is one strong argument against the contact engineer, who cannot know the equipment so intimately, and against the ticket-holding announcer as well.)

It's pointless for the engineer to "pad" his apparent productivity. This practice will not deceive management for long, nor will it con-

tribute to the operation's technical excellence and financial prosperity—and the operation must prosper before the employees stand any chance of so doing.

The engineer needs to develop avenues of genuine productivity within his technical domain. His efforts must contribute to the station's professionalism, and he must prove their merit to the front office.

Consider this: the **nominal** maintenance routine in many smaller radio stations consumes far less than an engineer's full time. Properly designed and installed, such a station can get by passably well without fulltime technical attention.

## **Being A Professional**

Without for a moment suggesting that an engineer should "make work" in order to look busy, I suggest that **nominal** maintenance is less than professional. It has been my observation that the "combination" chief engineer-plus-something-else invariably must take compromises. He can manage to keep an acceptable signal on the air pretty consistently, but there are numerous low priority technical details that become indefinitely postponed simply because he hasn't the engineering time to wrap them up.

Take, for example, the required annual proof of equipment performance measurements. Any modern equipment in factory test-line trim should surpass the FCC requirements with ease; these are, after all, **minimum** acceptance standards. Yet it is not uncommon, in those stations where the engineering staff is pressed for time, for the proof measurements to reveal substantially sub-standard performance. A year's nominal maintenance to keep the signal on the air and "sounding pretty good" has per-

mitted an insidious degradation to creep in since the previous measurements. (And one should consider more than mike input terminals. In radio, music rules and requires technical proofing.)

To complicate the problem, the overly-busy engineer then may feel compelled to meet the minimal requirements in the shortest possible time. This leads to those adjustments and repairs that most expeditiously raise the equipment to conformance. The motivation in this case is one of "squeaking over the line", rather than the more time-consuming goal of achieving the maximum performance of which the equipment is capable.

The obvious cure for this undesirable situation is more available engineering time. With more time during the proof measurements in which to strive for the equipment's **maximum** performance, it will be longer before the natural decline pulls that performance below the minimum limits. This alone can raise the station's average technical stature.

But there should be time for more than this. The proof of performance tests are only **required** yearly; they are to be **desired** more frequently. The conscientious engineer always will strive to keep his station's equipment performing better than the FCC requires—if he has the time.

Proof measurements are only one of many areas that suffer from engineering time limitations. Another common one is paperwork. This includes such basic necessities as diagrams and updated instruction manuals.

It's rare to find a small station where the engineer can put his finger on a correct diagram or current manual for every link in the program chain on a moment's

# NOW YOU HAVE A REAL CHOICE

This choice is beautiful!  
And functional.  
The A-20B is today's  
newest 8-mixer,  
full facility,  
monaural,  
audio console.  
Distinctive styling  
and solid-state design  
make the A-20B more  
compact than any other  
in its class. Yet it does the  
job of consoles twice its size  
and price. It will do the job  
you want. And do it in style.  
Learn how much more this console can do.



**SPARTA ELECTRONIC CORPORATION**

5851 FLORIN-PERKINS ROAD, SACRAMENTO, CALIFORNIA 95828 (916) 383-3353

14616 SCUTHLAWN LANE, ROCKVILLE, MARYLAND 20850 (301) 424-2920

A DIVISION OF COMPUTER EQUIPMENT CORPORATION

**\$1295**

Circle Number 22 on Reader Reply Card



give...so more will live  
**HEART FUND**



"AREN'T JUST THE TURNTABLES  
SUPPOSED TO REVOLVE?"

notice. Yet this very ability may be the key to restoring an equipment or circuit malfunction in the shortest possible time. Again, lack of time is a common cause of incomplete diagram files.

Disorganized files result from equipment repairs or circuit modifications, often made in haste in order to restore service as soon as possible and followed by the engineer's failure to revise diagrams and/or manuals accordingly. Once everything is working again, the press of time calls him to other things, and his good intentions become lost in the shuffle as the days become weeks and the weeks become months.

For that matter, how many operations **ever had** complete diagrams? Initial installations usually suffer from the press of time, too. Pressure to meet the planned completion date, fraught with the hazards of delivery delays, shipping damage, and defective equipment. If the installing technician(s) started with an overall diagram, the inevitable running changes arising as construction progressed may not have been noted. And very often a simple installation is wired from the engineer's head, with no comprehensive diagram on paper at all.

This means that, in many operations, an engineer should spend considerable time on completing and updating the technical files. Not only should they contain accurate manuals and diagrams on individual items of equipment, but complete interconnection diagrams should be indexed as well. These should include cable routings, terminal strip designations and numbers, and detailed expansions of complex distribution circuits. The continuity checks and cable-tracing that this requires in an un-diagrammed installation, if it is of any age, will keep a man busy for some time.

(It's not necessary for every radio engineer to obtain professional drafting instruments and painstakingly create masterpieces of the draftsman's art—although that would contribute to the operation's overall professionalism.)

Another situation frequently exists at those stations that have been established for some time, particularly under a succession of engineers of various philosophies. This

is the "confused conglomerate" of physical equipment: the result of piecemeal growth and modification over the years. Often a new item of equipment is "temporarily" installed in the most expeditious way and pressed into service. As personnel adapt to the sometimes-awkward operating procedures and become accustomed to them, the installing engineer's good intentions of tidying things up in a professional manner become lost to the urgency of more pressing chores.

### Looking Ahead

Once past changes have been assimilated, the broadcast engineer will want to direct his attention to the future. Despite its relatively long history, radio broadcasting is not technically cut-and-dried. It is in a constant state of evolution at an apparently increasing rate.

It is the engineer given freedom of time who makes the most effective use of new developments. It is he who can plan the assimilation of new apparatus into a human-engineered operating whole that invites the smoothest operation. It is he who is in the best position to evaluate the relative merits of available equipment, and who can best adapt the installation to his sta-

tion's individual operating philosophy.

Somewhere in his busy life, the broadcast engineer must reserve the time to keep himself from becoming obsolete. Fostered by military and space program demands, the evolution of electronic technology has gone into orbit. No one actively engaged in the field can afford to rest on yesterday's knowledge: to do so is to find that even the jobber catalogs soon become unintelligible!

### Automation

To illustrate this, take the contemporary innovation of program automation. Already hundreds of radio stations employ automation to some degree. Despite resistance, it is destined to assume a commanding role in broadcasting. The apparent economic benefit resulting from using manpower continuously for a few hours, instead of intermittently for many, simply is irresistible to most bookkeeping departments.

This suggests that the broadcast engineer should become an expert on automation—as many have had to do already. Full program automation, for example, uses an intri-

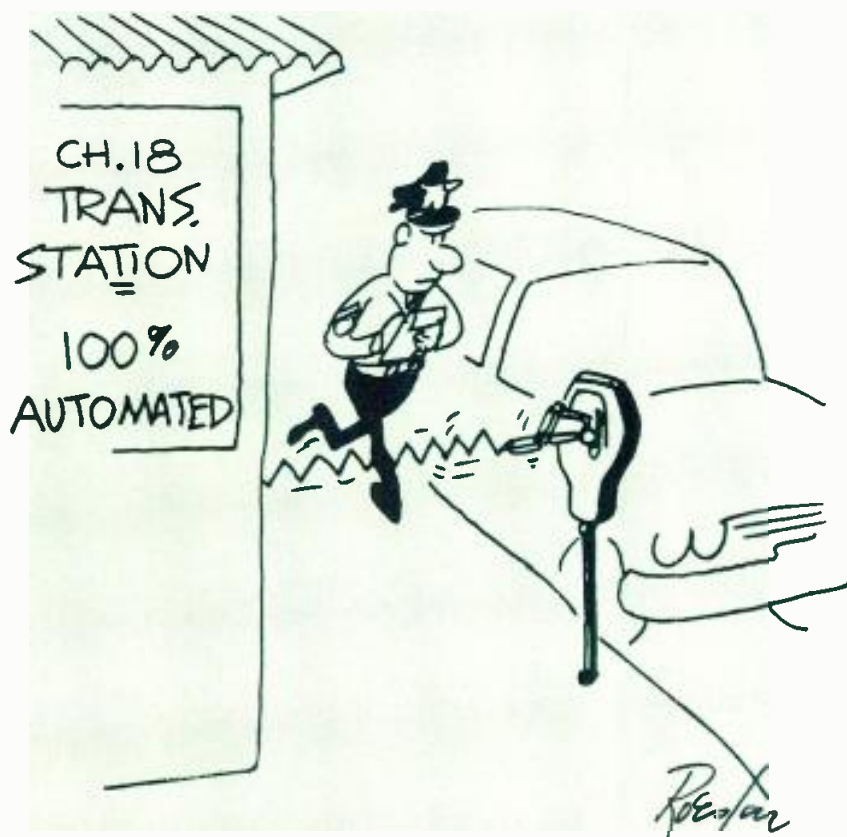

cate complex of electronic and mechanical equipment. Each element must perform consistently and continuously well; a failure by one is almost certain to confound the whole system. When it is unattended or unmonitored, a deranged automation system can create irreparable havoc with intended program and commercial schedules before the condition is discovered.

The preventive remedy for this lies in the engineer's knowledge and expert maintenance of the equipment. The more reliable he can keep the program automation, the more productive he becomes for his management. But he can go even further in this direction. Most automation packages are generally adaptable to many formats and specifically applicable to none. Once committed to automation, a station often finds itself somewhat limited in format flexibility. The engineer who can "customize" his automation facilities to fully serve a specific format, and adapt it readily for variations as their desirability arises, possesses an added value.

Program automation is merely the beginning, though. Another form of automation promises to invade the broadcast engineer's domain in the years ahead. This is automatic transmitter supervision, which will—when the FCC finally sanctions it—permit unattended operation.

As any engineer knows, it is entirely possible today to produce a system that will monitor important transmitter operating parameters almost continuously; that will initiate corrections when they stray beyond limits, or shut the transmitter down if a fault makes automatic correction impossible; and that will log the whole process with great accuracy. In other words, this automation can provide close supervision.

### **Automated Supervision**

Automated supervision is certain to be opposed at first glance by many broadcast engineers, who will view it as a threat to their jobs. It seems more likely in the long run, though, to require—in most radio operations—even more technical expertise and time than is currently needed. Successful and acceptable automated supervision will require a high order of reliability and stability. This means thorough main-

tenance and frequent calibration, and this can't be done by the usual announcer-with-a-ticket.

While automated supervision may displace a few engineers with little to do but transmitter watch, it will free many more to concentrate on the technical functions that they must slight today because a shift interrupts their productive efforts. It also will go far toward upgrading broadcasting in general, because it will replace the rather careless supervision common to most non-technical ticket-holders.

Tomorrow's completely automated operation will, of course, incorporate some form of overall control by computer. Programming, technical operation, logging, billing, traffic payroll—practically everything but selling, and maybe some of that—will be computer-directed. In smaller operations, this may be accomplished through a tie line to an outside commercial computer facility, which can handle the whole thing while it also is serving other clients.

In any event, computer control will lead the engineer deeply into digital circuits and interface equipment. The knowledge and time that he must bring to this certainly will greatly increase his value to his operation. Again, the engineer who fails to educate himself toward the future soon will find himself to be obsolete.

### **Association Challenge**

One possible source of continuing education is the engineers' association, of which there are many. It also is a possible source of many other member benefits, but unfortunately many associations are marginally effective, especially when it comes to promoting engineers' non-technical interests.

Generally, broadcast engineers are a pretty disunited lot. This arises naturally from their typical working conditions. Particularly in radio, the engineer works solo. He may chat a few moments with another engineer as shifts change, or—in a one-station market—he may be the **only** one for miles around. Either way, he's led by circumstance down the path of individualism.

Associations of broadcast engineers at local, regional and national levels could be influential in formu-

lating and promoting policies that would attract members and further their collective interests. In other words, such associations should concern themselves with more than just technical and organizational topics.

If associations are to develop this character, they must have the active support of individual members. The engineer who feels a need for effective organization needs to seek—or found—a local association, **and then participate actively.**

Associations can't be formed in the smaller markets of one, two or perhaps three broadcast engineers, of course. But most are within an hour's drive of a multi-station market. There, with the support of members (from both radio and TV) from surrounding towns, a local organization can develop its potential. Given strong associations in the larger markets across the nation, the foundation is laid for the commanding national voice that broadcast engineers presently lack. The benefits both to engineers and to station managements (in terms of better engineering) could be substantial.

An allotment of some of an engineer's time for periodic refresher sessions in an operation using non-technical operators would be a worthwhile investment. The reward would be consistently better technical performance—and a greatly diminished risk of FCC censure. Surely this is worth something to management! ▲

**In the final installment of this series, which is one part longer than we had anticipated, Mr. Coddington will briefly discuss the management viewpoint. Obviously, unless an objective stance is taken by engineers and managers, both will lose.**

**Where automation is concerned, there is little doubt the engineer cannot quit work and go back to school for training. Management, if it is at least going for equipment insurance, must participate in the expense sharing process.**

**Meanwhile, engineering sessions at seminars and conventions must completely screen out the "how great I am" papers and replace them with "how great you need to be" papers.**

**The Editor,**

## Riding Church Remotes

A large percentage of the country's stations broadcast a local church service each Sunday morning as one of the station's many contributions to its community.

For many years engineers have been attending church services to "ride the gain" on the weekly remote. More recently many stations have turned to a wide-dynamic-range transistor preamplifier installed in the churches. On one-mike-only remotes, the gain riding has been done at the control room. (Sometimes even by the automatic gain control station amplifier!) The advantage of the solid state units lies in their ability to run forever without heating problems, so they have been left on permanently.

Now, a new approach to the church remote is being used by a few stations. It couldn't be dependably used in the past because of the limitations of the art and the lung-power of preachers. Today, most churches are realizing that strategically-installed microphones and a good public address system is necessary because congregations are becoming accustomed to the PA approach in other walks of life. Most of these installations are quite good quality using acceptable microphones and well-designed layouts. Most compare favorably with frequency range and noise characteris-

tics expected from broadcast remote gear. So why not make use of them and take the burden off the poor engineer who has to go out each week and make a new church installation?

Figure 1 diagrams a typical installation which works very well. Since the secondary of the average PA output transformer is grounded to the chassis, the isolation audio transformer is necessary about 90 percent of the time. It is possible to buy good ones for little money now and they are easily obtainable. The value of the pad between the remote line and the isolation transformer will depend upon the application. A large church with a powerful amplifier will, naturally, need to be padded down more than the output from a small amplifier.

It's easy to put a meter on the line after the installation is made and watch the peaks on a typical service. Of course some one or some thing will be needed to ride the gain at the station end of the line, but the problem of someone forgetting to turn the remote amplifier on before the service, is automatically solved. The installation can be made permanently and the connection can usually be left to the telephone terminals at the church, so that each month or week, when the telephone company makes the change from

one church to the next, no station engineer is needed to make the set-up. (A test of course should be made after the installation and before the first use of the loop.)

In many small communities as many as 75 percent of the churches broadcasting have permanent PA installations which can be utilized in this way. The cost of the installation one time is a fraction of the cost of a new remote setup for each remote broadcast and the station engineer's time is conserved.

**Phil Whitney**  
**General Manager**  
**WINC**  
**Winchester, Va.**

## Revamp The Console To Simplify Operator Programming Tasks

Our on-air console, although a custom console, is quite similar to the commercially available consoles manufactured by Sparta and others. Our aim was to simplify the technical operation as much as possible, in order to free the combo man for the more creative task of programming his show.

These consoles incorporate an extra set of contacts on the audition-off-program switch for speaker muting and on-air lights. Unless you have an absolutely noise-free studio, the announcers usually turn the switch on and then open the pot to avoid the sudden rush of background noise. This makes turning on the microphone a two-step operation.

We transferred the leads for the muting function from the extra contacts on the audition-off-program switch to the contacts of the click-cue switch on the microphone pot. Now, merely opening the pot mutes the speakers, turns on the on-the-air lights, and of course puts the microphone on the air. In addition to simplifying the operation (for which our announcers are very grateful), it eliminates the possibility of producing the irritating squeal of feedback through the cue system if the microphone pot is accidentally clicked to cue.

This system necessitates moving the speaker mute contacts from NC to NO contacts, and on-air lights

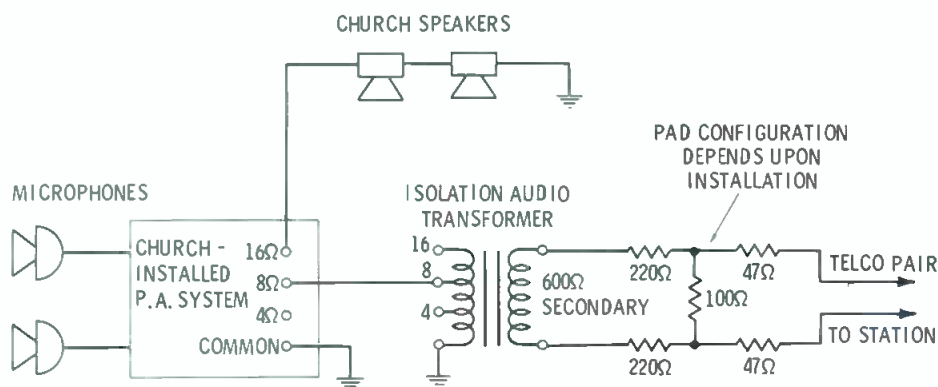

Figure 1

# Gainsmanship

...the art of broadcasting the maximum radiated signal without distortion, thumping, pumping or other undesirable effects. Automatic Level Controllers made gainsmanship possible. CBS Laboratories developed the original Audimax Automatic Level Controller more than 10 years ago and has been the leading supplier to the industry ever since.

Now, the new Audimax 4440—fourth generation Audimax—gives the industry new standards—adjustable recovery time, expanded return-to-zero function, long life Tantalum capacitors, space-saving slimline design and money saving add-on stereo capability.

You can set new standards of gainsmanship—  
increase your market coverage—improve quality.  
Write for full details or call to order (203) 327-2000.

Model 4440—Price \$725    Model 4450 (Stereo)—Price \$1,295



## CBS LABORATORIES

A Division of Columbia Broadcasting System, Inc. 227 High Ridge Road, Stamford, Connecticut 06905

Circle Number 24 on Reader Reply Card

## Engineer's Exchange

(Continued from page 50)

from NO to NC contacts, as the relay will now be pulled when the microphone is off. Alternatively, in a station where there are many functions controlled by this switch, an inverting relay may be added or the switch on the rear of the microphone pot can be changed from the 'spot-killer' type supplied to an ordinary 'on-off' type.

Additionally, we wired the inverting relay to the remote control cir-

cuit of one of our record tape decks through a disabling switch. This allows our announcers to make automatic air-checks to keep tabs on their performance without the bother of having to turn a tape deck on and off every time they go on mike.

**Randy Mayer**  
**General Manager**  
**Station WHCN**  
**Hartford, Ct.**

## What Do You Do With Poor Quality Religious Tapes?

Many of us have to contend with rather poor quality tapes provided by clients. An example may be religious programming prepared by non-technical personnel.

Consider the following comedy of errors:

Before taping, the client treats his tapes with a portable eraser, creating "erasure spokes."

He tapes his show at a low level on a quarter-track home type recorder. Your board operator plays the program on a professional machine which scans the full width of the tape, cranking up the gain to compensate for the low level.

Your overloads are set up rather tight, as they should be, to protect your modulation transformer. The powerful low-frequency energy in the "erasure spokes" remaining on three-fourths of the tape width, trips the over-load relays, putting your man off the air.

You receive a frantic phone call and spend part of your Sunday off in fruitless trouble-shooting of the transmitter, which was OK all the time!

These erasure spokes usually appear twice in each revolution of the tape reel and are inaudible at normal playing speeds; however they are apparent on the VU meter and in the cue speaker during fast-forward or rewind.

(A bad tape with a high hiss level can also produce a whistle around 30 kHz on each side of your carrier and possibly get you in trouble with Uncle.)

What to do? That decision rests with the business department which must decide whether to cancel the show, buy you a special machine to play it on, or encourage the client to furnish full-track tapes.

**Ted Shireman**  
**KALI Radio**  
**San Gabriel, Calif.**

---

Send Your  
Exchange Ideas  
to Broadcast Engineering  
Yes — We Pay

---

The incomparable  
new

**Ten70**



**World's finest  
cartridge tape  
equipment**

Here is the bold new standard in cartridge tape performance, versatility and ruggedness—the equipment that has *everything!* Five models of the magnificent Ten/70 are offered to meet every recording and playback application. All have identical dimensions. Any combination of two will fit in our sleek 19-inch roll-out rack panel, just 7 inches high.

Control features and options include manual high-speed advance, exclusive Auto-Cue with automatic fast-forward, automatic self-cancelling record pre-set, front panel test of cue and bias levels, built in mike and line level mixer, color-coded design for easiest possible operation.

Inside is a massive U.S.-made hysteresis synchronous "Direct Drive" motor, solid state logic switching, modular construction and premium components throughout, separate heads for A-B monitoring, full bias cue recording, transformer input and output, flip-top access to heads and capstan.

**THE CLASSIC 500 C SERIES.** Long the industry standard, SPOTMASTER'S 500 C series is still offered. Performance and specifications are second only to the Ten/70.

For complete details about SPOTMASTER cartridge units (stereo, delayed programming and multiple cartridge models, too), write or call today. Remember, Broadcast Electronics is the No. 1 designer/producer of broadcast quality cartridge tape equipment . . . worldwide!



**BROADCAST ELECTRONICS, INC.**

A Filmways Company

8810 Brookville Road, Silver Spring, Maryland 20910 • (301) 588-4983



# Everything in Modulation



With the new CBS Laboratories Volumax 4000 automatic peak controller, the broadcaster, for the first time, has the ability to use all the modulation his transmitter can take while maintaining the highest signal quality ever attainable. The Volumax 4000 combines all the achievements of earlier Volumax models with new slimline design and silent automatic speech asymmetry control.

That's everything in modulation. . . .

Priced at \$725. That's everything in moderation.

Write or call to order (203) 327-2000.

## CBS LABORATORIES

A Division of Columbia Broadcasting System, Inc. 227 High Ridge Road, Stamford, Connecticut 06905

Circle Number 38 on Reader Reply Card  
[www.americanradiohistory.com](http://www.americanradiohistory.com)

# NEW PRODUCTS

(Use circle number on reader service card for further information)

## TV Camera Lines Blossom

A new 9" viewfinder camera has been developed by **Riker Video** for use in broadcast, education and training studios.

Designated Model TVF-9/14, the new viewfinder camera is complete with an 8507A vidicon. It is compensated to provide 100% ampli-

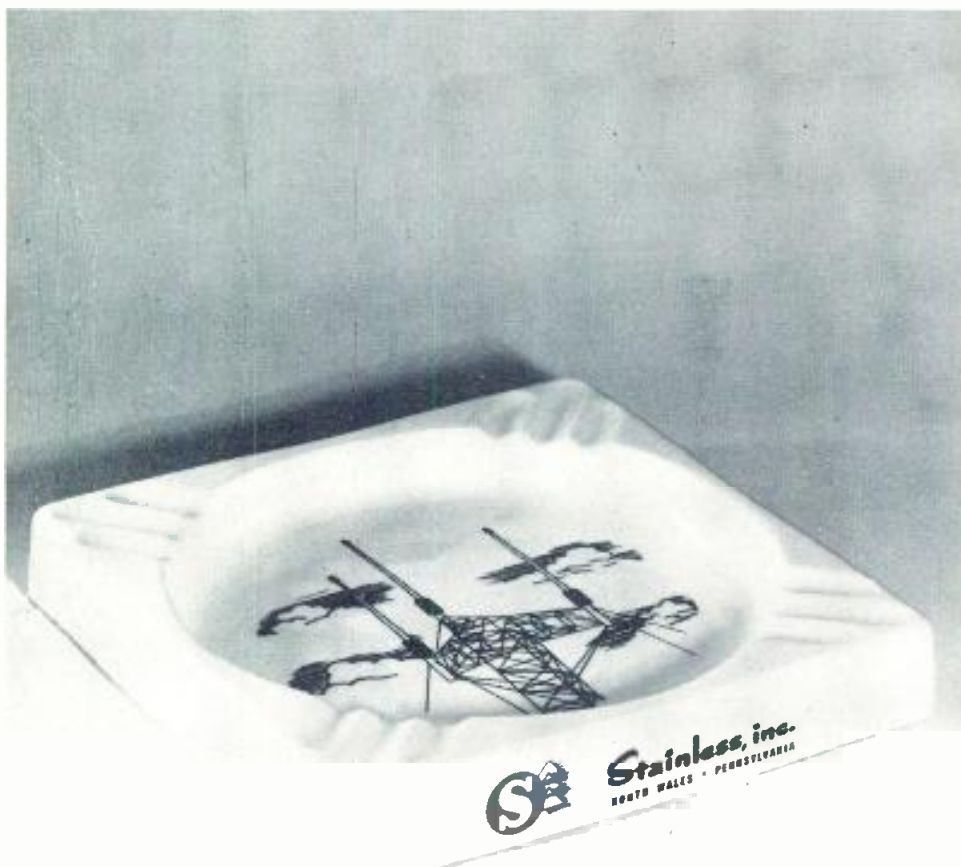

## our ashtrays tell quite a story!

Stainless ashtrays . . . You'll find them all over the world.  
And you'll find Stainless tall towers all over the world, too.  
Now, over a thousand ashtrays later, there's a lot of Stainless tall towers around.  
Call us for a conference. Who knows—  
you may leave with a Stainless Tall Tower . . . and an ashtray!

**STAINLESS, INC.** North Wales, Pennsylvania 19454 • Telephone—(215) 699-4871  
In Canada: Walcan Ltd., Toronto 12, Ontario  
Tall Towers for TV, CATV, ETV, Radio and Microwave

Circle Number 37 on Reader Reply Card

tude response at 500 TV lines, with limiting resolution in excess of 900 lines.

According to George Foster, Riker Marketing Manager, uncompensated cameras provide less than 40% amplitude response at 500 lines resolution.

The new TVF-9/14 is compact and light, weighing only 34 pounds. Thus, it can be handled easily on a "cam link" head and is suitable for field use as well as studio operation.

The 9" viewfinder monitor provides a full 600 line resolution, showing the scene in far greater detail than ordinary low resolution monitors.



The TVF-9/14 is completely self-contained. No separate camera control unit is required but a local/remote switch is provided to facilitate remote control. Options include full EIA RS-170 sync, a convenient side zoom control, crystal controlled RF output, and a wide choice of vidicon and Plumbicon (R) pickup tubes. Built-in AGC, which keeps contrast levels stable through a wide range of scene brightness changes, permits simplified Plumbicon operation.

Top and rear tally lights, plus intercom jacks are standard features. The TVF-9/14 lists for \$2575, and is available for immediate delivery.

Circle Number 60 on Reader Reply Card

### TV Camera

The Dage 800 television camera, a unique new modular design for maximum versatility, was announced by Gene Reich, manager of the Dage products section of **Visual Educom Inc.**

Compact and self-contained, the 15-pound Dage 800 camera has streamlined, modern design which enhances its appearance. It is switch-selectable for random inter-

BROADCAST ENGINEERING

lace or external drive. A third position of the switch selects another drive model, which can be crystal-driven horizontal, 2:1 interlace, or EIA RS-170, depending on the sync generator mode desired. Sync generator cards are plug-in modules and can be interchanged with the camera control unit to provide a wider range of operating modes. The camera is convertible to 525/60, 625/50, 873/60, and 945/60 line-scan rates.

Use of video amplifier with a bandwidth greater than 13 MHz provides a high-quality, 850-line resolution picture. An FET cascode front end in the video amplifier provides the best possible state-of-the-art signal-to-noise ratio of 40 dB.

Rear-mounted controls include beam, target, focus and blanking level. If the camera is switched to remote-control operation, the controls on the rear of the camera are non-interrelated with those on the camera control unit.



Dage's 800 camera is the basic module in a versatile TV system expandable to any level of sophistication desired. It can be easily converted to a viewfinder camera with the addition of the optional button-viewfinder. No additional parts are required to make this change. The seven-inch viewfinder can be ordered with the camera or added later. A viewfinder selector switch allows the camera operator to select either camera video, external input video, or a super of both to assure proper picture line up before going on-line. A large tally light on the camera is visible from any angle.

Another option which can be added later is the waveform sampler. With this addition, the waveform is displayed on the viewfinder at all times so that the cameraman can constantly monitor his video output.

Circle Number 61 on Reader Reply Card

Never let it be said:

**“BULOVA  
wouldn't give you  
the time of day!”**

**Never!** Because with a Bulova T-O-D System you can have a primary frequency standard, and a secondary standard for backup, plus automatic emergency switchover to power line frequency, or additional automatic switchover to battery power in the event of power line failure. You buy as much or as little of this optional backup as you require, and you can expand the emergency system in the future.



**Flexibility is the keynote.**

Your modular frequency stabilized system can be designed to control from one to 500 clocks. You can add digital or synchronous clocks as your needs grow.

The frequency standards, correction electronics, power supplies and clocks are all put together for you by the skilled Bulova team, using experience gained in over twenty years of aerospace technology and almost 100 years of providing accurate timekeeping, culminating

in the Accutron®. Experience that provides you a standard stability of plus or minus one second per year!

Learn more about how a Bulova T-O-D System can keep your air time accurate. It can save time and money, avoid late cues and costly make-goods.

One more point. Will it last? All Bulova T-O-D Systems have an anticipated trouble-free life of 20 years!

Write for complete information and specifications —



**BULOVA** AMERICAN TIME PRODUCTS

Electronics Division of the Bulova Watch Company, Inc.  
61-20 Woodside Ave., Woodside, N. Y. 11377 (212) 335-6000

Circle Number 25 on Reader Reply Card

## New Products

(Continued from page 55)

**Angenieux Corporation of America** now has available two completely motorized zoom lenses for vidicon cameras which can be remotely controlled up to a distance of 1,000 feet. The 4x20BT, 20-80mm, f/2.5, and the 10x15BT, 15-150mm, f/2.8, both motorized for all three functions (zoom, focus and iris), are available to fit all vidicon cameras with standard "C" mounts.

Added flexibility is provided for both lenses by the application of range extenders and a Retro-Zoom attachment.

By the use of range extenders, the 4x20BT can be converted from 20-80mm to either 30-120mm (with a 1.5X range extender) or 40-160mm (with a 2X range extender). A Retro-Zoom attachment, which fits over the front of the lens, changes the focal length to 14.5-58mm. By applying both the range extender and Retro-Zoom attachment, the focal length can be further changed to either 22-88mm by

## Motorized Zoom Lenses

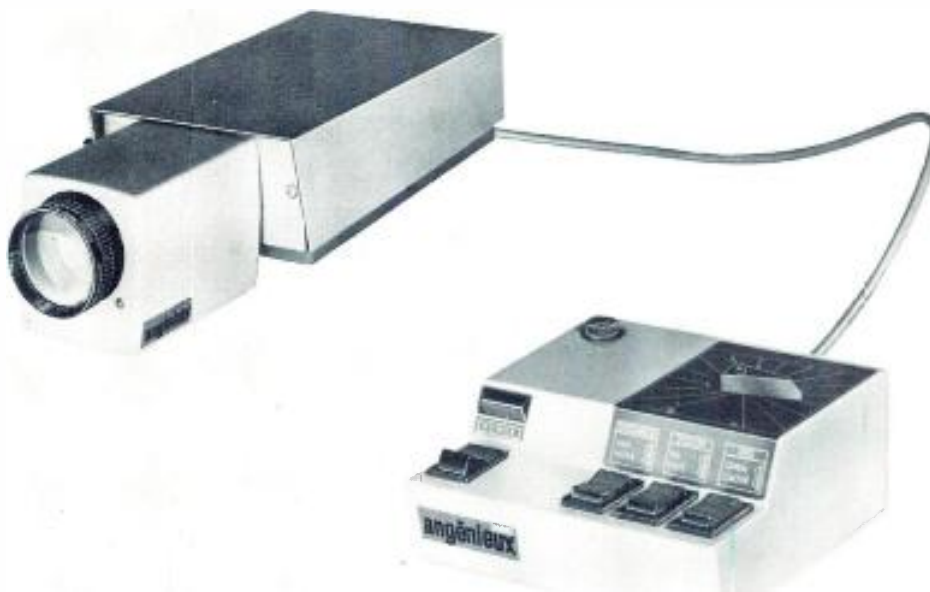

using the 1.5X range extender with Retro-Zoom or 29-116mm with the 2X range extender and Retro-Zoom. Focusing is as close as 2 feet when using the Retro-Zoom attachment. Accessory close-up lenses allow focusing to 20 inches.

The 10x15BT can be utilized as a 22-220mm zoom lens by adding a 1.5X range extender or a 30-300mm focal length by using the 2X range extender. Focusing without attachments is as close as 5 feet. Close-up lenses permit focusing as close as 22 inches.

The remote-controlled unit allows operation of the zoom lens under certain circumstances where it is not possible or desirable to have an operator near the camera. The zoom control unit has a speed range of 4 to 40 seconds. A special clutch arrangement provides an immediate stop of focus, zoom and iris motors without slowing down.

The flexibility of these lenses make them ideal for closed circuit television applications, especially industrial and CATV applications.

Circle Number 62 on Reader Reply Card

### Zoom Lens

**Canon, U.S.A., Inc.** has announced two new additions to their extensive professional photographic equipment line; a 12-120mm f 2.2 macro-boom fluorite lens and a single system Sound Scoopic 200 16mm motion picture camera.

Available the first of the year in the most reflex mounts, the macro-zoom lens features two solid calcium fluorite elements incorporated in the front component group. "Fluorite", according to Hirofumi Watanabe, Sales Manager of Canon, U.S.A., "has the ability to bring

## REELS & SPOOLS



## FOR CABLE HANDLING

No matter what type of cable you use, Hannay offers the widest range of reels and spools for live cable handling or storage. All reels are available with manual or power rewind options to make your job easier.

Send for Catalog H-7001-EC for detailed specifications and prices.



Circle Number 26 on Reader Reply Card

### Broadcast Engineering

To—

About

For—

The  
Broadcast  
Engineer.

Use It.

Read It.

Let's hear  
From you.

all the rays of the spectrum into, or very close to, the same plane of focus. In this way it completely eliminates chromatic aberrations and renders a higher degree of resolution than has yet been achieved by a 12-120mm zoom lens for 16mm cinematography".



A light, self-blimped body, fully automatic through-the-lens metering with manual override, registration pin movement, behind-the-lens gelatin filter slot, twin modular sound heads and a new formula 12.5-75mm f 2.5 zoom lens are the main attributes of Canon's entry into the single-system-sound on magnetic-stripped-film market.

Circle Number 63 on Reader Reply Card

#### High Power Sound Amplifier

The LT-3500 High Power Commercial Sound amplifier, introduced by **McMartin Industries**, features a continuous rating of 350 watts (RMS) with a paging and program service rating of up to 425 watts, the LT-3500 is the most powerful amplifier available for commercial sound applications.

Reliable operation is assured by the M\*GARD electronic fuse which has a five (5) microsecond response time for automatic compensation for transient voltages from lightning, switching and full output power and power surges. Separate AC and DC fuses guard against power supply malfunction and routine servicing is facilitated by swingout service

panels on both the front and rear of the amplifier.

Horn loudspeakers are fully protected and high frequency oscillations eliminated by an internal low pass/high pass active filter. Either segment may be switched in or out to tailor frequency response.

Circle Number 64 on Reader Reply Card

#### Time-Of-Day Systems

American Time Products of the **Bulova Watch Company, Inc.** offers a new series of frequency stabilized

master time-of-day systems. These systems are used to provide accurate time on a series of clocks in such installations as radio and TV studios, industrial plants, railroad and airline terminals and aboard ship.

A typical system consists of a primary frequency standard, correction and switching chassis, power supply and synchronous clocks. A master digital clock reads out the time to the nearest second. Where

(Continued on page 58)

# NOW! TOTAL CAPABILITY WITH THE FAIRCHILD INTEGRA II SYSTEM!

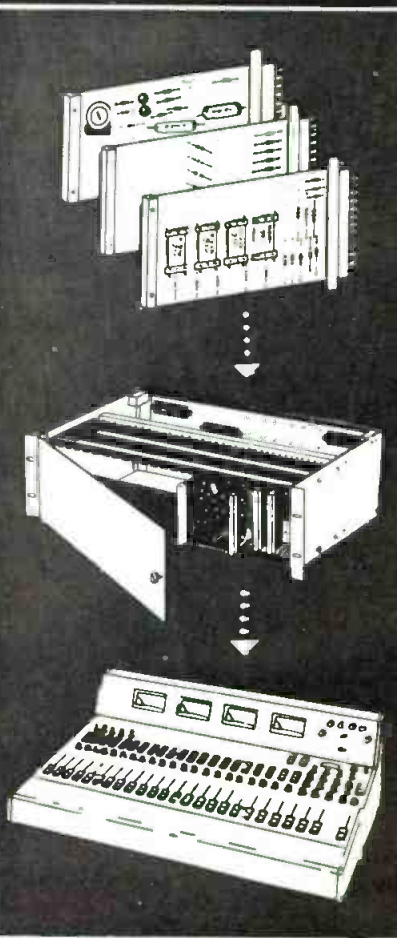

**Capability No. 1:** Easily integrated audio components.

**Capability No. 2:** Simple and efficient construction.

**Capability No. 3:** Practically any complex audio system can be designed.

**Capability No. 4:** Remote control of audio functions (optional).

**Capability No. 5:** Solid-state technology provides compact, efficient, convenient and economical audio control.

**Capability No. 6:** Unmatched convenience in maintenance.

**Capability No. 7:** Advanced light-controlled technology

**Capability No. 8:** Complete freedom from contact noise, distortion, frequency discrimination and mechanical problems.

**Capability No. 9:** No se-free and bounce-free perfect switching.

**Capability No. 10:** Space-age standards of component design and manufacture assure highest reliability.

**Capability No. 11:** Complete line of accessories.

**Capability No. 12:** Compatible with your existing equipment.

For complete details and new colorful Integra II brochure write to:

**FAIRCHILD** Sound Equipment Corp.

10-40 45th Avenue Dept. BE-2 Long Island City, N.Y. 11101

Circle Number 27 on Reader Reply Card

(Continued from page 57)

necessary, standby secondary standards and power supply can be supplied. In case of malfunction, the system will automatically switch to a secondary standard or standby power supply. Correction of all clocks, if necessary, is done semi-automatically with an accuracy of 0.1 second.

Systems are available to drive up to 500 synchronous clocks with an accuracy as great as plus or minus one second per year. Automatic alarm and indicator lights are standard. Provision to operate from batteries is available in case of power failure. Modular construction allows for expansion and improvement as needed.

Circle Number 65 on Reader Reply Card

#### Attenuators For CATV

Distortion-free AC signals, 0-300 MHz, for CATV or audio distribution systems is now provided by a 75 ohm plug-in "T" Pad, only .375" in diameter and .473" high, developed by **Aerovox Corporation**. Incorporating a thick-film cermet resistive element, the design pro-

vides minimum inductance with improved stability.

Units are available in a range of 11 values from 0 to 15 dB. Signal levels are determined at each CATV/CCTV or audio installation



by simply plugging in the proper Aerovox "T" Pad. Tolerances are  $\pm 0.05$  to  $\pm 1.0$  dB, depending on unit.

The plastic-cased plug-in unit mounts in the standard TO-5 base having 200" pin circle. Its gold plated half-hard corrosion resistant brass pins have rounded tips for easier insertion and minimum wear to the mounting socket.

Compact and stable, the relatively inexpensive "T" Pad is installed in PC boards to replace standard carbon composition components, especially in automatic control circuits where attenuation is needed over the frequency range from 0 to 300 MHz.

Circle Number 66 on Reader Reply Card

#### Cross Mod Analyzer

**Kaiser CATV** has introduced a Cross-Modulation Analyzer which provides modulated or unmodulated signals for testing on up to 32 channels. Such characteristics as cross modulation, second order distortion products, signal to noise ratio and hum modulation can be accurately measured by the analyzer in its various modes of operation.

The Model KTSS-NCTA Cross-Modulation Analyzer consists of a main frame containing an internal modulation oscillator, external modulation signal processor and AC power distribution. To the main frame are added module frames as required for the number of channels desired, up to a maximum of 32 channels.

## COOKE ENGINEERING..... QUALITY IN COMMUNICATIONS

### MULTI-CIRCUIT JACK



- The Multi-Circuit Jack — MCJ-12 is a 12-circuit self-normalling jack.
- It eliminates costly circuit duplication.
- Transfers are made by means of a 12-circuit patchcord.
- 16 jacks may be mounted in a standard 3 1/2" x 19" panel.
- Patch-cord is completely shielded.
- Entire jack may be unplugged from its cover without disturbing external wiring.
- Ask for complete technical information.

ALSO AVAILABLE IN 6-CIRCUIT NORMAL-THROUGH COAXIAL.

### COTERM® & COPATCH®



- If high-density is what you need in a patchfield, COTERM® and/or COPATCH® will meet the most critical demands.
- COTERM® 22T is a reliable non-normal-through switching and line terminating jack.
- COPATCH® 2-2A will handle two stand-by source circuits in their proper impedance. It is a non-normalling terminating coaxial patch jack.
- Complete technical information available. COTERM and COPATCH are registered trademarks.

### TWINAXIAL JACKS



- TwinTerm 20T: Self-normalling and self-terminating.
- TwinJax 20B: Self-normalling.
- TwinPatch 20: Dual jack, non-normalling, non-terminating.
- Available for use with standard 78, 95, and 124 ohm balanced cables.
- Accepts standard available twinaxial connectors on rear for permanent cabling.
- Bridging test probe for monitoring normal-through CRTS without interruption.

Rep. Inquiries Invited.

## COOKE ENGINEERING

900 Slaters Lane • Alexandria, Virginia 22314 (703) 548-3889  
A Dynatech Company

Each module frame accepts up to eight plug-in RF channel generators, and provides the necessary power, modulation signal and RF combining for the modules. The RF modules are crystal controlled and may be individually operated in an OFFF, CW, or Square Wave Modulated Mode. Design of the modules and the combining technique employed yield a high degree of isolation and freedom from spurious outputs.

Circle Number 67 on Reader Reply Card

### New 16-Track Recorder

Scully division of Dictaphone Corporation has announced a new 16-track studio tape recording system priced, it said, well below comparable systems on the market.

One of the principal features of Series 100, which will market for \$13,750, is a new combination record/play head design which

Scully claims eliminates the need for a separate playback head and the complicated switching involved in overdubbing.

While accessories have been eliminated, the company said, if wanted they are available as optional equipment.

The new head as design eliminates sync problems, according to Scully, and there is no switching noise. You can punch in and out without worrying about transient noise. What's more, the recorder can go from play to record to sync with no measureable difference in performance.

The circuit design, Scully notes, has reduced the space required for electronics over previous equipment by 90 percent.

According to the company, the Series 100 features easy tape handling. The tape transport, which em-

*(Continued on page 60)*

### Bi-directional Amps

A complete in-system line of two-way, solid state, wideband amplifiers by Electronic Industrial Engr., Inc., is designed to extend bi-directional options of existing installations or new construction for new services such as studio to headend or local origination.

All modular, the equipment includes trunk, trunk bridge, distribution and multi-set amplifiers that can be used in single or dual cable systems or in a combination instal-

lation with use of the 24 channel, in-system converter. The bi-directional capabilities are from 10 to 30 MHz.

All models are contained in a heavyduty RFI shielded housing designed to accommodate future modular adjustments and changeouts. Hermetically sealed, the units meet all weather and environmental conditions. Other features include: surge and lightning protection; built-in taps; sealed entry connectors; tilt compensated gain.

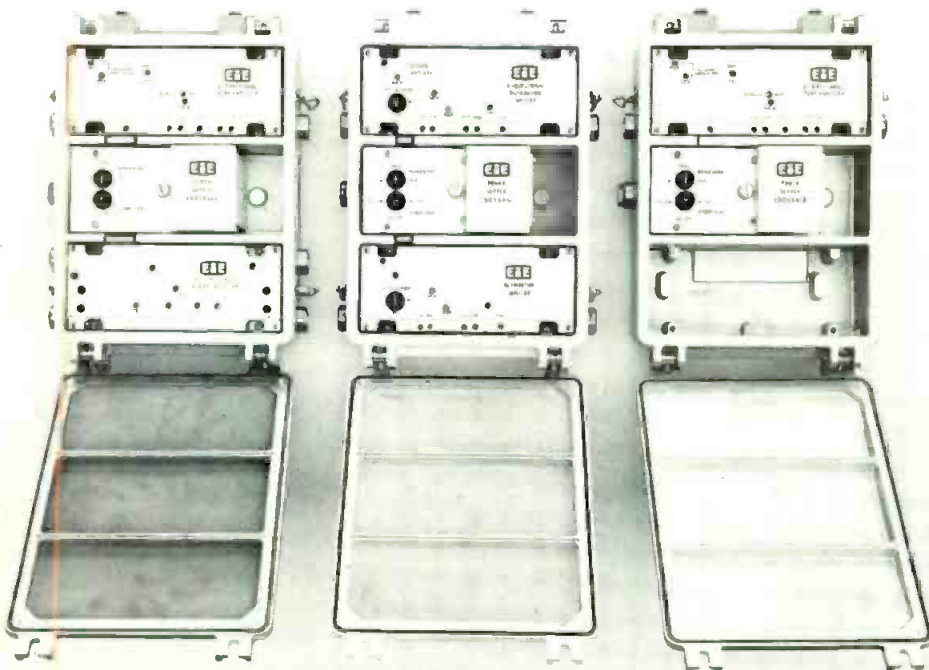

Circle Number 68 on Reader Reply Card

Number 84 in a series of discussions  
by Electro-Voice engineers



It is now possible and practical to program 4-channel source material on any existing FM stereo station. The broadcast is compatible with all current stereo and mono receivers.

The means is provided by the Model 7445 Electro-Voice 4-channel encoder. The device is simple and straight-forward. Requiring but 5 1/4" rack space, it is designed to accept 4 600-ohm balanced line inputs. Outputs are a pair of 600-ohm balanced lines, properly encoded for compatible 4-channel stereo broadcasting or recording. There is 0 dB gain, and no adjustments are required.

Only two switches are provided: on-off, and meter switching. Four standard VU meters allow monitoring the levels of all four inputs simultaneously, or the output levels of the two encoded channels. Set-up simply consists of providing appropriate external switching or patching of the encoder between the four-channel source and the multiplex generator.

The encoder can be inserted at any point in the reproducing chain, but it is suggested that it directly follow the four-channel source (usually a tape recorder or live studio) to simplify subsequent signal switching. The encoded signal can be handled exactly like a normal stereo signal and bandwidth, level, noise, and other signal characteristics remain unaltered.

The all-silicon solid-state construction meets strict broadcast standards and conventional discrete components are used throughout. Measured noise level is 70 dB below 0 dBm. Conservative design permits overloads up to +24 dBm with no more than 0.5% distortion.

Listeners with normal mono or stereo equipment will hear no significant change in signal quality or strength. And those listeners with the Electro-Voice Stereo-4 decoder\* (plus an additional stereo amplifier and speaker pair) will enjoy the benefits of four channel reproduction.

First encoders are now being delivered and decoders are in active production by Electro-Voice. In addition, many other firms are planning decoder production, either as separate units, or integrated into standard stereo receiver design.

\*Patents on Stereo-4 system applied for.

For further information on 4-channel stereo, or technical data on any E-V products, write:  
ELECTRO-VOICE, INC., Dept. 213V  
638 Cecil St., Buchanan, Michigan 49107

**Electro-Voice**  
a GULTON subsidiary

Circle Number 28 on Reader Reply Card

(Continued from page 59)

employs 2-inch tape, utilizes HTL (High Threshold Logic) integrated circuits. "The system is totally spill-proof," Scully said. "The operator can switch from any mode to any other without any problem." He added that the new recorder also offers a new cue mode and tape lift capacity in play mode.

The company also announced that an 8-track version is available and is priced at \$11,250. "Since it is the same basic design," Scully explains, "It can easily be converted to a 16-track system if needs change."

Circle Number 69 on Reader Reply Card

### Time Signal Receiver

A compact, lightweight fixed frequency, radio receiver which provides absolutely accurate voice time signals on a continuous basis, has been developed by **Coast Navigation School**, Santa Barbara, Calif.

Termed the Simex Time Standard, this completely new compact radio receiver (overall dimensions, 4"x8"x8") represents a breakthrough in the field of time signal monitoring. With it, one can receive an immediate voice time signal broadcasting Greenwich Mean Time anywhere in the world by simply turning the unit on.

The receiver operates on fixed frequencies at 2.5, 5, 10, 15, and 20 MHz to receive signals from WWV in Fort Collins, Colorado, and WWVH in Hawaii. An additional special frequency at 7.335 MHz provides for signal reception from Station CHU in Ottawa, Canada. (The Canadian voice broadcasts are delivered in both English and French every minute continuously. American stations broadcast a voice signal every five minutes, with continuous ticks in between.)

Circle Number 72 on Reader Reply Card

### Microphone

**Collins Model M-90** microphone is a highly directional type, ball screen microphone designed to increase working distance yet cut out unwanted background noise.

Ultra-close working distances are possible with no ill effects. An excellent microphone for broadcast or recording applications.

The M-90 microphone features a

### New Video Line

**International Nuclear Corporation**, a pioneer in the manufacture of Video-Broadcast auxiliary equipment, has introduced a new line of solid-state video switchers, video and pulse distribution amplifiers, sync generators and audio equipment. INC's new product line, while meeting the most stringent demands for full color reproduction and the ultimate in professional reliability,

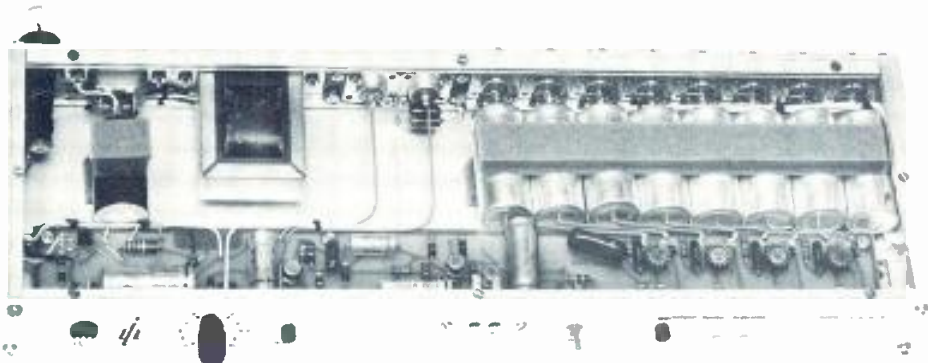

provides the small studio, CATV, Educational Television, CCTV, and others with fine equipment at low cost.

INC's new TDA2-D/8 Video/Pulse Distribution Amplifier and their new TSG-502-LL Sync Generator. The TDA2-D/8 amplifier is compact, completely transistorized, Solid-State, with differential input and 8 Video outputs. It replaces all tube-type amplifiers with no alteration of existing cables.

Circle Number 71 on Reader Reply Card

poptop ball screen with a four-stage blast filter that practically eliminates mike "pop", breath blast, wind noise, and feedback.

Circle Number 73 on Reader Reply Card

### Tape Cart Modified

Criterion 80, the advance design tape cartridge system introduced by **Gates Radio Company** in 1970, has undergone advance modifications. Now any model of the Criterion 80 may be either desk or rack mounted.

Both the basic Playback and Record units are designed for desk mounting . . . with optional rack adapters available for easy conversion to rack mounting. Gates, a Division of Harris-Intertype Corporation, has engineered these modifications to allow broadcasters greater flexibility in the use of Criterion 80.

Backed up by the rugged deck

The TSG-502-LL Sync Generator is a monochrome generator designed for broadcast, CATV, CCTV, ETV and small studio video origination. Switch selected for Bxt. 31.5 KC, Crystal or line lock or drive from INC Model TCS2 Color Standard. Solid-state with integrated circuits, it produces composite sync, composite blanking, horizontal drive and vertical drive signals in accordance with EIA-RS-170 and broad-

cast standards.

Also available is INC's new VMS-110 Video Switcher which provides 12 Videc inputs (6 non-composite and 6 composite inputs); 2 source terminated outputs, program and preview, solid-state video switching and mechanical, illuminated push buttons, mixer/fader control for fade-in, fade-out, lap-dissolve or super-impose two video signals with any desired degree of mixing.

and tape drive assembly, the Criterion 80 has the latest in silicon transistors, plug-in printed circuit boards and independent gain controls for the cue amplifiers.

Other Criterion 80 improvements include: output gain controls accessible from the front panel; automatic audio muting and transient suppression; and latching connectors for all external cables for a more dependable installation.

Circle Number 74 on Reader Reply Card

Send your  
New Products and  
Tech Data to:  
Broadcast Engineering  
1014 Wyandotte Street  
Kansas City, Mo. 64105

BROADCAST ENGINEERING



## BE Extends Coverage Of Communications Books

In view of the ever increasing challenge to the communications engineer and technician, we intend to bring a sharper focus on this column. We cannot hope to bring you all the technological explosion in our articles, so look for more extensive book reviews.

We hope those managers who have a technical kink in their makeup or a full fledged technical background will take time out of their busy schedule to look over some of these books. From time to time we will run reviews that will be especially interesting to the owner/manager.

The newly published volume, **Computer Circuits & How They Work**, helps to understand computers and what they can do. The author, Byron Wels, explains the inner workings of modern computers—computer circuits and how they work.

The book begins with a discussion of how computers work, including the “language” of computers, then proceeds to explain the principles of the central processor, the memory, control section, registers, etc.

The second section deals with comparators, error detection, and parity checking. Section three provides a comprehensive treatment of memories—the types used and how they function. The author describes the various operating modes and various performance criteria, as well as data storage and retrieval.

Section four is devoted entirely to circuits and applications, actual circuits designed to perform a wide variety of functions.

As a help to understanding, the author breaks the field of computer technology down into specific, smaller areas. Then in a step-by-step fashion, he explains how the various parts of a computer work and the technology associated with each part of the function.

The book is available through Tab Books, Blue Ridge Summit, Pa. 17214.

**Case Studies in Broadcast Management** has been written on a series of authentic problems, based on factual situations, which have challenged broadcast managers in recent years. They encourage thinking and discussion (and solving) “real world” problems in commercial radio and television operations. The author, Howard W. Coleman, has divided the text in two parts.

Case Study Problems offers detailed exploration of serious broadcast problems and solutions for far-reaching and long-range planning. It covers problems such as radio audience—where it is and how to enlarge it; station revenue and economy; programming; being independent in a four-station market; and a discussion of what it takes to fill a top management position.

Case Study Profiles, which are based on actual situations and are problems that one can solve quickly, involve potential lawsuits; what is good public service programming and how to accomplish it without losing

(Continued on page 62)

**D. J.'s... Combo-Men...  
Station Managers...  
Technical Assistants...  
Want to move up  
faster in  
Broadcasting?**

### Get yourself a First Class FCC License the CIE way!

No matter what your goals are in broadcasting—no matter which side of the microphone you want to work on—you'll earn more money, and get to do “your own thing” a lot faster, if you've got a First Class FCC License.

If you're a D.J. or Combo-Man looking for a better job and a chance to make a name for yourself—you'll find it's easier to get the spot you want at the station of your choice if you can say that you also have a First Class Ticket. Ask around and see.

If you're a station manager—having a First Class Ticket means you're better equipped both to supervise and to substitute for technical personnel—and to choose and evaluate new equipment. So you're worth more to any station owner.

If you're an announcer, technical assistant—or just an ambitious beginner waiting for a lucky break—you'll find that the “lucky breaks” come sooner if you have something more to offer your employer besides your interest and ambition. And that “something more” that separates the men from the boys in this business—is a First Class FCC License.

You've probably heard that it's very difficult to pass the FCC License exam. For un-trained men, it is hard. In fact, an average of two out of every three men who take the FCC exam fail.

There is one way, however, of being pretty certain that you will breeze through the FCC exam with flying colors. That's to take one of the FCC home study courses offered by the Cleveland Institute of Electronics. CIE courses explain things so clearly that better than 9 out of every 10 CIE graduates who take the FCC exam pass it. That's why CIE can afford to offer this ironclad, money-back Warranty: “A Cleveland Institute of Electronics FCC License course will quickly prepare you for a Government FCC License. If you don't pass the FCC exam after completing your course, CIE will refund all your tuition. You get an FCC License... or your money back!”

With that kind of Warranty you have nothing to lose on CIE training. And everything to gain.

So send today for our FREE booklet, “How To Get A Commercial FCC License.” CIE, 1776 E. 17th St., Cleveland, Ohio 44114.

**CIE** Cleveland Institute of Electronics  
1776 East 17th Street, Cleveland, Ohio 44114



Please send me your FREE book, “How To Get A Commercial FCC License.”

Print Name \_\_\_\_\_

Address \_\_\_\_\_

City \_\_\_\_\_

State \_\_\_\_\_ Zip \_\_\_\_\_ Age \_\_\_\_\_

Veterans & Servicemen: Check here for  
G.I. Bill Information

Accredited Member National Home Study Council

BE-68

Circle Number 30 on Reader Reply Card

(Continued from page 61)

your audience; a discussion of the in-fighting among local media.

The book is available through Communication Arts Books, Hastings House, Publishers, Inc., 10 East 40th St., New York, N.Y., 10016.

**Radio Transmitters** has been written by an experienced radio-transmitter designer of considerable reputation. The author, V. O. Stokes, gives a straight forward, practical account of the design of power amplifiers at frequencies up to 30 MHz for long distance communications and broadcasting. He presents logical reasons for the choice of power level, valve type, circuit configuration and components for various applications, reinforcing these with design examples.

This book will be of use to professional industrial engineers, communications maintenance engineers, post-graduate and senior undergraduate students and ham operators.

The book is available through the Van Nostrand Reinhold Company, 450 West 33rd Street, New York, N.Y., 10001.

**The Technique of the Sound Studio** is a completely revised and enlarged edition of the standard work in the field. The author, Alec Nisbett, has based the new material in this book on his recent experience and research in the areas of stereo, television and film sound, and radio.

The 559-page handbook describes how the highest standards may be achieved not only in the elaborately equipped studio but also with simple equipment out

on location. The book is concerned with general principles and not with the operation of particular items of equipment.

The most important chapters are those on microphone balance of speech and music, but while this is not a technical book (in the engineering sense) there is also a description of the characteristics of studios and microphones, together with some of the other equipment used. There are notes on the control of relative sound levels, on mixing, on the creation of sound effects, on sound quality, and on the editing of sound recordings.

The book is available through Communication Arts Books, Hastings House, Publishers, Inc., 10 East 40th Street, New York, N.Y., 10016.

**Servicing Transistor Equipment** provides a systematic guide to the servicing of transistor radio, television, tape, and high-fidelity equipment. The author, Gordon J. King, puts emphasis on speedy diagnosis of what unit problems.

The author describes semiconductors, transistors, and their operating principles, characteristics, and circuitry. While the text is based on home entertainment equipment, there are meaningful chapters on transistor fundamentals, circuit and transistor tests, and signal conditions and tests.

The book is primarily intended for the service technician; however, it will also be useful to students who are beginning a career in electronics.

The book is available through Hart Publishing Company, Inc., New York City, N.Y.

## ELIMINATE AIRBORNE DUST PROBLEMS ON VTR EQUIPMENT

### New ISOLAIR Unit by Liberty



This unit provides a laminar downflow of the cleanest possible air at the critical video head area. Excessive wear and damage by airborne contaminants are virtually eliminated, extending head life by 100% or more and insuring better overall VTR performance. The elimination of this dust problem by use of the Isolair results in great savings of time and money.

Also, the surrounding area in which an Isolair unit is operating benefits by a progressively reduced level of airborne particulate matter.

Chief engineers who have used the Isolair unit have attested to the multiple advantages provided by this low-cost VTR accessory.

- Meets Federal Standard 209a, Class 100.
- Easily installed and maintained.
- Requires no additional floor space.
- Eliminates need for any other dust control equipment.



FOR FURTHER INFORMATION CALL OR WRITE  
**LIBERTY INDUSTRIES, INC.**

598 Deming Road, Berlin, Conn. 06037  
Telephone (203) 828-6361

Circle Number 31 on Reader Reply Card

## ERASE RECORD REPRODUCE

### MONO - STEREO

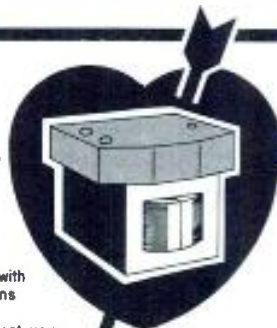

Professional Direct Replacement Heads with complete written and pictorial instructions

Our factory will clean, rebuild, adjust and test your head ASSEMBLY...install new MMI heads...replace minor hardware and modify your gate to accept our "NON-POPPING" springs



36 HOUR SERVICE - LOANERS AVAILABLE  
(612) 884-7393



**MINNEAPOLIS MAGNETICS, INC.**  
8125 PLEASANT AVE. SO., MINNEAPOLIS, MINN. 55420

Circle Number 32 on Reader Reply Card

# TECHNICAL DATA

For further information, circle data identification number on reader service card

**100. AMPEX CORPORATION**—An eight-page color brochure describing the new Instavision color and monochrome cartridge videotape recorder/player for serious closed circuit television and home recording and playback is now available. The Instavision recorder/camera system weighs less than 20 pounds and is designed for use in education, business, industry, medicine, sports and government applications as well as consumer use.

**101. AUDIO DISTRIBUTORS, INC.**—A comprehensive new catalog of Professional Audio equipment and accessories for broadcast and TV studios, theaters, schools, auditoriums, and other such applications is now available. The 128-page publication lists the complete product lines of 58 leading manufacturers of quality sound reproducing, recording, and broadcast equipment. Off-the-shelf delivery is available on most any item listed in the catalog.

**102. BLONDER-TONGUE LABS., INC.**—The complete line of Blonder-Tongue Laboratories home and MATV products is detailed in three new catalogs. The 16-page HOME PRODUCTS CATALOG contains specifications and photographs for mast-mounted preamplifiers, broadband amplifiers, amplified signal dividers, UHF converters, antenna rotators, antennas and miscellaneous home TV system accessories. The 30-page MATV PRODUCTS CATALOG contains detailed information on preamplifiers, broadband amplifiers, filters, traps, multiplexers, tapoffs, MATV electronic accessories and hardware items. Information on the FSM-2 Field Strength Meter and its accessories is also included. The 16-page ENGINEERED MATV SYSTEMS PRODUCTS CATALOG includes specifications, descriptions and photographs of single-channel amplifiers, low-noise preamplifiers, custom converters, tapoffs and the

complete line of Blonder-Tongue 75-ohm test equipment.

**103. CAMBRIDGE THERM-IONIC CORP.**—Cambridge Thermionic Corp. has just published a new brochure covering "Solid State Inductors and LC Filters", the lead item of which is a new solid state inductor, part number 536-2150-01. Advanced in terms of inductor design, the new device provides a lump inductance which is externally variable over an extremely wide range (1 Henry to greater than 100 Henries with higher values possible). Light in weight and pluggable into modern printed and IC circuitry, the inductor is produced in a 14 pin DIP package. Other filters covered in detail in the brochure include 1 MHz and 10 MHz Low and High Pass Block assembly, Band Pass and Rejection, Tunable Band Pass, Variable encapsulated coils (Ferrite and powered iron), toroids and baluns. Operating characteristics and dimensions are provided for all units.

**104. CARBONE-FERRAZ, INC.**—A four-page bulletin describing ferrule and cartridge fuses for semiconductor protection is now available. Construction features and materials are listed, and actual components of a cartridge fuse are pictured (including two macrophotographs of design-production details). Information is included on the TCR (fuse True-Current-Rating) system introduced by C-F engineers to permit checking applicability of a specific fuse in a particular circuit. Rating and dimension details are included for all stock ferrule and cartridge fuses.

**105. CHERRY ELECTRICAL PRODUCTS CORP.**—Everything you need to know in order to specify or order precision electrical switches is included in a new catalog just published by Cherry Electrical Products Corp. Included is a unique Switch Selector-Locator to

simplify selection of any of 24 different snap-action switch types listed in order of electrical rating. The new catalog also covers new Lever-wheel/Thumbwheel switches and Matrix Selector switches.

**106. CHRONO-LOG CORPORATION**—The Chrono-Log Series 8,000 Automatic Tape Search Control is described in a new two-page bulletin. The Tape Search Control, when used with a Chrono-Log Time Code Reader, permits automatic searching and retrieval of data from analog tapes. The bulletin gives complete technical data and

(Continued on page 64)



*Spotmaster*

## TP-1B Tape Cartridge Winder



This rugged and dependable tape winder fills a need in every station using cartridge equipment. No longer is it necessary to restrict your cartridge operation to stock sizes, or to tie up your conventional tape equipment loading cartridges. The TP-1B handles all reel sizes (up to 3600' of 1 mil tape), winds new or old cartridges in any length. Available with or without Spotmaster tape timer, providing precise minute and second calibration for creating exact-length tapes. TP-1B is \$104.50, with Tape Timer \$129.50. Lubricated tape and empty cartridges are also available.

**BROADCAST ELECTRONICS, INC.**  
A Filmways Company  
8810 Brookville Rd., Silver Spring, Md. 20910

## FREE CATALOG

### HARD-TO-FIND PRECISION TOOLS

Lists over 1700 hard-to-find tools used by electronic technicians, instrument mechanics, engineers, and scientists. Included are many types of pliers, tweezers, wrenches, soldering irons, wire strippers, relay tools, watchmakers tools, drills, precision grinders, files, optical equipment, lighting, vacuum systems, tool cases, and tool kits. Included also are a solder section and four pages of useful "Tool Tips" with valuable data on fasteners, color coding, drill and metal gauges, insulation facts, and tool selection. Write today for your free copy!



**JENSEN TOOLS and ALLOYS**  
4117 N. 44th Street, Phoenix, Arizona 85018

Circle Number 34 on Reader Reply Card

(Continued from page 63)

describes the operation of the Tape Search Control Unit in detail.

**106. COHU ELECTRONICS, INC.**—Distinctive features of the new Cohu 9300 Series production video switcher are listed in detail in a six-page, two-color technical data sheet (6-556). Details include two basic switchers with 14 and 21 inputs, block diagram, photographs and technical specifications.

**107. CTS CORPORATION**—CTS E-element crystals, which are well suited for filter applications, are described in new CTS Data Sheet E-100. These units have a low capacitance ratio and frequencies range from 70 to 250 KHz depending upon holder size requirements. The low electrical impedance and turning point in the room ambient temperature range also makes the E-element useful as a non-ovenized resonator in low frequency oscillators. Data Sheet E-100 contains complete characteristics for 24 standard CTS designs.

**108. ELECTRONIC ENGINEERING COMPANY OF CALIF.**—Computer Equipment Div. A new eight-page bulletin

describes use, compatibilities and general specifications of EECO's line of disc memory controllers. Designed to provide mini computers with low cost control and access to disc drives, three basic EECO Disc-controller models are described—ranging from a single disc drive control and 6.8 million data bytes storage to control of four disc drives with a 108.8 million data byte storage capacity.

**109. FAIRCHILD SEMICONDUCTOR**—A new 12-page brochure from Fairchild describes the company's TO-92 plastic transistor package and provides device specification guide for 75 transistors available in this ruggedly constructed package. The brochure describes the construction and design features that give this TO-92 package maximum mechanical and electrical reliability. Improvements are illustrated by an X-ray comparison with other TO-92 packages. In addition, photos of Fairchild's highly automated assembly line illustrate high volume production techniques from die attach and lead bonding to package molding and final testing. Reliability test data are summarized. Fair-

child's TO-92 product line consists of high speed saturated switches, general purpose amplifiers and switches, low level amplifiers, high voltage amplifiers, RF/IF amplifiers and oscillators, and monolithic amplifier transistors.

**110. GENERAL AUTOMATION, INC.**—A new pocket-sized book from General Automation serves as a convenient reference to GA's compatible family of fourth-generation automation computers and systems. The fully-illustrated, 44-page book, "Fourth Generation Computer Systems for Automation", provides general descriptions, special features, specifications, configurations, software, and lists compatible peripherals. A listing of office locations, computer applications, and a brief description of the company is also included. GA's family of automation computers and systems include: the fast System 18/30 for large-capacity supervisory control applications, the high-performance 16-bit SPC-16, the economical, compact 8-bit SPC-12 computers for locally-dedicated "worker" level control applications, and pre-engineered minicontrollers (system interface units) to provide system modularity and interface versatility.

**111. F. W. BELL, INC.**—Hall Effect Instruments and Components; an "Idea Stimulator" where Hall Generators are applied—or can be beneficially applied—is the best way to describe the new Bell Short Form Catalog. It highlights Gaussmeters, Magnet Processing Systems, Non-destructive Testing Equipment, Hall Multipliers, Wattmeter Transducers and a wide range of types and sizes of Hall Pak Generators.

**112. THE HALLICRAFTERS CO.**—A four-page, two-color brochure that features its newest 10-watt, extremely compact "Porta-Command" Model PC-210 FM 2-way radio operating in the 132-174 MHz frequency range which when combined with quick-change accessories permit the user to switch from portable to under-the-dash vehicular or base station operation, is now available. The illustrated brochure details all of the receiver, transmitter, mechanical and general operating specifications of the new all solid state, 1 to 12 channel radio for the exacting communication needs required in Public Safety, In-

## PROTECT YOUR SOUND REPUTATION

### VTR Audio Heads Manufactured and Reconditioned by TABER

*Nationally-recognized recorder head manufacturing and reconditioning experts.*

- Heads manufactured or reconditioned under controlled laboratory conditions.
- New or reconditioned heads are guaranteed to meet, or exceed, equipment manufacturer's specifications.
- Modern precision machine shop, and sophisticated laboratory installations insure highest quality newly-manufactured or reconditioned heads.
- Free loaner assemblies available on request.
- Cost: \$310.00 for four (4) new heads installed, or \$100.00 for four (4) reconditioned heads.



Taber's sophisticated quality control test insures total frequency response and uninterrupted sound playback. Maintain the high quality audio that your equipment was engineered to produce.

Call or write: **TABER** MANUFACTURING AND ENGINEERING COMPANY

OAKLAND INTERNATIONAL AIRPORT  
P. O. BOX 2365 • OAKLAND, CALIFORNIA 94614  
PHONE: (415) 635-3832 • SHIPPING ADDRESS: 2081 EDISON AVE. • SAN LEANDRO, CA. 94577

TABER IS THE NATIONAL  
DISTRIBUTOR OF  
STL TEST TAPES

Circle Number 33 on Reader Reply Card

dustrial, Transportation and Government Services. Also given in the new literature is a complete listing of all accessories available including a snap-on pack of rechargeable Nicad batteries, 12-V negative ground power source, AC power tray.

**113. KISTLER INSTRUMENT CORP.**—A complete, new line of high pressure transducers with ranges to 100,000 psi and 1 percent linearity is presented in a two-page Data Sheet No. 714-7/70. PSI range, linearity, output impedance, and time constant of eleven different models are compared in a specifications chart to enable ease of selection for individual applications. Dimensional drawings illustrate the three basic designs and three common installation methods. Diagrams show two typical Kistler systems; one a high-impedance system and the other a Piezotron® low impedance setup.

**114. LENKURT ELECTRIC**—A 12-page brochure describing the type 25B Data Transmission System, which provides speeds from 75 to 600 bits per second on a standard voice-grade telephone circuit, is now available. The 25B, believed to be one of the world's most versatile data, telegraph and telemetry transmission systems, is designed for universal application at transmission speeds of 75, 110, 150, 200 and 600 bits per second (b/s). By making more economical use of voice circuit bandwidth, the system offers reduced costs over similar data communications equipment. For example, up to twenty-five 75 b/s channels, eighteen 110 b/s channels, twelve 150 b/s channels, eight 200 b/s channels, or a single 600 b/s channel and a number of lower speed channels can be processed by the 25B for transmission over a single voice-frequency circuit. Featured by the 25B system is a basic commonality of equipment: a shelf assembly for multichannel installations, and a choice of three single-channel terminal subsets depending on application. Each system adheres to the accepted telecommunications standards of the EIA, Bell System and CCITT. The newly issued brochure includes a description of the basic equipment, application sheets for typical uses of the system, engineering data, and performance in-

formation.

**115. OHMITE MANUFACTURING CO.**—The electrical industry's most comprehensive line of rotary tap switches is described in a new twelve-page catalog. The publication features photographs, line drawings, electrical characteristics and mechanical specifications on Ohmite's expanded line of tap switches, including the miniature power tap switch, Model 711, the smallest switch available in its rating. Ohmite tap switches, except miniature Model 711 which is melamine-phenolic, are constructed of ceramic and metal to assure resistance to arcing, burning, and charring. Each switch is a single-pole, rotary, multi-position unit which can be assembled in gangs or "tandems" of two or three to form multi-pole assemblies. The catalog describes both power-type switches for high current ratings of 15 to 100 amperes AC and open-type or unenclosed switches for transferring lighter currents. In addition, a complete guide to Ohmite tap switches, with voltage ranges for individual switches, is included.

**116. ONAN DIVISION**—Onan Corporation. A comprehensive new 12-page folder entitled, "A Guide to the Selection and Installation of Onan Standby Electric Power Systems" is now available. The colorful 8½x11" brochure describes the need for emergency electric power in various types of public and private buildings of all sizes. Although aimed primarily at institutions and business establishments, the folder is of pertinent value to all with an interest in the use of—and need for—emergency electric generating equipment. The planning and selection of an emergency electric generating plant includes the consideration of such factors as: Capacity; Fuel; Cooling; and Load Transfer Controls, among others. Each subject is discussed at length in the folder, in plain matter-of-fact language.

**117. PANDUIT CORPORATION**—The complete line of Sta-Strap Cable Ties, Clamps and Markers is described in a new four-page bulletin now available. Detailed in the bulletin are twelve cable ties, three clamps and two marker ties. All are hand or tool applied, and are releaseable prior to tool installation.

## ADVERTISERS' INDEX

Acrodyne Industries, Inc. ....	13
Andrew Corp. ....	25
Belar Electronic Laboratory, Inc. ....	5
Broadcast Electronics ....	12, 52, 63
Bulova Watch Co. ....	55
CBS Laboratories ....	51, 53
CCA Electronics Corp. ....	8
Cleveland Institute of Electronics ....	61
Cohu Electronics, Inc. ....	1
Collins Radio Co. ....	IBC
Cooke Engineering Company ....	58
Ditch Witch Trencher Div. Charles Machine Works, Inc. ....	35
Eastman Kodak Company ....	18-a
Electro-Voice, Inc. ....	59
Fairchild Sound Equipment Corp. ....	57
Gates Radio Company Div. Harris-Intertype Corp. ....	9
The Grass Valley Group, Inc. ....	3
Clifford B. Hannay & Son, Inc. ....	56
Jensen Tools and Alloys ....	63
Liberty Industries, Inc. ....	62
Minneapolis Magnetics, Inc. ....	62
Moseley Associates, Inc. ....	16
North American Philips Co., Inc. AKG Div. ....	10
RCA Electronic Components ....	17
RCA Service Co. ....	37
Shure Brothers, Inc. ....	BC
Sparta Electronic Corp. ....	47
Spotmaster ....	12, 52, 63
Stainless Inc. ....	54
Sylvania Electric Products Inc. ....	18-b
Systems Resources Corp. ....	21
Taber Mfg. & Eng. Co. ....	64
Tape-Athon Corp. ....	15
Teac Corp. of America ....	IFC
Telex Communications Div. ....	12
Varian Associates - Eimac ....	7

# PROFESSIONAL SERVICES

**VIR JAMES**  
 CONSULTING RADIO ENGINEERS  
 Applications and Field Engineering  
 345 Colorado Blvd.  
 Phone: (Area Code 303) 333-5562  
**DENVER, COLORADO 80206**  
 Member AFCCE  
 TWX 910-931-0514

**AMPEX SERVICE COMPANY**  
 A Department Of Ampex Corporation  
 500 Rodier Drive, Glendale, California 91201  
 (213) 245-9373  
 Service center for repair, modification, re-building of all Ampex helical-scan video recorders and associated equipment. Also the complete Ampex audio line.

**WALTER F. KEAN**  
 CONSULTING RADIO ENGINEERS  
 19 E. Quincy Street  
 Riverside, Illinois 60546  
 (A Chicago Suburb)  
 Phone 312-447-2401  
 Member AFCCE

**CAMBRIDGE CRYSTALS**  
**PRECISION FREQUENCY**  
**MEASURING SERVICE**  
 SPECIALISTS FOR AM-FM-TV  
 445 Concord Ave. Phone 876-2810  
 Cambridge, Mass. 02138

**ALLSTATE COMMUNICATIONS**  
 ENGINEERS · CONTRACTORS  
 CATV · CCTV · VTR  
 1200 WEST CHESTNUT STREET  
 UNION, NEW JERSEY 07083  
 (212) 349-5240

**COMMERCIAL RADIO**  
**MONITORING CO.**  
 PRECISION FREQUENCY  
 MEASUREMENTS  
 AM-FM-TV  
 103 S. Market St., Lee's Summit, Mo.  
 Phone Kansas City, LaCleda 4-3777

## CLASSIFIED

### Equipment Wanted

450 to 700 foot used tower needed about August, 1971. D. R. Taylor, Chief Engineer, KOLN-TV/KGIN-TV, P. O. Box 30350, Lincoln, Nebraska, 68503, Phone 402-434-8251. 2-71-1t

### Equipment for Sale

G.E. Transmitter Type TT-42-A, modified (Ch. 2) used by WBBM-TV as its main transmitter until October 1, 1969. Equipment still installed at 33 North La Salle, Chicago. To be sold as is; buyer to remove. \$25,000. L. A. Pierce, 630 N. McClurg Court, Chicago, Illinois 60611. (312) WH 4-6000. 1-71-tf

RCA Transmitter Type TT-5, water-cooled (Ch. 2) used as a spare at the above location until October 1, 1969. Equipment still installed; to be sold as is. Buyer to remove. \$5,000. L. A. Pierce, 630 N. McClurg Court, Chicago, Illinois 60611. (12) WH 4-6000. 1-71-tf

### Equipment for Sale (Cont.)

**CARTRIDGE TAPE EQUIPMENT**—Completely reconditioned Spotmaster and Tapecaster Record/Playbacks. \$375.00. Playbacks \$250.00. 30-day money-back guarantee on all equipment. BROADCAST PRODUCTS CO., INC. 12330 Wilkins Avenue, Rockville, Maryland 20852. Ph: 301-933-3400. 10-69-tf

Surplus audio and video patch panels and patch cords, 500 to 500 ohm repeat coils flat to 20,000 cycles. Send for list. Gulf Electro-Sales, Inc., 6325 Beverly Hill, Houston, Texas 77027. 9-70-tf

**HELIAX—STYROFLEX.** Large stocks — bargain price — tested and certified. Write/call for price and stock list. Sierra-Western Electric, Box 23872, Oakland, Calif. 94623. Tele: (415) 832-3527. 1-71-tf

Finest RF coils, contactors, switches, custom ATU systems built for customers or dealers. Write or phone for catalogue. Geleco Electronics Ltd., 2 Thorncliffe Park Drive, Toronto 17, Ontario. Phone 416-421-5631. 8-70-tf

Bargain—General Electric Pyranol capacitors, 25 mfd. 6250 volts, 18 inches by 17 inches by 5 inches. Weigh 65 lbs. \$20 F.O.B. William Ackard, 729 E. 17th Ave., Denver, Colo. 80203. 1-71-3t

1—1KW A.M. Collins Transmitter for sale. A-1 condition. WPRT Radio Station, South Lake Drive, Prestonsburg, Ky. 4163. Ph: 886-2050. 2-71-1t

"Full Track Ampex 601, new motor \$250; Half Track Ampex 601 \$200; Ampex 620 monitor \$125; Gates M5167 Compressor \$125; Collins 26W limiter \$50; RCA microphones 77D \$75; 77D 50; 77DX \$125. KQIQ, Box 1400, Ventura California 93003 (805) 647-1400." 2-71-1t

**EQUIPMENT FOR SALE:** "Gates Am Frequency Monitor, Model M02890, Tuned to 940 ksc. Excellent condition. Manual included. AM Modulation Monitor, Model M02639, Excellent, Manual included. Gates M5144 R.F. Amplifier, as is, working with instruction book. All in use. 2-Gray 602-c Equalizers, One . . . McMartin Modulation Monitor, FM, TBM 3500 . . . One . . . McMartin Frequency Monitor, TBM 3000, Both Excellent. Two . . . Mosely SCG 4T Subcarrier Generators . . . one at 67khs . . . One at 26 khs . . . One never unpacked . . . one unpacked . . . Never used or hooked up. Radio Station WNRG, Grundy, Virginia 24614 . . . Telephone 703-935-2816." 2-71-1t

"New & Used Towers, Buy, Sell or Trade, Erect, Bill Angle, 919-752-3040, Box 55, Greenville, N.C. 27834." 2-71-tf

"MICROWAVE EQUIPMENT. 3-KTR 1000 Ratheon Microwave Receivers - 8 MGH range. Also, 6' Andrew Dish with 5' wave guides. For more information contact: Twin Village Co., Inc. Milton-Freewater, Oregon 97862—938-3388." 2-71-1t

**STANCLIFF-HOFFMAN M-9 MINITAPE RECORDER** w/charger, speaker amp. & manuals, excellent \$200. **MATCHING MIXER** for M-9 \$125. Dekko Films Incorporated, 126 Dartmouth St., Boston 16, Massachusetts. 536-6160. 2-71-tf

**TRANSMITTER, G.E.** FM, 10kW, modified to 15 kW, 4CX5000A grounded-grid finals, 4-400 driver, stereo exciter, and stereo generator. **PRESENTLY ON AIR. INSPECTION INVITED.** Spare G. E. final amplifier and power supply cabinets, plus two spare G.E. 3kW amplifiers. Best offer over \$4,000. Also, three plate transformers, 40KVA, 10kV, best offer. Contact KJOI, 2555 Briarcrest Road, Beverly Hills, California, 90210. (213) 278-5990. 2-71-1t

**FM EXCITER**, solid state, 20W, stereo, 38khz and 67 khz sca. Bauer models 660, 661, 662. Make offer. Broadcast Services, Inc. 7633 West Hill Lane, San Jose, California. 95129. 2-71-tf

"TELEVISION ENGINEERING HANDBOOK". Fink best offer, Bill Werner, 411 N. Stonestreet Ave., Rockville, Md. 2-71-1t

### Equipment for Sale (Cont.)

"FOR SALE: MOSLEY PCL-2B S-T-L TRANSMITTER AND RECEIVER, 2 COL-LINS AGC AMPLIFIERS MODEL 26-U-1 and THE SUPERIOR SYMMETRA-PEAK MODEL SP-63-1A. ALL IN GOOD CONDITION. CONTACT RUSS LATIOLAIS, CHIEF ENGINEER, KBBQ BURBANK, CALIFORNIA 91502. PHONE (213) 849-3356." 2-71-1t

Prodelin No. 122-845 6 1/2" line breakaway ass'y \$225.00. ea. Andrew No. 23187 adaptor section w/O ring and hardware \$10.00 ea. Bird No. 461000 line section. 60KW, 50 ohm, with 2 - 30 MC elements \$100.00 ea. All items are unused. A.R.C. Sales, 181 E. Wilson Bridge Rd., Worthington, Ohio 43085. 2-71-2t

### Help Wanted

**ATTENTION PROFESSIONAL ENGINEERS.** Here's a sample list of new positions. We protect your confidence & represent your interests ethically. Marketing Manager, equipment manufacturer, \$20,000+. Transmitter, Video, Audio designers \$12 - \$20,000. CATV systems & product designers \$11 - \$22,000. Sales Engineers \$12 - \$25,000. Microwave designers \$12 - \$20,000. Employer pays fees. No resume needed, just contact us. Everything's confidential. **ENGINEERS LOG** (personnel specialists for Broadcast Engineers). Box 252, Latham, New York 12110. Ph: 518 785-3840. 2-71-1t

Wanted combo announcer and 1st phone engineer. Announce on F.M. at night and strong on engineering. Dept. 249. Broadcast Engineering, 1014 Wyandotte, Kansas City, Mo. 64105. 2-71-1t

Job Headquarters for all Radio and Television Engineers. Immediate openings exist in 9 western states and elsewhere for qualified engineer and technical personnel. All categories from trainees to experienced transmitter maintenance, chief, assistant chief, live color video maintenance and technical operations. Send us your complete resume now. The AMPS Agency, 3924 Wilshire Blvd., Los Angeles, California 90005. Telephone DU 8-3116. By Broadcasters—For Broadcasters. 11-68-tf

### Training

To advance in electronics, knowledge and ability are required. Grantham offers correspondence and resident instruction, in depth, leading to the degree of Associate in Science in Electronics Engineering. G. I. Bill approved. Credit for previous training and experience allowed. Free Catalog Write: Dept. E-2, Grantham School of Electronics, 1505 N. Western Ave., Hollywood, California 90027. 6-67-tf

First phone through tape recorded lessons at home plus one week personal instruction in Washington, DC. Atlanta. Boston. Detroit. New Orleans, Minneapolis. Seattle. Denver, Portland. Los Angeles. Proven results. Our 17th year teaching FCC license courses, Bob Johnson Radio License Preparation, 1060D Duncan, Manhattan Beach, Calif. 80266. Phone 213-379-4461. 1-69-tf

**IMMEDIATE OPENINGS:** Qualify for any of the following positions: RCA CCTV Equipment, monochrome or color. Salesmen — TV Systems Engineers — Project Engineers — Supervisors — Managers — Maintenance Technicians — Video Engineers — to work either New York, Pennsylvania, New Jersey or California area. Write: RCA Rep. P. O. Box 268, New Hyde Park, New York 11040. 4-70-tf

### Services

**CRYSTAL & MONITOR SERVICE,** Frequency change, repair or replacement of oven type broadcast crystals. Also frequency change and recalibration or repair of AM frequency monitors, and H-P FM monitors. Fast service at reasonable prices. 30 years experience! Call or write: Eidson Electronic Co. Box 96, Temple, Tx. 76501. Pho. 817 773-3901. 9-70-12t

**B. F. CUSTOM CASSETTE CARTRIDGE DUPLICATION.** In cassette duplicating one to four channels. Editing master tape and pulsing for slide films. Storycraft Service Corporation, 18630 Detroit Avenue, Lakewood, Ohio 44107. (216) 221-4722. 1-71-6t

# You can do more

## with Collins new stereo consoles

Increase your station's capability and programming flexibility by selecting Collins 4-channel 212K-1 or 8-channel 212L-1. Both are all new, all solid-state. And packed with features such as reverse cue and stereo headphone output jacks.

The 212L-1 has dual stereo monitor outputs and a monaural program output.

Both consoles have fresh new styling—easy to look at, comfortable to use.

And under this new look . . . Collins design and manufacturing quality.

For more information, see your Collins representative or contact  
Collins Radio Company, Dept. 400, Dallas, Texas 75207.

Phone: (214) 235-7863 (direct line).



COMMUNICATION / COMPUTATION / CONTROL

Circle Number 2 on Reader Reply Card

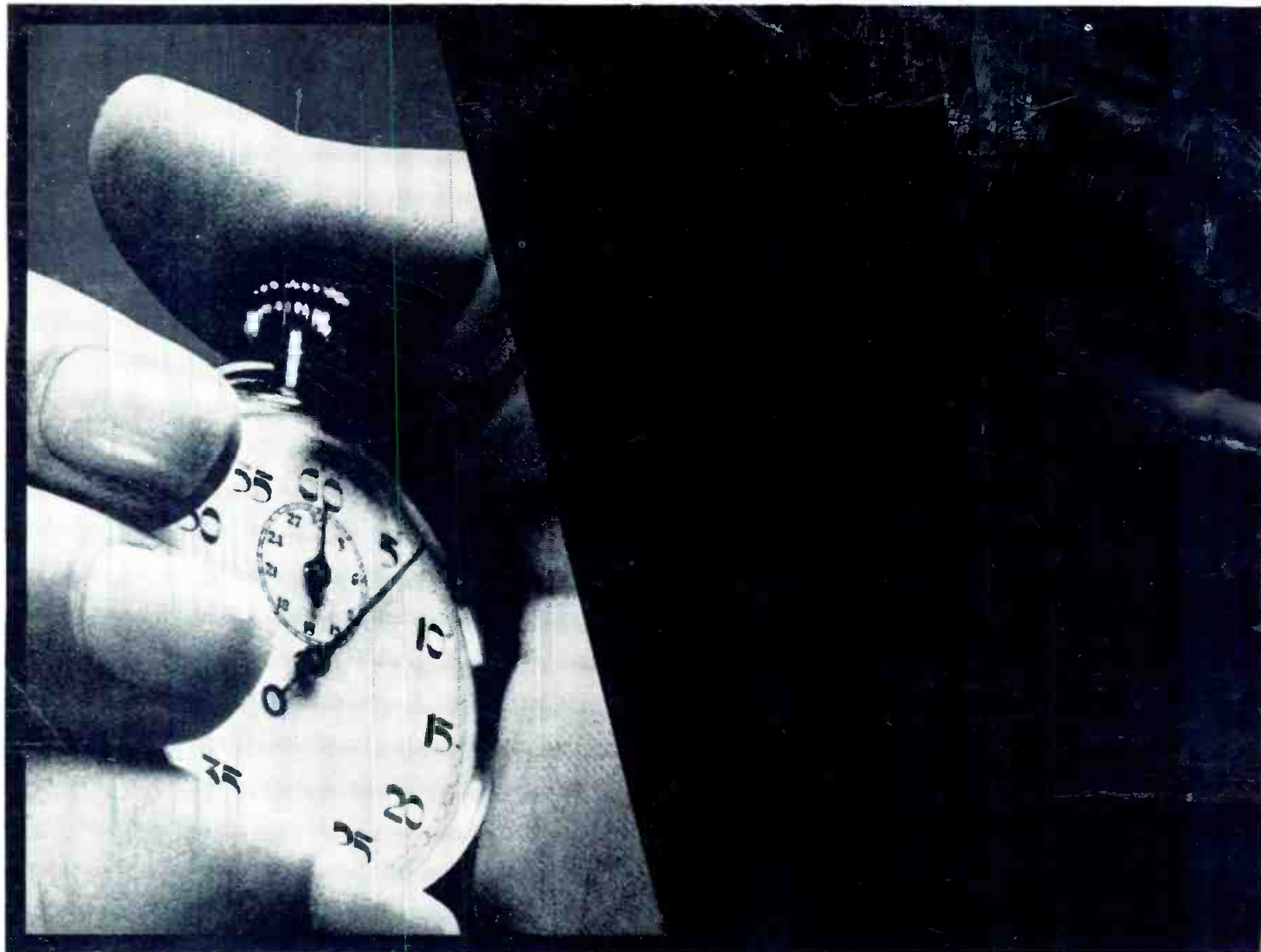

## Solve 7 problems...in seconds.



Something totally new to add to your bag of tricks! We call them *Plug-in Problem Solvers*. They're designed to provide seven common modifications in microphone and sound system setups without soldering or rewiring—just plug them in! The Model A15A Microphone Attenuator that prevents input overload; Model A15PR balanced line Phase Reverser; and A15HP High Pass and A15LP Low Pass Filters to modify low and high frequency response; A15PR Presence Adapter to add brilliance; A15RS Response Shaper to filter sibilance and flatten response; and the A15LA Line Adapter that converts low impedance microphone inputs to line level inputs. Carry them on every job. It's a lot easier than carrying a studio console with you! Shure Brothers Inc., 222 Hartrey Ave., Evanston, Ill. 60204.



**SHURE**

Circle Number 3 on Reader Reply Card