

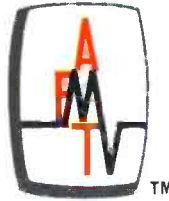

A HOWARD W. SAMS PUBLICATION



September, 1968/75 cents

Broadcast Engineering

*the technical journal
of the broadcast-
communications industry*



Keeping accurate time with WWV Page 14

model 1551 video test set



here's a new, lightweight portable video test set that's as reliable in death valley as it is on pike's peak



Removable front cover and accessories are self-storing.

available test signals

10 Step Linearity
Window
Sin² Window
Multiburst
Bar & Dot

features

Temperature stable
Reliable solid state design
Modular test signal generators
Dual isolated outputs
Self-storing accessories
Easily serviced in the field

Riker's new 1551 Video Test Set has been developed specifically for the telephone industry to insure accurate analysis of video transmission quality and is presently in use in a number of Bell System installations. The 1551 is lightweight, shock resistant and especially suited to field use, providing continuous and reliable operation over the widest possible range of climatic conditions.

All test signals generated by the 1551 are composite with standard EIA Sync. Dual outputs are provided at 124 ohms balanced and 75 ohms unbalanced allowing measurements to be made into balanced terminal equipment and unbalanced lines or facilities.

The plug-in design of the individual test signal modules makes it easy to service and maintain the test set in field locations. Failure or removal of any single module will not affect the performance of the remaining test signal generators. All accessories, including a removable cover, are self-storing to prevent loss during long term use.

RIKER

PRODUCTS FOR VIDEO ANALYSIS, SIMULATION & CONTROL.

RIKER VIDEO INDUSTRIES • 100 PARKWAY DRIVE SOUTH • HAUPPAUGE, L.I., NEW YORK 11787 • (516) 543-5200

- accepts composite or noncomposite signals
- cut is standard on Mix, Effects, and Preset/Program Buses
- automatic inhibit of non-synchronous dissolve
- fade to black with automatic cut
- automatic sync insertion
- no mid-fade color drop when fading to monochrome
- input over-voltage protection to ± 300 volts

All performance specifications lead the state of the art; all components used are selected from the latest proven lists. Cohu's new 9300 Series Video Switcher does it all... and does it now.

No single failure can disable the 9300 because of redundant power supplies and sectional fusing. Test points are easily accessible from the front. Cards are interchangeable plug-ins. Adjustable, preprogrammed

delay sections provide interchangeable output amplifiers.

Designed specifically for broadcasting, the 9300 Series Video Switcher features integrated circuits and modular construction with a convenient form factor for typical studio requirements and expansion capabilities. For more details, contact your nearest Cohu representative, or call Bob Boulio direct at 714-277-6700 in San Diego. But do it now! Box 623, San Diego, California. TWX 910-355-1244.

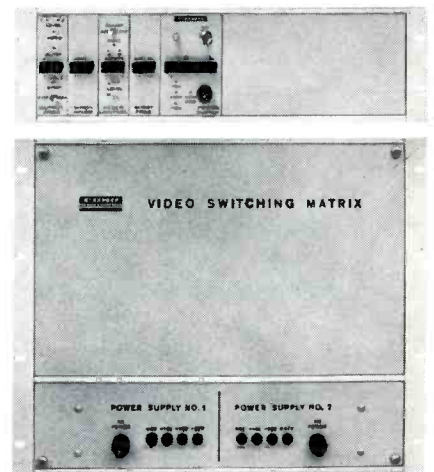

Cohu's New 9300 Series video switcher does it all... Now

COHU
ELECTRONICS, INC.
SAN DIEGO DIVISION

Circle Item 2 on Tech Data Card



Broadcast Engineering

The technical journal of the broadcast-communications industry

in this issue...

- 14 Keeping Accurate Time With WWV.** A description of WWV facilities and services including information for reworking station clocks. **Ron Merrell.**

- 20 Checking VTR Burst Phase.** A simple device which may be installed in the Ampex VR2000 recorder cabinet to furnish a visual indication of correct phase. **George W. Ing.**

- 27 Constructing a Transmitter Transfer Panel.** A switching unit designed for stations having a standby transmitter available for remote control operation. **Robert M. Crofingier.**

- 32 EAN Alarm System for Newsprinters.** A description of a unit that can activate an alarm at any location in the station when an EAN alert or test is received. **Frank B. Ridgeway.**

- 34 Building Transistor Audio Circuits-Part I.** First of a five part series of articles covering the basics of transistor audio circuits. **Norman H. Crowhurst.**

- 50 An EBS Monitor that Thinks for Itself.** A description of an EBS monitor that employs an integrated circuit logic to eliminate false indications. **Richard C. Factor.**

- 62 VT Logging the Easy Way.** A description of economical and efficient VT tape logging methods. **Michael Smith.**

- 66 A VIT Signal for Color.** Describes the use of 20T pulse testing for color. **Leo Lazarus.**

DEPARTMENTS

- Industry News 4
- Washington Bulletin ...47
- New Products69
- Engineers' Exchange ...77
- Tech Data80
- Ad Index83
- Classified Ads83, 84

ABOUT THE COVER

On the cover is the National Bureau of Standards' "atomic clock" located at the Boulder Laboratories. See **Keeping Accurate Time With WWV** on page 14.

EDITORIAL

GEO. H. SEFEROVICH, Director
 RONALD N. MERRELL, Editor
 ANN L. GURLEY, Editorial Assistant
 DUDLEY ROSE, Art Director
 LEE JOHNSON, Assistant Artist

REGIONAL EDITORS

GEORGE M. FRESE, Northwest
 HOWARD T. HEAD, Washington, D.C.
 ROBERT A. JONES, Midwest

EDITORIAL ADVISORY BOARD

LES NELSON, Chairman
 Howard W. Sams & Co., Indianapolis

CIRCULATION

R. VINCENT WARD, Director
 PAT OSBORNE, Manager

ADVERTISING

E. P. LANGAN, Director
 R. JACK HANCOCK, Manager
 S. F. WILSON, Production
 LEE MILLER, Promotion

REGIONAL ADVERTISING SALES OFFICES

Indianapolis, Indiana 46206

ROY HENRY
 HOWARD W. SAMS & CO., INC.
 4300 West 62nd St.
 Tele: 317/291-3100

New York, New York 10019

ALFRED A. MENGUS
 3 W. 57th St.
 Tele: 212/Murray Hill 8-6350

Los Angeles, California

G.R. HOLTZ
 THE MAURICE A. KIMBALL CO., INC.
 2008 Carson St., Suites 203-204
 Torrance, California 90501
 Tele: 415/392-3365

San Francisco, California 94104

THE MAURICE A. KIMBALL CO., INC.
 580 Market Street, Room 400
 Tele: 415/392-3365

London W. C. 2, England

JOHN ASHCRAFT & CO.
 12 Bear Street
 Leicester Square
 Tele: Whitehall 0525

Amsterdam C, Holland

JOHN ASHCRAFT & CO.
 W.J.M. Sanders, Mgr.
 Herengracht 365
 for Benelux & Germany
 Tele: 24.09.08

Paris 5, France

9 Rue Lagrange
 ODeon 20.87

Tokyo, Japan

INTERNATIONAL MEDIA REPRESENTATIVES, LTD.
 3, Nakanochō, Akasaka, Minato-ku
 Tele: 582-5881



BROADCAST ENGINEERING is published monthly by Intertec Publishing Corp., 1014 Wyandotte Street, Kansas City, Missouri 64105.

Subscription Prices: U.S.A. \$6.00, one year; \$10.00 two years; \$13.00 three years. Outside the U.S.A., add \$1.00 per year for postage. Single copies are 75 cents, back issues are \$1.00.



Robert E. Hertel, Publisher
 Intertec Publishing Corp.
 Subsidiary of Howard W. Sams & Co., Inc.



How a signal booster can amplify profits!

All you have to do is install our Audimax. It boosts your signal to a higher average level. Guarantees a big increase in your audience coverage. And the more people you reach the more money you make!

What's more — by automatically controlling audio levels, it frees engineers. Cuts costs. Amplifies profits.

And you'll have a happier audience, too! Our Audimax works without distortion, thumping, pumping and audio "holes". Bridges clear through program pauses without increasing background noise. Delivers a smooth, more pleasant sounding program.

Try it FREE for 30 days. No obligation. No strings attached. If you don't like it, send it back. The freight's on us! If you like what you hear, send us \$665.

Small price to pay for the biggest profit booster in the business!

Write. Or better yet — call us collect:
(203) 327-2000.



PROFESSIONAL
PRODUCTS
CBS LABORATORIES
Stamford, Connecticut. A Division of
Columbia Broadcasting System, Inc.

Circle Item 3 on Tech Data Card

Radio newscasting "matured" through crisis

Thirty years ago this month the world was faced with a crisis that brought about what some have called "the maturity of radio." It was the Munich crisis and it began when Adolph Hitler shocked all of Europe in a speech delivered at Nuremberg.

He intended to take the Sudetenland to "liberate" three-million German-speaking inhabitants. Prime Minister Neville Chamber-

lain got into a plane for the first time in his life and flew to see Hitler at his home in Berchtesgaden to affect a solution short of war.

During the 20 days of crisis that followed, some 200 radio engineers, operators and technicians worked to bring the latest news to this country. Broadcasts were relayed from Europe to Cape Town, from there to Buenos Aires and on to New York via short wave, when direct

transmissions were hampered by storms over the Atlantic.

Mutual taped foreign news broadcasts and replayed them to American listeners. And it was during this crisis that listeners came to recognize the news roundup of CBS. The technique had been used as an anniversary stunt by NBC in 1935. Through the tireless efforts of all media personnel involved, radio took a giant step forward.

INTERNATIONAL

A radio transmitter which will make the Roman Catholic Church station at Bogotá, Colombia, the most powerful in South America was flown from Love Field in July.

The 250 KW medium frequency transmitter was built by Continental Electronics on a contract with Acción Cultural Popular. Installation was scheduled to coincide with the visit of Pope Paul VI for the 38th International Eucharistic Congress.

Olympic TV Ready

A television switching complex that will become the nerve center for TV coverage of this year's Olympic Games in Mexico City has been completed at RCA's Camden, N.J. plant.

The system was designed for the Mexican government and will be installed in the Telecommunications Tower of its new Ministry of Communications Center. The switcher will handle video and audio signals incoming by microwave from the Olympics and from other points in Mexico and distribute them to all subscribers providing TV coverage for viewers on three continents.

IBS Goes International

In a joint communique issued from the Secretariats of the Intercollegiate Broadcasting System and the International Broadcasters So-

ciety, it was announced that an agreement has been reached on the ways and means for broadening services internationally.

The American based Intercollegiate System has been active on a national level since its incorporation in Rhode Island in 1939. The European established International Broadcasters Society is a relative newcomer, having started in 1961.

Brazil And U.S. Establish Link By Satellite

A space communications link was established in downtown Philadelphia using an Applications Technology Satellite "parked" in orbit 22,500 miles above the east coast of Brazil. The space communications exhibit was demonstrated during the IEEE conference in June by the **General Electric Space Systems Organization** personnel.

The experiment was designed to illustrate the use of satellite for mass dissemination of information.

Sponsored by the Philadelphia section of the IEEE, the three-day conference ranged over the technical aspects of communications systems and planning, concluding with a keynote address on "Communications in Education."

NATIONAL

Cablevision Brought To Carolinas And Georgia

More than 100,000 people in 25,000 homes in the Carolinas and Georgia soon will be served by **Jefferson-Carolina's Cablevision** according to George Green, general manager.

These 25,000 Cablevision subscribers are served by Cablevision systems in Greensboro, Charlotte, Gastonia, Sanford, Rockingham-Hamlet, Whiteville-Chadbourn, Lumberton and Dunn-Erwin in North Carolina; Union, Gaffney and Cheraw in South Carolina and Savannah in Georgia.

King Hussein Inaugurates Jordan's First TV System

His Majesty King Hussein of Jordan recently inaugurated Jordan's first television broadcasting system in Amman. In the photograph is King Hussein and Mr. R. Huntsman the engineer in charge of the studio installation.

Photograph by Hagop Toranian, Amman.



WHAT VIDEO DISTRIBUTION AMPLIFIER HAS ALL THESE FEATURES... ?

- Lowest cost per output
- Six identical source terminated outputs
- Cable equalizing for LF and HF compensation
- Hum bucking input for 46 db ground loop rejection
- Available with sync adding facility
- Built in power supply
- BNC source-terminated test output on front panel
- Plug-in module; silicon semi-conductors throughout
- Excellent performance characteristics

VIDEO DISTRIBUTION AMPLIFIER TYPE TA-901

Your best buy—feature for feature, dollar for dollar . . . 72 outputs in 5-1/4" rack space—at less than \$45 per output.

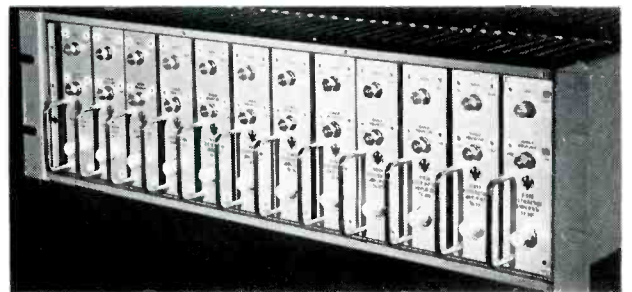

The Ward TA-901 Video Distribution Amplifier is a high performance, multi-purpose amplifier for distributing color or monochrome video signals in TV systems. Each TA-901 plug-in module, with built-in power supply, provides six source-terminated outputs. Twelve TA-901 amplifiers can be accommodated in a standard F-800 5-1/4" rack frame. Write or call for complete details.



WARD ELECTRONIC INDUSTRIES

142 CENTRAL AVE., CLARK, NEW JERSEY 07066 • (201) 382-3700

Circle Item 4 on Tech Data Card

INDUSTRY NEWS

(continued)

WHAG-TV Permit Granted

The Federal Communications Commission has granted a construction permit for television Channel 25, Hagerstown, Maryland, to Regional Broadcasting Company, a subsidiary of Adler Communications Corporation, which owns WAYE, Baltimore's only all-news radio station.

According to Adler Communications Corporation Executive Vice-President, W. Ronald Smith, the new television station will be called WHAG-TV and will be Maryland's most powerful commercial TV station operating with 350,000 watts visual.

Its signal will be transmitted from a tower 1900 feet above sea level on Fairview Mountain, west of Hagerstown, and will be received in Frederick, Frostburg, Hancock and Cumberland, Maryland; Charlestown, Martinsburg, Keyser and Berkley Springs, West Virginia; Waynesboro, Chambersburg and Gettysburg, Pennsylvania. Coverage will blanket an area of nearly 400,000 people.

Visiting WWV

New visiting hours have been announced for the radio stations WWV, WWVB, and WWVL at the National Bureau of Standards' field station near Fort Collins, Colo. The new hours are from 1:00 p.m. to 4:00 p.m. on Wednesday, each week. The gate to the site will be closed at all other times.

Groups or individuals who wish to visit the site during the "open" hours, should call the station (Fort Collins, 484-2218) and make arrangements for the visit.

New Facilities For KCRS Radio

Construction of West Texas' new KCRS radio broadcasting facility is underway in Midland. The 5,412 square foot building will house both studios and offices. The 5000

Watts, 550kc radio station is one of seven Wendell Mayes Stations in Texas. KCRS was established in 1935 by Clarence Scharbauer, Sr., and was purchased in 1957 by the Mayes group.

General Instrument Adds CATV Systems

General Instrument Corporation recently acquired all of the plant and assets of three New York State cable television (CATV) systems owned by Telihoras Corporation. The transaction, approved by the FCC, was announced by Martin H. Benedeck, chairman of the Board of General Instrument Corporation.

The three New York systems, serving Cortland, Wellsville and Penn Yan have a maximum total potential of 14,000 subscribers. Systems mileage, now totaling 132 miles, will be extended to a total of 174 miles.

WNAR Norristown, Pa. Has New Owner

Radio station **WNAR**, Norristown, Pa. has been sold by N. Joe, Sam G. and Farris E. Rahall to Charles F. Wister and Group, subject to FCC approval. Wister is president of **Wister Broadcasting Company, Inc.** Licensee of WPEO, Peoria, Ill. He is also a former Philadelphian and prior to taking over WPEO, had been active in broadcasting in the Philadelphia Market since 1950. He has been associated with WIP radio, WVUE-TV (channel 12), WIBG radio owned by Storer Broadcasting Company and WCAU radio and television, the CBS owned and operated stations in Philadelphia. The other member of the group (WNAR, Inc.) is Victor Mauck, Jr. a Montgomery County business executive.

ORGANIZATIONS

NAEB

William G. Harley, President of the National Association of Educational Broadcasters announced today a grant of \$20,000 has been awarded to the NAEB by the National Home Library Foundation. The money will be used to improve the quality of the NER Network service which provides 3,000 hours of taped programs monthly to 160 affiliate educational radio stations throughout the country. The funds will be utilized to re-equip the net-

work duplication center in Urbana, Illinois which is operated by the National Educational Radio division.

ASTM

The election of the new national officers for 1968-69 of the American Society for Testing and Materials was announced during the 71st Annual Meeting in San Francisco. The terms of the new officers and members of the board of directors began at the close of the meeting.

Harold N. Bogart, director, Numerical Control Office, Manufacturing Staff, Ford Motor Company, Dearborn, Mich., was elected president. He succeeds Frank J. Mar-dulier.

Raymond B. Smith, director, Engineering Standards, Renolds Metals Company, Richmond, Va. is the new vice president.

JTAC

Results of a comprehensive four-year study by over 200 of the nation's leading experts on the use of the radio spectrum were reported in July by Mr. Richard P. Gifford, the Chairman of the Joint Technical Advisory Committee, sponsored by the Institute of Electrical and Electronics Engineers and the Electronic Industries Association. Details of the study are reported in a new reference volume entitled Spectrum Engineering—The Key To Progress.

The paramount recommendation is that technical procedures relating to allocation and assignment of the radio spectrum, must be markedly changed through the adoption of a spectrum engineering philosophy and system design concept.

This will lead to the establishment of the "next generation" spectrum engineering system. To do so many new sources of technical information concerning the potential use of the spectrum, must be created and maintained. These sources will be incorporated into a data processing system for assignment of appropriate frequencies to users. This system will have a degree of flexibility which is unattainable using present day techniques.

NAB

Four broadcaster organizations joined recently in asking the U. S.

**Vital Video
proc. amp.
stab. amp.
will guarantee:**

- Instant sync and pedestal output when input signal is missing.
- New phase locked color burst with constant amplitude independent of chroma amplitude.
- Automatic new burst with correct number of cycles and correct breezeway, Burst phase control, local or remote.
- Burst output for phase - locking multiple studios, remotes, or stations in same viewing area.
- Plus built-in sync. generator.



In one 3½" package, "Vital" Model VI-1000 video processing amplifier performs all these functions: VTR proc. amp.; stab. amp.; AGC, APC amplifiers; clamp amplifier; sync generator; color lock; video and burst distribution amplifiers; and all the automatic safeguards against FCC violations.

FEATURES

- Extensive use of IC's.
- Complete blanking and sync regeneration including all vertical interval pulses or gated sync.
- In the absence of the input signal, internally generated sync and setup is provided.
- Auto/manual setup fully adjustable in either synchronous or non-synchronous modes.
- Original color burst or reinserted burst from local subcarrier or from highly stable phase-locked oscillator. Amplitude and phase adjustable, local or remote.
- Automatic switching between color/mono modes.
- VIT signals allowed to pass or be deleted.
- Auto/manual chroma level correction without distortion.
- Auto/manual video level control.
- Very high noise immune clamping.
- Adjustable regenerated pulse widths.
- Adjustable sync level.
- Adjustable white and black clip WITHOUT CLIPPING COLOR.
- White stretch, black stretch independently adjustable.
- Two input selector switch on front panel with 3-second fade in or out with automatic/manual bypass switch.
- Four isolated outputs: Composite or noncomposite.
- Pulse outputs: Composite sync, composite blanking, vertical drive, horizontal drive, front porch switching.
- All important functions remote controlled.

GOOD ENGINEERING IS VITAL



VITAL INDUSTRIES, INC.

3614 SOUTHWEST ARCHER ROAD
GAINESVILLE, FLORIDA 32601 - PHONE (904) 378-1581

Circle Item 5 on Tech Data Card

INDUSTRY NEWS

(continued)

Court of Appeals for the District of Columbia to reverse a Federal Communications Commission ruling which would clear the way for community antenna television operations in the Colorado Springs area.

They also asked the court to return the case to the FCC with instructions to "conduct further proceedings adequate to expose and resolve the substantial public interest questions presented."

Research Report

A research report prepared by Herman W. Land Associates, Inc., of New York City concluded July 18 that substitution of a nationwide wired system for on-air television might provide a modest increase in national entertainment but could reduce information programs and diminish or eliminate entirely a "considerable portion" of all types of local programming.

Furthermore, the Land report said, it appears highly unlikely that wired TV would provide the highly-specialized services envisioned by its proponents and might confront viewers with the choice of "paying for their favorite programs or doing without."

The 368-page document, commissioned by the National Association of Broadcasters, was submitted to President Johnson's Task Force on Communications Policy to assist in its current study of present and future communications needs and policies.

Advance Program IEEE-GB Symposium 1968

Thursday, September 19

9:15 A.M.-11:45 A.M.-East Room

Status Report on Video Standards—IEEE Video Signal Transmission Subcommittee 2.1.4—Frank Davidoff, CBS TV Network.

An Analysis of Test Pattern Signals—The Vertical Wedges—Richard T. James. AT&T.

Automatically Controlling Signal Levels in Live Color Cameras—Geo. F. Eustis, Jr., General Electric.

A New System for Precise Editing of Television Tape—T. V. Bolger, J. R. West, RCA.

Evaluation of Colormetric Performance of Color TV Cameras—C. A. Johnson, RCA.

Thursday, September 19

2:00 P.M.-4:00 P.M. - East Room

Planning and Installation of the Most Powerful TV Transmitter—The RCA TTV-110A at WPHL-TV—Robert E. Leach, U. S. Comm. Corp. and Donald R. Musson, RCA.

TV Transmitting Antenna Selection—Dr. José Perini, Syracuse University.

Various Methods of Determining Gain of a Proposed TV Transmitting Antenna—Dr. M. S. Siukola, RCA.

High Performance CATV Systems with 34 dB to 40 dB Trunk Spacing and High Level Distribution Amplifiers—G. P. Dixon, Co-Cor Electronics, Inc.

Friday, September 20

9:15 A.M. - 12 Noon - East Room

Color Uniformity in Multistation Markets—John H. DeWitt, Jr. Intl. Nuclear Corp.

A New Dimension in Television Air Links—Dr. Jos. Vogelmann, Chromally American Corp. and Ira Kamen, Laser Link Corp.

Field Strength Recording on Magnetic Tape—L. H. Montgomery, Radio Station WSM.

Computerized Techniques in Complete Station Automation—Duane M. Wiese, Gen. Elec. B/cg.

Panel Discussion: "Are Licensed Operators Realll Necessary?", with Panelists from—Government—Broadcasting—NABET—IBEW.

Friday, September 20

2:00 P.M. - 4:35 P.M.

Special Tour: COMSAT, 950

L'Enfant Plaza South, S.W. Washington, D. C.

Friday, September 23

7:00 P.M.-Reception-East Room

7:00 P.M.-Banquet-State Room

Saturday, September 21

9:15 A.M.-12 Noon - East Room

Broadband FM Antenna on Empire State Building—E. J. Vaughn, Consultant.

ABC's New Radio Network Facility—Sammie Aed and John Gable, ABC.

The Message Telephone Network to Broadcasting Studio Program Input Equipment for On-The-Spot Interviews—F. M. Serrell, The C&P Tel. Co.

Automatic Control of Loudness Level—B. B. Bauer, R. G. Allen, E. L. Torick, CBS Laboratories.

Precise Frequency Control of AM Carriers and its Applications—Frank D. Lewis, General Radio Co. and L. H. Montgomery, Radio Station WSM.

NTCA

Jerrold-operated community antenna television (CATV) systems have won 12 of the annual service-to-the-industry awards of the National Cable Television Association (NCTA). These were presented at the recent NCTA convention in Boston in recognition of outstanding advertising, public relations and subscriber promotions.

Perfect TV, Inc., Harrisburg, Pa., was presented with three awards—first- and second-place plaques and an honorable mention certificate—in recognition of special production.

The company's Florida TV Cable Co., Inc. received a first-place plaque for public relations in the Melbourne system, and a second-place plaque for a Washington's Birthday promotion in the Ormond Beach system.

Three honorable mention certificates went to the Greater Lafayette (Ind.) TV Cable Co., Inc. Two honorable mention certificates were awarded to the Pontiac (Ill.) TV Cable Co., Inc. ▲

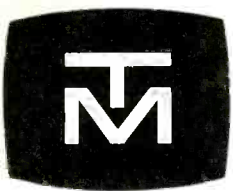

New from TeleMation ..TMC-2100 Vidicon Camera

Designed to be the most versatile camera
ever offered to the television industry



TMC-2100V



TMC-2100



REAR VIEW
TMC-2100

FEATURES:

- Camera may be operated self-contained or driven — All modes of operation are "switch selectable." Internal sync options are Crystal/Drive, 2:1 Interlace, and EIA.
- TMC-2100 non-viewfinder cameras feature all diecast or extruded framework — rugged but good looking!
- Extruded side panels hinge upward for easy access to camera circuitry and vidicon assembly.
- All circuit boards are made of high-quality glass epoxy materials and "plug-in" for easy field replacement.
- Addition of 7" transistorized viewfinder is simple but permanent. "Piggyback" look is avoided by use of full-length side panels and front casting.
- 800-volt power supply and 60-gauss focus field assure maximum performance from all vidicon tubes, including new separate-mesh types — 800 lines resolution guaranteed.



TELEMATION, INC.

2275 South West Temple/Salt Lake City, Utah 84115
Telephone (801) 486-7564

Circle Item 6 on Tech Data Card

SPOTMASTER

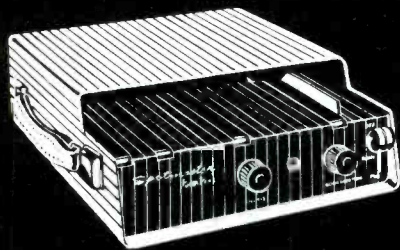

PortaPak I Cartridge Playback Unit



Your time salesmen will wonder how they ever got along without it! Completely self-contained and self-powered, PortaPak I offers wide-range response, low distortion, plays all sized cartridges anywhere and anytime. It's solid state for rugged dependability and low battery drain, and recharges overnight from standard 115v ac line. Packaged in handsome stainless steel with a hinged lid for easy maintenance, PortaPak I weighs just 11½ lbs. Vinyl carrying case optional.

Write or wire for full information.

Spotmaster

BROADCAST ELECTRONICS, INC.

8800 Brookville Road
Silver Spring, Maryland

THE MODEL 7036 COMMUNICATIONS RECEIVER



The newest of the Comrex communication equipment line, the Model 7036 is designed for newsroom monitoring, for remote broadcast pick up and for STL applications. Solid state throughout for reliability, MOSFET mixers for high spurious rejection, CRYSTAL filter for adjacent channel protection, IC, i.f., audio and squelch stages make this the finest receiver of its type manufactured today. In addition to the many features included such as: balanced output for phone line or recorder use, squelch operated relay for recorder starting and built in monitor amplifier and speaker, we can supply almost any additional feature that you require. Standard frequency ranges are 25 to 58 MHz and 148 to 174 MHz, but we build the receiver on special order, for any frequency up to 2.5 GHz and with any bandwidth up to 300 KHz.

COMREX

P. O. Box 51 West Concord, Massachusetts 01781
Area Code 617 369-6685

Circle Item 7 on Tech Data Card

LETTERS TO THE EDITOR

Letters to the Editor

"I wish to commend you and your staff for an excellent issue (June, 1968). I shall have to save the entire issue, rather than tearing out the articles that I wish to save.

"Hate to nit-pick, but the article "Silent Sensor" has an error that will produce no end of trouble and frustration. Refer to the combining network shown as Fig. 4. This is the first time that I can ever remember seeing it in print. This pad requires a balanced signal input and output. The schematic of the S.S. amplifier shows an unbalanced input. If it is to work with the pad, it must have a balanced input. There also is a problem of impedance matching.

"Placing this circuit across a 600 ohm line will cause a mismatch. The resistance values can be almost anything, as long as they are equal. The pad will work satisfactorily either way with an overall loss of 6 db for the 600 ohm configuration. Otherwise, I enjoyed every page. Thank you."

Richard R. Hogsbro
WLBE

Common Error

Referring to his article "Automatic Insertion of Network News", appearing in the July issue of **Broadcast Engineering**, the author writes:

"... one small gremlin crept into the schematic drawing of the unit. At the right edge of the schematic, the common ground terminal for PL-11, P-12, and P-13 is labeled as PL-13 also, and it should be PL-15. As far as I can see, this is the only error."

C. E. Gustafson
WKMI, WESO

Editorial Changes

Broadcast Engineering is constantly looking for Engineer Exchange items, manuscripts, photo coverage stories and letters to the editor that will be of high interest to its readers. An author's guide will be sent upon request.

COMPARE... YOU'LL BUY a CCA FM Transmitter

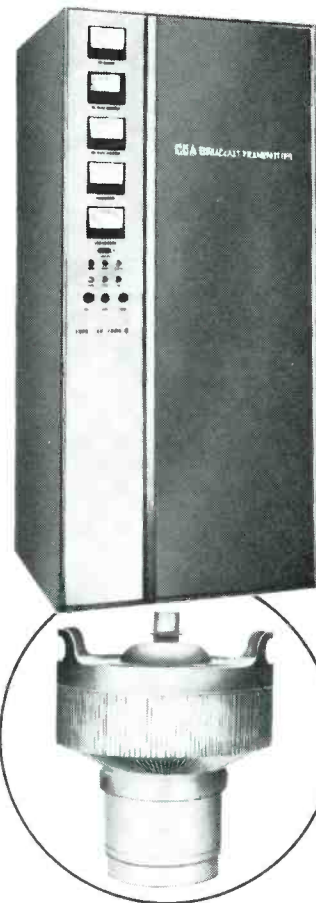

CCA is the only major FM equipment supplier who uses modern zero bias triodes in a grounded grid configuration. We've only lost three tubes in over 100 installations and some of these tubes are in operation after 20,000 hours. CCA tube cost is almost negligible. CCA FM Transmitters don't require neutralization. They're superstable and extremely reliable. They are very efficient and draw less power from the line than any competitive transmitter.

Compare — you'll agree with your fellow broadcasters. CCA FM transmitters cost less to buy, less to operate, are unsurpassed for reliability.



CCA Electronics Corp.

716 Jersey Avenue
Gloucester City, N. J. 08030
Telephone: (609) 456-1716

Our current catalog shows the entire Electro-Voice professional microphone line.

Strangely enough, so do Life, Time Newsweek, and U.S. News & World Report! Year after year after year!

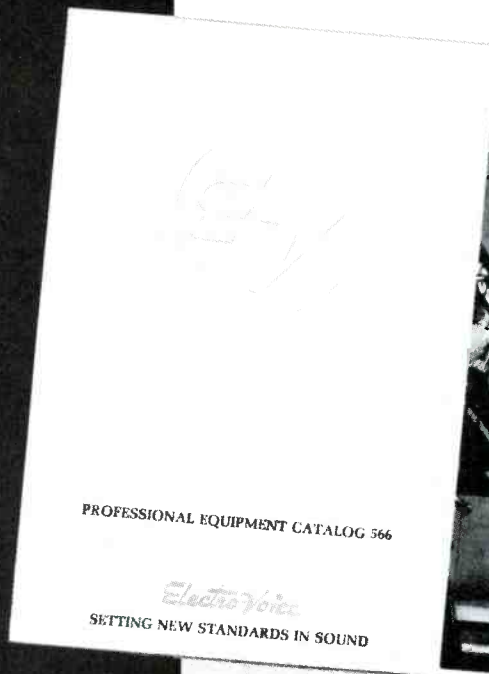

E-V For the 7th consecutive year we've counted microphones—by brand—in the four major newsweekly magazines. And, once again, Electro-Voice dominates the picture at major world news events.

We studied every editorial photo, in every issue, for a year. There were more Electro-Voice microphones seen than all other U.S. brands *combined!* E-V microphones were pictured 4.82 times more often than the next most popular brand.

We think this survey tells an important story about Electro-Voice quality and dependability. A story that is continued in TV, radio, movie, and recording studios throughout the world.

If you don't yet have a copy of our current catalog, fill out the coupon today. It will bring full details on the entire line. And to see E-V microphones in action . . . just keep reading.



Electro-Voice®
A SUBSIDIARY OF GULTON INDUSTRIES, INC.

- high fidelity speakers and systems • tuners, amplifiers, receivers
- public address loudspeakers • microphones • phonograph needles and cartridges • organs • space and defense electronics

ELECTRO-VOICE, INC., Dept. 981V
638 Cecil Street, Buchanan, Michigan 49107
Please send me the current Electro-Voice professional products catalog.

Name _____
Firm _____
Address _____
City _____ State _____ Zip _____

Circle Item 8 on Tech Data Card

AKG two-way microphones

An exclusive concept*

In the **AKG** two-way microphone system, the total response range has been subdivided between a high frequency and a low frequency transducer, each of which is optimally adjusted to its specific range (similar to a two-way speaker system). The two systems are connected by means of a cross-over network with the cross-over frequency at 500 Hz.

The cross-over network is housed in the lower portion of the microphone. In case of the D-202E and D-224E, the output circuit of the microphone contains an electrical bass attenuator to permit a reduction in low frequencies.

This unique arrangement achieves a number of previously unobtainable performance characteristics for cardioid dynamic microphones:

Flat frequency response over the entire audible range. The low as well as the high frequency system is optimally adjusted to its specific frequency range and the cross-over point, at 500 Hz, is unnoticeable.

Linear off-axis response. Sound reaching the microphone 90° off-axis is reproduced naturally. No frequency discriminating characteristics, which commonly arise from dynamic microphones, are audible.

Uniform front-to-back discrimination. The two-way system maintains a front-to-back discrimination of at least 20 db over its entire range, even in the critical low frequency and upper mid-range area.

Write for complete two-way microphone data.



MICROPHONES • HEADPHONES

DISTRIBUTED BY
NORTH AMERICAN PHILIPS COMPANY, INC.
100 EAST 42ND STREET, NEW YORK, NEW YORK 10017



D-200E

The basic two-way microphone. Incorporates all inherent features of the two-way technique: smooth frequency response; linear off-axis response; uniform front-to-back discrimination.
\$69.00 Net

D-202E

Professional two-way microphone. Extended, smooth frequency response. With bass roll-off of -20 db at 50 Hz. With sintered bronze cap which functions as windscreen, is water-proof and protects magnets from iron particles and dust.
\$130.00 Net

D-224E

Studio two-way microphone. Exceptional wide and smooth frequency response, normally expected only from condenser microphones. With bass roll-off switch and compensating windings to eliminate the effects of magnetic stray fields.
\$185.00 Net

*U.S. Patent No. 3,204,031

2-68

Circle Item 9 on Tech Data Card



Suddenly, every studio microphone in America is out of date!

Now you can get a special professional user price on your next Sony microphone purchase. Industry professionals are invited to send for complete specifications on the new solid-state C37-FET and C55-FET Condenser Microphones. Special prices will be quoted to you immediately by return mail.

Both of these sensational, new, Sony microphones deliver the ultimate in professional capabilities. Flat frequency response free from resonant peaks and dips. Warm, natural sound. Plus a wide dynamic range to capture the magnificence and true timbre of strings, woodwinds and piano. Field Effect Transistors replace the conventional vacuum tube and eliminate external power supplies and

connecting cables. And both microphones feature a self-contained, replaceable, 9-volt battery plus a built-in battery condition indicator.

In addition, the C55-FET utilizes a 90° rotating capsule for optimum cardioid pick-up characteristics in any application—hand-held solo performance or interview work, stand- or boom-mount. In the studio, the C55-FET's flexibility meets any microphone placement problem.

For complete specifications and special professional user prices, simply write to: Harold Watson, Sony/Superscope Microphone Sales Department, 8150 Vineland Avenue, Sun Valley, California 91352.

THE C37-FET:

Frequency Response: 20-20,000 Hz (± 2.5 db 30-18,000 Hz). Directional Characteristics: Uni- or omni-directional switch selected. Output Impedance: 50, 250 or 600 ohms balanced. Output Level: -50.8 db @ 250 ohms where 0 db = 1 volt/10 microbar. Noise Level: 24 db SL where 0 db = 2×10^{-4} microbar. Dynamic Range: 110 db.

THE C55-FET:

Frequency Response: 20-20,000 Hz (± 2.5 db 30-18,000 Hz). Directional Characteristics: Uni-directional cardioid (axis variable from 0° to 90°). Output Impedance: 50, 250 or 600 ohms balanced. Output Level: -50 db @ 250 ohms where 0 db = 1 volt/10 microbar. Noise Level: 24 db SL where 0 db = 2×10^{-4} microbar. Dynamic Range: 110 db.

You never heard it so good.

SONY **SUPERSCOPE**



Keeping accurate time with WWV

by Ron Merrell

"National Bureau of Standards, WWV, Fort Collins, Colorado; next time tone begins at ten hours, fifteen minutes Greenwich Mean Time." NBS station WWV offers this exacting time signal and other standardization services that often are overlooked or misunderstood.

Transmitting on 2.5, 5, 10, 15, 20 and 25 MHz, WWV offers a never ending flow of information that can be used by station engineers with little investment in time or money.

There are a number of economical receivers on the market that are capable of receiving on all the WWV frequencies. General coverage receivers used by SWL's and amateur radio operators make excellent monitors, but even a one-tube regenerative kit will suffice.

Optimum reception of WWV is dependent upon receiving location and propagation conditions. In the midwest, for example, 10 MHz normally works as an excellent receiving frequency. When the time signals on this frequency are weak, the signals on 5 MHz often are easily readable.

Also, the radiated power and frequencies used by NBS stations facilitates continuous reception throughout the country.

Frequency, MHz	Radiated power, kw			
	WWV	WWVH	WWVB	WWVL
0.020	—	—	—	2
0.060	—	—	12	—
2.5	2.5	1	—	—
5	10	2	—	—
10	10	2	—	—
15	10	2	—	—
20	2.5	—	—	—
25	2.5	—	—	—

Fig. 1

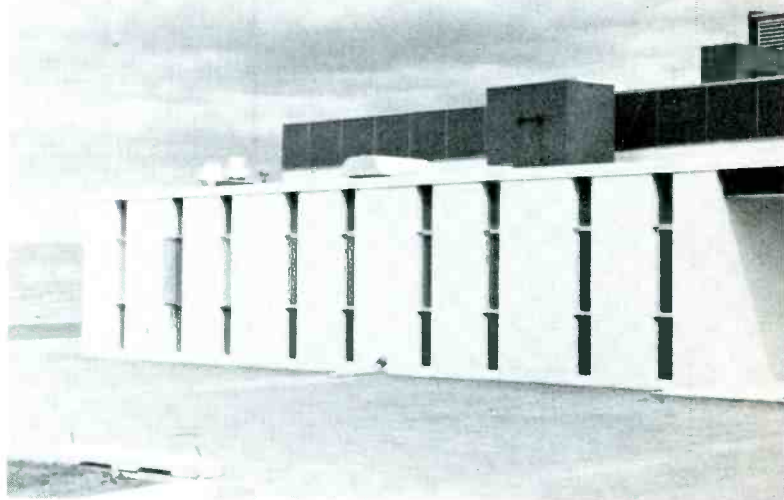

The broadcasts on 2.5 and 5 MHz from WWVH are from vertical quarter-wave antennas. The broadcasts on all other frequencies from WWV and WWVH are from Vertical half-wave dipoles.

Setting Station Clocks

The audio frequencies are interrupted at precisely three minutes before each hour (see Fig. 2). They are resumed on the hour and at five and ten minute intervals throughout the hour. Universal time is announced in International Morse Code each five minutes. This provides a ready reference to correct time for a clock that may be in error by a few minutes.

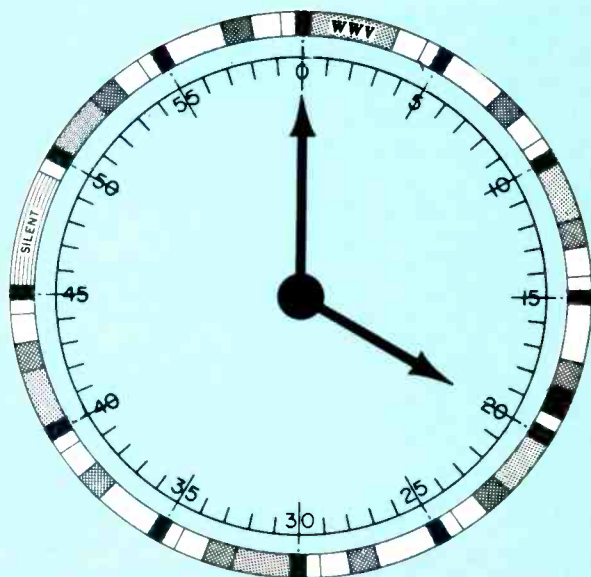
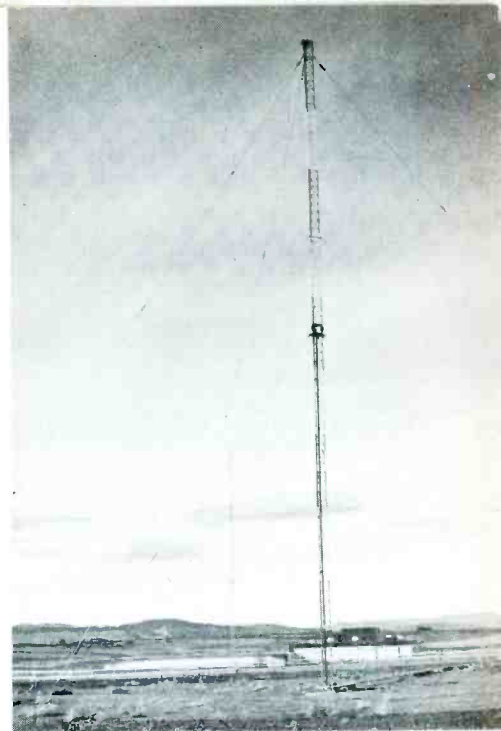
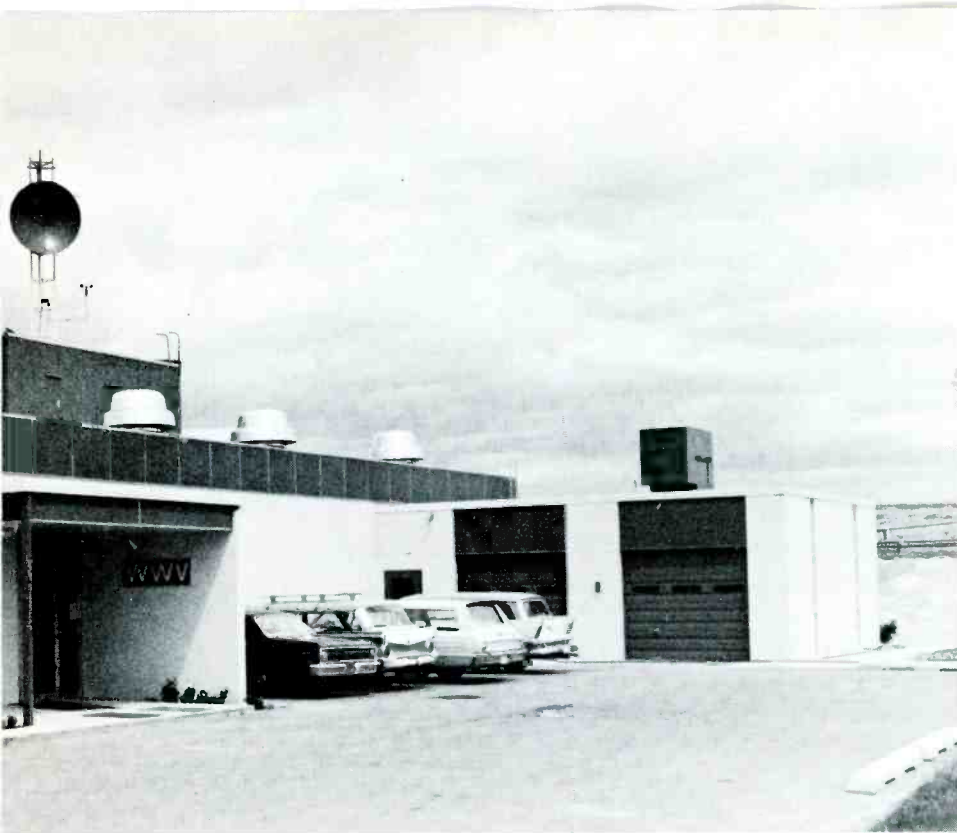

Fig. 2. The hourly broadcast schedule of WWV.



On the left is the WWV Transmitter building, and on the right, is the 5.0 MHz antenna with standby antennas in the background.

The time is given using the 24-hour system. (Midnight would be 0000 at longitude zero.) The first two figures give the hour and the last two the minutes after the hour when the tone begins.

For clocks that need to be reset often, it might help to install a switch on the side or bottom of the clock case to stop the clock for alignment. Otherwise, it will be necessary to unplug the clock. Unplugging the clock may complicate the procedure and result in additional errors.

If you know that the time is about 8:00 o'clock, you can remove the AC from the clock at the instant the second hand sweeps 12. Set the minute hand on

12. When the tone returns, immediately restart the clock. Until excessive AC line fluctuations or power failures occur, your clock should be off by no more than a fraction of a second.

By using the information in Fig. 2, it is possible to set station clocks without waiting for the five minute identification information. If you know your clock is close to accurate time, you can set it at the beginning or ending of the various information segments.

For example, the tone that begins each five minute period will stop after two minutes. You can adjust for this and start the clock at the instance the tone stops. (Exception: the tone segment that starts each new hour lasts three minutes.)

During most of each five minute period, seconds pulses are given at precise intervals. They are given by a double-sideband amplitude-modulation on each radio carrier frequency. Intervals are marked by the omission of the pulse at the beginning of the last second of every minute and by commencing each minute with two pulses spaced by 0.1 second.

If the second hand did not stop at 12 but went a few seconds beyond, you can count the time between pulses as seconds and restart the clock when the second hand and the seconds counted match.

This procedure may be used during all five minute periods except for a four minute silent period that begins at 45 minutes 15 seconds after each hour. Even this silent period offers a time reference. However, those who have tried to synchronize the clocks during this particular time period without this information have questioned their receiver calibration or assumed the WWV was experiencing transmitter troubles.

The Station Tone Clock

There are several ways to rework an electric clock to control local station time tones. Figures 3 and 4 are based on completing tone circuits by making electrical

SECONDS PULSES - WWV CONTINUOUS EXCEPT FOR 59th SECOND OF EACH MINUTE AND DURING SILENT PERIODS

STATION ANNOUNCEMENT

WWV - MORSE CODE - CALL LETTERS, UNIVERSAL TIME,
PROPAGATION FORECAST
VOICE - GREENWICH MEAN TIME
MORSE CODE - FREQUENCY OFFSET
(ON THE HOUR ONLY)

100 PPS 1000 Hz MODULATION WWV TIMING CODE

TONE MODULATION 600 Hz

TONE MODULATION 440 Hz

GEOALERTS

IDENTIFICATION PHASE SHIFT

UT-2 TIME CORRECTION

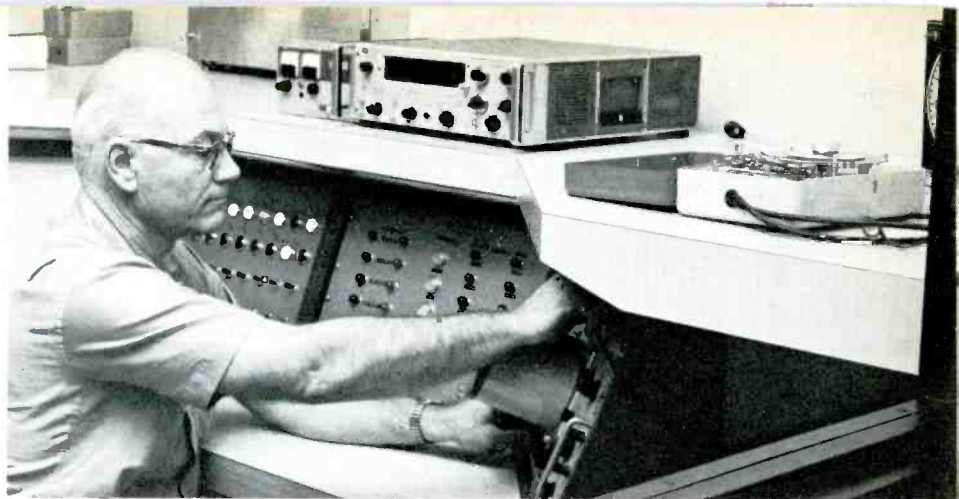
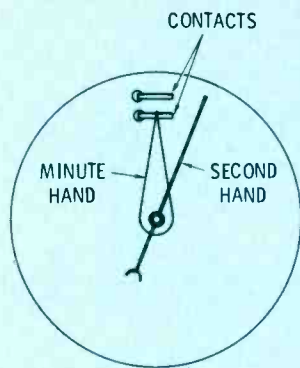

Engineer William Dirks in the control room, checking modulation.

contacts between spring wire and the clock hands. In all systems, a 10 or 12-inch clock face will make re-working easier.

Paint should be removed from the back of the hands. And since we are only concerned with tones every 60 minutes regardless of the hour, the hour hand may be discarded. . . A small relay may be used to apply the tone to some high level part of the circuit. There will be less trouble with contact noise if the tone is switched at high level and if the clock hands switch low voltage instead of the signal.

A unique method—though requiring more time to construct—is to replace the clock hands with thin aluminum discs. The hour hand has 12 small holes: the clock face, minute disc and the second disc have one hole each. A photocell behind the dial “sees” the light source for a brief time each hour as the holes line up. Widening the holes will make the beep last longer. If the discs are made of different diameters, numbers to indicate the time may be printed on their rims.

Standard Audio Frequencies

Standard audio frequencies of 440 Hz and 600 Hz

are sent on each radio carrier frequency at WWV. These audio frequencies are transmitted alternately at five minute intervals. The first tone period of each hour starts with 600Hz.

The accuracy of these audio frequencies is the same high precision as that of the carrier, but changes in the propagation medium occasionally will result in slight variations from the tone at WWV.

Since 1925 the frequency 440 Hz for the note A, above middle C, has been the standard in the music industry in the United States. WWV began broadcasting this standard in 1937.

Propagation Forecasts

During the International Morse Code portion of the time signal, a propagation forecast is sent. This occurs during the last half of every fifth minute. This forecast indicates the condition of the ionosphere at the time issued and the radio quality to be expected for the next six hours. These forecasts are based on data received from a worldwide network of geophysical and solar observatories.

The forecast is sent in code as a letter and number



NBS Physicist, Howard Machlan, at the console in the clock room.

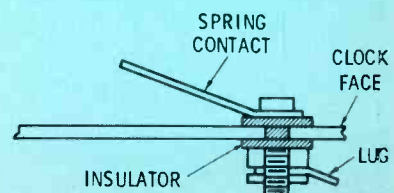
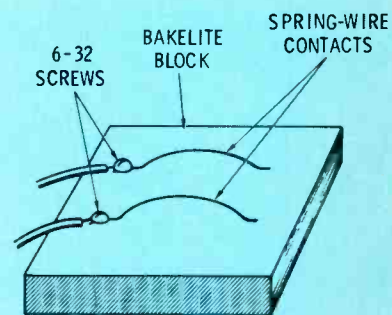

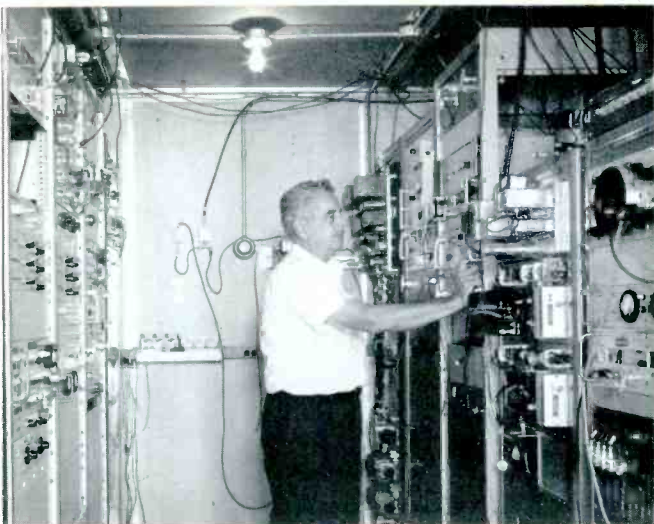

Electronics Engineer, Richard Carle, in shielded room at Ft. Collins site.

combination. The letter portion identifies the radio quality at the time the forecast is made. The letters "N," "U," and "W" are used and signify, respectively, normal conditions, unsettled or disturbed. The number represents the propagation quality on a typical North Atlantic path during the six hours after the forecast is given. Radio quality is based on the ITSA 1 to 9 scale which follows:

Disturbed	Unsettled	Normal
1. Useless	5. Fair	6. Fair-to-good
2. Very poor		7. Good
3. Poor		8. Very good
4. Poor-to-fair		9. Excellent

Summary

Correct time is as important to the listener as it is to the broadcaster. Since 1923, WWV has offered standardization services. The WWV standard of excellence offers each station the opportunity to be accurate.

While the services of WWV are free, there is one hazard involved in checking for accurate time—interference. If some local interference makes checking difficult, the alternate frequencies listed may not be covered. In fact, WWV's Canadian counterpart—CHU—offers time signals on 3330, 7335 and 14670 Hz. Thus, between the two stations there are nine frequencies used to broadcast time signals, ranging from 2.5 to 25 MHz.

There are other time signals available. The U.S. Naval observatory broadcasts time signals from Maryland over station NSS, from California and NPG, NPM in Hawaii and from NBA in the Canal Zone. Eight other countries also broadcast time signals, but none lift more rf power skyward than the American time broadcasters.

If station clocks needed constant resetting, interference, even with alternate time frequencies and stations available, might represent a problem. However, most receivers available today include noise limiting circuits. A system including a reworked master clock, time tone generator and time signal receiver will serve as an economical means of maintaining accurate time. ▲

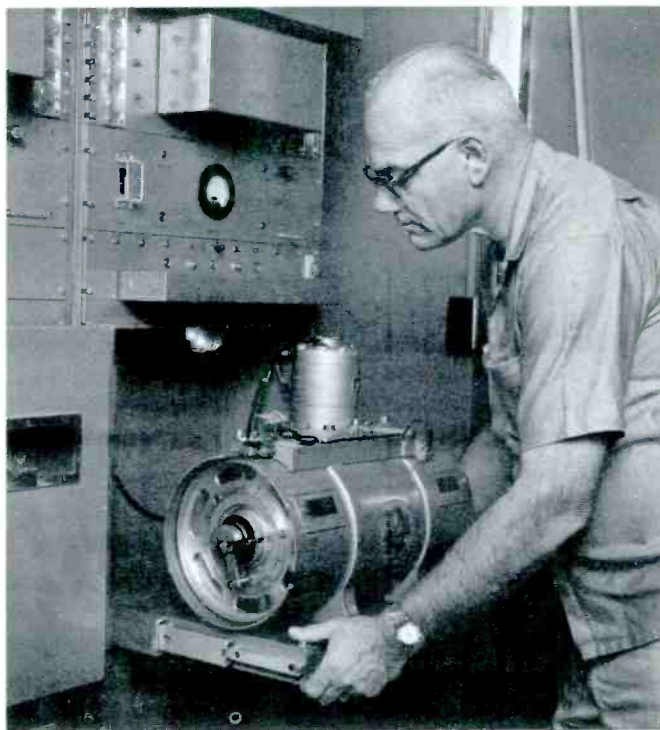

Dirks prepares to check one of the automatic voice announcers used to identify the station.

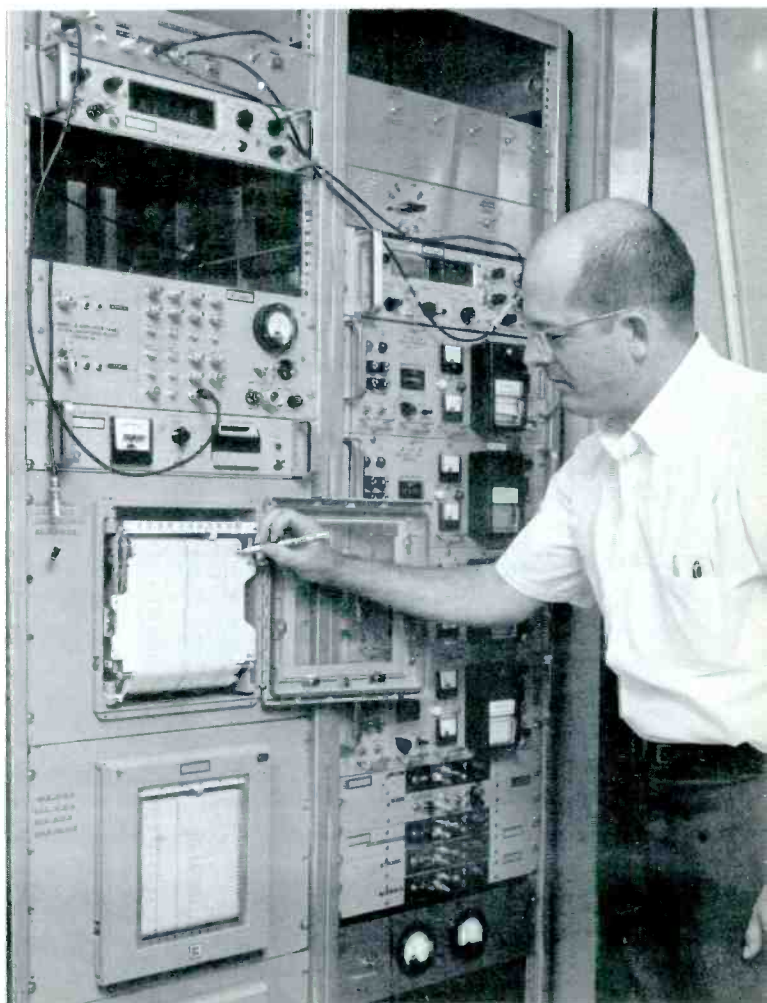

NBS Engineer John Milton, at the LF monitoring console.



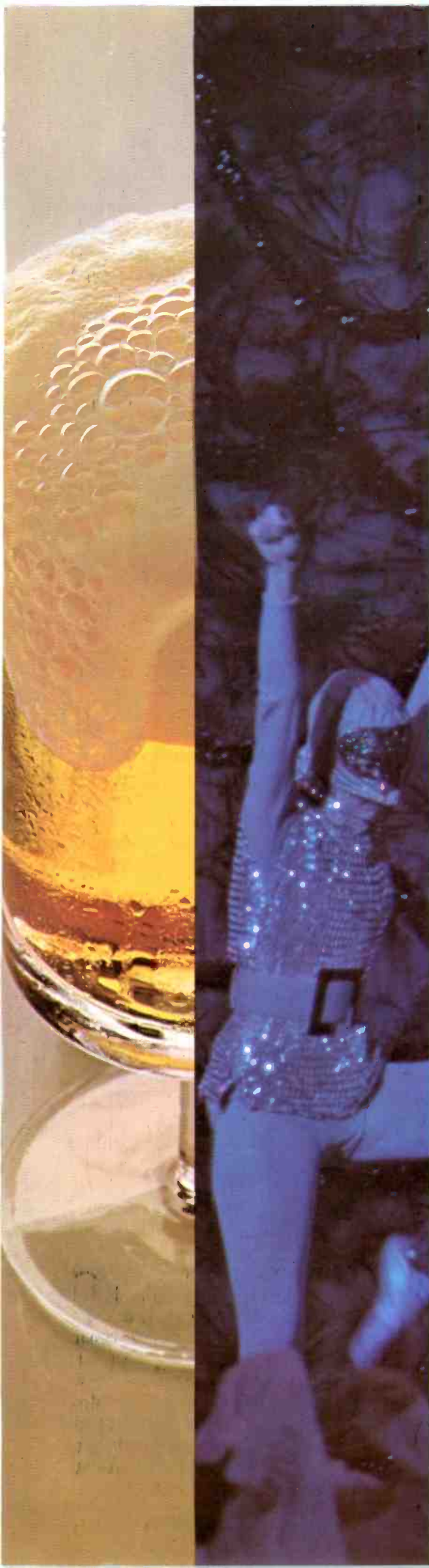

ELECTOGRAPHY



A new dimension in videotaping made possible by "Scotch" Brand Color Tape Plus

Electography is videotaping at its finest. Colors are brighter, clearer, livelier. Black and whites are stronger with amazing presence. Copies are perfect... matching the original picture and sound.

Electography is immediate. Lets you complete complex programming in hours. You see your work as you go. You're free to experiment... be more daring. You can use slow motion, fast motion, stop motion and reverse action. You can go out on location. Combine all types of existing footage (stills, film) with new footage. Edit instantly... electronically with 30 frame per second precision.

"Scotch" Brand Video Tape No. 399, Color Tape Plus, delivers the ultimate in electography. Gives you the response and full compatibility you need to make it all possible. Lets you use the most subtle lighting techniques. Gives you true colors... more dynamic black and whites... multiple generation copies undistinguishable from the master tape.

Want more information on electography and how you can take full advantage of this complete creative medium? Write: 3M Company, Magnetic Products Division, 3M Center, St. Paul, Minn. 55101.



"SCOTCH" IS A REGISTERED TRADEMARK OF 3M CO.

CHECKING VTR BURST PHASE

by George W. Ing

One problem in reproducing video tape color is maintaining proper phase relation between the color synchronizing burst signal and the other color signal components. Failure to do this results in normally pink faces reproducing as deep purple or green.

To minimize this problem, it is common to record color bars at the beginning of each tape so that, on playback, various adjustments may be made to optimize reproduction. A Vectorscope or similar device connected to the output will show if the correct phase relation exists between burst and bars. It is mandatory that the recorded bars be truly representative of the program material for this measurement to have any value.

At KSAT-TV the Vectorscope is placed near the camera encoders and is not convenient to the tape machines. A color monitor gives an approximation of correct phase relations, but the one monitor that serves three tape machines often is not available.

Vectorscope Substitute

To solve this problem, a substitute for the Vectorscope was developed. It compares the phase of burst with the phase of one bar of

the reproduced color bars, using the "spare" input to the waveform monitor associated with the tape machine. This device, inexpensive enough to install at each machine, can be checked with the Vectorscope at regular intervals.

In comparing the phase of one of the bars to burst phase, it is assumed that the color bars are in correct phase relation with each other. This is usually the case. It is more likely for burst phase to be in error in relation to the bars, because burst is removed and then later re-inserted in the tape recorder processing amplifier. The phase of the re-inserted burst is controllable, leading to possible errors in adjustment. (The comments here refer specifically to the Ampex VR 2000, but other type recorders operate in a similar manner).

Circuit Operation

The phase comparison device takes a small sample of the re-inserted burst, amplifies it and uses it to drive a subcarrier regenerator. The resulting CW signal is the exact frequency of burst. This signal is fed into a fixed delay line resulting in a signal which always lags burst by 192° , a phase position exactly 180° from that of the yellow bar.

A potentiometer controls the amplitude so that a signal may be developed which is equal in amplitude and opposite in phase to that of yellow. This signal is mixed with the reproduced color bars at one of the outputs of the processor. Then the yellow bar is "nulled" out on the waveform monitor display when the phase of re-inserted burst is correct.

Figure 1 shows the phase relations involved in the nulling process. Burst is at 180° and yellow at 168° . The nulling signal lags burst by 192° and yellow by 180° . Burst and yellow should be separated by 12° . In effect, the device enables the operator to adjust the phase of re-inserted burst to maintain the required 12° difference between burst and yellow.

The normal phase control for the burst re-inserted at the processor of the VR 2000 is a screwdriver adjusted variable delay line at the burst input to the processor. Since this adjustment is inconvenient, a more elaborate variable delay line was installed.

Added Delay Line

A four-section, 24-position wafer switch (Centralab PA-4006) is used to switch in or out of the circuit 23 different lengths of RG 187U sub-miniature 75 ohm coaxial cable. The shortest length is $6\frac{3}{8}$ inches for 1° phase shift, and the longest, 12 feet for 23° shift. Two sections of the switch are used for switching the inner conductors. The lugs on the other two sections serve as tie points for the cable shields.

The added variable delay line is placed in the 75 ohm line between the Colortec unit burst output and the processor burst input, effectively in series with the existing processor burst phase control. In the initial set-up, to be described later, the wafer switch is placed in the center of its rotation and proper phase adjusted by using the processor screw driver control. Then the operator can control burst phase plus or minus 11° with the wafer switch. When the phase comparison device is properly set up and a tape is re-

produced having incorrect phase relation between yellow and burst, the yellow bar will not null out until burst phase is adjusted. Once set up, the phase of the "nulling" signal always lags burst by 192° . When burst phase is adjusted so that yellow is nulled out by this signal, yellow will be exactly 12° from burst.

The nulling signal, does not appear in the output of the tape machine that feeds the program line. If not used otherwise, the non-composite output of the processor may be used to feed the phase comparison device, in which case, external sync is used at the waveform monitor. If the non-composite output is used for other purposes, the composite output of the processor may be looped through a video distribution amplifier and the output of this amplifier feeds the phase comparison device.

Block Diagram

Figure 2 shows the block diagram of the comparison unit and its connection to the VR 2000. The added wafer switch variable delay line is shown inserted in the 75 ohm line between the Colortec burst output and the processor burst input. For simplicity, only 3 of the 23 sections are shown. Note that it is not a tapped delay line.

The burst sample is taken from the emitter of the transistor stage just ahead of the burst adder in the processor. A 2N 2222 emitter follower stage is added to the processor circuit board to isolate the sampling point from the subcarrier regenerator.

The burst sample is amplified and then applied to an injection controlled oscillator which acts as a subcarrier regenerator. The CW output of the oscillator feeds a 12BH7 delay line driver. The delay line consists of a length of RG 59U coaxial cable terminated at 75 ohms. The method of determining length will be described later. The output of the delay line is mixed with the output of the tape machine processor by a 2000 ohm potentiometer. The pot equates the amplitude of the nulling signal from the delay line, to the yellow bar in the reproduced signal. The mixed signal is fed into the "spare" input position of the waveform monitor selector switch.

Construction

The injection controlled oscillator is used in some color receiver designs, in which video and burst from the detector are amplified, video is gated out by a pulse from the horizontal output transformer, and the remaining train of bursts

used to cause a 3.58 MHz crystal to ring. The output of the ringing crystal is then used to tightly lock an electron-coupled oscillator. In this application, since there is no video present, no gating action is required.

The necessary transformers and crystal, along with service data, can be purchased from the local replacement parts distributor for the receiver manufacturer, for about \$5.

The 2N 222 emitter follower added to the processor board uses the same circuit values as the 2N 2222 used as the burst input stage of the processor. Since this unit is on a slide out drawer, a flexible line must be used to connect the output of the 2N 2222 isolation stage to the subcarrier regenerator chassis. A twisted pair may be used instead of coax.

The subcarrier regenerator along with the wafer switch variable delay line and the amplitude control pot are mounted on a 19" rack panel which is installed on the right hand side of the VR 2000 cabinet. Plate voltage is obtained from one of the station's 285 volt regulated supplies, and filament power, from a small transformer mounted on the rack panel.

The experimental unit uses tubes because the special transformers de-

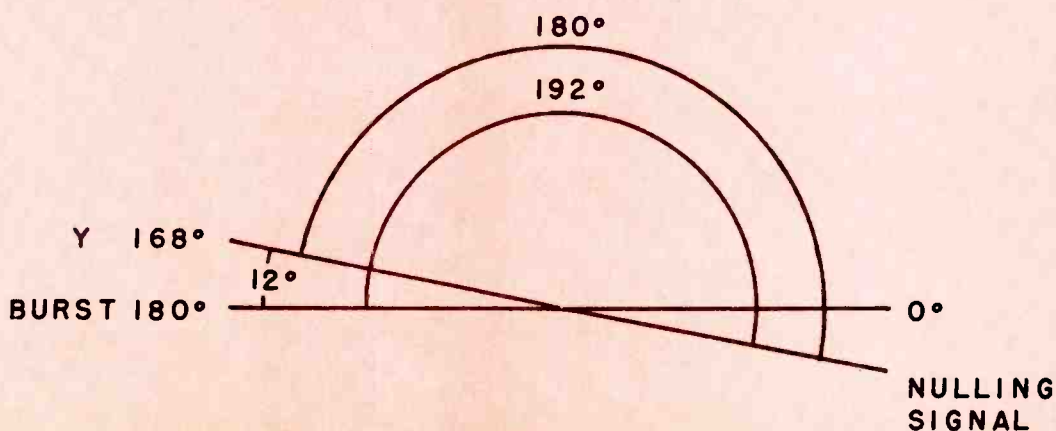

Fig. 1

signed for tube use were readily available. An all transistor design should pose no problems.

Set Up Procedure

The procedure requires the playback of carefully recorded color bars. First, the recorder should be checked with the alignment tape. Also, the bar output of the encoder should be checked with the Vectorscope to make sure that all vectors are within the tolerance boxes. Specifically note that yellow must be at 168° , exactly 12° from burst.

Set the Colortec burst selector switch to "Tape" burst. Next, the recording of the bars is played back and the normal check made of tracking, tip projection, guide height and playback equalization of the four channels. The latter should not be necessary if the Auto Chroma accessory is used.

Feed the output of the processor that normally goes to the program line into the Vectorscope. Set the

added wafer switch burst phase control to the center of its rotation. Adjust the processor screw driver adjusted burst phase control so that burst is exactly 12° from yellow. To this point, the procedure is similar to the one normally used for setting burst phase, except that a more convenient control has been added.

Now determine the length of delay line connected to the output of the injection controlled oscillator. Use a calibrated variable delay line if it is available. This unit has toggle switches for large increments of delay, and a wafer switch for $\pm 5^\circ$ adjustment. The calibrated delay line is terminated with 75 ohms and inserted between the output of the delay line driver and the amplitude control pot.

While playing back the bars, adjust the phase of the nulling signal by using the calibrated delay line. Also adjust amplitude by the 2000 ohm pot until the mixed signal at

the "spare" position of the waveform monitor shows a precise null of the yellow bar.

Initially, the calibrated delay line is not set for any particular delay. It is simply trial and error. Although the output of the oscillator is the exact frequency of burst, it is not the exact phase, otherwise all that would be necessary would be to add 192° of delay. Once the yellow bar is nulled by adjusting the delay line and the amplitude control, there is assurance that the nulling signal lags burst by exactly 192° . Next, the required delay is read off the calibrated delay line indicators and a length of RG 59U substituted in its place. The delay of this cable is approximately 2° per foot.

If the calibrated delay line is not available, various lengths of RG 59U must be tried. The installation at KSAT-TV required $57\frac{1}{2}$ feet. The slug tuning controls on the oscillator transformers will afford some degree of phase control.

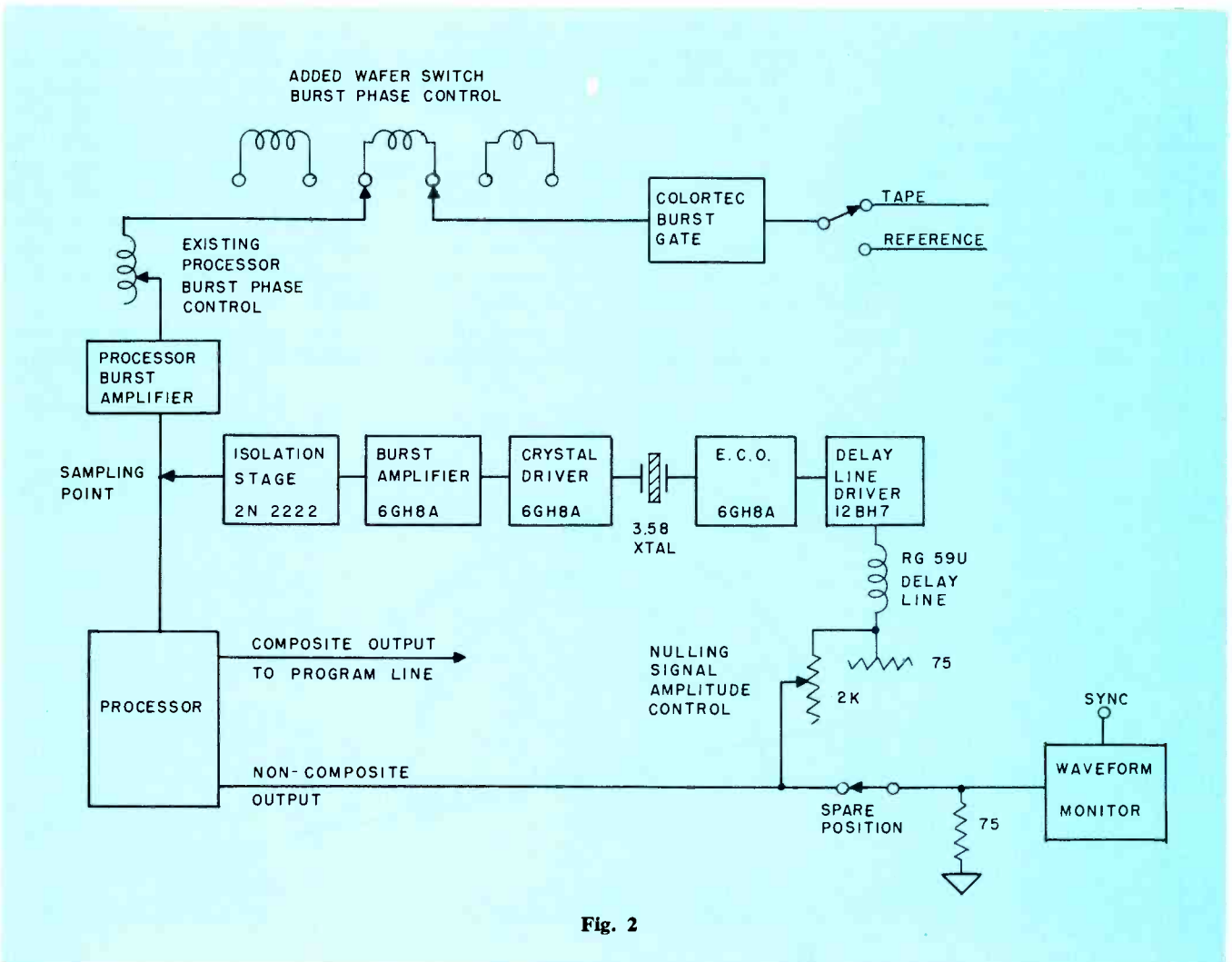

Fig. 2

Figure 3 (a) shows the color bars with the waveform monitor display knob in the "2 lines" position, and the response knob in the "high pass" position, with nulling signal absent. Figure 3 (b) shows the null when the nulling signal is present.

Correction Of Burst Phase

If a tape is played back which has incorrect phase relation between burst and the yellow bar, the yellow bar must be nulled out. Do this by alternately adjusting the wafer switch burst phase control and the 2000 ohm amplitude control. This should correct the burst phase.

During daily operation, the wafer switch should be returned to its center position after each tape playback. This minimizes the possibility of hastily loaded tapes being aired off phase. Only occasionally does a tape need burst phase correction. Since incorrect phase occurs often when dubbing, it is a good idea to include the color bars during this process to check phase.

The Colortec unit burst selector switch may be set to either "Tape" burst or "Reference" burst, but care must be taken to match phase between the two as described in the Ampex instruction book.

Sharpness Of Null

The yellow bar is used for null-

ing because it is the first color bar following burst, when using bars generated in order of descending luminance. This type generator is in use at many stations. Colortec and similar units compare tape burst with reference subcarrier, and derive an error signal to correct phase line by line.

The correction is most accurate immediately following burst. For this reason, the "I" bar would be good for nulling except that some stations do not include I and Q in their test bars. Some generators produce bars in order of descending phase. This device will null yellow no matter in what order it appears. If the color bars are recorded full field instead of split field, nulling is facilitated because I and Q are eliminated.

The "high pass" position of the waveform monitor is better for nulling because the clutter of luminance information is absent and the second and third harmonics of the mixed signal are removed because the response in this position falls off rapidly beyond 4 MHz. The presence of harmonics precludes a sharp null.

Since the device depends on both amplitude and phase nulling, it is important to adjust equally outputs of the four playback channels so that the amplitude of the yellow bar remains constant as the head out-

puts are switched. A refinement would be to clip top and bottom of the bars so that the amplitude of all reproduced yellow bars would be the same. This would eliminate amplitude adjustment of the nulling signal once it was set.

Proper tip projection and guide height adjustments minimize velocity errors which cause a cyclic variation of the phase of the yellow bar, making it difficult to null phase. The velocity error compensator accessory would be helpful.

Experience In Use Of The Unit

This unit does not supplant the Vectorscope, or similar precision phase measuring devices. However it does provide an inexpensive method of checking burst phase when there are a number of recorders in operation. Each unit must be checked against the precision phase measuring device at regular intervals.

The burst phase checker has been used for several months on one VTR machine with good results. However, the usual 30 seconds of color bars on commercial spot tapes does not allow enough time for the additional burst phase check. One minute is better.

The addition of clipper circuits to eliminate the amplitude null adjustment, and a 3.58 MHz band pass filter ahead of the waveform monitor to obviate the necessity of switching the monitor to the "high pass" position, would speed up the procedure.

Syndicated programs and others of longer duration usually have several minutes of bars, affording ample time for the burst phase check. Although this device was designed for use with the Ampex VR 2000, the same principle may be applied to monitor other color video tape recorders.

Summary

Proper reproduction of color from a video tape recorder requires the color synchronizing burst signal to be in proper phase relation with other color signal components. A simple device has been developed which may be installed in the Ampex VR 2000 recorder cabinet and used to furnish a visual indication of correct phase. A more conveniently adjustable burst phase control has been added to the recorder so the operator may adjust phase while watching the indication. ▲

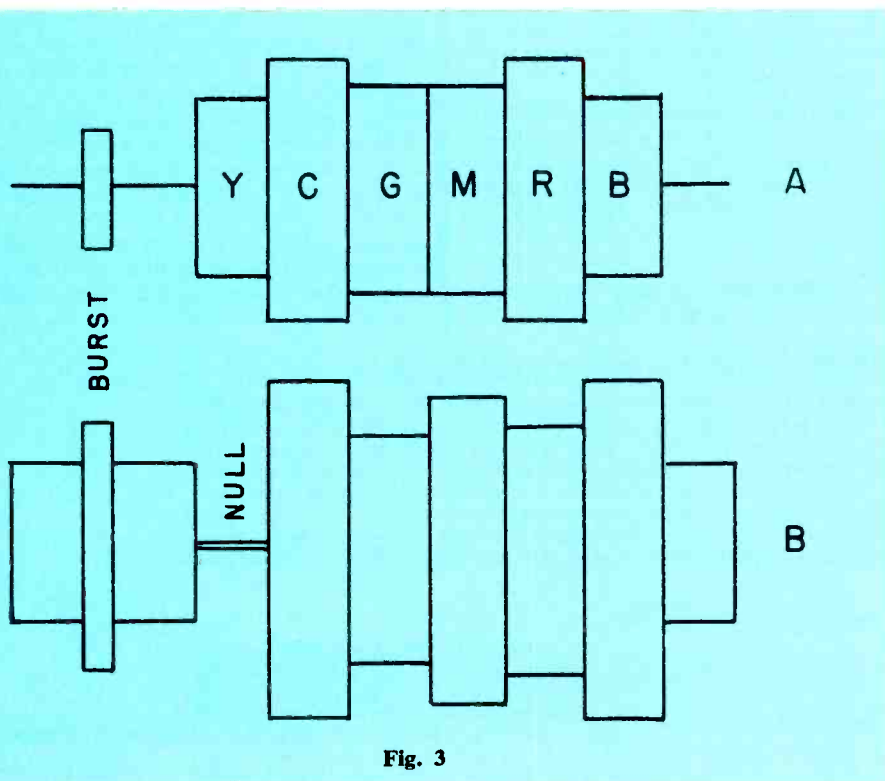

Fig. 3

Attention TV Stations:

We've got news for you!

FILMLINE'S professional color film processors now available for TV NEWS

The FILMLINE Models FE-30 and FE-50 are exciting new color film processors designed specifically for use in television station news departments. The design is backed by Filmline's reputation as the world's leading manufacturer of professional film processors for the commercial motion picture laboratory industry.

Now for the first time the television industry can enjoy the benefits of professional caliber equipment incorporating exclusive FILMLINE features that have paced the state-of-the-art in commercial laboratories, at a cost lower than processors offering less.

After you check these exclusive Filmline features you'll want to install a Filmline processor in your news department NOW!

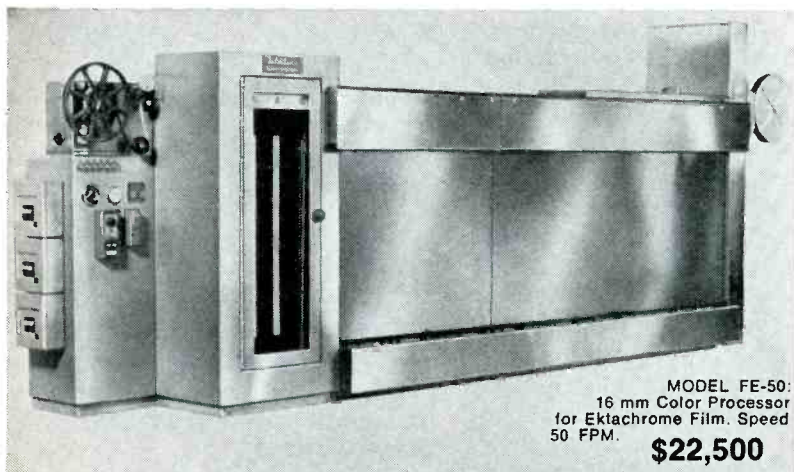

- **"FILMLINE OVERDRIVE FILM TRANSPORT SYSTEM"**
This marvel of engineering completely eliminates film breakage, pulled perforations, scratches and operator error. The film can be deliberately stalled in the machine without film breakage or significant change of film footage in solutions. The heart of any film processor is the drive system. No other film drive system such as sprocket drive, bottom drive or simple clutch drives with floating lower assemblies can give you the performance capability of the unique Filmline Overdrive Film Transport System.
- **"TORQUE MOTOR TAKE-UP"** gives you constant film take-up and does not impose any stress or strain on the film itself. Completely independent of the film transport system. This FILMLINE feature is usually found in professional commercial processors but is incorporated on the FE-30 and

FE-50 models as standard equipment. Don't settle for less!

- **"TEMP-GUARD"** positive temperature control system. Completely transistorized circuitry insures temperature control to well within processing tolerances. Temp-Guard controls temperatures accurately and without the problems of other systems of lesser sophistication.
- **"TURBO-FLOW"** impingement dryer. Shortens dry-to-dry time, improves film results, and carefully controls humidity content of your valuable (and sometimes rare) originals. Immediate projection capability is assured because the film dries flat without the usual curl associated with other film processors.
- **"ZERO DOWN TIME"** The reputation of any film processor is only as good as its reliability. The

combination of the exclusive and special added Filmline features guarantees trouble-free operation with absolute minimum down-time and without continual operator adjustments. Recapture your original investment in 2 years on maintenance savings alone. Filmline's "Push the button and walk-away processing" allows inexperienced operators to turn out highest quality film.

- **"MATERIALS, CONSTRUCTION AND DESIGN"** All Filmline machines are constructed entirely of metal and tanks are type 316 stainless steel, heliarc welded to government specifications. The finest components available are used and rigid quality control standards are maintained. Compare Filmline features to other processors costing more money. Feature-by-feature, a careful evaluation will convince you that Filmline offers you more for your investment.

Additional Features included in price of machine (Not as extras).

Magazine load, daylight operation ■ Feed-in time delay elevator (completely accessible) ■ Take-up time delay elevator (completely accessible) ■ Red brass bleach tank, shafts, etc. Prehardener solution filter ■ Precision Filmline Venturi air squeegee prior to drybox entry ■ Air vent on prehardener ■ Solid state variable speed D.C. drive main motor ■ Bottom drains and valves on all tanks ■ Extended development time up to two additional camera stops at 50 FPM ■ Pump recirculation of all eight solutions thru spray bars ■ Temperature is sensed in the recirculation line ■ All solutions temperature controlled, no chilled water required ■ Built-in air compressor ■ Captive bottom assemblies assure you constant footage in each solution ■ Change over from standard developing to extended developing can be accomplished in a matter of seconds ■ Impingement dryer allows shorter put through time.

Partial listing of Filmline Color Installations:— NBC- New York, NBC- Washington, NBC- Cleveland, NBC- Chicago, CBS & ABC Networks, Eastman Kodak, Rochester.

Laboratories: De Luxe Labs, General Film Labs (Hollywood), Pathe-Labs, Precision Labs, Mecca Labs, Color Service Co., Capital Film Labs, Byron Film Labs, MGM, Movie Lab, Lab-TV, Technical Film Labs, Telecolor Film Labs, Guffanti Film Labs, A-One Labs, All-service Labs, NASA Cape Kennedy, Ford Motion Picture Labs.

TV Stations: WAPI-TV, KTVI-TV, WXYZ-TV, WTPA-TV, WBTV-TV, WEAT-TV, WMAL-TV, WSYR-TV, WDSU-TV, WVUE-TV, WJXT-TV, WTOP-TV, WAVY-TV, KTAR-TV, WTVR-TV, WFBC-TV, WMAR-TV, WCKT-TV, WAVE-TV, WCPQ-TV, WAPA-TV, WCIV-TV, WJIM-TV, WWL-TV, KYW-TV, KETV-TV, WNBQ-TV, KSLA-TV, WSAZ-TV, WHP-TV, WHCT-TV, WTVQ-TV.

All prices F.O.B. MILFORD, CONN.



Send for Literature.

Time & Lease Plans Available.

"When you buy quality Filmline Costs Less"

BS-68

Circle Item 12 on Tech Data Card

When engineers get together,
the conversation turns to pickups.



It's an irresistible topic.
Especially since Stanton came out with the Model 500 stereo cartridge.
That's an engineer's pickup, if there ever was one.
Beautiful curve—within 1 db from 20 to 10,000 Hz, 2 db from 10,000 to 20,000 Hz.
Fantastically small moving system to trace the widest twists in the groove.
Light weight (only 5 grams!) to take advantage of low-mass tone arms.
And, of course, Stanton's legendary quality control.
No wonder engineers use the Stanton 500 for critical broadcasting
and auditioning applications.
And to impress other engineers with their pickupmanship.
(Available with 0.7 or 0.5-mil diamond, \$30; with elliptical diamond, \$35.
For free literature, write to Stanton Magnetics, Inc., Plainview, L.I., N.Y.)



simultaneous record & playback

... plus dubbing

with Collins' new compact Twintape System

Collins' new Twintape System, completely solid-state and available in monaural or stereo models, is the most convenient, flexible, and easy to operate cartridge machine on the market. The Twintape System consists of two units: the 642E Twintape Playback Unit, and the companion 216D Record Amplifier. Combined, these units permit:

- Playback on both cartridges simultaneously.
- Recording on one cartridge while playing the other.
- Dubbing from one cartridge to the other.

Tape transport assemblies in the Playback Unit are easily removed. Rugged, direct-drive capstan motors eliminate flywheels, rubber belts, etc., and produce extremely low wow and flutter. With extra heavy Mu-metal magnetic shields, the unit has very low susceptibility to magnetic pickup of noise. Rear terminal strips provide for optional remote control, automatic sequencing of multiple machines, cue detector contact outputs, etc. Routine maintenance of the Playback Unit may be performed in seconds.

Cue tone oscillators, record level metering, operation controls, and an amplifier are contained in the 216D Record Amplifier. One cue tone is standard, with option for three cue tones. The amplifier may be stacked compactly with the Playback Unit, or rack mounted with an optional adaptor.

All Twintape System electronic circuits are mounted on plug-in, etched epoxy boards.

For a descriptive brochure on this new Twintape System, write or call Broadcast Communication Division, Collins Radio Company, Dallas, Texas 75207. Phone (214) AD 5-9511.



COMMUNICATION / COMPUTATION / CONTROL



Constructing a transmitter transfer panel

by Robert M. Crotinger*

This transmitter transfer panel was designed for use in stations having a standby transmitter available for remote control operation. The change from the main transmitter to the auxiliary can be made by this unit from either the transmitter site or the remote control location. At

*Technical Director, KFMB, San Diego, Calif.

KFMB, San Diego, Calif., where the unit was designed and constructed, the main transmitter is an RCA BTA-5G and the auxiliary a Bauer one kw.

The purpose of the unit is to transfer the load from one transmitter to the other automatically while transferring the dummy load to the opposite transmitter. After

the action is initiated an industrial timer controls the sequence of events. This timer consists of a timer motor driving a series of cams which operate micro-switches. The angular position of the cam operation is adjustable as is the duration of the interval of microswitch operation. The actual event operation is controlled by separate relays.

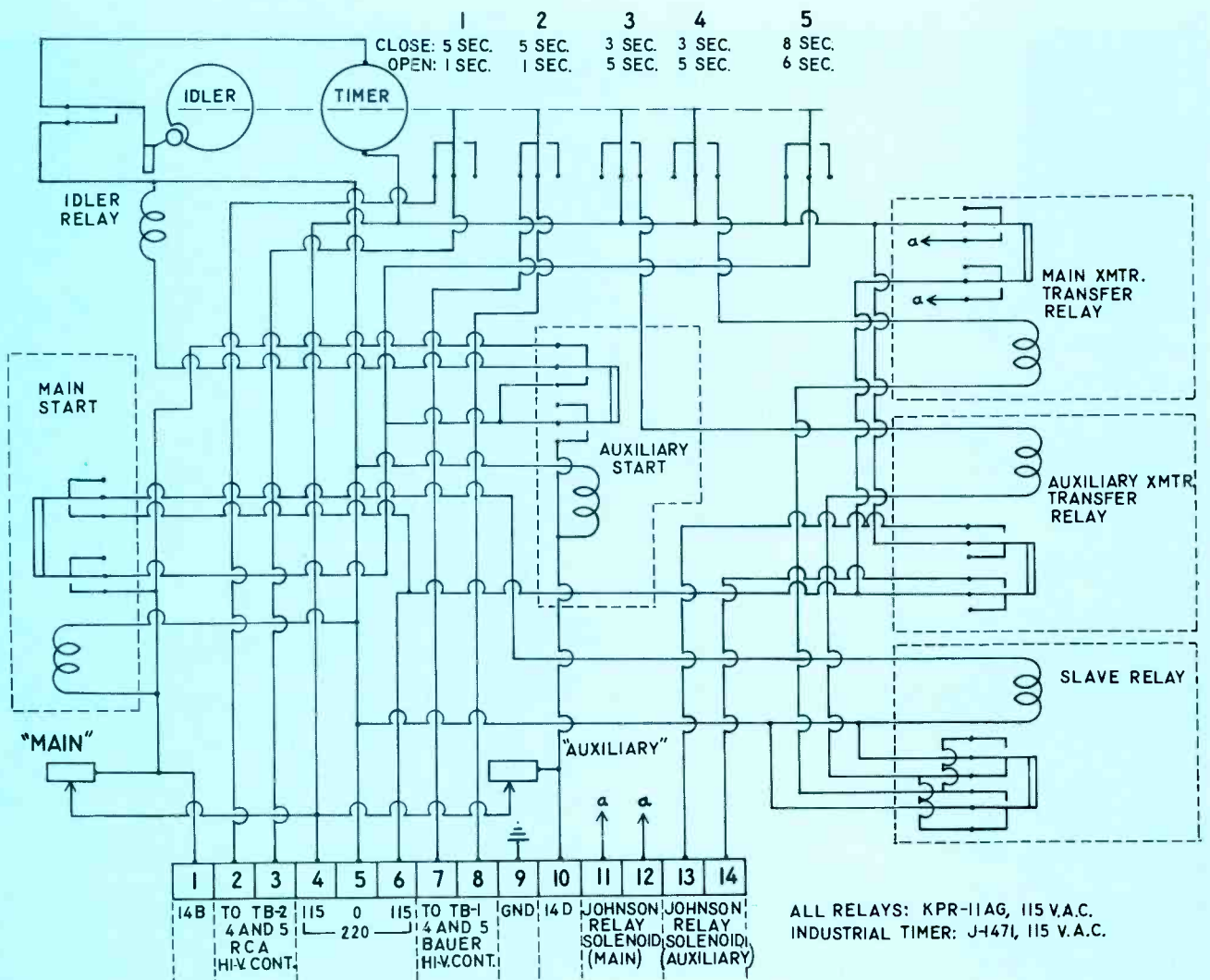

Operation Sequence

Operation is initiated either by the main or auxiliary push buttons, or by the application of a pulse of AC from the remote control unit. Pushing the main button, or a pulse from the remote control unit on 14B in schematic, initiates transfer of the antenna to the main transmitter. The main start relay coil is then energized by this pulse. The bottom contacts of this relay are the holding contacts and keep the relay pulled-in at this time. Their hot feed is obtained from timer section 5 which is normally closed at this time.

The idler relay is actuated at this time also. It is shunted across the main start relay through the N.C. contacts of the upper section of the auxiliary start relay. The pawl is pulled from the idler wheel and also

closes the SPST timer microswitch. The holding-in of the main start relay also holds in the idler relay and assures positive start of the timer. The timer now starts turning the cams for the remaining sequence and will continue running until the idler wheel returns to its original position. The idler relay will be de-energized before this occurs.

There are five sections in the timer. Section 1 and 2 act simultaneously. Section 1 completes the plate voltage interlock of the main transmitter and opens after one second removing the plate voltage from that transmitter. Section 2 duplicates with the auxiliary transmitter.

Likewise, Sections 3 and 4 (N.O.) act at the same time. Section 3 closes at three seconds completing the 115 VAC feed to the auxiliary transmitter transfer relay at the top of the coil. Section 4 completes

the hot 115 VAC feed to the main transmitter. Each relay feeds a solenoid of the transfer relay which is located in the antenna phasing cabinet. The position of the slave relay which completes the cold side of each of the transfer relays, determines which solenoid operates.

Since in this case the main button has been pushed, the main start relay is held-in. The upper contacts of the main start relay are holding-in the slave relay using the 115 VAC from the other side of the line. The slave relay thus completes the cold side of the main transmitter transfer relay, actuating it and leaving the cold side of the auxiliary transmitter transfer relay open.

The main transmitter transfer relay when operating applies 220 VAC from the outside legs of the line to the transfer relay in the phasing cabinet, transferring the main

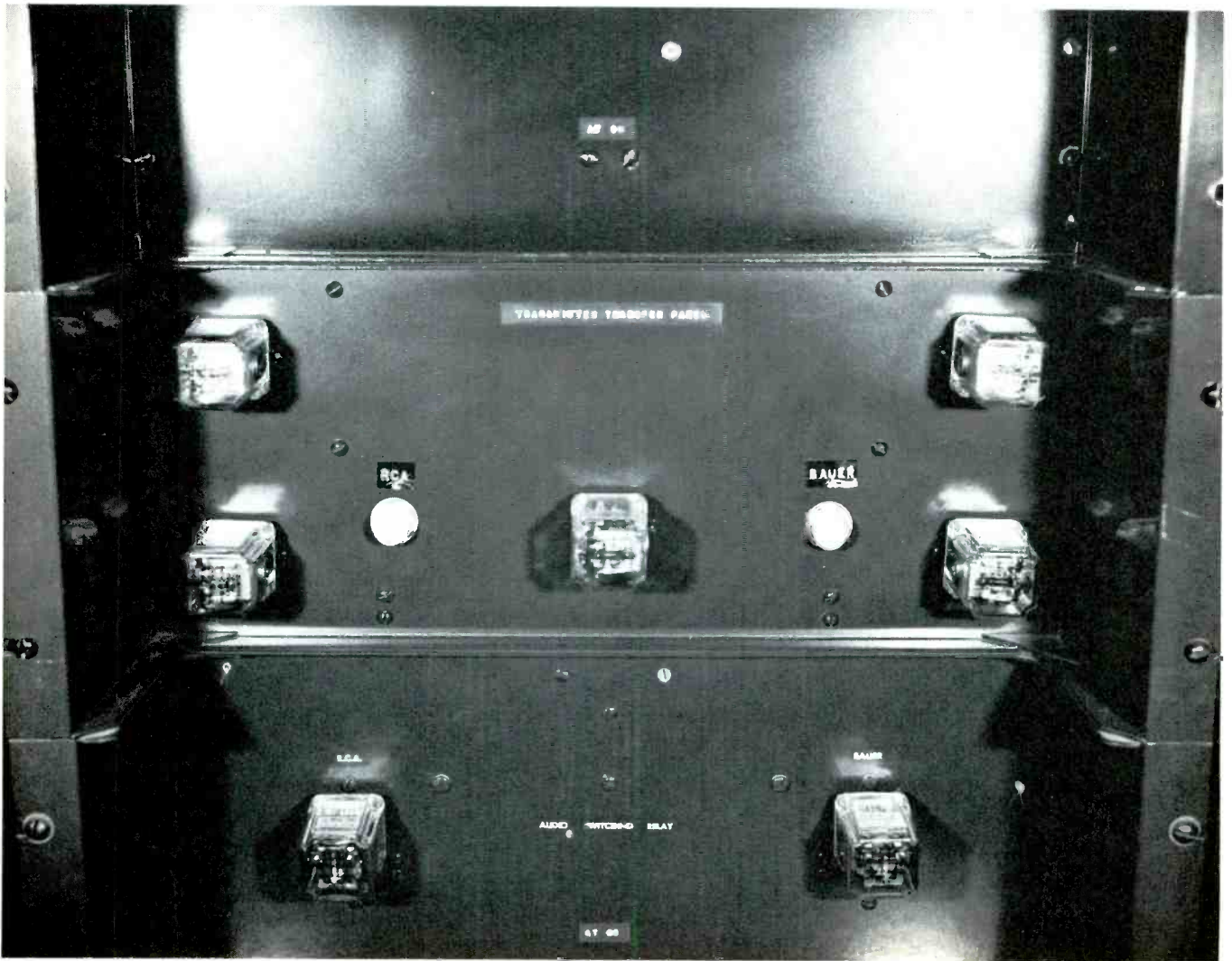

Fig. 2 Front view of transfer panel.

transmitter to the antenna load (common point). Timer section 4 remains closed for 2 seconds, until 5 second elapsed time, allowing sufficient time for the operation of the solenoid. At 5 seconds elapsed time, sections 3 and 4 open, removing the hot feed from the two KPR11AG transfer relays. Within this same time lapse sections 1 and 2 close, completing the HV interlocks on both transmitters and applying plate voltage, the transfer having been completed at this time.

At 6 seconds elapsed time section 5 opens dropping out the hot 115 VAC feed to the main start and auxiliary start relays holding contacts causing the relay which is held in to drop out. This also drops out the idler wheel solenoid leaving the cam free to determine its operation through the idler wheel.

At 8 seconds elapsed time sec-

tion 5 closes, re-applying the hot 115 VAC feed to the start relay holding contact arms. The idler solenoid does not operate at this time as it is shunted across the main start relay coil, which is now dropped out.

At the end of the total elapsed time, 10 seconds, the idler wheel falls into the cam slot dropping out the timer microswitch and removing the cold side of the supply from the timer motor. The unit is now ready for the next initiated operation.

If the operation is initiated from the auxiliary push button, the hot 115 VAC feed to the idler solenoid is completed through the upper contacts of the auxiliary start relay from the start relay holding contact supply through the section 5 microswitch. This prevents the feed to the idler solenoid from being applied to

the main start relay. Also, in this case, the slave relay, being un-energized, completes the cold side of the auxiliary transmitter transfer relay so that the proper solenoid on the RF switching relay will be energized.

Synthesizing a circuit to perform these operations was a problem as one function could jeopardize another. Information on the subject is rare; so as a result, the slave relay was used.

The unit, completed in June, 1965, has been in continuous, un-failing operation at KFMB for the past three years, being used regularly every Wednesday night on the maintenance schedule in addition to emergencies. However, it is expected that an exact duplication of the panel might not satisfy all the requirements for a particular installation. ▲

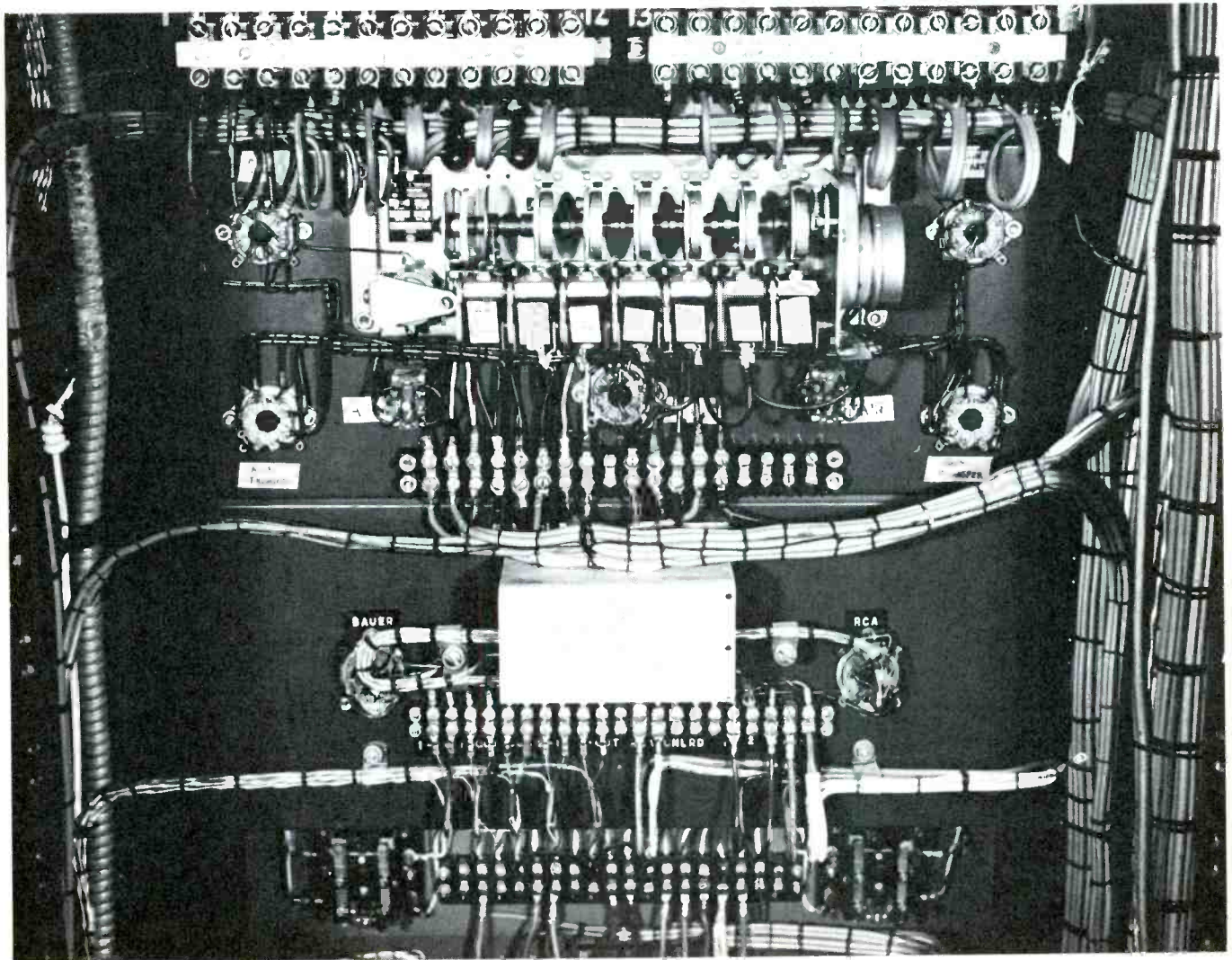
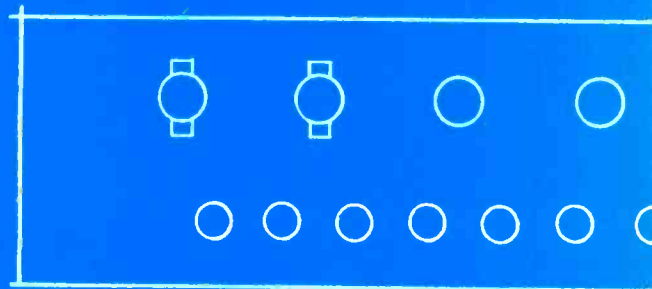
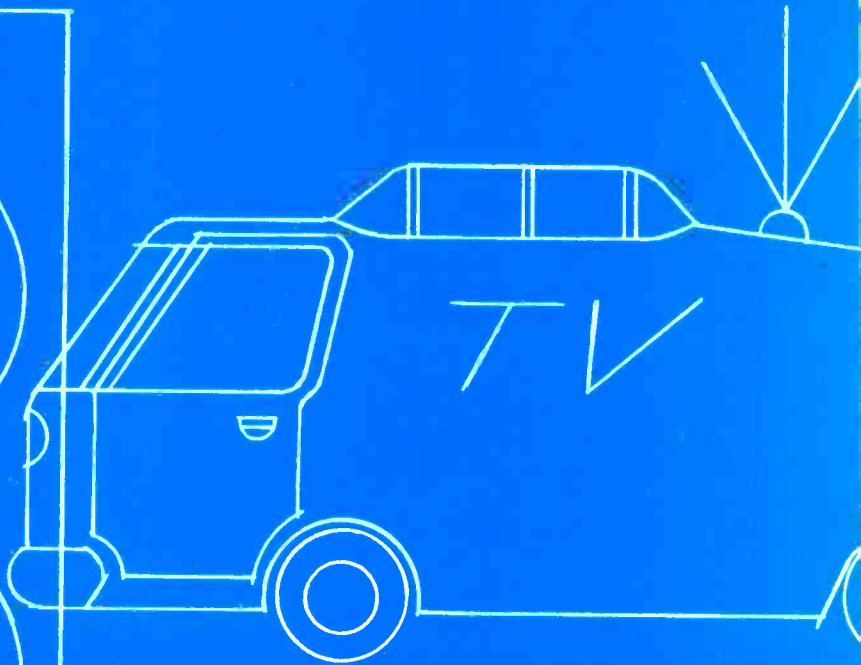
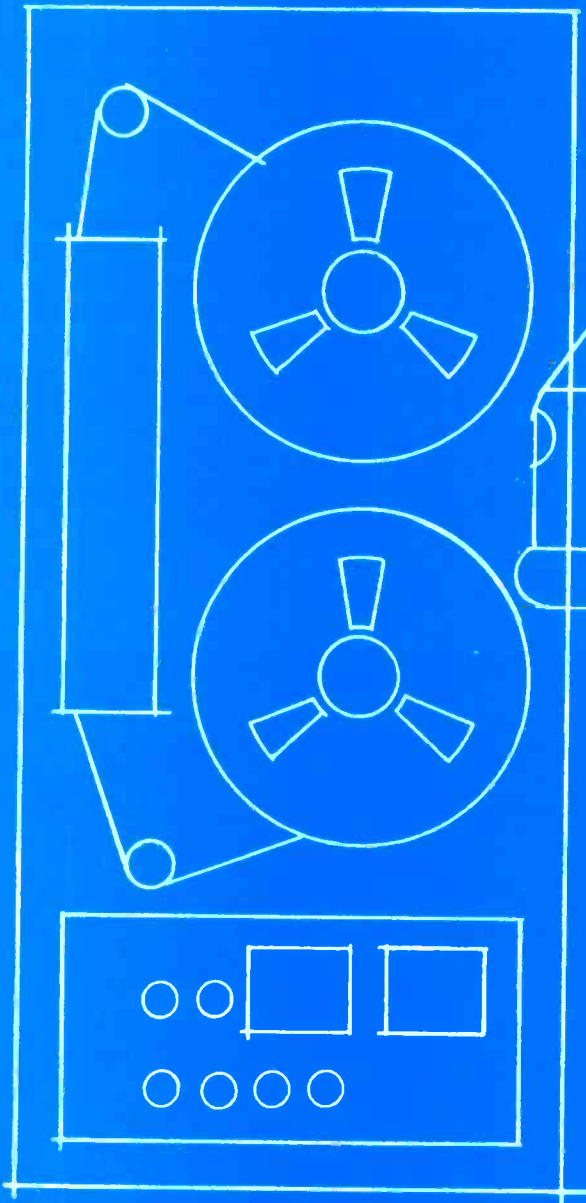
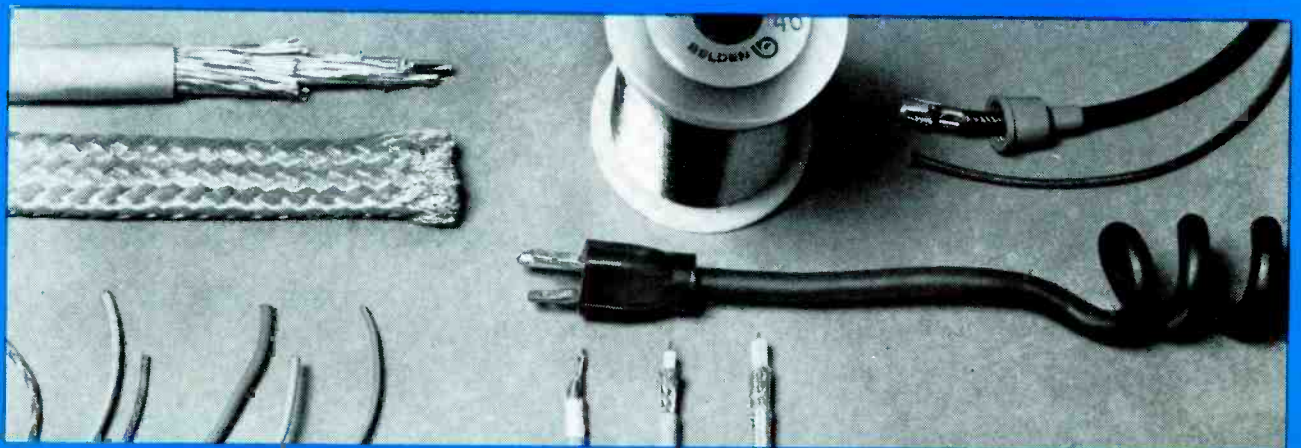

Fig. 3 Back view of panel showing wiring.

BELDEN...new ideas for moving electrical energy



Belden's systems



BELDEN

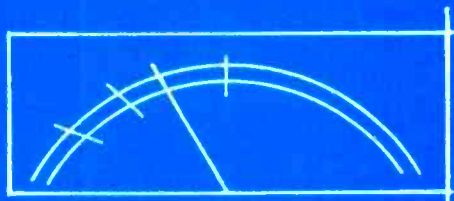
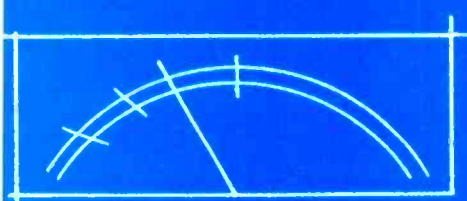
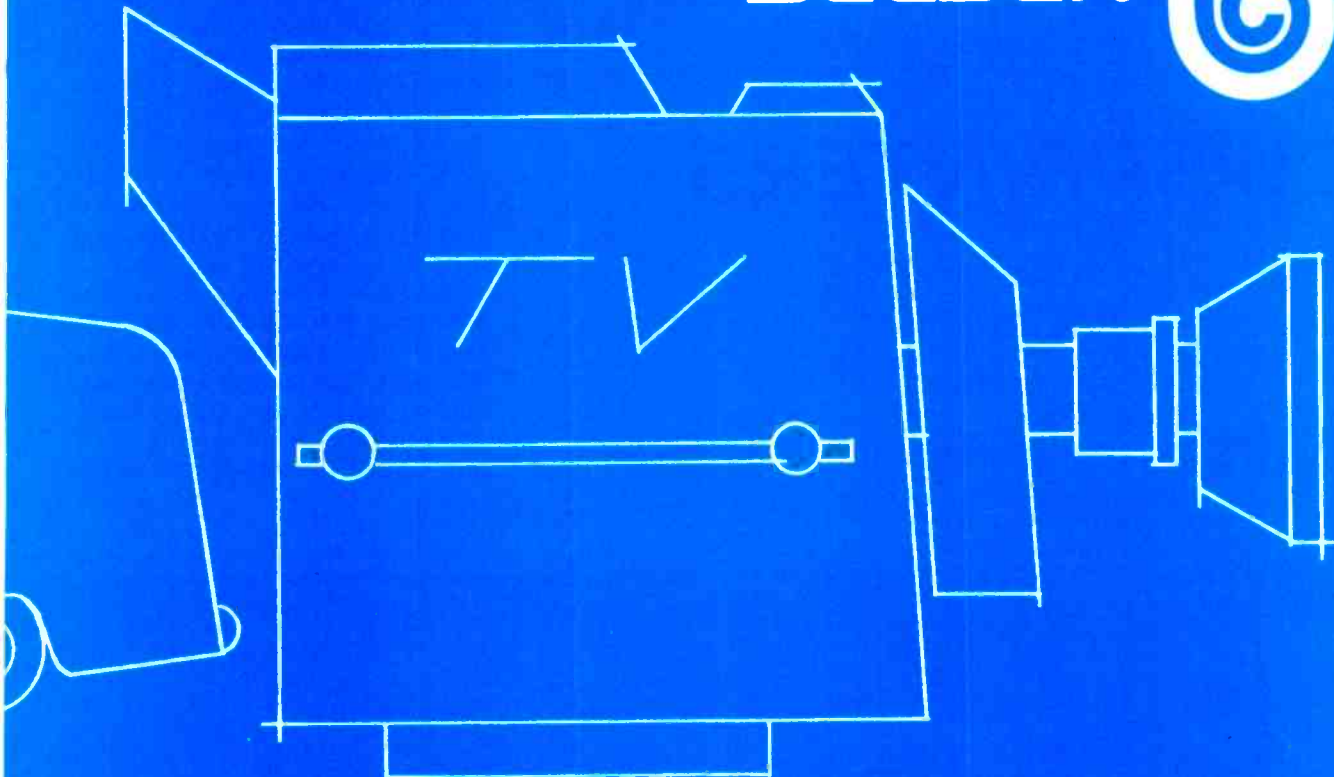

savvy is straight dollars and cents

There are two ways to sell wire and cable. Item by item without regard for the collective effect on economy and operation. And the Belden way: By exploring the requirements of the entire electrical system to determine what package of wire and cable will give the best overall value for the dollar. We make every type of wire and cable used in broadcasting . . . and are continually introducing new cable and wire innovations. Our Wire Systems Specialists often can suggest new types of cables that do a better job . . . or last longer . . . or give added value. Or provide a

more economical put-up*. What better dollars and cents reason could there be to talk to the people who make all kinds of wire for all kinds of systems? Belden Corporation, P.O. Box 5070-A, Chicago, Illinois 60680. Ask for our catalog, and the reprint article, "Key Questions and Answers on Specifying Electronic Cable."

*For example: You can get Belden cables in a one-piece put-up. No extra splice due to the usual two-piece put-up. So: less installation time . . . less chance for trouble.

G-4-B

EAN ALARM FOR NEWSPRINTERS

by Frank B. Ridgeway
Director of Engineering, WEBR, Buffalo, N.Y.

Almost every broadcast station in the United States is a subscriber to one or more national news services. These stations receive regular Emergency Action Notification tests, and appropriate entries must be made in the station log (Section 73.961, FCC Rules). In case of a national emergency, these news services will provide one method of transmitting an alert to broadcast stations.

All EAN alerts and tests on news wires are preceded by ten bells, and all news bulletins preceded by five bells. The unit described here can be used to activate an alarm, either visible, audible or both at any desired location in the station

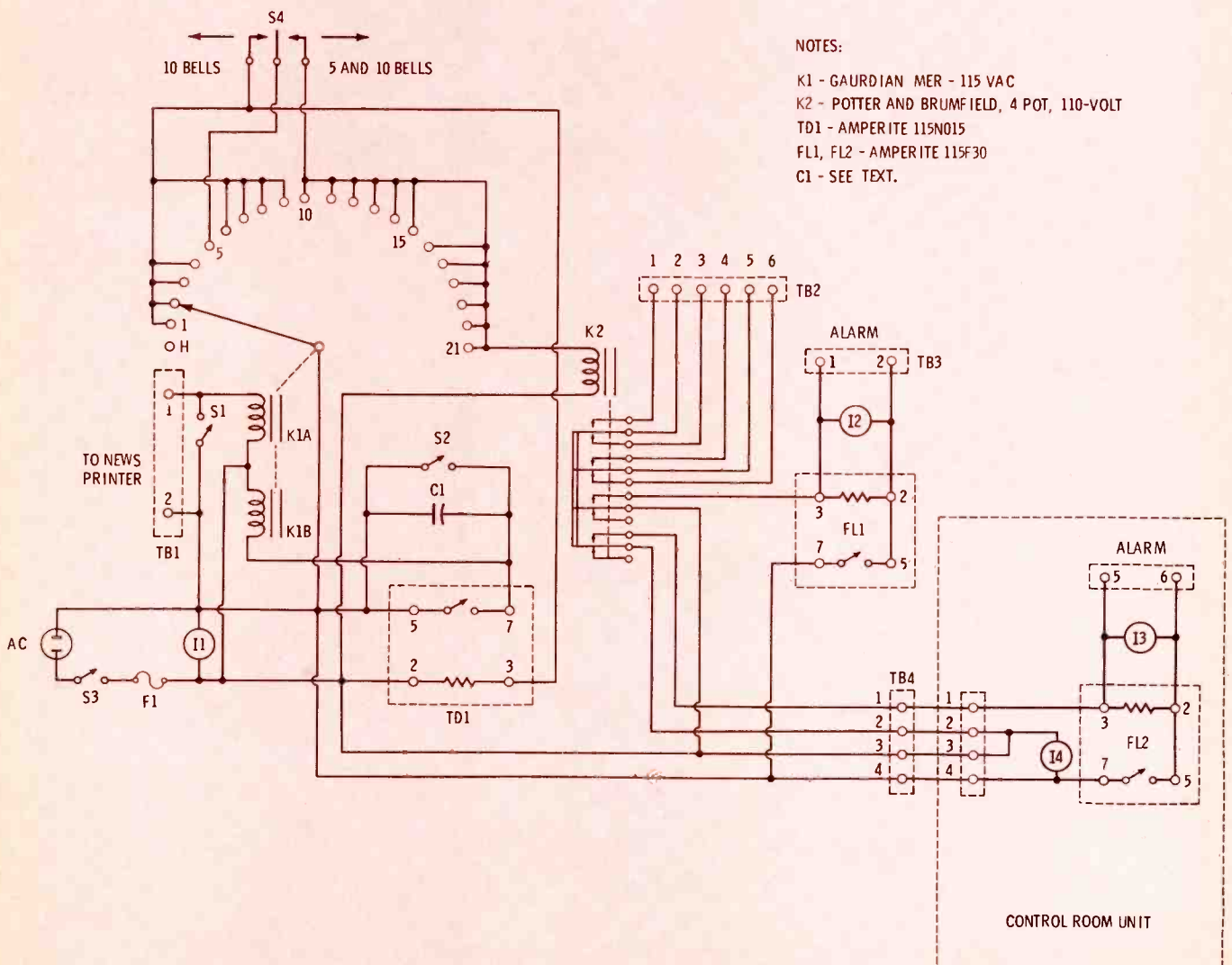

Fig. 1

when an EAN alert or test is received. In addition, it can be set to sound an alarm when a news bulletin is received.

This provision is a valuable asset in stations where the news machine is unattended at times. This unit offers definite advantages over a switch installed by news services that closes momentarily when a bell is sounded. When using the unit described here, each time a bell is sounded on the printer, a short is caused between terminals 1 and 2 of terminal board TBL (Fig. 1). Each bell then causes stepping relay KL to advance one position.

When switch S4 is in the five and

ten bells position, any number of bells less than ten, with the exception of five, step the relay and complete the circuit to terminal 3 on time-delay relay TD1. This action applies 110 volts to the heater unit of TD1 and, after approximately fifteen seconds the contacts between terminals 5 and 7 of TD1 close, applying voltage to winding K1B of the stepping relay. Excitation of K1B causes the stepping relay to return to its original position. Thus an accumulation of one- or two-bell signals is prevented from eventually tripping the alarm.

If five or ten bells are sounded, the stepping relay applies 110 volts

to relay K2. When the stepping relay is in the fifth or tenth position, the circuit to contact 3 of delay relay TD1 is not completed, and the relay remains in this position until it is reset manually. This means that once the alarm is sounded, it will continue to sound indefinitely until someone resets the unit.

Since the stepping relay used in this particular unit has more contacts (21) than required, the extra contacts are wired to the tenth contact, and any number of bells over ten will trip the alarm.

When K2 operates, voltage is applied to contacts 3 and 7 of normally closed flasher FL1, signal light I2, and alarm terminal strip TB3. After about thirty seconds, the flasher contacts open and close every thirty seconds. Simultaneously, voltage is applied to the terminals of flasher FL2 in the control-room unit.

The 110-volt supply for the control-room unit is obtained from the master unit in the news room to assure the control-room operator, through signal light I4, that the power to the master unit remains on.

When the news-bulletin alarm is not desired, switch S4 is placed in the "ten bells" position. This action connects contact 5 of the stepping relay in parallel with the other contacts below number 10. Switch S1 is a spring-return switch used for test purposes. Each time this switch is depressed, it shorts terminals 1 and 2 of TB1 and causes the stepping relay to advance one position. Switch S2 is a spring-return switch used to reset the stepping relay by placing 110 volts across winding K1B.

Additional remote units can be controlled by means of the additional contacts on relay K2, which are wired to the terminals of TB2. Capacitor C1 is placed across the contacts of delay relay TD1 to prevent arcing. It can have a value of from 0.01 to 0.1 mfd.

The construction of the unit is simple, and the parts may be arranged to suit the builder. This unit has been in service for several months at WEBR and has proved to be very dependable requiring no maintenance. ▲

Fig. 2 Rear view of master unit. "RY3" is on the left, the time relay "RY4" is next to the panel center, the flasher "G1" is in center next to the terminal strips, and the stepping relay is at the right.

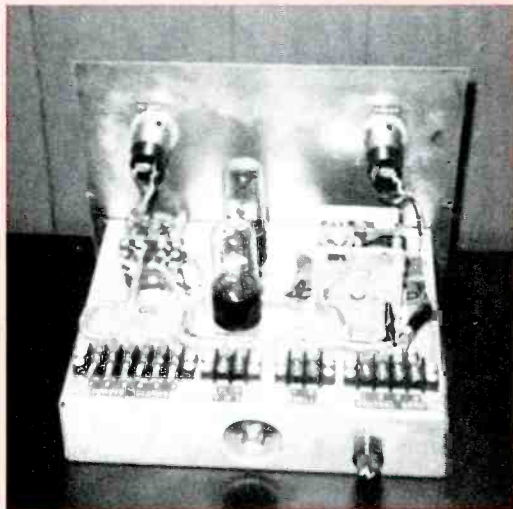
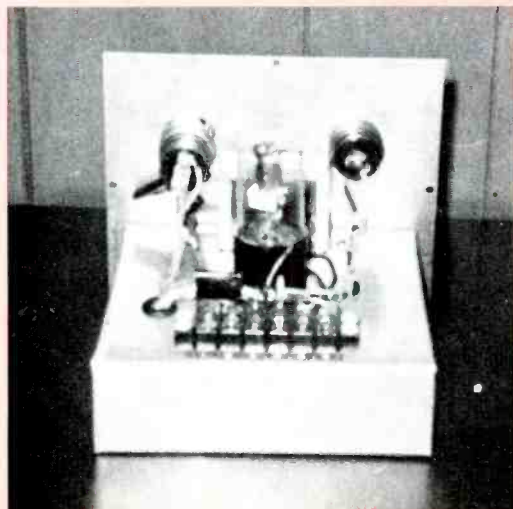

Fig. 3 Rear view of the control room unit. Flasher unit "F2" is in foreground.



Building Transistor Audio Circuits

by Norman Crowhurst

Part one of a five part series

Broadcast engineers have developed many circuits for their special needs, some of which, after a degree of development, have become widely used; others remain just a "home brew," used by only the designers. These circuits vary in complexity, from a simple stage to acquire a little extra gain, perhaps with associated electronic mixing, to more sophisticated circuits that provide equalization, noise suppression, level compression or expansion.

While tube circuits have been the engineer's traditional stock-in-trade for these jobs, transistors offer many advantages over tubes for building such circuits:

1. Their input and output impedances can provide a natural match for line and interconnection work.

2. Since they are basically current amplifying devices, they can be built into multiple-mixer circuits

with much less loss than equivalent tube circuits, which are essentially voltage amplifying devices.

3. They produce virtually no heat and require very modest power supplies, thus avoiding ventilation problems.

4. They are completely free from microphonics. Even tubes designed for low mechanical pickup are not entirely free from this. In low-level circuits, they produce effects that destroy the quality of reproduction.

There are two difficulties in using transistors: First is the fact that many audio engineers have not yet learned to think in transistor-circuit "language." If a ready-made circuit is not available from which to copy, many of our fraternity do not yet know where to begin in devising their own. They may have attempted to adapt something that was "nearly" what they wanted with disappointing results, which prompts them to "play it safe with tubes" when another transistor need arises.

Secondly, application bulletins seem to divide into two categories: Those that supply data which are unrelated to the job at hand; and those that give recommended circuits, none of which is just what we are seeking.

Load Resistance

The first step in understanding transistor language is to get a working acquaintance with how circuit components—particularly resistance values—affect various aspects of transistor performance. First we will go through a typical basic circuit and describe how to estimate values. Later, we will go into more specific problems in circuit building.

To provide an amplified output, the first thing a transistor needs is a load—a collector or emitter resistor, according to whether the circuit has common-emitter or common-collector configuration. Fig. 1 shows these two basic configurations;

either can use PNP or NPN type transistors, with corresponding polarity.

In a tube circuit, the load resistor, whether connected to the cathode or plate, provides the load line that can be laid across the plate-current curves to predict performance. With transistors, there is a little more to it than this simple procedure.

As a starting point it is convenient to assign the load resistor a value—say 1,000 ohm—and then, based on the supply voltage used, consider the working range of the transistor. Suppose the supply voltage is 12 volts. The 1000-ohm resistor will pass 12 ma when the transistor voltage is zero (which is the condition known as saturation) because the current is limited only by the resistor. If the collector current is controlled at 6 milliamps, the supply voltage will divide—half of it appears across the transistor and the other half across the resistor.

This conclusion is based on the assumption that the series resistor is the only load on the transistor. Most often, especially in grounded-emitter stages (Fig. 1-A), the stage will be loaded by the base of another transistor as shown in Fig. 2. While the DC (supply) voltage will divide as described, the AC (signal) voltage will divide differently. To the AC voltage, the input circuit of the following stage will be a virtual short-circuit. If the same type of transistor, operating in the same mode, is used in the second stage, the base-input impedance might be from 10 to 50 ohms (and variable, as we shall discuss later).

We can predict the AC operation by applying load lines to the collector-current curves (Fig. 3). The sloping line marked "1000 ohms" indicates the choice of DC operating points. Signal, or AC, conditions are indicated by the nearly vertical lines drawn through the hypothetical operating points at a slope that represents 50 ohms.

Now we find two advantages of operating the transistor at a potential closer to zero than the midpoint value of 6 volts: (1) almost twice the current swing is available for passing to the next stage; (2) transistor dissipation is greatly reduced, since it is the product of voltage and current.

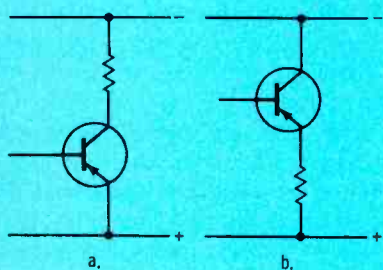

FIG. 1

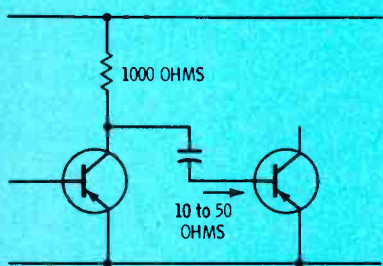

FIG. 2

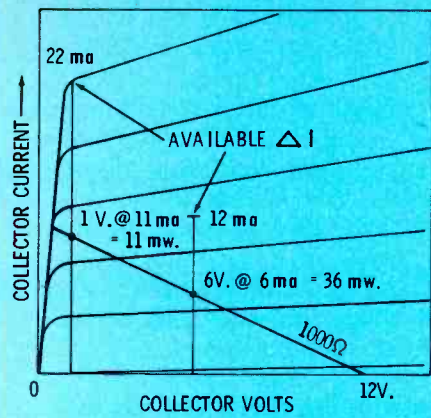

FIG. 3

Current Swing and Dissipation

With the 12-volt supply, a 1000-ohm collector resistor, and bias adjusted to drop 6 volts across the resistor, the collector current is 6 ma. Transistor dissipation, 6 volts at 6 ma, is 36 mw. Resistor dissipation is the same, but it is more important to consider transistor dissipation.

Still using the 1000-ohm collector resistor, but moving the operating point to 1 volt, collector current is 11 ma, since the resistor has 11 volts across it. This makes the transistor dissipation only 11 milliwatts—less than one third the value at 6 volts—and the available current swing is close to 22 ma peak-to-peak, almost double what it was at 6 volts.

Take this a step further. Suppose the transistor-dissipation limit is 300 mw. With a 6-volt operating point, the current limit is 50 ma, requiring a collector resistor of 120 ohms, instead of the 1000 ohms we started with. This would result in the maximum allowable dissipation at the quiescent operating point of 6 volts and 50 ma.

Peak-to-peak signal would be 100 ma (from 0 to 100). In the presence of such peak-to-peak signal (assumed sinusoidal,) the total dissipation (loads and transistor) will remain at 600 mw, because the supply remains at 12 volts and the average current is 50 ma. The 120-ohm resistor will dissipate 300 mw DC. The 35-ohm AC load (120 ohms and 50 ohms in parallel) will receive 50 ma peak, with 1.75 volts peak AC to correspond. Peak AC power is about 88 mw, or 44 mw

average, so the transistor dissipation at full sinusoidal signal drops from 300 to 256 mw.

Now assume we can set the operating point to a 1-volt collector potential. 300-mw dissipation would allow 300 ma of collector current. The collector resistor will drop 11 volts. A resistance of 36.7 ohms would produce this result. Rounding to 40 ohms, the current will be 275 milliamps, allowing a peak-to-peak swing (assuming the stage is coupled to a relative short circuit) of 550 milliamps.

The dissipation in the transistor will be 275 mw, allowing a margin, and the dissipation of the collector resistor (40 ohms) will be just over 3 watts (which isn't costly to obtain). By changing the resistor, the available current swing can be increased 5½ times, from 100 ma to 550, without exceeding the limit of transistor dissipation.

Biasing Problems

This theorizing is interesting, but we have yet to tackle the practical problem of securing the operating points about which we talked, 6 volts or 1 volt. This is accomplished by biasing the transistor in either of two basic ways. It is one thing to set bias to obtain an operating point, and another to be sure it stays there. Shift may be due either to substituting another transistor of the same type, or to temperature variations with the same transistor.

To find these possibilities, select, at random, 10 or 12 samples of the type and connect them in the circuit of Fig. 4, checking the base current needed to produce half and full collector current. (The production tolerances of transistors and their long-time stability are continually improving. This has, obviated the need to determine experimentally the parameters of a group of transistors, all of which are of a specific type. Nevertheless, the determination of the statistical limits of current gain of a number of transistors is not entirely superfluous.—Editor.) This is most easily done by adjusting the base-feed resistor to obtain the desired collector voltage (half-supply voltage, and close-to-zero, respectively), and then calculating the base current corresponding to the resistance setting obtained.

If the resistance box is set to 200,000 ohms, the base current is

60 microamps. With 280,000 ohms, it would be 43 microamps, or with 140,000 ohms, it would be 86 microamps.

In a group of sample transistors, a majority of the settings will be within fairly close range, e.g., close to 200,000 ohms, with a few stragglers beyond this range, e.g., as far as 140,000 to 280,000 ohms. Application of a little heat from a soldering iron (held close to, but not touching the transistor) will show what order of change can occur due to heat variations.

From the data in Fig. 4, an idea of reliable working-gain margins can be obtained. Gain is calculated by dividing base current into collector current. The latter was held at 6 milliamps, so 60 microamps of base

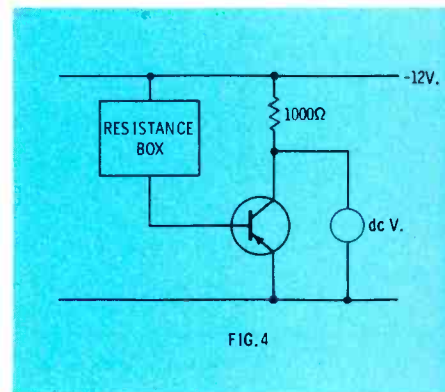

FIG. 4

current represents a gain of 100, while base currents of 43 and 86 microamps represent gains of 140 and 70, respectively.

Assume that the current gains thus computed are within the limits of 70 and 140, with most samples close to 100. Now we can think about biasing methods, according to the job at hand.

For grounded emitter operation, the two methods of bias are shown in Fig. 5. These methods are (1) resistor from supply to base; (2) resistor from collector to base. The second method provides some DC negative feedback which minimizes changes in operating point due to parameter changes. Now the value of R can be calculated for various values of current gain and collector resistance. For calculations in the circuit of Fig. 5A, the current passed by R1 is multiplied by the current gain, and the drop due to this amplified current through the collector resistor is subtracted from 12 volts.

For calculations in the circuit of

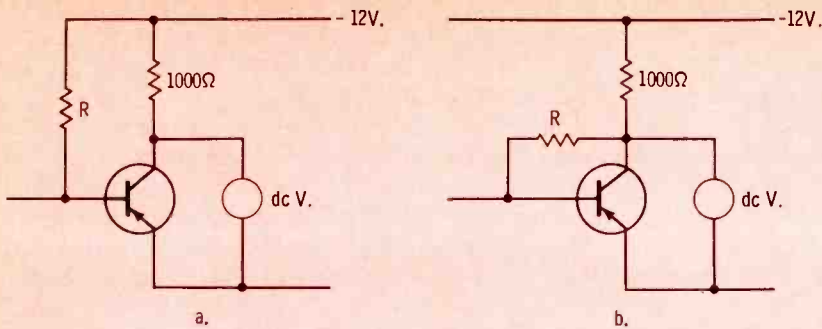

FIG. 5

Value of R1 x 1000	Collector voltage when current Gain is			Value of R1 x 1000	Collector voltage when current Gain is		
	70	100	140		70	100	140
68	0	0	0	10	1.5	1.1	0.8
82	1.75	0	0	15	2.1	1.57	1.16
100	3.6	0	0	22	2.85	2.16	1.63
120	5	2	0	33	3.85	3	2.3
150	6.4	4	0.8	47	4.8	3.8	3
180	7.3	5.3	2.7	68	5.9	4.9	3.9
220	8.2	6.5	4.4	100	7	6	5
270	8.9	7.6	5.8	150	8.2	7.2	6.2
390	9.8	8.9	7.7	220	9.1	8.2	7.3
560	10.5	9.9	9	330	10	9.2	8.4
820	11	10.5	10	470	10.4	9.9	9.2
1200	11.3	11	10.6	1000	11.2	10.9	10.5

Fig. 5B, the collector voltage is found by considering the emitter-to-collector resistance, R_2 , as being equal to the value of R_1 divided by the respective current-gain figures.

$$I_{R1} = \frac{E_{R1}}{R1}$$

$$I_{R2} = \frac{E_{R2}}{R2}$$

But,

$$G = \frac{I_{R1}}{I_{R2}} = \frac{E_{R1}/R1}{E_{R2}/R2}$$

Ignoring the base-to-emitter drop,

$$E_{R1} = E_{R2} \text{ and } G = \frac{R1}{R2}$$

and

$$R2 = \frac{R1}{G}$$

where G = current gain.

If the collector is capacitively coupled to the base of another grounded-emitter stage, the AC feedback will be effectively short-circuited. This has the effect of stabilizing the operating point without materially affecting the current gain of the stage.

One's immediate reaction to the last two paragraphs is probably that the second method of biasing is the better. We will return to this later; sometimes the other choice may prove better.

In a common-collector (emitter follower) circuit with capacitive coupling (Fig. 6), the second method of biasing is virtually the only one because the collector and supply point are one and the same. Some emitter followers use direct coupling and avoid the bias problem altogether, but we'll come to that later.

Emitter Resistor

In the grounded emitter circuit, shown in Fig. 7, an emitter resistor, much smaller in value than the collector resistor, is sometimes needed.

For DC operation (determining the operating point), it produces a voltage at the emitter that is related to the voltage at the collector by a ratio determined by the respective values of the emitter and collector resistors. The presence of this emitter voltage may help stabilize bias in circuits where the bias resistor connects to the supply point, rather than to the collector. This we will illustrate in a moment.

For AC (signal) operation, the emitter resistor divides the load, providing a smaller signal voltage at the emitter than that developed at the collector. Here again, we must consider the relation of the emitter resistor to the total loading in the collector circuit—including any loading due to the following stage.

The resistance of the emitter resistor, multiplied by the working current gain, reflects into the base circuit, and this reflected resistance fluctuates much less than the base-input resistance of the transistor itself. Thus, if the emitter resistor is 10 ohms and current gain is 50, the reflected resistance due to it is 500 ohms. Adding to this the base-to-emitter input resistance that fluctuates between 10 and 50 ohms will make the resultant input impedance fluctuate between 510 and 550 ohms, a considerable improvement in stability.

If the following stage has grounded-emitter configuration, the collector resistor is effectively short-circuited to AC. This means that the emitter resistor will provide considerable current-gain degeneration under this condition. Later we will introduce some calculations which show how this kind of circuit may be used effectively.

Base-to-Ground Resistor

Now let's consider the resistor from base to ground (Fig. 8). This resistor serves one or two functions, according to the circuit used. In all circuits using capacitive coupling between stages, this resistor is needed to avoid blocking if the input is overloaded.

For example, suppose the stage uses a bias resistor of 50,000 ohms, with no base-to-ground resistor, and the collector resistor of the preceding stage is 1000 ohms. A 50-mfd capacitor normally couples from the 1000-ohm collector resistor to a virtual short-circuit

The Innovators will strike again. Soon.

First, it was the
Norelco® 3-Plumbicon*
tube color camera which
since 1965 has
become the world's
most-accepted,
most-imitated
camera.

At the 1968 NAB show,
it was this tiny
blockbuster, a
color camera
6½ pounds light.



New developments
on their way
to you from
Philips Broadcast
are even more
exciting. But
for now ...

*Trade mark for television camera tubes.

Here's Total Station Capability from the Innovators at Norelco

(The people who re-invented color television.)

Philips Broadcast Equipment Corp. now offers you complete, turnkey service in television broadcast and production facilities.

From systems engineering through installation, and including financing, the quality and reliability that have made our Norelco color equipment the industry's standard of excellence is available for full system development.

Color pictures of the highest attainable quality start with the Norelco family of Plumbicon cameras. First, the PC-70 studio and field camera. Now used by all three major networks, numerous groups and more than one hundred independents, it has become in less than four years the undisputed world's champion.

And for extra mobility: Choose the PCP-70 portable, the "Little Shaver." Its picture matches that of the PC-70 precisely.

Finally, there's the PCB-701 special purpose color camera—the "Robot." Put it anywhere. It can pan, tilt and focus by remote control.

All are compatible with the PC-70 camera control unit. And the new-generation Norelco cameras, in addition to Contours out of green (electronic edge enhancement), have extended red sensitivity Plumbicon tubes for truer-than-ever reds of every shade.

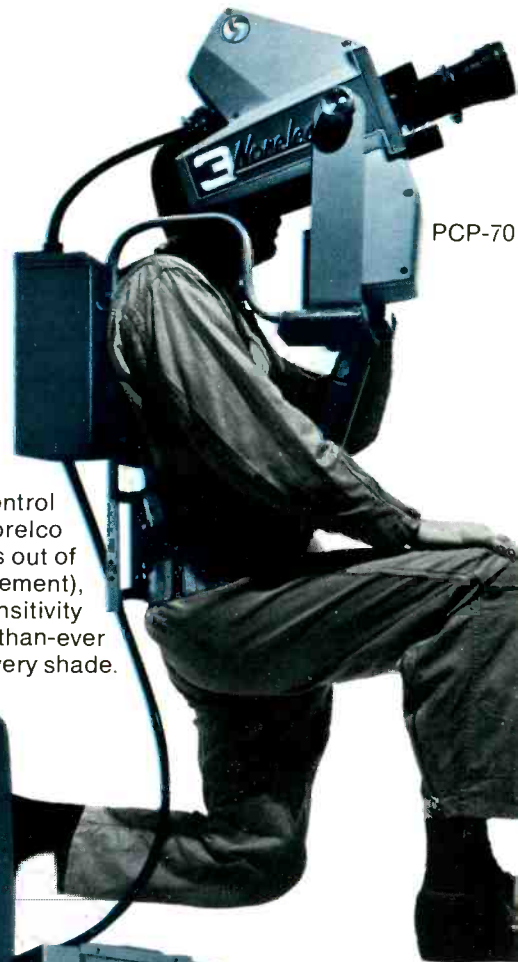

PCP-70



PC-70

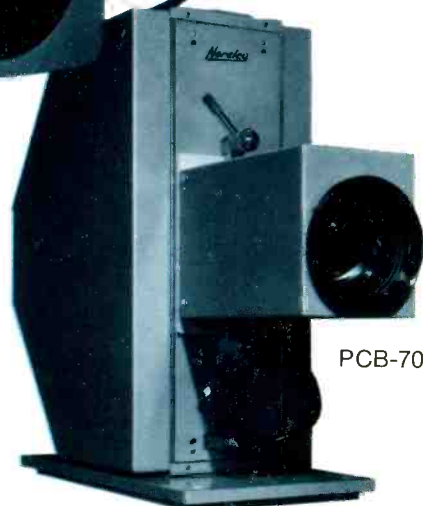

PCB-701

The heart of your film island—the Norelco PCF-701 film camera—provides for the first time, the advantages of the Plumbicon tube, establishing a new and heretofore impossible standard of color performance. Automatic light control is built into the camera's common light path. The eye-level monitor rotates for easy viewing, and side-mounted waveform monitor and drawer-mounted registration & operation panels facilitate signal checking and set-up. Norelco's PCM-800 multiplexer is designed specifically for the PCF-701 film camera. Slides can be supered over film on the same film island for the first time in color TV.



PCM-800

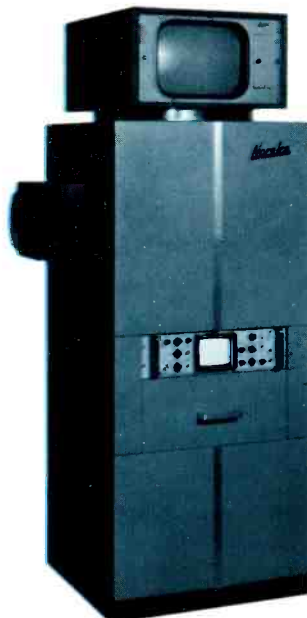

PCF-701



See your brilliant Plumbicon picture on 19" and 25" monitors fed by Norelco's new silicon solid-state distribution amplifier. Monitors work from either composite or non-composite video, with separate test signal input, and are easily switched from composite color signal to separate R-G-B inputs from front control panels. Bonded implosion-proof faceplates have anti-reflective coatings, and cabinet design allows close stacking without impairing ventilation. Distribution amplifier's modular plug-in printed circuit boards and other features allow connections on passive connector to determine performance for individual units. Eight amplifiers, each providing six outputs, are contained in a rack 5 1/4" high.

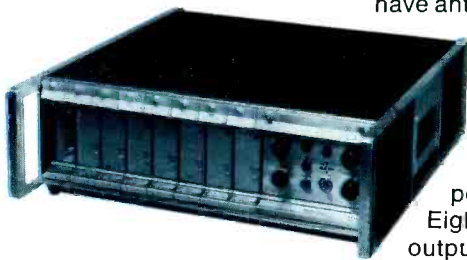

Norelco Multi-Match audio mixing desks provide superb performance and complete flexibility in units of modular, expandable construction. The Range 70 portable 12-channel system is designed for the 1970's and reflects the needs of the Sound Director. It is suitable for studio and field. For small studios, there's a Norelco 8-channel solid-state mixer, and — particularly for remotes and as auxiliary studio equipment — there's the light, compact 4-channel mixing unit that may be battery-operated.



Range 70

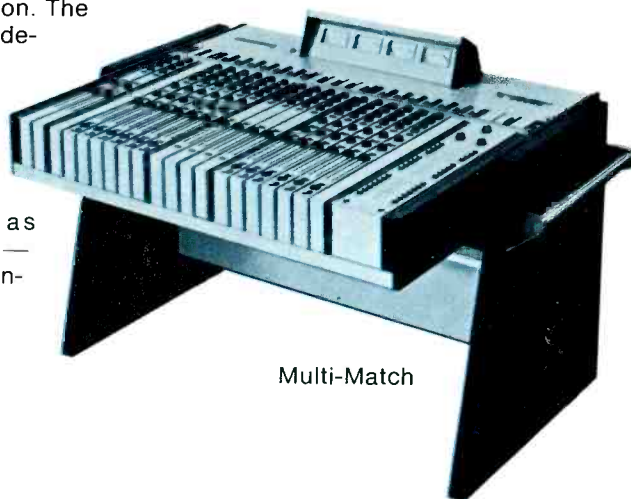

Multi-Match

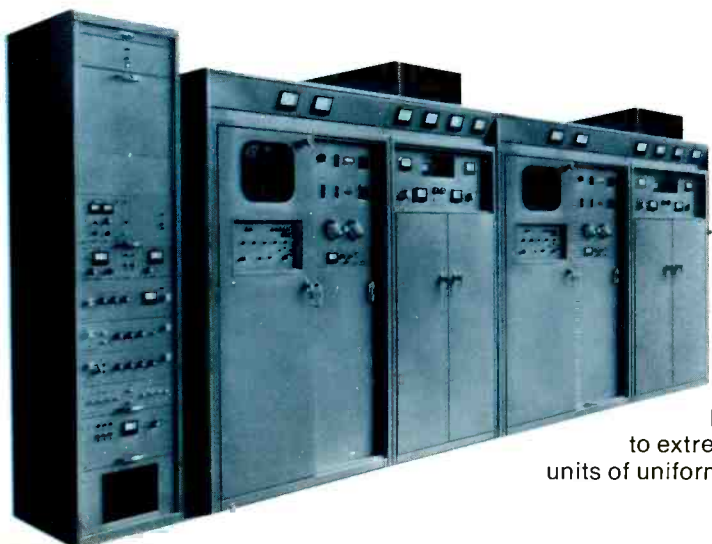

Norelco UHF transmitters, with outputs of 10, 30 and 55 kW, feature high-reliability klystron visual and aural amplifiers, silicon solid-state circuits and power supply units, and provision for parallel operation of two transmitters with automatic phase control for visual and aural carriers. Minor component variations have little effect on overall performance, thanks to extreme stabilization of circuitry. Modular units of uniform styling are joined to form in-line arrangement.

Here's Norelco Total System Capability at Work:

Hollywood Video Center—a modern, turnkey studio and mobile facility by Philips Broadcast

The television studio and mobile van completed in the spring of 1968 for Hollywood Video Center, a division of Western Video Industries, Inc., Hollywood, California, represented the first turnkey facility designed, engineered, installed and furnished by Philips Broadcast Equipment Corp.

As fast as the studios and mobile unit were finished—ahead of schedule—they went "on air." The widely syndicated *Steve Allen Show* was first to utilize HVC's Norelco-equipped studio facilities, and the big 40-foot van started a continuous schedule of field trips with *Operation: Entertainment* tapings for ABC.



Hollywood Video Center studios have four Norelco color cameras, as does the mobile unit. All cameras and control units are interchangeable, and provide total flexibility of equipment.



Van has four cameras with provisions for six. CCU's are on wheels, allowing transfer between studio and van.

Custom video switching systems in studio and van are identical. Studio also has Norelco PCF-701 3-Plumbicon film camera.



Hollywood Video Center President Rounsevelle Schaum, left, and John S. Auld, vice president and general manager, Philips Broadcast Equipment Corp. Gold key symbolizes completion of HVC mobile unit and studios.

Awarded to Philips for Outstanding Achievement in Engineering for the Development of the Plumbicon Tube



N.A.T.A.S. © 1949

Norelco

PHILIPS BROADCAST EQUIPMENT CORP.

299 Route 17, Paramus, N.J. 07652 • 201/262-7300

formed by the base input of the second stage. This circuit will produce a 3-dB roll-off point at about 3.2 Hz, which is satisfactory under normal operation. But when a signal drives the second stage to cut-off, the only resistance connected to the output side of the capacitor is the bias resistor, because the transistor base is now an open circuit. If this resistance is 50,000 ohms, the time-constant of the base circuit is 2.5 seconds, which may allow the amplifier to remain blocked for an extended period. Connecting a relatively low value of resistance from base to ground of the second transistor shortens this recovery time, without having much other effect on coupling or bias. For example, a 1000-ohm resistor will have little effect, bypassing a 50-ohm base input, but the RC time will drop from 2.5 seconds to 50 milliseconds.

Voltage-Divider Biasing

If the bias source is of the voltage-divider type shown in Fig. 9, and an emitter resistor is used, the resistor from base to ground still serves the unblocking function, but in addition, it is part of the arrangement that stabilizes the operating point. Let's take an example to illustrate how all these features tie together.

Suppose the collector resistor is 1000 ohms, the emitter resistor is 47 ohms, the limits of the transistor current gain are 70 and 140 with a median of 100. Supply voltage is 12 volts, and collector voltage is designed for 2 volts for the median-gain transistor. The 10-volt drop across the 1000-ohm collector resistor sets the nominal collector current at 10 ma. Therefore, the nominal base current (with a nominal gain of 100) needs to be 100 microamps. Continuing the nominal-condition calculation, emitter voltage will be $47 \times 100 \text{ ma} = 470 \text{ mv}$. The base voltage will be 490 mv, assuming a 20-mv drop between base and emitter.

We should make the voltage-divider current about 10 times the base current, to swamp current-gain variations. Establishing 1 ma as the current in the lower resistor sets its value at 490 ohms (470 ohms is the nearest standard value). The top resistor will need to pass 1.1 ma with 11.51 volts drop, requiring a resistor of 10,500 ohms (10K is nearest preferred value, and both,

standard values err in the same direction.)

Using these stock values, we can calculate the working collector voltage for transistors with current gains of 70 and 140, to represent extreme possibilities, as well as the average gain of 100.

Fig. 10 shows two identical stages and the calculations which must be made to determine the working gain of a stage. The emitter resistor is multiplied by the current gain to find the value of resistance reflected to the base. This reflected resistance is shunted across R2 (or R6) and the parallel circuit of the two resistances determines the effective input resistance.

As stated before, the nominal current of Q2 should be 10 times the base current, or 1 ma. However, since standard resistors are used for R1 and R2, the current through the base resistance and the bias resistor, R1, is increased slightly. The total current through the effective input resistance varies between 1.5274 and 1.14943 ma; an arbitrary value of 1.15 ma was chosen for the calculations on lines 4 through 8 of Fig. 10.

Gain and Impedance

Next we come to gain calculations and impedance relationships. The input impedance at the base will vary between 394 and 420 ohms (Fig. 10, line 8), according to transistor gain. The output impedance of the stage will be practically 1000 ohms because the collector impedance of the transistor, with a 47-ohm emitter resistor, will be much higher than the 1000-ohm collector resistor—essentially, the circuit is a constant-current source. To calculate overall gain, we have two alternatives at this point.

If successive stages are identical, they will have identical impedances to ground at corresponding points in their circuits. Further, the AC impedance to ground at all points from the collector of one stage to the base of the next is essentially constant so long as the frequency response is flat. Therefore, gain can be calculated in terms of signal voltage across the impedance. It also may be expressed in terms of current gain from one stage to the same point in the next.

The average impedance to ground of the circuit in Fig. 10 will be 411 in parallel with 1000 ohms, or 290

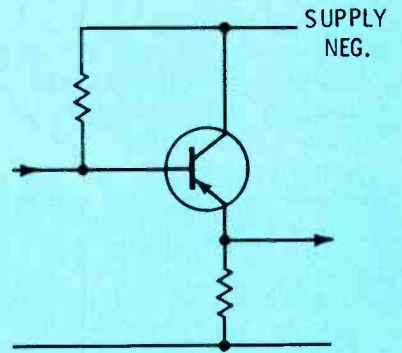

FIG. 6

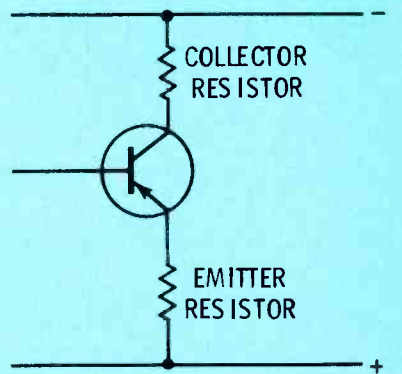

FIG. 7

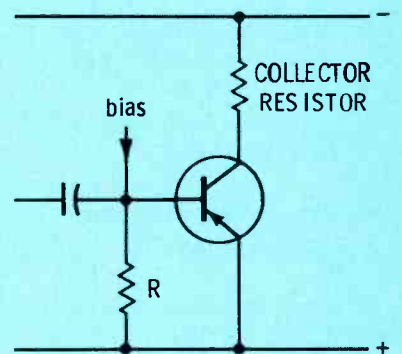

FIG. 8

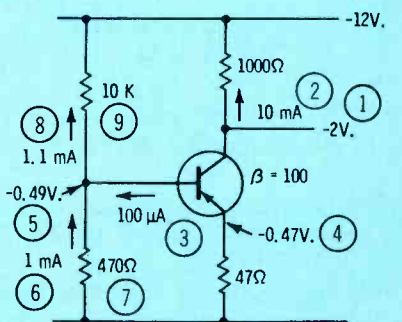

FIG. 9

ohms (Fig. 10, line 9). Assume a 1-mv signal at the base of one stage. Base-input resistance varies between 3300 and 6600 ohms, admitting input base currents of 300 or 150 nanoamps, respectively. With corresponding gains of 70 and 140, the collector current (AC) will be 21 microamps in either case. With an

AC collector load of 290 ohms (average) the collector voltage will be 6.1 mv, which represents a gain of 6.1. Impedance change due to change of gain is from 282 to 295 ohms, representing a change in gain of the order of from 5.9 to 6.2.

The alternative method of calculating, in terms of the current de-

livered to successive bases, is more detailed, but the results will be the same.

A gain of 6 sounds low. Why is it so low? The main reasons are: (1) The effective base-input resistance is from 3300 to 6600 ohms, depending on the reflected resistance from the emitter resistor, but the overall effective value is swamped down to 394 to 420 ohms by the biasing circuit. (2) The voltage gain is held down by the 47-ohm resistor which is significant in comparison with the total collector load of 290 ohms.

Suppose we decide to work at a higher DC collector voltage, which will allow the use of larger resistances in the bias-voltage divider. We could choose a value of 2.2K for the lower resistor of the divider and design the circuit for a nominal 6-volt collector potential.

Fig. 11 shows the new tabulation, still using a 47-ohm emitter resistor. To arrive at the value of the upper resistor of the voltage divider, proceed as follows: mean collector current is to be 6 ma, requiring a nominal base current of 60 microamps. Emitter voltage will be $47 \times 6 = 280$ mv, requiring a base voltage of about 300 mv. Current through the 2.2 K resistor is 136 microamps; an additional current of 60 microamps (the base current) makes the upper resistor need to pass 196 microamps with a drop of 11.7 volts, requiring 62K (nearest stock value). This is the starting point for figuring the base and emitter voltages, from which collector current and voltage are deduced. Collector voltage varies from 5.3 to 6.9, and gain varies inversely with voltage from 12 to 10.9.

From these two sets of calculations (Figs. 10 & 11), a fundamental relationship in this kind of circuit begins to show: the maximum gain—and this can be regarded as voltage gain—is set by the relative values of emitter and collector resistors. With 47 ohms and 1000 ohms, it can never exceed 20, because 1000 is approximately 20 times 47.

In practice, the values of bias resistors needed to stabilize the operating point against current-gain deviations of the transistor will reduce this gain because of their shunting effect on base-input resistance. Even without any such

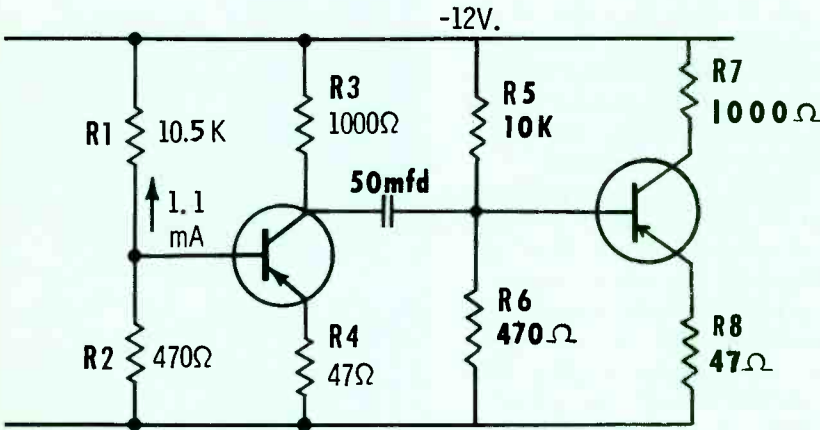

FIG. 10

1. Current gain	70	100	140
2. Resistance reflected from emitter to base (ohms) ($R4 \times$ current gain)	3300	4700	6600
3. Reflected resistance paralleled with $R2$ (ohms)	410	428	440
4. Base voltage (millivolts) ($1.15 \text{ ma} \times$ line 3)	472	492	506
5. Emitter voltage (millivolts) (line 4 - 20 mv)	452	472	486
6. Collector current (milliamps) (line 5 - 47)	9.6	10.0	1.03
7. Collector voltage (volts) ($12 - R3 \times$ line 6)	2.4	2.0	1.7
8. Collector-to-emitter voltage (volts) (line 7 - line 5)	1.95	1.53	1.21
9. Impedance of base circuit (ohms) ($R5$ paralleled with line 3)	394	411	420
10. Impedance of interstage network (ohms) ($R3$ paralleled with line 9)	282	290	295

shunting effect, the base-input resistance of the following stage, which varies from 3300 to 6600 ohms, shunts the 100-ohm collector resistor, and reduces the maximum gain of about 20 to a lesser value of from 16 to 18.

To increase the available gain, the 47-ohm emitter resistor can be reduced in value, with corresponding other changes. But let's take a look at the other way of stabilizing the operating point using a bias resistor from collector to base.

Collector-to-Base Biasing

The circuit is that of Fig. 5 B, where we see that using a 15K bias resistor will establish the collector voltage between the limits of 1.16 and 2.1 volts. We will calculate gain as an insertion gain. To do this we assume in Fig. 12 that the output load will be 250 ohms, so the AC collector load of the stage will be 200 ohms (250 in parallel with 1000). To permit a true calculation of insertion gain, the base-circuit input impedance also should be 250 ohms, working from a similar 1000 ohms source. This choice is somewhat arbitrary, but it is a starting point.

Now, if a 5-mv signal is applied at the input, across the 1000-ohm collector load and the 250-ohm input resistance, the signal across the 250-ohm input will be 1 millivolt. So, measuring the output in millivolts across the 250-ohm resistor, which output will be the same as the collector signal voltage, will indicate directly the insertion gain.

We calculate on this basis. The first step is to calculate the signal-feedback ratio, using this output load (200 ohms) with a 15K feedback resistor. This ratio is 1:75, because 15K is 75 times 200 ohms. To make the base-input impedance 250 ohms, or greater, the emitter resistor is multiplied by the working current gain of 43 (Fig. 12 line 1). An 8.2-ohm resistor will yield a nominal base-input resistance of 352 ohms.

A shunt of 920 ohms will reduce this to 254 ohms (viewed from the 1000 ohm source), and at the same time hold the recovery time constant to a reasonably low value to prevent blocking, as mentioned earlier. Now we calculate the combined base-input impedance (Fig. 12, line 3) for extremes of current gain, and from this the signal volt-

age at the base (line 4). Then, dividing line 4 by line 2 gives signal current into the base (line 5). Multiplying this by working-current gain (line 1) gives collector signal (line 6). Collector-signal voltage is found by multiplying by 200 ohms, the combined collector-load impedance.

Since the input signal at the base was 1mv, the output is numerically equal to gain. It varies between 22.4 and 26.6, with a median of 24.6.

Note the effect of feedback: current gain varies by a ratio of 2:1 (70 to 140). Working gain is held to 1.09:1 (22.4 to 26.6). Collector voltage is held to 1.8:1 (1.16 to 2.1), but collector current is held to 1.09:1 (9.9 to 10.84 milliamps). At this nominal operating point (about 1.5 volts DC at the collector) close control of collector current is not as good or as important as control of collector voltage.

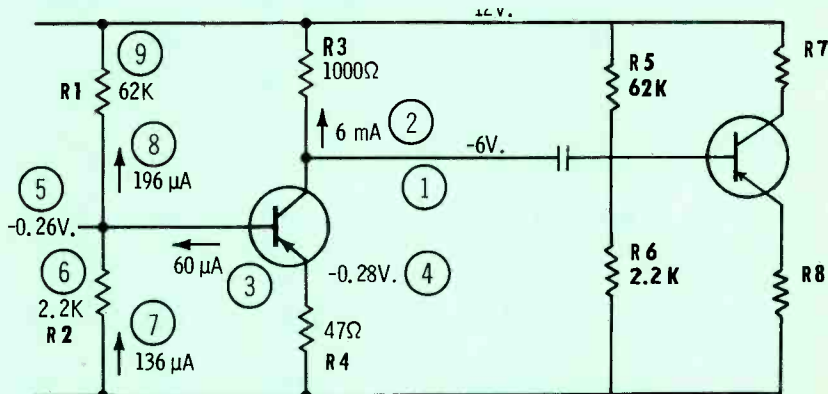

FIG. 11

1. Current gain	70	100	140
2. Resistance reflected from emitter to base (ohms) ($R_4 \times$ current gain)	3300	4700	6600
3. Reflected resistance	1320	1500	1650
4. Base voltage (millivolts) (.189 ma x line 3)	250	283	312
5. Emitter voltage (millivolts) (line 4 - 20 mv)	230	263	292
6. Collector current (milliamps) (line 5 - 47)	4.9	5.6	6.2
7. Collector voltage (volts) (12 - $R_3 \times$ line 6)	7.1	6.4	5.8
8. Collector-to-emitter voltage (volts) (line 7 - line 5)	6.87	6.14	5.51
9. Impedance of base circuit (ohms) (R_5 paralleled with line 3)	1290	1462	1610
10. Impedance of interstage network (ohms) (R_3 paralleled with line 9)	564	594	618

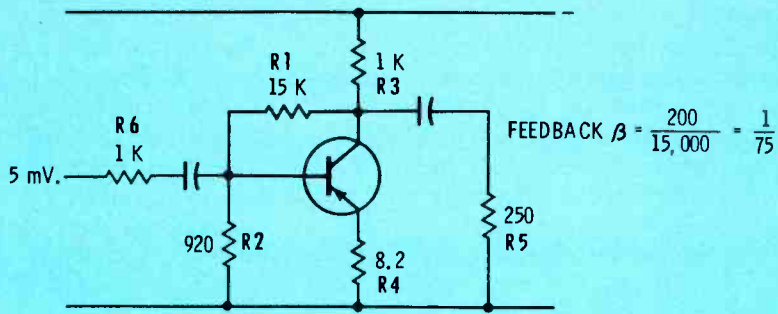

FIG. 12

1. Current gain (G)	70	100	140
2. Feedback (F)	.0133	.0133	.0133
$\frac{R3 \times R5}{R3 + R5}$ R1			
3. Working current gain (B)	36.2	43	49
$\frac{G}{1 + GF}$			
4. Resistance reflected to base (ohms) (B × R4)	295	352	402
5. Base-input impedance (ohms) (line 4 paralleled with R2)	223	254	278
6. Signal voltage at base (millivolts) (line 5 × 5 mv) (line 5 + R6)	.913	1.01	1.09
7. Signal current into base (microamps) (line 6) (line 4)	3.1	2.87	2.71
8. Collector signal current (microamps) (line 7 × line 3)	112	123	133
9. Collector signal voltage (millivolts) $\frac{R3 \times R5 \times \text{line 8}}{R3 + R5} = 200 \times \text{line 8}$	22.4	24.6	26.6
10. Insertion gain (line 9) (line 6)	24.5	24.4	24.4

For another example, let's pick a feedback-bias resistor of 100K. This will control the DC collector voltage between 5 and 7 volts. Fig. 13 shows the same sequence of calculations to arrive at insertion gain, which now varies between 48.2 and 72.8 a ratio of 1.5:1. Variations in collector voltage and current are held within limits of 1.4:1, which is slightly better than the variation of gain.

Superficially, it would seem that a practical circuit might use any value of bias resistor between 15K and 100K. But other factors need attention, such as reduction in distortion and the relevant signal level. We will develop these other criteria later, after we have developed the more fundamental calculations.

An important difference we should notice is that in the circuit of Fig. 5B the current-feedback factor is critically dependent on the loading produced by the following stage, which we have assumed in Figs. 12 & 13 to be 250 ohms. Change this value and the feedback factor changes. With this change the working gain, and therefore the value of input impedance at the base, reflected from the emitter resistor, also changes, although the resistor itself has not.

From this fact we see that considerable interaction between successive stages occurs in this circuit. This is a strong reason, in some applications, for using the biasing method of Fig. 5A, which avoids or reduces this stage-to-stage interaction. In a later article, we will apply these principles to some typical circuits to make this distinction more apparent—as well as to show how to optimize values according to specific needs. ▲

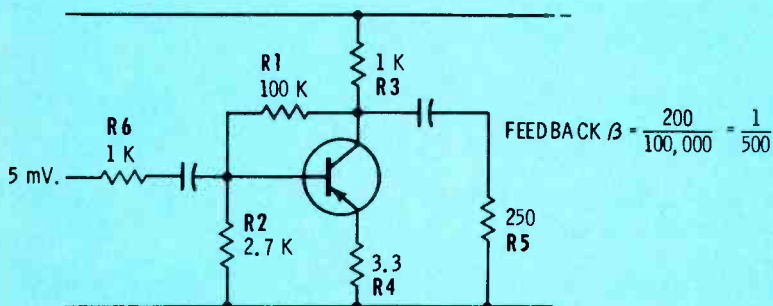
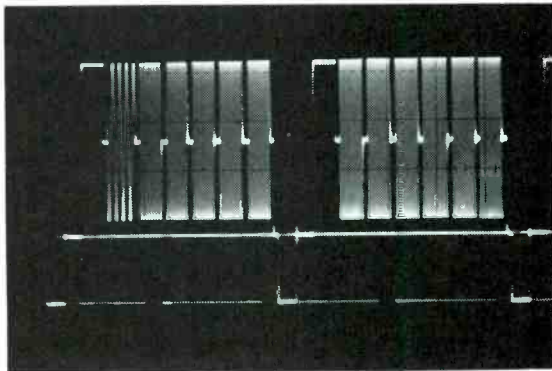

FIG. 13

1. Current gain (G)	70.0	100.0	140.0
2. Feedback (F)	.002	.002	.002
3. Working current gain (B)	64.1	83.3	109.2
4. Resistance reflected to base (ohms)	203.0	275.0	360.0
5. Base input impedance (ohms)	190.0	250.0	317.0
6. Signal voltage at base (millivolts)	0.8	1.0	1.2
7. Signal current into base (microamps)	3.94	3.64	3.33
8. Collector signal current (microamps)	241.0	303.0	364.0
9. Collector signal voltage (millivolts)	48.2	60.6	72.8
10. Insertion gain	60.25	60.6	60.7

Don't be satisfied with half the answer!

Check the FULL bandwidth of your studio facilities with the NEW Videometrics Polyburst.



Alternate Line

0.5 to 10 MHz

This new test signal provides a total of 12 different frequency bursts from 0.5 to 10 MHz over two sequential television lines. The first line contains the standard multiburst signal with white flag followed by 6 bursts from 0.5 to 4.2 MHz. The second line contains a white flag followed by another 6 bursts from 5 to 10 MHz. This alternate line signal is repeated over the entire active field.

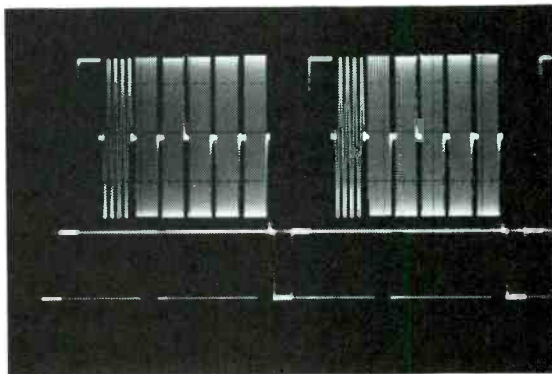

Low Band Only

0.5 to 4.2 MHz

Or by front panel switching, you can select the low band only (standard multiburst) or high band only, as pictured in the accompanying waveform photographs.

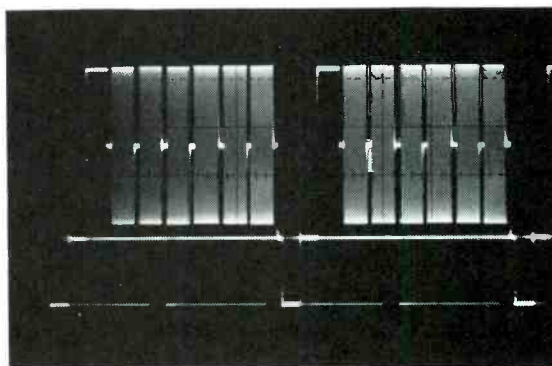

High Band Only

5 to 10 MHz

The polyburst is available individually in the Model 511A or as part of a complete modular test signal package, Model 503A.

Let Videometrics show you the difference truly professional test equipment can make to the performance of your television facilities. We manufacture a complete line of test signal generators including the Polyburst, Stairstep and Ramp, Sine Squared Pulse & Window and 20T Pulse for Full Field and VIT use.



VIDEOMETRICS, INC.

subsidiary of **CENTRAL DYNAMICS CORP**

33 Cain Dr., Plainview, N.Y. 11803

Tel. (516) 249-5662

Circle Item 17 on Tech Data Card

PL lines loaded?

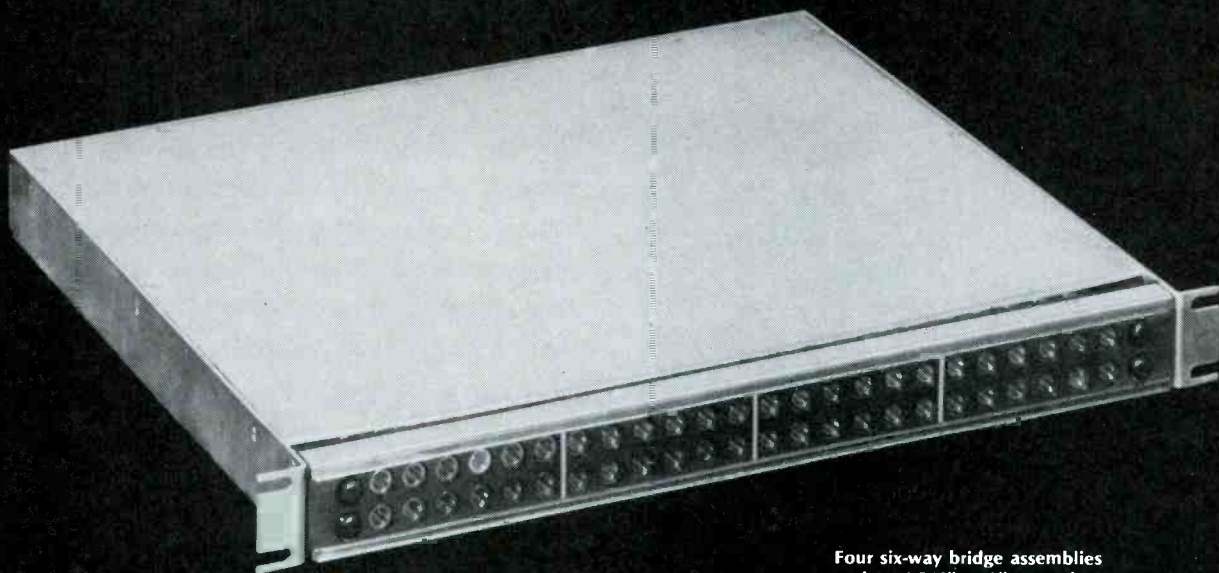

Four six-way bridge assemblies
in a 1-3/4" x 19" mounting.

SOLVE THE PROBLEM ECONOMICALLY WITH THESE SOLID-STATE SIX-WAY BRIDGES

They're an Atlantic Research Corporation Teleproducts Department **first**—truly compact six-way bridges that assure steady audio on your intercoms (balanced or unbalanced)... that offer solid-state reliability... and that are really low in cost!

Ideal for TV and radio stations, recording studios, and a host of other audio applications, each compact mounting shelf can contain up to four six-way bridge assemblies. Each assembly consists of a double row jack field with six individual amplifiers and resistive bridges (which are pre-wired into the jack field). Result: you get unlimited use of your PL lines!

Full specifications are just a call, a card, or a letter away. Act now! (All you have to lose are loaded PL lines.)

Teleproducts Department

ATLANTIC  **RESEARCH**

Atlantic Research Corporation / A Division of the Susquehanna Corporation
Shirley Highway at Edsall Road / Alexandria, Virginia 22314 / Tel. 703/354-3400, Ext. 485

Circle Item 18 on Tech Data Card

September 1968

Late Bulletin from Washington

by Howard T. Head

"Freeze" Imposed on AM Stations

The Commission has discontinued the acceptance of all applications for new AM radio stations, or for major power increases or other changes in existing stations. Applications for changes in transmitter site are not affected. The Commission stated that this "freeze" is being imposed to permit a study to determine whether there is a "significant national need" for new AM service. The possibility of combining AM and FM as a single aural service in any future allocations system will also be studied.

The Commission will continue to act on some 450 applications on file prior to the imposition of the new "freeze" (almost 50 such applications were filed on the last day). Also, the Commission will continue to accept and act on applications for "minor" changes in facilities, a loosely defined category which includes, among other things, minor changes in directional antenna patterns.

No indication has been given by the Commission as to the duration of the new freeze. Past experience indicates, however, that a substantial time is likely to elapse before the freeze order is lifted, or significantly modified.

NTCA To Issue Cable Technical Standards

The National Cable Television Association (NTCA) has embarked on a program to establish Technical Standards for CATV systems. Under the new program, NTCA has established a Standards Committee and an Engineering Sub-Committee which will prepare drafts of technical specifications covering all technical aspects of CATV planning and operation.

Standards already adopted or under study include standards on organization, graphic symbols, CATV amplifier distortion characteristics, subscriber visual carrier level, and noise level in cable systems. Generally speaking, these standards define terms, establish methods of measurement and related techniques, but do not specify numerical performance values, which are left to the users.

Additional Frequency Space Proposed for Land Mobile Operation

The Commission has issued two proposals both looking toward the reassignment on an exclusive or shared basis of frequency space in the UHF region for land mobile operation (see August, 1968 Bulletin). One aspect of the Commission's plan involves the sharing of the lower UHF television channels (Channels 14-20, 470 MHz-512 MHz) with the land mobile services in 25 major urban areas. Land mobile equipment is now operating in the 450 MHz-470 MHz band, and can be readily adapted for use in the 470 MHz-512 MHz band.

Operating and authorized television stations on Channels 14 through 20 will continue to hold their present frequency assignments. Land mobile operation will require co-channel and adjacent-channel protection of the Grade B contours of television broadcast stations, but "taboo" mileage separations (for protection against the effects of intermodulation, I.F. beat, local oscillator radiation, and image interference) will not be observed.

At the upper end of the UHF television broadcast band, the Commission proposes to reassign the frequency space now occupied by television Channels 70-83 (806 MHz-890 MHz). In addition, the frequency space from 890 MHz-960 MHz recently made available for non-government use (see August, 1968 Bulletin) would also be reassigned. The proposed new reallocation is as follows:

Frequency Band (MHz)	Service
806-846	Land mobile and television translators, shared.
846-893	Common carrier mobile and base.
893-919	Government. (915 MHz designated for Industrial, Scientific, and Medical Equipment.
919-947	Common carrier base.
947-952	Broadcast auxiliary as at present but reduced from 942-952 MHz.
952-960	Operational fixed.

Television translators now operating on Channels 70 through 83 would be permitted to continue operation on a shared basis with the land mobile systems. The Commission stated that little interference would be expected, since these translators serve predominately rural areas, while the land mobile systems are concentrated in urban areas.

Short Circuits

The Commission has proposed to reduce the required minimum indicating range for television aural frequency monitors for +3000 Hz to +2000 MHz...Slow-scan television is now permitted in the amateur bands below 420 MHz...The Commission has proposed to simplify the rules of governing station identification of AM and FM broadcast stations...UHF translators are to be tested in New York City (the first in large urban areas) during the construction of a multi-story World Trade Center there...The Commission's contract for research and policy studies in land mobile radio and computer communications has been awarded to Stanford Research Institute of California (see June, 1968 Bulletin)...The Commission has authorized further testing of dual language sound tracks by a Puerto Rican station, with Spanish dialogue on the television aural carrier and English dialogue on a companion FM station...The 1968 Fall Symposium of the IEEE Broadcasting Group will be held in Washington at the Mayflower Hotel on September 19-21, 1968.

Howard T. Head...in Washington



difficult installations made easy

The long continuous lengths of HELIAX® coaxial cable make any type of installation possible. Whether across a vast ravine or up the tallest tower, the installed cost is less. Corrugated inner and outer conductors absorb all stress. Andrew connectors firmly anchor both conductors to eliminate electrical problems. Consult your Andrew sales engineer or write Andrew Corporation, 10500 West 153rd Street, Orland Park, Illinois 60462.



870-foot self-supporting catenary installation of 5 inch HELIAX air dielectric coaxial cable (Type HJ9-50) at mountain top site of Station KBYU-TV, Provo, Utah.

Andrew
CORPORATION

31 YEARS OF ENGINEERING INTEGRITY

Circle Item 19 on Tech Data Card

10-66

AN EBS MONITOR THAT THINKS FOR ITSELF

By **Richard C. Factor**

Engineer, WABC AM-FM, New York

FCC regulations require each broadcast station to have a monitor which will respond when a monitored station transmits an Emergency Broadcast System (EBS) alert. Complying with the regulation is relatively simple, since all that is needed is a receiver with an AGC system and an alarm which will indicate when the AGC voltage changes (1). The ordinary type of monitor is limited in usefulness, however, because it will respond to any carrier outage, causing considerable operator inconvenience, especially if the monitored station is having transmitter trouble.

There are two cases in which a more accurate monitor is necessary: if the notification is to be logged automatically, or if it is impractical to monitor the audio output frequently. In a facility where a fast-paced show is in progress, and the engineer is in the same studio as the talent, there may be no time to plug headphones into a monitor jack before the alert broadcast is terminated. For these reasons, it is desirable to have an EBS monitor which will be as free as possible from false indications.

To distinguish a false alarm (a carrier drop-out) from a true alarm (carrier off five seconds, on five seconds, off five seconds, 1-kHz tone five seconds), some type of timing and logic is necessary. For maximum reliability, the unit to be described was built with all silicon semiconductors. The logic uses integrated circuits for simplicity and

low cost, as well as enhanced reliability. The use of IC's is somewhat novel in broadcast equipment. It will be assumed that the reader has a basic familiarity with the NOR gates and JK flip-flops (2).

Circuit Description

There are two inputs to the monitor: an AGC input and an audio input. The audio input level is not critical, because the signal is clipped to present a constant-amplitude signal to the active filter. Any input greater than -10 dBm should be satisfactory; input impedance is about 600 ohms. This unit was designed to work with a negative AGC voltage which becomes more negative as signal strength increases. The type of IC used requires two voltage levels, 0-0.2 volt, which corresponds to a 0 logic level, and 0.7-3.5 volts, which corresponds to a 1 logic level. It is necessary to translate the audio and AGC voltages to these levels. The AGC voltage is translated to a voltage 6 volts less negative by the input zener diode. The resulting voltage is applied to the input of emitter follower TR3, which raises the input impedance to about 500,000 ohms. The voltage at the emitter is applied to one end of an adjusting potentiometer, the wiper of which goes to the logic-gate input. With the pot set properly, an AGC voltage change of 0.5 volt is sufficient to make the output of G4 change state. With carrier on, the output is high (logic 1), and this

causes TR4 to conduct and light I1, indicating presence of carrier.

Translation of the audio is performed by a clipper, active filter, and rectifier so that signals in the range of 900-1100 Hz will give a high logic state. It would be possible to narrow this range considerably, but allowance must be made for inaccurately calibrated oscillators and tape-speed variation at the transmitting station. Clipping is performed by G3, which is biased as an amplifier, and which normally is overdriven considerably by the receive output.

The constant-amplitude output is lowered by R1, which is adjusted to give logic-1 output over the proper bandwidth. The active filter consists of an amplifier whose output is 180° out of phase with its input, and a feedback loop with nonlinear frequency characteristics. The attenuation of network C1-C2-R3-R4 is greatest at 1 kHz. Since this network introduces negative feedback, the amplifier gain increases at 1 kHz. Diode D1 rectifies the filter output to provide DC for the logic circuit.

After the signals from the receiver are converted into logic levels, it is necessary to convert the sequence of these logic signals into ultimate alarm activation. This is done with appropriate timing circuitry and a digital circuit known as a "shift register." The shift register consists of four flip-flops, FF1-FF4. They are so interconnected that no FF can flip until the

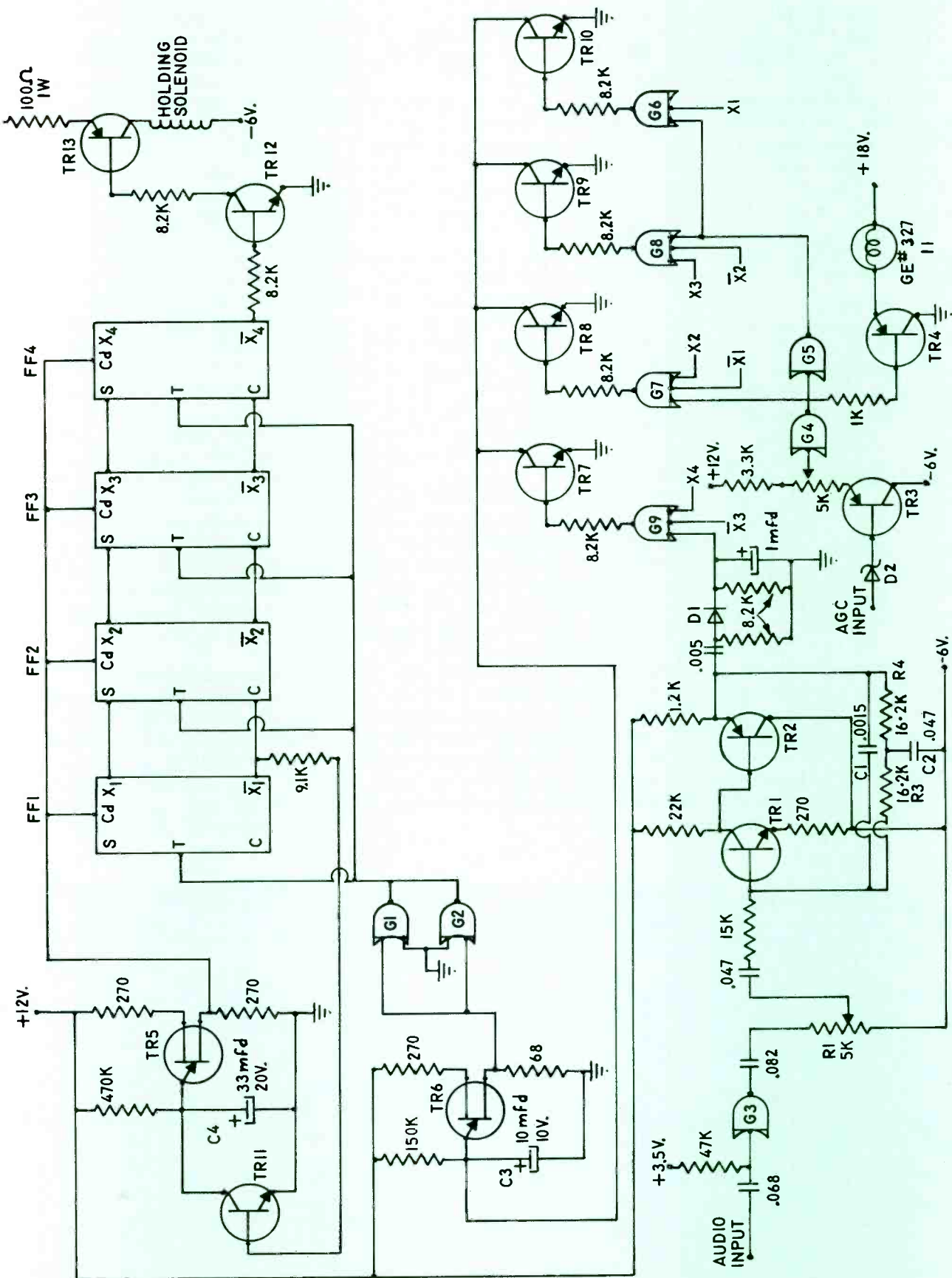

Fig. 1

one preceding it has done so. All the flip-flops are triggered simultaneously, but only one can flip on each pulse. Gates G1 and G2 are connected in parallel to comply with the IC loading rules, which specify that a gate cannot trigger more than three flip-flops simultaneously. The trigger pulses come from TR6, a unijunction transistor in a relaxation-oscillator configuration. This stage is timed so that, if left to itself, it will produce a positive pulse every 1.5 seconds or so. Gates G1 and G2 invert the pulse and shorten it to the 100 nanoseconds required by the flip-flops.

After TR6 has produced one pulse, FF1 changes state, and Q1 assumes the low state. Consequently, TR11 stops conducting and enables C4 to charge with a time constant of about 20 seconds. After this time, TR5 produces a positive pulse which resets all the flip-flops. Note that the reset input does not require an extremely fast pulse.

Transistors TR7-TR10 are connected in parallel across C3. Thus, if any of these transistors conducts, no pulse will be generated to trigger the flip-flops.

The logic gates are so arranged that only one transistor at a time is conducting, for example, until there is a break in the carrier, the inputs to G6 are both logic 0, the G6 output is logic 1, and TR10 conducts. When the carrier is interrupted, G5 applies a logic-1 input

to G6, the G6 output goes to logic 0, TR10 stops conducting, and C3 begins to charge. After TR6 generates the first timing pulse, output Q1 goes to logic 0; output Q2 is already logic 0, and the output of G4 is logic 0 because there is no carrier.

The output of G7 is therefore logic 1, and TR8 conducts. Capacitor C3 begins charging again when the carrier reappears and the output of G4 becomes logic 1. The next pulse from TR6 causes FF2 to change state.

By a little study, it can be seen that a logic-1 output (logic 0 at the Q outputs) advances through the shift register only when events occur in the specified order and within the specified time (before TR5 resets the flip-flops). When a logic-0 output appears at Q4, TR12 and TR13 stop conducting, and the holding solenoid is released to activate the alarm.

It was stated previously that TR6 will generate a pulse every 1.5 seconds if not subjected to external influences. A 1.5-second timing interval might appear too short, and indeed it is. However, Q7-Q10 will discharge C3 well below the point to which unijunction transistor will discharge it. Thus, the timing interval is increased to about 2.5-3 seconds. Since most EBS transmissions are sent manually, it is desirable to leave some margin of error for the transmitter operator. If less margin is desired, add a few microfarads to C3.

External Connection

So far, little has been said about the actual connection of the alarm unit. There is an excellent article in the January 1968 issue of **Broadcast Engineering** (1) covering both receiver connection and different relay arrangements. The relay arrangement to be used will depend on requirements of your station.

It is particularly difficult to derive AGC voltage from your receiver, you may wish to use an integrated circuit known as a voltage comparator. This circuit compares two input signals and changes logic level when one signal is only a few millivolts from a preset reference. Fig. 2 shows a sample hookup of this circuit. Be sure to obtain the manufacturer's data and application notes for the unit you plan to use.

The power supply (Fig. 3) for the original unit must supply several voltages: -6, 0, 3.5, 12, and 18 volts. It should be possible to design the alarm unit to use fewer voltages. In fact, if a 12-volt solenoid-held switch and 12-volt pilot lights were used, only the 12- and 3.5-volt sources would be necessary.

Special Components

The integrated logic circuits used here are members of the Motorola MC700P series. It will be noticed that several inputs to the dual gates are not used, and two complete gates are not used. All the unused inputs should be grounded. (It

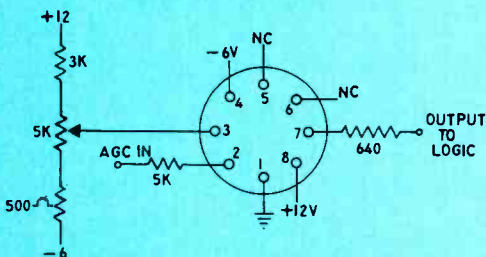

Fig. 2

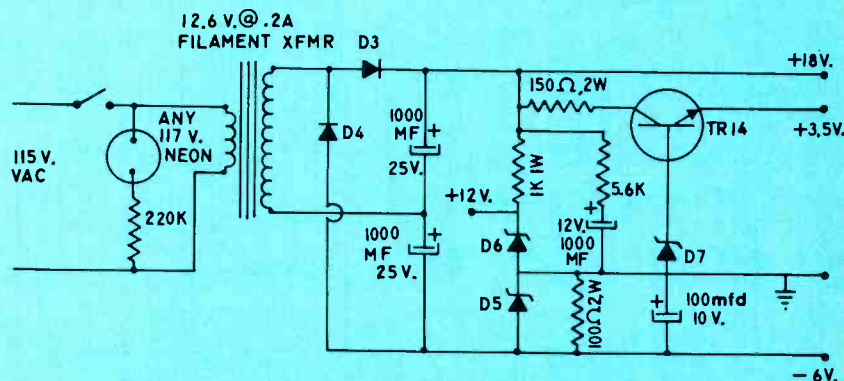
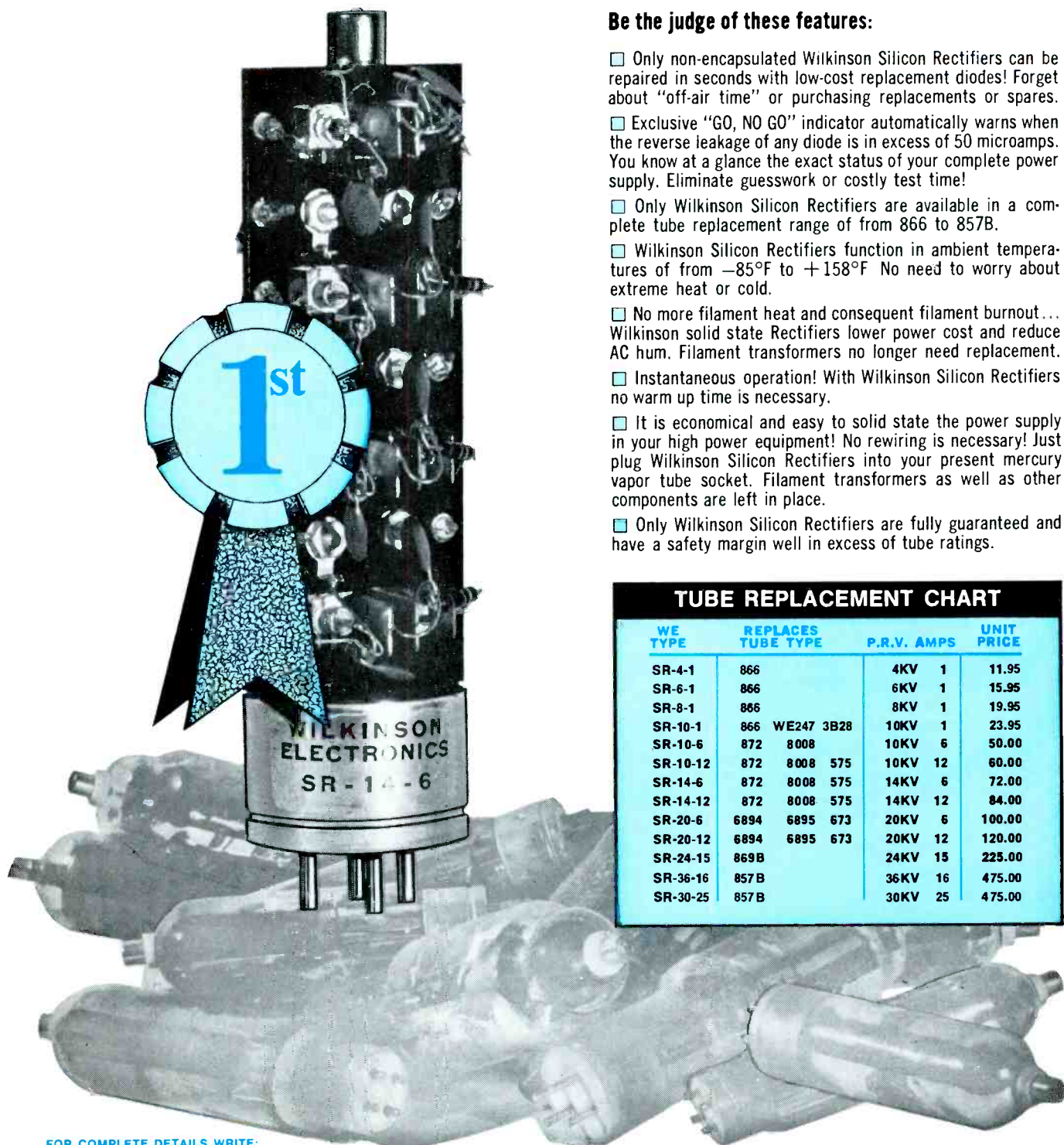

Fig. 3

Wilkinson Direct Replacement Silicon Rectifiers... Stand Out In A Crowd ...and Stand Up Forever!



Be the judge of these features:

- Only non-encapsulated Wilkinson Silicon Rectifiers can be repaired in seconds with low-cost replacement diodes! Forget about "off-air time" or purchasing replacements or spares.
- Exclusive "GO, NO GO" indicator automatically warns when the reverse leakage of any diode is in excess of 50 microamps. You know at a glance the exact status of your complete power supply. Eliminate guesswork or costly test time!
- Only Wilkinson Silicon Rectifiers are available in a complete tube replacement range of from 866 to 857B.
- Wilkinson Silicon Rectifiers function in ambient temperatures of from -85°F to $+158^{\circ}\text{F}$. No need to worry about extreme heat or cold.
- No more filament heat and consequent filament burnout... Wilkinson solid state Rectifiers lower power cost and reduce AC hum. Filament transformers no longer need replacement.
- Instantaneous operation! With Wilkinson Silicon Rectifiers no warm up time is necessary.
- It is economical and easy to solid state the power supply in your high power equipment! No rewiring is necessary! Just plug Wilkinson Silicon Rectifiers into your present mercury vapor tube socket. Filament transformers as well as other components are left in place.
- Only Wilkinson Silicon Rectifiers are fully guaranteed and have a safety margin well in excess of tube ratings.

TUBE REPLACEMENT CHART

WE TYPE	REPLACES TUBE TYPE	P.R.V. AMPS	UNIT PRICE
SR-4-1	866	4KV 1	11.95
SR-6-1	866	6KV 1	15.95
SR-8-1	866	8KV 1	19.95
SR-10-1	866 WE247 3B28	10KV 1	23.95
SR-10-6	872 8008	10KV 6	50.00
SR-10-12	872 8008 575	10KV 12	60.00
SR-14-6	872 8008 575	14KV 6	72.00
SR-14-12	872 8008 575	14KV 12	84.00
SR-20-6	6894 6895 673	20KV 6	100.00
SR-20-12	6894 6895 673	20KV 12	120.00
SR-24-15	869B	24KV 15	225.00
SR-36-16	857B	36KV 16	475.00
SR-30-25	857B	30KV 25	475.00

FOR COMPLETE DETAILS WRITE:

WILKINSON ELECTRONICS, INC.

1937 MACDADE BLVD. • WOODLYN, PA. 19094
TELEPHONE (AREA CODE 215) 874-5236 874-5237

Circle Item 20 on Tech Data Card

would be possible to save a few pennies by purchasing the precise number of gates required.) Fig. 4 shows the pin connections of the IC's used; don't forget to connect the ground and the 3.5 volts to each IC, even though these connections are not shown on the schematic.

A combination reset switch and holding solenoid is used in this EBS monitor. Such devices are manufactured by Microswitch and other companies. If there is a voltage on the holding solenoid, the switch remains in when pressed. (The solenoid will not pull in the switch, however.) Thus, if the solenoid is released, the switch will pop out and open (or close) the contacts. It will remain in this position until reset. If the switch is connected to the alarm, lights, etc., the one unit performs two functions. Of course, it is always possible to use a switch and a relay.

Conclusion

This EBS monitor has many advantages over the usual type. If you are troubled by false alarms, or don't have time to investigate every time the warning comes on, the added complexity of this unit is well worth the effort. Even if you don't need it desperately, it is relatively inexpensive and will provide valuable experience in working with IC's. ▲

References

1. Building EBS Receivers, Charles D. Sears, **Broadcast Engineering**, 1968, p 20.
2. Digital Circuits for Broadcasters, J. L. Smith, **Broadcast Engineering**, February 1968, p 12; March 1968, p 29; April 1968, p 24; and June 1968, p 26.

Parts List

- TR, 7, 8, 9, 10, 11, 12, 2N4074
- TR3, 13 2N3638
- TR4 2N3053
- TR5, 6 2N2646
- TR14 2N3053

Any of these transistors can be substituted for types with even remotely similar characteristics.

- FF1-FF4 MC790P
- G7-G9 each 1/3 MC792P
- G1-G6 each 1/4 MC724P
- D1, D3, D4 1N3193
- D2 1N754
- D5 1N3016
- D6 1N4742
- D7 1N3823

**MC724P
RTL QUAD 2-INPUT NOR GATE
(BOTTOM VIEW)**

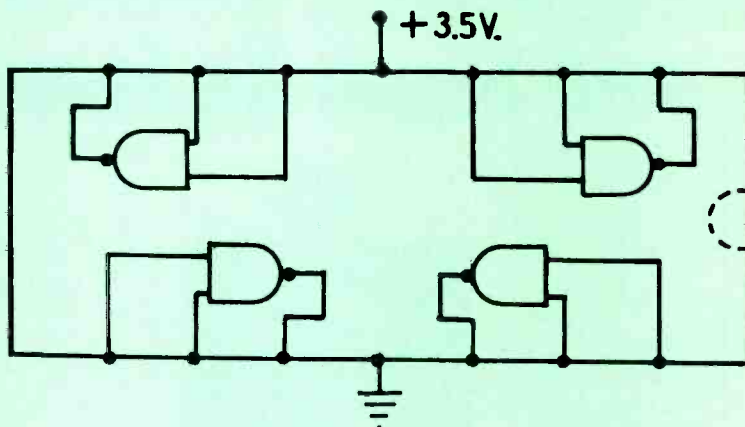

**MC790P
RTL DUAL 1K FLIP FLOP
(BOTTOM VIEW)**

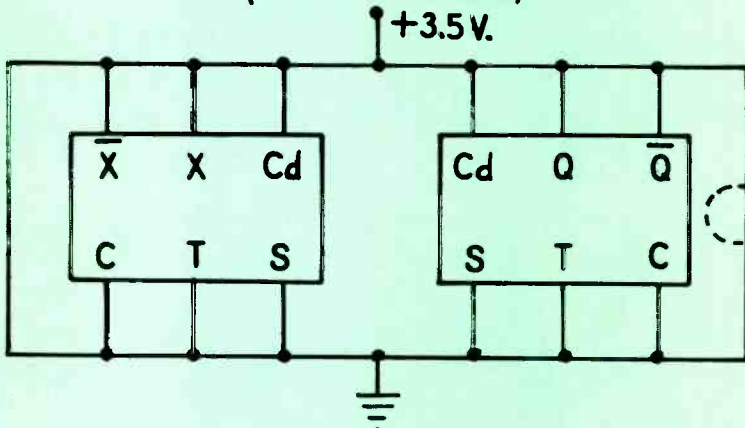

**MC792P
RTL TRIPLE 3-INPUT NOR GATE
(BOTTOM VIEW)**

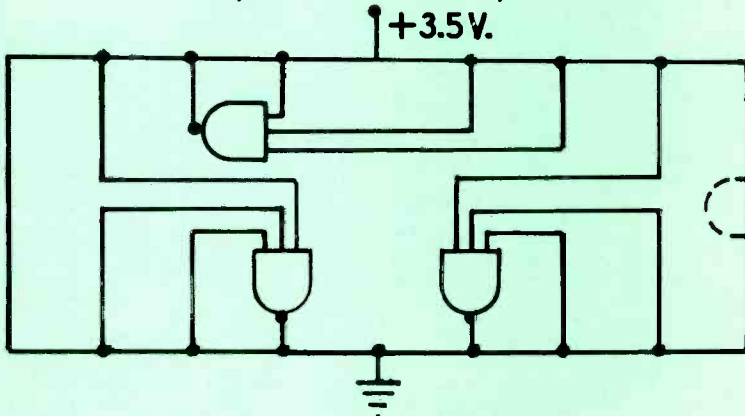
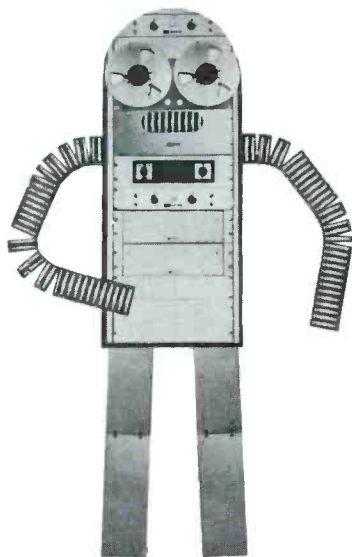

Fig. 4

We didn't sell Perry Ury on automation.



A thing on the late, late movie did.

"We call our system 'R-KO, the shy but friendly robot'," says Perry. "You simply tell the system what to do and when. It does it. It even logs what it has done and when."

Perry Ury has a Gates Automatic Tape Control System designed for the program requirements of WRKO-FM, a 100%-automated contemporary music station.

Yours are undoubtedly different. So Gates has a wide choice of basic automation systems, one of which can be adapted to your programming for more profitable broadcasting.

As a matter of fact, we may be able to get you fully automated for around \$65 a week. We're all experienced broadcasters so we understand budgets as well as program requirements.

The idea is worth a phone call, isn't it? Why not dial (309) 829-7006 right now? Or jot down your name, station and address on this ad and mail it to us.



*Perry S. Ury, V. P. & Gen. Mgr.,
WRKO-FM, Boston, Massachusetts*

GATES

AUTOMATIC TAPE CONTROL DIVISION

1107 East Croxton Avenue
Bloomington, Illinois 61702, U.S.A.

Circle Item 21 on Tech Data Card



Disney's Magic World of Sound... from Altec.

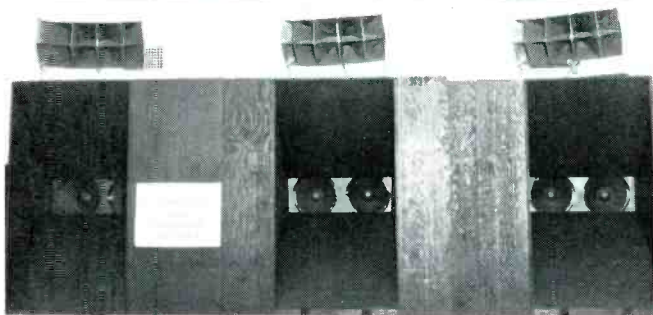
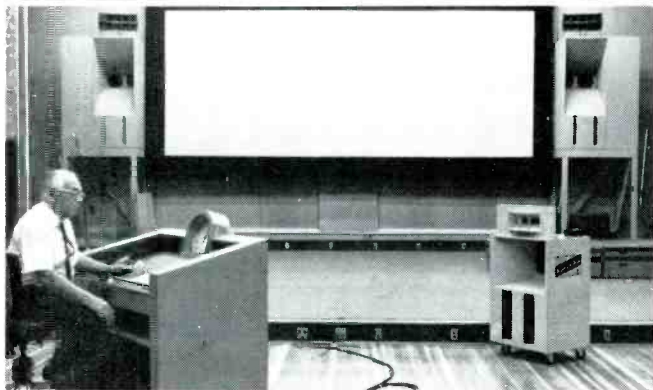

The magic that is Disney is not just a pat formula. It is a form of perfectionism that pervades everything which carries the Disney name. Certainly, there's a Disney look. But just as certainly there's a Disney sound. And that's where we come in.

For example, the new control console at the Disney Studio's orchestra stage is made up of 29 Altec slide-wire attenuators, 7 rotaries, and one 4-gang master. The works are powered by rack-mounted banks of Altec amplifiers. Monitoring in the control room is done in a big way—with three giant Altec A4 "Voice of the Theatre"® systems butted together in a single plane of the most powerful, pure sound you can get.

The stage itself uses three more A4's for monitoring, re-recording, and playback. (That's one good way to keep the musicians happy.) Eight caster-mounted A7 "Voice of the Theatre"® systems are mobile, may be moved where and as needed.

And that's not all. On the back lot Altec PA equipment provides the paging. Dialog stages at the Studios also use A4's, with Altec's space-saving 844A Monitor Speaker Systems in the compact transfer room. The list could go on, but the point is made.

So who listens when Altec Lansing sounds off at Disney? Everybody, that's who. And if you understand the remarkable expertise of Disney sound engineers, perhaps you should listen too. Let's hear from you.

ALTEC LANSING, A Division of
LTV Ling Altec, Inc., Anaheim,
California 92803



Write to Altec for a free copy of the valuable 12-page article "Professional Audio Control", reprinted in full from *Audio Magazine*.

VISIT ALTEC LANSING AT THE AUDIO ENGINEERING SOCIETY SHOW AT THE PARK-SHERATON BEING HELD IN NEW YORK OCTOBER 21-25.
Circle Item 22 on Tech Data Card

Instant Audio:

You create your own customized professional equipment with our Finished Solid-State Circuit Modules.

Make intercoms, line amplifiers, mixers, monitors, turntable pre-amplifiers, stereo amps, language labs, etc. They'll be better, cost you less.

AUDIO AMPLIFIERS

AA-100
UTILITY AMPLIFIER

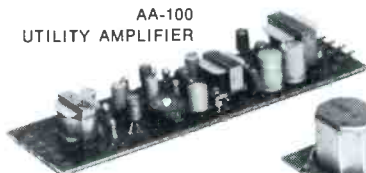

For general purpose uses; and to modulate TR-100 Transmitter (below). Includes volume control and input (low Z) and output transformers.

AA-300
PROFESSIONAL
AMPLIFIER

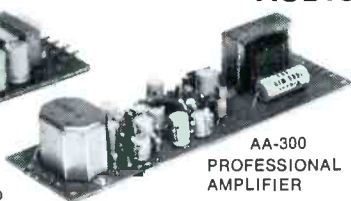

Designed for broadcast/recording/TV uses. Includes input and output transformers.

AA-400
PROFESSIONAL
POWER AMPLIFIER



When driven by AA-100 or AA-300, a hi-gain 1-watt audio system results.

AA-500
PROFESSIONAL
PRE-AMPLIFIER

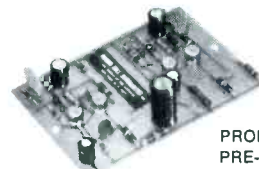

Specially designed for broadcast/TV/recording/hi-fi/commercial usage. With any low-level hi-Z input device, they deliver undistorted 5VRMS to drive a hi-Z input power amp. Usable with low-level low-Z mikes if fed by quality input transformer (150 to 50K Ω balanced). To feed 600 Ω lines, use a transformer (2.5 to 600 Ω balanced) in the output stage.

An IC Line/Monitoring Audio Amplifier that delivers 1-watt output.

High-reliability, professional amplifier excellent for broadcast/TV/recording use and general audio OEM and hobbyist applications. Only 1 millivolt of input signal can produce a full 1-watt output. The 2000 Ω input impedance is changeable by utilizing suitable input transformer.



Technical specifications:

Frequency response: ± 1 db, 20-20,000 cps (OTL). Power output: 1-watt RMS into 8 ohms. Harmonic distortion: Less than 0.5%, 20,20,000 cps at 1-watt. Input level: 1 millivolt for 1-watt output with 25db dynamic range. Input impedance: 2000 ohms unbalanced. Gain: 70db. Output impedance: 4 to 8 ohms (OTL). Circuit: 5 transistors, 1 integrated circuit. Power supply: 14-16 volts DC at 200 mA. Size: 8 1/2" Long, 2 1/2" Wide, 2" High. Weight: 4 oz. Accessories: BC-10 Steel Case with Barrier Strip, \$5.95.

REGULATED POWER SUPPLY

Zener-referenced, delivers highly stable, extremely low ripple DC output of 9VDC with loads up to 200mA; and unregulated 14VDC at 1 Amp. For wherever well-filtered regulated DC is needed. Input: 105-120VAC, 60cps, 5W. Regulation: Line + load 5MV. Ripple: Under full load 10MV, p-to-p. Max. Load Current: 200MA. 4 1/2" L x 2" W x 1 1/2" H. Wt.: 23 oz. Powers all our modules.



PS-300

TRANSMITTER

Complete crystal controlled 3-transistor transmitter for Citizens' Band. Factory pre-tuned for any CB channel; supplied with crystal. Modulation: CW or AM with external modulator such as AA-100. RF output: 100MW, 50 Ω load. Power: 9VDC, 50MA. 5 1/2" L x 1 3/4" W x 2" H, 3 1/2 oz. Add. CB Crystals: \$3.00 ea.

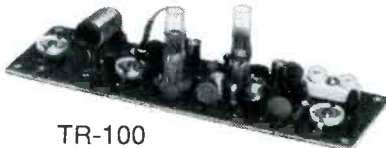

TR-100

POWER OSCILLATOR

All-transistor push-pull sine wave oscillator, 20KC-150KC, 1% harmonic distortion. Power needed: 18-22V, 100MA. Input terminals permit AM modulation (by amplifiers AA-100, 200, 300). Uses: biasing recorder heads, powering tape erasers, signal generator/transmitter. 5" L x 3" W x 2" H.

OS-100



Please send me the following circuit boards:

Model	Qty.	Price ea.	AMOUNT
AA-100 Utility Amplifier		\$ 7.95	\$
AA-300 Professional Amplifier		16.95	
AA-400 Professional Power Amplifier		10.95	
AA-500 Professional Pre-Amp (Linear)		23.95	
AA-500N Professional Pre-Amp (NAB equal.)		23.95	
AA-500R Professional Pre-Amp (RIA equal.)		23.95	
AA-700 IC Line Audio Amplifier		28.50	
BC-10 Steel Case for all Amplifiers		5.95	
PS-300 Power Supply		18.95	
TR-100 Transmitter		10.95	
OS-100 Power Oscillator		21.95	
		TOTAL	



ROUND HILL ASSOCIATES, INC.

325 Hudson Street, New York, N.Y. 10013

Send postpaid: enclosed is full payment. Send C.O.D.

NAME _____

ADDRESS _____

CITY _____

STATE _____ ZIP _____

DEALERS INVITED.

Circle Item 55 on Tech Data Card



ABC's "Lawrence Welk Show." Video taped on Memorex 78V.

When the show's rolling,



the tape must not fail.

If it does, you have trouble. Time and money trouble.

Think what your actors, singers, dancers and directors are costing you. Not to mention cameramen, lighting men, sound technicians, floormen, and all the other people who put your show together.

Plus your equipment. Cameras, cables, spotlights, sets. They're expensive, too.

We make our Memorex 78V high-chroma video tape for people who don't want trouble. Who are impatient with re-makes and don't want to waste the time or money.

Of course, if time and money are no problem, then you don't need our non-fail 78V.

Only patience.

(For information, write us: Memorex Park, Santa Clara, Calif. 95050.)

MEMOREX

TWO OF A KIND



THIS ONE

is a complete broadcast facility for use in recording or production studio, plus versatile portability for remote broadcast assignments. Rugged and compact, yet professional in every respect!

Exclusive features include:

- Two 3 speed custom turntable systems
- Removable solid state console
- Monitor and cue system
- Lift-Leaf work surface

A variety of optional accessories:

- Matching bench lid
- Removable equipment shelf
- Dynamic cardioid microphone

Send for detailed information on the AC - 155 Studio Control & Remote Unit.

Only \$1195

AND THIS ONE!

A complete audio center designed for master control use. Rich, scratch resistant wood grain finish cabinets add that custom furniture look to your studio at a surprising low cost. Plenty of storage or equipment rack space, too!

Standard features include:

- 8 Channel solid state console
- Dual 3 speed custom turntable systems
- Complete cartridge record/playback system
- Cartridge storage hutch
- Shipped completely assembled

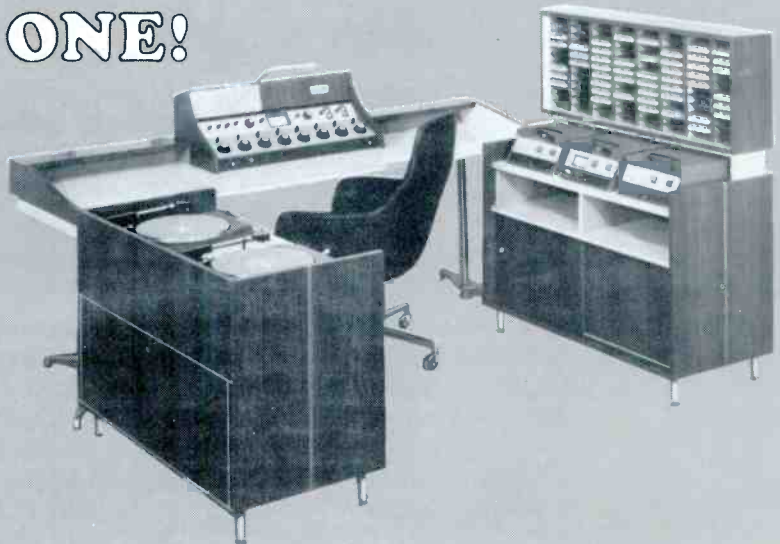

Write for complete information on Sparta SHOWCASE CONTROL ROOM CABINETRY
All cabinetry & equipment shown (except chair) — under \$4000.



ELECTRONIC CORPORATION

5851 FLORIN-PERKINS ROAD SACRAMENTO, CALIFORNIA 95828

A DIVISION OF COMPUTER EQUIPMENT CORPORATION (916) 383-5353

Circle Item 23 on Tech Data Card

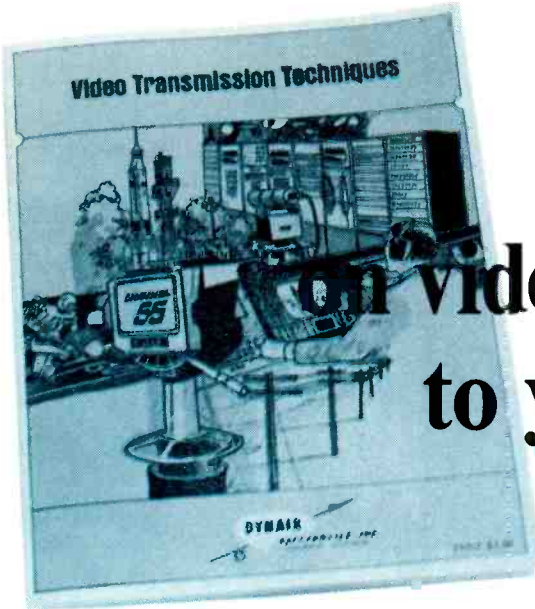

Add this free book on video cable transmission to your technical library

This new book "Video Transmission Techniques" will be coming off the presses shortly. Reserve your *free* copy now. Published by DYN AIR, this book covers problem areas such as hum, equalization, resolution/bandwidth, balanced-line transmission and many others. This is a limited printing . . . order your copy today.

Yes, for a limited time only, you can receive a free copy of this helpful new book, with absolutely no obligation! Just mail the coupon, use the literature request card or drop us a note and we'll reserve a copy for you.

Published by DYN AIR, a pioneer in the field of solid-state video cable transmission equipment, this book covers in detail the problems encountered with routing video through cables . . . and presents the solutions!

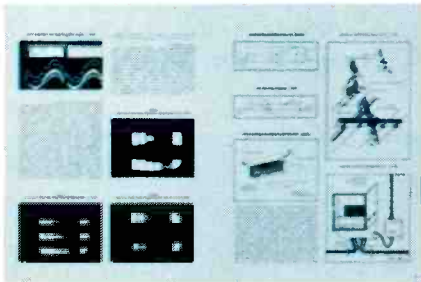

The photographs shown are sample pages reproduced directly from "Video Transmission Techniques" and are typical of the material presented. Pictorial diagrams, supported by easy-to-understand text and numerous photographs, charts and tables, make system design simple.

This book includes useful design information for a multitude of systems, both unbalanced and balanced . . . simple and complex. It covers everything from cable types to complex electronic terminations. The problems involved in selecting the

equipment for a particular application are discussed with the exact equipment detailed for many systems.

DYN AIR video transmission equipment is installed in numerous facilities throughout the world. We have supplied systems for transmitting video information over many miles of cable. DYN AIR systems are available with video bandwidths as great as 30 MHz, providing optimum high-resolution performance.

The practical building-block construction techniques used in solid-state DYN AIR equipment allow systems of virtually any size to be easily assembled. Plug-in modular etched circuit boards are used in most cases, assuring ease of maintenance. Equipment can be provided to suit almost any system requirement.

DYN AIR also manufactures a variety of other solid-state television equipment, including modulators and demodulators, video and pulse amplifiers, local and remote-control switching systems, switcher-faders,

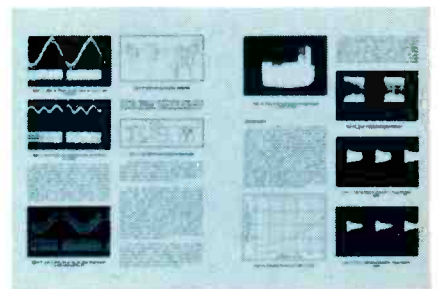
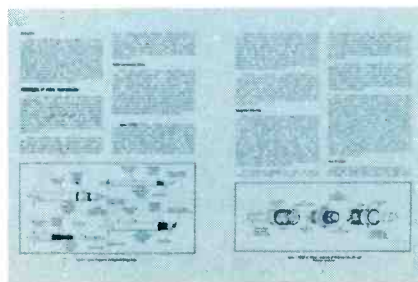

special effect generators, sync generators and sideband analyzers.

If you use this type of equipment, you might like to receive either our complete catalog or literature on specific devices; DYN AIR product information is available upon request—just write, outlining your needs.

DYN AIR
ELECTRONICS, INC.
SAN DIEGO, CALIFORNIA

6360 FEDERAL BLVD., SAN DIEGO, CALIF.
ZIP 92114 PHONE (714) 582-9211

Please send free copy of "Video Transmission Techniques"

Have you seen "Video Switching Techniques"?
Yes No

NAME _____

TITLE _____

COMPANY _____

ADDRESS _____

CITY _____

STATE _____ ZIP NO. _____

Circle Item 25 on Tech Data Card

VT Logging the Easy Way

By Michael J. Smith*

■ Tape life records should be kept to insure program quality control. A TV spot frequently comes up filled with annoying dropouts or tear-ups due to crimp damage, mishandling or tip head wear. It may even be a noisy program because the tape stock is worn out from excessive use.

The quality of any show or commercial is dependent upon tape quality. And one way to insure video quality is to use a logging method that eliminates the guesswork by quickly revealing all the information you need. But keeping records on the life of a video tape can be a thorny problem.

Logging information should include the tape age, number of plays, dropout clusters and previous damage. A ready reference to a tape's history and physical condition from a really complete tape label enables the engineer to quickly select the tape most suitable for the kind of recording to be made.

The result should be an improvement in program quality and an economical and efficient use of

*Operations Manager, NCST

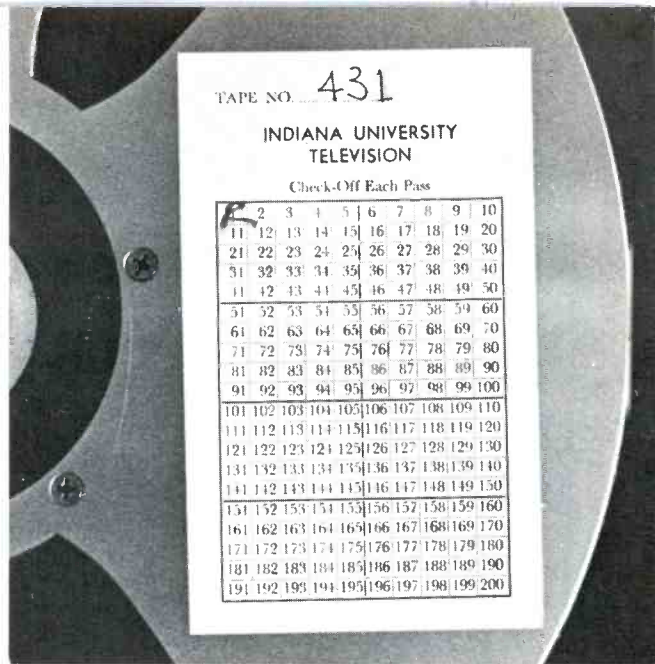

Fig. 1

video tapes. The idea of labels for tapes is certainly not a new one, but here are some ideas that show improvements over many systems in use today.

Functional Labels

Indiana University Radio and Television Services, the Eastern Educational Network, and Educational Network, and Educational Television Stations/Program Service are among those who use the labels pictured in figures 1, 2, and 3. One major advantage they reveal is that the label is placed on the tape reel where it can be marked easily by the tape operator, even during rapid reel changes.

To date, most tape record labels used are of rectangular shape. This label is sometimes difficult to fit on the small reels without obscuring the manufacturer's control number. Often it hangs over the edges (as seen in Fig. 2). When the label does not fit, it must be trimmed. Once on the reel, trimming is difficult, time-consuming, and it looks messy.

Fig. 4

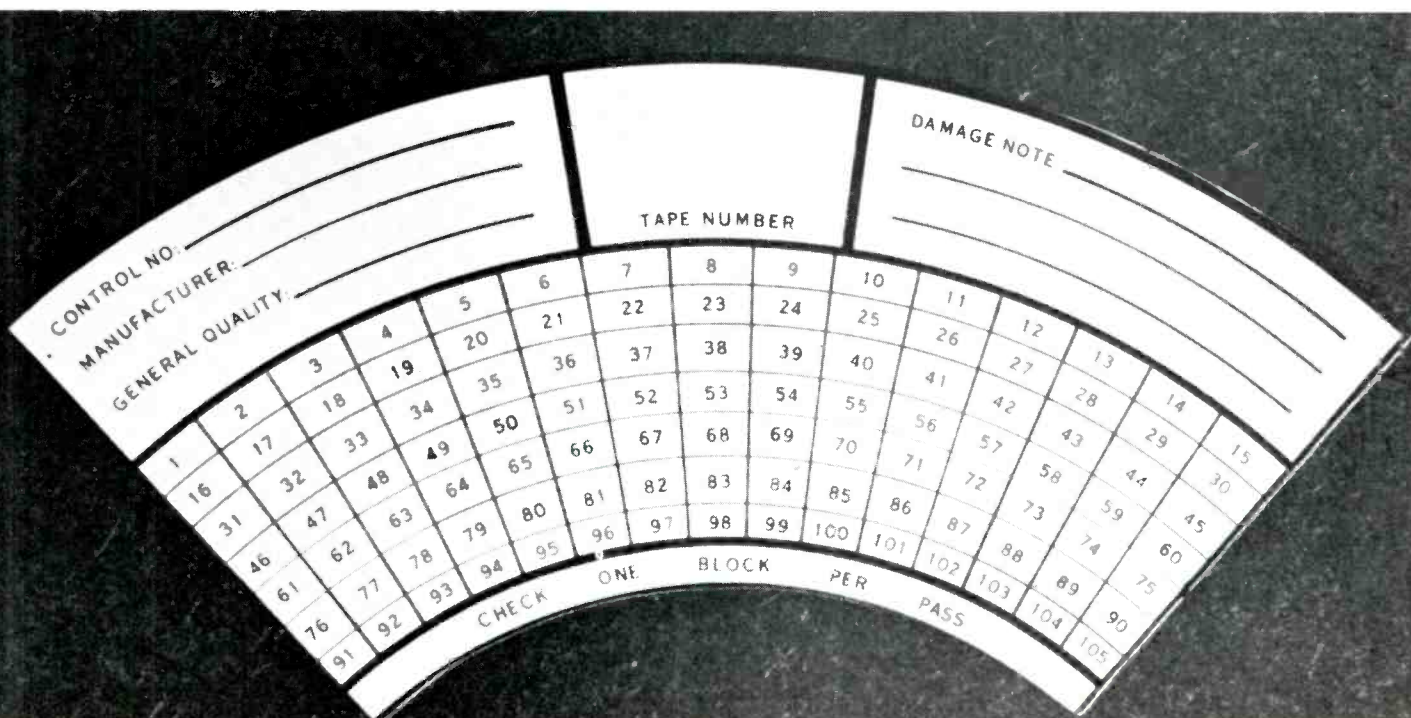

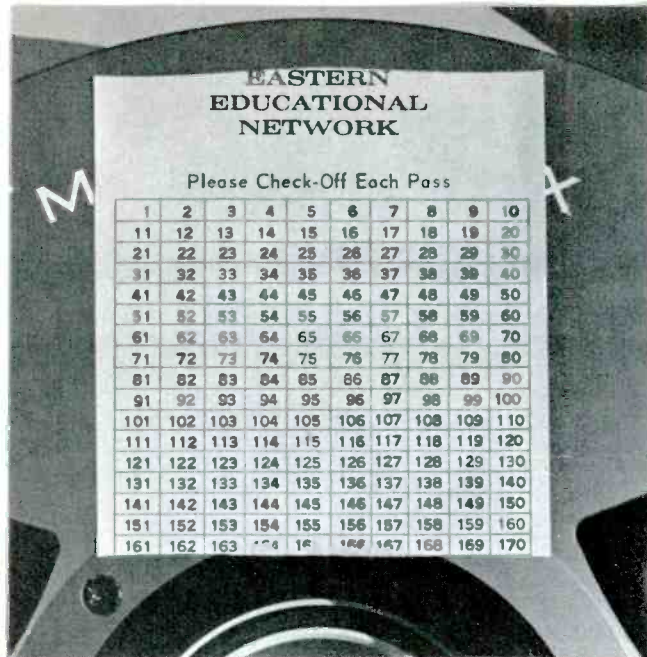

Fig. 2

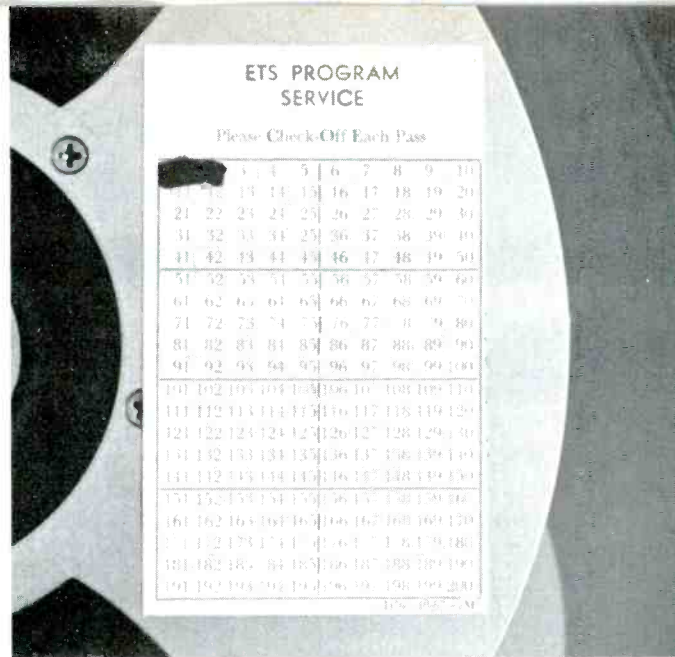

Fig. 3

A refinement of the rectangular design is a semi-circular label which provides maximum labeling efficiency and fits nearly any reel built around an NAB hub. Such a label is used by the Delaware ETV Network and the National Center for School and College Television (NCSCT).

As seen in figures 4 and 5, a tape label can be designed to provide information according to the operation situation of each shop. While the Delaware ETV labels space to note damage to the tape during its service life, the NCSCT label provides only for a record of plays. Other NCSCT information is kept in a traffic record system. Note the in-service date of the tape as well as the damage remark space offered.

While the Delaware ETV label was designed for use with 3-M videotapes, the label used by NCSCT was designed to fit on nearly all makes of 2 inch quadruplex format reel and many helical scan tape reels with an NAB hub. This accounts for the slight-

ly different dimensions of the two labels.

Printing the labels is not a major problem. NCSCT labels are printed by a nationally specialty label company. The labels are die cut from pressure sensitive stock, and can be ordered on continuous rolls for ease of storage and handling. A roll of labels can be mounted on or near the video recorder which is used to check new tapes, and dispensed like paper towels for easy access. Having the labels printed at a local printing shop can be a bit high for the first run, due to a die charge of \$50.00 or more. Reprints, however, can be as inexpensive as regular program labels.

The tape record label is a useful and functional tool in determining which tape to use for various recording situations. In addition, statistics gathered from the record labels of retired tape stock can show why tapes are becoming unsuitable for use, the average tape life, and how one brand compares with another. ▲

Fig. 5

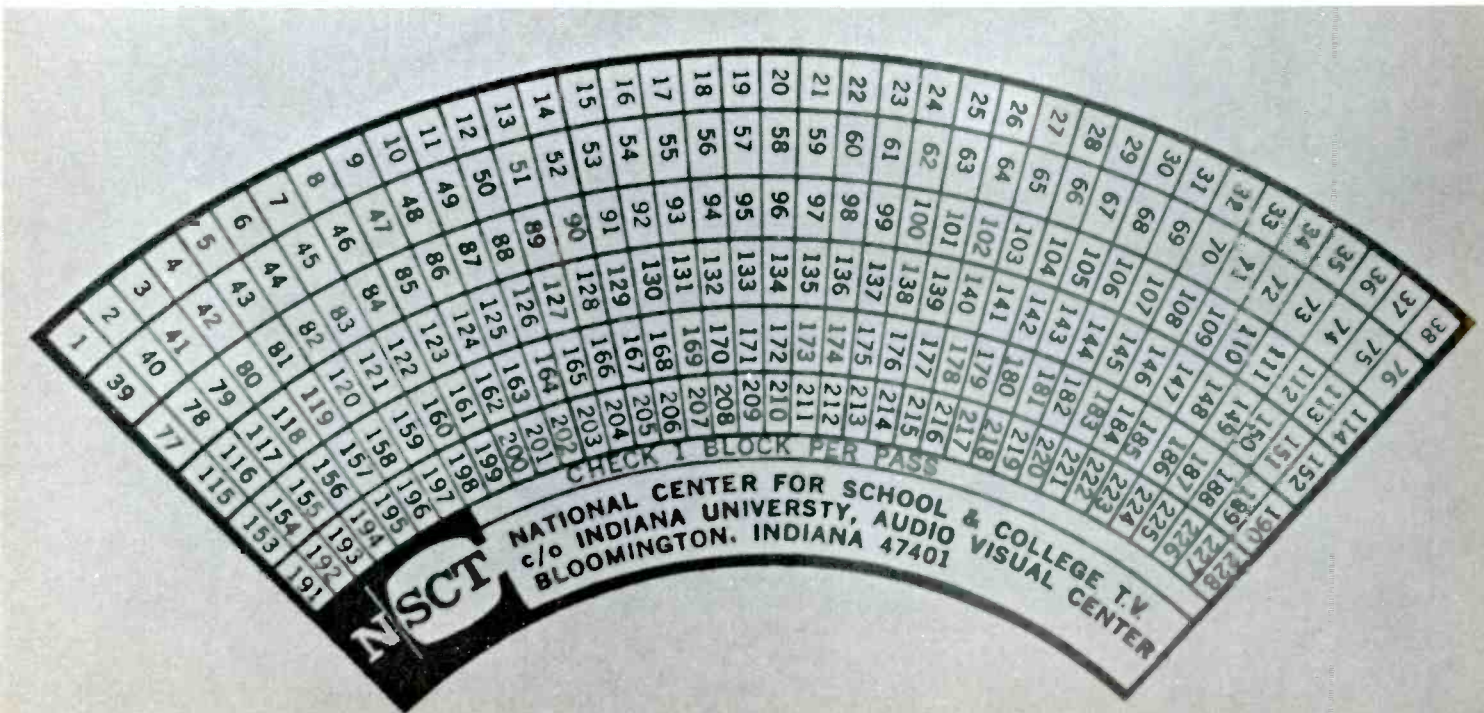

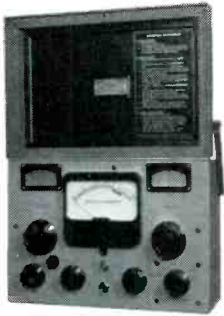

Four reliable reasons why experienced broadcast engineers prefer Nems-Clarke equipment ...now available from DEI

Model FIM-120E (WX2C)

In the broadcast industry, the quality, reliability, accuracy, and durability of Nems-Clarke equipment have earned it a reputation that is unique. DEI, now manufacturing and distributing this famous equipment, can assure you that it will continue to adhere to the same high standards that built this unmatched reputation.

Field Intensity Meter Model FIM-120E A compact, lightweight, portable instrument for measurements in the 540 to 1600 kHz range. Sensitivity range is from 10 uv per meter to 10 v per meter. Performance data includes a 540 to 1600 kHz frequency range and a 10 uv/m to 10 v/m intensity range. Power supplied by internal alkaline batteries, insures operation at 32°F and below and can be calibrated at any frequency at either high or low temperatures. Both linear and logarithmic indications permit use with recording equipment. Accuracy of this unit is essentially independent of battery voltage ambient temperature and modulation. Accuracy, linearity, and stability are vastly superior to any currently available solid state field intensity meter. Over 1,000 of these field-proven units are currently in use.

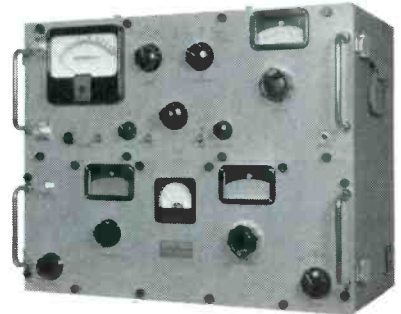

Model FIM-107A (Test Set)



Model PM-112

1.0 uv sensitivity. Signal generator output level is adjustable from 1 uv to o.l.v. A calibrated dipole provides 1.6 uv/m to 16 v/m field intensity measurements at 54 MHz.

Phase Monitor Model PM-112 This new solid-state unit replaces our model 108E and monitors phase and current relationships in directional AM arrays. Adaptable to remote control. Provision for switching of day-night reference levels can be provided. Performance data includes ± 1 degree phase accuracy, 0.5 degree phase resolution and 2% repeatable current accuracy. Will monitor up to 9 towers. Outputs are available for a digital voltmeter to provide increased resolution. Well over 100 of these units are now in world-wide use.

Precision Phase Monitor Model PPM-101 This unit is designed for use with critical directional AM arrays where a high degree of resolution and stability is required. Provides both phase and current indications. Contains digital counter. Nuvistor and solid-state design. Repeatable phase accuracy is ± 0.1 degree, phase resolution is 0.1 degree and repeatable current accuracy is within $\pm 0.1\%$. Will monitor up to 12 towers.

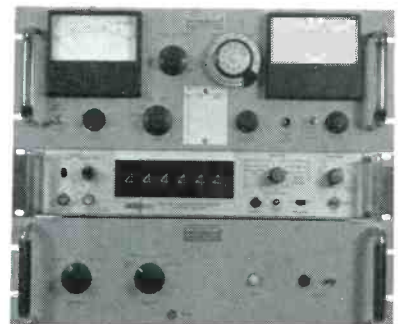

Model PPM-101

For full specifications, spares or service for these and other DEI/Nems-Clarke equipment, call or write today.

Nems-Clarke Equipment: Recognized as the Standard in the Broadcast Industry for Years

Defense Electronics, Inc.

PRODUCERS OF
DEI AND NEMS-CLARKE
EQUIPMENT



DEI
RESEARCH
DEVELOPMENT
MANUFACTURING

ROCKVILLE, MARYLAND (301) 762-5700; TWX: 710-828-9783; TELEX: 089602 • LOS ANGELES, CALIFORNIA (213) 670-4815 • INTERNATIONAL: ROCKVILLE, MARYLAND • CABLE: DEIUSA; INTELEX: 64102 • Sales Representatives: Rome, Italy • London, England • Madrid, Spain • Tel Aviv, Israel • Bromma, Sweden • Rijswijk, Holland • Koln, Germany • Paris, France • Zurich, Switzerland • Oslo, Norway
Circle Item 26 on Tech Data Card

BROADCAST EXECUTIVES—show this ad to the up-and-coming young men on your staff.

Want to move up fast in broadcasting?

This free book may change your life

It takes the mystery out of getting the FCC License you need for security and success

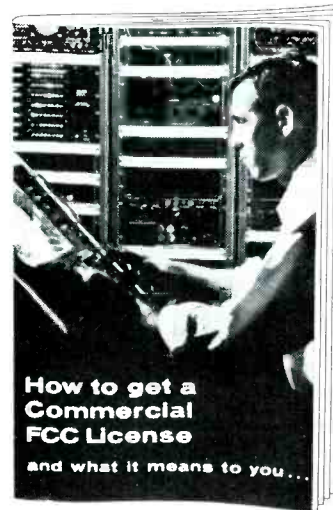

NO WONDER you're interested in a career in broadcasting. It puts you right "where the action is"—behind the scenes of show business, news reporting, politics. You meet famous people. You're the first to know the big news about fires, riots, plane crashes. You get to hear wonderful music. You feel in contact with an audience of thousands.

And one of the most secure high-pay jobs in the field is that of the licensed Broadcast Engineer. He's the key man required on the job by the United States Government

New job opportunities are opening up constantly for qualified license-holders. Many more will be needed to operate and maintain the countless new UHF-TV stations expected to begin operation, now that all new TV sets can receive UHF.

So if you dream of making broadcasting your life work, you need that Government FCC License.

But how do you go about getting it? Where do you apply, and when? How do you get ready for it?

To help you, we have published a 24-page booklet, "How to Get a Commercial FCC License." It tells you exactly which types of licenses and permits are issued by the Federal Communications Commission, and what kinds of electronic equipment each type allows you to operate and maintain.

You will learn which subjects must be mastered for each kind of license. Thirty typical exam questions will give you an idea of the level of training required. You'll be told where and how often the exams are held, and how to find out about the exams held nearest your home.

Frankly, the FCC exams are rough if you're unprepared. Two

"I GIVE CLEVELAND INSTITUTE CREDIT FOR MY 1ST CLASS COMMERCIAL FCC LICENSE,"



says Matt Stuczynski, senior transmitter operator, Station WBOE. "Even though I had only six weeks of high school algebra, CIE's AUTO-PROGRAMMED® lessons make electronics theory and fundamentals easy. After completing my CIE course, I took and passed the 1st Class FCC Exam. I now have a good job in studio operation, transmitting, proof of performance, equipment servicing. Believe me, CIE lives up to its promises. I really enjoy my work and I'm on my way up!"

out of three applicants fail to pass. Some fail seven or eight times.

But with the right preparation, it's easier than you would imagine. Better than 9 out of 10 CIE-trained men pass the exam with no difficulty. Our record is so good that we are able to promise every student in writing: *after completing your CIE course, you'll be able to pass your FCC exam, or CIE will refund your tuition in full.*

We'll send you a free copy of our school catalog in addition to your free FCC booklet. Then you can see for yourself how thorough our home study courses and teaching methods are. No obligation, of course.

To receive both books free, just mail coupon below. If coupon is missing, write to Cleveland Institute of Electronics, 1776 East 17th Street, Dept. BE-51 Cleveland, Ohio 44114. Do it right now—if you want a solid career in broadcasting, this could be the turning point in your life.

ENROLL UNDER NEW G.I. BILL

All CIE courses are available under the new G.I. Bill. If you served on active duty since January 31, 1955, or are in service now, check box in coupon for G.I. Bill information.

MAIL COUPON FOR FREE BOOKS

CIE Cleveland Institute of Electronics
1776 East 17th Street, Cleveland, Ohio 44114

Please send me, without cost or obligation, your 24-page booklet, "How to Get a Commercial FCC License," together with your school catalog of license-preparation courses.

NAME _____ AGE _____
(Please Print)

ADDRESS _____

CITY _____ STATE _____ ZIP _____

ADVANCED COURSE FOR LICENSE HOLDERS. Check box if you already have an FCC License and desire information about our Advanced Communications Engineering Course which has helped many broadcast engineers reach the top of their profession.

Check here for G.I. Bill information.

Accredited Member National Home Study Council
A Leader in Electronics Training...Since 1934

BE-51

A VIT signal for **COLOR**

By Leo Lazarus
Publications Supervisor, Telemet Company.

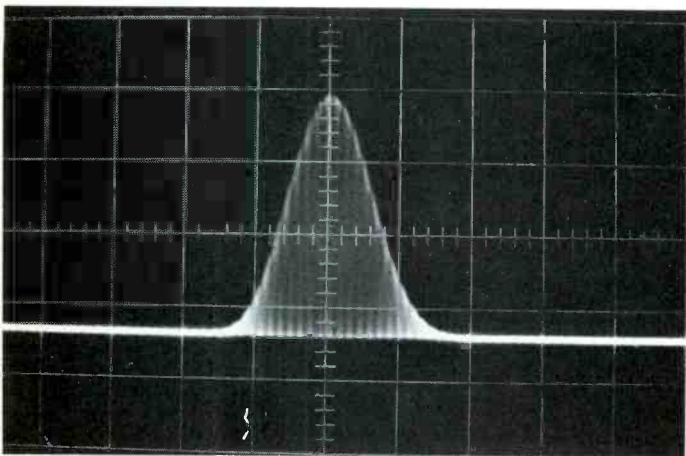

Fig. 1 Modulated 20T pulse showing no delay.

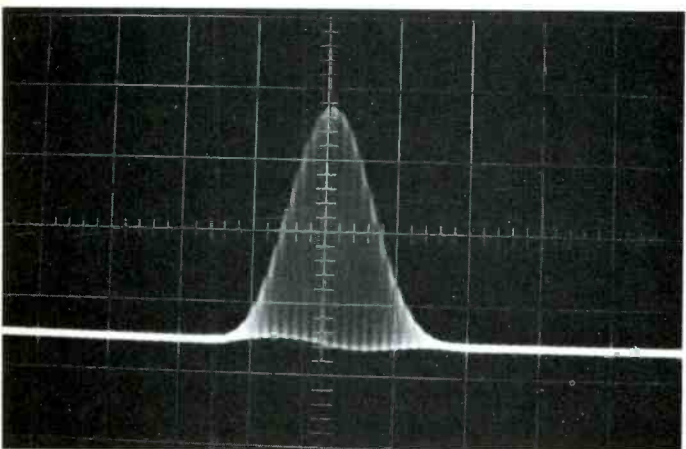

Fig. 2 Modulated 20T pulse showing 100 nanoseconds (3.58 MHz) delay.

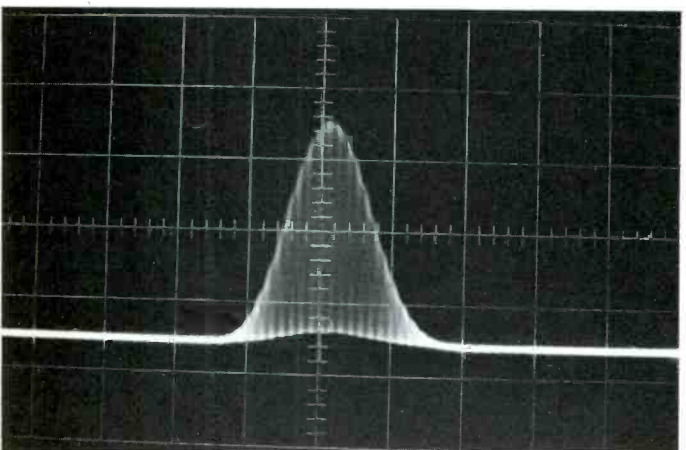

Fig. 3 Modulated 20T pulse showing 10 chrominance (3.58 MHz) attenuation.

Use of the 20T pulse method (3.58 MHz modulated with a sine squared 20T pulse) for exposing and measuring chrominance-luminance delay inequality was described in the March, 1967 issue of **Broadcast Engineering**. Test generators which provide this waveform now are equipped for vertical-interval testing. Economical test-signal receivers, which respond to the 20T pulse waveform, and give fast and accurate measurements of chrominance-luminance delay inequality, are also becoming available. These receivers can be positioned anywhere in the network path to provide dynamic monitoring and in-service trouble location for corrective measures.

The modulated 20T pulse has frequency characteristics which are representative of color signals. The 20T pulse envelope is representative of luminance information: the 3.58-MHz carrier is representative of the chrominance information. A change in the relationship of the signals, whether in time or amplitude, shows up in recognizable distortions.

Since it is a limited-bandwidth signal with high energy in the chrominance and luminance spectra, but with negligible energy outside the video band, transmission equipment that would distort the modulated 20T pulse would distort a color television signal. Besides providing visual indication of chrominance or luminance delay with respect to each other, the modulated 20T pulse indicates gain inequality of the two channels.

Fig. 1 shows the modulated 20T pulse with no delay inequality. Fig. 2 shows the same pulse exhibiting chrominance delay with respect to luminance. The sine wave distortion of the lower envelope at blanking level is characteristic of the sine squared test signal.

The test receiver separates the chrominance signal (3.58 MHz) and the luminance signal (20T pulse) into two discrete channels. Known delay is introduced into the luminance channel or vice-versa and the signal are recombined. The output signal from the receiver shows the addition of the delay by the change in the lower envelope. When the lower envelope assumes a straight line at blanking level, the delays are equalized. The amount of delay introduced is read out from a calibrated dial as the delay of the equipment under test. Accuracy to within ± 10 nanosec can be achieved with this method.

Attenuation of the chrominance signal, with respect to the luminance portion, also shows up in the tell tale lower envelope. It appears as a symmetrical hump rising above blanking level as shown in Fig. 3. On the other hand, higher comparative gain of the chrominance signal shows up in reverse; the hump peaks below blanking level. Known amounts of calibrated gain or attenuation inserted in the 3.58-MHz channel are used to measure the attenuation or gain. ▲

Uniquely designed
to seal out weather,
prevent conductor pull-out,
and to maintain integrity
of outer conductor.

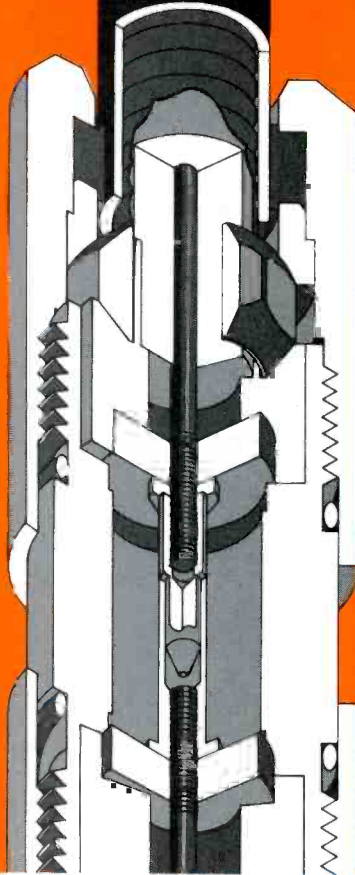

Get a real grip on coaxial connections.

Specify new Superior Continental connectors for Alumagard and Coppergard Coaxials.

Superior Continental offers a complete line of rugged, easy-to-use connectors for Alumagard and Coppergard Coaxials.

With Superior quality-built features

throughout. Like silverplated contacts. Teflon* insert. Iridited body and anodized grip nut.

And, of course, a tenacious grip that withstands a brutal 30 psi pressure test, yet never disfigures the cable.

Provide your coaxials with superior connections. With Superior connectors.

*DuPont Trademark

For information and prices, write or call:
Superior Sales and Service Division
P. O. Box 2327 Hickory, N.C. 28601 Phone 704/328-2171



**SUPERIOR
CONTINENTAL
CORPORATION**

Circle Item 28 on Tech Data Card



Tape-Athon takes station automation out of the luxury class

Two ways. First, by providing a totally automatic system at a reasonable price, actually less than half the cost of most others available, and secondly, by designing the system in a building-block configuration allowing expansion as budgets and requirements increase.

It now becomes possible for virtually any AM and/or FM station to automate for as little as \$5000. In fact, that's the model no. of Tape-Athon's system — the 5000.

A basic Model 5000, consisting of two music tape transports, a 24-cartridge Carousel for commercials, I.D.s and other announcements, the Programming Board, and timing equipment, provides all that's needed for many situations. Beyond that, the user can add more music or announcement capacity, a recorder, logger, or whatever refinements the station requires, still at a low investment.

THE COMPLETE STORY IS AVAILABLE IN BROCHURE 371. SEND FOR A COPY; IT ELIMINATES CLASS DISTINCTION.

Tape-Athon 523 S. Hindry, Inglewood, Calif. 90307 • 213-678-5445

Circle Item 29 on Tech Data Card

TAPECASTER



Model 700-RP

Solid state combination
record-playback unit

Broadcaster net price \$450.

For information write
Box 662 • Rockville, Maryland 20851
or call 301-942-6666

TAPECASTER



Circle Item 30 on Tech Data Card



**INSTANT
REVERBERATION**
only with **FAIRCHILD
REVERBERTRONS**

Reproduce the thrilling sounds of the Grand Canyon or the colorful reverberation qualities inherent only in good acoustical chambers. And because reverberated sound is apparently louder than the same non-reverberated signal, by utilizing the FAIRCHILD REVERBERTRON in motion picture, radio, television, or your own recording studio, you can create attention holding and realistic sound effects.

In addition to low cost the advantages of a FAIRCHILD REVERBERTRON are virtually unlimited for creating wide audience impact and literally hundreds of "ear appealing" sounds.

The next time you want to "glue" your audience's ears to the sound you're making be sure to use a FAIRCHILD REVERBERTRON.

SPECIFICATIONS OF MODEL 658B (Pictured above)

Compact, reverberation system for the "big" sound in a small space. Contains reverb equalization in mid and low frequency range; level control; solid state design. Size: Only 5 1/4" x 3 x 10" deep.

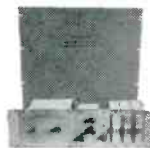

PROFESSIONAL MODEL 658A ALSO AVAILABLE:

The 658A is a complete solid state reverberation system with electronically controlled reverb time adjustments up to 5 seconds; mixing control for adjustment of reverberated to non-reverberated signal ratios; reverb equalization at 2, 3, and 5 KHZ. Size: 24 1/2" x 19".

Write to FAIRCHILD—the pacemaker in professional audio products—for complete details.

FAIRCHILD
RECORDING EQUIPMENT CORPORATION
10-40 45th Ave., Long Island City 1, N. Y.

Circle Item 31 on Tech Data Card

BROADCAST ENGINEERING



1 Delta Model OIB-1 Operating Impedance Bridge measures "in circuit" impedance of networks, transmission lines and antennas while operating at full or reduced power. Accuracy: $\pm 5\% \pm 1$ Ohm. Power Rating: 5kw with VSWR of 3:1.



2 Delta Model CPB-1 Common Point Bridge measures common point resistance to $\pm 2\% \pm 1$ Ohm, and resistance to $\pm 5\% \pm 1$ Ohm operating at full power.



3 Delta Model RG-1 Receiver/Generator, a combination signal generator with high output power, and receiver with excellent shielding and metering for use with Model OIB-1 or any other impedance bridge.

THE DELTA TRIO

for optimum
monitoring
of your
antenna
system

△ With this "Delta Trio", you can either "spot check", or continuously monitor actual "on-the-air" operating impedance of transmission lines, networks and antenna systems accurately to maintain a "clean signal" at peak operating efficiency.

△ If you're operating with a directional antenna, there's real value in being able to keep the radiating system in close adjustment at all times . . . continuously verify common point impedance to insure full power output . . . plus locating and correcting any antenna problems—fast!

△ Complete details and application data are available without obligation—just write or call Robert Foley—(703) 751-3133.

DELTA ELECTRONICS



4206 Wheeler Avenue
Alexandria, Virginia 22304 U.S.A.
(703) 751-3133

Exclusive Export Distributor
ROCKE INTERNATIONAL CORPORATION
13 East 40th St., New York, N.Y. 10016 U.S.A.
Cable: "ARLAB"

Circle Item 32 on Tech Data Card

NEW PRODUCTS

For further information about any item, circle the associated number on the Tech Data Card.

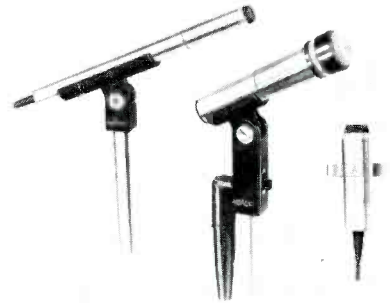

Microphones

(131)

Twelve new microphones have been introduced by **The Astatic Corporation**. Three series, the 810 Ultra-Cardioid, the 820 Omnidirectional Probe, and the 840 Lavalier, are suitable for public address use and for broadcast, recording, and other sound applications. The microphones are said to be "pop" and "blast" proof and have built-in wind filters. They can be used outdoors and indoors.

Each series is available in two types, with or without switches.

Astatic says the Model 810 has good positive anti-feedback characteristics. Its 25 db front to back ratio is the result of Astatic's Sibrophase Acoustic Filter, employing a sintered bronze method of acoustic phase shifting. Its unidirectional cardioid pattern minimizes reverberation problems.

It has a frequency response of 40-15,000 Hz, and impedance can be changed quickly either high or low. It includes an Astatic Easy-On Swivel Adaptor which permits quick and quiet removal of the microphone from floor or desk stands, and remounts as easily.

Model 820 has omnidirectional sensitivity for balanced sound from all directions. Its response of 40-18,000 Hz makes it suitable for choirs, vocal groups, and other music pickups.

Its slim, probe styling makes it good for hand held use. It is also

equipped with an Astatic Easy-on Swivel Adaptor; and like the 810, it can easily be adjusted to either high or low impedance operation.

The Model 840 Lavalier is a low impedance microphone with a response curve engineered to compensate for chest cavity resonance. It can be easily converted for hand use. Response is 50-12,000 Hz when used as a lavalier, and 50-16,000 Hz when set for hand use. It includes a tie-or-lapel clip attachment and a neck cord, and 30 feet of 1/8 inch flexible cable.



Planar Power Transistor

(132)

A new JEDEC registered high voltage fast switching Silicon NPN Planar Power Transistor is offered by Solitron Devices, Inc. The man-

ufacturers claim that this transistor is capable of collector to emitter sustaining voltages of 200V, with 10 amp gain of 5.0 and a beta of 15 to 120 at 5 amps. The gain curve is flat from 10 milliamps to 1 amp.

Saturation voltage collector to emitter is a maximum of 0.6V at 5.0 amps with ft. of 40 MHz. Switching times are in the micro-second range. The devices are said to be capable of dissipating 50 watts at 100 C Case Temperature.

This transistor can be used for deflection circuits, switching regulators, converters and whenever high voltage, high current, and fast switching characteristics are required.

Solid State Digital System

(133)

A new Model 2700 digital system is offered by Simpson Electric Co. It consists of a basic DC voltmeter which may be used in conjunction with nominally priced plug-in adapters to read AC voltage, DC current, DC resistance and other values.



As described by the manufacturer, this system uses integrated circuits and is all solid state with the exception of the numerical glow tubes used for four full time digits. Four DC voltage ranges from 999 full scale to 999.9 full scale are offered as standard. Plug-in adapters are available for other functions or electrical values. Polarity is indicated automatically by a lighted plus or minus sign. Input impedance is 10.2 megohms for all voltages in all ranges. Resolution is 100 microvolts in the 9999V DC range.

Convenience features include a push-button calibration check and an overrange indicator light on the front panel. Plug-in adapters are in-

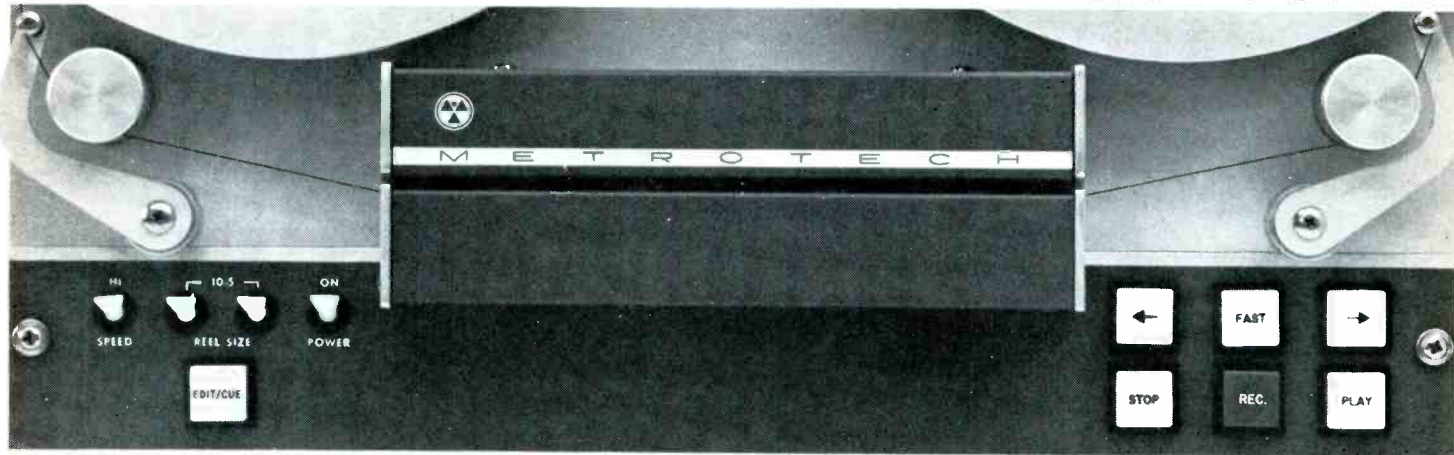

**Here is the new Metrotech 500A series.
It has all the features you expect
of an expensive professional recorder. Except price.**

(Same goes for our slow-speed logger, too.)



METROTECH INCORPORATED / 670 National Avenue / Mountain View, California 94040

12 years of trouble free performance in this Styroflex[®] coaxial cable installation

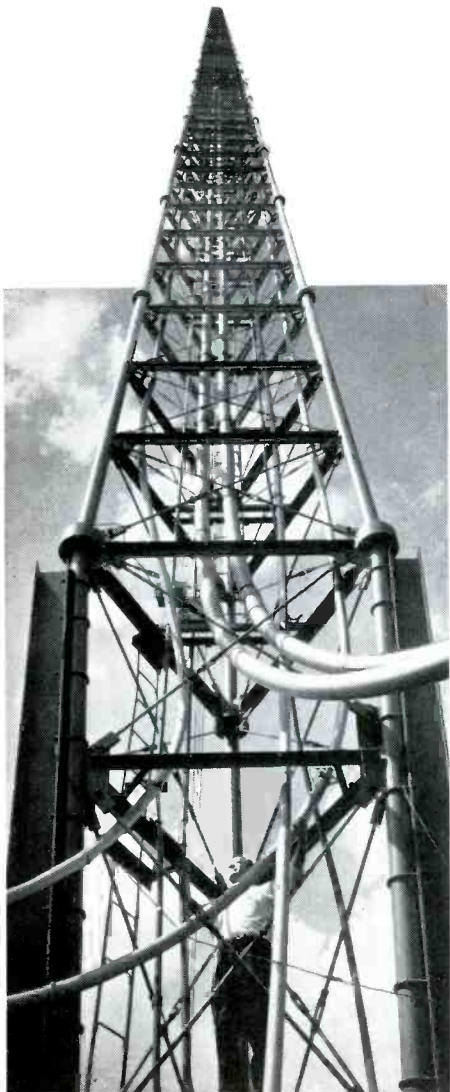

Since 1956 six Styroflex[®] coaxial cable runs have fed the 812-foot tower for WIIC-TV and WWSW-FM in Pittsburgh. A 6 1/8" cable serves as the main transmission line terminating in the main antenna carrying the combined aural and visual power from a 50 KW TV transmitter to the antenna on top of the tower. A second 6 1/8" line is used as a spare. A pair of 3 1/8" coaxial cables connect the 11 KW auxiliary transmitter to separate auxiliary antennas. Another 3 1/8" Styroflex[®] coaxial cable is used as the primary feed for the FM station, with a 1 5/8" cable acting as a standby line.

Styroflex[®] cable has an outstanding record in broadcast applications. Reliability and high power capabilities with uniform, low loss characteristics combine for superior performance. Availability in 1000 foot lengths eliminate the need for numerous connectors that can cause gas leakage problems with rigid line.

Other Phelps Dodge Electronics products produced to exacting specifications for the broadcast industry include: air dielectric and foam dielectric semi-flexible coaxial cable; coaxial cable connectors and accessories; rigid line and accessories; installation hardware.

Why not write for free catalog today: Phelps Dodge Electronic Products Corporation, 60 Dodge Avenue, North Haven, Connecticut 06473.



PHELPS DODGE ELECTRONIC PRODUCTS CORPORATION

Circle Item 34 on Tech Data Card

stalled from the top after loosening a single aircraft-type fastener. The system is priced at \$615.00.



**Viewfinder Television
Camera**
(134)

A new, low-cost viewfinder television camera has been announced by **Packard Bell**, Newbury Park, California, a subsidiary of Teledyne, Inc.

Designed for CATV program origination and for educational and industrial training applications, Model PB-920VF consists of the Packard Bell PB920 camera plus an integrally mounted, solid-state, five-inch monitor. All controls are located at the rear for operating convenience.

The monitor is also offered separately so that present owners of PB-820 and PB-940 cameras can economically convert them to viewfinders.

Two models are available: one for the PB-920 (as shown) and one for the PB-940. Both are offered with zoom lens controls as PB-920VFZ.



DC Voltage Standard
(135)

Cohu Electronics introduced its 0.001% accurate active DC voltage standard at the August WESCON show in Los Angeles.

The Model 355, has 10 parts per million accuracy guaranteed for 30 days by the manufacturer at stan-

**JAZZ • POP • LATIN
AMERICAN • ROCK
CHAMBER MUSIC •
TOP 40 • COUNTRY
CLASSICAL • FOLK**

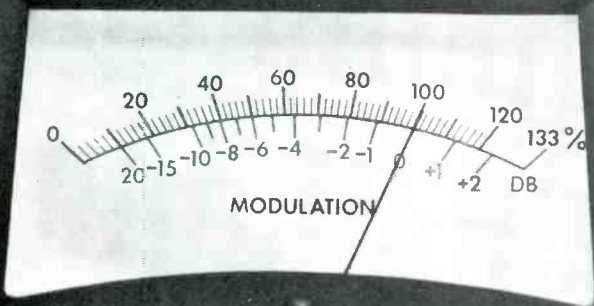

ONLY BELAR ACCURATELY MONITORS YOUR PROGRAM PEAKS

You can believe your meter—no matter what your program matter is—with Belar's state-of-the-art metering. It gives you a true peak modulation meter which responds accurately even to short duration program peaks. The built-in modulation calibrator combined with the true peak reading meter assures accurate modulation monitoring.



The solid-state Belar add-on monitor system starts with the FMM-1 for monaural. Add FMS-1 for stereo and the SCM-1 for SCA. These add-ons complete all your monitoring needs.



**BELAR ELECTRONICS
LABORATORY, INC.**

DELAWARE AND MONTROSE AVES.,
UPPER DARBY, PA. 19084 • BOX 83

Circle Item 35 on Tech Data Card

NOTICE TO READERS:

Be sure to take advantage of the Tech Data Card. Numbers correspond to ads, new products, and Tech Data. Also fill in the information on the right hand corner concerning occupation and type of articles preferred. Notice the data card deadline.

dard reference conditions. Three decade ranges supply voltages from zero to more than 1100 volts with seven-place precision.

Output current to 50 milliamperes is available at any voltage setting. Isolation, guard shielding and insulation permit full output voltage with either positive or negative terminal grounded, or two Model 355's in series to obtain more than 2000 volts with the 10 ppm accuracy.

Features include all solid state active circuitry, plug-in circuit card construction; high visibility in-line readout with illuminated decimal point; overcurrent and overvoltage protection and "self-checking" of linearity.

Closed-Circuit Television Camera

(136)

A new closed-circuit studio television camera designed for local or remote control in multi-camera operations has been placed on the market by **Ampex Corporation**.

Rein Narma, Ampex vice president-general manager, consumer and educational products division, said the new Model CC-327 cam-

clean magnetic tape heads -- completely



**send for free
samples and
literature.**

Write, or use the reader service number under this advertisement



THE TEXWIPE COMPANY

HILLSDALE, NEW JERSEY 07642

Circle Item 36 on Tech Data Card



era's design anticipates centralized control of one or more cameras.

It can be employed for single or multi-camera use in education, industry, business, military and medical closed circuit television applications.

An optional remote control unit operates system power, beam current, target voltage, pedestal and video gain. It is available on a single rack panel as a one or two-camera remote control. The unit comes ready for mounting in a standard 19-inch relay rack. A switch on the back of the camera is used to select local or remote control.

It also features a two-way communications system for dialogue between cameraman and the remote unit operator. Two headset receptacles on the camera and on the remote control accept standard telephone operator headsets.

Other features include a 9-inch electronic viewfinder; single cable operation; four-position, rear-actuated "C" mount lens turret; rear operated image tube focusing; top and rear tally lights; composite or non-composite output with internally generated industrial sync; and EIA RS-170 type output, composite and non-composite simultaneously when driven by an external EIA generator.



Cablecasting Origination Systems
(137)

NO BRAG - JUST FACT

WATCH FOR FACTS ABOUT THE STEREO MATES

FROM

MOSELEY ASSOCIATES INC.
111 Castilian Drive, Goleta, Calif. 93017

SEE NEXT MONTH'S B.E.

Circle Item 37 on Tech Data Card

The Spotlight Is on

Spotmaster

Superior Tape Cartridge Recording and Playback Equipment

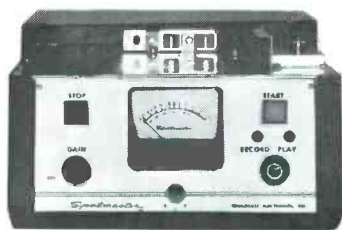

Model 500 C



Model 400 A

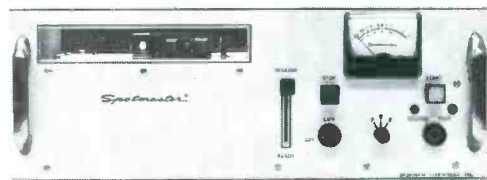

Model 500 CR

COMPACT 500 C SERIES—Completely solid state, handsome 500 C equipment features functional styling and ease of operation, modular design, choice of 1, 2, or 3 automatic electronic cueing tones, automatic record pre-set, separate record and play heads, A-B monitoring, biased cue recording, triple zener controlled power supply, transformer output . . . adding up to pushbutton broadcasting at its finest. Specs and performance equal or exceed NAB standards. Record-play and playback-only models are available.

RACK-MOUNTED 500 C MODELS—The 500 CR rack models offer the same Model C design and performance features and are equipped with chassis slides ready to mount in your rack. Each unit slides out for easy head and capstan cleaning and other routine maintenance.

All 500 C models carry iron-clad full-year guarantees.

ECONOMICAL 400 A SERIES—Now even the smallest stations can enjoy Spotmaster dependability with the low-cost, all solid state 400 A series, available in compact record-play and playback-only models. Performance and specifications are second only to the 500 C series.

For complete details about these and other Spotmaster cartridge units (stereo, delayed-programming and multiple-cartridge models, too), write, wire or call today. Remember, Broadcast Electronics is the No. 1 designer/producer of broadcast quality cartridge tape equipment . . . worldwide!

BROADCAST ELECTRONICS, INC.

8810 Brookville Road, Silver Spring, Maryland 20910; Area Code 301, 588-4983



new miniature electronic pliers

HOLD, BEND, CUT
ALL FINE WIRES
WITH EASE

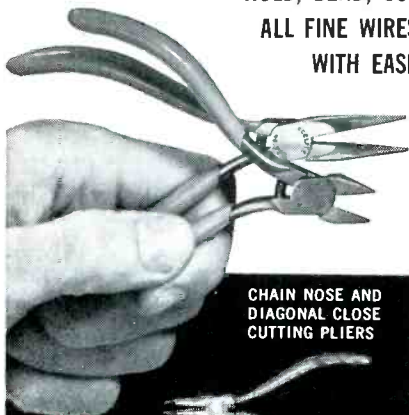

CHAIN NOSE AND
DIAGONAL CLOSE
CUTTING PLIERS

SPECIAL TIP
CUTTING PLIERS

RADIO AND TV PLIERS

Ideal for electronic, radio/TV, electrical service and assembly. Forged alloy steel construction. Precision machined. All have polished heads and shoulders. Comfortable "Cushion Grip" handles and coil spring openers speed work, reduce hand fatigue. Miniature round and flat nose pliers also available.

a complete line of regular pliers and snips, too

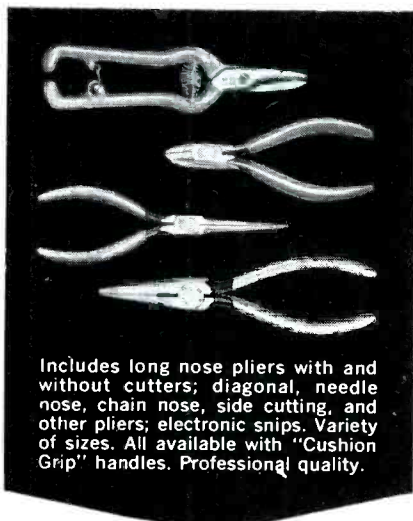

Includes long nose pliers with and without cutters; diagonal, needle nose, chain nose, side cutting, and other pliers; electronic snips. Variety of sizes. All available with "Cushion Grip" handles. Professional quality.

XCELITE

XCELITE, INC., 82 Bank St., Orchard Park, N.Y. 14127
In Canada contact Charles W. Pointon, Ltd.
Circle Item 38 on Tech Data Card

Automatic cablecasting origination systems for multiple information channels for CATV, have been developed by **Visual Electronics**. The manufacturer says that the systems can provide several channels of local origination that may be simply operated without the requirement for vidicon cameras, artwork, etc. They may be operated unattached via a wire service or locally with a typist-operator.

The systems are designed to be compatible with broadcast and cable television as well as data processing and data communication systems.

Alphanumeric "pages" of information are displayed with letters and numbers. Emphasis can be placed on certain words and figures. Messages can "crawl" and "roll". Key words or phrases can "blink" for emphasis. Channels of "page" information alone may be used or the information superimposed on locally originated television pictures to store and display titles, ads, announcements and other electronically generated character information.



Color Television Camera

(138)

A broadcast version of the IVC-100 color television camera has been placed on the market by **International Video Corporation**. The new version of the IVC-100 is designed for applications in commercial, educational and community antenna broadcasting.

External features include gain, iris, zoom and focus controls as well as intercom jack and tally light. The IVC-100 has a maximum of 28 internal set-up adjustments.

SPOTMASTER Tape Cartridge Winder



The new Model TP-1A is a rugged, dependable and field tested unit. It is easy to operate and fills a need in every station using cartridge equipment. Will handle all reel sizes. High speed winding at 22 1/2" per second. Worn tape in old cartridges is easy to replace. New or old cartridges may be wound to any length. Tape Timer with minute and second calibration optional and extra. Installed on winder or available as accessory. TP-1A is \$94.50, with Tape Timer \$119.50.

Write or wire for complete details.

Spotmaster

BROADCAST ELECTRONICS, INC.

8800 Brookville Road
Silver Spring, Maryland

SUPERIOR!



WILKINSON 4N1 Portable Solid-State

1. FIELD INTENSITY METER
2. NULL DETECTOR
3. STANDARD SIGNAL GENERATOR
4. AM MONITOR RECEIVER

SUPERIOR BECAUSE THE 4N1:

Measures field intensity with superior accuracy and reduces measurement time. • Requires only a bridge for easy RF impedance measurements. • Powered by rechargeable batteries and self-lighted for nighttime measurements. • Easier to carry and operate.

FOR COMPLETE DETAILS WRITE:

WILKINSON ELECTRONICS, INC.

1937 MacDADE BLVD. • WOODLYN, PA. 19094
• TELEPHONE (215) 874-5236 874-5237 •

Circle Item 39 on Tech Data Card

BROADCAST ENGINEERING

the new

JAMPRO

uhf

ZIG ZAG

offers greater flexibility and lower cost!



The ZIG ZAG Television Antenna offers more pattern & gain per dollar than any other uhf antenna.

High power gains are available with many computerized vertical patterns. Omnidirectional and cardioid patterns are available which will provide power gains from 8 to 56 and directional gains as high as 215! Power capabilities of 60 or 120 KW.

Fiberglass radomes are available.

Write for complete catalog and prices.

JAMPRO

ANTENNA COMPANY

6939 POWER INN ROAD SACRAMENTO, CALIFORNIA

A DIVISION OF COMPUTER EQUIPMENT CORPORATION

Circle Item 40 on Tech Data Card

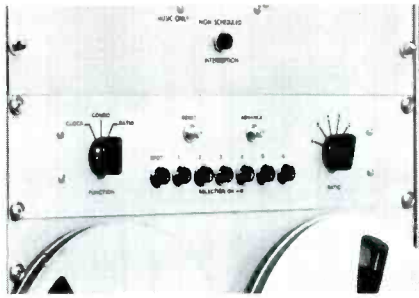

Music Announcement Ratio Control

(139)

A music-announcement ratio control is available from **Tape-Athon Corp.**, as an optional accessory to their Model 5000 Automatic Broadcasting System.

Designated as a "Ratio Switcher", the new unit may be set to play a certain number of musical selections prior to a spot announcement where such a format is desirable. A six-position switch on the system's control panel permits setting of the ratio from 1:1 to 6:1 to greatly simplify programming.

Other panel controls on the unit include a Function Selector, a Reset Control, and an Advance Con-

trol. The Function Selector has a setting for the system "Clock" that essentially places operation on a timed basis and eliminates the ratio function altogether. A second setting, "Combo", combines the clock and the ratio control to permit station I.D. every 30 minutes at which time the clock overrides the ratio control itself.

Microphone FET Follower

(140)

B & K Instruments, Inc., announces the FET follower for 1/4 and 1/8 inch condenser microphones. According to the manufacturer, 20 dB gain can be added to the 2618 and still keep a useful signal-to-noise ratio, making the 1/4 and 1/8 inch microphones more useful.

The manufacturer says that the FET will be useful to the aerospace industry and others working in ultrasonics and high frequency acoustics.

Any of the B & K measuring amplifiers or analyzers will power the 2618, or it can be driven with a 28 volt battery supply.

This is the most expensive turntable you can buy.



Also the cheapest.

It's a simple matter of economics. And quality.

At \$1350, the EMT-930st Turntable costs considerably more than any other turntable. But, for your money, you get a precision-made turntable that really slashes maintenance costs because it's virtually trouble-free. ("Still in excellent condition despite ten years of hard use," says one pleased radio station.*)

Typically, you get ± 0.035% rms flutter; low, low rumble; and you can cue to any beat or syllable with a wow-free start from the world's only remote-controlled turntable.

A lot of broadcasters must think the EMT-930st is a smart investment. Right now, there are more than 10,000 in use throughout the world. We know of only one greater value: our brochure. It's free. Send for it today.

*Name of this and other station users on request.

GOTHAM
AUDIO CORPORATION
2 WEST 46 STREET, NEW YORK, N. Y. 10036 • 212-CO-5-4111

Circle Item 41 on Tech Data Card

COLOR THE NEWS



ON THE
AIR IN
30
MINUTES

SMALLEST! LOWEST PRICED! EKTACHROME PROCESSOR

Add the impact of vivid color to local news coverage. Shoot in economical Super-8mm or 16mm Ektachrome. Develop 20 feet per minute in the fully-automatic Houston E-16-8-30 processor. All processing cycles are precisely timed and temperatures rigidly controlled to assure perfect results. Simple, goof-proof operation. Solutions never touch hands. Standard Kodak chemicals. About 8 ft. long. Fits anywhere. Use in lighted room. Finest Houston quality. Priced far lower than any comparable machine. Send for brochure.

HOUSTON

PHOTO PRODUCTS, INC.
THE WORLD KNOWS OUR PRODUCT

HOUSTON PHOTO PRODUCTS, INC.

655 E. 20th St.
Yuma, Arizona 85364
Phone: (602) 782-3677

*A Tradition of
Excellence since 1932*

Circle Item 42 on Tech Data Card



RCA broadcast service performing 35 years behind the scenes

Broadcasters' repair, modification, and overhaul needs are strictly behind the scenes. And RCA Service Company experts keep on providing *service* to keep all your broadcast equipment operating at peak performance. Take advantage of RCA's experience in AM, FM & TV servicing — on a contract or per-call basis. Dial either of these offices for full information about fast, dependable RCA service:
Chicago (312) WE 9-6117
Philadelphia (215) HO 7-3300
If you prefer, write: RCA Service Co.,
A Division of RCA
Technical Products Service,
Bldg. CHIC-225, Camden, N. J. 08101

RCA

BROADCAST ENGINEERING

ENGINEERS' EXCHANGE

Emergency Filter

Occasionally some stations have a remote broadcast being carried over a phone line where one side of the line becomes grounded, or for other reasons a loud "HUM" appears on the line. Often station personnel cannot correct this trouble and need to call a repair man. Usually by the time the line can be repaired, the program is practically over.

There is one thing which may save or improve the program. Take a solder gun such as the "WELLER" which uses a step down transformer and connect it across the line, tape the trigger down to keep the gun on, and adjust the gain to make up for the loss. The solder gun acts as a low frequency drain to by-pass the hum but has very little effect on audio frequencies, especially voice frequencies.

At WGAW we have had a remote broadcast line which had enough low frequency hum to modulate the transmitter 80 to 85%, with the audio program barely readable. Connecting the solder gun across the line reduced the hum level down to 10% and rescued an otherwise ruined broadcast.

An easy way to hook the "gun" across the line is to back out the screws at the rear of the patch plug and connect to the "gun" plug by means of a pair of clip leads.

Gordon V.N. Wiley,
Chief Engineer WGAW
Gardner, Mass.

Intensity Measurements

A common problem in taking AM field intensity measurements involves describing the measuring location accurately. Many consultants expect the field man to be able to place his feet in the same spot when additional measurements are needed. If the engineer remeasuring the point is not the same one who took the original measurements, the need for an accurate description is even greater.

Except when aerial photographs

or survey techniques are needed, a measuring location is generally pinned down by pacing from an easily located reference point. In a built-up area, there are many suitable landmarks: houses, street signs, fire hydrants, and numbered utility poles.

In rural areas and on open roads, reference points are not numerous. The standard automobile odometer can serve only to locate a point ap-

proximately with relation to some landmark. Fence posts and trees are not unique enough to identify particular ones. Surveyors and road engineers frequently face a similar problem. Their solution—flagging, a brightly colored plastic ribbon which when tied to any convenient object will make it a highly visible reference point. Flagging comes in several bright colors on roles one hundred yards long.

NEW . . . Type 19 Precision Antenna Monitoring System

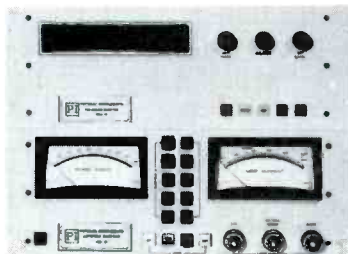

- ± 0.1 Degree Resolution
- Up to 12 Towers
- For DA-1, DA-2 or DA-3
- Mercury-Wetted Relays

For further information, contact:



POTOMAC INSTRUMENTS, inc.

932 Philadelphia Ave. • Silver Spring, Md. 20910
Phone: (301) 589-3125

Circle Item 43 on Tech Data Card

CONTEL IOI - Advanced Broadcast Equipment



CT-101-P

Cartridge Tape
Reproducer

CT-101-R

Cartridge Tape
Recorder/Reproducer



TT-101-AX

High Performance
Turntable System

CONTINENTAL ELECTRONIC WHOLESALE CORPORATION

1620 West 32nd Place / Hialeah, Fla. 33012
305 - 822-1421

Circle Item 44 on Tech Data Card

A piece of yellow flagging tied at head height can be spotted half a mile away. Long loose ends free to flap in the breeze make the tape even easier to spot. Flagging has excellent weather resistance, and it will stay in place and be useful for many years. Possibly, the only difficulty encountered with flagging comes from its popularity with so many groups. When running a proof, watch for flagging other than your own. If this is encountered, switch to a different color. It might even be necessary to use two colors at once to prevent possible confusion.

A few rolls of flagging can be a useful addition to the tool box of any engineer who takes field intensity measurements.

Eric Small
Washington, D.C.

Eliminating Blurp

On many control room consoles, if the monitor gain is tuned up high, a feedback "blurp" may be heard when the microphone key is closed. This is caused by the fact that the muting relay, which is energized by

the same key, closes a split second after the microphone contact leaves that controls the muting relay until it is almost closed. A relay contact bending tool or small soldering aid may be used. Once this is done, it will be impossible to make the microphone channel feedback, since the muting relay contacts will always close before the contacts for the microphone.

Barry Atwood
WBKY-FM
Lexington, Ky.

Improved Tuning for Heathkit Distortion Meter

Increasingly, small stations run their own audio proofs of performance using low-cost kit instruments. (See "Small-Budget Audio-Proof Package," *Broadcast Engineering*, June 1966). However, the Heathkit IM-12 Harmonic Distortion Meter has difficulty measuring distortion below 0.5% because of excessive backlash in the dial cord drive.

Since modern solid state equipment can measure well below 0.5% distortion, the instrument is improved by removing the original dial

and mounting a planetary drive to the tuning capacitor shaft. A two-inch size planetary drive covers the original frequency markings but fits neatly below the word "Frequency" on the front panel. To avoid hand capacity effects, ground the new drive firmly to the panel or use a 1/4-inch plastic extension shaft rather than the tuning capacitor's metal extension shaft.

This modification lowers the tuning ratio, but the freedom from backlash makes tuning easier down around 0.2% harmonic distortion.

Ronald Pesho, Chief Engineer,
KOFA (FM), Honolulu, Hawaii

FM transmitters can be neutralized quickly by removing plate and screen voltage from the finals and adjusting the neutralizing condensers for minimum radiated energy. Have a friend tune in the signal and hold the telephone receiver to the ear while adjusting for minimum tone. It should disappear if the receiver is located at least a mile from the antenna.

Albert Stratmoen, WPBZ
Lock Haven, Pa.

TAPECASTER

T C M

Unsurpassed in Quality...
Unparalleled in Performance



Model 700-P
solid state playback unit

SPECIFICATIONS

Equalization: NAB Standard

Frequency Response:

- ± 2db 50-12,000 cps @ 7.5 IPS
- ± 3db 40-15,000 cps @ 7.5 IPS

Distortion: 2% or less

Signal to Noise Ratio: 50 db or better

Wow and Flutter: 0.2% or less @ 7.5 IPS

Cue-Tones: Primary-1,000 cps (stop)
Secondary-150 cps (optional)

Motor: Hysteresis Synchronous

Broadcaster net price \$300.

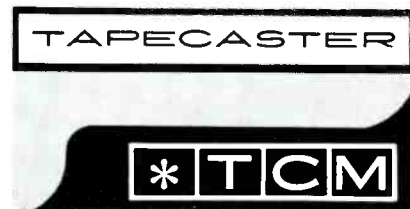

*TAPE CARTRIDGE MACHINE

Box 662 - 12326 Wilkins Avenue, Rockville, Maryland 20851 - Area Code: 301 - 942-6666

Circle Item 30 on Tech Data Card

It's a 33¹/₃ hour day for QRK!

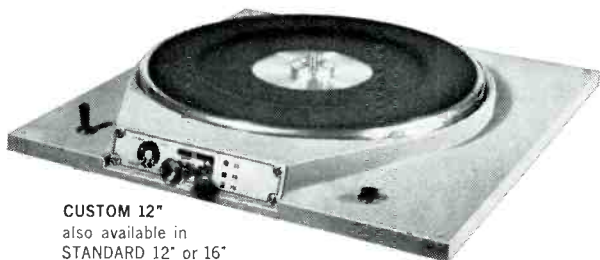

CUSTOM 12"
also available in
STANDARD 12" or 16"

33-1/3, 45, 78 or even 24 hours a day . . . the sun never sets on QRK Professional Turntables. Throughout the world thousands of them are working right now.

WHY? Because QRK's exclusive originality, precision manufacture and quality control have earned its place in the sun in all hemispheres. Since introducing the QRK principle 23 years ago, we've discovered there's something extra special about originality — besides being first with an idea Like a Michelangelo, it's always an original . . . You can't hang a QRK, but positioned on your console you can depend on its performance from now on, and like a Michelangelo . . . perhaps just a little dusting now and then. No matter what time you have, somewhere the sun is shining on a QRK.

Check one out or write your dealer or us for more information.



ELECTRONIC PRODUCTS

2125 N. BARTON, FRESNO, CALIFORNIA 93703

QRK's new direct line - (209) 251-0001



Circle Item 47 on Tech Data Card

give...so more will live
HEART FUND

**cut holes
fast!**

Round—Inches and mm

"Key"

Square

"D"

Double "D"



with Greenlee punches

Here's the simple speedy way to cut smooth, accurate holes in metal, hard rubber, plastics, epoxy, etc.

Save hours of hard work . . . punch clean, true holes in seconds for sockets, controls, meters, and other components. Easy to operate. Simply insert punch in a small drilled hole and turn with a wrench. For use in up to 16-gauge metal. Available at leading radio and electronic parts dealers.



GREENLEE TOOL CO

DIVISION OF GREENLEE BROS. & CO.

1866 Columbia Avenue, Rockford, Ill. 61101

Circle Item 48 on Tech Data Card

**When you're ready
to buy your next
professional
recorder...**



Look for:

LOW NOISE Pure sound reproduction is the minimum requirement for a professional recorder. Listen carefully for hum and other machine-produced noises—marks of an "amateur" machine. Incidentally, the noise level of all Crown recorders is lower than that of most other professional recorders. (Guaranteed minimum S/N of 60db at 7½ ips.)

WIDE BAND-WIDTH Any professional recorder will cover all the audible sound spectrum. Now try to find one with the band-width safety margin of a Crown. (Guaranteed minimum of ±2db, 30-25 kHz at 7½ ips and 30-15 kHz at 3¾ ips.) In side-by-side comparison, you'll discover that reproduction on a Crown at 3¾ ips is comparable to that of other professional recorders at 7½ ips, giving you savings of 50% on tape in many recording applications!

MINIMUM DISTORTION Wow, flutter and other signal distortions should be imperceptible at 7½ ips for professional quality tapes. Crown guarantees a minimum of 0.09% wow and flutter at 7½ ips.

FLEXIBILITY Look for a recorder with a full range of professional refinements. More than with any other professional recorder, you can "do anything" with a Crown—record sound-on-sound, create special equalization and echo effects, A-B monitor while recording, mix four microphones and much more.

INVESTMENT Professional electronic equipment is a good secure investment, with a slow rate of depreciation. A Crown is insured against obsolescence with a design acclaimed by professionals "years ahead of the industry." With only ten moving parts, normal care and routine service will assure like-new performance for ten years. In 1978, you'll be glad you purchased the very best—a Crown.

Write to **Crown International**
Box 1000, Dept.
Elkhart, Indiana 46514

MADE ONLY IN AMERICA

Circle Item 45 on Tech Data Card

**TECHNICAL
DATA**

70. **ALTEC LANSING**—"Instructions in the Use of Microphones for Sound Reinforcement" is the title of a new technical publication.
71. **AMPEX CORP.**—Bulletin V67-11 answers many questions about non-commercial videotape recording. Besides exploring many considerations of cost, interchangeability, and reliability, the brochure provides a glossary of videotape recording terms.
72. **ANACONDA ELECTRONICS**—A brochure entitled "CATV Products, Specifications & Prices" is available.
73. **ATLAS SOUND**—Form PP-1840 describes microphone stands, microphone booms, and studio accessories.
74. **B & K**—The "Short Catalog" lists and pictures all major elements of the B & K line of electronic measuring instruments.
75. **BELL**—Specification sheets on the new P/A MOD and TPA series, solid-state amplifiers are available.
76. **BENDIX**—A data sheet describes the new 2 watt Audio Amplifier featuring thick film fabrication. Maximum ratings and electrical characteristics in easy to read chart form are provided in the data sheet.
77. **BIRD ELECTRONICS**—Bulletin TLR 1-50kw-7 describes 50-ohm & 51.5 ohm coaxial terminations from 1000 watts to 50 kilowatts. Bulletin TLR8720-8 shows the new miniature 5000 watt Termiline Load.
78. **BLONDER-TONGUE LABORATORIES, INC.**—A brochure gives details for specifying and designing master antenna television systems in schools, hotels, hospitals and large apartment houses.

**MICRO-TRAK
MICRO-TRAK
MICRO-TRAK
MICRO-TRAK**

The Ultimate Stereo Tone Arm

Gray's new series of truly professional stereo instruments incorporate the most advanced "Broadcast Engineered" features available.

It's time to replace those old arms which continually give trouble in stereo conversions. What other arm offers these features: Fluid Anti Skate, Memory Balance, Micro Traking Pressures, Freedom from adjustment, ultimate reliability and the lowest possible operating cost per hour. . . .

A quick consultation with your Gray experts will give you all the answers, and explain how you can make the change to "Micro Trak" . . . the ultimate.

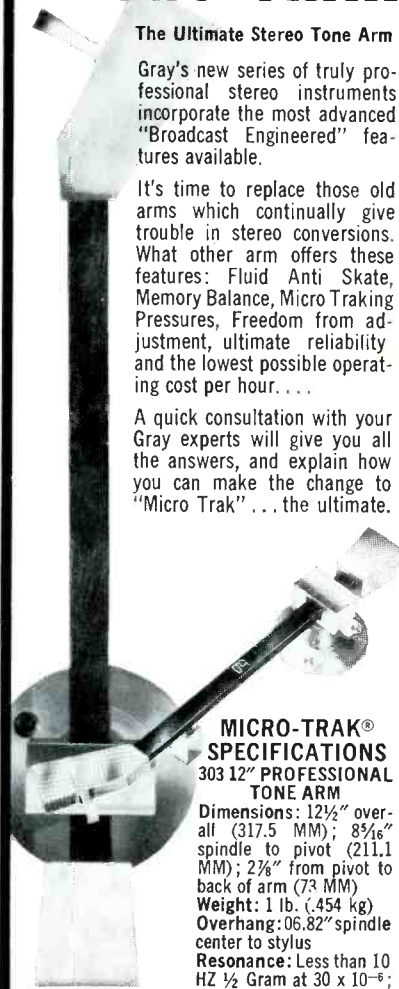

**MICRO-TRAK®
SPECIFICATIONS
303 12" PROFESSIONAL
TONE ARM**

Dimensions: 12½" overall (317.5 MM); 8¾" spindle to pivot (211.1 MM); 2¾" from pivot to back of arm (73 MM)
Weight: 1 lb. (.454 kg)
Overhang: .0682" spindle center to stylus
Resonance: Less than 10 HZ ½ Gram at 30 x 10⁻⁶; CM/DYNE Compliance

Tracking Error: 3.0 in radius 0° 0'; 3.75 in radius 1° 28'; 4.75 in radius 0° 0'; 5.5 in radius 2° 0'.

Micro-Trak is also available in a longer version for 16" turntables, for EMT turntables, and in special lengths for custom table sizes.

**THE GRAY LINE OF FINE
BROADCAST INSTRUMENTS**

- The 206 12-inch Tone Arm
- The 208 16-inch Tone Arm
- The 602-C Broadcast Equalizer
- The Telop—The Telojector
- The 602 I.M.P.

Impedance Matching Preamp

Write for complete product information

GR **GRAY RESEARCH &
DEVELOPMENT CO. DIV.**
155 Park Ave.
East Hartford, Conn. 06108

Circle Item 46 on Tech Data Card

BROADCAST ENGINEERING

NORTRONICS HAS THE REPLACEMENT TAPE HEAD YOU NEED FOR ANY TRACK STYLE OR FUNCTION!



To keep getting optimum performance from your tape recording equipment you must regularly replace worn tape heads. With Nortronics heads, adapters, and brackets, it can be done quickly and easily . . . and you can also *convert* track styles in minutes.

 *Replacements for*
**AMPEX • MAGNECORD
CONCERTONE • RCA •
CROWN**

 *as well as 1500 popular
priced recorders*

 REEL-TO-REEL OR
CARTRIDGE TYPES

 MONO/STEREO

 FULL TRACK
 HALF TRACK
 QUARTER TRACK
 EIGHTH TRACK

RECORD • PLAYBACK • ERASE

 RECORD
RECORD • PLAYBACK
ERASE

NORTRONICS Bulletin 7230A describes the complete line of Nortronics replacement heads, conversion and mounting kits, and accessories. Write for free copy.

 **Nortronics**
COMPANY, INC.

8101 Tenth Avenue North
Minneapolis, Minnesota 55427

Circle Item 49 on Tech Data Card

79. **BUCHANAN ELECTRICAL PRODUCTS**—Catalog G-106 gives engineering data and specification charts on the entire line of Buchanan products.
80. **COLORADO VIDEO**—SMPTE reprint "A New Method of Television Waveform Display" is available.
81. **COHU**—Data sheet 6-381 is concerned with a self-contained TV camera series that may be used for closed-circuit, educational or broadcasting.
82. **COLLINS**—A new console which functions as a studio production console and as a remote pickup amplifier is described in a brochure.
83. **COZZENS/CUDAHY, INC.**—The Darcy 440 Digital Multimeter is described in a brochure.
84. **CONCORD ELECTRONICS CORP.**—A data sheet gives details on a motorized zoom lens for Concord TV cameras.
85. **CROWN**—A specification and price sheet for the SA30-30 solid state power amplifier is offered.
86. **DELTA ELECTRONICS**—Specification sheets and application bulletins give information about the RG-1 receiver/generator OIB-J operating impedance bridge, and CB-1 and -1A common-point impedance bridges.
87. **DYNAIR**—"Video Switching Techniques" deals with the most common methods of switching video and audio information. The problems in selecting the type of switcher for a particular application are discussed.
88. **ELECTRONIC ENGINEERING CO.**—A price list for editing and control equipment for TV tape recorders is available.
89. **FAIRCHILD**—A technical bulletin gives details for Model 610 10 watt monitor amplifier.
90. **GATES**—A brochure gives details on automation equipment supplied by Gates.
91. **GRANGER**—A data sheet is available on new 3 and 5kw FM transmitters with solid-state exciters.

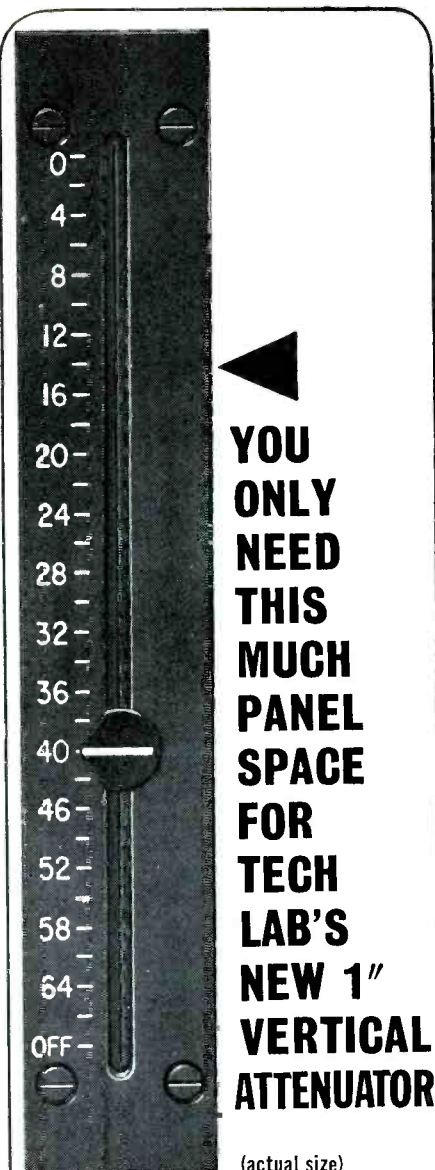

(actual size)

Here's the smallest vertical attenuator made in the U.S.A. . . . another first from Tech Labs, pioneers in vertical attenuators since 1937.

It uses little panel space . . . only 1" wide x 6" long. It provides quick change of levels on multiple mixers and assures long, noise-free life. Units are available in 20 or 30 steps with balanced or unbalanced ladder or "T", or potentiometer circuits. Standard Db per step is 1.5, others on order. Impedance ranges are 30 to 600 ohms on ladders or "T's" and up to 1 megohm on pots.

Don't wait, send for complete data today!
Need Video or Audio Rotary Attenuators?

All Tech rotary attenuators are precision made for extended noise-free service. Many standard designs available and specials made to your specs. Send for literature today.

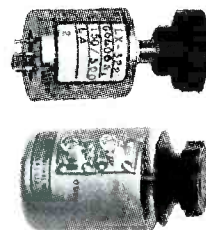

TECH LABORATORIES, INC.

Bergen & Edsall Blvds., Palisades Park, N.J. 07650
Tel: 201-944-2221 • TWX: 510-230-9780

Circle Item 59 on Tech Data Card

DID YOU KNOW—

that for only \$890 you can own a Push-button, Single DC Pair Remote Control System? Now, Rust Corporation offers the RC-1000. This solid state system with plug-in circuit boards is designed for the operation that requires a maximum of 22 control functions (11 ON/RAISE and 11 OFF/LOWER) and a maximum of 10 metering positions plus a calibrate position. Provisions for connecting external meters such as digital readout, modulation, frequency, etc., are included. The built-in pushbutton latching feature readily indicates the selected position. A clear plastic strip directly above permits adjacent labeling of each pushbutton function. By the addition of an external meter at the transmitter site, control achievements and other metering can be observed. This provision results in a one-man calibration system. Electrically the control functions are sent from the studio to the transmitter as frequency shift (FSK) of the carrier. Each metering sample passes through a DC isolator circuit which completely isolates the output from the input and is therefore "floating." RUST AUTOLOG Automatic Transmitter Logging equipment can operate through the RC-1000 and thus utilize the same single DC pair of telephone lines.

Rust
corporation

168 Tremont Street,
Everett, Mass. 02149
(617) 389-3380

Circle Item 51 on Tech Data Card

PROTECT YOUR SOUND REPUTATION



VTR

MANUFACTURED BY TABER

Nationally recognized recorder head manufacturing and reconditioning experts.

- Heads manufactured under controlled laboratory conditions.
- Heads guaranteed to meet, or exceed, equipment manufacturer's specifications.
- Modern precision machine shop, and sophisticated laboratory installations insure highest quality replacement heads.
- Free loaner assemblies available on request.
- Cost — \$310.00 for four (4) new heads installed.

TABER'S sophisticated quality control tests insure total frequency response and uninterrupted sound playback. Maintain the high quality audio that your equipment was engineered to produce.

Call or write: **TABER** MANUFACTURING AND ENGINEERING COMPANY

OAKLAND INTERNATIONAL AIRPORT, BLDG., L-821
P. O. BOX 2365 • OAKLAND, CALIFORNIA 94614
Telephone (415) 635-3832

Circle Item 52 on Tech Data Card

92. **C. H. GURNSEY & Co.**—A brochure listing the services of C. H. Gurnsely & Co's tele-communications department is offered.
93. **HEINEMANN ELECTRIC**—Offbeat circuit design ideas is the subject of a new booklet.
94. **HUGHEY & PHILLIPS, INC.**—Tower Obstruction Lighting Kits and Control Units for Attended Installations are discussed in Bulletin HPS 188.
95. **JAMPARO** — Descriptions, patterns, specifications, and prices are included in an 8-page brochure on circuitry polarized FM antennas.
96. **JOA**—Prices and data are given for new cartridges and cartridge-reconditioning service.
97. **KRUSE-STROKE**—A new brochure contains charts, illustrations, and specifications pertaining to the Model 5000 microwave sweep generator.
98. **KUHN**—A brochure gives details about the 373A equalizer.
99. **L-W PHOTO, INC.**—Models 1900 and 1900M TV film chain projectors are described in literature.
100. **MARANTZ**—"The Sound of Marantz" is a catalogue featuring high fidelity-stereo equipment.
101. **McCURDY RADIO INDUSTRIES**—A brochure on AM, FM, and TV broadcast audio equipment is offered.
102. **MICHIGAN MAGNETICS**—A catalog shows the full line of magnetic tape heads for all audio applications.
103. **MICROWAVE** — Brochures describing Microwave TV lines are offered.
104. **D. B. MILLIKEN**—Model DMB-R1 video film recording system is described in data sheets.
105. **MONSANTO**—A catalog has been released on the electronic instruments developed and manufactured at the Electronics Technical Center.
106. **MOTOROLA**—A home study course in 2-way radio servicing is the subject of a new booklet.

IT'S A FACT . . . YOU PROFIT WE DO THE WORK



Let JOA Cartridge Specialists recondition and rebuild your worn cartridges to give you EXTRA CARTRIDGE LIFE . . . EXTRA ENGINEERING TIME.

—JOA will inspect, service and reload your cartridges with ANY LENGTH tape

NO EXTRA CHARGE FOR—

- (a) FOAM TEFLON FACED PRESSURE PADS
- (b) replacement of minor parts
- (c) VISIBLE SPLICE
- (d) EVERY cartridge COMPLETELY PRETESTED under actual broadcast conditions

NO MINIMUM

48-hour Processing

20 or more cartridges SHIPPED PRE-PAID

Need NEW CARTRIDGES fast? JOA will ship immediately . . . from stock . . . any size Fidelipac, precision manufactured NAB cartridge.

JOA—the cartridge service of authority—serving the broadcast industry. Authorized distributor for NORTRONIC HEADS phone or write



Cartridge Service
P. O. Box 3087
Philadelphia, Pa. 19150
Area Code 215, TUrner 6-7993

Check Item 53 on Tech Data Card

more performance at less cost!

KUSTOM
BROADCAST
CONSOLE

ONLY
\$495⁰⁰



Has all the control flexibility, adaptability, fidelity and dependability of equipment costing much more. All solid state. Six input channels. Full switch and gain control flexibility. Use on remotes or for studios. Write for full-facts catalog sheet.

Sold exclusively through
UNITED RADIO INDUSTRIAL

829 W. Burnside St.
Portland, Oregon 97209
503/226-6334

Check Item 54 on Tech Data Card

BROADCAST ENGINEERING

Advertisers' Index

Altec Lansing, Div. of LTV Ling Altec, Inc.	56
Andrew Corp.	49
Atlantic Research Corp.	46
Belar Electronics Laboratory, Inc.	72
Belden Corp.	30-31
Broadcast Electronics, Inc.	10, 73, 74
CBS Laboratories, Div. of CBS, Inc.	3
CCA Electronics Corp.	10
Central Dynamics Corp.	45
Cleveland Institute of Electronics	65
Cohu Electronics, Inc.	1
Collins Radio Co.	26
Comrex Corp.	10
Continental Electric Supply Co.	77
Crown International	79
Defense Electronics, Inc.	64
Delta Electronics, Inc.	69
Dynair Electronics, Inc.	61
Electro-Voice, Inc.	11
Fairchild Recording Equipment Corp.	68
Filmline Corp.	24
Gates Radio Co.	21
Gotham Audio Corp.	75
Gray Research and Development Co.	79
Greenlee Tool Co., Div. of Greenlee Bros. & Co.	80
Houston Photo Products, Inc.	76
International Nuclear Corp.	Cover 3
Jampro Antenna Co.	75
JOA Cartridge Service	82
3M Company, Magnetic Products Div.	18-19
Memorex Corp.	58-59
Moseley Associates, Inc.	73
Metrotech, Inc.	70
North American Philips Co., Inc.	12
Nortronics Co., Inc.	81
Phelps Dodge Electronics	71
Philips Broadcast Equipment Corp.	37-40
Potomac Instruments, Inc.	77
QRK Electronic Products, Inc.	80
RCA Service Co.	76
Riker Video Industries, Inc.	Cover 2
Round Hill Associates, Inc.	57
Rust Corp.	82
Sparta Electronic Corp.	60
Stanton Magnetics, Inc.	25
Superior Continental Corp.	67
Superscope, Inc.	13
Taber Manufacturing and Engineering Co.	82
Tape-Athon Corp.	68
Tapecaster Electronics	68, 78
Tech Laboratories, Inc.	81
TeleMation, Inc.	9
Telemet Co.	Cover 4
The Twexipe Co.	72
United Radio Supply, Inc.	82
Vital Industries	7
Ward Electronic Industries, Inc.	5
Wilkinson Electronics, Inc.	53, 74
Xcelite, Inc.	74

Professional Services

VIR JAMES
CONSULTING RADIO ENGINEERS
Applications and Field Engineering
345 Colorado Blvd.
Phone: (Area Code 303) 333-5562
DENVER, COLORADO 80206
Member AFCCE
TWX 910-931-0514

JAMES C. McNARY
Consulting Engineer
National Press Bldg.
Washington 4, D.C.
Telephone District 7-1205
Member AFCCE

**CAMBRIDGE CRYSTALS
PRECISION FREQUENCY
MEASURING SERVICE**
SPECIALISTS FOR AM-FM-TV
445 Concord Ave. Phone 876-2810
Cambridge, Mass. 02138

**JOHN H. MULLANEY
and ASSOCIATES**
Suite 71,
1150 Connecticut Ave., N.W.
Washington, D. C. 20036
Phone 202-223-1180
Member AFCCE

CRYSTAL AND MONITOR SERVICE—
Frequency change and repair service for
AM monitors including G.R., RCA, Gates,
W. E., and Doolittle; also H-P 335B FM.
AM monitors bought and sold. What have
you, what do you need? New or regrind-
ing of AM crystals for RCA, Gates, Bli-
ley, W.E., and J-K oven holders, repairs,
etc. Fastest service, reasonable prices.
Over 25 years in this business. Eidson
Electronic Co., Box 96, Temple, Texas
76501. Phone 817 773-3901. 2-67-tf

**ROSNER TELEVISION
SYSTEMS**

ENGINEERS 120 E. 56 St. New York N. Y. 10022	CONTRACTORS 29 South Mall Plainview N. Y. 11803
-------------------------------------------------------	----------------------------------------------------------

TAPE CARTRIDGE SERVICE
Completely recondition your old tape
cartridges, all sizes of new tape car-
tridges in stock available for immediate
shipment. Will supply complete price
list on request.

M.S.I. CARTRIDGE SERVICE
279 W. Main Street
Amsterdam, N. Y. 12010
Phone (Area Code 518) 843-2242

AMPEX HEAD ASSEMBLY

Relapping and replacement head ser-
vice for all AMPEX professional stu-
dio model recorders. Our precision
relapping extends head life for max-
imum use. Brand new shelf stock re-
placement heads of our manufacturer
available when relapping not advis-
able. Prices include thorough assem-
bly cleaning, optical and electrical in-
spection and complete testing on Am-
pex equipment. Monaural assembly re-
lapping . . . \$35.00 complete. Monaural
assembly replacements . . . \$119.50
complete. "Loaner" assemblies avail-
able. For more data, contact LIPPS,
INC., 1630 Euclid St., Santa Monica,
Calif. 90404 (213) EX 3-0449.

FRANK A. ZOELLER
TELEVISION SYSTEMS
CONSULTANT

20 Years Experience

Box 366 • San Carlos, Cal. 94070
(415) 593-1751

GUARANTEED FIRST PHONE, 4-6
weeks, Broadcast Engineering Academy,
3700 Lemay Ferry, St. Louis, Mo. 63125.
314/892-1155. 5-68-tf

Classified

Advertising rates in the Classified
Section are fifteen cents per word.
Minimum charge is \$2.00. Blind
box number is 50 cents extra.

Equipment for Sale

EQUIPMENT FOR SALE

Scully tape recorders as low as \$13.55
weekly. Three Spotmasters, one record
/playback, and two playbacks, all
three, \$38.25 monthly. Multiple units,
Spot Five, \$47.25 monthly. Two QRK
or Russco deluxe turntables, \$10.80
monthly. Lower payments with trade.
Write for list. Purchase your cart-
ridges from us, we ship freight pre-
paid. Audiovox, Box 7067-55, Miami,
Florida 33155. 4-68-tf

Coils, Contactors, Switches, Complete
ATU systems. Top Quality, Lowest Prices,
Fast Delivery, No Duty. Write for cata-
logue: Geleco Electronics Ltd., 2 Thorn-
cliffe Pk. Dr., Toronto 17, Ont. 416-421-
5631. 11-67-12t

CARTRIDGE TAPE EQUIPMENT

Completely reconditioned and guaran-
teed. Spotmaster Model 500 Record/Play-
backs, \$350.00. Model 505 Playbacks
\$250.00. 30-day moneyback guarantee on
all equipment.

BROADCAST PRODUCTS COMPANY
18804 Woodway Dr., Derwood, Maryland,
20855
(301) 926-4600 3-67-tf

Everything in used broadcast equipment. Write for complete listings. Broadcast Equipment and Supply Co., Box 3141, Bristol, Tennessee. 11-64-tf

"AUDIO EQUIPMENT"—Whatever your needs, check us first. New and used. Ampex, Altec, AKG, EV, Fairchild, Neumann, Langevin, Rek-O-Kut, Uher, Viking. Send for equipment." Audio Distributors, Inc., 2342 S. Division Ave., Grand Rapids, Michigan 49507. 6-66-tf

Audio Equipment bought, sold, traded. Ampex, Fairchild, Crown, McIntosh, Viking, F. T. C. Brewer Company, Town & Country Plaza, Pensacola, Florida. 3-64-tf

FOR SALE: Western Electric Model 405 B 5 KW AM transmitter with reactors, tubes and manuals. Removed in working condition \$2150. Contact: Chief Engineer or Manager, K-BUC Radio, San Antonio, Texas 78220. Phone: 512-222-9191. 9-68-1t

CO-AXIAL CABLE Helix, Styroflex, Spiroline, etc. Also rigid and RG types in stock. New material. Write for list. Sierra-Western Electric Co., Willow and 24th Streets, Oakland, Calif. Phone 415 832-3537. 5-66-tf

TOWERS, lights and accessories. AM, FM communication, CATV, sales, erection and complete service, world wide. Write Dixie Steeplejack Company, 2832 Riverview Blvd. West, Bradenton, Florida. tf

Color movie labs for less than \$5000! Use new Fulton Automatic Processors. Fast, low cost, reliable. Design proven ten years in TV, commercial labs, missile bases. Fulton Productions, Inc. Manufacturing Div., Box 980, Tulare, Calif. 93274. 7-68-3t

Automating? Seeburg LU-200 changer. Plays 100 45 rpm records. Identical to units used in many automation systems. Do it yourself. \$250 FOB. Gene Landau WAPO Chattanooga, Tennessee. 9-68-1t

Equipment Wanted

We need used 250, 500, 5K & 10K Watts AM Transmitters. No junk. Guarantee Radio Supply Corp., 1314 Iturbide St., Laredo, Texas 78040. 3-66-tf

Used Equipment for 3 KW FM station stereo, automation. No junk. Broadcast Engineering, Dept. 219, 1014 Wyandotte St., Kansas City, Mo. 64105 9-68-1t

One RCA Type BTF-5D FM Transmitter in good condition. WFAH, 393 Smyth Ave., Alliance, Ohio 44601 9-68-1t

Used RF Bridge in good shape wanted. Write P.O. Box 4151, San José, Costa Rica. 9-68-1t

Employment

Job Headquarters for all Radio and Television Engineers. Immediate openings exist in 9 western states and elsewhere for qualified engineer and technical personnel. All categories from trainees to experienced transmitter maintenance, chief, assistant chief, live color video maintenance and technical operations. Send us your complete resume now. The AMPS Agency, 3924 Wilshire Blvd., Los Angeles, California 90005. Telephone DU 8-3116. By Broadcasters—For Broadcasters 11-66-tf

OPENINGS—1st Phone Engineers experienced—maint. audio, video, videotape, TX. (also will train 1st or 2nd class engineer for Master Control Position) send resume. Chief Engineer, WGBH-TV, 125 Western Ave., Boston 02134. 9-68-2t

THE GRASS VALLEY GROUP

is forming a SALES organization.

Broadcast Television Engineers

are needed for all areas.

Sales experience helpful but not essential.

GRAVCO SALES, INC.
6311 Yucca St.,
Los Angeles, California
Call or Write:
(213) 462-6618

CATV Technicians are urgently needed in all parts of the country. Send resume to Nationwide CATV Consultants, 645 N. Michigan Avenue, Chicago, Illinois 60611. No fee and confidential. 8-68-tf

WANTED—Assistant Chief Engineer for established Midwest VHF full color station. Must be knowledgeable in all operational phases. Broadcast Engineering Dept. 217, 1014 Wyandotte St., Kansas City, Mo. 64105. 8-68-2t

Chief Engineer or Supervisor retiring to warm, dry climate for physical reasons: Looking for minimal employment preferably with Educational FM plant. Twenty years experience: stereo, SCA, all transmitters, audio. Reply to Broadcast Engineering, Dept. 216, 1014 Wyandotte St., Kansas City, Mo. 64105. 8-68-2t

Engineering position available to work with PC-70's, VR-2000's and TK-27's in outstanding metropolitan VHF operation. First Class license required. Write Dept. 218, Broadcast Engineering, 1014 Wyandotte St., Kansas City, Mo., 64105. 9-68-tf

To work with VTR's, studio equipment and install color equipment. Experience desired. Send resume and salary requirements to Mr. Ronald Lask, Chief Broadcasting Engineer, University of Illinois Medical Center, P.O. Box 6998, Room 314, 907 Building, Chicago, Illinois 60680. 9-68-1t

Major New York firm, sound studio completing new installation, seeks chief engineer, experienced all phases of audio. Excellent opportunity. Broadcast Engineering Dept. 220, 1014 Wyandotte St., Kansas City, Mo. 64105 9-68-1t

Training

To advance in electronics, knowledge and ability are required. Grantham offers correspondence and resident instruction, in depth, leading to the degree of Associate in Science in Electronics Engineering. G. I. Bill approved. Credit for previous training and experience allowed. Free Catalog. Write: Dept. E-2, Grantham School of Electronics, 1505 N. Western Ave., Hollywood, California. 90027. 6-67-tf

First phone through tape recorded lessons at home then one week personal instruction in Minneapolis, Atlanta, Washington, Detroit, Denver, Seattle, or Los Angeles. Sixteen years FCC license teaching experience. Proven results. 95% passing. Bob Johnson Radio License Preparation, 1060D Duncan, Manhattan Beach, Calif. 90266. Telephone 379-4461. 4-68-tf



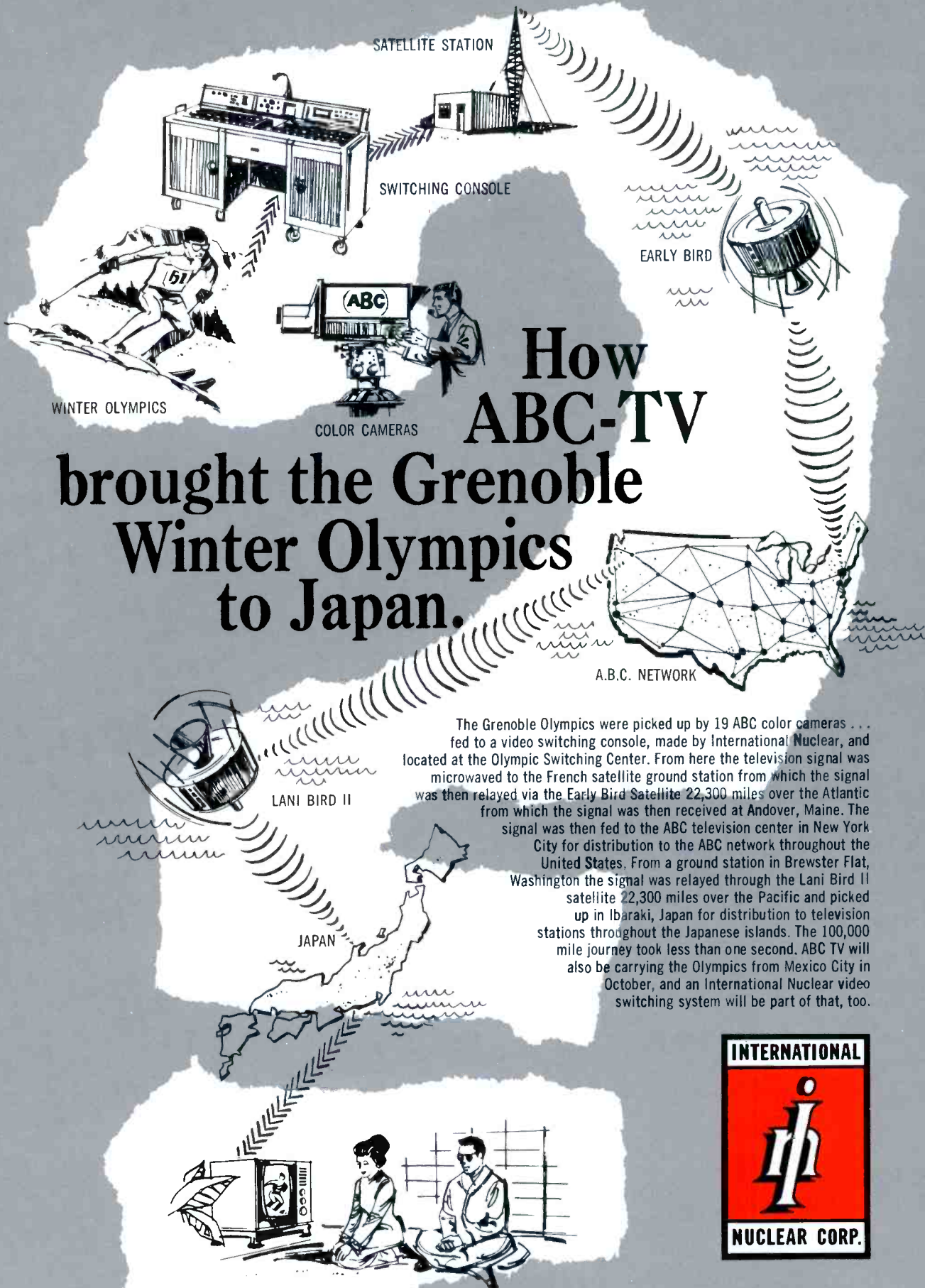

How ABC-TV brought the Grenoble Winter Olympics to Japan.

The Grenoble Olympics were picked up by 19 ABC color cameras . . . fed to a video switching console, made by International Nuclear, and located at the Olympic Switching Center. From here the television signal was microwaved to the French satellite ground station from which the signal was then relayed via the Early Bird Satellite 22,300 miles over the Atlantic from which the signal was then received at Andover, Maine. The signal was then fed to the ABC television center in New York City for distribution to the ABC network throughout the United States. From a ground station in Brewster Flat, Washington the signal was relayed through the Lani Bird II satellite 22,300 miles over the Pacific and picked up in Ibaraki, Japan for distribution to television stations throughout the Japanese islands. The 100,000 mile journey took less than one second. ABC TV will also be carrying the Olympics from Mexico City in October, and an International Nuclear video switching system will be part of that, too.



INTERNATIONAL NUCLEAR CORPORATION • 608 Norris Avenue • Nashville, Tennessee 37204 • Phone: (615) 254-3365

THE "KIND-HEARTED" SYNC GENERATOR

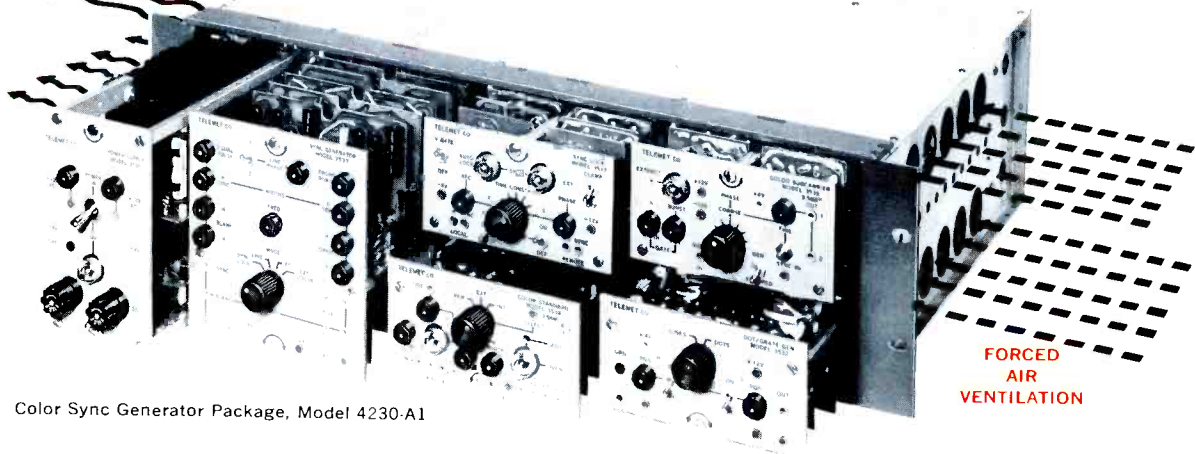

Color Sync Generator Package, Model 4230-A1

Most of today's sync generators use soldered-in microcircuits squeezed into a space that only a microbe could get in to repair. For very low priced generators, this is ideal—but MURDER for the broadcast engineers who have to maintain them. Here's why Telemet's new Model 4230-A1 is so "kind-hearted":

♥ PLUG-IN UNITS WITH PLUG-IN SUBASSEMBLIES. ♥ PLUG-IN INTEGRATED CIRCUITS. ♥ ADEQUATE FRONT PANEL TEST POINTS (COLOR CODED). ♥ BLUE RIBBON CONNECTORS. ♥ "STRAIGHT THRU" FORCED AIR VENTILATION. ♥ MINIMUM NUMBER OF INTEGRATED CIRCUIT TYPES. ♥ EXTREMELY RUGGED CONSTRUCTION. ♥ INCORPORATES THE BEST FEATURES OF ALL TELEMET SYNC GENERATORS.

The basic equipment (frame, power supply and sync generator) is \$1,800. Plug-in accessories include: Model 3533-A1 Automatic Sync Lock Module; Model 3536-A1 Automatic Sub-Carrier Regenerator Module; Model 3534-A1 Color Standard Module with Proportional Oven; Model 3532-A1 Dot Grating Module.

Most of the engineers at this year's NAB Show who looked inside this sync generator—bought it...confirming that our heart *was* in the right place.

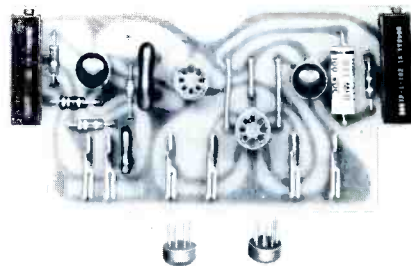
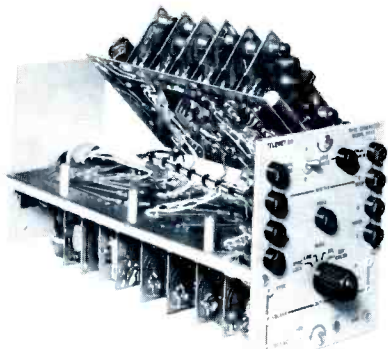

▲ Plug-In Integrated Circuits Simplify Maintenance
 ↓ Hinged Circuitry for Easy Access

TELEMET COMPANY

185 DIXON AVENUE / AMITYVILLE, NEW YORK 11701 / PHONE: (516) 541-3600

Circle Item 57 on Tech Data Card

