

A HOWARD W. SAMS PUBLICATION



NOVEMBER 1966/75 cents

# Broadcast Engineering

*the technical journal  
of the broadcast-  
communications industry*



# ABSOLUTE STABILITY!



## WITH THE ENCODED COLOR-BAR GENERATOR

### SPECIFICATIONS

**INPUTS**—Sync, Blanking, Burst Flag, 3.58 MC/S

**OUTPUTS**—two—either Comp or Non-Comp—  
White, Yellow, Cyan, Green, Magenta, Red,  
Blue—I, Q, B, W

**CONTROLS**—Split Screen, Full Raster, 75%  
amplitude, 100% amplitude.



Now it is no longer necessary to tie up an encoder in order to produce color test signals.

The new RIKER MODEL 5618 provides standard ENCODED COLOR BAR SIGNALS. With a front panel switch you may select full raster or split screen presentations. A second switch selects color bars at 100% or 75% amplitude. All-transistor circuitry assures ultimate accuracy and stability.

This new precision color test signal generator is designed for use in checking studio facilities, setting up video tape recorders, and mobile vans. Color testing at transmitters can now be performed without requiring a video source from the studios, thus freeing facilities and personnel. The RIKER MODEL 5618 ENCODED COLOR BAR GENERATOR releases your studio encoders for program use.

The MODEL 5618, comprised of 2 RIKER all-transistor video modules, may be used as single test instrument or plugged-in with other RIKER test modules.

Send for information



**RIKER VIDEO INDUSTRIES, INC.**

*...thinking always of tomorrow*

North Lane, Huntington Station, New York Phone 516 HA 1-3444 Atlanta Los Angeles, Detroit, Washington, D.C.

# Color!

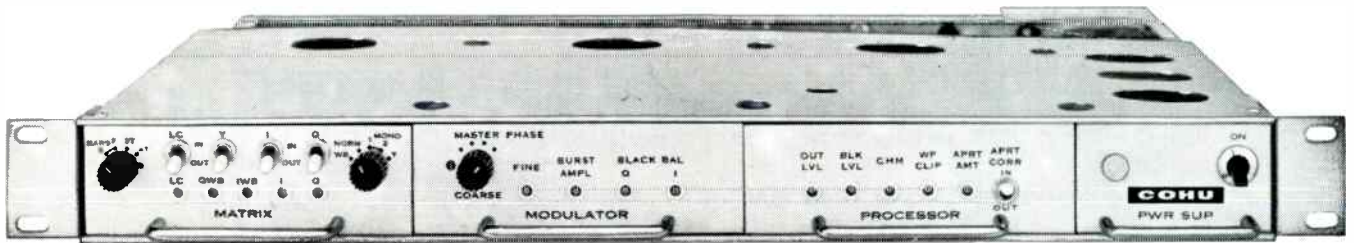

## With this solid-state video encoder by Cohu!

Incorporates all these special features in 1¾ inches of rack space:

- Accepts RGB or RGBM inputs (requiring only sync, blanking and subcarrier inputs in addition); and provides three line outputs
- Includes integral NTSC full or split color-bar and burst-flag generators
- Provides RGBM-luminance correction, to compensate for gamma error introduced by the monochrome pickup tube without loss of resolution, and luminance channel aperture correction
- Utilizes silicon-transistorized plug-in circuit modules
- Has subcarrier phase adjustable over a 370° range
- Should red or blue signal fail, front panel switch provides immediate compatible monochrome output by routing green input to luminance channel

Cohu's Model 9830-071 exceeds all NTSC and FCC specs and is completely compatible with all color systems. Available as options: circuits for controlling camera-to-bar, green-to-y, color-to-monochrome and burst on-off functions from remote locations.

Cohu also stocks sync generator and accessory systems, monochrome/color switching matrix, switcher control and remote control units, pulse and video distribution amplifiers, and portable monochrome and color vidicon cameras. Get full details direct or from your nearest Cohu engineering representative.



Box 623  
San Diego, Calif. 92112  
Phone: 714-277-6700

Circle Item 2 on Tech Data Card

**publisher**  
Howard W. Sams

**general manager**  
Donald W. Bradley

**editor**  
William E. Burke

**managing editor**  
James M. Moore

**associate editor**  
Harold E. Hale

**regional editors**  
George M. Frese, Northwest  
Howard T. Head, Wash., D.C.  
Robert A. Jones, Midwest  
George C. Sitts, East  
Allen B. Smith, North Central  
Martin J. Taylor, Southwest  
and Latin America

**research librarian**  
Bonny Howland

**production**  
Esther M. Rainey, *Manager*  
Paul A. Cornelius, Jr., *Photography*

**circulation**  
Pat Osborne, *Manager*

**advertising sales offices**  
Hugh Wallace, *Sales Manager*

**central and midwestern**  
Roy Henry  
Howard W. Sams & Co., Inc.  
4300 West 62nd St.  
Indianapolis, Ind. 46206  
291-3100

**eastern**  
Gregory C. Masefield  
Howard W. Sams & Co., Inc.  
3 West 57th St.  
New York 19, New York  
MU 8-6350

**southwestern**  
C. H. (Jake) Stockwell  
C. H. Stockwell Co., 4916 West 64th St.  
Mission, Kansas, RA 2-4417

**western**  
LOS ANGELES OFFICE  
G. R. (Jerry) Holtz  
The Maurice A. Kimball Co., Inc.  
2008 West Carson St., Suites 203-204  
Torrance, California, 90501  
320-2204

SAN FRANCISCO OFFICE  
The Maurice A. Kimball Co., Inc.  
580 Market St., Room 400  
San Francisco 4, California  
EX 2-3365

**foreign**  
LONDON W.C. 2, ENGLAND  
John Ashcraft, Leicester Square  
Whitehall 0525  
AMSTERDAM  
John Ashcraft, Herengracht 365  
Telefoon 24 09 08  
PARIS 5, FRANCE  
John Ashcraft, 9 Rue Lagrange  
ODeon 20-87  
TOKYO, JAPAN  
International Media Representatives,  
Ltd., 1, Kotohiracho, Shiba,  
Minato-Ku, Tokyo  
(502) 0656

Copyright © 1966  
by Howard W. Sams & Co., Inc.

BROADCAST ENGINEERING is published monthly by Technical Publications, Inc., an affiliate of Howard W. Sams & Co., Inc. Editorial, Circulation, and Advertising headquarters: 4300 West 62nd Street, Indianapolis, Indiana 46206. SUBSCRIPTION PRICES: U.S.A. \$6.00, one year; \$10.00, two years; \$13.00, three years. Outside the U.S.A., add \$1.00 per year for postage. Single copies are 75 cents, back issues are \$1.00.



the technical journal of the broadcast-communications industry

# Broadcast Engineering

Volume 8, No. 11

November, 1966

## CONTENTS

### Features

#### Grounding Towers for Lightning *J. L. Marshall* 11

Part 1—Safety to life and equipment is the paramount consideration of this thorough series.

#### A Statewide ETV System *William C. Lewis* 14

In the State of Delaware every public-school classroom is tied to a statewide system with standard, professional installation techniques.

#### Redundant Remote Amplifier *Charles D. Sears* 18

A remarkably versatile unit which provides its own spare is described.

#### 2500-MHz ETV Systems *John F. X. Browne, Jr.* 21

Part 3—A further study of 2500-MHz system engineering requirements is presented.

#### Reducing Disc Playback Distortion *Lewis A. Edge, Jr.* 36

This article deals with radio's major sound source—the record—and tells how to make it sound better.

#### The Broadcast Engineer and the NEC *C. G. Cunningham* 40

Knowledge of the National Electrical Code is important to every broadcast technician.

### Departments

Letters	6	News of the Industry	56
About the Cover	34	New Products	62
Book Review	34	Engineers' Tech Data	69
Washington Bulletin	43	Advertisers' Index	71
Engineers' Exchange	48	Classified Ads	72

At an elevation of 8300 feet, in Utah's Oquirrh Mountain Range, is KBYU-TV's mountain-top antenna installation. The antenna is fed by a coaxial cable which spans 870 feet and was installed by a three-man team.

For details, see page 34.

(Photo courtesy of the Andrew Corp.)



***“...CBS Volumax performs flawlessly. Please do not invent any more until we wear these out. At the present rate of deterioration, we will need to replace them by 2015 A.D.”***

This is what station WRNC in Raleigh, North Carolina, said about our equipment. They own both the Audimax Automatic Level Control and the Volumax Automatic Peak Controller. Station WIGS in Gouverneur, New York, wrote, “Enclosed find check for Volumax 400. You couldn’t get it back from us for twice the price . . .” KLIN in Lincoln, Nebraska, purchased Audimax. They told us, “It is an engineer’s dream for absolute level control”. WAYB in Waynesboro, Virginia, tells us, “Purchased a Volumax and we are tickled to 99 and 44/100% modulation with it . . . Congratulations on a fine product”. Station KHOW in Denver, Colorado, said, “It was surprising to receive equipment that exceeded specifications”.

There isn’t enough space here to include all the letters we’ve received praising Audimax and Volumax. But judge for yourself. Like all CBS Laboratories equipment, they’re available for a 30-day free trial. Audimax \$665. Volumax \$665. FM Volumax \$695. Write to us, or better yet call The Professional Products Dept. directly — Collect. Telephone (203) 327-2000. Maybe you’ll be in our next ad.



**CBS LABORATORIES**  
Stamford, Connecticut. A Division of  
Columbia Broadcasting System, Inc.

## Why are 6 FAIRCHILD CONAX'S on top of the EMPIRE STATE BUILDING?



Several New York FM and TV stations, including WNEW-TV, WPIX-FM, WPIX-TV, WOR-FM, WOR-TV, and WQXR-FM, value their transmission location on top of the Empire State Building and they also value their audience. The FAIRCHILD CONAX allows these stations to maintain high average listening levels without danger of over-modulation caused by high frequency spikes and thereby increasing fringe area coverage. The super-fast attack and release times of the FAIRCHILD CONAX makes this instantaneous control inaudible to the listener's ear.  The FAIRCHILD CONAX does not "muddy-up" the top in an effort to control it. Easily integrated into existing systems, the FAIRCHILD CONAX does not obsolete conventional compressors or limiters — it actually improves their performance.  Only the FAIRCHILD CONAX is the world accepted solution for high frequency pre-emphasis problems. Join the "1000 Club"... the satisfied users of the FAIRCHILD CONAX in recording and broadcasting throughout the world.  Write to FAIRCHILD — the pacemaker in professional audio products — for complete details.

**FAIRCHILD**  
RECORDING EQUIPMENT CORPORATION  
10-40 45th Ave., Long Island City 1, N. Y.

Circle Item 5 on Tech Data Card

## LETTERS to the editor

DEAR READERS:

BROADCAST ENGINEERING is changing from letterpress printing to the more modern offset method. In addition to permitting us to print each issue faster and more efficiently, the new process will enable us to provide clearer reproduction of drawings and photographs. Next month, you'll notice that BE is being printed on a new type of paper, which we think you will find much more readable than the high-gloss stock we have used previously.

DEAR EDITOR:

In the August 1966 issue of BROADCAST ENGINEERING, you published a fine article on AM frequency searches. In the article, you referred to the desirability of having a list of pending applications. You did not, however, specify where this list may be obtained. Could you tell me? I enjoy your publication very much.

FRANK E. PENNY

Gales Ferry, Conn.

*A contract for duplication and sale of certain FCC public records is held by Cooper-Trent, Inc. Among the information available from this source is the "AM Broadcast Pending Application List by Frequency," which contains a tabulation of all standard-broadcast applications pending before the Commission. The listing is issued monthly, and it can be purchased on a single-copy or yearly subscription basis. A monthly "Combined Listing of AM Pending Applications by Frequency and by States" and an "FM Listing" are also available.*

*The address is: Cooper-Trent, Inc., 1130 19th St., N. W., Washington, D. C. 20036.*

### Correction

In the "Review of Professional Microphones" in our September and October issues, the address for Shure Brothers was listed incorrectly. It should have been:  
Shure Brothers Incorporated  
222 Hartrey Avenue  
Evanston, Illinois

Replace  
857B  
tubes  
directly  
with  
lifetime

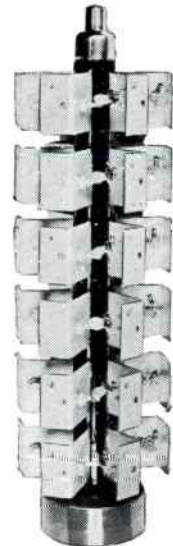

## WILKINSON

### 36-16 Silicon Rectifier Stacks! Because...

- Wilkinson 36-16 Silicon Rectifier Stacks virtually last forever.
- Immediately repairable in minutes.
- Eliminate arc-backs, pre-heating and warm-up time.
- Eliminate filament transformer and auxiliary heaters.
- Operate from  $-85^{\circ}$  to  $+185^{\circ}$ F ambient.
- "Go-No Go" instantaneous proof of performance.

Only **\$475**

(less than the cost of a filament transformer .. and you don't need them!)

**SPECIFICATIONS:** Model SR-36-16 replaces tube type 857B PRV repetitive 36 KV. PRV transient 42 KV. RMS current 16 amp. Surge current 1 sec. 160 amps. Forward voltage drop 25V.

For complete details on Wilkinson Silicon Rectifier Stacks, write on your company letterhead today to:

**WILKINSON**  
ELECTRONICS, INC.

1937 MACDADE BLVD. WOODLYN, PA. 19094  
TELEPHONE (215) 874-5236 874-5237

Circle Item 4 on Tech Data Card

BROADCAST ENGINEERING



**complete  
audio-video  
package**

Shopping for the most advanced audio and video equipment, but can't find anything that's really new? Pick up your phone and we'll be happy to tell you about the most exciting developments in audio-video systems, and how they can help you get more for your money. Follow the broadcasting leaders who are switching to Ward—you'll enjoy the company.



---

**WARD ELECTRONIC INDUSTRIES**

142 CENTRAL AVE., CLARK, N. J. 07066 • (201) 382-3700

---

Circle Item 6 on Tech Data Card

**Two of the three major networks use  
Norelco cameras for their prime-time color shows.**

**If that doesn't convince you to buy a  
Norelco 3-tube Plumbicon\* color camera,  
take a trip on us.**

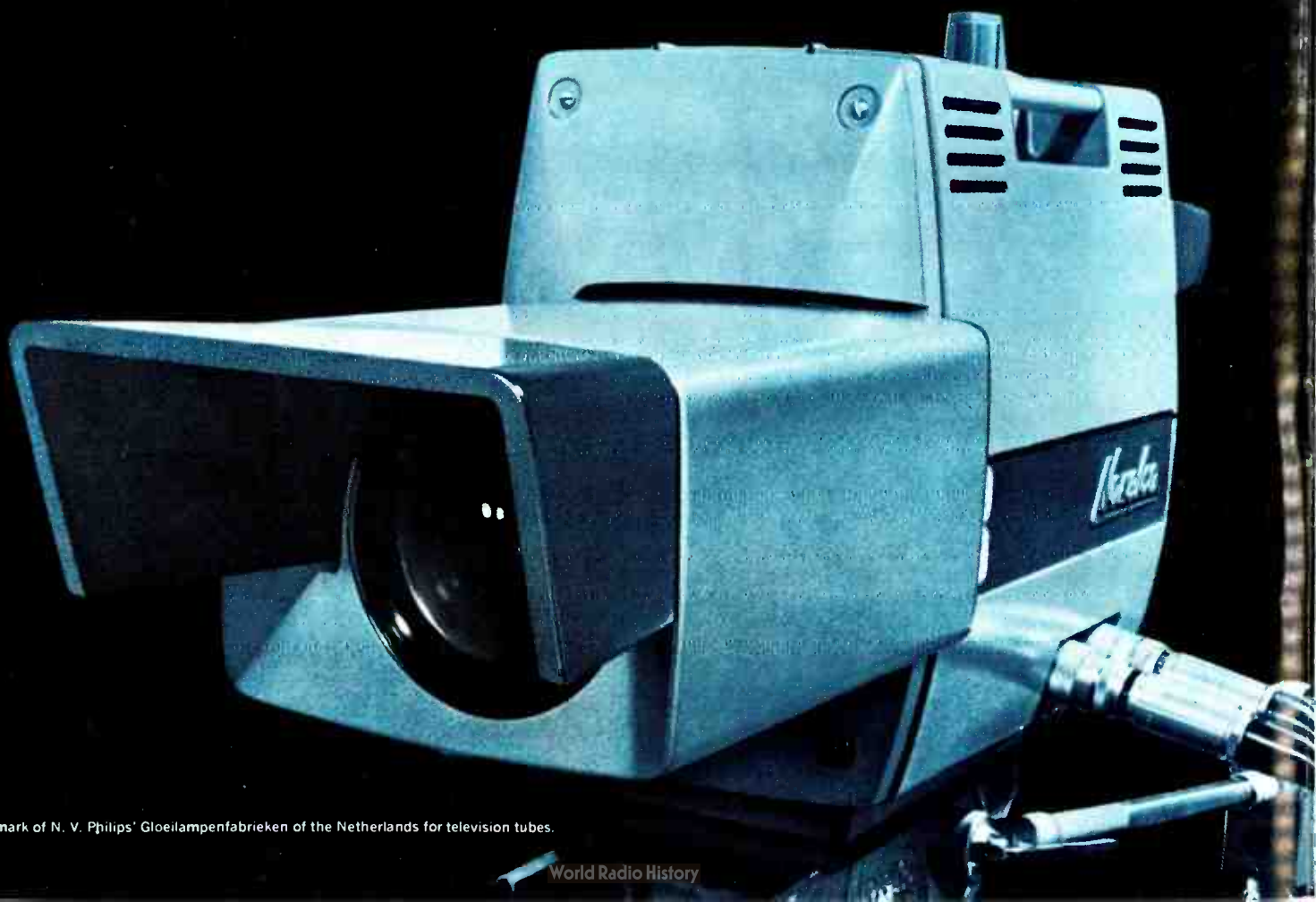

\*Trademark of N. V. Philips' Gloeilampenfabrieken of the Netherlands for television tubes.



This is an invitation to discover—at our expense—the practical, everyday reasons why you should now be using the new Norelco 3-tube Plumbicon rather than any other color TV camera on the market. Do this. Call, or write us direct. We'll schedule and pay for a trip to a station now using the Norelco 3-tube Plumbicon TV camera—subject to the availability of the station's time and technical personnel. They'll tell you and show you why they chose the new Norelco. You'll see it in program action. You'll learn for yourself—at no cost to yourself—why the Norelco Plumbicon TV camera is used for more programming than all other new generation makes.

**Here's a partial list of stations now using the new Norelco**

EAST	
STATION	LOCATION
WNHC-TV	New Haven, Connecticut
WNEW-TV	New York
REEVES SOUND STUDIO	New York
SOUTH	
WAGA-TV	Atlanta, Georgia
WJBF-TV	Augusta, Georgia
WCYB-TV	Bristol, Virginia/Tenn.
WKRG-TV	Mobile, Alabama
WSPA-TV	Spartanburg, S.C.
MIDWEST	
WFIE-TV	Evansville, Indiana
WFRV-TV	Green Bay, Wisconsin
WISH-TV	Indianapolis, Indiana
WEST	
KABC-TV	Los Angeles, California
KTTV	Los Angeles, California
KXTV	Sacramento, California

When you visit one of these stations you'll be able to separate the facts from the fiction regarding color TV cameras. Facts and fiction like this:

**FICTION:** A 4-tube camera produces a sharper picture than a 3-tube color camera.

**FACT:** This concept is as obsolete as the 12-cylinder car. The Norelco 3-tube PC-70 Plumbicon Color Camera produces a sharper color and monochrome picture than any 4-tube camera. Reason: the first practical application of the unique "contours-out-of-green" principle provides both horizontal and vertical aperture correction. The contour signal produced from the green channel, is simply fed to all three channels.

**RESULT:** A startling increase in color and monochrome sharpness — on the home receiver—plus the same tolerance to misregistration that a fourth tube provides. All with one less tube, less maintenance, minimum operational make-ready time and trouble-free color matching.

**FICTION:** "Contours-out-of-green" creates an excessive noise problem.

**FACT:** Absolutely not. But some 4-tube cameras do have a noise problem. Check the "specs." You'll discover that these 4-tube models recommend a fixed gamma of 0.5. We provide continuously variable gamma and recommend an 0.45 operating point. This stretches blacks and gives you more detail in dark areas and shadows. A gamma of 0.5 hides noise by compressing blacks. Result: the 4-tube camera loses dark area detail and literally demands the use of flat lighting.

**FICTION:** By this time next year Norelco will be selling a

four tube camera.

**FACT:** Definitely not. We made the best possible 4-tube camera but decided not to sell it. While using it to compare 3-tube vs. 4-tube, we discovered what every 4-tube manufacturer has since learned: 4-tube resolution is inherently less than 3-tube; that extra light split to the Y channel reduces the light to the RGB channels, causing noticeable lag. (Try moving a light object against a dark background with a camera using 4 photo conductor pick-up tubes. You'll see what we mean.)

**FICTION:** The Norelco PC-70 is made in Holland and won't be in full production for years.

**FACT:** The PC-70 camera is made by Norelco in Mt. Vernon, N. Y., where existing and constantly expanding facilities are meeting the demand for the most economical, easiest to use and maintain, color TV camera available today.

**Other reasons to choose the Norelco PC-70:**

A simple but remarkable 3-way beam split prism that eliminates the need for shading controls. (Because of their complicated beam split, many 4-tube models require as many as 16 shading controls.)

No magenta cast, a problem even some of the newest 4-tube cameras haven't solved.

Lens interchangeability.

No set-up operating controls in the camera head except for tube-focus and back-focus positions. Eliminates the need for a two-man set-up and for hectic on-the-set adjustments.

Now get all the reasons to choose the Norelco PC-70. Get them from the men behind the camera, Today, call our sales representative, Visual Electronics, or call us directly.



**NORTH AMERICAN PHILIPS COMPANY, INC.**  
900 South Columbus Avenue, Mount Vernon, New York 10550

Circle Item 7 on Tech Data Card

# 15 Years Old and Still Ahead of the Times!

 It may not look revolutionary today, but fifteen years ago the E-V 655 shown here was unique. Then it was the only truly omnidirectional dynamic microphone on the market. And it offered ruler-flat response from 40 to 20,000 cps, plus plenty of output for critical broadcast applications.

Even today, those specs are first rate. Many of the early 655's are still proving that in dependable daily service. But during the years, E-V has continued to refine and improve so that today's Model 655C can set even better records for performance and service.

Having proved the point, the 655 inspired a complete series of Electro-Voice omnidirectional microphones that serves every need over a wide price range. The full benefit of our fifteen years of design leadership is lavished on even the most modest model in the line.

For instance, every slim E-V dynamic microphone uses the famed Acoustalloy<sup>®</sup> diaphragm. This E-V exclusive insures more uniform response while withstanding the effects of high humidity, temperature, corrosion and shock. It makes E-V omnidirectional microphones almost indestructible.

You'll learn the real value of engineering leadership when you put any of these slim E-V dynamics to work in the field. You can do it with the extra assurance of a *lifetime* guarantee against defects in materials or workmanship. See them now at your franchised E-V microphone headquarters, or write for complete catalog today.



Normal trade discounts apply to list prices shown.

**ELECTRO-VOICE, INC.**  
1162V, 638 Cecil St.  
Buchanan, Michigan 49107

**Electro-Voice<sup>®</sup>**  
SETTING NEW STANDARDS IN SOUND

# GROUNDING TOWERS FOR LIGHTNING

By J. L. Marshall\*

Part 1—Many steps can be taken to reduce danger to life when lightning strikes a broadcasting tower.

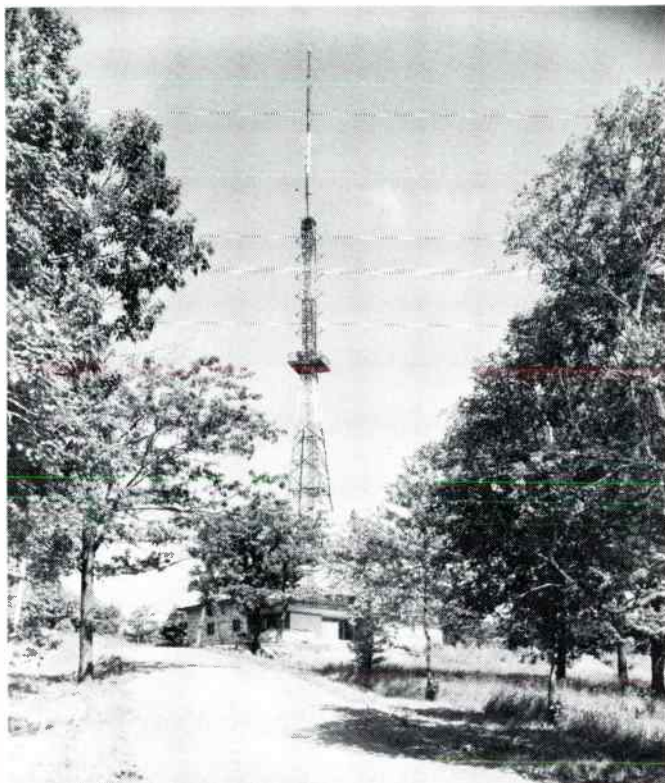

Transmitter building and former tower of CBMT and CBFT, near Montreal, Quebec, where some of the grounding techniques described in this article were developed and put into practice.

The reason for grounding a television or FM tower for lightning is the protection of personnel and equipment. The safety of life is, necessarily, the prime consideration, and the design of a tower grounding system must, therefore, take into consideration many factors that contribute to extreme danger to the human body.

The effects of electric shock depend upon what parts of the body are in contact with the voltage source, the phase of the heart cycle at the instant of shock, whether the person's body is wet or dry, the duration of the applied voltage, and the frequency and magnitude of the electric current. As a generalization, it can be said that currents in excess of 200 ma through the body can be lethal.<sup>1</sup>

Another variable for which an assumption must be made is the magnitude of the lightning stroke current. Based upon numerous measurements<sup>2</sup>, the maximum stroke current rarely exceeds 100,000 amperes<sup>2, 3, 4</sup>. (See Fig. 1.)

Television towers are often located on hills where the terrain is rocky and the earth conductivity is low. Table 1 shows the range of resistivity values for soil compositions which vary from loam (which has a relatively low resistance) to granite (which has a high resistance).

\*Canadian Broadcasting Corp., Montreal, Quebec

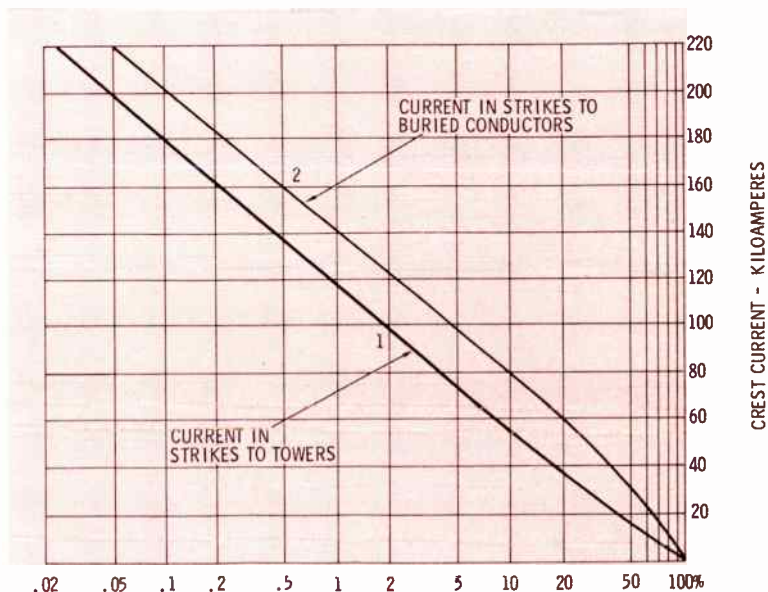

Fig. 1. Curves show percentile of lightning strokes in which the stroke current exceeds the ordinate. The curves represent the maximum current which occurs during the stroke.

The lightning path through a tower is comprised of two circuit elements in series, the tower proper and the ground or ground system. The tower surge impedance determines what voltage exists along its height, but this is of secondary importance except when someone is on the tower during a lightning strike. The voltage at the tower base is the more important quantity, and it is largely determined by the ground-system impedance. The current in the tower also induces voltages in nearby conductors.

For convenience of explanation, a 300-foot tapered, self-supporting tower with a base foundation width of 60 feet (or a radius of approximately 9 meters) will be considered. The tower will be assumed to be situated on a hill composed largely of igneous rock but overlain with clay loam one foot in depth. For this two-layer case, the apparent resistivity is substantially lower than the value for the rock at short distances from the tower, but if a large property is considered, *e.g.*, a 200-foot radius, the apparent resistivity will approach that of the rock itself, if the rock formation is deep compared to the surface soil. Although soil resistivity measurements are the most effective means for obtaining a reliable value, a judgement will be made for our example: a resistivity of 5000 meter ohms, assuming a property radius of 70 meters (about 230 feet).

### Tower Base Potential

The potential at the tower base<sup>5</sup>, where no ground system is installed, can be expressed as:

$$E = \frac{\rho I}{2\pi B} \quad (\text{eq. 1})$$

where,

- E = potential at the tower base
- $\rho$  = the earth resistivity in meter ohms
- I = the current in the lightning stroke in amperes
- B = the radius of the tower base in meters

This expression assumes that the tower base structure approaches or envelops the shape of a hemisphere in the earth. Here the word "earth" includes the substance upon which the tower foundation rests. (See Fig. 2.)

From eq 1, the potential at the perimeter of the tower base (9-meter radius) for the assumed value of  $\rho$  and the maximum expected value of I is:

$$E = \frac{5 \times 10^3 \times 10^5}{2\pi \times 9} \\ = 8,900,000 \text{ volts}$$

The electric field intensity<sup>3</sup> at the tower base can be expressed by

$$E = \frac{\rho I}{2\pi B^2} \quad (\text{eq 2})$$

which, in this example, amounts to  $10^6$  volts per meter.

Table 1. Earth Resistivity<sup>2</sup>

Meter Ohms	Geological Formation
10 Unusually low	Loam Clay
100 Low	Shale
300 Medium	Limestone
1000 High	Sandstone
3000 Very high	Coarse Sand & Gravel Granite
10,000 Unusually high	Gneisses

### Soil Ionization

Soil will ionize when the voltage stress is above specific values. These lie between  $10^6$  and  $2 \times 10^6$  volts per meter for internal ionization, and between  $10^5$  and  $5 \times 10^5$  v/m for ionization at the surface. The higher values are for sand and gravel and the lower values for clay and loam. An assumption of  $E_0 = 10^5$  v/m will be made for surface breakdown voltage gradient in our example.

The radius of the conducting area around the tower base is extended by surface ionization until the effective voltage falls to below the breakdown gradient. This extended radius is given by:

$$r_0 = \left( \frac{\rho I}{4E_0} \right)^{1/2} \quad (\text{eq 3})$$

and for the values assumed previously, the radius is 35 meters from the perimeter of the tower base.

Consider now the voltage drop across 3 meters extending outward from the edge of the ionized plane<sup>2</sup>.

$$V = \frac{I\rho}{2\pi} \left( \frac{1}{r_0} - \frac{1}{r} \right) \quad (\text{eq 4})$$

where,

r = the radius to the outer point (38 meters in this case)

$$V = \frac{10^5 \times 5 \times 10^3}{2\pi} \left( \frac{1}{35} - \frac{1}{38} \right) = 194,000 \text{ volts}$$

The gradient will be approximately 65,000 volts per meter. This would be lethal to human beings as the following section will indicate.

As the tower base potential drops below the ionizing value, dangerous voltage gradients will occur at points nearer and nearer to the tower. Similarly, for lightning strokes developing tower base voltages below the ionizing value, high voltage gradients will exist over the area close to the tower.

### Resulting Current

The current through the body<sup>5</sup> of a person standing on the ground is

$$i = \frac{\pi bes}{\rho} \quad (\text{eq 5})$$

where,

b = the equivalent radius of the human foot, which is taken to be 7 cm

e = the electric field intensity in the ground in volts per meter

s = the distance between the person's feet (approximately one-half meter)

$\rho$  = the resistivity of the surface soil, in this case 100 meter ohms

Then, for a gradient of 65,000 volts per meter

$$i = \frac{\pi \times .07 \times 65,000 \times .5}{10^2} = 71.5 \text{ amps}$$

It is apparent that the lower resistance of the top soil layer tends to lower the voltage gradient, but on the other hand permits a larger current to pass through the body.

### Grounding

From the literature<sup>2-6</sup>, it is evident that the surge impedance of a tower ground system, while several times higher than the steady-state value, can generally be neglected because the current at the corresponding instant is usually at a low value. This is particularly true where the structure is connected to the center point of ground conductors, which are electrically short.

Buried-radial ground conductors make the most effective ground system where the surface soil is shallow. The resistance of the ground system is reduced by increasing the number of radials, but the rate of reduction diminishes as the radials are increased in number (due to mutual resistance between radials).

The usual AM radio tower is located in loam or clay soil, and has an extensive radial ground system. This is an ideal condition for lightning grounding, and

one that can only be approached in the TV-tower example under consideration.

The resistance of a radial ground system is given by<sup>2</sup>

$$R_n = \frac{\rho}{n \pi \Gamma} \left[ \log \frac{2\Gamma}{(2ad)^{1/2}} - 1 + N(n) \right] \quad (\text{eq 6})$$

where,

n = the number of radials

$\Gamma$  = the length of each radial in meters

a = the wire radius in meters

d = depth wire is buried, in meters

$N(n) = (n-1) \log (2 \times 1.707) - \log n$ , when  $n > 6$ .

Logarithms are to base e.

In our example, the radials would be buried in approximately one foot of surface soil, and the effective resistivity of the whole body of earth is  $5 \times 10^3$  meter ohms (as previously assumed).

With eight 30-meter radials of No. 10 wire (a = .13 cm),

$$R_n = \frac{5000}{8\pi \times 30} \left( \log \frac{60}{.028} - 1 + 6.52 \right) = 87.2 \text{ ohms}$$

If No. 0 wire were used, the resistance would be 83.4 ohms. Hence, the conductor diameter has small effect on the resistance of a system.

For twelve radials of No. 0 wire, 30 meters long, R is 75.6 ohms. If the length of the radials were increased from 30 to 60 meters, the resistance would be 39.4 ohms. This last condition will be adopted as the initial part of the ground system.

Buried conductors in the form of rings have a resistance only slightly greater than buried radials of the same length. If the 12 radials were joined by circular rings of wire at 5-meter intervals from the tower, the

• Please turn to page 30

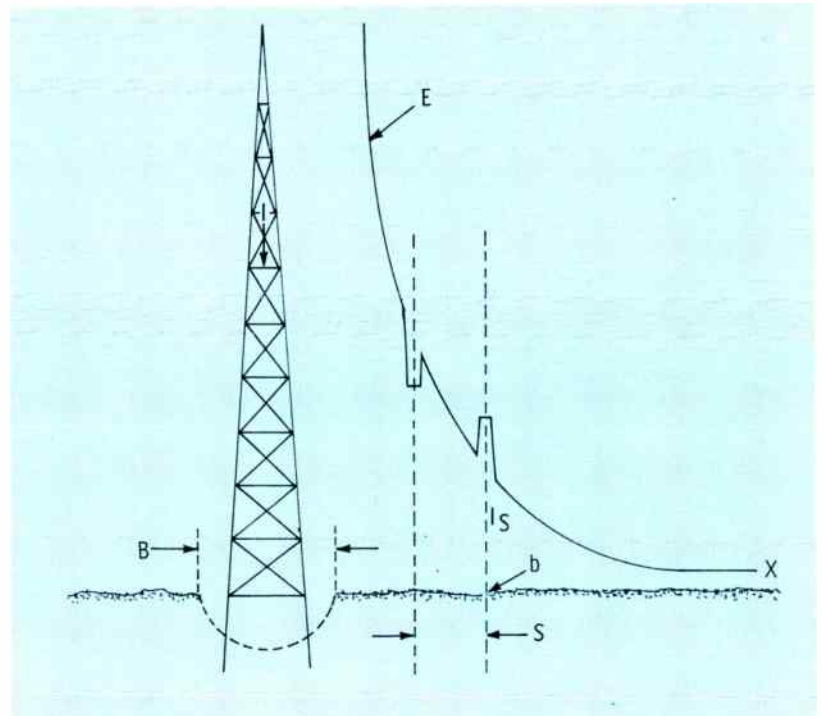

Fig. 2. The potential at the surface of the earth near an electrode containing lightning current. Note that the potential decreases as the distance from the tower is increased.

# A STATEWIDE ETV SYSTEM

by William C. Lewis\*—An extensive closed-circuit plant distributes educational programs throughout the state of Delaware.

Closed-circuit educational television systems are often visualized as using low-cost, low-quality equipment; as being operated by people "playing television"; and as being viewed by small groups who accept poor quality as inherent in ETV. This is certainly not true in the state of Delaware.

The Delaware Network's Educational Television Resources Center,

located in Dover, is being equipped with modern, high-quality monochrome television equipment. Quadrature video tape recorders, the latest film equipment, image-orthicon cameras, and complete lighting and staging facilities are all located in a modern television plant which will be operational statewide by the fall of 1966. As the network serves every public school classroom in the state, the potential audience exceeds 102,000.

The network was implemented by

Delaware House Bill No. 623, "An act to establish an Educational Television Board for the State of Delaware, to set forth the duties and powers of such Board, and to provide an appropriation for the operations thereof." It was signed into law July 8, 1964. The Educational Television Board is made up of the six members of the State Board of Education, and three representatives of higher education in the state. The State Superintendent of Public Instruction serves as executive officer of the ETV Board. Much of the network's success can be attributed to its close relationship with the state public educational program.

Prior to the arrival of the first of the television staff members in January, 1965, a number of decisions had been made by the ETV Board regarding overall network operation. The network was to be a three-channel facility with transmission facilities from the point of origination to each school provided by the Diamond State Telephone Company (a member of the Bell System). The state was divided into twenty-three television districts, some of which combine smaller school districts into a single television district. One key school in each TV district was chosen as a "head-end" school, and transmission facilities were developed in such a manner that these key schools could block state signals and substitute locally originated material for transmission to schools within the district. The Board also decided to locate the Resources Center on the campus of Delaware

\*Technical Services Director, Delaware Educational Television.

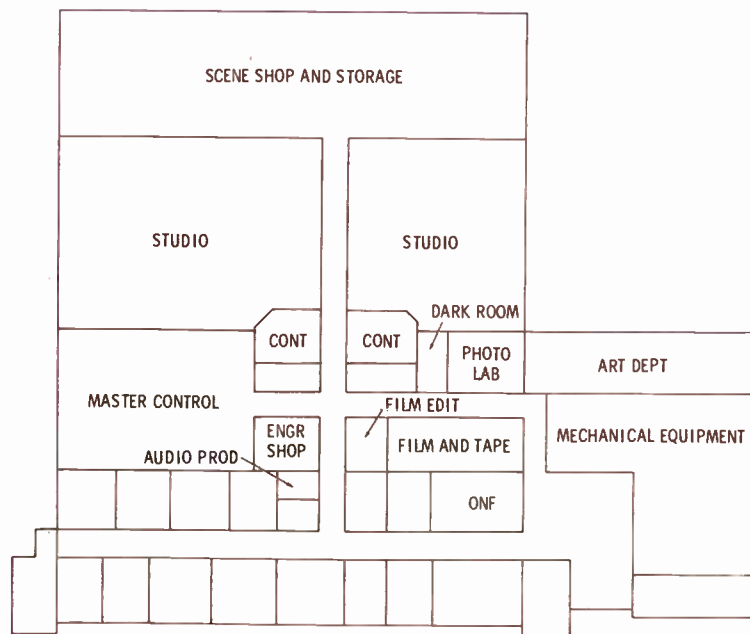

Fig. 1. Educational Television Resources Center has complete facilities.

State College just outside Dover.

### Origination

Because the target date for initial operation of the network was set for September, 1965, and because of the fact that the first year's financial allocation would revert to the state general fund on June 30, 1965, two origination plants had to be planned and implemented early in the year. One, a temporary facility to meet the September programming deadline, needed no production capability because the first year program material was to be on film or video tape acquired from outside sources. The second was to be the permanent facility from which future programming would originate.

The all-new Delaware Educational Television Resources Center was occupied by the ETV staff on June 1, 1966. The building provides about 23,000 square feet of operating space. Its cost, exclusive of equipment or furnishings, was a half million dollars. A conscious effort has been made to keep nonfunctional areas to a minimum. The plant layout is a cooperative effort of the technical services and production personnel employed by the network. (Fig. 1.)

Two studios are provided. The larger is 40 by 60 feet; the smaller is 40 by 40 feet. Each studio has an adjacent production control room. All technical support is located in the master control room, a 35- by 44-foot area nearby. Network master control, telecine, and video tape center are located in the master control area (Fig. 2). A small audio production room is also provided.

Across the rear of the building adjacent to both studios is a large, more or less unfinished area. This room, 30 by 108 feet with a 20-foot ceiling, houses a scene shop, set storage, shipping and receiving, a paint shop, etc. A raised platform in one end of the room raises the overall square footage available for these functions to slightly more than 4000 square feet.

Film and tape storage is located in a 15- by 30-foot area with a 20-foot ceiling. The film editing facility is adjacent to the film storage area, with darkroom, photo lab, and graphics room immediately across the hall. The future need for a 16-



This half-million-dollar building houses the Delaware ETV Resources Center.

mm film processor has been anticipated in the layout.

Approximately 6000 square feet of administrative office space, mechanical equipment room, telephone equipment room, corridors, etc., make up the remainder of the plant. The structure is air conditioned.

The Resources Center will be equipped with six video-tape recorders, four complete telecine chains, audio equipment, zoom-lens image-orthicon cameras, and commercial switching. A facilities delegation system will be used so that film and video tape facilities will be available for production or network feed.

During the 1965-66 school year,

the network origination facilities were located in two surplus refrigerator trailers and a military bus. These were placed in a "T" configuration and a covered platform built to join the open ends of the three vehicles. Bell System television transmission equipment was located in an adjacent house trailer.

Three video tape recorders and three film chains, along with necessary master control and terminal equipment, were located in the temporary structure. Here the operating problems were numerous. High humidity, heat and cold, dust and dirt made the facilities an engineering nightmare. Ladies' hair dryers



Fig. 2. Spacious master control room serves origination studios of network.

were employed to defrost optical multiplexers on cool, damp mornings. Credit for a nearly perfect operational year goes to the technicians, most of whom came from commercial television. They worked long hours in the poorest of conditions, but kept the network "on the air." Less than 30 minutes of programming was lost during the 1965-66 year.

### Distribution

To provide transmission facilities throughout the state, the Diamond State Telephone Company decided to combine a microwave backbone (Fig. 3) with a network of cable extending from seven points along the backbone (Fig. 4). As the system developed, 100 miles of microwave and 380 miles of cable routes were established.

The microwave system makes use of frequencies in the 11-gHz band, because interference with existing 6-gHz systems had to be avoided. The frequencies used are repeated every other hop with the signal oppositely polarized when frequencies are repeated. This is to reduce overshoot interference. The distance between towers varies from 19 to 10 miles, and tower height varies from 240 to 160 feet. Design fade margins, considering typical rainfall, range from 32 dB to 35 dB. Noticeable fading due to severe rainfall occurred only once during the 1965-66 operational

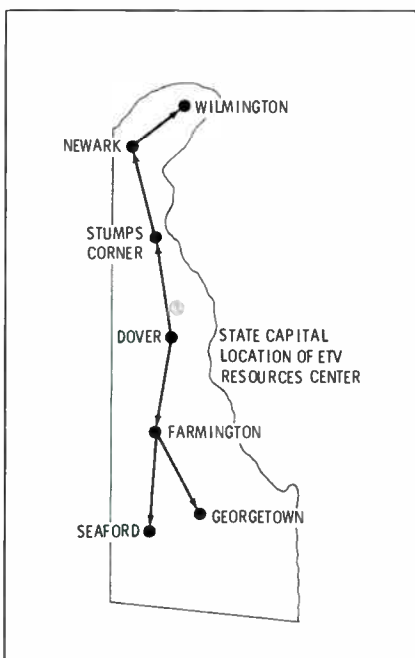

Fig. 3. Microwave system "backbone."

year. One type of microwave equipment was used throughout and was supplied as a turnkey installation.

The cable transmission facilities from the microwave backbone to the school make use of 75-ohm coaxial cable. The cable follows existing telephone routes wherever possible. Throughout the system, 30.9 miles of cable lie in underground conduit, 202.4 miles are on poles, and the remaining 156 miles of cable are buried. Fewer than 200 poles had to be placed during the construction of the network.

Aural and visual carriers for three channels (2, 4, and 5) are generated at each of the microwave towers. These signals are modulated by the baseband video and balanced audio signals available at the output of the microwave equipment, and are fed into the cable system. Signals are amplified at 4000-foot intervals along the cable. There are about 500 amplifiers located throughout the state. The cable is equalized to provide flat response in the 20- to 290-MHz band.

Telephone company service has been excellent. Line outage was handled with dispatch, and picture quality throughout the state has been maintained at a high level. No construction charges have been assessed; and no contract exists, as yet, obligating the state to long-term operation or termination charges should the network go dark in the near future.

### Facilities at the Schools

Few ETV operations have gone beyond facilities for program production and transmission. In most cases, each school must provide a master antenna system and television receivers. Although the Delaware Educational Television Board has not been able to furnish receivers, every school in the state has been wired to receive the network programs in every classroom. Field service is also provided.

Early in January, 1965, a survey to determine the status of existing MATV systems was undertaken by the state. The school wiring project became the most difficult part of the overall construction job. Existing systems ran the gamut from long runs of 300-ohm twinlead installed with "loop and droop" techniques to the most modern 75-ohm MATV systems. Amplifiers were found in offices, on window sills, in crawl spaces, in skylights, and in rural mail boxes under building eaves. Cables were pinched, run loose near heavy traffic areas, and few had any type of strain relief. Cable was installed with clothesline rope, screw eyes, shingle nails, and other devices unsuitable for outside plant wiring installations (Fig. 5).

As a result of the survey and simultaneous discussions with master antenna television equipment manufacturers and suppliers, a definitive procurement specification

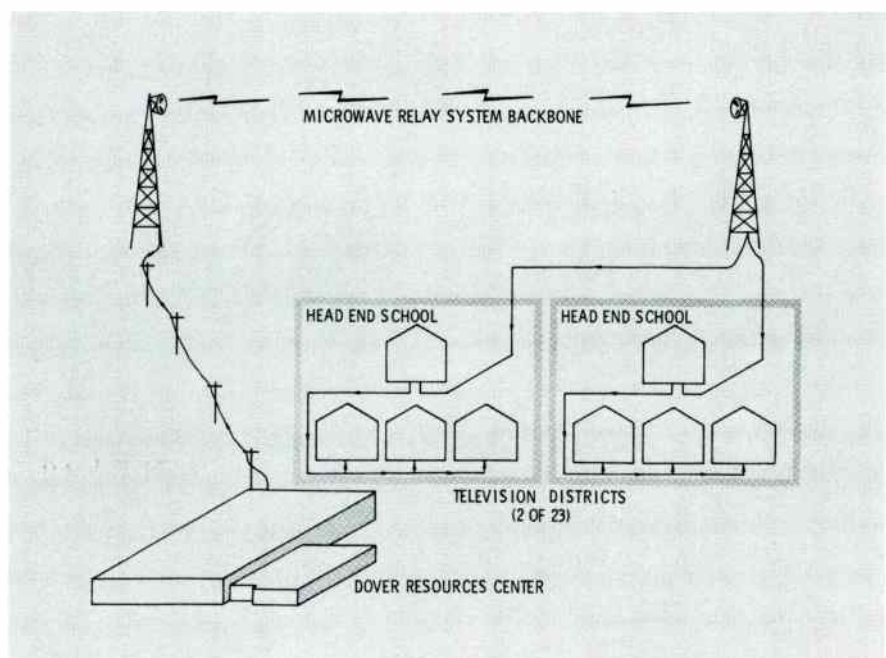

Fig. 4. Each "head-end" school feeds other district schools through cable.



was written. Bids to wire every school in the state were invited, and contracts were awarded to two major equipment companies.

As each school installation was completed, a network field technician checked for compliance with the contract specifications. Each outlet in each school was checked for proper level and for overall system balance. Discrepancies were reported to the contractor.

All classrooms in the state are equipped so that all teachers with television receivers have access to the network programming (Fig. 6). All new school construction in the state must provide for master antenna television systems as a part of the basic building. Evidence of the impact of the availability of quality instructional television is that schools throughout Delaware are purchasing more and more television receivers for classroom use.

### System Maintenance

A three-man field-service team provides the service necessary to keep all of the MATV systems in top working order. Each man drives a fully equipped service vehicle and, when necessary, can call on technical support from other field technicians or from studio technical personnel. Master antenna television system service is available to any school in the state within 12 hours after a call to the Resources Center trouble number.

As a result of experience gathered during school wiring, a new and more definitive wiring specification has been written for future MATV systems. This specification has been adopted by the Educational Television Board, and has been endorsed by the State Board of Education. New school construction, which must include MATV facilities, must comply with these specifications if the school is to receive service from the network.

The network technical field team is also available to assist in the planning of systems to be installed in schools. The service is available to school administrators or to architects retained by the schools. When a system is installed, network field technicians perform a final check to insure that the system satisfies the contract.

The constant and immediate availability of technical help has done much to assure the success of the network in Delaware schools. There is a direct relationship between school faculties who are unhappy with the television program and schools with a high record of technical problems. Teachers are becoming critical viewers with a growing awareness of good and bad picture quality. Unlike commercial broadcast television, the loss of a program today may have a lasting effect in the classroom where the program was to have been a part of a tightly structured lesson. The teacher, who controls the viewing of 30 students, has so many resources to support a teaching program that a minor technical problem can cause that teacher to dismiss television from the classroom. If that teacher is an opinion leader in the school, it is quite likely that the viewing habits of many teachers, and their students, will be affected. The Delaware ETV staff firmly believes that the most successful instructional television program is the one which assures high technical reliability from the camera to the face of the classroom receiver.

Once a technical facility is established, the programming transmitted must meet the schedule of the teacher. The daily sign-on time for the Delaware Network during the 1965-66 broadcast year was 7:30 a.m.,

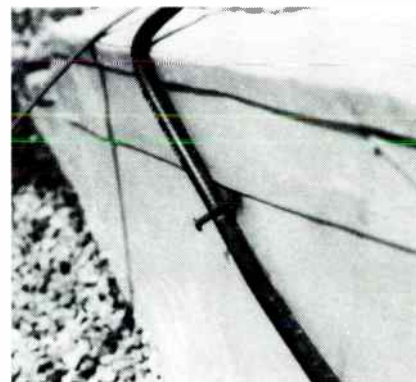

Fig. 5. One example of poor techniques used in old installations.

with sign off at about 4:15 p.m. In an average day, 55 programs were transmitted. This necessitated a reel change every ten minutes throughout the day. Programs ranged in length from 6 to 35 minutes and were repeated often enough that they might be effectively worked into classroom schedules in the 165 schools served by the network.

### Conclusion

Rushed to completion in nine months, the Delaware Network has enjoyed a favorable reception in its first year. In the future, as the operation is refined and programs are produced tailored to Delaware curricula, television will become an increasingly meaningful resource to every teacher. It is hoped that the lessons learned in Delaware will help educators everywhere to benefit from the dynamic medium of television. ▲

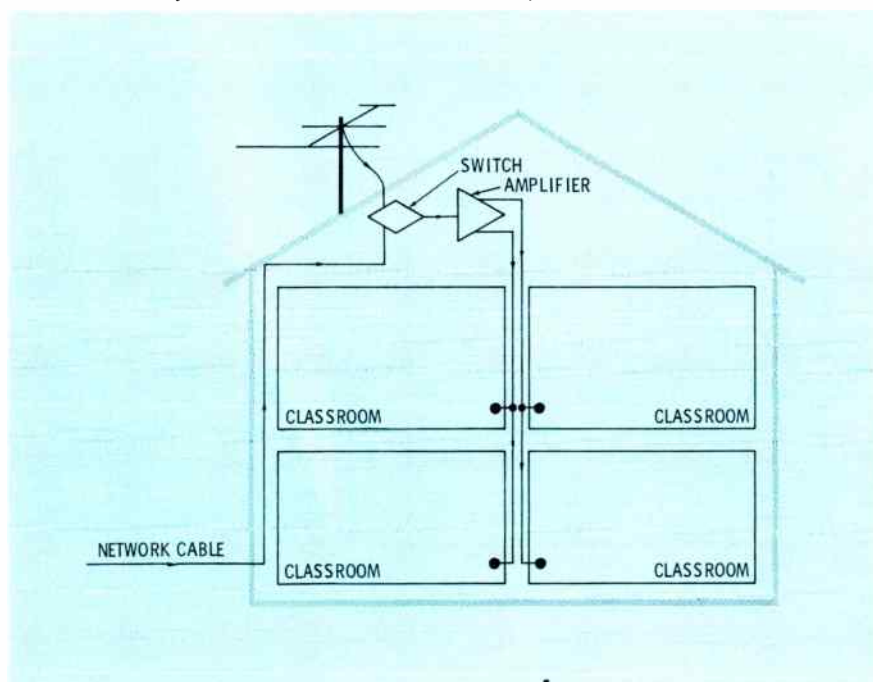

Fig. 6. Each school has been provided with cable and antenna signal sources.

# REDUNDANT REMOTE AMPLIFIER

by *Charles D. Sears*, Chief Engineer, WIAN,  
Indianapolis, Indiana—This inexpensive,  
transistorized unit contains its own spare.

WIAN required a small, inexpensive remote amplifier for a large number of athletic-event originations. Because AC power is frequently unavailable or inaccessible, battery operation seemed desirable. Other requirements were: small physical size, for convenience in carrying the unit long distances; reliability, because of the circumstances under which these broadcasts sometimes originate; and versatility, so that the unit could be applied to various uses. At least two micro-

phone inputs were also necessary, because frequently more than one announcer worked an event.

Our initial thought was to build a simple two-microphone remote amplifier using preamplifiers for each input, and a line amplifier for their combined output. After much thought and reflection upon previous remote-amplifier failure, it occurred to us that the "redundant" concept of construction would not only provide greater reliability and versatility but would be cheaper as well, be-

cause it required only two amplifiers instead of three. Fig. 1 is a block diagram of the unit as conceived.

An unusual feature of the remote unit is the microphone input arrangement ahead of the amplifier networks. This was the result of concern for the two-microphone requirement. If one amplifier failed, the second microphone would be lost without this arrangement. The circuit consists of three microphone inputs, one normalled to each amplifier and a third which can be

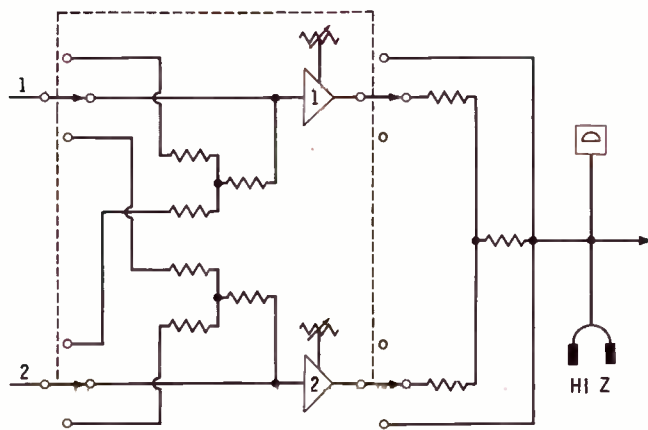
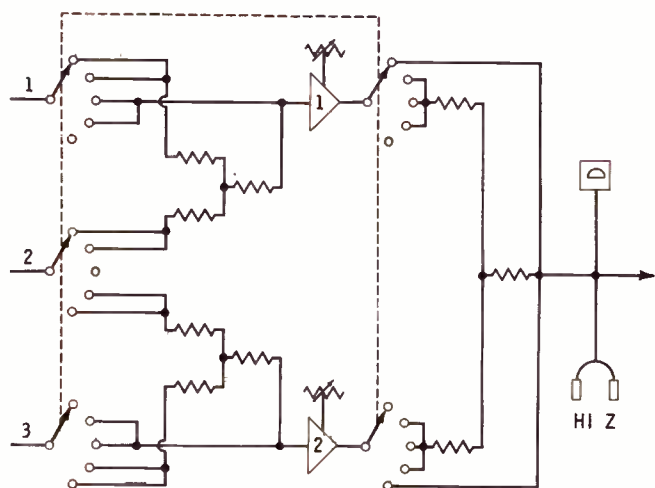

Fig. 1. Microphone No. 2 can be switched to both channels.

Fig. 2. Simpler version provides two microphone inputs.

switched to one or the other amplifier. This arrangement results in a bonus—availability of a third microphone.

Variations of this arrangement are possible. A mixing network could be designed so that either microphone could be switched instantly from one channel to the other. This is shown in Fig. 2. It permits a smaller installation since only two microphone inputs and a three-position, four-gang switch are employed.

In Fig. 1, with the three-microphone input, position one has microphones one and two fed through a mixing network to amplifier one, while amplifier two is disabled. Position two mixes microphones one and two, and microphone three is nor-

mal through amplifier two, with the two amplifiers mixed at the output. Position three is normal with microphone three removed from the circuit. Positions four and five reverse the processes of positions two and one, respectively. The design of the two-microphone network functions similarly. The preceding is for use when low-impedance amplifiers are employed.

When high-impedance-input amplifiers are used, it is not so essential that resistor-type combining networks be used, since mixing two low-impedance microphones seems to have little effect on the impedance mismatch which already is present. The overall response will not be as good as that to be ex-

pected when impedances match, and signal loss is to be expected.

Each amplifier has its own battery so that if one battery fails, the other amplifier can continue to operate. Because the amplifiers are of the transistor type, it is unlikely that a battery would fail with careful routine maintenance, but it is possible, and this contingency is satisfied. A battery-selector switch is incorporated in the overall design to accommodate this feature. If either battery or amplifier fails, it is simple to switch off the defective channel and continue operation on the other unit. It is a good practice to conserve battery life by switching off the channel not used when only one microphone is in service.

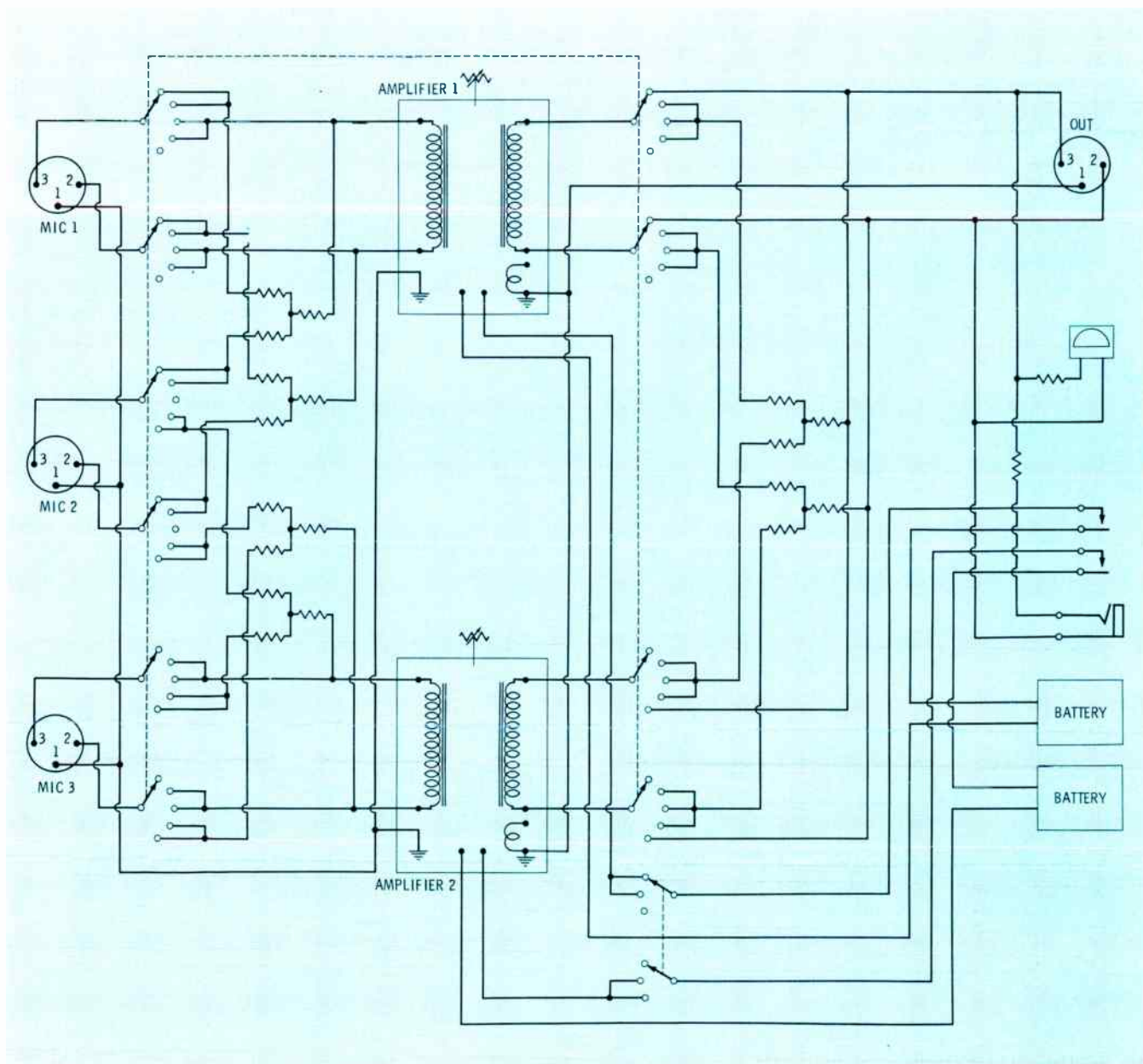

Fig. 3. Complete circuit of balanced redundant amplifier provides sophisticated operation with one ten-gang switch.

The amplifiers used in our unit were the printed-circuit type of commercial manufacture, with either 50 ohms or hi-Z input and 500 or eight ohms output. Each amplifier has its own built-in input and output transformers. Extra matching transformers, therefore, were not required. Output quality of these inexpensive amplifiers has not been exceptional, but has been adequate for speech.

A two-inch decibel-reading volume-level indicator was purchased for the unit, but operators found the meter very hard to read. Therefore, employment of at least a three-inch meter is strongly recommended.

A wiring diagram of the unit as it was originally built is shown in Fig. 3. Values of resistors used in the output mixing circuit are for balanced output. Resistors are of the carbon type,  $\pm 5\%$ ,  $\frac{1}{2}$ -watt.

The concept of this remote amplification unit can be extended to any number of inputs, or channels. Combining networks, however, must be redesigned for each addition.<sup>1</sup>

Because this is, in a sense, a dual-channel amplifier, its use can be easily extended to stereo pickup. This would require an additional meter and a headset with individual wiring for each headset receiver (not the three-wire type, because there is no common and the two amplifier circuits cannot be mixed). Fig. 4 shows how the unit can be made convertible from monophonic to stereophonic operation. Note that this circuit is for the output only. The four-pole, double-throw switch is connected to the output of both amplifiers. In one position it feeds both amplifiers into a combining network and thence to No. 1 meter through a line isolating pad, and on to output No. 1. With the switch in the other position, each amplifier feeds a separate line isolation pad and its associated output terminals, bypassing the output combining network and feeding each earphone separately. In position No. 1 it will be necessary to use monophonic headphones if audio in both earphones is desired.

The choice of line amplifiers is left to the reader for several reasons: excellent commercially manufactured units are available, but individuals may prefer to build them; the quality of the output may very well determine the type of amplifier to be employed; and the impedances of both input and output may be the criteria by which a particular series of amplifiers is selected. For easy maintenance, particularly in the field, plug-in modules appear to be most satisfactory.

Since the WIAN unit was built, we have achieved a degree of operating reliability higher than that of any previous experience. Operators have found the unit very easy to carry, and no time has been wasted searching for AC outlets. Crowds have not kicked loose a power cord, and no remote has been lost because a spare amplifier was not available when the primary unit failed. ▲

<sup>1</sup> Sears, Charles D. "Audio Combining Networks." BROADCAST ENGINEERING, Sept. 1966, page 16.

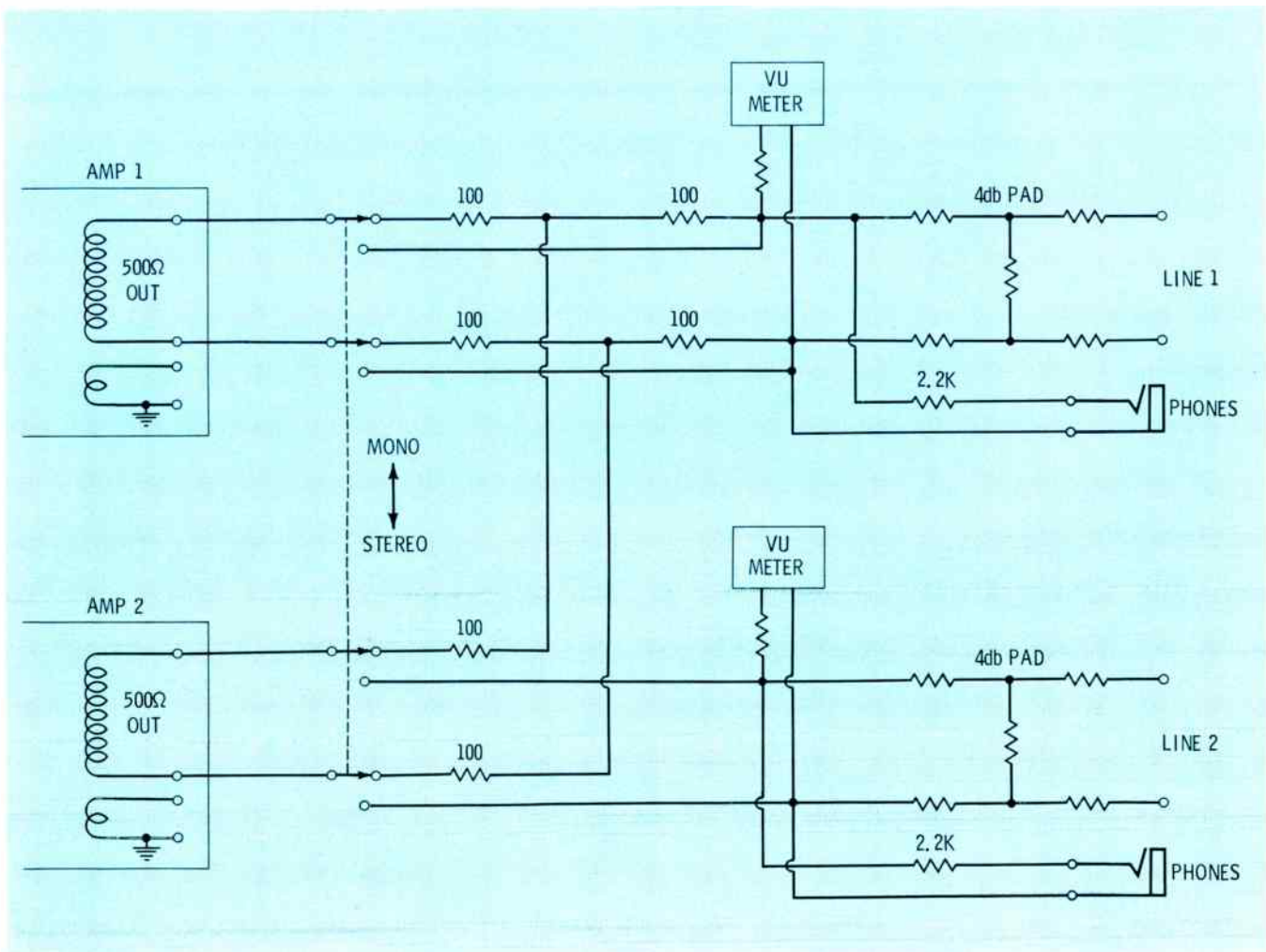

Fig. 4. Output circuit of the redundant remote amplifier modified for operation in monophonic or stereophonic mode.

# 2500-MHz ETV SYSTEMS

By John F. X. Browne, Jr.\*

—Part 3. Fading and transmission systems are the principal subjects of this portion of the series.

## Fading

Fading conditions may be present in any microwave system, and the severity of the fading is related to the length of the path and general atmospheric conditions in the area.<sup>1</sup> A fade margin is usually allowed in the design of microwave systems; i.e., the system is designed so that under normal propagation conditions, the received signal is in excess of the amount required to produce noise-free picture. If, for example a fading of 15 dB will be experienced on a 15-mile path, and the minimum acceptable signal (C/N ratio) is 40 dB, then under normal conditions the system should be designed for a 55 dB (40 + 15 dB) C/N ratio. The amount of the available margin is an indication of system reliability, and, if the margin equals the deepest recorded fade, the system theoretically has a path reliability of 100%.

Usually, it is impractical to design for this degree of reliability; furthermore, in 2500-MHz systems with path lengths of less than 10

miles, fading will not be an important consideration. If it is assumed that noise is just visible in the picture at a C/N ratio of 40 dB, then the design center of 46 dB C/N ratio used in this discussion allows a fade margin of 6 dB.

In practice, the threshold of acceptability is usually quite low, a signal-to-noise ratio of about 30 dB. This is a very noisy picture, but one which people will watch (as determined by subjective testing). If this value is used to make fade margin calculations, the C/N ratio of 46 dB gives a margin of 16 dB or more at all receiving locations in the hypothetical system being considered. This is 6 dB in excess of that required (10 dB) for the longest path of 15 miles.

Assuming, however, that an additional receiving installation is added to the system after the transmission end has been established at an ERP of 20 dBw, and that the path length to this location is 20 miles, the received signal at this location will be, under normal conditions and with a 6-ft dish:

$$P_R = P_{ER} + G_{RA20} - L_{T20} \quad (\text{eq 8})$$

where

$P_R$  = received signal

$G_{RA20}$  = receiving antenna gain at 20 miles

$L_{T20}$  = total losses at 20 miles (path loss + connector loss)

Then,

$$\begin{aligned} P_R &= 20 \text{ dB} + 31 \text{ dB} - 132.5 \text{ dB} \\ &= -81.5 \text{ dBw} \end{aligned}$$

This will yield a C/N ratio of 43.5 dB (125 dBw - 81.5 dBw) which is 2.5 dB below the design center of 46 dB but an excellent picture under normal conditions.

From Table 1 it can be seen that 20-dB fades can be expected over a 20-mile path. This will result in a C/N ratio (under fading conditions) of 23.5 dB (43.5 dB - 20 dB). If the minimum usable signal is defined at a C/N ratio of 30 dB, there is a good possibility that the

\*Brown Associates  
Telecommunications Consultants  
Birmingham, Mich.

Table 1

Path Length	Approximate Maximum Fade Depths
5 miles	— dB
10 miles	2 dB
15 miles	10 dB
20 miles	20 dB



A typical receiving antenna installation shows tower and other components.

signals will be unusable a certain percentage of the time.

The designer must overcome this 6.5 dB deficiency by using a higher gain receiving antenna or a convertor with a lower noise figure, or a combination of both. In this case, an 8-ft receiving dish and a 3-dB improvement in the convertor noise figure would provide the desired fade margin.

The establishment of criteria for minimum acceptable signals should be carefully considered, as should the specific method to be employed in making C/N measurements. There is a wide variation in the methods used to measure C/N ratios. It would be wise to conduct tests on the convertor chosen for the system in order to establish the noise threshold by the system of measurement selected, and by subjective viewing on a known receiver.

Special receiving problems may arise when an intervening obstruction does not permit proper clearances with practical antenna heights. A tall building, for example, may completely obstruct a particular path. Careful transmitter site selection will minimize these problems, but they are often unavoidable in large urban areas.

Several methods are available to overcome this type of problem. Passive repeaters (or beam benders), passive reflectors, and cable relays are often used to provide signals to a location that otherwise would be without service. If permission can be obtained to mount a passive reflector or repeater on a nearby building or structure that has an obstruction-free path, the problem can be solved in a straight-forward manner. If this is not possible, it will be necessary to install or lease a cable from a com-

mon carrier to the nearest school that has good path conditions.

The passive reflector is used to change the path of the signal as shown in Fig. 1. The critical parameters here are the distance between the reflector and the receiving dish, and the size of the reflector. As this distance increases, the size of the reflector must also increase. The reflector should be regarded as a re-radiator of energy with a gain proportional to the effective projected area of its surface.

The gain of a reflector may be calculated from the formula

$$G_R = \frac{4 \pi A \sin \theta}{\lambda} \quad (\text{eq 9})$$

where

$G_R$  = reflector gain

$A$  = area of the reflector in square feet

$\theta$  = angle of incidence

$\lambda$  = wave length in feet

For practical purposes this resolves to

$$G_R = 10 \log (70A) \quad (\text{eq 10})$$

An 8-ft x 10-ft reflector positioned at a 45° angle of incidence to the path has an approximate gain of 38 dB over an isotropic antenna at 2600 MHz. Since the reflector receives and re-radiates energy, the gain in this case is 76 dB (38 + 38).

The path shown in Fig. 1 (A and B) must be considered as two separate paths, AB and BC. The path loss at 2600 MHz for any distance D is given by

$$L_T = 105 + 20 \log D \quad (\text{eq 11})$$

where

$$D = AB \text{ or } BC$$

The following computations are based on path AB of 5.0 miles and BC of 0.1 miles.

	GAIN	LOSS
ERP	= 20 dBw	
Loss path AB =		- 119 dB
Gain Reflector =	38 dB	
Gain Reflector =	38 dB	
Loss path BC =		- 85 dB

$$\text{Gain Rec. Ant (4-ft)} = 27 \text{ dB}$$

$$\text{Misc. Losses} = \frac{-2 \text{ dB}}{123 \text{ dBw} - 206 \text{ dB}}$$

The net signal received will be

$$S = G + L \quad (\text{eq 12})$$

where

$S$  = net signal received

$G$  = transmission path gain

$L$  = transmission path losses

In this case

$$S = 123 \text{ dB} + (-206 \text{ dB}) = -83 \text{ dBw}$$

Assuming a noise threshold of -125 dBw, the C/N ratio is equal to 42 dB (+125 - 83). This is 4 dB below the design center of 46 dB, and an adjustment must be made. A six-ft dish with a gain of 31 dB must be used in order to meet the minimum signal requirements.

Note that although the reflector solved the problem, the size of the unit is 8 ft x 12 ft. This could present mounting problems because of wind loading. Also note that 0.1 mile (528 ft) is a practical maximum at which this size reflector can be used, and that the losses increase rapidly as the distance between reflector and receiver increases. A rule-of-thumb is that space loss increases by 6 dB when the distance is doubled. Thus, if the BC path length were increased to 1056 ft (doubled—a 6 dB loss), the maximum AB path length would be 2.5 miles (halved—gain 6 dB), at which distance sufficient signal using the same components would be available.

Another approach to solving this problem would be the use of two receiving dishes back-to-back, as shown in Fig. 1 (B).

Applying this technique to the previous situation, it will be found that the required repeater gain is 76 dB if a 6-ft. dish is to be retained at the receiver. A 10-ft dish has a gain of 36 dB so that two identical dishes back-to-back would yield a gain of 72 dB (neglecting losses in the inter-connection of the two dishes), which is 4 dB below that required. This loss could be made up by using a 10-ft dish at the receiver. While this

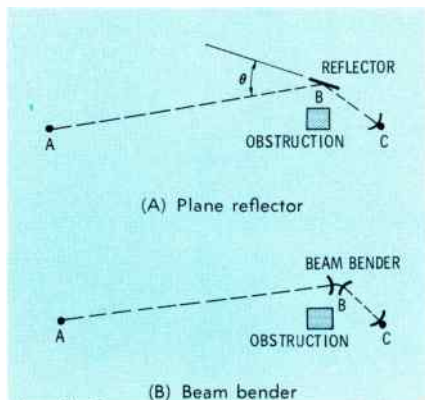

Fig. 1. Two types of passive reflector for directing signals around obstruction.

approach is theoretically sound, the size of the dishes required is very large and may not be practical.

Normally, reflectors or passive repeaters will be practical only when the distance from the repeater to the receiver is relatively small. The choice of either approach will depend primarily upon the specific factors of each case.

### Transmission System

The usual transmitter output power is 10 watts peak visual, although higher power will sometimes be approved by the FCC when a need is established. The desired ERP of the system under consideration was determined to be 20 dBw or 100 watts. Thus, the combination of antenna gain, line and other system losses, and transmitter power must yield an ERP of 20 dBw.

The path profiles made earlier were used to determine both receiving and transmitting antenna heights. We will assume that the transmitting antenna height was determined to be 250 feet, and the transmitter will be located 100 feet from the base of the tower. Also assume that an omni-directional antenna is required to cover all of the receiving locations in this case. The gain of typical antennas varies from 10 to 15 dB, and an antenna of 13-dB is initially chosen for computations in this design.

The combination of transmitter power and antenna gain would then yield an ERP of

$$P_{ER} = P_T + G_T \quad (\text{eq 13})$$

where

$P_T$  = transmitter power output in dBw

$G_T$  = transmitting antenna gain

therefore:

$$P_{ER} = 10 + 13 = 23 \text{ dBw}$$

This is 3 dB above the desired 20-dBw ERP, and allows 3 dB for the transmission line and other system losses. The total transmission line length is 350 feet, and if coaxial line is used, the maximum usable size at these frequencies is 1-5/8 in. This line has a loss of about 1.5 dB/100 ft at 2600 MHz. Therefore, in this application, the total loss would be

5.25 dB ( $3.5 \times 1.5$ ).

In order to achieve the desired ERP it will be necessary to use a lower loss line or a higher gain antenna. Neglecting economic considerations, the next step would probably be the selection of a lower-loss transmission line. Waveguide is the only means available to reduce these losses. Typical waveguide will have a loss of 0.4 to 0.6 dB/100 ft, depending on the type selected and the operating frequency.

Assuming a waveguide loss of 0.5 dB/100 ft, the loss in this system would be 1.75 dB ( $3.5 \times 0.5$ ). In the absence of any other losses, the ERP would now be

$$P_{ER} = P_T + G_T - L_c \quad (\text{eq 14})$$

Where

$L_c$  = cable losses

In this case

$$P_{ER} = 10 + 13 - 1.75 = 21.25 \text{ dBw}$$

which is slightly above the desired 20-dBw minimum level.

In practice, other losses can be anticipated from connectors, transitions from waveguide to coax, and the insertion losses of multiplexing devices when more than one channel is being transmitted over the common antenna system.

The selection of a transmitting antenna, however, involves more than obtaining suitable gain. The FCC requires that power be radiated only in the directions necessary to cover specified receiving locations. While many systems will require an omni-directional antenna, some can be adequately served with directional antennas, and a directional antenna is desirable in cases where it can be used effectively. If, for example, the receiving locations can be covered from the transmitter site with a 180° horizontal pattern, a 3-dB gain can be realized over an omni-directional antenna of the same number of elements or aperture size. Fewer elements or a smaller aperture will be required in the directional antenna, resulting in an increase in vertical beamwidth, which is usually desirable.

Both horizontal and vertical antenna patterns must be carefully considered in system design. As the

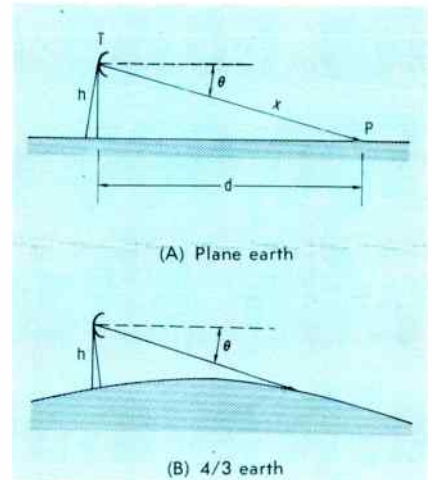

Fig. 2. Effect of a narrow horizontal beam width with a 1° depression angle.

horizontal gain of antennas increases, the vertical beamwidth decreases, and the power available below the horizontal plane (extending from the radiation center) decreases rapidly. The vertical pattern is not uniform, and some very deep nulls are usually present in high-gain antennas.

Consider a horizontally polarized antenna with a vertical beamwidth of 2° and a gain of 14 dB. The antenna will be mounted 250 ft above ground. In this antenna the power will be 3 dB less than the maximum at a depression angle of 1° below the horizon. [Fig. 2 (A)]

The distance from the antenna to the ground may be calculated [for small angles (0° to 10°) where  $\sin \theta \cong \tan \theta$ ] from the following: Since

$$\sin \theta \cong \frac{h}{d} \quad (\text{eq 15})$$

where

$h$  = height of transmitting antenna in feet

$d$  = distance from the antenna



Omnidirectional transmitting antenna is side mounted with UHF unit on top.

# No noise after 500,000 operations with Altec rotary attenuators.

## Here's proof.

No need to get involved in the old-fashioned daily cleaning of contacts when you use Altec rotary attenuators. That's because Altec attenuators *stay* clean, as proved in recent tests. We applied a 15,000-Hz tone at -90-db to the attenuator input and 90-db gain to the output. This test firmly establishes stability, both physically and relative to noise, after repeated long-term operations.

Running the units for 500,000 operations showed no increase over the insignificant residual noise. In a second test, we ran units for 4000 operations, let them idle for four weeks, then repeated the operations to a total of 50,000. Still no noise.

If you think about it, 500,000 operations come out to more than 1370 operations every day of the

year without an increase in noise! But Altec rotary attenuators are even better than that, because they were still going strong and noise-free after 500,000 operations!

So, just for old times' sake, go ahead and clean your Altec attenuators once a year—even if they don't need it!

### Here's why Altec rotary attenuators are best:

**1. Pure silver precision-lapped brushes & contacts.** By using fine (pure) silver instead of copper alloy (coin silver), we eliminate the major cause of noise-causing contaminants. Coin silver oxidizes, reducing conductivity and increasing noise level. Altec's pure silver sulphides, actually forming a wear-reducing lubricant. Pure silver is one reason for Altec's lowest contact resistance, less than 1.0 milliohm! Altec's solid silver contacts are cold-forged, giving them as much density

as silver can have. Compare this to ordinary silver plating of competitive units, which is spongy and easily wears off.

**2. Unique double-nested brushes.** Altec's unique suspension system permits the use of pure silver brushes.

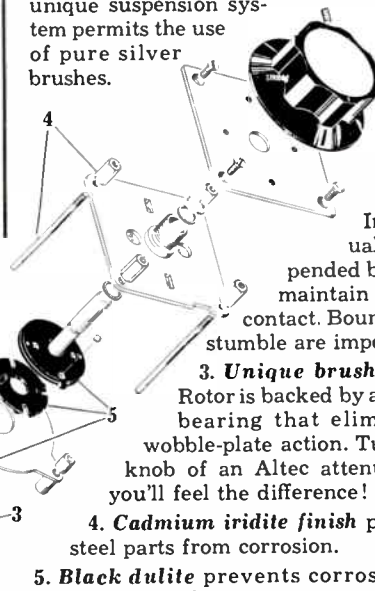

Individually suspended brushes maintain perfect contact. Bounce and stumble are impossible.

**3. Unique brush rotor.** Rotor is backed by a thrust bearing that eliminates wobble-plate action. Turn the knob of an Altec attenuator—you'll feel the difference!

**4. Cadmium iridite finish** protects steel parts from corrosion.

**5. Black dulite** prevents corrosion on cold rolled steel parts.

**6. Thrust bearing** is made of spring brass.

**7. Brush tension springs** are of beryllium copper.

The most commonly needed Altec rotary attenuators are available off the shelf for prompt delivery. Custom configurations made to your requirements. Write for our new precision attenuator literature.

### New gain set now available

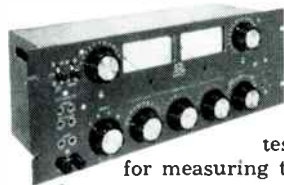

The new Altec gain set is a precision test instrument for measuring the gain, loss, frequency response, and signal level of audio devices. Simultaneous input and output and two VU meters permit simultaneous readings, and the unit can be used for balanced or unbalanced circuits. Write for complete data.



© 1966 AL  
A Division of **LSV** Ling Altec, Inc., Anaheim, California

Circle Item 18 on Tech Data Card

base to the point where the signal strikes the ground in feet

$\theta$  = depression angle

and

$$\sin \theta = \frac{h}{x} \quad (\text{eq 16})$$

when

$x$  = path length from the antenna to the ground

then

$$x \approx d \quad (\text{eq 17})$$

Substituting in (eq 15), we arrive at

$$d = \frac{h}{\sin \theta} \quad (\text{eq 18})$$

or

$$d = \frac{h}{\tan \theta} \quad (\text{eq 19})$$

For small angles

$$\sin \theta \text{ and } \tan \theta = 0.0174\theta \quad (\text{eq 20})$$

therefore

$$d = \frac{h}{0.0174 \theta} \quad (\text{eq 21})$$

then

$$D = \frac{0.011 h}{\theta} \quad (\text{eq 22})$$

where

$D$  = distance from the antenna base to the point where the signal strikes the ground in miles

$\theta$  = depression angle in degrees

Developing (eq 22) for the case at hand

$$D = \frac{0.011 \times 250}{1} = 2.7 \text{ miles}$$

Re-computing the signal calculations for this distance and applying a correction factor for the reduced power available:

	LOSS	GAIN
Space loss (2.7 miles)	114 dB	
Misc. loss	2 dB	
ERP		20 dBW



# IS YOUR VIDEO ON THE LEVEL?

## Solid State Color STABILizing AMPLifier with A.G.C. model VI-500

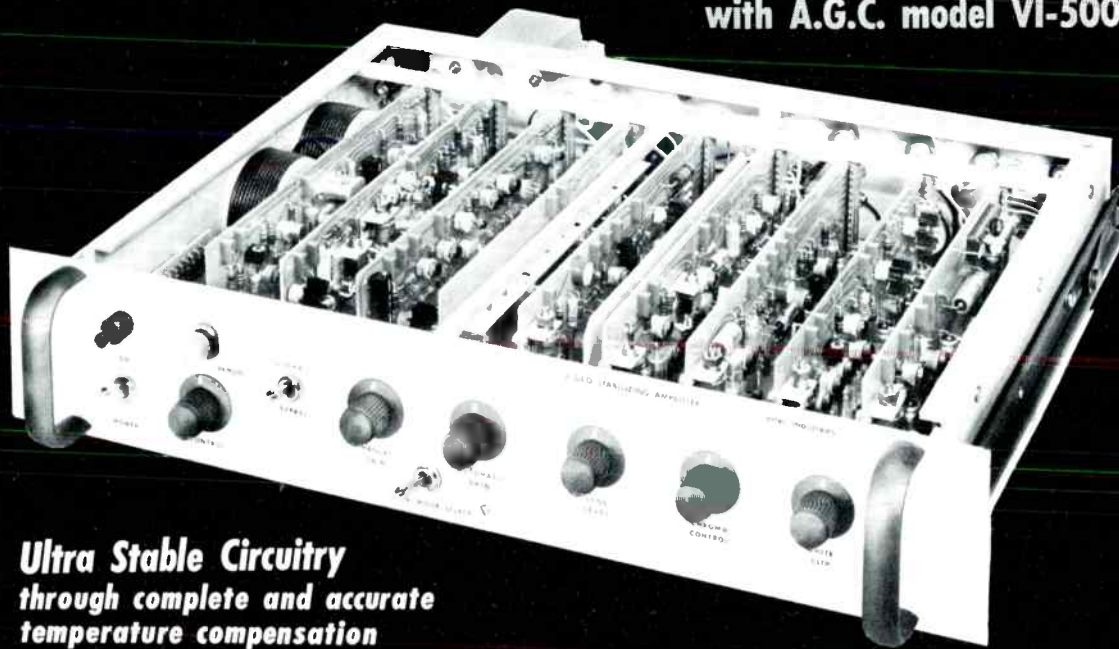

**Ultra Stable Circuitry**  
through complete and accurate  
temperature compensation

### **AUTOMATIC VIDEO LEVEL CONTROL**

Maintains video peaks constant to a preset level, with reference to blanking.

### **CLAMPING**

Sync tip clamps remove hum, tilt and other low frequency disturbances.

### **SYNC LEVEL**

Sync level is maintained at a constant amplitude despite large variations in input.

### **EQUALIZATION**

Accurately compensates for losses in up to 1000 feet of coaxial cable.

### **REMOTE CONTROLS**

Automatic/Manual video gain  
Sync Level  
White Clip  
Chroma Control  
By-pass switch

### **WHITE CLIP**

Adjustable sharp white clip remains fixed with respect to blanking.

### **CHROMA CONTROL**

Chroma response continuously adjustable  $\pm 4$  db. from unity.

### **WHITE STRETCH**

Stretch adjustments provide a high degree of flexibility to compensate for transmitter characteristics.

### **NON-COMPOSITE COLOR OUTPUT**

Mono. or Color non composite output board in lieu of white stretch is available at additional cost.

### **APPLICATION**

Wherever there is video and you want to assure:

- Constant levels
- Constant clean sync
- Elimination of tilt, hum and low frequency disturbances.

Price for the VI-500 \$1,750.00 Remote controls \$150.00 . . . Have you placed your order yet?

GOOD ENGINEERING IS VITAL



Write for complete information and specifications.

## VITAL INDUSTRIES

3614 SOUTHWEST ARCHER ROAD  
GAINESVILLE, FLORIDA—PHONE 372-7254

Circle Item 9 on Tech Data Card

Correction factor 3 dB  
 Rec. Ant. Gain (2-ft dish) \_\_\_\_\_ 21 dB  
 119 dB 41 dBw

the depression angle below the horizontal increases, the radiated power falls off sharply in high-gain antennas because of the narrow beamwidth employed.

For the purposes of this discussion assume that the relative antenna power gain is down 15 dB at a depression angle of 2.5° below the horizon. A school site located 1.1 miles away will receive a signal 15 dB below the value calculated when the effect of the narrow beamwidth is neglected. The signal calculation

would then be:

	LOSS	GAIN
Path loss (1.1 miles)	106 dB	
Misc. loss	2 dB	
ERP		20 dBw
Correction factor	15 dB	
Rec. Ant. gain (2-ft dish)		21 dB
	123 dB	41 dBw

The received signal, therefore, will be (-119 + 41) = 78 dBw.

This is considered satisfactory, since the minimum acceptable input level was previously determined to be -79 dBw. It was originally stated that the 2-ft dishes could be used up to 4.9 miles. However, as

The received signal would be -82 dBw, or 3 dB less than the minimum acceptable; a 4-ft dish, therefore, must be used at this location even though it is much closer than sites requiring a 2-ft dish.

In practice it must be remembered that the depression angle formula gives the distance to the 4/3 earth surface. However, the antenna is not at the surface but elevated to a position that assures the proper fresnel zone clearance. In making computations for depression-angle/beam-width effects, the height of the receiving antenna above sea level should be subtracted from the height of the transmitting antenna above sea level, in order to derive the effective transmitting antenna height.

In cases where many receiving sites are located close to the transmitter site and the transmitting antenna is high, it may be necessary to employ a transmitting antenna that has null fill-in to assure adequate signal levels. Electrical or mechanical beam-tilting may also be employed to reduce the problems by lowering the beam. If, for instance, the farthest receiving site is at 10.0 miles, then from (eq 22)

where

$$D = \frac{0.011 h}{\theta}$$

then

$$\theta = \frac{0.011 h}{D} \quad (\text{eq 23})$$

In this application

$$\theta = \frac{0.011 \times 250}{10}$$

$$= 0.3^\circ \text{ (approximately)}$$

# NEW FROM **EMCEE**



**1KW  
 TRANSLATOR**  
 UHF

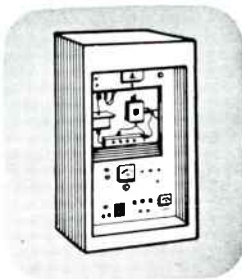

**1KW  
 TRANSMITTER**  
 UHF

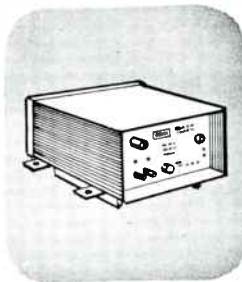

**1 WATT  
 TRANSISTORIZED  
 TRANSLATOR**  
 VHF ONLY

Send for full details . . . now



**Electronics Missiles and Communications Inc.**

160 EAST THIRD STREET, MT. VERNON, NEW YORK 10550

TELEPHONE: (914) 668-3012

Circle Item 10 on Tech Data Card

# "New York's Great New Sound is WNEW-FM—'Where The Girls Are'—backed up by our Scully 280's."

**MAX WEINER**  
Chief Engineer  
WNEW, New York

WNEW-FM is only one of a growing parade of broadcasters who specify SCULLY recording equipment because its superior performance is proven by the toughest test of all; the daily grind of schedules that must be met without a hitch. SCULLY offers the finest solid-state instrumentation available plus **exclusive plug-in construction . . .** for minimum down-time, fast, easy repair when necessary, no complicated wiring disconnects or desoldering. Relays, modular sub-assemblies, electronic chassis solid-state amplifiers are all **plug in.**



"Seven Scully units in our FM control rooms give our recording crew the precision, flexibility and operational ease they demand."



Alison Steele, one of the three glamorous gals who make the new sound on WNEW-FM 14 hours daily.



Mr. Weiner, left, demonstrates Scully 280's to Program Director John Dale.

## SCULLY RECORDING INSTRUMENTS CORPORATION

480 BUNNELL STREET, BRIDGEPORT, CONN. 06607 • TEL. (203) 335-5146

Makers of the renowned Scully Lathe, since 1919 symbol of precision in the recording industry.



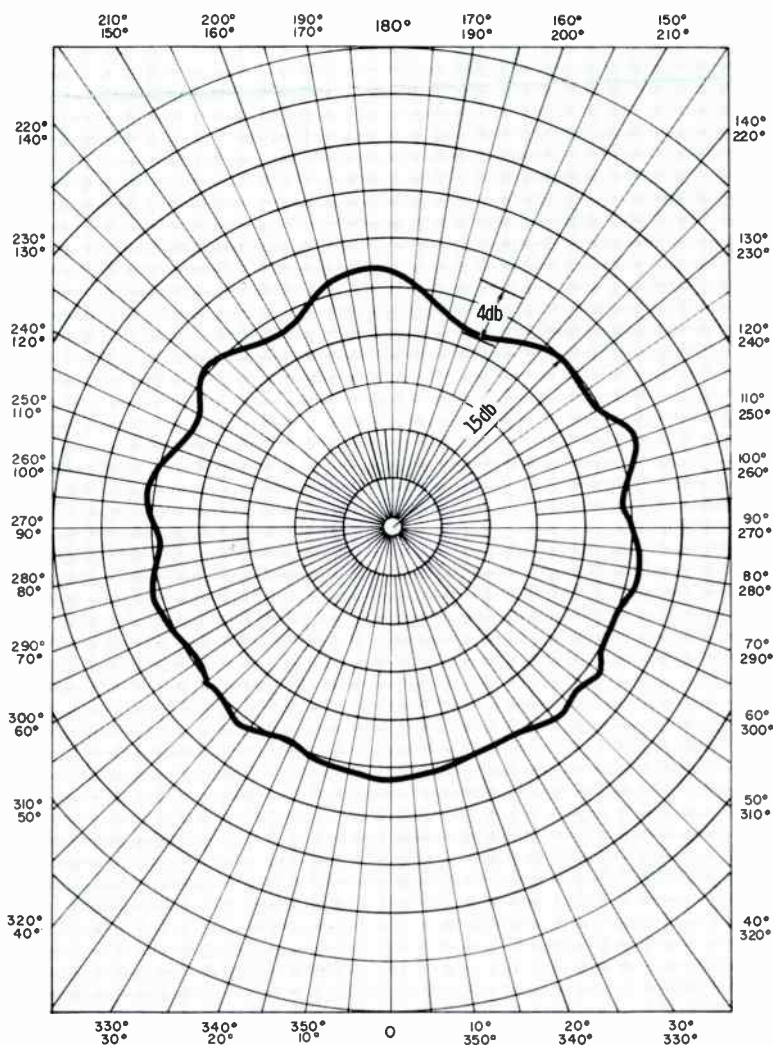

Fig. 3. Omnidirectional antenna pattern shows signal-strength nonuniformity.

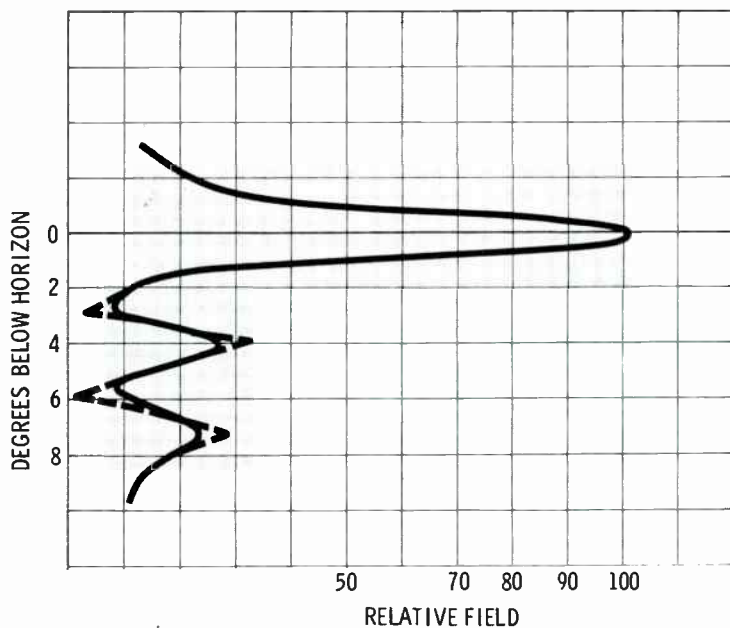

Fig. 4. Vertical pattern of horizontally polarized, very directional antenna.

Knowing also that power is radiated above the horizontal, as well as below, the beam could be tilted  $0.3^\circ$ , plus an amount that would still provide satisfactory signals at this location (normally about  $0.75^\circ$  total).

The horizontal pattern of an antenna is usually not uniform, with typical free space variations of as much as  $\pm 2$  dB from the nominal gain. Fig. 3 shows a typical horizontal pattern with variations as high as  $\pm 2$  dB. Fig. 4 shows a vertical pattern of a horizontally polarized, very directional antenna with relative amplitudes expressed in percentile of relative radiation strength. If the antenna is side mounted on a tower, noncircularity can increase significantly. If the antenna pattern is known with accuracy, the correction factors for noncircularity should be applied to signal calculations.

When using a directional antenna, the horizontal gain in a particular direction may vary considerably from the maximum lobe gain, and correction factors must be applied to signal calculations.

### Conclusion

It is evident from this discussion that there are many factors to be investigated and considered in the design of a good 2500-MHz system. The basic principles of microwave transmission apply to path and signal calculations, while the transmitter-antenna considerations are more typical of ordinary broadcast applications.

The next article in this series will discuss additional planning considerations regarding the use of repeaters, equipment available for 2500-MHz systems, and installation and measurement techniques. ▲

1. For a general reference on this subject, readers are referred to J. J. Igli, "UHF Radio Engineering," *Proc. IRE*, Jan. 1953, p. 115.
2. From time-to-time abnormal refraction charts are published by the Institute for Telecommunication Sciences and Aeronomy (formerly the Radio Propagation Laboratory of the U.S. Bureau of Standards) and are available from the Superintendent of Documents, Washington, D. C.
3. The Standard 0 db level for this work is 1 w.
4. A discussion of predicted fading will be found in a handbook on microwave systems engineering published by Sarkes-Tarzian.

# YOU WON'T FIND A PANIC BUTTON ON A MAGNECORD!



When Magnecord engineered a long list of safety factors into their professional line of tape recorder/reproducers . . . they engineered the emergencies out! A sturdy die-cast mainplate, supporting the transport in every model, insures precise location of internal parts under the roughest operating conditions. Rigid die-cast head mounts eliminate alignment problems. Professional quality hysteresis synchronous

capstan motor and individual reel drive motors are heavy duty models, and the capstan shaft assembly is re-inforced for extra strength and longer life.

While you are taping, safe-guard operating features protect your thinnest tapes. With Magnecord you get top-notch performance and superb fidelity to keep your taping facility operating at maximum capacity, even after years of constant use. Ask a broadcaster who uses one . . . MagneCORDs are built to take it!

Write now for the full story on the complete line of durable quality MagneCORD tape instruments.

*MagneCORD 8+ Reels now available from Audiotape®. See your local dealer.*



#### MAGNECORD MODEL 1021

Fully transistorized professional tape recorder/reproducer for monaural operation. For use in main or production control room.



#### MAGNECORD MODEL 1022

Fully transistorized professional tape recorder/reproducer two channel (stereo) for use in main or production control room.



#### MAGNECORD MODEL 1028

Professional quality 2 channel (stereo) tape recorder/reproducer for recording master tapes. (10½" reel capacity) Available in ½- or ¼-track.



#### MAGNECORD MODEL 1048

Professional 2 channel (stereo) recorder/reproducer for use in main studio, production studio or conference recording. (10½" reel capacity) Model 1048 is available in ½- or ¼-track.

**MagneCORD**

® DIVISION OF THE  
TELEX CORPORATION  
P. O. Box 1526 / Tulsa, Oklahoma 74101

MANUFACTURER OF TELEX HEADSETS  
AND OTHER FINE ACOUSTIC DEVICES

Circle Item 12 on Tech Data Card

## Grounding Towers

(Continued from page 13)

ground-system resistance would be reduced by approximately 25%. The new value for the system resistance would be about 30 ohms.

Through chemical treatment, soil resistance can be reduced from 15 to 90%, depending on the texture of the soil. The larger reductions occur in soils of high resistivity. A rock formation is impermeable to chemicals, so only a moderate reduction in the resistivity of the surface soil and a corresponding reduction in the voltage gradient can be expected.

A further reduction in resistance is possible by using ground rods. (See Fig. 3.) These are, however, difficult to install in rocky terrain. If 12 ground rods (or tubes) of 1-inch diameter (1.3-cm radius) are spaced 50 feet apart, at a radius of 100 feet from the center of the tower, each rod 10 meters long and bonded to a buried radial wire, then the resistance to ground of each rod may be expressed as:

$$R = \frac{\rho}{4\pi\gamma} \log \frac{2\gamma}{a} \quad (\text{eq 7})$$

where,

$\gamma$  = the half-length in meters

$a$  = the radius in meters

From this formula, it can be determined that individual rods will have a resistance of 532 ohms. Twelve such rods will have a combined resistance of approximately 8% of the value for a single rod, or about 43 ohms. The resistance of a buried wire system was calculated to be 30 ohms. The two systems in parallel yield a combined resistance of about 18 ohms.

Considering voltages again, a ground-system resistance of 18 ohms and a stroke current of 100,000

amperes will produce a voltage at the tower base of  $1.8 \times 10^6$  volts. If this voltage is substituted in eq 1, the equation may be solved for an equivalent earth resistivity produced by the ground system.

$$\begin{aligned} E &= \frac{\rho I}{2\pi B} \\ \rho &= \frac{2\pi B}{I} E \quad (\text{eq 8}) \\ &= \frac{6.28 \times 9}{10^5} 1.8 \times 10^6 \\ &= 1000 \text{ meter ohms} \end{aligned}$$

The field intensity, or gradient, for this condition is

$$\begin{aligned} e &= \frac{\rho I}{2\pi B^2} \quad (\text{eq 9}) \\ &= \frac{10^3 \times 10^5}{6.28 \times 81} \\ &= 2 \times 10^5 \text{ volts/meter} \end{aligned}$$

at the side of the tower. Application of eq 3 shows that for  $\rho = 1000$ , ionization of the surface soil will exist out to a distance of 11.2 meters from the side of the tower. A person would be in danger out to some greater distance. Let us consider a distance of 45 meters out from the side of the tower and find the voltage gradient from the voltage drop across an interval of five meters. For  $\rho = 1000$  meter ohms, and a maximum stroke cur-

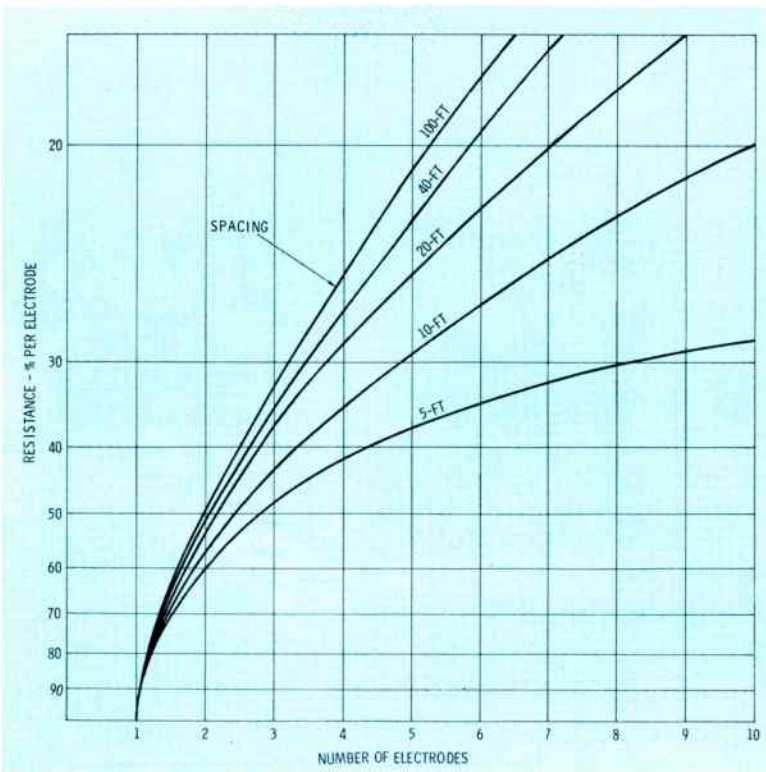
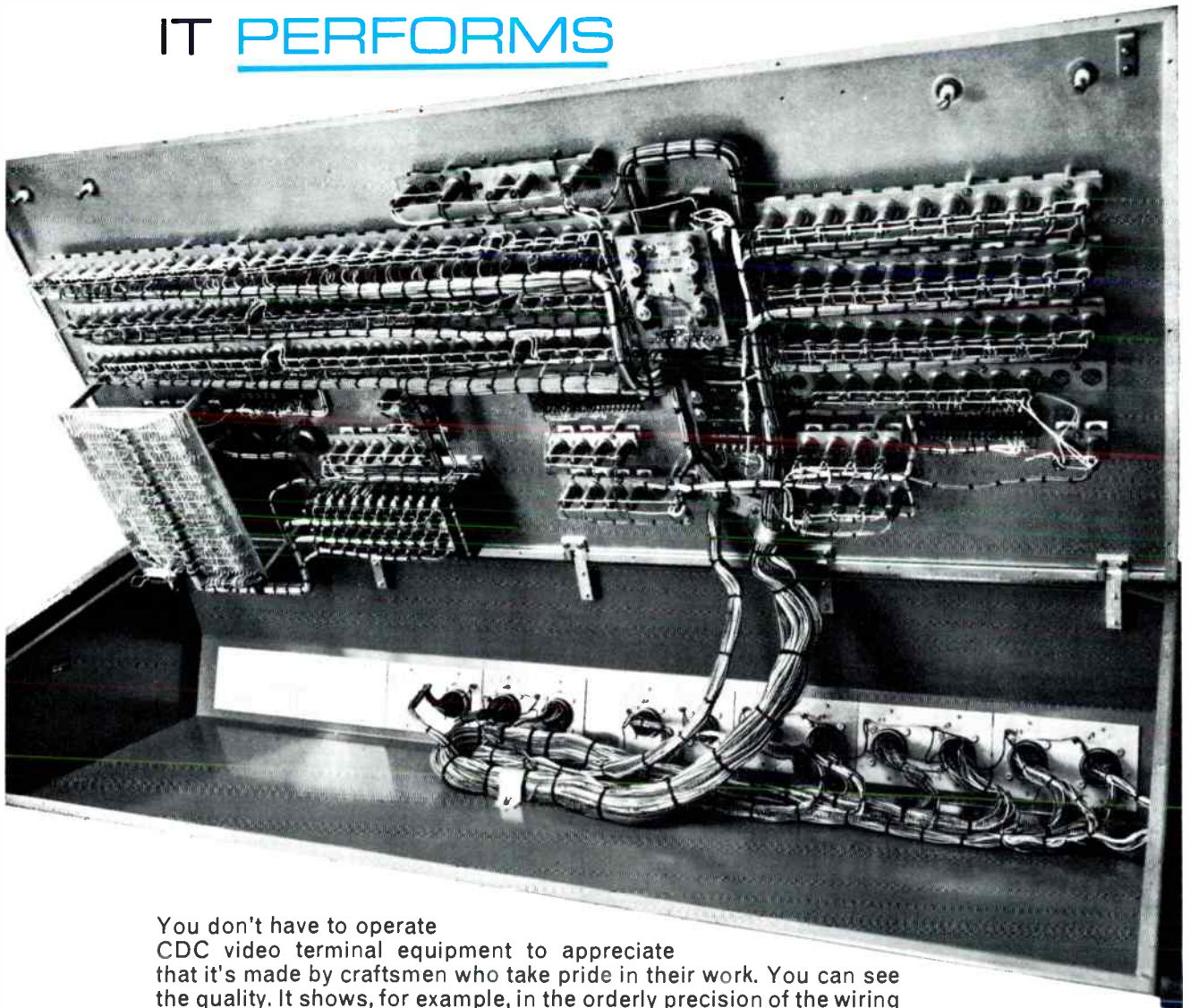

Fig. 3. The number of electrodes and the spacing between them both contribute toward the efficiency of a ground system which employs driven copper rods or tubes as its elements.

THIS IS WHAT  
QUALITY LOOKS LIKE.  
OVER 40 TV STATIONS  
IN THE U.S. KNOW HOW  
IT PERFORMS



You don't have to operate CDC video terminal equipment to appreciate that it's made by craftsmen who take pride in their work. You can see the quality. It shows, for example, in the orderly precision of the wiring—a far cry from the usual helter-skelter tangle. Every piece of CDC equipment is a precise, skilled interpretation of the most sophisticated designs in the industry. Naturally, quality of product is reflected in quality of performance. CDC custom-designed equipment meets or exceeds the most stringent performance specifications.

CDC video terminal equipment is crafted in Canada, sold and serviced in the United States by our own people. Over 40 TV stations in the U.S. have installed it in the past year alone. Ask any one\* of them how they feel about it. Then we're pretty sure you'll want to see us.

\*Closest installation to your area supplied on request



**CENTRAL DYNAMICS CORPORATION**

HEAD OFFICE: 903 Main St., Cambridge, Mass. 02139

Circle Item 13 on Tech Data Card

rent of  $10^5$  amperes, the voltage drop would be (from eq 4)

$$V = \frac{10^5 \times 10^3}{2 \times 3.14} \left( \frac{1}{45} - \frac{1}{50} \right)$$

$$= 3.5 \times 10^4 \text{ volts}$$

The voltage drop per meter, or gradient, is then  $35,000/5$ , or 7000 volts per meter. This would produce a current through the body (from eq 5) of

$$\frac{3.14 \times .07 \times 7000 \times .5}{1000}$$

$$= 0.77 \text{ amp}$$

This value is above the dangerous level. It could be reduced further by putting a thin layer of high-resistivity material (such as gravel or crushed stone) over the surface, or by providing wooden walkways. A layer of crushed stone with a resistivity of 3000 meter ohms will have little effect on determining the voltage gradient, but it will reduce the conduction of current through the body. The new value for this current is

$$\frac{3.14 \times .07 \times 7000 \times .5}{3000}$$

$$= 0.26 \text{ amp}$$

This approaches the "safe" value. For this condition, the property could be regarded as "safe" at distances exceeding 50 meters from the tower. The "average" lightning-stroke current is about 20,000 amperes; for this value the property would be "safe" at distances greater than 25 meters from the tower.

This article will conclude in next month's issue with a discussion of radial systems, buildings adjacent to towers, and the case of tall buildings which are used to support transmitting antennas. ▲

### References

<sup>1</sup> H. A. Pochler, "The Effects of Electric Shock," *Electronic Engineering*, May 1945.

<sup>2</sup> E. D. Sunde, *Earth Conduction Effects in Transmission Systems* (D. Van Nostrand Co.)

<sup>3</sup> Lewis, *Protection of Transmission Systems Against Lightning*, (Wiley Co.)

<sup>4</sup> H. Leyburn, "Continuity of Electricity Supply," *I.E.E. Proceedings* Vol. 101, Pt. I, 277.

<sup>5</sup> R. Rudenberg, "Fundamental Considerations on Ground Currents," A.I.E.E. Booklet *Grounding Principles & Practice*.

<sup>6</sup> Davis & Johnston, "The Surge Characteristics of Towers and Tower-Footing Impedances," *Journal I.E.E.*, Vol. 88, Pt. II.

<sup>7</sup> G. H. Brown, R. F. Lewis and J. Epstein, "Ground Systems as a Factor in Antenna Efficiency," *Proceedings of the Institute of Radio Engineers*, June 1937.

## From ColorTran...

Solid-State Dimming Control Systems for Television and Theatrical Lighting...

Flexible modular design to meet all lighting control requirements.

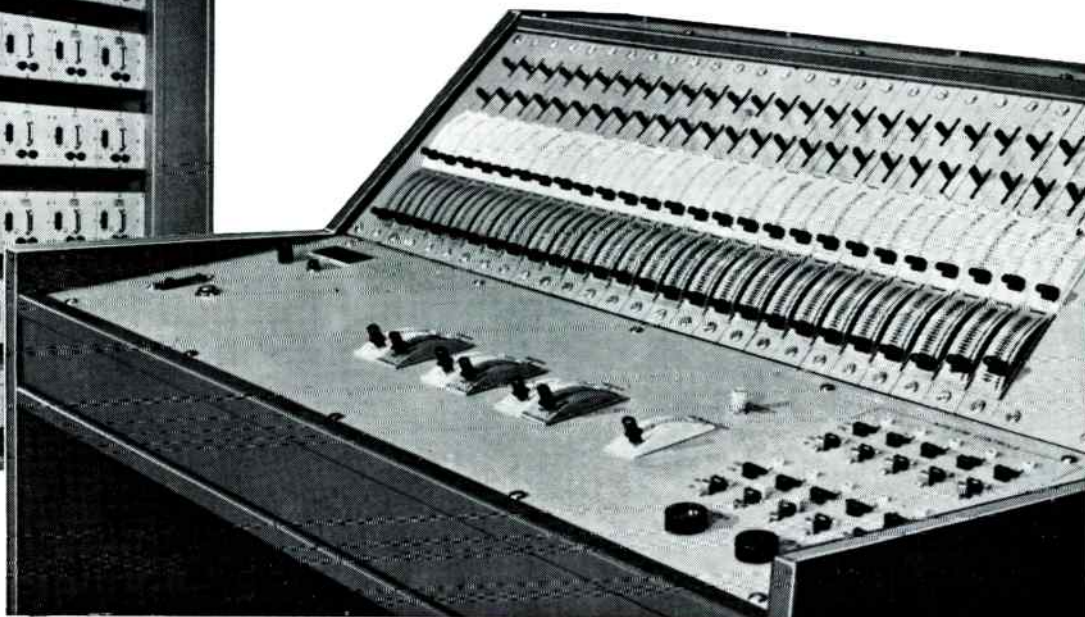
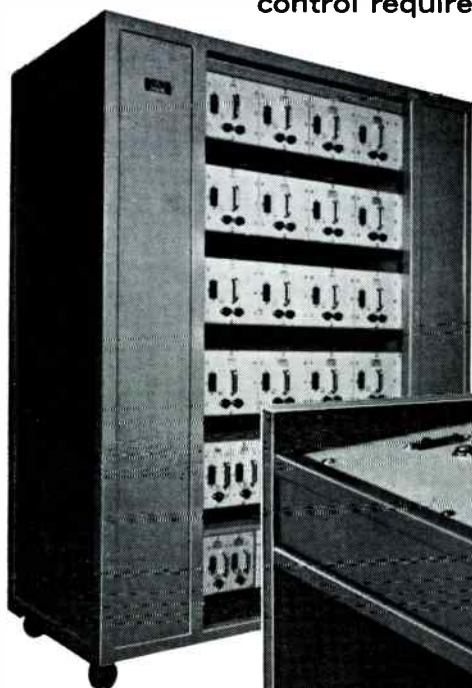

(213) 843-1200  
1015 Chestnut St. Burbank, California

A BERKEY PHOTO COMPANY



*Inquiries will receive prompt attention.*

Circle Item 14 on Tech Data Card



# MEMO

TO: General Manager  
FROM: Director of Engineering

Like for you to look over this Computer-Programmer. I've been checking into what's available and this looks like the one for us. for several reasons:

1. It's a pretty sophisticated system. We could integrate our entire studio operation—master control switching, studio switching, audio functions, machine controls—the whole works.

2. All the peripheral equipment—machine control interfaces, video and audio switching gear, etc.—comes with it.

3. Most important—it works! It's made by Sarkes Tarzian, Inc. in Bloomington, Ind. They're the only ones I've found with actual computer experience in broadcasting—in both large and small stations. This 4th generation model of theirs has all the bugs worked out. Looks like they meet our basic criteria: they've got the experience, the equipment, and they've applied both.

What do you think?

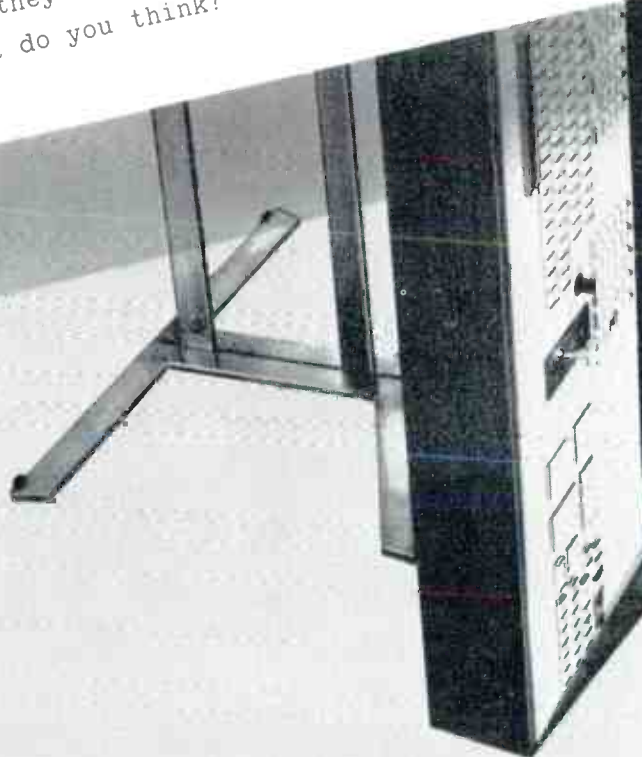

## Give your tapes and mats a clean start!



**New AE-100 Automatic Degausser erases 12" or less tape reel or up to 100 CUE-MAT\* mats in 50 seconds.**

The AE-100 is motor driven and completely automatic. It provides uniform, complete erasure for 1/4" tapes and mats without the guesswork of other degaussers. Shuts itself off automatically. Load it. Start it. Forget it.

What's more, the AE-100 is compact, lightweight, and practically priced. Ask your distributor or write Ampex Corporation, 401 Broadway, Redwood City, Calif. 94063.

\*TM-Ampex Corporation

# AMPEX

Circle Item 16 on Tech Data Card

## Unsurpassed!!!

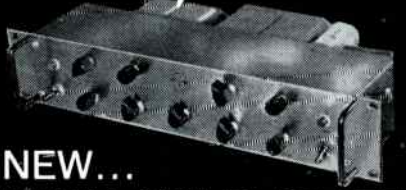

## NEW... LANG SOLID STATE PROGRAM EQUALIZER

Unsurpassed in design, performance and versatility, the new LANG SOLID STATE PROGRAM EQUALIZER PEQ-2 incorporates the finest features found in quality equalizers,

### PLUS THESE EXCLUSIVE FEATURES...

- Eight low boost shelf frequencies • Four low droop shelf frequencies • Eight high boost peak frequencies • Six high droop shelf frequencies • Frequency select switches and equalization controls for all boost and droop functions • All controls and switches may be used simultaneously • Low frequency peak boost by use of boost and droop controls • Equalization "on" lamp indicates when equalization is taking place • Engraved stainless steel panel blends harmoniously with other equipment • Plug-in transistor amplifier and power supply cards • Compact size: 3 1/2"x19".

For complete details and new Lang Catalog write:

**LANG ELECTRONICS INC.**  
507 FIFTH AVE., N.Y. 17  
For all your audio needs - look to Lang!

34 Circle Item 18 on Tech Data Card

## VITS Corrections

Pat Finnegan, author of "Vertical Interval Test Signals," has called our attention to some errors that occurred in the publication of the article, which appeared in the August 1966 issue of BROADCAST ENGINEERING.

On page 21, the first line of the second paragraph should read, "The  $\sin^2$  pulse is developed . . ." The sentence beginning in the fourth line of the same paragraph should read, "The cycle starts from the zero-voltage axis, increases in amplitude until it reaches its positive peak, decreases from that point until it reaches the zero axis, changes polarity and increases in negative voltage until it reaches the negative peak, and decreases in voltage until it returns to the zero axis."

In Fig. 3C, 0.254  $\mu\text{sec}$  should be 0.25  $\mu\text{sec}$ ; in Fig. 3D, 0.1254  $\mu\text{sec}$  should be 0.125  $\mu\text{sec}$ , and 0.254  $\mu\text{sec}$  should be 0.25  $\mu\text{sec}$ . In Fig. 4A, the rise time on the left should be 0.25  $\mu\text{sec}$ .

On page 40, the drawings for Figs. 6 and 7 should be interchanged to agree with the text and captions. In the figure which was shown as Fig. 6, the statement "Ringing caused by vertical side-band filters . . ." should read, "Ringing caused by vestigial side-band filters . . ."

An added point that should be made is that most present-day generators can be obtained with a VITS capability.

And finally, the correct call letters of the stations of which Mr. Finnegan is chief engineer are WLBC, WLBC-TV, and WMUN (FM), Muncie, Indiana. ▲

## HAVE A CAMERA?

or access to one?

We have a continuing need for 4" x 5" color transparencies for use as cover illustrations. And we pay cash for those we use. If you know of an interesting scene relating to a technical aspect of broadcasting, here is your opportunity to see it on the cover of Broadcast Engineering—and earn some cash at the same time!

## About the Cover

**Broadcast Engineering**  
The technical journal  
of the broadcast  
communications industry



South and west of Salt Lake City, Utah lie the towering mountains of the Oquirrh Range. On a rock pinnacle in this range, at an elevation of 8300 feet, KBYU-TV has completed its antenna installation: a 46-foot, four-legged, braced, galvanized-steel tower that supports a 52-foot, 24-inch diameter helical antenna. The antenna telescopes eight feet into the tower in such a way that three-degree interval rotation is permitted at the base for signal directionalization, and tilt of ten degrees may also be accomplished. The tower foundations and coaxial cable anchors are drilled into the rock in order to provide 125-mph wind protection.

The unique feature of the installation is the long (870 feet) flexible coaxial lead from the transmitter to the antenna. This was required because the nearest possible transmitter site is on a levelled ground area several hundred feet below the pinnacle.

The cable, five inches in diameter, has been constructed as a catenary span, sags 35 feet from a straight line, and is stretched between a 90-foot antenna tower and a 15-foot base tower. The coax is supported between six radially spaced stands of 1/2-inch high-strength galvanized-steel cable clamped to the Heliac® on six-foot, eight-inch centers. The coaxial cable can translate freely in a lateral direction under severe wind conditions without rotation and without destructive strains. ▲

**8** reasons why we call new  
 “Scotch” Video Tape No. 399

**color  
 tape  
 plus!**



**1. Livelier, truer colors:**

Colors appear brighter, clearer, life-like. Up to 5db better signal-to-noise ratio for multiple generation copies. New oxide, new binder, new coating technique make this possible.

**2. Stronger black & whites:**

Compatible high fidelity resolution with startling presence. Minimal background interference or blur. It's a picture that's truly *alive!*



**3. Longer life:** Capable of 2,000 passes with no oxide rub-off or increase in dropouts; no visible indication of head to tape contact. Almost impossible to wear out. Virtually unlimited shelf life.

**4. Improved sound:** Dynamic range is substantially improved across the sound spectrum. Tape background noise is significantly reduced. New No. 399 gives you living sound to match the picture!

**5. Cleaner running:** Will not shed, block or rub-off. Leaves no oxide deposit on heads or guides. Assures better results—averages less than 15 dropouts per minute.



**6. Perfect copies:** Create up to 4th generation duplicates that only the most experienced eye can distinguish from the master tape.

**7. Total versatility:** Can be used for both high-band and low-band recording. Recorders need no special adjustments or setups.

**8. Field proven:** Thoroughly tested and proven in actual broadcasting use by networks, local television stations and production studios.



**Scotch Video Tape No. 399**

opens a new dimension in video quality. Delivers the believability and presence of live broadcast with the advantage of instant playback. Provides “see it now” control of program content.

**color  
 tape  
 plus!** adds a new  
 dimension to  
 your programming.

**FIND OUT HOW** Color Tape Plus adds a new dimension to your programming. Write: 3M Company, Magnetic Products Division, St. Paul, Minn. 55119.

**Magnetic Products Division 3M**

“SCOTCH” IS A REGISTERED TRADEMARK OF THE 3M COMPANY.

# REDUCING DISC PLAYBACK DISTORTION

by Lewis A. Edge, Jr.\*—New developments in record playback equipment, proper adjustment, and good maintenance can improve this important sound source.

In recent years, home receiving equipment has been improved to a stage of development previously known only to high-fidelity enthusiasts. Consequently, the public has become more sound conscious. Recognizing that better equipment was in many homes, a well known music magazine conducted a poll to determine which was the best-sounding FM station in the New York area. How would your station rate if a similar poll were conducted in your area?

The better-sounding home equipment demands more from the broadcast station. Required proof-of-performance measurements and routine response, noise, and distortion measurements help to warn the engineer when the audio console and transmitter are deficient, but these tests omit the sound source that provides the greatest part of most stations' programming — turntables, arms, and cartridges. These also need to be examined, and in view of improvements and developments in professional equipment, perhaps to be replaced.

Pickup cartridges, for example, have been enhanced in quality. If cartridges are more than three or four years old, it is quite possible that much better sound can be achieved by replacing them with one or more of the new stereo models. This may involve the design and installation of impedance-matching networks, however, to compensate for turntable preamplifier or equalizer input-impedance demands which, in older units, are usually of much lower value. Matching can also be accomplished by changing the input characteristic of the preamplifiers

or equalizers. There is also a possibility that the vertical-component signal of stereo cartridges will introduce second-harmonic distortion in the form of background noise, but installations observed have not indicated this to be a problem.

Also, modern pickups and arms can track correctly with forces of less than three grams. Lighter pressures not only save records, but permit much longer stylus life. The mass of the stylus assembly and the transducer must be accelerated, stopped, and accelerated again in the reverse direction several thousand times a second to reproduce music faithfully. Greater moving mass requires more pressure to keep the stylus in the groove. Also, the groove walls must do all of the work related to stylus movement. A heavy stylus assembly will crush through and smooth out the delicate high-frequency engravings on the soft groove walls. Therefore, it is not the heavy tracking force, but the high stylus-assembly mass that is mainly responsible for the damage.

One of the effects of an excessively heavy stylus assembly is loud "needle talk." Most of the sound known as needle talk is actually a vibration of a portion of the record in contact with the stylus. Needle talk should be no more than barely audible when a loud passage of music is played (with speaker muted) in a quiet room.

Another cause of loud needle talk is poor cartridge compliance (the ability of a stylus to move laterally and vertically in the groove). The rubber-like damping material in a cartridge provides the necessary restoring force to the stylus assembly and helps to reduce resonances and

subsequent peaks in frequency response. If the cartridge design requires very stiff damping, it will also require a heavy stylus force to track the middle and lower frequencies. Therefore, a good cartridge will have low moving mass and high compliance. These factors do not in themselves constitute a good design. They do, however, contribute to better high-frequency response and lower tracking pressures required for clean tracing of the groove modulation.

Low tracking pressures, while solving some problems, create others. Stylus assemblies are more easily damaged, and the design and maintenance of the pickup arm is more critical. Both vertical and lateral bearings must have very low friction, and the wires connecting the arm to the preamplifier must not interfere with free movement of the arm. Most new pickup arms are designed to accommodate the newer cartridges, and many of the older arms are usable. When in doubt, adjust the tracking pressure for slightly less than zero so that the stylus is about  $\frac{1}{8}$  inch above a record. With many arms, the simplest way to do this is to place a number of small weights (coins, for example) on the counterweight side of the pivots, sliding them closer to or farther away from the rear of the arm to obtain the desired results. The arm should then move freely in both vertical and lateral directions, but should not swing, on its own, either toward the center or toward the outside of a record if the turntable is level.

Regardless of the cartridge being used, tracking error is an important factor to be considered. A deviation from perfect tangency between

\*Chief Engineer, WGKA and WGKA-FM, Atlanta, Ga.

the axis of a cartridge and the record groove can cause distortion. This is especially true of the inner grooves of a record where more information is recorded in less space. A minimum-distortion orientation of the base of the arm may be achieved as is shown in Fig. 1. A proper adjustment will result in minimum tracking error where such error has the greatest effect.

To reduce playback distortion further, check for any vertical tilt between the stylus and the record. The apparent angle of tilt is doubled by placing a mirror under the stylus as shown in Fig. 2.

The recording industry has standardized the vertical cutting angle at  $15^\circ$ . Most of the newer cartridges are built to conform to this standard. The arm should be perfectly parallel to the record surface with the stylus in the groove when one of these cartridges is used (Fig. 3).

To adjust stylus pressure properly (after all of the other necessary arm and cartridge adjustments have been made), set the tracking force to the minimum recommended by the cartridge manufacturer. Play a disc with high-level modulation, and listen for break-up or distortion. Increase the tracking force in small increments until the distortion and break-up is no longer heard. Once again, check the tracking force. If the force exceeds the maximum recommended by the cartridge manufacturer, either the cartridge is defective or there is something wrong with the arm. An inexpensive and accurate stylus force gauge (with instructions) is available for about \$1.00 from most hi-fi or professional-audio-equipment dealers.

To check cartridge response and preamplifier equalization, a good test record is necessary. The writer uses the \$10 CBS Laboratories BTR-150 test record, which was designed for broadcast use, and provides information for several tests. There are a number of other test records available. If a test record has been used very much, however, it probably will need replacing before meaningful measurements can be achieved. The amplitude of the high-frequency test bands is reduced somewhat with each play, even when good, light-tracking arms and cartridges are used.

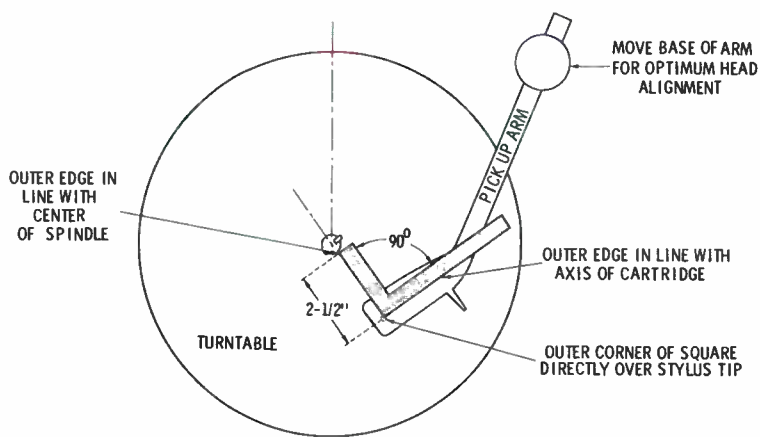

Fig. 1. Proper arm orientation is important in the reduction of record wear.

If the equalization in a cartridge preamplifier is adjustable, and if the cartridge being used is free from extreme response peaks, the controls can be adjusted to provide a reasonably flat response. Most of the newer stereo magnetic cartridges are made to work into 47,000 ohms. If the equalization on the cartridge preamplifier is not adjustable, the high-frequency response of a magnetic cartridge may be increased or decreased somewhat by increasing or decreasing the value of the load resistors. Frequency response of  $\pm 2$

dB from 30 Hz to 20 kHz is not an unreasonable measurement to expect from some of the better stereo cartridges.

Many stations employ the General Electric VR-2 cartridge. It has been widely employed for a number of reasons, among them the facility for quick stylus change. Two models of the unit were manufactured, a high-impedance version and a professional unit of about 1500 ohms. (In these units, model or type number is not marked on the

• Please turn to page 54

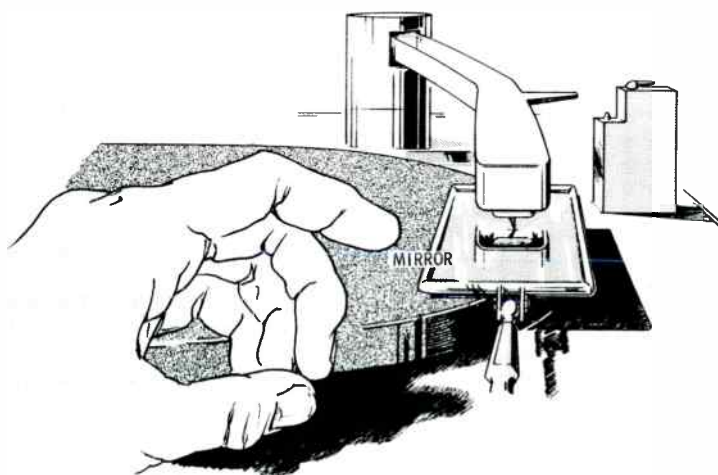

Fig. 2. Lateral tilt is easily measured with a mirror used to double angle.

**RCA**  
NEW  
LOOK



FILM CAMERAS AND PROJECTORS

TV TAPE EQUIPMENT

TRANSMITTERS

# RCA...the

*"MATCHING" MEANS A BETTER INVESTMENT*

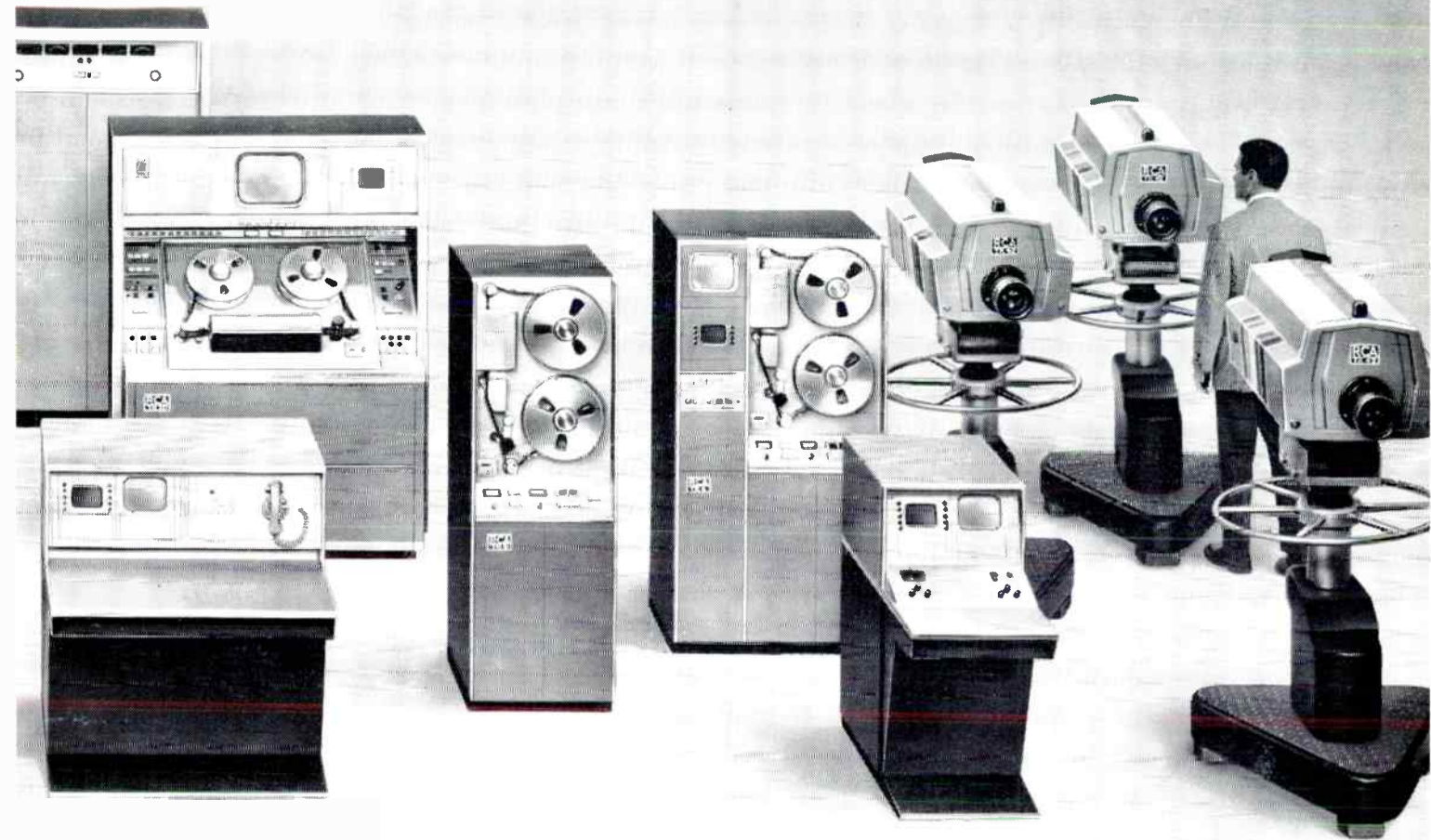

CONTROL CONSOLES, SWITCHING AND EFFECTS

LIVE CAMERAS

# matched line

The "Matched Line" is the end result of a multi-million-dollar engineering program to produce a new generation of broadcast equipment. RCA Matched Equipment reflects the newest in styling, performance and operation.

Matching means equipments that are designed to provide the ultimate in performance when used together... equipments that are designed and styled to fit together efficiently, and to provide the finest, most modern appearance for the whole station. It means installations that are compact, yet easily expandable, that offer greater reliability, and that provide for easy operation and maintenance. It means simplicity in ordering, easier follow-up and guaranteed satisfaction... from one factory, one ultimate source of responsibility, one set of designers and engineers. And it means equipment that is designed for tomorrow, assuring a better investment.

If owning equipment that performs and looks better together, and lasts longer, appeals to you, why not consider RCA's Matched Line? From "big tube" cameras, advanced quadruplex recorders, film and slide projectors... to transistorized switching, controls, transmitters and antennas, the RCA Matched Line is a good thing, all the way, for you.

*See your RCA Broadcast  
Representative. Or write RCA  
Broadcast Television Equipment,  
Building 15-5, Camden, N. J.*



**The Most Trusted Name in Television**

World Radio History

# THE BROADCAST ENGINEER AND THE NEC

by C. G. Cunningham\*—Every broadcast engineer is directly affected by provisions of the National Electrical Code or similar regulations.

Most broadcast engineers feel that if they can avoid violating FCC regulations they should have no regulatory worries. Unfortunately, this is not true! There are 433 pages of additional regulations affecting the technical side of broadcasting. These are the National Electrical Code (NEC), published by the National Fire Protection Association.<sup>1</sup> It is an American Standard (ASA C1-1965), and, in most states, slightly modified versions of the NEC are the law of the land, forming the heart of the laws that regulate electrical construction. In many states these laws have teeth; violators are subject to arrest and fines.

Several sections of the Code are directed specifically at broadcasting and related activities. And, regardless of the legal status of the Code, it is an excellent minimum standard for areas of work where most broadcast engineers are weakest.

The purpose of this article is to stimulate an awareness of this document and its areas of interest to broadcast engineers. Naturally, in such limited space the treatment is far from exhaustive. It should, however, give the reader a good idea of what job areas might profit from a direct look at the Code.

## Power Wiring

The bulk of the NEC is devoted to the distribution of electrical power within structures. In this respect, it is of prime importance to broadcast technical facilities. Since the 1962 edition of the National Electrical Code, many things have changed with the old, familiar power wiring. The broadcast engineer charged with planning or executing

expansion, modification, or construction of facilities must familiarize himself with current provisions.

For example, all new electrical outlets on 15- and 20-ampere circuits *must be of the grounding type*. The outlet ground terminal must be connected to a *separate* grounding conductor that normally does not carry current. (In some cases, the grounding conductor can be the conduit, where it is used.)

The Code also specifies materials to be used, size of conductors, over-current protection, grounding of system and equipment, and many other related matters. Moreover, many state codes further restrict materials, sizes, and even use of circuits.

If all this sounds complicated, it is. And it involves the construction phases of facilities, where mistakes are very expensive. The best way to avoid these errors is to have your state Electrical Administrative Board (or its equivalent) review your plans. Usually they are happy to do so. If they are not, or the plans are too extensive for a quick review, engage the services of an electrical engineer who is registered in the state and is familiar with the local and national electrical codes.

## Specific Code Provisions

Article 810 of the 1965 National Electrical Code specifically covers radio and television equipment, and it refers to other pertinent sections. Other sections directly affecting broadcast-station technical practice include Wiring Methods, Sound Recording and Similar Equipment, Emergency Systems, Remote Control and Signal Circuits, and Communications Circuits.

If there is a theme that ties all

these together, it is safety—to structure, equipment, and life. With things electrical, the key to safety is insulation and grounding, and protecting them.

For most broadcast engineers, the Radio and Television section of the NEC holds essentially one provision: Use only approved equipment. The remainder is devoted to receiving stations and amateur stations.

## Audio Distribution

Even if Article 810 appears to ignore professional broadcast facilities, these are given great attention in the other sections referenced. Much of this attention is aimed at areas where broadcast engineers often tend to be careless: audio distribution, and remote control and signaling.

Broadcasters usually favor 600-ohm systems to facilitate easy impedance matching and avoid serious equalization problems. To comply with the code, only about 8 watts of peak audio power can be distributed on a 600-ohm pair without enclosing it in conduit or equivalent protection or otherwise treating it as power wiring. To be exact, the audio output may not exceed 70 volts when loaded and 100 volts when unloaded if an unprotected pair is to be used.

Code Article 640, which pertains to sound recording and reproduction, also restricts to 75% the depth to which wireways and gutters may be filled. Wireways must be bonded section-to-section in a secure electrical manner, and the entire assembly must be grounded with at least a No. 14 copper conductor.

<sup>1</sup> The National Electrical Code is published by the National Fire Protection Association, 60 Batterymarch Street, Boston, Mass. 02110. The price is \$1 per copy.



This section restricts the rating of conductors used with central power supplies. Filament leads must be protected with overcurrent protection not exceeding 15 amperes, and an appropriate wire size must be used. Plate and bias supplies must be protected with overcurrent devices having a rating not in excess of one ampere.

#### Remote Control And Signaling

One of the most frequent and dangerous practices is the improper mixing of signal and power circuits in raceways, boxes, and terminal cabinets. Article 725 of the National Electrical Code covers various definitions and restrictions of a general nature.

A Class 2 remote-control or signal circuit is one which has the available power limited to 150 volts and about 100 volt-amperes, depending on the operating voltage. This limitation may be provided by a fuse or other overcurrent device unless the operating voltage exceeds 60 volts; then the current must be limited by some other means as well (such as a high-leakage-reactance transformer).

This is the only class of circuit where bell wire, speaker cord, and the like can be used for wiring. Even then it must be separated from light and power conductors by at least two inches or equivalent protection, such as conduit, porcelain tubing, etc. Class 2 circuits may not be installed in the same raceway, compartment, outlet box, terminal box, or junction box with light and power conductors or Class 1 signal circuits unless they are segregated by a partition. (Where power-supply leads are introduced into a box for the sole purpose of supplying the device that operates the Class 2 signal conductors, an exception is made.)

Class 1 systems, those in which the available power is not suitably limited as in Class 2, are generally treated — installed, protected, guarded against — in much the same manner as power circuits. Requirements for wire size, raceway size, and overcurrent protection are slightly more liberal. Class 1 circuits may be installed in the same raceway and cabinet with other

Class 1 circuits and in some cases with power-supply conductors.

The distinctions between these two classes of circuits, and their different handling and protection, embody important general concepts for making safe electrical installations. As a result, they affect many areas of broadcast engineering practice; the safety principles inherent in the separation of limited-power and unlimited-power circuits are universally useful. That is why this section of the National Electrical Code is referenced in almost every

application to broadcast nonpower wiring.

#### Communications Circuits

Where audio, remote-control, or signal wiring leaves the immediate premises, it falls under the provisions of Article 800 of the NEC, Communications Circuits. In most cases, this kind of job is handled by the local telephone company. When it isn't, the provisions of Article 800 should be studied before an installation is made.

• Please turn to page 46

**BEYER**

*The Microphone That Picks Up Where Others Leave Off!*

Beyer microphones are the world-wide standard by which others are judged. Now, for the first time, the full line of Beyer microphones and accessories is available in North America through the worldwide sales and service facilities of Elpa Marketing Industries, Inc. The Beyer line covers the full spectrum of price and performance for every need, in all types, ranging from heavy duty models for professional broadcast and studio use, to popular-priced models for ham or CB operator, student or audiophile. For faithful service and total dependability, regardless of budget, the buy line is Beyer — now the new standard of quality in the U.S.

See the Beyer Line at your favorite Hi-Fi dealer or write for literature to Dept. A 411

ELPA MARKETING INDUSTRIES, INC.  NEW HYDE PARK, NEW YORK 11044

# An all-solid-state microwave TV relay progress report

## on the air . . .

KVOS-TV, Bellingham, Wash. • KEPR-TV, Pasco, Wash. • KIMA-TV, Yakima, Wash. • KIRO-TV, Seattle, Wash. • WFIQ-TV, Mobile, Ala. • KMED-TV, Medford, Ore. • KQEO-TV, ETV, San Francisco, Cal. • KVIE-TV, ETV, Sacramento, Cal. • KNBC-TV, Hollywood, Cal. • KWGN-TV, Denver, Colo. • WTWO-TV, Terre Haute, Ind. • KOLO-TV, Reno, Nev. • WDIQ-TV, Dosier, Ala. • KHFI-TV, Austin, Texas • WRAL-TV, Raleigh, N.C. • WCNY-TV, ETV, Syracuse, N.Y. • KOAP-TV, ETV, Portland, Oregon • ABC Network, New York, N.Y. • CBS Network, New York, N.Y. • NBC Network, New York, N.Y. • WEDH-TV, ETV, Hartford, Conn. • WROH-TV, ETV, Rochester, N.Y. • WWTW-TV, Cadillac, Mich. • WGEM-TV, Quincy, Ill. • WLOS-TV, Asheville, N.C. • KTVB, Boise, Ida. • WHDO-TV, Toledo, Ohio • KTVH-TV, Wichita, Kan. • KHET-TV, ETV, Honolulu, Hawaii • WITA-TV, San Juan, P.R. • CFRN-TV, Edmonton, Alberta, Canada • CBC Network, Montreal, Can. • CKLW-TV, Windsor, Ont. • XEW-TV, Mexico City, Mex. • XEIP-TV, ETV, Mexico City, Mex. • XET-TV, Monterrey, Mex. • TV-2, Panama City, Panama • STATE TV of Norway, Oslo, Norway • STATE TV of Belgium, Brussels, Belgium • STATE TV of Spain, Madrid, Spain • NHK Network, Tokyo, Japan

## on the air soon . . .

KFMB-TV, San Diego, Cal. • KWTX-TV, Waco, Texas • WJCT-TV, Jacksonville, Florida • KHTV, Houston, Texas • KATV, Houston, Texas • KPRL-TV, St. Louis, Mo. • KTCA-TV, ETV, St. Paul, Minn. • WSCO-TV, Cincinnati, Ohio • KTCI-TV, ETV, St. Paul, Minn. • WBMO-TV, Atlanta, Ga. • WCHS-TV, Charleston, W. Va. • WERO-TV, Pittsburgh, Pa. • WOR-TV, New York, N.Y. • WTIC-TV, Hartford, Conn. • WPTZ-TV, Plattsburgh, N.Y. • KMVT-TV, Idaho Falls, Idaho • YNSA-TV, Managua, Nic. • STATE TV of The Netherlands, The Hague, Netherlands • STATE TV of Colombia, Bogota, Col. • BELO HORIZONTE-TV, Belo Horizonte, Brazil • RADIO BANDIRANTES-TV, Sao Paulo, Brazil • STATE TV of Eire, Dublin, Eire



## be happy

Today Microwave Associates all-solid-state TV relay is one of the most exciting equipment-innovations in the TV broadcast industry. Happy users abound. And for good reasons. It's reliable. Silicon-all-solid-state reliable. No klystrons, no high voltages. No tube failures, aging, or varying modulation sensitivity. It's versatile. Use it rack-mounted or portable. Transmit high fidelity color over single or dual channels, in single or bi-directional relay. Hot or cold standby protection. 115 volt or 230 volt AC power, 12 or 24 volt DC power.

It's serviceable. Transmitter and receiver are of modular construction, have built-in metering, and all controls are mounted on front. Field experience shows that maintenance costs may be cut by as much as 80%.

The MA-2A and MA-7A relays, used as TV pickup, provide versatile, fast reaction capabilities. Receiver and transmitter include self-contained power supplies, and audio program multiplex. Yet the entire microwave relay link fits into a car, sets up in minutes . . . and you're on the air.

As a rack-mounted STL, use the MA-2A or MA-7A as a single or dual channel relay in one or two directions. You'll need only 7 inches of rack space for each unit. Run it with hot or cold standby.



There's no warm-up time needed, because there's not a single filament or high-voltage power supply in the entire relay system.

For multiple-hop intercity relay, put it on a mountain top . . . And forget it! An 80 ampere-hour watt battery will provide emergency standby power, and the use of silicon semiconductors assures optimum life and reliability. Both receiver and transmitter are encased in rugged, weather-resistant aluminum cases, rack or cabinet mounted.

All accessories are available, including tripods, pan heads, 2, 4, 6, 8, and 10 foot dishes, feedline, remote control monitors, automatic switchovers, fault alarm, plus special antennas for mobile van or helicopter use. The MA-2A and MA-7A series relay equipment follows EIA, CCIR, and FCC recommendations for both color and black & white television relay. In addition, complete documented recommendations tailored to your own particular application are available. Want to be happy too? Write.

Model	Band MHz	*Nominal RF Power	Nominal RCVR Noise Figure without preamp	with preamp	Allocation
MA-2A	1990-2110	2 watts	10 dB	5 dB	TV Auxiliary broadcast STL, remote TV pickup, intercity relay
MA-7A	6875-7125	.5 watt	12 dB	5.5 dB	TV Auxiliary broadcast STL, remote TV pickup, intercity relay

Also available at other frequencies in the 1300 to 2300 MHz band for international allocation requirements. \*18 watt output TWT amplifiers available.



**MICROWAVE ASSOCIATES**

Burlington, Massachusetts

Offices: Burlington, Mass.; 9911 Inglewood Ave., Inglewood, Cal. • Hyde House, Edgware Rd., London NW9, England. Subsidiary: Microwave Associates, Ltd., Luton, Beds, England.

Circle Item 21 on Tech Data Card

November 1966

We interrupt this magazine to bring you...

## Late Bulletin from Washington

by Howard T. Head

### FM and UHF Both on the Way Up?

Recent reports indicate that FM radio and UHF television, for many years the stepchildren of the radio and television industry, are at long last on their way to success. Available statistics indicate that of the more than 30,000,000 radio receivers manufactured during the past year, more than 25% were capable of FM reception. By far the biggest FCC rule-making activity is the assignment of new FM channels to accommodate station applicants.

In UHF television, independent stations in the larger markets are looking forward to the financial break-even point, and many applications for new stations are still pending before the Commission. FCC Commissioner Robert E. Lee, UHF's staunchest advocate, has forecast that the results of a Census Bureau survey, taken in August of this year, will show 37% of the nation's television receivers capable of both VHF and UHF reception. This penetration is the result of all-channel legislation which became effective April 30, 1964, and the sale of new television receivers to the public at the unprecedented rate of almost 11,000,000 per year.

### New CATV Reporting Form Issued by FCC

The Commission has adopted and distributed to all known CATV system operators a new form (FCC Form 325), to be used by existing systems for reporting information (October 1966 Bulletin). The form requires complete information concerning the communities served, the number of subscribers, the date when service began, and the channel capability of each system, together with the television stations actually carried. Details with respect to local origina-tions, such as news, time and weather, local film, and local live events must also be supplied. Complete information is required concerning owner-ship, including all stockholders having an interest of 5% or more. Details regarding cross-ownership and family ownership must also be furnished.

In issuing the form, the Commission has relaxed a requirement originally proposed for the submission of a map showing the location of cable lines as of February 15, 1966. Although the map is not now required, however, systems must retain in their files information from which such maps may be prepared.

### CATV Carriage of Distant Signals Common

The National Community Television Association (NCTA) has completed a survey of 1,650 operating CATV systems which indicates that the carriage of distant signals -- beyond the Grade B contours of television stations -- is common practice. According to the survey, over 90% of the operating CATV systems carry at least one such signal. Approximately 2/3 of the systems provide cable carriage of both local signals (Grade B or better) and those of distant stations.

The Commission continues to receive an increasing flow of petitions by CATV systems for permission to import distant signals into communities within the top 100 markets (see June 1966 BROADCAST ENGINEERING). In many instances, the Commission has issued cease-and-desist orders against CATV systems undertaking such carriage without prior permission.

The confusion over CATV includes uncertainty over the proposed revisions of the 1909 Copyright Act which would deal, among other things, with CATV carriage of copyrighted programs. Although a new copyright bill has been approved by the House Judiciary Committee, there is no likelihood that new legislation will be adopted in this session of Congress.

#### NAB Supports Proposals on Instruments and Logging

The National Association of Broadcasters (NAB) has filed comments supporting an earlier proposal of the American Broadcasting Company (ABC) to revise the FCC Broadcast Technical Standards to permit the use of digital readout meters, printers, or other numerical readout devices as indicating instruments for AM, FM, and television equipment. Under the present Rules, conventional indicating instruments must be employed.

Both ABC and NAB point out that technological advances have substantially changed the metering art, and that broadcast stations should be permitted to take advantage of the increased accuracy and improved convenience of the new devices. The use of the new indicating instruments is of particular importance in connection with remote control and automatic logging.

#### Tests of Land Mobile-TV Channel Sharing Planned

The Commission has established a Government-Industry Committee to study testing of the feasibility of sharing the television broadcast channels by the Land Mobile Radio Services (August 1966 Bulletin). At a meeting called by the Commission's Chief Engineer, Ralph Renton, on September 29, a Steering Committee and a Technical Planning Committee, each consisting of one representative from each of seven sponsoring organizations, were formed. The Technical Planning Committee now has under study details of the technical information which must be developed if meaningful tests of sharing are to be conducted. As a result of this work, it is expected that recommendations will be made to the Commission as to needed tests of interference to television reception from land mobile operation.

At present, tests are being contemplated only for the sharing of VHF television channels. Proposals have been made to the Commission, however, to expand the inquiry to include UHF channel-sharing, as well as the outright re-assignment of one or more UHF television channels for the exclusive use of land mobile services.

#### Short Circuits

The Commission has extended until November 30 the date for filing reply comments on proposals for using space satellites for television (and radio) relaying within the United States; there seems to be little doubt that such systems will be approved in the near future, with only problems of ownership and control to be decided. . . . The American Broadcasting Company has developed an automatic loudness control, which is now in operation at its own radio stations and some affiliated stations. . . . The Commission has issued a final report describing proposed new curves of television field strength vs. distance in the low VHF, high VHF, and UHF bands. . . . Recent Rules waivers for translators in Utah and Connecticut indicate a growing disposition on the part of the Commission to encourage television translators; for these systems, power limits were waived, operation was permitted on UHF channels below the regular translator band, and a microwave feed to at least one translator was approved.

Howard T. Head. . . in Washington



## difficult installations made easy

The long continuous lengths of HELIAX® coaxial cable make any type of installation possible. Whether across a vast ravine or up the tallest tower, the installed cost is less. Corrugated inner and outer conductors absorb all stress. Andrew connectors firmly anchor both conductors to eliminate electrical problems. Consult your Andrew sales engineer or write Andrew Corporation, P. O. Box 807, Chicago, Illinois, U.S.A. 60642.



870-foot self-supporting catenary installation of 5-inch HELIAX air dielectric coaxial cable (Type HJ9-50) at mountain top site of Station KBYU-TV, Provo, Utah.

**Andrew**  
CORPORATION

**29 YEARS OF ENGINEERING INTEGRITY**

10-66

# Advanced, Solid State

## Spotmaster

### Super B Series

MEETS OR EXCEEDS ALL NAB SPECIFICATIONS AND REQUIREMENTS



#### And Here's the New Economy King **COMPACT 400-A**



Don't let their low price fool you. New, solid state SPOTMASTER Compact 400's are second only to the Super B series in performance and features. Available in both playback and record-playback versions, these Compact models share the traditional SPOTMASTER emphasis on rugged dependability.

#### Top Quality Tape Cartridges

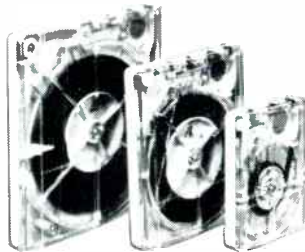

Superior SPOTMASTER tape cartridges are available in standard timings from 20 seconds to 31 minutes, with special lengths loaded on request. In addition, Broadcast Electronics offers a complete selection of blank cartridges, cartridges for delayed programming and heavy duty lubricated bulk tape. Prices are modest, with no minimum order required.

Introducing the Super B, today's truly superior cartridge tape equipment.

New Super B series has models to match every programming need—record-playback and playback-only, compact and rack-mount. Completely solid state, handsome Super B equipment features functional new styling and ease of operation, modular design, choice of 1, 2 or 3 automatic electronic cueing tones, separate record and play heads. A-B monitoring, biased cue recording, triple zener controlled power supply, transformer output . . . all adding up to pushbutton broadcasting at its finest.

Super B specs and performance equal or exceed NAB standards. Our ironclad one-year guarantee shows you how much we think of these great new machines.

Write, wire or call for complete details on these and other cartridge tape units (stereo, too) and accessories . . . from industry's largest, most comprehensive line, already serving more than 1,500 stations on six continents.

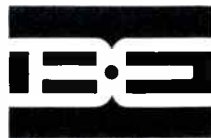

### **BROADCAST ELECTRONICS, INC.**

8800 Brookville Rd., Silver Spring, Md.  
Area Code 301 • JU 8-4983

Circle Item 23 on Tech Data Card

### **Broadcast Engineer & NEC**

*(Continued from page 41)*

In general, this section of the Code provides for protection, separation, size, insulation, and grounding of the circuits involved. They are treated as Class 2 systems with special considerations for aerial and underground cables. Once again, great stress is laid on protecting these circuits from accidental contact with light and power wiring.

#### **Emergency Systems**

Many broadcast installations have emergency power systems. Where local regulation requires this by law, the National Electrical Code is explicit concerning the type, installation, control, and protection of the emergency supply.

Where not legally required, the emergency system nonetheless must meet certain conditions. The chief ones require that emergency-system wiring be kept strictly separate from other wiring, never entering another enclosure with it except at the transfer switch. The code also requires that the emergency system be permanently connected (no portable plug-in units) and, of course, conform to the installation practices of the rest of the code.

#### **Conclusion**

Admittedly, many of the requirements of the National Electrical Code mentioned in this article seem nothing more than "common sense." This is true; all standards of good technical practice are little more than distilled common sense, much of it learned the hard way. Conversely, much of the Code may seem to be unnecessary. It must plead guilty to an absence of clarity: any document written generally enough to cover a 100-story office building as well as a one-room shack, to say nothing of a modern broadcast facility, makes for pretty thick reading. However, it offers a well proven guide to a safe and practicable installation.

It should be emphasized that, although most local codes are patterned after the NEC, many of them differ significantly in some details. The broadcast engineer concerned with changes in facilities should make himself familiar with the applicable regulations to ensure a safe and legal installation. ▲

# Here's that new Collins Speech Console you've been hearing about



## We've stepped up production to give OFF-THE-SHELF Delivery

Users across the nation are praising the new Collins 212S-1 Speech Console. They're talking about its:

- Noiseless photoconductive cells (no pops, clicks or hums).
- Reduction in wiring (less wire: less noise).
- Elimination of worn or dirty mechanical contacts (ending your most troublesome maintenance problem).
- Accessibility for fast, easy trouble-shooting (re-

place solid-state amplifiers and control elements with quick shuffle of circuit cards).

- Stereo and monaural designs (to fit your need).

Acceptance of the 212S-1 has been rapid and widespread. With each installation, demand has increased. To meet this demand, we've gone to an off-the-shelf production schedule.

Compare this Console with any on the market. Then contact your nearest Collins sales engineer.

COMMUNICATION / COMPUTATION / CONTROL



COLLINS RADIO COMPANY / DALLAS, TEXAS • CEDAR RAPIDS, IOWA • NEWPORT BEACH, CALIFORNIA • TORONTO, ONTARIO  
Bangkok • Beirut • Frankfurt • Hong Kong • Kuala Lumpur • Los Angeles • London • Melbourne • Mexico City • New York • Paris • Rome • Washington • Wellington

Circle Item 24 on Tech Data Card

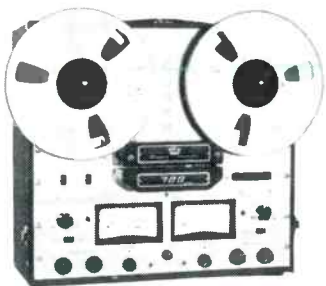

MODEL 1/4 TRACK STEREO  
**SX724 ONLY \$975** **DATE**

**NEW!**

Modular Transport  
 Low-Noise Circuitry  
 Third Head Monitoring

World's Finest Recording Quality

Speed	Response	S/N
7-1/2	±2db 30 to 25,000	55db
3-3/4	±2db 30 to 15,000	50db

Crown International  
 BOX 1000, DEPT. BE 11  
 ELKHART, INDIANA

**MADE ONLY IN AMERICA**

Circle Item 26 on Tech Data Card

# ENGINEERS' EXCHANGE

## Sine/Square-Wave Generator

by John Nance,  
 Director of Engineering,  
 CFTK, CKTK, CHTK, British  
 Columbia, Canada

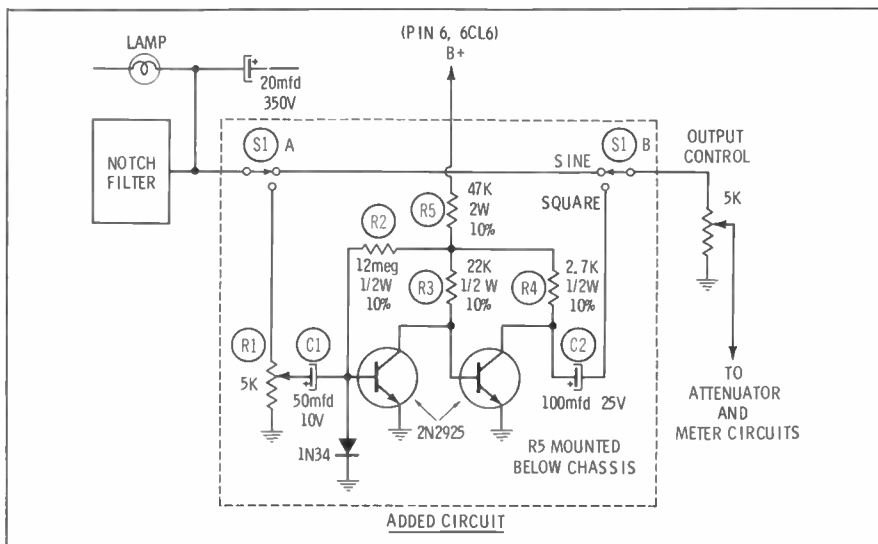

The following modification will convert a Heathkit Model AG-9A

Audio Generator into a sine/square-wave generator suitable for audio-amplifier testing.

The device consists of a two-transistor clipper, powered by the internal supply of the generator, which may be switched in and out of the circuit. Its position in the circuit is such that the output controls and meter are effective for both square and sine waves. The clipper was chosen over a Schmidt trigger because of its simplicity and stability.

The output has a rise time of less than 0.5  $\mu$ sec and a tilt of less than 2% between 30 Hz and 10 kHz, which is adequate for audio-amplifier testing. Below 30 Hz a slight tilt is introduced, but it is less than that found in many good AC-coupled oscilloscopes. Tilt at 10 Hz (measured on a Tektronix 524AD, DC coupled) was less than 5%, while in the AC-coupled mode the tilt was 30%. Above 10 kHz the corners tend to become rounded, although the waveshape is good enough to produce meaningful tests up to 100 kHz. The waveform rounding is caused by capacitive effects in the output attenuator and the rather slow rise time.

With the circuit values chosen,

## Solid-State SCA SUBCARRIER GENERATOR



3 1/2" x 19"

MODEL SCG-4T

- All silicon semi-conductors JEDEC registered
- Excellent distortion and frequency response characteristics
- Automatic electronic muting with adjustable delay
- Peak reading deviation meter calibrated in KHz
- New highly stabilized oscillator
- Gold plated, etched copper, plug-in circuit cards

Send For Bulletin #316

**MOSELEY ASSOCIATES, INC.**

135 Nogal Drive, Santa Barbara, California 93105  
 Telephone (805) 967-0424

Circle Item 25 on Tech Data Card



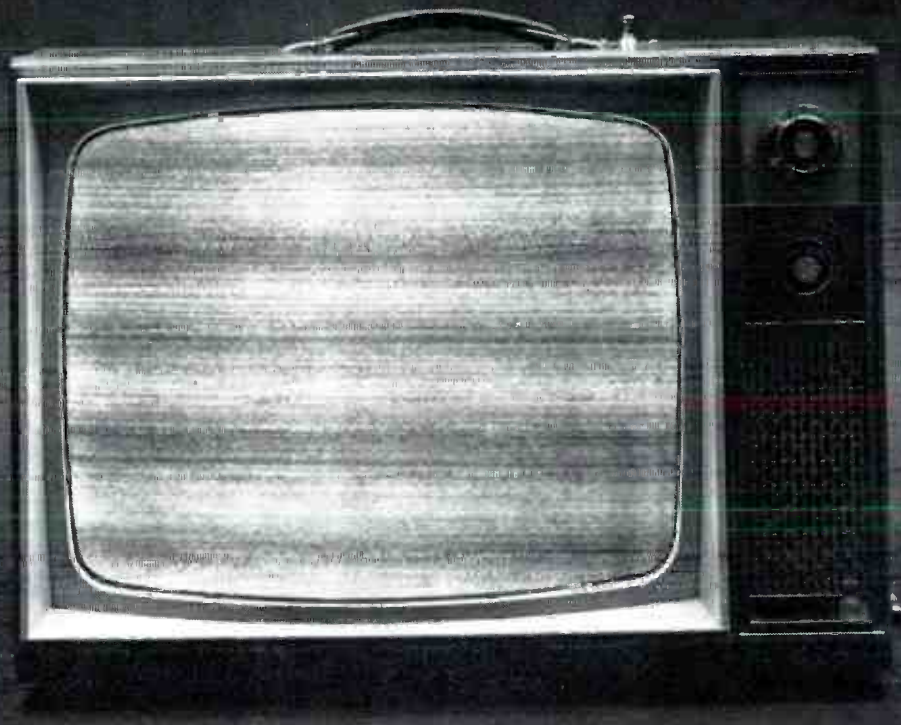

## This kind of programming costs you money

You're in business for one reason: to make a profit.

Anything that takes away from your profit-making is your enemy. That's why you're way ahead when you choose Lenkurt microwave transmission equipment for your CATV or ETV system.

For instance, there's our 76 TV microwave relay system that has become the standard of the industry, due to its outstanding performance, ease-of-maintenance, and economical operation. 76 TV is designed to handle monochrome or color transmission and lets you insert and drop programs with ease at intermediate locations.

There is also Lenkurt's 75A, the ideal backbone microwave relay system. Because of its non-demodulating heterodyne repeaters, 75A delivers clear, sharp monochrome and color TV pictures regardless of distance, terrain, or weather.

Lenkurt microwave systems have proved themselves in virtually every situation. From high on Freel Peak in Nevada where 76 TV brings in a sharp high-resolution picture (even

when snow levels reach 20 feet), to an ETV closed-circuit system at the University of Kansas Medical Center. And our 75A has been transmitting high quality pictures for a number of CATV networks in New York and Pennsylvania.

And remember, when you buy Lenkurt equipment, you are buying more than hardware; you are purchasing Lenkurt's heritage and reputation for quality and continuity.

It all comes down to this: when you're thinking about microwave transmission equipment, for any application, think of Lenkurt. We'll show you how to improve your picture — both TV and profit. Write or call Lenkurt Electric Co., Inc., San Carlos, California. Other offices in Atlanta, Chicago, Dallas, and New York City.

***LENKURT ELECTRIC***  
SUBSIDIARY OF  
GENERAL TELEPHONE & ELECTRONICS **GTE**

Circle Item 27 on Tech Data Card

World Radio History

**YOU CAN GET MORE  
FROM YOUR CARTRIDGES**



**JOA gives you MORE  
CARTRIDGE PERFORMANCE  
... that's practical!  
MORE ENGINEERING TIME  
... that's economical!**

Let JOA Cartridge Specialists recondition and rebuild your worn cartridges and keep your engineering personnel "engineering."

**—JOA will inspect, service and re-load your cartridges with ANY LENGTH tape**

**NO MINIMUM**

**NO EXTRA CHARGE FOR—**

- (a) **FOAM TEFLON-FACED PRESSURE PADS**
- (b) **replacement of minor parts**
- (c) **VISIBLE SPLICE**

**ALL cartridges PRETESTED under actual broadcast conditions  
48-hour Processing**

**Need NEW CARTRIDGES fast? JOA will ship immediately . . . from stock . . . any size Fidelipac, precision manufactured NAB cartridge.**

**JOA—the cartridge service of authority—serving the broadcast industry.  
phone or write**



Cartridge Service  
P. O. Box 3087  
Philadelphia, Pa. 19150  
Area Code 215, TUrner 6-7993

Circle Item 28 on Tech Data Card

the output, as read on the internal meter, will be within one dB when switching from sine to square wave. If the change is more than 1 dB, change the value of R4. R1 is adjusted for best symmetry of the output square wave, and should have no effect on the output amplitude.

R1 is mounted on the chassis beside the oscillator and meter controls. S1 is mounted on the front panel just below the words AUDIO GENERATOR. The remainder of the circuit is mounted at the side of the meter on a piece of phenolic board extended to mount under the meter terminals. It is a good idea to mount a 1/2-amp fuse on the rear apron of the oscillator case.

stations should have all or most of the parts required to build it. It can be used for bridging a remote line to feed the public-address amplifier at a remote pickup; it can be used

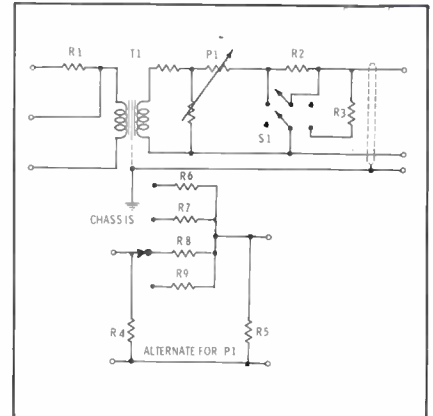

### Variable-Loss Bridging Unit

by Luther Crumbaugh  
Technical Supervisor  
KGER, Long Beach, Calif.

Many uses can be found for this low-cost, versatile unit, and most

as a 500-ohm to 50-ohm matching unit with only the 16-dB loss in the output matching pad; or it can be used to add a temporary input to a low-level mixer (e.g., the high-level output of a tape recorder). When used with a high-quality amplifier, the unit becomes a gain set with good noise-measuring capabilities.

The unit should be assembled in a small components box and grounded as indicated; the transformer should be very well shielded. The switched pad shown may be substituted for the variable control. Some liberties have been taken with some of the resistor values, but distortion measurements do not indicate any problems with the values shown. S1 gives a choice of either 500- or 50-ohm output.

At the high-loss settings, this unit furnishes an output of a few millivolts, which is sufficient to drive a high-impedance microphone channel or the unbalanced high-impedance input of a tape recorder. A short jumper should be attached to the ground terminal and used to ground one side of the output when feeding unbalanced amplifiers. Most applications will require this procedure, and, since no two amplifiers are wired alike, simply touching the ground jumper to one and then the other of the two output terminals will indicate which side should be grounded to eliminate the hum. The output cable should be shielded and the shield tied to the component box as indicated.

Other variations of this idea are, of course, possible, and the unit can

**TREPAC**

## "BUILDING BLOCK" TONE SYSTEM

The TREPAC DATATONE System, a complete line of "off the shelf" modular tone equipment, provides an economical means of expanding existing or new control and communications networks, Multi-channel control and/or teletype, with or without voice communications, may be operated over a single communications link.

"Building block" design permitting budget controlled growth capability as well as compatibility with existing equipment, permits the design engineer the freedom necessary to develop a communications system tailored to his individual needs.

Both AM and FSK transmitters and receivers, power supplies, loop D.C. supplies, regenerative repeaters, and two-way D.C. repeaters, telemetering adapters, diversity combiners, and an extensive filter line are available from stock.

Each module has a test socket in the front panel which allows "by the numbers" testing of operating systems by

For additional information, contact: Datatone Division RS:

**TREPAC CORPORATION OF AMERICA**

30 W. HAMILTON AVE., ENGLEWOOD, N. J. • PHONE: (201) 567-3810 • TWX (201) 567-4977  
SOLID STATE ELECTRONICS for TELECOMMUNICATIONS

Circle Item 55 on Tech Data Card



TYPICAL TRANSMITTER-RECEIVER  
-POWER SUPPLY MODULES.



TYPICAL 19 INCH RACK MOUNTING.

inexperienced personnel. This, together with plug-in frequency determining elements and single type plug-in transistors, permit a realistic approach to the maintenance problem.

# Why is Belden specified by most broadcast engineers?

Belden designs and manufactures a complete line of audio, camera, and control cables to meet every TV and radio broadcasting, recording studio, and remote control need.

Many Belden Audio and Broadcast Cables feature Beldfoil\* shielding. This superior cable shield provides 100% protection against crosstalk . . . increases electrical reliability . . . reduces cable diameter and weight . . . is easier to terminate . . . usually lower in cost.

Here is just a part of this complete line, available from stock. Ask your Belden Electronics Distributor for complete information. Request also a copy of the latest Belden Electronics Catalog.

\*Belden U.S. Pat. 3,032,604  
Belden Trademark—Reg. U.S. Pat. Off.)

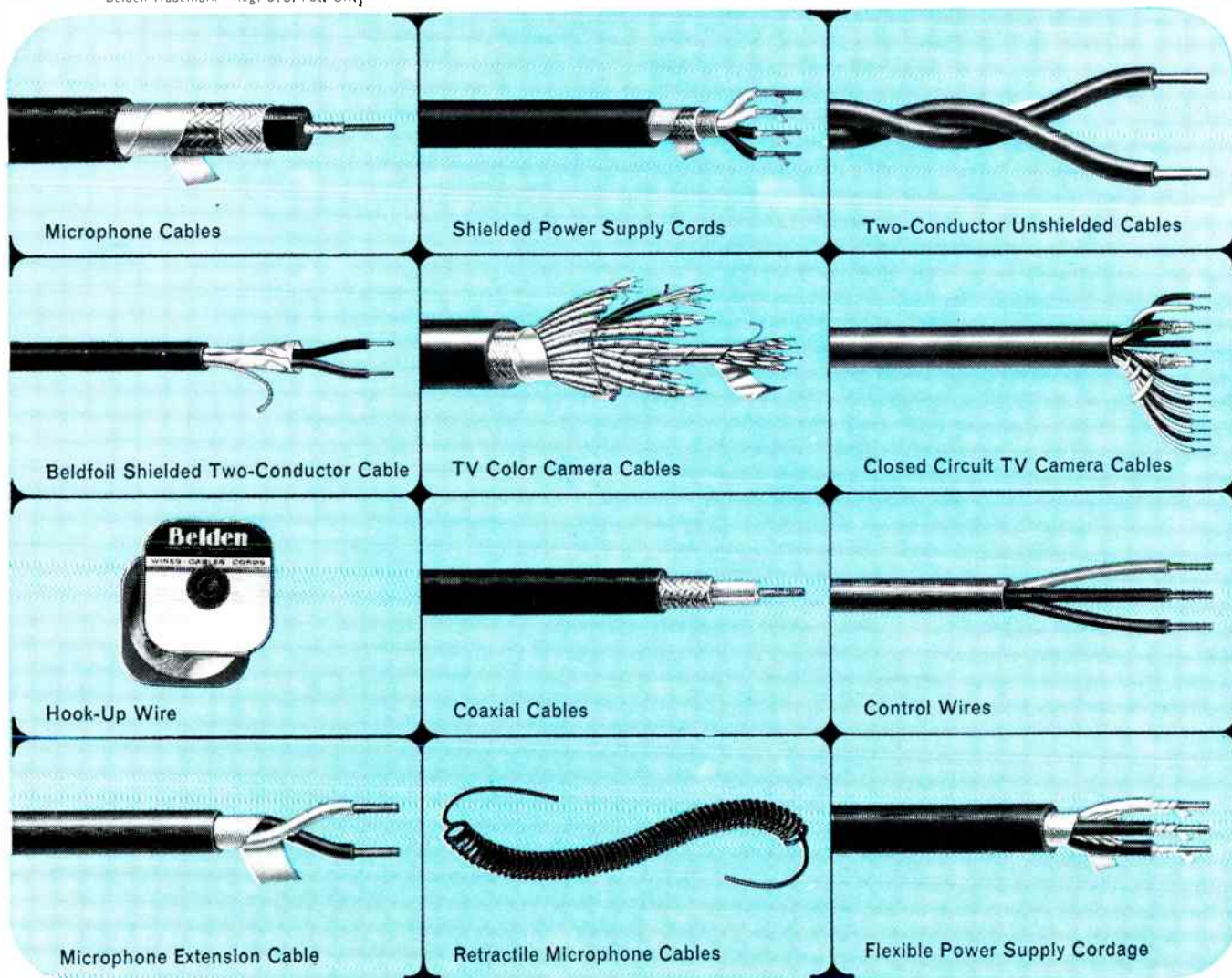

8-5-6

see your Belden Electronics Distributor



electronic wire and cable

BELDEN MANUFACTURING COMPANY • P.O. Box 5070-A • Chicago, Illinois 60680

Circle Item 29 on Tech Data Card

November, 1966

51

**IT'S  
YOUR  
MOVE!**

**MAKE THE  
MOST OF IT...**



with SPARTA'S Showcase Audio Control Center



**TIME! SAVE MOVING COSTS! GAIN FLEXIBILITY!**

These new mix 'n match cabinet units have the custom look of richness and quality; yet they save you money because they come to you all ready to install. Let SPARTA show you how many ways you can save on your next move!

The New A-20 Audio Console **IS A REAL MOVER!**

SPARTA moves you into expanded capability, fast! —with this sleek styled console. The NEW A-20

has 22 inputs, 8 mixers with both audition and program mixing. Other quality features include relay muting, individual electronic modules, self contained power supply, monitor & cue amplifier, to name just a few — and it's completely transistorized.



\$995.

**SPARTA**  
ELECTRONIC CORPORATION

5851 FLORIN-PERKINS ROAD • SACRAMENTO, CALIFORNIA • (916) 452-5353

Circle Item 30 on Tech Data Card

be made as elaborate and flexible as is desired.

**Parts List**

R1	10K	
R2	470	
R3	47	
R4, R5	570	
R6	1600	(15dB)
R7	4500	(25dB)
R8	14K	(35dB)
R9	45K	(45dB)
S1	DPDT	
T1	500/500 ohm	
P1	Mallory T-500	

**Moisture Condensation Protection**

by James M. Wilder  
Engineering Supervisor.  
WBIE, Marietta, Georgia

We experienced such high humidity at times that drops of water formed in the transmitter cabinet during the night. In our old transmitter we found that two 150-watt light bulbs connected in series and burning at half brilliancy provided enough air circulation through the cabinet to eliminate the condition.

When our new 10,000-watt transmitter was installed, we found the same condition, although we had built a concrete-steel building to house the new equipment. We immediately installed two bulbs connected in series in each of the cabinets and have had no recurrence of the condition.

**Fusing for Lightning Protection**

by Frederick C. Hervey,  
WHKW, Chilton, Wisconsin

Adding extra fuses in all "hot" leads of adjustable filament transformers will most likely save them from destruction by lightning. In fact, placing fuses in all known trouble spots (ahead of any component which has been damaged by lightning) is a good practice which can save valuable equipment from destruction. ▲

**JAMPRO DUAL POLARIZED FM ANTENNA WILL**

# INCREASE YOUR SIGNAL!

Now you can achieve RF radiation the **EASY, PRACTICAL WAY!** The new JAMPRO dual polarized FM antenna will increase your signal many times to establish new listeners in hilly areas, give you more signal to home radios using built-in antennas and car FM sets. Contact JAMPRO today for a dual polarized system especially suited to your ERP requirements.

## CONVERT YOUR EXISTING ANTENNA

A new, low cost Dual Polarized Conversion Kit is now available from JAMPRO. Complete with power divider, vertical elements, and instructions for field installation, you can convert your present FM antenna into a dual polarized system. Contact JAMPRO for details.

Contact JAMPRO for newly developed technical information regarding Dual Polarized antenna measurements and performances.

# JAMPRO

**ANTENNA**  
6939 POWER INN ROAD

**COMPANY**  
SACRAMENTO, CALIFORNIA

PHONE:  
AREA CODE 916  
442-1177

Circle Item 31 on Tech Data Card

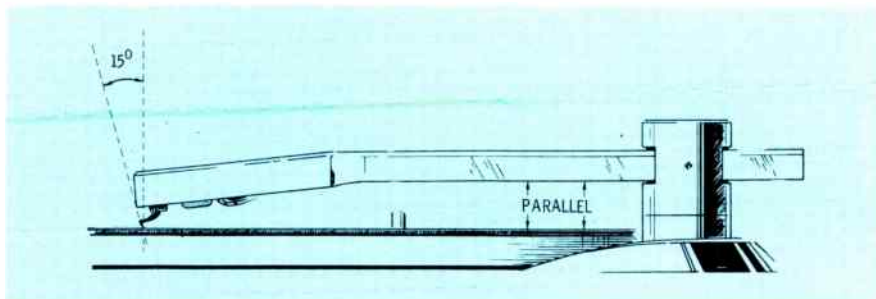

Fig. 3. Vertical tracking angle requires cartridge shell to parallel disc.

case. The professional unit is chrome plated, and the high-impedance version is of a brass color.) Many turntable preamplifiers, therefore, have been designed for a 1500-ohm input. In order to use a 47,000-ohm cartridge, it will be necessary to provide an impedance-matching network, or to change the input impedance characteristic of the preamplifier or equalizer. This is because working a high-impedance into a low-impedance input will result in at least loss of high-frequency response. Signal-strength loss in a 47,000-to-1500 ohm matching network will be approximately 20 dB, so it might be necessary or desirable to replace both the cartridge and the preamplifier. Before taking this step, however, check the preamplifier or equalizer for its designed input impedance.

Low-rumble requirements for stereo operation are more critical than those for monophonic operation. A monophonic cartridge, or a stereo cartridge with its two outputs paralleled for monophonic use, re-

sponds audibly only to lateral groove modulation; a stereo cartridge operating stereophonically requires vertical response as well. On a stereo disc, the lateral modulation provides the sum signal ( $L + R$ ), and the vertical modulation provides the difference signal ( $L - R$ ). It can be seen from the geometry of the stereo groove shown in Fig. 4 that playing the left and right channels recorded in phase will produce lateral movement of the stylus. Playing left and right channels recorded  $180^\circ$  out-of-phase will produce vertical movement of the stylus. It is easy to see why vertical vibration, or rumble, becomes an important factor in the selection of broadcast turntables for stereo operation.

Turntable assemblies for broadcast use present special problems to equipment manufacturers. The turntable is usually quite heavy, and since fast starts are required, the drive motor must be powerful enough to overcome the inertia of the turntable in a very short time. Vibration in the massive drive motor

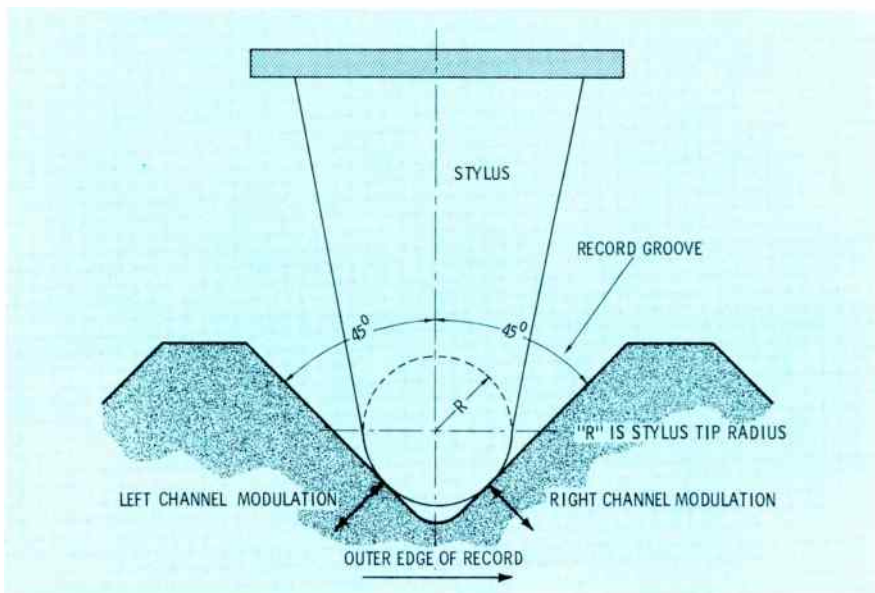

Fig. 4. Geometry of stereo record groove shows how stereo effect is achieved.

causes most rumble problems — usually in the region of 30 Hz. Worn motor bearings or hardened rubber motor mounts can magnify the problem. Flat spots on the idler wheel of a rim-driven turntable will produce a rapid low-frequency thumping sound. The vibration causing a rumble problem can often be located by holding a wooden pencil between one's teeth and touching the pencil point to various parts of the turntable.

Rumble level may be measured with an audio VTVM by noting the level of some reference tone on the test record (usually 5 lateral centimeters per second at 1 kHz). Then, while playing an unmodulated groove, increase the sensitivity of the meter in measured amounts until the rumble level can be read. For stereo, measure one channel at a time and average the results. If paralleling the outputs of a stereo cartridge reduces the measured rumble, some of the vibration in the turntable is in the vertical plane.

The predominant frequency of the rumble can be found with a distortion meter. With the meter in the "distortion" mode, and the sensitivity of the meter set high enough to get a good reading, sweep the frequency dial slowly and watch for a dip on the meter.

For top-40, ethnic, and some pop-music operations, use of a notch filter designed to attenuate the rumble frequency, or a high-pass filter to attenuate frequencies below 50 Hz, can usually result in overall sound improvement, and reduced waste of transmitter modulating power. There is little, if any, musical information below 50 Hz on 7-inch, 45-rpm discs. For stations at which frequencies below 50 Hz are important, the chief engineer must be extra careful in his selection and maintenance of turntables. ▲

*Editor's Note: Reproduction can be improved and record wear reduced when 0.7-mil styli are substituted for the 1.0-mil styli employed in certain cartridges. The 0.7-mil stylus is not now being produced commercially, but at least one manufacturer has indicated the item can be made available if sufficient interest in the product is generated.*



**ELCON  
Color-  
Matched  
Tubes**

**typical of the foremost  
television camera tube line . . .  
from English Electric Valve**

**THE NEW STANDARD OF QUALITY AND  
LONG LIFE FOR ALL I.O. CAMERAS.**

Performance-proven for highest quality and exceptional long-life operation in black-and-white image orthicon cameras, the EEV ELCON 4415E/4416E multiply that quality *and savings* threefold for color.

Matched color sets of ELCON tubes are selected on the basis of camera control operating parameters, as well as tube sensitivities and signal current outputs. And, in most cases, the need for trimming with neutral density filters is completely eliminated . . . orbiting is not required . . . and sensitivity is improved.

*The pace-setting EEV pick-up tube line also includes 3" and 4½" ELCON-target image orthicons. plus a complete range of Vidicons . . . all reflecting the unparalleled tube-to-tube consistency and quality of the world's foremost tube manufacturer.*

**the  
Blue  
Ribbon  
Line**

**VISUAL ELECTRONICS CORPORATION**  
356 west 40th street • new york, n.y. 10018 • (212) 736-5840

**FIRST BY ANY STANDARD**

# NEWS OF THE INDUSTRY

## INTERNATIONAL

### TV in Jordan

The Hashemite Kingdom of Jordan recently awarded equipment contracts for two television stations, scheduled to begin operation in June 1967. The transmitters will be located in Amman and Jerusalem, on CCIR channels E-3 and E-6, respectively. Directional antennas will be used to secure the desired coverage from both transmitters.

The antenna contract was awarded to **Jampro Antenna Co.**, which will also supply the steel supporting towers, installation, and checkout. The contract for the transmitters and studio equipment was awarded to **The Marconi Company**, while **Ampex Corp.** will furnish the video tape equipment.

The entire Jordanian television project is under the supervision of **RTV International Inc.**

## NATIONAL

### Lighting Consultant Firm

A new firm, located in Bridgewater, Connecticut, is offering a consulting service for television and theatre lighting and for the audio-visual fields. **Charles Neenan Associates** has been formed by Mr. Neenan, who until recently served as managing engineer, Lighting and Electrical, with CBS in New York. In addition to being responsible for much of the planning and installation for CBS Broadcast Center in New York, he has had similar responsibilities for TV City in Hollywood and several CBS local stations.

For the past two years, Mr. Neenan has served as Chairman of the Illuminating Engineering Society, Theatre, Television, and Film Lighting Committee. During this time, he has organized an annual lighting symposium for the theatre, television, and film industries in the United States and Canada.

### Pay-TV

**Kahn Research Laboratories, Inc.** has filed technical data on its Pay-TV

system with the Federal Communications Commission.

According to preliminary studies by the developer, the cost of the home decoder would be about \$40. Special billing cards would be handled on a monthly basis.

The fully solid-state decoder is designed to provide instantaneous synchronization and therefore not aggravate reception difficulties caused by low-flying aircraft.

### New UHF Station

A construction permit for a television station on channel 39 in Miami has been granted to a company headed by two Miami businessmen.

The FCC awarded the permit to **Tele-Americas Corp. of Florida**, equally owned by Maurice A. Ferre, president of Maule Industries, Inc., and Juan E. Serralles, a Miami attorney. Ferre is president of Tele-Americas Corp., Serralles is secretary-treasurer, and the latter's law partner, Milton Adkins, is vice-president.

The new television station is to provide programming in Spanish for an estimated 250,000 Latin American residents of South Florida.

### New Recording Studio

A new commercial recording studio and sound research laboratory offering both creative and technical services to film producers, critics, advertising agencies, and other clients has opened in Cleveland, Ohio.

One of the unusual features of **Motion Picture Sound, Inc.** is its "Mellotron," a sound-effects machine capable of producing a wide variety of taped effects when the keys of its organ-like console are pressed.

Other facilities include Cinema-scope projectors; JAN projector; four-track, 35-mm recording equipment; echo chamber; a sound-proof "dialogue room"; and test equipment.

### WKBS Doubles Power

**WKBS-TV**, Channel 48 in Philadelphia, has doubled its effective radiated power to a million watts. Station engineers estimate that the new

power will mean a substantial increase in both primary and fringe coverage areas. They also predict that the power increase will mean better color reception on most receivers.

### WPHL to One Megawatt

**WPHL-TV** has turned on its high-power transmitter capable of producing an effective radiated power of 1,050,000 watts on channel 17. This 68% increase in power for the Philadelphia independent will extend the coverage area considerably beyond the former radius of 50 miles. However, the principal effect is expected to be much greater signal intensity within the area previously covered.

The station's transmitting tower in the Wyndmoor-Chestnut Hill area tops off at 1,002 feet above sea level from one of the largest self-supporting TV towers in the United States. Coverage resulting from the new power boost will extend from Lancaster County to the Atlantic Ocean and from Dover, Delaware to above the Lehigh Valley.

## ORGANIZATIONS

### NAB

In a recent action, the National Association of Broadcasters has objected to a proposal to construct two microwave stations which would distribute three channels of nonbroadcast television programming in Texas —on the grounds that it will lead to pay-TV.

Names of the Engineering Conference Committee for the 1967 NAB show have been announced. Benjamin Wolfe, vice-president for engineering of the Westinghouse Broadcasting Co. has been named chairman of the committee. The Convention Committee has decided that product exhibits in 1967 will be limited to the same space used in 1966. The limitation was made necessary by increasing attendance.

Members of the Small Market Radio Committee have reviewed means to relieve small-broadcaster personnel shortages and obtain changes in broadcast technical requirements.





# CCA OFFERS FROM STOCK AM-FM BROADCAST TRANSMITTERS AT REALISTIC PRICES



**DELUXE 1KW AM**



**DUAL RELIABLE 5KW AM**

### QUALITY AM

	DELUXE	DUAL RELIABLE
250W	\$3,495.	\$8,500
500W	\$4,545.	\$9,500.
1KW	\$4,850.	\$11,500.
5KW	\$13,900.	\$19,500.
10KW	\$17,900.	\$31,500.
50KW	\$89,500.	\$104,000.

CCA offers an outstanding line of deluxe and "Dual Reliable" AM transmitters. All equipments stress conventional, high level plate modulation; standard parts; full accessibility; silicon rectifiers; minimum tube costs; minimum maintenance requirement; and lowest power consumption. "Dual Reliable" transmitters represent the epitome of conservative design.

### 3RD GENERATION FM

10W	\$1,295.	5KW	\$9,900.
250W	\$3,495.	10KW	\$13,500.
1KW	\$5,195.	15KW	\$17,500.
3KW	\$7,995.	20KW	\$22,500.
10KW Amplifier \$9,900			

CCA is the only major equipment supplier which utilizes high mu, zero bias triodes. The use of these high power EIMAC triodes solve all the problems which "2nd Generation" tetrade designs exhibit. No need to neutralize, no complexities such as bias and screen supplies; and exceptional tube life with tremendous power output capability.



**3KW FM**



**10KW FM**

### SC-1D MULTIPLEX SUBSIDIARY GENERATOR

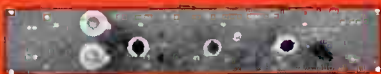

The CCA SC-1D is an inexpensive but reliable subcarrier generator which can be used with all modern FM transmitters to achieve a 2nd broadcast channel.

### LA-1D AUDIO LIMITING AMPLIFIER



A favorite of many broadcasters is the CCA-LA-1D audio limiter. This "workhorse" prevents overmodulation and performs this task without "thumping" or introducing distortion. Front panel controls for gain, output and "recovery time" make operation of the LA-1D an "engineer's delight".

### MODEL AMM-1D AM MODULATION MONITOR



A popular addition to the CCA product line is our FCC type approved AM modulation monitor. This instrument guarantees instantaneous supervision of transmitter operation and is an essential tool for every broadcaster.

CCA Electronics offers a complete broadcast package including materials supplied by outstanding vendors such as towers, antenna, transmission line and studio equipment. Contact your area CCA representative for a quotation.

### CCA TRANSMITTER ACCESSORIES

AMM-1D AM Modulation Monitor	\$595.
AMF-1D AM Frequency Monitor	\$845.
LA-1D Audio Limiter	\$375.
AGC-1D AGC Audio Amplifier	\$320.
RC-1D Remote Control System	\$995.
RFA-FM Remote FM RF Amplifier	\$395.
RFA-AM Remote AM RF Amplifier	\$425.
LTU Antenna Tuning Units	*
AM RF Loads	*
AM Antenna Phasors	*
SC-1D FM Subcarrier Generator	\$495.
SG-1D FM Stereo Generator	\$1295.

\*PRICE BASED ON POWER



**CCA ELECTRONICS CORPORATION**  
716 JERSEY AVENUE, GLOUCESTER CITY, CAMDEN COUNTY, NEW JERSEY  
SPECIALISTS IN BEACON, BROADCAST, COMMUNICATION & AIRPORT TRANSMITTERS

Circle Item 34 on Tech Data Card

NEMS-CLARKE

provides the capability  
to remotely monitor  
AM directional  
arrays having up  
to 9 towers

Model 112  
Phase Monitor

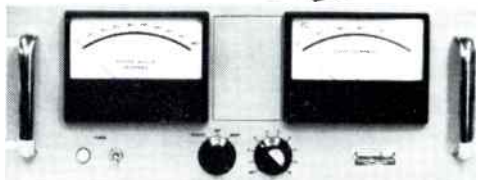

Model 113  
Remote Meter Panel

The Model 112 Phase Monitor is an advanced, all-solid-state unit which provides phase and current measurements of AM directional arrays having up to 9 towers. Easy-to-read panels provide phase readout of  $\pm 1$  degree accuracy with 0.5 degree resolution, and loop current readout with .5% repeatable accuracy. Automatic Day-Night switching of reference levels is also available. Phase angle and loop current outputs are provided for direct readout on a chart recorder or digital voltmeter, or can be fed over land lines for direct studio readout on the Nems-Clarke Model 113 Remote Meter Panel. The optional Model 113 unit contains duplicate phase and current meters.

The Model 112 Phase Monitor is very simple to operate; easy to read; and incorporates all circuitry necessary to permit future adaptation to remote control. Silicon transistors are used throughout for high reliability, long life and excellent temperature stability. Panel meters are of the taut-band type to eliminate pointer binding, and have mirror scales to improve reading accuracy.

V-29

For further information, write or call:

**Vitro ELECTRONICS**

Producers of NEMS-CLARKE Equipment  
A Division of Vitro Corporation of America  
919 Jesup-Blair Drive • Silver Spring, Maryland (301) 585-1000

Circle Item 35 on Tech Data Card

#### SMPT E

A series of special and unusual presentations highlighted the 100th Society of Motion Picture and Television Engineers Technical Conference, held at the Ambassador Hotel in Los Angeles October 2-7. More than 80 papers were presented during the conference. Annual awards were announced and given to recipients, including honorary membership (38th in the society's history) to Dr. Elmer W. Engstrom, Chairman of the Executive Committee of the Board and Chief Executive Officer of RCA.

#### IEEE

A call for papers to be presented at the 19th Annual Southwestern IEEE Conference and Exhibition, to be held in Dallas next April, has been announced. Abstracts of 20-minute papers should be held to 200 words, double spaced. An original and five copies should be submitted to the Technical Program Chairman, Professor Arwin A. Dougal, The University of Texas, Engineering-Science Bldg. 112, Austin, Texas 78712. ATIN: SWIEECO. The deadline for abstracts is December 16, 1966. Two copies of an 80-word abbreviated biographical sketch should be included with the abstracts. Topics of special interest include: Microelectronic Technology and Applications, Solid State and Microwave Devices, Laser and Coherent Electro-Optics Technology and Applications, Physical Electronics, Computer Theory and Design, Networks and Communications, Electric Power Generation and Distribution, Systems Engineering, Antennas and Propagation, Geoscience Electronics, Biomedical Electronics, and Engineering Education.

The Ottawa section of the IEEE will hold its second Electrical and Electronic Measurement and Test Instrument Conference January 9-11, 1967. Topics will cover a broad range of instrumentation design and applications. A complete program is available from: EEM TIC '67, Box 6105, Station J, Ottawa 13, Ontario.

#### NCTA

The Executive Committee of the National Community Television Association, on recommendation of the Public Relations Committee, has retained Public Relations counsel (Richards and Associates of Washington, and Irving Gould Advertising, Inc. of Philadelphia) to begin implementation of the comprehensive informational program on behalf of the CATV industry adopted by the membership at its annual convention in Miami.

The Committee authorized employment of a management consultant firm to assist in orderly expansion and revision of NCTA headquarters activities and organization. Newly authorized staff positions were discussed, but no decisions have been made on personnel to fill the positions of staff engineer and membership services director.

A new Community Services Committee has been appointed to explore uses of CATV designed to serve local communities.

## PROPERTY TRANSACTIONS

The acquisition of **Georgia TV Cable Co., Inc.** and three affiliated companies has been announced by **GT & E Communications Inc.**, a subsidiary of **General Telephone & Electronics Corp.** The purchase of Georgia TV Cable and its affiliates, which together provide CATV services to 14 communities in eastern Georgia, represents the first multicity CATV acquisition by GT&E Communications since it was formed in April, 1965.

**Entron, Inc.**, has signed a contract with **Peoples Broadcasting Co.** of Lancaster, Pennsylvania (radio station

WLAN) for a turnkey CATV system for that city. The work is being done by **Systems Construction Corp.**, a wholly owned Entron subsidiary.

Subject to FCC approval, the stock of **McLean County Broadcasting Co., Inc.**, operator of **WIOK**, Normal, Illinois has been sold for a consideration of \$200,000 plus assumption of other considerations to **Illinois Broadcasting Company**, operator of **WSOY** AM-FM, Decatur, and **WVLN** and **WSEI** (FM) Olney, Illinois. Merrill Lindsey is president of IBC. **WIOK** operates on 1440 kHz with 1 kw day and 500 watts night.

## PERSONALITIES

**W. Lawton Metcalfe** has been named chief engineer of **WTVT, Channel 13**, Tampa-St. Petersburg, Fla., by Eugene B. Dodson, vice-president of the **WKY Television System, Inc.** and manager of **WTVT**.

Metcalfe succeeds **William U. Witt, Jr.**, who has been named director of engineering of **WTV** (formerly **WUHF-TV**), the system's newly acquired station in Milwaukee.

At the same time Dodson appointed **Adrian R. Snow** as maintenance supervisor of **WTVT**, succeeding Metcalfe.

A Tampa native, Metcalfe was graduated from Hillsborough High School and attended North Carolina State College in Raleigh. During World War II he served as a U.S. Army Signal Corps first lieutenant in the United States and in the European Theater.

Metcalfe began his broadcasting career with **WPTF** in Raleigh, N.C., in January, 1942. In June, 1951, he became transmitter engineer for **WDAE** radio in Tampa, and during the next eight years was employed by another Florida West Coast television station, serving as remote supervisor. He became a member of the **WTVT** engineering department in May, 1963, and later became supervisor.

Born in Brooksville, Fla., Snow was graduated from Hillsborough High School and attended the University of Tampa. Previously employed by another Tampa area television station, he joined **WTVT** in May, 1965. Snow is married and has two daughters.

**Collins Radio Co.** has named **John L. Humphreys** a sales engineer for broadcast communication.

He will service radio stations in Pennsylvania, Delaware, Maryland, and parts of Virginia and West Virginia.

Humphreys has extensive experi-

## SERIES 700 BY TAPECASTER

**Delayed Programmer  
for telephone  
interview shows**

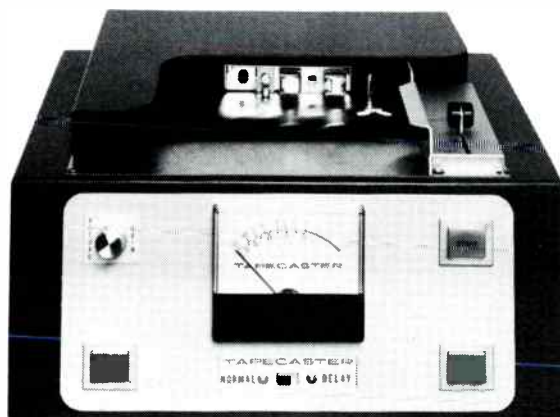

**Model 700-RPD**

**Broadcaster Net Price \$500.00**

**Signal-to-Noise Ratio  
10 DB better than  
competitive delay unit**

**The only all silicon solid state cartridge machine that can be used both as a delayed programmer and a combination record-playback unit.**

## TAPECASTER ELECTRONICS

**Box 662, 12326 Wilkins Avenue  
Rockville, Maryland 20851, Area Code 301 942-6666**

Circle Item 33 on Tech Data Card

**IT'S  
YOUR  
MOVE!**

**MAKE THE  
MOST OF IT...**



with SPARTA'S Showcase Audio Control Center



If your plans include a move or remodeling of your facilities, **SAVE INSTALLATION TIME! SAVE MOVING COSTS! GAIN FLEXIBILITY!**

These new mix 'n match cabinet units have the custom look of richness and quality; yet they save you money because they come to you all ready to install. Let SPARTA show you how many ways you can save on your next move!

The New A-20 Audio Console **IS A REAL MOVER!**

SPARTA moves you into expanded capability, fast! —with this sleek styled console. The NEW A-20

has 22 inputs, 8 mixers with both audition and program mixing. Other quality features include relay muting, individual electronic modules, self contained power supply, monitor & cue amplifier, to name just a few — and it's completely transistorized.



\$995.

**SPARTA**  
ELECTRONIC CORPORATION

5851 FLORIN-PERKINS ROAD • SACRAMENTO, CALIFORNIA • (916) 452-5353

Circle Item 37 on Tech Data Card

ence in broadcast station management and engineering. He resides at Reston, Virginia.

Consolidation of engineering and merchandising activities for major products in a newly created department headed by **Andrew F. Inglis** has been announced by the Broadcast and Communications Products Division, **Radio Corporation of America**. Mr. Inglis will direct the new Engineering and Merchandising Department from the Division's Camden, N. J., headquarters. The department is to bring together planning, development, and design of new and improved products for the broadcast and communications industry.

Mr. Inglis was associated with a Washington, D. C. radio and TV consulting firm before joining RCA in 1953. In RCA, he has held several executive posts, including responsibility for the Division's broadcast product development program and TV systems engineering. In 1958, he became manager, RCA Closed Circuit TV Department, and later was in charge of the Division's film recording and scientific instrument activities. For the past three and one-half years he has been division vice-president, Communications Products Operations, at RCA's Meadow Lands, Pa., facility.

**Elmer Smalling III** has joined the engineering staff of **WRCP AM-FM** in Philadelphia, a Rust Craft station. Previously, Mr. Smalling was chief engineer of **WBUX** in Doylestown, Penn.

**Glenn W. Malme** has recently joined **Altec Lansing** as advertising manager. Mr. Malme assumes advertising responsibility for **Gonset, Inc.**, makers of amateur radio equipment, and its recently acquired **DuMont Laboratories** mobile communications equipment; the **Peerless Electrical Products Division**; and **Altec Lansing**, producers of commercial sound equipment, hi-fi stereo ensembles, speakers, microphones, and telephone-industry products.

Mr. Malme has had substantial experience in the electrical-electronic products field, and has an electrical engineering background. ▲

**MOVING?**

*Don't Lose Touch . . .*

Receive BE as usual at your new address

Write: **BROADCAST ENGINEERING**

Circulation Department

**4300 West 62nd Street  
Indianapolis, Indiana 46206**

# Why does this EIA Sync Generator look so professional?



Because it's engineered by pro's for pro's with these time-tested Telemet features: ■ One of the few solid state sync generators that fully meet RS 170 specs by having pulse amplitude control. ■ Test points and major adjustments are up front. ■ Additional mounting frames may be wired into other locations for fast generator installation.

We've sold more than 500 of these units in the U.S.A. to date. Chances are, you may know an engineer who uses one. Ask him about the Telemet Model 3507 . . . then ask us.



## TELEMET COMPANY

185 DIXON AVENUE, AMITYVILLE, N. Y. • PHONE (516) 541-3600

Circle Item 38 on Tech Data Card

for your tower  
requirements  
check

**ROHN** ✓  
**SYSTEMS**



**A complete tower erection service that has these special advantages:**

- ✓ **DEPENDABILITY**
- ✓ **RELIABILITY**
- ✓ **COMPLETE ENGINEERING**
- ✓ **COAST TO COAST SERVICE**
- ✓ **REPRESENTATIVES WORLD-WIDE**

Be sure to obtain price quotations and engineering assistance for your complete tower needs from America's foremost tower erection service.

**ROHN SYSTEMS, INC.**

6718 W. Plank Road Peoria, Illinois  
Phone 309-637-8416 • TWX 309-697-1488

Circle Item 40 on Tech Data Card

## NEW PRODUCTS

For further information about any item, circle the associated number on the Tech Data Card.



### Lightweight Parabolic Antennas

(60)

An antenna product line designed to provide ruggedness and light weight for microwave ETV transmission is offered by **Prodelin Inc.** Intended to meet the requirements of the ETV sys-

tems currently being installed throughout the country in the 2500-2700 MHz band, these antennas feature a spun-aluminum dish with a closed rolled bead at the perimeter for extra strength. Sizes are 1, 2, 3, and 4 feet, and all sizes employ dipole feeds and incorporate a reinforced back structure for additional rigidity. A pipe-mount device is incorporated to permit one-man installation. An elevation mechanism operating independently of the pipe mount is also provided for adjustments of up to plus or minus 7°.

Another feature of these antennas is that the dipole feed is encapsulated by a polyethylene radome, and the void inside the radome is filled with a cellular urethane foam to seal the unit from rain, wind, dust and other foreign matter. All aluminum parts are primed and painted, and all steel parts are galvanized.

This new line is offered with accessories such as an antenna radome, disk-rim support rod for extra rigidity

**TREPAC**

### "BUILDING BLOCK" TONE SYSTEM

The TREPAC DATATONE System, a complete line of "off the shelf" modular tone equipment, provides an economical means of expanding existing or new control and communications networks, Multi-channel control and/or teletype, with or without voice communications, may be operated over a single communications link.

"Building block" design permitting budget controlled growth capability as well as compatibility with existing equipment, permits the design engineer the freedom necessary to develop a communications system tailored to his individual needs.

Both AM and FSK transmitters and receivers, power supplies, loop D.C. supplies, regenerative repeaters, and two-way D.C. repeaters, telemetering adapters, diversity combiners, and an extensive filter line are available from stock.

Each module has a test socket in the front panel which allows "by the numbers" testing of operating systems by



TYPICAL TRANSMITTER-RECEIVER  
-POWER SUPPLY MODULES.



TYPICAL 19 INCH RACK MOUNTING.

inexperienced personnel. This, together with plug-in frequency determining elements and single type plug-in transistors, permit a realistic approach to the maintenance problem.

For additional information, contact: Datatone Division RS:

**TREPAC CORPORATION OF AMERICA**

30 W. HAMILTON AVE., ENGLEWOOD, N. J. • PHONE: (201) 567-3810 • TWX (201) 567-4977

**SOLID STATE ELECTRONICS for TELECOMMUNICATIONS**

Circle Item 55 on Tech Data Card

## SPOTMASTER

RS-26



### Tape Cartridge Racks

RM-100



... from industry's most comprehensive line of cartridge tape equipment.

Enjoy finger-tip convenience with RM-100 wall-mount wood racks. Store 100 cartridges in minimum space (modular construction permits table-top mounting as well); \$40.00 per rack. SPOTMASTER Lazy Susan revolving cartridge wire rack holds 200 cartridges. Price \$145.50. Extra rack sections available at \$12.90.

Write or wire for complete details.

*Spotmaster*

**BROADCAST ELECTRONICS, INC.**

8800 Brookville Road  
Silver Spring, Maryland

Circle Item 39 on Tech Data Card

Some plain talk from Kodak about tape:

**Kodak**  
TRADEMARK

## Double or nothing... or the noble art of dubbing

One good tape deserves another. That's another way of saying that half the fun in having a good-quality, home tape-recording system should consist of being able to make tape duplicates. The reasons for dubbing can be as varied as you want. Perhaps as simple as sending your Aunt Mabel a particularly good tape of the kids—a tape you also want for your own tape library . . . or because you want to exchange tapes with a fellow audiophile . . . or because you want to edit a tape to go along with a movie or slide film without chopping up the original tape . . . or simply to preserve your early tape recordings on modern, more efficient KODAK Sound Recording Tape.

**Takes two to swing.** If you already have a second tape recorder on hand, you're ready to get started. If not, find a good friend that will lend you his. But do be particular about your friend. Because that old cliché about the weakest link applies in spades as far as dubbing equipment goes. Also be particular about the tape you use . . . but as they say on radio, more on this later.

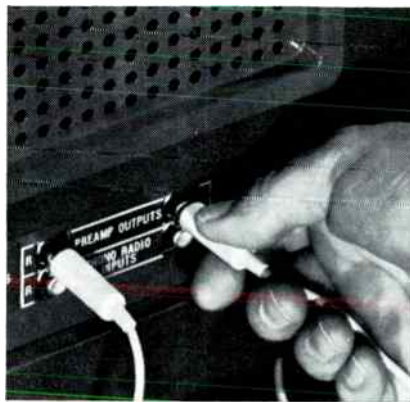

**Read the instructions.** First off—and though it may seem obvious—make sure your two tape systems are in the best possible condition. Look at it this way—the dubbed recording will be at best a second generation recording . . . it's going to combine all the deficiencies present in your original tape recording, in the playback recorder, and in the recording equipment. So read both instruction books . . . then clean the heads with one of the commercial preparations available for that purpose . . . and demagnetize the heads if you can lay your hands on a degausser.

Next, connect your two tape machines—the “master” and the “slave.” If you have a choice, take your output from the master at the pre-amp stage rather than at the amplifier. No reason to add its distortion to your dubbing. For the input to the slave, you usually have a choice—one marked “mike” or “high-impedance” (usually in the 50,000-200,000 ohms range), the other marked either “radio,” “phono,” “tuner,” “tape” or “low-impedance” (in the 500-ohm range). You want the latter one.

**Choose your tape.** Signal-to-noise is the touchiest area in dubbing. Picking a tape that will give you the lowest noise level on the duplicate without lowered output makes a lot of sense. We've got just the tape for you: KODAK Sound Recording Tape, Type 34A. It packs five or more additional decibels of undistorted output than the usual low-noise tapes. When dubbing on KODAK Sound Recording Tape, Type 34A, set the recording level on your slave unit at 4 decibels over your normal level—that's just slightly higher than normal if you set your level by a VU meter. Because you can put a lot of signal on this tape, you can play it back at lower gain . . . and, Eureka, there's your low noise!

KODAK Tapes—on DUROL and Polyester Bases—are available at most electronics, camera, and department stores. To get the most out of your tape system, send for free, 24-page “Plain Talk” booklet which covers the major aspects of tape performance. Write: Eastman Kodak Company, Department 940, Rochester, N.Y. 14650.



EASTMAN KODAK COMPANY, Rochester, N. Y.

Circle Item 41 on Tech Data Card

NEMS • CLARKE

offers a  
**UHR\*AM**  
 measurement  
 capability  
 with the  
**FIM-135**  
 FIELD INTENSITY  
 METER

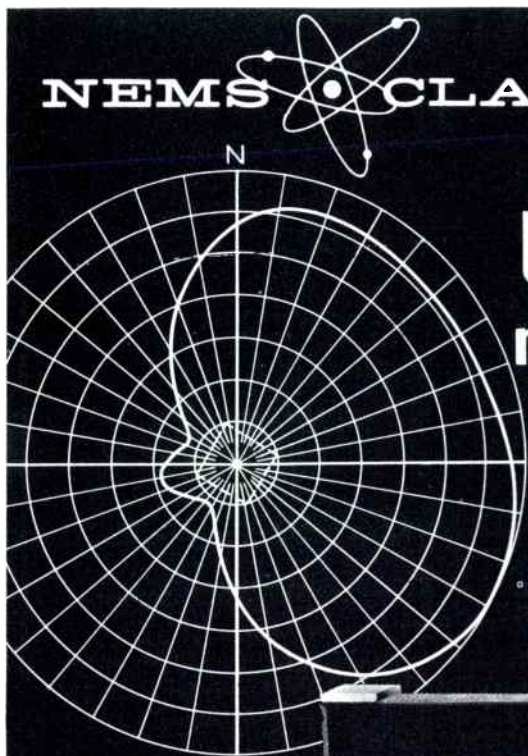

(\* ultra high reliability)

- All Solid State
- 175-Hour Mercury Battery
- Taut-Band Meter Movement
- Lightweight
- Crystal or VFO Operation
- Tuning from 540 to 1600 KC
- Front Panel Speaker
- Use as Null Detector



The new Model FIM-135 Field Intensity Meter provides exceptional reliability in the field due to its extremely ruggedized construction, solid-state design, and long life Mercury battery. Its lightweight (9 lbs.), compact (6½" x 10" x 6½"), and simplified design provides ease of handling and operation in the field.

Dial locks provide a fixed setting at any point across the entire broadcast range. A taut-band meter movement accurately displays from 10 microvolts per meter to 10 volts per meter, making it equally effective for interference studies at low signal strength and for close-in measurements on high-power directional arrays. A special input jack permits receiver use as a null detector for RF Bridge measurements. V-27

For complete information, call or write:

**Vitro ELECTRONICS**

Producers of NEMS-CLARKE Equipment  
 A Division of Vitro Corporation of America  
 919 Jesup-Blair Drive • Silver Spring, Maryland (301) 585-1000

Circle Item 42 on Tech Data Card

in high-wind areas, and a variety of roof-top and wall mounts. Beam tilt and null fill-in (as required) are also available.



**Right-Angle Bulkhead Plug**  
 (61)

The "ConheX" right-angle bulkhead plug features a mounting section located on the cable side of the right angle. The new Sealectro Corp. units, designated "ConheX" No. 50-029-0019, are available in either 50- or 75-ohm impedances and have a rated working voltage of 400 volts rms at sea level. Contact current rating is 1.5 amps DC maximum; contact voltage drop is 4 mV maximum at 1 amp; and insulation resistance is 10<sup>8</sup> megohms minimum. VSWR is less than 1.2:1 from 1 to 5 GHz, and less than 1.4:1 from 5 to 10 GHz.

The connectors are designed so that, when properly assembled to the compatible cable, the pullout force is equal to the breaking strength of the cable. After 500 cycles of mating and unmating, the connectors show negligible loosening of parts or change in electrical parameters.



**High-Voltage Power-Supply Modules**  
 (62)

A series of fully regulated, high-voltage power-supply modules for use with CRT's, image-pickup tubes, pho-



tomultiplier tubes, neon read-outs's, klytrons, twt's, bwo's, and other microwave and vacuum tubes is being marketed by **High Voltage Power Supply Co.**

The series is line-operated and covers voltage requirements from 200 to 2500 volts at 20 ma to 2 ma with DC output floating and adjustable. The units are packaged in Mil-T-27 HA cases and feature independent line and load regulation and short-circuit protection with automatic recovery.

Features include: regulation at high voltage, self-recovering short-circuit protection at high voltage, completely silicon solid-state at high voltage. The unit is designed to be used as a component.



**8-Track Tape Duplicating System**  
(63)

Eight-track cartridges for use in the Lear-Jet automobile stereo tape players are recorded on this **Lang Electronics, Inc.** 8-track, 1/4" tape duplicating system.

The Lang system is built around the standard Ampex 300 tape transport. Controlled from a single source and starting with the 2-track 1/2" master tape, four 2-track playback machines feed into an 8-track 1" mastering recorder. The resulting 8-track master is then used on the duplicator. The solid-state electronics, masters, bias amplifier, and controls are installed in a single housing.



**Flashing Indicator Lights**  
(64)

**Dialight** has added a flashing light to its listing of indicator devices. This indicator light mounts in a 1/2" clearance hole.

Using a characteristic of high-brightness neon lamps in combination with solid-state components, flashing operation is obtained on 110/125-volt AC power without moving elements or contacts.

## "Want a Good Job in Broadcasting?"



## You'll Need a First Class FCC License."

Matt Stuczynski knows. He's the Senior Transmitter Operator of Radio Station WBOE. His story is typical of hundreds of men who have used Cleveland Institute Training as a springboard to success in Broadcasting. Here's what Matt says about Cleveland Institute:

"I give Cleveland Institute credit for my First Class FCC License. Even though I had only 6 weeks of high school algebra, CIE's AUTO-PROGRAMMED™ lessons really made electronics theory and fundamentals easy. After completing the CIE course, I took and passed the First Class Exam. I now have a good job in studio operation, transmitting, proof of performance, equipment servicing. Believe me, a Commercial FCC License is a 'must' for a career in Broadcasting."

If you want rapid advancement in broadcasting, the first step is a First Class FCC ticket with *your* name on it. And Cleveland Institute Home Study is a fast, economical way to get one. What's more, CIE backs their licensing programs with this money-back warranty:

"A CIE License Course will quickly prepare you for a First Class FCC License. If you complete the course but fail to pass the exam *on your first attempt*, CIE will refund all tuition."

With Cleveland Institute you get your First Class FCC License or your money back! Send coupon today for FREE book or write to Cleveland Institute of Electronics, 1776 E. 17th St., Dept. BE-32, Cleveland, Ohio 44114.

**NEWS FOR VETERANS: New G. I. Bill may entitle you to Government-paid tuition for CIE courses if you had active duty in the Armed Forces after Jan. 31, 1955. Check box in coupon for complete information.**



**MAIL COUPON TODAY FOR FREE BOOK**

**CIE** Cleveland Institute of Electronics

1776 East 17th Street, Cleveland, Ohio 44114

Please send me your FREE book, "How To Get A Commercial FCC License."

Name \_\_\_\_\_ (please print)

Address \_\_\_\_\_

City \_\_\_\_\_ State \_\_\_\_\_ Zip \_\_\_\_\_

Occupation \_\_\_\_\_ Age \_\_\_\_\_

**Veterans check here for GI Bill information**

Accredited Member National Home Study Council  
A Leader in Electronics Training . . . Since 1934

BE-32

Miniaturized driving circuitry is enclosed within the body of the light. An extending edge of the circuit card exposes eyeletted openings for external wire connections.

Based on life tests at maximum voltage, the NE-2J lamps which are used have an average life of 5000 hours. Lamp replacement is made from the front of the panel.

Described as Catalog No. 928-1422-1631-638 series, these lights are available from stock. The price is \$4.60 in minimum quantities.



**Dual-Beam Scope**  
(65)

A dual-beam oscilloscope in the 25-MHz range is now offered by **Data Instruments Division**. The D53 is a laboratory-type scope designed for wide-band, multiple-trace applications including differential measurements and high-DC-sensitivity applications.

The main frame contains the cathode-ray tube, power supplies, and the delays. Built into the main frame of the D53 are two features: (1) Both the signal delay and the

sweep delay are built into the main frame. The appropriate amplifiers automatically connect to the delays when they are plugged into position. This eliminates the necessity of incorporating a delay line into each of the different amplifiers used with the scope. The signal delay is 0.25  $\mu$ sec, and the sweep delay is continuously variable to 50 msec in two ranges. (2) The CRT is a specially designed split-beam, rectangular, 8.5-kv tube which uses the mesh principle. This high-sensitivity tube is used to provide a brighter trace and greater display accuracy. Each beam gives a 6-cm  $\times$  10-cm display area calibrated by a removable edge-lit graticule.

Time-base and horizontal amplification are provided by a plug-in module. At present this module is standard and is considered part of the main frame. Other horizontal amplifiers will be available later. The D53 provides horizontal deflection of both beams at speeds up to 0.5  $\mu$ sec/cm in 22 calibrated ranges. It also contains provisions for varying the sweep delay and has a single-shot facility with lockout.

Triggering can be derived from either amplifier, from the supply frequency, or externally. The unit can be triggered on 2 mm of internal display or 0.2 v peak-to-peak external. The horizontal amplifier is available for external use with a bandwidth of DC to 1 MHz (-3 db). X expansion is variable up to 10 screen widths.

The D53 accepts all standard Data Instruments amplifiers. In addition, two new vertical amplifiers utilizing the signal delay are available: The CD amplifier with sensitivities to 100  $\mu$ v/cm, and the HD amplifier with bandwidth of DC to 25 MHz and a rise time of 14 nanoseconds.

Price of the main frame including time base and horizontal amplifier is \$915. Six vertical amplifiers range in price from \$80 to \$160.

# Metro-Tel

PERFORMANCE-PROVEN

## TV equalizers & delay lines

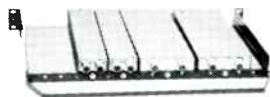

Used by the leading networks in their TV expansion programs. Modular designs; anodized aluminum housing; shelf-coordinated; shelves designed to fit standard 19" cabinets.

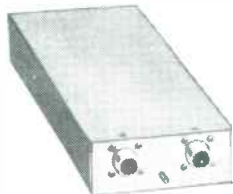
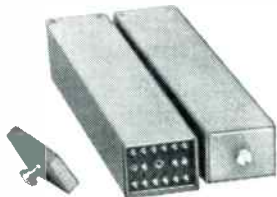

### TV LINE EQUALIZER 323E

For use with Western Electric 724 Cable or equivalent. Compensates for loss in cable lengths in 50 ft. steps from 50 ft. to 300 ft. Equalizer plus cable = 3 db attenuation  $\pm$ .1 db from 0 to 8 megacycles.

### TV DELAY LINES 7292

Input and output impedance of 75 ohms; convenient coax connectors for input and output. Delay time: .05, .1, .1, .2, .4, .6, .8, microseconds, steps selected by strapping terminals. Total delay of 2.25 microseconds.



409 Railroad Avenue, Westbury, N.Y. 11590  
(516) 333-7650

Circle Item 43 on Tech Data Card



STANDARD 12"  
also available  
in STANDARD 16"  
and CUSTOM 12"

- Belt drive
- or puck drive

Naturally we're prejudiced — but then, we've had more experience than anyone else in direct drive turntables. QRK's patented mechanism has never been equaled for long-time, no-trouble service; for fast start and accurate cueing; for simplicity of operation — thanks to our "Platter-dapter" that spins all disks with no need for pop-up gadgets. Hundreds are "voting puck" every year. Bandwagon anyone?



See your dealer today or call or write us for complete information.

**QRK ELECTRONIC PRODUCTS**  
2125 N. Barton — Fresno, California

Circle Item 45 on Tech Data Card



**Solid-State 50-Watt  
Power Amplifier**  
(66)

The AM-50 is a general-purpose, solid-state power amplifier designed for professional monitoring and sound-reinforcement applications. Developed and manufactured by Langevin, it is rated for continuous sine-wave operation and features protection against damage from overload and short-circuit in its circuit design.

The power amplifier is designed to be compatible with the Langevin Model AM-2A nine-channel mixer and supplies operational power for it by direct plug-in connection. Signal circuitry is connected by plugging directly into the AM-2A or the self-powered Model AM-1A mixer-amplifier.



**Four-in-One Field Meter**  
(67)

Wilkinson Electronics, Inc., has de-

veloped a transistorized portable field meter with four separate functions: (1) field-intensity meter; (2) null detector; (3) standard-signal generator; and (4) monitor receiver.

In the Model 4N1, a measured loop antenna provides RF input to a sensitive receiver, and audio output from the speaker identifies the signal to be measured. RF gain is adjusted to the receiver set point on the meter. With the loop out of the circuit, the calibration oscillator is then set to calibrated output, and its signal is atten-

uated to match the meter reading of the initial signal. The multiplication factor of attenuation, X1, X10, etc., is then applied for direct reading of field intensity. Because the loop is out of this circuit on oscillator set, no nulling is required. The unit reads field strength directly from 10  $\mu\text{v}/\text{m}$  to 10  $\text{v}/\text{m}$  with an accuracy of 3% in the frequency range of 535 kHz to 1605 kHz.

A standard-signal generator is incorporated which has calibrated output from 10 microvolts to 1 volt with

**Solid State REMOTE CONTROL SYSTEM**

**MOSELEY ASSOCIATES, INC.**  
135 NOGAL DR. SANTA BARBARA, CALIF.  
(805) 967-0424

- Only 1 DC pair required
- 10 channels
- Write for Bulletin 214

Circle Item 47 on Tech Data Card

**AVAILABLE LOCALLY FROM YOUR DEALER!**

**NORTRONICS 8000 SERIES PROFESSIONAL REPLACEMENT HEADS FOR AMPEX, MAGNECORD, CONCERTONE, RCA, CROWN**

*Available for all track styles and functions, plus Record or Playback Types in 3 or 4 Channel Heads!*

Now you can reduce "downtime" by using Nortronics replacement heads—available locally and immediately from your dealer! Pick the head and track style YOU need from Nortronics' full professional line. After initial changeover, replace heads or convert track styles in minutes! Precision engineered adapters and mounting brackets let YOU make the initial changeover... let YOU service YOUR recorders according to YOUR needs.

See your dealer; write for details; or call 612-545-0401



8143-E Tenth Ave. No. • Mpls., Minn. 55427

Circle Item 46 on Tech Data Card

**TELEVISION ENGINEERS**

We are interested in contacting 10 Station Engineers capable of design or field engineering. Excellent opportunities in TV Development Engineering and Systems Engineering with Sarkes Tarzian, Inc., Broadcast Equipment Division.

TV station engineering experience required, BSEE or equivalent desirable. Send resume of experience, or call, Mr. Biagio Presti, Broadcast Equipment Division, Sarkes Tarzian, Inc., Bloomington, Indiana, Area Code 812, 332-7251.

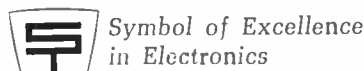

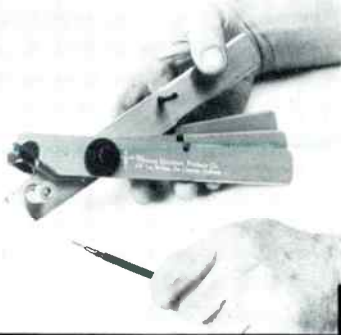

NEW MODEL CX-1

## COAXIAL CABLE STRIPPER

Developed and used by NASA ■ Prepares cable for connectors in 10 seconds ■ Adjusts for stripping requirements of all standard co-ax connectors ■ Close-tolerance adjustment prevents nicked conductors ■ With removable inserts, accepts cable from .075" to .435" OD.

PRICE \$39.50 F.O.B. San Clemente  
Specify cable O.D. when ordering

Western Electronic Products Co.  
107 Los Molinos, San Clemente, Calif. 92672

Circle Item 48 on Tech Data Card

## SPOTMASTER

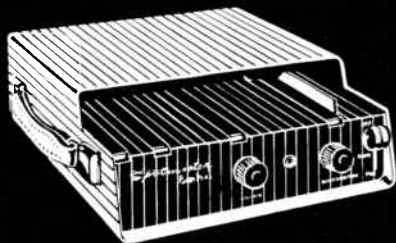

### PortaPak I Cartridge Playback Unit

Your time salesmen will wonder how they ever got along without it! Completely self-contained and self-powered, PortaPak I offers wide-range response, low distortion, plays all sized cartridges anywhere and anytime. It's solid state for rugged dependability and low battery drain, and recharges overnight from standard 115v ac line. Packaged in handsome stainless steel with a hinged lid for easy maintenance, PortaPak I weighs just 11½ lbs. Vinyl carrying case optional.

Write or wire for full information.

*Spotmaster*

**BROADCAST ELECTRONICS, INC.**

8800 Brookville Road  
Silver Spring, Maryland

Circle Item 49 on Tech Data Card

an accuracy of  $\pm 3\%$ .

The monitor receiver incorporated in the unit has a sensitivity of better than 5 microvolts and as a portable unit can be used for off-air monitoring in fringe areas.

The use of the unit in conjunction with an RF bridge simplifies the measurement of RF impedance. The 4N1 replaces AC-operated oscillators and BFO receivers. Since null detection is visual, earphones are unnecessary.

The unit weighs 12 pounds including nickel cadmium batteries which are rechargeable from AC or automobile. A built-in speaker is featured, and the line charging cord disappears. The panel is self-illuminated and has a large meter and dials. The power supply is automatically turned off when the cover is closed. The unit comes in a cowhide case which has a shoulder or hand strap.



### Compact Video Recorder (68)

Marketing of the VR-6000 Series compact videotape recorders for closed circuit uses has been started by **Ampex Corp.** Prices of the recorders start at \$1095. The machines, which record pictures and sound on magnetic tape for immediate playback through television receivers, are designed for a wide range of training and communications applications in business, education, government, and other fields.

The VR-6000 Series is compatible with and complements the Ampex VR-7000 Series, a heavy-duty closed-circuit videotape recorder line for industrial and educational uses.

Initial deliveries consist of the Model VR-6000, a luggage-mounted portable model selling for \$1450. A new companion camera, the Model CC-6400, sells for \$549. Other models in the VR-6000 Series, including a deck version for \$1095, will be available later.

Model VR-6000 comes in a carrying case with built-in handles and has many features similar to the VR-7000. It features both video and RF outputs, and can be connected directly to any television monitor or receiver. Model VR-6000 can be used with any vidicon television camera.



### Multiple Outlet CATV Tap-Off (69)

The **Benco "Stinger"** multitap transformer is supplied with one, two, or four tap spigots. All three models are back-matched to minimize reflections and tap attenuation. Values range from 13 dB to 40 dB.

The "Stinger" will mate with all conventional pressure-tap cable blocks and can be used with aluminum or RG-type cable without cutting the distribution cable.



### Video Analyzer (70)

The Model 302 Video Analyzer provides a means of utilizing the television camera as a scientific instrument. Similar in principle to the sampling oscilloscope, this device allows low-cost chart recording of video waveforms, and simultaneously generates a large, dynamic data display on conventional TV monitors. Noise reducing characteristics allow significant video detail to be extracted from weak signals.

**The Colorado Video, Inc.** Model 302 may be used for rapid, convenient, visual data reduction in three scanning modes and one static mode. Specified accuracy is better than 3%, and several functions may be remotely controlled.

Price of the unit is \$1950. ▲

## ENGINEERS' TECH DATA

### AUDIO & RECORDING EQUIPMENT

90. ATLAS SOUND—Catalog 566-67 shows new models of PA speakers, microphone stands, and accessories for commercial sound applications.
91. BAUER—Product-line brochure indicates the variety of audio and transmitting equipment manufactured.
92. BRITISH INDUSTRIES—Booklets catalog Garrard turntables, Wharfedale speakers, and Ersin "Multicore" solder.
93. MAGNECORD—Folder contains description and specifications for the 1021 monaural and the 1022 stereophonic magnetic tape recorder reproducers.
94. QUAM-NICHOLS—General Catalog 66 lists public-address, sound-system, high-fidelity, automotive, musical-instrument, and replacement speakers.
95. TAPECASTER—Brochure on the Series 700 tape-cartridge machine provides specifications and schematics for the monophonic, stereophonic, and telephone-delay units.
96. VIKING OF MINNEAPOLIS—Literature describes the PB-10 tape-playback preamplifier.

### COMPONENTS & MATERIALS

97. ALFORD—Product Bulletin No. 608 is for AMCI Quadrids®, which are hybrid-like 3-dB couplers for applications where two signals of equal amplitude, but 90° phase difference, are required.
98. IEC/MULLARD—Descriptive literature and price list pertain to the special-purpose tube range featuring the 6076/QY5-3000A transmitting tetrode.
99. STACO—Specification sheet supplies complete data regarding the new 1000 series variable autotransformers.
100. SWITCHCRAFT—New Product Bulletin 163 describes two new, completely molded headset-replacement, coiled cords for headsets terminated with a "Micro-Plug."
101. TROMPETER—New Catalog T6 gives information on the complete line of patching equipment, connectors, etc., in coax, twinax, and triax.
102. WATERS—Data sheet illustrates coaxial switches, illuminated knobs, and coaxial antenna switches with "automatic grounding."

### MICROWAVE DEVICES

103. LENKURT—Brochures apply to Type 76 microwave equipment for TV application and Type 75A microwave equipment for long-haul broadband radio transmission.
104. MICRO-LINK—Booklet outlines principles of 2500-MHz ETV including equipment, laws, and financing.

### MISCELLANEOUS

105. CLEVITE—"The Growing Family of Clevite Ceramic Filters" for electronic communications is described in Bulletin No. 94025, which outlines and illustrates reasons ceramic filters are often used in place of other types.
106. TEXAS ELECTRONICS—Catalog illustrates and details line of meteorological instruments for radio, television, and CATV employment, including scanning installations.
107. VENT-RAK—Kit contains complete component specifications, details, and ordering information for the 5000 series of Slim-Line enclosures.

### MOBILE RADIO & COMMUNICATIONS

108. MOSLEY ELECTRONICS—Catalog lists complete line of 1966 Citizens-band equipment.



# 'BEST IN THE PATCH FIELD ...'

William D. Kelly  
Chief Engineer  
WNEW-TV, New York, says:

"COTERM is far superior to any product of its kind. It is rugged, reliable and safe. Based on my experience, I can't recommend COTERM too highly for any engineer who wants a trouble-free operation."

## COTERM®



COTERM® provides the broadcast engineer with a new standard of dependability. With COTERM you have normal-through coaxial circuits without the use of patchcords. When the load side is patched the source is terminated automatically in the proper impedance.

Active circuits may be tested without signal interruption. COTERM is compact, permitting high density on the patch field—22 jacks on the standard 19" x 1¾" panel.

COJAX® offers all the same advantages except self-termination of source when the load side is patched. All COTERM-COJAX accessories are compatible.

## QUICK DISCONNECT CONNECTOR



The unique snap lock feature allows easy insertion and removal even in the densest patch field. Available for a wide range of coaxial cables and simple to attach with standard tools.

# COOKE Engineering Company

735 N. Saint Asaph Street, Alexandria, Va. Telephone: 703-548-3889

Circle Item 50 on Tech Data Card

# Color Problems?

## AEM HAS

### THREE

## NEW ANSWERS

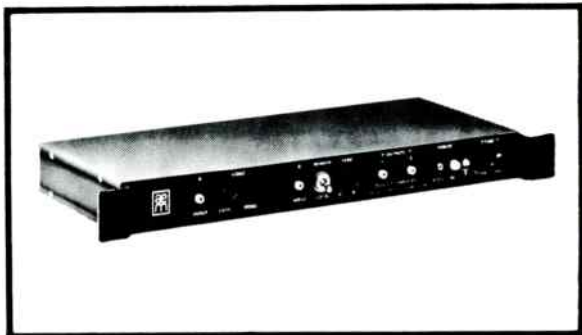

**LAP AMPLIFIERS**—Here's the new LDA-series of lap-dissolve amplifiers that AEM developed especially for color. Photo-electric cells, remotely controlled by DC circuitry, assure a velvety transition between two inputs. All solid state (silicon semiconductors exclusively), the LDA provides the signal handling characteristics of a high performance distribution amplifier. Differential phase and gain do not change even during the lap interval. Embarrassing color shifts and level changes become a thing of the past. And the price is just as attractive as the performance: LDA-1, \$555.00; LDA-2 (sync adding), \$585.00.

**COLOR SENSORS**—We are introducing a Color Sensor attachment to the LDA amplifiers which samples both incoming channels and then closes a relay when *either* input has color burst . . . gives your switching system the information it needs to react properly. LDA-1 with Color Sensor, \$595.00; LDA-2 with Color Sensor, \$625.00.

**BURST GENERATOR**—Our new black Burst Generator with CONTROLLED chroma background will allow you to control color fades to black or any hue. The variable chroma feature also acts as a source for coloring backgrounds of monochrome slides and movies. Color Burst Generator, just \$595.00; standard black Burst Generator, \$545.00.

Call or write for more information about AEM video equipment. Feature for feature, there is nothing comparable on today's market!

### APPLIED ELECTRO MECHANICS, INC.

2350 Duke Street, Alexandria, Virginia 22314  
PHONE: (703) 548-2166



Circle Item 51 on Tech Data Card

### POWER DEVICES

109. HEVI-DUTY—Bulletin 7-22 supplies data on line-voltage regulator using saturable-core reactor.
110. TOPAZ—28-page catalog No. 52066 provides general information regarding power-conversion devices and catalogs a line of solid-state DC-to-AC and AC-to-AC equipment.

### RADIO & CONTROL ROOM EQUIPMENT

111. MOSELEY ASSOCIATES—Data Sheet No. 215 describes and gives specifications of a new compact, solid-state direct FM subcarrier generator, Model SCG-4T.

### REFERENCE MATERIAL & SCHOOLS

112. CLEVELAND INSTITUTE OF ELECTRONICS—New pocket-size plastic "Electronics Data Guide" includes formulas and tables for: frequency vs wavelength, dB, length of antennas, and color code.
113. GATES—Engineering reports offered are: "Power Dividers for Directional Antenna Systems," by R. Bush, and "New Network Audio Systems Amplifiers," by W. Kabrick.
114. HAYDEN BOOKS—64-page catalog lists Hayden and Rider technical books for engineers, technicians, and management.

### STUDIO & CAMERA EQUIPMENT

115. CLEVELAND ELECTRONICS — A 52-page quick-reference, step-down diecut catalog covers complete information on vidicon, Plumbicon®, and image-orthicon deflection components. Included are photographs, specifications, technical data, and dimensional drawings.
116. INTERNATIONAL NUCLEAR—Subject of literature is Model TVM2 Video Modulator for conversion of standard color TV receiver to color monitor.
117. KEMLITE—Series of brochures details specifications and applications of reflectors, high-intensity electronic flash tubes for photography, and straight and helix second-generation flash units for laser pump and other research applications.
118. QUICK-SET—Folder is for television and motion-picture camera equipment, including tripods, heads, dollies, and units for console requirements.
119. TV ZOOMAR—Described is the Model 10x40 10-to-1 zoom lens for image-orthicon cameras.

### TELEVISION EQUIPMENT

120. COHU—Data sheets 6-415, 6-435, and 6-418 cover the Model 2470 Sync Generator Systems, Model 9830-071 Color Video Encoder, and Model 9800-151 Video Distribution Amplifier, respectively.
121. COLORADO VIDEO—Data sheet describes the Model 401 Video Plotter which operates in four modes and employs a disc video memory.
122. VITAL—Data sheets give specifications of Model VI-500 stabilizing amplifier, Model VI-10A video distributing amplifier, and Model VI-20 pulse-distribution amplifier.

### TEST EQUIPMENT & INSTRUMENTS

123. KRS DIV. DATAPULSE—Technical information offered is "Evaluation of Video Tape with the KRS/Orion VTA-101 Video Tape Analyzer," a report which discusses the need for an accurate and efficient method of evaluating videotape quality, and how this instrument achieves that end.
124. SECO—Catalog sheet is on the new Model 107C Deluxe Tube Tester.
125. VITRO—Four-page data sheet covers "Nems-Clarke" field-intensity meters, phase monitors, spectrum-display monitors, FM rebroadcast receivers, jacks, jack panels, and plugs.

### TOOLS

126. AIR SPACE DEVICES—"SAF-T-CLIMB," a device for prevention of falls when climbing vertical structures, is discussed in literature.

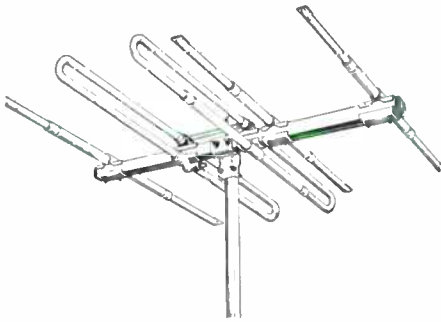

if **THIS** Yagi design doesn't solve your problem...

choose from over **100** other Taco ruggedized Yagi antennas



There is simply no compromise when you specify a TACO Yagi antenna or antenna system. As a pioneer manufacturer and prime supplier of Yagi antennas, TACO has developed models for every communications need—point-to-point, rebroadcast TV, Translator, CATV, MATV, ETV, or sophisticated tracking arrays.

TACO Yagi antennas are available in 5, 8, and 10 element designs in single or multiple arrays for vertical or horizontal polarization. These are cut and tuned for specific broad or narrow bands in the frequency range from 30 MHz to 500MHz.

TACO catalogs almost one hundred and fifty different types of Ruggedized Yagis—each suited to do a particular job best. TACO's tremendous backlog of experience in special-function design is matched by no other antenna manufacturer.

Send for complete catalog data today.

**TACO** antennas and antenna systems

**JERROLD ELECTRONICS CORPORATION**  
Government and Industrial Division  
Philadelphia, Pa. 19106

Circle Item 52 on Tech Data Card

November, 1966

## Advertisers' Index

Altec Lansing, Div. LTV Ling Altec, Inc. ....	24
Ampex .....	34
Andrew Corp. ....	45
Applied Electro Mechanics, Inc. ....	70
Belden Mfg. Co. ....	51
Broadcast Electronics, Inc. ....	46, 62, 68
CBS Laboratories, Div. of CBS, Inc. ....	5
CCA Electronics Corp. ....	57
Central Dynamics Corp. ....	31
Cleveland Institute of Electronics .....	65
Cohu Electronics, Inc. ....	3
Collins Radlo Co. ....	47
ColorTran Industries, Inc. ....	32
Cooke Engineering Co. ....	69
Crown International .....	48
Eastman Kodak Co. ....	63
Electronics, Missiles and Communications, Inc. ....	26
Electro-Voice, Inc. ....	10
Elpa Industries .....	41
Fairchild Recording Equipment Corp. ....	6
International Nuclear Corp. ....	cover 3
Jampro Antenna Co. ....	53
Jerrold Electronics, Government & Industrial Div. ....	71
JOA Cartridge Service .....	50
Lang Electronics, Inc. ....	34
Lenkurt Electric Co., Inc. ....	49
Magnecord, Div. of Telex Corp. ....	29
Metro Tel Corp. ....	66
Microwave Associates .....	42
Minnesota Mining & Mfg. Co. ....	35
Moseley Associates, Inc. ....	48, 67
Norelco .....	8, 9
Nortronics Co., Inc. ....	67
QRK Electronic Products .....	66
RCA .....	38, 39
RCA Electronic Components and Devices .....	cover 4
Rohn Systems, Inc. ....	62
Riker Industries, Inc. ....	cover 2
Sarkes Tarzian, Inc. ....	33, 67
Scully Recording Instruments Corp. ....	27
Sparta Electronic Corp. ....	52, 60
Tapecaster Electronics .....	59
Tech Laboratories, Inc. ....	71
Telemet Co. ....	61
Trepac Corp. of America .....	50, 62
Visual Electronics Corp. ....	55
Vital Industries .....	25
Vitro Electronics, Div. of Vitro Corp. of America .....	58, 64
Ward Electronic Industries .....	7
Western Electric Products Co. ....	68
Wilkinson Electronics, Inc. ....	6

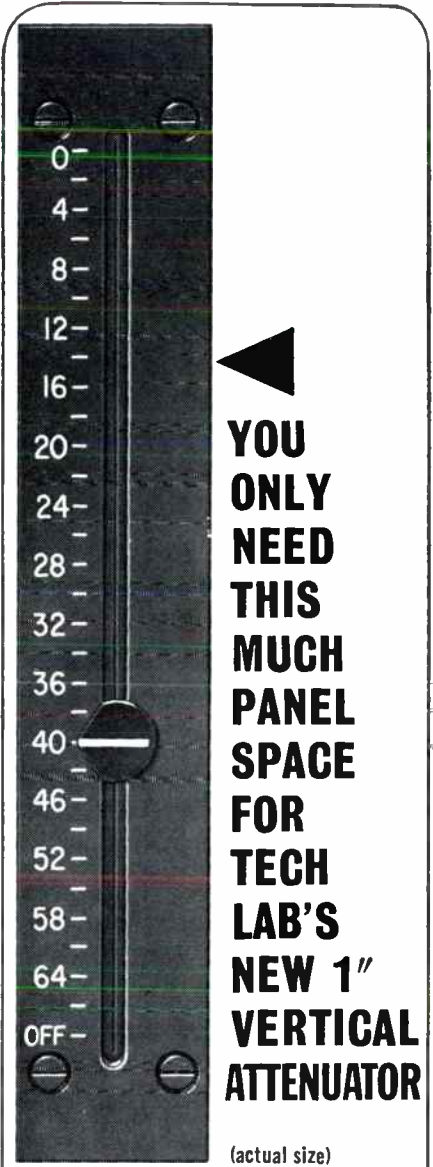

**YOU ONLY NEED THIS MUCH PANEL SPACE FOR TECH LAB'S NEW 1" VERTICAL ATTENUATOR**

(actual size)

Here's the smallest vertical attenuator made in the U.S.A. . . . another first from Tech Labs, pioneers in vertical attenuators since 1937.

It uses little panel space . . . only 1" wide x 6" long. It provides quick change of levels on multiple mixers and assures long, noise-free life. Units are available in 20 or 30 steps with balanced or unbalanced ladder or "T", or potentiometer circuits. Standard Db per step is 1.5, others on order. Impedance ranges are 30 to 600 ohms on ladders or "T's" and up to 1 megohm on pots.

Don't wait, send for complete data today!  
**Need Video or Audio Rotary Attenuators?**

All Tech rotary attenuators are precision made for extended noise-free service. Many standard designs available and specials made to your specs. Send for literature today.



**TECH LABORATORIES, INC.**  
Bergen & Edsall Blvds., Palisades Park, N.J. 07650  
Tel: 201-944-2221 • TWX: 510-230-9780

Circle Item 53 on Tech Data Card

## Professional Services

**VIR JAMES**  
**CONSULTING RADIO ENGINEERS**  
 Applications and Field Engineering  
 345 Colorado Blvd.  
 Phone: (Area Code 303) 333-5582  
**DENVER, COLORADO 80206**  
 Member AFCEC

**JAMES C. McNARY**  
 Consulting Engineer  
 National Press Bldg.  
 Washington 4, D. C.  
 Telephone District 7-1203  
 Member AFCEC

**AMPEX HEAD ASSEMBLY RECONDITIONING SERVICE** for all Ampex professional model recorders. This professional service features precision relapping of all heads for maximum head life. Your assembly is thoroughly cleaned and guides are replaced as required. Price includes optical and electrical inspection and complete testing on Ampex equipment in our plant. Full track or half track assemblies . . . \$35.00. One to two day service. "Loaner" assemblies available if necessary. LIPPS, INC., 1630 Euclid Street, Santa Monica, California 90401. (213) EX 3-0449. tf

**VIDEO TAPE RECORDER AUDIO HEAD ASSEMBLY SERVICE**  
 Precision relapping of all heads and supporting posts, including cleaning and testing. Ampex head assembly with "cue" tracks, \$75.00 complete. RCA units also relapped. One to two day service. LIPPS, INC., 1630 Euclid St., Santa Monica, Calif. 90401. (213) EX 3-0449. tf

## Classified

Advertising rates in the Classified Section are ten cents per word. Minimum charge is \$2.00. Blind box number is 50 cents extra. Check or money order must be enclosed with ad.

The classified columns are not open to the advertising of any broadcast equipment or supplies regularly produced by manufacturers unless the equipment is used and no longer owned by the manufacturer. Display advertising must be purchased in such cases.

### EQUIPMENT FOR SALE

**TALL TOWERS**  
 Guyed — Self-supporting  
 Advisory and Inspection Service  
 Enquiries invited from  
 AM-FM-TV Stations  
 Dept. 161 10-66-21  
**BROADCAST ENGINEERING**

CO-AXIAL CABLE Heliax, Styroflex, Spiroline, etc. Also rigid and RG types in stock. New material. Write for list. Sierra-Western Electric Co., Willow and 21th Streets, Oakland, Calif. Phone 415 832-3527 5-66-1f

Television / Radio / communications gear of any type available. From a tower to a tube. Microwave, transmitters, cameras, studio equipment, mikes, etc. Advise your needs—offers. Electrofind Co., 440 Columbus Ave., NYC. 212-EN-25680. 8-64 tf

NEW QRK TURNTABLES, all models available. will take any equipment in trade, regardless age or condition. Audiovox, 4310 S.W. 75 Ave., Miami, Florida. 9-66-41

Audio Equipment bought, sold, traded. Ampex, Fairchild, Crown, McIntosh, Viking, F. T. C. Brewer Company, 2400 West Hayes Street, Pensacola, Florida. 3-64-1f

COMMERCIAL CRYSTALS and new or replacement crystals for RCA, Gates, W. E., Biley, and J-K holders; regrinding, repair, etc. BC-604 crystals; also service on AM monitors and H-P 335B FM monitors. Nationwide unsolicited testimonials praise our products and fast service. Edison Electronic Company, Box 96, Temple, Texas. 5-64 1f

OBSOLETE TUBES—80% discount — 6SD7, 7E6, 19V8, 1616, 6E91, 6C8, 6J7, 6L7, 12K8, 14H7, 14R7. Large variety of other obsolete numbers. List free. H. Goldman, 28 Joseph, Bethpage, N.Y. 11714 10-66-6f

Complete Laboratory Test Equipment, Pulse Scopes, Q-meters Weston Analyzers, Vtoms, General Radio Meters, States WR-52 Dummy Loads. Original cost \$75,000 for \$5,000. Contact D. B. Williamson & Associates, P. O. Box 42, Cobourg, Ontario, Canada. 416-372-5401. 10-66-21

Trim 504 Audio Patch cords \$4.00. Audio jack panels for 19" racks, 10 pair \$8.95. Repeat coils 500-500 ohm flat to 20kc \$1.00 —Relay racks and equipment cabinets. Write for list. Gulf Electro Sales, Inc., 7031 Burkett, Houston, Texas. 4-66-1f

"AUDIO EQUIPMENT — Whatever your needs, check us first. New and used. Ampex, Altec, AKG, EV, Fairchild, Neumann, Langevin, Rek-O-Kut, Uher, Viking. Send for equipment list." Audio Distributors, Inc., 2342 S. Division Ave., Grand Rapids, Michigan 49507 6-66-6f

G. E. Phono cartridges for broadcast use. Prompt service. Send for price list. Ridge Audio Co., 91 E. Lake Rd., Skaneateles, N.Y. 13152 9-66-11

Everything in used broadcast equipment. Write for complete listings. Broadcast Equipment and Supply Co., Box 3141, Bristol, Tennessee. 11-61-1f

FREQUENCY MONITOR SERVICE for A.M. monitors including G.R., RCA, Gates, Doolittle, W. E., etc. Frequency change and other services. Reasonable prices, prompt service. Call or write before shipping. Edison Electronic Co., Temple, Texas. 9-66-1f

### EQUIPMENT WANTED

We need used 250, 500, 5K & 10K Watts AM Transmitters. No Junk. Guarantee Radio Supply Co. 1314 Hurbide St., Laredo, Texas 78010. 3-66-1f

USED A.M. FREQUENCY MONITOR WANTED that will operate satisfactorily with Rust RI-108 remote control system. Contact Chief Engineer, WGKA Radio, 1140 Peachtree St., NE, Atlanta, Ga. 30309. 11-66-11

### EMPLOYMENT

IMMEDIATE OPENING FOR CHIEF ENGINEER—Need First Phone to supervise technical growth of existing CCTV and new FM services on growing campus. TV design and installation experience required. Previous personnel supervision advisable. Send credentials to Radio-TV Section, Instructional Materials Center, Colorado State College, Greeley, Colorado, 80631. 10-66-21

Job Headquarters for all Radio and Television Engineers. Immediate openings exist in 9 western states and elsewhere for qualified engineer and technical personnel. All categories from trainees to experienced transmitter maintenance, chief, assistant chief, live color video maintenance and technical operations. Send us your complete resume now. The AMPS Agency, 3974 Wilshire Blvd., Los Angeles, California 90005. Telephone DU 8-3116. By Broadcasters — For Broadcasters

FREE PLACEMENT for TV and Radio Chief Engineers and both studio and transmitter engineers. All fees paid by the station. Send resume to: Nationwide Broadcast Personnel Consultants, 645 North Michigan Avenue, Chicago, Illinois or call: 312-337-7075. 9-66-11

Wanted immediately — Studio technicians with 1st Class license. Top wages — large market VHF station. Contact Arthur Bone — WJRT-TV, Flint, Michigan, 313-239-6611 collect. 9-66-3f

WANTED: Technicians for RCA closed circuit television—systems planning — color television — video tape — TV cameras — maintenance — sales engineers etc. RCA representative, 143-08 94th Avenue, Jamaica, New York, 212-297-3336 9-66-1f

Chief Engineer experienced all phases of AM-FM radio station technical operation and maintenance, including directional array. This is permanent job with growing firm. Car necessary. Phone or write, Howard B. Hayes, Vice President, WPIK-WXRA, 523 First Street, Alexandria, Virginia, 22314. Phone (703) 683-3000. 11-66-11

AUDIO COMMUNICATIONS SPECIALISTS—Work on the Apollo Program with General Electric at Cape Kennedy, Fla. The position involves working with operational intercommunication and paging systems required for checkout and launch of space vehicles, and include launch readiness reviews, design modifications, and component analyses. IIS diploma required with 4 years industrial experience including 1 year experience in communication and special audio systems. Write to: Mr. F. Gibb La Motte, Apollo Support Dept., General Electric Co., Room 1180-K, P. O. Box 2500, Daytona Beach, Fla., 32015. 11-66-11

TELEVISION SYSTEM SPECIALISTS—Positions open on the Apollo Program with General Electric at Cape Kennedy, Fla. Duties include adequacy reviews of TV installations at the launch site, liaison work in support of operational TV systems used for checkout and launch of space vehicles, preparation of installation and test procedures for TV systems, support of design and system engineering on all Television installations. IIS diploma necessary, industrial training school or training courses desirable. 4 years industrial experience desirable with at least 1 year's work involving television or communication systems. Write to: Mr. F. Gibb LaMotte, Apollo Support Dept., General Electric Co., Room 1180-K, P. O. Box 2500, Daytona Beach, Fla. 32015. 11-66-11

KREP FM, 35 kw, stereo, Santa Clara, Calif., 45 mi. S of San Francisco, adult popular music station, wants experienced engineer with first class lic. and good voice to pull board shift as well as chief's duties. Must know SCA engineering. Station 2 years old and booming. Excellent opportunity. New equipment throughout. Send audition tape and background to R. E. Podesta, 2775 Park Avenue, Santa Clara, Calif. 8550/mo. start. 11-66-11

AM/FM Station Manager — Imagination, experience in administration, programming, sales, network caliber announcer. Under 40 with family, top references. Prefer small town-Southern California. Broadcast Engineering, Dept. 163. 11-66-11

Prominent Hollywood independent film and general recording facility seeks crackerjack engineer; small secured stock investment buys 10% interest for right man. Box 38027 Hollywood, California, 90038. 11-66-21

## TECHNICIANS

Experienced technicians wanted by major network for testing new equipment. Must be thoroughly familiar with basic circuits and all types of audio and color video equipment.

Steady position, excellent salary and fringe benefits for those qualified. Send detailed resume including salary requirements to:

Box BE 1830, 125 W. 41 St.  
 NYC 10036

11-66-11

### BUSINESS OPPORTUNITIES

Financial Assistance desired establishing Christian programmed radio station. Eight years broadcast background. First phones. Box 162 Broadcast Engineering. 11-66-11



**You'll never  
get a  
blue face  
from us.**

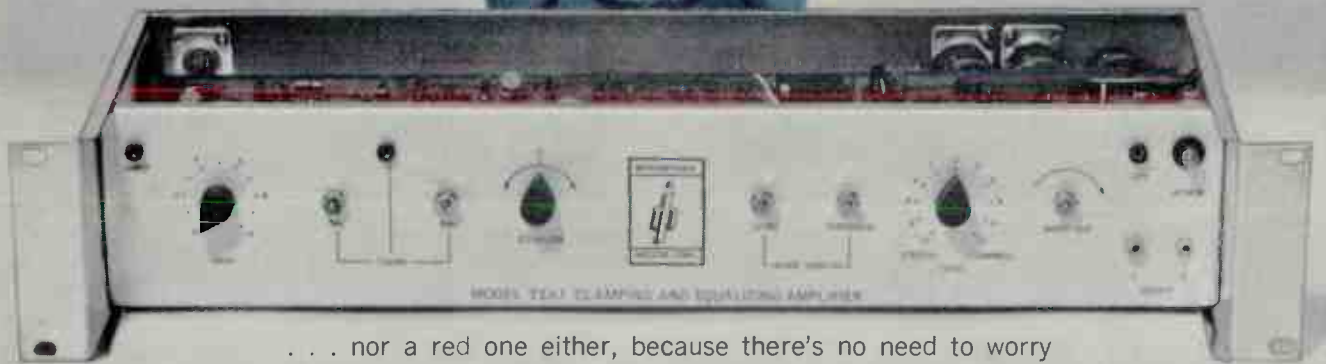

. . . nor a red one either, because there's no need to worry about your color signal when you use our TSA1 Clamping/Equalizing Video Amplifier. Tip clamping does it. No disturbance of color burst or other chrominance information in or about blanking or back porch levels. Gain . . . continuously adjustable from zero output to 6 db with no bounce. 28 db gain also available. Sync stretching or compressing. White stretching and clipping. All solid state. Fits standard rack. Heck man, don't take our word for it . . . TAKE 30 DAYS AND TRY IT OUT . . . AT OUR EXPENSE!

**PRICE: \$850.00 EACH, F.O.B. NASHVILLE, TENN.**

**28 db gain \$75.00 additional, designated TSA1HG**



*We invite your inquiry . . . please write:*

**INTERNATIONAL NUCLEAR CORPORATION**

*"Transistorizing the Television Industry"*

608 NORRIS AVENUE • NASHVILLE, TENN. • PHONE 615-254-3365

# Announcing... for color and black and white, the new family of RCA image orthicons with a *big difference here* that *shows up big here*

Now RCA brings you the "BIALKALI PHOTOCATHODE" in the new RCA-8673 and -8674 Image Orthicons. This major engineering innovation has greatly improved compatibility with its non-stick target, maintaining resolution and sensitivity over an extended tube lifetime and improving performance of *existing* color or black-and-white cameras. A simple change in a resistor chain provides proper voltages for a trio of these new Bialkali Photocathode Tubes. Wide-range, the 8673 and 8674 fit spectral requirements of all three channels...eliminating the need for another tube type for the blue channel.

Another big difference: the re-designed image section provides reduced distortion and freedom from "ghosts." These new tubes are available singly or as matched sets—a trio of 8673 /S or 8674 /S types for color service... types 8673 and 8674 for black and white. Main construction difference is in the target-to-mesh spacing. The closer-spaced 8673 enhances S/N ratio for quality performance under sufficient illumination. The 8674 has greater sensitivity under limited illumination. For complete information about the new RCA Bialkali Photocathode Image Orthicons, ask your RCA Broadcast Tube Distributor.

RCA Electronic Components and Devices, Harrison, N.J.



The Most Trusted Name in Electronics



USE THIS CHART TO SELECT REPLACEMENT TYPES FOR THE TUBES YOU ARE NOW USING

UNDER SUFFICIENT LIGHTING LEVELS	
For color pick-up, If you're now using... You can replace with:	
4513/S 7513/S	8673/S
For black & white pick-up, If you're now using... You can replace with:	
4513 7513 7513/L 8093A 8093A/L	8673
UNDER LIMITED LIGHTING LEVELS	
For color pick-up, If you're now using... You can replace with:	
4415S 4416S	8674S
For black & white pick-up, If you're now using... You can replace with:	
7293A 7293A/L	8674

AVAILABLE FROM YOUR RCA BROADCAST TUBE DISTRIBUTOR

