



A HOWARD W. SAMS PUBLICATION



OCTOBER 1966/75 cents

Broadcast Engineering

*the technical journal
of the broadcast-
communications industry*

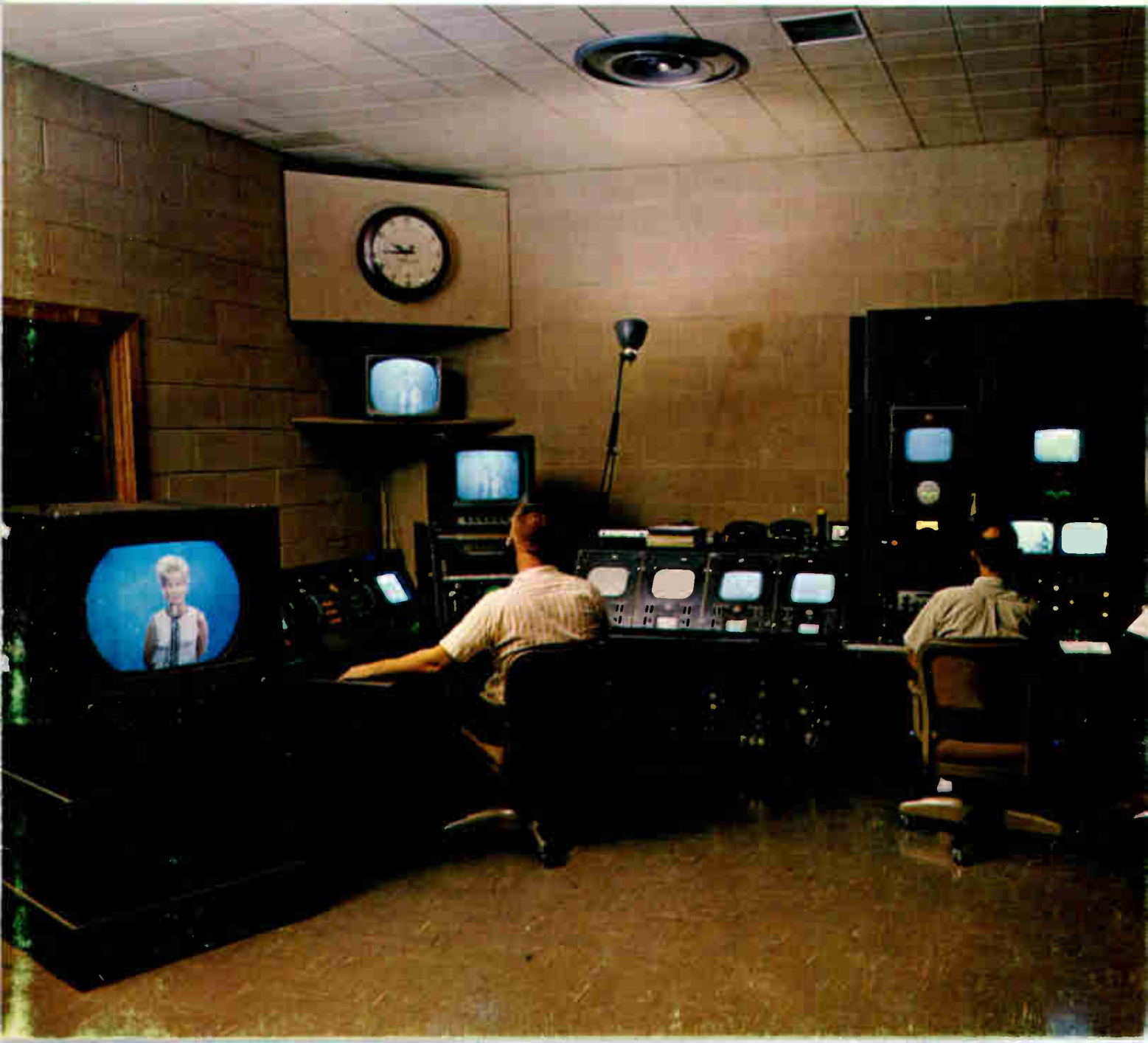

Get Started
for \$4300



**WITH THE SAME
EQUIPMENT THE NETWORKS
ARE NOW BUYING**

NOW RIKER ENGINEERING AND RESEARCH COMBINES...

- THE RIKER NEWLINE SYNC GENERATOR
- THE RIKER NEWLINE COLOR PACK
- THE RIKER COLORIZER
- THE RIKER RACK FRAME AND POWER SUPPLY

To enable you to supplement network color presentations with your local station-breaks using your existing monochrome cameras. For the first time for only \$4,300. (a fraction of the normal costs of full color film facilities) you can do the following: WITH THE RIKER COLORIZER—color monochrome slides—fade to any color—color ID's and titles. This is the only equipment that can generate color pictures from monochrome slides. ••• THE NEWLINE SYNC GENERATOR and COLOR PACK enables you to Sync-Lock and Phase-Lock to a remote or network color signal. You can do inserts in any color when used with the Riker SPECIAL EFFECTS system. There is sufficient space for 7 additional Riker modules for the normal expansion of your facilities. None of this equipment will become obsolete with the installation of complete color facilities.

MODEL 5619 RIKER COLORIZER—Consists of 2 All-Transistor Modules • A 6 position switch selects the following modes of operation: Any 3 Pre-selected Colors • Manual Selection of Color • Automatic Cycling Through the Color Spectrum at a Selectable Rate • Color Generated from a Monochrome Camera Output

MODEL 6620 NEWLINE SYNC GENERATOR—Features All-Transistor • Built-in Sync-Lock and Burst-Flag • Compact 1 3/4" Rack Space • Ultimate stability • Built-in Power Supply • EIA Sync • Self-contained Power Supply

MODEL 6621 NEWLINE COLOR PACK—Features All-Transistor • 1 3/4" Rack Space • Precision Color Frequency Standard Exceeding FCC Color Specs • Built-in Sub-Carrier Regenerator • Input: Comp Video for Sub-Carrier Regenerator • Output: 2 @ 3.579545 MC and 2 @ 31.5 KC

MODEL 903 RIKER REGULATED POWER SUPPLY—Input Voltages: 90-130 Volts AC • 190-250 Volts AC • Frequency 50 or 60 Cycles • Output Voltages: Minus 12 Volts DC Nominal • Output Impedance Less Than 0.5 ohm • Maximum AC Ripple 75 Millivolts RMS • Minus 15 Volts DC Unregulated • Maximum AC Ripple 1 Volt RMS • Will Provide All Operating Voltages For Any 9 Riker Modules

ALL FOUR FOR ONLY \$4,300



Send for information

RIKER VIDEO INDUSTRIES, INC.

...thinking always of tomorrow

Norden Lane, Huntington Station, New York Phone 516 HA 1-3444 Atlanta Los Angeles, Detroit, Washington, D.C.

Introducing the most versatile vidicon camera ever built – Cohu's new 3200 series!



IT'S A CCTV CAMERA – completely self-contained. Just add a single coaxial cable to any video monitor and it's ready to operate. Want high resolution? Plug in one of four optional integrated-circuit sync generator boards for 525-, 729-, 873-, or 945-line scan patterns.



IT'S A BROADCAST CAMERA, TOO! Add a "mounts-in-minutes" 5-inch viewfinder and the Cohu 3200 is ideal for studio, education, or remote applications. An optional film chain adapter further enhances its versatility and provides all necessary remote controls.

For prices, delivery and full details, contact Cohu engineering representatives in major cities throughout the United States and Canada.

COHU
ELECTRONICS, INC.
SAN DIEGO DIVISION

Box 623
San Diego, California 92112
Phone: 714-277-6700



the technical journal of the broadcast-communications industry

Broadcast Engineering

Volume 8, No. 10

October, 1966

publisher

Howard W. Sams

general manager

Donald W. Bradley

editor

William E. Burke

managing editor

James M. Moore

associate editor

Harold E. Hale

regional editors

George M. Frese, Northwest
Howard T. Head, Wash., D.C.
Robert A. Jones, Midwest
George C. Sitts, East
Allen B. Smith, North Central
Martin J. Taylor, Southwest
and Latin America

research librarian

Bonny Howland

production

Esther M. Rainey, *Manager*
Paul A. Cornelius, Jr., *Photography*

circulation

Pat Osborne, *Manager*

advertising sales offices

Hugh Wallace, *Sales Manager*

central and midwestern

Roy Henry
Howard W. Sams & Co., Inc.
4300 West 62nd St.
Indianapolis, Ind. 46206
291-3100

eastern

Gregory C. Masfield
Howard W. Sams & Co., Inc.
3 West 57th St.
New York 19, New York
MU 8-6350

southwestern

C. H. (Jake) Stockwell
C. H. Stockwell Co., 4916 West 64th St.
Mission, Kansas, RA 2-4417

western

LOS ANGELES OFFICE
G. R. (Jerry) Holtz
The Maurice A. Kimball Co., Inc.
2008 West Carson St., Suites 203-204
Torrance, California, 90501
320-2204

SAN FRANCISCO OFFICE

The Maurice A. Kimball Co., Inc.
580 Market St., Room 400
San Francisco 4, California
EX 2-3365

foreign

LONDON W.C. 2, ENGLAND
John Ashcraft, Leicester Square
Whitehall 0525

AMSTERDAM

John Ashcraft, Herengracht 365
Telefoon 24 09 08

PARIS 5, FRANCE

John Ashcraft, 9 Rue Lagrange
ODEon 20-87

TOKYO, JAPAN

International Media Representatives,
Ltd., 1, Kotohiracho, Shiba,
Minato-Ku, Tokyo
(502) 0656

Copyright © 1966

by Howard W. Sams & Co., Inc.

BROADCAST ENGINEERING is published monthly by Technical Publications, Inc., an affiliate of Howard W. Sams & Co., Inc. Editorial, Circulation, and Advertising headquarters: 4300 West 62nd Street, Indianapolis, Indiana 46206. SUBSCRIPTION PRICES: U.S.A. \$6.00, one year; \$10.00, two years; \$13.00, three years. Outside the U.S.A., add \$1.00 per year for postage. Single copies are 75 cents, back issues are \$1.00.

CONTENTS

Features

Live Cameras for Color TV

11

A comprehensive survey of all live-color cameras now being manufactured.

Review of Professional Microphones

24

Part 2. — Concluding list of operating characteristics, appropriate curves and graphs, photographs, and descriptions of professional microphones in production.

2500-MHz ETV Systems

John F. X. Browne, Jr.

36

Part 2. — Some design considerations in this new service are presented.

Quantitative Measurements of Video Quality

Paul Kaufman and George Scherer

44

Use of an oscilloscope in the evaluation of picture quality is discussed.

Solid-State Chopper Revisited

Robert L. Zuelsdorf

48

This popular construction feature has been modified for color applications.

Departments

Letters 6

Engineers' Exchange 52

Washington Bulletin 55

News of the Industry 60

New Products 73

Engineers' Tech Data 79

Advertisers' Index 81

Classified Ads 82

Emphasizing this month's concentration on television is this photograph of master control at WLWI, Indianapolis, Indiana.



“...CBS Volumax performs flawlessly. Please do not invent any more until we wear these out. At the present rate of deterioration, we will need to replace them by 2015 A.D.”

This is what station WRNC in Raleigh, North Carolina, said about our equipment. They own both the Audimax Automatic Level Control and the Volumax Automatic Peak Controller. Station WIGS in Gouverneur, New York, wrote, “Enclosed find check for Volumax 400. You couldn’t get it back from us for twice the price . . .” KLIN in Lincoln, Nebraska, purchased Audimax. They told us, “It is an engineer’s dream for absolute level control”. WAYB in Waynesboro, Virginia, tells us, “Purchased a Volumax and we are tickled to 99 and 44/100% modulation with it . . . Congratulations on a fine product”. Station KHOW in Denver, Colorado, said, “It was surprising to receive equipment that exceeded specifications”.

There isn’t enough space here to include all the letters we’ve received praising Audimax and Volumax. But judge for yourself. Like all CBS Laboratories equipment, they’re available for a 30-day free trial. Audimax \$665. Volumax \$665. FM Volumax \$695. Write to us, or better yet call The Professional Products Dept. directly — Collect. Telephone (203) 327-2000. Maybe you’ll be in our next ad.

 **CBS LABORATORIES**
Stamford, Connecticut. A Division of
Columbia Broadcasting System, Inc.

Circle Item 3 on Tech Data Card

Even if you bought your tape machine today...

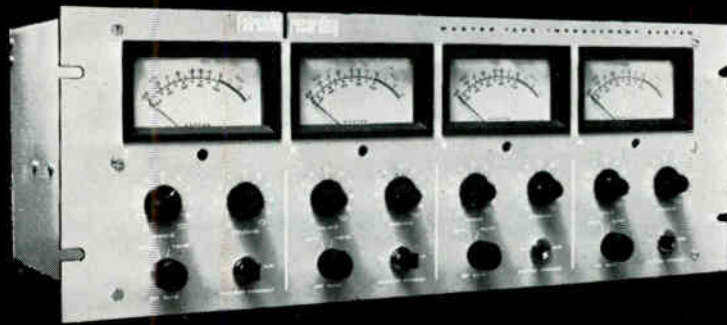

the FAIRCHILD Master Tape Improvement System has made it obsolete!

Here's why! Only the FAIRCHILD MTIS with "focused-gap" head design radically reduces bias-induced noise to a point where it is no more than 1.5 db greater than the noise of virgin or bulk-erased tape . . . Only the FAIRCHILD MTIS has an overall Signal/Noise ratio of 72 db with a 75 mil track width (the track width of one channel on a 4-track 1/2" recording) . . . Only the FAIRCHILD MTIS dramatically increases the recording level by 4 db compared to present standards . . . Only the FAIRCHILD MTIS sets new system standards for low harmonic, inter-modulation, and cross modulation distortion of only .5% . . . And only the FAIRCHILD MTIS comes in a compatible, convertible package allowing you to update your present tape transports to the high quality "state-of-the-art" recording standards.

FEATURES:

- Exclusive "focused-gap" recording head design • 4MHz (4,000,000 cycles) bias frequency • Silicon solid state direct-coupled electronics • Compatible, convertible packaging technique for easy installation in all existing professional type tape transports • Space saving electronics package only 7" x 19"
- Selective erase is available with multi-track units to allow complete re-recording flexibility • Mandatory for motion picture studios, broadcasting and recording studios where definitive performance is a prerequisite • Ideal for the preparation of highest quality 8-track master tapes for high speed duplication.

Only the FAIRCHILD Master Tape Improvement System puts you a giant step forward in quality tape recording.

Write to FAIRCHILD — the pacemaker in professional audio products — for complete details.

FAIRCHILD

RECORDING EQUIPMENT CORPORATION
10-40 45th Ave., Long Island City 1, N. Y.

Circle Item 4 on Tech Data Card

LETTERS to the editor

DEAR EDITOR:

After contacting many manufacturing companies, it amazes me how little concern there is for customer relations.

While making inquiries that possibly would have meant a sale, I received responses such as these in about 60 per cent of the cases.

Company A: We requested information to be sent to our antenna site. The material was addressed to our location of a year ago. Apparently this company has no up-to-date records. The material arrived at our studios, but this delayed its use; our transmitter is 10 miles from our studios.

Company B: We requested information and received instead a catalog containing none of the information requested.

Company C: No reply at all.

Perhaps some of the manufacturing companies will read this letter and proceed accordingly.

DENNIS W. STICKLEY, Engineer
WEIR, Weirton, W. Virginia

In the article "Servicing Solid-State Audio Equipment" (July 1966 BROADCAST ENGINEERING, page 18), the schematic portion of Fig. 2 was accidentally inverted, while the waveforms remained in their proper positions. The figure should have appeared as it is shown below. In the same article, the sentences beginning with the 24th line from the top of the first column on page 19 should read: "The base of the NPN driver is grounded, and no current flows through it. Consequently, there is no voltage on the emitter of the PNP driver."

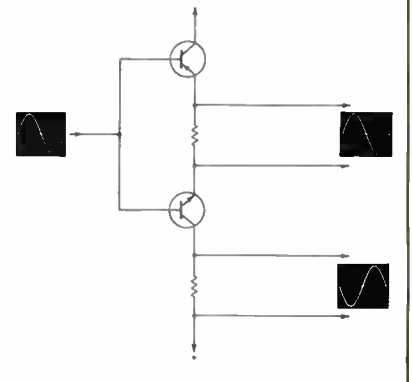

COLOR HI-BAND DROPOUTS

Eliminated by Revere-Mincom Dropout Compensator...

Due to the shorter wave length and lower tip projection employed in Hi-band VTR, dropout problems are 5 or 6 times more prevalent than those encountered in low-band recording. These distracting white flashes destroy otherwise prime program content and good, clean video signals.

The Revere-Mincom Dropout Compensator restores the clarity and sparkle of Hi-band/Color VTR by detecting the dropouts as they occur and replacing the "lost" signal with stored information from the previous scan line of the same field.

Moderately priced, the Dropout Compensator features maintenance-free, solid-state circuitry, standard rack mounting and compatibility with all VTR equipment.

Rescue old tapes. Insure optimum playback quality in new COLOR/HI-BAND recordings. Save money by eliminating unproductive engineering evaluation time and unnecessary wear on expensive recorder heads and VTR equipment.

Call or write today for a demonstration of the remarkable Dropout Compensator.



Revere-**3M**
Mincom
Division COMPANY

300 S. Lewis Rd., Camarillo, California
(805) 482-1911

Riker Industries
Huntington Station, L. I., N. Y.
(516) HA 1-3444

Circle Item 5 on Tech Data Card



the
Blue
Ribbon
Line

If two is company, Visual's a crowd!

If manufacturing capability and technological know-how are part of the criterion by which a major broadcast equipment supplier is judged, then Visual Electronics Corporation has to come out right at the top of the list.

Because, directly and indirectly, Visual has far and away the largest and finest engineering and production services in the broadcast industry.

The key is Visual's unique relationship with the most progressive "blue-ribbon" organizations throughout the world, as well as its own extensive manufacturing, sales and field-service facilities.

And the result is that you can place your confidence in the world-wide Blue Ribbon Line . . . assured of the quality and product superiority of North American Philips and Conrac . . . English Electric Valve and Favag . . . McCurdy Radio Industries and Jampro . . . Allen Electronic and CSF . . . Fernseh and Visual Electronics Laboratories . . . to name just a few.

These are the results that count — from the companies that count!



for TOP PERFORMANCE in TV ANTENNAS

VHF SUPER TURNSTILE



Typical
Pattern

DESCRIPTION
Improved mechanical construction
Wide variety of Gains
Power rating to 50 kw
Beam tilting and null fill available at no increase in cost

UHF ZIG ZAG

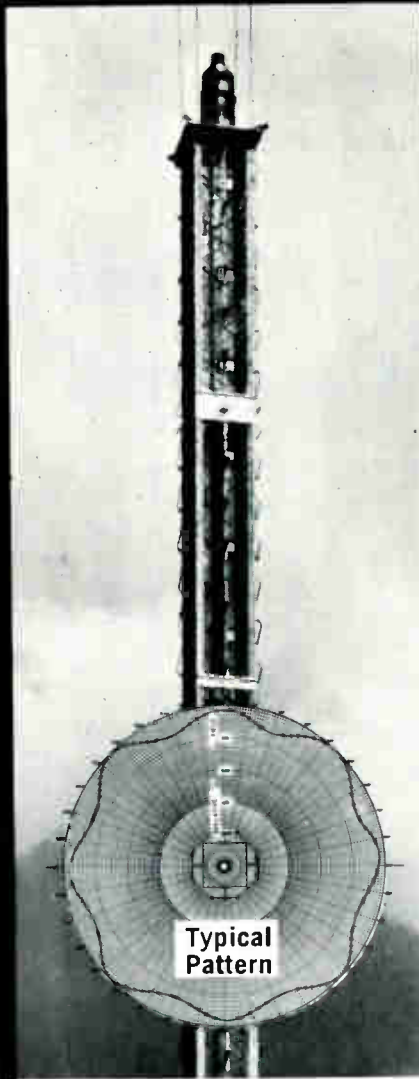

Typical
Pattern

DESCRIPTION
Simple panel construction
All copper elements
All Teflon insulated
Low VSWR
Inputs to 50 kw
Gain of about 30 per panel

CORNER REFLECTORS

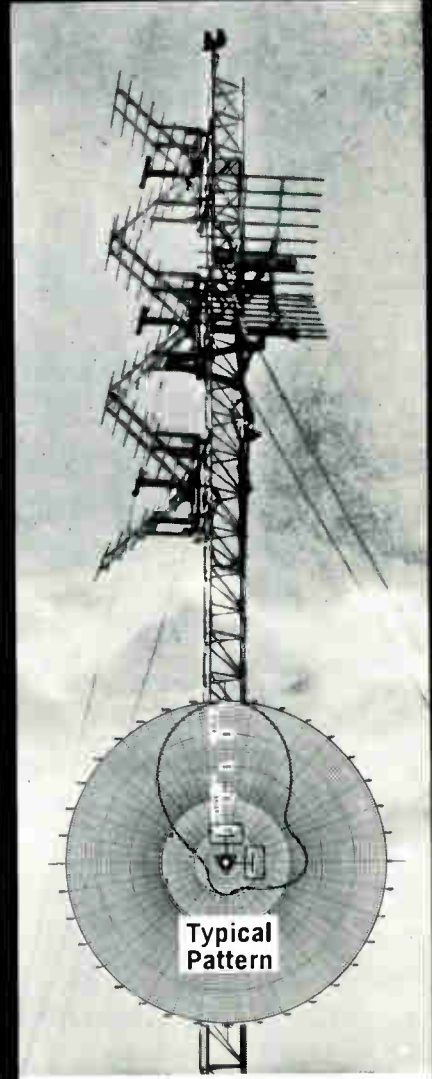

Typical
Pattern

DESCRIPTION
Wide variety of frequencies from Channel 2 through 83
Low VSWR
Versatile for fill in or directionals
Gains of generally around 10 per corner

J A M P R O

- TV Antennas
- Coax Switches
- Notch Diplexers
- FM Antennas
- Harmonic Filters
- ETV Antennas

**ANTENNA
COMPANY**
6939 POWER INN ROAD

**ANTENNA
COMPANY**
SACRAMENTO, CALIFORNIA

PHONE
AREA CODE 916
422-1177

LIVE CAMERAS FOR COLOR TV

As the color boom continues, so does interest in color origination equipment for television. A number of camera designs have evolved, and certain advantages are claimed for each. To make the broadcast engineer aware of the kinds of live-camera equipment that are

available, BROADCAST ENGINEERING has invited each manufacturer to describe his product. The opinions expressed are those of the individual manufacturers; this magazine serves only as a medium of communication between them and the reader.



COHU

Principal features of the Cohu 1000 series color television system are compactness (camera weighs 35 pounds); all-solid-state circuitry; automatic light-level compensation; remote control to 1000 feet; built-in registration reference; low-cost operation; and an optional nine-inch viewfinder.

Correct registration in the Cohu camera is achieved by internal reference.

without reference to the external environment. The control unit consists of a 19" rack enclosure containing easily accessible all-solid-state plug-in circuits.

The specially-designed $f/1.9$ optical system focuses the color images from any "C" mount vidicon format objective lens onto three vidicons.

Standard outputs are red, green, and

blue video on separate 75-ohm coaxial outputs. Efficient and simple color-separating optics and three vidicons furnish good light sensitivity. The use of precise, stable optics and deflection circuits results in proper color registration over long periods of operation. Color balance and fidelity are maintained by low-noise linear video amplifiers having excellent gain stability. Video amplification is by solid-state feedback amplifiers using keyed clamps on all color channels for black-level control. Adjustable gamma correction is provided on all three channels.

The design minimizes the number of adjustable parameters and the frequency of adjustment, making the camera simple to operate.

Cohu broadcast cameras have all optics and camera circuits except the external lens enclosed within a rectangular metal housing. Intercommunication jacks and a tally light are mounted on this housing. Access to camera circuits and optics is easy and rapid. An optional monochrome video viewfinder may be mounted on the camera housing.

The Cohu color camera control determines the principal operating conditions of the color camera chain and provides red, green, and blue video outputs, and selectable combinations of these same outputs to waveform monitoring and setup equipment. Front panel controls provide for master control of the significant video signal parameters; for monitoring of each vidicon's target voltage; for selection of individual color channels or combinations to permit setup adjustments; reticle selection, shutter control, and iris control of the camera itself. Intercom jacks enable direct communication between control room and camera crews.

A hinged panel conceals individual color channel controls, which are adjusted during system setup. These controls provide for adjustment of gain, white peak clipping, aperture, and black level for each video channel. Controls are available for vertical and horizontal size, target voltage vertical centering, horizontal centering, focus, and scanning beam current. Loop-through jacks on the rear panel accept the necessary horizontal drive, sync, and blanking signals from the external sync generator.

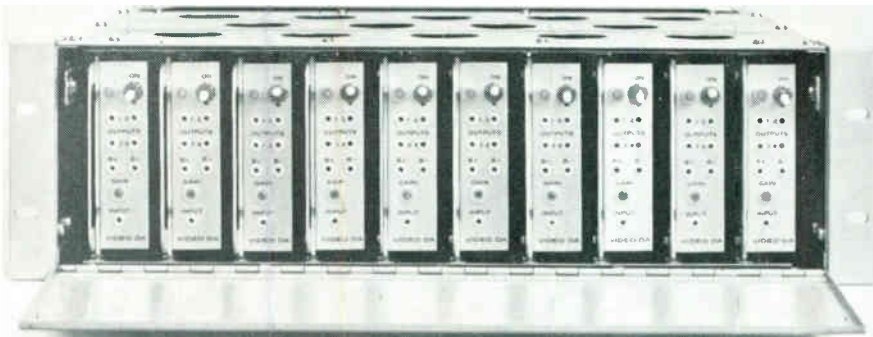

Solid-state video amplifiers use keyed-clamp black-level control.

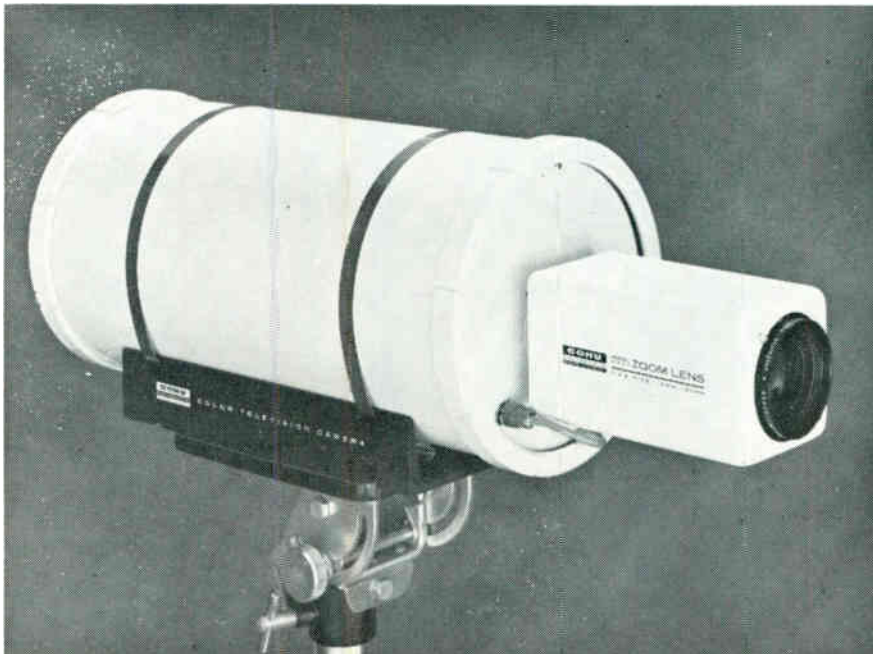

Industrial version of Series 1000 Cohu color camera has zoom lens.

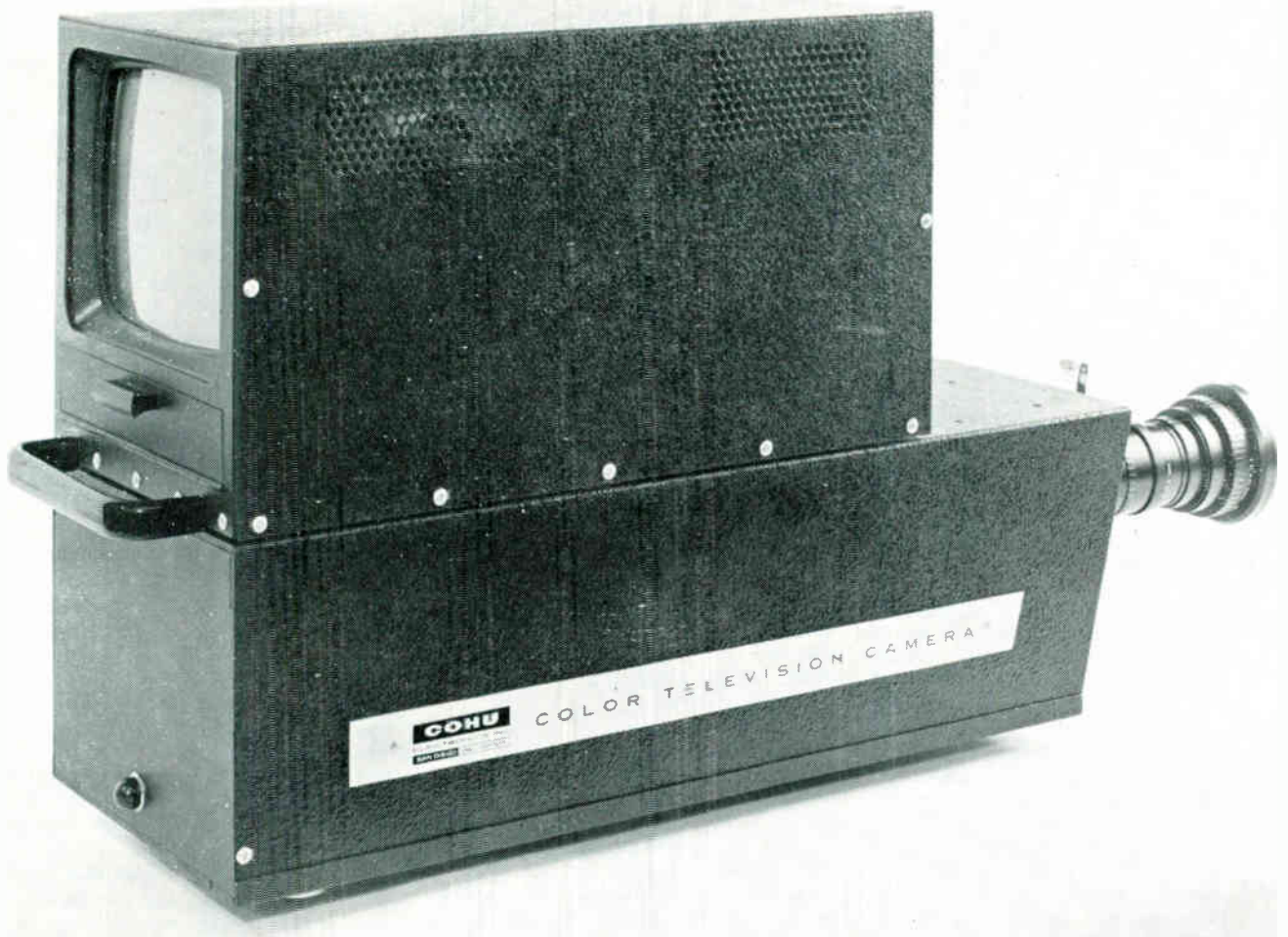

Cohu 1000 Series color camera for broadcast applications features low cost, compactness, and light weight.

Cohu accessory equipments for color camera systems are compatible with all existing broadcast equipment and are designed to meet or exceed all industry and government regulatory standards. Cohu offers the industry's first integrated-circuit sync generator—the 2470 series, a dependable source of timing pulses for an entire video system.

Studios that require tie-in of network and local synchronizing pulses, and any closed-circuit installation that involves synchronization from more than one source, have a need for the 2470 series plus the plug-in genlock module and color standard with colorlock. These provide all the timing signals required for operation of color camera chains.

The Cohu color encoder produces encoded signals to meet all NTSC and FCC specifications and occupies only 1 $\frac{3}{4}$ " of vertical space in a 19" rack. The color video chain provides the complete NTSC output signal to a transmitter or color receiver.

A Cohu broadcast color camera system sells for \$25,000, FOB, San Diego. Options at additional cost include a solid-state viewfinder; zoom lens; RGB. setup and monochrome monitors; cable assemblies; and color encoder.

Circle Item 60 on Tech Data Card

October, 1966



Cohu 2470 Series integrated sync generator is an accessory item.

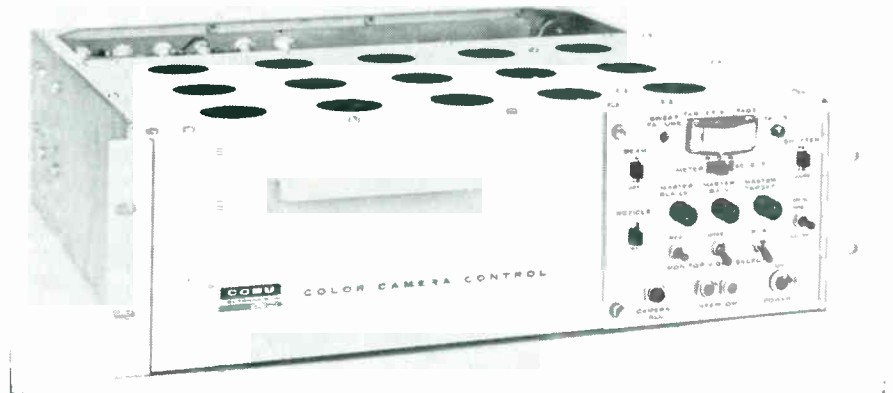

Control unit for the Cohu camera has solid-state plug-in circuits.

GENERAL ELECTRIC

Following the introduction of the industry's first "4-V" separate luminance film camera at the 1963 NAB Convention, the General Electric Company introduced at the 1966 NAB Show a new live color camera, the PE-250. Weighing only 156 lbs., including zoom lens, again featuring the well-proven 4-tube approach, this new camera utilizes Plumbicon® pickup tubes for superior live color reproduction. It was designed for both studio and portable service. Completely transistorized (excluding pickup and display tubes), it requires less than 500 watts of input power at 90 to 135 or 180 to 270 volts AC. The General Electric PE-250 will operate with up to 2,000 ft. of camera cable (greater lengths at slightly reduced performance). Two-position carrying handles are built in.

The PE-250 price is \$70,720.00. This includes a complete operating system, 10-to-1 zoom lens with a 2X and 3X extender, a deluxe type studio counterbalanced pedestal, cam head, 9" picture monitor and 529 Textronix scope, headsets, 50-ft. camera cable, TV-112 transistorized encoder, rack and shelf, and interlock harness. General Electric service engineering checkout and instruction at customer premises is also included in this price.

The zoom lens has a continuous range of 10 to 1 (18 to 180mm f/2.2). This approximates 1.4" to 14" in the familiar 3" I.O. camera. The zoom control is built into and is located on the right side of the camera, using solid rods rather than flexible cables for better control of the position of the lens. Next to the camera viewfinder a built-in focal length indicator shows the actual position of the 10-to-1 zoom lens for the cameraman's convenience, providing accurate "return" shots. The focus control of the lens is built into and is part of the single pan handle, of the twist grip type, making "rim shots" simple.

It isn't necessary to remove the lens or shroud from the General Electric PE-250 to change or add the 2X or 3X extenders. The lens access port is easily removed, and two finger-tight lock screws are loosened, permitting the lens to slide forward on its two stainless steel bearing support rods. Insertion or removal of the extender is then made. The lens is repositioned and the camera is again operational. The zoom lens that is part of the General Electric PE-250 was selected especially for its long back-focal distance, eliminating the need for relay lenses between it and the luminance pickup

tube, achieving a simple and highly efficient optic system.

The color separation to the three red, blue, and green color pickup tubes is achieved by the use of standard front surface and dichroic mirrors. These optics are enclosed in a light and dustproof housing. A seven-position filter wheel just behind the zoom lens is provided, and a selection of neutral density and color filters is included.

The General Electric PE-250 live color camera includes a solid-state high voltage supply for the viewfinder, which produces a brightness of 150 foot lamberts. The transistorized modules utilized throughout the system are plug-in type. The input preamplifier consists of a pair of field-effect transistors (FET) operated in cascode, chosen for non-microphonic performance with very high gain and low noise.

Space-age simplified metering is built into the camera head and camera control unit power supply, in the form of a single "Go—No-Go" meter, sampling all important camera voltages by means of a quick-select rotary 20-position switch. A "green" mid-point, normalized meter indication quickly assures the operator of normal functions of all circuits.

Simplified, fast, and accurate color registration of all four pickup tubes is achieved by the unique differential registration method that General Electric introduced in its color cameras in 1958. By reversing the polarity of any one of the three chroma picture video elements and comparing it with the luminance element displayed simultaneously, the monitor presentation will reveal the most minute registration differences, permitting precise registration alignments.

The registration controls on the PE-250 feature a combined coarse and vernier control in a single knob.

The video processing amplifiers, cable compensators, and video logic circuit modules are located at the camera control unit. The drawer and plug-in board techniques used in General Electric color cameras permit fast and accurate servicing under normal conditions with full accessibility to all circuit points and components in normal circuit operating conditions, obviating the need for extender boards.

The power supply for the PE-250 is located at the camera control unit position. A voltage regulator board for +20 and -20 volts is also provided for use in the rack circuits. All voltages are also checked at the camera head meter dis-

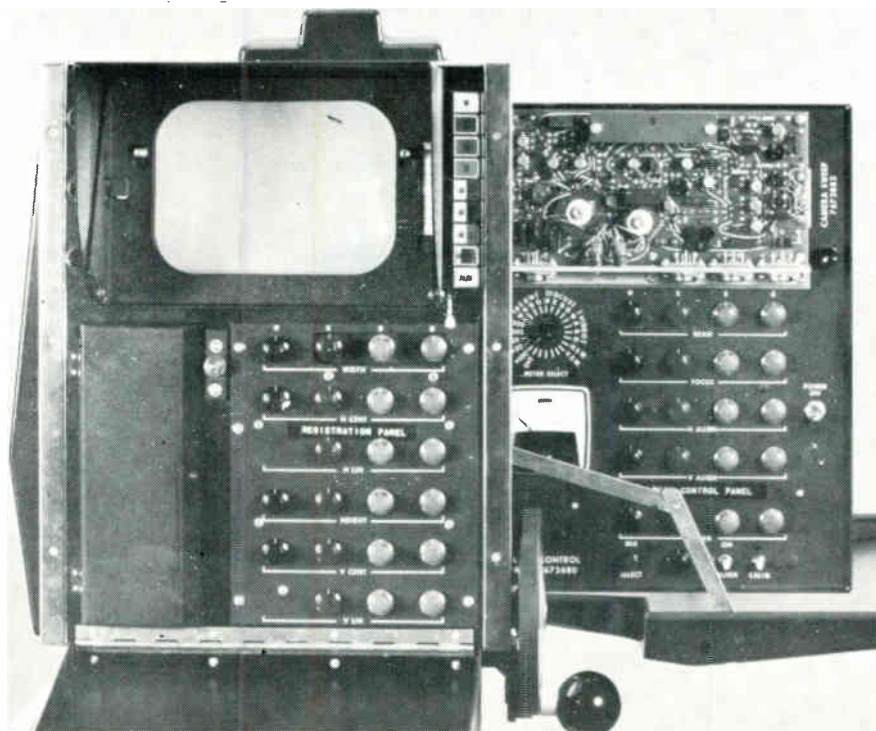

Rear view of PE-250 camera shows door open for access to controls.

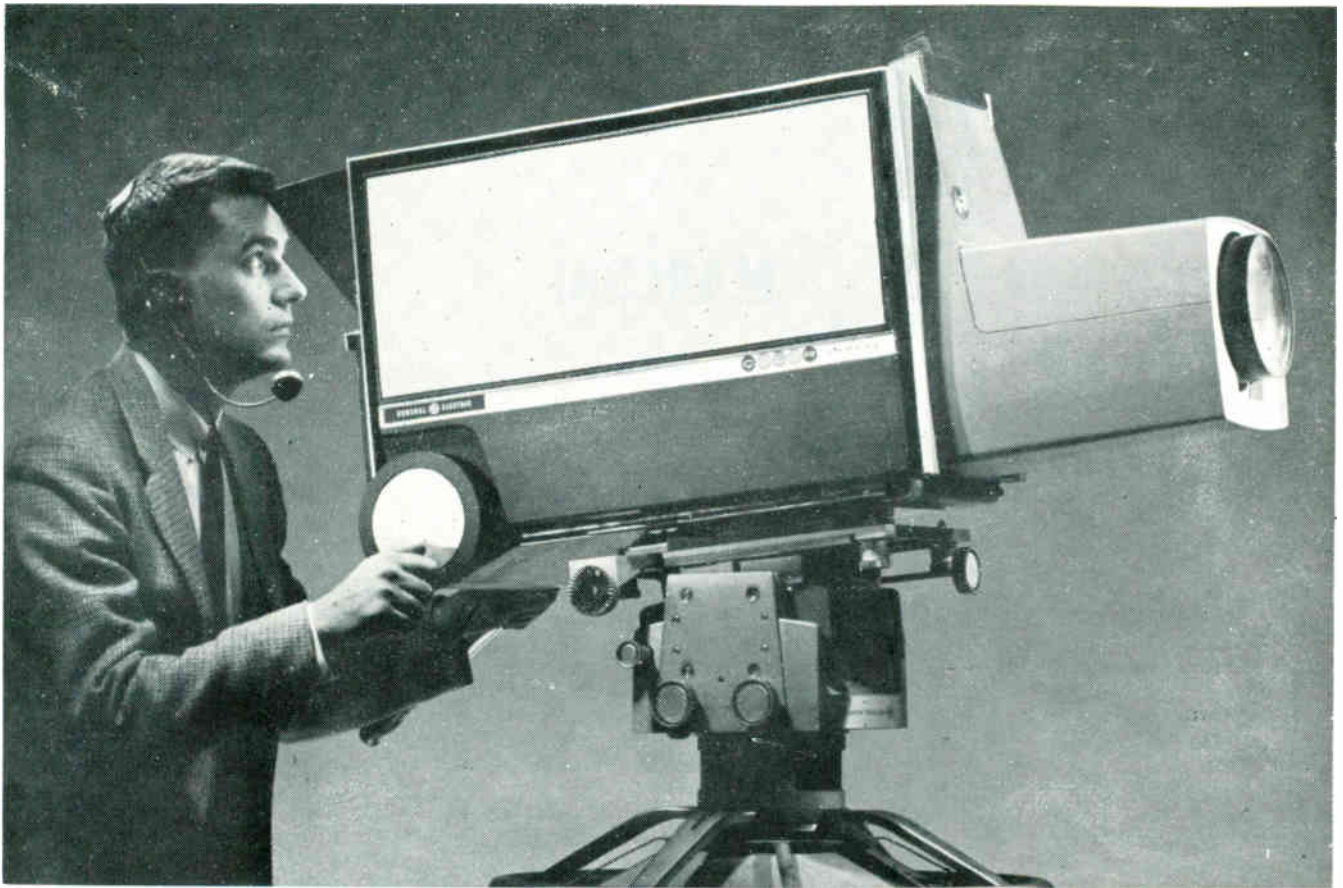

Completely transistorized GE Model PE-250 color camera uses 4-tube approach and employs built-in zoom lens.

discussed above to assure correct voltage at the camera head, regardless of cable length.

The remote monitor switcher panel contains the necessary selector push buttons for the monitoring facilities. It also contains a test switching board, which allows the selection of any one of three optional test signal inputs, and applies the test signal to the input of the pre-amplifier first stage. The circuit is so arranged that the first button is used to apply a signal to the viewfinder only (auxiliary input), such as special effects, for example. The second button (marked test 1) is used to apply grating to the preamps and to superimpose it on the video. This is used to facilitate the setting of linearity. The third and fourth buttons (test 2 and test 3) are used to apply any other optional signals, such as sine-squared pulse, square wave, multiburst, etc., to the preamp input. When test 2 or 3 is depressed, the beam is cut off so that the pickup tube is inoperative. These test buttons are interlocked with the "on the air" tally system so that no test signal can be aired accidentally. This panel also contains the selector buttons for the picture and waveform monitor inputs plus two color selector push buttons for certain encoder modes of operation discussed below.

The transistorized TV-112 encoder produces an NTSC color signal from the four camera outputs (W, R, G, B) of the PE-250 camera. The TV-112 has a built-in power supply making it self-contained in a 5 1/4" drawer. The inputs to TV-112 are camera and color bars at 0.7V P-P; sync, subcarrier, and blanking are at any value between 0.75 to 4.5V P-P. These inputs can be looped-through for group-

ing with other TV-112 encoders, which facilitates quick and accurate matching. Six outputs are provided, which consist of four line outputs (2 composite — 2 switchable composite or noncomposite). These line outputs can be switched simultaneously from color to monochrome. For monitoring, both a color composite output and a separate monochrome output are provided, all H-time balanced.

From the camera operator's point of view of the PE-250, there is a large 8" viewfinder with over 150 foot lamberts of high-light brightness. An extra large, clear area under the 8" viewfinder is provided for cue cards, shot order, etc. A locking device is provided to set the position of the pan handle (focus control built in). Next to it are dual intercom jacks with individual volume control. Located on this same panel is an AC convenience outlet that is controlled by a thermal overload circuit breaker switch. The zoom control mentioned earlier is

built into the right hand side of the PE-250, with a large flywheel type control permitting fast, smooth changes of the 10-to-1 zoom lens. The actual setting of the zoom lens is translated electrically to a focal length indicator with a bright red pointer mounted next to the viewfinder. On the left side are the viewfinder brightness, contrast, and focus controls. The "on the air" tally light is located just inside of the viewfinder hood. On the right side of the viewfinder is a row of nine illuminated push buttons permitting selection of individual channels or combinations for quick registration checks, or special effects supers or inserts.

The General Electric PE-250 live color camera combines stability, accessibility, and light weight, providing simplified operation and maintenance. The picture quality produced by the PE-250 is the highest standard of electronic color reproduction in the industry today.

Circle Item 61 on Tech Data Card



Power supply for the PE-250 is at the camera control-unit position.

MARCONI

With the imminence of the introduction of color television in Britain and other European countries, and with 15 years of successful experience of color camera manufacture behind them, the Broadcasting Division of the Marconi Company decided in 1964 to evaluate the existing state of the art.

The exercise was no academic one. The time was ripe to design a new color camera, but over the years a number of different possible configurations had become possible. Which one of the many should be the choice?

The design team was assigned the task of considering the problem in terms of the following main factors:

1. Performance and reliability
2. Operational flexibility
3. Cost
4. Sensitivity
5. Size and weight
6. Immunity to environmental conditions

The resultant hardware, the Marconi Mark VII color camera, was introduced at the 1966 N.A.B. Convention, and some measure of the design team's success can be gauged from the current state of the order book which already stands at well over 200, of which 170 are for the United States.

General Features

The Mark VII camera uses four Plum-bicon® tubes, providing separate luminance, red, green, and blue signals. It is primarily intended for use with zoom lenses (*i.e.* no turret). A relay optical system enables standard image orthicon lenses to be used. The camera can operate either on 525-line, 60-fields or 625-line, 50-fields standards and is not "color-system conscious"; external encoding equipment is provided to enable it to be

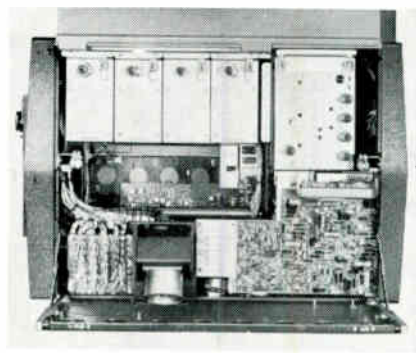

The Mark VII camera with covers open.

used with any color system, whether NTSC or any of the proposed European alternatives.

The complete channel comprises the camera, the camera control unit (CCU), and the power supply unit (PSU). In addition to the main control panel on the CCU, a simple operational control panel (OCP) is available; this incorporates the main operating controls, namely iris, master black, master gain and ON-OFF switching, and permits control of these facilities from any convenient position up to a distance of 150 meters from the CCU.

The particular value of this remote control facility stems from the high stability inherent in the design of the Marconi Mark VII, whereby "hands-off" operation is achieved. After setting up the main CCU control panel, control is switched to the simple OCP which embodies only those controls necessary to obtain desired artistic effects.

The camera has been designed for quick conversion to full-sensitivity, black-and-white operation employing the luminance channel only. In this condition all the input light is directed to the luminance tube, and the camera provides all the usual facilities of a modern black-and-white camera.

All the active circuit elements are semiconductor devices, except for one nuvistor in each head amplifier and a corona regulator in the power supply unit. The camera can be used with up to 2000 ft (600 meters) of camera cable. Both light and heavy duty cables are available.

Camera Tube Configuration

A four-tube configuration was chosen, not only because of the superior compatible black-and-white picture it provides, but also because of the relative independence on accurate camera registration of the color picture, and because of the facility it provides for rapid conversion to full-sensitivity, black-and-white working. Plum-bicon® tubes were chosen after careful evaluation of the various merits and demerits of all types of tube, during which it was found that the Plum-bicon® has significant advantage for both luminance and coloring positions. Furthermore, its linear characteristic enables sensitivity to be traded for signal-to-noise ratio without upsetting the grey-scale tracking between luminance and coloring tubes. Maximum advantage may thus be taken of whatever ambient light level happens to be available.

The Optical System

The Mark VII camera is designed to use standard image orthicon 10:1 zoom lenses of 40-mm image diagonal, and in particular those by Evershed Power Optics (Angenieux) and Rank Taylor Hobson, which normally incorporate servo-control of zoom, focus, and iris in the lens assembly. The iris is remotely controlled from either the CCU or OCP positions.

A zoom preselection unit ("shot box") is available for use with servo-controlled lenses.

A relay optical system is employed to provide an adequate optical path length in which to accommodate the light-splitting systems and to permit the best disposition of the camera tubes. The luminance-chrominance light-splitting prism surface functions also as the luminance spectral response trimming filter, so that the luminance tube receives only that part of the incoming light it requires. This gives additional light for the color tubes. Prism-type dichroic surfaces split the remaining light into red, green, and blue components.

The Viewfinder

This employs an 18-cm kinescope providing a bright high-definition picture. The complete assembly is pivoted, permitting it to be tilted over a wide angle. The controls associated with the viewfinder are mounted at the rear of the camera, together with the talk-back facility controls. These are the only controls used in normal operation, which are embodied in the camera structure.

The Camera Control Unit

The CCU embodies a panel containing

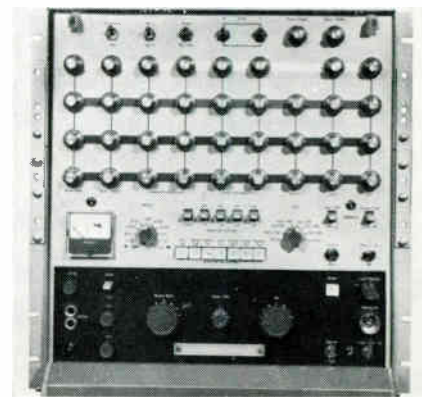

Panel for the CCU has chain controls.

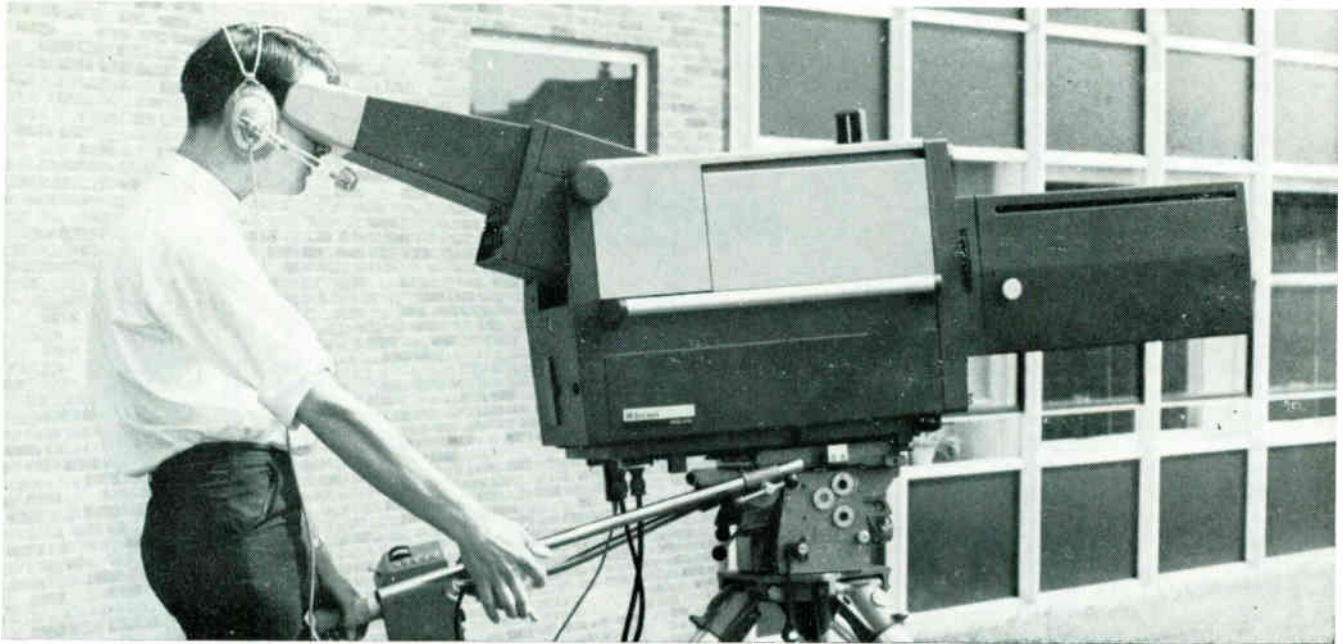

The Marconi Mark VII color camera uses four Plumbicon[®] tubes and is intended for employment of zoom lenses.

all the necessary controls for complete operation of the camera. A light-colored upper section carries the setting-up controls and monitoring and test facilities, while the lower darker section contains the operation controls which, alternatively, may be remoted to the OCP. Communication facilities are grouped to the left and the main channel switches to the right.

Performance

Sensitivity on the Mark VII is high; particular care has been taken to eliminate all avoidable losses in light transmission through the optical system and to reduce the noise contributed by the first stage of the head amplifier. With average camera pick-up tubes the following is an indication of what may be expected:

At an illumination of 230 ft candles (2,500 lux), color temperature 3000°K, peak scene reflectance 60% and aperture f/8, the channel signal-to-noise ratios are (luminance) 40dB, (red) 36dB, (green) 40dB, and (blue) 37dB. With the iris opened to f/4 and master gain increased by 6dB, an acceptable picture can be obtained with 30-ft candles (325 lux) illumination. The noise figures are for a bandwidth of 5.5 MHz in the luminance channel and of 1.8 MHz in the color channels.

Resolution of the luminance channel

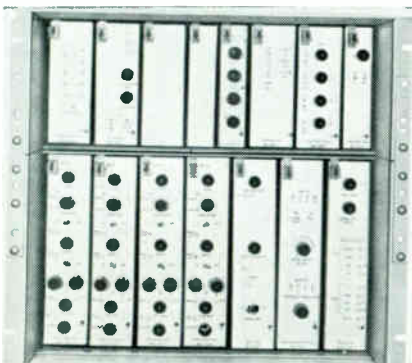

View of the Camera Control Unit (CCU).

is such that only a small amount of aperture correction is required with an average Plumbicon[®] tube to obtain 100% modulation at 400 lines. This is achieved by careful design of the deflection yoke and by operating the tube with the relatively high focus electrode potential of 750 volts.

Image registration in the Mark VII is less critical than in a three-tube camera, since the high-quality luminance signal is obtained from a separate pick-up tube. Further, since the signals from the color tubes do not contribute to the luminance signal, the registration of the color images need not be so precise. This makes for easier setting up. In the Mark VII camera, a registration accuracy of 0.05% can be achieved in Zone 1 (the central area covered by a circle of diameter 0.8 of picture height).

The camera will maintain this performance for long periods, this being a function of the very high standard of design and manufacture adopted for those elements affecting registration, including the pick-up tube, and the scanning, centering, alignment, and focusing currents. In the Mark VII, both the fixed optical components and the yokes are rigidly attached to a substantial aluminum plate mounted vertically in the camera. To prevent external magnetic fields from causing spurious deflections of the camera tube beams, the yokes are doubly screened and the optical system so designed that the camera tubes are substantially parallel to one another. At the same time the orientation of the images is similar.

Color balance is maintained for long periods without readjustment. The characteristics of the four channels are matched to within 1% over the greater part of the dynamic range through the use of special circuit techniques.

Geometry (the placing of points in the two-dimensional picture plane) requires good deflection and focusing yoke design to obtain a truly rectilinear image. A high degree of linearity of the line and field scanning currents is also needed. In the Mark VII, the location of picture

points is within 1% of the picture height of their position over the greater part of the picture.

General Circuit Design Techniques

The extensive use of silicon transistor amplifiers with large amounts of negative feedback gives a performance and stability considerably better than that possible with thermionic valves.

The small circuit modules employed embody thin-film resistors and capacitors. The thin-film process developed by the Marconi Company yields highly stable resistors having a temperature coefficient of ± 10 parts per million per °C.

Printed-wiring board construction is used almost entirely throughout the camera channel.

Conclusion

The design of the Marconi Mark VII color camera channel was evolved after an exhaustive consideration of all possible approaches and configurations. The result is a highly reliable equipment, astonishingly easy to operate as a consequence of its stability, and providing top quality color and black-and-white pictures. Excellent monitoring and test facilities are provided, and the entire channel is designed for easy access for maintenance.

Circle Item 62 on Tech Data Card

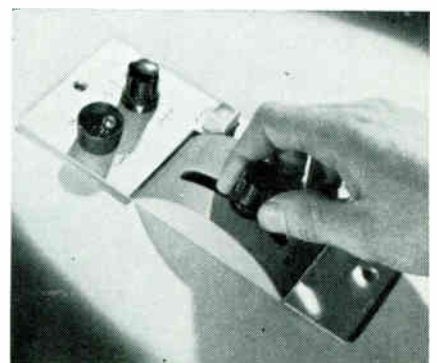

The Operational Control Unit in use.

NORELCO

Since the advent of the Plumbicon® tube, first introduced in the Norelco color camera by North American Philips Company at the National Association of Broadcasters meeting in Washington, D.C., March, 1965, the interest which broadcasters have shown in the acquisition of color facilities has been intensely heightened. In all probability, it has indirectly influenced the increase in the sale of household color receivers because of the enthusiastic acceptance of the "color breakthrough" by the broadcaster.

The development of the Plumbicon made possible many things favorable to the broadcaster. For the first time it provided a high quality studio color camera of manageable weight and size, provided brilliantly faithful color reproduction, dramatically improved the signal-to-noise ratio, and gave the broadcaster flexibility he had never known before in a color camera. The impact was overwhelming.

It was obvious that the introduction of the Norelco color camera was a clear challenge to the manufacturers who had previously been the only source of supply. This new equipment clearly illustrated that desired technical improvements were now available. The signal was "go" — full speed ahead. The rush to install color broadcasting facilities was limited by supply; and since the demand for cameras could not be met hurriedly, broadcasters began placing orders on a first-come, first-serve basis. To date more than 100 Norelco color cameras are in service. Even the second generation camera, the newly introduced all-module transistorized PC-70, is also in service.

From a practical standpoint, it is impossible to employ mass production methods throughout the manufacture of television cameras. Tooling requirements and the relatively limited number of units needed by the television industry preclude

any manufacturer from employing any other than meticulously supervised hand-crafted methods of construction. The Studio Equipment Division of North American Philips Company at Mount Vernon, New York, expanded their production capacities in round-the-clock operations in a serious effort to minimize delivery waiting time as orders continued at a fast pace.

Having the advantage of the world's largest research facilities behind both the Plumbicon tube and its associated electronics development, North American Philips was able to manufacture and supply those cameras which were responsible for the marked improvement in color television reception witnessed by network audiences across the nation.

This chronological summary leads to the description of the features of the second generation PC-70 Norelco color camera while establishing a platform for the Plumbicon three-tube design which the Norelco Studio Equipment Division steadfastly maintains to be the most practical of all the color cameras available.

The adoption of four-tube Plumbicon cameras by some manufacturers was prompted by the tendency of earlier vidicon and image orthicon four-tube cameras to misregistration, caused by the hot tube-type deflection amplifiers which were employed. Transistorized circuitry has eliminated drifting tendencies and thus the need for a separate luminance channel. Before the development of the Plumbicon, the four-tube camera was a necessity because three vidicons did not have the required sensitivity for complete color, and three image orthicons produced unmanageable bulk and operation complexity. The resultant compromise was a combination of image orthicon for luminance and three vidicons for chrominance.

Is the fourth Plumbicon simply a marketing innovation? Hardly so, because there has not been a single plausible engineering reason for a fourth tube. Exhaustive studies have indicated it can increase the sharpness of the monochrome image noticeably but only when the camera is in misregistered state. It would be guileful not to admit that a Norelco Plumbicon four-tube color camera was used as a reference for all of the criteria established in the development of the three-tube commercial versions of the Norelco camera. Since there are no plans to produce four-tube Norelco color cameras in the near future, a further expansion of some of the findings leading to this judgment may be of interest.

Numerous studies have been made by

the Studio Equipment Division on all the factors relating to the claimed advantages of four-tube designs, by comparing the constantly updated Norelco four-tube laboratory model with factory-produced commercial three-tube units. It became obvious that the principal advance which could be made in monochrome and color sharpness would be provided by vertical aperture correction. Although the extent of horizontal aperture correction advantage is limited by the bandwidth of the transmission system—particularly the receiver, vertical aperture correction (being a low frequency correction) produces a startling increase in sharpness — not only on the studio monitor, but more importantly on the receiver in the home. Briefly, it enhances a vertical transition from black to white by slightly darkening the preceding line and whitening the succeeding line in the transition.

The second important finding concluded that the sharpened edges which are thus produced from the green channel of the three-tube camera can be fed very simply into the red, green, and blue channels. This provides the same tolerance to misregistration that a fourth tube provides; but, in addition, it provides sharper edges in the vertical direction as well. The result is a marked improvement over the results with the fourth tube, but accomplished with greater long-term economy and less technical and operational complexity. In reviewing the additional electronics required to maintain and service the four-tube versions, it is axiomatic that even if four-tube performance were equal to the three-tube version, the three-tube concept would be the better of the two. Color matching is another operational problem. Most owners of more than one four-tube color camera will testify willingly to the difficulties encountered in color matching one camera to another.

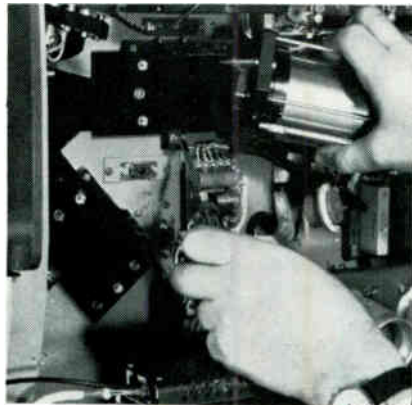

Replacement of the Plumbicon® tube.

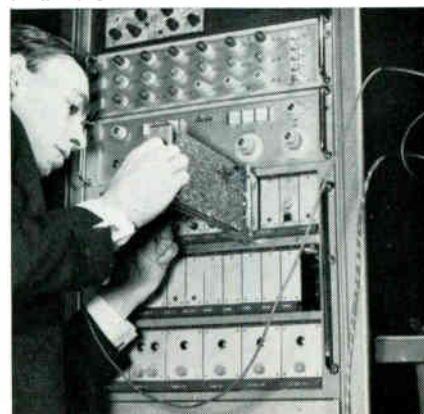

Registration and control panel of chain.

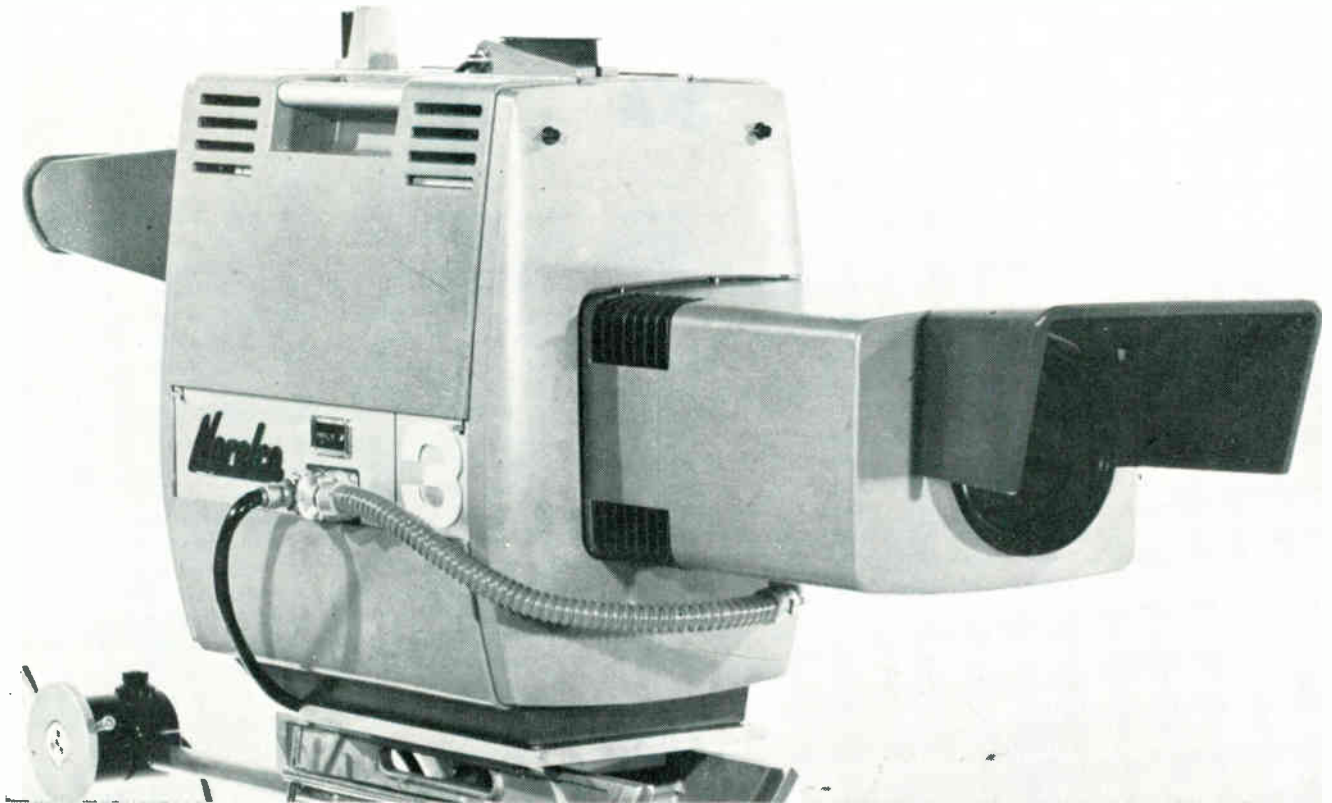

Newest version of Norelco Plumbicon® Model PC-70 color camera features "contours-out-of-green" principle.

Unlike all other color cameras in use which have complicated beam-split systems with dichroic mirrors, and field and relay lenses, the Norelco system is unique and extremely simple. In this patented system, color interference layers are enclosed in a sealed prism assembly. Color trimming filters on the exit faces of the prisms provide suitable color camera characteristics in conjunction with the spectral separation curves of the dichroic layers and the spectral response of the Plumbicon tubes. The advantages of this system contribute greatly to the superiority of the Norelco camera. For example, it eliminates the need for optical relays; eliminates dichroic mirrors and resulting ghost images and spurious reflections normally caused by these; eliminates undesired optical aberrations; and has negligible color errors due to polarized light. It is ideal for outdoor use because it is completely sealed off from dust and moisture. Simplicity of the assembly and its mounting, coupled with its small size and light weight makes it extremely reliable. It requires no adjustment and is free of operational difficulties normally expected of complicated beam splits.

Deliveries of all color cameras today are linked to the availability of key critical components such as lenses. Most cameras are designed around either Angenieux or Taylor Hobson lenses. To minimize the effect which might result from shortages in lens supply, the Norelco camera was designed to employ the lenses of either of these manufacturers, currently the only producers of high quality zoom lenses. Either the Norelco PC-60 or the PC-70 Color Cameras will accept either manual- or servo-operated lenses supplied by these manufacturers.

and are designed to accommodate this interchangeability easily. This versatility of lens interchange will insure better availability of cameras, particularly while lenses are one of the manufacturing bottlenecks still to be overcome. In recent field experiences the Angenieux 12 x 50 zoom with a 600-mm focal length proved to be excellent for outdoor sporting events. Several of these are now in operation.

The new PC-70 electronics unit includes a built-in encoder and color bar generator combination entirely contained in three standard plug-in modules included as an integral part of the system and need not be purchased separately.

The Norelco PC-70 system of setup controls follows the recommendations of the network operations and experienced stations in locating the registration and color balance controls at the camera control unit. There are no set-up or operating controls in the camera head except for focus adjustments of the Plumbicon tubes. Experience has upheld this as very desirable from a reliability viewpoint because of the required mobility and the possibility of bumping and other forms of shock which might readily misalign manually adjusted operating controls in the camera head. From a practical operational standpoint, this feature eliminates the necessity for a two-man setup, and can be completed by less expert cameramen. More importantly, it eliminates the need for setting up the camera on the set during the difficult and distracting period prevailing prior to show time. Operational make-ready can be completed in a short period of time in the relative quiet of the control room.

In designing the PC-70 the most care-

fully followed of all the engineering criteria was maintenance simplicity. As a result, all circuits are mounted on plug-in cards — easily removable from the camera. If a Plumbicon tube replacement is required, the complete yoke assembly can be quickly removed, reinstalled, and optically aligned — all in less than 15 minutes. This exclusive facility is identical for each of the channels.

Now, what about performance? It is obvious from more than a year of ever widening on-air experiences that Norelco three-tube cameras with the contours-out-of-green principle are now offering broadcasters the highest quality color pictures available, providing consistent results beyond comparison—with a facility, economy, maintainability — yet to be matched.

The price of a complete PC-70 chain is \$71,900 with manual lens system, and \$75,900 with a servo lens system.

Circle Item 63 on Tech Data Card

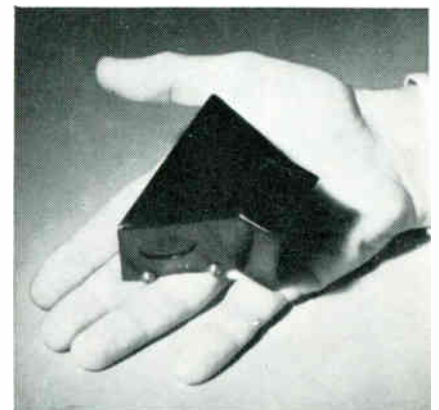

Camera color-separation prism block.

RCA

Since this year's NAB Convention, more than 100 RCA TK-42 color cameras have been shipped to broadcasters. The camera production rate is being further increased during the last quarter, and the high level of output will be continued into 1967. It is expected that at least 300 of the TK-42 cameras will be in broadcast service by the time the 1967 NAB Convention begins.

In 1962, National Association of Broadcasters conventioners witnessed a technological premier: the first public demonstration of a four-tube color TV camera. It was a Radio Corporation of America experimental unit which, after four years of careful testing and refinement, has become a commercial camera and is being delivered in quantity as RCA's TK-42.

The separate luminance principle which the TK-42 pioneered has proven that it produces consistently better color pictures. Most of the broadcast industry agrees, since nearly all camera builders have adopted the four-tube system.

The fourth channel, for which only RCA among all camera makers uses the big 4½-inch image orthicon, assures high-quality monochrome pictures as well. Resolution is in the order of 700 lines.

These are the TK-42's other advantages: a built-in zoom system eliminates the color matching problem; electronics are completely transistorized in standard modules for top performance and reliability; stabilized circuits maintain high quality pictures with infrequent adjustment.

The high-quality monochrome signal is produced directly by the image orthicon rather than by the matrixing process employed in three-tube color cameras. Therefore, the quality is independent of the registration accuracy of the red,

green, and blue channels. The high-quality monochrome signal is desirable for viewing the color signal on monochrome receivers, and also is a necessary component of a high-quality color signal.

Parenthetically, three-tube color systems have no separate tube to produce a monochrome signal. Rather, an M signal component, or luminance signal, is developed by matrixing the three color tube outputs. This M signal is then combined with the I and Q chrominance signals to form the composite color signal. Therefore, the quality of the matrixed M signal, particularly the resolution, is dependent upon the registration accuracy of the images on the color tubes. Poor resolution in the M signal component will impair the quality of both the color and monochrome signals.

Circuits of the camera, and rack-mounted auxiliary equipment, are packaged in the form of plug-in modules, now standard for most RCA equipments. The plug-in module, which features compactness, easy access, and quick replacement by spares, also permits checking under operating conditions. The standard module concept quickly promotes operator familiarity with circuits and equipment that otherwise might take much time to acquire.

Built into the TK-42 is a versatile lens system that eliminates the need for a conventional lens turret and assortment of lenses. This system will handle virtually any requirement in the studio or field. The basic zoom lens, together with an accessory wide angle adaptor, covers a total focal length range of 25 to 1 (1.6 to 40 inches). Lens zoom and focus are controlled at the rear of the camera by two handles. (These same handles are used to pan, tilt, and dolly the camera.)

The wide-angle adaptor is used for focal lengths from 1.6 to 8 inches and from 3.2 to 16 inches. Selection between the two ranges is made smoothly by a lever at the rear of the camera—without need to re-focus. Without the wide-angle adaptor, the zoom lens can be operated in either of two selectable ranges, 4 to 20 inches and 8 to 40 inches.

The TK-42 camera brings to color operation a simplicity and ease of adjustment, making it possible for one man to achieve camera setup without an assistant. No vectorscope is needed. Special camera test pulses, as well as image orthicon alignment circuitry and a color bar generator, are built into the camera equipment, cutting down on the amount of plant equipment required.

The TK-42 offers many features for simplified operation. Several functions previously performed manually can now be automatic. There is provision on the control panel to permit either manual or automatic operation.

Control of the four channels proportionately and simultaneously is accomplished by automatic white and black level controls, maintaining proper modulation and picture colorimetry. The result is accurate control of picture brightness and color quality at all times.

Monitoring of the TK-42 is simpler than other camera systems that require continual observation of three separate (R, G, B) waveforms to maintain correct signal levels.

The TK-42 monitor display features the simplicity of a single waveform—familiar to monochrome operators. This is made possible by special circuits that accomplish non-additive mixing of M, B, R, G signals.

Styled for ease of handling and operation, the center of the viewfinder kinescope is near to the optical axis of the taking lens. Thus, the camera operating height is more convenient at all times, with the viewfinder in a position normally near the eye level of the operator. This results in a lower center of gravity, increasing the mechanical stability.

Except for the high-voltage rectifier in the viewfinder, the TK-42 is completely transistorized. Thus, advantage is taken of all the space and power saving benefits of solid-state circuitry, as well as the increased reliability, reduced maintenance, and improved performance these circuits bring. Transistors used are readily available, unmatched types requiring no selection for replacement.

Stabilized circuits give the TK-42 uniformly high performance over long periods of time without day-to-day alignment. This assures high-quality color pictures, without long set-up times or continual readjustments.

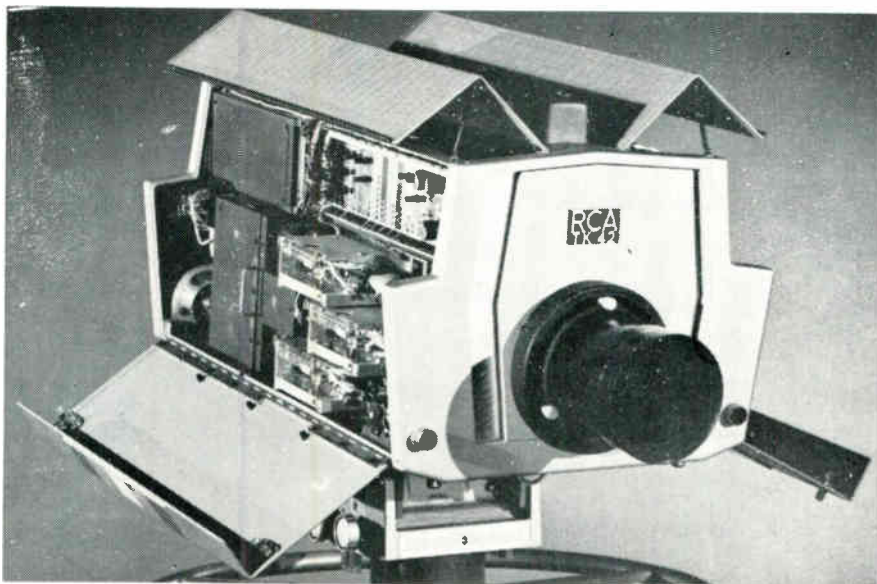

View of the TK-42 with access doors open shows built-in zoom lens.



RCA's TK-42 color camera employs separate-luminance principle with an image-orthicon tube for monochrome.

A unique cooling and heating system maintains optimum temperatures for the four pickup tubes, to help prevent any variations in camera performance. Aging of components and ambient temperature changes are compensated for by feedback stabilization circuits. Precise reference devices maintain critical voltages and currents at proper values. Some are stabilized to less than 0.1 percent variation. As a result, the TK-42 comes up to operation for rehearsal pictures in only one minute after starting. And after on-air pictures are once achieved they stay that way.

New equipment features in the TK-42 simplify the television system by reducing the amount of equipment needed. The only input signals required are sync, blanking, subcarrier, and burst flag. Horizontal and vertical drive pulses derived from sync are generated within the camera. Also, video output is automatically corrected for colorplexer and camera cable delay, eliminating any need for pulse distribution amplifiers and delay lines for other cameras in the system. Furthermore, the TK-42 uses only a single camera cable one-inch in diameter.

The camera auxiliary, including power supply and a built-in color bar generator, requires only 24½ inches of rack space. Two control panels, one a remote panel 4" x 7", and the other a color control panel 8" x 7", are mounted in a stand-

ard control console. A picture monitor and a waveform monitor are also mounted side by side in the same compact console.

The TK-42 is designed to operate on power sources in the ranges of 90 to 130 volts or 180 to 260 volts at 47 to 63 Hz, and on international 625-line, 50-field, or 525-line, 60-field television standards. Individual color burst filters are available for each standard. Or, the TK-

42 can be equipped with both filters, if desired, for switchable operation on either standard.

A price of \$82,000 is for a complete camera chain (not a stripped-down model) and includes all of the items, less accessories, shown in RCA ordering information literature.

Circle Item 64 on Tech Data Card

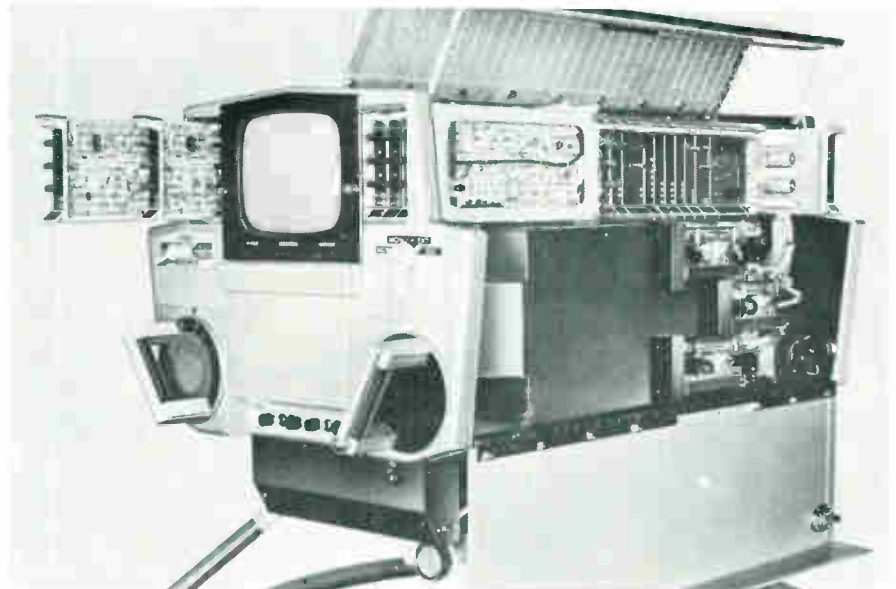

Handles control zoom and focus at the TK-42 operating position.

SARKES TARZIAN

Sarkes Tarzian, Inc. has entered the color television camera field with a number of significant optical, mechanical, and electrical design innovations featured in their equipment.

Tarzian is the first manufacturer to offer a selection of different image pickup tubes in a color camera. Their Polychrome live camera system (Series 88) can be ordered with four Plumbicons® or with one image orthicon and three vidicons. In fact, the special optical design permits selection of any combination of tube and image formats. Considering the high cost of color equipment, this design feature is expected to be important to broadcasters concerned about possible obsolescence of their expensive color equipment. As new pickup tubes with special image formats are developed, the broadcaster can continue to update his Tarzian camera equipment simply by installing the new tubes (with possible electronic changes required), avoiding a substantial investment in new cameras.

Optical Design

Optics used in the Tarzian Polychrome camera feature several unusual design developments. For instance, Plumbicon tube cameras require adjustment of light density value without color change. This is often accomplished with discrete neu-

tral density filters, but these limit the equipment to three or four discrete levels. By incorporating a continuously variable neutral density wheel, following the zoom objective lens, Tarzian has provided for density changes without limiting the user to discrete values. Thus, the camera is as much at home in the variable lighting conditions of outdoor applications, as in the studio.

Also, orthicon/vidicon-type cameras (except for certain orthicons) require orbiting of the image in order to prevent burn-in. But complexity of the electronic system in color cameras makes it impractical to orbit electronically, as is commonly done in monochrome equipment. And all images must be orbited together to maintain registration. Tarzian has solved this problem by placing an optical wedge orbiter behind the objective lens in the image orthicon/three vidicon-type camera.

Two methods of color beam splitting are commonly used in color camera designs. One method employs dichroic mirrors, the other a sealed dichroic interface in a glass prism block. Both have their advantages and disadvantages. The disadvantage of the dichroic mirror is the ghost reflection from the second surface of the mirror, as well as the introduction of astigmatism. The prism designs introduce light polarization and a color change

across the surface of the dichroic layer, which results from the varying angles of incidence of light arriving at the dichroic layer. Both of these effects are most serious at angles approximating 45 degrees, an angle commonly used in color equipment design. These problems can be eliminated only by minimizing the angle of the dichroic surface (when sealed in a prism block) to the incident ray. In the Sarkes Tarzian optical design, each dichroic reflecting surface is at a minimum angle to the incident rays, and the dichroic layers are especially designed wedge-shaped layers. These two features combine to eliminate the polarization problems and spectral shift across the field of the dichroic, commonly found in sealed prism assemblies. The specially designed multi-layer dichroic also provides a very smooth optical bandpass. According to Tarzian engineers, elimination of polarization and spectral shift marks a significant breakthrough in optical system design leading to excellent improvement in color results.

In order to achieve the flexibility of offering any type pickup tube combination, Tarzian engineers went to a special double relay system to solve the varying image format problem. With the appropriate selection of relay #2, any image format can be selected. The color trim filters are located in the collimated light path between the two relay lenses.

Mechanical Design

Generally, the prism optical design is a more compact system, which permits a reduction in the overall size and weight of the camera head assembly. Also, the special Sarkes Tarzian optics lend themselves to an extremely rugged mechanical assembly. A welded magnesium camera housing provides a light-weight, rugged case, with a $\frac{5}{8}$ " magnesium center plate containing all the camera optics and electronics. This type of double folded construction prevents any mechanical torsion on the camera optical system, avoiding mechanical misalignment in the system, which occasionally results from rough handling on remotes.

The Polychrome viewfinder assembly is completely removable, and the basic camera head weighs less than 100 pounds. The viewfinder slides in and out on a chassis track and can be completely removed by unplugging one cable. Or the complete viewfinder assembly, with viewfinder, can be removed. Thus the equipment is as portable as most present day black-and-white cameras.

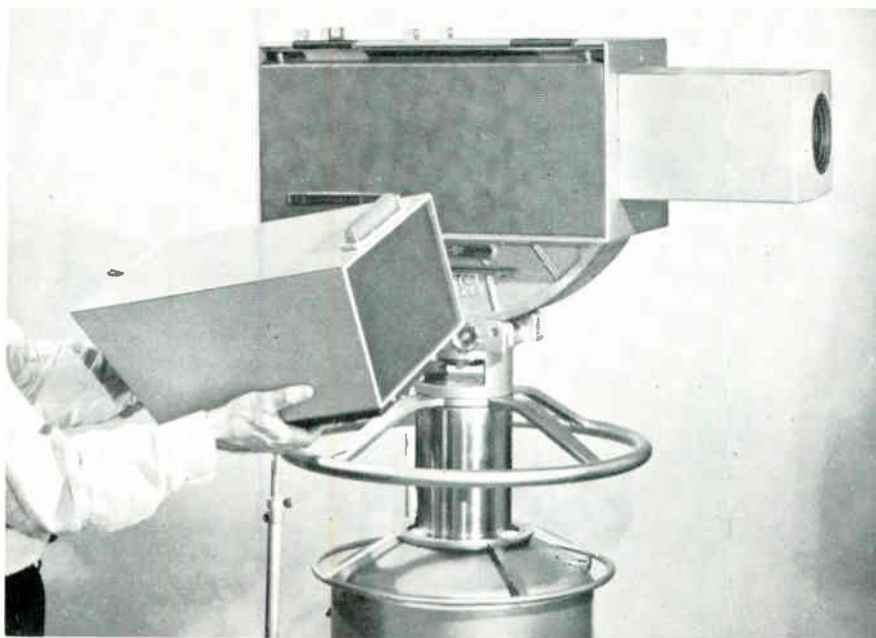

Polychrome camera has removable viewfinder, reducing camera weight.

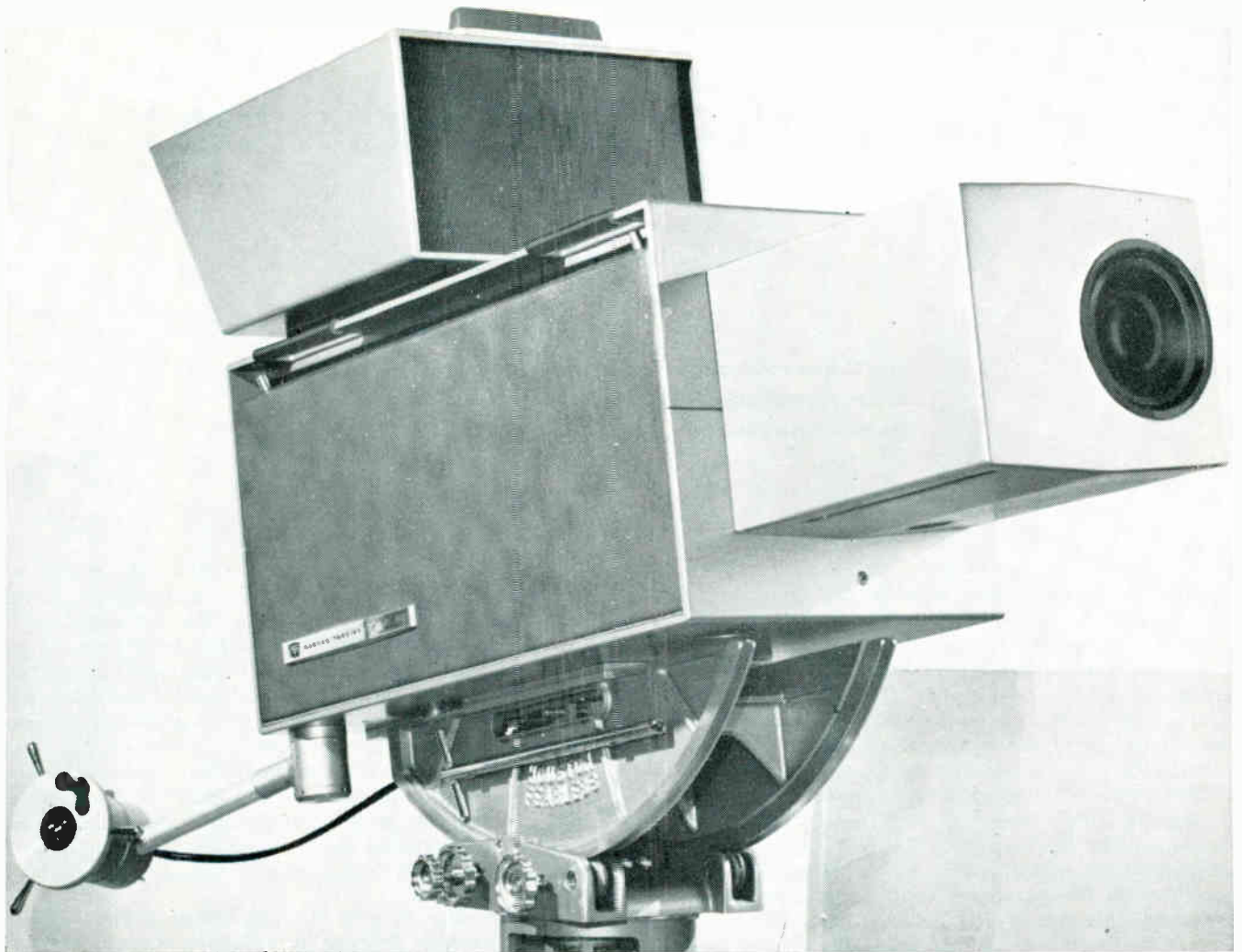

Sarkes-Tarzian Series 88 Polychrome color camera can be ordered in a variety of pickup-tube configurations.

Electronics

Most of the camera electronics are concentrated in two rack-mounted 5¼" modules. These include the video processing unit and the Colorcoder®. In addition, the power supply used occupies only 3½" of rack space.

Operating controls are limited to set-up, gain, and sensitivity. Sensitivity operates the iris system in the studio camera unit and the position of the neutral density disc in the film camera unit. A color bar generator is incorporated in every unit and can be remotely switched into the input of the system. Monitoring facilities include M, R, G, B selected by pushbutton; additive and non-additive mixing of the four channels; and other test positions including provision for measurement of I gain, Q gain, phase, etc. All modules in the color processor and Colorcoder® units are transistorized, plug-in design.

Rack mounted color processing and encoding electronics are common to both the live camera series and film camera series equipment. Use of interchangeable electronics between live and film cameras has obvious advantages in operation and maintenance, especially in emergency situations.

Styling of the Sarkes Tarzian color cameras marks a departure from past designs with a contemporary look, ac-

centuated by textured, Naugahyde® door panels. According to Biagio Presti, manager of the Broadcast Equipment Division, "Our technical and mechanical innovations in color equipment have created widespread interest and acceptance in

the industry, resulting in necessary expansion of our manufacturing facilities." Delivery on the Tarzian color equipment is from 90 to 120 days, according to Presti. Live camera systems are priced under \$70,000.

Circle Item 65 on Tech Data Card

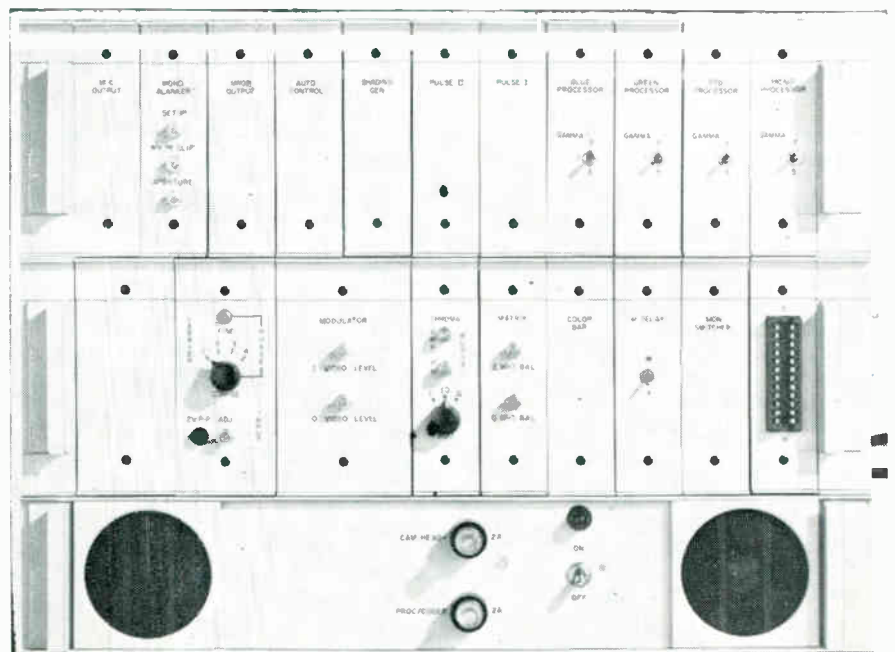

Series 88 camera processing equipment requires 14-inch rack space.

REVIEW OF PROFESSIONAL MICROPHONES

Part 2. The conclusion of a comprehensive survey of professional microphones being manufactured and available to the broadcast industry.

The following pages contain the second half of the microphone survey which began in the September issue. In compiling this information, **BROADCAST ENGINEERING** has attempted to present comparative data on every microphone of professional calibre being manufactured and marketed today. Data include pictures, response curves, physical dimensions, weight, sensitivity, limitations, special properties, price, and — where of particular interest — directional characteristic curves. Generally, specifications, where available, follow industry standards. For output level, frequently called sensitivity, a reference standard of 10 dynes per cm² has been used. The term "hum level" refers to hum pickup and is usually referenced to 0.001 or 0.003 gauss at 60 Hz, depending on the manufacturer. Exceptions to either rule are generally noted. In this survey are the products of five nations. Since international standards are not universally employed by the manufacturers, it has not been possible to be uniform in the data presented.

The price indicated is usually a list price. It is an industry practice to extend a forty percent discount to the list price where a microphone is purchased for professional use but this is not always the case. The exact point-of-sale price, in the end, depends on the manufacturer and/or your professional audio products dealer.

Determining whether a microphone is of professional

calibre is, of course, a matter of judgment. In this we have used the criteria of the purchasing habits of the broadcast and recording industries. Because each of the manufacturers listed is well known for the integrity of his products, we have relied upon published specifications for the data included. Although considerable variation in frequency response does exist, we have given special consideration for their intended use (i.e., lavaliers for voice frequencies only, etc.). A few microphones listed would not appear to satisfy professional requirements. Their inclusion in the survey is deliberate: each of them has specific application to unusual situations which, from time to time, are encountered by broadcast and recording services.

If a particular favorite does not appear in this listing, it will be for one or more of the following reasons: (1) it is no longer being manufactured, (2) it was not reported to us, or (3) it has not generally been accepted.

In this survey only the general properties of each microphone have been presented. A compilation of all the characteristics and measurements would entail publication of hundreds of pages of material. Obviously this could not be done in a monthly publication. The survey is, then, a guide. For complete information about a particular microphone, a list of manufacturers or their representatives with proper addresses, follows.

Altec-Lansing

Altec-Lansing Corp.
1515 S. Manchester Ave.
Anaheim, California

AKG

North American Philips Co., Inc.
Professional Products Div.
100 East 42nd Street
New York, New York 10017
Visual Electronics Corp.
356 West 40th Street
New York, New York 10018

Electro-Voice

Electro-Voice, Inc.
Buchanan, Michigan 49107

Neumann

Gotham Audio Corp.
2 West 46th Street
New York, New York 10036

PML

Ercona Corp.
432 Park Ave., So.
New York 16, New York

RCA

Broadcast & Communications
Products Div.
Radio Corporation of America
Camden, New Jersey 08102

Sennheiser

Sennheiser Electronics
25 W. 43rd Street
New York 36, New York

Shure

Shure Bros. Inc.
2040 W. Washington
Chicago, Illinois

Sony

Sony Superscope, Inc.
8150 Vineland Avenue
Sun Valley, California 91353

Syncron

Syncron, Inc.
10 George Street
Wallingford, Connecticut

Turner

The Turner Co.
909 17th Street, NE
Cedar Rapids, Iowa

University

University Sound
9500 West Reno
P.O. Box 1056
Oklahoma City, Okla. 73101

PML D44B

Dynamic cardioid—Stand-mount, lavalier, or hand-held—Output level: -51 db—Impedance: 200 ohms balanced or hi-Z unbalanced (connection change)—Dimensions: 5" long (dia not available)—Weight: 4.7 oz—Finish: black eloxal and chrome-plated grid—Accessories furnished: 30-ft cable; stand adapter (5/8"-27 thread)—Price: \$39.95. Comments: A windscreen, which serves to minimize wind noises and popping from close talking, is built into the unit.

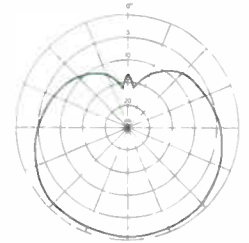
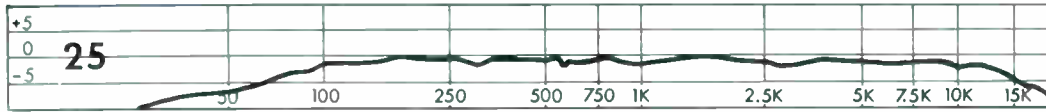

PML DS-24

Cardioid dynamic — Wireless — Impedance: transmitter input, 200 ohms—Dimensions: microphone including transmitter, 7" x 1-1/4" dia—Accessories required: M-33 receiver, \$175; 1930 stand adapter, \$4.95 (5/8"-27 thread); L-24 recharging device, \$25—Price: microphone and transmitter, \$295. Comments: This is a microphone with a

built-in FM transmitter which operates on the frequencies 26.10 or 26.48 MHz. For AM, FM, or TV studio use, alternate frequencies in the 88-108 MHz (FM) band can be supplied. At the latter frequencies, any good FM tuner can be used as a receiver. The microphone is equipped with a windscreen for outdoor or anti-pop employment.



PML EC61A

Microminiature cardioid condenser system—Lavalier, hand-held, stand, or shock mount—Output level: hi-Z, -40 db; 600 ohms, -52 db; 200 ohms, -58 db; 30/50 ohms, -64 db—Impedance: unbalanced, hi-Z; balanced, 30/50, 200, 600—Dimensions: 2-11/16" x 11/16" dia—Weight: 1-1/4 oz—Vital accessories: 4315 power supply 4-1/2" x 2" dia weighing 1 lb, 1 oz or 4316 power supply 4-1/2" x 2" dia weighing 11 oz (incl batts)—Accessories available: 4335 windscreen.

\$29.95; 4211 lavalier adapter, \$4.95; signal cables, \$5 up; 4310 stand adapter (5/8"-27 thread); 1910/18 shock-proof mount—Price: EC61A, \$109.50; 4315 AC power supply, \$49.50; 4316 DC power supply (batteries not included), \$39.50

Comments: A ten-foot cable terminated in a locking connector mates to the power supply. There is a ten-foot signal cable from the power supply to the input. At high-Z no extensions of signal cable may be used. At all other impedances, extensions up to 150 ft may be employed without attenuation.

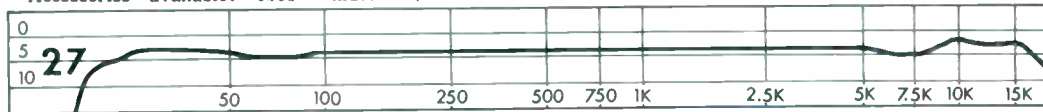
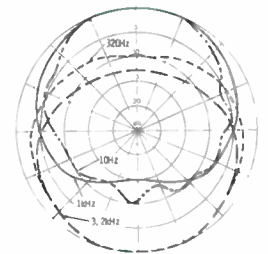

PML EK61A

Microminiature condenser omnidirectional system—Lavalier, hand-held, stand, or boom-mounted—Output level: hi-Z, -42 db; 600 ohms, -54 db; 200 ohms, -60 db; 30/50 ohms, -66 db—Impedance: hi-Z, 600, 200, 30/50 ohms—Dimensions: 2-11/16" x 11/16"

dia—Weight: 1-1/4 oz—Accessories: see Model EC61A—Price: \$99.50.

Comments: The principal differences between Models EC61A and EK61A are in the cases, response, and sensitivity. Power supplies and accessories, vital and available, are identical.

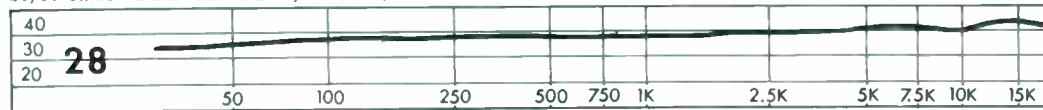

PML RD-36

Dynamic cardioid—Flexible shaft, fixed-position mounting—Output level: -54 db—Impedance: 200 ohms and hi-Z (cable change)—Dimensions: 4-1/8" x 1-1/4" dia—Weight: 5.1 oz—Finish: black and silver gray—Accessories furnished: 18-ft, 2-conductor, shielded cable; flexible gooseneck

with mounting adaptor (5/8"-27 thread)—Price: \$89.50.

Comments: Designed for high-quality public-address applications, the microphone's cardioid pattern serves to reduce feedback and background noise problems.

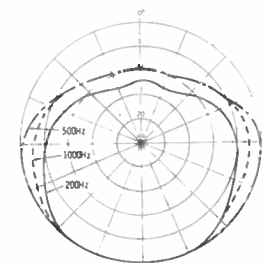
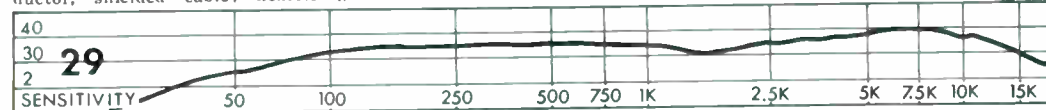

PML TC4

Condenser system cardioid—Stand or boom mount—Output level: -45 db—Impedance: 200 ohms balanced—Dimensions: microphone 3-3/4" × 1-1/2" dia; C7110 power supply 3-5/8" × 2-5/8" × 1-3/16"; E3000 power supply 6" × 4" × 4"—Weight: 4.5 oz; C7110 power supply 12 oz; E3000 power supply 2 lb—Accessories furnished: stand adapter, 5/8"-27 thread—Vital accessories: power supplies, C7110 (DC, rechargeable batteries), E3000 (AC)—Available accessories: boom mount, gooseneck—Price: microphone, \$250; C7110 power supply, \$79.50; E3000 power supply, \$100.

Comments: The microphone features a field-effect transistor integral to the microphone which provides frequency response ±3 db from 30-20,000 Hz, according to the curve provided.

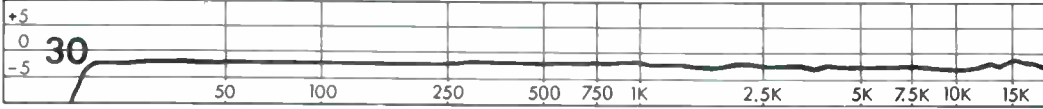
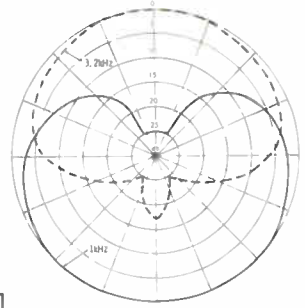

PML TC6/8

Cardioid condenser system with built-in, battery-operated power supply—Can be used with Transmitter S28 as a wireless system or conventionally with cable connectors.—Output: -60 db—Impedance: 200 ohms balanced—Dimensions: 8" × 1-1/4" dia—Weight: 12 oz—Accessories furnished: stand adapter (5/8"-27 thread)—Accessories available: Wireless Transmitter S22, Wireless Transmitter S28, Wireless Receiver M33, battery charger (power supply) C-7110, 1910/18 shockproof mount—Price: TC6 microphone,

\$295; TC8 microphone \$395; Wireless transmitter S28, \$195; Receiver M33, \$175.

Comments: Microphones TC6 and TC8 are identical except that the Model TC8 gives 30-db compression over 100-db input. Transmitters S22 and S28 connect directly to the microphone. The power supply is an integral part of the unit. Batteries can be charged without being removed from the unit. All circuitry in the power supply and transmitters employs field-effect transistors and printed circuits.

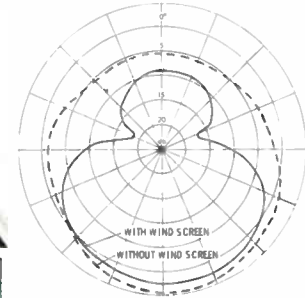

RCA BK-1A

Semi- (horizontal) and non- (vertical) directional dynamic—Hand-held or stand-mounted (ball and socket, 1/2"-pipe thread)—Output level: -52 dbm—EIA sensitivity: -146 db—Impedance: 30, 150, 250 ohms (shipped 250)—Hum: -102 dbm—Dimensions: 7-3/4" × 1-7/8" dia—Weight: 18 oz—Finish: low-luster gray and satin chrome—Accessories furnished: 30-ft. 3-conductor, cadmium-bronze cable with special shielding and neo-

prene jacket—Accessories available: desk stand—Price: \$86.

Comments: The microphone is featured as insensitive to wind and mechanical vibration—especially suitable for outdoor or close-proximity use. It is nondirectional when mounted vertically; a semidirectional characteristic is obtained when it is horizontally mounted—in which case it is essentially nondirectional for frequencies below 2000 Hz.

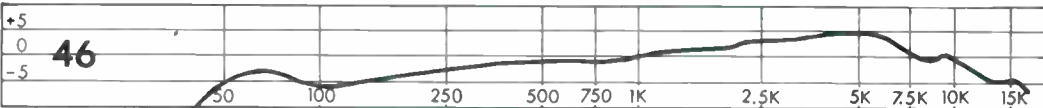
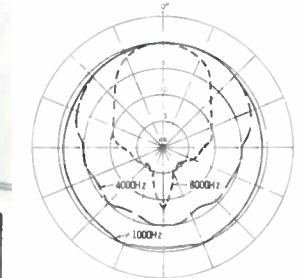

RCA BK-5B

Uniaxial velocity—Stand or boom mounted (cushion mount, 1/2" female pipe thread)—Output level; -56 dbm—EIA sensitivity: -150 db—Hum: -128 dbm—Impedance: 30, 150, 250 ohms (changeable)—Dimensions: 7" × 1-3/4" dia—Weight: 1 lb, 11 oz—Finish: low-luster gray enamel—Accessories furnished: cushion mount; 30-ft flexible cable of cadmium-bronze wire—Accessories available: boom unit, windscreen, desk stand—Price: \$158.

Comments: Incorporated in the unit is a blast filter which reduces damage from gun blasts and other violent noises. The moving element is a thin corrugated metallic ribbon placed between the pole pieces of a magnetic circuit. One side opens to the atmosphere and the other to an acoustic labyrinth, whose phase-shift openings give the unidirectional characteristic. The labyrinth houses an impedance-matching transformer and a switch for selecting response characteristic.

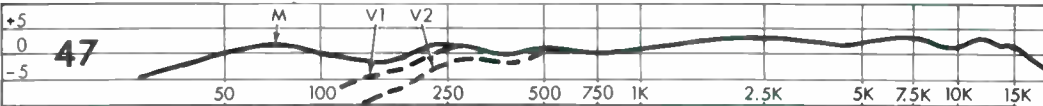
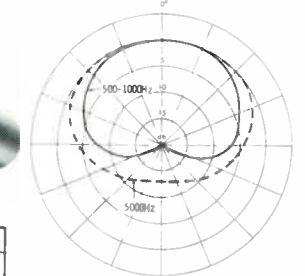

RCA BK-6B

Semi-directional dynamic—Lavalier—Output level: -65 dbm—EIA sensitivity: -159 db—Hum: -112 dbm—Impedance: 30, 150, 250 ohms (changeable)—Dimensions: 2-9/16" × 15/16" dia—Weight: 2.3 oz—Finish: low-luster gray—Accessories furnished: neck lanyard and 30 ft of especially flexible, cadmium-bronze cable—Accessories available: Clamp-type holder; stand adapter for 13" and 19" flexible stand—Price \$86.

Comments: A special internal acoustic resonator is employed to support the response to lower frequencies, and a damped resonator placed in front of the diaphragm reduces high-frequency emphasis while extending the upper limit. The result is a balance for speech when used "off mike."

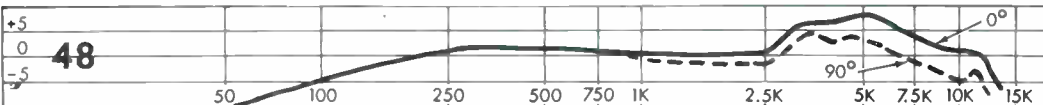
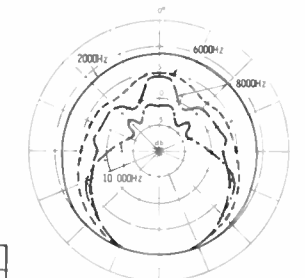

RCA BK-11A

Bidirectional velocity — Stand- or boom-mounted (1/2" pipe thread)—Output level: -56 dbm—EIA sensitivity: -150 db—Hum: -130 dbm—Impedance: 30, 150, 250 ohms (shipped 250)—Dimensions: 8" x 2-7/8" x 2-3/8"—Weight: not available—Finish: low-gloss, deep amber gray and non-reflecting stainless steel—Accessories furnished: 30-ft of tinned, cadmium-bronze flexible cable—Accessories available: desk stands, portable stands—Price: \$131.25.

Comments: Mechanical-injury, internal-shock, and vibration isolation are provided between

the case and the element. The bottom portion of the microphone contains the impedance-matching transformer, frequency-compensating reactor, and three-point switch for selecting frequency-response characteristics. The switch shaft is slotted and accessible through a hole in the mounting base. The unit is supported by a swivel mounting which permits a 45° forward or backward tilt.

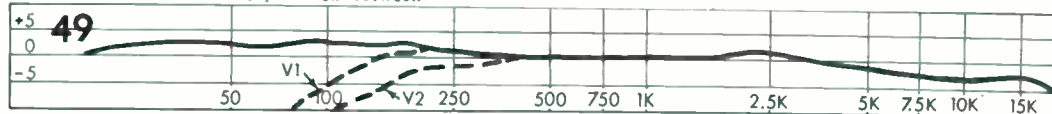
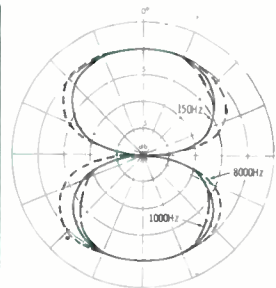
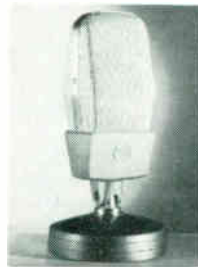

RCA BK-12A

Subminiature nondirectional dynamic—Lavalier—Output level: -60 dbm—EIA sensitivity: -154 db—Hum: -120 dbm—Impedance: 30- to 250-ohm unloaded inputs—Dimensions: 1-1/2" x 3/4" dia—Weight: 0.7 oz—Finish: bronze epoxy and matte gold—Accessories furnished: lavalier holder, tie clip; cable clip; and 30-ft of 2-conductor, shielded, highly flexible cable—Price: not available.

Comments: A line-impedance voice coil permits use with 30- to 250-ohm unloaded inputs without changing the microphone's impedance. A micron-mesh acoustical filter provides dirt and moisture protection. A complete replacement cartridge can be installed in minutes. The cartridge is designed to be handled roughly. Frequency response, designed for lavalier use, is from 60 to 18,000 Hz.



RCA KU-3A

Cardioid velocity — Boom or suspension mounting—Output level: 30 ohms, -49 dbm; 150/250 ohms, -51 dbm—Impedance: 30, 150, 250 ohms (connectable)—Dimensions: 8" x 3" x 3-1/2"—Weight: 2 lbs, 13 oz—Finish: flat two-tone amber gray—Accessories furnished: cable pigtail and resilient mounting—Price \$575.

Comments: The unit features uniform frequency response and output level over the normal front pickup angle of 90°. A switch permits selection of frequency response for music or voice use.

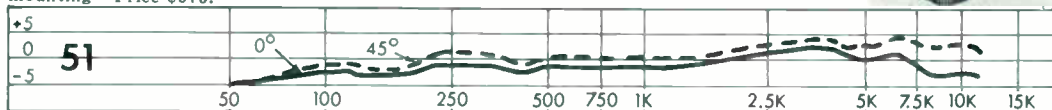
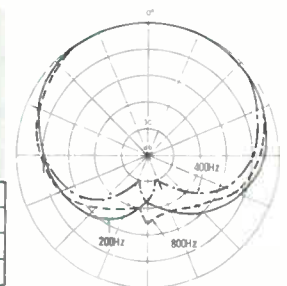

RCA MI-10006-A

Vardirectional condenser system — Boom mounted—Output level: 30 ohms, -33 dbm; 150/250 ohms, -36 dbm—EIA sensitivity: -128 dbm—Impedance: 80, 150, 250 ohms—Dimensions: length, 6" (8-3/4" with windscreen, 22" with MI-1008 ultradirectional attachment); diameter, 1-1/2" (4-1/2" with windscreen)—Weight: 1 lb, 12 oz; 2 lb, 2 oz with windscreen—Finish: microphone, shadow blue; hanger, pebble tone—Accessories furnished: 25-ft boom-type microphone cable, hanger, small windscreen—Accessories available: MI-10008 ultradirectional attachment, large windscreen—Price: Microphone, \$400; MI-10008, \$95.

Comments: A self-contained, small, light-

weight dry-battery supply will provide for over a year's operation. The ultradirectional attachment is easily removed, permitting change from a narrow, long-range pickup zone to a broad cardioid pattern. A switchable voice filter is provided for low-frequency attenuation when the microphone is used for voice pickup.

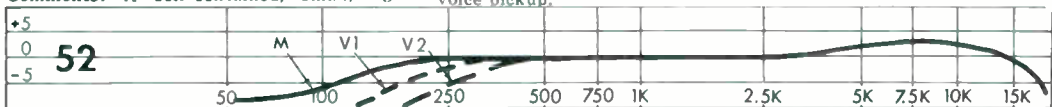

RCA SK-30/31

Omnidirectional dynamic—Hand-held or stand-mounted (5/8"-27 thread)—Output level: -56 dbm—EIA sensitivity: -150 db—Impedance: SK-30, 50-250 ohms; SK-31, 30,000 ohms—Dimensions: 4-1/2" x 1-1/2" dia—Weight: 5 oz—Finish: Midnight blue—Accessories furnished: SK-30, 20-ft, 2-conductor shielded cable without plug; SK-31, 20-ft, 1-conductor shielded cable without plug—Ac-

cessories available: 5/8"-27 swivel adapter—Price: not available.

Comments: The microphone is available in both low-(conventional) and high-impedance versions. It is intended for use in public-address and paging applications. Response curves are not available, but it will respond from 60 to 12,000 Hz.



RCA SK-39A

Semidirectional dynamic—Hand-held or stand-mounted—Output level: -54 dbm—Hum level: -105 dbm—EIA sensitivity: -148 db—Dimensions: 2-3/4" long, 2-1/4" high, 2-7/8" dia—Weight: 1 lb—Finish: Light and dark gray—Accessories furnished: 25-ft, 2-conductor, shielded cable—Price: \$23.40.

Comments: Intended for remote-pickup and mobile use, this microphone employs a rising response curve which provides improved speech intelligibility in close proximity to high ambient noises.

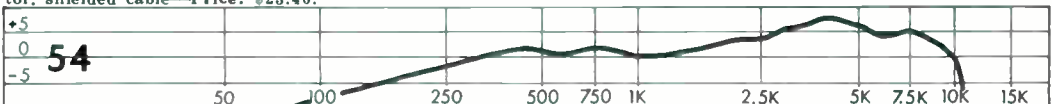

RCA SK-45B

Cardioid dynamic—Stand mounted (5/8"-27 thread)—Output level: 200 ohms, -56 dbm; 15,000 ohms, -58 db below 1 volt/dyne/cm²—Hum level: -106 dbm—EIA sensitivity: -150 db—Impedance: 200, 15,000 ohms (connectable)—Dimensions: 5-1/2" × 1-5/8" × 2"—Weight: 1 lb—Finish: Satin chrome and low-luster gray—Accessories fur-

nished: 25-ft, 2-conductor, shielded cable without plug—Price: \$45.

Comments: A swivel arrangement, integral to the unit, allows tilting of the head forward or backward through an arc of approximately 45° each side of the vertical position.

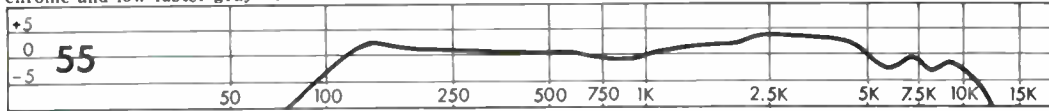
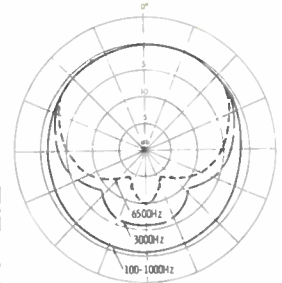

SK-46

Bidirectional velocity—Stand-mounted (5/8"-27 thread) Output level: 200 ohms, -58 dbm; 15,000 ohms, -60 db below 1 volt/dyne/cm²—Hum level: 200 ohms, -115 dbm; 15,000 ohms, -98 dbm below 1 volt—EIA sensitivity: -152 db—Impedance: 200 ohms, 15,000 ohms (changeable)—Dimensions: 5-1/8" × 1-29/32" × 1-3/8"—Weight: 13 oz—Finish: satin chromium and low-luster gray

—Accessories furnished: 25-ft, 2-conductor, shielded cable without plug—Price: \$54.95.

Comments: Relatively sensitive to wind, this microphone is not recommended for outdoor use. An integral swivel arrangement permits tilting the microphone back approximately 85°.

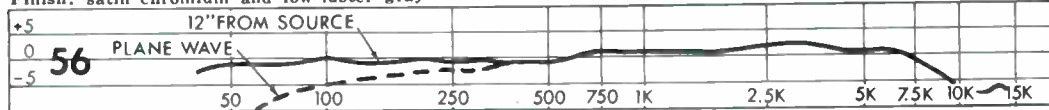
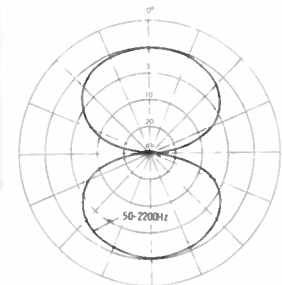

RCA 77-DX

Variable-pattern cardioid velocity—Stand- or boom-mounted—Output level: bidirectional, -50 dbm; unidirectional, -53 dbm; nondirectional, -56 dbm—Hum level: -128 dbm—Impedance: 30, 150, 250 ohms (changeable)—Dimensions: 11-1/2" × 3-3/4" × 2-1/2"—Weight: (including 1-1/2 lb cable) 3 lbs—Finish: satin chrome or low-luster gray—Accessories furnished: cushion mount (1/2" pipe thread), 30-ft, 3-conductor, shielded cable without plug—Price: \$206.

Comments: The directional characteristic of this microphone is adjusted by means of a positionable shutter. When completely closed, the microphone is nondirectional. Opening the shutter introduces phase shift controlling the directional characteristic. The bottom portion of the microphone contains an impedance-matching transformer and switch for selecting response characteristics for voice or music.

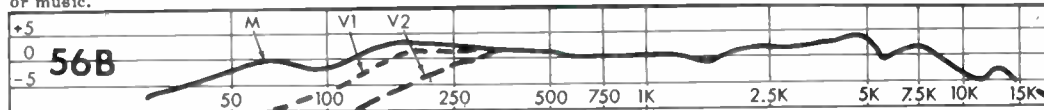
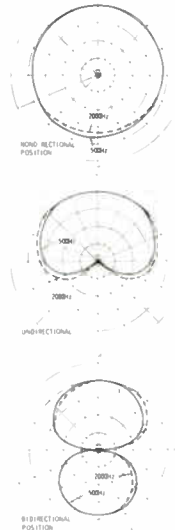

Sennheiser MD 21

Omnidirectional dynamic—Stand-mounted or hand-held—Output level: -53 db—Impedance: 200 ohms (30,000 ohms available in Model MD 21HN)—Dimensions: 4.72" × 1.81" × 1.81"—Weight: Approximately 9.2 oz—Finish: Hammer stove enamel—Accessories available: table and floor stands, flexible shaft, transformers, windscreens—Price: \$65.

provided on the housing to mate with stands. A three-point Tuchel cable connector (0.188" dia) is standard, but a larger connector is available for professional applications in Model MD 21/2.



Comments: In order to increase fidelity at the higher frequencies, a slow rise to +6 db above "O" level occurs at frequencies above 1000 Hz. A female tripod thread is

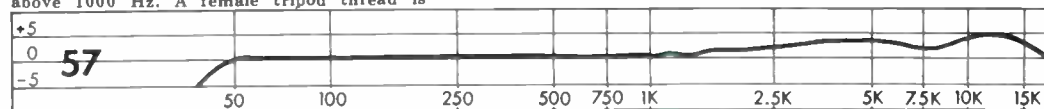

Sennheiser MD 211

Omnidirectional dynamic — Hand-held or stand-mounted—Output level: -57 dbm—Impedance: 200 ohms—Dimensions: 4-3/4" × 7/8" dia—Weight: not available (light)—Finish: satin chrome—Accessories available: matching transformer, flexible shaft, table and floor stands, windscreens, clamp (5/8"-27

adapters)—Price: \$115. Comments: The cable which connects the microphone to the console or recorder may extend up to 650 ft without additional amplification. Response is guaranteed up to ±2.5 db of the published curve. A miniature Tuchel connector is standard, but adapters are available for the standard 5/8"-27

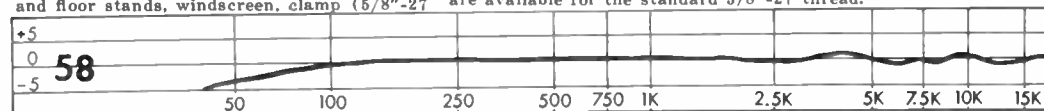

Sennheiser MD 214

Omnidirectional dynamic—Lavalier—Output level: -59 dbm—Impedance: 200 ohms—Dimensions: 3" × 1-1/8" × 1-1/8"—Weight: not available (light) — Finish: nonglare enamel—Accessories furnished: shielded cable and neck cord—Price: \$110.
Comments: Mechanical noise occurring when the microphone rubs against clothing is

overcome by unique construction; an inner housing contains the moving-coil transducer, and this housing is mechanically isolated from the outer shell. The neck cord is designed for easy and silent removal.

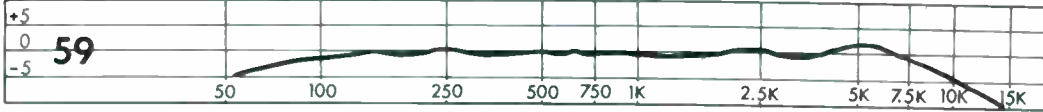

Sennheiser MD 421, HN, and 421/22

Cardioid dynamic — Hand-held or stand-mounted—Output level: -53 db—Impedance: MD 421-421/22, 200 ohms; MD 421 HN, 200/24,000 ohms—Dimensions: 6.96" × 1.9" × 1.81"—Weight: 13.4 oz—Accessories furnished: adapter with 3/8" camera tripod thread, boom mount, 16-ft pigtail cable—

Accessories available: desk and floor stands, flexible shaft, windscreen, matching transformers—Price: \$114.
Comments: Models MD 421 and MD 421 HN have been fitted with an additional attenuator for low frequencies, because of the tendency for directional microphones to emphasize low frequencies during close speaking.

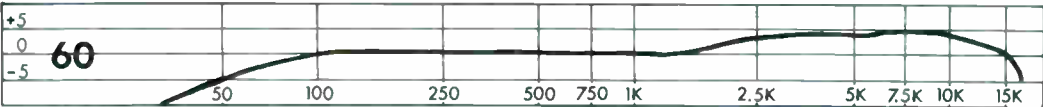

Sennheiser MKH 404, 405

Cardioid condenser system — Hand-held or stand-mounted—Output level: MKH 404, -37 dbm; MKH 405, -27 dbm—EIA sensitivity: MKH 404, -131.5 db; MKH 405, -121.5 db—Impedance: MKH 404, 100 ohms; MKH 405, 10 ohms—Dimensions: 5-3/16" × 3/4" dia—Weight: 3.5 oz—Accessories available: numerous—Price: microphone only, \$230.

Comments: The Model MKH 404, with an output impedance of 100 ohms, is designed for connection to circuitry having a minimum impedance of 2000 ohms. This permits connection to unbalanced circuitry with cables of extreme length. Model MKH 405 (impedance 10 ohms) is intended for insertion into 200-ohm balanced inputs. The microphones are intended for employment in large studios with master power supplies.



Sennheiser MKH 804, 805

Extremely directional condenser system—Stand- or boom-mounted — Output level: MKH 804, -31 dbm; MKH 805, -21 dbm—EIA sensitivity: MKH 804, -125.7 db; MKH 805, -115.4 db—Impedance: MKH 804, 180 ohms unbalanced and ungrounded; MKH 805, 10 ohms balanced and ungrounded—Dimensions: 22" × 3/4" dia—Weight: 14 oz—Ac-

cessories available: numerous—Price: microphone only, \$342.
Comments: A novel combination of the principle of interference with that of pressure gradients results in the narrow frontal lobe. Like the Model MKH 404 series, this microphone series is designed for use into high-impedance, unbalanced or standard, balanced inputs. Normally, power is supplied by a master system.

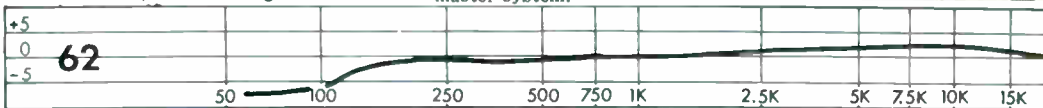

Shure Bros. SM5A/B

Cardioid dynamic—Stand and boom mount—Output level: -57 db—Hum level: -120 dbm—EIA sensitivity: -150 db—Impedance: SM5A, 50 ohms; SM5B, 150 ohms—Dimensions: 9-29/32" × 4-1/2" dia; shock mount, 5-23/32" × 5-1/32" × 1-1/2"—Weight: 1 lb, 15 oz—Finish: textured dark gray enamel, light and dark gray plastic foam windscreens—Accessories furnished: shock mount—Accessories available: cartridge assembly, sus-

penders, windscreen, desk mount, 5/8"-27 stand adapter—Price: \$225.
Comments: The windscreen assembly and rotatable mount are integral to the microphone. A two-stage mechanical filter isolates the unit from vibration. The suspension elements are internal to the windscreen to prevent wind noise generation in the suspension assembly.



Shure Bros. SM50

Omnidirectional dynamic — Hand-held or stand-mounted—Output level: -58 db—EIA sensitivity: -150 db—Impedance: 30/50, 150/250 ohms (changeable)—Dimensions: 6-37/64" × 1-33/64" dia—Weight: 8 oz—Finish: Textured dark gray enamel—Accessories furnished: swivel adapter, 20-ft, 2-conductor, shielded cable with Cannon connector—Accessories available: desk stand—Price: \$75.
Comments: A built-in wind and breath filter serves to reduce wind noise, "blasting," and

"pop." It is easily removed for replacement or cleaning. The microphone is designed for optimum intelligibility.

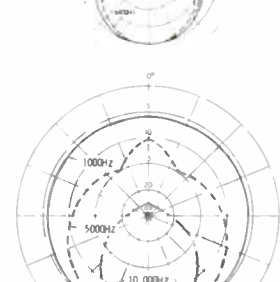
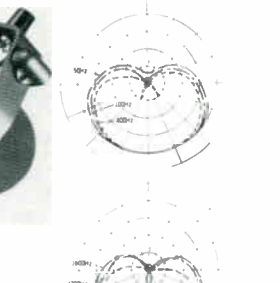
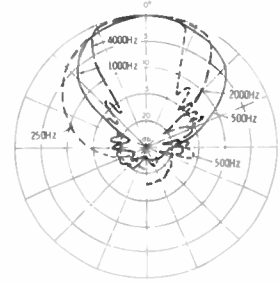
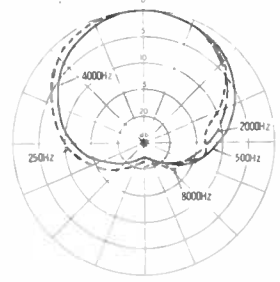
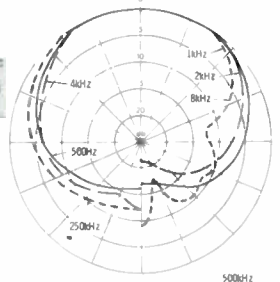
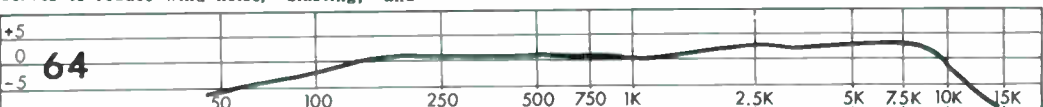

Shure Bros. SM33

Super-cardioid velocity — Stand-mounted — Output level: 30/50 ohms, -57.5 db; 150/250 ohms, -54 db—**EIA sensitivity:** -150.5 db—**Impedance:** 30/50, 150/250 ohms (changeable)—**Dimensions:** (overall) 7-61/64" × 2-1/16" × 1-3/8"—**Weight:** 1 lb, 10 oz—**Finish:** textured light and dark gray enamel—**Accessories furnished:** shock mount; 20-ft.

2-conductor, shielded cable with XLR-3-11-C connector; adapter for 1/2" pipe thread or 5/8"-24 thread on request—**Price:** \$129. **Comments:** The shock mount is built-in for quiet operation. Impedance is changed by resoldering at the receptacle and of the microphone. The shock mount is threaded 5/8"-27.

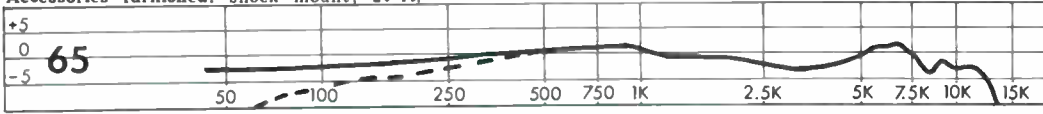
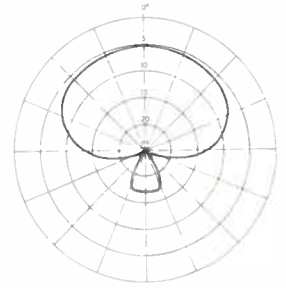

Shure Bros. SM56

Cardioid dynamic — Stand mount — Output level: -56.0 db—**EIA sensitivity:** -148 db—**Impedance:** 30/50, 150/250 ohms (switchable)—**Dimensions:** 8" × 2-1/16" overall; microphone 4-3/4" × 1-15/64" dia.—**Weight:** 1 lb, 3 oz—**Finish:** textured dark gray enamel — **Accessories furnished:** swivel shock mount; 20-ft, 2-conductor, shielded cable with XLR-3-11C connector—**Price:** \$81. **Comments:** The cartridge and microphone body are separately mounted for quiet operation. Impedance selection is accomplished

with a convenient switch, and an accessory switch adapter functions as "on-off" for the microphone output.

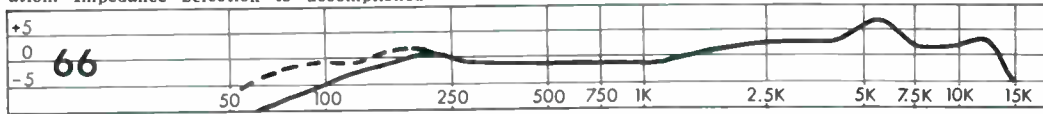
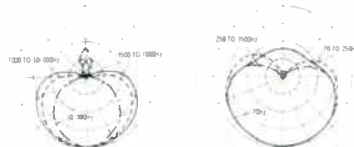

Shure Bros. SM57

Cardioid dynamic — Hand-held or stand-mounted—Output level: -56 db—**EIA sensitivity:** -148 db—**Impedance:** 30/50, 150/250 ohms (changeable) — **Dimensions:** 6-17/64" × 1-1/4" dia.—**Weight:** 10 oz—**Finish:** textured dark gray enamel—**Accessories furnished:** swivel adapter for 5/8"-27 thread; 20-ft, 2-conductor, shielded cable with Cannon connector—**Price:** \$63. **Comments:** An adjustable swivel adapter is supplied which permits the microphone to be tilted 90° from vertical to horizontal. The cartridge is shock mounted to provide for quiet operation.

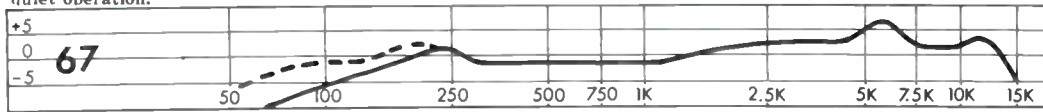
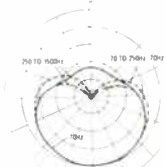
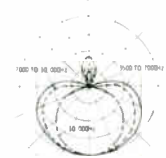

Shure Bros. SM58

Cardioid dynamic — Hand-held or stand-mounted—Output level: -56.0 db—**EIA sensitivity:** -149 db—**Impedance:** 30/50, 150/250 ohms (changeable) — **Dimensions:** 6-29/64" × 2" dia.—**Weight:** 15 oz—**Finish:** textured dark gray enamel and matte chrome — **Accessories furnished:** slip-on swivel adapter; and 20-ft, 2-conductor, shielded cable with Cannon connector — **Accessory available:** S33 p desk stand—**Price:** \$81. **Comments:** An easily removed, self-contained, spherical windscreens serves to con-

trol "pop" and wind noise in outdoor locations. The swivel stand adapter is threaded for 5/8"-27 installations.

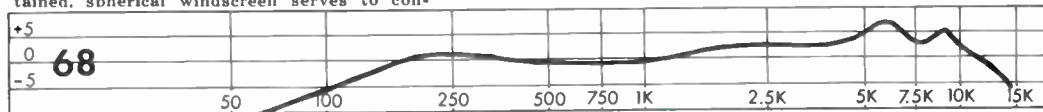
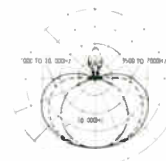
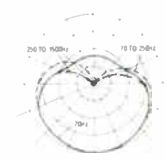

Shure Bros. SM76

Omnidirectional dynamic — Hand-held or stand-mounted—Output level: -60 db—**EIA sensitivity:** -152 db—**Impedance:** 50, 150 ohms (changeable) matches up to 250 ohms — **Dimensions:** 8-9/32" × 25/32" dia — **Weight:** 7 oz—**Finish:** textured dark gray enamel—**Accessories furnished:** swivel adapter and 20-ft, 2-conductor, shielded cable with XLR-3-11C connector—**Price:** \$105.

Comments: A slip-on swivel adapter, threaded 5/8"-27, permits the microphone to be tilted through 90° from vertical to horizontal. Output impedance is adjusted by resoldering connections in the male insert at the receptacle end of the microphone.

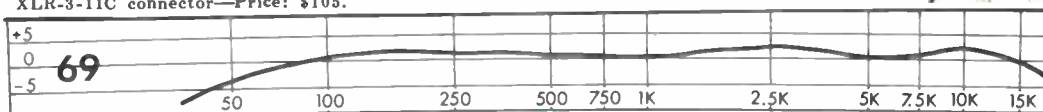
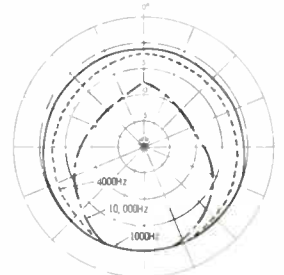

Shure Bros. 300

Bidirectional velocity—Stand-mounted—Output level: 30/50 ohms, -60.5 db; 150/250 ohms, -59.0 db high Z, -57.5 db—EIA sensitivity: -154 db—Impedance: 30/50, 150/250 ohms, high Z (switchable)—Dimensions: 9-7/32" x 1-3/8" x 2-1/16"—Weight: not available—Finish: textured dark gray enamel—Accessories furnished: swivel shock mount for 5/8"-27 thread; 20-ft., 2-conductor, shielded cable with XLC-3-11C conductor;

1/2" pipe-thread adapter available on request—Price: \$90.

Comments: The microphone is mounted in a special live-rubber vibration-insulation unit which swivels and is adjustable so that the head can be tilted 45° forward and 90° backward. A multi-impedance switch provides three output impedances. A two-position switch adjusts low-frequency characteristic.

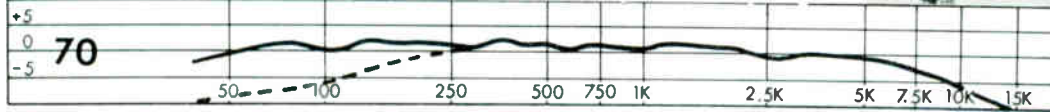
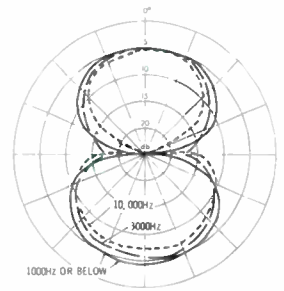

Shure Bros. 570

Omnidirectional dynamic—Lavalier—Output level: -60 db—EIA sensitivity: -153 db—Impedance: 50 to 250, 150 nominal ohms—Dimensions: 2-19/32" x 25/32" dia—Weight: 2 oz—Finish: nonreflecting gray with stainless steel grille—Accessories furnished: lavalier cord; belt clip; 30-ft., 2-conductor, shielded cable—Available accessory: A57R swivel adapter—Price: \$57.

Comments: Exclusive "Flex-Grip" assembly is designed for right or left attachment to shirt or blouse, or neck cord. A belt-clip assembly secures the cord and helps firm attachment by holding the cable to the body. The frequency-response characteristic is tailored to lavalier use.



Comments: Exclusive "Flex-Grip" assembly is designed for right or left attachment to

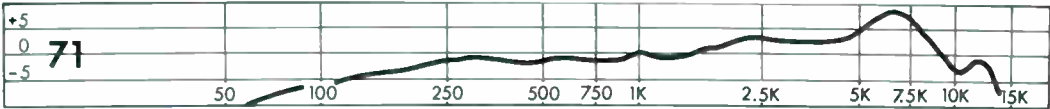

72. Shure Bros. 571

Omnidirectional dynamic—Concealment, hand-held, or inconspicuous stand mounting—Output level: -60.5 db—EIA sensitivity: -153 db—Impedance: 50 to 250 ohms, 150 ohms nominal—Dimensions: 2-19/32" dia—Weight: 2 oz—Finish: nonreflecting gray with stainless steel grille—Accessories furnished: A57R stand adapter threaded 5/8"-

27; 30-ft., 2-conductor, shielded cable—Accessories available: lavalier attachments—Price: \$57.

Comments: The Model 571 is a special version of the Model 570 lavalier microphone for use where it is necessary to conceal a microphone in television and motion-picture applications, or where it is desirable to have the microphone as inconspicuous as possible.

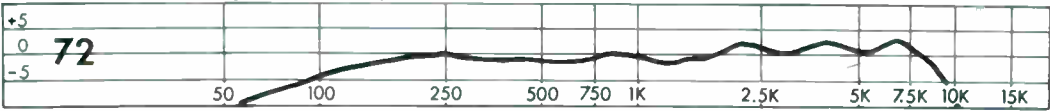

Sony C-38

Switchable omnidirectional or cardioid condenser—Stand-mounted—Output level: -52 db @250 ohms where O db = ±1 v/10 μb—Impedance: 50, 250, 600 ohms—Dimensions: 8-1/4" x 2-3/16" dia—Weight: 1 lb, 3 oz—Accessories furnished: 5/8"-27 tpi adapter—Accessories available: 3000-hour battery pack—Price: \$325.

Comments: A special FE transistor has been designed by the manufacturer to replace a conventional vacuum tube. This permits use of the microphone without external power supplies and impedance matching amplifier. Contained within the microphone case are: CP-3 condenser capsule, FE transistor, 9-volt battery (for 300 hours of operation), and DC-to-DC converter to provide 140-volt polarizing voltage. Operating controls include a directional-characteristic selection switch, a power switch, and a 3-position low-frequency attenuator. Where prolonged operation is required, an accessory battery pack, utilizing 6 size "D" flashlight cells, will provide cumulative operating periods in excess of 3000 hours.

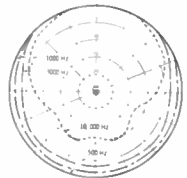
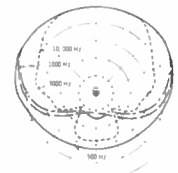
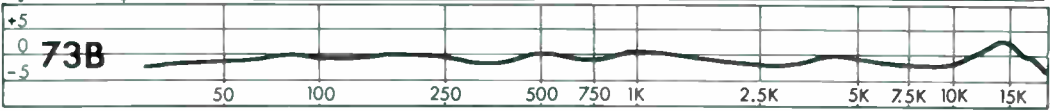
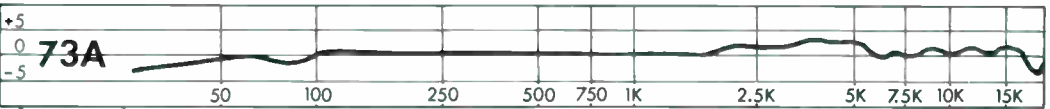

Sony CR-6

Condenser system—Wireless—Price: \$450. Comments: The CR-6 wireless system consists of a condenser microphone, transistorized transmitter, two battery cases (lavalier and hand-held probe), receiver, and a portable carrying case. The frequency response of the system extends from 50 to 10,000 Hz with an S/N ratio greater than 35 db. The miniaturized transmitter and microphone are housed in a capsule less than three inches long. For hand-held use, power is supplied from a small battery pack which can be attached directly to the microphone/transmitter capsule. Or, if desired, the other battery pack can be connected to the capsule by

means of a small cord, permitting lavalier use. The transmitter and receiver may be separated by distances up to 300 ft. The receiver incorporates an automatic squelch circuit which mutes the receiver output whenever the transmitter is turned off. The transmitter operates on a carrier frequency of 33.14, 35.02, or 42.98 MHz; the selected frequency must be specified at the time of purchase. The receiver incorporates AFC and RF tuning and audio output power meters.

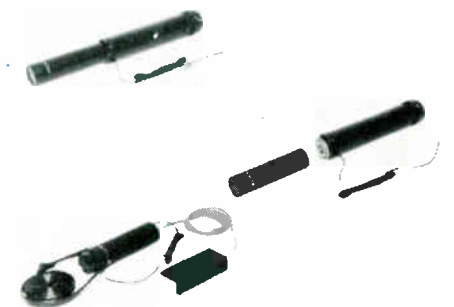

Sony F-121

Cardioid dynamic — Hand-held or stand-mounted—Output level: 50 ohms, -58.2 dbm; 150 ohms, -57.8 dbm; 10,000 ohms, -58. dbm—EIA sensitivity: 50 ohms, -151 db; 150, 10,000 ohms, -151.8 db—Hum level: below 6 db/mgauss—Impedance: 50, 150, 10,000 ohms—Dimensions: 7" x 1-9/16" dia—Weight: 200 grams—Finish: satin anodized aluminum—Accessories furnished: 20-ft Type CC-13 microphone cable, A-6N desk

stand, SAD-8N clip-on holder, deluxe carrying case—Price: \$99.50.
Comments: An integrated windscreen covers both the diaphragm and acoustical delay network openings. This is to provide immunity from wind-caused noise. An "ON-OFF" switch is installed in the case; an electrical interlock prevents accidental operation of the switch. Impedance selection is accomplished by changing one lead wire.

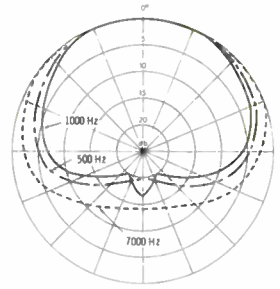

Syncron S-10

Cardioid condenser — Hand-held or stand-mounted—Output level: -53 dbm at 10 dyne/cm²—Impedance: 200 ohms—Dimensions: 7-3/8" x 7/8" dia—Weight: 9 oz including battery—Finish: satin nickel—Accessories furnished: mercury battery, carrying case, swivel mount, 20-ft 2-conductor shielded cable—Accessories available: S-101 windscreen (\$14.95), S-102 desk stand (\$19.95), and S-103 suspension (\$29.95)—Price: \$240.

volts when continuous service is a factor. The mercury battery provides about 1000 hours of operation; end-of-life is indicated by a slight increase in distortion.

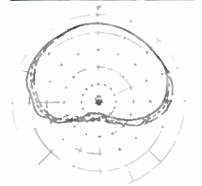
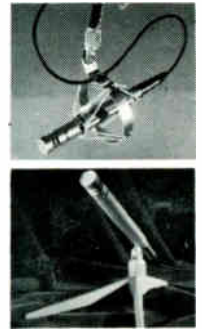

Comments: Solid-state circuitry, including a field-effect transistor, is used. With a single 9-volt mercury battery (NEDA 1611M or equivalent) as its power supply, the microphone is completely self-contained. Substitution of a three-wire shielded cable adapts the S-10 for remote on-off switching. The addition of an S-104 battery bypass permits operation from an external source of 8-9



Turner 58A

Essentially nondirectional dynamic—Lavalier—Output level: -57 db—RETMA sensitivity: -150 db—Impedance: 50, 200 ohms (connection change)—Dimensions: 4" x 1" dia—Weight: 3-1/2 oz—Finish: nonreflecting neutral gray on aluminum—Accessories furnished: support clip; neck cord; 25-ft, 3-conductor, shielded, celanese-braided cable—Accessories available: model G-4 desk stand in matching finish—Price: \$57.

Comments: The Model 85A features Turner's new "DYNAFLEX" nonmetallic diaphragm. The selectable output-impedance change is made by color-coded wires on the amplifier end of the microphone cable.

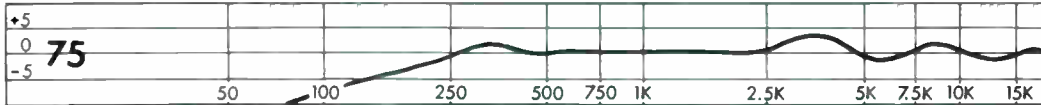
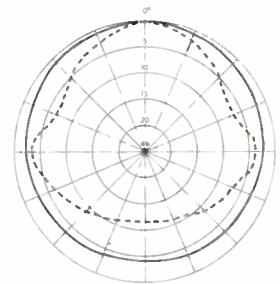

Turner 510

Cardioid dynamic — Hand-held or stand-mounted—Output level: -55 db—Impedance: 50 ohms (matches 35- to 80-ohm inputs), 200 ohms (matches 150/250 ohm inputs)—Dimensions: 6-13/16" x 1-17/32" dia—Weight: 12 oz—Finish: neutral blue-gray, nonreflecting—Accessories furnished: slip-on adapter for 5/8"-27 thread; 20-ft, 3-con-

ductor, shielded, black plastic cable—Accessories available: desk stand—Price: \$150.
Comments: Concealed ports allow entrance of sound to the rear of the "DYNAFLEX" diaphragm to provide the controlled combination of pressure and phase shift that results in the cardioid pickup pattern. Output impedance is selected at the free end of the cable.

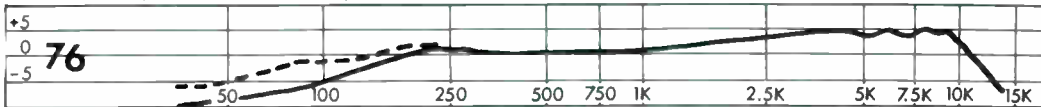
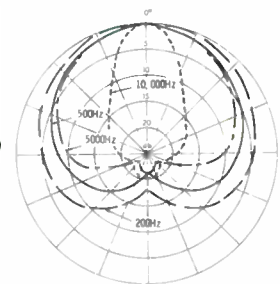

University 1000

Cardioid dynamic — Hand-held or stand-mounted—Output level: 50/200 ohms, -54 db; 20,000 ohms, 17 mv/10 dynes/cm²—Hum level: -120 db—EIA sensitivity: -147 db — Impedance: 50, 200, 20,000 ohms (changeable) — Dimensions: 8-13/16" x 1-3/4" dia — Weight: not available — Finish silver gray and nonreflecting black—Acces-

sories furnished: 18-ft, 2-conductor, shielded, vinyl cable; SA 10 slide-on stand adapter—Price: \$124.50.
Comments: The generating element is internally vibration-insulated on closed-cellular foam neoprene. It is protected from dust and iron particles by silk and electroformed mesh screens. Output impedances are changed by the use of push-on connectors on the output socket.

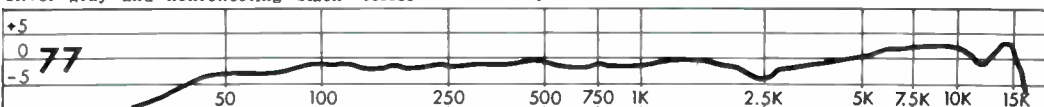
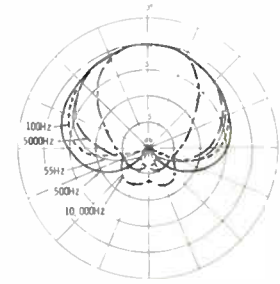

University 1040

Cardioid dynamic — Hand-held or stand-mounted—Output level: 50/200 ohms, -54 db; 20,000 ohms, 17 mv/10 dynes/cm²—Hum level: -120 db—EIA sensitivity: -147 db—Impedance: 50, 200, 20,000 ohms (changeable)—Dimensions: 10-1/16" × 1-3/4" dia—Weight: not available—Finish: silver gray and nonreflecting black—Accessories furnished: 18-ft, 2-conductor, shielded, vinyl

cable; SA 10 slide-on stand adapter—Price: \$139.50.

Comments: The Model 1040 has highly directional characteristics designed to yield superior results in noisy or reverberant locations, particularly when a discrete sound source is of primary interest. Push-on (no solder) leads to gold-plated connector terminals are employed in output impedance selection.

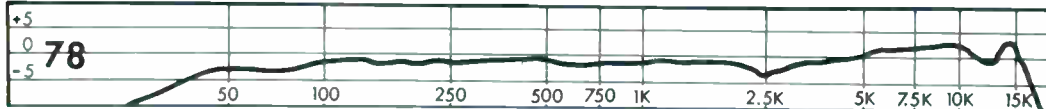
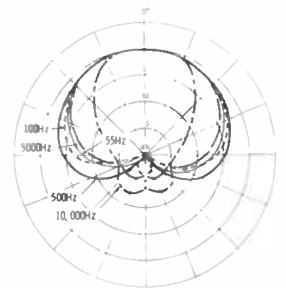

University 1050

Cardioid dynamic — Hand-held or stand-mounted—Output level: 50/200 ohms, -54 db; 20,000 ohms, 17 mv/10 dynes/cm²—Hum level: -120 db—EIA sensitivity: -147 db—Impedance: 50, 200, 20,000 ohms—Dimensions: 10-3/8" × 1-3/4" dia—Weight: not available—Finish: silver gray and nonreflecting black—Accessories furnished: 18-ft, 2-conductor, shielded, vinyl cable; stand adap-

ter with "OFF-ON" switch; 5/8"-27 NPSM stand receptacle; receptacle for XLR-3-11C plug—Price: \$144.25.

Comments: The microphone features a unique internal shock mounting arrangement for the generating element which isolates it from spurious sound and unwanted extraneous noises. Discrimination is achieved by an internal network of inductive, resistive, and capacitive acoustical elements.

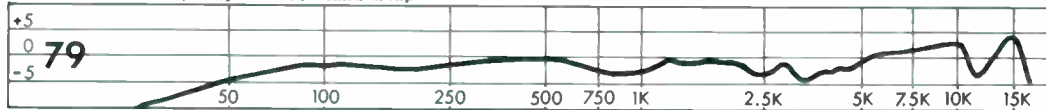
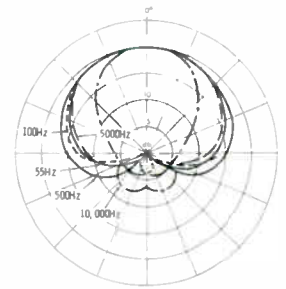

University 2000

Omnidirectional dynamic — Hand-held or stand-mounted—Output level: 50 ohms, -50 db; 20,000 ohms, 28 mv/10 dynes/cm²—Hum level: -120 db—EIA sensitivity: -143 db—Impedance: 50, 20,000 ohms—Dimensions: 6" × 1-5/32" dia—Weight: not available—Finish: silver gray and nonreflecting

black—Accessories furnished: 15-ft, 3-conductor, shielded, vinyl cable; SA10 slide-on stand adapter—Price: \$44.75.

Comments: This relatively low-priced unit is designed to accommodate situations where rough handling is anticipated. It is designed for enhanced bass-response characteristics.

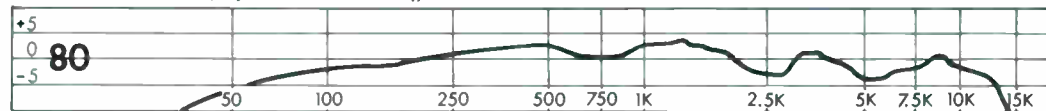
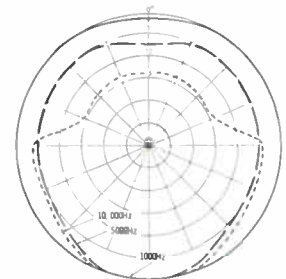

University 2040

Omnidirectional dynamic — Hand-held or stand-mounted—Output level: 50 ohms, -50 db; 20,000 ohms, 28 mv/10 dynes/cm²—Hum level: -120 db—EIA sensitivity: -143 db—Impedance: 50, 20,000 ohms—Dimensions: 8-5/8" × 1-5/32" dia—Weight: not available—Finish: silver gray and nonre-

fecting black—Accessories furnished: 18-ft, 2-conductor, shielded, vinyl cable; switch and stand adapter—Price: \$51.

Comments: The microphone "OFF-ON" switch is integral to the casing. The unit stresses durability and improved low-frequency response.

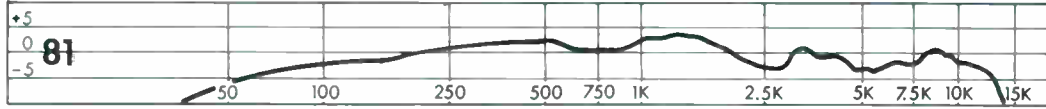
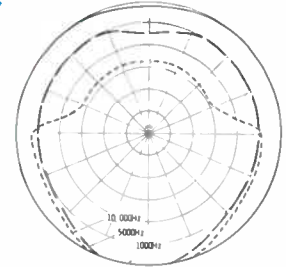

University 2050

Omnidirectional dynamic — Hand-held or stand-mounted—Output level: 50 ohms, -50 db; 20,000 ohms, 28 mv/10 dynes/cm²—Hum level: -120 db—EIA sensitivity: -143 db—Impedance: 50, 20,000 ohms—Dimensions: 8-15/16" × 1-5/32" dia—Weight: not available—Finish: silver gray and nonreflecting black—Accessories furnished: 18-ft, 2-

conductor, shielded, vinyl cable; "OFF-ON" switch and swivel adapter—Price: \$55.75.

Comments: Similar to other University microphones of the 2000 series, the case of the Model 2050 is designed to accommodate the swivel stand adapter with build-in "OFF-ON" switch.

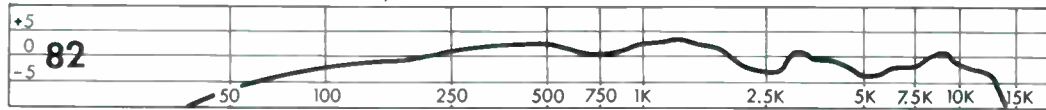
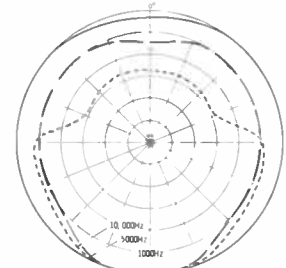

University 4000

Omnidirectional dynamic—Lavalier—Output level: 50/200 ohms, -55 db; 20,000 ohms, 16 mv/10 dynes/cm²—Hum level: -120 db—EIA sensitivity: -148 db—Impedance: 50, 200, 20,000 ohms—Dimensions: 5-1/8" × 1-1/8" dia—Weight: not available—Finish: silver gray and nonreflecting black—Accessories furnished: 18-ft, integrated, flexible plastic cable; neck cord; clip—Price: \$93.25. Comments: Impedance selection in this mi-

crophone is accomplished with "push-on" connectors inside the microphone case. It is designed to compensate for bass overemphasis in lavalier applications.

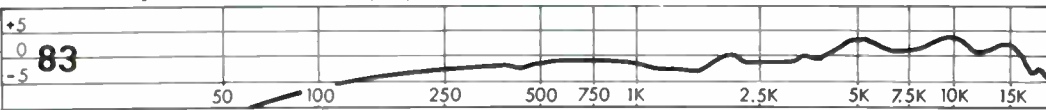
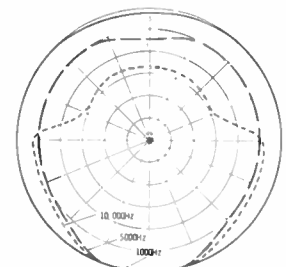

University 4040

Omnidirectional dynamic — Hand-held or stand-mounted—Output level: 50/200 ohms, -55 db; 20,000 ohms, 16 mv/10 dynes/cm²—Hum level: -120 db—EIA Sensitivity: -148 db—Impedance: 50, 200, 20,000 ohms—Dimensions: 6-7/8" × 1-1/8" dia—Weight: not available—Finish: silver gray and nonreflecting black—Accessories furnished: 18-ft,

integrated, flexible cable; stand adapter—Price: \$105.75.

Comments: This microphone varies from other "4000" series microphones in that an "OFF-ON" switch is incorporated into the case.

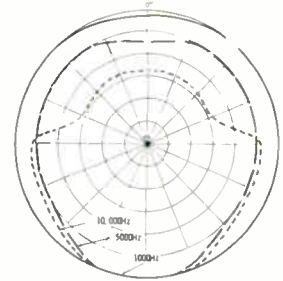
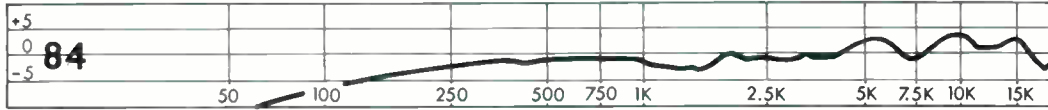

University 4050

Omnidirectional dynamic — Hand-held or stand-mounted—Output level: 50/200 ohms, -55 db; 20,000 ohms, 16 mv/10 dynes/cm²—Hum level: -120 db—Impedance: 50, 200, 20,000 ohms—Dimensions: 6-7/8" × 1-1/8" dia—Weight: not available—Finish: silver-gray and nonreflecting black—Accessories furnished: 18-ft, integrated, flexible plastic

cable; stand adapter with "OFF-ON" switch; 5/8"-27 NPSN stand receptacle — Price: \$109.75.

Comments: Intended for location-type broadcast use, the Model 4050 is designed to compensate for bass overemphasis when used for close talking. The stand adapter, made for this particular microphone, employs an "OFF-ON" switch.

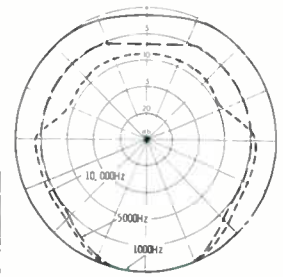
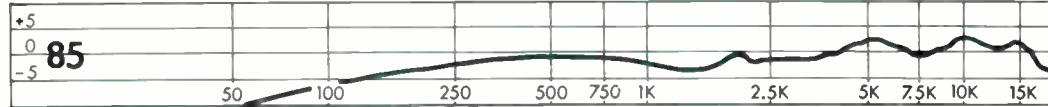

University 4080

Omnidirectional dynamic — Lavalier — Output level: -55 db—Hum level: -120 db—EIA sensitivity: -148 db—Impedance: 50, 200 ohms—Dimensions: 3-3/8" × 1-3/32" dia—Weight: not available — Finish: antique bronze — Accessories furnished: 25-ft, integral, flexible cable; neck cord; clip—Price: \$91.50.

Comments: This is the smallest of the University line of lavalier microphones. Its shape is designed so that its presence will tend to merge into the wearer's clothing. Compensation for bass overemphasis is built into the designed response characteristic of the microphone.

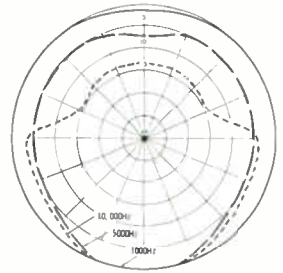
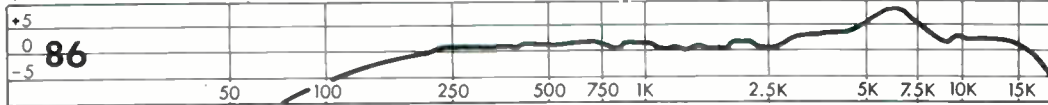

University, 5000, 5020, and 5050

Super cardioid dynamic—Hand-held or stand-mounted—Output level: 200 ohms, -54 db; 20,000 ohms, 13 mv/10 μb—EIA sensitivity: -147 db—Impedance: 200, 20,000 ohms—Dimensions: 5000, 7-7/16" × 2-3/16" dia; 5020, 8-5/16" × 2-3/16" dia; 5050, 9-5/8" × 2-3/16" dia—Weight: not available—Finish: satin chrome—Accessories furnished: 5000, wired-in cable and SA-10 stand adapter; 5020, SA-10 stand adapter; 5050, switch and swivel stand adapter—Price: 5000, \$85.95; 5020, \$94.95; 5050, \$99.95.

Comments: The highly defined cardioid pattern of this microphone series is wide angle, with a precise taper characteristic to reject unwanted sound at the rear hemisphere of the newly developed spherical design.

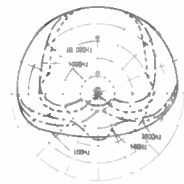
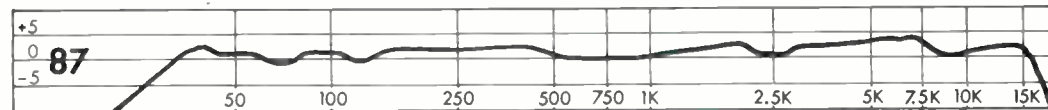

University 8000, 8100

Cardioid dynamic — Hand-held or stand-mounted—Output level: 250 ohms, -60 db; 20,000 ohms, 8.5 mv/10 μb—EIA sensitivity: -154 db—Impedance: 250, 20,000 ohms—Dimensions: 6-3/8" × 1-23/32" dia—Weight: not available—Finish: satin chrome and black—Accessories furnished: 15-ft, 3-conductor, shielded, vinyl cable; stand adapter—Price: 8000, \$58.25; 8100, \$63.25.

Comments: This microphone series achieves its cardioid pickup characteristic from an internal network of inductive, resistive, and capacitive acoustical elements. A unique mounting arrangement provides shock protection for the generating element. Model 8100 is distinguished from the Model 8000 by a case-mounted "OFF-ON" shorting switch.

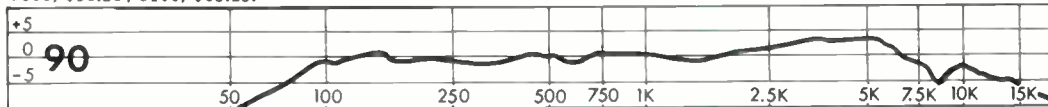

University Attache

Cardioid dynamic — Lavalier — Output level: -57 db—EIA sensitivity: -151 db—Impedance: 150 ohms—Dimensions: 3-11/16" × 1-1/8" dia—Weight: 5 oz—Finish: satin chrome and black—Accessories furnished: 15-ft, spring-loaded cable; neck cord; leatherette carrying case; stand adapter—Price: \$66.25.

Comments: A unique feature of this microphone is that the integral spring-loaded microphone cable permits ceiling or overhead suspension without other support. Not illustrated are the response characteristic and polar graph. Response sensitivity extends from 50 to 15,000 Hz and the pattern is typically cardioid.

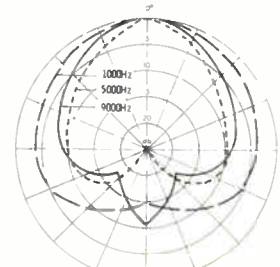



Don Ellington has a stubborn streak. Try to set up a shipping schedule on an upcoming Memorex video tape product before Don has given it his okay. Can't be done. Not with any number of previous approvals — from lab performance trials, field tests or production line checks. Don's job is to make sure, beyond all doubt, that when you screen a reel of a new Memorex video tape, it will look as good on the monitor as it does on paper. It's no job for a yes-man.

MEMOREX
Precision Magnetic Products

Santa Clara, Calif. Branch Offices in Boston, New York, Philadelphia, Washington, Atlanta, Orlando, Dallas, Chicago, Detroit, St. Louis, Dallas, Denver, Los Angeles, San Francisco, Honolulu. Offices and Affiliates in London, Cologne, and Paris. Distributors in Japan, Canada, India, Australia, and New Zealand.

Circle Item 8 on Tech Data Card

2500-MHz ETV SYSTEMS

by John F. X. Browne, Jr.*
Part 2—Path analysis is the first step
in system design.

In Part 1 of this series the basic aspects of 2500-MHz systems were discussed. Included were FCC requirements, channel assignments, and typical costs.

This article, Part 2 of the series, deals with the technical aspects of system design.¹

It is essential that the design of 2500-MHz facilities be undertaken on the basis of a complete system from the input of the transmitter to the input of the classroom receiver. In specifying system components, it is usually advantageous to define the desired performance of the system—i.e., the quality of the signal on the classroom receiver—and work back towards the transmitter. There are, however, practical limitations imposed by the characteristics of available equipment. The variables, other than path considerations, that affect system performance include the characteristics of receiving/transmitting antennas and transmission lines as well.

Since 2500-MHz installations are essentially point-to-point microwave

systems modified for reception at many points, it is necessary to analyze each path between a transmitter site and each receiving site in order to ascertain that proper clearances exist. It is not within the scope of this article to discuss all the factors affecting path reliability in microwave systems, but it would be advantageous for the engineer planning a system to review microwave propagation theory. This discussion will be limited to the more obvious factors influencing system performance, followed by a listing of other factors that may be important under certain conditions in specific applications.

The first step in this analysis is the preparation of profile graphs of each path, giving the height above sea level of all natural and man-made formations and structures. If topographic maps are used for this purpose it should be remembered that the elevations shown do not include the height of trees, and that buildings and other structures might not be indicated. Check the date on the map—some maps in circulation are over ten years old.

After development of the profile

graphs, it would be wise to inspect visually each path by driving along or flying over the route of the path over the ground. Buildings, water towers, etc., in the direct line of the path, or within a perpendicular distance of 250 feet from the path, should be recorded on the graph. A typical path profile might appear as shown in Fig. 1. The profiles are normally made on 4/3-earth-radius paper, which takes into account signal bending (refraction) under standard atmospheric conditions.

A basic assumption has been that the transmitter site is known. This is typical since it is usually desirable to construct the facilities at an existing centralized location. The path profiles, based on the use of a particular transmitter site, may indicate that the particular location selected is not very good because of path obstructions which will require the use of high receiving antennas at most schools. In this case, the process will have to be repeated for each potential transmitter site until a suitable location is found.

Assuming that the transmitter site has been located and that path profiles are completed, an arbitrary value is usually assigned to the transmitting height. This assignment should, however, be practical in terms of possible FAA or local restrictions on the maximum height of structures in that location, the size of the land parcel available to erect a tower (including an allowance for guying), and the anticipated losses in the transmission line system required between the transmitter and antenna. The assigned value of transmitting antenna height is indicated next on each path profile.

Fresnel Zone Clearance

Receiving antenna heights can now be determined for each location by applying the clearances required

*Browne Associates, Telecommunications Consultants, Birmingham, Mich.

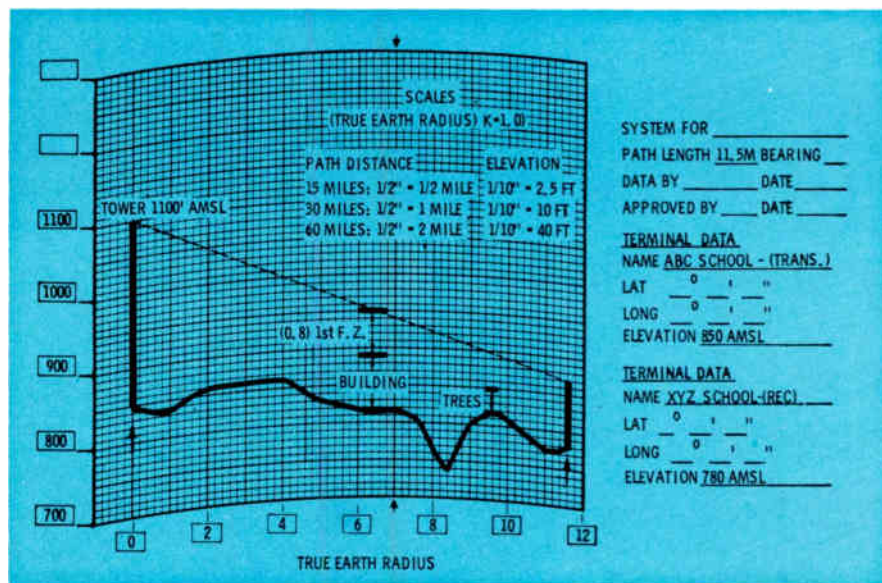

Fig. 1. Path profile on 4/3-earth-radius paper is first step in analysis.

at each point along the path. This clearance is normally equal to the first fresnel zone radius. A fresnel zone may be defined as an imaginary curved surface between a transmitting and a receiving antenna, signal reflection at any point on which will result in a reflected path length exactly one-half wave-length longer than the direct distance between the antennas. Fig. 2 (A) represents a hypothetical fresnel zone in which paths a, b, and c satisfy the electrical path length requirement. Zone boundaries may be calculated from the formula

$$F_1 = 131.5 \sqrt{\frac{\lambda d_1 d_2}{d}} \quad (\text{eq 1})$$

where

F_1 = perpendicular distance from the path TR to a point at which a reflected signal path would be exactly one-half wave longer than the path TR (In this application, Point P)

λ = wavelength in meters

d_1 = distance from T to P in miles

d_2 = distance from P to R in miles

d = distance from T to R in miles

The significance of the first fresnel zone is that a signal striking an obstacle at point P [Fig. 2 (B)] will be reversed in phase by 180° and theoretically will arrive at R in opposite phase at the receiving antenna, thereby cancelling the direct path signal. Since, however, the path length TPR is exactly one-half wave-length longer than TR, the signal will take 180° longer than the direct path, and the phase reversal suffered at point P will present a signal at R exactly in phase with the direct path. The consequence is that the received signal increases by 6 dB.

The radius of the first fresnel zone varies with the distance along the path, being a maximum in the center

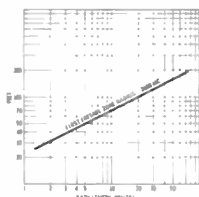

Fig. 3. Midpath first fresnel zone radius as a function of path length.

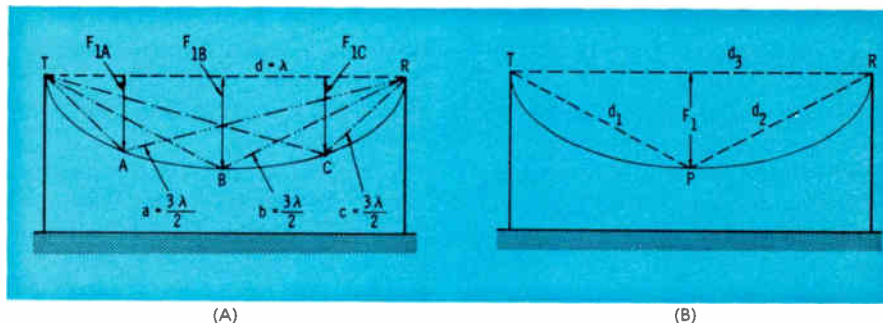

Fig. 2. Fresnel zones determine required path clearances around obstacles.

of the path and a minimum at each end. On a path ten miles long, the maximum first fresnel zone radius at the center of the path, or five miles from each end, is approximately 70 feet. By application of (eq 1) we can see how this figure was derived

$$\begin{aligned} F_1 &= 131.5 \sqrt{\frac{\lambda d_1 d_2}{d}} \quad (\text{eq 1}) \\ &= 131.5 \sqrt{\frac{0.115 \times 5 \times 5}{10}} \\ &= 70 \text{ feet (approximately)} \end{aligned}$$

Thus, for full first fresnel zone clearance, the direct path between the two antennas should be at least 70 feet above any obstruction on the surface at mid-point. In actual practice it has been determined that 0.6 of the first fresnel zone radius usually will provide adequate clearance (in the example above, approximately 45 feet). However, the clearance should not be less than this value in any case, and a margin of safety will be afforded by using a slightly higher value. Fig. 3 gives the first fresnel zone radii for different path lengths at mid-path. The clearance actually required at any given point on the path can be calculated by first determining the fresnel zone clearance from (eq 1) or Fig. 3, multiplying the result by 0.6, and then applying the earth curvature correction factor of $4/3$. From this we can derive

$$F_{1C} = 105.2 \sqrt{\frac{\lambda d_1 d_2}{d}} \quad (\text{eq 2})$$

where

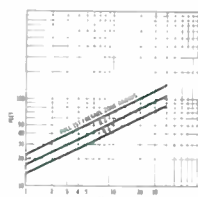

Fig. 4. Working clearances for signal paths can be obtained from graph.

F_{1C} = practical first fresnel zone clearance in feet with correction factors applied.

With (eq 2) it is possible to calculate a working fresnel zone clearance directly, without employing earth curvature ($4/3$) graph paper. Fig. 4 is calculated to show working clearances with correction factors of 0.6 and 0.8 ($4/3 \times 0.6$).

Care should be taken to eliminate the possibility of over-designing the path clearances to the extent that the first fresnel zone radius is exceeded (because of possible problems with interference from second fresnel zone reflections).

Variations in the amount of beam bending are caused by changes in the dielectric constant of the atmosphere, and allowances are normally made in path clearances to accommodate abnormal refraction. In the short distances normally encountered in 2500-MHz systems, this is usually not a problem except in some parts of the country along the eastern seaboard, the Gulf Coast regions, and the Pacific Coast.² If any doubt exists, or if longer paths are encountered, a further investigation should be made of the record of atmospheric conditions, particularly in regard to temperature inversions, and appropriate correction factors applied. These correction factors can be as high as two times the normal path clearances, as shown in Fig. 5.

The path analyses are complete when the transmitting antenna height and the height of each receiving an-

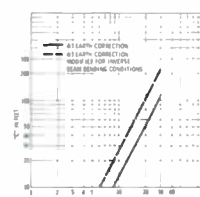

Fig. 5. Curves embodying corrections for earth bulge and beam refraction.

tenna have been determined—with proper clearances at all points on each path.

Other considerations include special attention to over-water or smooth-earth paths, where surface reflections arriving out-of-phase at the receiving antenna may cause some signal cancellation or fading conditions caused by reflected signals whose phase relationship varies with the many changes in atmospheric refraction.

Signal Level Calculations

Normally it is desired to have system performance adequate to provide a noise-free picture at each receiver. The selection of antennas, convertors, and distribution system components will be governed by the performance requirements used in system design.

The distribution systems normally are not as critical as the other components. Low-noise amplifiers are universally available, and the distribution system can be designed to provide a high-level (1,000-3,000 μ v) signal at each outlet with negligible noise in S/N ratios. The designer must ascertain, however, the input level to the amplifier(s) required to provide sufficient level for viewing (with appropriate S/N ratios), but not so much that overloading occurs.

Care should be exercised in the selection of the VHF channels to be used in the distribution system and outlet receivers. Co- and adjacent-channel interference can be quite severe in the presence of strong local VHF signals. Direct pickup of these signals at the receiver can be minimized by specifying coaxial inputs to the receiver tuner. Suitable traps are available to reduce undesired signals to acceptable levels within the distribution system.

To insure noise-free pictures it is normally necessary to have a C/N (carrier-to-noise) ratio of about 46 dB at the convertor output. In order to calculate the required signal level at the input of the convertor, it is necessary to know the noise figure or the signal threshold for a C/N ratio of 0 dB. There are some variations among manufacturers' equipment in this regard, but for the purposes of this discussion a threshold of -125 dBW will be assumed for the con-

vertor.³ Thus, in order to achieve the 46 dB C/N ratio, an input level of 46 dB above -125 dBW (-79 dBW) will be required at each receiving location.

The noise threshold of a convertor can be determined in the following manner. The theoretical noise, or equivalent noise input, is given by the equation

$$N_L = -144 + 10 \log (\text{bandwidth}) \quad (\text{eq 3})$$

Where

$$N_L = \text{Noise threshold}$$

Thus, over a 6-MHz bandwidth, the noise threshold would be

$$N_L = -144 + 10 \log 6 \\ = -136 \text{ dB}$$

Where

N_L = theoretical noise level threshold for 0 dB noise figure. To find the actual threshold, it is necessary to add the unit's self-noise figure to the theoretical value derived from (eq 3). A self-noise figure of 10 dB would result in a working threshold of

$$N_T = N_L + N_U \quad (\text{eq 4})$$

where

$$N_U = \text{Self-noise of unit}$$

In our application

$$N_T = -136 + 10 \\ = -126 \text{ dB}$$

Stated differently, at a signal input of -126 dBW, the C/N ratio of the output signal would be 0 dB. All the computations used in this article are based on a noise threshold of -125 dBW or a convertor with a noise figure of 11 dB.

The next calculation is that of losses between the transmitting antenna and the convertor input. The initial calculation should be made for the receiving point with the greatest loss, usually the most distant receiving location. In our example, a distance of 15 miles will be used. The free space loss at 2600 MHz over a 15-mile path is 128.5 dB. This has been derived from the standard formula for fading

$$L_F = 36.6 + 20 \log f + 20 \log d \quad (\text{eq 5})$$

where

$$L_F = \text{free space loss in dB} \\ f = \text{frequency in MHz} \\ d = \text{distance in miles}$$

At 2600 MHz and 15 miles distance

$$L_F = 26.6 + 20 \log (2600) + \\ 20 \log (15) \\ = 128.5 \text{ dB}$$

Other losses encountered in this portion of the system are usually small and are mainly in the cable between the antenna output and the convertor input.

RG/8 cable has a loss of approximately 13 dB/100 ft at 2600 MHz, and 1-5/8-in line has a loss of about 1.5 dB/100 ft. Because of the high losses encountered with the smaller cables (such as RG/8), it is normally desirable to mount the convertor as close to the antenna as possible. If the convertor must be mounted away from the antenna, a low-loss and high-cost cable (such as 1-5/8 in) may be necessary in order to minimize losses.

It is meaningful to refer to effective radiated power (ERP) when making signal level analyses. Assuming that a six-foot receiving dish is the maximum practical size to use (because of tower and mounting considerations), the ERP required to achieve the desired input level of 79 dBW, previously calculated, can be determined.

A 6-ft dish at 2600 MHz has a gain of approximately 31 dB. Estimating cable/connector losses between the convertor and antenna at 1.5 dB, the total losses become

$$P_{ER} = L_{T15} - G_{RA15} - P_D \quad (\text{eq 6})$$

where

$$P_{ER} = \text{effective radiated power} \\ L_{T15} = \text{total losses at 15 miles} \\ G_{RA15} = \text{gain of receiving antenna at 15 miles} \\ P_D = \text{desired power level}$$

In the 15-mile situation

$$P_{ER} = 130 \text{ dB} - 31 \text{ dB} - 79 \\ \text{dB} \\ = 20 \text{ dBW} \\ = 100 \text{ watts}$$

The combination of antenna gain, transmission line loss, and transmitter power must yield an effective radiated power of 100 watts to achieve the desired C/N ratio at the receiver of least input signal.

The receiving dishes for all other locations can be selected easily now that the ERP has been determined. At five miles the path loss will be

• Please turn to page 43

2500 MHz Systems

(Continued from page 38)

[from (eq 5)]

$$G_{AR5} = L_{T5} - P_D - P_T \quad (\text{eq } 7)$$

where

G_{AR5} = receiving antenna gain at 5 miles

L_{T5} = free space loss at five miles.

Therefore, at a distance of five miles

$$G_{AR5} = 119 \text{ dB} - 79 \text{ dB} - 20 \text{ dB} = 20 \text{ dBw}$$

Consequently, the receiving antenna gain, G_{AR} , must be at least 20 dB. If a loss of 1.5 dB is assumed between the antenna and convertor, the antenna gain must be 21.5 dB. A 2-ft dish has a gain of 21 dB; but in order to preserve the minimum acceptable signal level, it would be necessary, in this case, to use a 4-ft dish with a gain of 27 dB.

A 4-ft dish with a gain of 27 dB would be usable up to the point where the losses equal 126 dB. Again assuming that 1.5 dB losses would be encountered in the antenna-convertor connection, the re-

mainder of the loss, 124.5 dB, would be equivalent to the free space path loss on a path of nine miles.

Thus, as a rule-of-thumb for this system, it has been determined that:

2-ft dishes can be used 0.0 to 4.9 miles

4-ft dishes can be used 5.0 to 9.5 miles

6-ft dishes can be used 9.6 to 15 miles

While this is convenient for cost estimations in large systems, and for rough calculations of any system performance, it will be shown in later discussion that other factors may alter the figures derived from the calculations above. ▲

1. For a general reference on this subject, readers are referred to J. J. Igli, "UHF Radio Engineering," *Proc. IRE*, Jan. 1953, p. 115.
2. From time-to-time abnormal refraction charts are published by the Institute for Telecommunication Sciences and Aeronomy (formerly the Radio Propagation Laboratory of the U.S. Bureau of Standards) and are available from the Superintendent of Documents, Washington, D.C.
3. The standard 0 db level for this work is 1 mw.

YOU CAN GET MORE FROM YOUR CARTRIDGES



JOA gives you MORE CARTRIDGE PERFORMANCE ... that's practical! MORE ENGINEERING TIME ... that's economical!

Let JOA Cartridge Specialists recondition and rebuild your worn cartridges and keep your engineering personnel "engineering."

-JOA will inspect, service and re-load your cartridges with ANY LENGTH tape

NO MINIMUM NO EXTRA CHARGE FOR-

(a) **FOAM TEFLON-FACED PRESSURE PADS**

(b) **replacement of minor parts**

(c) **VISIBLE SPLICE**

ALL cartridges PRETESTED under actual broadcast conditions 48-hour Processing

Need NEW CARTRIDGES fast? JOA will ship immediately . . . from stock . . . any size Fidelipac, precision manufactured NAB cartridge.

JOA—the cartridge service of authority—serving the broadcast industry.

phone or write



Cartridge Service
P. O. Box 3087
Philadelphia, Pa. 19150
Area Code 215, TUrner 6-7993

Circle Item 13 on Tech Data Card

New heads for old!



We can rebuild your head assembly, install three new heads, give it the same specs, same warranty, same performance as a new one, yet save you up to 40%. Your Ampex professional audio distributor will be glad to send us your Ampex 350 series or 300 series full-track head assembly. We will completely rebuild it, including 1) replacement of all heads with brand new, latest model stacks; 2) replacement of all tape guides and minor hardware; 3) precision alignment of all components; 4) complete checkout of the final assembly. All this will be done at the factory and your assembly will be on its way back within 48 hours from time of receipt. (The cost is only \$138.60 and you'll have saved \$92.40.) Similar savings are also available on head assemblies for Ampex duplicators, some 400 series recorders and special head configurations. Prices upon request. Contact your Ampex Professional Products distributor or write Ampex, Dept. 7-14, Redwood City, California 94063 for Bulletin #A120.

AMPEX

Circle Item 12 on Tech Data Card

October, 1966



SCA SOLID STATE RECEIVER

Dayton Electronic Products Company • 117 E. Helena St. • Dayton, Ohio 45404 • 513/461-4951

Circle Item 11 on Tech Data Card



TELEMATION

for Television Systems

Planning and Design
Equipment and Installation
ETV — CCTV — CATV
Industrial / Military / Broadcast



Camera Systems



Telecine



Local Control Adapter

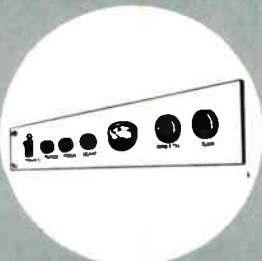

EIA Camera Control

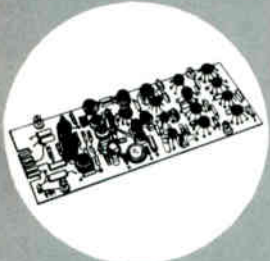

2:1 Interlace Sync Generator



VR-660 Video Processor



3-Way Optical Multiplexer

From
Telemation
—where experience
powers pacesetting
products!



TELEMATION, INC.
2275 So. West Temple / Salt Lake City, Utah 84115
TELEPHONE (801) 486-7564

QUANTITATIVE MEASUREMENTS OF VIDEO QUALITY

by Paul Kaufman and George Scherer*

—Comparison of camera resolution is simplified and more accurate when an oscilloscope is employed.

Comparison of television cameras or camera tubes in a given circuit is difficult to make by subjective means. Determining resolution by noting the gradual extinction of test-pattern resolution wedges, even on a good monitor is often inaccurate. As the resolution capability of the camera approaches that of the monitor, reliable judgment becomes difficult. Similar considerations hold for the evaluation of square-wave or step response (preshoot and overshoot) and gamma (gray-scale rendition). With an oscilloscope, however, an accurate, quantitative measurement of camera capabilities is possible.

The use of an oscilloscope to observe camera performance is common technique. It is relatively easy to synchronize a stable scope with a video waveform, at either the frame or line rate. Even at the line (horizontal) rate, however, a discrete line will not be visible; all that will be seen is every line in the raster, superimposed one on the other. What is desired is a method that permits any given line in the raster to be singled out for display of the video information it contains. This would make possible quantitative measurement of the depth of modulation at any degree of detail (resolution), percent of preshoot and overshoot (step response), amount of black or white compression (gamma), or any other basis of comparison that may be desired.

A sophisticated type of oscilloscope is required for all of these tests. It should have a frequency response comfortably in excess of the highest video frequency of interest in the system under test, so that its own limitations are not imposed on the measurements. As a rule of thumb, for the U. S. standard 525-line, 60-frame system, about one

MHz of bandwidth is required for every 80 lines of horizontal resolution. Thus, a 650-line resolution system requires a bandwidth slightly greater than 8 MHz. In practice, a scope with 15-MHz response provides excellent results. The oscilloscope must also be capable of having its sweep circuit triggered by only one (selectable) horizontal sync pulse out of the 525 identical such pulses which occur each frame, and trigger consistently on that particular pulse each frame. This requires not only a triggered sweep, but an auxiliary circuit similar to the sweep, and of similar stability and accuracy, which will "arm" the main sweep at the proper time in the frame (i.e., during the horizontal sync pulse which occurs before the desired line begins).

A general-purpose laboratory scope with a "delayed sweep" feature is ideal for this purpose. Generally, oscilloscopes of this capability have a terminal at which a positive-going "gate" signal (i.e., an output pulse) is present during the time main sweep is activated. By adding the gate signal to the video line feeding the monitor, a noticeable brightening of the line selected for observation occurs. If the gate signal is negative, the line will be darkened (assuming standard black-negative polarity is employed). In either case, a small DC component will be added to the video feeding both monitor and scope, but this is usually of no consequence to the performance of the measured circuit under consideration.

A typical measurement setup is shown in Fig. 1. The horizontal and vertical sync signals, used to trigger the scope sweeps, may be obtained from the vidicon blanking pulses of a self-contained camera. The cam-

See us at the NAEB Convention
Muehlebach Hotel — Kansas City — Oct. 23-27
Booths 30-31 / Suite 1060

Circle Item 57 on Tech Data Card

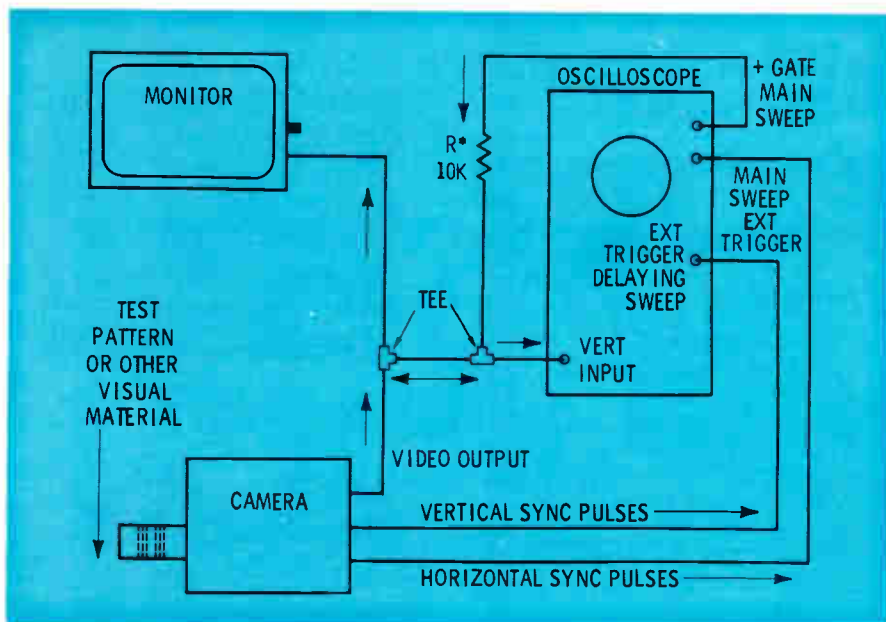

Fig. 1. Test setup for comparing camera/monitor resolution using oscilloscope.

era manufacturer's service manual should be consulted for exact location of the take-off points (usually the blanking or deflection circuit). In a system using a separate sync generator, the scope trigger inputs may be bridged across the horizontal and vertical driving-pulse lines. The value of resistor R (shown connecting the gate signal to the video line) may be varied, depending on the gate voltage available from the scope and the amount of brightening desired.

Oscilloscope setup is best accomplished in the following manner: With the scope in the "main sweep normal" mode (externally triggered), set the main sweep for a rate such that the length of the scope screen will be swept in 63.49 microseconds (one horizontal interval). This means that a variable sweep multiplier is required. If your scope is not so equipped, the next slower rate, ordinarily 10 μ sec/cm for the usual 10-cm screen of a five-inch scope, should be used. For the 10- μ sec/cm rate, slightly more than one complete line will be displayed. Switch to the "auxiliary sweep" mode (auxiliary sweep being used to deflect the CRT beam), also externally triggered, and set the sweep rate so that at least a full field (16.7 msec) is displayed. A good choice for five-inch oscilloscopes is 2 msec/cm. Switch to the "main sweep delayed" mode. Vary-

ing the "centimeters of delay" control on the oscilloscope will now display the waveform of video information contained in a single line of the raster on the instrument screen and cause that line in the video display to brighten perceptibly. The brightened line indicates the point at which the pulse used to trigger the main sweep is produced.

NEW! LANG PROGRAM EQUALIZER MODULE!

COMPACT FOR CONSOLE MOUNTING!



MODEL PEQ-3

The new LANG PEQ-3 is identical in circuit design to the time-tested and field-proven rack mountable PEQ-2. Unsurpassed in performance and versatility, the new LANG PEQ-3 Program Equalizer Module is designed specifically for mounting in consoles either vertically or horizontally. The LANG PEQ-3 Program Equalizer Module—

INCLUDES THESE OUTSTANDING FEATURES:

- Eight low boost shelf frequencies • Four low droop shelf frequencies • Eight high boost peak frequencies • Six high droop shelf frequencies
- Frequency select switches and equalization controls for all boost and droop functions • All controls and switches may be used simultaneously • Low frequency peak boost by use of boost and droop controls • Engraved black anodized panel • Plug-in transistor amplifier and power supply cards • Plug-in blue ribbon connector strip • Compact size: 3 1/2" high x 10 3/4" wide x 9" deep.

FOR COMPLETE DETAILS AND NEW LANG CATALOG WRITE

LANG ELECTRONICS INC.
507 FIFTH AVENUE, NEW YORK, N. Y. 10017

For all your audio needs — LOOK TO LANG!

REMOTE CONTROL REELS FOR MICROPHONE CABLE



Industrial Electric's remote control reels are specially designed for retraction of microphones attached to various lengths of multi-conductor cable. 115 volt reversible chain driven motor. Gear limit switch for raising and lowering mikes. Remote operation by drum controller, push button station or relays. Available with 2 to 8 conductor slip rings.

TAKE CARE OF YOUR CORD WITH A PORT-O-REEL!



Save time. Save wear and tear on microphone cable. Use a Port-O-Reel. Level wind. Holds 150' of cable. Cable will last longer. Can be equipped with power cord for lighting.

Write for catalog No. 61-A

The most complete line of reeling devices and collector rings in the world.



INDUSTRIAL ELECTRIC REELS INCORPORATED
1503 CHICAGO ST.
OMAHA, NEBRASKA 68102

Circle Item 13 on Tech Data Card

*Blonder-Tongue Laboratories, Inc., Newark, New Jersey

SOLID-STATE CHOPPER REVISITED

by Robert L. Zuelsdorf, Engineering Supervisor, WKOW, WKOW-TV, Madison, Wisconsin—This versatile transistorized unit must be modified for color applications.

The Solid-State Chopper was designed to produce a reference pulse for modulation checks with a minimal effect on the video monitor.^{1, 2, 3} The chopper pulse, being about two lines in width, removes one or two sync pulses while producing its reference level. Monitors and oscilloscopes using sync-tip DC restorers accept this video with no difficulty. In the two years since the first chopper was designed, WKOW-TV installed color film and video tape facilities, and a Conrac CYA color

monitor was added to the control-room equipment. This monitor employs a back-porch clamp, and will not tolerate the missing pulses. A flicker is introduced at the top of the picture, and an intermittent hue shift occurs. To prevent the occurrence of problems of this nature when using the chopper with clamped equipment, a modification has been devised. The modification eliminates removal of the sync pulses and provides more precise timing of the output pulse.

To achieve this, some additional circuitry has been added with only one important change made to the original circuit. Fig. 1 is the revised circuit, and Fig. 2 is the original design. The original stages perform identical functions; however, instead of driving the chopper transistor directly, the output of multivibrator Q6-Q7 is used to form two 50- μ sec pulses. These pulses are timed to occur during the active scanning time. This leaves the horizontal sync interval undisturbed.

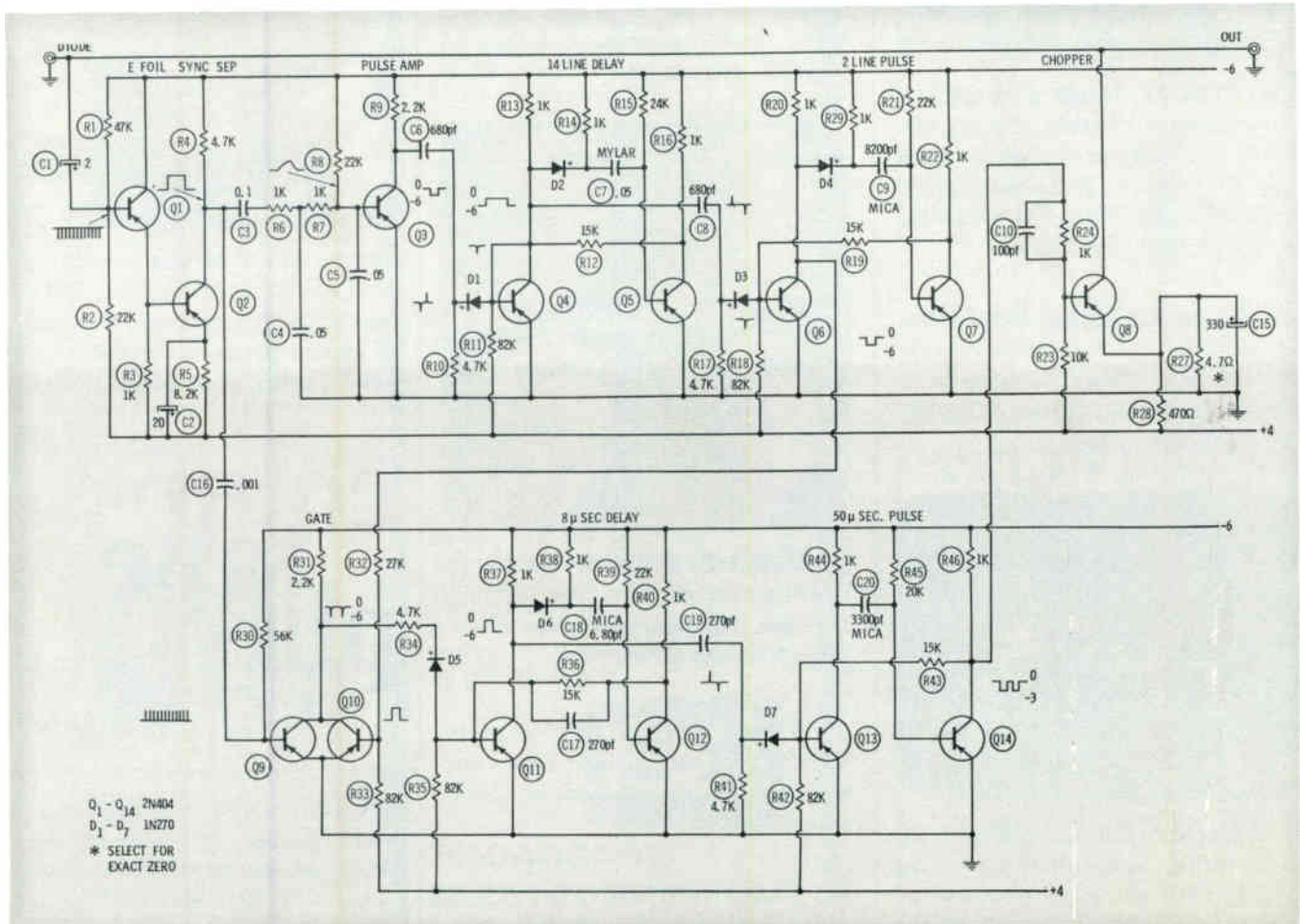

Fig. 1. The solid-state chopper after modification to comply with the new requirements of color-converted systems.



difficult installations made easy

The long continuous lengths of HELIAX® coaxial cable make any type of installation possible. Whether across a vast ravine or up the tallest tower, the installed cost is less. Corrugated inner and outer conductors absorb all stress. Andrew connectors firmly anchor both conductors to eliminate electrical problems. Consult your Andrew sales engineer or write Andrew Corporation, P. O. Box 807, Chicago, Illinois, U.S.A. 60642.



870-foot self-supporting catenary installation of 5-inch HELIAX air dielectric coaxial cable (Type HJ9-50) at mountain top site of Station KBYU-TV, Provo, Utah.

Andrew
CORPORATION

29 YEARS OF ENGINEERING INTEGRITY

10-66

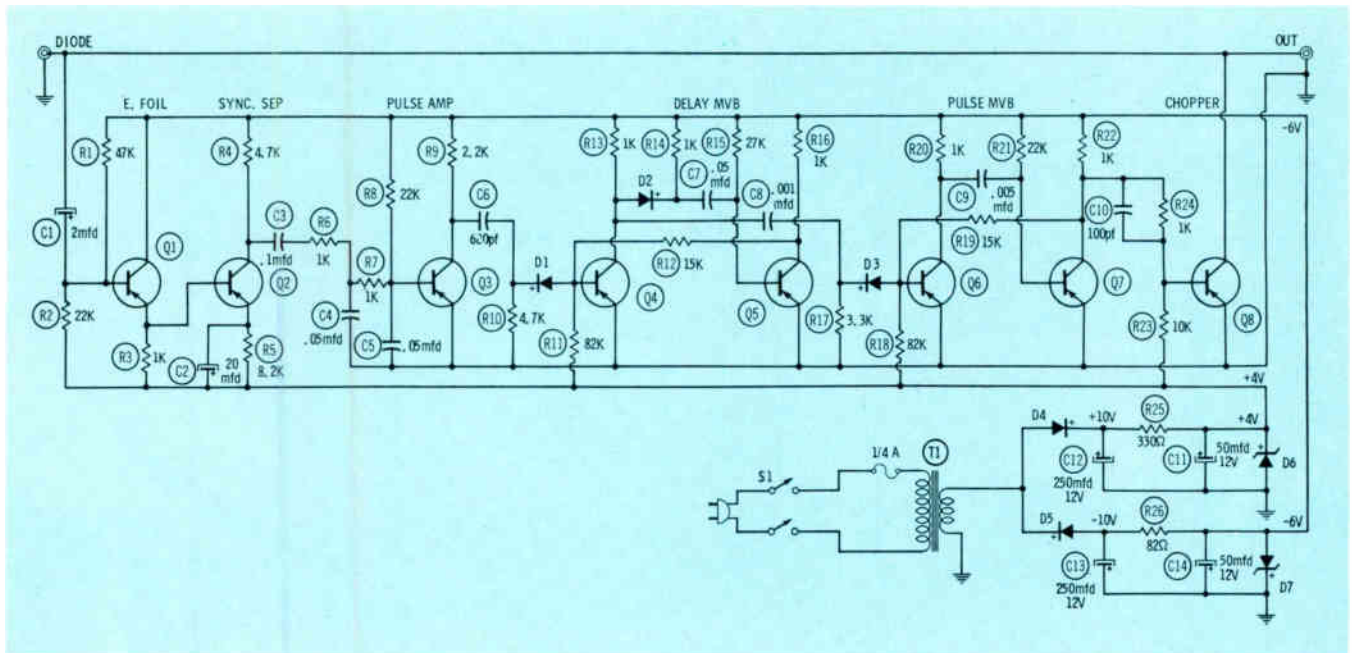

Fig. 2. The original solid-state chopper as it appeared on page 26 of the June, 1964 issue of BROADCAST ENGINEERING.

The addition of R29 and D4 sharpens the trailing edge of the two-line pulse. This pulse and separated sync are fed to gate transistors Q9 and Q10. When the two-line pulse is present, the gate passes two sync pulses and applies them to the

8- μ sec delay multivibrator. The arrival of a sync pulse causes this one-shot stage to produce an 8- μ sec pulse, which is differentiated by C19 and R41, and applied to trigger diode D7. Since the trailing edge of this pulse is used for triggering, the

50- μ sec-pulse multivibrator does not fire until 8- μ sec after the leading edge of sync. And, as it completes its cycle a few μ sec before the next sync pulse, the sync and horizontal blanking interval is not disturbed. The output from Q14 is then used

• Please turn to page 58

ColorTran FOCUSING

BROADS

MULTI-BROAD

For wide, high intensity coverage.

VARIABLE BROAD

For extreme wide coverage.

Exclusively

from ColorTran...

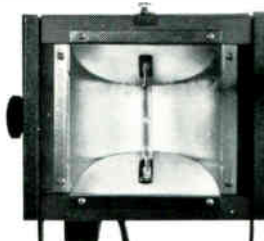
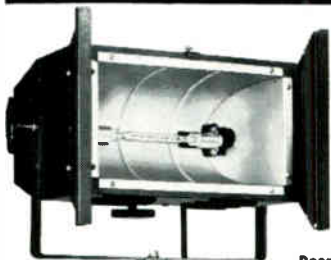

Rear views of Broads showing focusing control knobs.



Write for Detailed Literature

Focusing Single Broads designed for smoothest, most powerful fill lights in Motion Picture and TV studios. Lightweight and compact. Ideal for color work requiring constant color temperature of 3200°K, using long-life quartz-iodine lamps.

Also available — fixed-focus single and double broads.

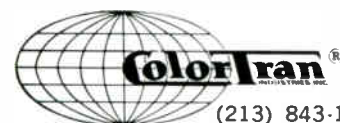

(213) 843-1200

1015 Chestnut Street, Burbank, California

ColorTran meets every lighting challenge . . . with Academy Award Winning Quartz-Iodine lights.

A BERKEY PHOTO COMPANY



Circle Item 16 on Tech Data Card

Collins could sell FM transmitters for 20% less



BUT then they wouldn't be the best in the world

All Collins transmitters could be sold for less.

- Corners could be cut on transformers (narrowing safety margins for continuous operation).
- Less shielding could be used against spurious radiation (sacrificing some degree of stability).
- Standards on components, wiring, cabling and switches could be lowered.
- Collins' rigid testing could be bypassed.
- Meeting proper load conditions could be left to luck.
- Money devoted to research and development could be saved.
- Collins' 2-year warranty could be cut to the 1-year period of other manufacturers.

All these compromises could lower the price—as well as the *quality, performance* and *reliability* of the product—about 20%. But then Collins transmitters wouldn't be known for their careful engineering, conservatively-rated components, and precision manufacturing techniques.

Collins gives the broadcaster a discount in the form of quality and service. And that's worth a lot more than 20%.

For technical information on any FM transmitter ranging from 250w to 20kw, contact Collins Radio Company, Broadcast Communication Division, Dallas, Texas. Area Code 214, AD 5-9511.

COMMUNICATION / COMPUTATION / CONTROL



COLLINS RADIO COMPANY / DALLAS, TEXAS • CEDAR RAPIDS, IOWA • NEWPORT BEACH, CALIFORNIA •
Bangkok • Beirut • Frankfurt • Hong Kong • Kuala Lumpur • Los Angeles • London • Melbourne • Mexico City • New York • Paris • Rome • Washington • Wellington

Circle Item 17 on Tech Data Card

CATV CABLE & CONNECTORS

Times CATV seamless aluminum sheath cable—in continuous lengths up to ½ mile—requires fewer splices, costs less to install and maintain. Weathertight. Offers 30 db minimum return loss for minimum ghosting. Outlasts and outperforms so-called "economy" cable (which costs still more to replace) and lives up to your system's planned potential.

Matching, instantly-installed Timatch® connector fits Times and other semiflexible CATV cables. One piece. Reusable. Matches the life of the cable itself. Has exclusive CoilGrip® clamp.

Write for full data on cable and connectors.

Timatch® perfect match connectors



Cable: Available in seamless lengths up to ½ mile

For full data, contact Times at your local Jerrold Sales Engineer

TIMES
WIRE & CABLE Dept. 610
Wallingford, Conn.



- Please send complete data on connectors and CATV cable.
 Please have a field representative call.

Name _____

Company _____

Address _____

City _____ State _____

ENGINEERS' EXCHANGE

Increasing Low Stepper Voltage

by Walter Moring, Eng.
WCSC-TV
Charleston, S. C.

On more than one occasion I have encountered problems with the low stepper voltage in the Gates Model RDC 10 Remote Control Unit. A modification I have made will permanently furnish the proper voltage, and make the stepper operate smartly whenever it is called upon.

The 24-volt DC stepper power supply consists of a transformer center-tapped to ground with 12 volts each side fed into a sulphur-oxide rectifier. Internally, the rectifier is a bridge type with a final voltage of 24 volts DC for the stepper coil.

First, remove the rectifier, then disconnect center tap of the power transformer. The capacitor for filtering should be changed to 500 μ fd. Ground the bottom half of the trans-

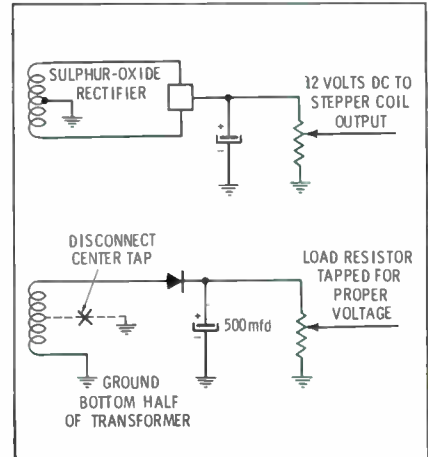

former secondary and leave the center tap disconnected. This becomes

WARNING:

Power supply voltage is increased from 12 to 24 volts. In order to protect relays, adjust output voltage at the tapped load resistor from the minimum voltage position to a satisfactory position.

Fast, easy head replacement for cartridge machines!

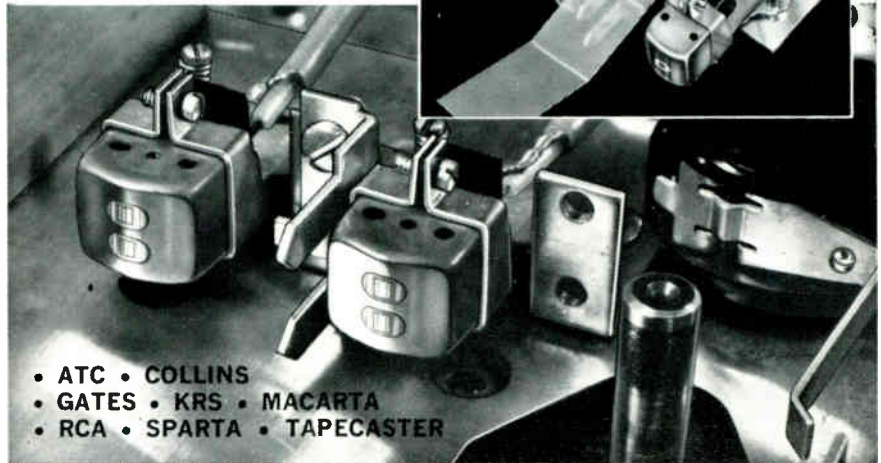

- ATC • COLLINS
- GATES • KRS • MACARTA
- RCA • SPARTA • TAPECASTER

Through a unique system of Nortronics Quik-Kits and No-Mount Heads, rapid, economical replacement or NAB conversion is possible on more than 55 different cartridge machines!

You can replace worn rear-mount heads with high quality Nortronics no-mount heads—in minutes! Quik-Kits are pre-assembled and semi-aligned . . . fully adjustable for height, azimuth and face alignment. All heads are Professional Type, laminated core with hyperbolic contour and all-metal faces.

For full details—see your Authorized Nortronics Distributor, or write for Section E, Head Replacement Guide.

Nortronics
COMPANY, INC.



8143-F Tenth Ave. No. • Mpls., Minn. 55427

Circle Item 19 on Tech Data Card

BROADCAST ENGINEERING

a half-wave rectifier, but ripple has never been a problem.

Next, install a rectifier of proper rating (50 volts at 2 amps is adequate). This arrangement has always given relief to stepper problems, and changes in voltage after the sulphur-oxide rectifier ages.

Remote Radio Broadcasts

by Giles W. Brown
Chief Engineer
WKWS, Rocky Mount, Va.

Like many radio stations, WKWS has a permanent remote broadcast that originates from a local church each Sunday. Our procedure was to send a man to the church with our transistorized remote amplifier, microphones, cables, etc. Frequent changing of batteries in the amplifier was necessary. To avoid the need for having a staff member at the remote location during the broadcast, and to save batteries, we devised the simple device shown.

The church uses a public-address system during the services. We simply installed a line-to-voice-coil transformer and a T pad in a small box and connected them between the public-address amplifier and the telephone line. We set the pad for a usable level to the line with the highest level encountered and closed the box. Now it is only necessary to use the input to the console from the telephone line.

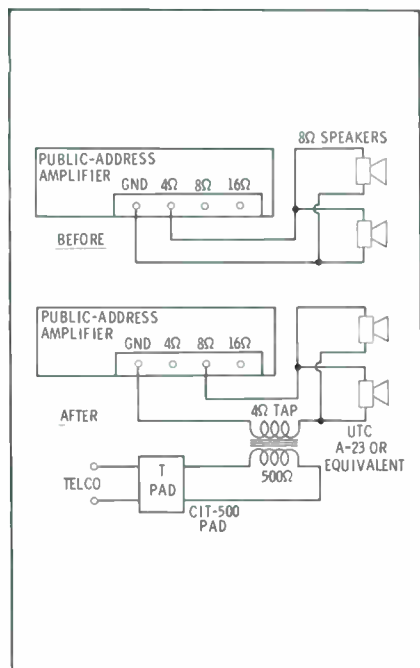

NEMS-CLARKE

the equipment most specified for antenna and signal measurement

112 PHASE MONITOR

**PPM-101
PRECISION PHASE MONITOR**

**108E
PHASE MONITOR**

**107A
FIELD INTENSITY MONITOR**

**SDM-520
SPECTRUM DISPLAY MONITOR**

**FIM-135
FIELD INTENSITY METER**

Over the years, the Nems-Clarke tradename has been the symbol of accuracy, quality and reliability in the field of antenna and signal measurements. Nems-Clarke equipment is FCC approved, and has been universally accepted as the standard of excellence throughout the industry. For further information on Nems-Clarke equipment, call or write:

V-28

Vitro ELECTRONICS

Producers of NEMS-CLARKE Equipment
A Division Of Vitro Corporation Of America

919 Jesup-Blair Drive • Silver Spring, Maryland
2301 Pontius Avenue • Los Angeles 64, California

Circle Item 20 on Tech Data Card

**THIS MICROPHONE
SUPPRESSES "POP"
...EVEN IN THE
TIGHT CLOSE-UP
"DANGER ZONE"**

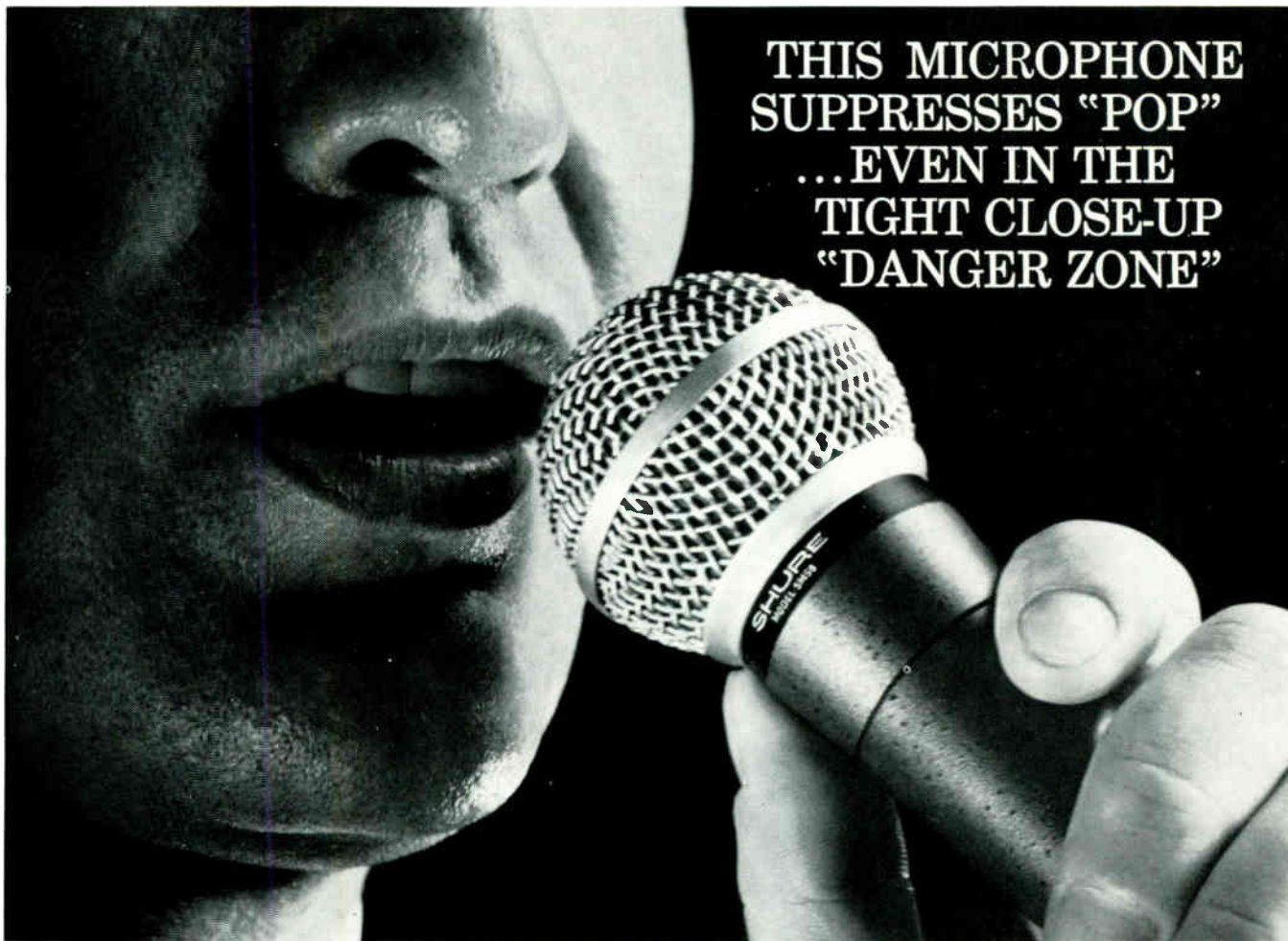

The Shure SM58 *self-windscreened* unidirectional microphone is ideal for broadcast uses such as remote news, sports, interview and vocal recordings because it eliminates or minimizes the irritating "pop" caused by explosive breath sounds. With the SM58 you will have the peace-of-mind assurance that you're delivering the quality audio that goes with pop-free pickup. It's great for studio announcing, too—or wherever the announcer or vocalist has the audio-degrading habit of "mouthing" the microphone. Of course, the same filters that eliminate pop also do away with the necessity for an add-on windscreen in outdoor uses.

On the other hand, the unusually effective unidirectional cardioid pickup pattern (uniform at *all* frequencies, in *all* planes) means that it is a real problem-solver where background noise is high or where the microphone must be operated at some distance from the performer. Incidentally,

but very important, the SM58 tends to control the low frequency "boominess" that is usually accented by close-up microphones.

All in all, close up or at a distance, the Shure SM58 solves the kind of ever-present perplexing problems the audio engineer may have felt were necessary evils. The SM58 might well be the finest all-purpose hand-held microphone in manufacture today. And, all things considered, it is moderate in cost.

Other features: the complete pop-proof filter assembly is instantly replaceable in the field, without tools. Filters can be easily cleaned, too. Stand or hand operation. Detachable cable. Rubber-mounted cartridge minimizes handling noise. Special TV-tested non-glare finish.

For additional information, write directly to Mr. Robert Carr, Manager of Professional Products Division, Shure Brothers, Inc., 222 Hartrey Ave., Evanston, Illinois 60204.

SHURE

SM58

SELF-WINDSCREENED UNIDIRECTIONAL DYNAMIC MICROPHONE

OTHER SHURE PROFESSIONAL MICROPHONES... FOR SUPERIOR AUDIO



**MODEL SM5
CARDIOID BOOM DYNAMIC**

Because its cardioid directional pattern is uniquely uniform with frequency and symmetrical about its axis, the SM5 is singularly independent of the effects of environment. Even in extreme situations (such as with tight sets, low ceilings, hard walls, cw microphone angles, traffic or air-conditioner noise and rumble and changing distance) the SM5 minimizes sound coloration and ambient noise pickup.



**MODEL SM76
3/4" OMNIDIRECTIONAL
DYNAMIC**

Ideal for interviews and audience participation, yet unusually smooth wide range response (40-20 KC) for critical music reproduction. Instantly detachable from stand. Steel case with Cannon connector.



**MODEL SM50
OMNIDIRECTIONAL
DYNAMIC**

Self-windscreened and pop-free for news, sports, remotes, and interviews. Also ideal for many studio and control room applications. Comfortably balanced for hand or stand use. Natural response.

October 1966

We interrupt this magazine to bring you...

Late Bulletin from Washington

by Howard T. Head

Commission Establishes CATV Task Force

Since the Commission adopted new Rules and Regulations governing CATV, filings by CATV systems and television broadcast stations have become increasingly heavy. The Commission has now set up a special CATV task force, headed by former Hearing Examiner Sol Schildhause, to deal with the expanding CATV load.

The most immediate problems confronting the Task Force are the disposition of various petitions dealing with required carriage and nonduplication, and requests by CATV systems within the top 100 markets to carry distant signals -- i.e., signals from stations which do not have calculated Grade B service at the location of the CATV system. One early job of the Task Force will be the preparation of a form on which all CATV systems will report ownership (June, 1966 Bulletin).

Consideration has been given to establishing a CATV Bureau to operate apart from the Broadcast Bureau; formation of the Task Force, however, is only a tentative step in that direction.

Court Stays FCC Action

The U.S. District Court at San Diego, California, has stayed a Commission action which would have prevented the San Diego CATV systems from providing service by means of cables installed since the Commission asserted CATV jurisdiction. The Court order is temporary, pending full-dress proceedings on the merits of the case.

18-gHz Microwave Shows Promise

In New York City, early results of the TelePrompter experiments (June, 1966 Bulletin) indicate that the use of an 18-gHz microwave system, modulated with the entire 54-MHz to 216-MHz band, shows promise as a substitute for CATV trunk cables. One serious problem still being studied is the rather severe attenuation in this frequency band due to rainfall.

Initial tests were made with very narrow beam widths and small amounts of power (less than 1 watt). Further tests are under way with a traveling-wave-tube power amplifier having an output rating up to 250 watts. It is planned to use this higher power in conjunction with transmitting antennas having a beam width on the order of 15° in the horizontal plane, which might transform this service from a point-to-point system to service rendered over a substantial area.

AM Problems Still Under Study

The Commission continues to make slow progress on two basic policy questions govern-

ing the operation of standard broadcast stations. The question of whether to permit higher powers on the 12 unduplicated U.S. Class I-A clear channels remains unsolved, and still under study are various possible solutions to the question of whether and under what circumstances daytime-only AM stations should be permitted to operate prior to local sunrise. A solution to this problem is complicated by the fact that our treaties with other countries do not permit presunrise operation on clear channels reserved for priority use by other North American countries. Some relief in this regard, however, may result from the negotiations for a new standard broadcast treaty with Mexico now under way (September, 1966 Bulletin).

Television Translator Policies Being Relaxed

Although there have been no recent substantive changes in the Rules governing television translators, individual case decisions indicate an inclination on the part of the Commission to relax these requirements. Recently, the Rules were waived to permit operation of a VHF translator by a television broadcast licensee to provide service beyond the Grade B contour of the parent station. Also, the Commission has granted waivers of the 100-watt maximum power limitation on UHF translators. In a recent Indiana case, UHF translators were authorized in a city where they would duplicate the programs of local UHF television broadcast stations.

The Commission still has under consideration proposals to reserve the top 14 UHF channels for exclusive use, and to permit translator operation on any UHF channel on a noninterference basis. However, no early action is expected on these proposals, which are in conflict with other requests for regular television broadcast stations.

Broadcast-Station Fines on the Increase

The Commission continues to issue an increasing number of notices of apparent liability (fines) arising from improper operation of broadcast stations. Common infractions in recent weeks have included failure to make and keep on file current audio proofs of performance of AM and FM stations, and the operation of stations with defective remote-control equipment. Failure to observe licensed sunrise and sunset times has also resulted in fines. One licensee was fined for failure to keep a maintenance log, although the fine was cancelled when the licensee explained that the maintenance log and operating log had been kept together, but that in the future the requirement for a separate maintenance log would be met.

The first fines for late license renewal falling under the standardized fine schedule (July, 1966 Bulletin) have been levied. Involved were 28 stations, with fines ranging from \$25 to \$200.

Short Circuits

NAB is preparing to file a petition for relaxation of the present inspection requirements for AM directional stations operated by remote control. . .The Rules governing instructional television fixed stations (ITVFS) have been changed to reduce from five to four the number of channels which may be used by one licensee in a single area. . . New Rules have been finalized to permit the use of television intercity STL relays to transmit AM and FM program material during off hours. . .The National Community Television Association (NCTA) is paying increasing attention to the origination of local programming by CATV systems. . .The Commission has established a special office to study recent proposals for television relay from earth satellites in conjunction with educational television stations.

Howard T. Head. . .in Washington

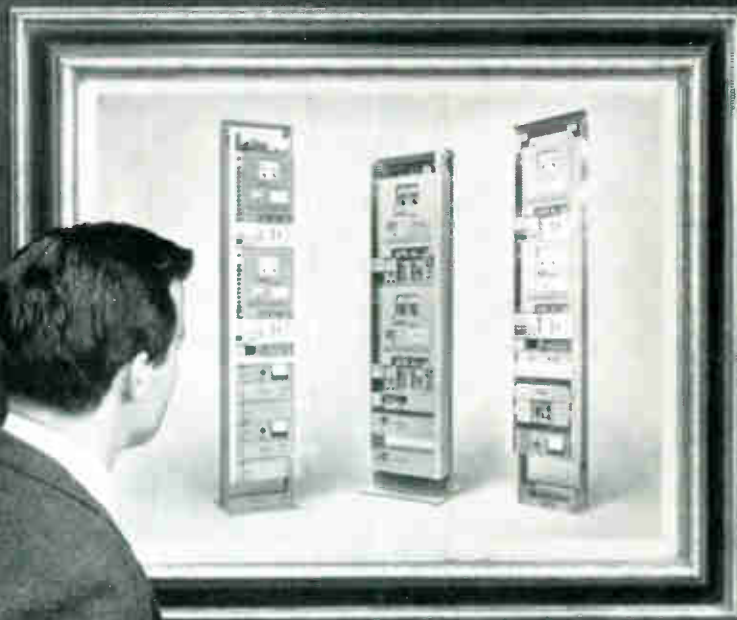
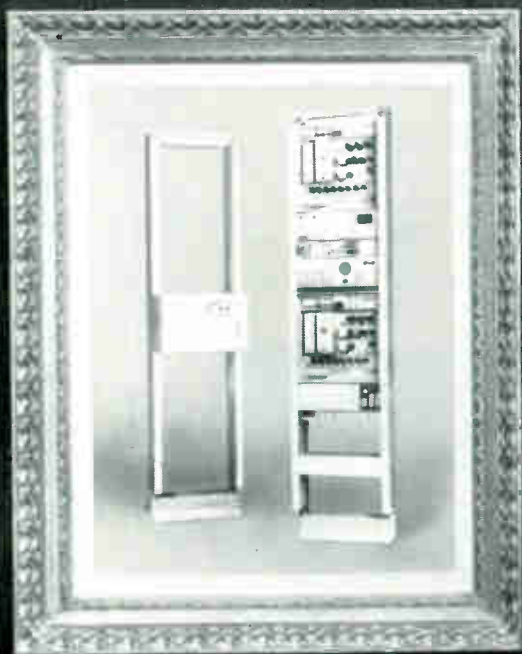
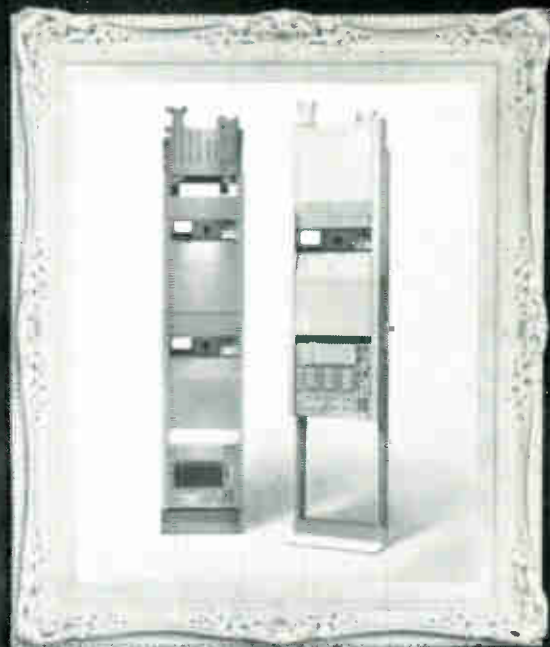
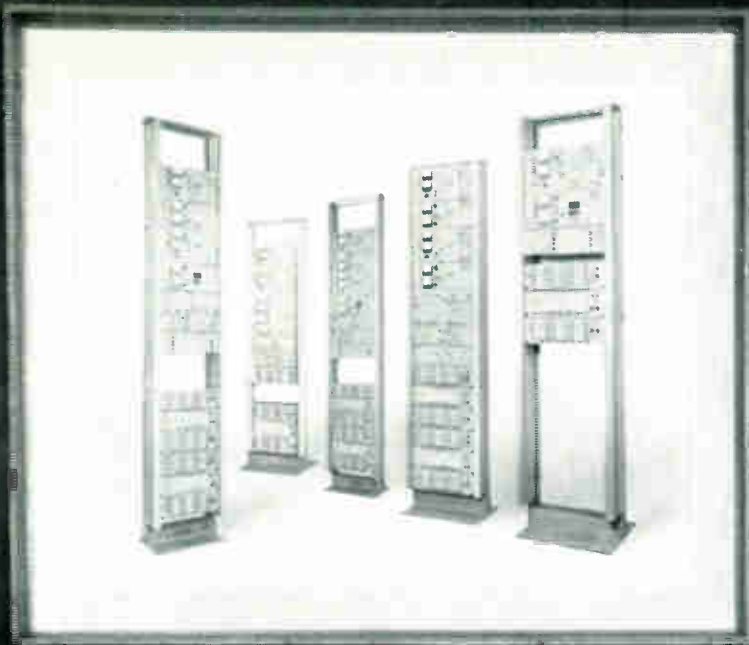

Microwave masterpieces

Lenkurt's gallery of 12 microwave systems . . . put them all together and you have an exhibit unmatched *anywhere* in the world.

For instance, take our widely-used light route 71 radio systems that provide high quality service for up to 48 multiplex voice channels in the 450 mc band and up to 300 channels in the 2,000 mc band.

Then, there's our time-proved 300 channel 74B that provides high quality, point-to-point communications for common carrier, industrial and government systems.

And, of course, there's our 1 watt solid-state 76 series microwave radios handling up to 960 channels for commercial, industrial, and government services, as well as TV applications. Or our long haul solid-state 5 watt 75 series

with heterodyne repeaters.

But just as important as our equipment is our philosophy. Simply stated it's this: We never squeeze you to fit one of our systems. Instead, we tailor a system to fit your needs. It's part of Lenkurt's heritage and reputation for quality and continuity.

When you're thinking of going microwave, get into the picture with Lenkurt. And smile.

Lenkurt Electric Co., Inc., San Carlos, California. Other offices in Atlanta, Chicago, Dallas, and New York City.

LENKURT ELECTRIC
SUBSIDIARY OF
GENERAL TELEPHONE & ELECTRONICS GTE

Solid-State Chopper

(Continued from page 50)

to control the chopper transistor.

With the values shown, the chopper pulses just precede the network VIT pulses. Increasing C7 slightly would move the chopper pulse into the VIT region or just after it. This brings up an interesting point. Some interest has been shown in using the original chopper as a VIT keyer. This has not been entirely satisfactory because of its inability to maintain a precise starting and ending time of the chopper pulse. With this modification it is only necessary that the end of the 14-line delay pulse fall within the proper line, because the pulse start time is determined by horizontal sync.

If usage of the chopper as a VIT keyer is contemplated, R15, R21, and R45 should be variable so that pulse placement, number of lines, and front-porch width are controlled. If desired, R39 could also be varied to change back-porch width, but this is not necessary. The power

supply, while adequate for chopper usage, is not suitable for VIT keying in its original form. The half-wave -6 Volt supply, now more heavily loaded, shows a noticeable amount of ripple. This could cause a shift in the pulse delays and movement of the VIT signal from one line to another. A full-wave supply, with a zener diode and emitter-follower regulator, will provide satisfactory performance. The best solution would be a 12-volt, center-tapped transformer with full-wave supplies for -6 volts and +4 volts.

In addition to usage as a chopper with a diode², or other type of demodulator³, the unit may also be used in conjunction with a tuner for off-the-air monitoring. When used with a tuner, it is possible to chop the diode detector directly, or to drive the IF grids to cutoff and thus produce a zero carrier reference. In either case, it is usually most satisfactory to pick up video for the sync separator from the tuner output. In many instances, the video level at the diode is insufficient, because it

is less than 0.5 volt. The output video, normally about 1 volt, will provide adequate sync for reliable keying. To accomplish this, it is necessary only to remove the input end of C1 from the input jack and bridge it across the tuner output.

The usefulness and versatility of this unit have been demonstrated. It may be used as a chopper with a tuner, a diode, or other type demodulator, or employed as a keyer¹. Video output from the chopper is now compatible with industry standards, and may be processed by any equipment, with or without clamping. In modified form, the Solid-State Chopper should prove to be an even more valuable unit. ▲

1. Zuelsdorf, R. L. "Solid-State Chopper for Modulation Checks." BROADCAST ENGINEERING (June 1964), p. 26

2. *Ibid.*

3. Peters, R. L. "Chopper Modification." BROADCAST ENGINEERING (Jan. 1966), page 48

4. L'Roy, R. E. "Letters to the Editor." BROADCAST ENGINEERING (Sept. 1965), page 6

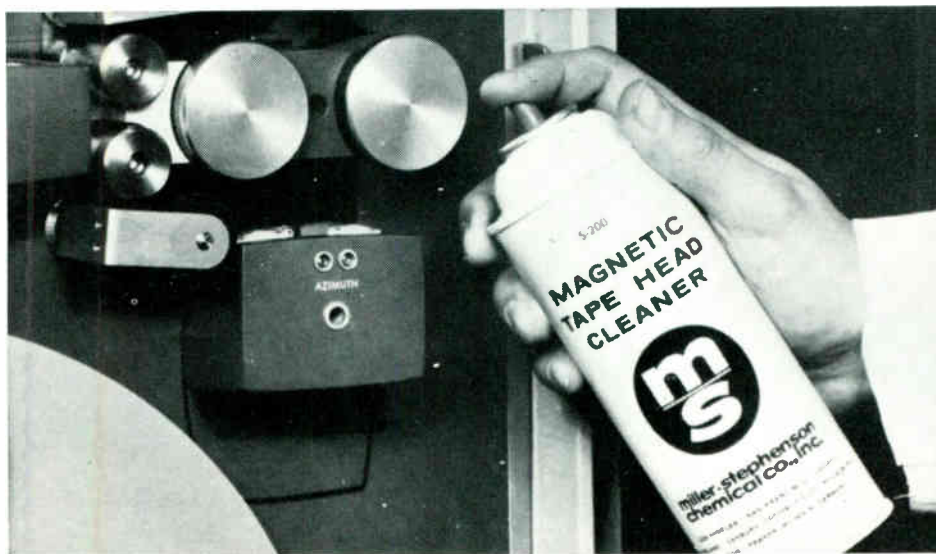

Swabs are for babies; S-200 is for cleaning tape heads (even while tape is running)

If you've been cleaning tape heads with a twist of cotton on a toothpick—stop. Save time and do a better job with S-200 Magnetic Tape Head Cleaner. S-200 is a formulation of Freon TF[®] with other fluorocarbons in convenient aerosol cans. It thoroughly cleans tape heads, guides and helical scan slip rings in seconds, can be applied to running tape without interfering with

transmission. And heads stay clean longer. Users report over twice as many passes of tape between cleanings with S-200 than with swabs. S-200 Magnetic Tape Head Cleaner is recommended by leading tape manufacturers. Available in 6 and 16-oz. cans.

Write on letterhead for literature and free sample.

©Du Pont trademark



**miller-stephenson
chemical co., inc.**

Route 7, Danbury, Conn.

Circle Item 23 on Tech Data Card



Your photo can be out before the fire is out.

How?

With a Polaroid slide that's ready to show about 4 minutes after you snap the picture.

It's made with Polaroid Land Projection Film Type 46-L.

Click the shutter, pull the tab and wait two minutes for continuous tone subjects such as news pictures or wire service photos. (Wait only 15 seconds for line copy subjects—charts, graphs, etc.—with film Type 146-L.)

There. You have a fully developed transparency.

Now dip it into a quick-drying hardening solution.

Frame it in a snap-together $3\frac{1}{4} \times 4$ plastic frame or standard 35mm mount.

And you're ready to show it on any 35mm or lantern slide projector.

Rear-screen or direct in-system projection, you'll get a bright, sharp, grain-free picture.

At about $\frac{1}{3}$ the price of conventional lantern slides. Get 'em while they're hot.

POLAROID TRANSPARENCY FILM

NEWS OF THE INDUSTRY

INTERNATIONAL

Microwave Power Devices

Present-day microwave transmitters and heterodyne frequency generators, such as varactors and traveling-wave tubes, will be outmoded within the next few years by a new generation of microwave power generators, Robert

Caruthers, a scientist of **International Telephone and Telegraph Corp.**, stated at the 1966 IEEE International Communications Conference.

Mr. Caruthers pointed out, "All new baseband repeated developments for low-power line-of-sight microwave links are now on an all-solid-state basis—even much above 6 GHz. A similarly dramatic replacement of traveling-wave tubes in favor of the up-converter varactor transmitter has occurred

in 2-GHz bands with powers adequate for long-haul CCIR use."

On the trend toward simplification, Mr. Caruthers said, "As varactor chains and power transistors progress higher in power and frequency, there is a growing tendency to minimize stages in varactor chains."

He added, "Where two years ago device suppliers were pessimistic about the chances of power transistors ever exceeding 500 MHz, now even greater power-output devices are being developed at 1 GHz. Fifteen watts at 1 GHz will soon be a reality, and several watts are forecast at 2 GHz by the end of this year."

NATIONAL

Purchases Relay

American Television Relay has purchased a New Mexico microwave system from **Microrelay of New Mexico**.

The system relays CBS-TV to Channel 10 in Roswell, and Albuquerque channels to cable TV systems at Roswell, Carlsbad, and Artesia.

Plans include expansion of the microwave system to other New Mexico communities, and the addition of a Spanish language and four independent Los Angeles channels.

ENDORSED BY ELPA

BEYER

The Microphone That Picks Up Where Others Leave Off!

Beyer microphones are the world-wide standard by which others are judged. Now, for the first time, the full line of Beyer microphones and accessories is available in North America through the worldwide sales and service facilities of Elpa Marketing Industries, Inc. The Beyer line covers the full spectrum of price and performance for every need, in all types, ranging from heavy duty models for professional broadcast and studio use, to popular-priced models for ham or CB operator, student or audiophile. For faithful service and total dependability, regardless of budget, the buy line is Beyer — now the new standard of quality in the U.S.

See the Beyer Line at your favorite Hi-Fi dealer or write for literature to Dept. A410

ELPA MARKETING INDUSTRIES, INC. NEW HYDE PARK, NEW YORK 11044

Circle Item 26 on Tech Data Card

SPOTMASTER

PortaPak I Cartridge Playback Unit

Your time salesmen will wonder how they ever got along without it! Completely self-contained and self-powered, PortaPak I offers wide-range response, low distortion, plays all sized cartridges anywhere and anytime. It's solid state for rugged dependability and low battery drain, and recharges overnight from standard 115v ac line. Packaged in handsome stainless steel with a hinged lid for easy maintenance, PortaPak I weighs just 11½ lbs. Vinyl carrying case optional.

Write or wire for full information.

Spotmaster

BROADCAST ELECTRONICS, INC.
8800 Brookville Road
Silver Spring, Maryland

Circle Item 25 on Tech Data Card

BROADCAST ENGINEERING

EIMAC 15 kW tetrode offers high power gain for advanced transmitters

Most new high-power 20 kW FM transmitters use the EIMAC 4CX15,000A tetrode for service as a Class-C amplifier. The tube features a new internal mechanical structure which minimizes rf losses, and is capable of operation at full power ratings to 110 MHz. EIMAC also recommends the 4CX15,000A for 220 MHz operation at lower power levels for VHF-TV transmitters. ■ EIMAC's long experience in tube technology and ceramic-to-metal sealing leadership have combined to produce a tetrode of optimum design and structural integrity. That's why the 4CX15,000A is used in more new transmitters than any other ceramic tetrode with similar characteristics. For more information write Product Manager, Power Grid Tubes, or contact your nearest EIMAC distributor.

RADIO-FREQUENCY POWER AMPLIFIER OR OSCILLATOR
Class-C Telegraphy or FM Telephony (Key-down conditions)

MAXIMUM RATINGS

DC PLATE VOLTAGE	10,000 MAX. VOLTS
DC SCREEN VOLTAGE	2,000 MAX. VOLTS
DC PLATE CURRENT	5.0 MAX. AMPS
PLATE DISSIPATION	15,000 MAX. WATTS
SCREEN DISSIPATION	450 MAX. WATTS
GRID DISSIPATION	200 MAX. WATTS

EIMAC
Division of Varian
San Carlos, California 94070



**KEEP TOMORROW'S
NEEDS IN MIND
TODAY WITH BELAR**



**ADD-ON
MONITOR
SYSTEM**



The Belar ADD-ON MONITORING SYSTEM allows the broadcaster to fulfill his monitoring requirements as the needs arise. The basic unit is the FMM-1 Frequency and Modulation Monitor for monaural use, and when requirements call for SCA, add the plug in SCAM-1 SCA unit. For stereo the FMS-1 Stereo unit completes the system.

Today's monitoring requirements make this system a must.

BELAR ELECTRONICS LAB.
1204 Childs Avenue • Drexel Hill, Pa.

American Television Relay is a subsidiary of Ameco, manufacturer of cable antenna TV equipment.

**New Facility For
Super-Power Transmitters**

Continental Electronics, Dallas-based subsidiary of LTV Electrosystems, Inc., has announced plans to construct a new building at a cost, including equipment, of approximately \$1,400,000.

J. O. Weldon, president of Continental Electronics and Chairman of the Board of LTV Electrosystems, Inc., said the new building is slated for occupancy on December 31, 1966. It will contain more than 79,000 square feet of floor space and will double the production capacity of the Continental Electronics companies.

Volume production of super-power transmitters will be housed in the new building. The facility is designed for fabrication, assembly, and test of transmitters in the 40- to 250-KW power range and a production ratio of as many as 10 per month of five different designs on a single shift operation.

Some 300 people will be employed in the new building under present plans. The building is so designed that it can be expanded to double its initial capacity as required in future years. Constructed of brick and concrete, the building will include two floors, with the second story approximately half the size of the first floor. Major production areas, shops, and supporting offices will be included in the floor plan.

Continental Electronics recently announced a contract for a \$15 million VLF station for NATO in Norway and a contract for ten 250,000-watt high frequency transmitters for the United States Information Agency in the amount of \$2,358,000.

Regional Depots to be Opened

Ampex Corporation is undertaking a major expansion of its nationwide parts and service facilities with the opening of four regional depots and 16 local service centers.

The regional depots service, repair, and rebuild all Ampex broadcast and closed-circuit video, instrumentation, computer, and audio products. They also maintain a complete inventory of parts, components, and finished goods, including magnetic tape. Regional depots now are in operation in Hackensack, N. J., Elk Grove Village, Ill., and Los Angeles, Calif. A fourth depot opened in Dallas, Texas, in July.

Ampex service centers specialize in servicing and maintaining Ampex professional and consumer audio products and closed-circuit video products. Service centers in Sunnyvale, Calif., and

**CINEMA
PRECISION
AUDIO
EQUIPMENT**

AUDIO ATTENUATORS



Cinema's new compact rotary slide-wire attenuator is now available for your mixing consoles as single or ganged units. A must where smooth control is desired. Other standard types are also available for applications demanding precision noiseless attenuation, reliability and long term stability.

GRAPHIC EQUALIZER

The Cinema Graphic Equalizer offers a compact system of extreme flexibility. Each of the six controls permit the operator to equalize or attenuate that portion of the spectrum 8 db. This is an active unit having zero insertion loss and up to 35 db additional gain.

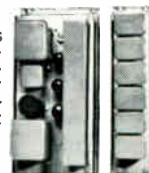

DIP FILTER

Features a notch depth of 50 db minimum and which is continuously variable from 30 to 9,000 cps. Extremely useful for removing single frequency noise and for harmonic distortion measurements.

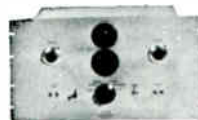

PROGRAM EQUALIZER

Provides for accurate frequency response corrections in audio equipment. Easy operation of the two control knobs allow over 395 curve combinations. Detented action of the controls permits reference dial settings for future duplication of desired characteristics.

DEGAUSSERS

Cinema bulk degaussers are a favorite with sound men throughout the world. Provides erasure of program material and residual noise from magnetic tapes on reels up to 17 inches in diameter and 2 inches wide. Also, "Pencil" type degaussers are available for erasing small areas thus avoiding splicing.



Hi-Q's Cinema precision audio equipment is backed by an enviable reputation generated by over 25 years of outstanding service in critical sound recording, broadcast and laboratory applications. Many other custom audio products are available. Put the benefit of our experience to work for you. Write for Hi-Q's Cinema precision audio equipment literature today.

Hi-Q AEROVOX
DIVISION CORPORATION
CINEMA PLANT

1100 CHESTNUT STREET, BURBANK, CALIFORNIA 91503
PHONE: 213-849-5511 • TWX: 213-846-3578

Circle Item 29 on Tech Data Card

BROADCAST ENGINEERING

SOMETHING SPECIAL IN

COLOR VIDEO

THE BBRC MARK VII: AN ADVANCED DEVELOPMENT IN COLOR SPECIAL EFFECTS GENERATORS

The Mark VII, designed for the most critical studio and van applications, assures low maintenance and trouble-free operation.

The Mark VII is capable of color inserts (color matting). The output video of the Mark VII is the combination of background video and artificially generated color inserts. Any color within the range of the NTSC spectrum may be generated by the settings of the manual controls. The basic system can handle a variety of monochrome or color signals of either composite or noncomposite format at the inputs.

A non-additive mixing technique, insensitive to variations in video brightness levels, is incorporated for a new effect with lap-dissolves. The Mark VII systems consist entirely of transistorized plug-in modules, expandable on a building block basis to allow for a variety of pattern cards. Control panels can be selected for present needs or future requirements.

Priced from \$1810.00. For immediate information call your local distributor, or write to BBRC Video Marketing.



BALL BROTHERS RESEARCH CORPORATION • BOULDER, COLORADO 80301 • TEL 303/442-2965 • TWX 303/443-6290



Jerrold, but has not been active in the company's day-to-day operations in recent months. Recently, he won the Pennsylvania Democratic nomination for Governor. Mr. Shapp and his wife, along with Mr. Alex Satinsky, the Company's legal counsel, will resign from the Board of Directors, according to the Jerrold statement.

Robert H. Beisswenger, who has been serving as president and chief operating officer, will become chief executive officer as well. There will be no change in the present management group, Mr. Beisswenger said.

PERSONALITIES

Francis A. Oliver, of **Arvin Industries, Inc.**, Columbus, Indiana, has been selected to head the working group on tape recording, playback heads, tape decks, and transports for the **Electronic Industries Association's** committee on P-8 sound system components.

Mr. Oliver, manager of Arvin's magnetics department, said that his group will deal with correlating and compiling industry standards for magnetic recording heads and transport mechanisms. He extended an invitation to all companies engaged in design work relating to heads and transports to participate in the group's activities.



Mr. Gressens

Robert J. Gressens has been named executive vice-president of **Automatic Electric Company**, Northlake, Ill., a subsidiary of **General Telephone & Electronics Corp.** Mr. Gressens, who is now president of **Lenkurt Electric Co., Inc.**, San Carlos, Calif., another GT&E subsidiary, will assume his new position on September 1.

Charlton W. Hunter, president of **Lenkurt Electric Co. of Canada, Ltd.**, will succeed Gressens at San Carlos.

Mr. Gressens became president of **Lenkurt** in 1963, having previously

served as vice-president, manufacturing, of **Automatic Electric Co.** He joined **Automatic Electric** in 1961,



Mr. Hunter

and was named executive assistant to the vice-president, manufacturing, after serving in various engineering, production, and training capacities.

Hunter joined **Lenkurt of Canada** in 1952 as applications and sales engineering manager. In 1956, he became manager, sales engineering division. He has also served as manager of the commercial division, assistant general manager of the Canadian company, vice-president and general manager, and as president.

The Lindsay Communications Sales Division of Anaconda Wire and Cable Company has announced the appointment of **Alden L. Haldeman** as territorial manager of the western area, based in **Monrovia, Calif.** He was formerly a salesman covering **California and Nevada.**



Mr. Haldeman

Mr. Haldeman joined **Lindsay** in 1962 from **Haldeman-Hawk Sales Co.** and **Ritter Engineering Co.** A graduate of the **University of Iowa**, he also attended **Miami University, Oxford, Ohio.**

He is a member of the **Iron & Steel Engineers Society** and **Delta Kappa Epsilon Fraternity.**



Mr. Stultz

James I. Stultz has been appointed marketing manager of **Moseley Associates, Inc.**

Mr. Stultz attended **San Jose State College** and **Stanford University**, majoring in engineering and business administration. Since graduation, he has accumulated 15 years of marketing experience in the electronics field.

Prior to joining **Moseley Associates**, Mr. Stultz was affiliated with **Ampex Corp.** in various sales capacities, and served as vice-president and general manager of **Vega Electronics Corp.**

In his new position with **Moseley Associates**, he will be responsible for all national and international sales coordination and marketing functions.



Four members of the **KDKA Radio** engineering department were honored recently for a total service of 120 years with the **Pittsburgh** station. At the celebration are (left to right): **Walter Glaus**, 20 years; **John Scigliano**, 25 years; Assistant Chief Engineer **Glenn Luther**, 35 years; Chief Engineer **T. C. Kenney**, 40 years; and General Manager **Wallace Dunlap**, who presented service awards. Seven others on **KDKA'S** technical staff have from 22 to 37 years of service on their records.

**For CATV . . . Superior
coaxial cables are the best**

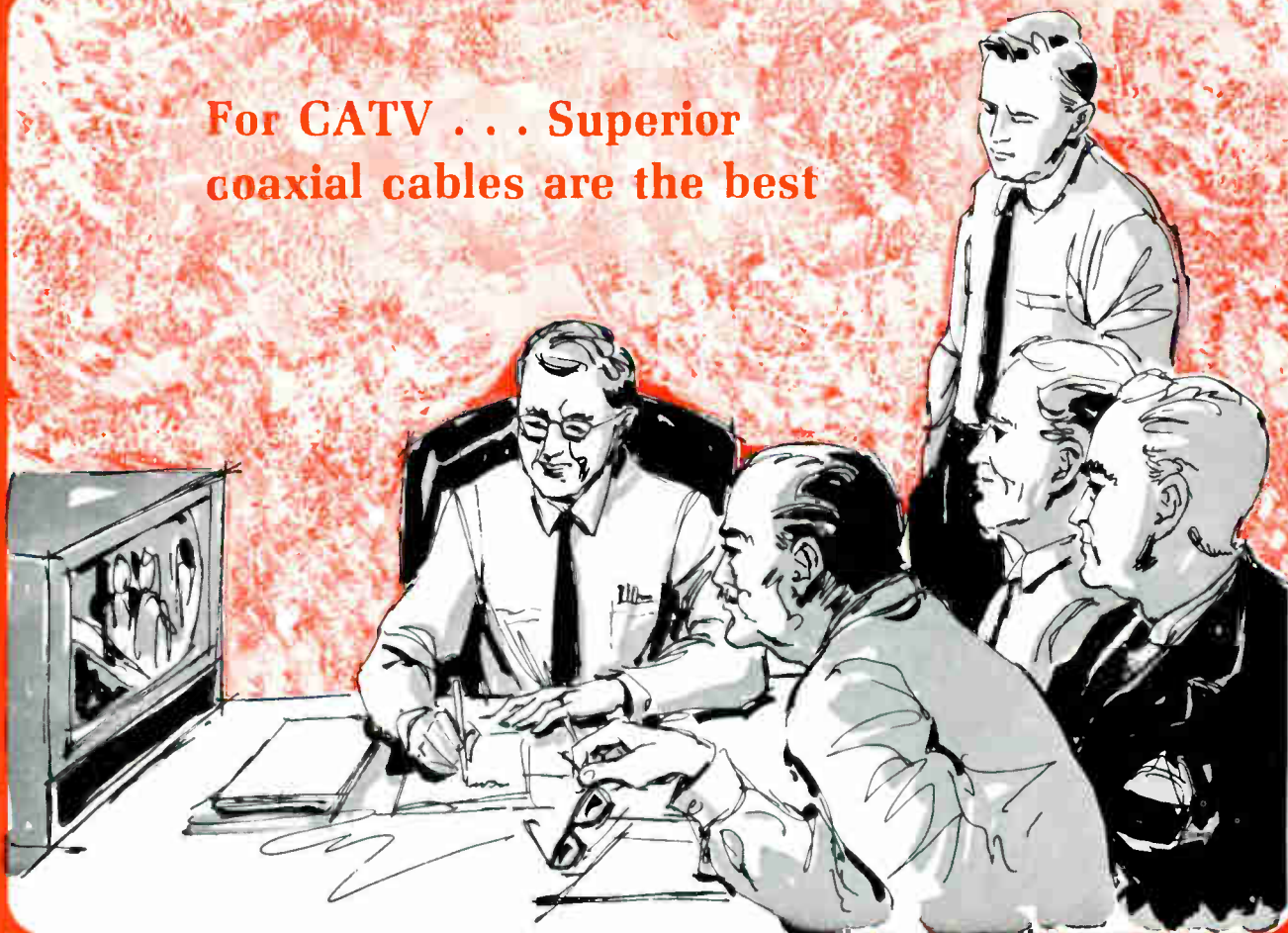

Superior never compromises on quality

Superior Coaxial Cable has earned respect for built-in reliability and stable performance — proved in CATV applications which already total millions of feet.

Superior manufactures coaxial cable under specially devised systems of quality control and sweep-tests every reel over its entire length prior to shipment.

There is no need to settle for less than the ability to make all frequencies available to your customers. There is no reason to risk any attenuation discontinuity — or any of the skipping and jumping frequencies often found in ordinary cable. For long-term transmission stability, full spectrum capability and outside plant reliability — you can rely on every foot of Superior Cable.



**75 ohm coaxials
with "Coppergard"
corrugated copper shield**

Cell-O-Air[®] expanded polyethylene dielectric is for aerial installations; "Solid-D" solid natural polyethylene dielectric is for direct burial installations. Guaranteed five years.



**75 ohm coaxials
with "Alumagard"
solid aluminum shield**

Newest addition to the Superior line — for aerial installation — Cell-O-Air[®] expanded polyethylene dielectric; extra high strength solid aluminum sheath. Guaranteed five years.

Balloon coaxial cable, 75 ohm air dielectric, also available.

For detailed information and prices, write



SUPERIOR CABLE

SUPERIOR CABLE CORPORATION / HICKORY, NORTH CAROLINA 28601

10264



'BEST IN THE PATCH FIELD ...'

William D. Kelly
Chief Engineer
WNEW-TV, New York, says:

"COTERM is far superior to any product of its kind. It is rugged, reliable and safe. Based on my experience, I can't recommend COTERM too highly for any engineer who wants a trouble-free operation."

COTERM®

COTERM® provides the broadcast engineer with a new standard of dependability. With COTERM you have normal-through coaxial circuits without the use of patchcords. When the load side is patched the source is terminated automatically in the proper impedance.



Active circuits may be tested without signal interruption. COTERM is compact, permitting high density on the patch field — 22 jacks on the standard 19" x 1¾" panel.

COJAX® offers all the same advantages except self-termination of source when the load side is patched. All COTERM-COJAX accessories are compatible.

QUICK DISCONNECT CONNECTOR



The unique snap lock feature allows easy insertion and removal even in the densest patch field. Available for a wide range of coaxial cables and simple to attach with standard tools.

COOKE Engineering Company

735 N. Saint Asaph Street, Alexandria, Va. Telephone: 703-548-3889

Circle Item 34 on Tech Data Card

Mr. **Marion B. Paul** has been appointed chief engineer of station **WFIE-TV**. The station is located in **Evansville, Indiana**.

John D. Haskett has been appointed chief engineer of **Overmyer Communications Company's** new facility, **WSCO-TV**, **Newport, Ky.** (near **Cincinnati**).

For the past four years, Mr. Haskett has been a member of the engineering staff of the **WCPO** stations. Previous to that assignment, he was in military electronics research with the **Crosley Division, Avco Corp.** He assisted in building **Cincinnati** radio station **WCIN**, and also built an **AM and FM** station in **Detroit**, where he was chief engineer. Since 1960 he has served as a broadcast engineering consultant for stations throughout the **Middle West**.

Mr. Haskett studied engineering at the **University of Cincinnati** and at **Ohio State University**. He is an associate member of the **Audio Engineering Society** and is a charter member of the **Society of Broadcast Engineers**.

Spencer-Kennedy Laboratories has announced the appointment of **William J. McGuckin** as western regional manager, with headquarters in **Phoenix**.

In his new position, Mr. McGuckin will be responsible for all **SKL** sales and service activities in the western **U.S.**, as well as national advertising and public relations programs. He will also be responsible for certain areas of the company's market research and product development programs.

Mr. McGuckin joined **SKL** in **March of 1966** and has been serving on a temporary assignment as public relations director at the **Boston** headquarters. He previously was director of marketing for the **American Institute of Technology**, and was advertising manager for the **General Electric Computer Department**, located in **Phoenix**.

Daniel T. Green has been appointed **New England** sales representative by **Visual Electronics Corp.** Mr. Green formerly was vice-president of the **Comrex Corp.**, **West Concord, Mass.** He was instrumental in the successful introduction of the **Comrex** wireless microphone systems.

Mr. Green served with the **U.S. Marine Corps** from 1946 through 1948, and was recalled to active duty in 1950 during the **Korean war**. He graduated from the **University of Connecticut** in 1953 with a **B.S. degree** in business administration.

By action of the **Board of Directors**, Mr. **William G. Laird** has been appointed vice-president, engineering, of **TeleMation, Inc.**

Mr. Laird is a graduate of **Idaho State University Technical School**. He has been with **TeleMation** and its affiliates, **Electronic Sales Corporation** and **ELSCO Colorado, Inc.**, since 1962. Prior to that time he was at **KLIX**, **Twin Falls, Idaho**.

Dr. Peter E. Axon has been elected a vice-president of **Ampex Corp.** Dr. Axon is managing director of **Ampex Great Britain Limited** and **Ampex Electronics Limited**, **Reading, England**, and general manager of **Ampex's** **Europe, Africa, and Middle East** area. As the company's first employee resident in **Europe**, he set up **Ampex Electronics, Ltd.**, in 1958.

Prior to joining **Ampex**, Dr. Axon was a member of the research department of the **British Broadcasting Corporation** and was associated with developmental work on magnetic television recording equipment.

He is a member of the **Institution of Electrical Engineers, London**, where he received his **B.Sc., M.Sc., and Ph.D.** He is a member of the **Institution of Electrical Engineers**.

Lee Whitehurst, studio supervisor of engineering with **WSM-TV**, has been named assistant chief engineer of the station. Mr. Whitehurst is technical supervisor of the **National Life Grand Ole Opry** television series currently under production, and is active in the operation of **WSM-TV's** **nimbus** weather satellite project.

The soundest sound in Broadcasting is the new sound of GATES

Gates Executive, 10-channel stereophonic, fully transistorized console, meets the critical needs of stereo or monaural dual-channel broadcasting.



Gates Diplomat, 10-position dual-program channel, completely transistorized console, provides all of the audio-system facilities of the Executive with exception of stereo.

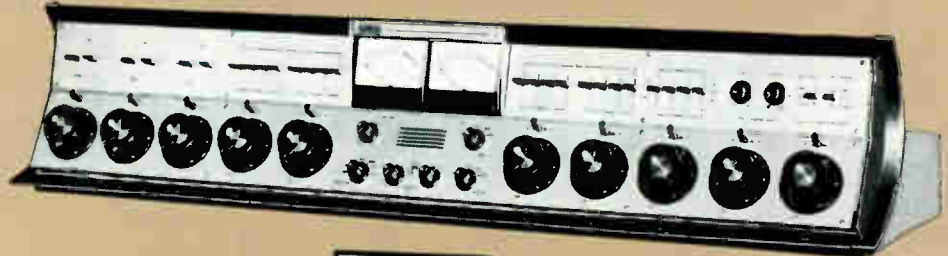

Gates President, dual-channel, completely transistorized console, provides 8 input mixing channels, has totally new 12-position control center. Program selection is by individual illuminated touch-control keys for precise finger-tip control. Eight ladder-type mixers accommodate 28 inputs for exceptional versatility in AM, FM or TV dual-channel broadcasting.



Gates Ambassador, completely transistorized 5-channel console. 22 medium- and high-level inputs are provided with input expansion potential to 30 by using all of the 3-position utility switches.



The "Solid Statesmen" of Broadcasting... Gates Fully Transistorized Consoles

Transistor amplifiers for superb sound reproduction. Precise finger-tip control. Ease and versatility of programming. These are the features you'll like in Gates Audio Control Consoles. And there are infinitely more. To name them all takes 24 pages in our four new illustrative brochures. "Must" reading for the progressive broadcasting engineer or executive. Write for "Solid Statesmen" console brochures.



GATES RADIO COMPANY • QUINCY, ILLINOIS 62301, U.S.A.
A subsidiary of Harris-Intertype Corporation

Why does this EIA Sync Generator look so professional?



Because it's engineered by pro's for pro's with these time-tested Telemet features: ■ One of the few solid state sync generators that fully meet RS 170 specs by having pulse amplitude control. ■ Test points and major adjustments are up front. ■ Additional mounting frames may be wired into other locations for fast generator installation.

We've sold more than 500 of these units in the U.S.A. to date. Chances are, you may know an engineer who uses one. Ask him about the Telemet Model 3507 . . . then ask us.



TELEMET COMPANY
185 DIXON AVENUE, AMITYVILLE, N.Y. • PHONE (516) 541-3600

Video Quality

(Continued from page 46)

resolution wedges of a standard test pattern. Figs. 3(A) and 3(B) show similar presentation of a line through the step function, or square-wave area of the chart. Any departure from the ideal step (as the line goes from reference white to reference black) is quantitatively visible. Fig. 4 shows a line selected through the Indian head.

This technique allows similar quantitative measurements to be made and recorded for numerous camera - amplifier or pickup - tube parameters. ▲

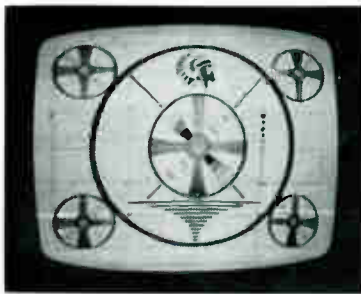

(A) Test Pattern



(B) Trace

Fig. 3. Line through the step function, or square-wave area of chart.

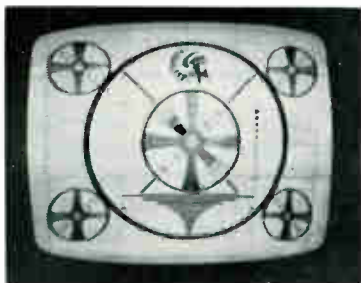

Fig. 4. Display obtained from selection of a line through the Indian head.



CCA FM - 10,000 D
10 KW FM

Reliable FM BROADCAST TRANSMITTERS

YOUR CHOICE OF TRUE FM POWER

at
Realistic Prices

10W	\$1,295.00	5KW	\$ 9,900.00
250W	\$2,795.00	10KW	\$13,500.00
1KW	\$5,195.00	20KW	\$22,500.00
3KW	\$7,995.00	40KW	\$37,500.00

The CCA FM-10,000D, 10KW FM broadcast transmitter incorporates engineering features which are standard in all CCA FM broadcast transmitters. These include:
Zero bias high mu triodes with grids connected directly to DC ground. This eliminates the requirement for neutralization, RF bypass capacitors and bias supplies. In addition, all transmitters contain silicon rectifiers with minimum of 200% safety factor, 300% reserve in air cooling, minimum tube cost, automatic overload recycling, multiplex and stereo operation.



CCA ELECTRONICS CORPORATION
GLOUCESTER CITY, NEW JERSEY
(609)-456-1716

YOUR
INQUIRY
INVITED

AM & FM TRANSMITTERS AT REALISTIC PRICES

Circle Item 39 on Tech Data Card

Solid-State SCA SUBCARRIER GENERATOR



3½" x 19"

MODEL SCG-4T

- All silicon semi-conductors JEDEC registered
- Excellent distortion and frequency response characteristics
- Automatic electronic muting with adjustable delay
- Peak reading deviation meter calibrated in KHz
- New highly stabilized oscillator
- Gold plated, etched copper, plug-in circuit cards

Send For Bulletin #316

MOSELEY ASSOCIATES, INC.

135 Nogal Drive, Santa Barbara, California 93105
Telephone (805) 967-0424

Circle Item 3 8 on Tech Data Card



D-202ES — THE MOST NOTABLE ADVANCEMENT IN DYNAMIC MICROPHONE DEVELOPMENT



For Boom Operation—No frequency discriminating characteristics in off-axis pickup.

In the D-202ES, two independent microphone capsules are incorporated in a single microphone housing, connected by means of a cross-over network, free of phase distortion. Each of the capsules is optimally adjusted to a specific frequency pickup range; one for low frequencies, and the other for high frequencies. The cross-over is at 500 cps.

This unique arrangement achieves a wide, smooth frequency range (30-15,000 cps ± 2 db) and a cardioid pattern with a front-to-back discrimination of never less than 20 db over the entire frequency range. In addition, the microphone offers a 90° off-axis response which is completely parallel to the 0° (on-axis) curve.

These features offer several advantages in practical applications: The flat frequency response enables control of feedback at any frequency. The uniform front-to-back discrimination of at least 20 db virtually eliminates feedback and offers almost complete freedom in microphone and speaker placement.

The parallel 90° off-axis response is of particular importance in sound reinforcement and recording applications, to achieve a natural reproduction of all frequencies introduced to the microphone $\pm 90^\circ$ off-axis.

The D-202ES utilizes a sintered bronze screen which is extremely rugged and protects the microphone systems from iron particles and dust. It also acts as a windscreen and is waterproof.

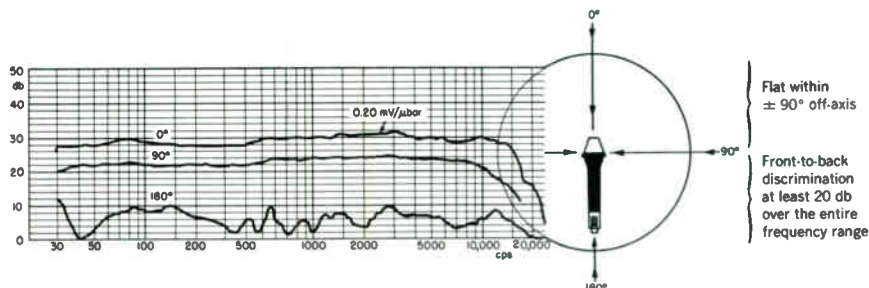

Norelco®
PROFESSIONAL
SOUND PRODUCTS

NORTH AMERICAN PHILIPS COMPANY, INC.
Professional Products Division, 100 East 42nd St., New York, N. Y. 10017

NEW PRODUCTS

For further information about any item, circle the associated number on the Tech Data Card.



Tape Cartridge Eraser
(110)

A magnetic tape cartridge eraser designed to operate with a two-pass hand motion and "wipe" any used tape in 3 seconds has been developed by **Sparta Electronic Corp.**

The unit, Model CE-2, accommodates all sizes of tape cartridges and tape reels as large as 10½-in. diameter and ½-in. width. A button-type

"on" switch, recessed within a circular guard to prevent accidental operation, operates with a "click," signaling that the unit is in use.

Model CE-2 operates on line voltages from 90 to 135 volts AC, 50 to 60 Hz; nominal power consumption is 900 watts, and the duty cycle is one minute on, three minutes off.

With a 10-ft. cord, the unit is priced at \$39.50.

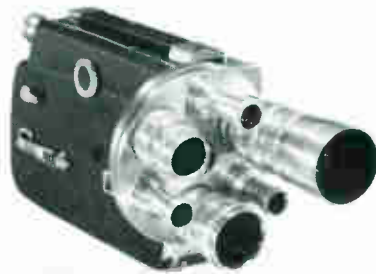

16-mm Turret Camera
(111)

Eastman Kodak Co. has announced

Scala Precision Antennas

- ★ OFF-THE-AIR PICKUP — FM or TV
- ★ LOW POWER UHF, VHF TV TRANSMITTING
- ★ STL AND TELEMETERING ANTENNAS

Engineered to meet rigid FM and TV station specifications, and to endure the tests of weather and time.

Built to your specifications by

SCALA RADIO CORP.

1970 Republic Ave.
San Leandro 1, Calif.
94577
Area 415-351-3792

Circle Item 43 on Tech Data Card

Solid State REMOTE CONTROL SYSTEM

— RADIO AND WIRE

- 1 AC wire pair or STL
- 21 channels
- Write for Bulletin 214
(for radio: Bulletin 213)

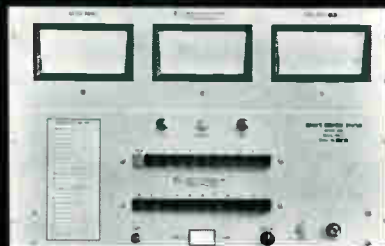

MODEL
PR-21



MOSELEY

ASSOCIATES, INC.

135 NOGAL DR. SANTA BARBARA, CALIF.

(805) 967-0424

Circle Item 42 on Tech Data Card

**Replace
857B
tubes
directly
with
lifetime**

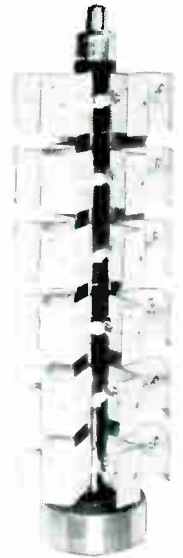

WILKINSON

**36-16 Silicon
Rectifier Stacks!
Because...**

- Wilkinson 36-16 Silicon Rectifier Stacks virtually last forever.
- Immediately repairable in minutes.
- Eliminate arc-backs, pre-heating and warm-up time.
- Eliminate filament transformer and auxiliary heaters.
- Operate from -85° to +185°F ambient.
- "Go-No Go" instantaneous proof of performance.

Only **\$475**

(less than the cost of a filament transformer .. and you don't need them!)

SPECIFICATIONS: Model SR-36-16 replaces tube type 857B PRV repetitive 36 KV. PRV transient 42 KV. RMS current 16 amp. Surge current 1 sec. 160 amps. Forward voltage drop 25V.

For complete details on Wilkinson Silicon Rectifier Stacks, write on your company letterhead today to:

**WILKINSON
ELECTRONICS, INC.**

1937 MACDADE BLVD. WOODLYN, PA. 19094
TELEPHONE (215) 874-5236 874-5237

Circle Item 41 on Tech Data Card



♥♥♥ RADIO STATION WFOX ♥♥♥ LOVES REK-O-KUT

Chief Engineer Edward Wille depends on Rek-O-Kut turntables, as he has for over a decade to deliver the finest in recorded sound for his disc jockey shows. Hundreds of radio stations use Rek-O-Kut turntables. They operate with the same clock-like precision for many years. Owning a Rek-O-Kut is a long-term love affair.

ALMOST EVERYONE LOVES REK-O-KUT



REK-O-KUT B-12H TURNTABLE \$165.00

Three speed. Noise level: 59 db below average recording level. Wow and flutter: 0.085% RMS. Custom-built, heavy duty Hysteresis Synchronous motor for constant speed and "hush" performance. On-off signal indicator. Less tone arm and base.



KOSS

REK-O-KUT

2227 N. 31st STREET • MILWAUKEE, WISCONSIN 53208
Circle Item 44 on Tech Data Card

that the Cine-Kodak K-100 turret camera is again available. The 16-mm professional motion picture camera will be sold through Kodak educational markets dealers.

The K-100 camera offers simple film loading, interchangeable telescopic finders, a long-running motor, a three-way exposure lever, a full speed range, and a selection of lenses.

This six-pound portable camera operates over a wide temperature range because of its use of nylon gears.

The Cine-Kodak K-100 turret camera is priced at less than \$530 with 25-mm f/1.9 lens and 25-mm viewfinder.

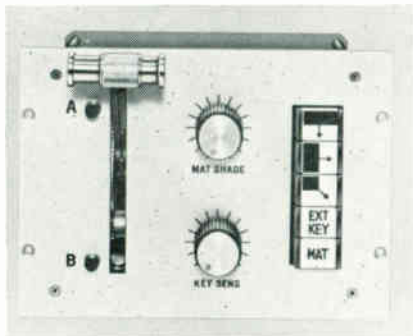

Special-Effects Generator
(112)

A remote control assembly for use

SPOTMASTER

RS-26



Tape Cartridge Racks

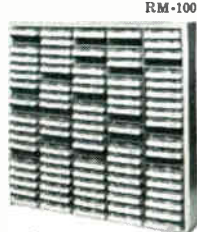

... from industry's most comprehensive line of cartridge tape equipment.

Enjoy finger-tip convenience with RM-100 wall-mount wood racks. Store 100 cartridges in minimum space (modular construction permits table-top mounting as well); \$40.00 per rack. SPOTMASTER Lazy Susan revolving cartridge wire rack holds 200 cartridges. Price \$145.50. Extra rack sections available at \$12.90.

Write or wire for complete details.

Spotmaster
BROADCAST ELECTRONICS, INC.
8800 Brookville Road
Silver Spring, Maryland

Circle Item 46 on Tech Data Card

October, 1966

Waters . . . when you're working with

RF . . . designing

RF . . . designing

. . . developing . . . testing
. . . checking . . . switching



DUMMY LOAD/WATTMETER
Mod. 334 . . . \$89.95



REFLECTOMETER
Mod. 369 . . . \$115

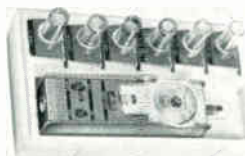

"LITTLE DIPPER"® RF DIP OSCILLATOR
Mod. 331 . . . \$129.75



WIDE RANGE ATTENUATOR

Model 371-1 UHF . . . \$27.95
Model 371-2 BNC . . . \$29.95
Model 371-3 N . . . \$37.95

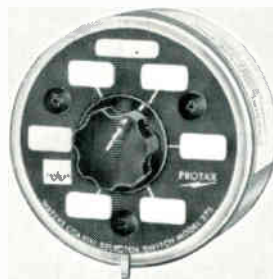

PROTAX Mod. 375 . . . 6 position rear mounted axial connectors . . . \$13.95

PROTAX Mod. 376 . . . 5 position side mounted radial connectors . . . \$12.50

We've the unique theory at Waters that reliable products are somewhat difficult to produce without reliable test equipment. So we manufacture reliable test equipment, particularly in the field of radio frequency. Interested? Your inquiry will bring full data.

DUMMY LOAD/WATTMETER . . . Non-inductive and oil-cooled with direct reading of output to 1000 watts at 52 ohm load. Operates from 2 to 230 megacycles; VSWR less than 1.3:1 up to 230 mc. Calibrated scales provide accurate readings at 0-10, 0-100 and 0-1000 watts.

REFLECTOMETER . . . Measures forward and reflected power in RF watts simultaneously on a unique double meter. Covers 30 to 230 megacycles at 52 ohms on two separately set forward scales of 200 and 1000 watts (20 and 200 watts reflected) to insure accurate readings. Comes complete with directional coupler and interconnecting cable.

"LITTLE DIPPER"® RF DIP OSCILLATOR . . . Fully transistorized RF dip oscillator performs as grid dip oscillator, absorption wave meter and signal generator for field use. Operates 2 to 230 megacycles with 7 overlapping plug-in coils. Compact and lightweight.

WIDE RANGE ATTENUATOR . . . Provides stepped attenuation to 225 mc at 50 ohms from 0 to 61 db in 1 db steps. Used with receivers, signal generators, converters and other low level frequency equipment. Available with UHF, BNC and Type "N" connectors.



WATERS
MANUFACTURING INC.
WAYLAND, MASSACHUSETTS

COAXIAL SWITCHES

Waters makes a Coaxial Switch for every RF switching need! Built with internal ceramic switch and silver plated conductors, each switch rates at 1000 watts and comes with markable escutcheon plate and knob. Our new PROTAX models for antenna switching ground entire antenna systems automatically when equipment is not in use. (Operate to 150 mc)

SELECTOR SWITCH Mod. 335 . . . Single pole, six position, 7 UHF Connectors . . . \$12.95	ANTENNA TRANSFER SWITCH Mod. 341 . . . Single pole, double throw, 3 UHF connectors . . . \$11.45
TRANSFER SWITCH Mod. 336 . . . Double pole, double throw, internally strapped, 4 UHF connectors . . . \$11.45	RADIAL SELECTOR SWITCH Mod. 378 . . . Single pole, five position, 5 UHF connectors in radial position . . . \$10.95
DUAL TRANSFER SWITCH Mod. 331 . . . Double pole, double throw, 8 UHF connectors . . . \$12.95	

Circle Item 45 on Tech Data Card



Who says you're too small for automated broadcasting?

Maybe you've said it yourself.
But you might be wrong.

You see, some folks have a
mistaken idea about automating
a radio station. They think it
means throwing a switch, locking
the front door, and going home.

The real purpose of station
automation is to help you attain
greater operating efficiency and
save money on operating costs.

Now, how much would you be
willing to pay to attain
both goals?

\$65.00 a week?

Well, you might be interested to
know that for the price of a

few extra spots per week you
can fully automate your station.
It might be less. It might be
more. It depends entirely on what
you want to accomplish.

You may want to automate only
certain segments of the day.
Or an entire weekend.
Or FM totally.

Whatever the goal, ATC has the
answer. And that answer will
relieve valuable, creative air
personnel from purely
mechanical control room
operations and make them
available for more productive
pursuits. Better programs, better
newscasts, sharper
commercial's, more sales.

You can buy ATC equipment
outright. Or finance it. Or lease it.

So, maybe it's time to find out
once and for all whether you're
big enough for automation.
We're willing to bet you are.

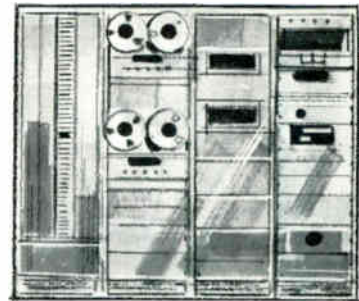

All of our people are
broadcasters. Their intimate
knowledge of your business
makes communications easy
and satisfying. They speak
your language.

To hear them speak it, call
309-829-7006 today.

AUTOMATIC TAPE CONTROL DIVISION
1107 East Croxton Avenue
Bloomington, Illinois 61702, U.S.A.

GATES
Gates Radio Company,
Quincy, Illinois



with the Mark VI-AR special effects generator is being manufactured by the **Ball Brothers Research Corp.** The Mark VI-AR produces horizontal, vertical, and corner wipes, and has an external key for keyed inserts. Matting or lettering is accomplished with a circuit that allows the operator to select any lettering shade between black and white, independent of the amplitude of the matting video signal.

The remote control features lighted push-button selection of wipe, key, and matting operation and a fader-type control for positioning the split screen presentations for the three wipe patterns. The fader assembly allows more uniform wiping action by the operator because of the linear control motion.

Tally-light contacts are provided to indicate which video sources are being used: lights on the control panel warn the operator when more than one video is being used in the effects generator. The remote-control unit has an attached 6-ft. control cable and a 50-ft control-cable extension for flexibility in operation and test of the unit. Control voltages are all DC, and video is used only in the Mark VI-AR chassis. The remote-control chassis dimensions are 5.28-in. × 7.5-in. × 3.75-in. The electronics chassis is rack-mounted and requires only 3½-in. of rack space.

The unit has an internal power supply (117 VAC) to operate the special effects generator and associated remote-control circuits. The unit sells for under \$2,000 and has a one-year warranty.

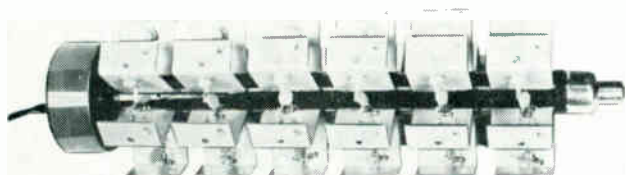

16-amp Silicon Rectifier

(113)

Wilkinson Electronics has introduced a 16-amp model SR-36-16 silicon rectifier to complement its line of direct-replacement silicon rectifier stacks. The new item replaces the vacuum-tube 857B, plugs directly into the tube socket with no rewiring, and has the following specifications: PRV repetitive 36 KV; PRV transient 42 KV; RMS current 16 amps; surge current 160 amps; forward voltage drop 25 V; ambient temperature range -65° to +70°C. The price of the model SR-36-16 is \$475.



Steel Cabinets

(114)

Vent-Rak, Inc., produces a low-priced, heavy-duty electronic cabinet line. Designated the 5000-Series SLIM-



FOCUS ON QUALITY

BY **Cletron**

CLETRON, manufacturer of Orthicon and Vidicon Deflection Components for Commercial and Military applications offers you quality-engineered products and services that have been incorporated as standards in the country's leading manufacturing companies of Television Camera Equipment.

Write today for additional technical literature, drawings and engineering specifications on the complete line of Cletron Deflection Components.



*Quality products by Cletron . . .
Manufacturers of Deflection Components, Custom
Transformers and Sound Reproducing Devices . . .*

Cletron CLEVELAND ELECTRONICS, INC.

DEFLECTION COMPONENTS DIVISION
2000 Highland Road • Twinsburg, Ohio 44087

RUSSCO

HEAVY DUTY—PROFESSIONAL QUALITY

Broadcast Turntables



Approved Performance

Unconditionally Guaranteed

—against defects in material or workmanship when given normal maintenance

SOLD DIRECT —OR TO DEALERS

By Top Radio Stations from Coast-to-Coast!

- Single lever controls 33 & 45 speeds, plays 45 RPM'S without adapter
- Illuminated speed indicators
- Instant acceleration to required speed in 1/10 to 1/16 of a turn
- Sold with or without arm
- Adaptable for any make tone arm



SEPARATE TONE ARM MOUNTING PLATE—EASY TO INSTALL

LCW Priced \$139⁵⁰ & \$169⁵⁰

RUSSCO

BROADCAST PHONO

Preamplifiers

STEREO MODEL I-S \$96

MONAURAL MODEL I-M \$48



- Fully Transistorized for years of dependable service
- Built-in audio level controls

SPECIFICATIONS
HARMONIC DISTORTION: less than one tenth of one percent

NOISE LEVEL: better than minus 65 DB.

OUT PUT IMPEDENCE: 150-600 ohms

RUSSCO POWER SUPPLY UNITS model 1-P supplies power for up to 4 mono units ... price \$40

Call or write for folder

RUSSCO Electronics Mfg.
6879 N. SUNNYSIDE, CLOVIS, CALIF.
PH. 299-4692

LINE-MODULAR Cabinet, the enclosure is intended to combine ruggedness with ease of assembly.

The line features a 12-gauge, self-aligning steel frame that does not require lateral bracing. Rails are die-punched and machine tapped 10/32 to RETMA pattern, and exterior design is such that separate cabinets can be bolted together to form bays.

The cabinet frame has two basic parts and can be assembled in a few minutes using work-bench tools. The frame members and all assembly hardware are packed in one carton.

Side and rear panels are designed to permit quick, easy removal by activating a "trigger" mechanism. Various color combinations are available. Packaged with the side panels are all cabinet trim members and top plate. Rear panels are separately packaged.

The new cabinets are available from stock in six sizes: 19 in. x 24 in. x 30 in., 19 in. x 28 in. x 30 in., 19 in. x 24 in. x 61½ in., 19 in. x 28 in. x 61½ in., 19 in. x 24 in. x 71½ in. and 19 in. x 28 in. x 71¾ in. All six stock sizes are to be available through franchised stocking distributors.

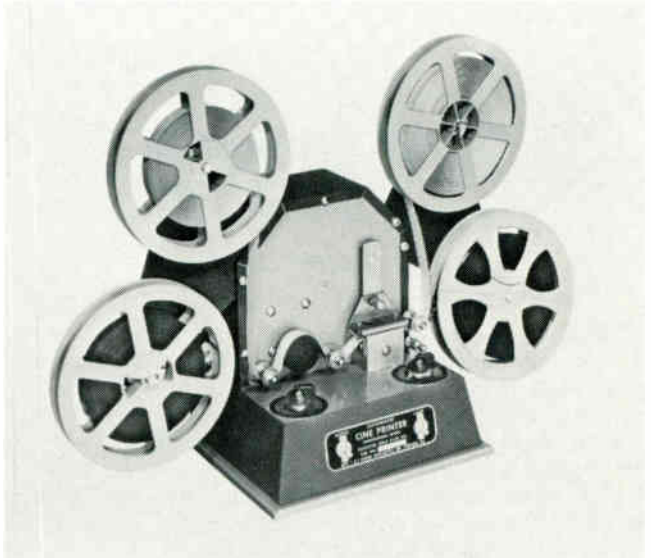

16-mm Duplicate Printer (115)

A low-cost fully automatic cine printer for making color or black-and-white duplicates of 16-mm sound or silent film has been introduced by the Superior Bulk Film Company, Chicago.

This custom-made printer has an all-electric drive with fully automatic take-up arms and a self-adjusting compensating clutch. A stainless steel, self-locking film gate holds the film firmly and in line. The light control varies for extreme light to extreme dark print requirements. A filter receptacle is built in for printing color film.

The printer has a 400-foot capacity and operates at a speed of 25 feet per minute. Sound and picture may be printed at the same time or separately.

Care and maintenance of the Automatic Cine Printer is minimum. The constant-speed motor is designed for hours of continuous operation. No batteries are required; the printer can be plugged into any 110-volt 60-Hz outlet.

This all-metal unit is finished in two-tone brown and tan and weighs 16 pounds. The complete unit sells for \$175. A special adapter for duplicating 8-mm film is available for \$9.50.

ENGINEERS' TECH DATA

AUDIO & RECORDING EQUIPMENT

66. ATLAS SOUND — Catalog 566-67 exhibits complete equipment line including PA loudspeakers, microphone stands, and accessories.
67. CROWN INTERNATIONAL—Specification sheet is for new SX700 series stereo 2- and 4-track, 3-head recorders with built-in microphone (Hi-Z) and +4 dBm output. Unit has 2-speed transport.
68. GATES — Folders describe "Cartrtape II" cartridge machines and their application to television.
69. MEMOREX — Four-page brochure tells about a series of magnetic video tapes for closed-circuit TV.
70. QUAM-NICHOLS — General Catalog 66 lists public-address, replacement speakers.
71. SPARTA — Product guide details new Sparta-Matic® Model 300C series tape-cartridge systems.
72. SWITCHCRAFT — New Product Bulletin 162 illustrates and provides specifications for Part No. 378, "Tini-Tee" adapter with dual output jacks for two separate earphones, and Part No. 3843, "Personal Earphone Kit," which includes dynamic driver, hygenic earpiece, and 5-ft of coiled cord.
73. VIKING OF MINNEAPOLIS — Solid-state monophonic tape playback preamplifiers are the subject of a brochure about Models PB-10 and PB 10-22.

CATV EQUIPMENT

74. AMECO—Offered is a new CATV equipment catalog which includes specifications, photos, and prices for more than 200 basic products. A special section is on engineering, construction, and financing.
75. BLONDER-TONGUE — A 12-page catalog provides complete specifications on entire CATV line including head-end, distribution, and subscriber gear.
76. FINNEY — All-weather, heavy-duty, 75-ohm, single-channel TV antennas for commercial use are described in Catalog No. 20-340.

COMPONENTS & MATERIALS

77. DENSON — Catalogs 964D-1 and 965A-1 feature new, used, and surplus radio and TV broadcasting equipment.

cut holes fast!

Round—inches and mm

"Key"

Square

"D"

Double "D"

with Greenlee punches

Here's the simple speedy way to cut smooth, accurate holes in metal, hard rubber, plastics, epoxy, etc.

Save hours of hard work . . . punch clean, true holes in seconds for sockets, controls, meters, and other components. Easy to operate. Simply insert punch in a small drilled hole and turn with a wrench. For use in up to 16-gauge metal. Available at leading radio and electronic parts dealers.



GREENLEE TOOL CO

Division of Greenlee Bros. & Co.
1866 Columbia Avenue, Rockford, Ill. 61101

Circle Item 51 on Tech Data Card

For a top job in broadcasting . . . get a FIRST CLASS FCC LICENSE ...or your money back!

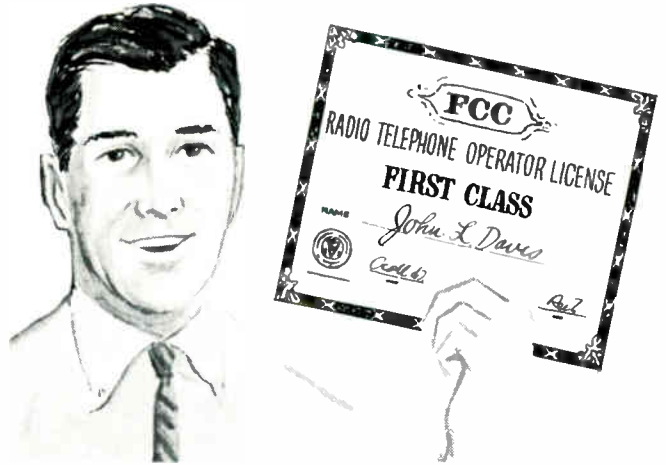

YOUR key to future success in electronics is a First-Class FCC License. It will permit you to operate and maintain transmitting equipment used in aviation, broadcasting, marine, microwave, mobile communications, or Citizens-Band. Cleveland Institute home study is the ideal way to get your FCC License. Here's why:

Our electronics course will *quickly* prepare you for a First-Class FCC License. Should you fail to pass the FCC examination after completing your course, you will get a *full refund* of all tuition payments. You get an FCC License . . . or your money back!

And only CIE offers you new, up-to-the-minute lessons in all these subjects: Logical Troubleshooting, Microminiaturization, Single Sideband Technique, Pulse Theory and Application, Boolean Algebra, and many more.

You owe it to yourself, your family, your future to get the complete details on our "proven effective" Cleveland Institute home study. Just send the coupon below for **FREE** book or write to Cleveland Institute of Electronics, 1776 E. 17th St., Dept. BE-31, Cleveland, Ohio 44114.

NEWS FOR VETERANS

New G. I. Bill may entitle you to Government-paid tuition for CIE courses if you had active duty in the Armed Forces after Jan. 31, 1955. Check box in coupon for complete information.

MAIL COUPON TODAY FOR FREE BOOK



CIE Cleveland Institute of Electronics
1776 East 17th Street, Cleveland, Ohio 44114

Please send me your **FREE** book, "How To Get A Commercial FCC License."

Name _____ (please print)

Address _____

City _____ State _____ Zip _____

Occupation _____ Age _____

Veterans check here for GI Bill information

Accredited Member National Home Study Council
A Leader in Electronics Training . . . since 1934

BE-31

**ANOTHER
LITTLE
BLACK
BOX
FROM**



**FOR COLOR
A NEW
LAP AMPLIFIER**

FEATURES:

- * VELVETY-SMOOTH TRANSITIONS
- * GUARANTEED INHERENT TRACKING
- * HI-PERFORMANCE DA SPECS
- * ELIMINATION OF CLAMPING
- * FAULTLESS COLOR RENDITION
- * IDEAL UNIT FOR COLOR SWITCHING SYSTEMS
- * DUAL OUTPUTS
- * BRIDGING INPUTS
- * LOCAL AND REMOTE CONTROL
- * ALL SILICON SEMICONDUCTORS
- * UNUSUAL PRICING—\$555.00

**FEATURE FOR FEATURE, THERE IS NOTHING COMPARABLE
ON TODAY'S MARKET.**

FOR MORE INFORMATION
CALL OR WRITE

APPLIED ELECTRO MECHANICS, INC.

**2350 Duke Street
Alexandria, Va. 22314**

703-548-2166

Circle Item 52 on Tech Data Card

78. INTERNATIONAL ELECTRONICS — Descriptive literature and prices on the IEC/Mullard special-purpose tube range featuring the 6076/QY5-3000A transmitting tetrode are subject of offer.
79. SIGMA — Sheets deal with heat-shrinkable, self-sealing, thick-wall plastic tubing and molded parts.
80. SKYDYNE — Equipment transportation-case catalog lists 29 stock ABS thermoplastic cases designed for portable equipment.
81. WATERS — Literature outlines functions and features of coaxial switches (Protax® automatic-grounding antenna switch).

MICROWAVE DEVICES

82. LENKURT — 36-page catalog covers product line in microwave radio, multiplex, data transmission, and related equipment. Performance information, descriptions, and photographs are included.
83. MICROWAVE ASSOCIATES — Bulletins 2034 and 2036 describe compact, lightweight "Transfer" and "Remote Actuation" coaxial switches; Bulletin 9022 gives complete data on the MA-2T wide-band microwave relay system; Bulletin 1054 is for the MA-138E ferrite switch; and a new Master Catalog C-15 (120 pages) covers the complete microwave component line.

MISCELLANEOUS

84. TEXAS ELECTRONICS—Catalog illustrates and details line of meteorological instruments for radio, television, and CATV employment, including scanning installations.

MOBILE RADIO & COMMUNICATIONS

85. MOSLEY ELECTRONICS — Catalog lists complete line of 1966 Citizens-band equipment.

POWER DEVICES

86. EN-POWER — "Ready-Charge" lifetime "D" cell is subject of descriptive sheet. Unit features nickel-cadmium cell and integral recharging circuit.
87. HEVI-DUTY — Bulletin 7-22 supplies data on line-voltage regulator using saturable-core reactor.
88. SOLA — New 12-page catalog is for SOLATRON® line-voltage regulators.

REFERENCE MATERIALS & SCHOOLS

89. CLEVELAND INSTITUTE OF ELECTRONICS — New pocket-size plastic "Electronics Data Guide" includes formulas and tables for: frequency vs wavelength, dB, length of antennas, and color code.
90. HAYDEN BOOKS — New 64-page catalog lists Hayden and Rider technical books for engineers, technicians, and management.

STUDIO & CAMERA EQUIPMENT

91. CLEVELAND ELECTRONICS — A 52-page quick-reference, step-down diecut catalog covers complete information on vidicon, Plumbicon®, and image-orthicon deflection components. Included are photographs, specifications, technical data, and dimensional drawings.
92. COHU — Data sheet 6-440 discusses new 1000 series color television system with 400 lines horizontal resolution, three vidicons.
93. EASTMAN KODAK — Literature illustrates and provides specifications for Model 285 16-mm television projector, its accessories, and Ektachrome 5242 (35mm) and 7242 (16mm) color film.
94. TV ZOOMAR — Described is the Model 10x4C 10-to-1 zoom lens for image-orthicon cameras.

TELEVISION EQUIPMENT

95. BALL BROS. — Four-page brochure covers operation and technical specifications of the MARK IX video-pulse distribution amplifier.
96. VITAL — Data sheets give specifications of Model VI-500 stabilizing amplifier, Model VI-10A video distribution amplifier, and Model VI-20 pulse-distribution amplifier.

TEST EQUIPMENT & INSTRUMENTS

97. HEWLETT-PACKARD — Four-page brochure discusses, illustrates, and provides specifications for the Model 191A television oscilloscope.
98. VITRO—Four-page data sheet covers "Nems-Clarke" field-intensity meters, phase monitors, spectrum-display monitors, and ancillary equipment.

Advertisers' Index

Aerovox Corp.62	Lenkurt Electric Co., Inc.57
Ampex43	Memorex Corp.35
Andrew Corp.49	Miller-Stephenson Chemical Co., Inc. ...58
Applied Electro Mechanics, Inc.80	Minnesota Mining & Mfg. Co.47
Automatic Tape Control, Inc.76	Moseley Associates, Inc.71, 73
Ball Bros. Research Corp.63	Norelco Professional Products Div.72
Belar Electronics Lab.62	Nortronics Co., Inc.52
Belden Mfg. Co.64	Polaroid Corp.59
Broadcast Electronics, Inc.46, 60, 75	RCA Broadcast & Communications Products Div.39, 40, 41, 42
CBS Laboratories, Div. of CBS, Inc. ... 5	RCA Components & Devicescover 4
CCA Electronics Corp.71	RCA Service Co.81
Cleveland Electronics, Inc.77	Rek-O-Kut74
Cleveland Institute of Electronics79	Revere-Mincom Div., 3M Co. 7
Cohu Electronics, Inc. 3	Riker Industries, Inc.cover 2
Collins Radio Co.51	Russco Electronics Mfg.78
ColorTran Industries, Inc.50	Sarkes Tarzian, Inc.46
Cook Engineering Co.68	Scala Radio Corp.73
Dayton Electronic Products Co.43	Shure Bros., Inc.54
Eimac Div. of Varian Assoc.61	Sparta Electronic Corp.64
Elpa Industries60	Superior Cable Corp.67
Fairchild Recording Equipment Corp... 6	Telemet Co.70
Gates Radio Co.69	Telemation, Inc.44
General Electric Co.65	Teltron, Inc.81
Greenlee Tool Co.79	Times Wire & Cable52
Industrial Electric Reels, Inc.45	Visual Electronics Corp.8, 9
International Nuclear Corp.cover 3	Vitro Electronics, Div. of Vitro Corp. of America53
Jampro Antenna Co.10	Waters Mfg. Inc.75
JOA Cartridge Service43	Wilkinson Electronics, Inc.73
Lang Electronics, Inc.45	



FROM REPAIRS TO COMPLETE OVERHAUL

- Video tape recorder service
- TV camera overhaul
- Antenna inspection measurements
- Microphone & pick-up repairs
- Transmitter performance measurements
- Custom fabrication
- Installation supervision
- Console repairs
- TV projector service
- Microwave service

Broadcasters have selected RCA for dependable service over the past 30 years.

To guard performance of all your equipment . . . simply telephone one of the following field offices:
 Atlanta (phone 355-6110),
 Chicago (WE 9-6117),
 Philadelphia (HO 7-3300),
 Hollywood (OL 4-0880).
 Or contact Technical Products Service, RCA Service Company, A Division of Radio Corporation of America, Bldg. 203-1, Camden, N. J. 08101.

you demand reliability
Teltron offers it!



teltron, Inc.
 THE ANSWER TO A NEED

QUALITY IMAGE ORTHONON TUBES

Guaranteed performance at a savings of 35% to 65%

For further information write:

TELTRON, INC. Dept. E, 7 Bala Ave., Bala Cynwyd,
 Pennsylvania 19004 • 215 - 664-6672



**The Most Trusted Name
 in Electronics**

Professional Services

VIR JAMES
CONSULTING RADIO ENGINEERS
Applications and Field Engineering
345 Colorado Blvd.
Phone: (Area Code 303) 333-5502
DENVER, COLORADO 80206
Member AFCC

JAMES C. McNARY
Consulting Engineer
National Press Bldg.
Washington 4, D. C.
Telephone District 7-1205
Member AFCC

AMPEX HEAD ASSEMBLY RECONDITIONING SERVICE for all Ampex professional model recorders. This professional service features precision relapping of all heads for maximum head life. Your assembly is thoroughly cleaned and guides are replaced as required. Price includes optical and electrical inspection and complete testing on Ampex equipment in our plant. Full track or half track assemblies . . . \$35.00. One to two day service. "Loaner" assemblies available if necessary. LIPPS, INC., 1630 Euclid Street, Santa Monica, California 90404. (213) EX 3-0449. tf

VIDEO TAPE RECORDER AUDIO HEAD ASSEMBLY SERVICE
Precision relapping of all heads and supporting posts, including cleaning and testing. Ampex head assembly with "cue" tracks, \$75.00 complete. RCA units also relapped. One to two day service. LIPPS, INC., 1630 Euclid St., Santa Monica, Calif. 90404. (213) EX 3-0449. tf

Classified

Advertising rates in the Classified Section are ten cents per word. Minimum charge is \$2.00. Blind box number is 50 cents extra. Check or money order must be enclosed with ad.

The classified columns are not open to the advertising of any broadcast equipment or supplies regularly produced by manufacturers unless the equipment is used and no longer owned by the manufacturer. Display advertising must be purchased in such cases.

EQUIPMENT FOR SALE

TALL TOWERS
Guyed — Self-supporting
Advisory and Inspection Service
Enquiries invited from
AM-FM-TV Stations

Dept. 161 10-66-21

CO-AXIAL CABLE Helix, Styroflex, Spiroline, etc. Also rigid and RG types in stock. New material. Write for list. Sierra-Western Electric Co., Willow and 24th Streets, Oakland, Calif. Phone 415 832-3527 5-66-1f

Television / Radio / communications gear of any type available. From a tower to a tube. Microwave, transmitters, cameras, studio equipment, mikes, etc. Advise your needs—offers. Electrofind Co., 440 Columbus Ave., NYC. 212-EN-25680. 8-64 tf

NEW QRK TURNTABLES, all models available, will take any equipment in trade, regardless age or condition. Audiovox, 4310 S.W. 75 Ave., Miami, Florida. 9-66-4t

Audio Equipment bought, sold, traded. Ampex, Fairchild, Crown, McIntosh, Viking, F. T. C. Brewer Company, 2400 West Hayes Street, Pensacola, Florida. 3-64-tf

COMMERCIAL CRYSTALS and new or replacement crystals for RCA, Gates, W. E., Biley, and J-K holders; regrounding, repair, etc. BC-604 crystals; also service on AM monitors and H-P 335B FM monitors. Nationwide unsolicited testimonials praise our products and fast service. Eidson Electronic Company, Box 96, Temple, Texas. 5-64 tf

Power generator, 35KVA, 230 volt, 3 phase, \$1000. RCA 86-A-1 limiter, \$100. Johnson SPDT RF contactor, 25 Amps, \$75. KSJB, Jamestown, North Dakota. 10-66-1t

EMERGENCY POWER GENERATOR, International Harvest Model U-21, 30kw, 3-phase, 60 cycle, 90.4 amperes, 240 volts. Only slightly used. WKYX, Paducah, Kentucky. 10-66-1t

FOR SALE: 170 foot G-16 stainless tower. Good condition, complete. You take it down. Available immediately. Contact manager, WPRW, Manassas, Virginia. 10-66-1t

OBSOLETE TUBES—80% discount — 6SD7, 7E6, 19V8, 1616, DF91, 6C8, 6J7, 6L7, 12K8, 14H7, 14R7. Large variety of other obsolete numbers. List free. H. Goldman, 28 Joseph, Bethpage, N.Y. 11714 10-66-6t

Complete Laboratory Test Equipment. Pulse Scopes, Q-meters Weston Analyzers, Vtvs. General Radio Meters, States WR-52 Dummy Loads. Original cost \$75,000 for \$5,000. Contact D. B. Williamson & Associates, P. O. Box 42, Cobourg, Ontario, Canada. 416-372-5401. 10-66-2t

CO-AXIAL CABLE, Andrew Helix — 90' of 7/8" diameter plastic insulation with Andrew 75 AN connector on one end and 1-5/8" connector on other end. ITA REMOTE CONTROL, 2 units, greatly modified, to sell for parts value, \$500.00. Call 934-5300 — KDFM, Walnut Creek, California. 10-66-1t

TEKTRONIX RM16 OSCILLOSCOPE. New same as RM17 except for high intensity display DC to 10MC bandwidth sync. Up to 15MC. \$550.00. E. Sierra, 2259 Marco Dr. Camarillo, Ca. 93010. 10-66-1t

Trim 504 Audio Patch cords \$4.00. Audio jack panels for 19" racks, 10 pair \$8.95. Repeat coils 500-500 ohm flat to 20kc \$4.00—Relay racks and equipment cabinets. Write for list. Gulf Electro Sales, Inc., 7031 Burkett, Houston, Texas. 4-66-tf

"AUDIO EQUIPMENT — Whatever your needs, check us first. New and used. Ampex, Altec, AKG, EV, Fairchild, Neumann, Langevin, Rek-O-Kut, Uher, Viking. Send for equipment list." Audio Distributors, Inc., 2342 S. Division Ave., Grand Rapids, Michigan 49507 6-66-6t

G. E. Phono cartridges for broadcast use. Prompt service. Send for price list. Ridge Audio Co., 91 E. Lake Rd., Skaneateles, N.Y. 13152 9-66-1t

Everything in used broadcast equipment. Write for complete listings. Broadcast Equipment and Supply Co., Box 3141, Bristol, Tennessee. 11-64-tf

FREQUENCY MONITOR SERVICE for A.M. monitors including G.F., RCA, Gates, Doolittle, W. E., etc. Frequency change and other services. Reasonable prices, prompt service. Call or write before shipping. Eidson Electronic Co., Temple, Texas. 9-66-tf

EQUIPMENT WANTED

We need used 250, 500, 5K & 10K Watts AM Transmitters. No Junk. Broadcast Electronics Corp. 1314 Iturbide St., Laredo, Texas 78040. 3-66-tf

EMPLOYMENT

SUPERVISING ENGINEER — Graduate electrical engineer with at least 5 years A.M. Broadcast transmitter experience, first class license desirable, for administration, supervision and training assignment at church related shortwave radio station in Ethiopia. For application and further details write Engineering, Box 654, Addis Ababa, Ethiopia. 7-66-4t

ENGINEER

Circuit Designer

Experienced on solid state video and pulse broadcasting equipment

Riker Video Industries, Inc.

Norden Lane, Huntington Station, N.Y.

11746 516 HAMILTON 1-3444

TECH WRITER

Experienced on solid state commercial broadcasting or related equipment

Riker Video Industries, Inc.

Norden Lane, Huntington Station, N.Y.

11746 516 HAMILTON 1-3444

TIGERS—NO PUSSYCATS HERE

We are hunting for tigers who want to explore a

G-R-R-O-W-I-N-G

phase of the television industry

M-A-T-V or C-A-T-V
SOUND AUDIO

Position open for aggressive individuals with strong following in a related field of communications. Must have immediate sales following. Do not apply if background not as required. Electronic Distributor Salesman. The limits of the demand for our products are beyond the horizon and a firm solid future lies ahead. Based in: Protected territory. Heavy travel, Company car. Full expenses paid. Top salary, generous company paid benefits. Investigate the potential of this exciting field. We have a place for you! !!!
Send detailed letter to:

Dept. 159, Broadcast Engineering 10-66-1t

Immediate Opening — Television Technician First Phone Required. Contact Chas. W. Baker, C.E. WTPA-TV, Harrisburg, Penna. 10-66-1t

IMMEDIATE OPENING FOR CHIEF ENGINEER—Need First Phone to supervise technical growth of existing CCTV and new FM services on growing campus. TV design and installation experience required. Previous personnel supervision advisable. Send credentials to Radio-TV Section, Instructional Materials Center, Colorado State College, Greeley, Colorado, 80631. 10-66-2t

Wanted — General Manager — CATV system. Northeastern CATV seeking young aggressive man familiar with systems operations, promotion, internal procedures, etc. Willing to pay for ability. Please forward all details to Dept. 160. 10-66-1t

Job Headquarters for all Radio and Television Engineers. Immediate openings exist in 9 western states and elsewhere for qualified engineer and technical personnel. All categories from trainees to experienced transmitter maintenance, chief, assistant chief, live color video maintenance and technical operations. Send us your complete resume now. The AMPS Agency, 3974 Wilshire Blvd., Los Angeles, California 90005. Telephone DU 8-3116.

By Broadcasters — For Broadcasters

FREE PLACEMENT for TV and Radio Chief Engineers and both studio and transmitter engineers. All fees paid by the station. Send resume to: Nationwide Broadcast Personnel Consultants, 645 North Michigan Avenue, Chicago, Illinois or call: 312-337-7075. 9-66-1t

Immediate openings for two experienced engineers with First Class License at new television station in Central Wisconsin's ideal vacation land. Will also consider A.M. Chief Engineer with extensive construction experience. Contact John Gort, Chief Engineer, WAOW-TV, Wausau, Wisconsin, Telephone A/C 715, 842-2251. 9-66-2t

Wanted immediately — Studio technicians with 1st Class license. Top wages — large market VHF station. Contact Arthur Bone—WJRT-TV, Flint, Michigan, 313-239-6611 collect. 9-66-3t

WANTED: Technicians for RCA closed circuit television—systems planning — color television — video tape — TV cameras — maintenance — sales engineers etc. RCA representative, 143-08 94th Avenue, Jamaica, New York, 212-297-3336 9-66-1t

HELP WANTED — Broadcast Technician—Engineer for top AM-FM-TV station. FCC First required. Send resume to Technical Director, WBEN, Inc., Buffalo, N.Y. 14207. 10-66-1t



**MODEL TSC2
SYNC
COMPARATOR**

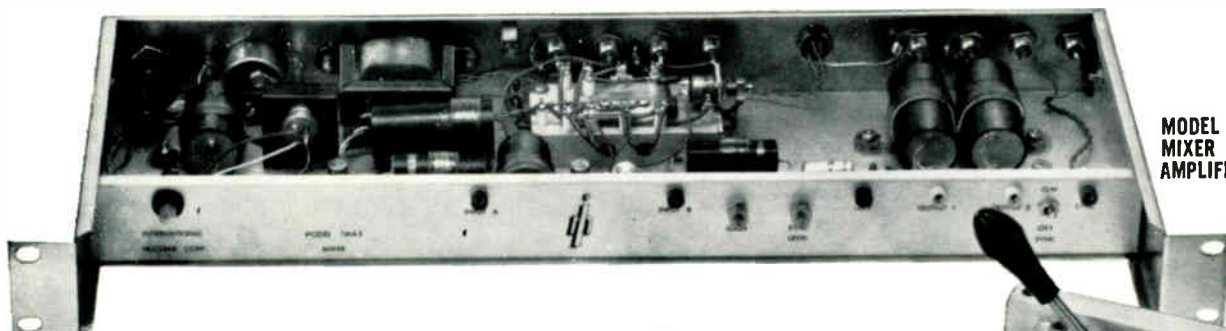

**MODEL TMA2
MIXER
AMPLIFIER**

**New, Compact,
Transistorized Video
Mixing Equipment
from International Nuclear**

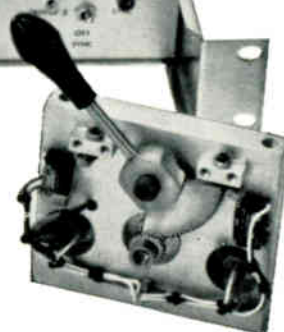

**FADER ARM
for use with
TMA2**

MODEL TMA2 MIXER AMPLIFIER WITH CONTROL ARM
Transistorized throughout. Fits any standard rack. Provides lap-dissolves, supers and fades to or from black. Easily integrated with video switching systems. Excellent with color, monochrome or both. We've tested it to our complete satisfaction. We invite you to do the same. 30 DAY TRIAL.

PRICE: \$1,775.00 EACH, FOB NASHVILLE, TENN.
Complete with Control Arm and 50 ft. interconnecting cable.

MODEL TSC2 SYNC COMPARATOR Also fully transistorized and fits standard rack. Designed for use in conjunction with TMA2 MIXER. When two composite signals (0.5 volts to 1.5 volts P-P) are fed into the two bridging inputs, the unit will recognize a lack of synchronism and the small time difference between the two signals. 30 DAY TRIAL.

PRICE: \$550.00 EACH, FOB NASHVILLE, TENN.
Complete with 50 ft. and 3 ft. control cables.



We invite your inquiry . . . please write:

INTERNATIONAL NUCLEAR CORPORATION

"Transistorizing the Television Industry"

608 NORRIS AVENUE • NASHVILLE, TENN. • PHONE 615-254-3365

RCA **color** capability VIDICONS

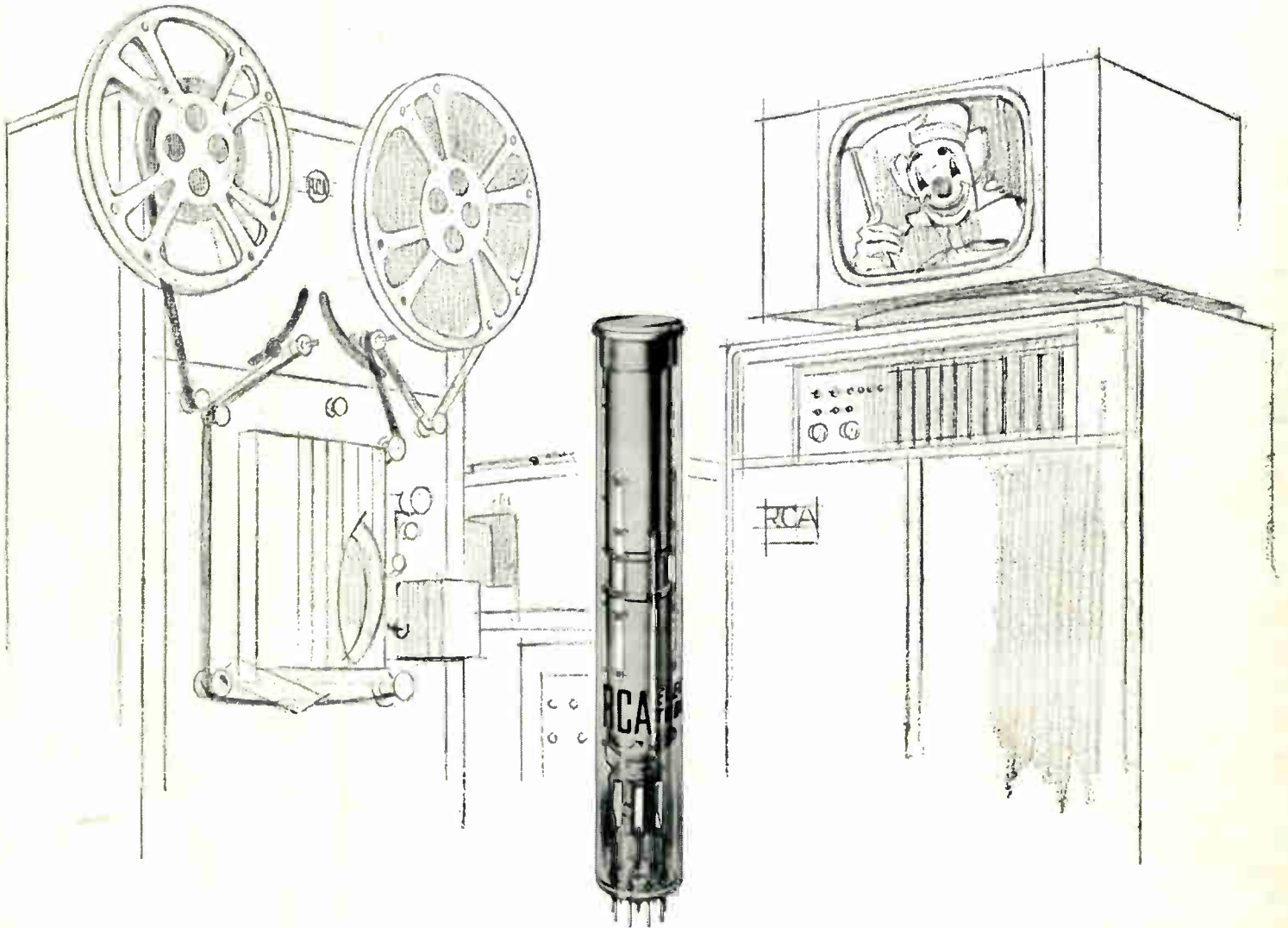

**7735B For Exceptional Sensitivity
and Low-Lag Characteristics**

**8134 or 8134/V1 For Lightweight,
Compact, Color Camera Systems**

8480 or 8480/V1 For Finer Broadcast Color Film Pickup

AVAILABLE FROM YOUR RCA BROADCAST TUBE DISTRIBUTOR

For complete technical information, ask for RCA's new Camera Tube catalog, CAM-600B. RCA Electronic Components and Devices, Harrison, N.J.



The Most Trusted Name in Electronics