



A HOWARD W. SAMS PUBLICATION



TM

APRIL 1965/75 cents

# Broadcast Engineering

*the technical journal  
of the broadcast-  
communications industry*



# RIKER'S SPECIAL EFFECTS ARE VERY SPECIAL!

You start with a basic  
9 Wipe all-transistor system.  
Plugging in one additional  
module gives you  
29 different basic wipes  
that can multiply into  
thousands by using  
two or more buttons  
simultaneously . . .  
thousands more than  
any other. Push-button  
selection allows instant  
changes of wipes "ON AIR"  
Expanding the Riker system  
is as simple as  
plugging in modules.

Here are modes of operation:

- Key
- Wipe
- Wipe/Key
- Mix/Wipe
- Additive Mix
- Non-Additive Mix
- Non-Additive Mix/Wipe
- Normal, Normal-Reverse, Reverse
- Rainbow Insert
- "Joy Stick" Positioner
- Electronic Spotlight
- Camera Scan Positioner
- Modulated Wipes
- Comp or non-comp operation

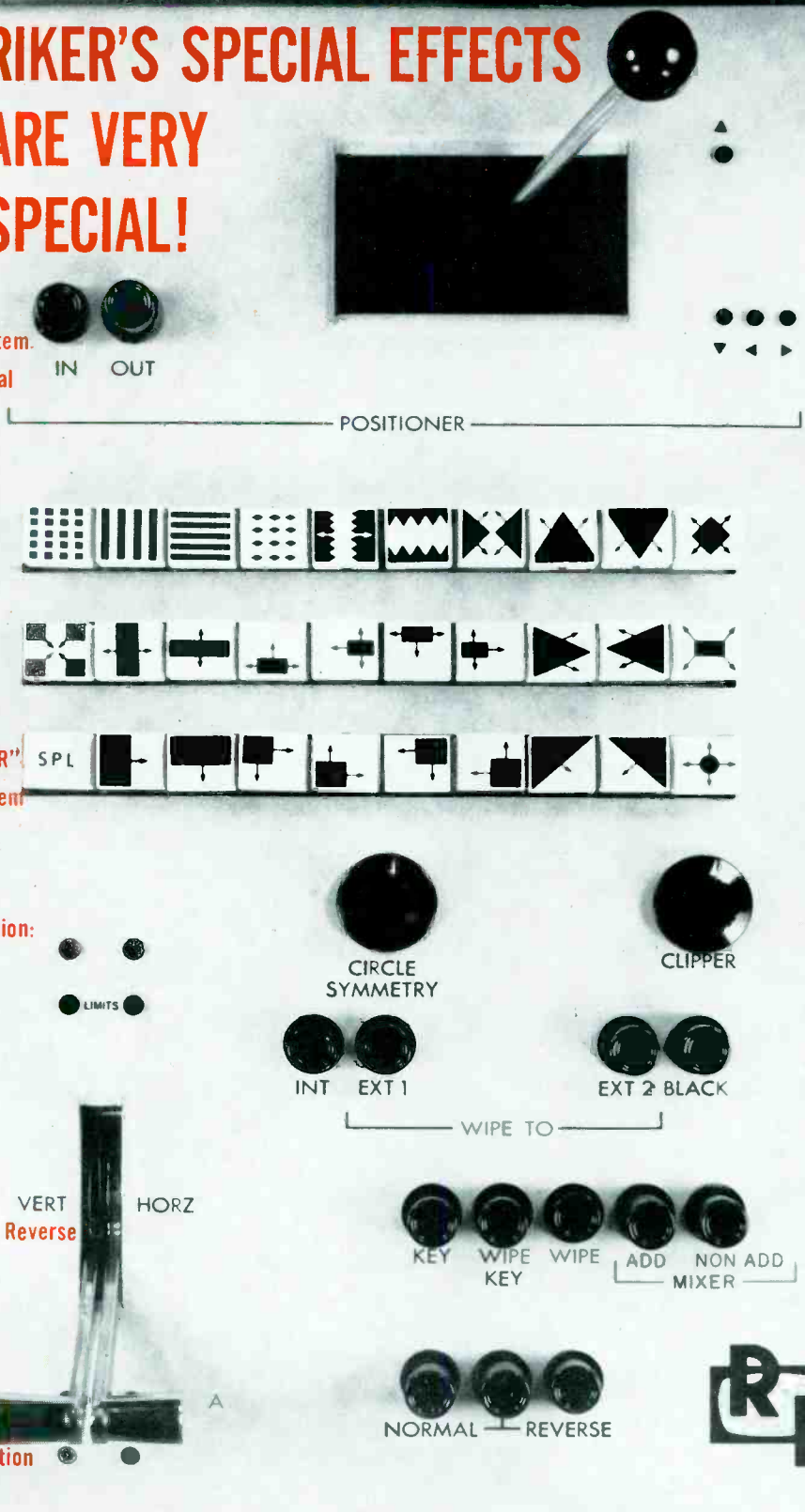

SPECIAL EFFECTS? RIKER'S REALLY ARE . . . in every way!

**RIKER INDUSTRIES, INC.**



*...thinking always of tomorrow*

NORDEN LANE, HUNTINGTON STATION, NEW YORK. PHONE 516 HA 1-3444

• MIAMI • LOS ANGELES • DETROIT

Circle Item 1 on Tech Data Card

# THIS IS

# AL-100R

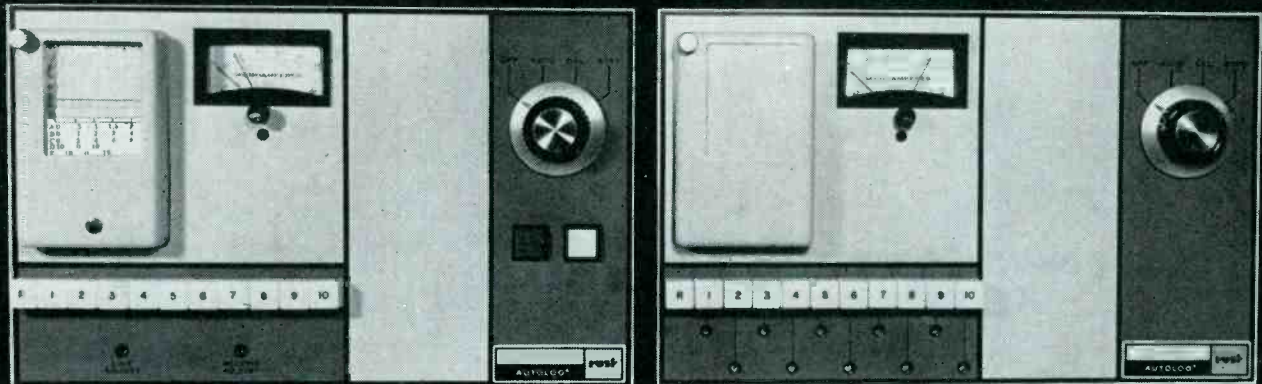

The most advanced remote transmitter logging system ever developed.

The AL-100R is compatible with any DC metering remote control system and will do remotely everything the AL-100 does locally.

Write for further details:

# rust



## corporation of america

Eastern Division  
195 Mass. Avenue  
Cambridge, Mass.

Washington, D.C.  
13205 May Court  
Silver Spring, Md.

Western Division  
2921 South 104th St.  
Omaha, Nebraska

RUST FM STEREO TRANSMITTERS • AUTOLOG • RUST REMOTE CONTROL



**Announcing  
The New  
FAIRCHILD  
F-22  
Condenser  
Microphone**

**New  
advanced  
design with  
low-noise  
field effect  
transistor!**

The FAIRCHILD F-22 Condenser Microphone uses a field effect transistor as the microphone pre-amplifier. This field effect transistor has an extremely high input impedance that complements the high impedance characteristics of the condenser capsule for an outstanding improvement in signal-to-noise ratios. No complicated RF circuitry is used in an effort to improve signal-to-noise ratios. The absence of vacuum tubes eliminates the problem of noise, microphonics, and the expensive periodic replacement of the tube.

The FAIRCHILD F-22 provides the user with the most often needed pickup pattern—cardioid—with outstanding front to back cancellation characteristics thereby making it ideal for broadcast, TV, sound re-enforcement and recording. Extremely low hum susceptibility allows easy use in a variety of operating fields and the basic high sensitivity of the F-22 allows integration into a variety of circuits and a variety of studio and field operating conditions.

A new convenience... the F-22 is self-powered. The F-22 eliminates the bulky, heavy, cumbersome remote power supply associated with conventional condenser microphones. The F-22, as illustrated, is complete—just plug into a studio audio line and you have the smoothest, cleanest sound possible. This self-contained power supply allows new ease of operation in studio work and in field assignments. The use of a field effect transistor with its low noise and low current drain requirements allows the operation of the F-22 with long life mercury cells. The use of minimal parts and the use of missile-grade components throughout assure the user of continuous quality.

By breaking away from traditional condenser microphone design and using the latest in solid state-field effect transistor technology and micro-circuitry, FAIRCHILD is able to produce this quality condenser microphone at an astonishingly low and sensible price, thereby putting the ultimate microphone quality within the reach of every sound engineer. price **\$219**

Write to Fairchild — the pacemaker in professional audio products — for complete details.

**FAIRCHILD**  
RECORDING EQUIPMENT CORPORATION  
10-40 45th Ave., Long Island City 1, N.Y.

Circle Item 3 on Tech Data Card

the technical journal of the broadcast-communications industry

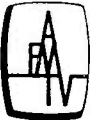

**Broadcast Engineering**

Volume 7, No. 4

April, 1965

**CONTENTS**

**FEATURES**

<b>What to Do in Tower Emergencies</b> . . . . .	<b>13</b>
by George M. Sklom — Every station engineer should know what to do when trouble develops in the antenna system.	
<b>Wireless Microphones</b> . . . . .	<b>16</b>
by Ray L. Fetterman — A discussion of equipment and methods for sound pickup without connecting wires.	
<b>Multiple-Function Remote Control Pair</b> . . . . .	<b>18</b>
by L. C. Sandlin — An interesting use of relays and semiconductor diodes to obtain control of several functions over one telephone pair.	
<b>RF Power Measurements</b> . . . . .	<b>20</b>
by Patrick S. Finnegan — A description of the equipment and methods used to determine whether or not the station is operating within the prescribed power limits.	
<b>Part 73 and the Broadcaster</b> . . . . .	<b>23</b>
by Lawrence L. Prado, Jr. — Compliance with the FCC Rules and Regulations is a vital part of the broadcast operator's job; here are some ideas to help in meeting this responsibility.	
<b>A Tower Emergency</b> . . . . .	<b>28</b>
by Len Spencer — Here is a true story illustrating what happens when a tower falls.	
<b>Building A Transistorized Synchronizing Generator</b> . . . . .	<b>36</b>
by Lawrence P. Segar — In addition to construction details, this article shows how synchronizing waveforms are produced.	
<b>Television in American Samoa</b> . . . . .	<b>42</b>
by H. Eugene Larson — Education is now being carried on in the Samoan Islands by means of television.	
<b>Directional Antenna Stability</b> . . . . .	<b>48</b>
by J. Gordon Elder — An engineering consultant discusses the factors that can cause directional patterns to shift.	
<b>An RF Patching System for TV</b> . . . . .	<b>60</b>
by Bill Kessel — Some relatively simple plumbing facilitates maintenance, testing, and RF switching during emergencies.	
<b>Synchronized Tape Systems for Films</b> . . . . .	<b>64</b>
by Allen B. Smith — A discussion of synchronizing methods for double-system motion-picture sound recording.	
<b>Checking Broadcast Spurious Emissions</b> . . . . .	<b>74</b>
by Elton B. Chick — A practical discussion of how these important measurements can be made.	

**DEPARTMENTS**

Letters to the Editor . . . . .	6	New Products . . . . .	86
Bulletin from Washington . . . . .	33	The Chief Engineer . . . . .	88
Book Review . . . . .	58	Engineers' Tech Data . . . . .	89
About the Cover . . . . .	62	Advertisers' Index . . . . .	90
Engineers' Exchange . . . . .	77	Classified Ads . . . . .	90
News of the Industry . . . . .	85		

PUBLISHER: Howard W. Sams

EDITOR: Forest H. Belt

SUBSCRIPTION PRICE: U.S. \$6.00, one year; \$10.00, two years; \$13.00, three years. Outside U.S.A. add \$1.00 per year for postage. Single copies, 75 cents, Back issues, \$1.00.

BROADCAST ENGINEERING is published monthly by Technical Publications, Inc., an affiliate of Howard W. Sams & Company, Inc. Editorial, Circulation, and Advertising headquarters: 4300 West 62nd Street, Indianapolis 6, Ind. Copyright © 1965 by Howard W. Sams & Co., Inc.



A HOWARD W. SAMS PUBLICATION



# THE VME 600

## Video Tape Recorder

### IS THE ONE BEST BUY!...



### Because

*VME 600 is the only VTR you can buy  
for less than \$10,000 that...*

- 1** Uses a broad tape that permits a band width of better than 3 mc. (i.e. that gives a picture so clear that it will not be fuzzy when demonstrated on a 21" monitor instead of a 9" monitor.)
- 2** Consumes tape at less than 80" per second (VME 600 consumes tape at less than 8" per second.)
- 3** Can be stopped and single-framed or run in slow motion in either direction.
- 4** Runs continuously for more than an hour... and without reversing at that.
- 5** Operates with a single plug-in head that precludes any and all alignment problems. The head is guaranteed for 500 hours and can be replaced for \$25.00.
- 6** Pushes the tape into the head instead of pulling the tape around the head drum under tension (which can cause stretch and distortion.)
- 7** Permits a sound track in half a dozen languages (or a bilingual training tape.)

VME 600 is the only truly portable VTR.  
No other weighs less than 80 pounds.  
VME 600 weighs only 40 pounds.



The VME 600 can assure tape interchangeability if it is operated at 7.5" per second or it can be slowed down to 5.1" per second by just turning a switch (for maximum tape economy where interchangeability is not needed.)

**And the price is only  
\$2995!**

Circle Item 4 on Tech Data Card

Write today on your company letterhead for complete details.

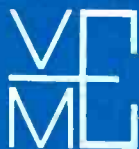

**VIDEO-MEDICAL ELECTRONICS CORP.**

TIME & LIFE BUILDING  
ROCKEFELLER CENTER

NEW YORK, N. Y. 10020. Telephone: 245-2431

Cable: VIDMEDCO, NEWYORK / Telex 274573

Exclusive distributors for:

Fernseh Wireless (26 lbs.) Monochrome Camera with Remote Sync. Used by networks at political conventions.

# An *Allenized* VTR provides

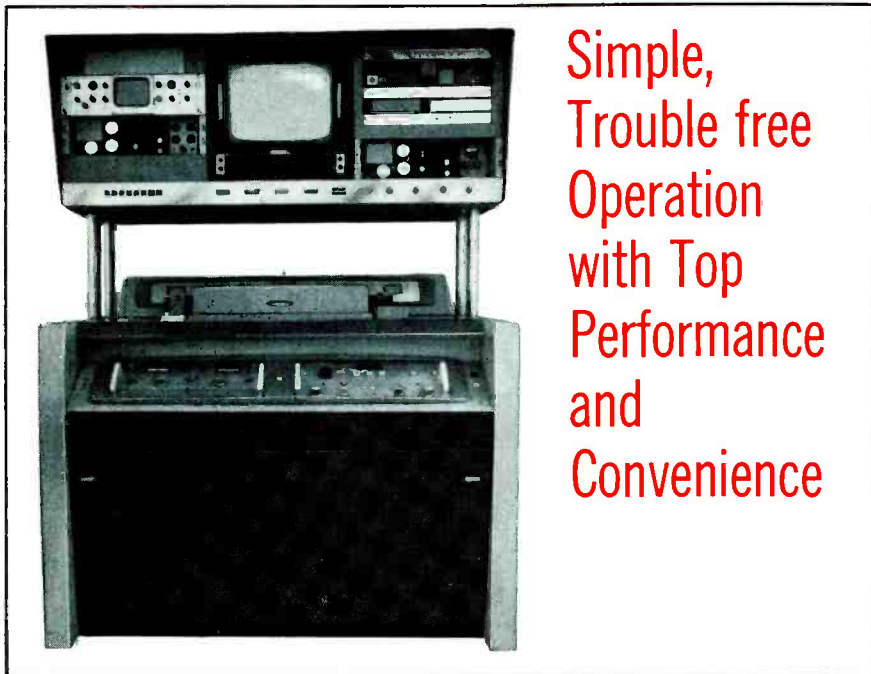

Simple,  
Trouble free  
Operation  
with Top  
Performance  
and  
Convenience

Available as a complete machine to add to your facilities. Available as system components to re-equip your existing VTR by factory rebuilding exchange.

- Simpler Operation — far fewer controls and adjustments
- Best Performance — routinely meets or exceeds all performance specifications of the latest, most expensive "deluxe" VTR equipment
- Stable "Sync-lock" Servo — positive lock both frame and line comparable to best sync generator "gen-lock" — with instantaneous lock-up after tape guide pulls in
- Stable Signal System — incorporates all current deviation standards and will accommodate all currently-proposed standards for high band operation
- Factory-Rebuilt VR1000 Transport — self-contained flat tape console for greatest tape handling convenience
- Plug-In Modules interchangeable with no readjustments



**VISUAL ELECTRONICS CORPORATION**

356 west 40th street • new york, n. y. 10018 • (212) 736-5840

LOOK TO VISUAL FOR NEW CONCEPTS IN BROADCAST EQUIPMENT

Circle Item 5 on Tech Data Card

## LETTERS

to the editor

DEAR EDITOR:

In the November 1964 issue of BROADCAST ENGINEERING, there appeared an article entitled "Protective Maintenance at the Studio," in which the author offers a cure for the problem of announcers who work too close to the microphone. I feel there is an important point to be considered if anyone desires to try this idea.

Mr. Williams advocates replacing the coupling and/or cathode-bypass capacitors with lower values to provide bass attenuation in the microphone preamplifier. It must be remembered that the annual FCC-required audio proof of performance will be unacceptable when taken on a console with this modification for the very reason that the bass attenuation will be obvious. I note that some console manufacturers even "hand-pick" certain values for each console preamplifier in order to provide audio response as nearly "flat" as possible.

Since the audio proof must include the entire audio chain of the station, from the input of the microphone preamplifier to the transmitter output, perhaps it would be wiser to leave the preamplifier as designed and simply use a filter between the microphone and the preamplifier. This would allow easy removal of the attenuating device when taking the audio proof and would simultaneously reflect the true operating characteristic of the station's audio console and system, which is a goal of the audio proof.

WILLIAM A. KINGMAN

Chief Engineer,  
KOWL, Lake Tahoe

Mr. Kingman has brought up an important point that should be kept in mind by all station engineers: No equipment modifications should be made that adversely affect the required technical performance of the station. In this case, the problem may not be as serious as it sounds, at least in the case of AM stations. The limits for audio response for these stations are specified only for the range between 100 cps and 5000 cps. Thus, strictly speaking, the response below 100 cps could fall off considerably without resulting in noncompliance with the Rules. However, as this letter brings out, the philosophy of not correcting one wrong thing with another "wrong thing" is a good one.—Ed.

DEAR EDITOR:

In the December 1964 issue of BROADCAST ENGINEERING you published a story regarding a transmitter tube which had been in service in our Lampertheim, Germany, transmitter station for an unusual length of time.

In your story you inadvertently used the term "water-cooled" 50,000-watt

BROADCAST ENGINEERING

# MODERNIZING?

## START WITH THE MOST ADVANCED TRANSMITTER INPUT & OUTPUT EQUIPMENT

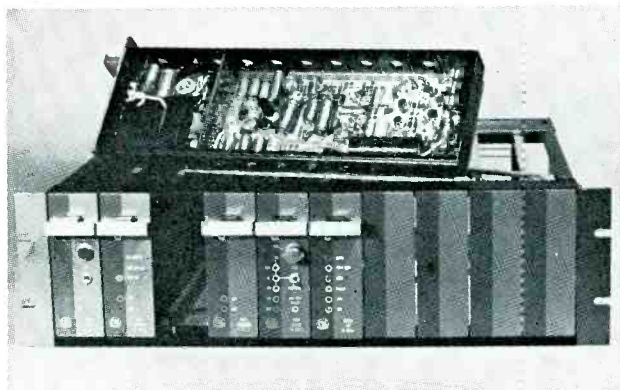

CDL SOLID-STATE TRANSMITTER INPUT STABILIZING AMPLIFIER . . . for Color/Monochrome Operations.

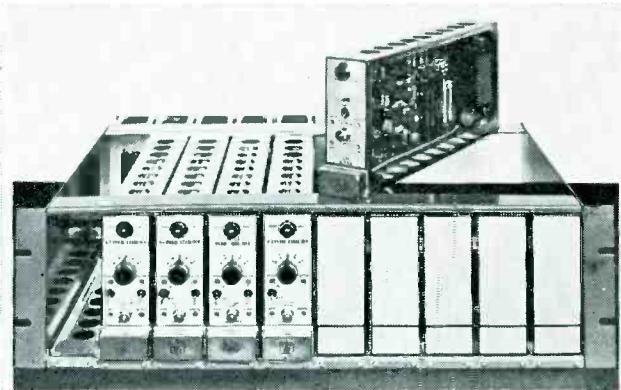

WARD VIDEO LOW PASS FILTER & COLOR PHASE EQUALIZING SYSTEM. Features built-in Solid-State Isolation Amplifiers & Regulated Power Supplies.

### YOUR TV TRANSMITTER

CO-EL UHF VESTIGAL SIDE BAND FILTER FOR KLYSTRON TRANSMITTERS.

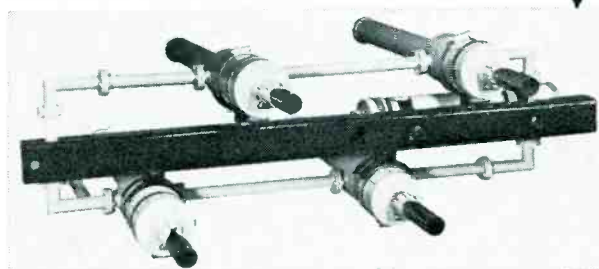

CO-EL UHF NOTCH DIPLEXER — No Gases Needed — For use with up to 50KW transmitters.

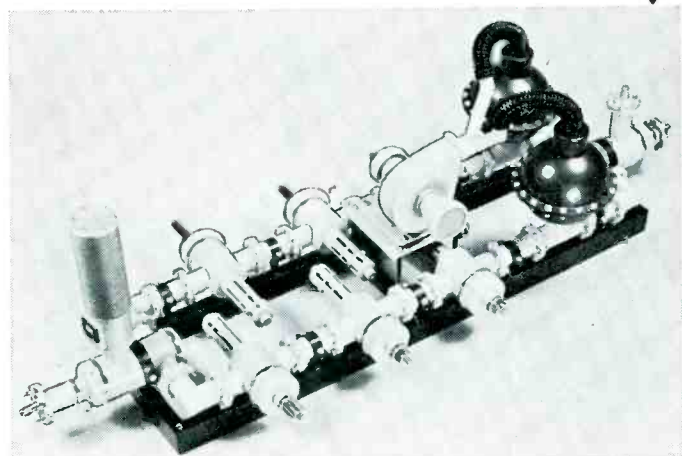
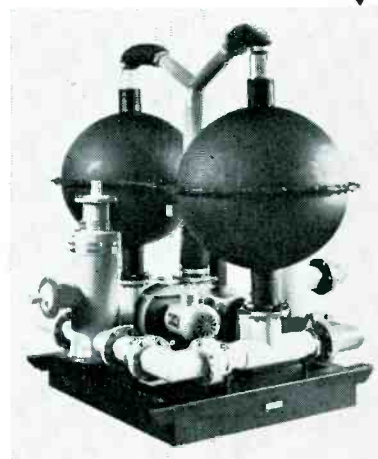

CO-EL UHF FILTERPLEXER — No Gases Needed — For use with up to 50 KW Transmitters.



**Ward Electronic Industries**

P.O. BOX 1045 • MOUNTAINSIDE, NEW JERSEY • (201) 232-1167

**Only  
Collins' new  
212S-1 Solid State  
Speech Input Console  
offers you  
noiseless photoconductive control\***



It's the newest \*switching technique in speech input consoles. It's noiseless. The switch is made of a photoconductive cell and a lamp in a sealed container. The cell shows a very high resistance when the lamp is off, a low resistance when the lamp is on. This makes a switch with no contacts to wear, bounce or become contaminated.

A similar device for \*level control of the program material is also used. The photoconductive cell responds to a variable voltage from a potentiometer to control attenuation in the signal path. This control eliminates the maintenance time normally required for cleaning and relubrication of mixer controls.

Collins' new 212S-1 was designed primarily for stereo, but you can use it for monaural, too. It provides monaural output simultaneously on both program channels from a single input, or you can handle completely separate monaural material from inputs through two program outputs. One switch controls this function.

Like all other Collins broadcast equipment, the 212S-1 is easy to install and maintain. Simple removal of a protective cover exposes the input/output terminals on the deck. Cable

access ports through this deck permit an installation that's free of the "haywire look." Removal of another protective cover exposes the wiring to card box receptacles. And you can inspect the cards simply by lifting the hinged card box to the vertical position. An extender card is furnished for troubleshooting at the component level with the cards connected to the rest of the console.

The modules as used in the 212S-1 lend themselves to custom studio installation. The cards may be utilized in a variety of configurations depending on your requirements. Send the block diagram of your requirements to Collins for a quotation.

**212M-1 Monaural Console**

The basic concepts and characteristics of the 212M-1 Monaural version are the same as the 212S-1 stereo version. The same modules, in less quantity, are used with only single program and monitor outputs.

These are a few of the many features which make Collins' 212S/M-1 two of the most versatile, adaptable and reliable speech input consoles in the Collins line. For complete details and specifications on the new 212S/M-1, call or write Broadcast Communication Division today.



COMMUNICATION / COMPUTATION / CONTROL



COLLINS RADIO COMPANY / World Headquarters / Dallas, Texas



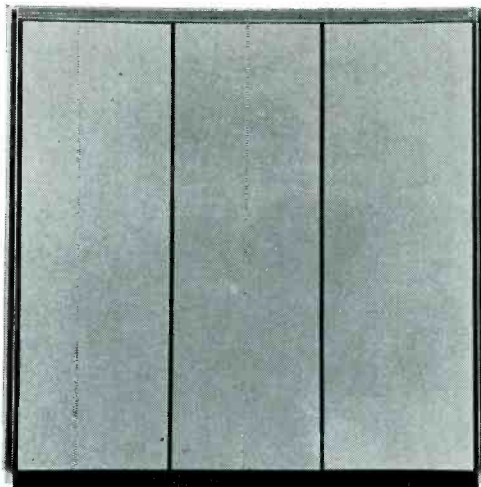

Put your  
station on a  
solid state footing  
with  
Collins' new 820E/F-1  
AM Transmitter

It's the most extensively transistorized transmitter in the 5-10 kw power range. It features solid state devices in the low-level audio and driver, the power supply circuits and the r-f exciter.

This new exciter is a high stability ovenless-crystal oscillator operating in the 2.1 to 4.3 mc range, with division to standard broadcast frequency by thin-film components.

The 10 kw model, shown above, uses six tetrode vacuum tubes in the r-f driver, power amplifier and modulator circuits, but requires only two tube types.

Tuning of Collins' new 820E/F-1 is automatic. A phase-comparator circuit in the power amplifier stage automatically controls the PA tuning as loading is adjusted. Since the tuning capacitor is at a higher network impedance point and since it requires less padding capacitance than the loading capacitor, tuning correction is fast enough to take place well within the time required for loading changes.

Collins designed this new transmitter for easy, space-saving

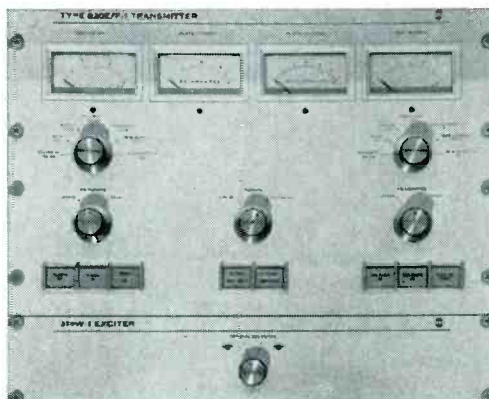

installation, as well as extended reliability. It measures just 69" high x 67-7/16" wide x 32" deep.

For attended operation such as a combination station, all metering and control of the transmitter is accomplished from a separate extended control panel, which requires no remote control authorization. All meters, controls and status indicators are contained on a 12 1/4" x 19" panel supplied with 50 feet of multiconductor shielded cable for connection to the transmitter.

When operating rules permit completely unattended operation without transmitter log, the 820E/F-1 will be immediately adaptable to that concept without rebuilding or modification. It is truly the transmitter for both the present and the future.

Thinking about a new AM transmitter for your station? Think about Collins' extensively transistorized 820E/F-1. Let a Collins Sales Engineer show you what this new transmitter has to offer. Call or write Broadcast Communication Division today.

COMMUNICATION / COMPUTATION / CONTROL



COLLINS RADIO COMPANY / World Headquarters / Dallas, Texas

Circle Item 6 on Tech Data Card

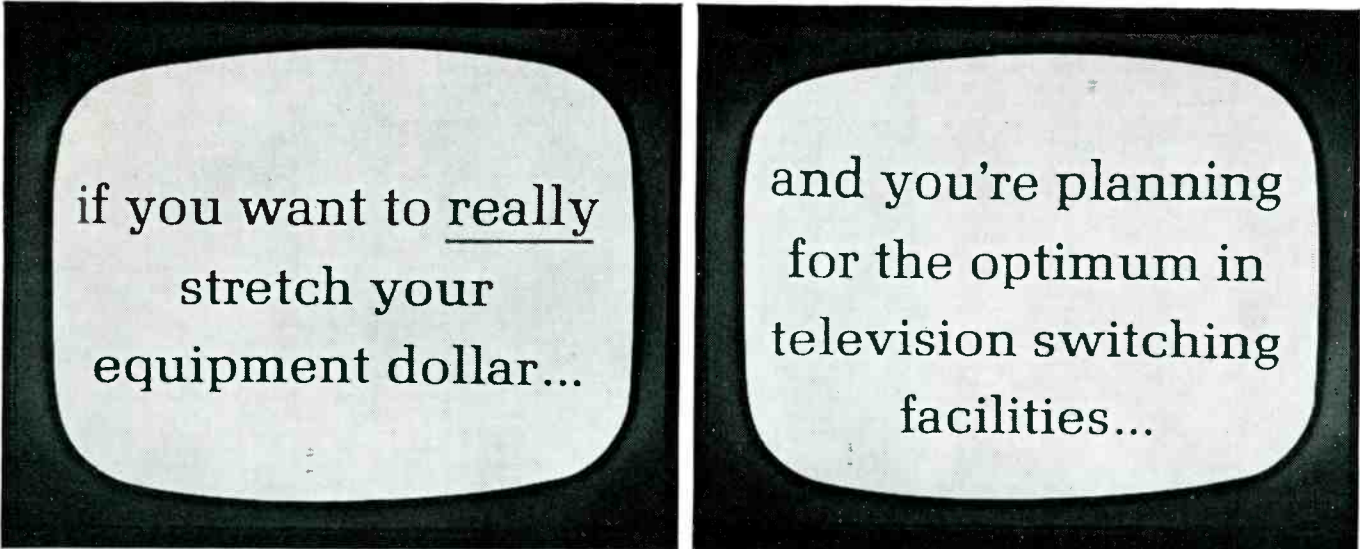

if you want to really  
stretch your  
equipment dollar...

and you're planning  
for the optimum in  
television switching  
facilities...

**How to get a real assist from the hottest video switching design team anywhere—(and all it costs you is a postage stamp!)**

Let's get one thing straight: If all you want is preset signal routing, there are lots of suppliers in the field. But if you want to go the whole route and obtain ultimate flexibility, you need to consider random "on air" video switching — and that's our specialty.

You can talk anything from studio control to master control . . . to master exchange for a complete network. We can come up with answers based on experience.

We use solid state plug-in electronics — and since our active switching component is the ultra reliable wire spring relay of the telephone industry, we are able to supply tally and sophisticated manual or automated machine control circuitry. The additional cost is minimal and in many cases there is no increase in physical size.

Northern Electric switching is designed for both color and monochrome signal routing, and can be supplied in sizes varying from a simple 2x1 module to a complex 100 x 200 master exchange. You can even specify solid state circuitry in the mixer — and get fading and mixing of composite signals without change in sync or setup levels. You can have audio follow video, or audio separately controlled. You can also have digital display.

Reliability? One station reports our switcher has operated for four years without maintenance. Another is in a mobile color unit that's constantly on the move from coast to coast.

We provide *know-how first, hardware second*. To find out just how we can help you, fill in the check boxes on the page at the right and mail it in. We'll then be in a position to talk "systems", complete with recommendations and a budget price. No obligation, of course.

talk with the design  
team that built  
the largest commercial  
broadcast switcher  
in North America

# Customized

random "On Air"

# Switching

**TEAMWORK STARTS HERE.** As soon as we receive your outline, our experience is at your disposal. Without obligation.

Name \_\_\_\_\_

Title \_\_\_\_\_ Company \_\_\_\_\_

Address \_\_\_\_\_

City \_\_\_\_\_

**SWITCHING REQUIREMENTS**

Video  Audio Follow  Audio Separate

Video Inputs  Bridging  Terminating

No. of Audio Circuits \_\_\_\_\_

Cable Equalization for color

**PURPOSE:**

Studio  Mobile  Master Control   
Master Exchange

Size \_\_\_\_\_ Inputs \_\_\_\_\_ X \_\_\_\_\_ Outputs

ANTICIPATED FUTURE EXPANSION YES  NO

If so, maximum size \_\_\_\_\_

Inputs \_\_\_\_\_ X \_\_\_\_\_ Outputs

**TYPE OF SWITCH**

1. "On Air"  2. Signal Routing

CONTROL PANELS YES  NO

CONTROL CABLE LENGTH \_\_\_\_\_

TALLY No. OF CIRCUITS  
(MACHINE, ON AIR LIGHTS ETC.) \_\_\_\_\_

NORTHERN ELECTRIC SOLID STATE  
MIXING AMPLIFIER YES  NO

**RE-ENTRY REQUIREMENTS:**

Mix to Effects  Effects to Mix

Mix to Effects to Mix

PROVISION FOR AUTOMATION YES  NO

MACHINE CONTROL DELEGATION YES  NO

AUTOMATIC FADES YES  NO

AUTOMATIC DISSOLVES YES  NO

AUTOMATIC PRESET ENTRIES YES  NO

SPACE LIMITATIONS IF ANY YES  NO

STANDARD 19" RACKS

STANDARD 23" TELEPHONE RACKS

SPECIAL RACKS  KIND \_\_\_\_\_

COMMENTS \_\_\_\_\_

1065-1

**Northern Electric**   
COMPANY LIMITED

Department 9950, Belleville, Ontario, Canada

Circle Item 7 on Tech Data Card

## MORE NEW STUDIO EQUIPMENT FROM ALTEC

# LATEST ATTENUATOR LINE ACHIEVES LESS THAN 1 MILLIOHM CONTACT RESISTANCE, LOWER NOISE, EASIER UPKEEP, LONGER LIFE



The hoped-for possibility has developed into working reality—we've managed to come up with the finest attenuators yet developed. More than 300 types are available with either solder terminals or as plug-ins, either rotary or straight-lines, and in such categories as mixers, calibrated controls, calibrated grid control pots, VU range extenders, decade attenuators, impedance matching networks, decade resistors, faders, and stereo pan potentiometers. And they're all listed in the new Altec Attenuator Catalog which we've printed as a convenient reference for your aid.

### A LITTLE ABOUT A LOT OF IMPORTANT IMPROVEMENTS

You might like to know how some of these improved attenuators were engineered. For instance, "coin" silver, which is normally used to make brushes, contains copper and is subject to oxidation—reducing conductivity and raising noise level, among other things. So we've made our brushes of "fine" (pure) silver because it doesn't oxidize—it sulfides. Silver sulfide does not reduce conductivity; in fact, it actually has a helpful lubricity. We use dual brushes on all our attenuators—both rotary and straight-line models. They are independently sprung and so guided as to eliminate "stumble" from contact to contact.

### ADDED DEVELOPMENTS

Our new attenuator line is designed so that we'll be able to gang up to 8 of them in tandem, enabling you to operate the whole group with one control. We've produced rotary attenuators that will give you more steps in less space. How? Instead of putting them in the conventional round cans—we're building ours in square ones. And we're using the corners (space that previously went to waste) for the wiring.

### DON'T FORGET THE CATALOG

The new Altec Attenuator Catalog we mentioned above has all the technical characteristics and other relevant data on the new line. We'll be delighted to send it to you. So write today, Dept. BE-4.



**ALTEC LANSING**  
A Division of *LS* Ling Altec, Inc.  
ANAHEIM, CALIFORNIA  
© 1965 AL

Circle Item 8 on Tech Data Card

tube. The tube is actually vapor-cooled, or, more specifically, steam-cooled.

It will be appreciated if you will pass along this information to the readers of your excellent magazine.

JOSEPH F. MORGAN

Assistant to Director,  
Radio Liberty Network,  
New York, New York

Steam is really water, but the temperature does make a difference! We're glad to set the record straight concerning the "260-year-old" tube.—Ed.

DEAR EDITOR:

I look forward each month to the next issue of BROADCAST ENGINEERING, finding it a much needed source of broadcast engineering and technical information. Since most of it is an excellent reference source, I would like to see you make binders available to properly retain complete yearly issues. Keep up the good work.

CHARLES E. CLARK

Chief Engineer, WMOA,  
Marietta, Ohio

Thanks for the kind words, Mr. Clark, and for the suggestion. We've been planning to offer binders soon; watch B-E for an announcement.—Ed.

DEAR EDITOR:

Regarding your answer in the "Chief Engineer" section of the January 1965 issue of BROADCAST ENGINEERING, I would not place any signs on a tower without first consulting the tower manufacturer regarding wind and ice loading.

C. W. MASON

Chief Engineer, KFI,  
Los Angeles, California

The question Mr. Mason is referring to and the "Chief Engineer's" answer were confined to those physical and electrical deviations in the tower characteristics that might lead to noncompliance with the FCC Rules and Regulations. The structural characteristics of the tower must also be taken into account when any sizeable mass is added—if they are not, a most embarrassing situation may result, and the station engineer will have need of the article appearing on page 13 to this issue.—Ed. ▲

### Broadcast Engineering

Vol. 7, No. 4

April, 1965

**EDITORIAL:** Editor, Forest H. Belt; Managing Editor, James M. Moore; Associate Editor, Allen B. Smith; Washington Correspondent, Howard T. Head.

**CIRCULATION:** Manager, Pat Tidd; Assistants, Katherine Krise and Cora LaVon Willard.

**PRODUCTION:** Manager, Esther M. Rainey; Art, Louis J. Bos, Jr.; Photography, Paul A. Cornelius, Jr.

**ADVERTISING:** Sales Manager, Hugh Wallace; EAST—Gregory C. Masefield, Howard W. Sams & Company, Incorporated, 3 West 57th Street, New York, N. Y., Phone MU 8-6350; MIDWEST—Robert N. Rippy, Howard W. Sams & Co., Inc., 4300 West 62nd Street, Indianapolis 6, Ind., Phone AX 1-3100; SOUTHWEST—C. H. Stockwell Co., 4916 West 64th Street, Mission, Kansas, Phone RA 2-4417; LOS ANGELES 57, CALIF; Maurice A. Kimball Co., Inc., 2550 Beverly Blvd., Phone DU-8-6178; SAN FRANCISCO, Maurice A. Kimball Co., Inc., 580 Market Street, Phone EX 2-3365; PARIS 5, FRANCE, John Ashcraft, 9 Rue Lagrange, Phone OD 20-87; LONDON W.C. 2, ENGLAND, John Ashcraft, 12 Bear Street, Leicester Square, Phone WHITEHALL 0525; TOKYO, JAPAN, International Media Representatives, Ltd., Kisha Kurabu 14, 2-chome Marunouchi, Phone (502) 0656.

BROADCAST ENGINEERING

# WHAT TO DO IN TOWER EMERGENCIES

by **George M. Sklom**, Associate,  
Walter F. Kean, Consulting Radio  
Engineers, Riverside, Illinois—The station  
engineer can be prepared for that  
"once-in-a-lifetime" emergency.

This article is offered as a guide to those people in charge of standard broadcast stations who experience antenna trouble which prevents normal operation. The necessary steps required to "stay legal" in the eyes of the governmental agencies concerned, the Federal Communications Commission and the Federal Aviation Agency, will be discussed, and an attempt to provide useful technical remedies will be made.

## Rules Compliance

The Rules and Regulations of the Federal Communications Commission require that knowledgeable operators be in charge of broadcast stations so that the licensee can meet his obligation to operate the station properly in the "public interest, convenience, and necessity." That part of the obligation to operate in the "public interest" requires the operator to return to normal operation as soon as possible after an emergency and to choose intelligently the mode of temporary operation to prevent unnecessary interference. The obligation to operate the facility for the public "convenience and necessity" requires that in case of emergency some means be employed

to continue to render broadcast service to the area.

Perhaps one of the most often neglected duties in time of antenna malfunction is notification to the Federal Communications Commission in accordance with Section 73.57 of the Rules and Regulations. Upon determination that the trouble cannot be corrected in a matter of a few minutes, the Commission should be notified. The Washington and District Commission offices should be informed of what the

problem is, the temporary mode of operation being utilized, and an estimate of the time necessary for return to normal operation. Of course, when repairs have been made, the Washington and District offices should be notified of that fact also.

In the case of tower collapse, or even failure of AC to the tower, another important notification must be made to the Federal Aviation Agency. In Part 17 of the Rules and Regulations (Construction, Marking, and Lighting of Antenna Struc-

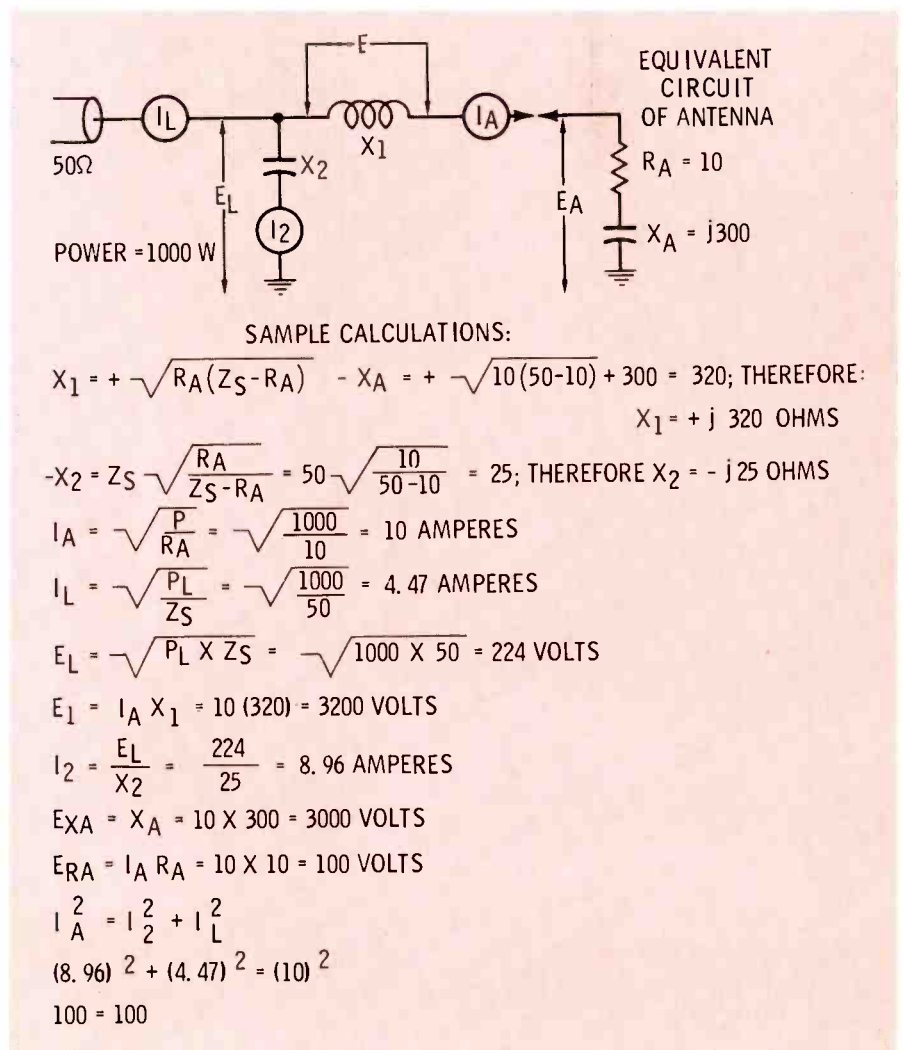

Fig. 1. Sample calculations showing the high reactive voltages for a tower stub.

## Editor's Note

The tower at a broadcast station is usually taken for granted. It stands day after day, through fair weather and foul—usually. But any number of misfortunes can befall the antenna system of an AM station. These can range from a defective component in a tuning unit to the complete collapse of a tower.

To show that such emergencies really happen—and what to do about them — BROADCAST ENGINEERING in this issue presents two articles on this subject. Beginning on this page, George Sklom gives a practical discussion of "What to Do in Tower Emergencies." Then beginning on page 28, Len Spencer tells how the emergency was handled when a tower did fall at CKAC.

tures), Section 17.37(b) requires that the licensee:

... shall report immediately by telephone or telegraph to the nearest Flight Service Station or office of the Federal Aviation Agency any observed or otherwise known failure of a Code or rotating beacon light or top light not corrected within thirty minutes, regardless of the cause of such failure. Further notification by telephone or telegraph shall be given immediately upon resumption of the required illumination.

The purpose of the transmitter and maintenance log is to show technical operation of the station, and any periods of abnormal operation should be shown therein. To many it may seem unnecessary to mention this, but many operators seem to think that equipment failure testifies to weakness on their part and fail to log abnormal operation. In order to protect the licensee, and therefore you job, "stay legal." Notify the FCC and the FAA if necessary, and log actual operation.

### Tower Collapse

Even in the event of a tower collapse, some interim operation must be employed as soon as possible to finish the broadcast day. The problem will be examined for stations employing either directional or nondirectional antennas.

### Nondirectional Antennas

If a stub of the tower, 50' or more, remains, you will probably get

on the air more quickly by trying to feed the remaining portion of the tower than by using a horizontal wire. It will be necessary to operate at low power due to the high reactive voltages that may exist, as shown in the sample calculations of Fig. 1. The tower base will exhibit low resistance and high capacitive reactance—approximately 10 ohms resistance and 300 ohms reactance, depending upon frequency. In such a case you will have to make drastic modifications in the antenna matching circuit, using the components in the tuning unit and perhaps whatever else you can find. Methods of estimating the matching-circuit component values will be discussed later in this article.

You will have to resort to a horizontal wire antenna if you have lost the entire tower or to allow reconstruction of the original tower. You should attempt to get .25 wavelength of wire as high above the ground as possible; keep in mind the danger of injury to persons coming in contact with the wire, and be sure to place the antenna out of reach. Also remember that for horizontal wire antennas measuring between .25 and .5 wavelength the maximum radiation is broadside to the wire. Consider the position of the most important service area, and orient the wire accordingly if possible. Matching this type of antenna also will be discussed in a later portion

of this article.

Whatever antenna is used, the ultimate check on the adjustment of the matching network is maximum antenna current, so it is necessary to place a meter in series with the antenna. The power that can be run depends on the antenna, the adjustment of the matching network, and the transmitter. Power will have to be determined by the indirect method set forth in Section 73.52 of the Rules and Regulations. When the matching network is adjusted properly, the transmitter will tune up near the normal values of plate voltage and current. State the amount of DC input in the notice to the Commission.

### Directional Antennas

If the station uses a directional antenna and the tower problem has destroyed all licensed patterns, you will have to go nondirectional. Of course, if the tower in which the problem exists is idle in one normal mode of operation, operate the remaining licensed pattern. Remember not to exceed the power limitation for whatever mode of operation you choose. For instance, if the station is licensed to operate with 5 kw day and .5 kw night and you are forced to use the night pattern during daytime hours, don't get excited and apply 5 kw to .5-kw components and meters.

It is necessary to use judgment in

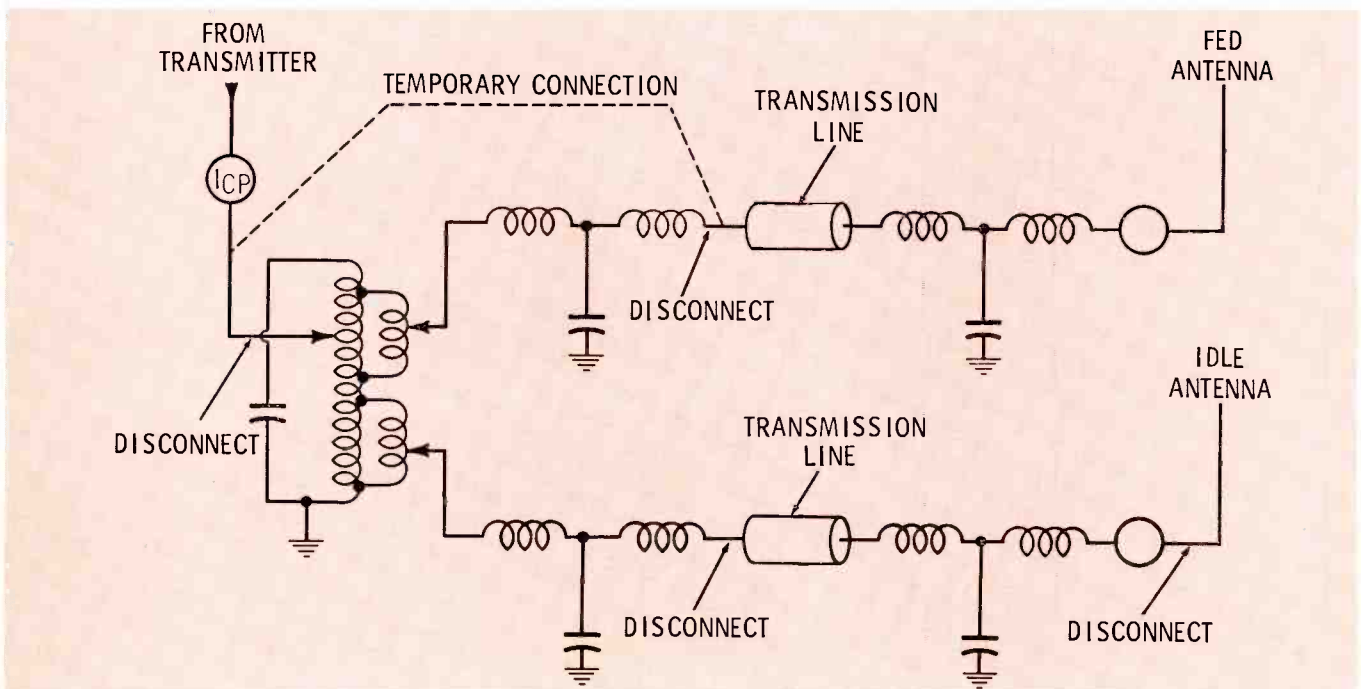

Fig. 2. Modifications made to antenna matching circuit permit feeding power to a remaining tower in a directional array.

choosing the interim power in cases of emergency. In no case should you exceed the normal licensed power. Of course, it is desirable to operate with enough power to render service to your primary community, but keep in mind the protection function of the directional antenna. When operating in the nondirectional mode, do it with as little power as is reasonable. In any case, evaluate the channel conditions as best you can, make your decision, and tell the FCC what you are doing. The Commission will certainly consider the interference you may be causing and suggest alternative measures if it feels them necessary.

Where it is necessary to go nondirectional at a normally directional station, the phasor may be bypassed as shown in Fig. 2. Towers that are left standing and are not fed should be "floated" if approximately .25 wavelength and grounded if approximately .5 wavelength. Attempt to go nondirectional using the tower which was used for nondirectional operation at the time of the antenna proof of performance (provided, of course, it is not the defective one). The proof-of-performance report should also show the original nondirectional circuit, so try to reproduce it. Adjustment of the matching circuit in this case is the same as that to be discussed for a nondirectional station.

### Defects Without Collapse

A change in impedance of some component of the antenna tuning circuit or the antenna itself can upset the operation as much as a fallen tower. In a nondirectional operation, the cause of impedance change can usually be tracked down to the transmission line, a component in the antenna tuning unit, the base insulator, guy insulators, lighting chokes, or FM or TV transmission-line isolation sections. At a directional station, the same possibilities for trouble exist along with a few more, such as sample-line isolation coils, power-dividing tank, and transmission-line phase shifter—and a greater number of towers is involved. Whatever the cause, until the problem is corrected and the circuit impedance returned to normal, temporary antenna measures must be utilized just as in the case of a tower collapse.

### Matching the Antenna

If you are forced to use a horizontal wire antenna, you are going to have to do some simple calculations and a lot of guessing. The number of feet per wavelength can be determined by dividing 984 by the frequency in megacycles. The length of a quarter-wave antenna can be determined by dividing 246 by the frequency in megacycles and multiplying the result by .95 to correct for the "end effect," or capacitance added to the system by the insulators.

The impedance at the feed point will be greatly affected by the way in which the antenna is positioned—primarily by height above ground. Radiation resistance generally increases linearly with height above ground to approximately .25 wavelength. Typical values are about 30 ohms resistance and 30 ohms capacitive or inductive reactance. First

connect the end of the wire antenna directly to the transmitter output terminal and tune for resonance. If this is not successful, attempt feeding the wire antenna at the antenna tuning unit using the components of the tuning unit and even the transformation action of the transmission line as a matcher. A word of caution concerning the RF line-current meter on the transmitter: The impedances to be encountered are unknown; therefore, let the overload relay protect the transmitter final, and keep your eye on the RF line meters to avoid burning them out. There is nothing so disconcerting as to try and then abandon several matching attempts before stumbling onto the fact that the first attempt disconnected the load from the transmitter by burning out the meter.

While the impedance of the horizontal wire or the stub of a par-

• Please turn to page 80

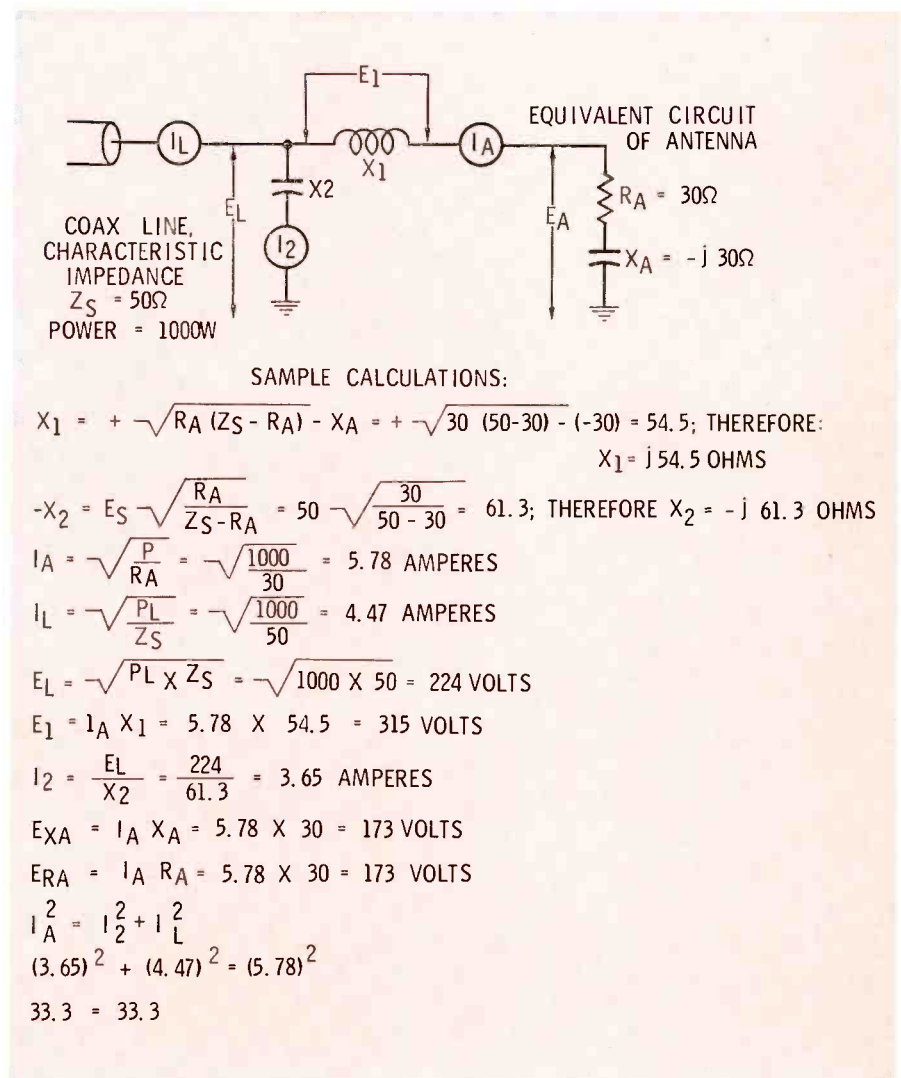

Fig. 3. Matching network, calculations for a 1/4-wave horizontal wire antenna.

# WIRELESS MICROPHONES

by Ray L. Fetterman, Markham, Illinois—Improved wireless pickup equipment can simplify the job which faces engineers on many remote productions.

Many situations requiring highly mobile audio-pickup equipment for radio, live television, and filmed productions have confounded broadcasters and cameramen for years. They have strung cables, suspended microphones from long, ungainly booms, and even tried a few wireless microphones, most of which have been only marginally useful, from time to time. Chances are, however (unless you've investigated wireless systems recently), you'd be surprised to learn that solid-circuit techniques and miniaturized components have made a quite a difference in the quality and reliability obtainable from FM-wireless microphones.

Experience gained in the motion-picture industry (where huge indoor sets and outdoor location scenes require highly sophisticated sound

techniques) has enabled a few manufacturers to perfect wireless-microphone equipment which can make production of special events a much simpler task. To do this, they had to overcome several problems which have slowed general acceptance of these special-purpose pickups.

## Development

In earlier days, for example, a pickup apparently perfect in all respects would suddenly fade or suffer audio distortion far beyond that which the engineer could control from the mixer panel. One transmitter designed specifically for fully concealed wireless-microphone applications might function perfectly for one individual (on a certain day!) whether he hand-held the microphone or concealed it on his person; the same unit might fail

miserably when used by another individual due that old bugaboo . . . body capacitance! Other factors which create headaches for the wireless-microphone user are temperature and humidity variations (especially on location), static-producing high-tension lines, fluorescent lights, automobile - ignition noise, and RF interference from other transmitters. Temperature variations can detune an unstable transmitter unexpectedly; the other factors will, of course, interfere with the received signal.

Some early units transmitted in the standard broadcast band (540 kc to 1600 kc). These systems, quite understandably, didn't work out too well. Too often, a powerful AM station's signal would boom in over the system and completely block reception of the remote pickup. Soon after, however, most manufacturers switched to FM transmission in one of two bands: 25 to 45 megacycles or 88 to 108 megacycles (entertainment band). During the early development of wireless microphone transmitters, only Mil-Spec semiconductors and miniaturized components were of high enough quality to ensure success in applications where stringent size and stability requirements are paramount. Limited availability and the high cost of these components usually ruled out most of the more dependable ones. Today, however, the price and availability of semiconductors and other essential components lend themselves to the design of units which will provide fade-free, drift-free transmission of audio signals. The rapid development of microcircuitry is even more encouraging. Sizes of the concealed transmitters and of self-contained lavalier-style transmitter/



Fig. 1. Hand-held mike has integrally mounted telescoping antenna system.





Fig. 2. Setup of several receivers used for political or indoor sports coverage.

microphone packages can be reduced without sacrifice of operating performance.

#### Equipment Available

Most wireless-microphone transmitters are packaged within the body or case of a standard lavalier microphone, or in a separate unit which will accept plug-in pickups. A few of the separate-case models feature built-in microphones, but these are not recommended for professional service, except for nightclub entertainment use or public address.

Telecasts and radio broadcasts of most special events, news programs, panel shows, interviews and the like, do not require microphones which must be concealed. What they do require are units which have no cables to impede the movements of the newsmen, MC's, or guests. In these applications, the self-contained lavalier-type wireless microphone is the ideal solution. One well-known West Coast firm produces two versions of a self-contained microphone-transmitter unit. These units are FCC approved and operate at frequencies in the 25-mc to 45-mc band. Their standard model is a lavalier unit 1" in diameter and 5" long. The microphone itself is a dynamic type having an acoustic response of 80 cps to 14,000 cps. Complete with mercury battery, it weighs only seven and a half ounces. A neck cord and/or waist cord function also as the an-

tenna for efficient transmitter operation. Their hand-held wireless microphone (see Fig. 1) is  $\frac{3}{8}$ " longer than its lavalier counterpart and has a telescoping whip antenna mounted integrally. If greater range is required, there is also available a helmet which has a longer whip antenna attached to the crown. Several versions of the hand-held and lavalier microphones may be seen, from time to time, on various telecasts. These units employ sensitive FM receivers (shown in operation in Fig. 2) to round out the system. Sensitivity is on the order of 1.5 microvolts, or better.

Many small microphones avail-

able today will meet the requirements of the recordist and the audio engineer. Most are of the dynamic type and are available in high-, low-, or adjustable-impedance types and cover the audio-frequency range demanded by the filming industry as well as by broadcasters. In some instances, ultra-small magnetic and crystal microphones have to be employed for the sake of maximum concealment. These units can be concealed in brooches, necklaces, or boutonnieres worn on the person of a performer. These types should be considered only where maximum concealment is required (in dramatic programs, for example), as their frequency-response range seldom exceeds 100 cps to 5000 cps.

The size of most separate-case wireless microphones approximates that of a pack of king-sized cigarettes. Fig. 3 shows a transmitter unit of this configuration which is satisfactory for many applications. Small as they are, these still present problems when it comes to concealment in tight-fitting costumes or athletic attire, or on the person of a woman. Faced with this problem, an independent motion-picture company in California has developed an ideal transmitter/battery-package unit. The transmitter case and the separate battery pack are each the size of a "flip-top" cigarette lighter, and yet there is no sacrifice in the quality of the audio signal

• Please turn to page 79.

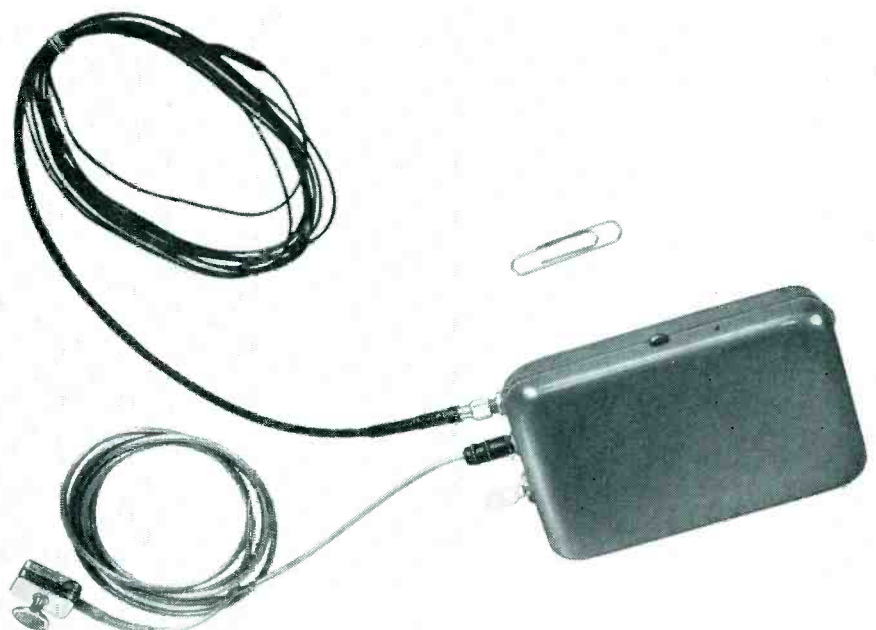

Fig. 3. Typical cigarette-pack-sized transmitter uses buttonhole microphone.

# MULTIPLE FUNCTION REMOTE CONTROL PAIR

by **L. C. Sandlin**, Chief Engineer,  
KWHK, Hutchinson, Kansas —  
Economy in the use of line facilities  
can be realized by appropriate  
arrangements of diodes and relays.

Although a relatively simple device, the relay can form the basis of systems that perform relatively complicated functions. Over the years, the number of such applications has steadily increased. One such interesting and useful circuit will be described here.

## Control Circuit

Fig. 1 shows the basic principle which permits eight functions to be obtained with a single telephone pair, four diodes, and four relays. The following sequence explains the biasing and connections required to obtain those eight functions. In the first six steps, the bias polarity is with reference to ground (which also provides the return path).

1. With a positive voltage applied to the top side of the phone line, diode X1 is forward biased, and relay K1 is energized.
2. With a negative voltage applied to the top side of the line, diode X2 is forward biased, allowing relay K2 to be energized.
3. With a positive voltage applied to the bottom side of the phone line, diode X3 is forward biased, energizing relay K3.
4. With a negative voltage applied to the bottom side of the line, diode X4 is forward biased; K4 is energized.
5. With the two wires of the phone line connected together and a positive voltage applied, diodes X1 and X3 are forward biased, and relays K1 and K3 are energized.
6. With the two wires of the phone line connected together and a negative voltage applied, diodes X2 and X4 are forward biased, K2 and K4 are energized.
7. With a positive voltage applied to the top side of the phone line

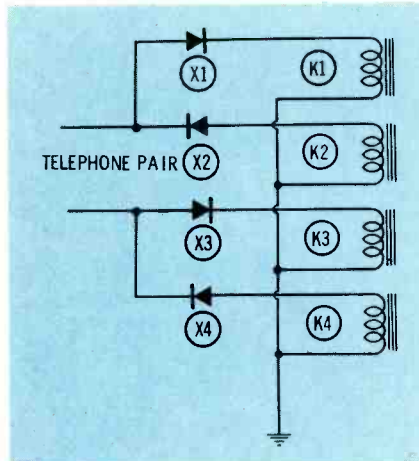

Fig. 1. Basic relay and diode connection.

8. With a negative voltage applied to the top side of the phone line and a positive voltage to the bottom side, diodes X2 and X3 are forward biased, and K2 and K3 are energized.

Each relay thus operates under three different sets of conditions. It is now necessary to be sure each relay operates its associated circuit during only one of these three movements. A series of counter-checks makes this possible.

When switch S1 (Fig. 2) is closed, a negative voltage is applied to relay K1 through wire W1 and diode X1. Relay K1 energizes relay K5; a pair of normally open (NO) contacts of K5 then closes to complete the circuit from terminal 1 of the terminal board through normally closed (NC) contacts on relays K7 and K8 to terminal 2.

Switch S2 applies a positive voltage through wire W1 and diode X2 to relay K2. Relay K2 energizes relay K6. The NO contacts on relay

K6 close to complete the circuit between terminals 3 and 4 of the terminal board, through NC contacts on relays K7 and K8.

Switch S3 applies a negative voltage through wire W2 and diode X3 to relay K3. Relay K3 energizes relay K7. NO contacts on relay K7 then complete the circuit between terminals 5 and 6 of the terminal board, through NC contacts on relays K5 and K6.

Switch S4 applies a positive voltage through wire W2 and diode X4 to relay K4. Relay K4 energizes relay K8. NO contacts on relay K8 close to complete the circuit between terminals 7 and 8 of the terminal board.

Three-pole switch S5 applies a negative voltage simultaneously through wires W1 and W2 to relays K1 and K3. The closing of relays K1 and K3 closes relays K5 and K7 and results in completion of the circuit between terminals 9 and 10 of the terminal board. When relays K5 and K7 close, they protect the first circuits called for by switches S1 and S3 since the NC contacts have now been opened.

Switch S6, also a three-pole type, applies a positive voltage through wires W1 and W2 to relays K2 and K4. Relays K2 and K4 operate and cause relays K6 and K8 to pull in and complete the circuit between terminals 11 and 12 of the terminal board.

In this case also, the circuits closed by K6 and K8 individually (between terminals 3 and 4 and terminals 7 and 8, respectively) remain open due to the opening of NC contacts on these relays.

Switches S5 and S6 must be adjusted to assure that the contacts to wires W1 and W2 make before the contact to ground. One of the "hot"

contacts is likely to close before the other, and if the ground return is completed first, a function assigned to one of the double-pole switches will be performed.

Switch S7 makes wire W1 negative with respect to wire W2. Application of this voltage closes relays K1 and K4, which in turn close relays K5 and K8. The latter relays open the circuit between terminals

13 and 14 of the terminal board. These two relays protect the previously described circuits by opening NC contacts.

Switch S8 makes wire W1 positive with respect to wire W2. This causes relays K2 and K3, and therefore relays K6 and K7 to operate. The circuit between terminals 15 and 16 of the terminal board is thus opened. The circuits previously

described are protected by the appropriate relay contacts.

Any of the terminal pairs 1-2 through 11-12 can be used to actuate a relay connected in a manner similar to that used for K9. Terminal pairs 13-14 and 15-16 can be used to open the coil circuit of a latching-type relay.

• Please turn to page 84

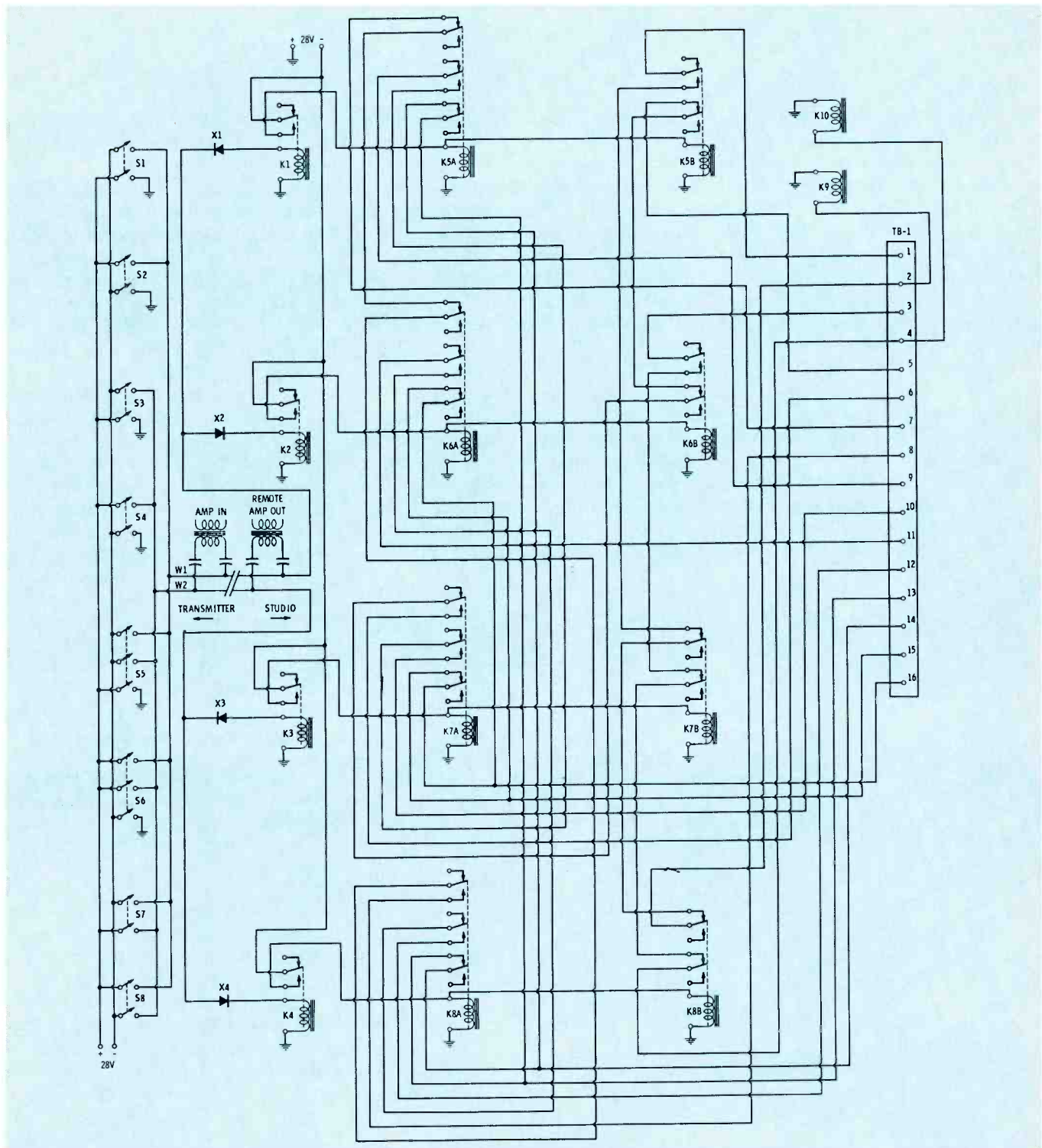

Fig. 2. Arrangement of relays, diodes, and switches used at KWHK provides control of eight functions over a single telephone pair.

# RF POWER MEASUREMENTS

by Patrick S. Finnegan, Consulting Author, Chief Engineer, WLBC AM-TV, WMUN FM, Muncie, Indiana — Some methods to use to assure compliance with the Rules and license provisions concerning station power.

All broadcast stations are authorized to operate with a definite power output that will enable them to provide the necessary service without causing objectionable interference to other stations. Since the FCC prescribes specific tolerances for the operating power, some accurate power-measuring means must be employed not only in the original setup but also in day-to-day operation. The FCC Rules require that instruments of known accuracy be permanently installed or readily available and that checks be made at prescribed intervals and, in some instances, in a prescribed manner.

The power-measurement equipment and techniques used at a given station are influenced by the car-

rier frequency, power, type of modulation, and service. In television and FM broadcasting, high-gain antennas and long transmission lines are used. In these services, power measurements must be based in part on manufacturers' stated gain and loss figures for the antenna and transmission line. Less indirect methods are possible where standard broadcast stations are involved.

Even though normal readings from accurately calibrated power-measuring instruments are logged at prescribed intervals, the operator cannot assume the signal is reaching the desired service area. The efficiency of the radiating system is a major factor in determining how much of the transmitter power is

actually reaching the service area. Gradual deterioration of the radiating system can result in reduced efficiency. One good example of such deterioration came to light in recent years when most of the class IV AM stations increased their power. The FCC required a new determination of the antenna base resistance before a modified license was issued. Many of these stations discovered that the base resistance had changed, and they were actually radiating less power than was supposed. The only way to be absolutely sure of the amount of power being radiated is to make field-strength measurements. Those stations with directional antennas are required to make a number of field-strength measurements periodically. Although the number of points measured does not constitute a complete survey, the readings are still useful in observing the efficiency of the radiating system.

## AM Power Measurements

Standard AM stations are normally required to use the direct method of power measurement. In order that this method may be used, the antenna resistance at the base of the tower must be determined and the RF current at this point measured. The power is then computed by multiplying the resistance by the square of the current.

The antenna-current meter must be installed permanently at the same point where the antenna resistance was measured (Fig. 1). This point must be electrically adjacent to the tower; nothing else is permitted between the meter and the antenna except the lead itself, which

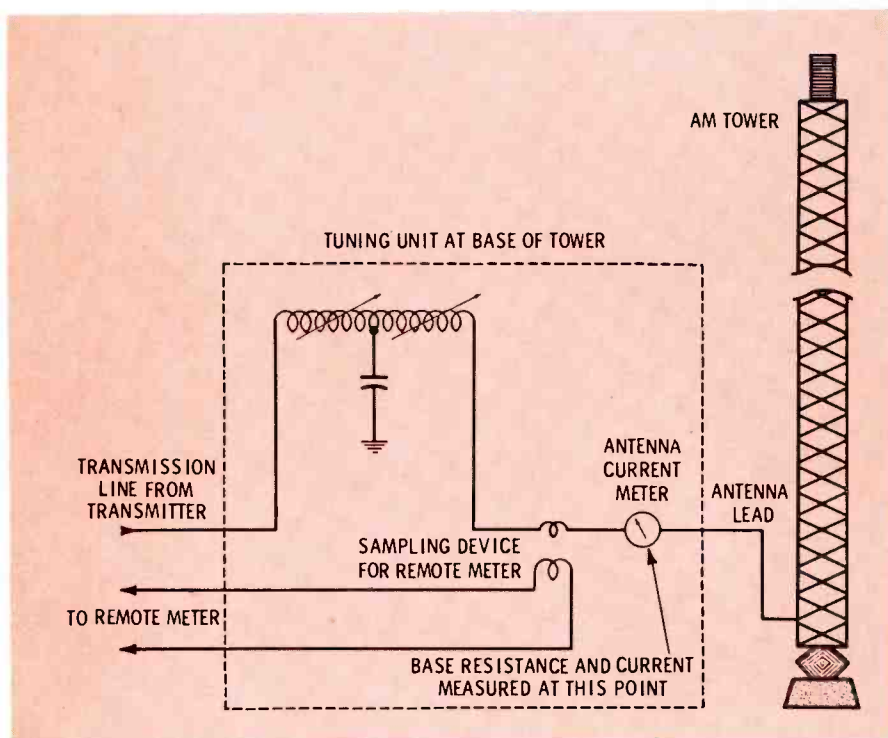

Fig. 1. Location of the antenna-current meter in the feed system of an AM tower.

becomes part of the antenna. This requirement is necessary to insure that no variable quantity, such as an adjustable coil, can be introduced to change the antenna resistance. When installing a sampling device for a remote antenna-current meter, it is important to be sure the sampling device is on the transmitter side of the permanently installed antenna meter.

Thermocouple RF ammeters are required for measuring antenna current. Each meter must meet certain specifications enumerated in the FCC Rules—length of scale, accuracy, number of divisions, etc. Citations have been issued in cases where the station engineer had replaced a burned out antenna current meter with one that did not meet the FCC specifications.

When a station uses a different power for day and night operation, it is more convenient to use an expanded-scale meter so that both currents may be read accurately on a single meter instead of using two different meters. The FCC permits the use of an expanded-scale meter, providing it meets the requirements established for such meters.

A directional antenna array is treated as a complete radiating system; therefore, power is measured at the common input point of the system (Fig. 2). Readings of the various base currents, sampling currents, and phase differences are necessary so that the system can be adjusted initially for the proper pattern and kept in adjustment thereafter. To compensate for losses in the directional-antenna system (including lines, etc.), the Rules specify that 92.5% of the measured common-point resistance must be used in computing power for stations having transmitter powers of 5 kw or less and 95% of the common-point resistance must be used for stations of greater than 5 kw transmitter power.

While all standard broadcast stations are normally required to use the direct method of power measurement, there are a few instances in which the indirect method must be used. For example, changes in the antenna may be in progress, or the antenna meter may be burned out when no spare is available. During such a temporary emergency

period, power is computed by multiplying the product of plate voltage and plate current of the output stage times an efficiency factor given in the Rules. The numerical value of this factor depends on the method of modulation, the class of output stage, and the transmitter output power. The specified factor must be used, even though the power computed in this way may be less than normal because the particular transmitter may be capable of a better efficiency than that given in the Rules. When all operating conditions are normal except for a defective antenna ammeter, there is often a strong temptation to continue operating the transmitter with the input power that was in use before the meter failed. Should the Radio Inspector observe such operation, the station will be cited for a technical violation unless the normal efficiency is the same as the efficiency specified for indirect power determination.

The output power must be maintained between the limits of 5% above and 10% below the licensed value. The antenna current must be read without modulation. Since the antenna meter is a thermocouple type, the meter indication is a result of the heating effects of the RF current. Such meters inherently introduce a delay between the time the antenna current changes and the time at which the meter reading changes correspondingly. Modern programming techniques leave few pauses in which to take readings.

There are two simple techniques that can be used to enable the operator to determine at a glance

whether the power output is within tolerances. The meter may be ordered with special red marks for the three points: 10% low, normal, 5% high. As an alternative, the values of current for each of these points may be calculated and typed on a card posted next to the meter.

### FM Power Measurements

FM stations have the option of using either the direct or indirect power measurement method. Only in recent years has equipment become available to make direct power measurements practical, however, and older transmitters use the indirect method. Most of the older transmitters have meters to monitor output power, but these instruments can not be calibrated accurately and, therefore, serve only to indicate that RF is present.

Power is computed by the indirect method the same as for AM; that is, the power is equal to the product of plate voltage, plate current, and an efficiency factor. The efficiency factor is established by the manufacturer of the transmitter and is published in the instruction book.

Modern transmitters have built into them one or more directional couplers, detectors, and a meter so that the system may be calibrated to indicate transmitter output power accurately. The directional coupler is basically a small loop inserted into the transmission line at the transmitter output in such a manner that it will sample only the forward or reflected wave. The unit is designed to affect the system

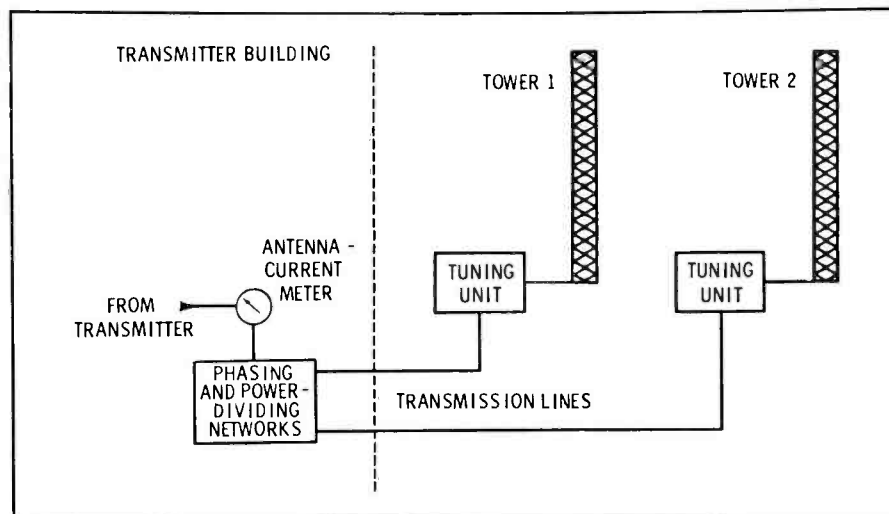
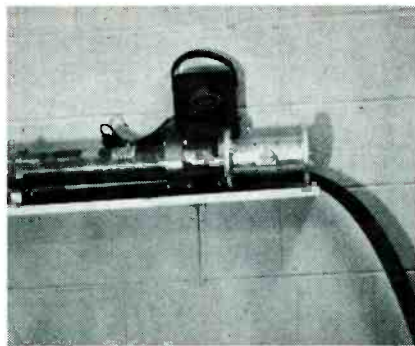

Fig. 2. Measurement of antenna current at common point of directional antenna.



(A) 15-kw water-cooled unit



(B) 1.5-kw UHF air-cooled unit

Fig. 3. Two types of dummy loads used in measuring the power of TV transmitter.

VSWR as little as possible. The sampled voltage is rectified by a crystal or tube rectifier, and the rectifier output is read on a meter. The use of two directional couplers inserted in the line, one sampling forward and the other reflected power, permits monitoring VSWR with the output meter.

Directional couplers may be either fixed or adjustable. Those that can be adjusted are provided with markings to show depth of penetration and some means of indicating the correct positions for sampling the forward or reflected voltage. Locking devices are also incorporated to prevent accidental movement after adjustments have been made.

Before any combination of devices may be used to indicate power output accurately, it must be calibrated. Calibration is not difficult, providing an accurate wattmeter and dummy load are available. The

dummy load must have zero reactance, and its resistance must be equal to the surge impedance of the transmission line. It must also be capable of absorbing the full transmitter output power continuously.

After the dummy load has been connected in place of the transmission line, the transmitter should be adjusted for full licensed power output into the dummy load as read on the wattmeter. The measurement must be made with no modulation. With full power indicated on the wattmeter, the transmitter reflectometer should be adjusted to read 100% and the calibrating controls locked. As a further check on the reflectometer and diodes, transmitter power should be adjusted to 90% and 105% of the licensed value and an observation made of how well the reflectometer tracks with the wattmeter.

After all calibration is done and the locking devices have been set,

the plate voltage and plate current of the output tube or tubes should be recorded. This provides an accurate measure of transmitter efficiency because both the input and output power have been read at the same time and under the same conditions. Transmitter efficiency in per cent is equal to 100 times the quotient of the output power divided by the input power.

### TV Power Measurements

Television power output measurements are somewhat more complicated than those for AM or FM. Two transmitters are involved, each having a different method of modulation and each with a different licensed output power.

### Aural Transmitter

The power output of the sound transmitter may be determined by either the direct or indirect method. The method of measurement is basically the same as for FM transmitters, but there are a few differences.

Output power is measured at the point immediately following the diplexing unit used to feed the two transmitters into one transmission line. These units contribute some power loss—as much as 10% of the transmitter output at UHF. Because of the losses, the transmitter must produce more power than the actual power input to the transmission line. When using the indirect

• Please turn to page 82

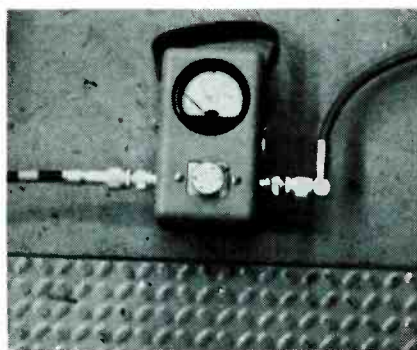

Fig. 4. Wattmeter in typical test setup.

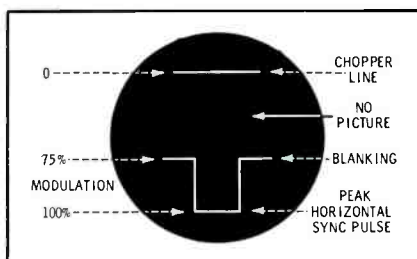

Fig. 5. Content of standard black picture.

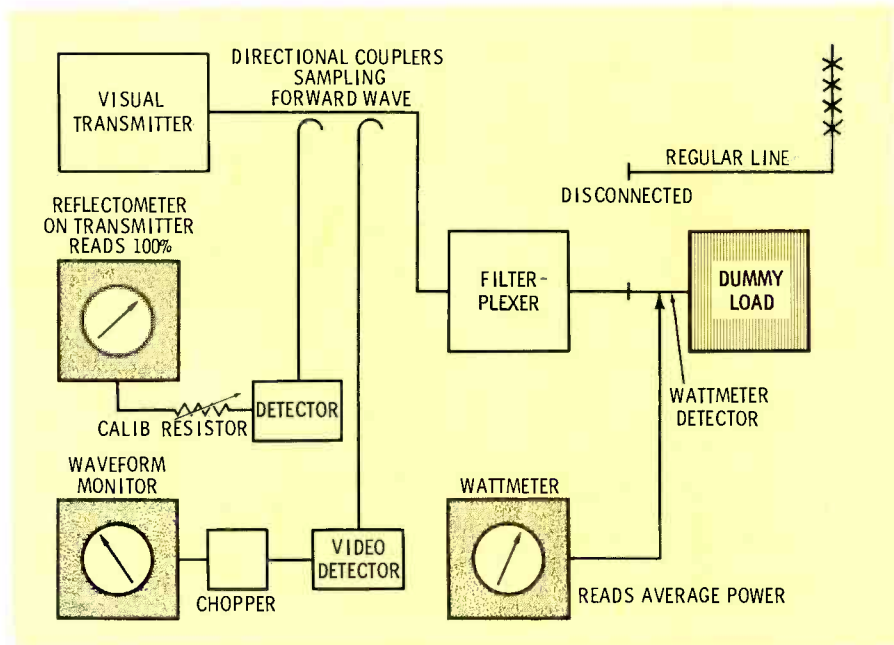

Fig. 6. Equipment arrangement used for direct measurement of TV output power.

# PART 73 AND THE BROADCASTER

by Lawrence L. Prado, Jr.,  
Chief Engineer, WWNH, Rochester,  
New Hampshire—Some practical  
hints to help the broadcaster comply  
with the Rules and Regulations.

The broadcast industry operates within a framework of certain technical rules, regulations, and standards which serve as guides for a vigorous and flourishing system of broadcasting. These standards are constantly in a state of modification or revision as the state of the art develops; as new techniques are introduced, standards are reappraised and rewritten to reflect new thinking.

Volume III, Part 73, of the FCC Rules and Regulations contains the technical requirements necessary for the operation of broadcast stations in the public interest. Yet, how many currently licensed radio stations have on hand an up-to-date copy of Part 73? Volume III, which includes part 73, may be obtained from the Superintendent of Documents, U. S. Government Printing Office, Washington, D. C. The price is \$4.50. With this purchase, revised pages are sent periodically over an extended period until a complete revision is made and it is necessary to renew the subscription. Transmittal sheets sent with the revisions give complete instructions as to what copy to remove and replace. To avoid confusion, the new pages should be inserted in their proper places as they are received.

Having a current copy of Part 73, however, doesn't mean that station operation is in compliance with the Rules. Many station owners, managers, and engineers rarely consult the Rules and Regulations on so-called "minor" matters. Inspection by the FCC usually discloses various conditions of noncompliance, some minor, others serious enough to result in an official citation.

## Logging

Are you operating in compliance with current rules and regulations?

Examine the Operating Log and the various entries made over an entire broadcast day. Does the log indicate that the EBS receiver was tested and found to be satisfactory prior to putting the carrier on the air? Does this same log indicate the time the carrier was put on the air? Most logs are accurate in this respect; however, many fail to indicate the time modulation (program) commenced. Procedures vary from station to station, but it is common to apply power to the filaments approximately 30 minutes before air time. This is called the warm-up period and should be entered on the log as such. At the same time power may also be applied to the various monitors and amplifiers,

and, in a combo-type operation, the news machine may be cleared. This is also the time to test the control-room microphone, turntables, tape-cartridge units, and the like.

About 10 minutes before actual air time, the carrier should be put on the air without any modulation. Some stations find it is necessary to conduct an audio-tone test prior to actual sign on. If this is done, it should be recorded in the log. The actual headings or log layout should indicate the entire opening procedure in some convenient manner. A sample of such a log is shown in Fig. 1. Of course, no log is perfect, and what is suitable for one station may not be desirable

SAMPLE		W W N H		930 KC		5 KW	
Rochester, New Hampshire		TRANSMITTER LOG		Base Currents and Pattern Changes			
Day	Monday	Date	January 6, 1964	Tower	Day	Night	Time
Opr.	John A. ...	On Duty	6:55	Off Duty	6:25	Lic No.	P-1-1002
Opr.	John A. ...	On Duty	7:30	Off Duty	1:00	Lic No.	P-1-1002
Opr.	John A. ...	On Duty	1:00	Off Duty	4:00	Lic No.	P-1-1002
Pgm On		6:25	Pgm Off	2:30	Wx-Temp	Clear	64°
Mon Points		68.5V	231V	3.1mv	248.5V	2.1mv	266V
Measured by		John A. ...	Ch. Eng.	Time	1:50	1:33	

Time	PA Ep Volts	PA Ip Amps	Ant or Icp Amps	Freq Dev Cps	MAGNITUDES			PHASE			REMARKS	
					1	2	3	1	2	3		
6:30	97.5	1.97	10.42	-1.2	0.1	12.7	0.1	0.1	0	0	0	Ante Filaments On - Base lights normal
6:50	97.5	1.98	10.42	-1.2	0.1	12.8	0.1	0.1	0	0	0	Ante Carrier On
6:55	97.5	1.98	10.42	-1.2	0.1	12.8	0.1	0.1	0	0	0	Adj. Filament - fact 1.5 Tr, 10.4 Icp, 5.8k - Note
6:58	97.5	1.98	10.4	-1.2	0.1	12.8	0.1	0.1	0	0	0	5:50 - All com lines, 7.8 per sec
6:59	97.5	1.97	10.4	-1.2	0.1	12.8	0.1	0.1	0	0	0	Adj. Filament 1.5 Tr, 10.4 Icp, 5.8k - Note
7:00	97.5	1.97	10.4	-1.2	0.1	12.8	0.1	0.1	0	0	0	Adj. Filament 1.5 Tr, 10.4 Icp, 5.8k - Note
7:05	97.5	1.97	10.4	-1.2	0.1	12.8	0.1	0.1	0	0	0	Adj. Filament 1.5 Tr, 10.4 Icp, 5.8k - Note
7:10	97.5	1.97	10.4	-1.2	0.1	12.8	0.1	0.1	0	0	0	Base lights off
7:15	97.5	1.97	10.4	-1.2	0.1	12.8	0.1	0.1	0	0	0	Base lights on
7:20	97.5	1.97	10.4	-1.2	0.1	12.8	0.1	0.1	0	0	0	Base lights on
7:25	97.5	1.97	10.4	-1.2	0.1	12.8	0.1	0.1	0	0	0	Base lights on
7:30	97.5	1.97	10.4	-1.2	0.1	12.8	0.1	0.1	0	0	0	Base lights on
7:35	97.5	1.97	10.4	-1.2	0.1	12.8	0.1	0.1	0	0	0	Base lights on
7:40	97.5	1.97	10.4	-1.2	0.1	12.8	0.1	0.1	0	0	0	Base lights on
7:45	97.5	1.97	10.4	-1.2	0.1	12.8	0.1	0.1	0	0	0	Base lights on
7:50	97.5	1.97	10.4	-1.2	0.1	12.8	0.1	0.1	0	0	0	Base lights on
7:55	97.5	1.97	10.4	-1.2	0.1	12.8	0.1	0.1	0	0	0	Base lights on
8:00	97.5	1.97	10.4	-1.2	0.1	12.8	0.1	0.1	0	0	0	Base lights on
8:05	97.5	1.97	10.4	-1.2	0.1	12.8	0.1	0.1	0	0	0	Base lights on
8:10	97.5	1.97	10.4	-1.2	0.1	12.8	0.1	0.1	0	0	0	Base lights on
8:15	97.5	1.97	10.4	-1.2	0.1	12.8	0.1	0.1	0	0	0	Base lights on
8:20	97.5	1.97	10.4	-1.2	0.1	12.8	0.1	0.1	0	0	0	Base lights on
8:25	97.5	1.97	10.4	-1.2	0.1	12.8	0.1	0.1	0	0	0	Base lights on
8:30	97.5	1.97	10.4	-1.2	0.1	12.8	0.1	0.1	0	0	0	Base lights on
8:35	97.5	1.97	10.4	-1.2	0.1	12.8	0.1	0.1	0	0	0	Base lights on
8:40	97.5	1.97	10.4	-1.2	0.1	12.8	0.1	0.1	0	0	0	Base lights on
8:45	97.5	1.97	10.4	-1.2	0.1	12.8	0.1	0.1	0	0	0	Base lights on
8:50	97.5	1.97	10.4	-1.2	0.1	12.8	0.1	0.1	0	0	0	Base lights on
8:55	97.5	1.97	10.4	-1.2	0.1	12.8	0.1	0.1	0	0	0	Base lights on
9:00	97.5	1.97	10.4	-1.2	0.1	12.8	0.1	0.1	0	0	0	Base lights on
9:05	97.5	1.97	10.4	-1.2	0.1	12.8	0.1	0.1	0	0	0	Base lights on
9:10	97.5	1.97	10.4	-1.2	0.1	12.8	0.1	0.1	0	0	0	Base lights on
9:15	97.5	1.97	10.4	-1.2	0.1	12.8	0.1	0.1	0	0	0	Base lights on
9:20	97.5	1.97	10.4	-1.2	0.1	12.8	0.1	0.1	0	0	0	Base lights on
9:25	97.5	1.97	10.4	-1.2	0.1	12.8	0.1	0.1	0	0	0	Base lights on
9:30	97.5	1.97	10.4	-1.2	0.1	12.8	0.1	0.1	0	0	0	Base lights on
9:35	97.5	1.97	10.4	-1.2	0.1	12.8	0.1	0.1	0	0	0	Base lights on
9:40	97.5	1.97	10.4	-1.2	0.1	12.8	0.1	0.1	0	0	0	Base lights on
9:45	97.5	1.97	10.4	-1.2	0.1	12.8	0.1	0.1	0	0	0	Base lights on
9:50	97.5	1.97	10.4	-1.2	0.1	12.8	0.1	0.1	0	0	0	Base lights on
9:55	97.5	1.97	10.4	-1.2	0.1	12.8	0.1	0.1	0	0	0	Base lights on
10:00	97.5	1.97	10.4	-1.2	0.1	12.8	0.1	0.1	0	0	0	Base lights on

Fig. 1 Sample operating log shows several entries fully describing each day's operation.

for another. Careful design and possible changes must be considered.

When the foregoing information has been recorded, is the station then in compliance? Not unless the operator or engineer has signed the log. Provisions should be made in the log for entering the license number of the operators or engineers if a combination of nondirectional and directional operation is used and third-class operators are employed. Readings of the final plate voltage, plate current, antenna current (remote metering is most common), and frequency deviation should be recorded when the carrier is applied. The 10-minute carrier-on period without modulation is used for this purpose and to make any necessary adjustments to the final stage to maintain authorized operating power. If it is necessary to adjust the PA plate voltage and/or plate loading to achieve this condition, it is necessary to make an entry to that effect in the operating log. Such an entry might read, "Adj PA loading for 1.30 Ip, 10.8 Iant, 5 kw-Day." Frequency-monitor deviation must be recorded (and must be within  $\pm 20$  cps of the assigned frequency). The condition of the tower lights must be observed and recorded.

Rubber-stamp logs are common, but common sense indicates that the readings should vary throughout a broadcast day. Section 73.113 states that all meter readings of the transmitter PA final-stage voltage and current, antenna current, common-point current, and sample-loop current magnitudes must be made without modulation. This section further states that all the readings shall be made **before** any corrections and/or adjustments are made to the equipment to obtain the appropriate normal operating values. Any such corrections must be entered in the operating log. Depending on the type of equipment, this may consist of adjusting the final PA plate voltage and/or the PA plate loading; perhaps both adjustments will be required. Some meters may also require recalibration. If the plate voltage is low due to line-voltage fluctuations, then it is likely that the filament voltage is also low. A suitable correction of the latter is to be desired, yet it is rarely done by third-class operators

because of lack of training.

The ever-present program log is another source of trouble for most stations. The fundamental problem is usually a lack of knowledge concerning what constitutes proper entries. Announcers must sign in and out, indicating the correct time. All entries must accurately describe what was broadcast. The present method of inspection by the FCC allows few loopholes: An hour or two of tape recording of actual air signal, plus timing, is conducted a few miles away from the station. When the inspector arrives at the station, the program-log entries are compared with his rough log and tape. What does one use for an excuse if a station break has been missed, yet logged? Keeping an accurate and current record is the best advice one could give concerning the program log.

Another common trouble involves station breaks or ID's. A station break is considered to be the airing of the call letters and location of the station. Section 73.117 requires that station breaks be made within 2 minutes of the hour and half hour (or 15 minutes past the hour and 45 minutes past the hour) for all regular programs. (Exceptions are listed for programs of a special nature—operators should be thoroughly familiar with all requirements).

Another serious problem that occurs in many stations is the blank operating period between shifts. Logs show that one person will sign out properly, say at 10:00 AM, but the relief man does not sign in until one-half hour later, at 10:30 AM. Both entries are properly made and in all respects do comply; however, a glance at the log indicates that no one was on duty for 30 minutes. A good method is to have the relief man sign in five or ten minutes before the shift change. This prevents (or should) minus-margin arrivals, allows an exchange of information as to possible program changes and the like, and makes for better employee harmony.

#### Operator Instruction

It isn't enough to hire an engineer or combo man with a valid license and give him a work or engineering schedule. Failure on the part of the station licensee to

properly instruct personnel usually results in noncompliance with one or more sections of Part 73.

For example: A new announcer-engineer is hired to cover a board schedule that includes an engineering watch. The first duty of the Chief Engineer, or perhaps the Program Director, is to ascertain that the operator license, if required, is valid and of the proper grade for the operation of the station. This means that a third-class license must now have the broadcast endorsement. Certainly the new man may operate the console in typical announcer fashion, but he may not keep the operating log, make transmitter adjustments, nor conduct an EBS test, etc., unless his valid license of the proper grade is posted as specified in Section 73.92.

Assuming the license is posted properly, the new man should still receive actual instruction in the operation of the transmitter and know fully how to tune, adjust, and reset the EBS receiver as well as conduct an EBS test. He should understand thoroughly the proper method of making meter readings and entering them in the operating log and what to do in the event of an outage. Many stations merely give the basic console operating functions and overlook any possible outage or malfunction; when one occurs, the new man is on his own. Suitable written instructions for new personnel are not only necessary, but are actually an asset to the licensee. Broadcasting equipment is expensive, and one careless mistake or adjustment made without previous instruction could result in far more expense and damage than the extra day or two of wages required for proper training.

#### Remote Control

The problem of compliance becomes somewhat complicated when remote control is used either for a transmitter within the same building or across town. The place the licensee considers to be the principal control point of the transmitter governs many factors, covered by as many sections of Part 73. In each case, the Commission desires that the necessary meters for which the operating log is maintained be in full view of the operator. Compliance may be had in various ways: The transmitter and associated



equipment may be placed in such a position as to be in full view through a window, or, if the transmitter is located in a basement transmitter room, the proper meters and control functions may be extended or remoted to the principal control point or position. Exceptions to this requirement are not very common, especially with regard to control of the operating power level.

Just where and what is the principal control point or position? This is the place in the station where **full control** of the transmitter is obtained, including observation of the various monitors and meters. This is the control room in most stations. If the transmitter is in the next room and the meters are observed through a window (in direct view) from the control room, the transmitter room is the principal control position (if FCC authorized) unless the high-voltage (final PA plate) control and power adjustment control(s) are extended into the control room. Regulations require that the means to conduct an EBS test be available at the control point. In a few cases, the Commission has authorized stations to remote the required meters and monitors without the other necessary control functions when the transmitter is installed in an adjacent room with unlimited access from the main control position. Remember that the rules require the capability for turning the transmitter on and off (EBS tests) and making any adjustment required to maintain operating power from the control point. If these provisions are not available at your control position, you are not in compliance, regardless of how many meters have been extended or remoted.

Directional operations that make use of a combo man (first-class) must provide means for observing the phase monitor from the control point. Even if the foregoing requirements are met, a station is not in compliance if the phase monitor is located in the basement next to the transmitter and the sole announcer-operator is upstairs in the control room. Regulations require that the phase indications and sample-loop magnitudes be observed for every mode of directional operation. How does a station comply in this case?

Quite simply: Move the phase monitor to the control point and extend the sample lines. It might be pointed out here that just any old length of coaxial cable for the sample line extensions will not suffice. Each line extension has to be identical in length in order to obtain the proper phase-monitor indications. Ideally, all the various meters, monitors, and control functions should be in the same room as the operator for either type of operation. (For complete requirements governing the remote control of directional stations, refer to a current copy of Part 73.)

### Posting of Licenses

All licenses and other instruments of authorization must be posted in the location the licensee considers to be the principal control point, with due consideration given to the meaning of the word "control." If more than one control point is listed on the station authorization, a photocopy of the station license and other instruments of station authorization shall be posted at each additional control point. All terms must be visible, not hidden 10 and 12 deep in one frame. Practical solution? Buy more frames. Each operator must post his original license, or if it is posted at another station, a valid FCC Form 759 certification statement is posted in lieu of the original license. The place where the licenses are displayed makes an ideal location to post step-by-step operating instructions, which also should be posted in the transmitter room. Remember that an operator must sign his license before it is considered valid. Fig. 2 shows licenses and other material posted in a control room.

### EBS and EANS

Sometime during each week of broadcasting, there should be indicated on the operating log four test alerts pertaining to the EBS and EANS systems. Regulations require that a station air one EBS test alert per week between 8:30 AM and local sunset, Monday through Friday. During this period, the station also should receive one test EBS alert from the key station it monitors. Strange as it may seem, some broadcast stations are still receiving

citations for failing to monitor an EBS key station or not having a suitable receiver in the station.

Two EANS (teletype) test alerts are sent weekly (on Saturday and Sunday) via UPI and AP. Appropriate entries must be made in the operating log concerning these tests, including the time and date the test was received and the time and date it was logged. This ruling prevents a loophole for stations not on the air for the Sunday evening test. The test is to be picked up Monday morning as the teletype machine is cleared and logged at that time to indicate that it was, in fact, received. Complete compliance requires that a proper authenticator list and instruction card be posted at the teletype machine.

### Keeping and Using the Maintenance Log

The recent introduction of the maintenance log has produced no end of confusion and citations for some stations. The FCC does not prescribe a specific log form. One method would be to use a single sheet for an entire week to record the daily transmitter and associated apparatus inspections and the daily tower-light inspections. The licensee must bear in mind that Section 73.93(5)(e) requires that an inspection be made at least once each day, five days per week, by an operator holding a valid first-class radiotelephone license. The interval between successive inspections must be no less than 12 hours. The operator may be employed full time as a staff member, or, as an alternative, the station may contract in writing for the services of one or more such

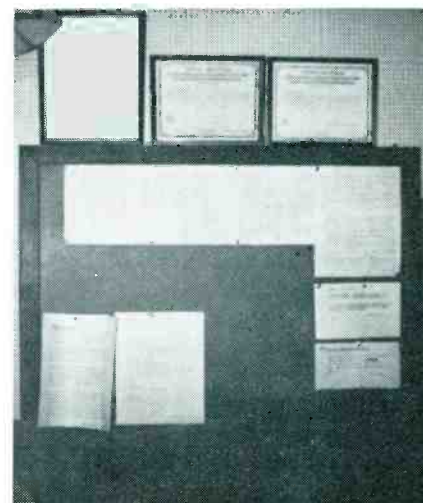

Fig. 2. Licenses posted in control room.

operators on a part-time basis.

The maintenance log was designed to eliminate the complete lack of any record of work done pertaining to actual maintenance, but the station should do more than merely maintain a maintenance log in accordance with Section 73.114. By using a single weekly sheet, the Chief Engineer can have all the basic information on one side, while the reverse side may be used to describe actual work performed.

### Keeping Records

One system of record keeping that works well, provided it is maintained, is to use the single-sheet weekly maintenance log and daily operating log with preprinted headings. Several standard ring-binder-type folders may be used to file the Rules and Regulations; the operating logs; the maintenance logs; records of frequency measurements made externally (these also may be inserted with the maintenance or operating log); and the EBS rules, regulations, and public notices. Several expanding wallets suitable for storing standard-size papers should be obtained to complete your record keeping. The binders become full in time (about six months for some). By removing the contents twice a year to the expanding-wallet folders (they have a flap with a string tie), a complete file and suitable protection are obtained. Gum-type labels affixed to the front of each wallet serve to identify the contents.

The same idea may be extended a bit further to include the yearly audio proof of performance measurements, weekly monitor-point measurements, and a host of other records that should be easy to locate when an inspector arrives.

### Physical Maintenance

Quarterly tower inspection seems to cause a great deal of difficulty as far as citations are concerned. Complete failure to examine the tower or to stock spare lamps causes many unpleasant experiences during inspections. Even if a station has a maintenance contract with a professional tower company, it is still necessary to carry spare lamps. A recent official interpretation of Section 17.37(c) indicates

that most engineers should be able to accomplish the required maintenance, but with typical reserve the interpretation states that climbing the tower or towers and physical inspection of the structure, guys, etc., while extremely desirable, is not actually required. In a typical station installation, the quarterly inspection would entail checking the photocell unit, magnetic contactor (if used), current transformer, flasher, and any associated wiring. Notice that this does not cover the wiring up the tower, cluster lamps, beacons, and fixtures, or the physical condition of the structure. Field glasses will give one an indication of paint condition on the tower without climbing. A contract that provides for a complete relamping and inspection twice per year and emergency service in case of lamp failure and the like does not comply with Section 17.37(c).

The FCC does not say that you as Chief Engineer must climb, but someone (a professional who knows what he is doing) must if the station is to comply with this section of the Rules and Regulations (Fig. 3). Sample loops should be checked as often as the tower (that is, quarterly) to ascertain their physical condition. Strange phase monitor indications could be caused by a sample loop that is flapping around in the breeze.

In reporting a defective beacon to the nearest FAA station, the re-

porting person should record the full name of the person he speaks with, the time the call was made, and all other necessary information concerning the beacon outage in both the operating log and maintenance log. The same procedure should be repeated when the beacon has been repaired. In most cases you will be asked by the person at the FAA station to give your name. A complete and detailed report of the repairs made should be entered in the maintenance log and signed by the person making the repairs. A spare flasher motor, mercury switch, and basic photocell components mean minimum repair time.

### Conclusion

While the Rules and Regulations provide flexibility and set forth the conditions under which they are applicable, material deviation from the fundamental principles is not permitted. When in doubt about the meaning of a particular rule, it would be far safer to obtain official interpretation than to guess or to ignore the rule. These rules will necessarily change as technology does, and broadcasters should keep abreast of the changes. By so doing they can keep their equipment operating at optimum efficiency, satisfy the regulations set forth by the FCC, and keep operating costs down. ▲

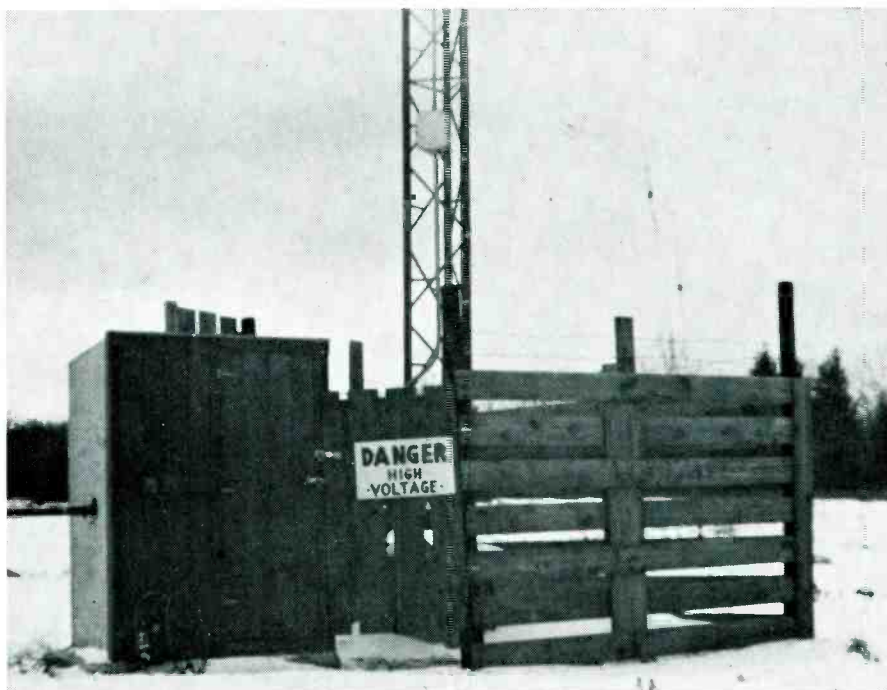

Fig. 3. Flasher mechanism for lighting system is at 15' level on tower.

The soundest sound in broadcasting is the new sound of GATES



ATTACHE "70"



DYNAMOTE "70"



COURIER "70"



UNIMOTE "70"

## Four new portable transistorized remote amplifiers from GATES

Four handsome, fully transistorized models. All rugged, compact and lightweight. Studio console quality.

ATTACHE "70"—three microphone mixing channels. Two are switchable to accommodate tape recorders or turntables. Extremely light weight—10 lbs. with batteries.

DYNAMOTE "70"—four channels. Broadcasting's newest and most deluxe. Accommodates nine signal sources, including two high-level inputs, two magnetic phonos and built-in tone oscillator. Weighs 12¼ lbs., including batteries. Ideal

for major news coverage or complex remote originations.

COURIER "70"—two-channel amplifier provides two microphone mixing channels, master gain control, illuminated VU meter. Weighs only 8¾ lbs. with batteries.

UNIMOTE "70"—single-channel, fully transistorized remote or utility amplifier is no larger than a table radio. Ideal for mounting under a lectern or pulpit.

For full details, write for ADV-160, our new attractive 8-page illustrated brochure.

**HARRIS  
INTERTYPE  
CORPORATION**

# GATES

GATES RADIO COMPANY  
A Subsidiary of  
Harris Intertype Corporation  
QUINCY, ILLINOIS 62302

Offices: New York, Houston, Los Angeles, Washington, D. C.  
Export: Roche International Corporation, New York City  
In Canada: Canadian Marconi Company, Montreal

Circle Item 9 on Tech Data Card

[www.americanradiohistory.com](http://www.americanradiohistory.com)

# A TOWER EMERGENCY

by **Len Spencer**, Consulting Author,  
 Technical Director, CKAC, Montreal,  
 Quebec, Canada — Towers really  
 do collapse; here's what happened  
 when one did.

As the evening shift drew to a close, the transmitter operator listened nervously to the howling wind that shook the windows of the transmitter building with every powerful gust. After logging all the meter readings at 11 PM, he stepped outside to check the lights on the 327' towers and to have a closer look at the stormy night. He mentally checked off the lights on each 100' section and both 500-watt aviation beacons. Then he hastily returned to warmth of the transmitter room, for a Canadian January gale is no place to linger.

Everything seemed to be functioning perfectly, but some sixth



Fig. 1. Top section fell from front tower.

sense warned him to be extra alert, and he went over to the final power

stage of the 50-kw transmitter for another check of the antenna current.

Suddenly every overload relay flashed to the "Off" position, and the transmitter went dead. The audio meters were still indicating modulation, and subconsciously the operator realized there had not been a power surge, for the lights had not even flickered.

He pushed the "On" button and waited for the automatic sequence to take over. Every section responded until the power stage, and again the protective relays shut down the transmitter. He actuated the "Change-Over" button and ran

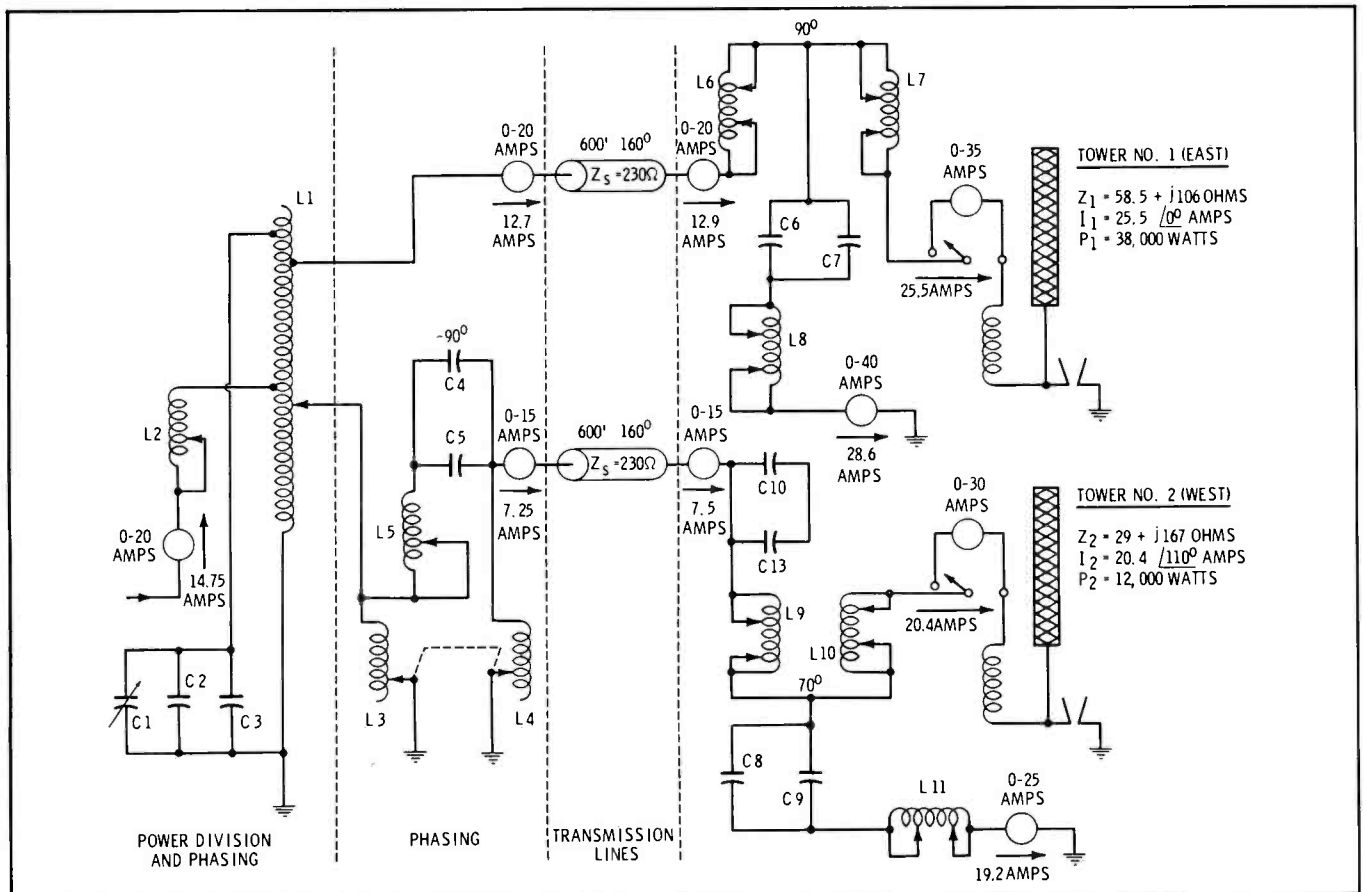

Fig. 2. Antenna tuning, phasing, and power division circuits used at station CKAC.

# COMPARE

★ *Operating Costs* ★

★ *Performance Features* ★

Feature for feature the Dage Television DV-300 Portable VTR measures up to any standard of comparison...if your facility does not yet own a DV-300 why not arrange for a demo... *seeing is believing.*



**DAGE**

*Head operating costs:  
per hour \$ .197*

*(2000 hour warranty  
and only \$395  
replacement cost)*

*tape costs:  
\$58.29 per reel (1 hr.)*

*400 record/erase  
cycles minimum*

*low tape usage*

*1-inch tape 5.91 IPS*



DV-300 Recorder

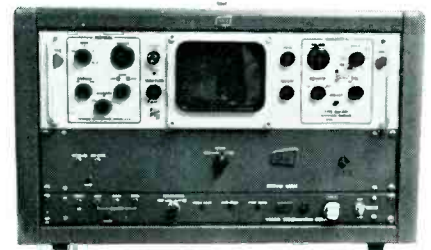

F-300 Signal Stabilizer

- **MEETS FCC BROADCAST REQUIREMENTS**
- **100% SOLID STATE CIRCUITRY — PLUG-IN MODULES**
- **LOWEST PER HOUR OPERATING COST OF ANY HELICAL SCAN BROADCAST VTR**
- **330 LINE RESOLUTION — 38 db SIGNAL-TO-NOISE RATIO**

#### **DV-300 Standard Features**

Still Frame  
Self-Contained Video Monitor  
Pulse-Cross Circuitry  
Audio Monitor Amplifier and Speaker  
Variable Speed Slow Motion  
forward and reverse

Visible tape edit and search  
thru forward and fast rewind

#### **Companion F-300 Signal Stabilizer**

Stability — meets FCC requirements  
Waveform Monitor (optional)

**Dage Television Company** • DIVISION OF DAGE-BELL CORPORATION  
455 Sheridan Avenue, Michigan City, Indiana (219) 874-3251 Att: Dept. 30-D

# SPOTMASTER

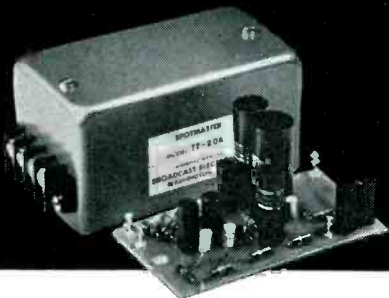

## EQUALIZED TURNTABLE PREAMPLIFIER

The Model TT-20A is a compact, low distortion, transistorized turntable preamp for VR cartridges, with built-in NAB equalization. Design ingenuity reduces residual noise level to better than 65 db below rated output. Small current requirements permit 6 volt dry cell battery operation, eliminating AC hum worries. Response, 30-15,000 cps  $\pm$  2 db... output —12 dbm, 600 ohm emitter follower... distortion under 1% at double rated output... size, 2½ x 2½ x 5½". Priced from \$46.50; transformer output and power supply available. Also available as a flat amplifier Model BA-20A. Write or wire for complete details.

*Spotmaster*

**BROADCAST ELECTRONICS, INC.**

8800 Brookville Road  
Silver Spring, Maryland

Circle Item 12 on Tech Data Card

# New! Lang Solid State AMPLIFIER/SPEAKER

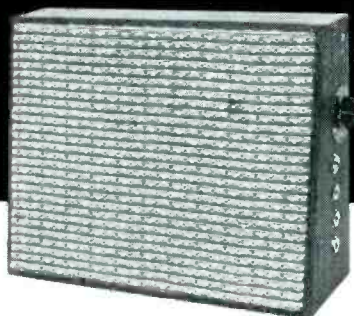

... for superb broadcast monitoring!

Primarily intended for use in broadcast offices where good quality monitoring is required, the LANG AMPLIFIER/SPEAKER contains its own solid state amplifier, power supply, and volume control. Stands vertical (as pictured) or horizontal if desired and can readily be hung on your wall.

**Price: \$78.**

Also available with input selector switch for use where monitoring of several lines is required.

For complete details and new Lang Catalog write:

**LANG ELECTRONICS INC.**  
507 FIFTH AVE., N.Y. 17  
For all your audio needs — Look to Lang!

Circle Item 13 on Tech Data Card

to the antenna meter on the 10-kw standby equipment. There was a loud snap as the changeover switch between the 50- and 10-kw transmitters went into place; the meters on the emergency equipment slowly climbed up—to a complete shut-down!

The operator now connected the dummy antenna and tried the 10-kw transmitter once more; it worked beautifully. Leaving the equipment in operation, he put on his heavy ski jacket and cap and went outside.

As he looked at the two-tower array, he hardly believed what he saw: The top 100' of the east tower, which the transmitter crew called No. 1, had disappeared, but every obstruction light on the remaining 200 still glowed brightly! The No. 2 tower still stood in the swirling snow storm.

The operator phoned the technical director, who asked him to sleep at the transmitter and promised to be there by daylight; not only would it be useless to flounder around in the dark, but they would need an extra pair of snowshoes.

The storm blew itself out during the night, and the dawn was sunny and cold (—10° F). In its fall, the 127' of steel tower had driven the aviation lights deep into the ground; the rest of the section was draped over the top of a nearby tree (Fig. 1).

Of course the main idea was to get back on the air as soon as possible with the 10-kw transmitter so as not to risk putting sible. It was decided to drive the full voltage of the 50-kw output across the antenna tuning coils at the base of the tower (Fig. 2).

The power-division section was bypassed and the 10-kw tank circuit was hurriedly connected directly to the transmission line (Fig. 3). By this means the station was quickly returned to the air—too quickly, for after about an hour of operation a call was received from the DOT (Canadian equivalent of the FCC) monitoring station. They wanted to know what CKAC was doing on 760 kc when it was assigned to 730 kc.

It was then discovered that in the haste to return the station to the air the transmission line to the broken tower had been left connected to the power-division coil.

PROGRAM DIRECTORS  
CHIEF ENGINEERS  
EXECUTIVES

## SAVE TIME

Identifying, Evaluating, Cataloging,  
Inspecting 16mm Motion Picture Film  
on the



**moviola**  
**LIBRARY**  
**READER**

- View at up to five times sound speed.
- View at governed sound speed.
- Twelve sided prism, high quality, projection system.
- Rapid rewind without switching reels.
- Performs all functions forward and reverse.
- Available with or without sound.

**moviola**  
manufacturing co.  
motion picture | tv equipment

5539 Riverton Ave., North Hollywood, Calif.  
Telephone: 877-2173  
Cable Address: Moviola, North Hollywood, Calif.

Circle Item 11 on Tech Data Card

Every TV Station  
Doesn't Use Belden  
Wire and Cable...

but most of them do!

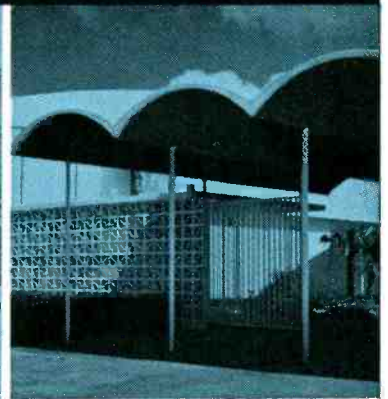

## like **WBAL-TV**

### BALTIMORE

In their new \$2,000,000 studio building, Belden Audio, Camera, and Control Cables were used exclusively.

## **WGN-TV**

### CHICAGO

In this mammoth new Mid-America TV and radio broadcasting center, 90% of all Camera, Microphone, and Audio Cables are Belden.

## **KTRK-TV**

### HOUSTON

The exclusive use of Belden Camera, Audio, and Control Cables by this ABC affiliate helps them to maintain their continuous, highly efficient programing.

power supply cords • cord sets and portable cordage • magnet wire • lead wire • automotive wire and cable • aircraft wires • welding cable

*Better Built—Better Buy—Belden*



The extensive use of Belden wire and cable by radio and television stations reflects the engineered quality of all Belden wire and cable. It offers lighter weight, lower coefficient of friction, greater flexibility, easier termination, and exclusive Beldfoil\* insulations for elimination of crosstalk.

Belden manufacturers a complete line of wire and cable for all TV and radio broadcasting, recording studios, remote control circuits, and similar applications. Call your Belden electronic distributor, or write for catalog.

\*Belden Trademark—Reg. U.S. Pat. Off. 8-6-3

**BELDEN MANUFACTURING COMPANY • 415 South Kilpatrick • Chicago, Illinois 60644**

Circle Item 14 on Tech Data Card

# A First Class FCC License

...or Your Money Back!



Your key to future success in electronics is a First-Class FCC License. It will permit you to operate and maintain transmitting equipment used in aviation, broadcasting, marine, microwave, mobile communications, or Citizens-Band. Cleveland Institute home study is the ideal way to get your FCC License. Here's why:

Our training programs will *quickly* prepare you for a First-Class Commercial Radio Telephone License with a Radar Endorsement. Should you fail to pass the FCC examination after completing your course, you will get a *full refund* of all tuition payments. You get an FCC License . . . or your money back!

You owe it to yourself, your family, your future to get the complete details on our "proven effective" Cleveland Institute home study. Just send the coupon below TODAY. There's no obligation.

## MAIL COUPON TODAY FOR FREE CATALOG

### Cleveland Institute of Electronics

1776 E. 17th St., Dept. BE-18  
Cleveland 14, Ohio

Please send FREE Career Information prepared to help me get ahead in Electronics, without further obligation.

#### CHECK AREA OF MOST INTEREST -

- |   |  |
|---|--|
| <input type="checkbox"/> Electronics Technology | <input type="checkbox"/> First-Class FCC License   |
| <input type="checkbox"/> Industrial Electronics | <input type="checkbox"/> Electronic Communications |
| <input type="checkbox"/> Broadcast Engineering  | <input type="checkbox"/> _____ other _____         |

Your present occupation \_\_\_\_\_

Name \_\_\_\_\_ (please print) Age \_\_\_\_\_

Address \_\_\_\_\_

City \_\_\_\_\_ Zone \_\_\_\_\_ State \_\_\_\_\_

Accredited Member National Home Study Council

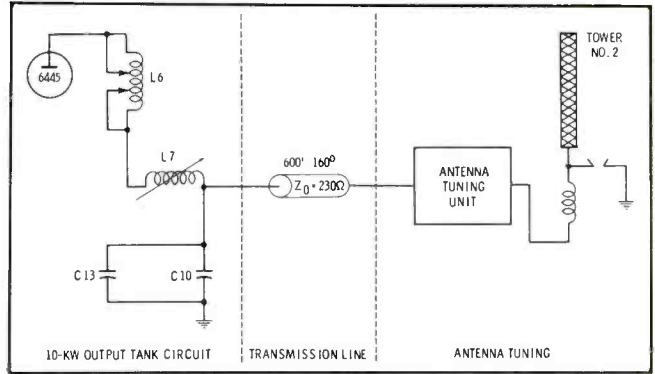
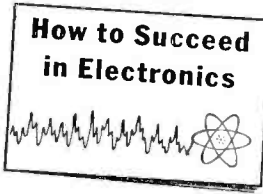

Fig. 3. Emergency circuit alterations for bypassing phasor.

When this was removed and grounded, the spurious 760-kc signal disappeared completely. At the same time, L11 in the antenna tuning circuit was jumpered.

Since the station does not own an RF bridge, a consulting engineer was called to recheck the work and to tune up the remaining tower. Such tuning was necessary because the removal of part of one tower changed the mutual impedance between towers and, therefore, the impedance of the remaining tower. The system had been tuned for maximum current in the antenna base meter after as much power as possible was being put into the transmitter end of the RF line. Only a minor change in the antenna tuning network was required.

Adjustment would have been easier if tower No. 1 had remained standing, since that tower has no phasing circuits in the feed and the power-dividing coil could have been used directly.

Although a tower failure of this kind is something that happens once in a lifetime, we at CKAC are now prepared with emergency measures to use should either tower suffer mechanical failure. We also learned that despite the necessity for all speed in getting back on the air, it is much better to restrain that impulse to do something "fast" and sit down and think it over "first." ▲

## Monitor Switcher

Instead of using a picture monitor for each of our film-chain cameras, we have installed a Dow-Key DK-60 coaxial relay. By merely flicking the AC power switch on or off, our projectionist can monitor either camera.

The hook-up is quite simple. AC power is connected through a switch to the coil of the relay. The "antenna" connection on the relay goes to the picture monitor. The "receiver" connection goes to one camera, and the "xmtr" connection goes to the other camera.

JAMES W. SLATE

College of William and Mary

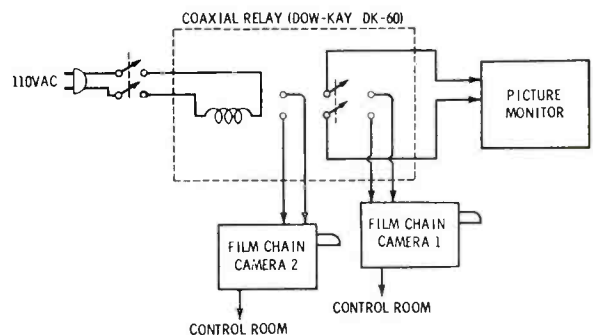



April 1965

We interrupt this magazine to bring you...

## Late Bulletin from Washington

by Howard T. Head

### Congress Proposes Tower-Height Limit

The House of Representatives Committee on Interstate and Foreign Commerce has held hearings on a resolution which would limit the overall height of FM and television towers to 2000' above ground, except under special circumstances. Testimony at the hearings indicated general support on the part of broadcast interests, but aviation groups asked for more stringent FAA control over the height and placement of tall towers. Although the resolution does not specifically deal with antenna farm areas, there was considerable broadcaster sentiment against establishment of mandatory farm areas; however, permissive grouping of tall towers was endorsed.

The Commission's Notice of Proposed Rule Making dealing with tall-tower antenna farms (March 1965 Bulletin) has been held in abeyance pending Congressional action on the House resolution.

### Engineer as New Commissioner?

Since the resignation of Commissioner Frederick W. Ford on January 1 to become President of the National Community Television Association (NCTA), the Commission has had only six members. In at least one recent case, involving the imposition of nonduplication requirements on translators, a 3-3 tie vote resulted.

There have been numerous suggestions in recent months that an engineer be selected as the new Commissioner. Engineers have served on the Commission in the past, but since the retirement of Commissioner T. A. M. Craven in 1963, the Commission has not included a member of this profession among its membership.

### Relaxed Translator Regulations Proposed

The Commission has proposed a relaxation of television-translator regulations to permit VHF translators to operate with output powers up to 100 watts and UHF translators to operate on channels below channel 70. At present, VHF translators are limited to a maximum output of 1 watt, and UHF translator operation is permitted only on channels 70 through 83.

Operation under the relaxed regulations would be permitted only on channels specifically assigned to a community in the Table of Assignments. Most of

the unused commercial VHF channels are in western states, but a number of UHF channels would be available for such operation in all parts of the country.

The Commission hopes that these low-power translator operations may eventually grow into full-fledged television broadcast stations. During the initial period of translator operation, the much more liberal translator requirements, such as those permitting unattended operation, should provide an impetus to initial development.

#### Studies of FM Modulation Monitoring

The NAB and the Commission have undertaken further studies of the overmodulation citations received by various FM and television licensees as a result of inspections by the Commission's mobile monitoring unit. (See November 1964 Bulletin.) These studies have revealed that the principal reason for the citations has been the fact that the monitoring unit employs an oscilloscope to determine modulation percentages, whereas the stations rely on commercial modulation monitors. Almost without exception, the station monitors had been type-approved by the Commission.

Very substantial discrepancies were found between the modulation percentage indicated by the oscilloscope and that indicated by the modulation monitors. In some instances, the modulation monitors indicated a percentage of modulation as low as 50% for an indication on the oscilloscope of 100% modulation.

Cooperative studies between the NAB and the Commission are continuing, in the hope of resolving the disagreement between the two methods in the reasonably near future.

#### Low-Power UHF Stations Considered

Under a revision of the present UHF television channel allocation plan now being considered by the Commission, all assignments on channels 70 through 83 would be withdrawn. These channels would then be made available for relatively low-power operation on a demand basis. The low-power stations, intended for use mainly in smaller cities, would employ effective radiated powers up to 10 kw and effective antenna heights up to 300'.

Allocation standards for these low-power UHF stations would be considerably relaxed, with cochannel and adjacent-channel separations substantially less than the present 155-mile cochannel and 55-mile minimum adjacent-channel separations between full-power stations. Present requirements would continue to apply on channels 14 through 69. The new proposal is expected to be announced at the time of publication of the new Table of UHF Assignments (March 1965 Bulletin).

Howard T. Head... in Washington

# new Tektronix transistorized video-waveform monitor

with capability for  
analyzing VIT signals

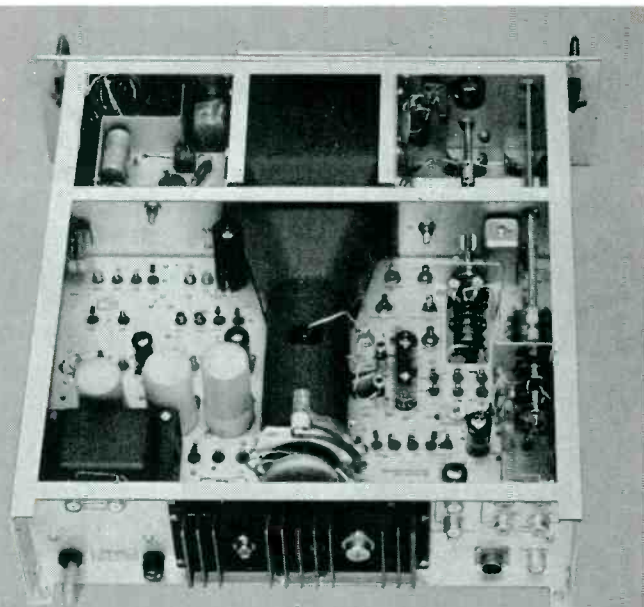

You're looking at the back and top of a new video-waveform monitor, Type RM529. There are 45 transistors, 7 tubes, and 2 high-voltage rectifiers. All but 2 tubes and 2 transistors are socketed for easy servicing. There's no fan—it is not needed with the low power consumption of 80 watts to assure clear, quiet, long-life operation. Extremely compact, the Type RM529 uses an extremely bright CRT with a full 6-centimeter by 10-centimeter viewing area—yet the instrument occupies only 5 1/4 inches of standard rack height.

you can do more with the  **RM529**  
than you can with any other video-waveform monitor.

## Here's why:

**frequency responses**—Four different frequency-response characteristics necessary to monitor all Video Test signals are provided:

1. CHROMA Response centered at 3.58 Mc bandwidth  $\pm 400$  kc to measure differential gain.
2. LOW PASS -6 db at 500 kc to see axis shift on Multi-Burst.
3. FLAT To 5 Mc  $\pm 1\%$ , to 8 Mc  $\pm 3\%$ .
4. IRE 1958 STD 23-S-1. Color subcarrier -20 db.

**line selector**—Provides stable displays of the Vertical Interval Test signals. Adequate brightness is provided even at the fastest sweep speed. Can display any line desired. Brightening pulse automatically intensifies the displayed line as viewed on the associated picture monitor. No modification to the picture monitor is required.

**field selection**—Positive acting circuit allows selection of the odd or even field for display. Noise will not cause random field changing.

**dc restorer**—A feedback-type restorer acts during the backporch time. Not affected by presence of color burst. Does not distort the burst. Front-panel switch can disable the restorer—when other than video waveforms are viewed.

Type RM529 Video-Waveform Monitor . . . . . \$1100  
For waveform photography, a Tektronix Type C-27 Camera is recommended. Bezels are available to adapt other cameras to the Type RM529.

U. S. Sales Price f.o.b. Beaverton, Oregon



**Tektronix, Inc.**

P.O. BOX 500 • BEAVERTON, OREGON 97005 • Phone: (Area Code 503) 644-0161 • Telex 036-691  
TWX: 503-291-6805 • Cable: TEKTRONIX • OVERSEAS DISTRIBUTORS IN OVER 30 COUNTRIES  
TEKTRONIX FIELD OFFICES in principal cities in United States. Consult Telephone Directory.

Circle Item 15 on Tech Data Card

# BUILDING A TRANSISTORIZED SYNCHRONIZING GENERATOR

by Lawrence P. Segar, Assistant Professor of Electrical Engineering, University of North Dakota — Part I. Before construction is undertaken, here is an overall description of how the unit operates.

The station synchronizing generator is the basic timing unit of the television system. In addition to serving as the timing unit, this piece of equipment generates, shapes, and arranges in proper sequence all pulses necessary in the control of the system.

The synchronizing generator shown in Fig. 1 and described in the following paragraphs is constructed to provide standard signals for the United States 525-line monochrome television system. The synchronizing generator provides the following four signals to the associated television equipment: (1) horizontal driving signals, (2) vertical driving signals, (3) blanking

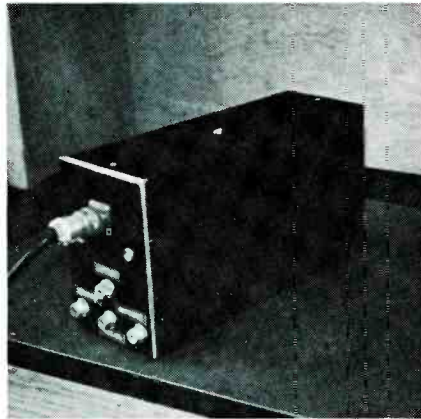

Fig. 1. Outside view of sync generator.

pulses, and (4) combined horizontal and vertical, or composite, synchronizing signal.

The overall synchronizing generator can be separated into four sections, each of which performs a distinct function. These sections are: (1) the timer section, (2) the pulse-generating section, (3) the pulse-shaping section, and (4) the output section. Fig. 2 shows the connections between the timing, pulse-generating, and pulse-shaping circuits.

## Timer Unit

The timer unit generates a symmetrical square wave with a repetition rate of 31,500 cps. This voltage is necessary for the generation of equalizing and vertical-synchronizing pulses. A square wave having a repetition rate of 60 cps and having its leading edge coincident with the leading edge of every five-hundred-twenty-fifth 31,500-cps square wave is also generated. This 60-cps signal is used to trigger all vertical-blanking and driving multivibrators.

In order to obtain stable frequencies, a phase lock is obtained with the 60-cps power-line voltage. An astable multivibrator is used to develop the 31,500-cps signal. The frequency of the multivibrator is made variable from approximately 24,000 cps to 48,000 cps by varying the base-return voltage from two to six volts. The output of this multivibrator triggers the first of four frequency-dividing monostable multivibrators which divide the 31,500-cps frequency by three, five, five, and seven. A phase-comparator circuit compares the phase relationship of the resulting 60-cps square wave and the 60-cps line signal. The comparator supplies a different DC voltage to the base return of the 31,500-cps multivibrator for each different phase relationship between the two signals.

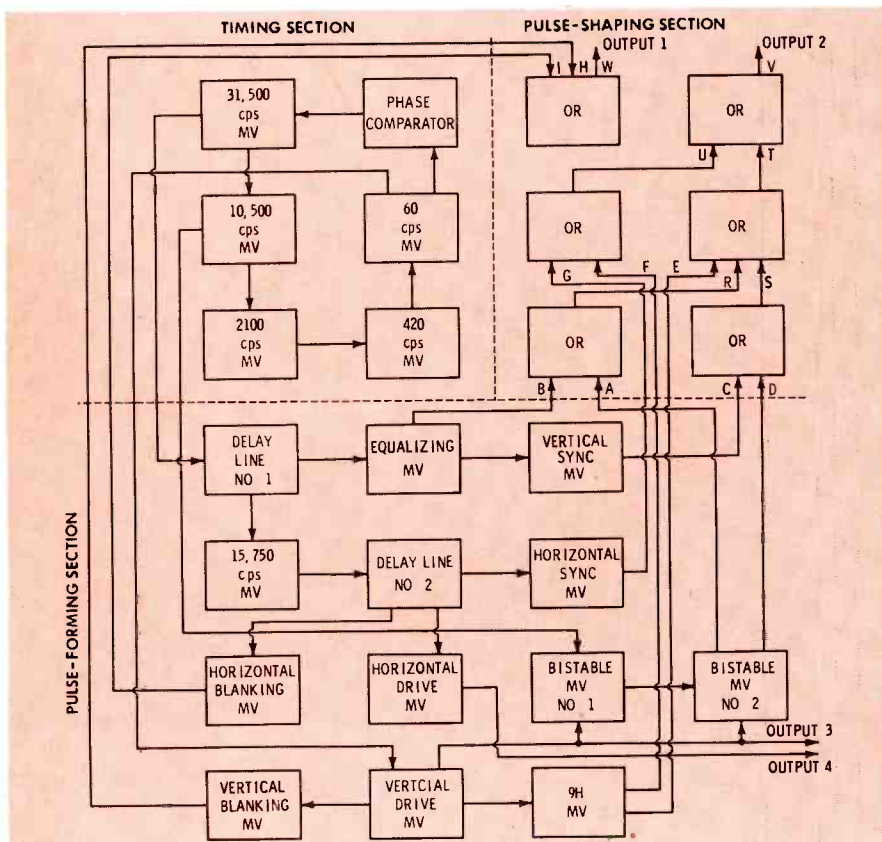

Fig. 2. Block diagram shows the interconnections between portions of generator.



YOUR SYLVANIA DISTRIBUTOR GIVES

# FAST DELIVERY

Prompt, helpful service is the rule with your Sylvania Distributor. Same-day service wherever possible from his complete inventory of rugged, dependable industrial and commercial tubes in any quantity.

Next time you need electronic tubes in a hurry, try him first. You'll be glad you did.

Electronic Tube Division, Sylvania Electronic Components Group.

**SYLVANIA**  
SUBSIDIARY OF  
GENERAL TELEPHONE & ELECTRONICS **GTE**

NEW CAPABILITIES IN: ELECTRONIC TUBES • SEMICONDUCTORS • MICROWAVE DEVICES • SPECIAL COMPONENTS • DISPLAY DEVICES

Circle Item 16 on Tech Data Card

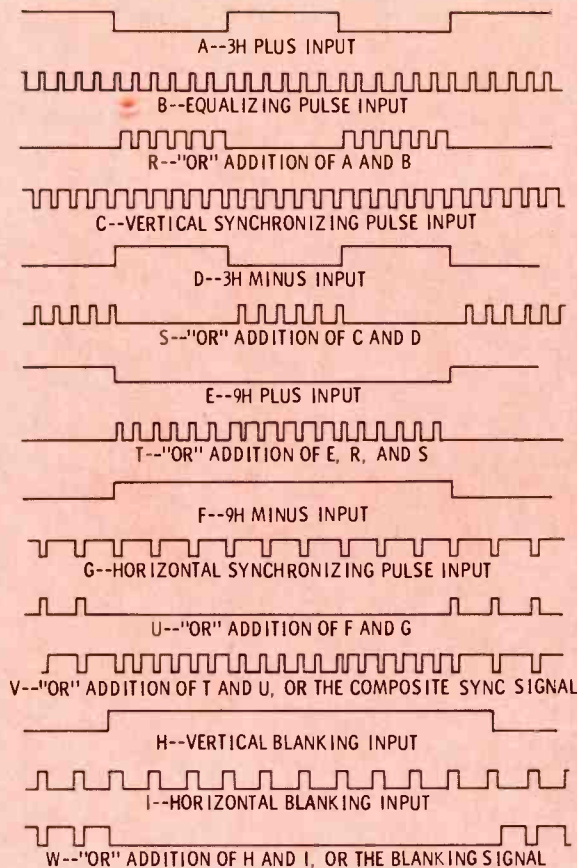

Fig. 3. Synchronizing waveforms are made by combining pulse trains in OR circuits.

### Pulse Former

In the pulse-forming section, the equalizing, vertical - synchronizing, horizontal - blanking, horizontal-driving, vertical-blanking, and vertical-driving pulses are formed. In order to establish correct time relationships between the pulses which are added in the shaper unit, two delay lines are used. The pulses used to obtain the final output signals are formed by monostable multivibrators in this section of the generator. The multivibrators are triggered either from the delay lines or from other multivibrators in the section.

Fig. 2 shows the 31,500-cps input applied to a delay line. The vertical-synchronizing and the equalizing-pulse triggers are delayed by approximately .025H (H represents time of 1 period at horizontal-sweep frequency), or 1.59 usec. The trigger to the 15,750-cps frequency-dividing multivibrator is not delayed; therefore, triggering of this stage occurs before triggering of the multivibrators which produce the vertical-synchronizing and equalizing pulses. Triggering of the hori-

# Spotmaster

## NEW 500 SERIES . . . World's Most Advanced Cartridge Tape Equipment

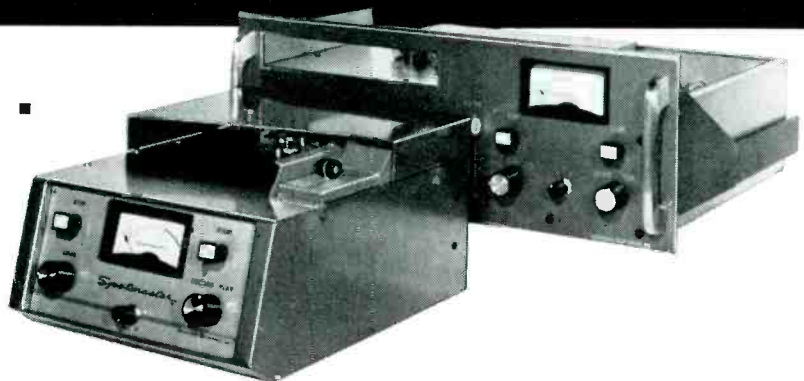

From the established leader in tape cartridge systems —SPOTMASTER—comes today's most advanced units, the 500B series. Featuring all-modular, all-solid-state design and your choice of 1, 2 or 3 automatic electronic cueing tones, the 500B continues the SPOTMASTER tradition of superior quality at sensible prices.

Check these other SPOTMASTER features:

- Meets or exceeds all existing and proposed NAB standards.
- Separate record and reproduce heads. A-B monitoring. Biased cue recording. Zener controlled power supply.
- Popular 500A series, today serving over 1,000 sta-

- tions world-wide, now available at new low prices.
- 14 models match every programming need: recorder-playback and playback-only . . . compact and rack-mount . . . monophonic and stereo.
- Delayed Programming option permits instant deletion of objectionable material from live originations.
- Heavy duty construction throughout, with rugged hysteresis synchronous motors, top specs and performance.
- Lease/purchase option. Ironclad guarantee for one full year.

Write for complete information:

**BROADCAST ELECTRONICS, INC.**  
8800 Brookville Rd., Silver Spring, Md. JU 8-4983 (301)



Circle Item 17 on Tech Data Card

# The Key to Quality in any CATV system

## **SUPERIOR COAXIAL CABLE** with "Coppergard"

"Cell-O-Air"  
expanded  
polyethylene  
dielectric

- Long-term transmission stability
- Sharp, clear pictures without interference
- Full spectrum capability
- 27 db minimum return loss

Quality-controlled from raw materials through every critical phase in the manufacturing process, SUPERIOR Coaxial Cable with Coppergard offers you performance unmatched by any other cable!

**EVERY REEL  
SWEEP-TESTED  
OVER ITS  
FULL LENGTH**

"Solid-D" solid  
polyethylene  
dielectric

### **CHOOSE SUPERIOR CELL-O-AIR® COAX FOR AERIAL PLANT**

Attenuation db/100' at 68° F					
	Ch. 2	Ch. 6	108 mc.	Ch. 7	Ch. 13
4920	0.72 db	0.89 db	1.03 db	1.35 db	1.50 db
4930	0.43	0.65	0.76	1.02	1.15

### **CHOOSE SUPERIOR "SOLID-D" COAX FOR BURIED PLANT**

Attenuation db/100' at 68° F					
	Ch. 2	Ch. 6	108 mc.	Ch. 7	Ch. 13
6020	0.71	0.87	1.00	1.31	1.48
6030	0.52	0.64	0.75	1.00	1.13

*For full information, write*

## **SUPERIOR CABLE**

SUPERIOR CABLE CORPORATION • HICKORY, NORTH CAROLINA

8574

*"Hear me out. I'm the New Uher 4000-S.  
the greatest little professional tape recorder in the whole wide  
world. There is no end to my versatility. I have traveled  
everywhere...from the top of Mt. Everest to the bottomless pits  
of Africa (take me anywhere, I weigh less than 9 lbs.).  
Here is just a resume of my most important features:  
(I hope I'm not going too fast for you).  
RANGERTONE: exclusive accessory for lip synchronization for  
professional and home movies. AKUSTOMAT: (a tape saver)  
You simply speak and I record. You stop speaking I stop.  
(quite intelligent.) DIA-PILOT: Impulse transmitter  
for fully automatic control of slide projectors and  
animated displays. Fully transistorized, four speeds (15/16, 17/8,  
3/4, 7/2) Records up to 8 1/2 hours on 5" reel. Piano keyboard  
for rewind, start/playback, pause stop, record and fast forward.  
Built-in battery "pak" or AC powered. Large illuminated VU meter.  
My references: Well ask any professional radio or TV commentator,  
reporter, engineer or anthropologist. Thank you for your time.  
Additional information furnished upon request or see your  
dealer for a full demonstration.  
Sound begins and ends with a Uher\* Tape Recorder."*

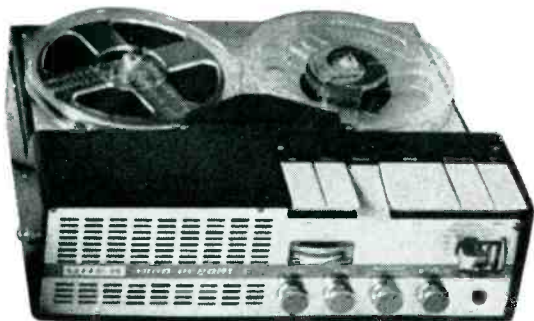

**TO, martel**  
MARTEL ELECTRONICS

(\*PRONOUNCED U-ER)

LDS ANGELES: 2356 SOUTH COTNER, NEW YORK CITY: 1199 BROADWAY, CHICAGO: 5445 NORTH LINCOLN AVENUE

Circle Item 19 on Tech Data Card

zontal-blanking and driving multi-vibrators is obtained directly from the 15,750-cps signal, but the trigger for the horizontal-synchronizing multivibrator is delayed .025H by a second delay line.

The vertical-drive multivibrator is triggered directly from the 60-cps input signal, and the vertical-blanking and the 9H triggers are obtained from the output of the vertical-drive multivibrator. The 10,500-cps input triggers a chain of two bistable multivibrators (designated No. 1 and No. 2 in Fig. 2), which reduces the repetition rate to 2625 cps. The output of the second bistable multivibrator is a symmetrical square wave occurring 2625 times per second with both signal polarities present. The 9H signal and the 2625-cps symmetrical square waves are used to generate the composite synchronizing signal.

Since 2625 cps is not divisible by 60 cps, each bistable multivibrator must be reset by one of the 60-cps signals. The trailing edge of the vertical-drive pulse is used to accomplish this triggering.

#### Pulse Shaper and Outputs

The pulse-shaper unit combines the pulses formed in the pulse-former unit to obtain the four output waveforms required. Horizontal- and vertical-drive waveforms are acceptable directly from their respective multivibrators, so direct connection between the pulse-former unit and the output circuits is used. The synchronizing and blanking signals are composite waveforms which require the addition of several previously formed pulse trains. Fig. 3 shows how the signals present at the input of each OR circuit in the pulse-shaper are added to obtain the two composite signals.

Identical output circuits are used to amplify the four output waveforms for application to 75-ohm loads. Each output stage consists of two inverter amplifiers and an emitter-follower output circuit.

The overall electrical design and operation of the synchronizing generator have been described. Next month, the specific circuits used will be described, and construction considerations will be discussed. ▲

## RUSSCO BROADCAST Turntables

**Separate Tone Arm mounting plate for easy installation**

- Single lever controls 33, 45, 78 speeds
- Plays 45 RPM's without adapter
- Illuminated speed indicators
- Sold with or without arm (GREY or REK-O-KUT)
- Instant acceleration
- Heavy duty — professional quality
- Competitive low price
- Call or write for folder

**Unconditionally Guaranteed**  
— against defects in material or workmanship when given normal maintenance

**SOLD DIRECT — OR TO DEALERS**

**RUSSCO Electronics Mfg.**  
6879 N. SUNNYSIDE, CLOVIS, CALIF.  
PH. 299-4692

Circle Item 20 on Tech Data Card

### CUSTOM SPECIALISTS TO BROADCASTERS

Broadcasting is your business . . .

Serving you is our business . . .

- Equipment Sales
- Custom Fabrication
- Installation Supervision
- 24-hour Parts Service
- Complete Test Facilities

Think first of WE for complete, reliable broadcasting equipment and service.

**Wilkinson Electronics, Inc.**  
1937 W. MacDade Blvd.  
Woodlyn, Pa. 19094  
Telephone: 215-874-5237

Circle Item 21 on Tech Data Card



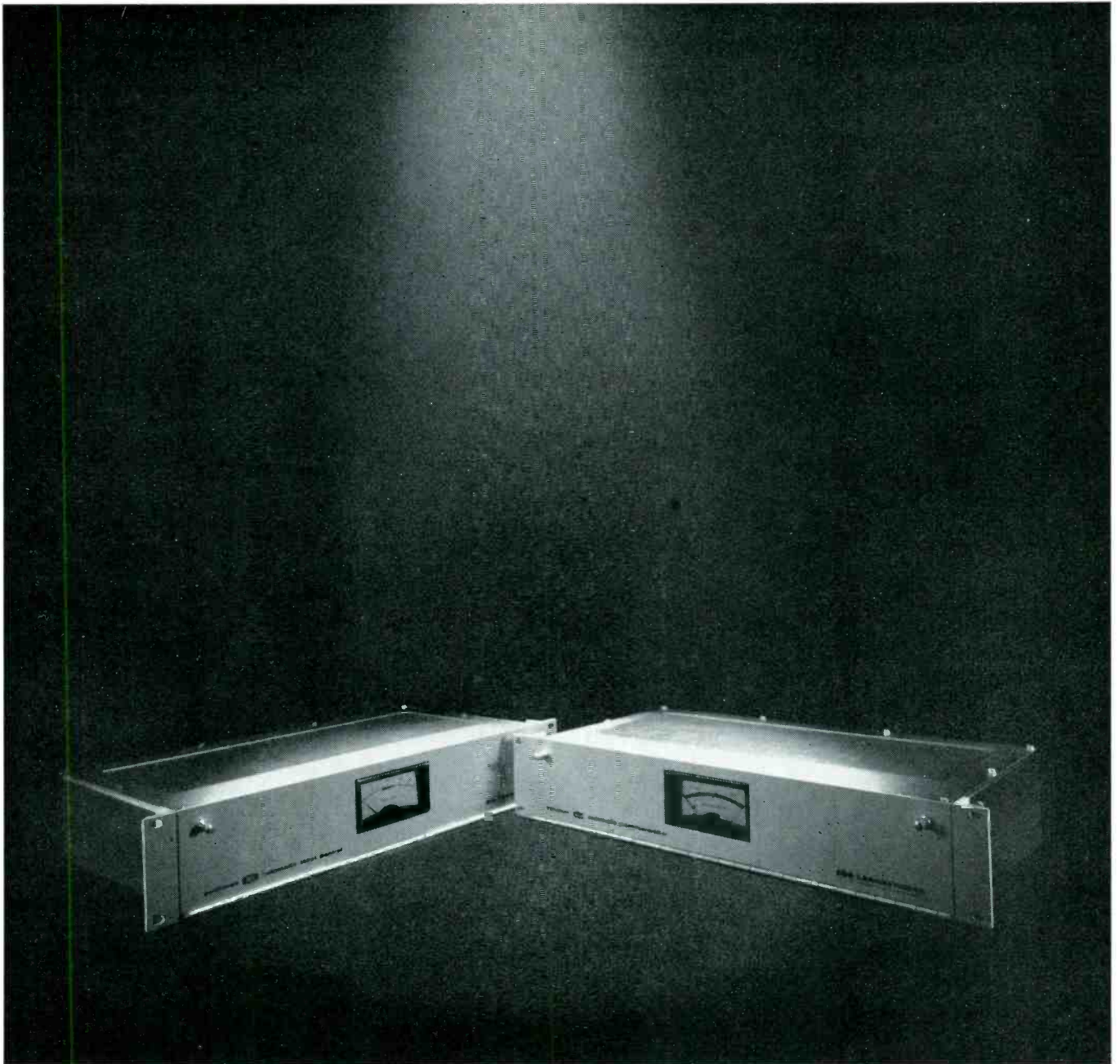

**See the Max Brothers increase your program power up to 8-fold!**  
 (That's the new solid state Audimax on the left... and the Volumax on the right)

Hear this unique combo perform free in your studio for 30 days! Now CBS Laboratories gives you the famous Max Brothers (Audimax and Volumax) both solid state for the first time. They'll perform *free* in your studio for 30 days. Then, if you're not convinced that solid state Audimax can "ride" gain to increase program power up to 4-1, and solid state Volumax can control modulation peaks for as much as an additional 2-1 increase, you can cancel the Max Brothers, with no obligation.

See why the Max Brothers are broadcasting's new money-making stars! Audimax is an automatic level controller that outmodes the ordinary AGC. A brilliant studio technician without human shortcomings. By automatically controlling audio levels, it frees engineers, cuts costs and boosts your signal. Volumax has a few specialties of its own. It outmodes conventional peak limiters by controlling peaks automatically without side effects. By expanding effective range and im-

proving reception in fringe areas, it brings in extra advertising revenues. Call or write CBS Laboratories for a bulletin with complete details on Audimax and Volumax. REMEMBER! Together, the Max Brothers can increase your program power up to 8-fold. Decrease operating costs. Bring in more advertising. For just \$665 each. Can you afford *not* to ask for a FREE 30-day trial?

**CBS LABORATORIES**  
 Stamford, Connecticut. A Division of  
 Columbia Broadcasting System, Inc.

Circle Item 22 on Tech Data Card

# TELEVISION IN AMERICAN SAMOA

by **H. Eugene Larson**, Consulting Author, Engineer, KVZK, Pago Pago, American Samoa — Television forms the basis of the modern educational system in this American territory.

American Samoa is an unincorporated territory of the United States administered by the Department of the Interior. It is comprised of the eastern islands of the Samoan group, which is located in the Pacific Ocean approximately 2,000 miles southwest of Hawaii and 1,600 miles northeast of the northern tip of New Zealand. There are seven islands in the American Samoan group. The administrative offices are near Pago Pago Harbor on the island of Tutuila.

The present Governor, H. Rex Lee, decided to improve an archaic Samoan educational system by making extensive use of instructional television. The U. S. Congress approved funds for this TV system in 1963. The project included the construction of a TV center which houses the studios, control areas, offices, a library for the lesson

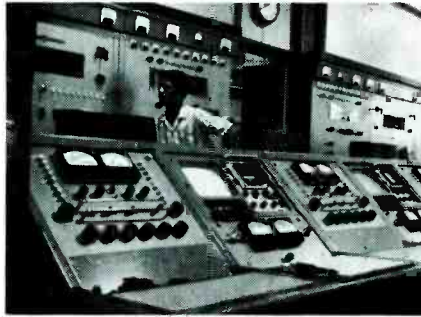

Fig. 1. View of transmitter control room.

preparation, a shop for set construction, graphics areas, and photographic dark rooms. Also included are a mountaintop transmitter and new consolidated school buildings designed for television teaching.

As the system now operates, three levels of instruction are prepared in the studio building. The lessons are either recorded on TV tape for later release or are relayed by microwave to the transmitter on

Mount Alava. Three transmitters (see Fig. 1), operating on channels 2, 4, and 5, broadcast the material to consolidated school sites on the American Samoan islands of Tutuila, Aunu'u, Ta'u, Olosega, and Of'u. Islands in the Western Samoa group also receive the signals.

## TV Studio Building

The TV building in the village of Utulei contains four studios located around a ground-floor central control area (Fig. 2). Each studio has a control room (Fig. 3) equipped with video monitors, a video switcher, remote controls for film and slide projectors (Fig. 4), and an audio console. Located in master control are synchronizing generators, control units, channel amplifiers and power supplies for six image-orthicon cameras, and four vidicon film and slide cameras. A 16-mm film projector and a dual-drum slide projector are multiplexed into each vidicon film camera. Three microwave transmitters are used to relay the pictures and sound to the transmitter site on Mount Alava. Four television tape machines are used to record and play back the TV lessons. All switchers are rack-mounted relay types with vertical-interval switching used in the output lines. Tally-light con-

• Please turn to page 45

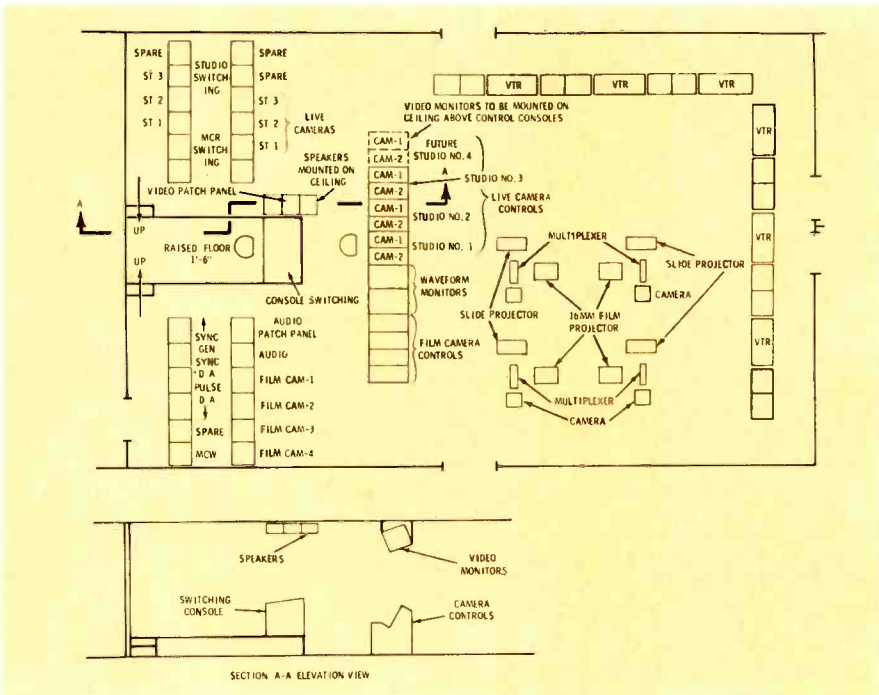

Fig. 2. The station studios are arranged around this ground-floor central control area.



Fig. 3. Video and audio master control.

# WHEN KOSS & REK-O-KUT PLEDGE THEMSELVES TO QUALITY, HERE'S WHAT THEY MEAN

When John C. Koss purchased control of Rek-O-Kut, he discussed "quality" with Sid Simonson (Rek-O-Kut Manufacturing Vice-President) and Hal Dennis (Rek-O-Kut Sales Vice President). "There's a reason why everyone thinks of Rek-O-Kut as the very finest in single-play turntables. There's a reason why every audio engineer in the business knows and respects Rek-O-Kut equipment," said Koss.

"The reason," Simonson explained, "is that for over 25 years, we paid particular attention to purchase of parts and raw materials. Then we tooled for absolute precision in machining and assembly. If something wasn't perfect, we scrapped it!"

"Good," said Koss, "that's what I do with our headphones and that's what I want continued with our turntables." And that's what is now being done at the Milwaukee plant.



**KOSS PRO-4 STEREOPHONES** \$45.00

Truly a professional instrument. Frequency response: 30-20,000 cps. Impedance: 50 ohms to be used with 4, 8, or 16 ohm outputs. Fluid-filled ear cushions for positive seal and comfort over long listening periods. Highest quality drivers mounted in acoustically designed chambers provide unusually smooth frequency response. Equipped for boom mike attachment.



**REK-O-KUT B-12H TURNTABLE** \$165.00

Three speed. Noise level: -59 db below average recording level. Wow and flutter: 0.085% RMS. Custom-built, heavy duty Hysteresis Synchronous motor for constant speed and "hush" performance. On-off signal indicator.

Write for complete details and specifications on all Koss and Rek-O-Kut products.

**KOSS** **REK-O-KUT**

2227 N. 31ST STREET • MILWAUKEE 8, WIS.

Circle Item 23 on Tech Data Card

JAMPRO

DUAL POLARIZED FM ANTENNA WILL

# INCREASE YOUR SIGNAL!

Now you can achieve RF radiation the EASY, PRACTICAL WAY! The new JAMPRO dual polarized FM antenna will increase your signal many times to establish new listeners in hilly areas, give you more signal to home radios using built-in antennas and car FM sets. Contact JAMPRO today for a dual polarized system especially suited to your ERP requirements.

## CONVERT YOUR EXISTING ANTENNA

A new, low cost Dual Polarized Conversion Kit is now available from JAMPRO. Complete with power divider, vertical elements, and instructions for field installation, you can convert your present FM antenna into a dual polarized system. Contact JAMPRO for details.

Contact JAMPRO for newly developed technical information regarding Dual Polarized antenna measurements and performances.



# JAMPRO

ANTENNA COMPANY  
6939 POWER INN ROAD SACRAMENTO, CALIFORNIA

PHONE:  
AREA CODE 516  
442-1177

Circle Item 24 on Tech Data Card

## TV In Samoa

(Continued from page 42)

tacts in the output-line switcher control an audio - follows - video switcher, which is located in the audio rack along with audio output line AGC amplifiers. AC wiring travels through trenches in the floor. DC-control, video, and audio cables are located in overhead cable trays.

### Transmitter

Before the transmitter building was completed, construction was started on a mile-long aerial cable tramway running between a lower terminal on Mauga'o'ali'i Ridge near the studio building and the transmitter site on Mount Alava. This tramway system was used to carry the transmitters and the antenna to the mountain site. It now provides the transmitter operators with a scenic commuting ride across Pago Pago Harbor. Tourists also make the aerial tramway trip a part of their island sight-seeing.

Space is provided in the transmitter building for six transmitters; three are installed and in use. The



Fig. 4. Camera control units and monitors.

building contains living quarters, storage and shop space. Culinary water for use in the building is collected on the roof and stored in a redwood tank. The antenna system consists of a 4-bay batwing for channels 4 and 5 above a 4-bay channel-2 antenna. The antennas are mounted on the top of a 100' self-supporting tower. The diplexer for combining channels 4 and 5 is located in the bay behind the transmitters.

### Schools

Classroom buildings were constructed in the manner of the traditional Samoan fale (an oval perimeter of posts with a thatched roof). However, concrete posts and redwood shingles were used instead of log posts and thatch. When the project is completed, there will be 26 consolidated elementary schools in operation. Students in levels one and two sit on mats on the floor while viewing their lessons on 21" TV receivers. Students in higher levels use conventional desks. External audio amplifiers and speakers are used to overcome the high ambient noise levels found in some locations. Conduits are provided for the RF distribution cables, and some schools are equipped with an RF distribution amplifier to overcome splitter and tap-off losses. De-snowers are used at difficult receiving locations.

### Conclusion

The Samoan TV system is attracting considerable attention from all over the world. The system is unique because all of the elementary school instruction is done through television; most mainland systems use television for enrichment or partial teaching. This installation will probably be the model for many other instructional television systems. ▲

# Automatic Broadcasting as easy as

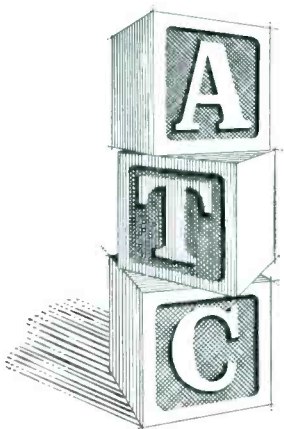

Send for FREE 35-pg. booklet "Planning for Automated Broadcasting." Or call collect today 309-829-1228.

**AUTOMATIC**  **TAPE CONTROL**  
1107 E. Croxton Ave. Bloomington, Ill.

Circle Item 26 on Tech Data Card

April, 1965

## NORTRONICS DOES IT AGAIN!

Ever since cartridge machines were first introduced into broadcasting, the process of replacing worn, rear-mount heads has been both expensive and time consuming. **NO LONGER!**

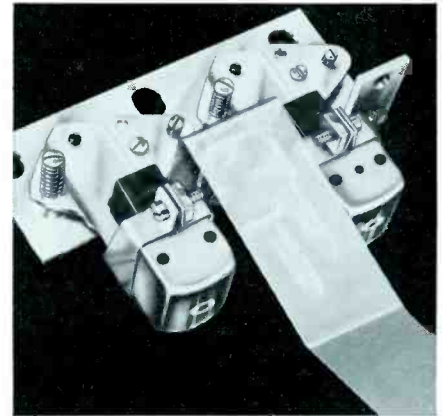

Nortronics, as part of their constant effort to increase quality and ease of operation through advanced research and development, have pioneered a revolutionary, new method... a Quik-Kit assembly which accommodates no-mount heads in your cartridge equipment. What's more, now you can replace worn heads with genuine Nortronics laminated core, hyperbolic, all-metal face no-mount heads!

These unique Quik-Kits are semi-aligned and completely assembled; micrometer adjustments for height, azimuth and face alignment as well as a special lock screw to "freeze" adjustments, are provided.

Write for Form No. 7208 today! It gives complete information about converting your cartridge machines to no-mount heads, and which Nortronics heads to use.

  
**Nortronics**

8143 Tenth Ave. N., Minneapolis, Minn. 55427

Circle Item 25 on Tech Data Card



## Improve your image the proven way

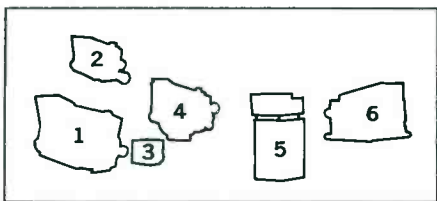

From G.E.'s complete line you will find the camera that will add just the right snap to both your station image and your viewers' reception. G-E camera

systems are the finest...the result of pioneering research in solid-state circuitry that has led to increased reliability, optimum performance and greater economy. G-E camera systems are user proven...in station after station where G-E equipment is now building better images...creating better pictures.

**1. PE-23—First Professional Transistorized Studio Vidicon Camera.** Proven by more than two years of network

use. Ideally suited for news, panel and quiz shows, as well as educational programming. Soon to be available with advanced lead-oxide pickup tubes.

**2. PE-26—Television's Newest, Portable, All Transistorized 3" I.O. Studio System.** Best 3" I.O. picture you ever saw—in a smaller, lighter package. Completely transistorized. Perfect for remote applications.

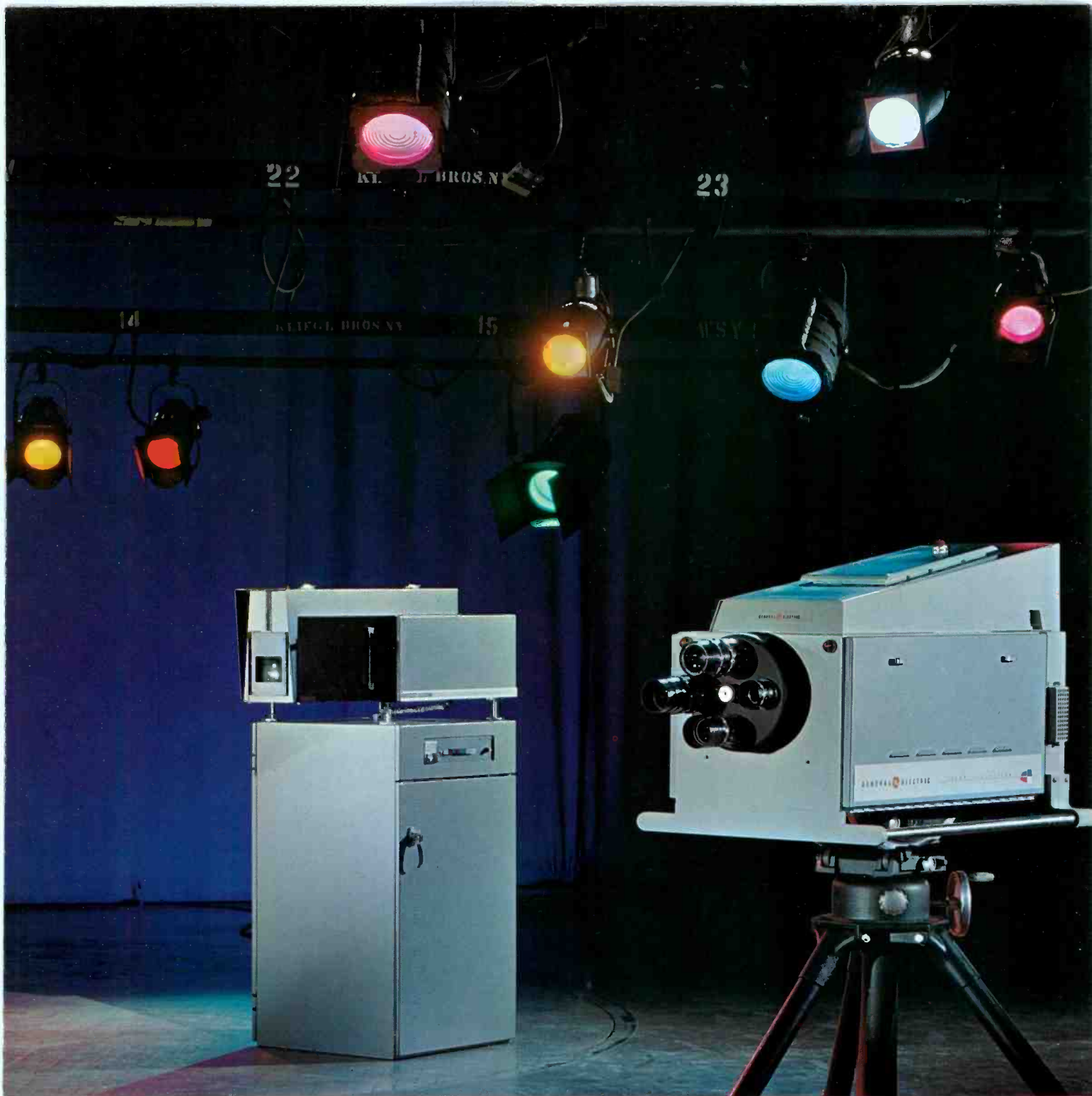

Studio location courtesy WSYR-TV, Syracuse, N.Y.

## with General Electric 1965 Cameras.

**3. PE-27—Advanced Transistorized Version of Television's Most Widely Accepted Film Camera.** Best response, lowest noise, least lag from a 1" separate mesh vidicon tube. Transistorized. Designed for hands-off operation.

**4. PE-29—The Aristocrat Of All Monochrome Cameras.** Designed to give finest picture quality for exacting studio productions and video tapings. Owners agree. Side by side comparisons prove it.

**5. PE-24—First 4-Vidicon Universal Film Camera.** Now programming finest quality color and monochrome film for 26 local stations and the ABC-TV Network.

**6. PE-25—Television's Most Advanced 3-I.O. Studio Color Camera.** Unmatched stability and excellent color registration. Extensively transistorized. Consistently sharp, true and clear pictures.

For all your camera requirements, contact your G-E Broadcast Equipment Representative, or, General Electric Company, Visual Communications Products, Building 7-315, Electronics Park, Syracuse, N.Y. 13201. GE-12

Visual Communications Products,  
**GENERAL  ELECTRIC**  
 Electronics Park, Syracuse, N.Y.

# DIRECTIONAL ANTENNA STABILITY

by **J. Gordon Elder**, Consulting Author, Consulting Engineer, King City, Ontario, Canada — A review of some of the causes of array instability and some of the possible remedies.

Many aspects of AM array design, installation, and adjustment have already been considered in recent issues of this magazine. The discussion that follows concerns array stability and design methods for its improvement. This subject has become quite important in recent years, especially since satisfactory stability is a prerequisite for remote-control authorization. In addition, due to the increased occupancy of the band, the suppression of radiation toward other stations often requires a highly directional pattern and a multi-tower array.

## Stability Factors

Assume that the preliminary design has yielded a theoretical pattern that meets all protection requirements. Whether or not these can be achieved and maintained in practice depends on several factors, including tower height and spacing; site and surroundings; ground sys-

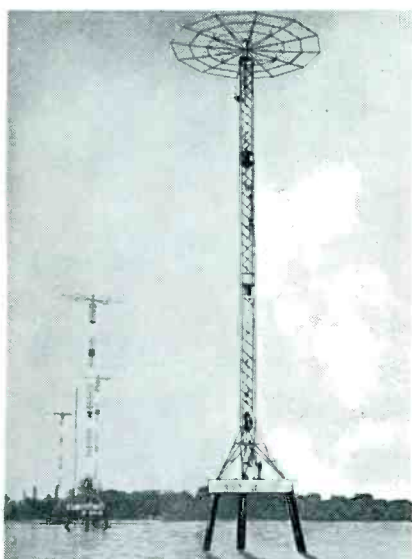

Array of 150' top-loaded self-supporting towers in Lake Ontario for station CKEY.

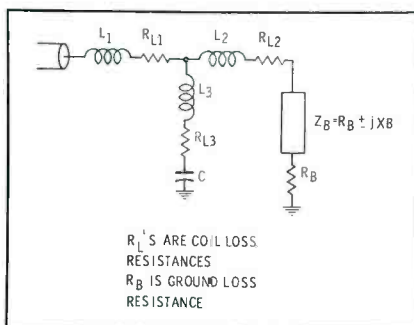

Fig. 1. Equivalent circuit of a tower and its tuning unit shows loss resistances.

tem; tuning, phasing, and power-division system; and monitoring system.

## Array Design

First consider the tower itself. An antenna may correctly be regarded as an impedance transformer which matches its own driving-point impedance to the characteristic impedance ( $Z_0$ ) of free space. In broadcast arrays, the base operating impedance may be a few ohms to a few hundred ohms. The value depends on tower height and spacing and the driving currents (Table 1). The impedance of free space is a constant 340 ohms.

Based on the preliminary pattern calculations, both a tentative site and tower height may be selected. Driving-point impedances can be calculated for use in estimating the efficiency and stability of the array. There are various ways of assessing array stability. One method assumes small phase shifts and current changes on each tower, for example,  $\pm 2^\circ$  and  $\pm 2\%$ . Alternatively, if there is a critical (low-resistance) tower in the array, the maximum permissible variations in the magnitude and phase of its current may be calculated.

If protection requirements require a front-to-back or front-to-side ratio of more than 20:1 (26 db), it is usually found that the permissible current variations are quite small; they may be less than  $\pm 1\%$  and  $\pm 1^\circ$  per tower in a critical array. Small errors such as these can easily occur due to seasonal temperature changes, variations in moisture content of the ground, and gradual changes in the system. Therefore, considerable care is required during design, construction, and routine maintenance to ensure that adequate stability is achieved and maintained. Based on protection requirements, the stability analysis, planned precautions and experience, the consulting engineer assigns a maximum expected operating value (MEOV) of radiated field in protected directions.

## Resistance Variations

A principal source of instability is changes in the loss resistance of the ground system (Fig. 1). For design calculations, the loss is often assumed to be two ohms per tower, but the actual value may average from less than one ohm to several ohms, depending on the type of soil and the size and condition of the ground system. Losses can be reduced by: (1) use of a large ground system (at least 120 radials of .4 wavelength average per tower), (2) a large sheet of copper mesh laid at each tower base with little or no soil over it (to reduce dielectric losses) and all radials soldered to it, (3) wire fences and other conductors kept well clear of the towers, and (4) a site that is free from vegetation.



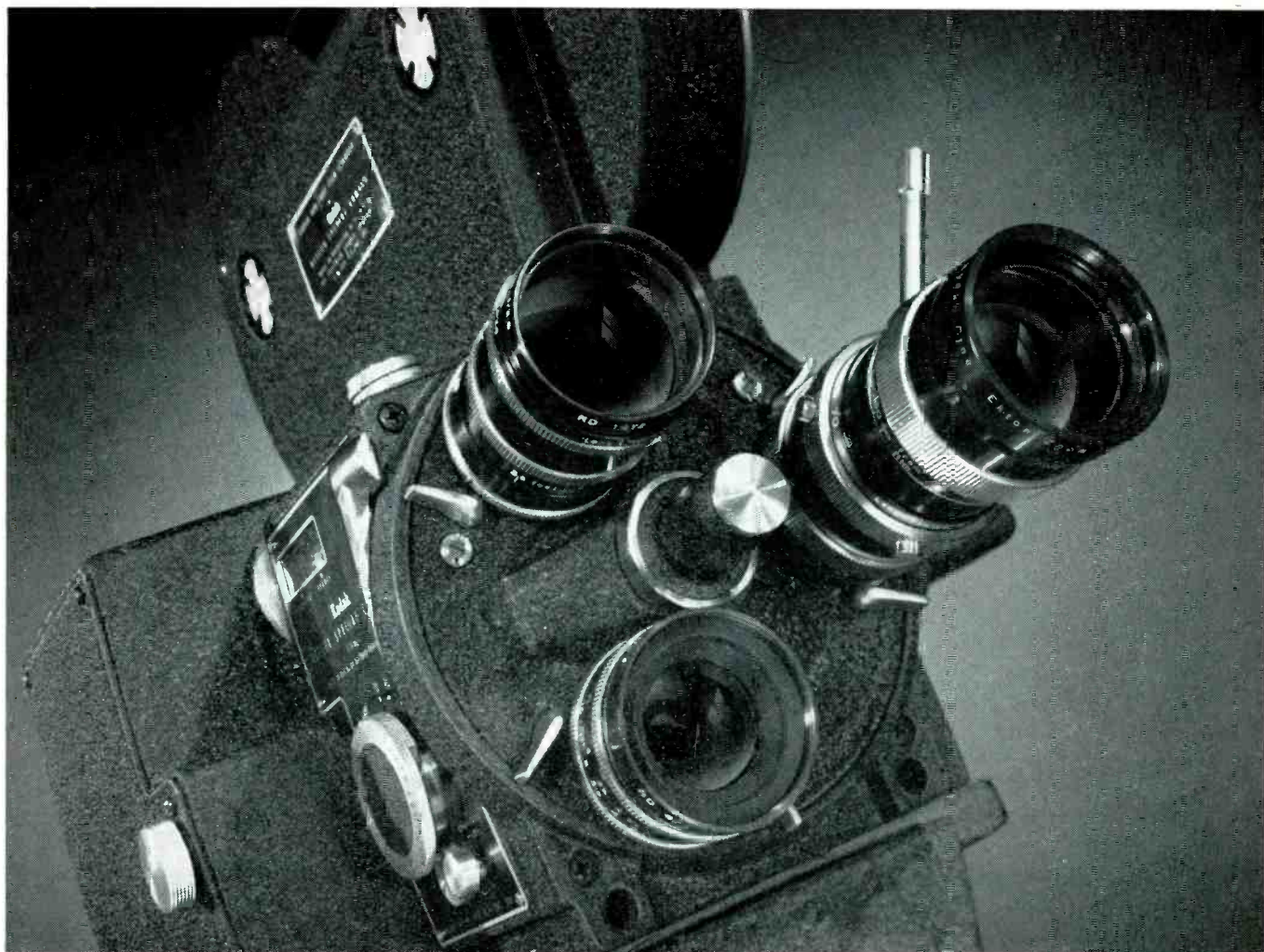

Looking for the camera that's versatile and trouble-free, the one designed to meet all your station's needs? Meet the

## KODAK Reflex Special Camera

With the KODAK Reflex Special Camera and its accessories you have a complete 16mm motion picture system, both sound and silent. The camera provides the most accurate reflex viewing and is ruggedly engineered for continuous day-to-day performance in the field and in the studio. But most important, the camera's optical and film-transport systems assure recorded images unmatched in sharp-

ness and steadiness. Here are some of the quality features contributing to its versatility:

**1.** Variable shutter permits exposure and depth-of-field control in addition to that provided by lens diaphragm. This feature is particularly valuable when shooting news events in low-light conditions.

**2.** Ground-glass reticule shows exact scene which reaches film, provides accuracy as

great as any camera-rackover system but with the speed and convenience of reflex viewing.

**3.** Adjustable eyepiece can be locked into position. Normal 10X magnification can be increased to 20X for precision focusing—assuring extreme sharpness in the projected image.

**4.** Three-lens turret provides flexibility to meet any situation. Type R lens mounts and positive-action turret afford great accuracy and speed of lens change.

**5.** Nine KODAK EKTON Lenses have been developed for this camera, ranging in focal length from 10mm to 150mm, including a new  $f/2.2$

zoom lens with variable focus from 17.5 to 70mm. These superb optics yield images of extraordinary resolution.

**6.** Single-system sound-recording accessory provides the portability and dependability necessary for news reporting and features maintenance-free transistorized amplifier.

**The KODAK Reflex Special Camera is part of a rapid-access 16mm TV film system that takes you from "on the spot" to "on the screen" in minutes. It includes camera, pre-stripped films, processor and projector. For a brochure with complete details, write to:**

Motion Picture and Education Markets Division **EASTMAN KODAK COMPANY** Rochester, N. Y. 14650

or the regional sales offices: New York, Chicago, Hollywood

Circle Item 28 on Tech Data Card

**THIS  
IS  
SOLID-STATE.**

**THIS  
IS  
NOT...**



Everyone knows that solid-state is as *modern as tomorrow* . . . and vacuum tubes are as *dated as the horse and buggy era*. The day a tube-type CATV system is fired up, it is obsolete, antiquated, outmoded. ■ And everyone also knows that Ameco is the CATV manufacturer who *pioneered* and *originated* the solid-state concept in cable television equipment. While competition scoffed and said it couldn't be done . . . Ameco's Research and Development Department went ahead and did it! ■ Now the others are attempting to go solid-state in a desperate effort to catch up with Ameco's three year lead. ■ So if your company is considering CATV . . . solid-state Ameco is the one to consider. Might just as well go with the *recognized leader* in the cable television field . . . Ameco. You'll be glad you did.



P. O. Box 11326  
PHOENIX, ARIZONA 85017  
TELE: 602-252-6041

**AMECO QUALITY...  
THE ENVY OF CATV**

Circle Item 29 on Tech Data Card

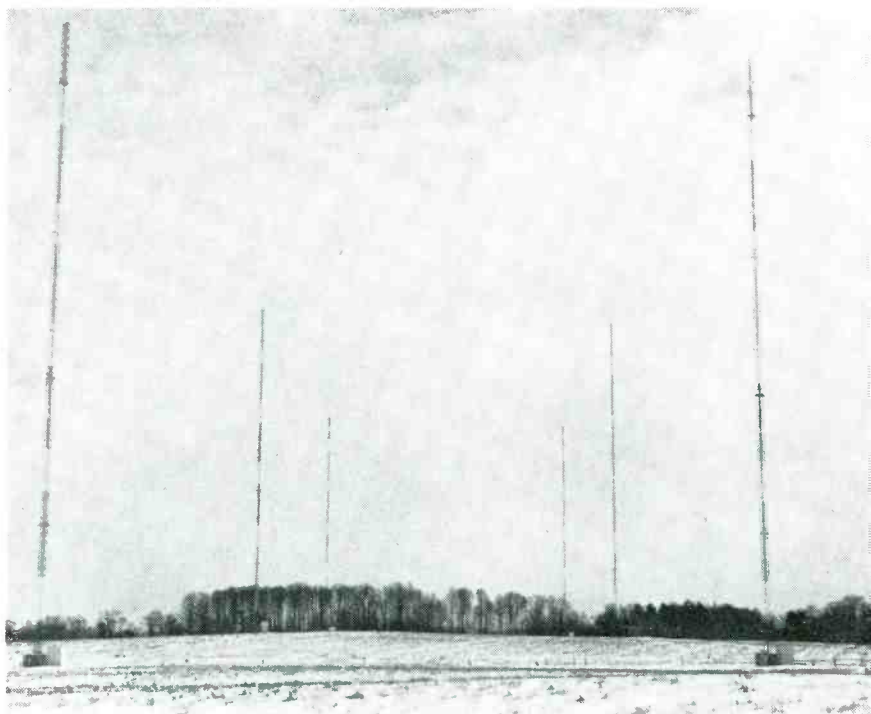

This wide-spaced six-tower parallelogram directional array is used at station CHIC.

The effect of variations in ground losses can be reduced by using tall towers and wide-spaced arrays to raise the driving point or operating resistances. For example, assume that the loss resistance increases by .25 ohm. If the tower involved has an operating resistance of 50 ohms—which is about equal to that of a single 90° tower—the increase is only .5%. If a —90° section is used for matching, the tower current would fall by about 1% and its phase would lead by .3°. On the other hand, if the tower is almost parasitic and has an operating resistance of only 1 ohm, the increase is 25%. This would probably cause excessive changes in the phase-monitor readings for that tower and excessive pattern distortion.

A slight change in tower reactance may be caused by guy wire icing, or broken or dirty insulators.

The effect is similar to that of a resistance change, inversely proportional to the operating resistance.

For these reasons (among others) parasitic towers are disfavored. If the use of such a tower is unavoidable, a fixed resistor may be built into the matching section to increase and stabilize losses. Similarly, short towers and close-spaced arrays should be avoided whenever possible.

The above example illustrates the improved stability resulting from higher operating resistance and taller towers. In addition, increased tower height helps to raise the horizontal radiation efficiency of the array. Otherwise, this may be less than the minimum required for the station. Large highly directive arrays can also be adjusted more quickly during the initial proof if driving-point impedances are mainly resistive and approximately equal to

**Table 1. Factors Determining Base Impedance**

PARAMETERS	DERIVED FROM	DETERMINE
Self impedance $Z_S$	tower height & diameter	Base operating impedance $Z_B$ $(R_B \pm jX_B)$
Mutual impedance $Z_M$	$Z_S$ and spacing	
Base current ratio & phase	pattern shape	

# How does this 7 FOOT MONSTER help solve your sound problems?

 The giant microphone shown here is the biggest microphone in captivity! The Model 643 is also the most directional microphone sold today. It helped E-V win the first Academy Award for microphone design in 22 years.

But beyond this, the 643 has been one of our most effective field research tools, offering a far-reaching insight into the nature of directional microphones, and their applications.

An obvious result of 643 research is our unique Model 642. Same E-V Cardiline™ principle\*, but only 18 inches long. It reaches up to twice as far as any other broadcast unidirectional microphone to give you better long distance pickups than were dreamed possible a few years ago.

And this same basic research stimulated the development of our new Model 668 cardioid microphone. It uses the Continuously Variable-D® cardioid principle (a creative development from our exclusive Variable-D patent\*) to provide smoother cardioid action—plus more versatility—than any other boom microphone you can use.

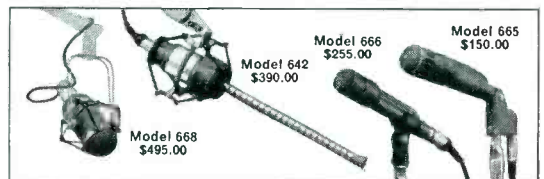

But let's not ignore the most popular professional cardioid microphone of all, the Model 666. Here's where the Variable-D principle got its start. And since the introduction of our seven foot laboratory, the 666—and its companion, the 665—has been further refined to offer better performance and value than ever before.

From such startling microphones as the 643, come continuing basic improvements—and the tools you need to solve your most difficult sound problems. Only E-V provides this kind of design leadership. E-V microphones in your studio will give you a big head start toward better sound. After all, we're at least seven feet ahead of everybody!

**ELECTRO-VOICE, INC.**

Dept. 451V, Buchanan, Michigan 49107

**Electro-Voice®**  
SETTING NEW STANDARDS IN SOUND

Circle Item 30 on Tech Data Card

# UP-DATE

YOUR OLD 3"

R.C.A. / IMAGE  
G.E. / ORTHICON  
DUMONT / T.V. CAMERA  
MARCONI / & OTHERS



with a



## 3" IMAGE ORTHICON DEFLECTION YOKE

(Part No. OY-64)

- Flatter Field
- Sharper Corners
- Improved Resolution
- Quieter Image Section
- Better Cooling for Longer Tube Life

## and 3" IMAGE ORTHICON ALIGNMENT COIL

(Part No. OA-3)



Write today to:

**CLEVELAND ELECTRONICS, INC.**  
1975 East 61st St. • Cleveland, Ohio 44103

Another quality product by  
Cletron... Manufacturers of Deflection  
Components, Custom Transformers  
and Sound Reproducing Devices

Circle Item 31 on Tech Data Card

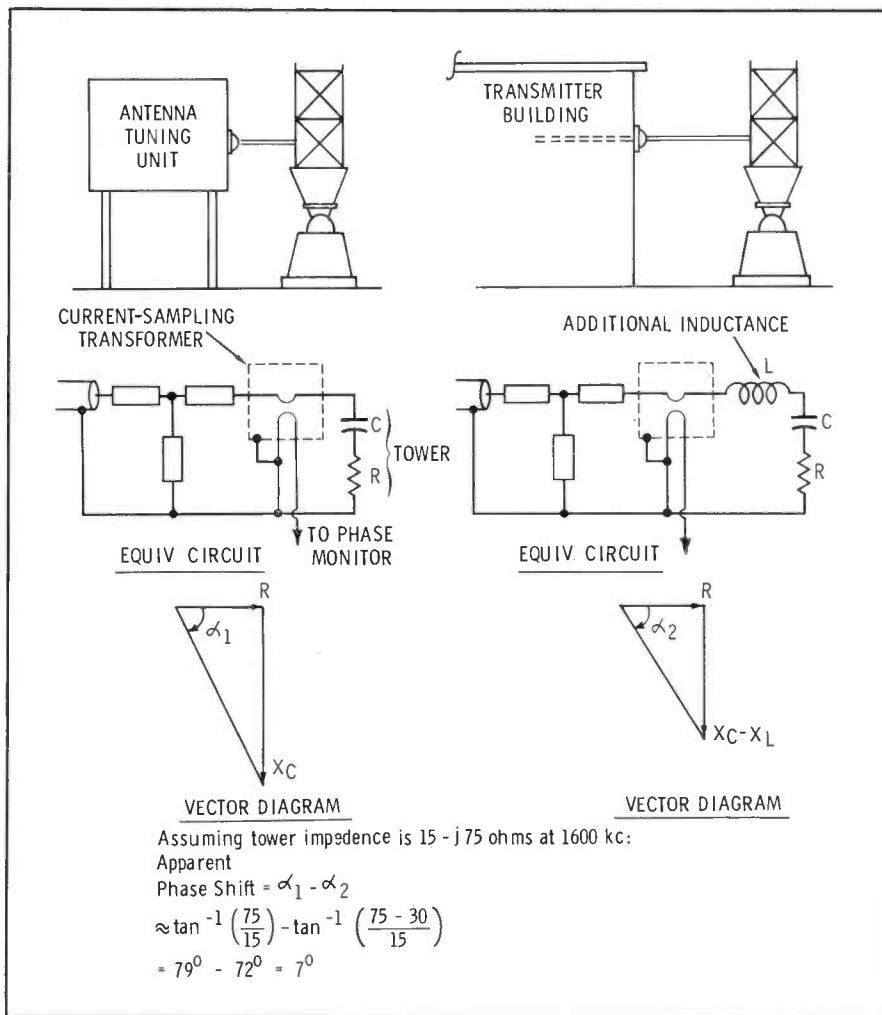

Fig. 2. Measurement of antenna current at common point of directional antenna.

the line impedance. In some cases, inversion of tower currents during the design provides the identical pattern with improved driving-point impedances.

### Construction Considerations

To achieve good stability, all power and coaxial cables on the site should be buried. All RF grounds must be properly made using heavy copper strap. All tuning components must be conservatively rated. Coils must be mounted at right angles and adequately spaced to avoid mutual coupling. Low values of capacitive reactance should be obtained by using a large capacitor—not a small one in series with a large coil (the combination operating near resonance), since this would cause instability and reduce the circuit bandwidth.

Suitable design of the RF power distribution system may provide inherent compensation for changes in tower operating impedances and

thus improved stability.

If there are high-voltage transmission towers or tall chimneys near the site, it is probable that these will reradiate some of the transmitted power. From their electrical height and the induced voltage, their influence may be assessed approximately. Measurements taken during the proof of performance will determine which obstructions, if any, must be detuned to avoid excessive null fill. Unfortunately, reradiators are really loosely coupled parasitic radiators and subject to the stability problems mentioned earlier.

### Monitoring Considerations

Thermocouple ammeters are usually calibrated by the manufacturer at room temperature. On a hot summer day, readings will be low by 5% or more, and in mid-winter they will be high. Temperature variations slightly alter tuning component values and the electrical length of coaxial cable. For these



## Live couldn't. Scotch® Brand Video Tape did.

### Kept ice cream from melting for KAKE-TV!

Video tape makes sure the ice cream always looks its most appealing on tv. Pleases the sponsor, Steffen's Dairy. Brings in the customers. And makes the commercials less expensive to produce.

Used to be at KAKE, Wichita, the ice cream dishes were set up under the lights prior to the 10 p.m. news. But began to melt before the mid-program commercial. Adding an extra man to put the ice cream in place at the last second was considered. But going to video tape proved both more convenient and less expensive.

KAKE now tapes virtually all evening commercials by local clients in advance. Less crew is needed during the evenings. The advertiser enjoys greater control over his commercials. And the commercials themselves have *live* picture quality without danger of an on-the-air goof.

*KAKE is among more than 200 stations throughout the country that are utilizing 3M's video tape program to show advertisers that taped commercials best show their merchandise. Stations near you are now offering a variety of helpful reference materials as well as production service. Give them a call. Or write 3M Magnetic Products, Dept. MDV-45, St. Paul, Minn. 55119.*

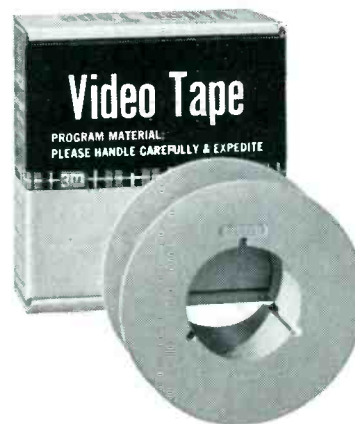

Magnetic Products Division **3M** COMPANY

"SCOTCH" AND THE PLAID DESIGN ARE REG. TMS OF 3M CO. © 1965, 3M CO.

Circle Item 32 on Tech Data Card

# Oxide shed after one hour use

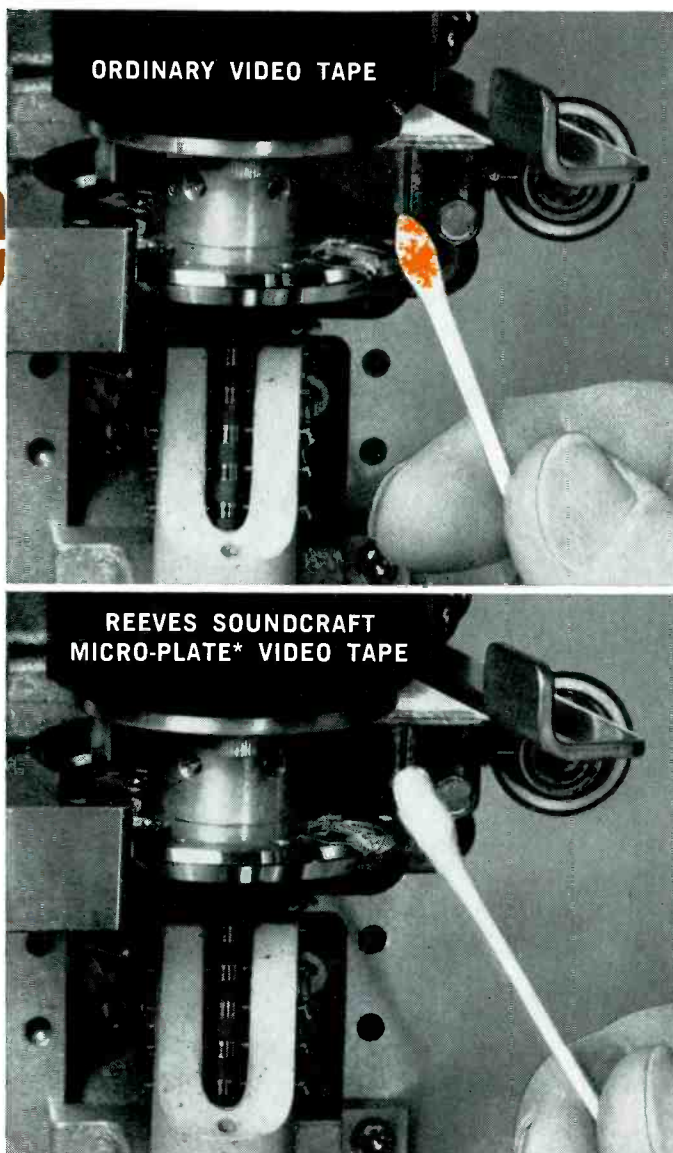

What happens too frequently *during* one hour use can't be illustrated. The picture is *gone*—the inevitable result of oxide shedding from your ordinary video tape.

One of the major causes of lost or poor quality video images is oxide shedding which takes place when ordinary video tape passes over your recording heads! Deposited there as a powdery substance, it can melt under heat (friction). It can foul the head or be redeposited on the tape. This progressive buildup ultimately prevents intimate tape-to-head contact resulting in loss of video picture.

But here's *proof* that Soundcraft MICRO-PLATE\* Video Tape *eliminates* undesirable oxide shedding.

Run any ordinary video tape for one hour. Clean your heads with a cotton swab. Note the large residues of oxide on the swab. Now repeat the process with Reeves Soundcraft. By comparison, the swab is spotless. *Even after 500 hours with Reeves Soundcraft, your head wheel panel is as clean and free of oxide discoloration as when it was installed in the machine.*

A unique oxide/binder system combined with the MICRO-PLATE\* process makes the difference. The result is the smoothest surface of any tape made today. Prove it—by making your own oxide shed test. Order a reel of Soundcraft MICRO-PLATE\* Video Tape today—or write for complete specifications. \*T.M.



**REEVES SOUNDRAFT**  
DIVISION OF REEVES INDUSTRIES INC.  
GREAT PASTURE ROAD, DANBURY, CONN.

New York • Chicago • Los Angeles • Export: C.B.S. Int'l., 46 E. 52 St., N.Y.C. • Toronto: Applied Electronics.

Circle Item 33 on Tech Data Card

reasons, the tuning huts of critical arrays are occasionally heated to a constant ambient temperature. In this case the huts may also be shielded and heat insulated.

In many recent AM installations the transmitter building is located beside one of the towers. The open line feeding that tower may be 10' longer than those from the other antenna tuning units. This would involve an additional self inductance of about three microhenries and a reactance of nine ohms at 540 kc or thirty ohms at 1600 kc. If base-current sampling transformers are used for phase monitoring, this difference in line inductance would result in phase readings different from the theoretical values in order to develop the correct pattern (Fig. 2). The shift will often be less than 7° if the frequency and/or operating resistance is lower than shown, but it will be greater if the tower's electrical height is about 90° and the array produces operating impedances that are almost resistive. However, it is helpful to consider this source of error when adjusting an array. Measurements to equalize the physical or electrical lengths of the sampling lines will not avoid it, though pairing towers and adjusting for a null on their axis will. The discrepancy could be avoided by including a two- or three-turn surge-limiting coil in the short feed lines only or by using sampling loops. It is evident that other sources of error will frequently be more important than this one, especially in the case of a close-spaced array.

Precision phase monitors are available that have a resolution of  $\pm .1\%$  for magnitude and  $\pm .1^\circ$  for phase. They are necessary for the successful operation of a highly critical array.

## Conclusion

Some of the problems associated with critical arrays have been outlined. It will be apparent that arrays of this type can be very expensive if properly engineered. The advantages of this approach may not be apparent to management; it is up to the engineer to convince them that a marginal design installed at minimum cost is false economy. ▲

# What's the big deal about Times' new 2000 ft. seamless sheath CATV cable?



**Plenty!** It not only saves you money in installation and maintenance. It performs better throughout the life of your CATV system . . . and actually increases system profits.

**1. Easily saves you 10% on installation and shipping costs.** 2,000 ft. lengths mean fewer splices. This saves you 8% in the cost of labor and splice connectors. Only 1 reel needed for 2,000 ft. of cable instead of 1 reel for each 1,000 ft. saves you an additional 2% in handling and shipping.

**2. Increases profit.** The fewer the splices, the less maintenance needed. Every splice is a potential trouble-expense point. Less maintenance means less labor cost and more profit over the life of the system.

**3. Improved electrical performance.** Times JT-1000 cable, in 2,000 ft. lengths, is manufactured with a guaranteed 26db minimum return loss—a must for minimum ghosting. Seamless tube sheath gives you the radiation protection you need when high power level amplifiers are used. And because it's seamless, Times JT-1000 cable won't let in moisture vapor that stops your signal short of target.

And don't forget . . . long after so-called economy cable has been replaced, Times JT-1000 cable will still be a top performer.

It's a fact: Re-installing a cable system costs more than the original installation. With a so-called economy system, your system starts deteriorating the day you put it in. But Times' JT-1000 cable keeps pace while you're upgrading your system and lives up to your system's planned potential. Why not take advantage of this direct way to improve your system's profits?



**TIMES**  
WIRE AND CABLE

Division of the International Silver Co.

Transmission System Design and Engineering/Standard & Special Coaxial Cable/Multiconductor Cable/Complete Cable Assemblies/Teflon\* Hook-Up Wire  
COPYRIGHT 1965

\*A DU PONT TRADEMARK

Circle Item 34 on Tech Data Card

April, 1965

55

# Next Month In Broadcast Engineering

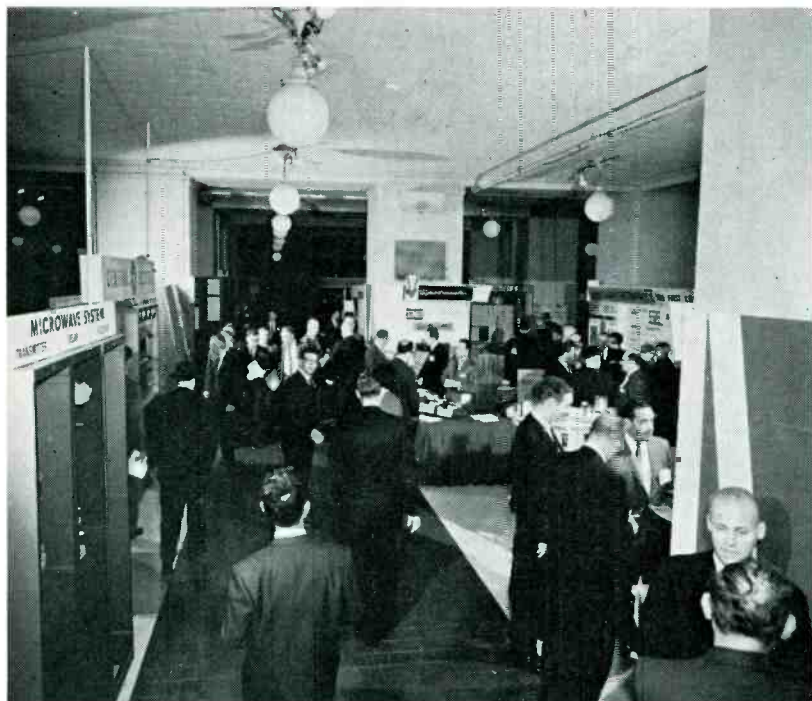

## COMPLETE COVERAGE OF THE NAB SHOW

●  
Automate to Make, Not Save, Money

●  
Phase Monitor Sensitivity

●  
The Versatile Cathode Follower

●  
Solid-State Microwave Relay

**Plus: Engineer's Exchange, Book Reviews, Washington Bulletin, Letters, Products, News, and Other Interesting Features.**

Reserve your copies now! Simply fill in and send us the convenient subscription card bound into this issue — you'll receive the Broadcast Engineer's Maintenance Guide free of charge.

## Two BE Consulting Authors Promoted

Two long-time members of the BROADCAST ENGINEERING Consulting Author staff, Elton B. Chick of the Rounsaville stations and Melvon G. Hart of the Balaban stations, have been promoted to positions of increased responsibility in their respective organizations. Readers will recall articles by both of these men which give ample evidence of their capabilities and interest in all phases of broadcast engineering.



Having served as director of engineering off the Rounsaville stations for several years, Mr. Chick has recently been elected a vice-president of that group and appointed general manager of the Louisville station, WLOU. Prior to this most recent appointment, Mr. Chick headquartered at WCIN, Cincinnati, where he directed the engineering activities of the six-station group.



Engineering direction of the two-station Balaban group is now the responsibility of Melvon G. Hart, recently appointed technical director of WIL, St. Louis, Missouri and KBOX, Dallas, Texas. Mr. Hart was previously technical director for the St. Louis station and has been a member of the Balaban engineering staff since 1956. ▲



# You asked for it — Now here it is!

## An All New Solid State Video Clamper / Stabilizer Amplifier

The Vital Video Clamper/Stabilizer Amplifier was designed to answer the need for a video processing unit which provides highest performance on color and monochrome television signals. It also has very high stability of all functions, achieved through the use of complete and accurate temperature compensation and excellent power supply regulation.



MODEL VI-500 VIDEO CLAMPER/STABILIZER AMPLIFIER

*Here are a few of the functions performed by this unit:*

- Maintains constant video and sync. levels at the output, measured in reference to blanking, despite large variations in video and/or sync. levels at the input. The peak to peak input level can vary from 0.5 volt to 4 volts while white peaks are held constant, within 2% of the present level at the output, measured in reference to blanking. May be used with non-composite signals.
- Provides a clean video signal at the output even if the input signal is mixed with as much as 10 volts of hum or other low frequency disturbances. More than 50 db. reduction of extraneous 60 cycle hum in the video signal is achieved by means of driven sync. tip clamps. There is less than 1% tilt on a 60 cycle square wave.
- Reformed, noise free sync. is combined with the composite output signal and maintained at a constant preset amplitude in reference to blanking regardless of input level variations. This sync. portion of the output signal is independently adjustable from less than 0.1 volt to more than 0.75 volt, peak to peak. An auxiliary sync. output is also provided which delivers a constant 4 volts, peak to peak of clean, reformed sync.
- Equalization for up to 1000 feet of Belden 8281 cable is provided which is accurate within 0.25 db. to 10 mcs. and is continuously adjustable for any length of Belden 8281 cable from zero up to 1000 feet. Negligible envelope delay is introduced at any setting. This equalization is also suitable for other cable types.
- A white stretch circuit (which may be completely switched out) has great flexibility of adjustment to more accurately match the compression characteristics of transmitters.
- Four identical video outputs are provided with 40 db. isolation at 3.58 mcs. between outputs.

### *Applications include:*

- At the outputs of cameras, switchers, video tape recorders, microwave systems, long lines and off-air pickups.
- At the inputs of video tape recorders, microwave systems and transmitters.

Price for the VI-500 complete with remote controls . . . . . \$1390.00

*Write for complete information and specifications*

**VITAL INDUSTRIES** 3614 SOUTHWEST ARCHER ROAD  
GAINESVILLE, FLORIDA—PHONE 372-7254

Circle Item 35 on Tech Data Card



**Let FAIRCHILD  
put teeth  
into your  
sound!**

### FAIRCHILD DYNALIZER

The newest approach for the creation of "apparent loudness" — the Dynalizer is an automatic audio spectrum equalizer which redistributes frequency response of the channel to compensate for listening response curves as developed by Fletcher-Munson. Adds fullness and body to program material. Completely automatic with flexible controls. Easily integrated into existing equipment. Two models available: Model 673 — Dynalizer only (17 db insertion loss.) Model 683 — Complete no loss Dynalizer system (as illustrated.)

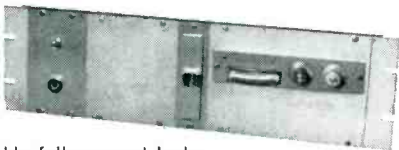

### FAIRCHILD CONAX



The world-acknowledged device that eliminates distortion problems caused by pre-emphasis curves. Allows higher average program levels through inaudible control of high frequencies. Invaluable in FM broadcast and disc recording. Eliminates stereo splatter problems in multiplex channels. Mono or stereo.

### FAIRCHILD LIMITER

Fast attack stereo limiter with low distortion and absence of thumps. Sum and difference limiting position eliminates floating stereo image, despite amount of limiting used in one of the two channels. Also includes regular channel A and B limiting. Dual controls and dual meters provided. Now used throughout the world in recording and broadcast studios. (Mono model available.)



### Introducing the New FAIRCHILD REVERBERTRON

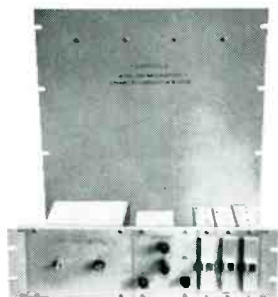

Reverberation now comes in a compact, portable, attractive and rack mountable package 24½" high by 19" wide with the FAIRCHILD REVERBERTRON. The REVERBERTRON, Model 658A, comes complete with mixing system for reverberated to regular signal mixing and contains a unique electronic control of reverberant time. Three time periods available at the flick of a switch — fast (staccato); a moderate time period; and a prolonged time decay for unusual effects.

The compact size of the FAIRCHILD REVERBERTRON and its relatively low cost now allows every studio and broadcaster to have the production-plus of controlled flexible reverberation with the FAIRCHILD REVERBERTRON.

Write to Fairchild — the pacemaker in professional audio products — for complete details.

# FAIRCHILD

FAIRCHILD RECORDING EQUIPMENT CORP., 10-40 45TH AVE., LONG ISLAND CITY 1, N. Y.

Circle Item 36 on Tech Data Card

## BOOK REVIEW



**Understanding Lasers and Masers;** Stanley Leinwoll; John F. Rider Publishers, Inc., New York, New York; 96 pages, 6" x 9", paperbound. Over the last decade or so the acronyms "laser" and "maser" and related words have appeared increasingly often in both technical and non-technical writing. It is the purpose of this book to provide the reader with an understanding of what these devices are, how they work, and how they are used.

The book is divided into seven chapters. The first describes the underlying principles of laser and maser amplification. The next three chapters describe, in general terms, various types of gas and solid-state lasers and masers. As a part of the descriptions, the history of the development of these devices is traced.

The fifth chapter discusses past, present, and future applications of masers and lasers. As in the earlier chapters, the history of development forms an integral part of the discussion. Scientific experiments and uses in military, industrial, and medical applications receive mention. Descriptions of some "do-it-yourself laser kits" conclude the chapter.

A chapter on communications applications describes qualitatively the methods used to modulate and demodulate the coherent light beam produced by the laser. Methods of internal and external modulation are included. The final chapter lists some of the laser products currently on the market.

The book is illustrated with drawings and photographs. The language is simple, and only a little of the simplest algebra is used in a few of the explanations. The book is written for the beginner, the reader who knows little or nothing about masers and lasers and wishes to get a general idea of what they're all about.

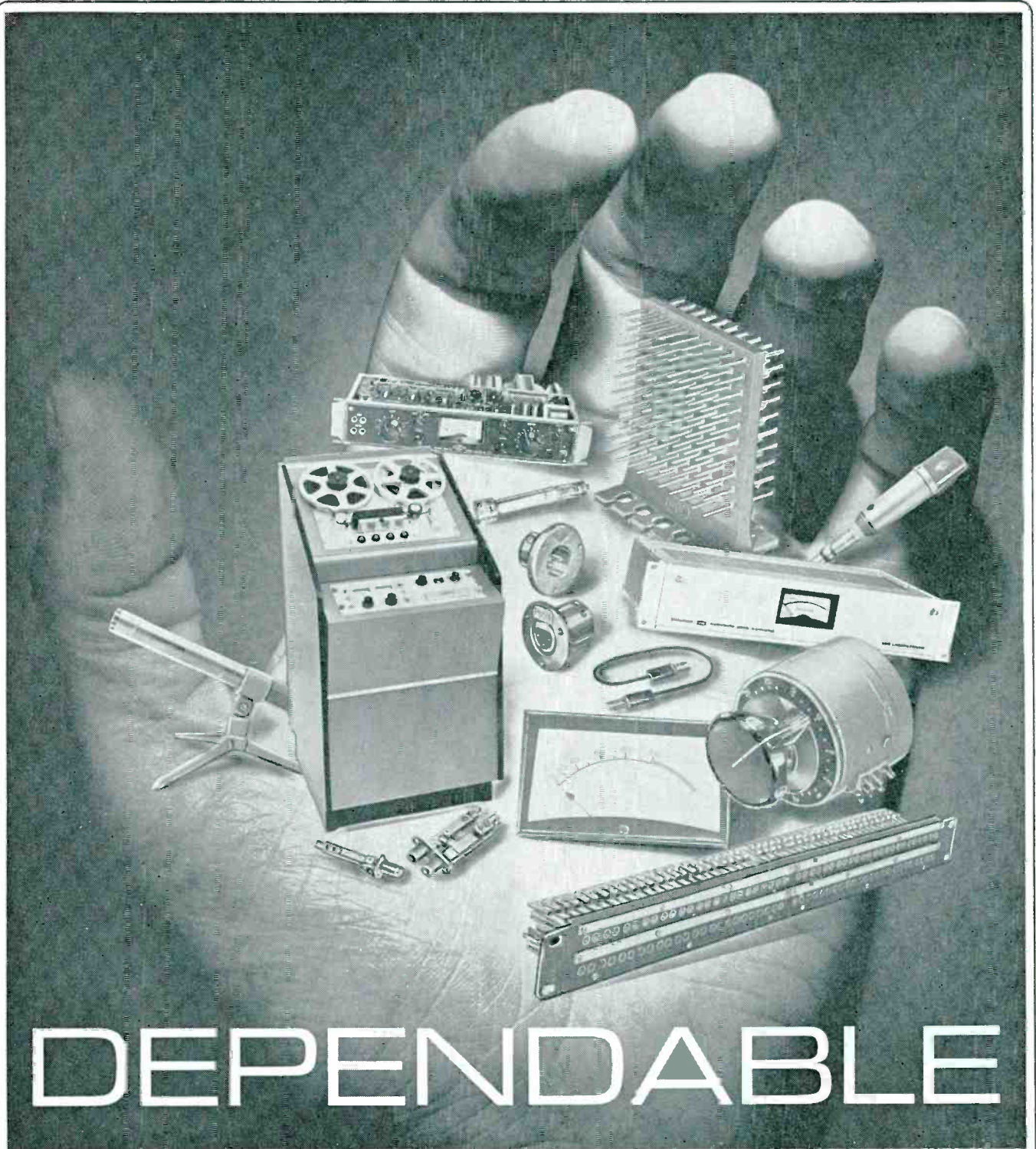

# DEPENDABLE



**HARVEY RADIO CO., INC.**

103 West 43rd Street / New York, N.Y. 10036 / (212) JUdson 2-1500  
 Federal Electronics, Inc. (Subsidiary) / Vestal Parkway, Vestal, N.Y. / (607) PIONEER 8-8211

"Anything, anywhere, anytime, always" is Harvey's other name. From the most sophisticated tape decks to the smallest replacement parts for professional broadcast and studio recording equipment. All from the greatest names in the business. No need to hunt when you can call *Harvey-collect* — from anywhere in the U.S. Your first order will demonstrate the dependability of America's oldest distributor of professional equipment. Phone or write today.

Always on hand: A.D.C. • ALTEC • AMPEX • A.P.I. • CANNON • CBS LABORATORIES • DAVEN • ELECTRO-VOICE • LANGEVIN • MCINTOSH • NEUMANN • PULTEC • R.C.A. • SENNHEISER • UNIVERSAL AUDIO

Circle Item 37 on Tech Data Card

# AN RF PATCHING SYSTEM FOR TV

by **Bill Kessel**, Consulting Author,  
Chief Engineer KTVT, Ft. Worth, Texas—  
An interesting and versatile system to  
simplify maintenance, testing, and  
emergency operations.

There are many configurations which can be used to tie the output of a television transmitter and its associated equipment to the transmission lines which feed the antenna. These range from fixed lines, which must be disassembled in order to do any checking, to motorized switches that will change connections at the push of a button.

In designing a transmitter installation at KTVT, we decided against either of these extremes. The first is too static and leaves no leeway for quick checks at various points in the system or for fast switching of components in an emergency. The motorized system that would satisfy our needs would be prohibitively expensive. Our design, therefore, falls between the two extremes.

There were two main considerations in the design of the system. Since there was to be no standby antenna or transmitter at the new

location, we needed a quick and easy way to bypass any piece of gear which might go bad. We also needed a fast means of connecting any component of the system into the dummy load for testing.

This was accomplished as shown in Fig. 1. Panels A and B use 1½" coax patches and have 3 poles. Panel C uses 3½" coax patches and has 7 poles. The patches for panels D and E use 6" coax and have 7 poles.

The question may arise here as to whether the patches used on panels D and E are not too cumbersome to handle easily. It was necessary to use the 6" patches at this point because of the power involved. The 6" patch is somewhat large and heavy but can nevertheless be handled by one man.

The A and B panels are mounted at the top of the driver transmitters—one on the aural and one on the

visual. They are mounted close to the output spigot of the transmitter to keep the plumbing as short as possible. Panels C, D, and E are grouped behind the transmitter, adjacent to the filterplexer and power divider (see Fig. 2).

Our solution to the problem of making the antenna and transmission line redundant was to install a General Electric TY-53 helical antenna with a two-line feed. This antenna is a three-bay device which is normally fed with one line. By using power division at the bottom, we are feeding two bays with one line and one bay with the other. Thus, in case of failure in either one of the lines or in a section of the antenna, we are able, by patching, to continue operation on the undamaged portion. Operation on fewer than the full three bays of the antenna results in reduced power but does not affect the cir-

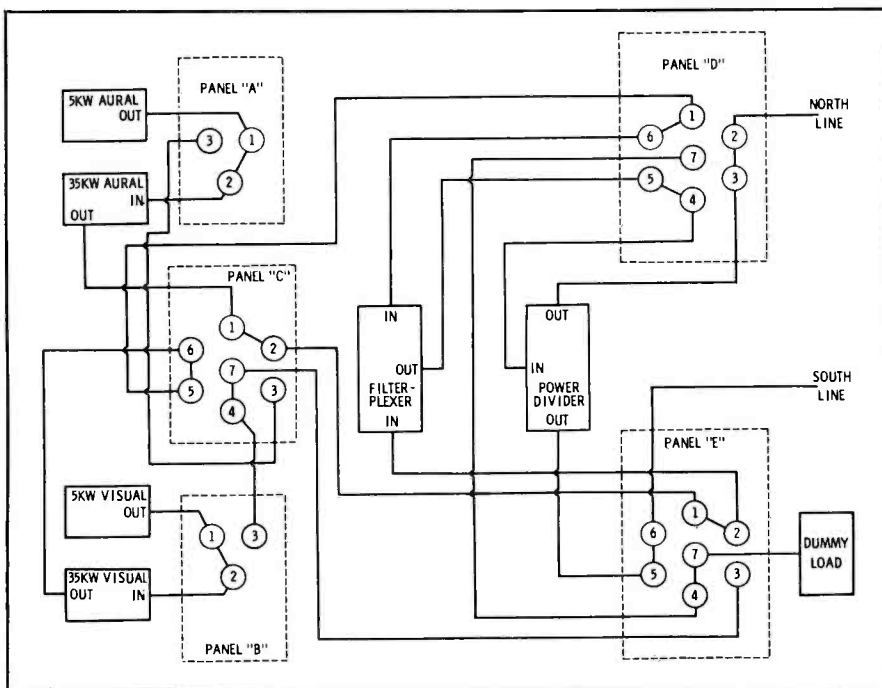

Fig. 1. Interconnection diagram of the RF-patching system shows panel layouts.

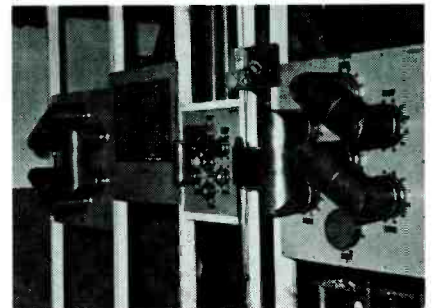

Fig. 2. Relative size of patches seen in view of panels "C", "D", and "E."

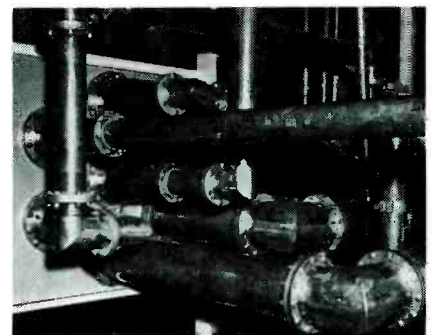
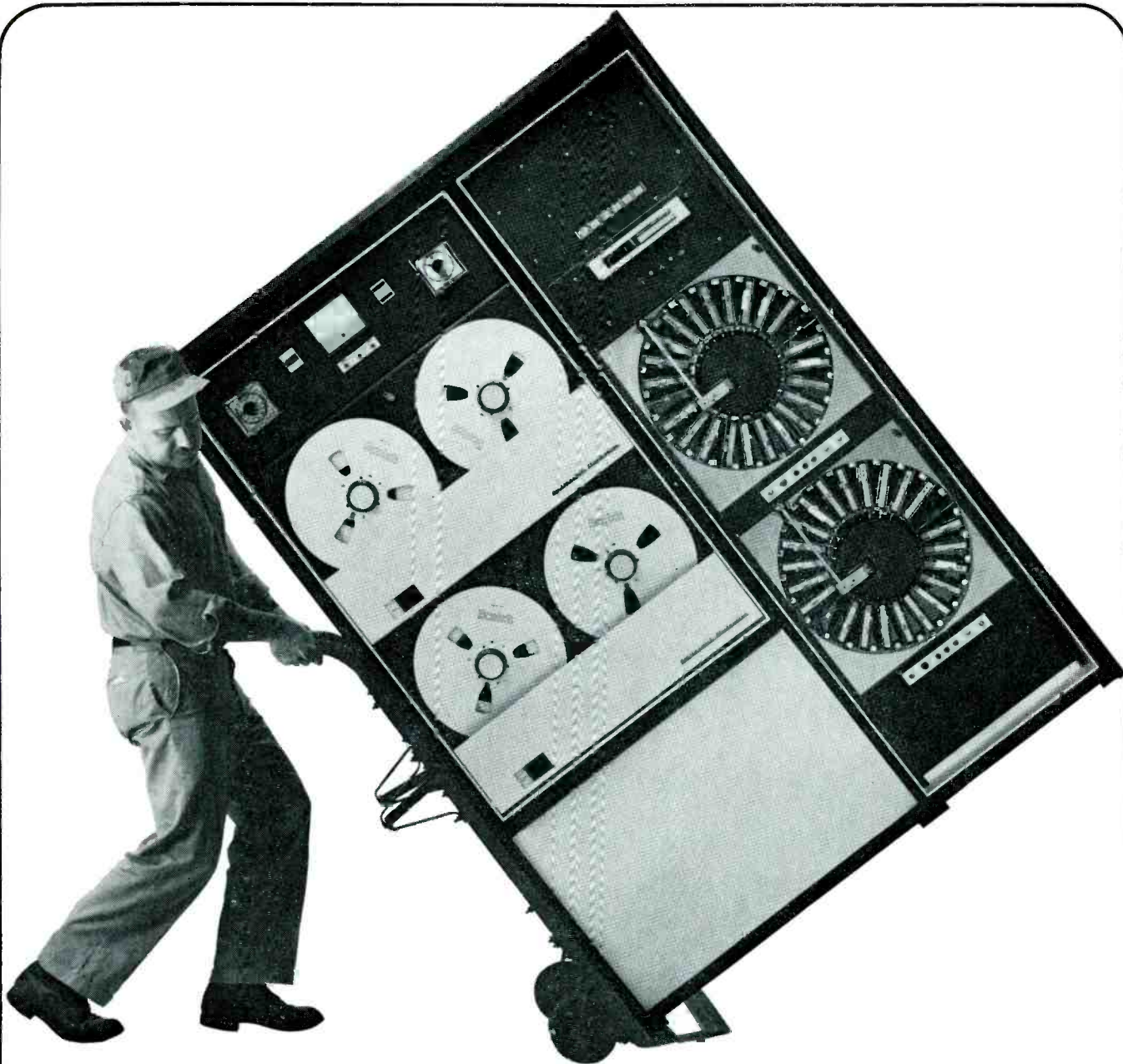

Fig. 3. Rear view, panels "C," "D," "E."



## HERE'S PROLOG I...

it separates you from AM and puts you in FM automatically!

two tape transports provide 12 hours of music without repeating any selection, and you can alternate from tape to tape at any time interval desired  single cartridge and up to 48 rotating cartridge units can be scheduled to play at any time interval desired  can be expanded into major Prolog System for unattended programming and logging

for brochure on Prolog Type 100-2 System, write Commercial Sales, Continental Electronics Mfg. Co., Box 17040, Dallas, Texas 75217 and request Prolog I

**LTV** *Continental Electronics*  
A DIVISION OF LING-TEMCO-VOUGHT, INC.

Circle Item 38 on Tech Data Card



# take me out to the ballpark...

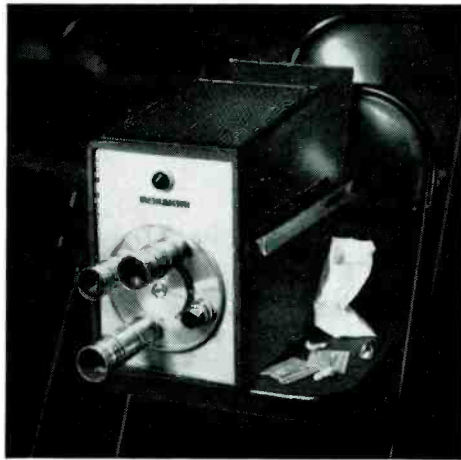

**(and leave me there)**

The Blonder-Tongue Observer 2 is a broadcast quality vidicon viewfinder camera. It's extremely light and portable, making it ideal for remotes. Also, picture quality is so close to that of an image orthicon, you can use it for up to 80% of your studio work.

You can buy the Observer 2 for a fraction of the cost of an image orthicon—\$4160. But, the biggest saving is in operating costs. For example, you can buy seven vidicon tubes for the price of a single image orthicon—and each vidicon lasts twice as long.

The B-T Observer 2 has an 8" viewfinder screen, a 4 lens turret, and reliable solid-state circuitry. To arrange for a demonstration by your local Blonder-Tongue representative, write:

**BLONDER-TONGUE**  
9 Alling Street, Newark, New Jersey 07102  
home TV accessories • closed circuit TV •  
community TV • UHF converters • master TV

Circle Item 39 on Tech Data Card

cularity of the pattern.

The patches as shown in Fig. 1 are set for normal operation. Changing the patches on panels A and B from 1-2 to 1-3 lifts the respective driver from its associated amplifier. The driver output then appears on panel C where it can be routed directly on the air through the filterplexer or, by way of panel E, to the dummy load. An overall rear view of panel E is shown in Fig. 3.

Further inspection of Fig. 1 will show that the dummy load can very quickly be connected to the output of any of the transmitters. It can just as quickly be connected to the output of the filterplexer or to either output of the power divider. Thus, in case it becomes necessary to go to one-line operation, the dummy load is readily available to connect to the unloaded spigot on the power divider.

It will also be noted that by pulling the patches between 5-6 on panel E and 2-3 on panel D it is possible to look directly into the transmission lines going up the tower for DC pulse measurements, etc.

While a system such as this will add to the cost of an installation, we feel that it will pay for itself through time saved in maintenance procedures and during emergencies. ▲

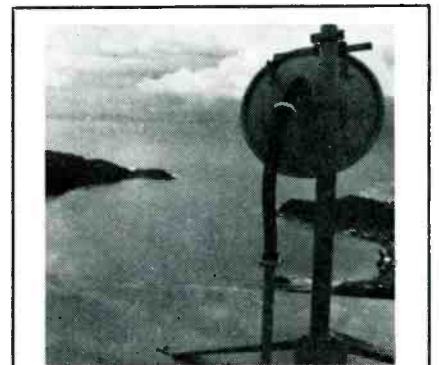

## About the Cover

Our cover this month shows the view of Pago Pago Harbor from the television transmitting site atop Mount Alava. Television is being used to bring the advantages of modern education to the Islands. For the story, turn to Page 42.

1. **STOP** you lost your turn by missing our ad in the March issue. Go back and look at page 86.

**BIONIC INSTRUMENTS, INC.**

# Just What Does a TV Computer Programmer Do?

First thing it does is go to work saving money—if it's Tarzian's new Automatic Programmer for Television (APT). APT starts paying its own way immediately by eliminating make goods caused by operator error. It can't get flustered—can't panic. Prime time, or any time.

With a Tarzian computer programmer, productions run smoother . . . faster. At APT's command, intricate combinations of switches, fades, dissolves, supers, pre-rolls, previews, etc. are executed precisely as required by your programming. With NO mistakes. And all automatically, free-

ing station personnel for more productive effort. APT speaks your language, too. All this solid state workhorse needs to go into action is the information right off your program log. No confusing translation into computer lingo. And anyone who can read the log can load it into the computer. It's really that simple.

APT is a true computer—not just an automation switcher. It was designed solely for television—not modified from some other use. It's all solid state. It interfaces readily with existing equipment. And, it costs less than a VTR.

*First computer programmer designed specifically for television by a major television manufacturer.*



*A call or letter brings our brochure with all the details.*

**S A R K E S**  
BROADCAST EQUIPMENT DIVISION



**T A R Z I A N**  
BLOOMINGTON, INDIANA

Circle Item 41 on Tech Data Card

# SYNCHRONIZED TAPE SYSTEMS FOR FILMS

by **Allen B. Smith**, SMPTE—A simple and concise explanation of portable double-system sound-recording techniques using control-signal synchronization.

For many years, American television news cameramen have used magnetic and optical sound-recording cameras both for on-the-spot action news coverage and for longer documentary film productions. Sound, synchronized with the visual image, contributes tremendously to the impact of these specialized television programs; it is, as a matter of fact, essential. As a necessary and inseparable element of the medium, however, synchronized sound has suffered from the widespread use of single-system techniques by which sound is recorded directly on the film (either optically or magnetically).

The limitations of the single system are primarily twofold. Because the sound track is physically a part of the film which carries the visual images, independent editing of visual and aural content (for smoothness, cut-action shots, fades, dissolves, multiple images, and many other special effects) is impossible. Secondly, optical sound quality is only marginal—the upper frequency limit seldom exceeds 3500 cps in practice—and magnetic-stripe response, though better, still falls short of the capability of the FM sound channel used in television broadcasting. The first shortcoming fairly well precludes imaginative

film production, while the second is wasteful for its failure to provide maximum utilization of the sound quality inherent in FM systems. Even aside from limited frequency response, both single-system techniques (magnetic and optical) introduce serious distortion products using average equipment under most field conditions. There are at least three relatively new and excellent single-system cameras, but even these are restricted in their adaptability for serious film production (except in double-system use, of which some are capable) and will likely be limited to large-station and network news coverage where immediacy is more important than visual excitement. High initial cost (in the \$5,000 to \$15,000 range) discourages their use by most smaller stations.

## Double-System Sound

The picture is not completely dark for the station wishing to obtain the maximum advantage from film, however, because there is a second possible approach. Double-system sound recording provides separate film and sound tracks which can be cut independently, timed, and combined in a composite print for a result limited only by the imagination and technical competence of the producer and his staff. Since editing and makeup of the separate picture and sound reels require rather lengthy preparation, double-system techniques are not generally applied to day-to-day newsfilm production. They are admirably suited, however, for most other film applications (particularly so to commercial spots) because of their versatility and adaptability to special effects.

With separate picture and sound tracks, a method of positive synchronization must provide a means for assuring the correct relative position of the picture and sound information (26-frame separation for optical sound, 28 frame for magnetic—see Fig. 1) as each scene is edited. If all shooting were done in the studio, the problem could be resolved easily by using synchronous motors to power both camera and recorder. If sprocketed 16-mm, acetate-base magnetic film were used on the recorder (a common commercial film practice) to eliminate mechanical slippage and stretching, the 60-cps line frequency would ensure precise synchronization of picture and sound, and a clap-stick would give visual and aural start marks for reference during editing. Since studio and sound stage are seldom available during the production of documentary films, however, film producers have had to use a different synchronizing method to avoid carrying massive gasoline-powered AC generators into the field (although high-budget Hollywood film companies still use this approach).

The requirements for a portable synchronous sound/film system are rather demanding. The recorder, first of all, must be small and light;

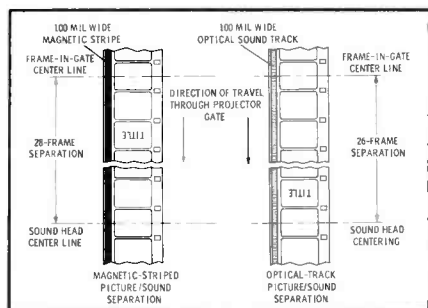

Fig. 1. Relative positions of both picture and sound tracks on final 16mm print film.

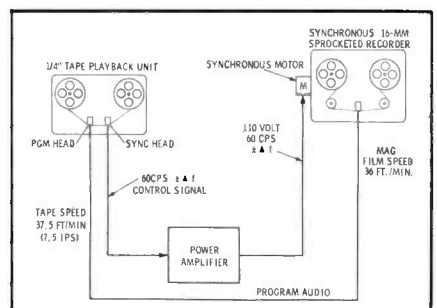
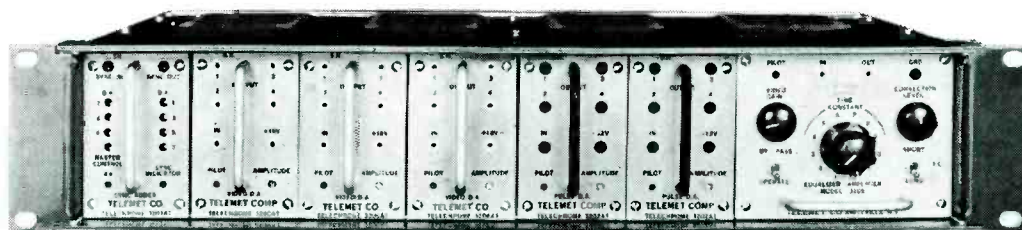

Fig. 2. Power-amplifier resolving method is most direct of the three basic techniques.



# SATISFY ALL DISTRIBUTION REQUIREMENTS

*with these transistorized and completely self-contained modules*



**MODEL 4000** Rack Mounting Frame provides common mounting facility for any combination of modules.

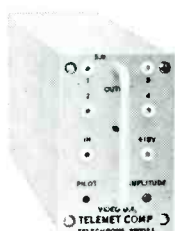

**MODEL 3200**

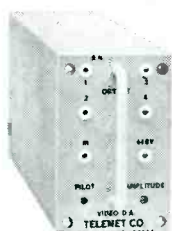

**MODEL 3206**

**MODELS 3200 and 3206** Video Distribution Amplifiers feature high impedance bridging inputs and 4 identical isolated outputs, source terminated in 75 ohms.

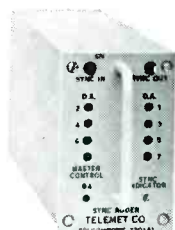

**MODEL 3201**

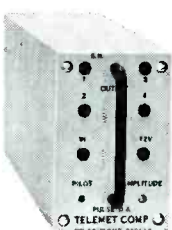

**MODEL 3202**

**MODEL 3201** Sync Adder provides a means of mixing sync into any or all video amplifiers in the frame.

**MODEL 3202** Pulse Distribution Amplifier regenerates sync, blanking or drive pulses, providing 4 identical isolated outputs.

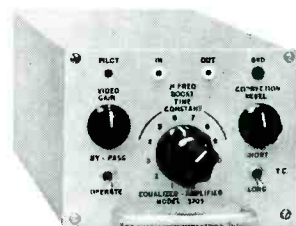

**MODEL 3205**

**MODEL 3205** Equalizer Amplifier now contains frequency boost circuits providing up to 10 db at 4.5 Mc. Slope adjustable to match cable. Also provides adjustable time constant correction. Ideal for Frequency Phone Correction of long coaxial lines.

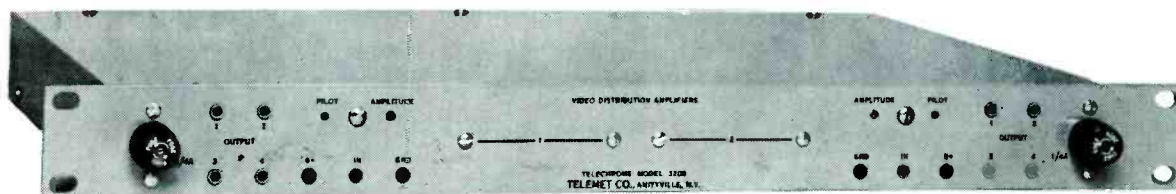

**NEW MODEL 3208** Dual Video Distribution Amplifier actually contains 2 separate and completely independent amplifiers and power supplies of the Model 3206 type in a space-saving configuration.



**TELEMET COMPANY**  
a division of  
**GIANNINI SCIENTIFIC CORPORATION**  
185 DIXON AVENUE, AMITYVILLE, N. Y. • PHONE (516) 541-3600

Circle Item 42 on Tech Data Card

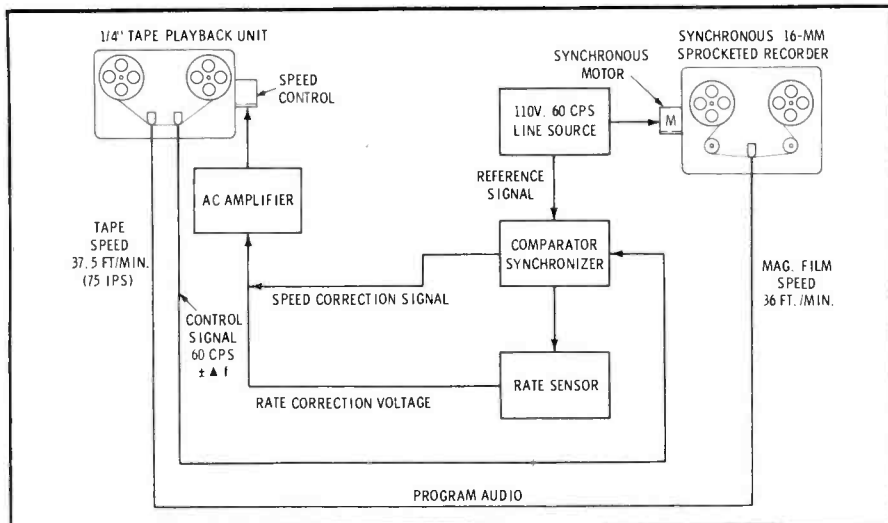

Fig. 3. This system compensates for errors in relative speed, smooths correction rate.

yet it must have a broad and flat frequency response—a tough requirement even for most studio recorders. There must also be a means for assuring a constant relative speed for the camera- and recorder-drive motors or a means for correcting speed differences at a later stage. Early (relatively unsuccessful) attempts used a camera-mounted sprocketed-film recorder which had a flexible-shaft coupling between the camera and recorder; this approach is now seldom seen in broadcast use.

### Control-Signal Sync

Electrical control-signal synchronization of compact recorders using standard 1/4" magnetic tape has proved an ideal answer. A new generation of high-quality recorders (primarily of European origin) was described in an earlier article\*, and these recorders provide the basis for the portable system.

The control-signal concept of syn-

chronization is relatively simple, once the basic problems of double-system film work are understood. The difficulties stem, as already indicated, from the need for precise speed control of both film and tape. This requirement is complicated by the fact that 1/4" magnetic tape sometimes stretches significantly during long runs and slips as it is pulled through the recorder by the capstan/idler drive system. The net result of speed variations and stretch/slippage errors is a loss of synchronization between picture and sound. It must also be understood that for editing purposes, the final sound track must be on sprocketed magnetic or optical film (the trend—primarily for reasons of quality—is to magnetic). Control-signal synchronization using the portable recorders, therefore, is only an intermediate step between filming on location with practically unlimited physical freedom and the transfer of the sound track to sprocketed film for easier and more imaginative editing.

The control-signal system compensates for speed variations and

mechanically induced errors by using a camera-generated 60-cps signal as a time-based reference at a standard level of 1.2 to 1.8 volts. The reference signal is applied to the 1/4" tape through a separate recorder head which erases a narrow segment of the program audio and records the 60-cps control signal in its place; the control track and the program-audio track exist side-by-side on the same tape.

### Resolving the Sound

The program audio is resolved (transferred to sprocketed film) by one of three basic methods. Using the power amplifier method (Fig. 2), the 60-cps reference signal is taken from the tape during playback, amplified, and used as the power source for the synchronous drive motor in the sprocketed-film recorder. The frequency variation of the control signal determines the speed of the sprocketed-film unit. Any change in the 60-cps time-based reference signal (whether caused by camera or recorder speed variations) will result in a corrective effect on the sprocketed 16-mm film recorder.

The second system (Fig. 3) has two basic elements: the synchronous sprocketed recorder which is driven directly from the 60-cps line, and the playback unit which uses a closed-loop feedback system. Output of the feedback loop is regulated by the control signal which is compared in the comparator/synchronizer to a reference voltage derived from the 60-cps line source. A rate-sensor circuit then smooths the action of the correction voltage to eliminate rate-change effects which distort the program audio, particularly on slow, sustained musical passages. This system uses a rotary-shaft resolver which receives a reference voltage into its rotor windings and the 60-cps error-correction voltage into its stator windings. When the phase of the two signals is identical, there is no rotary motion of the resolver shaft; a phase error causes the shaft to rotate through an arc proportional to the magnitude of the error. This rotary-shaft motion is linked to a potentiometer which applies a correction voltage to the speed-control unit in the recorder. Rate correction is provided by an additional voltage derived from the motion of the po-

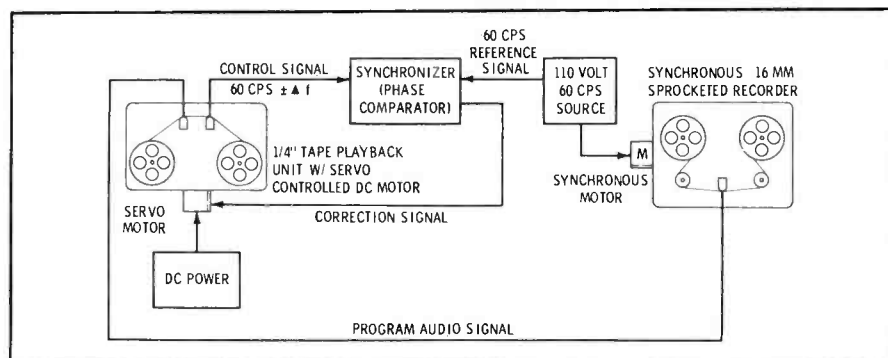
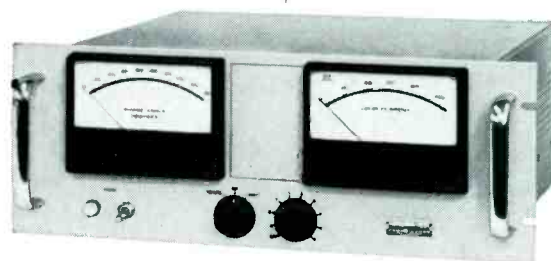

Fig. 4. In servo-motor method, the frequency differential generates the correction signal.

*New*  
*solid state phase monitor*

*can be remoted  
replaces Type 108E  
simple to operate*



Nems-Clarke offers a completely new phase monitor to broadcasters who are planning new facilities or modernizing old ones. □ The type 112 Phase Monitor is a replacement for the type 108E. It is much simpler to operate, easier to read accurately, and incorporates all circuitry necessary to permit future adaptation to remote control. Silicon transistors are used throughout for high reliability, long life and excellent temperature stability. □ Phase angle is read out on a panel meter having a continuous 0 to 180° scale. Readings are not affected by modulation and they are presented instantly as each tower is selected, with no adjustments required. Loop current is read out on a single meter, as a percentage of the reference tower. Automatic day-night switching of reference levels is incorporated. □ For both phase angle and loop current, a proportional, linear D.C. voltage is generated, so that these functions may be read out on a chart recorder, digital voltmeter, or fed over lines for remote metering. □ Panel meters are of the taut-band type, to eliminate pointer binding, and have mirror scales to improve reading accuracy. Vitro Electronics, 919 Jesup-Blair Drive, Silver Spring, Md.

SPECIFICATIONS: Absolute Accuracy:  $\pm 1.0$  degree • Resolution: 0.5 degree • Input Impedance: 51 or 75 ohms • Number of Inputs: Up to 9 • Input Level: 1.5 to 20 volts, rms • Size: 19" wide x 7" high x 14" deep behind panel • Power Input: 115/230 v., 50-60 cps, 15 watts •

**VITRO ELECTRONICS**

**NEMS-CLARKE—RECOGNIZED STANDARD IN BROADCAST EQUIPMENT**

Circle Item 43 on Tech Data Card

# AT LAST CARTRIDGE SERVICE YOU CAN COUNT ON



## DID YOU KNOW . . . . .

You can have your old cartridges reconditioned by experts  
no charge for minor parts  
**ALL** cartridges **PRETESTED** under actual broadcast conditions  
no minimum  
no service charge for small orders  
return shipment in 48 hours  
factory trained personnel  
new cartridge warranty  
You can have any size Fidelipac tape cartridge shipped immediately from stock  
You can have all cartridge parts for do it yourself cartridge maintenance.

JOA incorporates all of these as a part of their service to the broadcaster.

phone or write:



Cartridge Service  
P. O. Box 3087  
Philadelphia, Pa. 19150  
Area Code 215, TUrner 6-7993

Circle Item 44 on Tech Data Card

# New! Lang Solid State AMPLIFIER/SPEAKER

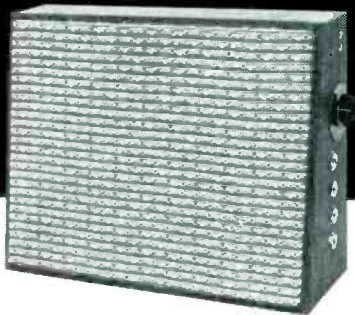

... for superb broadcast monitoring!

Primarily intended for use in broadcast offices where good quality monitoring is required, the LANG AMPLIFIER/SPEAKER contains its own solid state amplifier, power supply, and volume control. Stands vertical (as pictured) or horizontal if desired and can readily be hung on your wall.

Price: \$78.

Also available with input selector switch for use where monitoring of several lines is required.

For complete details and new Lang Catalog write:

**LANG ELECTRONICS INC.**  
507 FIFTH AVE., N.Y. 17  
For all your audio needs — Look to Lang!

Circle Item 45 on Tech Data Card

tentiometer. Speed correction is accomplished by a variable-capstan system or by a variable-speed servo motor. This system, which is used on equipment manufactured or modified by Rangertone, Inc., provides smooth and constant speed correction.

The third basic system of resolving the field-recorded sound track is shown in Fig. 4. This system takes advantage of the servo-motor capstan drive used in the Nagra portable recorder. The sprocketed recorder is driven synchronously from the 110-volt, 60-cps line, thus maintaining a constant speed. The synchronizer also receives an input from the line for comparison with the control signal which is fed from the recorder on playback. In the synchronizer, a difference voltage appears when the frequency of the two signals is not identical, and it is this voltage which is used to control the speed of the servo motor to correct for the variation. This system provides a very high degree of stability, but it has a narrow margin (about  $\pm 1.5\%$ ) of speed correction and can introduce wow if the rate of correction becomes excessive.

### Detailed Operation Of A Hypothetical System

As mentioned previously, portable synchronous recording using  $\frac{1}{4}$ " magnetic tape is simply an intermediate step between live sound and the sprocketed 16-mm magnetic film required for double-system editing. The purpose of the control signal is to provide a time-based reference against which the actual physical length of the final picture and sound films can be compared. The end result must be a one-to-one footage correspondence between picture and sound for each separate scene shot on location (see Fig. 5). With the three basic systems

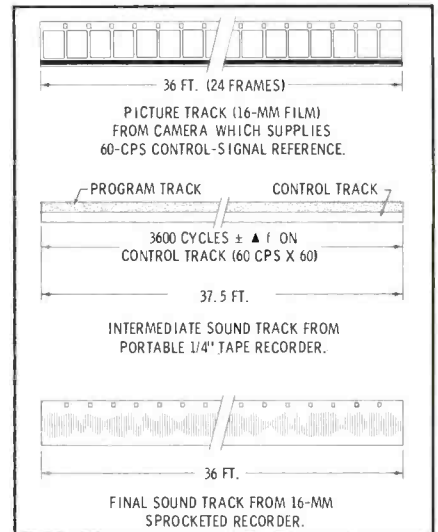

Fig. 5. Relative physical dimensions of elements comprising synchronizing system.

fairly well outlined, a better understanding of the entire control-signal concept can be obtained by reference to Fig. 6, which illustrates a hypothetical system reduced to simple terms for clarity.

A common approach to portable double-system recording (illustrated in Fig. 6A) employs a camera equipped with an electromechanically governed DC drive motor powered by a battery pack. The synchronizing signal is supplied by a small rotary generator mounted in the camera. (It is also practical to use a 110-volt 60-cps synchronous drive motor powered by a transistorized DC-AC inverter. The sync pulse is then derived from a small transformer which is mounted in the camera and connected across the power source in parallel with the drive motor.) The sync pulse is cable-connected through the recorder to a separate recording head which has its own high-frequency bias circuit. A narrow segment of the  $\frac{1}{4}$ " tape receives the control signal. Program audio is applied to the tape, through a separate head, by means of standard audio prac-

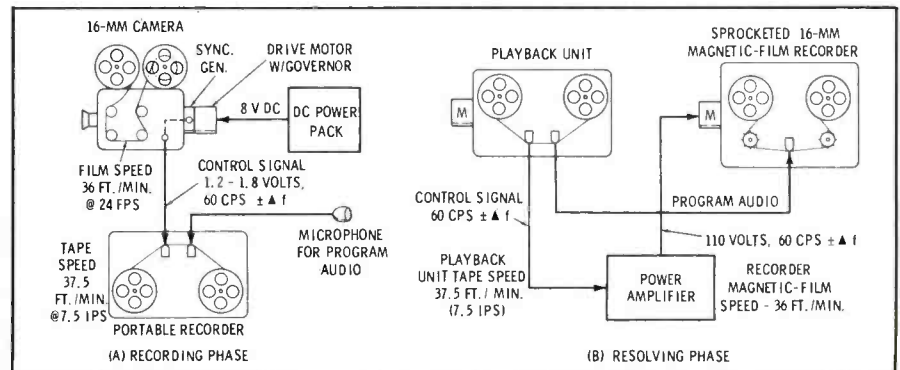
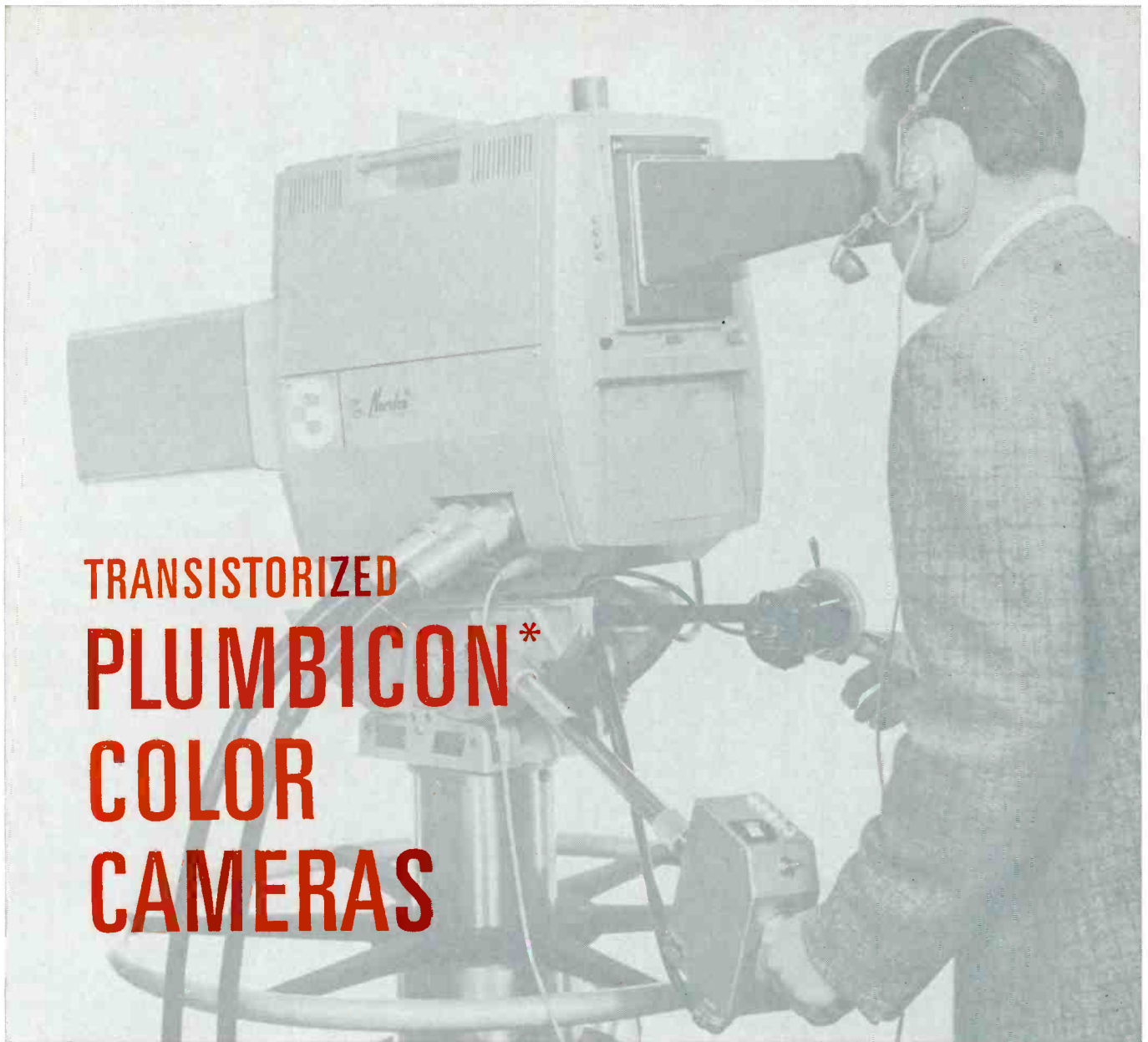

Fig. 6. Hypothetical setup shows function of portable double-system sync equipment.



# TRANSISTORIZED PLUMBICON\* COLOR CAMERAS

*Size and weight* of these new cameras are comparable to current black-and-white cameras. The ultimate in compact design and low power consumption permit their use in difficult areas.

The heart of these new cameras is the PLUMBICON TV Camera Tube. Its ideal characteristics eliminate many of the problems common to other types of pickup tubes. The long linear light transfer properties and extremely low dark current, provide unexcelled "genuine" color over an extended tonal range and enable operation under less scene illumination . . . resulting in less heat on the set. (*Typical operation 125 foot candles*).

The PLUMBICON, developed by Philips, is used in a wide range of Norelco color and black-and-white cameras manufactured in Mount Vernon, N. Y.

*\*PLUMBICON is a registered trademark.*

*Norelco Studio Equipment . . .  
represented nationally by*

**VISUAL ELECTRONICS CORPORATION**

356 West 40th Street • New York, N. Y. 10018

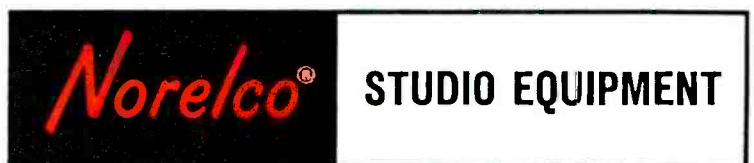

**NORTH AMERICAN PHILIPS COMPANY, INC.**  
900 South Columbus Avenue, Mount Vernon, New York 10550

Circle Item 46 on Tech Data Card



# 12th SPRING CONVENTION AND EXHIBITS

## OF THE AUDIO ENGINEERING SOCIETY

HOLLYWOOD ROOSEVELT HOTEL  
7000 Hollywood Boulevard

Showing Professional Audio Equipment for Studio and Laboratory

### APRIL 27 - 30 TECHNICAL SESSIONS ON

- Magnetic Tape Recording and Applications
- The Solid State of Audio
- Microphones and Loudspeakers
- Audio Applications I
- Disc Recording
- Audio Applications II
- Recording and Broadcast Studio Applications

plus sessions at POLICE FACILITIES AUDITORIUM  
130 N. Spring Street, Los Angeles and

THE MUSIC CENTER  
135 N. Grand Avenue, Los Angeles

SESSIONS: Tuesday through Thursday, 9:30 a.m., 1:30 and 7:30 p.m. Friday, 9:30 a.m., Police Facilities Auditorium, noon, Music Center. Annual Award Banquet, Thursday, 7:30 p.m.

EXHIBITION: Tuesday and Wednesday, noon to 8:00 p.m.; Thursday, noon to 5:30 p.m.

For Program, write or telephone: William L. Robinson, Convention Chairman

Capitol Records, Inc.  
1750 N. Vine Street  
Hollywood 28, California  
(213 HO 2-6252)

The Audio Engineering Society

Circle Item 47 on Tech Data Card

tices through a single microphone or a multiple-microphone/mixer arrangement.

In operation, the camera and recorder maintain rather unchanging speeds because of their high degree of speed regulation. The linear speeds are quite different—36 ft/min (24 frames per second) for the film in the camera and 37.5 ft/min (7.5 inches per second) for the 1/4" tape—their relative speed varies only a small amount. It is the small relative speed error that must be corrected using the control-signal reference; their absolute linear speeds are incidental to the system.

The relative speed difference is seen by the tape's control-signal track as a frequency difference. This is true because there are but two conditions of relative speed variation: (1) The relative speed of the film is faster than that of the tape (whether caused by an increase in camera speed or by a decrease in recorder speed); (2) the relative speed of the film is slower than that of the tape (whether caused by a decrease in camera speed or by an increase in recorder speed). Since the control-signal frequency is pro-

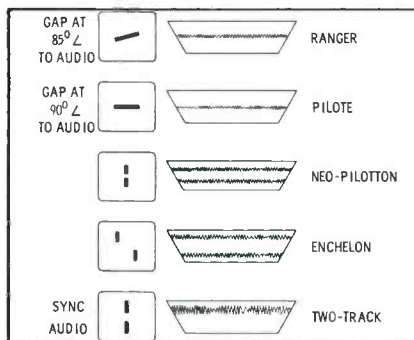

Fig. 7. Record-head arrangement of the four control-signal synchronizing methods.

portional to the relative film speed, under condition (1) above, the control-signal track sees an increased frequency (more complete cycles per linear measure); under condition (2), it sees a decreased frequency (fewer complete cycles).

During transfer to sprocketed film (Fig. 6B), the control signal is recovered from the tape by a standard playback head, amplified by the power amplifier to a 110-volt level, and used to power the sprocketed recorder. If we assume, initially, that the playback unit has a synchronous motor and will thus maintain a constant speed, the action of the control-signal voltage is more easily apparent. When the frequency of the control-signal voltage is higher than its normal 60-cps rate, the frequency-dependent synchronous motor in the sprocketed recorder increases speed, and the 16-mm magnetic film moves at a rate which corresponds exactly to the relative speed increase of the film in the camera (during the filming of the scene) which put the increased-frequency control signal on the tape. Similarly, when the control-signal frequency is lower than its normal 60-cps rate, the sprocketed recorder slows to a rate which corresponds to the original decrease in relative film/tape speed. The result is a sound track on 16-mm sprocketed magnetic film recorded at 36 ft/min in exact synchronism, scene for scene, with the picture film.

Visual and aural start-cue marks are obtained during filming using the time-honored clap stick or by using a separate unit on the camera which simultaneously flashes a light to "bloop" one picture frame and operates a relay which feeds the 60-cps sync pulse to the recorder. The "flash frame" on the picture film corresponds in synchronous time to the start of the control sig-



## Assure 100% COMPLETE ERASURE of Recorded Tape ON THE REEL

Use the **Magneraser**®

— the Original and still the best! Quickly erases a reel of magnetic tape or sound film of any size or type. Erasure is 100% complete even on severely overloaded tape. Lowers background noise level of unused tape 3 to 6 db. Also demagnetizes record-playback and erase heads. Only \$24.00. Two-year Guarantee. Available at your dealer's or write us.

## New ULTRA-SENSITIVE FLUTTER METER



With built-in Three-Range Filter, 3 kc Test Oscillator, High Gain Pre-amplifier and Limiter. Filter Ranges: 0.5 to 6 cps; 0.5 to 250 cps; 5 to 250 cps. Designed for rapid visual indication of flutter and wow. Meets standards set by the IEEE . . . Condensed Specs.: Input Voltage, 0.001 to 300 Volts; Ranges, 0.01 to 3%; Limiter Range, 20 db.; Oscillator (built-in), 3000 cycles; Net Price, \$495.00 . . . Write for complete specifications and free 12-page booklet on Flutter.

**AMPLIFIER CORP. of AMERICA**  
398 Broadway, New York 13, N. Y. • WO 6-2929

Circle Item 48 on Tech Data Card

# EIMAC

## announces broad new line of reliable vacuum capacitors

Need a really reliable fixed or variable vacuum capacitor? Bothered because you can't find a capacitor conservatively rated to meet increased power and current ratings of today's advanced transmitters? Relax. Try a VacCap. New Eimac VacCaps feature a unique patented design which results in higher rf rms current ratings. All-copper-and-ceramic construction permits manufacture at higher bakeout temperatures, with improved vacuum and longer life. And

prices are competitive! VacCaps, fixed and variable, can deliver any value of capacitance up to 1500 picofarads at any voltage from 5 to 50 kV, and at current ratings up to 225 amperes. No special cooling is required. For details and technical data contact Applications Engineering, Power Grid Tube Division.

EITEL-McCULLOUGH, INC., San Carlos, Calif.

In Europe, contact Eitel-McCullough, S.A.,  
15 rue du Jeu-de-l'Arc, Geneva, Switzerland



Circle Item 49 on Tech Data Card

# More changes in FM rules

FCC adopts plan allowing short-spaced stations to improve their coverage

.....and Bauer has the packages to help you increase your effective power economically and quickly. The Bauer 1 KW FM Transmitter, for instance, with a



four bay antenna will give you maximum power with watts to spare. AMPLIFIER ONLY AVAILABLE IF YOU WANT TO USE YOUR EXISTING EXCITER. Features include: Automatic Power

Control—Lowest Tube Investment in the Industry —Automatic Voltage Control —Solid State Rectifiers —Stable Grounded Grid Operation—Remote Control Provisions. Both packages available in "Kit" form or factory assembled. High Power Amplifiers available for special Vertical Power Combinations.

Increase your power and coverage by calling Bauer today for all the facts.

# Bauer

ELECTRONICS CORPORATION

1663 Industrial Road, San Carlos, California  
Area Code 415 591-9466

Circle Item 50 on Tech Data Card

nal, thus providing visible and audible cue marks for the editor.

## System Variations

The manner of recording the all-important control signal varies considerably from system to system, but the concept is identical for all. Fig. 7 shows the track configurations for the four methods in common usage. A fifth method using two separate half tracks is also illustrated, but this approach is seldom taken by professionals, primarily because of the lack of suitable portable equipment. The previously mentioned article in the January 1965 issue gives a description of these various methods and discusses the equipment with which each system is used.

An interesting variation of the control-signal system of synchronization is used by several professionals in conjunction with the Eclair 16-mm camera and Perfectone recorder. The Eclair is particularly suited for highly mobile film assignments because of its unique physical design and quiet operation. Synchronism in this system is obtained as shown in Fig. 8 and depends on two matched-frequency 10.6-kc crystals. One crystal is divided down to 60 cps and used to stabilize a transistorized, battery-powered AC inverter which powers a standard 110-volt, 60-cps synchronous camera motor. The cameraman, therefore, has a completely independent 60-cps synchronous unit. The second of the two matched crystals is divided down for use in the recorder to provide a 60-cps control signal, just as if it were being received from the camera unit. The 1/4" tape is resolved in the normal manner, using the control signal as a synchronous reference.

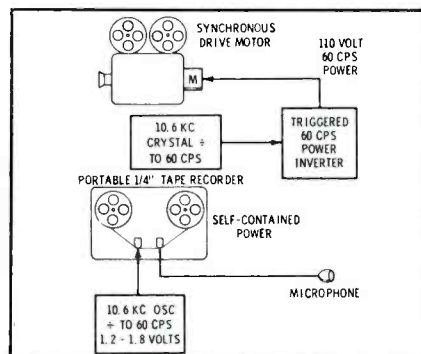

Fig. 8. Camera and recorder use matched crystals to provide the synchronization.

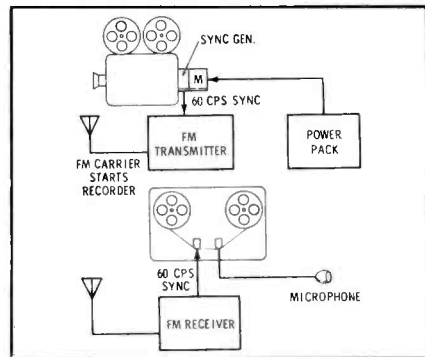

Fig. 9. Wireless synchronization is provided by transistorized transmitter and receiver.

The crystals used in this system are vacuum sealed and exhibit stability on the order of  $10^{-6}$ . This tolerance permits a loss in synchronization of no more than  $\pm .14$  frame at 24 fps for a continuous, 10-minute 16-mm film run which represents 14,400 frames. For all practical purposes, this degree of accuracy constitutes complete synchronization. Using a three-man crew and a wireless microphone, absolute physical independence of cameraman, sound man, and reporter/interviewer is attainable.

Yet another control-signal system is shown in Fig. 9. In this system a small, transistorized unit at the camera transmits the synchronizing signal to a receiver used in conjunction with the recorder. When the camera is started, the transmitter's carrier signal starts the recorder. Then, when the camera and recorder are up to speed and the take begins, the camera is "blooped," and the 60-cps control signal is transmitted simultaneously to the recorder. The cameraman, therefore, controls operation of the recorder and retains complete freedom from interconnecting cables.

## Conclusion

The advantages to be obtained from double-system filming more than outweigh the disadvantages of the system, particularly since portability is so necessary to modern film practice. Double-system work requires more time and planning, but for professional results in visual effects and sound quality, no other approach will deliver nearly as much. New equipment and new techniques promise greater enjoyment for viewers across the nation and increased freedom of expression for the film-unit director, the cameraman, and the editor. ▲





## Sony targets the sound you want

### Telemike Exclusive: Built-in Monitor Facility\*

Now, with *three* readily interchangeable sound tele-probes, similar in principle to changeable telephoto lenses, you can 'zoom' in from varying distances for the precise sound you're after. The 18-inch probe may be used for 'close-ups,' as far back as 75 feet from the sound source; the 34-inch probe from 150 feet. A 7-foot probe is optional for distances beyond 150 feet.

\*The most unique feature, a Sony exclusive, is the built-in, battery powered, solid state monitoring amplifier in the pistol grip handle, which assures the operator that he is transmitting the source with pin-point accuracy.

**OTHER FEATURES, OTHER USES:** The new Sony F-75 Dynamic Tele-Microphone is highly directional at the point of probe, with exceptional rejection of side and back noises (35 to 40 db sensitivity differential). Recessed switching allows quick selection of impedances (150, 250 and 10K). The uniform frequency response, controlled polar pattern, and unprecedented rejection of background noise eliminates feedback interference in P. A. systems.

The complete Sony F-75 Tele-Microphone includes two sound probes, 18 and 34 inch lengths, monitoring pistol grip handle and the Sony dynamic headset, all in a velvet-lined compartmentalized carrying case, for *less than \$395*. For specifications and a catalog of the complete line of Sony microphones, visit your nearest Sony/Superscope franchised dealer, or write: Superscope, Inc. Dept. 52, Sun Valley, Calif. *The best sound is Sony.*



Circle Item 51 on Tech Data Card

# CHECKING BROADCAST SPURIOUS EMISSIONS

by **Elton B. Chick**, Consulting Author,  
 Director of Engineering, Rounsaville radio  
 stations — A practical discussion of an  
 important part of a station's annual  
 performance measurements.

The expansion of facilities in the communications and broadcast fields has been enormous during the past decade, and the problem of control of harmonic and other spurious emissions from the many transmitters has become a serious one. For standard broadcast stations, new limits on spurious emissions were imposed during this period; FCC Rule 73.40 gives the requirements for transmitters. It goes without saying that every broadcast station should regularly check for such emissions; in fact, Rule 73.47 requires "measurements or evidence showing that spurious radiations, including radio-frequency harmonics, are suppressed or are not present to a degree capable of causing objectionable interference to other radio services." This requirement is a part of the annually required Equipment Performance Measurements. The intent of this article is to offer suggestions which will aid in compliance with these rules.

## Requirements

A close look at Rule 73.40 re-

veals that the suppression of spurious emissions is to be considered in band segments related to the carrier frequency. These are emissions removed from the carrier frequency by: (1) 15 to 30 kc, (2) 30 to 75 kc, (3) more than 75 kc. Fig. 1 shows the positions of these bands in relation to the carrier frequency. It also shows the amount of reduction, specified in decibels related to the unmodulated carrier level, required within each band.

## Measurements

How does one go about checking such emissions? The ideal way would be to use a field-intensity meter which has a wide tuning range so that it could be used to check not only the adjacent channels but the harmonic frequencies as well. Unfortunately, such an instrument is not widely available. However, many stations do possess or have access to field-intensity meters which measure within the broadcast band. These instruments are most helpful in checking in the adjacent channels, and for stations having carrier frequencies below

800 kc they can be used for checking the strength of the second harmonic.

When a standard field-intensity meter is available, the measurements necessary to check adjacent channels (except for stations at or near either end of the broadcast band) can be made easily. One procedure for conducting these tests is to set up the field-strength meter a short distance from the station—a mile or more, depending on the station's power—and listen within the bands shown in Fig. 1. The strength of any emission from the station outside the assigned channel should be recorded. Also, the strength of the station's carrier at this point should be measured and logged. The relative strength of the spurious emission is computed as follows:

$$N = 20 \log_{10} \frac{E_1}{E_2}$$

Where:

N is the number of decibels below carrier level,  
 $E_1$  is the strength of the carrier

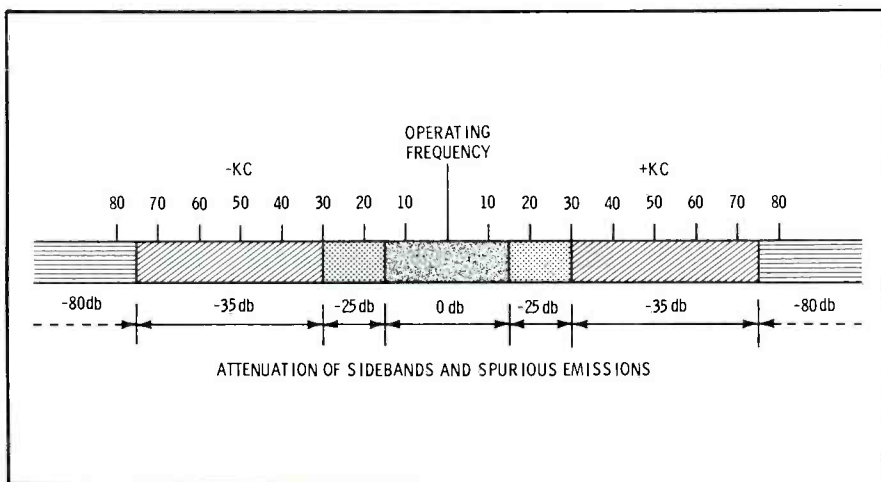

Fig. 1. Diagram shows required levels of signal suppression in various frequency bands.

BANDS	ATTENUATION	SIGNAL
±15 kc	0 db	100 mv/m
±15-30 kc	25 db	5.62 mv/m
±30-75 kc	35 db	1.75 mv/m
±75+ kc	80 db	.01 mv/m

in mv/m, and

$E_s$  is the strength of the spurious emission in mv/m.

As an example, consider a point where the carrier has a strength of 100 mv/m and a spurious emission which has a strength of 2.5 mv/m is observed 25 kc from the carrier. The magnitude of the spurious emission is then:

$$N = 20 \log_{10} \frac{100}{2.5} = 32 \text{ db}$$

This emission is thus more than 25 db below the carrier level and may be considered to be in compliance with the FCC rules unless the signal is causing harmful interference.

Consider now the case of a 10 mv/m signal at the same point. Its level would be only 20 db down, and correction would be required. Table 1 shows the signal levels corresponding to the required amounts of attenuation and a 100 mv/m carrier level.

Observations such as those described above should be made at several points and in several directions. This is especially true of stations using directional antennas, since the radiation pattern of spurious emissions is likely to be different from the pattern at the carrier frequency.

In checking for harmonics and other undesirable radiations outside the broadcast band, unless a suitable field meter is available the best bet is to use a high-quality communications receiver. This type of receiver, especially one having multiple-conversion circuitry, is quite selective and is less likely to generate spurious signals within itself than are other types.

A communications receiver used to check for harmonics should be in good working order, accurately calibrated or have a built-in crystal calibrator, and equipped with a good outdoor wire antenna that is 25 or 50' long and in the clear. In using the communications receiver, the observations will have to be evaluated subjectively. One point to keep in mind is the importance of learning whether any harmonics or other spurious radiations present cause interference. This is difficult to evaluate accurately, since a harmonic can cause interference several

# 25 Pounds of Versatility.

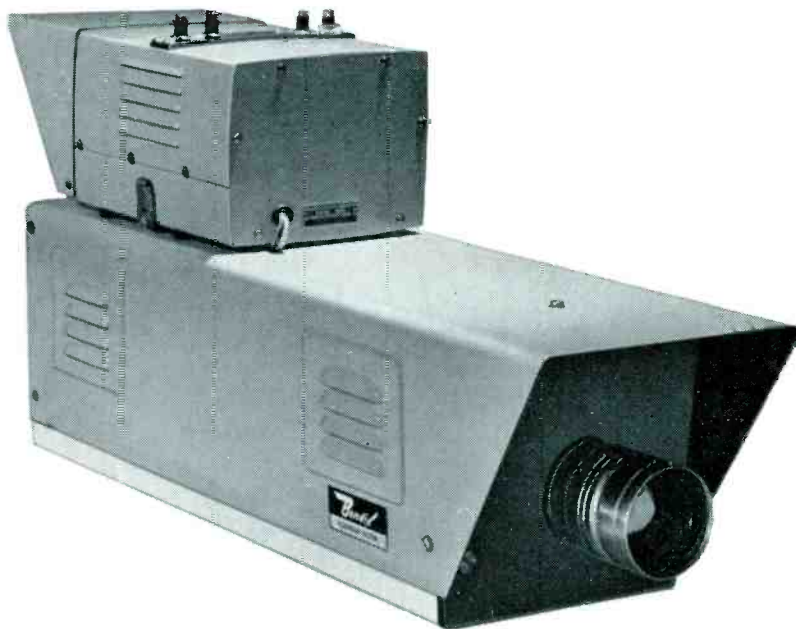

## The Bendix BX-8A Image Orthicon.

The Bendix BX-8A Image Orthicon Camera System is a remarkable development for the television industry.

There's nothing like it for portability and performance. It's rugged, reliable and stable. It provides studio quality pictures under field conditions. It makes remote pickup possibilities as varied as the imagination, and is unexcelled for many studio jobs.

The American Broadcasting Company selected the BX-8A camera and proved its value during the Winter Olympics, the political conventions, the Summer Olympic tryouts, and other special events.

Here are some of the features that attracted ABC:

- Small size, light weight (camera unit 25 lbs.)
- Excellent resolution under varying light conditions
- Remote control of all camera functions (control unit separable from camera by more than 1000 feet)
- Detachable viewfinder, intercom options
- Stability in outdoor environments
- Adaptability to a variety of lens systems
- Very low power consumption
- Meets all EIA standards for broadcast television
- Compatible with normal broadcast facilities

We can't tell you all of the other features of the camera here. But we would like to give you the complete story. To get the picture first hand, contact us for details at Baltimore, Maryland.

**Bendix Radio Division**



Circle Item 32 on Tech Data Card

hundred miles away while causing no local problem. Observations made at several points and in different directions are most helpful in gaining a true picture of harmonic radiation.

In addition to listening on the harmonic frequencies, checks should be made at other frequencies both above and below the carrier frequency. Although such an occurrence is unusual, a transmitter can produce spurious emissions below its fundamental frequency, often as a result of some internal oscillation

within the transmitter or as the result of a heterodyne process involving signals from other stations.

In investigating this condition, it is helpful to consider the heterodyne or image frequencies that may be developed with other local stations. The frequencies of these emissions can be predicted accurately so that a check of them is simplified. As an example of the possibilities, consider two stations in close proximity whose frequencies are 630 kc (station A) and 1240 kc (station B). The following frequencies could be

produced by mixing of signals from the two stations:

- 1870 kc, the sum of the carrier frequencies between the carrier frequencies
- 610 kc, the difference between the carrier frequencies
- 20 kc, the difference between the 2nd harmonic of A and the fundamental of B
- 650 kc, the difference between the 3rd harmonic of A and the fundamental of B
- 590 kc, the difference between the 2nd harmonic of B and the 3rd harmonic of A

These are only five of the many possible combinations. When three or four stations are located nearby, the possibilities are rather disconcerting. Fortunately, most of the combinations do not develop, and the FCC rules regarding distance and frequency separation help to minimize the problem.

#### Summary

To summarize, in searching for spurious emissions these five steps are helpful:

1. Check the exact harmonic frequencies, and where possible measure the strength of the spurious signals and compute their value in relation to the carrier.
2. Check for undesirable sidebands within the range of 15 to 75 kc from the carrier. The levels of these emissions are most easily measured with a standard field-intensity meter.
3. Check for heterodyne frequencies by evaluating the possible combinations up through the 3rd harmonics of the station under observation and nearby stations.
4. Check as much of the remaining spectrum as is practical.
5. Keep notes on all observations for later reference.

Numerous manuals and some recent articles give information on the cure of spurious emissions. Generally, such emissions are eliminated either by transmitter repair and adjustment or by RF traps and filters at the output of the transmitter. (See "Cross Modulation—Cause and Cure," by Robert A. Jones, *BROADCAST ENGINEERING*, July 1964, p. 24.) Good luck and good hunting! ▲



## INNOVATION

... ANOTHER KEY TO

## SPARTA SUCCESS

### SPARTA A-20 AUDIO CONSOLE



The new transistorized Sparta A-20 is designed for continuous usage for AM, FM, and TV audio control rooms, recording studios. It employs eight faders that can mix from a selection of sixteen audio inputs. With added features like individual amplifier modules, both program and audition channels, exceptional input switching versatility, self contained power supply, monitor amplifier with speaker — the A-20 really is — an "Innovation".

Contact your Spartaman today for complete catalog information.

**LOOK  
TO  
SPARTA  
FOR THE  
KEY  
TO  
BETTER  
BROADCASTING**

# SPARTA

**ELECTRONIC CORPORATION**

6450 FREEPORT BLVD. • SACRAMENTO, CALIF. 95822

Circle Item 53 on Tech Data Card

# ENGINEERS' EXCHANGE

## Speeding Routine Line Checks

by M. Barlow, Montreal, Quebec

At any station faced with 24-hour programming, overworked technicians, and operators who have limited technical knowledge, anything that reduces the routine maintenance load is a help. At our station we have three audio lines to the FM transmitter, one each to the AM and SW transmitters, and an emergency feed to AM from an FM receiver. Routine frequency and distortion runs on all these lines occupy considerable time and require operators at the studio and both transmitter sites. The natural tendency was to forget the routine tests and work on something else instead.

To give a "go-no-go" indication, we have adopted a modification of a routine TV transmitter test in which a pulse-and-bar video signal is originated by master control and the off-the-air waveform is compared with a photo taken after a complete system check. For our audio test, we have recorded a one-minute tape of seven test tones ranging from 100 cps to 15 kc (with appropriate voice announcements in between). After program hours, the operator plays this tape (always from the same machine) through his console (always switched the same way) and logs the VU-meter readings. He then repeats the tape, feeding the tone signals in turn to each transmitter through its associated line and logging the modulation-meter reading for each tone. A separate record sheet for each audio line is provided so that each week's readings are under each other. By adjusting levels so that the 400-cps reading is the same each week, it is easy to see whether any change in response has occurred since the previous check.

The actual readings may indicate a rather poor response, since they are the sum of the individual frequency responses of everything from tape machine to transmitter monitor. However, it is only **changes** that are important if the system is

initially within the required response limits. Changes of more than 1 db are brought to the attention of the maintenance crew, who can then check out each part in turn in the normal way. In this manner the operators can check the performance of the system and leave the maintenance men free until unsatisfactory performance develops. This method does not, of course, provide a check for distortion or noise, so these should still be checked from time to time.

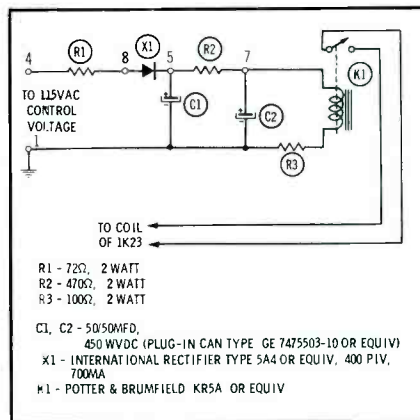

## Substitute Time Delay

by Bruce L. Mackey, Chief Engineer  
WKRT, Cortland, New York

Recently, the power-interruption reclosure relay, 1K24, in our GE XT-1-A AM transmitter failed. The purpose of this relay is to prevent reapplication of plate power to the transmitter after the occurrence of a line-voltage interruption of greater duration than three seconds. The original time-delay relay uses a mechanical assembly to introduce a delay of about three seconds before its normally closed contacts are opened. As long as the contacts remain closed, full plate voltage is reapplied to the transmitter as soon as primary power is restored. When the contacts open after three seconds, it is necessary to wait for the normal time delay (45 seconds) before plate voltage can be applied.

To avoid the expense of a duplicate relay, we decided on the accompanying circuit, which directly replaces 1K24. The circuit connections are made to the pins of an octal socket (the pin numbers are

shown on the diagram) which is mounted in a hole punched in the transmitter panel on which the original relay was installed. The electrolytic capacitor employed is a plug-in type for ease of replacement. The unenclosed relay is mounted on the rear of the panel, since in this location only filtered air reaches the relay during normal operation of the transmitter. The time delay obtained with the circuit shown is identical to that of the mechanical unit being replaced.

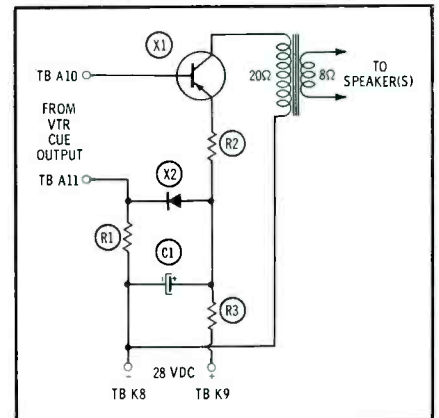

## Cue Amplifier for Video Tape Machine

by Norman E. Hall, Studio Supervisor,  
KERO-TV, Bakersfield, Calif.

When we first received our VR-1000B video tape machines, we simply hooked the 8-dbm cut-track output to a 500-ohm-to-voice-coil transformer and then to a speaker to allow us to use a sequence of tones for cue purposes. After several complaints from the operators that the cue audio level was too low, we decided to increase this level as simply as possible.

We built a single-transistor amplifier that operates from the tape-machine 28 VDC supply. The amplifier uses a single 2N301A power transistor and draws .5 amp from the supply. The unit uses 14 watts of power, of which 9 watts is dissipated in R3.

The 20-ohm-to-8-ohm output transformer was a homemade unit, but several commercial units are available, such as the Chicago Stancor TA-12, the Triad TV-29X or TY-64X, and the UTC CAT-15. Another possible source of a suitable transformer is a car radio having a transistor output stage. Or if the builder isn't squeamish about

running DC through the speaker voice coil, the transformer could be eliminated.

The silicon diode used for X2 was a "bargain-counter" 750-ma, 400-PIV top hat unit, but almost any small silicon diode would work as well. The transistor was mounted on a heat sink, but if the unit were mounted in a small metal chassis-box, the transistor could be mounted to the chassis with an insulated mounting kit, and the heat sink would not be needed. The unit was constructed on a 3½" by 5¼" piece of prepunched terminal board; matching push-in terminals were used. The completed unit was mounted on the rack No. 2 terminal assembly in the space left for terminal board G, which was not included in either of our machines.

The 500-ohm cue output of the machines is available at terminals 10 and 11 of terminal board A; the input terminals of the amplifier are connected there. The amplifier output may feed one or more speakers. The 28 VDC is available at terminals 8 (+) and 9 (-) of terminal board K.

In testing the unit before connecting it to the machines, we used a 12-volt lantern battery with good results. If we were to start this project again, we would probably use an integral 8 VDC supply. This would eliminate R3 and the needless dissipation of heat from this resistor.

## Turntable Inputs For Remotes

by Roy Gallagher, Ft. Lauderdale, Fla.

The need for a lightweight remote amplifier with two phono inputs (and one or more microphone inputs) for remote DJ shows and "record-hops" led us to modify a standard remote-line amplifier for such use. For the sake of economy, we took the direct approach to pro-

**STANCIL-HOFFMAN CORP.**  
 • MINTAPE PROFESSIONAL BATTERY Operated Portable Recorder, Mono Stereo, Synchronous.  
 • MAGNETIC FILM RECORDERS, Single and Multi-Channel, 16, 17½, 35 MM.  
 • BROADCAST LOGGING Recorders, Slow Speed Single Channel to 32 Channels.  
 • HIGH SPEED TAPE DUPLICATORS for Full, Half and Two Track Stereo Duplication.  
 921 N. Highland Ave., Hollywood 38, Calif.

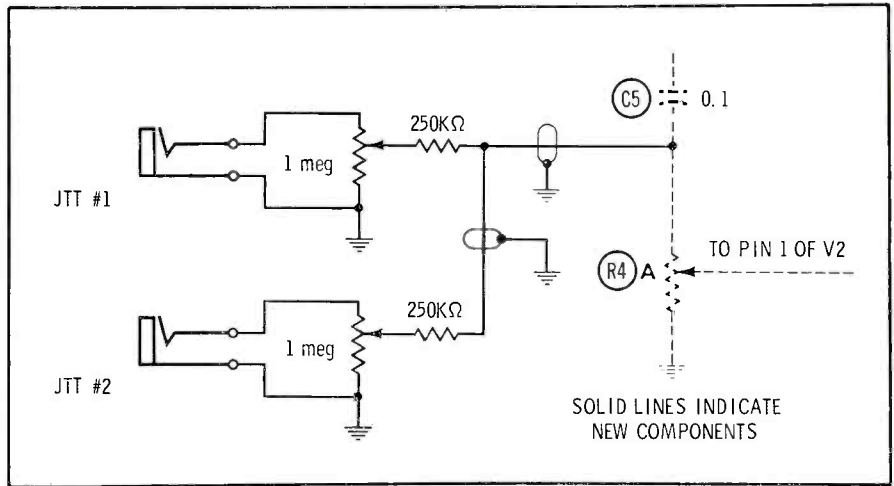

cedure, using a Gates Dynamote as our starting point. The Dynamote has a four-channel, low-level mixer which feeds a program amplifier having a dual volume control that governs the input level to the grids of the second and third stages of the amplifier. The output of this amplifier feeds a VU meter, a line pad, and an elaborate switching system. One switch selects one or the other of two program lines or an order line to feed the program out. The other switch places the operator's headphones across the amplifier or across either program line. Since very few stations today will use two lines, these switches may be removed. In their place, a couple of one-megohm volume controls, one for each turntable, can be mounted (see photo). The microphone-input panel on the rear of the unit has plenty of space for mounting two standard phone jacks.

Since most ceramic cartridges give good bass response with a one-megohm load, and since the output level is just right to feed into the grid of the second tube (5879) in the program amplifier (see diagram), we chose ceramics. The resistors in series with the center contact of each volume control prevent interaction between the controls and prevent the shorting to ground of the input from the microphone preamplifier stage. Note that the combined output of the turntables is fed to the high side of only one of the pots in the dual master control. This requires no alteration of the amplifier's printed-circuit board, since the master control is mounted on the front panel where it's very easy to reach.

The selector switches on the

front panel can be treated in a number of ways. We removed them completely, soldering and taping the necessary leads to keep the unit functional; unused leads were clipped from the switches and their ends taped. The headphone switch was wired so that it was across the amplifier output at all times; this corresponds to the center position of the original switch. The line-selector switch was removed, and its leads were soldered and connected so the output of the amplifier normally feeds line No. 1. Two 2000-ohm resistors, connected from each line terminal directly to its corresponding headphone jack on the rear of the unit, allow a quick check of the output. It will also be possible to listen to the cue signal from the line, if necessary.

We built a portable console using two turntables and the altered remote amplifier and have found it useful for broadcasting "real-live" DJ programs. Total cost for parts used in adding two turntable inputs to the remote amplifier was around \$6. ▲

### SALES ENGINEER BROADCAST EQUIPMENT

Profitable, growth-minded company, leader in broadcast equipment field, has immediate opening for sales engineer to travel and sell technical equipment primarily to AM, FM and TV stations in exclusive territory. Requires good knowledge of broadcast equipment. Must be sales minded. Self-starter. BSEE or equivalent and minimum three years in field of radio broadcasting. Excellent salary plus commission. Travel expense paid. Complete company benefits. An equal opportunity employer.

Send resume to Broadcast Engineering, Dept. 124.

## Wireless

(Continued from page 17)

obtained with this miniature unit. It is tuneable over the entire 88-mc-to-108-mc range and has jacks to accept microphone and antenna plugs. A belt-type antenna usually provides optimum signal fidelity, but, in instances where a directional pattern persists, the addition of an over-the-shoulder run of flexible wire cures the problem. The developers of this equipment lease a complete sound-recording package to TV and motion-picture studios, including an expert audio engineer and the closely guarded transmitter-receiver system. The cigarette-lighter size of transmitter case is, of course, ideal for concealment.

Extreme distances are not required for the majority of remote-pickup assignments. If the camera and sound crew can obtain good-quality audio at 200' without having to conceal cable-connected microphones, use boom microphones, or dub in the dialog at a later time, they'll be quite happy. Still, sensitive receivers are a necessity for several reasons. Due to the low power of the transmitters and the conditions under which they must operate most of the time, receiver sensitivity of 1.5 microvolts, or better, is generally required. With the combination of a top-quality FM receiver (either a modified commercial unit or one specifically designed for wireless-microphone service) and a stable, drift-free transmitter, almost all interference problems are eliminated. To say that all interference can be eliminated by superior equipment would be stretching a point, but a properly shielded ignition system, for example, will not be picked up by a first-class system. Some foreign cars set up a buzz that cannot be eliminated, as do some older domestic vehicles, but cars or trucks used in a major production can be quieted electrically so they can drive within inches of a wireless microphone without producing any interference. High-tension power lines will cause little trouble as long as the transmitter is kept within a nominal 300' range of the receiver. In extreme cases where action occurs more than approximately 300' from the mixer console and receiver, field-located

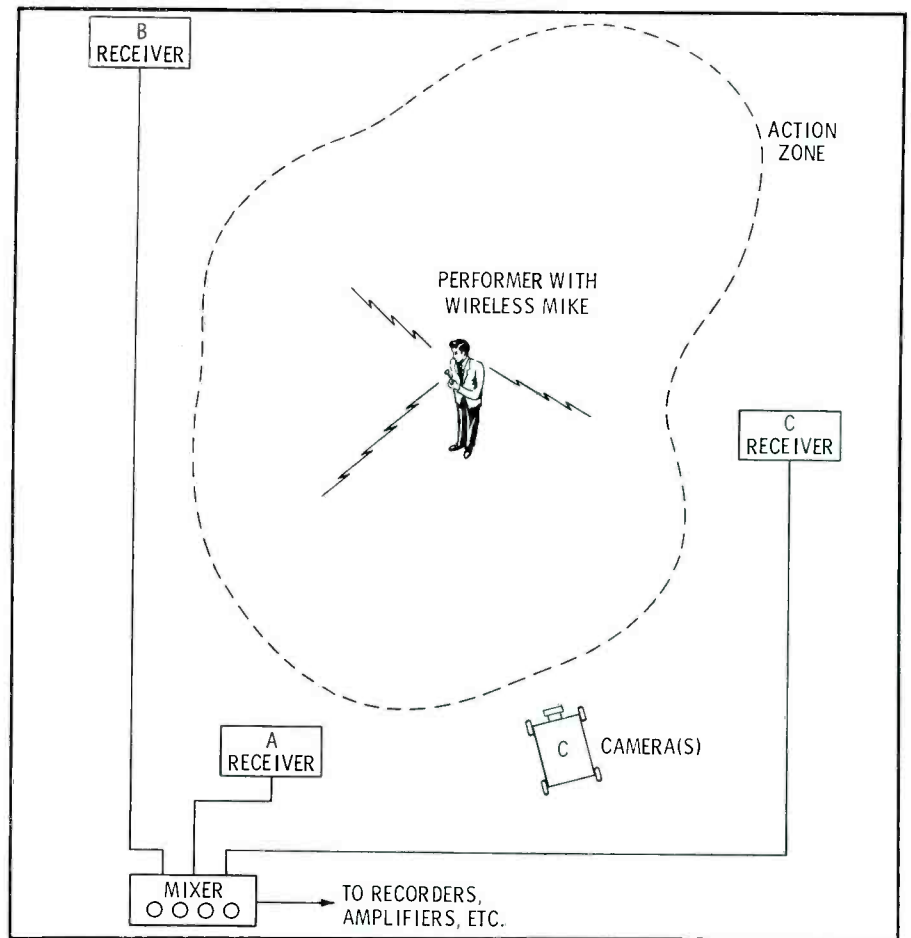

Fig. 4. Multiple-receiver setup requires an engineer with mixer to distribute audio.

receivers can be set up (see diagram in Fig. 4).

On sound stages or at other locations where FM transmission encounters difficulties (where objects impede line-of-sight transmission), auxiliary antennas should be employed. Ordinarily, the whip antenna which is a part of the microphone will do the job perfectly, but in a few cases another approach must be taken. One method is to run a loop of wire to the area in which the action will take place, with the wire directly on the ground when on location or hooked to the overhead beams in a sound stage.

### Conclusion

Broadcasters and news cameramen can use the wireless microphone in many of their pursuits. Having such instruments, they can be on-the-spot without being obvious about it and capture the candid reactions of their subjects. A typical setup for reportage is illustrated in Fig. 5. The less expensive cigarette-pack-sized transmitters are an excellent tool for the roving reporter. The reporter may

cover the action with the transmitter unit while his receiver and tape recorder remain running safely in his car a few yards away. The remote-event broadcaster and newsmen will find a wide variety of uses for wireless microphones and remote taping of varied events. Specifications demanded by broadcasters will help to overcome many of the faults encountered in wireless-pickup equipment now available, and we'll see rapid advances made in wireless pickup techniques. Even so, several units now available can be used to good advantage by many broadcasters. ▲

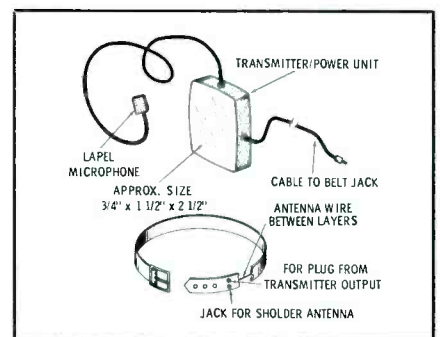

Fig. 5. Compact wireless setup has belt-type antenna for greatest concealment.

# Alright... Cut it out



Yes . . . cut out those slow starts, annoying maintenance and bothersome adjustments with a QRK Professional Turntable. Simplified, patented design provides "blast-off" acceleration for instant "queing." Exclusive Platter-dapter plays 4.5's, 10's or 12's without pop-up gadgets. All this PLUS sustained performance backed by a full year warranty AND prompt service.

- Only 3 moving parts
- PLATTER-PROTECTOR Rim
- Oilite Bearings
- Positive fingertip control



Now...

# Cut this out

...and get **FREE** an accurate full range STROBOSCOPE test disc with our detailed illustrated brochure on QRK turntables.

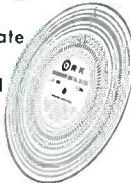

NAME \_\_\_\_\_  
 ADDRESS \_\_\_\_\_  
 CITY \_\_\_\_\_  
 STATE \_\_\_\_\_



Send this coupon or write to



**ELECTRONIC PRODUCTS**

2125 N. Barton • Fresno, California

## What to Do

(Continued from page 15)

tially destroyed tower can only be guessed, the operator who has some towers of his directional system remaining knows more of the problem he is facing. The antenna-resistance report of a nondirectional station or the proof-of-performance report of a directional station provide information describing the base impedance of at least one tower. In most directional antenna systems, the towers are all similar, so a good estimate is that the base impedances of all towers in the system are similar.

Fig. 3 shows an L network best for use where the short-antenna resistance is less than the characteristic impedance of the transmission line. At least for the stub antenna, a larger inductance will be needed in the output arm than the operator may be accustomed to seeing. This is because an unusual type of antenna is being matched.

Using the estimated value of antenna impedance and the transmission-line impedance, first calculate and come as close as possible to constructing a network similar to the one shown in Fig. 3. In the circuit of Fig. 3, when  $I_A^2 = I_2^2 + I_L^2$ , the circuit presents a resistive termination to the transmission line. It is then necessary to adjust the network for the proper resistance of the termination while maintaining the required current relationship. The

optimum termination can be determined by adjustment of the network while keeping in mind you desire maximum antenna current; normal values of transmitter current and voltage; and, of dubious value, equal current at both ends of the transmission line. Remember that in a line one-half wavelength long, it is possible to have equal currents at both ends even though the line is improperly terminated, so evaluate such an indication carefully.

To tune the circuit of Fig. 3, the current-squared relation should first be obtained. It is helpful when making these adjustments to attempt to maintain a constant value of transmission-line current,  $I_L$ , approximately equal to  $\sqrt{W/Z_s}$ , where  $W$  is the anticipated power output of the transmitter. Should the transmitter require overloading to obtain the desired line current, the input resistance of the coupling network is too great, and shunt reactance  $X_2$  must be changed to a more positive value. Conversely, if the transmitter is under-loaded when the desired value of  $I_L$  is obtained, it follows that the input resistance of the network is too small and a more negative value of  $X_2$  is required. The value of  $X_1$  also affects the input resistance substantially, and since the antenna reactance is not known, it is impossible to predict the effect on input resistance of an increase or decrease of  $X_1$ . Trial and error adjustment of the com-

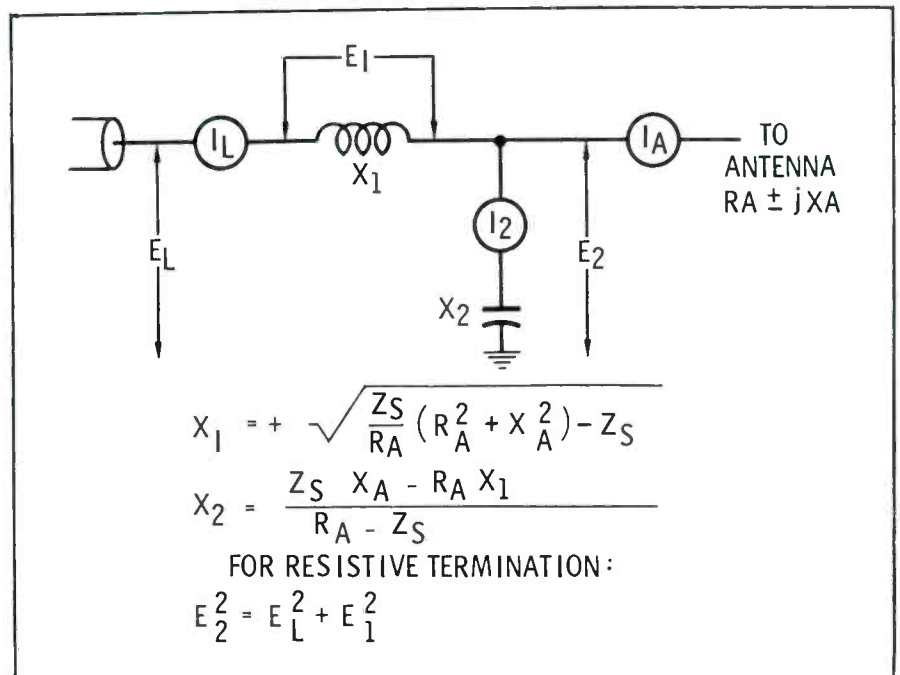

Fig. 4. Network for use when the antenna resistance exceeds the line impedance.



ponents—in a systematic manner and with orderly notes—is necessary.

The circuit of Fig. 4 is used where the antenna resistance is greater than the characteristic impedance of the transmission line. Adjustment of this circuit requires a vacuum-tube voltmeter. When  $E_2^2 = E_L^2 + E_1^2$ , the network presents a resistive termination to the transmission line. In this circuit,  $X_1$  controls input reactance and has negligible effect upon input resistance, whereas with the circuit of Fig. 3 there is substantial interaction on input resistance and reactance. The adjustment is made by setting  $X_2$  to give the desired input resistance and then removing with  $X_1$  whatever reactance is present.

More practically, this means adjusting the components until the voltage-squared relationship is obtained and then checking to see if the line has the same current at both ends. If the line current at the transmitter is greater than the line current at the coupling unit, it follows

that the resistance looking into the coupling unit is greater than the line impedance. To increase the input resistance, decrease the capacitance at  $X_2$ . To decrease the input resistance, increase the capacitance at  $X_2$ .

Calculation of the reactance of a capacitor is straightforward. Estimation of reactance of a coil is a little more difficult. Experience shows that when a coil is mounted among all the other components in a network and on a metal panel, the reactance can be expected to vary linearly with the number of turns. A typical coil that is likely to be encountered would have an inductance of  $17 \mu\text{h}$ , 16 turns, and a 15-amp rating. Unless you have more definite information, begin by calculating the reactance of a  $17\text{-}\mu\text{h}$  coil at your frequency, and assume the reactance to be distributed linearly along the turns of the coil. Also remember that large values of reactance can be produced by a parallel circuit tuned to either side of resonance.

Do not overlook the importance of knowing where your transmitter

normally tunes, either by knowing the dial numbers or the position of the variable inductor or capacitor. You will be better able to estimate the load you are working into and the power output of the transmitter when you have achieved resonance at the normal settings.

### Conclusion

It would be wise to anticipate these problems well before an emergency actually occurs. Consult a good standard text for additional discussion on wire antennas and matching circuits. It may be advisable to erect a horizontal wire antenna temporarily and assemble and adjust a network such as described here during the experimental period. Even if the antenna and network are not assembled, the calculations may be made without the pressure of an emergency. Then if an antenna emergency does arise, you will be at least partly prepared, and your preparation will help you handle the situation calmly and efficiently. ▲

**PREPARE  
TO BE!!!!  
AMAZED**

*see and hear the famous*

**SINGING**

*Just push a button...and it sings the*

**CLOCK**

*exact time...in rhyme!*

**GRC**

**COMMERCIAL RECORDING CORPORATION**

2425 CARLISLE / DALLAS, TEXAS 75201  
Call us collect! PHONE: 214-748-8004

**creators of the "money maker"**

Circle Item 55 on Tech Data Card

# WANTED

## OLDEST MAGNECORD MODEL PT6

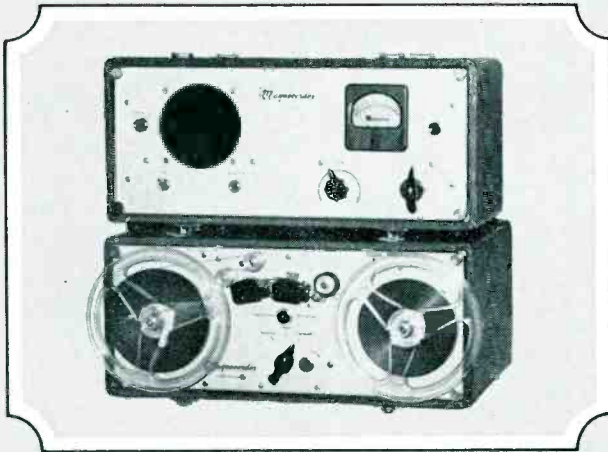

Thousands of Magnecords are delivered . . . never to be seen by our service department. This is marvelous testimony to Magnecord reliability and long life. But even we don't know just how long a Magnecord keeps performing. That's why Magnecord, America's first magnetic tape recorder manufacturer, is offering a reward for the oldest operating PT6. We're giving a new Magnecord just to satisfy our curiosity!

## REWARD

In exchange for the oldest operating Model PT6, Magnecord will give a choice of any new model in the magnificent 1000 series.

### MAGNECORD ANNOUNCES NEW ONE YEAR WARRANTY

In the belief that users of quality tape equipment buy performance rather than paper promises, Magnecord has always issued a 90 day warranty. While others concentrated on promises we concentrated on performance. Magnecord acceptance has

proven the wisdom of this policy. But from now on, each Magnecord gets a one year warranty. However, you can expect the same reliability and lasting quality that has kept Magnecord first choice of discriminating tape equipment users.

Get contest rules and entry blank at your Magnecord dealer or write:



**Magnecord Sales Div.**  
MIDWESTERN INSTRUMENTS

Subsidiary of the TELEX Corporation  
P. O. Box 7509 / Tulsa, Oklahoma 74105

Circle Item 56 on Tech Data Card

## RF Techniques

(Continued from page 22)

method of power measurement, these power losses must be considered. For example: The licensed aural power is 2 kw at the input to the transmission line. If the diplexer has a 10% loss, the transmitter must deliver 2.22 kw to make up the loss.

When the direct method is used, a dummy load and wattmeter are connected in place of the transmission line immediately following the diplexer. The transmitter is adjusted to provide the power required at this point (as indicated on the wattmeter), and the reflectometer on the transmitter is adjusted to 100%. This automatically compensates for the diplexer loss. No modulation is applied to the aural transmitter during these measurements, and the visual carrier should not be on. It is a good idea to check the tracking of the reflectometer with the wattmeter at the 80%, 100%, and 110% power points.

Although the indirect method is permitted, it is seldom used. Since the load and wattmeter are required for power measurements of the visual transmitter, it is a simple matter to check the aural power at the same time.

### Visual Transmitter

Measurement of the visual-transmitter power is even more complicated. Only the direct method of measuring power output is permitted, and the power level must be constantly monitored with a peak-reading device during operation.

The sideband filters, diplexers, etc., are considered a part of the visual transmitter, and the output power is measured immediately following these units. Losses from these units are incorporated into the visual transmitter design. (Filters, diplexers, etc., are not considered part of the aural transmitter.)

Loads and wattmeters differ according to the carrier frequency and power they are required to measure. Low-power loads are usually air cooled (Fig. 3A), while high-power units are water cooled (Fig. 3B). Old-style loads for VHF transmitters were water cooled, and the temperature rise of the water was used to determine power from a nomograph or by calculation. Pres-

ent-day VHF loads are used with a separate wattmeter. UHF loads are water cooled and use a separate wattmeter. A typical small wattmeter is shown in Fig. 4. The high-power model uses no resistor. Instead, a section of special transmission line, matched to the main transmission line and shorted at the end, is used as a load. Whatever type of load and wattmeter is used, only the average power while the transmitter is modulated with a standard black picture is read (Fig. 5).

Since the operating power must be monitored with a peak-reading reflectometer, it is necessary to calculate the peak power after the average power has been determined. The FCC specifies that the average power must be multiplied by a factor of 1.68 when calculating the peak power. This factor is based on the waveform content of the black-picture signal.

After the load and wattmeter have been connected in place of the regular transmission line (Fig. 6), the cooling (if used) should be turned on, the aural transmitter turned off, and the visual transmitter turned on. It is at about this time that the engineer may wish he had more hands and could be in more than one place at the same time. It is best to have one man watch the CRO, keep the chopper going, and make sync-level adjustments while the second man makes adjustments to the black level and drive controls, keeps the transmitter accurately tuned, and observes the wattmeter. It is amazing how much change in the average power reading results from small changes in sync, black level, and stage tuning. All adjustments should be made in small increments until the required conditions of modulation, stage tuning, final-stage plate current and voltage, and average power output are met. The calibrating control should then be adjusted so the reflectometer reads 100%, and the control should then be locked in place. The required average power level is equal to the peak power divided by 1.68. Stage tuning and coupling devices can affect sync levels and, therefore, the power measurements. Hence, the best time to make power measurements is after the transmitter has been ad-

justed for best bandpass and all coupling and tuning adjustments have been completed.

The FCC requires that reflectometers or other direct power-measurement devices used to monitor output power, whether for FM or TV, be calibrated at intervals no greater than 6 months apart. Appropriate data describing these calibrations must be entered in the maintenance log.

Disconnecting a coaxial line to install a dummy load, or for any other reason, always introduces the possibility of something going wrong when the line is returned to its normal connection. A good precautionary technique is to compare the VSWR reading obtained before opening the line with the one obtained after the line has been reconnected. Any increase in VSWR value is sufficient reason to look for something wrong.

And most important of all—remember to disconnect the dummy load and connect the transmitter back to the antenna! ▲

## ELIMINATE DOWN TIME

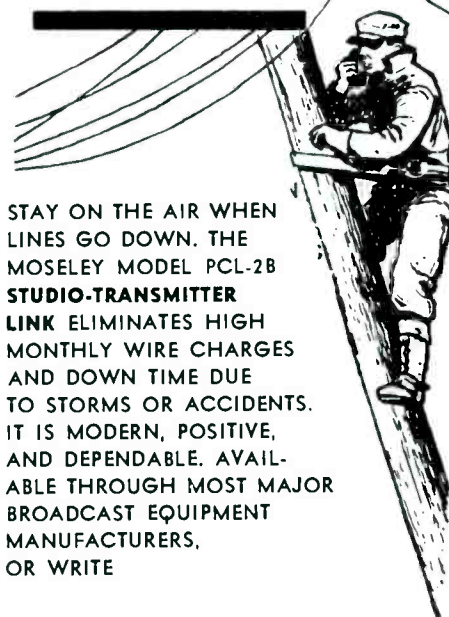

STAY ON THE AIR WHEN LINES GO DOWN. THE MOSELEY MODEL PCL-2B STUDIO-TRANSMITTER LINK ELIMINATES HIGH MONTHLY WIRE CHARGES AND DOWN TIME DUE TO STORMS OR ACCIDENTS. IT IS MODERN, POSITIVE, AND DEPENDABLE. AVAILABLE THROUGH MOST MAJOR BROADCAST EQUIPMENT MANUFACTURERS, OR WRITE

 MOSELEY ASSOCIATES INC.

Circle Item 58 on Tech Data Card

## Scala Precision Antennas

- ★ OFF-THE-AIR PICKUP — FM or TV
- ★ LOW POWER UHF, VHF TV TRANSMITTING
- ★ STL AND TELEMETERING ANTENNAS

Engineered to meet rigid FM and TV station specifications, and to endure the tests of weather and time.

Built to your specifications by

**SCALA RADIO CORP.**

2814 19th STREET  
SAN FRANCISCO 10  
VA 6-2898

Circle Item 57 on Tech Data Card

Ask for Catalog No. GC-65



# BIRD

## Remote Control Pair

(Continued from page 19)

### Switching Circuit

A variety of combinations of functions can be controlled with this unit. The arrangement used at KWHK is shown in Fig. 3. Relay K9 is energized through terminals 1 and 2, and K10 is energized through terminals 3 and 4. These relays correspond, respectively, to relays CR1 and CR2 in Fig. 2 on page 10 of the June 1964 issue of **BROADCAST ENGINEERING**.

Terminals 5 and 6 energize relay K11, which latches through one set of its own contacts and NC terminals 13 and 14. This relay switches spare line No. 1 into program line No. 1, which normally carries program material to the transmitter. Terminals 7 and 8 control K12 which also is connected as a latching relay. Action of this relay switches the network source into program line No. 1. Either or both of these relays can be released by an open circuit between terminals 13 and 14.

Control - circuit action between

terminals 9 and 10 closes latching relay K13, which switches spare line No. 2 onto program line No. 2, normally used for network transmission. Similarly, K14 operates to switch the program source onto network program line No. 2. Either or both relays can be released when the control-circuit path between terminals 15 and 16 is opened.

For KWHK, this system is better than a dial stepper setup because almost instantly we can start or stop our automatic programmer, switch two-way mobile units on the air, or, if necessary, change from local program to network or to either of two

remote broadcast points via the spare line inputs. At the transmitter, in addition to our regular telephone, we have an extension on our first line at the studio. This gives us a better answering service when the studio is unattended. By leaving line No. 1 set into the beeper amplifier, which in turn is patched into one of the spare line inputs, we can put our newsmen on the air via telephone when the use of a car radio is impossible.

All this helps in our constant effort to bring about efficiency and improved quality in the programs that we present to our listeners. ▲

# SPOTMASTER

## Tape Cartridge Winder



The new Model TP-1A is a rugged, dependable and field tested unit. It is easy to operate and fills a need in every station using cartridge equipment. Will handle *all* reel sizes. High speed winding at 22½" per second. Worn tape in old cartridges is easy to replace. New or old cartridges may be wound to any length. Tape Timer with minute and second calibration optional and extra. Installed on winder or available as accessory. TP-1A is \$94.50, with Tape Timer \$119.50.

Write or wire for complete details.



**BROADCAST ELECTRONICS, INC.**  
8800 Brookville Road  
Silver Spring, Maryland

Circle Item 59 on Tech Data Card

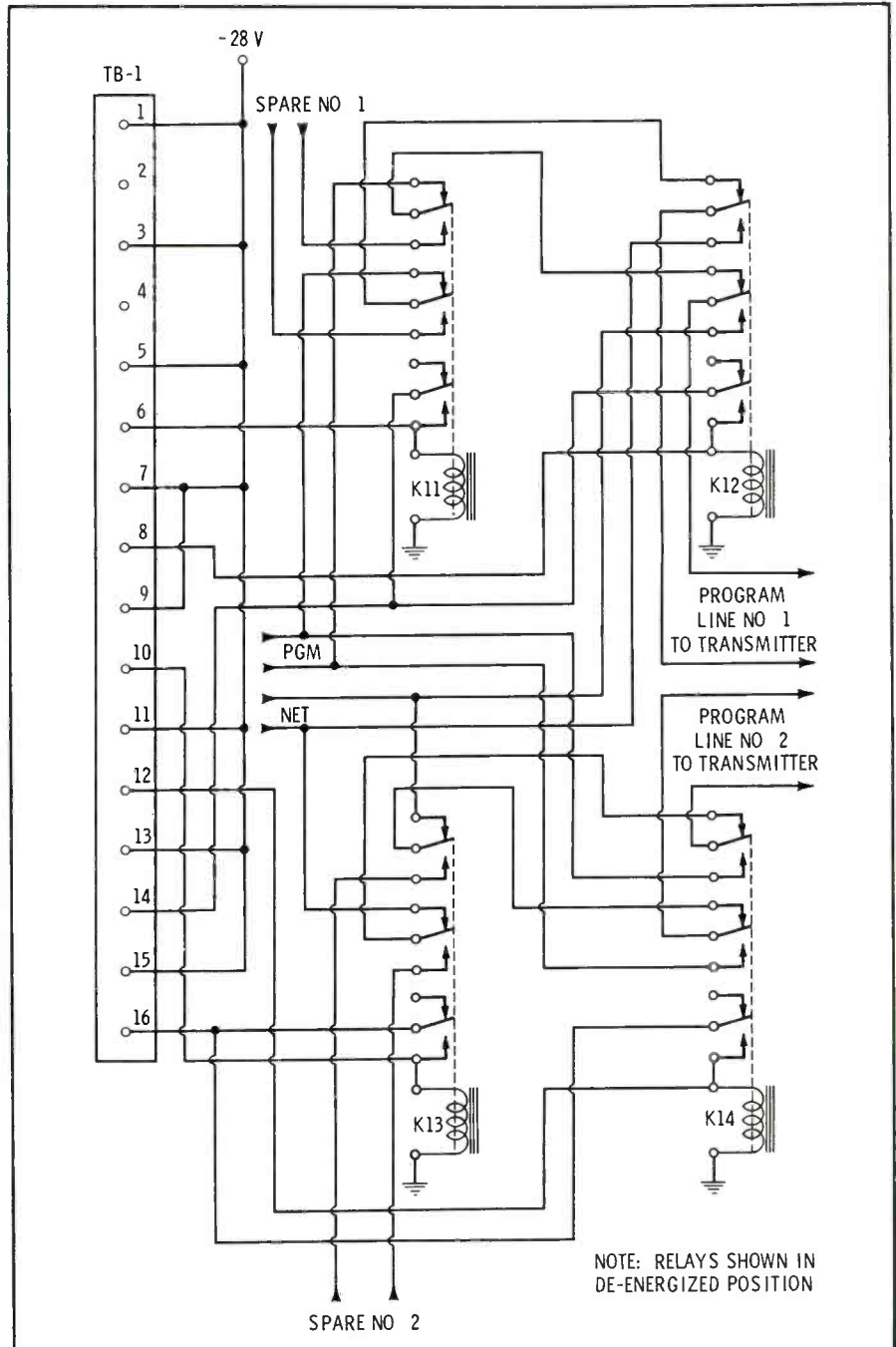

Fig. 3. A circuit-switching arrangement used in conjunction with remote control.

# NEWS OF THE INDUSTRY

## NATIONAL

### Salary Survey

Results of recent surveys by the **National Associates of Broadcasters** show that radio and TV-station employee's salaries have increased 6% and 7%, respectively, over the past two years. As reported by **TELEVISION DIGEST**, the salary ranges were as follows:

#### Television

	Low	High	Ave
Announcers	\$105	\$237	\$153
Chief Engineers	158	279	207
Cameramen	73	160	96
Floormen	51	118	77
Technicians	95	180	129
Sales Managers	189	454	...

#### Radio

	Low	High	Ave
Announcers	\$ 78	\$245	\$104
Technicians	80	192	101
Chief Engineers	98	257	125
Traffic Managers	62	120	72
Sales Managers	136	464	187

Pay rates varied widely according to the size of station and to a lesser degree according to geographic location (North or South).

### Towers Being Built

Three TV towers ranging to 1529' in height are to be built by **Dresser-Ideco**. Station KHMA-TV, a commercial television station at Houma, Louisiana, will be the owner of the 1529' tower. This will be a guyed tower designed to survive winds of hurricane strength. At Joplin, Missouri, Station KODE-TV has ordered a 999' guyed tower, which will also incorporate a 200' AM radiator. The third tower is for the University of Washington, Seattle, which has contracted for a 590' self-supporting tower for that university's educational TV project.

### Stereo by Satellite

In a recent test, a stereo signal transmitted from the earth was received by a satellite orbiting at an altitude of 5000 miles and retransmitted back to earth. The test, involving **Collins Mfg. Co.** stereo equipment, took place at NASA's Goddard Space Flight Center communication ground station at Goldstone Dry Lake, California. Engineers described the test as a success.

The purpose of the test was to gather further proof that the American method of stereo broadcasting (known to radio engineers as the "Pilot-Tone" method) should be adopted as a world standard. Results of the test will be presented to a meeting in Vienna, Austria, March 25-April 7, of Study Group X of the Commission Consultatif International de Radio (CCIR). At the Vienna meeting, Study Group X is slated to consider making a recommendation for interna-

tional standardization of stereo broadcasting. This recommendation would be presented to a plenary session of the CCIR in 1966 for adoption.

During the test, a stereo recording of voice, music, and tones for measurement was fed into a stereo generator. The generator provided a single, composite signal for modulating a NASA transmitter, which beamed the signal to the orbiting Relay II satellite. After receiving the signal, Relay II retransmitted it back to earth. On the ground, the signal was received by NASA equipment and fed into a stereo modulation monitor to unscramble the composite signal into left- and right-channel outputs, which were tape recorded. Both recordings—before and after—will be played at the meeting in Vienna to illustrate that with use of the "Pilot-Tone" method stereo quality can be maintained through a satellite relay.

### VOA Modernization

The New York headquarters of the Voice of America is undergoing a complete modernization. Prime contractor for the job is **Fairchild Recording Corporation**, of Long Island City. The planned improvement at VOA includes installation of completely new studios and a master-control room. The equipment employs only solid-state circuitry.

### CATV School

**Entron's** first three-day course in CATV-system maintenance was conducted by Heinz Blum, Vice-President, Engineering. Students from New York, New Jersey, Illinois, Minnesota, Tennessee, Alabama, Mississippi, North Carolina, New Mexico, and Pennsylvania participated in the course, which included instruction in all phases of installation, operation, and maintenance of Entron CATV systems.

The welcoming address to the group was given by Ed Whitney, Entron's Vice-President. Irving Kuzminsky, the company's Director of Advanced Engineering, discussed head-end equipment and alignment. Other topics covered included

theory; maintenance of various units; and systems layout, extensions, and practices. Each school day consisted of eight hours of instruction and alignment practice. Similar classes are planned for the near future.

### Large-Scale CATV Modernization

One of the nation's largest operators of CATV systems, **H & B American Corp.**, has announced a major modernization program. Five systems will be completely rebuilt, one will be partially rebuilt, and one new system will be installed. All systems will use solid-state equipment.

According to Leon Papernow, Vice-President of Operations, this modernization is being undertaken to provide subscribers with more program variety and improved picture quality. Once the changeover is completed, all seven systems will be capable of carrying up to 12 TV channels and 20 FM stations.

To implement the program, H & B has purchased from Jerrold Electronics, in the largest single equipment-purchase contract in the history of CATV, enough solid-state equipment to send signals through more than 500 miles of cables.

## INTERNATIONAL

### Training Plans for Foreign Broadcasters

The Committee on International Broadcasting of the **National Association of Broadcasters** has arranged to train three foreign broadcasters in United States television stations. Kim Kyu, program manager, Dongyang Telecasting Network Company, Ltd., Seoul, Korea, will be assigned to the American Broadcasting Company through ABC International. He will work at the network and in ABC-owned and -operated stations. Jacques Cogniaux, program director for Belgian National Radio and TV, will train at WBAL-TV, Baltimore. Anton Kjaedegaard, chief of programming in the cultural department, Danish State TV, will be assigned to WTOP-TV, Washington. Each broadcaster will spend two months in practical training assignments at his host television station. The placement program is being carried out in cooperation with the State Department. ▲

Ask for Catalog No. GC-65



QUALITY INSTRUMENTS  
RF POWER

**BIRD**

# NEW PRODUCTS

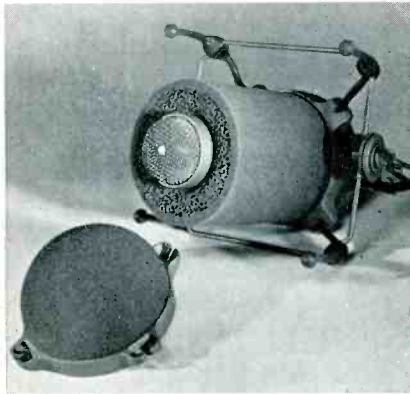

## Foam Windscreen

A special windscreen made from an "open-pore" polyurethane foam is an integral part of a number of professional-model microphones manufactured by **Electro-Voice, Inc.** The windscreen reduces the velocity of air entering the microphone from wind or fast movement and prevents distortion of sound. Called Acoustifoam (TM), the porous material is manufactured by the Foam Division, **Scott Paper Company**. The material does not affect frequency response or the polar pattern of microphones.

Acoustifoam is a porous ester-type polyurethane foam which has no exterior surface membranes to block pas-

sage of sound. With 97% of its volume consisting of air space, the foam is made of thousands of interconnecting strands which break up the air stream and substantially reduce its velocity. Windscreens made of Acoustifoam have operated effectively in outdoor wind velocities up to 40 mph. The polyurethane windscreens also protect sensitive microphones against airborne dust particles. Dust that collects on the interior strands of the material may be removed by washing the windscreen under running water. If severely soiled, the foam may be washed in a mild soap. Excess water is squeezed out.

Circle Item 106 on Tech Data Card

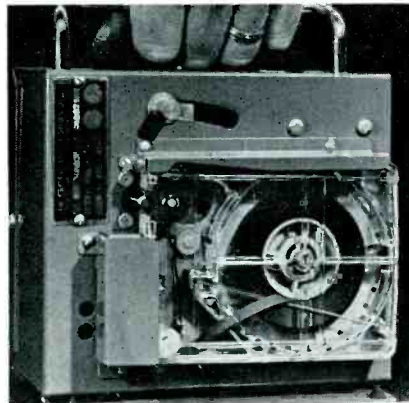

## Cartridge Tape Playback

This new portable tape-playback is a cartridge type for radio stations. It is the Model 200B "Audio-Magic" introduced by **LaCrosse Electronics, Inc.** The unit employs a four-stage transistor amplifier with 5" speaker and operates on 115 volts AC with a 1-watt output at less than 3% distortion. Tape speed is 7½ ips. Price is \$49.95.

Circle Item 107 on Tech Data Card

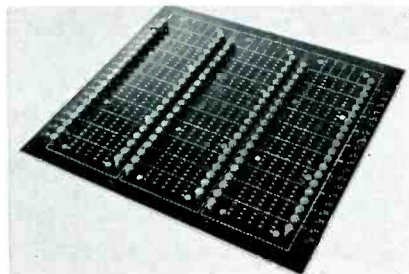

## Program Boards

Cordless program boards for timecasting TV and radio broadcasting operations are now available from **Selectro Corp.**, Mamaroneck, N. Y. The new "Selectro-board" provides the advantages of matrix design, with either bussed or individual outputs, operations indicator lights, RF patch areas, and appropriate front-panel markings. The unit provides instant visual readout of the program plan, plus elapsed-time and real-time identification. The electrical contacts are rated at 5 amps. Shorting pins, diode holders, component holders, and illuminated monitoring pins are available as plug-in accessories.

Circle Item 108 on Tech Data Card

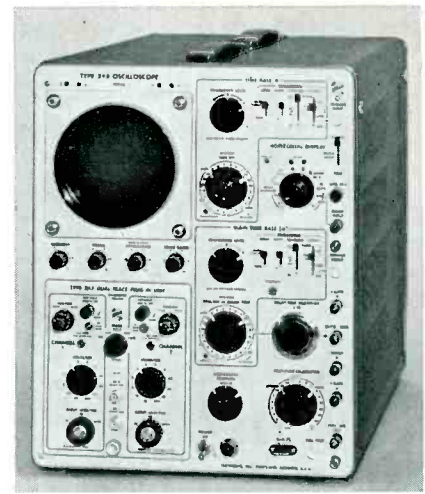

## Multipurpose Wideband Oscilloscope

A new wideband oscilloscope, the Type 546 by **Tektronix, Inc.**, accepts the new 1-A Series Plug-In Units for general-purpose DC-to-50-mc dual-trace applications and also the "letter-series" plug-ins for strain gage, multichannel, differential, and operational amplifier applications in the DC-up-to-30-mc area. Dual-trace sensitivity with a Type 1A1 Plug-In Unit is to 50 mv/cm from DC to 50 mc and to 5 mv/cm from DC to 28 mc. For applications demanding greater sensitivity, the two input channels can be cascaded to provide single-trace displays at approximately 500 uv/cm sensitivity from 2 cps to 15 mc. Sweep range of the Type 546 is from 0.1 usec/cm to 5 sec/cm, with sweep magnification extending the fastest sweep to 10 nsec/cm. Triggering facilities, including automatic and single-sweep operation, provide for triggering beyond 50 mc. Continuously variable calibrated sweep delay, with trace brightening to indicate the exact portion of signal that appears on the magnified display, enables precise time measurements. Signal delay is through a delay line that requires no tuning and has uniform transient response. A 6-cm by 10-cm internal graticule, with controllable illumination, allows parallax-free measurements and waveform photography with sharp delineation of the graticule markings. The price is \$1750.

Circle Item 109 on Tech Data Card



## Adjustable Tape Cartridge

An adjustable tape cartridge designed to NAB standards is available from the

## KILL THE HEAT!



Replace hot tube rectifiers NOW with life-time, indestructible, no-heat silicon.

2400 PIV-1 amp  
replaces 5R4... \$3.95

1800 PIV-1 amp  
replaces 5U4... \$1.95

Replacements available for most tubes. Order 10 or more for Special Quantity prices.



**Wilkinson Electronics, Inc.**  
1937 W. MacDade Blvd.  
Woodlyn, Pa. 19094  
Telephone: 215-874-5237

Circle Item 60 on Tech Data Card

**Amerline Corp.** Polyurethane pressure pads can be adjusted with a screw driver without taking the cartridge apart, and the patented hyperbolic take-off hub assures excellent fidelity. A Delrin-to-nylon center bearing provides smooth tape motion and each loaded cartridge is tested for minimum wow and flutter with a 3 kc test tone. No bearing lubrication is required. Tape lock and guide features prevent tape loosening. Stock sizes range from 40 seconds to 5½ minutes. Empty cartridges are also available from stock.

Circle Item 110 on Tech Data Card

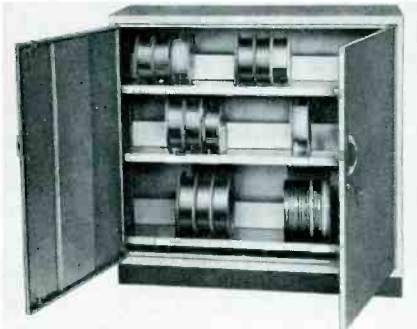

### Tape and Film Storage

To meet the growing need for film and video-tape storage facilities, the **Jack C. Coffey Co., Inc.**, North Chicago, Ill., is producing add-on filing and storage units with capacities ranging from eight 14" video-tape reels to 45 6", 6½", and 8" reels. The equipment may also be used for storage of 16 mm motion-picture films in reels or cans. These LUXOR units can be used with present film or tape cabinets having lock-stacking or add-on features to provide added storage space under lock and key. Four basic units form many combinations to suit various video-tape library requirements. Mobile or stationary bases for permanent locations or movable storage and an adjustable-height, big-wheel utility table for general studio and library use are also available.

Circle Item 111 on Tech Data Card



### Dynamic Cardioid Microphone

**AKG of America** is now offering the D-119CS, a new member of the AKG D-19 group of dynamic cardioid microphones. The D-119CS has a frequency range of 40 to 16,000 cps with a deviation of only ±3 db. The cardioid characteristics of this microphone give an effective front-to-back discrimination of approximately 15 db. Sensitivity is listed

sa -75 db. The unit is provided with bass-attenuation switch (-10 db at 50 cps) and noiseless on-off switch. It is delivered with matching connector, stand adapter, 15' cable and wind-protection cover. Impedance is 200 ohms; a high-impedance transformer (AKG U-212) is available.

Circle Item 112 on Tech Data Card

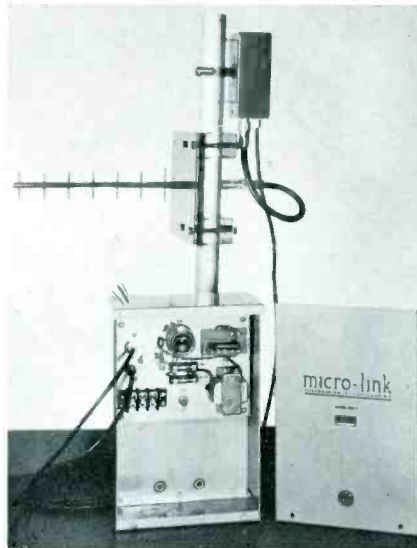

### ETV Converter

Reception of up to five program channels in the 2500-mc Instructional Television band is possible with **Micro-Link Corporation's** Model CE-5 receiving converter. The equipment consists of a mast-mounted converter and an associated indoor-mounted power supply. The converter is completely weather-proof, weighs three lbs, and is provided with necessary mounting hardware. A single coaxial cable supplies power to and carries signals from the converter.

The equipment employs all-solid-state circuitry. Technical specifications include an input frequency range of 2500 to 2686 mc, an output frequency of 168 to 222 mc, a passband ripple of less than ±1 db, and noise figure of less than 13 db. Input impedance is 50 ohms; output impedance is 75 ohms. Frequency stability of ±.005% or better is obtained through crystal control. Maximum input level is -30 dbm (7 millivolts)

for 1% intermodulation (5 channels). The operating temperature range is -40 to +140°F. Price of the CE-5 is \$800.

Circle Item 113 on Tech Data Card



### New Microphone Accessory

This new microphone accessory makes possible instantaneous microphone removal as well as safe attachment to any stand or support—both without threading on or off. The Model LO-2 is made by **Atlas Sound**, Div. of American Trading and Production Corp. The quick-disconnect feature of the accessory is achieved by a special two-piece interlocking design. One half stays with the microphone, and the other half remains on the stand. A positive lock holds the microphone securely and safely in place until a pushbutton is deliberately released. Price is \$3.50 list. ▲

Circle Item 114 on Tech Data Card

**STOP** you lost your turn by missing our ad in the March issue. Go back and look at page 86 for **NEW REMOTE CONTROL** from **BIONIC INSTRUMENTS, INC.**

Circle Item 91 on Tech Data Card

Get NEW CATALOG of wattmeters, loads, filters, switches

QUALITY INSTRUMENTS  
FOR RF POWER MEASUREMENT



**BIRD ELECTRONIC CORPORATION**

30303 AURORA RD. • CLEVELAND (SOLON) OHIO 44139

Circle Item 61 on Tech Data Card

## THE CHIEF ENGINEER

... Helps Solve Your Technical Problems

Readers are invited to send their questions to the "Chief Engineer"; those of most general interest will be published.

I am the Chief Engineer of an AM broadcast station. We have just completed the construction of our station in accordance with our construction permit, and during this time, I ran into a problem which was solvable in our case, but might have been difficult to solve in other cases.

Our construction began during the

month of November under rather mild weather conditions. After the tower was erected, the weather turned quite cold, and the ground became frozen. Fortunately, the freeze line did not extend more than a few inches into the ground, and we were able to bury the ground system, as required by the construction permit. I am curious, however, what would have happened if the ground had frozen to a significant depth, such as occurred in the following few weeks, thus not permitting us to bury our ground system.

This is a practical problem that confronts many broadcast stations, particularly in the northern portions of the

country. If you had not been able to bury the ground system due to the ground being frozen, the proper procedure would have been to install the ground system above the ground. You would then file the required material with the Commission in connection with your license application, which would include impedance measurements as required by FCC Form 302. You would indicate in Paragraph 13 of FCC Form 302 that the ground system had been laid on the ground, and that further information would be supplied when the ground system was buried. After the spring thaw, you then would be able to bury the ground radial wires in accordance with the specifications outlined in the original application.

After the burial of the ground system, you would be required to file a separate Form 302, together with the new measured impedance resulting from the burial of the ground system. A few ohms difference in the measured resistance would be expected.

**We propose to install a studio/transmitter link (STL) for broadcast of the aural program material between our studio and our transmitter. Do we need a licensed operator on duty if remote control is contemplated, or is unattended operation permitted?**

Section 74.533(a) of the Commission's Rules indicates that such an aural broadcast STL may be operated by remote control providing a licensed operator of the proper grade is stationed at the control point at all times. Part (b) of this Section, however, permits the operation of intermediate relay stations without a licensed operator on duty provided certain safeguards, which are outlined, are complied with. This means that for a single-hop transmission, a licensed operator is required to be on duty at the control point at all times. However, in cases of multi-hop transmission, unattended operation is permitted for the intermediate relay stations.

**What are the Commission's rules relative to permissible variations in phase readings of a directional antenna? I note specifically that the ratio of our currents may not vary more than  $\pm 5\%$ , but nothing is said about phase.**

The Commission has no rules regarding permissible variations in phase for a standard-broadcast directional antenna. In cases such as this, unwritten Commission policy usually applies.

One rule of thumb used by the Commission's engineers is that a variation in relative phase of any of the towers in a directional antenna system should not vary more than  $\pm 2^\circ$  from the licensed value. However, this does not mean that occasional excursions beyond this limit will not be allowed, since such variations can occur from time to time because of climatic or other changes. It does mean that phase variations which are greater than this amount for extended periods of time may make the station vulnerable to citation. ▲

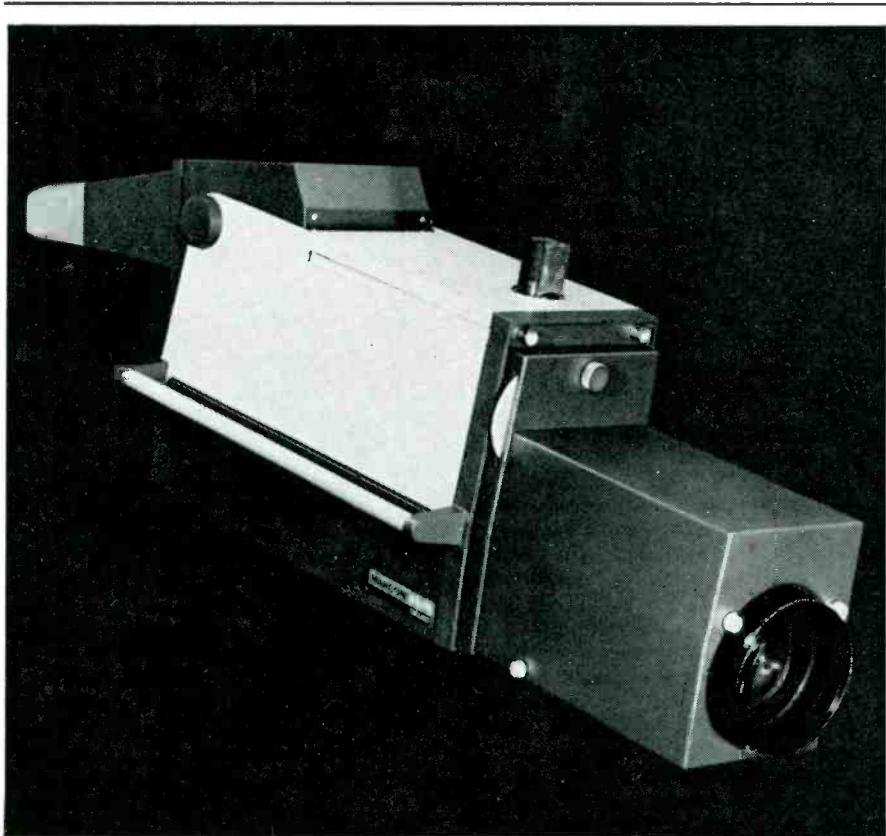

WORLD'S FIRST FULLY TRANSISTORIZED TILTING VIEWFINDER  
4 1/2" IMAGE ORTHON ZOOM CAMERA

The new Marconi Mark V. Here's the broadcasting and teleproduction camera that's as advanced as the Mark IV when it was introduced 5 years ago. And everybody's still trying to catch up with that one. Here are some of the things they'll have to shoot for to equal the new Mark V: integrated 10 to 1 zoom lens; a unique tilting viewfinder; near perfect linearity and geometry; precision mechanics; superbly stable circuitry. You can have as little or as much remote control as you

desire. Two new types of joy-stick remote control panels make the Mark V extraordinarily easy to operate. The lens may be manually or servo controlled. And it's from Marconi, makers of the world's standard television camera. The new Marconi Mark V and the whole line of Marconi equipment is distributed by Ampex. Term leasing and financing are available. For complete information call your Ampex representative or write to: Ampex Corp., Redwood City, California.



© AMPEX CORP. 1965

# AMPEX

Circle Item 62 on Tech Data Card



# ENGINEERS' TECH DATA

## AUDIO & RECORDING EQUIPMENT

64. ATLAS SOUND—Catalog 564 describes line of public-address speakers and microphone stands for commercial and industrial sound-distribution systems.
65. ATC—Specification sheet on solid-state multiple-cartridge unit suggests monophonic and stereophonic applications for automated systems.
66. BROADCAST ELECTRONICS—Packet contains specifications and prices for Spotmaster tape-cartridge systems and new Portapak 1 portable playback unit for use by salesmen.
67. CINE SONIC SOUND—Data sheet describes rental service which supplies background music on 7", 10½", and 14" reels, stereo or mono.
68. CONCORD ELECTRONICS—Brochures on Model WX-8010 wireless microphone, R-series automatic tape recorders for broadcast use.
69. EASTMAN KODAK—Brochure S1-6 gives useful and interesting information about sound recording tape.
70. EDLEMAN & ASSOCIATES—Data on Model 520 broadcast equipment and Model DV-300 portable video recorder.
71. GIBBS—Brochures describe principles of sound reverberation and give locations of dealers.
72. GOTHAM—Descriptive material and application notes on Neumann U-64 cardioid microphone.
73. HARVEY—Engineering bulletin on Langevin 4000-series solid-state sound reinforcing modules.
74. MAGNASYNC—Brochures and booklets describe magnetic-film sound equipment for motion-picture work.
75. MILES—Sound reproducing and indexing system providing six hours recording time on continuous belt in covered in brochures.
76. QUAM-NICHOLS—1965 catalog lists speakers for background music, high-fidelity systems, autos, and general replacement.
77. SENNHEISER—Instructions for the connection of dynamic and condenser microphones.
78. SPARTA—Illustrated product brochure gives complete specifications and prices of Sparta-Matic tape units, Sparta audio consoles, turntables, preamplifiers, and other studio equipment.
79. VIKING—RP-120 professional-type tape amplifier is described in booklet.
80. WALLACH ASSOCIATES—Series of brochures describes line of cabinets for storing tapes, records, filmstrip, slides, etc.

## COMPONENTS & MATERIALS

81. AMPEREX—Newly revised edition of semiconductor catalog lists items for many applications.
82. CORNELL DUBILIER—Write for descriptive material on TV, FM components, rotor systems, and a cross reference guide for vibrators.
83. SPRAGUE—Twelve-page folder shows line of transistors and Unicircuit® networks.
84. SWITCHCRAFT—New product bulletin 150 gives information on complete line of "Lo-Cap" lever switches with phosphor-bronze actuator and contact springs.

## MICROWAVE DEVICES

85. MICRO-LINK—Brochures on Model 520A portable microwave relay link, and Model 600 fixed-station relay link with planning tips.
86. MOSLEY—Literature describes Citizens-band antennas.

## MOBILE RADIO & COMMUNICATIONS

87. G-E—Bulletin ECR-1174 describes lease arrangements for Porta-Mobile two-way radio equipment for on-the-spot news remotes.

## POWER DEVICES

88. HEVI-DUTY—Bulletin 7-12 provides data on line-voltage regulator which uses saturable-core reactor.
89. TERADO—Booklet gives information on Galaxy 50-20 power inverter.

## RADIO & CONTROL ROOM EQUIPMENT

90. ALTEC LANSING—Folder shows line of audio equipment for broadcasting uses.
91. BIONIC—Brochure on small two-line remote control amplifier having individual controls for each transmitter circuit.
92. GATES—Four solid-state remote amplifiers described in application sheets.
93. KARG—Data sheets provide information of crystal-controlled FM broadcast monitor Model XT-3.
94. RUST—New Autolog AL-100R data sheet for remote-control of broadcast stations.

## REFERENCE MATERIAL & SCHOOLS

95. BLONDER-TONGUE—Booklet entitled "How to Set the Stage for Educational TV" briefly describes the requirements and benefits of ETV broadcasting.
96. CLEVELAND INSTITUTE—Booklet describes courses in electronics, including those for broadcast engineering and FCC license preparation.

## STUDIO & CAMERA EQUIPMENT

97. CLEVELAND ELECTRONICS—Data concerns modifications using new deflection yoke and alignment coil to update 3" image orthicon cameras.
98. DU MONT—Brochure and technical data on the Du Mont TC-175 transistorized, closed-circuit television camera with 700-line resolution.
99. ROANWELL—Brochure gives technical specifications of broad line of headsets for camera and control-room use.
100. ZOOMAR—Information in brochures gives particulars on Angenieux zoom lenses for IO and vidicon cameras, describes remote-controlled pan and tilt head.

## TELEVISION EQUIPMENT

101. MOSELEY—Solid-state, 21-channel remote-control system for AM, FM, TV described in brochure.
102. TELEMET—Literature describes new solid-state color-processing amplifier, color-bar generator, clamper amplifier, and cable terminal equipment for 124-ohm balanced PEVL cable.
103. VITAL—Data sheets provide information on Models VI-10A video-distribution amplifier, Model VI-20 pulse-distribution amplifier, and Model VI-500 video clamper/stabilizer amplifier.

## TEST EQUIPMENT & INSTRUMENTS

104. DELTA—Application bulletin No. 2 describes installation and use of common-point impedance bridges.

## TRANSMITTER & ANTENNA DEVICES

105. CCA—Catalog sheets on full line of AM and FM transmitters and other broadcast equipment.

## Professional Services

### VIR JAMES

CONSULTING RADIO ENGINEERS  
Applications and Field Engineering  
345 Colorado Blvd.  
Phone: (Area Code 303) 333-5562  
**DENVER, COLORADO 80206**  
Member AFCCE

### JAMES C. McNARY

Consulting Engineer  
National Press Bldg.  
Washington 4, D. C.  
Telephone District 7-1205  
Member AFCCE

### LAWRENCE BEHR ASSOCIATES, Inc.

RADIO ENGINEERING CONSULTANTS  
FM Applications and Field Engineering  
also  
AM—Communications—CATV  
LAWRENCE BEHR, PRESIDENT  
2501 East Fourth Street  
Greenville, North Carolina  
919-PL 8-3966

### OSCAR LEON CUELLAR

Consulting Radio Engineer  
AM-FM-TV  
411 Phoenix Title Building 623-1121  
Directional Antennas Design  
Applications and Field Engineering  
Tucson, Arizona 85701  
Member IEEE

### CARL E. SMITH

CONSULTING RADIO ENGINEERS  
AM, FM, TV and CATV  
8200 Snowville Road  
Cleveland, Ohio 44141  
Phone: 216-526-4386  
Member AFCCE

### CAMBRIDGE CRYSTALS PRECISION FREQUENCY MEASURING SERVICE

SPECIALISTS FOR AM-FM-TV  
445 Concord Ave. Phone 876-2810  
Cambridge, Mass. 02138

## Classified

Advertising rates in the Classified Section are ten cents per word. Minimum charge is \$2.00. Blind box number is 50 cents extra. Check or money order must be enclosed with ad.

The classified columns are not open to the advertising of any broadcast equipment or supplies regularly produced by manufacturers unless the equipment is used and no longer owned by the manufacturer. Display advertising must be purchased in such cases.

## EQUIPMENT FOR SALE

Everything in used broadcast equipment. Write for complete listings. Broadcast Equipment and Supply Co., Box 3141, Bristol, Tennessee. 11-64 6t

Ampex Head Assemblies for 300 and 400 series recorders reconditioned. Service includes lapping and polishing all three head stacks, cleaning entire assembly, readjusting and replacement of guides, and realignment of stacks as to azimuth and zenith. Full track assemblies—\$60.00. Taber Manufacturing & Engineering Co., 2619 Lincoln Ave., Alameda, California. 5-64 tf

G.E. FM FREQUENCY AND MODULATION MONITOR 4BM1A1. Best offer over \$700 takes it. Write: Roy Trumbull, P.O. Box 247, Corte Madera, Calif. 4-65 1t

Television/Radio/communications gear of any type available. From a tower to a tube. Microwave, transmitters, cameras, studio equipment, mikes, etc. Advise your needs—offers. Electrofind Co., 440 Columbus Ave., NYC. 212-EN-25680. 8-64 tf

COMMERCIAL CRYSTALS and new or replacement crystals for RCA, Gates, W. E. Bliley, and J-K holders; regrinding, repair, etc. BC-604 crystals; also service on AM monitors and H-P 335B FM monitors. Nationwide unsolicited testimonials praise our products and fast service. Eidson Electronic Company, Box 96, Temple, Texas. 5-64 tf

Parabolic antennas, six foot dia., new, solid surface with hardware, dipole, etc. \$125.00 each. S-W Electric Cable Company, Willow & Twenty-Fourth Streets, Oakland, California. 832-3527. 10-64 tf

Will buy or trade used tape and disc recording equipment—Ampex, Concertone, Magnecord, Presto, etc. Audio equipment for sale. Boynton Studio, 295 Main St., Tuckahoe, N. Y. 1-64 tf

Laboratory Test Equipment, microwave components, all frequency and makes at real low prices. Write or call for information. Jericho Electronic Supplies, Sid Gordon Electronics, 80 West Jericho Turnpike, Syosset, Long Island, N. Y. (516) WA 1-7580. 12-64 6t

AMPEX 350 SERIES reconditioned capstan idlers for \$7.50 exchange. Send us your old ones, or order them for \$10.00 and get \$2.50 back after sending the old ones in. Ours have new bearings, the rubber softened and surface precision ground. TABER MANUFACTURING & ENGINEERING CO., 2619 Lincoln Ave., Alameda, California. 1-65 12t

AMPEX 350 SERIES reconditioned capstan drive motors (BODINE NCH-33 only) \$85.00 exchange. Send us your old one, or order for \$100.00 and get \$15.00 back after sending old one in. Ours have new bearings and rewind stator. Package motor well. TABER MANUFACTURING & ENGINEERING CO., 2619 Lincoln Ave., Alameda California. 1-65 12t

Two Pultec PC 10 R1AA equalized phono amplifiers, 18 months old, \$195.00 each. Neuman DST62 stereo phono cartridge 10 hours use, \$45.00. Shipped prepaid with check or money order. W. R. Pletcher, 604 Thornhill Drive, Lafayette Hill, Pa. 3-65 2t

Parabolic antenna, 4-ft. diameter. New solid surface aluminum with hardware and dipole, \$85 each. Empire Device heads for NF 105, half price. Jericho Electronics Supplies, Sid Gordon Electronics, 80 West Jericho Turnpike, Syosset, Long Island, N.Y. (516) WA. 1-7580. 3-65 3t

ELECTRONIC TUBES—Top Brands SOLD at substantial savings; (Minimum Order \$15.00). Authorized GE AmpereX, Dumont and Eimac Distributor. Send for FREE Buyers' Guide for all your Tube Requirements. TOP CASH PAID for your excess inventory. (New Only—Commercial Quantities). Metropolitan Supply Corp., 443 Park Avenue South, New York, N.Y. 100161 (212) MU 6-2834. 3-65 5t

McJONES 612A 6KW watercooled load 44-1000MC. Save half. In new condition at \$375.00 F.O.B. Wilkinson Electronics, 1937 W. MacDade Blvd., Woodlyn, Pa. 19094. 21-5-874-5236. 4-65 1t

New RCA 50KW watercooled load AM with pump and flow indicator, \$1,200.00 value for \$550.00 F.O.B. Wilkinson Electronics, 1937 W. MacDade Blvd., Woodlyn, Pa. 19094. 215-874-5236. 4-65 1t

Audio Equipment bought, sold, traded. Ampex, Fairchild, Crown, McIntosh, Viking, F. T. C. Brewer Company, 2400 West Hayes Street, Pensacola, Florida. 3-64 tf

Surplus recording equipment for sale. Scully, RCA, Magnecord, Concertone. Send for list. Boyd Recording Service, 2924 Lemmon Ave. East, Dallas, Texas. 4-65 1t

REL Stereo FM Microwave links, 944 mcs. Currently in operation. New receivers (alone worth \$2,000.00) plus many spare tubes and parts. \$2,800 complete. KPEN, 1001 California Street, San Francisco 8, California. TUXedo 5-4311. 4-65 1t

## EQUIPMENT WANTED

A 469-B condenser manufactured by Western Electric Company for their 504 B2, 3 kw FM transmitter. Contact Bill Bratton, Chief engineer, WLAP, Lexington, Ky. 606-255-6300. 11-64-6t

## Personnel

Engineering Supervisor—First phone, 14 years T.V. experience; network T.V. remote supervisory, design, construction, maintenance, operations, administration. Desires responsible position. Write Broadcast Engineering, Dept. 127.

## Advertisers' Index

Altec Lansing Corp.	12
AMECO	50
Ampex Corp.	88
Amplifier Corp. of America	70
Audio Engineering Society, Inc.	70
Automatic Tape Control, Inc.	45
Bauer Electronics Corp.	72
Belden Mfg. Co.	31
Bendix Corp.	75
Bionic Instruments, Inc.	62, 87
Bird Electronics	83, 85, 87
Blonder-Tongue Labs	62
Broadcast Electronics	30, 38, 84
CBS Labs, Inc.	41
Cleveland Electronics	52
Cleveland Institute of Electronics	32
Collins Radio	8, 9
Commercial Recording Corp.	81
Continental Electronics	61
Dage TV Co.	29
Eastman Kodak Co.	49
Eitel-McCullough, Inc.	71
Electro-Voice, Inc.	51
Fairchild Recording Co.	4, 58
Gates Radio Co.	27
General Electric Co.	46, 47
Harvey Radio	59
International Nuclear Corp.	Cover 3
JOA Cartridge Service	68
Jampro Antenna Co.	44
Lang Electronics, Inc.	30, 68
Magnecord, Midwestern Instruments	82
Martel Electronics	40
Minnesota Mining & Mfg. Co.	53
Moseley Associates	83
Moviola Mfg. Co.	30
Norelco Audio Video Products	69
Northern Electric Co., Ltd.	10, 11
Nortronics	45
QRK Electronics	80
RCA Electronic Components and Devices	Cover 4
Reeves Industries	54
Rek-O-Kut	43
Riker Industries	Cover 2
Russco Electronics Mfg.	40
Rust Corp. of America	3
Sarkes Tarzian, Inc.	63
Scala Radio Co.	83
Sony Superscope	73
Sparta Electronics Corp.	76
Stancil-Hoffman Corp.	78
Superior Cable Corp.	39
Sylvania Electric Products	37
Tektronix, Inc.	35
Telemet Co.	65
Times Wire & Cable Co.	55
Video Medical Electronics Corp.	5
Visual Electronics Corp.	6
Vital Electronics	57
Vitro Electronics	67
Ward Electronic Industries, Inc.	7
Wilkinson Electronics	40, 86

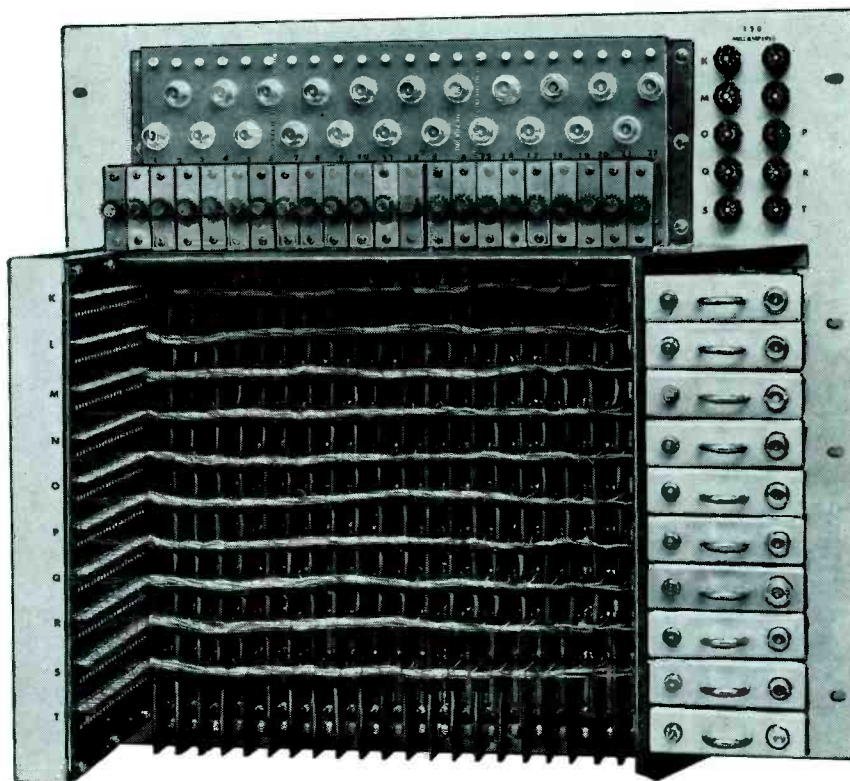

# WE CAN CUSTOM MAKE YOUR SWITCHER

ANY NUMBER INPUTS OR OUTPUTS TO SUIT YOUR NEEDS

If you have special switcher requirements that demand custom manufacture, then International Nuclear can be of service to you. An International Nuclear audio and video crossbar switcher can be assembled to house any number of inputs or outputs. Each input line is a printed circuit. All amplifiers and power supplies are completely solid state. A single standard type transistor is used throughout the circuitry. All components are readily accessible and operate well within their rating. Custom switchers handle double re-entry switching as well as composite or noncomposite switching. The new reed-type relays which we use are metal contacts operating in a glass sealed atmosphere. Control of these relays is accomplished by an external push-button and tally light console. Telephone companies and space programs have proven that this type of relay is the only reliable method of switching video.

We invite your inquiry, write or phone collect today.



Custom Portable Switcher  
Designed Especially for ABC

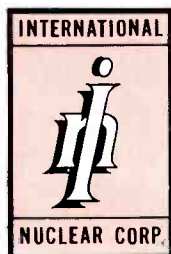

**INTERNATIONAL NUCLEAR CORPORATION**  
608 NORRIS AVENUE • NASHVILLE, TENN. • PHONE 254-3366

Circle Item 63 on Tech Data Card



CREATED BY THE HAND OF EXPERIENCE

## AND NOW...THE RCA-8501 FOR 10 KW UHF-TV

Designed for operation in the 1- to 10-KW range the RCA-8501, forced-air-cooled tetrode, allows greater economies in RF amplifier design and operation. Featuring Cermolox<sup>®</sup> design, this new tube offers the advantages of its military prototypes—high perveance, high gain, low voltage operation, forced-air cooling... plus a rugged long-life thoriated tungsten filament. A single tube delivers 5.5 KW peak sync at 890 Mc.

To keep up-to-date on RCA innovations, keep in touch with your local RCA Broadcast Tube Distributor. He is ready to provide current information on new and improved RCA types. Ask for a copy of Product Guide for RCA Power Tubes, PWR-506A.

RCA ELECTRONIC COMPONENTS AND DEVICES, HARRISON, N. J.

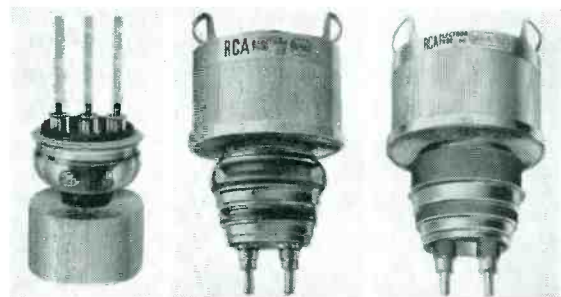

Familiar names—RCA-5762/7C24, -6166, -6166A/7007—yet today's improved RCA versions are still the best buys a broadcaster can make—kept in the forefront of broadcast technology through continual improvement by experienced RCA design and production engineering.



The Most Trusted Name in Electronics