

A HOWARD W. SAMS PUBLICATION



APRIL 1964/75 cents

Broadcast Engineering

*the technical journal
of the broadcast-
communications industry*



ITA UHF TV TRANSMITTER



HIGHEST
Quality
LOWEST COST

"WORK-HORSE" OF DEPENDABILITY AT PEAK PERFORMANCE

The ITA 12.5 and 25kw UHF TV TRANSMITTERS offer you, the broadcaster, tremendous advantages in equipment at an unparalleled cost. ITA transmitters are much lower in price and guarantee higher performance and dependability. Designed by the best engineering team in the business, ITA's UHF TV transmitters feature field-proven components of top quality for long life and easy maintenance. ITA transmitters are *your best buy*...let us show you *how* and *why*. Write, wire or telephone today for complete information.

- ★ Klystron Power Tubes Warranted 3000 Hours
- ★ Common Aural and Visual Exciter
- ★ Designed for Remote Control
- ★ Designed for Power Increase
- ★ Simplified Circuitry
- ★ Very Low Driving Power Required
- ★ Full Overload Protection
- ★ Long Life Silicon Rectifiers
- ★ Meet FCC Color Standards



ELECTRONICS
DIVISION OF TRIANGLE PUBLICATIONS, INC.

130 EAST BALTIMORE AVENUE, LANSDOWNE, PENNSYLVANIA
CL 9-8200

Circle Item 1 on Tech Data Card

**This is the
California station
that switched to UHF
and gained coverage.**



KERO-TV, Bakersfield, Calif., has a unique case history. In mid-1963 under FCC ruling, the station switched from VHF to UHF, and **gained** overall market coverage.

On Channel 10, KERO-TV enjoyed leading coverage of the rich southern San Joaquin Valley market. The prospect was not bright that UHF could maintain this coverage.

The station management and station owners, Transcontinent Television Corporation, determined to hold the KERO-TV market with advanced new equipment never before used in commercial broadcasting. The decision: become the first user of the new General Electric UHF Zig-Zag Panel Antenna and new G-E 25 KW Klystron Transmitter.

Results: the UHF installation has met or exceeded all specifications. To the north, the new UHF signal sends KERO-TV Grade A coverage 88 miles away and into Fresno County for the first time. Grade B coverage seems limited only by the horizon. Overall coverage exceeds that of the previous VHF signal.

The new G-E 25 KW UHF transmitter offers the broadcaster new compactness, stability, ease of installation, simplified operation, and a minimum of maintenance.

The new G-E Zig-Zag Panel UHF Antenna at KERO-TV is housed in a fiber glass cylinder to protect it from the unusually severe rime icing conditions at the transmitter site atop Mt. Breckenridge, 7,622 feet above sea level. Its unusual directional capabilities result from the versatility of its computer-plotted pattern design, combined with both electrical and mechanical tilt. Its power gain is 74.4, for the highest Effective Radiated Power (1.76 Megawatts) of any U.S. UHF television station.

If you have UHF plans, this General Electric transmitter-antenna combination will provide you maximum ERP in desired directions and depression angles.

Contact your G-E Broadcast Equipment Representative, or: General Electric Company, Visual Communication Products, 212 West Division Street, Syracuse, New York 13204.

**This is the
new G-E UHF
equipment that
did it.**

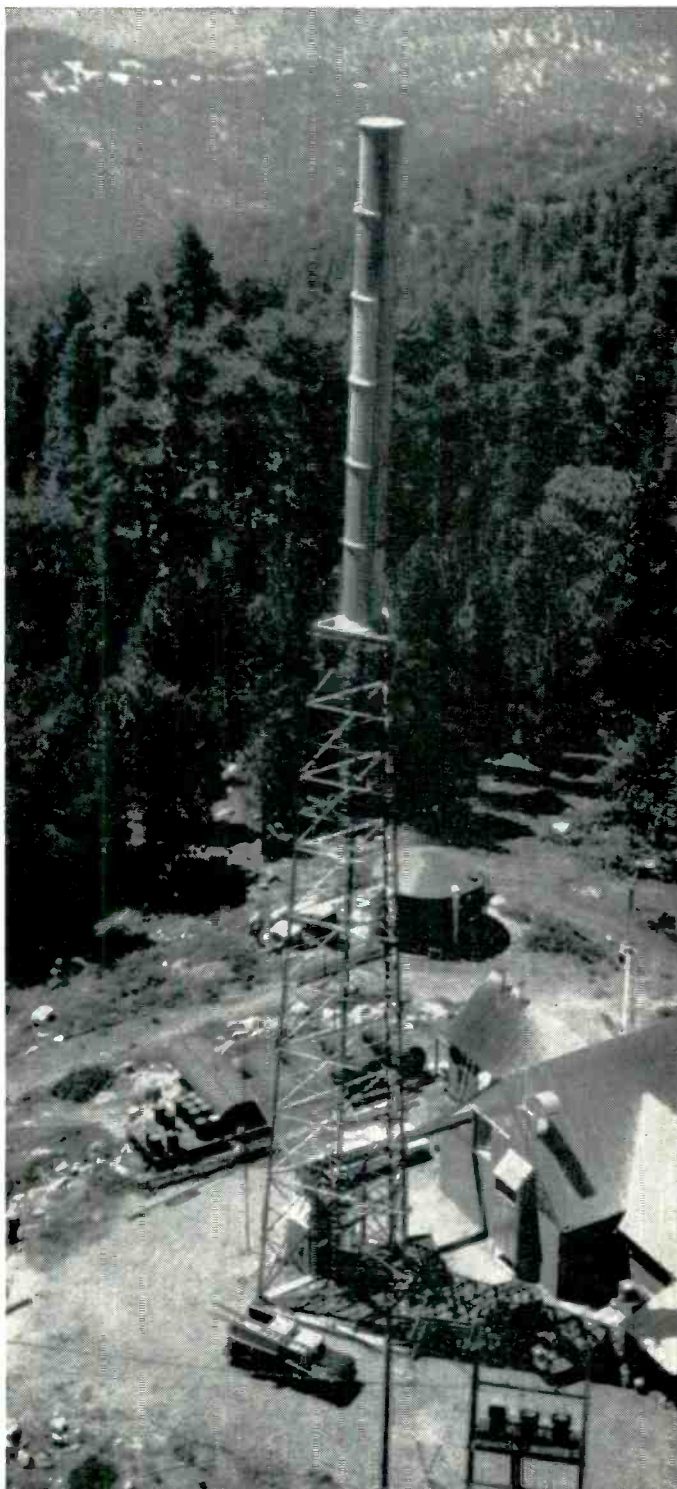

GENERAL  ELECTRIC

Circle Item 2 on Tech Data Card



Crown
— first choice
of those who
demand the best!

NEW

**Solid
State
RECORDERS**

**INCOMPARABLE
PERFORMANCE**

Quarter-Track Record/Play Data			
ips	db	cps	s/n
7-1/2	±2	50 — 28,000	54db
3-3/4	±2	30 — 18,000	52db
1-7/8	±3	30 — 13,000	46db

The most complete recording instruments ever designed for stereo use. Audio circuitry, ±1/4 db from 10-100,000 cps; extended range, 5-500,000 cps. Plug-in circuit modules are printed on epoxy and gold plated. Engineered to space craft reliability.

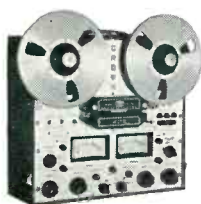

THE HALLMARK
OF CROWN—
SUPERLATIVE
CRAFTSMANSHIP
THROUGHOUT!

**INDIVIDUAL PERFORMANCE
RECORD SUPPLIED
WITH EACH CROWN**

WRITE DEPT. BE-04



Crown
INTERNATIONAL
1718 Mishawaka Rd. • Elkhart, Ind.

Circle Item 3 on Tech Data Card

the technical journal of the broadcast-communications industry



Broadcast Engineering

Volume 6, No. 4

April, 1964

CONTENTS

FEATURES

FCC FM/TV Enforcement Unit	13
by John McKinney — Design and operational details of a mobile inspection unit constructed and used by the FCC.	
Hi-Voltage Silicon Rectifier Applications in Transmitters	16
by Mlynar & Jaeger — Discussion of the uses for solid-state rectifiers in high-power transmitter circuits.	
Television Tape Techniques Today	18
by Joe Roizen — Conclusion of a two-part article on video recording equipment and techniques.	
Design of a Semi-Automatic Control Table	20
by Len Spencer — Description of a console which switches turntables, tape recorders, and other studio gear.	
Practical Aspects of Modern Tape Cartridge Recording	24
by Melvon G. Hart — How to get the most out of cartridge tape equipment through proper techniques.	
The Shape of Broadcasting to Come, 1984	34
by Lawrence J. Cervone — A look at developments in the field and possible innovations during the next 20 years.	

DEPARTMENTS

Letters to the Editor	6	About the Cover	49
Bulletin from Washington	27	New Products	50
Engineers' Exchange	42	Engineers' Tech Data	54
Book Reviews	46	Advertisers' Index	56
News of the Industry	48	Classified Ads	56

PUBLISHER: Howard W. Sams

EDITORIAL: Exec. Editor, Verne M. Ray; Editor, Forest H. Belt; Managing Editor, Stuart N. Soll; Washington Correspondent, Howard T. Head.

CIRCULATION: Manager, J. A. Vitt; Fulfillment: Manager, Pat Tidd; Assistants, Katherine Krise and Cora LaVon Willard.

PRODUCTION: Manager, Robert N. Rippy.

ADVERTISING: Sales Manager, Dave L. Milling; EAST—Gregory C. Masefield, Howard W. Sams & Company, Incorporated, 3 West 57th Street, New York, N. Y., Phone MU 8-6350; MIDWEST—Hugh Wallace, Howard W. Sams & Co., Inc., 4300 West 62nd Street, Indianapolis 6, Ind., Phone AX 1-3100; SOUTHWEST—C. H. Stockwell Co., 4916 West 64th Street, Mission, Kansas, Phone RA 2-4417; LOS ANGELES 57, CALIF., Maurice A. Kimball Co., Inc., 2550 Beverly Blvd., Phone DU-8-6178; SAN FRANCISCO, Maurice A. Kimball Co., Inc., 580 Market Street, Phone EX 2-3365; PARIS 5, FRANCE, John Ashcraft, 9 Rue Lagrange, Phone ODeon 20-87; LONDON W.C. 2, ENGLAND, John Ashcraft, 12 Bear Street, Leicester Square, Phone Whitehall 0525; TOKYO, JAPAN, International Media Representatives, Ltd., Kisha Kurabu 14, 2-chome Marunouchi, Phone (502) 0656.

SUBSCRIPTION PRICE: U.S. \$6.00, one year; \$10.00, two years; \$13.00, three years. Outside U.S.A. add \$1.00 per year for postage. Single copies, 75 cents, Back issues, \$1.00.

BROADCAST ENGINEERING is published monthly by Technical Publications, Inc., an affiliate of Howard W. Sams & Company, Inc. Editorial, Circulation, and Advertising headquarters: 4300 West 62nd Street, Indianapolis 6, Ind. Copyright © 1964 by Howard W. Sams & Co., Inc.

 A HOWARD W. SAMS PUBLICATION



BROADCAST ENGINEERING

For AM performance that rivals FM fidelity... the Gates VANGUARD I. This pacesetter 1000 watt AM transmitter combines the reliability of solid state circuitry with a single tube amplifier. Transmitter is completely self-contained. Operational adjustments and 100% accessibility are both from the front. Built-in remote metering facilities are provided as are accommodations for top or back air exhaust. For the full story of Vanguard I—the pacesetter with the new shape in AM—write for ADV. 140.

shape in AM Transmitters

The new

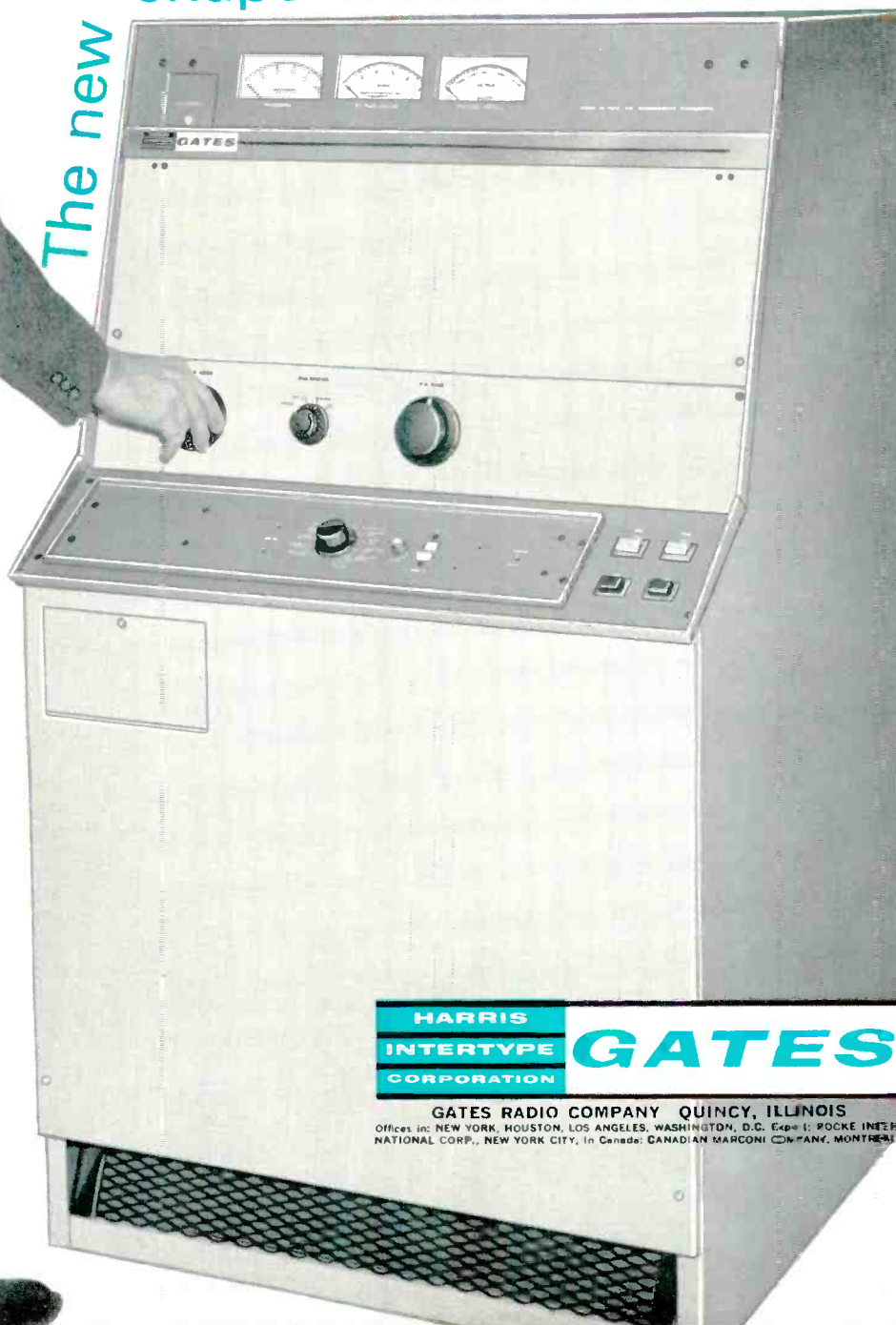

HARRIS
INTERTYPE CORPORATION **GATES**

GATES RADIO COMPANY QUINCY, ILLINOIS
Offices in: NEW YORK, HOUSTON, LOS ANGELES, WASHINGTON, D.C. Export: POCKE INTER-
NATIONAL CORP., NEW YORK CITY, In Canada: CANADIAN MARCONI COMPANY, MONTREAL

Circle Item 4 on Tech Data Card

DYNAMIC NEWS FROM ALTEC

2 New Microphones Expressly for Professional Use

Two new studio dynamics—Altec 688A Omnidirectional; Altec 689A Cardioid—have been developed by Altec specifically for broadcast, recording, and TV use. Part of the famed Altec Series 680, these microphones offer maximal characteristics to meet and exceed the strictest professional recording and broadcast standards. Each is equipped with the exclusive Altec "Golden Diaphragm" which is not only extremely rugged in use but which also contributes inherent low resonance qualities and peak-free response. These two new microphones plus Altec's famed M20 Omnidirectional Condenser Microphone System and M30 Cardioid Condenser Microphone System now offer the industry superb qualities and characteristics to meet any and all requirements that can be imagined.

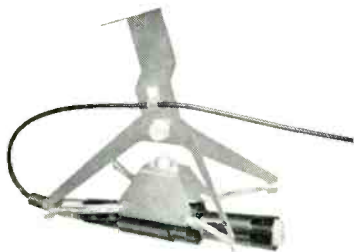

ALTEC 688A OMNIDIRECTIONAL DYNAMIC MICROPHONE—\$90 net. Extremely uniform response from below 35 to over 20,000 cycles. Highly efficient. Low hum pickup. Shown in an Altec 181A Boom Mount. Output Impedance: 30/50, 150/250 and 20,000 ohms (selection by connections in microphone cable plug). Output Level: —55 dbm/10 dynes/cm². Hum: —120 db (Ref.: 10⁻³ Gauss). Dimensions: 1 1/8" diameter at top (1 1/2" largest diameter), 7 1/2" long not including plug. Weight: 8 ozs. (not including cable and plug).

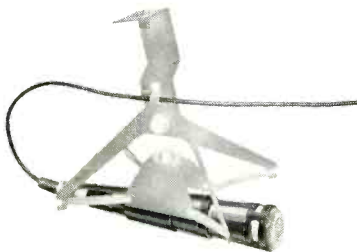

ALTEC 689A CARDIOID DYNAMIC MICROPHONE—\$108 net. High front-to-back discrimination for an average of over 20 db from 40 to over 16,000 cycles. Virtually flat response throughout this frequency range. Output Impedance: 30/50, 150/250 and 20,000 ohms (selection by connections in microphone cable plug). Output Level: —54 dbm/10 dynes/cm². Hum: —120 db (Ref.: 10⁻³ Gauss). Dimensions: 1 1/2" diameter at top, 7 1/8" long not including plug. Weight: 11 ozs. (not including cable and plug).

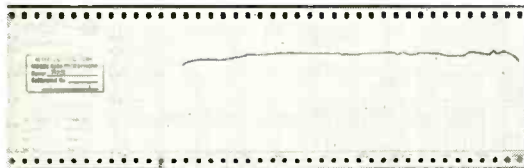

Each 688A and 689A microphone comes with its own individual response curve made by a Bruel & Kjaer servo-driven recorder in conjunction with an Altec anechoic chamber. The curve serves as a permanent record of the unit's response characteristics for immediate reference at any time required.



ALTEC M20 OMNIDIRECTIONAL CONDENSER MICROPHONE SYSTEM—\$233 complete with base, stand attachment, and power supply. This is the famous "Lipstik"—so named for its miniature size—the only American-made condenser on the market. The M20 provides the wide, uniform frequency response of a laboratory standard—an exceptional microphone for broadcast and recording of highest quality.

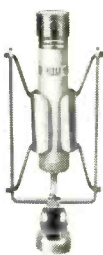

ALTEC M30 CARDIOID CONDENSER MICROPHONE SYSTEM—\$280 complete. This directional microphone offers the superb response characteristics of the condenser with the ruggedness and small size available only from Altec. 20 to 20,000 cycle range with better than 10 db front-to-back discrimination at the extremes, better than 20 db in the mid-range.

ANNOUNCING AN IMPORTANT NEW DIVISION AT ALTEC

The Audio Controls Division was recently organized at Altec Lansing Corp. The new division specializes in design and manufacture of precision attenuators, equalizers, filters, networks and switches, as well as custom consoles and associated products specifically for the recording and broadcast industries. It is headed by Arthur C. Davis, a Fellow of the AES and well-known in this field as a leading design engineer and manufacturer.

For specific engineering details and free demonstration, call your nearest Altec Distributor (see Yellow Pages) or write Dept. BE4



ALTEC LANSING CORPORATION
A Subsidiary of Ling-Temco-Vought, Inc.
ANAHEIM, CALIFORNIA

© 1964 ALTEC LANSING CORPORATION

Circle Item 5 on Tech Data Card

LETTERS to the editor

DEAR EDITOR:

I have been waiting to see what new forms would pop up from various stations in compliance with the new FCC Rule concerning maintenance logs. I definitely urge you to ask stations to submit their new formats to you; then you could come up with a feature article on maintenance logs.

The log from KBFM, Lubbock, Texas, in the "Letters" column of the January '64 issue, appears to be lacking one important detail required by the FCC under Par. 3.284(g): "The statement shall also specify the amount of time . . . which was devoted to such inspection duties."

At WWDS we sign our log with the date and time the inspection is begun and completed, at each examination of transmitting equipment.

Reid Hackney

Chief Engineer, WWDS,
Everett, Penn.

Glad to hear of your interest in logs; why not send a sample of yours in to keep the ball rolling.—Ed.

DEAR EDITOR:

After glancing through the January issue, I feel I must take exception to some of the comments presented in the Engineers' Exchange item, "Care of Frequency Monitors."

It is unfortunate that the author did not specify the make and model of the unit to which he was referring. Inexperienced engineers, to whom the article was directed, might not realize that some monitors do not employ an adjustable crystal-oven thermostat as a means of frequency calibration; further, all AM frequency monitors do not employ an aural monitoring jack.

I cannot agree that one should wait several months to recalibrate a frequency monitor, as the article suggests—to do so invites trouble. Most modern AM frequency monitors will stabilize sufficiently within a few hours after servicing to allow accurate recalibration.

The suggestion that the monitor calibrate trimmer and the transmitter carrier-frequency trimmer should be set so the monitoring service has a zero reading during recalibration is, to my way of thinking, not sound; a defective or inoperative monitor will often indicate zero deviation instead of the actual carrier frequency deviation. I have found it desirable to set transmitter carrier frequency slightly off zero at all times, so that it can be readily seen that the monitor is actually functioning properly.

Bruce L. Mackey

Chief Engineer, WKRT Radio,
Cortland, N. Y.

Newcomers to frequency monitors take note; and thanks to you, Bruce, for filling in the specifics. Any further comments, readers?—Ed.



The commanding presence of Sony sound



Now enter the world of the professional. With the **Sony Sterecorder 600**, a superbly engineered instrument with 3-head design, you are master of the most exacting stereophonic tape recording techniques.

Professional in every detail, from its modular circuitry to its 3-head design, this superb 4-track stereophonic and monophonic recording and playback unit provides such versatile features as: ■ vertical and horizontal operating positions ■ sound on sound ■ tape and source monitor switch ■ full 7" reel capacity ■ microphone and line mixing ■ magnetic phono and FM stereo inputs ■ 2 V.U. meters ■ hysteresis-synchronous drive motors ■ dynamically balanced capstan flywheel ■ automatic shut off ■ pause control and digital tape counter—all indispensable to the discriminating recording enthusiast. Less than \$450,* complete with carrying case and two Sony F-87 cardioid dynamic microphones.

Multiplex Ready!

SONY

SUPERSCOPE

The Topway to Stereo

* Yes, less than \$450!

Sony tape recorders, the most complete line of quality recording equipment in the world, start at less than \$79.50. For literature or name of nearest dealer, write Superscope, Inc., Dept. Sun Valley, Calif. In New York, visit the Sony Salon, 585 Fifth Avenue.

Circle Item 6 on Tech Data Card

Conrac picture monitor for 13" consoles

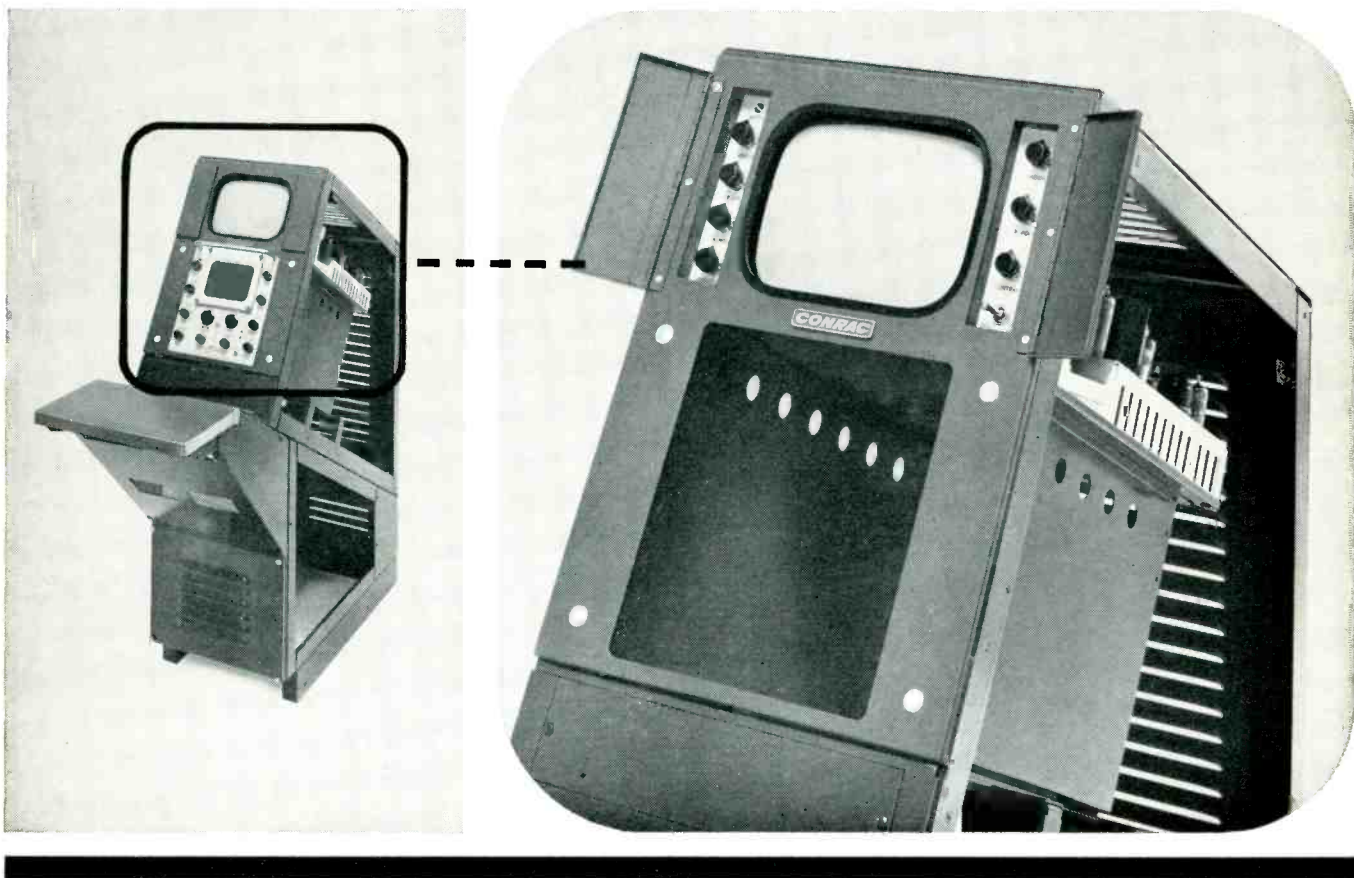

Specifically designed to fit thirteen-inch consoles, the CONRAC CT8/TU is a direct replacement for the monitor portion of older master monitors. The housing has mounting facilities for the Tektronix 527 Scope to allow modernization of your equipment with a minimum of inconvenience.

This broadcast-quality monitor features low voltage regulation, video bandwidth flat to 10 megacycles, provisions for plug-in sync drop relay, and a kinescope with a laminated, bonded safety shield.

For complete specifications write CT8/TU across your letterhead and send it to CONRAC, Glendora, California.

CONRAC *DIVISION* Glendora, Calif.
GIANNINI CONTROLS CORPORATION

Circle Item 7 on Tech Data Card

PREDICTION FOR 1964:

This will be the local TV station's most popular program!



3M announces the first comprehensive program to help TV stations, advertisers, agencies create new profits with video tape!

Now, for the first time, local tv stations, tape producers, advertisers and agencies can receive real assistance in creating and producing better-selling commercials on video tape.

Here is a complete program that includes both professional demonstration and reference materials from 3M, maker of SCOTCH® BRAND Video Tape. Local tv stations and tape producers will be able to offer expanded production counsel and services. They can provide practical materials to help advertisers take full advantage of video tape's production convenience and versatility, "live" picture quality, and the speed, certainty, flexibility that only tape can provide.

A few of the new materials: A 25-minute demonstration tape shows production techniques, actual commercials, explains tape's

benefits. The "Comparator," a pocket-size quick reference guide to the relative advantages of tape, live and film production for tv commercials. "The Television Producer," a deluxe 50-page encyclopedic workbook of how-to tape production information. The program includes industry achievement recognition, many additional pieces of helpful literature.

If you operate a tv station with video tape recording equipment, and haven't received full details on this program, please contact us. Call or write 3M Magnetic Products Division, Dept. MDV-44, St. Paul 19, Minn.

SCOTCH® IS A REG. TM OF 3M CO., ST. PAUL 19, MINN. ©1964, 3M CO.

Magnetic Products Division 

GATES NEW FM FIVE-G... A DYNAMIC TRANSMITTER FOR A NEW ERA OF FM BROADCASTING



This new 5 KW FM transmitter from Gates is the result of *Value Analysis* . . . a concept in product development and manufacturing that has created a superior product with greater value and increased quality. In *Five-G*, more of your equipment dollar is devoted to putting the FM signal on-the-air.

FIVE-G is equipped to fill every transmitting need. Here is a brief review of some significant steps forward in FM:

DIRECT CRYSTAL CONTROLLED CASCADE FM EXCITER: Gates proven direct crystal controlled cascade FM exciters are used by more prominent FM broadcast stations from coast-to-coast, by more stereo stations and stations broadcasting SCA services than any other exciter. Cascade modulation uses two separate phase modulators with the same modulating signal applied to both stages. Performance capabilities are double and produce outstanding advantages over other FM exciters such as;



better frequency stability, improved low frequency response and simplified circuitry. Within a matter of minutes, **Five-G** may be equipped for stereo by simply adding the Gates stereo generator in the space provided.

COMPONENTS PAR EXCELLENCE: One look at the names of the manufacturers supplying components for the **Five-G** will confirm the judgment exercised by the Gates *Value Analysis* team in selecting and testing the materials that make-up this advanced transmitter. The power-packed **Five-G** utilizes a final tube (4CX5000A) that others often choose for a ten kilowatt transmitter. In-

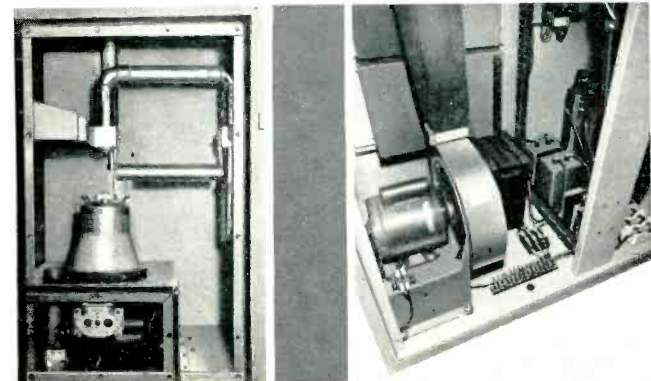

ternal design is compact, yet ample room is provided for easy maintenance and cool operation.

SELF-CONTAINED: **Five-G** is completely self-con-

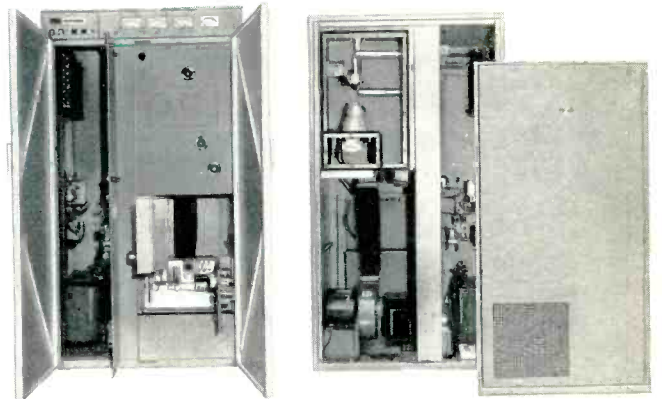

tained. The plate transformer, blowers and stereo generating/ SCA* equipment are all contained in the beautifully styled cabinet. Here is the first transmitter allowing maintenance and service from both the front and rear. A full length front access door is fully interlocked and all components are within easy reach. No additional equipment is required in the transmitter for remote control. Simply connect the **Five-G** to a transmitter control unit, tie in the telephone line to the studio and you are ready for complete remote control operation.

PUSHBUTTON OPERATION: Daily operation is simple. On-off functions are controlled by the four lighted pushbuttons at the top left of the transmitter. No need to open the front doors when turning **Five-G** on or off.



WANT THE WHOLE STORY? Write for Adv. 139 and read how *Value Analysis* created a new transmitter for the new era of FM.

* Optional.



Circle Item 10 on Tech Data Card

BROADCAST ENGINEERING

FCC MOBILE FM/TV ENFORCEMENT UNIT

by John McKinney*—Equipment carried and techniques employed in the FCC field engineering mobile units.

The Field Engineering Bureau of the Federal Communications Commission has, since the inception of broadcasting, found it necessary to provide mobile monitoring and measuring facilities to carry out its enforcement work. In the mid-1920's as part of a modernization program, mobile units equipped with the most up-to-date measuring and monitoring equipment were utilized by field personnel.

The rapid growth of TV and FM broadcasting following World War II made evident the need for special mobile enforcement facilities. Accordingly, staffing plans were prepared initially for two, and later for the present three, TV mobile enforcement units—one unit on each coast and a third in the approximate center of the country, at Grand Island, Nebraska.

The TV unit engineer is generally accompanied by an engineer from the district office. A "visit" to a TV or FM station by the two engineers includes monitoring, signal analysis, and physical inspection. Generally, preinspection monitoring is conducted before the physical inspection. This procedure permits pointing out discrepancies to the licensee and discussing relevant matters with the engineers con-

*Engineer in Charge, TVC, FCC Field Engineering Bureau, Central TV Enforcement Unit, Grand Island, Neb.



Fig. 1. Exterior view of mobile unit.

cerned. This is a more satisfactory solution than enumerating many minor discrepancies on paper. Where the correction of a minor discrepancy can be made on the spot by a slight adjustment or a tube replacement, we are then in a position to check the results of this adjustment and avoid the issuance of a formal written notice. This we call "cooperative enforcement." However, formal notices are issued where they are deemed advisable.

The first two mobile monitoring units were practically identical in design. They were housed in small trucks with Metro-style bodies. The equipment was placed in three racks immediately to the rear of the driver's compartment with the equipment facing the rear doors of the truck. Weight and space limitations prevented the inclusion of a gasoline-powered AC plant, and it was necessary to obtain power from commercial sources by means of heavy-duty extension cords. Where possible, arrangements for "borrowing" power were made at motels where we stopped overnight. Where this was not feasible we often obtained the needed power at gasoline service stations.

As more equipment was added to the mobile unit, it soon became apparent that a larger truck was required. It was decided that the

new truck should be large enough to carry its own AC power plant. A vehicle of conventional design was chosen. The first of the new mobile monitoring units was constructed at Grand Island, Nebraska, for use of the Central TV Enforcement Unit. A second unit patterned after this prototype has now replaced the original Eastern TV Enforcement Unit, and a third such vehicle is now under construction for the Western Unit. This article will describe the equipment carried in these units and the methods employed in making some of the more common measurements.

The Mobile Monitoring Unit

The unit to be described (Fig. 1) uses a 2½ ton truck chassis with a 208-hp V-8 engine, a 4-speed transmission, and a dual-speed rear axle. The box was custom built to our specifications and measures 12' x 8' on the outside; there is 6'-5" of head room inside. The box is of steel construction with 2" of fiberglass insulation on top and sides. The flooring is 2" thick, narrow oak planking.

Cooling is accomplished by means of a one-ton air conditioner in a compartment extending over the cab roof and by an exhaust fan in the left rear corner of the van. The equipment provides heat in cool weather, supplemented by a small 750-watt, in-the-wall electric heater located in the front wall of the box.

The power plant is an air-cooled, 5 - kva, gasoline - powered plant housed in its own compartment under the left front portion of the van. In addition to the power plant, provisions have been made to use commercial power whenever such an arrangement is desirable, such as during maintenance periods at

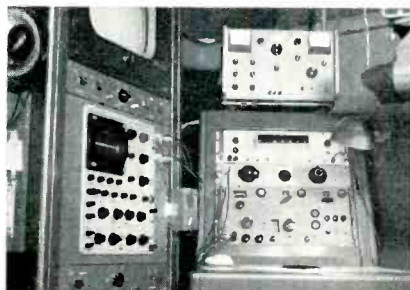

Fig. 2. Freq. counter; other equipment.

the home base. For this purpose, 100' of cable is coiled in the engine compartment and a changeover switch wired into the circuit. A third source of AC power is the 100-amp alternator on the truck engine. This unit provides 1000 watts of power at 120 volts from the 3-phase step-up transformer. However, this latter source is not suitable for powering the measuring equipment because the frequency varies from 20 to 300 cycles per second depending on the engine speed.

The equipment is mounted in standard heavy-duty racks, each equipped with its own blower for cooling. As there is no access to the rear of the racks, all servicing must be performed from the front. With this in mind, equipment was mounted on ball-bearing slides, and connecting cables were left long enough to allow sliding the equipment forward for servicing. Power supplies and rack blowers were mounted on chassis brackets rather than slides since they seldom require much servicing or extensive adjustment.

RF wiring impedance is kept at 50 ohms using RG-58/U cable and BNC-type fittings. Coaxial switches are employed for setting up the commonly used measuring circuitry. Patching is kept to a minimum. The AC and audio wiring is conventional. Steel-tube conduit carries the wiring from rack to rack.

An adjustable dipole antenna fed by a coaxial line is used for all VHF measurements. The dipole is mounted on an extendable mast which can be rotated from the operating position. UHF reception is accomplished by means of a corner-reflector antenna which mounts on the same mast; the antennas are stored during transit. At the rear of the truck, a side-mount automobile whip antenna feeds the communications receiver used for reception of standard-frequency signals from Bureau of Standards station WWV. In weak-signal areas this short antenna is supplemented by a 12' whip normally carried within the truck.

Frequency Measurements

The basic tool for all frequency measurements is the electronic counter. The counter used in this unit is transistorized and has direct

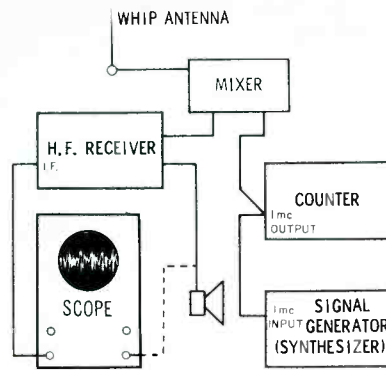

Fig. 3. Block diagram of setup for standardizing and AM modulation measurement.

in-line readout; it is capable of reading up to 220 mc. Since the counter time base is compared to WWV during all measurements, it is practical to measure frequencies to an accuracy of a few parts in 10^7 . (One part in 10^7 represents an accuracy of ± 10 cps at a frequency of 100 mc.)

The companion unit to the counter is the frequency meter (better described as a frequency synthesizer). This instrument has a basic range of 20 to 40 mc with usable harmonic output to 1000 mc. Although it is an accurately calibrated instrument, it is used basically as an extremely stable transfer oscillator for making certain measurements. The counter and frequency meter are the top and bottom units in the small rack at the right in Fig. 2.

Both the counter and the frequency meter employ a 1000 kc crystal as a standard. We have revised the circuitry so that the counter crystal serves both instruments, eliminating the need for zeroing two crystals to WWV. While the truck is in transit, the crystal heater is kept at operating temperature by means of the power plant by an automatic changeover relay when-

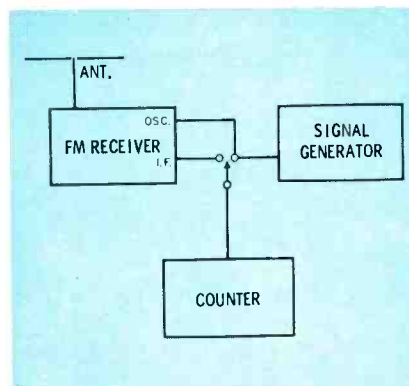

Fig. 5. Center-freq. measurement setup.

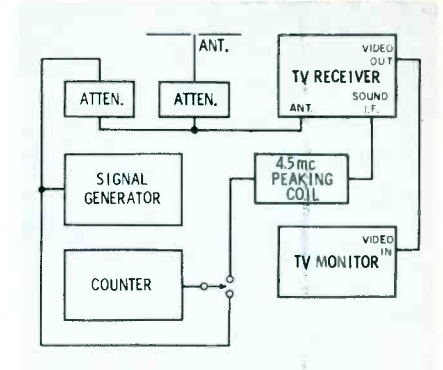

Fig. 4. Diagram for TV video and aural-to-video carrier frequency measurements.

ever the plant is started. This arrangement avoids a warmup delay of from 45 minutes to one hour each time a stop is made for a frequency measurement.

Fig. 3 shows the setup for standardizing the counter time base. Both visual and aural beating observations can be made. The receiver and scope are also employed for making modulation measurements of AM stations within the range of the receiver (500 to 30,500 kc).

Measuring Carrier Frequencies

Fig. 4 is a block diagram showing the method for making TV frequency measurements. To measure the TV visual frequency, the generator is adjusted to within 1 cps of the incoming carrier by observing the beat on the picture monitor. The generator frequency is simultaneously measured on the counter. The 4500 kc visual-to-aural separation is measured directly with the counter by adjusting the fine tuning of the receiver approximately midway between the visual and aural carrier so that a suitable mixture of the two carriers is fed through the receiver input circuitry.

Fig. 5 shows the method of making center-frequency measurements

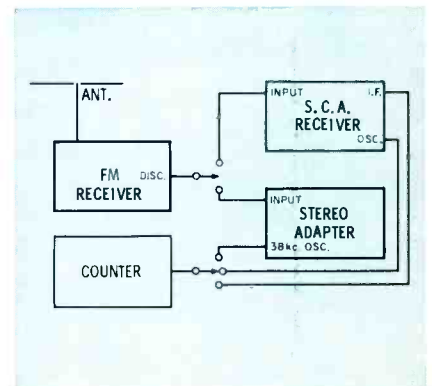

Fig. 6. Setup for multiplex freq. check.

of an FM broadcast station or the aural transmitter of a TV station. This will require a little explanation for full comprehension.

We have modified the FM receiver by supplying it with two additional outputs and one additional input circuit. One output circuit is directly from the discriminator before de-emphasis and is used for modulation measurements and for coupling the SCA-stereo receiver. The second output is from the second IF amplifier of the receiver and provides a low-impedance (50 ohms) IF source. The third connection is a 50-ohm input connection to the cathode of the receiver high-frequency oscillator.

The receiver employs a 21.4-mc IF channel. The high-frequency oscillator operates above the received-signal frequency. In other words, the oscillator frequency minus the received frequency is equal to the IF. If two of these parameters are accurately known, the third can be determined. The correct oscillator frequency can be calculated by adding the assigned frequency of a station to the intermediate frequency. For example, to measure a signal assigned to 99.1 mc:

$$\begin{array}{r} 99,100,000 \text{ Assigned} \\ + 21,400,000 \text{ IF} \\ \hline 120,500,000 \text{ Oscillator setting} \end{array}$$

Our generator operates between 20 and 40 mc, so we divide 120,500 by four and generate a fundamental frequency of 30,125.000 kc (with usable harmonics up to 1000 mc). To precisely obtain this frequency, the generator dial is adjusted until the desired frequency is displayed on the counter. With this signal coupled into the cathode circuit of the high-frequency oscillator of the receiver, the receiver dial is "rocked" until the receiver oscillator is captured by the external signal source. The counter is then switched over to the IF output, and the IF of the receiver is read out on the counter. If the measured IF is **above** 21.4 mc, the station is **below** the assigned frequency; conversely, if the IF is **below** 21.4 mc the station is **high** in frequency by the difference between the reading and 21.4 mc. Due to the continuing variation under modulation of the frequency of the FM carrier under measurement, there may be a small variation in average reading within

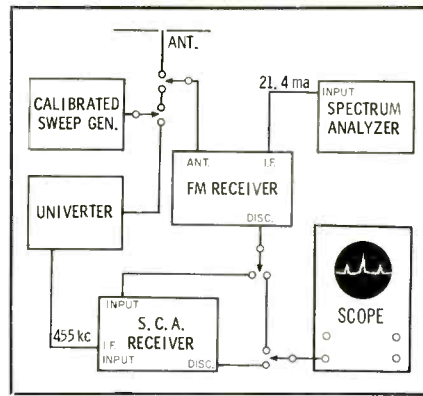

Fig. 7. Block diagram of arrangement for modulation measurements of FM signals.

three or four cps of the center frequency.

Subcarrier Measurements

Fig. 6 illustrates the equipment line-up for frequency measurements on SCA and stereo subcarriers. The stereo adapter in use contains a free-running, 38-kc oscillator which locks to the second harmonic of the received 19-kc pilot carrier. A connection was added to the adapter enabling us to measure the 38-kc oscillator frequency on the counter. When no stereo pilot carrier is being received, the oscillator runs approximately 20 cps higher than 38 kc. When a stereo signal is tuned in, the oscillator will lock to the received pilot. All that is necessary is to divide the counter reading of this locked frequency by 2 to arrive at the pilot-carrier frequency.

Our SCA receiver uses a super-heterodyne circuit for SCA conversion. A variable oscillator (390 to 455 kc) is used to beat against the

receiver audio (taken directly from the discriminator before de-emphasis) to produce an IF which is amplified and fed to the SCA discriminator. The measurement technique here is the same as for the main-carrier FM signal, with the exception that a substitution oscillator is not required due to the excellent stability that can be obtained from an oscillator operating near 400 kc. We merely read the IF and the oscillator frequency and then subtract to obtain the SCA center frequency. For example:

$$\begin{array}{r} 460,000 \text{ IF} \\ - 395,000 \text{ Osc.} \\ \hline \end{array}$$

65.050 SCA Center Frequency

The TV color subcarrier is measured directly from the 3.58 mc oscillator in the same manner as that employed for reading the stereo pilot frequency.

Modulation Measurements

Fig. 7 shows the basic block diagram of the equipment used for aural-modulation measurements of FM carriers. Here, the key piece of equipment is the calibrated sweep generator and its companion unit, the Univerter. The calibrated sweep generator is a precision instrument having an RF output range from 54 to 250 mc. Calibrated sweep is available from 0 to 250 kc in four accurately calibrated ranges. Modulating frequencies extend from 50 cps to 25 kc. The Univerter converts the output frequency of the generator to lower frequencies while retaining the same calibrated sweep. With it we are able to produce a 455 kc signal swept 7.5 kc (or any amount between 0 to 250 kc) for calibration of the SCA-receiver discriminator.

Modulation measurements of FM emissions are made as follows: With the oscilloscope vertical amplifier connected to the receiver discriminator, the signal from the calibrated sweep generator is fed into the receiver input. The generator is tuned to the receiver frequency, and the output from the generator is increased to a point beyond limiter saturation. Internal sweep is applied to the horizontal amplifier of the oscilloscope, and the vertical gain is adjusted to make 100% modulation (25 kc for TV or 75 kc for FM) equal to a given

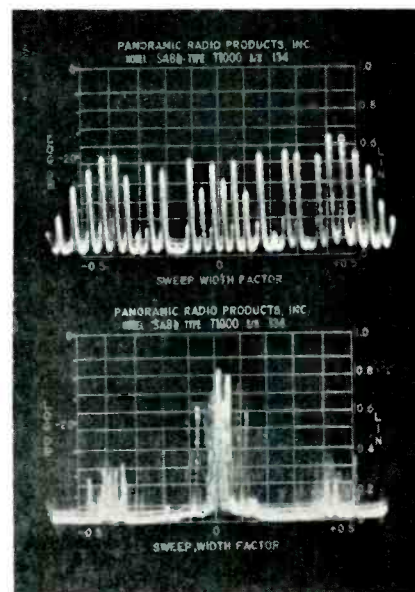

Fig. 8. Two spectrum analyzer displays.

● Please turn to page 46

HIGH VOLTAGE SILICON RECTIFIERS IN TRANSMITTERS

by P. Mlynar and O. Jaegar* — A look at the applications for solid-state rectifiers in high-voltage transmitter circuits.

The advantages of solid-state rectifiers are well known — maintenance-free operation, extremely long life, instant start-up, and compactness. Their acceptance by the broadcast industry has been largely due to the trend toward remote-control operation, where equipment reliability is paramount. It is to insure against inadvertent transmitter down-time during remote-control operation that many are replacing mercury-vapor tubes with silicon-rectifier assemblies. This is true not only for new equipment but for old.

A secondary, but nevertheless important, consideration that is hastening the trend toward semiconductors is lower cost. Several years ago the engineer who suggested to his general manager that it might be a good idea to install solid-state rectifiers ran the risk of receiving a lecture on the economic facts of broadcasting life; today he can assure his boss that the cost may be less than a set of replacement mercury-vapor tubes. Moreover, he can also advise him that actual installation time for the conversion job will be very short.

As an example, consider the cost and time of installation in a 50-kw high-level broadcast transmitter utilizing 9 to 12 kv at 10 to 12 amps total plate current (final amplifier and modulator combined). The corresponding high-voltage silicon-rectifier package consists of a rectangular assembly, with self-contained exhaust fan, that measures only 19" high and 7" on a side. This assembly can be installed in approximately one hour. Relay switches, fail-safe devices, and other overload protectors used with the tube rectifiers, are all left in place. No wiring changes are required ex-

cept for removal of anode connections to the rectifier tubes.

The natural skepticism of some engineers concerning dependability of silicon assemblies is heightened by the suspicion that they are physically too small to do the job. Yet key network stations, utilizing the installation just described, have been running for two years without a single moment's down-time caused by the rectifier assembly. An even more dramatic demonstration of reliability is provided in the fact that a silicon-rectifier assembly installed in a 1-million-watt power supply at the Voice of America transmitter in Bethany, Ohio, has provided trouble-free operation for nearly two years.

To demonstrate overload capabilities of solid-state equipment, a 1-megawatt power supply (feeding a superpower shortwave broadcast transmitter running fully modulated into the antenna system) was manually short-circuited directly across the 40-mfd filter capacitor to ground with a three-inch-wide solid copper strap. After the reset circuitry was activated, the transmitter came back on the air and has been

running without a single flicker for over a year.

Comparison of Rectifier Types

Before getting into the design of silicon-rectifier assemblies and circuit considerations involved in their application, let's briefly compare their performance not only with mercury-vapor tubes, but with an earlier type of solid-state rectifier, the selenium-rectifier assembly.

The well-known mercury-vapor disadvantages include:

1. Arc-back due to hot-weather "streaming".
2. Nonconduction in cold weather.
3. Life expectancy of approximately 12,000 hours of operation (more in some cases).
4. Require warm-up time.
5. Power dissipated by heaters.

The selenium high-voltage assembly represented the first major break-through in solid-state rectification. However, a majority of engineers considered that its advantages over tubes were counterbalanced by its disadvantages. These include:

1. Assemblies are large in comparison to tubes.
2. They are not permanent, since the forward characteristics are relatively unstable and quite often change with time. Thus a specially designed transformer is required to compensate.
3. They require excessive cooling because of operating temperature limitations.
4. Their size and special voltage requirements prohibit direct physical replacement in existing tube spaces.
5. They are less efficient than mercury-vapor tubes.
6. They exhibit poor regulation under large load variations.



Fig. 1. A typical module of the high-v silicon rectifier assemblies (background).

*Semiconductor Div., Westinghouse Electric Corp.

In contrast, silicon-rectifier assemblies are extremely compact (Fig. 1); they operate easily in the ambient temperatures encountered in transmitter operation; they perform indefinitely; they are economical and efficient; and they display excellent regulation under varying loads. Of course, silicon rectifiers are exactly like any other electronic component in that they must be operated within their ratings if maximum reliability and performance are to be obtained.

Design Considerations

Replacement of tubes by silicon-rectifier assemblies is, as has been explained, an easy physical task. Not so easy, however, is knowing how to design the assemblies to compensate for the many possible variations in parameters or system conditions that can jeopardize performance. The following must be taken into consideration in determining the correct application of silicon assemblies:

1. The type of rectifier configuration.
2. The rms voltage applied to the rectifier assembly.
3. The operating ambient.
4. The temperature of the operating ambient.
5. The load-current requirement.
6. Total system reactance.
7. Type of overload protection.
8. Transient voltage suppression (if any).

Suppression of Transients

Normally, existing transmitter power supplies utilize the familiar full-wave center-tapped configuration, so well suited for tube rectifiers. In such a circuit, silicon rectifiers can directly replace the tubes. Transient voltages, characteristic of this type circuit, are compensated for by installing an inexpensive transient-suppression network which permits successful operation with a minimum voltage-safety requirement. Consisting of a resistor and capacitor connected in series across the secondary of the transformer, the network offers relatively little impedance to high transient voltages generated by energizing the transformer primary or by interrupting transformer current. Both transients result from energy storage in the transformer inductance. Suppression of transients is impor-

tant because they can damage silicon diodes.

Less prone to generation of transients, the full-wave bridge configuration is recommended when silicon diodes are to be used. Its desirable characteristics stem from the unique arrangement of the rectifying elements. This is best explained by comparison with the full-wave center-tapped configuration.

In the center-tapped circuit, the diode arrangement offers a relatively high impedance to voltage transients generated at the transformer secondary and terminated by the closed loop of the diode configuration. Such a transient puts one leg of the rectifier assembly in forward bias and the other leg in reverse bias. Although the same transient conditions exist in single-phase bridges, their magnitude is not as large. Also, in the center-tapped configuration, each leg must withstand twice the peak voltage from line to ground of the transformer secondary, or essentially twice the output voltage of the rectifier assembly. In the full-wave bridge, however, each of the four legs is normally required to block only the peak voltage of the transformer secondary — essentially the output voltage of the bridge.

Also of importance are transients generated from the series inductance (swinging choke) used in the power-supply filter. Under drastic load conditions or load changes — such as transformer energization or de-energization, or transmitter-tube malfunction (intermittent shorting) — the series inductor can generate transient voltages in the reverse direction across legs of the rectifier assembly. Unless compensated for, this can destroy the diodes. There are several methods of preventing damage.

The first, or "brute force" method is to shunt the choke with a non-linear resistor having negative coefficient of resistance as a function of voltage. Thus it will dissipate very little power under normal operating conditions but will handle a large amount when overvoltages are encountered, thereby preventing transients from being impressed across the rectifier assembly. The chief disadvantage of the brute-force method is that it involves a waste of power.

A second, more subtle and effi-



Fig. 2. Twenty-six silicon rectifier stacks in this cabinet supply high and low voltage.

cient method is to shunt the choke with a resistor and capacitor connected in series.

Other and more involved circuit factors must be taken into consideration. These calculations are more properly left to the experienced application engineer because building reliability into the design and application of silicon high-voltage assemblies is an art in itself.

High-Voltage Applications

A high-voltage semiconductor application is defined as one in which the recurrent peak voltage is 3,000 volts or greater and in which voltage capability is obtained by con-

• Please turn to page 52

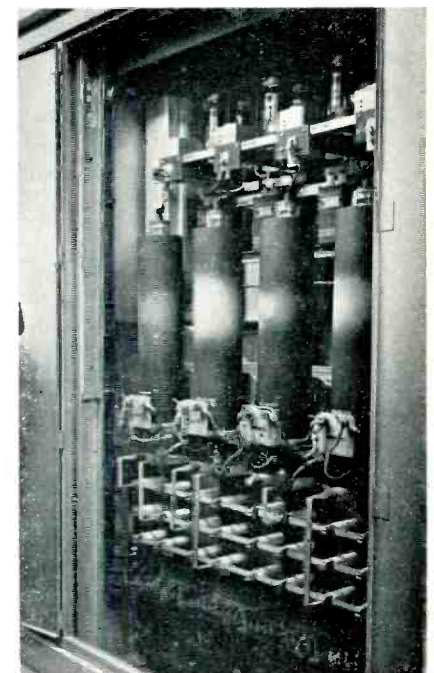

Fig. 3. Back view of a rectifier cabinet.

TELEVISION TAPE TECHNIQUES TODAY

by Joseph Roizen* — Part Two. A further discussion of the technical aspects of electronic editing, NTSC color, signal processing, and helical scan systems.

The first part of this article on video tape recording equipment (November, 1963) touched briefly on the systems used in electronic editing, NTSC color recording, advanced signal processing, and helical recorders. It is the purpose of this second and concluding part to provide a more comprehensive discussion of the technical aspects of these systems.

Video Tape Editing

Video recordings on magnetic tape can be edited either mechanically or electronically. In both cases, editing is accomplished by referencing to magnetic impulses recorded along the bottom edge of the tape and superimposed on the control-track signal. These pulses are referred to as "frame" pulses and occur every 30th of a second. They are physically located to delineate the point at which the tape should be cut by a mechanical splicer. The frame pulses are made visible (in mechanical editing) by the application of a highly evaporative solution containing small magnetic particles. The particles concentrate in proportion to the magnetic intensity of the signals on the tape and, therefore, clearly indicate the high-flux frame pulses.

There are several types of splicers which utilize either an external cutter or a built-in guillotine to cut the tape. A low-power microscope attached to the splicer enhances location of the cut line. A European semi-electronic system for mechanical splicing has been developed which utilizes a rotating magnetic head to locate a frame pulse and visually displays its position on a small oscilloscope. The cutting process, however, is similar to the all-mechanical systems.

Mechanical editing has several disadvantages, not the least of which is the deterioration of tape at the splice because of the added thickness of the splicing material. It is also difficult to locate to a precise frame without repeated recycling of the material to be edited.

The latest editing systems consist of an electronic control device which precisely times the onset of a recording so that it will be coincidentally continuous with previous recordings. The erasure of previous recordings can also be accomplished with extreme accuracy and selectivity, permitting the removal of video only or audio only (or both) and the subsequent addition of one component or the other (or both). This makes possible the recording of consecutive segments, non-consecutive segments, or inserts in a manner which makes the splice point appear like a camera cut. Thus, the compilation of a complex production with only a single camera is possible. The limitation of this system lies in the human element, since the minimum segment length is limited by the reaction

time of the video operator. It is therefore difficult to reduce the individual segment to less than a few seconds with any degree of accuracy.

To extend this system further and circumvent the operator problem, there is a device which includes a small diode logic matrix capable of counting frame pulses and sensing pre-established cue marks. Recordings can be made automatically by the video operator on a preplanned programming arrangement. A block diagram of such a system is shown in Fig. 1. With such a system the minimum segment can be reduced to a single frame, and the recorder will automatically record individual frames in sequence at a cycling rate determined by the program requirements. The length of each segment can be from one to eighteen frames, and the resultant compilation of these segments is an animated sequence of the desired duration. The animation device can be preset so that sequential action may be previewed without actually committing the material to tape. When the program director is satisfied that the series of sequences is properly timed, he may then put the video recorder in the "record" mode and complete the recording. The repeated cycling required when recording short segments would normally cause excessive wear of the tape. In order to minimize this, two precautions are taken. The video erase head is kept out of contact with the tape path except during the period when it is actually required for erasure, and the female guide assembly brings the tape in contact with the rotating head only for the minimum period necessary. This reduces to 12 the number of passes for even the shortest sequences, which is well within tape longevity limits.

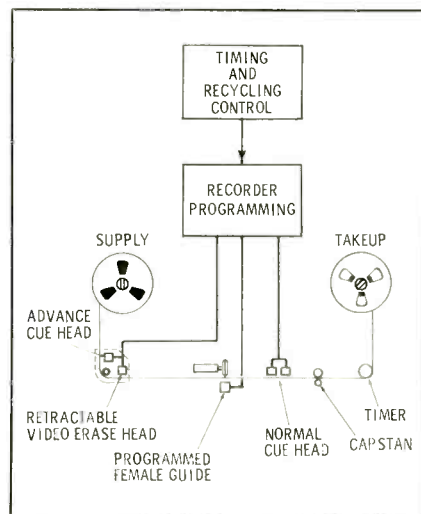

Fig. 1. An electronic tape editing system.

*Video Recording Equipment Engineer, Portola Valley, Calif.

NTSC Color Recording

The color recording systems presently in use divide into two basic categories. The older is known as the burst-lock system and operates on the principle of stabilizing the chrominance component of the composite color signal and band-limiting the luminance component to less than 3 mc. A newer system is based on electronic time-base correction which utilizes a variable delay line whose time constant can be set on a line-by-line basis and is determined by the phase difference between recovered tape burst and the 3.58-mc color subcarrier generator.

The Burst-Lock System

There are two variations of the burst-lock system which yield comparable results. A regenerated subcarrier is used to heterodyne or decode the chrominance information which is then stabilized.

The burst-lock system depends on the fact that a rotating video head assembly, because of its own momentum, is incapable of accelerating or decelerating sufficiently within a one-line period to greatly affect the phase of the color signals appearing on that line. The color burst is separated from the composite signal and is used to key a local oscillator which will continue for the rest of the line period at the phase and frequency of its triggering signal (Fig. 2). Since the regenerated 3.58-mc signal is derived from tape, it is shifting in time with the variations which are occurring in the chrominance signal due to head rotational instabilities. The regenerated subcarrier can, therefore, be used to decode the chrominance information, and a stable local color-reference generator can then be utilized for retransmission of the color signal.

The demodulated composite video encounters three channels (Fig. 3). The simplest is a 0-3 mc low-pass filter which passes the luminance component and effectively attenuates subcarrier information so as to avoid moiré in the recomposed signal. The second path is a filter having a bandpass from 2 to 5 mc, which passes the bulk of the chrominance information. The third path is through the burst separator to the 3.58-mc regenerator. Paths 2 and 3 combine to yield a stabi-

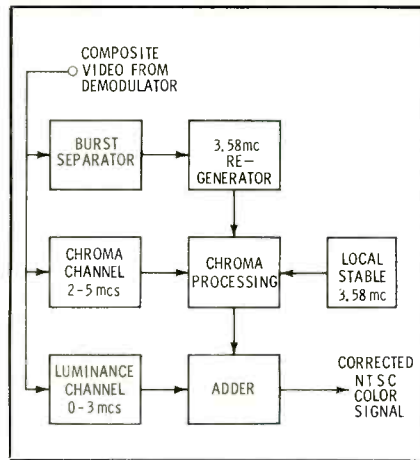

Fig. 3. Plan of burst-lock color system.

lized chrominance component. This output is then added to path one to form a new composite color signal which can be transmitted.

This system has some limitations. It produces a relatively poor final monochrome picture because of the excessive band limiting. It also gives a limited color image due to the combinations of luminance band limiting and edge beats occurring at the transitions due to interaction between the stabilized chrominance information and random timing of the luminance signal. This system is also difficult to keep in adjustment because of the many controls involved and the complex signal paths. Approximately one extra rack of equipment is involved in performing either the heterodyne or decode/encode function.

Electronic Time-Base Correction

The advent of electronic time-base correction through the use of variable delay lines (for geometric picture accuracy) led to the development of a similar device which performs a more refined function in a color video recorder. In this system, shown in Fig. 4, the color-burst signal on the back porch is separated from the composite signal and is fed into a circuit which precisely establishes the crossover period for the 3.58-mc signal. A similar crossover detector samples the studio reference subcarrier, and a comparison is made between the tape burst and studio subcarrier. As long as they are coincident, no correction is made, and the composite color signal goes through a fixed delay period which is inherent in the color accessory. When there is a difference in phase between the studio subcarrier and the tape burst, that difference generates a voltage whose polarity and amplitude is proportional to the direction and magnitude of the error. This voltage causes an instantaneous shift in delay of the variable delay line, which is in the path of the composite signal. This shift advances or delays the composite signal by an amount equal in time to the measured phase lead or lag. The output, therefore, is properly time-base corrected and comes out at the correct color phase.

● Please turn to page 44

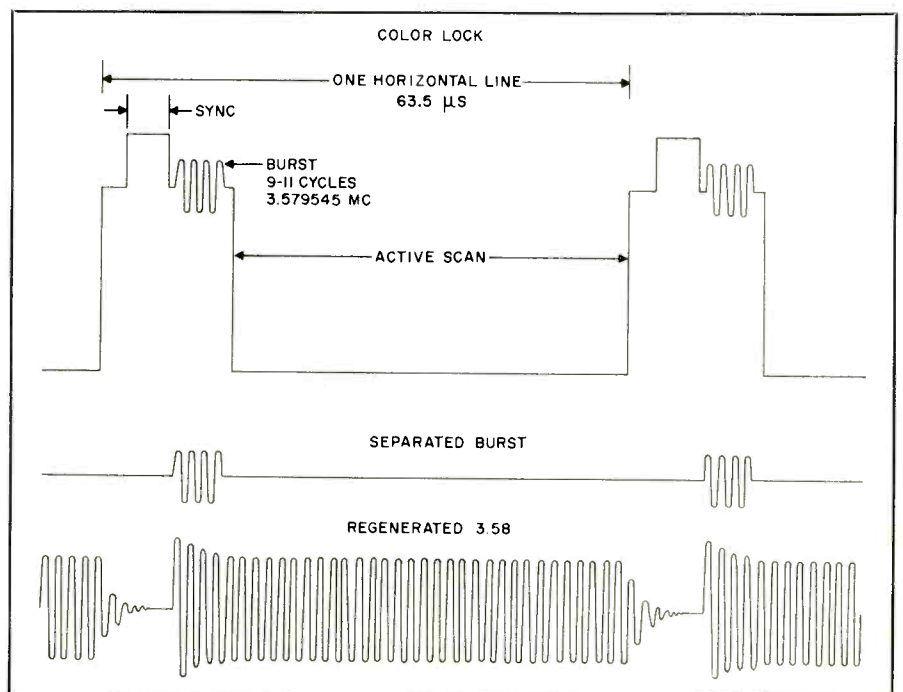

Fig. 2. Regeneration of 3.58-mc signal from phase lock oscillator in burst-lock system.

DESIGN OF A SEMI-AUTOMATIC CONTROL TABLE

by *Len Spencer** — Operational and design considerations of a control console for audio and radio control rooms.



Fig. 1. Front view of announce position.

The continuing struggle by radio and television stations against rising costs and greater competition has caused many of them to consider some form of automation, for maximum use of either time or personnel. Although full automation is generally efficient, the complete elimination of the human element can result in a mechanistic or juke-box type of production which may destroy a station's public image or

*Technical Director, CKAC, Toronto.



Fig. 2. Completed switcher console panel.

personality. Furthermore, legitimate fears of automation often create a morale problem among the staff.

Here at CKAC we decided to steer a compromise course. While not pretending to have the final answer, we hope the description of equipment and operation given here may serve as a guide to others.

It was decided that the overall specifications of the equipment should be as follows:

1. All solid-state amplifiers.
2. Push-button control of turntables, cartridges, tape machines, remotes, microphones, and talk-back facilities.
3. Provision for bypassing master control to feed the transmitter directly.
4. A completely clear working area for the announcer and for interviews.
5. All position designations in French.
6. Automatic volume control.
7. Methods for cueing turntables, cartridges, and remote-control broadcasts.
8. Method for overriding with voice-over.
9. Method for intermixing three turntables.
10. Monitoring off the air, quick component replacement, and easy servicing of gain controls and control desk.

Equipment Arrangement

The completely clear working space in front of the announcer permits him to work with someone directly opposite him, either on a two-announcer program or for interviewing. This requires the controls to be located well over toward the right, as shown in Fig. 1, a front view of the equipment.

On the right in Fig. 1 are shown two turntables and two cartridge

units. The turntables are modified by the addition of push buttons. For cueing purposes, the push button on the right starts the table separately from the cue position at the bottom of the gain control on the switching complex (Fig. 2). This push button is shielded against accidental operation.

Again referring to Fig. 1, the second push button on the turntables connects the pickup output to the cueing amplifier to permit spotting of the discs. When this has been done, the pickup arm is left on the platter for automatic start from the switcher. Starting is accomplished using the push buttons below the three turntable gain controls.

The turntables on each side of the announcer operate at 33 $\frac{1}{3}$ and 45 rpm, while the 16" turntable at his left rear has an additional 78-rpm drive. On the announcer's right is the third cartridge unit. Not shown in Fig. 1 is a Lazy-Susan cartridge holder for two hundred cartridge tapes, which occupies the space at right rear.

In Fig. 3, notice that the pickup button on the turntable can be actuated simultaneously with the start button (for cueing) by using two fingers. This photo shows the



Fig. 3. Rear view of announcer's position shows turntable switches and cue speaker.

control table from the announcer's position. Notice also an illuminated button at the far end of the cartridge machine. This switch permits cueing of the tape; each cartridge machine is so equipped. These cueing controls are interlocked with three buttons designated Cassettes Contact (Fig. 2) that are controlled by the slide attenuator above them, and a telephone-type key that can be switched to the "off" position.

The dual-pedestal desk houses the completely transistorized equipment which includes preamplifiers, intermediate booster amplifiers, line monitor, cue amplifiers, and power supply. The preamplifiers and the line, cue, and intermediate amplifiers use printed circuits. All electronic equipment is designed on a plug-in basis to provide easy access for checking and maintenance.

The power amplifier and cue amplifier with its associated loudspeaker can be seen under the switcher in Fig. 3. Note also a headphone cord which is in a double jack assembly mounted below the desk. This jack may be used for monitoring the output or for testing; a vu-meter with a standard load will read 8 vu when the outgoing line is receiving the proper level. The left-hand jack (cue) is connected permanently across the output of the cue amplifier and is not affected by the mute relays when all speakers are cut during "microphone-on" operations.

The announcer has control of the following facilities:

1. Three turntables, 2 on the left side and one on the right of the desk unit.
2. Three cartridge tape playback units, 2 on the left and one on the right of the desk unit.
3. One reel-to-reel tape machine, preset in the master control room but operated from the switcher panel.
4. Seven incoming remote lines.
5. Remote control of all turntables and tapes from the switcher panel by means of the illuminated warning buttons below the appropriate slide attenuators.

A limiter-amplifier is used instead of a standard line amplifier since no vu meter is incorporated in the control table. The entire operation is normally monitored from the air by means of a fixed-tuned monitor receiver in the left pedestal.

An automatic cartridge-tape switcher is installed in the left pedestal; this operates in conjunction with the remote push buttons on the switcher panel. It selects the proper tape to the switcher and locks out unused cartridge playback units from the audio bus.

The Switcher

Now refer back to Fig. 2, a photo of the switcher itself; the functions of each control will be described. Starting with the top row and reading from left to right, the first illuminated button selects the monitoring function. Normally the monitoring is done from the air. If

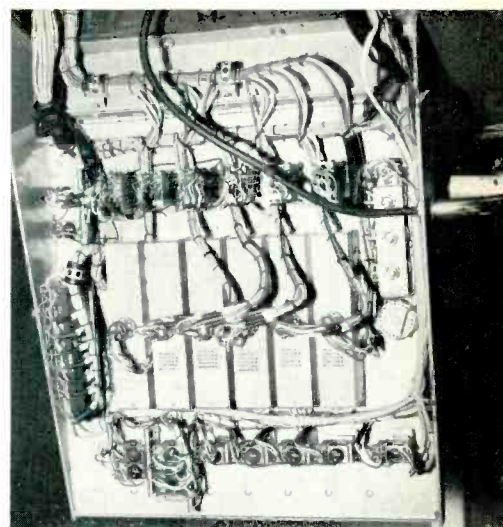

Fig. 4. Underside of switcher raised in position for inspection and maintenance.

the transmitter (or the program lines to it) suddenly fail, the announcer pushes this button. If he hears the output from the table, he calls master control by pushing the Interphone button at the bottom left.

Continuing across the top of the panel you will see a row of six keys, used for selecting the incoming sources. The first three keys connect the turntables, the fourth is the microphone key, and the fifth key controls the cartridge-type input. Key number six connects the fader below it either to the tape machine in master control through the illuminated buttons below the fader or to one of the remote lines (through one of the seven buttons on the right).

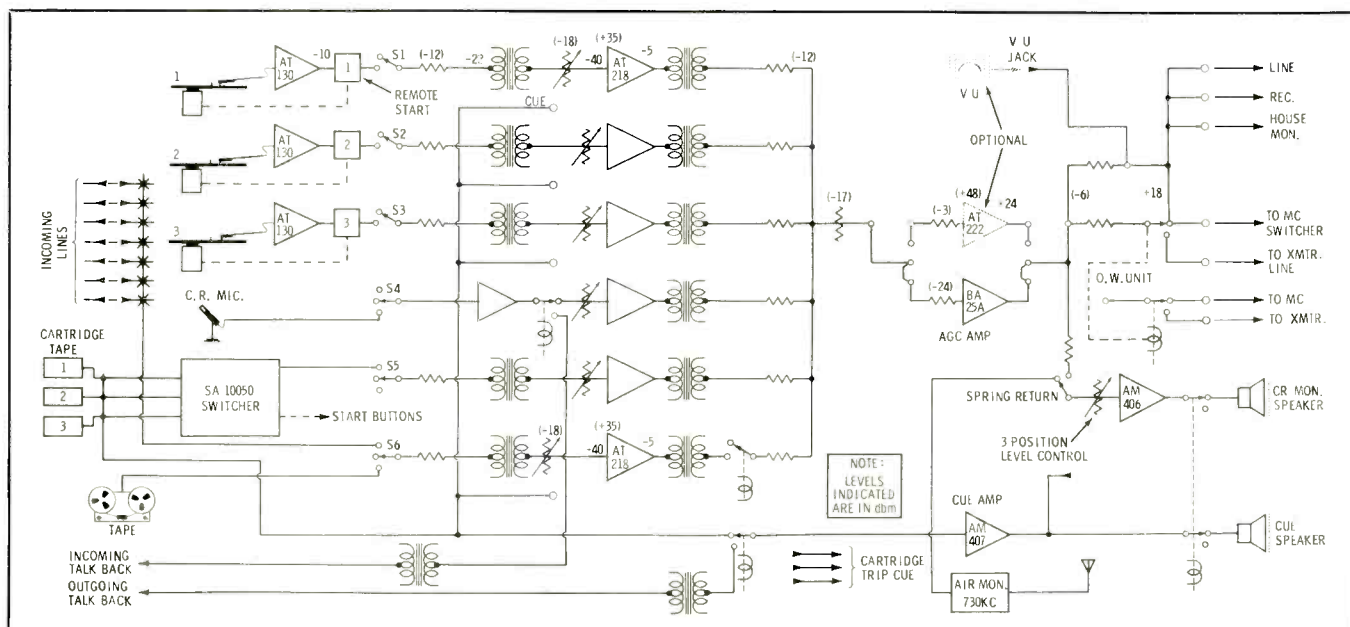

Fig. 5. A functional and operational block diagram of the semi-automatic switching table for studio and control room equipment.

The top illuminated button on the right is normal to master control. The lower button transfers the output from the desk (or table if you wish) directly to the transmitter line, bypassing master control; it also connects a telephone to the transmitter phone line so that the announcer can talk directly to the transmitter, which is manned 19 hours a day.

There remains only the large knob on the left, which controls the speaker volume. It has Closed, Middle, and High positions. Trimmer controls are used so that each level remains constant.

Provision is made for accepting cue signals from external equipment so that further automation could be adapted.

Fig. 4 shows how the switcher is opened for servicing. The faders are connected to individual plugs, allowing any one to be removed from the panel without disturbing circuit operation. Fig. 5 is a functional diagram of the control desk.

Turntable and Tape Operation

A preset audio delay is used to hold off the program until the turn-

table is up to speed. This prevents wow and background noise even though the fader associated with the particular machine is already in the normally open position. This automatic start-control system is designed on the "fail-safe" principle: Should the control circuits fail due to power-supply or fuse failure in the DC system, the turntables will drop back to normal manual control. Each turntable is self contained and supplies its own control power; therefore, failure of the automatic start in one unit will not affect operation of the others.

For cassette (cartridge tape) operation, fader 5 controls all tape outputs through a relay switcher unit located in the left pedestal. Tape machines may be started either by controls on their own front panels or by the remote buttons located below fader 5. This fader may be left open at its normal operating position.

When a unit is loaded with a cartridge, the "ready" lamp on the unit lights. By actuating the associated "contact" button, the appropriate switcher relay is caused to connect the unit to the fader bus,

and the tape is locked in. The tape will run and recue itself, dropping the relay out. The red indication is given in the remote push button when the switcher relay locks to the fader.

If a second cartridge is punched up, it will lock in and release the previous cartridge, and the red light will change accordingly. For example, if cartridge 3 is punched up before cartridge 1 releases, cartridge 3 will lock in, button 3 will show red, and relay 1 will be released. Cartridge 1, however, will continue to run until it recues itself for future use. This operation can be seen by the amber (ready) and green (run) lamps on the cartridge units. Each tape unit has an illuminated "cue" button. Depressing this button transfers the tape output from the program bus to a cut or audition bus. ▲

The overall concept of the system described in this article was designed by the author. Construction and assembly of the solid-state amplifiers were in the hands of McCurdy Radio Industries, Ltd., of Toronto, whose assistance and skill is gratefully acknowledged.

ANOTHER EXAMPLE OF "TOTAL VALUE" ASSURANCE...

COMPLETE LINE AUDIO PLUGS FOR AUDIO/ELECTRONIC APPLICATIONS FROM AUTHORIZED CANNON DISTRIBUTORS

On a moment's notice... Cannon quality and service from the most efficient distributor network in the electronics industry.



Cannon's complete line of audio plugs is readily available to you through local sources. Featuring the most advanced audio/electronic design concepts, these plugs exceed all specifications for reliability and performance in low level circuit applications. CANNON® Audio Plugs are available to you in a wide selection of shell sizes, contact layouts and connector types and meet all requirements for use with: radio, television, microphones, amplifiers, tape recorders, computers, control devices, and other audio and instrumentation applications. For more information on audio plugs, contact the Cannon Authorized Distributor in your area. For Cannon's Distributor Directory, containing complete purchasing information, write to:

Our 50th Year
ITT CANNON ELECTRIC INC.
3208 Humboldt St., Los Angeles 31, California
CANNON® PLUGS
A SUBSIDIARY OF INTERNATIONAL TELEPHONE & TELEGRAPH CORP.
©1964 ITT CANNON ELECTRIC INC.

Circle Item 11 on Tech Data Card



INTRODUCING THE WORLD'S NEWEST MICROPHONES... GUARANTEED FOR FIVE YEARS!

ALL NEW DESIGN...ALL NEW PERFORMANCE—Today... from the laboratories of University...an advanced technology has produced a great new breed of microphones for broadcasting, TV, professional and home recording, P.A., ham and CB applications. Each one represents a clean and dramatic break with tradition...with outmoded notions. Each one is far superior to any other microphone in its class. Let other microphone manufacturers offer the usual two to three-year warranty. Every University microphone—whether designed for the professional studio or the home recordist—is sold with a five-year warranty. For complete specifications, write: Desk BE-4, LTV/University, 9500 West Reno, Oklahoma City, Oklahoma.

EXAMPLES OF THIS GREAT NEW LINE!

MODEL 8000—A high performance dynamic cardioid for only \$29.95 net! Response: 70-13,000 cps. Sensitivity: -148 db (EIA). Output Level: -55 db/1mw/10 dynes/cm². Includes 18 ft. cable with Cannon plug and receptacle, and desk stand adaptor.

MODEL 2040—VOICE REALISM AT ITS BEST! New omnidirectional dynamic microphone that has astounded hams in initial trials! Modulation free of the harshness and muddy effect common to most microphones in this class. Ideal for upgrading P.A. and home tape recording performance as well.

MODEL 1000—CARDIOID DYNAMIC. Unique directional characteristics provide unexcelled discrimination against unwanted sounds—assure superior results even in noisy or reverberant locations. Internally shock-mounted—sensitive elements float, vibration-free, on polystyrene ribs! For any application requiring a truly discrete sound source.



**LTV
UNIVERSITY**

A DIVISION OF LING-TEMCO-VOUGHT, INC.

Circle Item 12 on Tech Data Card

April, 1964

U-27

23

PRACTICAL ASPECTS OF MODERN CARTRIDGE TAPE RECORDING

by **Melvin G. Hart*** — An analysis of cartridge tape operation with time proven techniques for good results.

A trade publication recently reported that radio stations throughout the country had been asked by a major advertising agency and a local sponsor **not** to transfer their commercial ET's to cartridge tape. In traveling around the midwest, I have had the opportunity to listen to many radio stations, both large and small. I can readily understand the advertiser's concern. Cartridge-tape quality ranges from "live" to unintelligible. A poor cartridge tape recording can usually be traced to one or more of a relatively few sources. The predominant causes are improperly adjusted equipment and an inadequately trained operator. A quality recording cannot be produced without good equipment that is properly adjusted and operated.

Four years ago, we at WIL began programming exclusively on cartridge tape twenty-four hours a day, seven days a week. Having lived for the past four years with the problems involved in cartridge tape recording, we have been able to accumulate information that can be gained only through direct experience.

Comparison of Systems

A comparative review of the relative advantages and disadvantages

*Chief Engineer, WIL, St. Louis, Mo.



Fig. 1. Cartridge machines mounted on drawer slides to facilitate maintenance.

of the two systems, direct air play of discs and transfer of material to cartridge tape, may be in order at this point.

Discs

First, what are the disadvantages of playing commercial disc recordings directly on the air?

Record Wear—This is one of the more noticeable faults of the disc system. After the recording has been "back-cued" a few dozen times, the first few grooves become worn through "to the felt." Needle scratch is never heard on a cartridge tape recording. Transcriptions and records that must be constantly handled quickly become dirty, scratched from record racks, and deteriorated in other ways.

Wrong Speeds—There are at least three speeds on a broadcast turntable. How many times can you recall having heard a record or ET started, or even played all the way through, at the wrong speed?

Spot Rotation—Most commercial ET's have six to twelve different cuts or spots that are meant to be played in a predetermined order. When the log calls for "ET number 70069, side b, cut three" and the operator is rushed, you may hear "side a, cut one." With cartridge tape equipment the rotation is determined when the cartridge is recorded and cannot be altered by careless playback.

Record Quality—This does not usually apply to an agency ET, but the quality of popular 45-rpm records varies considerably. It is sometimes necessary to try all equalizer settings before a reasonably good sound can be obtained.

Varying Levels—One lp record may need the pot wide open, while the next one is "hot." You are probably thinking, "That's why the operator has a control and vu

meter." This is true, but a correction can be made only after the mistake has been aired. With properly prerecorded cartridges, levels are substantially the same from cartridge to cartridge, and the operator is relieved of much gain riding.

Miscellaneous Faults—These include such things as the operator bumping the turntable while a record is on the air, turning off the wrong table, or picking up the wrong arm. Such things do happen.

Cartridge Tape

What are the disadvantages of the cartridge tape system? Properly set up, operated, and maintained, this equipment does not automatically become automation. We have found that using cartridge tapes instead of playing records and transcriptions directly on the air has created a full-time job for at least one man, and has added an expense for rewinding. The process of rewinding is an art in itself and is handled by one of our staff men who has set up his own business rewinding tapes for numerous stations.

Extra Equipment Cost—At WIL we have over \$5,000 invested in cartridge tape equipment. This includes two record playback combinations and eight playback-only machines.



Fig. 2. Test bench setup employed for rapid inspection of cartridge equipment.

Introducing Micro-Plate* Video Tape from Reeves Soundcraft



FINALLY A HEAVY DUTY VIDEO TAPE YOU CAN DEPEND ON FOR LONGER TAPE LIFE—LONGER HEAD LIFE—BETTER PICTURE

Forget everything you know about Video Tape life capability! Field tests on Reeves Soundcraft new heavy duty Micro-Plate* Video Tape have reported up to 700 passes without appreciable tape or head wear.

This phenomenal wear quality is a result of Soundcraft's new "Micro-Plate", an exclusive Soundcraft process that produces a tape surface so smooth you cannot visually tell which side has the oxide. Order "Micro-Plate" Video Tape from Reeves Soundcraft today.

*T.M.

REEVES SOUND-CRAFT
DIVISION OF REEVES INDUSTRIES INC

Main Office: Danbury, Connecticut • New York • Chicago • Los Angeles • Export: C.B.S. International, N.Y.C. Canadian Reps: Vancouver • Toronto • U. K. Reps: Soundcraft Magnetic Ltd.

Circle Item 13 on Tech Data Card



April, 1964

25

Extra Maintenance—Ten machines require a considerable amount of maintenance and special tools, such as a stroboscope and head-alignment gauges. Extra tubes, heads, relays, idler rollers, and other replacement components are kept in stock at all times.

Why, then, do we use cartridge tape equipment? For one reason only—consistent quality. We at WIL are firmly convinced that cartridge-tape quality exceeds that obtainable with discs. Tight program-

ming would be a physical impossibility without cartridge tape. However, quality can be obtained in only one way—the entire system must be properly installed, maintained, and operated. An untrained operator can just as easily make a bad cartridge tape recording as a bad acetate ET.

Installation

To start at the beginning, tape machines must be mounted in a reasonably level position. If they

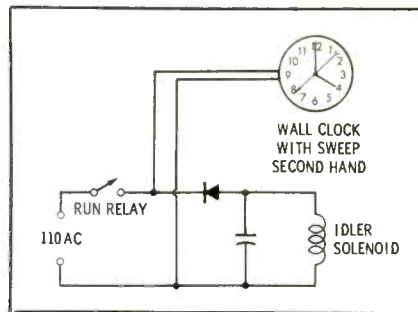

Fig. 3. Timing clock circuit connections.

are installed in a slanted console the tape in the cartridge will not pull properly, and the recording will "wow."

An excellent method of mounting the machines is on drawer slides, as shown in Fig. 1. This allows the unit to be rolled out of the rack so the heads may be easily cleaned. Using plug-in connections permits the machine to be removed for maintenance and replaced by a spare without turning a single screw. This is especially helpful when the operator on duty has a machine failure while he is alone; oiling is also greatly facilitated.

A test setup utilizing a set of remote-control buttons, a high-fidelity amplifier, and a vu meter has been installed on the test bench as shown in Fig. 2. This setup facilitates a quick check of machines believed to be defective.

Recording Procedure

A standard recording procedure must be set up and closely adhered to by all operators. If possible all recording should be assigned to one or two men only.

Preliminary Steps

At the beginning of a recording session, all tape heads are cleaned with denatured alcohol. Commercial head cleaners are not used because they leave a residue that gets into the cartridges. Using a 1000-cps test tape, all controls are set to indicate 100% or 0 vu on the console meters and the recorder meters. After this initial setup, all levels are controlled with the console attenuators. Input and output controls on the machines are carbon pots and will soon get noisy if they are constantly adjusted.

When a tape cartridge is selected from stock, it is inspected for tape wear, pressure-pad adjustment, and the position of the splice. A recording cannot be made over a splice

• Please turn to page 32

Choosing a Tall Tower Design ?

CHECK THESE

Stainless TOWER ELEVATOR FEATURES

A dependable elevator simplifies inspection, speeds emergency repairs - day or night, in any weather.

Builders of the WORLD'S TALLEST TOWERS, we stress the importance of straightforward design — for your greater safety, equipment reliability and convenience.

Before you decide, why not get full details on STAINLESS elevator towers. Write today.



Stainless, inc. NORTH WALES • PENNSYLVANIA

IN CANADA: WALCAN, LTD., CARLETON PLACE., ONTARIO

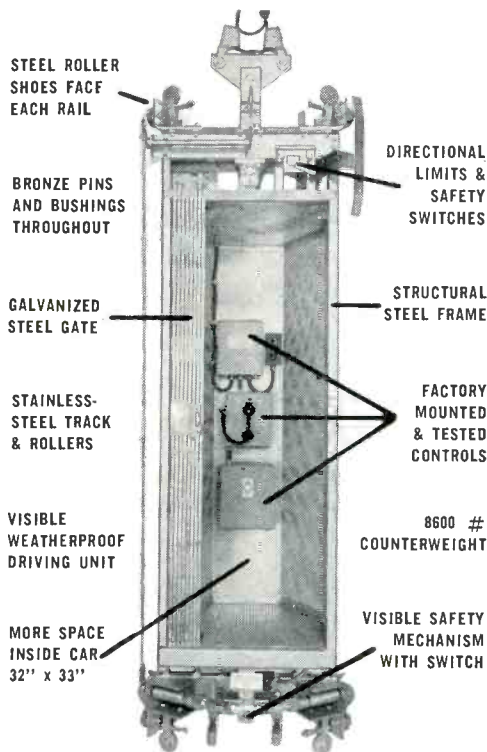

Circle Item 14 on Tech Data Card

QRK PROFESSIONAL TURNTABLES

offer you more...

- QUALITY
- CONTINUOUS PERFORMANCE
- SIMPLICITY

Quality all the way with QRK. Full speed range—33, 45, 78. Built rugged with jewel precision. Plays 45's without adapters. Rocket acceleration — EZ queuing. Single idler maintains constant speed regardless of normal wear.



Priced from \$115 to \$235.

Send for detailed folder!

RUSSCO Electronics Mfg. 1406 Clovis Ave. — Clovis, Calif.

Phone CY 9-4692

Circle Item 15 on Tech Data Card

We interrupt this magazine to bring you ...

Late Bulletin from Washington

(Editor's Note: This new department will be handled by Howard T. Head, prominent Consulting Engineer and partner of A.D. Ring & Associates in Washington. Mr. Head has joined the BROADCAST ENGINEERING special staff as Washington Correspondent. In the months to come, Mr. Head will report and comment on happenings in FCC that will affect the fields of broadcasting, microwave, and CATV. These fields are becoming closely inter-related; it becomes more difficult to separate news which affects only one of them, as all are involved in important decisions pending before the Commission.-- Forest H. Belt)

And now ... from Washington ... here is Howard T. Head!

It appears the FCC's hopes are coming true -- that the implementation of all-channel receiver legislation will stimulate UHF television broadcasting. More than 10 applications for new UHF stations have been filed in recent weeks, a significant increase. The Commission has also established a government-industry Committee for the Full Development of All-Channel Broadcasting (CAB). This committee, under the chairmanship of Commissioner Robert E. Lee, is considering ideas and plans that will help promote UHF development.

The Technical Committee of CAB has adopted engineering recommendations for new propagation curves at UHF and for establishment of uniform aural-visual power ratios for both VHF and UHF. The recommendation latter suggests 10% to 20% for all frequencies, compared with the present 50% to 70% at VHF and 10% to 70% at UHF. Receiver manufacturers agree that receiver design can be simplified by close tolerance on aural signals; field tests indicate little loss in sound performance. The Commission will act on this recommendation shortly.

The Commission has proposed new rules to permit certain FM stations -- those now operating at less than the maximum height and power established for their classes -- to increase height and power. The recent adoption of fixed mileage separations between new FM stations found numerous existing stations operating farther apart than necessary. Rules do not now permit these stations to increase height and power. Under the proposed new rules, however, various alternatives are suggested: a uniform horizontal power increase for all stations; selective increases where mutual agreement is reached between closely spaced stations; and a protected-contour concept, which would permit increases where the 1 mv/m contours of other stations were not violated. Directional antennas could be used for this purpose by existing stations, but not by stations who want new short-separation assignments.

An increasing number of FM broadcasters are taking advantage of a long-established, but hitherto generally obscure, provision of the Rules (Section 73.316) which permits FM stations to radiate as much power in

vertical polarization as is authorized by their license for standard horizontal polarization. The vertically polarized signal is of particular advantage with automobile FM receiver installations; almost all employ vertical whips, whose response to horizontal polarization may be down by 20 db or more. Reports also indicate substantial improvement in home reception for many areas.

The Commission will act soon in the long-pending matter of establishing uniform hours for daytime-only AM stations. Various proposals have been considered, and Chairman Henry announced the Commission's intention to reach a decision before Congress adjourns.

The Commission staff continues to study technical standards which might be proposed in connection with excessive loudness of commercial announcements. Possible approaches being considered are: establish regulations governing permissible amount of audio limiting; require that modulation levels not exceed 100% on either negative or positive peaks.

This is Howard T. Head in Washington....

Thank you, Howard....And now, from around the world ...

Stockholm, Sweden -- A recent addition to the international Consulting Author staff of BROADCAST ENGINEERING is Hans Richter. A broadcast recording-studio manager at Studio 9 in Stockholm, Hans will be responsible for keeping readers informed of broadcasting activities in the Scandinavian countries. His first report is of a new TV studio opened by the Swedish Broadcasting Corp. It is custom-built and is one of the most modern and well-equipped in Europe.

London, U.K. -- Six new TV stations are planned by the Independent Television Authority. Counties to be served by these translators include Bedford, Central Berkshire, Caithness, Dundee, Scarborough, and the Isle of Man. The additions will raise the number of ITA transmitting facilities to 29 in the British Isles.

Trinidad, W.I. -- A three-hop tropospheric-scatter system is planned for telephone communications among the Carribean islands of Trinidad, Barbados, St. Lucia, and Antigua. From Antigua, a coaxial cable will connect the system to St. Thomas (Leeward Is.) and thence to Florida, U.S.A. On the islands themselves, VHF and microwave links will connect the scatter-station terminals with local systems.

Copenhagen, Denmark -- Many new broadcasting activities will soon be taking place in Denmark and Sweden. This increased activity will begin with the installation of a television transmitter in the Oresund between the two countries.

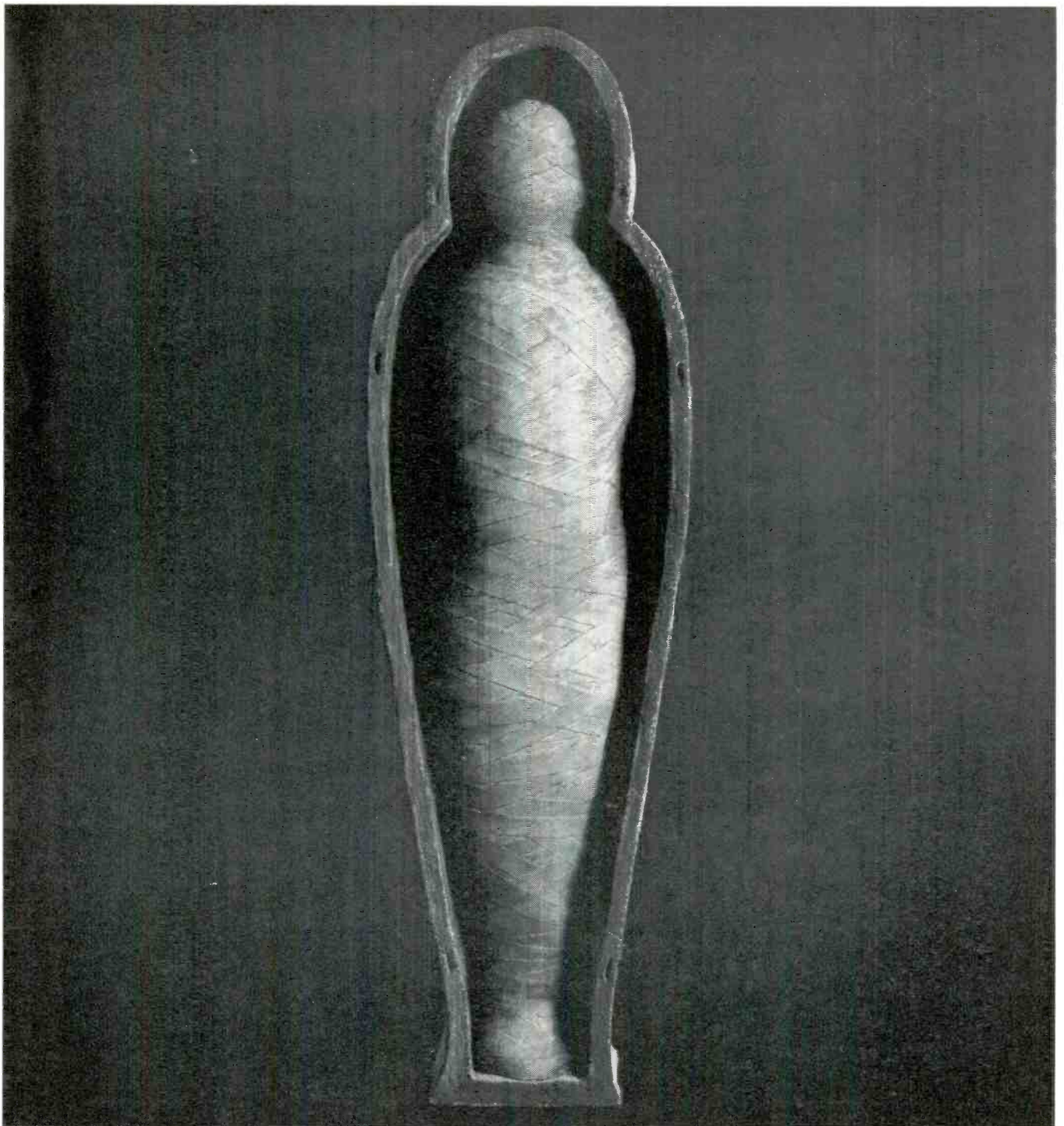

The Egyptians had a way with tape, too!

To this day, no one has learned the Egyptian's secret with mummy tape! Everyday, however, more and more recording engineers learn about RCA's Red Seal tape and use it exclusively. What's the secret? Originally, RCA developed Red Seal tape strictly for its own recording purposes. In doing so, chemical engineers and physicists were brought together with sound engineers in the country's most modern tape plant. Quite naturally,



they developed the finest tape ever. To maintain this superb Red Seal quality, RCA exercises relentless quality control! 101 tests in all. Magnetic tests for frequency response, distortion, drop-out, noise and print-through. Physical tests for coating thickness, anchorage, layer-to-layer adhesion, aging, cupping and slitting. So, why not preserve the purity of your sound with Red Seal Recording tape! Remember, the best is made by RCA.

RED SEAL RECORDING TAPE



The Most Trusted Name in Sound
Circle Item 16 on Tech Data Card

for audio

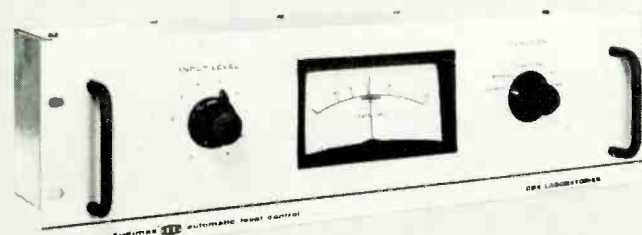
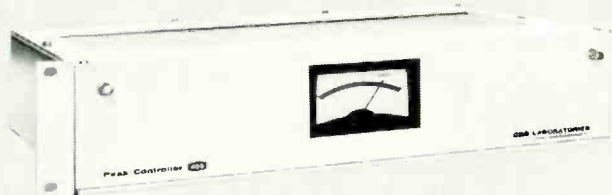

PEAK CONTROLLER, the successor to the peak limiter, can double radiated program power because its microseconds-fast response permits maximum control of peaks without any undesirable side effects. In sharp contrast, old-fashioned limiters cause reduced program levels because of their dependency on long recovery time to prevent "pumping."

In AM broadcasting, additional power benefit can be enjoyed because the CBS Laboratories Peak Controller can limit negative peaks while permitting greater than 100% modulation on positive peaks.

The all solid-state Peak Controller is a companion to and normally should be used with an automatic level control such as the CBS Laboratories . . .

AUDIMAX, which raises average program level, permitting a 4-to-1 increase in radiated program power.

When used as a team, the Peak Controller and the Audimax can increase a station's effective program power by an astonishing factor of nearly 8 to 1 without increased carrier power.

SEVEN STEPS TO BETTER LISTENING, CBS Laboratories' new test record, permits you to blend electronic components, room acoustics and the characteristics of your own ears into one well-tuned system for the enjoyment of all recorded sound.

Simple verbal instructions right on the disc allow even a novice to get the most from his home music system, monaural or stereo. Yet, laboratory perfection in the selection of test techniques and in the recording process make this a tool useful to the most discriminating audio engineer.

Accompanying text by famed high-fidelity authority Edward Tatnall Canby, explains in detail how each test and adjustment leads to maximum system performance from pickup to loudspeaker.

Available for the first time anywhere at the NAB convention. Pick up a copy at our booth at the special NAB price of only \$4.

**all new
all at the NAB
all from CBS LABORATORIES**

for video

Mix 'em or match 'em, the complete line of plug-in CBS video equipment can be used in any combination with all units in a frame powered by the same power supply. For the utmost reliability two power supplies can be used with automatic switching in case of malfunction. While each unit performs different functions, they all have two things in common — they are designed to make optimum use of solid-state components and they are guaranteed to match or exceed published specifications. All are equally useful with monochrome or color signals.

SELF-CLAMPING VIDEO DISTRIBUTION AMPLIFIER combines the functions of a high performance video distribution amplifier and a line-keyed clamp. Eliminates 60-cycle hum, tilt, bounce, switching transients without degrading monochrome or color video components in any way. Requires no external drive. Particularly useful in distribution of video signals which are not synchronized with the local time base, where clamping action is desired. Available with 3 outputs and automatic gain selection or with 4 outputs and variable gain control.

SYNC SEPARATING AMPLIFIER removes synchronizing pulses from composite signals and amplifies video signal without degrading color burst or chroma signals. Remote control permits amplification of composite signal without removal of sync when desired as in mixing or special effects operations. Switching transients are down at least 40 db below signal level. Available with 3 outputs and automatic gain selection or with 4 outputs and variable gain.

SYNC MIXING AMPLIFIER adds synchronizing pulses to video signals and amplifies composite signal. Remote control permits amplification of original video signal without addition of sync when desired. Separate control of video gain and sync gain. 4 outputs.

VIDEO DISTRIBUTION AMPLIFIER provides amplification and distribution of video frequency signals without distortion. Unlike combination video/pulse amplifiers, no quality compromise has been necessary in design. Available with 3 outputs and automatic gain selection or with 4 outputs and continuous gain control.

PULSE REGENERATIVE AMPLIFIER processes and regenerates synchronizing and driving pulses. Result is clean pulse in original form without degradation. Available with 2 or 4 outputs.

POWER SUPPLY provides DC necessary to operate any combination of CBS Laboratories video amplifiers within one frame. An equipment frame can be equipped with two power supplies to provide continuous power automatically should one of the supplies malfunction.

EQUIPMENT FRAME occupies 7 inches of a standard rack. Frame holds one power supply and 10 video distribution, pulse regenerative or sync mixing amplifiers or two power supplies and 8 amplifiers. Self-clamping and sync separating amplifiers each replace two video distribution amplifiers. Available for standard video chassis or Thomas-Betts connectors.



See Them All In Booth 62W At the NAB Convention. If you're not attending the convention, we'll gladly send you complete specifications. Better Still, Prove It To Yourself. Every piece of CBS Laboratories audio or video equipment can be purchased on a 30-day trial basis. Buy the equipment, install it, use it. If it doesn't fully meet our published specifications or your expectations, return it for full credit.

Where Broadcast Quality Begins . . .

CBS LABORATORIES

High Ridge Road, Stamford, Connecticut

A Division of Columbia Broadcasting System, Inc.

Cartridge Recordings

(Continued from page 26)

without causing a "blip." If the splice is not visible, the cartridge is placed in the "splice-seeker," which runs the cartridge until the splice is just past the heads and then stops. This machine was designed and built in the WIL engineering department and has been a major contributor to cartridge-recording quality. If such a device is not available, the cartridge should be placed in a playback machine and run through until the splice is in view just past the head assembly.

Next the cartridge is bulk-erased, using a slow circular motion on all sides of the cartridge. Improper erasing can cause a high noise level on the tape.

Setting Levels

After the erasing operation, levels are checked. It is extremely important that all operators watch the levels closely so the tape is neither undermodulated nor overmodulated. The record, ET, or reel-to-reel tape recording is played at least part-way through to determine the proper setting for the console attenuator. When this has been done, the material is cued up and the cartridge tape placed in the recorder. The cartridge-tape start button must be pressed a fraction of a second before the record is released. If both are started simultaneously, there will be an "overcue" on the cartridge. This is caused by the sound track crossing the play head before the tape has stopped.

Finishing the Recording

After the recording is completed, the console pot should be closed and the cartridge allowed to run to cue or to the proper elapsed time if multiple cuts are being made. Never stop the cartridge and then start it again to run to cue. This will cause a "pop" on the tape. At

WIL we use a 12-inch wall clock with a sweep second hand for timing; the glass was removed to facilitate resetting the hands. The clock is controlled by the run relay in the recorder as shown in Fig. 3. This affords precise timing for multiple cuts. The "dead" time between cuts should be evenly distributed so that there is not a long cue time at the end of the last cut.

Monitoring and Duplication

By using a stereo head in place of the original cue head, the audio may be monitored while the recording is being made. This eliminates the need for running the cartridge through a playback machine to check the quality.

By using two recorders, duplicate cartridges may be produced when necessary. A relay system (Fig. 4) allows the operator to control two machines at the same time.

Playback

Since the quality of reproduction is determined primarily in the recording process, there are few precautions to take during playback. The prime factor in maintaining playback quality is cleanliness. The heads must be cleaned frequently; a small speck of dirt or oxide on the head will cause a loss of high-frequency response and cause the tape to sound muffled. Idlers must also be kept clean and free of grease, oil, and oxide. Plain alcohol is the best cleaning agent for this purpose.

At WIL the last link in the chain before the cartridge-tape audio signal is mixed into the console is a frequency-compensating amplifier. Frequency compensation was found to be an absolute must with the older machines that had poor low-frequency response. This deficiency has been corrected in later models now in use, but our special amplifier does give a full, rich sound to the tapes. The unit was built in the WIL engineering department and is a modification of a standard commercial unit.

Cartridge tape equipment can produce a better on-the-air sound than the direct reproduction of disc records. It must, however, be properly maintained and operated by competent technical personnel. You can't just set it down, plug it in, and expect good results. ▲

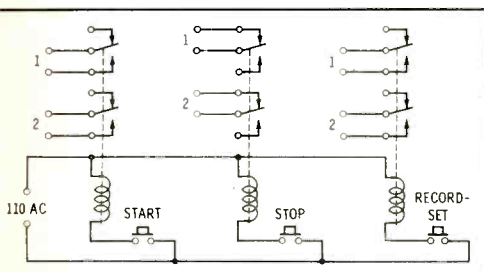

Fig. 4. System used for simultaneous control of two tape machines for duplication.

Check these Authorized RCA Microphone Distributors for the one nearest you

Alabama

Ack Radio Supply
3101 4th Avenue, South
Birmingham, Ala.

Arizona

Midland Specialty Co.
1930 North 22nd Avenue, P.O. Box 6658
Phoenix, Arizona

California

Hollywood Radio & Electronics, Inc.
5250 Hollywood Blvd., Hollywood 27,
Calif.

Radio Products Sales, Inc.

1501 South Hill Street
Los Angeles 15, Calif.

Dunlap Radio & TV Supply Co.

1800 - 18th Street, Sacramento, Calif.

Western Radio & TV Supply

P. O. Box 1728, 1415 India Street
San Diego 1, Calif.

Zack Electronics

1444 Market St., San Francisco, Calif.

Colorado

Kierulff Electronics Company

1200 Stout Street, Denver, Colorado

Newark Denver Electronic Supply Corp.

2170 S. Grape Street, P. O. Box 22045
Denver, Colorado

National Radio Parts Distributing Co.

572 Albany Ave., Brooklyn, New York

Connecticut

Radio & Appliance Dist., Inc.

95 Leggett Street, East Hartford, Conn.

District of Columbia

Electronic Wholesalers, Inc.

2345 Sherman Avenue, N. W.

Washington 1, D. C.

Florida

Flagler Radio Co., Inc.

1068 West Flagler St., Miami 36, Fla.

Southeast Electronics, Inc.

1125 Rosselle Street, Jacksonville, Fla.

Thurow Electronics, Inc.

121 S. Water Street

P. O. Box 1529, Tampa, Fla.

Georgia

Specialty Distributing Co.

763 Juniper Street, N. E., Atlanta, Ga.

Illinois

Newark Electronics Corp.

223 W. Madison St., Chicago 6, Illinois

Indiana

Graham Electronic Supply

122 South Senate Ave., Indianapolis, Ind.

Ohio Valley Sound

20 E. Sycamore Street, Evansville, Ind.

Kansas

Radio Supply Co.

115 Laura, Wichita, Kansas

Massachusetts

De Mambro Radio Supply Co., Inc.

1095 Commonwealth Avenue
Boston, Mass.

A. W. Mayer Company, Inc.

895 Boylston Street, Boston 15, Mass.

Minnesota

Lew Bonn Company

1211 LaSalle Street, Minneapolis, Minn.

Missouri

Burnstein-Applebee Co.

1012 McGee Street, Kansas City, Mo.

Interstate Industrial Elect.

2218 So. Jefferson Avenue

St. Louis 4, Mo.

**RCA Microphone Distributors
(Continued)**

Waren Street
Y.
o Company, Inc.
rd Street, New York 36, N. Y.
tronics, Inc.
Avenue, South
N. Y.
ics Corp.
street, New York, N. Y.
ment Corp.
Street, Buffalo, N. Y.
son Electronics
th Street, New York 1, N. Y.

holesalers, Inc.
street, Winston Salem, N. C.

ctronic Parts Corp.
t Avenue, Cleveland, Ohio
, Inc.
reet, Cincinnati, Ohio

y, Inc.
udson, Oklahoma City, Okla.

rbey Co.
h Street, Reading, Pa.
ompany
venue, Pittsburgh 22, Pa.
sen & Co.
ue and 51st Street
Pa.

ds Co.
Avenue, Providence, R. I.

Supply Co., Inc.
ll Street, Columbia, S. C.

istributing Co.
et, Memphis, Tenn.
buteing Co.
nd Avenue, Nashville, Tenn.
oliance Distributors, Inc.
t Street, Chattanooga 8, Tenn.

adio Supply Co.
Street, Laredo, Texas
, Inc.
street, Austin, Texas

onics Supply Co.
G, P. O. Box 1360
as
y Co.
er Freeway, Dallas 7, Texas
eering Co.
Dallas 4, Texas
Co.
eeway, P. O. Box 1657
as

Co., Inc.
oad Street
Va.

ebe Co.
Avenue
ashington

Famous RCA Microphones

Now available through local distributors



RCA BK-1A
Non-directional
dynamic mike



RCA BK-5B
Uniaxial ribbon mike



RCA BK-6B Miniature
semi-directional
dynamic lavalier mike



RCA 77-DX Polydirectional
ribbon-type microphone
available in satin-chrome
or TV grey finish



RCA BK-11A Bi-direc-
tional ribbon mike



RCA SK-39A
Non-directional
dynamic mike



RCA SK-45B
Non-directional
dynamic mike



RCA SK-46 Bi-direc-
tional ribbon mike

Now you can get world-famous RCA microphones RIGHT OFF THE SHELF—from local Authorized RCA Microphone Distributors.

This is good news for broadcasters. No longer need you accept substitutes for your favorite RCA microphones in emergency situations. RCA Microphone Distributors carry complete stocks available for immediate delivery. Call your nearest RCA distributor for fast service.

GET FULL TECHNICAL INFORMATION. CALL YOUR NEAREST RCA MICROPHONE DISTRIBUTOR OR WRITE: RCA ELECTRONIC COMPONENTS AND DEVICES, DEPT. 451, 415 SOUTH FIFTH STREET, HARRISON, NEW JERSEY.



The Most Trusted Name in Sound

Circle Item 18 on Tech Data Card

THE SHAPE OF BROADCASTING TO COME—1984

by Lawrence J. Cervone*—Examining the possibilities in the future of broadcasting equipment and methods.

Just 19 years ago the atomic bomb changed the course of civilization overnight. The year 1984 is only 20 years away, so we are at about the halfway point of a new period in the world's history. In today's world of rapid technological change, 20 years is a long time. During the past 20 years mankind has experienced progress at the fastest rate ever known.

About 200 years ago Benjamin Franklin said, "It is impossible to imagine the height to which the power of man over matter may be carried in 1,000 years." We need not hold Mr. Franklin to his rhetorical "1,000 years." Today, we have the advantage of experiences in the growth of radio and television broadcasting and the knowledge of the role of electronic technology. We are, therefore, in a much better position to understand how new scientific discoveries in electronics and the state of matter may influence the type of broadcasting equip-

ment 20 years from now. We do not really know exactly what they will be, but can apply some foresight in considering the broad technological advances to come.

But first let's philosophize a bit about this business of mass communications, of which radio and TV broadcasting are such an important part. By virtue of its speed and range, broadcasting is an unrivaled instrument for communication between peoples. Through radio, the listener in Tokyo can follow a U.N. conference of world leaders in New York. The size and composition of the audience that can be reached by a single broadcast staggers the imagination! Television is even more extraordinary with its enhancement of radio by adding sight to sound.

Most of us would chuckle at the crude and amateur (by today's standards) methods of broadcasting utilized when it all started just 41 years ago. Perhaps the best illustration is to recall the hot "tomato-can" microphone, which looked just like the popular food container.

This unit was literally hot, and no torch singer of the early 20's would dare fondle it affectionately as TV vocalists often do with today's microphones. The "tomato-can" microphone had a sizable DC-excited field coil, and the steady current all through the broadcast made the outer casing almost a dull red hot.

Broadcasting has come a long way since then, thanks to the dedication of America's scientists and engineers who have contributed so much to the development of modern broadcasting equipment—men such as Major Armstrong, whose pioneering work in FM is known to all; Raymond A. Heising, considered by many as the inventor of high-level modulation while at Bell Labs; Philo T. Farnsworth, who independently conceived the idea of magnetic deflection which made TV possible; and William H. Doherty, who made many contributions to broadcasting, particularly in earlier approaches to transmitter design.

What new inventions and concepts can broadcasters expect to be commonplace 20 years from now? In projecting the future care must be taken not to repeat the overly conservative outlook which has prevailed in the past in other industries. One must weigh the possibility that the pendulum may have swung too far in the other direction and the result may be error in the form of unrealistic expectations. It's important to strike the right balance between overconservatism and irresponsibility in forecasting the realistic possibilities ahead.

It has been said often that if one is going to be a prophet, it's best to look far ahead—far enough ahead so that one will be gone by the time an evaluation of his predictions takes place.

In making a list of potential 1984

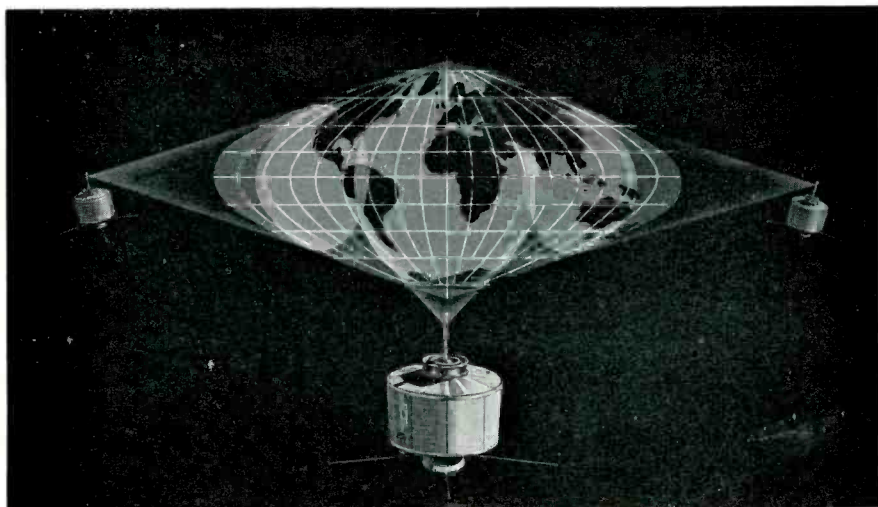
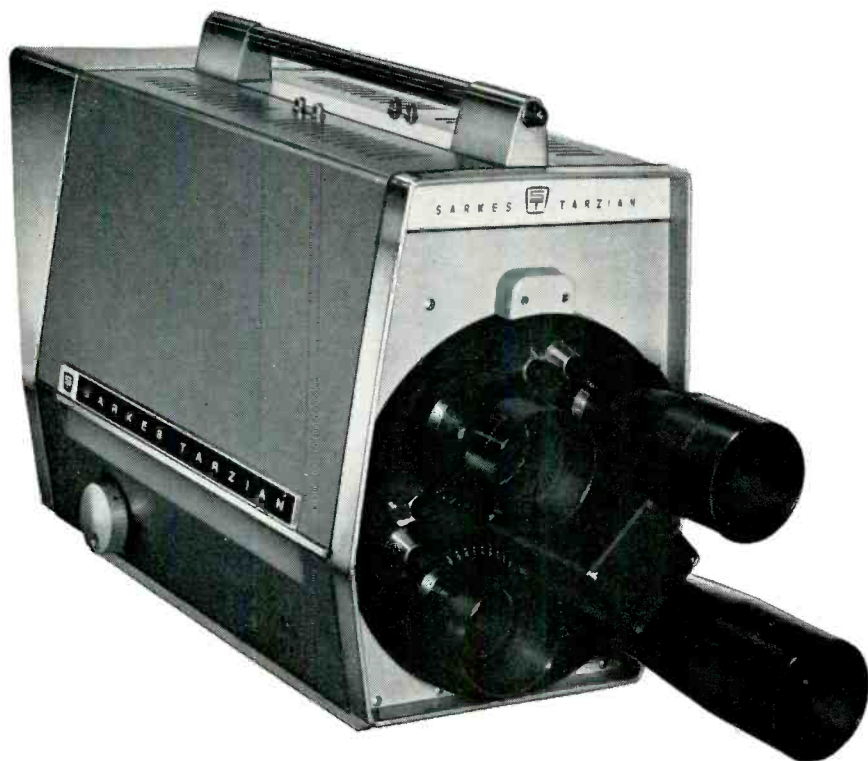

Fig. 1. A three satellite system might provide a global communications network with uninterrupted, twenty-four-hour-a-day television and telephone service.



Now—Go Fully Solid State—All Cameras

● For the first time, you can update your camera gear—all of it—to solid state equipment.

Tarzian set the standards for solid state television with the first studio camera to have all camera circuits completely transistorized. Now, Tarzian is first again with a complete line of fully transistorized studio and remote cameras to meet all your programming needs—including the outstanding new Image Orthicon studio camera (see it—try it at NAB) and the 1-inch vidicon, or 1.5" image pick-up camera.

Common to this select line of cameras is a versatile processing unit, thoroughly field-tested and in operation more than a year—a full year longer than any other available—and presently in use in major market stations with unqualified broadcast quality performance.

All Tarzian cameras bring you the maintenance-free, economical operation of completely solid state circuitry—readily accessible on plug-in printed circuit cards. All feature the same dependable performance and striking design that broadcasters have come to expect—and rely upon—from Tarzian.

SARKES  **TARZIAN**

BROADCAST EQUIPMENT DIVISION • BLOOMINGTON, INDIANA
Circle Item 19 on Tech Data Card

NOW AVAILABLE:

“ All about extra TV Coverage and fill in via ” Translators

• Write today for your Planning Package from EMCEE, the Translator manufacturer with more experience and more models . . . UHF VHF . . . 1 watt to 100 watts.

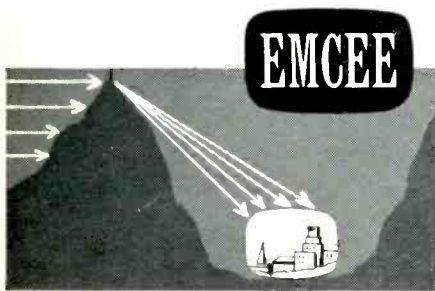

See us at
NAB Convention
Booth 54-W

ELECTRONICS,
MISSILES AND
COMMUNICATIONS, INC.
160 E. Third St., Mount Vernon, N. Y.
10550 • 914-668-3012

Gentlemen:

Please send your "TV Coverage Planning Package."

Name _____

Address _____ City _____ State _____

Circle Item 43 on Tech Data Card

developments, it became apparent that they fell into two categories. The first was a list of items that should come through normal extensions of present technology; the second a list of more revolutionary developments requiring more dramatic advances.

Nevertheless, looking ahead toward 1984 it's pretty certain that just through the **normal evolutionary** process of technological refinement, these developments will occur:

1. The vacuum tube will disappear from almost all types of broadcast apparatus which will become more compact, smaller, and simpler than anything practical by today's standards.
2. Most broadcast equipment—audio, video, and RF—will be 100% solid state, or fully transistorized. Even the largest of transmitters will be completely solid state.
3. Consoles as we know them today will be much simpler, incorporating electronic mixing. There will be no faders to control; automatic leveling devices will be as standard as limiters are today.
4. The use of microcircuitry will be commonplace. It will soon be possible to place hundreds of transistors on a one-inch block of silicon and then lay in resistors and capacitors by thin film techniques. Resistors and condensers will be unrecognized in the new concept of micromodular construction and will not be replaced individually—an entire module will be removed when an outage occurs. The result will be greater reliability and standardization.
5. Everything will be remote controlled—AM, FM, and TV transmitters. The remote control will be of the simplest type. For AM, one meter indication is all that really will be necessary. The next real progressive step will be a go and no-go transmitter control system with automatic changeover to a standby transmitter. Perhaps this will be an FCC requirement.
6. There will be widespread use of automation devices. In radio, this may be in the form of a master library of prerecorded

cartridge tapes which could be automatically selected by push-button control. The industry can look forward to a uniform standard of cartridge tape recordings for foolproof interchangeability. In TV, automated systems will be used extensively for control of slide projectors, movie projectors, video tape, and network feed. General-purpose digital computers will control video programming and studio lighting.

None of the evolutionary changes in equipment discussed so far will have a profound effect on the operation of radio or TV stations. Although equipment might look different and might be designed differently, and regardless of the new form, it will perform functions similar to those required today.

What equipment the industry will actually have in 1984 is to a great extent dependent on the broadcasters, who are the real decision-makers. Only they can decide whether the realistic possibilities of normal evolutionary change in equipment will be like an avalanche, taking the industry by storm, or a slow and gradual acceptance, eroding further gains.

It has been said that broadcasters have been reluctant to accept new concepts in equipment styling and design, or have accepted them slowly. If broadcasters accept the new more quickly than they have in the past, then certainly there will be important and rapid technological advances. Only the success of a new design as measured by customer acceptance and purchases inspires engineers to further creative effort.

Manufacturers and their engineers must look to the broadcasters as their primary source of inspiration and approval. They also need broadcasters' ideas, imagination, and initiative with the FCC or others to assure that progress is not stifled with archaic rules and regulations put together when "radio" was in the forefront of scientific knowledge.

Now let's take a look at some more revolutionary developments that might substantially change the entire concept of broadcast operations. What **startling** developments can be expected 20 years hence? Some developments which could

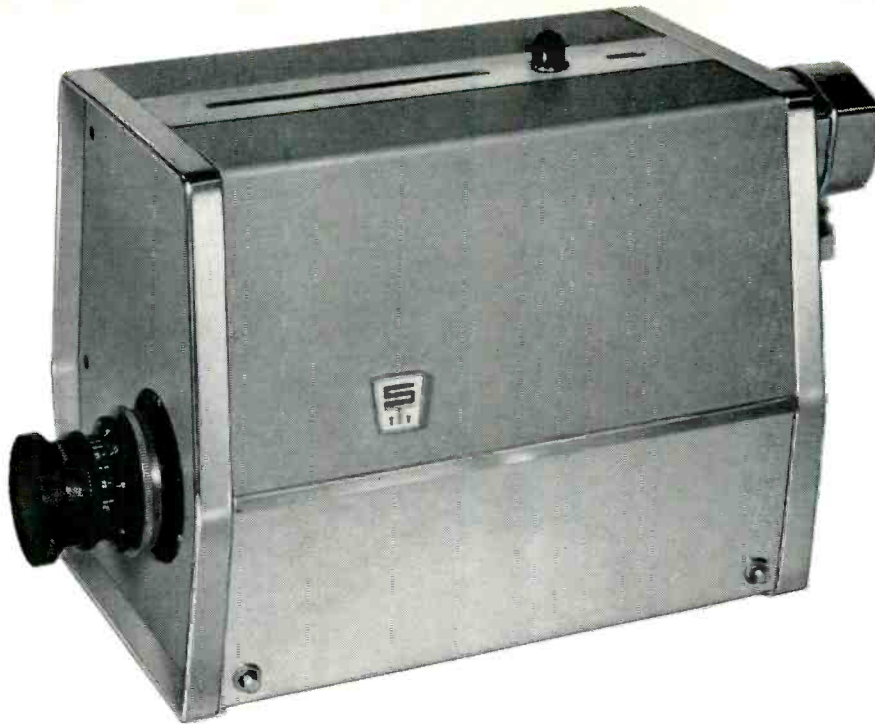

Of Course It's Solid State —It's from Tarzian

● Tarzian's 1500F film camera system is fully solid state—like all other cameras in the Tarzian line—to enable you to completely update your camera equipment.

Your first look tells you this Tarzian film camera is long on quality. Swing up the easy-open side panels, and you'll see the quality runs throughout. Especially designed for television film and slide pick up, the 1500F camera system uses a 1" or 1.5" image pick up tube, is entirely solid state—including the pre-amplifier—and is designed to mount on any standard multiplexer. All circuitry is immediately accessible on plug-in printed circuit cards.

Features absolute black pedestal stability and white peak stability which actually releases one man from your operation. New advances in solid state design deliver better than 1% sweep linearity, 1.5% geometric distortion, and greater than 46 DB S/N (0.4 μ amp Beam current—F8 lens stop opening.) And, of course, the camera system takes advantage of the superior qualities of 35 mm optics.

Find out how easy it is to put this finest of film camera systems into your studio—call or write:

SARKES  **TARZIAN**

BROADCAST EQUIPMENT DIVISION • BLOOMINGTON, INDIANA

Circle Item 20 on Tech Data Card

very well be a reality in 1984 might include:

A true speech synthesizer. Let's call this a machine which could take the printed word from your news ticker and transform the words instantaneously through a speech synthesizer into real professional talented speech. In this way the teletype transmitter would send symbols representing speech, and another machine at the radio or TV station would translate the speech symbols back to actual

speech which could be programmed on the air instantaneously.

Let's go further. Khrushchev, or his successor, or his successor's successor, speaks to the world from Moscow in Russian, or in Chinese. His spoken word is instantaneously processed by computers and translated into another spoken language, which is then transmitted from Russia direct to New York or anywhere else in the world, using communications satellites as relays or reflectors. Just imagine the audience

that broadcasters could command, in their market areas, by being able to broadcast in English a speech by a world leader at the very instant he is making the speech in a different language, thousands of miles away.

In TV, the possibilities are even more astounding. Through communications satellites, sight could be added to the translated sound, and all in color. It is believed that even before 1984 worldwide television will be predominantly color, and intercontinental television will be a reality (Fig. 1). Communications satellites will be broadcasting directly to home radio and TV receivers bringing special programs to a worldwide audience. Perhaps by 1984 global communications needs will be served more by satellites than by cable and conventional radio.

As suggested earlier, transmitters will be all solid state. To project further, the AM transmitter might be nothing more than a box mounted on a tower, remotely controlled and powered by its own solar cells—no power-line failures to worry about. AM towers may not be as large as those of today. Perhaps in place of the tall structures there will be just a small 30' tower and a reflector to provide horizontal radiation at excellent efficiency.

Then to really whet appetites, how about three-dimensional TV, in color? Advertisers soon will have three dimensional printing in color—3-D printing presses have already been built, and three-dimensional color television is certain to come. The aural component of all television will be stereo, to provide

FAST DELIVERY for



BRITISH and AMERICAN TV CABLES

We offer speedy delivery of cables, connectors and complete cable assemblies for all cameras.

BIW cables are unusually flexible for smooth, easy camera movement, yet are rugged and tough to resist blows and rolling stock damage.

Let us know your requirements. We'll be glad to send complete information and quotations.



"Designers and makers of Specialty Cables since 1905"

BOSTON INSULATED WIRE & CABLE COMPANY

Main Office and Factory
80 Bay St., Boston 25, Mass.
Tel. COlumbia 5-2104

Canadian Factory
Boston Insulated Wire & Cable Co., Ltd.
118 Shaw St., Hamilton, Ontario
Tel. JACkson 9-7151

Circle Item 21 on Tech Data Card

Scala Precision Antennas

- ★ OFF-THE-AIR PICKUP — FM or TV
- ★ LOW POWER UHF, VHF TV TRANSMITTING
- ★ STL AND TELEMETERING ANTENNAS

Engineered to meet rigid FM and TV station specifications, and to endure the tests of weather and time.

Built to your specifications by

SCALA RADIO CORP.

2814 19th STREET
SAN FRANCISCO 10
VA 6-2898

Circle Item 22 on Tech Data Card

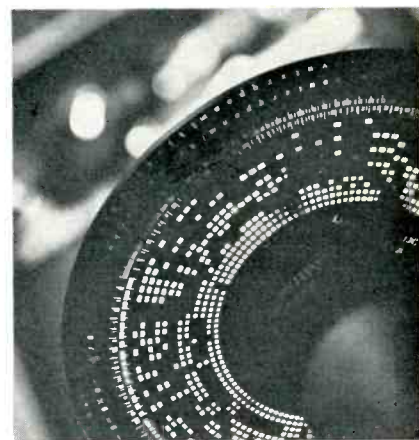
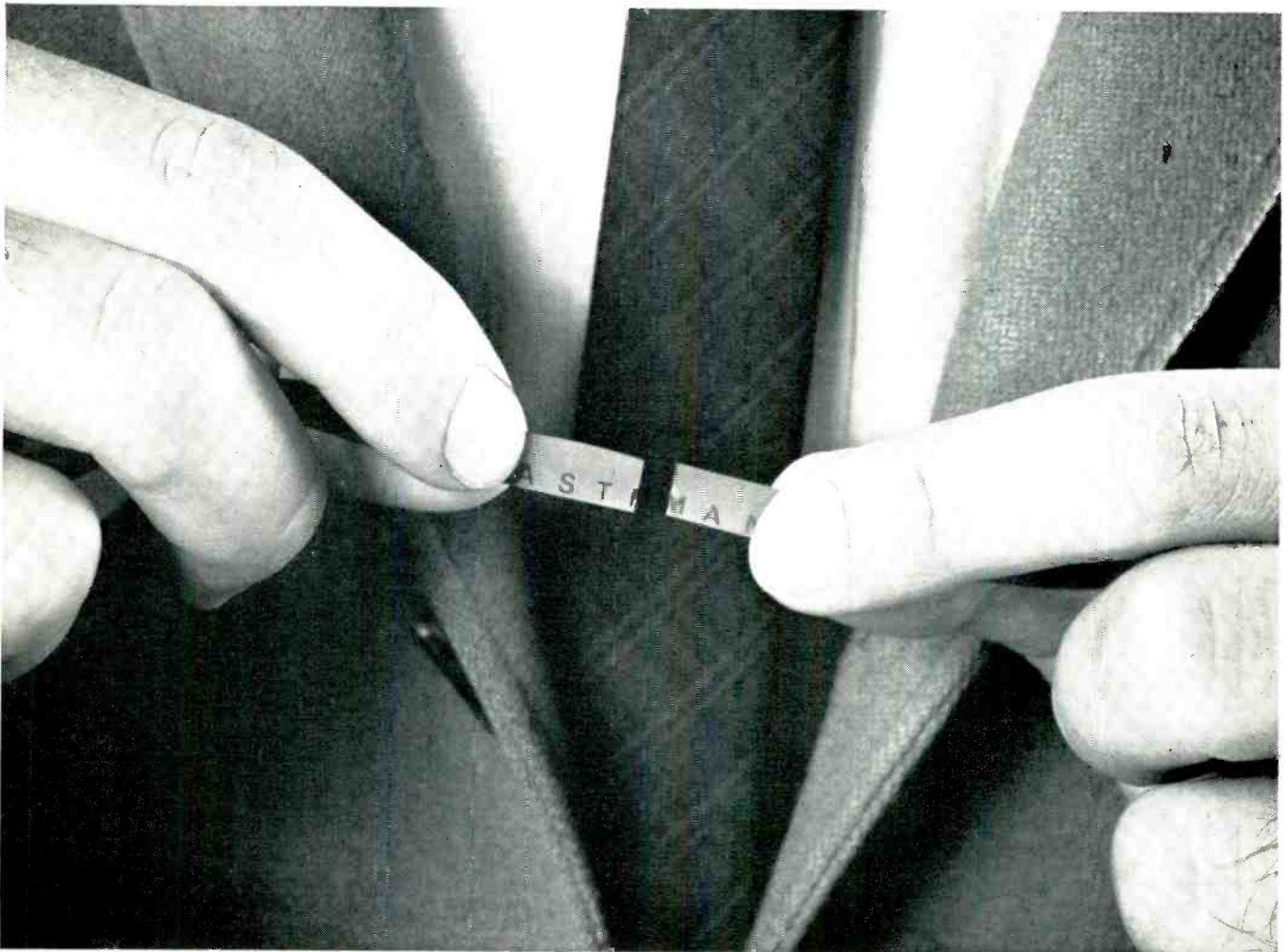

Fig. 2. Future broadcasters might use a recorder with which they could record a 30-minute TV show in color on a 10-inch disc.

BROADCAST ENGINEERING

Now...a new EASTMAN Sound Recording Tape!



Take a piece of the new Eastman tape. See how tough it is... how clean it breaks under stress.

Look! No stretch...when it breaks—it breaks clean!

NEW! Support material for EASTMAN Sound Recording Tapes is DUROL Base. A specially prepared form of cellulose triacetate—smooth, tough, durable, highly flexible—provides high strength with low elongation. When equipment accidents happen, it breaks clean. Splices are made easily, quickly—with minimum program loss.

Another important feature: "Lifetime Coding," your assurance of highest quality. Printed on the back of all EASTMAN Sound Recording Tapes is a continuously repeated, permanent legend. This identifies Eastman Kodak Company as the manufacturer and provides a convenient means of indexing these tapes.

For information, see your electronic supplier or write
Magnetic Products Sales

EASTMAN KODAK COMPANY
Rochester 4, N.Y.

April, 1964

New "R-type" binder. This gives a smoother, tougher surface, thereby reducing tape noise and distortion. In addition, it provides extreme abrasion resistance, preventing oxide build-up at the head. Even more important, however, are the amazing magnetic properties of coatings of "R-type" binder which make possible two superlative tapes—both available now...

At leading electronic supply houses: Ask for Type A303 for all general recording work. It has vastly superior low-print through characteristics. Need a special purpose high-output tape with remarkably low noise performance? Try Type A304!

© Eastman Kodak Company, MCM LXI



Unique ultra-handy Thread-Easy Reel with indexing scale and built-in splicing jig.

Circle Item 23 on Tech Data Card



TRAFFACOUNTING®

A flexible traffic and accounting system that provides station PROGRAM LOGS, AVAILABILITIES, SALES PRODUCT ANALYSIS, AFFIDAVITS and INVOICES.



PROLOG®

A simple, easily operated system that automatically performs station PROGRAMMING, LOGGING, AUTHENTICATING.

■ SEE THEM BOTH IN OPERATION AT THE NAB SHOW BOOTH 26W

LTV
Continental Electronics
BOX 5024 / DALLAS, TEXAS 75222

Circle Item 24 on Tech Data Card

greater listening pleasure, clarity, and "presence."

Numerous changes can be expected in recording, particularly in the method of video recording. The industry can look forward to a new optical recording device, using optical filaments and photomultipliers which can read millions of bits per second. This might be in the form of a disc-type video tape recorder which could record a 30-minute color television show on a 10" disc (Fig. 2). But if this is premature, certainly there will be low-priced TV tape recorders for home use as well as for professional applications.

A truly remote television camera will be perfected; it could be a light, compact camera made possible by fiber optics. Perhaps this will be a system whereby only the lens of a TV camera would be brought to the scene of an event. The picture would be carried back to the electronic gun at a remote location by way of a fiber-optical line.

To conserve TV spectrum space with improvement in picture quality, digital television is certainly a possibility. An image will be converted by computer into bits of information to be transmitted and then reconverted at the receiver and displayed on the screen as usual. But, with digital techniques all the information required for a TV picture could be accommodated by much less than the 4.5 mc bandwidth needed today.

By 1984 the shortage of spectrum space available to the broadcaster might become severe, and the use of compatible single sideband for both AM and international HF broadcasting might be required. An advantage of this transmission technique is its compatibility with most existing AM transmitters and all AM receivers. Since the compatible SSB signal occupies approximately one-half the bandwidth required for an AM wave, co-channel and adjacent-channel interference is reduced. Therefore, it could be possible using compatible SSB to double the AM and HF broadcasting spectrum.

From the listener's viewpoint, AM radio in 1984 will sound like the FM of today, due to better receivers, transistorized audio, and

solid-state transmitters. FM radio will be 100% stereo. The AM and FM services will be fully integrated; both will provide a needed service and one will not replace the other. Nationwide UHF TV will be utilized to its fullest. The nation will have grown to over 260 million people by 1984, with over 100 million passenger cars. AM, FM, and TV will all be needed—and, in fact, strained—to communicate the information, entertainment, and education necessary in an affluent and highly technical society. It is not at all unlikely that, with proper utilization of the spectrum, the nation will have 5,000 AM stations, 3,000 FM stations and 2,500 TV stations with some of these stations providing facsimile service on a regular basis directly to homes and offices.

This dynamic growth in the 20 years ahead, combined with the revolutionary changes in the technology of covering important events, is bound to mean that broadcasters—AM, FM and TV—will capture audiences substantially greater than ever before. Although the nation will probably have a coast-to-coast educational television network to provide formal instruction, easing the load of the overburdened educational system, commercial radio and television will be far stronger and far more important to our way of life than they are today.

In tomorrow's broadcasting, computer may well speak to computer. The language may be digital but, regardless of the mechanics of originating and the mechanics of transmitting a program, let us hope—indeed, let us pray—that in America broadcasting will always be free. In this age of the nuclear deterrent, we must recognize that the most important contest between freedom and Communism is the contest for men's minds.

As long as radio and television remain as truly competitive commercial enterprises, serving the public as a medium of entertainment, information, and mass communication, our democratic society will last for centuries. And, the spirit of the free enterprise system will inspire scientists to further enhance the art of broadcasting and the technological advancement of whatever equipment may be required. ▲

NEW! CLAMPING/EQUALIZING VIDEO AMPLIFIER

Model TSA1 Clamping/Equalizing Video Amplifier is all solid state, designed to process signals from microwave, mobile gear, master control, or feed corrected signals to the input terminals of a television transmitter. It has a self-contained regulated power supply.

Controls are provided for sync stretching or compressing, white stretching and white clipping. The equalizer will equalize approximately 500 feet of cable. As in all International Nuclear solid state equipment, high stability is achieved with minimum maintenance.

The TSA1 Clamping Amplifier employs clamps to remove low frequency deficiencies. The clamping technique, however, is different. Tip clamping is employed which does not disturb burst and other chrominance information in or about blanking or back porch levels. This makes the TSA1 particularly adaptable for color transmission.

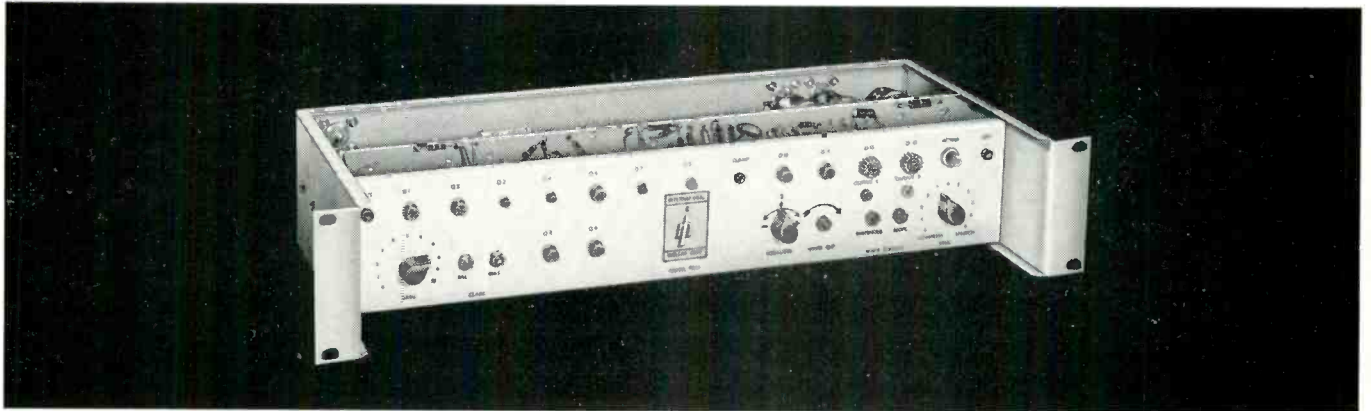

MODEL TSA1 CLAMPING/EQUALIZING VIDEO AMPLIFIER

... **\$750⁰⁰** each . . . f.o.b.
Nashville, Tennessee

Write for complete information and specifications Dept. T-1

INTERNATIONAL NUCLEAR CORPORATION

608 Norris Avenue

Nashville, Tennessee



ENGINEERS' EXCHANGE

Correcting High Line Voltage

by F. C. Hervey, Transmitter Supervisor, WHKW, Chilton, Wisc.

We had a high line voltage problem here at WHKW, too, and solved in the most direct way—at the cause. Our station is located at the bitter end of a long 3-phase feeder, our load running about 25 kva. Normal rural phase-to-phase voltage is supposed to be 240 volts, $\pm 10\%$. Ours, however, varied from a low of about 240 to a high of 256 volts! The result, of course, was a short life for everything from tower lamps to tubes.

After going around and around with the power company, and checking with their maintenance crews, we finally latched on to a set of transformers for our little "substation" in the back yard. These transformers have a few adjustable taps; regular models have only fixed ratios.

We now have a nominal 220 volt service into the building, with a

high of approximately 230 volts. Our own lighting transformers for the usual 220/110 volt split service supply rack power from 110 to about 115 volts. The increase in small tube and lamp life was practically unbelievable. Outages due to capacitor, resistor, and transformer failure have been reduced accordingly. Powers supplies in rack mounted gear are now set for a 125 volt line to produce slightly less than six volts on the tube heaters, and B+ voltages just under equipment ratings. The 10 kw transmitter was not affected since all of its voltages are controlled with line adjusters.

A good deal of talking was required to convince the power company to make the change, because it meant they had to round up the special transformers for our 33,000/240 3-phase service—they also had to stock a couple of extras for emergency equipment. However, there is nothing like having supply voltages on the low side to lengthen

component life—it is well worth a hassle with the local utility.

Modifying the P60 & P75 Recorders

by Peter H. Van Milligan, Maintenance Technician, WMBI AM FM, Chicago, Ill.

In using the popular P60 and P75 Magnecord tape recorders, we devised two modifications that help maintain high efficiency. These involve placing the Micro-type switch in the capstan motor circuit so the motor will not run continuously and replacing the record/play switch with a push button actuated with a push button actuated relay.

These few wiring changes are necessary to break the capstan circuit and rewire the switch:

- A. Connect points 6 and 7 together.
- B. Remove wire from point 6.
- C. Remove wire from point 1.
- D. Connect the leads removed from 6 and 1 together.
- E. Disconnect wire from point 10.
- F. Extend wire removed from

SAMS TECHNICAL BOOKS of special interest to Broadcast Engineers



SECOND-CLASS RADIOTELEPHONE LICENSE HANDBOOK

New printing! Now contains Q & A material for the 3rd-Class Broadcast Endorsement. Order QAN-1 \$3.95

TRANSISTOR CIRCUITS FOR MAGNETIC RECORDING

A comprehensive coverage of transistor configurations in audio circuitry. Hardbound. Order MTR-1 \$9.95

PASSIVE AUDIO NETWORK DESIGN

A guide to the operation and maintenance of attenuators, equalizers, and wave filters. Order AHT-1 \$4.95

INTERMODULATION & HARMONIC DISTORTION HANDBOOK

A complete reference on the generation and measurement of audio signal distortions. Order INT-1 \$3.95



SEND NO MONEY • FULL RETURN PRIVILEGE

Howard W. Sams & Co., Inc., Dept. BE-464
4300 W. 62nd Street, Indianapolis, Ind. 46206

Send me the following books:

- QAN-1 AHT-1 BILL ME (I pay postage)
 MTR-1 INT-1 \$ enclosed. Send Postpaid.
 FREE Booklist

Name

Address

City Zone State

ORDER TODAY

for your tower requirements check

ROHN SYSTEMS



A complete tower erection service that has these special advantages:

- ✓ DEPENDABILITY
- ✓ RELIABILITY
- ✓ COMPLETE ENGINEERING
- ✓ COAST TO COAST SERVICE

Be sure to obtain price quotations and engineering assistance for your complete tower needs from America's foremost tower erection service.

ROHN SYSTEMS, INC.

6718 W. Plank Road

Peoria, Illinois

See Us at Booth 57W at the NAB Show

Circle Item 45 on Tech Data Card

BROADCAST ENGINEERING

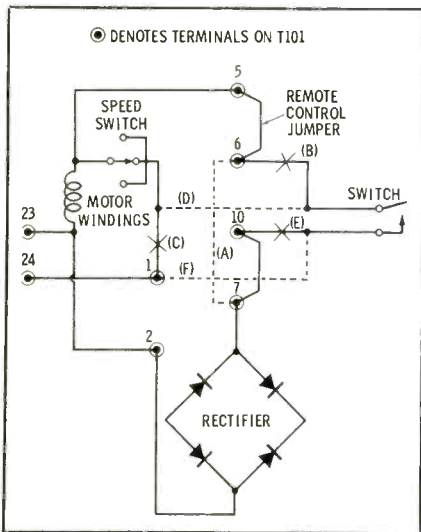

point 10, and connect it to point 1.

To replace the rotary record/play switch, follow the diagram that shows the push button actuated relay assembly. When the circuit is wired as shown, the record relay will be energized by depression of the record button in the forward mode. In any other mode, the relay will drop out.

The relay mounting bracket is constructed of 1/16" aluminum formed as shown in the diagram. The assembly is held in place by the push button switch bushing, when it is mounted on the panel in place of the old rotary switch.

A new 6 conductor power cable will be required to provide the extra wire for the relay; this lead is tied to pin No. 5 on plug P105. (In both diagrams, the dashed lines indicate new wiring.)

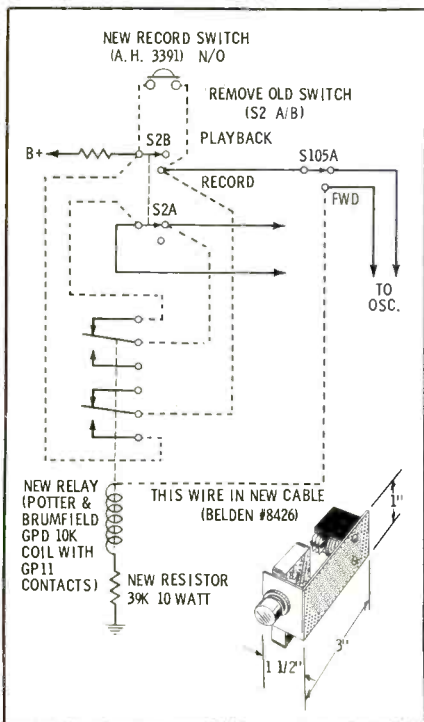

Enjoy Dynamic Programming with Spotmaster ... the International Standard of Excellence in Cartridge Tape Systems

Check SPOTMASTER

- ✓ Compact and rack-mount models
- ✓ Recorder-playback and playback-only models
- ✓ Monophonic and stereo units
- ✓ Delayed programming option
- ✓ Superior quality

500A
Compact
Recorder-
Playback



500A-R
Rack-Mount
Recorder-
Playback

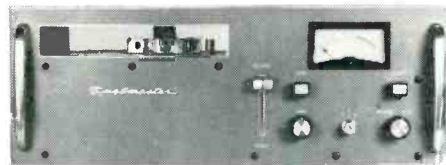

SPOTMASTER tape cartridge equipment is the preferred choice on five continents. These quality-engineered machines permit snap-in cartridge loading and split-second, one-hand operation ... plus all the other time-tested and field-proven SPOTMASTER features.

Write or phone today for full details about the wide range of rugged, dependable SPOTMASTER equipment ... their outstanding features and options ... modular construction ... easy maintenance ... complete line of accessories ... competitive prices ... lease/purchase plans. Remember, all SPOTMASTER models are backed up by an ironclad, full-year guarantee.

NEW DELAYED PROGRAMMING OPTION

The optional SPOTMASTER 500 A-DL (Delayed Programmer) provides a 5-second to 16-minute delay in the broadcast of program material. Permits instant censoring and deletion of objectionable material from interviews and other live originations while the program is on the air ... also meets many other delayed programming requirements. With the DL function switched off, the unit operates as a standard 500A recorder-playback. Available in rack or compact models.



BROADCAST ELECTRONICS, INC.

8800 Brookville Road, Silver Spring, Maryland
Telephone: Area Code 301 • JUniper 8-4983

Sold nationally by:
VISUAL ELECTRONICS
356 W. 40th St., New York, N. Y.

Canada:
Northern Electric
COMPANY LIMITED
Branches from coast-to-coast in Canada

Tape Techniques

(Continued from page 19)

Since the composite signal has already been geometrically positioned on a line-by-line basis to an accuracy of .03 microseconds, the further phase corrections are invisible from a geometric standpoint, but they serve to render the proper hue (dominant wavelength) to each horizontal line in the image. The advantage of this system is that it gives a full-bandwidth monochrome image, since no band separation or band limiting occurs. It is also capable of correcting the subcarrier phase on each line to an accuracy of ± 4 nanoseconds. This high degree of correction yields a stable subcarrier pattern, guaranteeing dot interlace.

Advanced Signal Systems

The bandwidth capabilities of present-day transverse recorders are limited by the transducers in the video head assembly. The upper frequency limits of these transducers, which are a direct result of their resonant frequencies, are in the order of 7 to 8 mc. This figure is the upper deviation boundary for the FM modulation system. It is necessary to make the lower deviation boundary as high as possible to avoid intermodulation between the minimum carrier frequency and the maximum information-carrying video frequency. For normal American systems, no serious problem has been encountered since a 4.2-mc bandwidth can be fitted into this spectrum without difficulty. To minimize interaction in a color recorder, which contains high-energy information around the subcarrier frequency of 3.58-mc, the carrier deviation for color recording is somewhat narrower than for standard monochrome operation.

European television systems involve a wider bandwidth (5.5 mc) and a considerably higher subcarrier frequency (4.3 mc). This requirement has led to the development of a specialized video recorder capable of handling a 625-line NTSC signal. Since the carrier and deviation had to be moved up to accommodate the signals, it was necessary to increase the head response spectrum. This was done by mounting a four-channel nivistor preamplifier adjacent to the head drum, thus reducing lead length and stray capacitance.

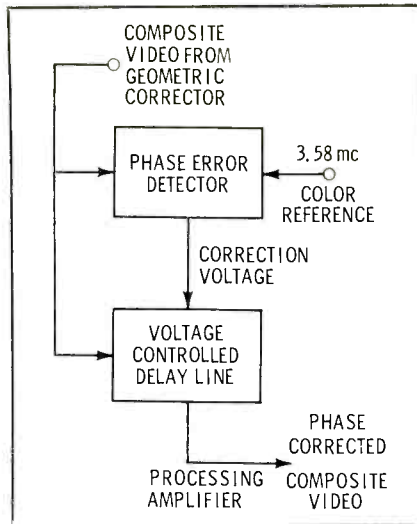

Fig. 4. A color phase correcting system.

The transducer resonance is now in the order of 10 mc, which permits operation of carrier and deviation from 7 to 9 mc. In addition to this change, considerable improvement with regard to differential gain and phase in the rest of the signal path was also accomplished. The result is an effective bandwidth of 5.5 mc, down 6 db at 6 mc. Carrier limits are 7.2 and 9.3 mc, and differential gain and phase are adequate for NTSC color operation. Signal-to-noise ratio is in the order of 43 db and moiré in the order of -34 db. The K factor for a 2T pulse is better than 2%. The application of these developments to the 525-line standard would yield considerable improvement; however, it would require a change in presently established operational standards.

The Helical Recorder

Experimental work on helical recording has been going on since 1956 and has resulted in a number of different approaches to the problem, which have spawned a growing variety of machines with no com-



Fig. 5. A helical recorder which uses 1" tape and plug-in circuit board modules.

mon standard. It seems unfortunate that compatibility was not considered as an important factor by the various manufacturers, and at the present time none of the helical recorders will interchange tapes with each other. The basic advantage of helical recording lies in the inherent simplicity as compared to transverse or quadraplex machines.

Helical recording is possible with either one head or two, the tape being wrapped in either a full helix or half helix. The advantage of the single-head approach is further simplification. The disadvantage is the dropout, or crossover period, when no signal is available while the head is going from one edge of the tape to the other. This dropout period can be placed in the vertical blanking interval and masked by regenerated blanking signals that are added into the composite output. The two-head approach permits scanning the tape for a little more than 180° by each head and thus provides an overlap period during which head switching can be accomplished. Helical recorders are inherently less time-base stable than transverse recorders because the scanning angle is shallow (approximately 9°) and is therefore in the direction of longitudinal motion.

In a transverse recorder, the time-base stability of the image is directly related to the rotational stability of the head assembly. Since the scanning is at right angles to the tape motion, any flutter and wow in the tape affects only the audio track and is of no concern to the video image. The helical recorder, however, has its video writing head moving in almost the same direction as the tape. Consequently, instabilities in tape motion and head rotation sum up to produce a more detrimental time-stability figure. The simpler helical recorders, although adequate for closed-circuit operation, cannot have their output signals transmitted on the air because they do not meet FCC horizontal-stability requirements. It is necessary to add additional servo controls to make a helical recorder acceptable for broadcast use.

Tape Transport

The transport system of a helical recorder must provide two basic functions. The tape must be moved from reel to reel over a relatively



Fig. 6. This helical model employs 2" tape and has a "joy-stick" tape motion control.

large scan area in which the rotating head assembly is located, and the guiding must be precise. The movement of the tape must be done with great longitudinal speed accuracy, and the tension on the tape must be maintained within fairly close limits to permit subsequent interchangeability between similar machines. Since the scan angle is shallow, the track on the tape is relatively long. Any changes in tension between record and playback will cause the video head to mis-scan the track and produce time-base errors as well as a poor signal-to-noise ratio. Obviously, in addition to the longitudinal speed accuracy, the tape must be guided in and out of the scan area with great precision so that it will occupy in replay the exact position that it did in record, regardless of what machine the recording was made on.

To make the recorder economical in operation, relatively low tape speeds are used to give long playing times for a small reel. The head-to-tape speed of the scanning assembly must be high enough to record frequencies in excess of 3 mc and is, therefore, in the order of 500 to 700 inches per second. A typical recorder weighs less than 100 pounds and can provide up to five hours of continuous program material. In addition to the video, there are two audio tracks and a control track for playback timing. The tape longitudinal speed is 3.7 inches per second, and each head records a little more than a complete field of a 60-field television signal. The nonbroadcast type helical recorder does not require a tape-tension servo, and differential stretch of tape is compensated for by a manual control. Typical broadcast models of helical recorders are shown in Figs. 5 and 6. ▲

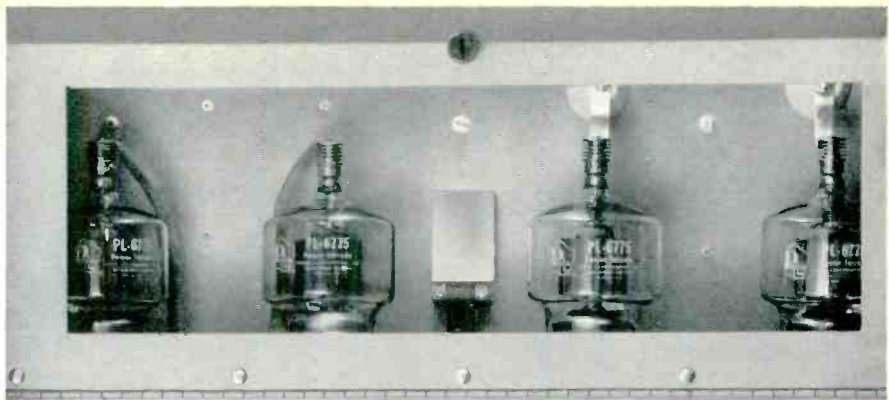

" PL-6775 TETRODE RUGGED . . DEPENDABLE "

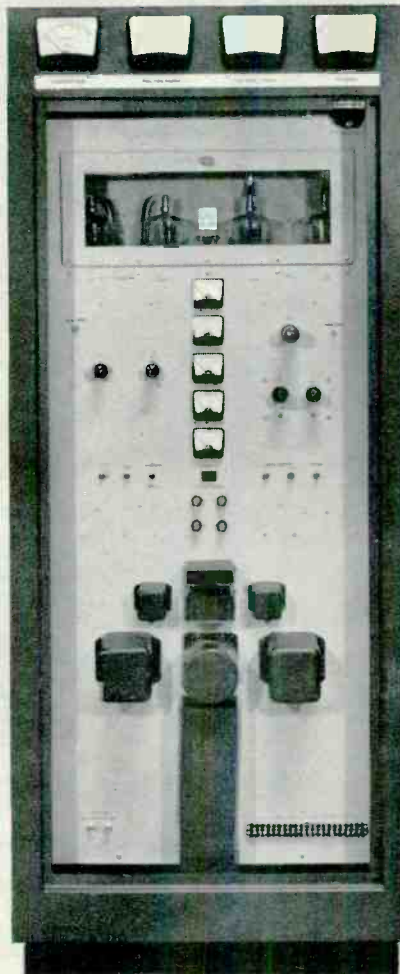

"We have found the PL-6775 dependable and rugged and capable of extended long life without the possibility of internal shorts."

Those are the words of Mr. Paul Gregg, Sales Manager of Bauer Electronics Corporation, manufacturer of quality broadcast transmitters and accessories. Shown in the photographs are Bauer's Model 707 1000-watt AM broadcast transmitter, which uses Penta PL-6775 power tetrodes in both the modulator and RF amplifier.

Mr. Gregg is not alone in his praise of the PL-6775. Many broadcasters have switched to the PL-6775 and found it an excellent tube. Directly interchangeable with the 4-400A, the PL-6775 features a one-piece plate cap and seal, exclusive ribbed anode for even distribution of heat, and a special filament insulator which minimizes the possibility of inter-electrode shorts.

Take the first step toward improved performance, today, by writing for your free copy of the PL-6775 data sheet. We'll include a copy of our latest Summary Catalogue, which briefly describes all Penta products and gives their prices.



PENTA LABORATORIES, INC.

312 NORTH NOPAL STREET, SANTA BARBARA, CALIFORNIA

EXPORT DIVISION: FRAZAR & HANSEN, SAN FRANCISCO 11, CALIF.

Circle Item 27 on Tech Data Card

Professional Line Stereo Magnetic Tape Heads by NORTON



Send now for technical literature with specifications on the complete Norton line of magnetic heads.

NORTON
ASSOCIATES, INC.

240 Old Country Road, Hicksville, N.Y.

Circle Item 28 on Tech Data Card

SPOTMASTER Tape Cartridge Winder



The new Model TP-1A is a rugged, dependable and field tested unit. It is easy to operate and fills a need in every station using cartridge equipment. Will handle all reel sizes. High speed winding at 22 1/2" per second. Worn tape in old cartridges is easy to replace. New or old cartridges may be wound to any length. Tape Timer with minute and second calibration optional and extra. Installed on winder or available as accessory. TP-1A is \$94.50, with Tape Timer \$119.50.

Write or wire for complete details.

Spotmaster

BROADCAST ELECTRONICS, INC.
8800 Brookville Road
Silver Spring, Maryland

Circle Item 29 on Tech Data Card

FCC FM/TV

(Continued from page 15)

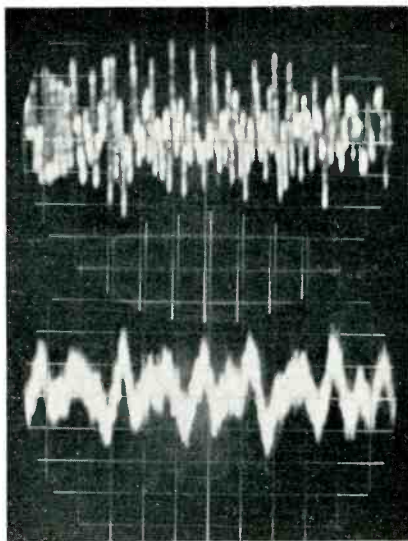

Fig. 9. Typical FM modulation displays.

number of centimeters deflection above and below the center line of the graticule. With the oscilloscope so calibrated, the received signal is then tuned in, and the percentage of modulation is read from the oscilloscope graticule.

One word of caution is given to those who may care to duplicate this method of modulation measurement. It is important that the coaxial-cable leads connecting the oscilloscope to the receiver discriminator be kept as short as possible. The distributed capacitance of this lead will bypass the high-frequency components of the audio and result in an underdisplay of the high frequencies on the oscilloscope.

When the station under measurement is using SCA injection, the SCA signal will show up as a broad line on the oscilloscope; the width of this line is proportional to the amount of injection of the subcarrier. It is at these higher frequencies that the capacitance of the interconnecting cable becomes critical.

The spectrum analyzer shown in Fig. 7 operates directly from the tuner output (21.4 mc) and has a maximum display width of 1000 kc. With it we are able to obtain a visual display of the signal and sidebands or spurious products associated with it. Using the logarithmic scale and tables compiled from Bessel functions, the injection of a stereo pilot carrier is determined. The top display in Fig. 8 shows the spectrum-analyzer display with 75-kc sweep at a modulating frequency of 7500 cps being fed into the re-

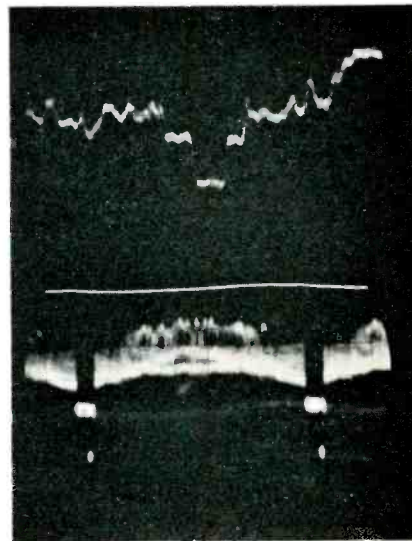
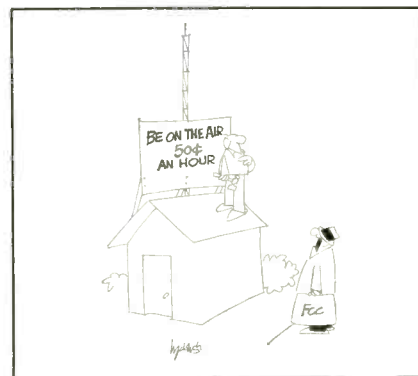

Fig. 10. TV signal oscilloscope displays.

ceiver from the sweep generator. The lower display, made with no change in sweep width, shows the spectrum of an FM station using 67-kc SCA carriers. The photo was taken during a period of low modulation to obtain better clarity.

The top exposure in Fig. 9 shows a typical FM broadcast station modulation display on the oscilloscope. This station carries a 67-kc subcarrier for background music. This is the same signal shown on the spectrum analyzer in Fig. 8. The lower exposure in Fig. 9 shows the modulation display of an FM station not employing a subcarrier. Both of these stations were peaking at approximately 100% total modulation; however, the first station has approximately 15% of its modulation devoted to the subcarrier insertion. Therefore the excursions above and below the mean center are less in the photograph.

The swing of the SCA carrier is measured in the same manner as that of the main carrier, except that the Univerter output is fed into the



"Yes, You! . . ."

BROADCAST ENGINEERING

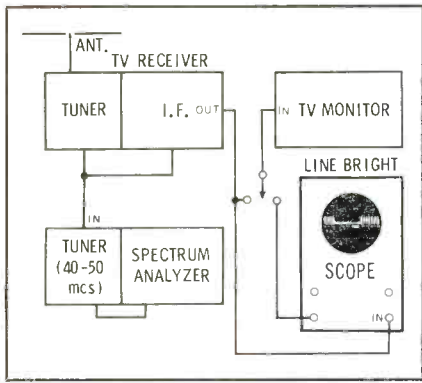

Fig. 11. Block diagram of television waveform and spectrum analysis circuit.

SCA-receiver IF input and the oscilloscope is calibrated for 7.5 kc swing at 455 kc.

TV Waveform Analysis

Little need be said concerning these measurements since all TV engineers are familiar with the process. The only difference in our case is that we use a signal off the air to feed the TV analysis oscilloscope. A zero-carrier device with a trigger circuit has been added to the receiver to provide for visual modulation measurements in much the same fashion that the chopper operates on the transmitter monitor. Fig. 10 shows an expanded horizontal pulse in the top display and a vertical field with the zero-carrier (100% modulation) line in the lower display.

The spectrum analyzer depicted in Fig. 11 is a different one from that mentioned under FM modulation measurements. This analyzer has a maximum display width of

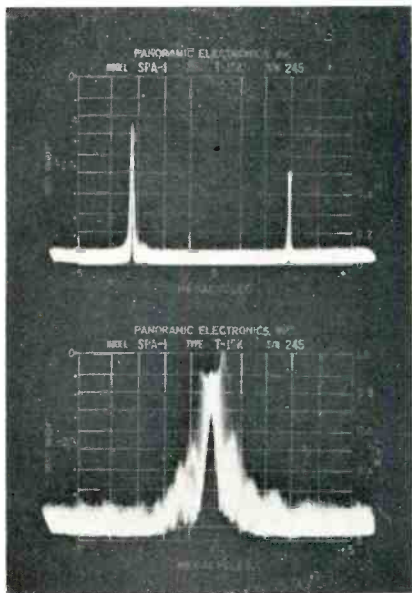
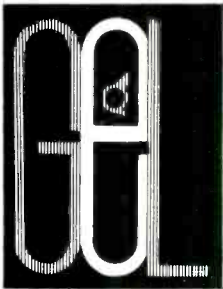

Fig. 12. Analyzer displays of TV signals.

10 mc for TV analysis. It is fed from the TV tuner at the 40 to 45 mc intermediate frequency. Its primary use is for measuring the relative strengths of the visual and aural carriers and for detecting undesirable sideband products or mixtures. With full sweep applied to the transmitter, an accurate determination of the lower-sideband attenuation can be made. The photos in Fig. 12 were taken from this analyzer. The top display shows the relative amplitudes of the visual and aural carriers. In this photo the

gain of the analyzer was drastically reduced, and there is very little excursion of the trace for the video modulation products. In lower display, only the visual carrier is shown (expanded) with the gain of the analyzer increased.

There is much more to the story of our measurement work — more than could be covered in a single article. What I have given in this article is a summary of the equipment carried by the TV enforcement Units of the FCC and a glimpse at our operations. ▲



BROADCAST DIVISION

has become...



with the dependability and expert craftsmanship known internationally in broadcasting.

rust corporation of america
195 Massachusetts Avenue, Cambridge, Mass.

GEL FM STEREO TRANSMITTERS
RUST REMOTE CONTROL AUTOLOG

Circle Item 30 on Tech Data Card

ANNOUNCING! NEW TOOL TO SOLVE TV LIGHTING PROBLEMS



Now used by major TV networks and stations in U.S. and abroad, the A-500 spot brightness meter permits fast analysis of any TV lighting problem. Features $\frac{1}{2}^\circ$ acceptance angle—1/4000 typical scene. Selectable color response—film, TV, eye. Applications include rapid, accurate measurement of scene luminance (brightness) ratios, lighting balance, screen brightness, costume and scenery reflectance, and kinescope brightness and contrast. Two versions: A-500 fL for measuring footlamberts and A-500 EC with integral exposure computer. Write for brochure.

GAMMA SCIENTIFIC, INC.
5841 Mission Gorge Road, San Diego 20, Calif.

In Action at NAB—Booth O

Circle Item 31 on Tech Data Card

OUR SECOND BEST* SALESMAN . . .

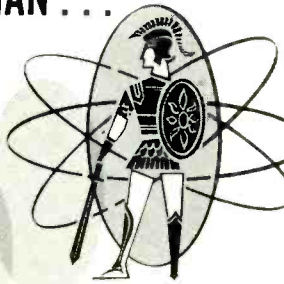

THE SPARTAMAN

The "Spartaman" is your area sales representative of SPARTA ELECTRONIC CORP. — the man qualified to help you solve your broadcast equipment needs with technically superior, performance-proven equipment for AM, FM, Television, and Stereo broadcasting . . . including cartridge tape systems and other studio equipment.

If you don't know your "Spartaman", call or write us direct.

* OUR PRODUCTS ARE
OUR BEST SALESMEN!

SPARTA
ELECTRONIC CORPORATION
6430 FREEPORT BOULEVARD
SACRAMENTO 22, CALIFORNIA
Circle Item 32 on Tech Data Card

NEWS OF THE INDUSTRY

Color Television for Brazil

The first British image orthicon color channel to be sold outside the U.K. has been ordered from Marconi by Televisao Excelsior of Brazil. Previously ordered equipment includes 18 Mark IV camera channels, one 16mm fast-pull-down telerecorder, telecine equipment, and a wide range of special effects devices delivered recently. This latest order is for one color channel plus two 21" color monitors, modified to accept a coded input, and ancillary NTBC coding equipment. The camera channel ordered is identical to that which was demonstrated at the Fourth National Electrical and Mechanical Fair at Sao Paulo in the summer of this year. The Marconi 3" I.O. Color Camera Channel, Type BD 848, incorporates a tilting viewfinder which is affixed to the top of the camera and may be adjusted over a wide range according to the camera angle. A versatile control unit is included which is interchangeable with the one used on the three-vidicon color camera. The camera channel is currently in use with the BBC for their color television experimental transmissions, and also by the Smith Kline and French mobile color TV unit for hospital demonstrations of surgical techniques.

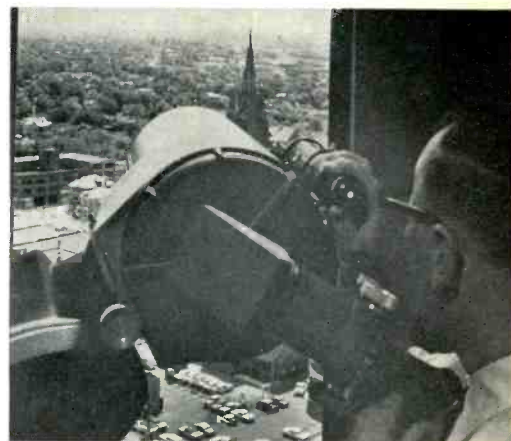

Over the rooftops of Fort Wayne, Ind., voice communication is carried on via a 10-ke channel riding a helium-neon gas laser beam. The 3.3-mile path is between the ITT Industrial Laboratories plant and the Lincoln Tower Building in downtown Fort Wayne. Optically, the transmitter uses Brewster windows and confocal optics coupled with a collimator and 2" aperture lens. The receiver, shown here, is an 8" cassegranian telescope with a special ITTIL-developed multiplier phototube.

KHJ Adds News Facilities

A major expansion of local coverage facilities, part of KHJ Radio's stepped-up emphasis on news, was announced today by Martin S. Fliesler, vice president and general manager of the RKO General Broadcasting station. The facilities include three cars equipped with two-way radios that enable the vehicles to remain in constant contact with the newsroom while cruising greater Los Angeles. The equipment is dual-channel, operates in the 450-mc band, has a transmitter output of 15 watts, and is crystal-controlled. Installation of a repeater station on Mt. Wilson to increase both coverage area and dependability is currently under way. In addition, the station has installed new fixed-frequency, crystal controlled short-wave monitors in its news-room to keep tabs on activities of the Los Angeles City and County Fire Departments, Sheriff's Department, California Highway Patrol and Los Angeles Police Department; each agency has issued appropriate authorization.

Two Fla. CATV's Jointly Owned

The Jerrold Corp. and Meredith Broadcasting Co. of Omaha, Nebr., have contracted for joint-ownership of two new CATV systems to be installed at Melbourne/Eau Gallie, and Ormond Beach, Fla. The new CATV systems will provide expanded TV and FM coverage for over 18,000 homes. Jerrold Electronics is to install and maintain the new systems. This is the first venture in CATV for Meredith Broadcasting, a division of the Meredith Publishing Co. ▲

Uganda Orders Antennas

Five television broadcasting antennas were recently ordered by the Government of Uganda, in East Africa, from Jampro Antenna Co. Jampro supplied that country's first TV antenna in June of 1963, for its station at Kampala, which began broadcasting on October 6, 1963. The 7-mc-bandwidth CCIR antennas are designed for tower-leg mounting, with both omnidirectional and directional patterns. The six stations will all use Marconi 5-kw transmitters and notch diplexers to feed the 14-bay antennas. Each antenna, on a 500' tower, has a power gain of 12, for an erp of approximately 54 kw.

FM Net Organized

WVBR-FM, Ithaca, N. Y., recently began a special evening program service by air relay to WCLF-FM in Corning, N. Y., and WKOP-FM, Binghamton, N. Y. To be known as the Cornell Radio Network, the hookup will operate between 7:30 and 10:30 every evening except Saturday, featuring programs of classical music and special affairs. All programming will originate at WVBR-FM, an independent station owned and operated by students of Cornell University. In 1958 it became one of four student-owned-and-operated college stations to receive a commercial FM license. In 1961 WVBR-FM was the first college station in the country to operate throughout the year, and the first such station to affiliate with a major commercial network (QXR).

ABOUT THE COVER

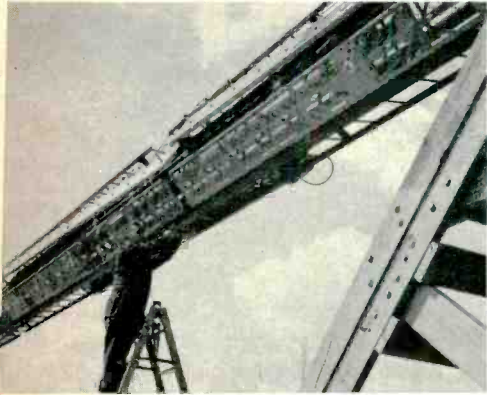

On July 1, 1963, Bakersfield, Calif., NBC affiliate KERO-TV changed from VHF channel 10 to its new UHF channel 23. The conversion was made in line with the FCC's decision to make all telecasting in the area UHF. Since a UHF signal transmitted at the same power used for VHF would reach only a fraction of the existing audience, the Transcontinental Television Corp. station management and engineers decided to design a new transmitting system for the maximum power output allowed by the FCC — 1.76 megawatts erp at 3,697' above average terrain (equivalent to 5 megawatts at an effective height of 2,000'). A G-E zig-zag panel UHF antenna and the first G-E 25-kw UHF klystron transmitter were installed at the station's transmitter-antenna site 22 miles east of Bakersfield, atop Mt. Breckenridge (the scene shown on this month's cover). Supervisor Vernon Shatto is seen below in the transmitter building opening the visual amplifier door of the big transmitter's 100-watt exciter. The setup provides a modified cardioid pattern which covers the entire southern San Joaquin Valley; antenna gain is 74.4 in the maximum lobe. The 60' antenna, which consists of 10 panels and has a combination of 1.5° mechanical and 1.5° electrical tilt, is protected in a 5' diameter fiberglass radome. In commenting on the switch to UHF, Arthur M. Mortensen, KERO's general manager, said, "We are proud to be a part of this advancement of the television industry and happier still that we will be able to continue our service to our loyal viewers and . . . to bring the commercial messages of our fine sponsors into the maximum number of homes in our market area."

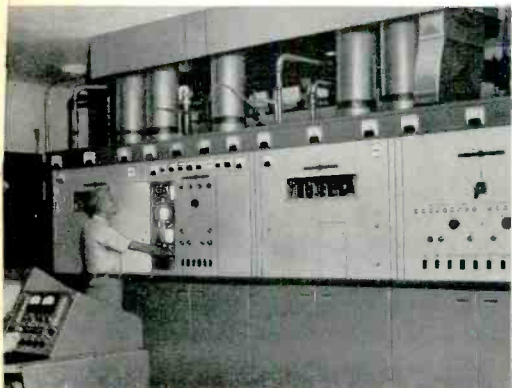

SIMPLICITY . . . RELIABILITY

from the leader in solid-state video switching systems

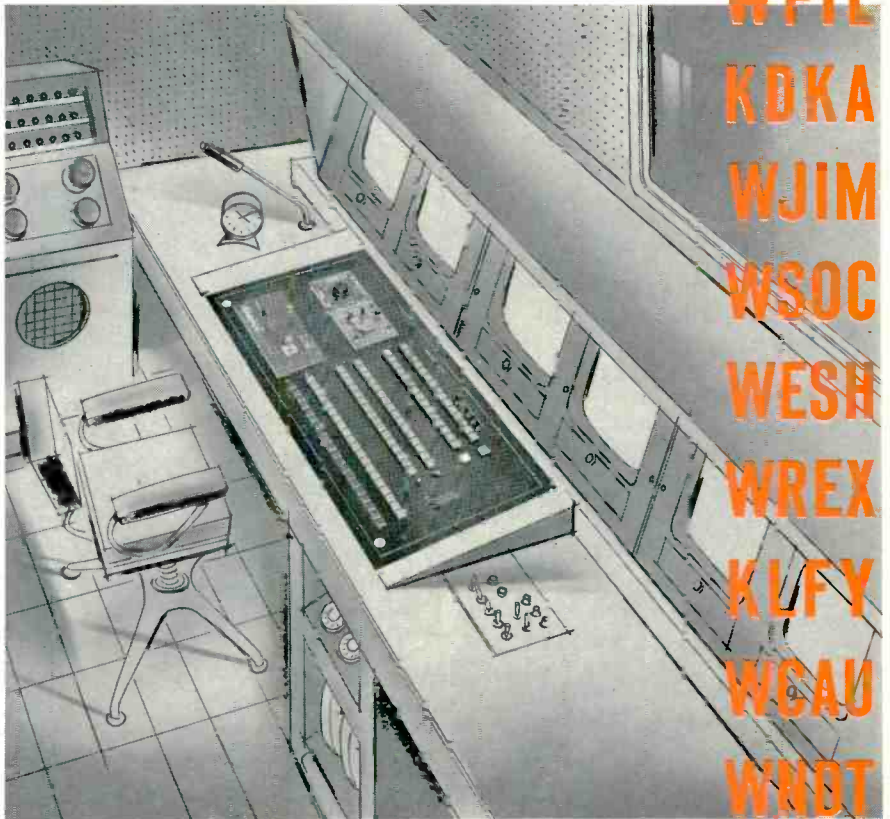

THE BIG SWITCH

...to top performance with **economy**

Visual's leadership in performance-proven video switching systems is unmatched in the broadcast field. Whatever the switcher requirements — large or small — Visual's switching system provides maximum flexibility.

Contact Visual for your video and audio switching system requirements.

VISUAL, *the leader* . . .
is first to offer a complete
solid-state broadcast facility

VISUAL ELECTRONICS CORPORATION

356 west 40th street • new york, n. y. 10018 • (212) 736-5840

Circle Item 33 on Tech Data Card

KPIX

WFIL

KDKA

WJIM

WSOC

WESH

WREX

KLFY

WCAU

WNOT

WVFT

KUED

KLIX

BOL-TV

PTV



For ALL Your Ampex 350 Series Cabinets... Look to LANG!

LANG 350 SERIES RACK CABINET

A compact housing for all Ampex 350 and 400 series Recorders/Reproducers and a flexible approach to most mounting problems, with wide choice of panels. Horizontal position of the tape transport provides ease of operation.



Price complete: \$65.00

LANG DE LUXE CABINET



This sturdy attractive, and compact housing for all Ampex 350 and 400 series Recorders/Reproducers has extremely rigid construction with adjustable vertical mounting rails to permit installation of virtually any type of equipment. 1/2" recessed panel mounting and rounded corners makes this Lang Deluxe Cabinet second to none. Wide choice of panels and mounting material available. Comes complete with casters.

Price: \$99.00

LANG 350 SERIES CONSOLE

Cabinet provides for comfortable editing at desk height with ample leg room and accommodates any single or multi-channel 350 series Ampex Recorder. Meter panels are mounted at eye level with additional space for monitor amplifiers and speakers. Unique construction provides easy accessibility to service all components.

Prices start at \$160.00

For complete details and the new 1964 Lang Catalog write to:



LANG ELECTRONICS INC.
507 FIFTH AVE., N. Y. 17

Circle Item 42 on Tech Data Card

NEW PRODUCTS

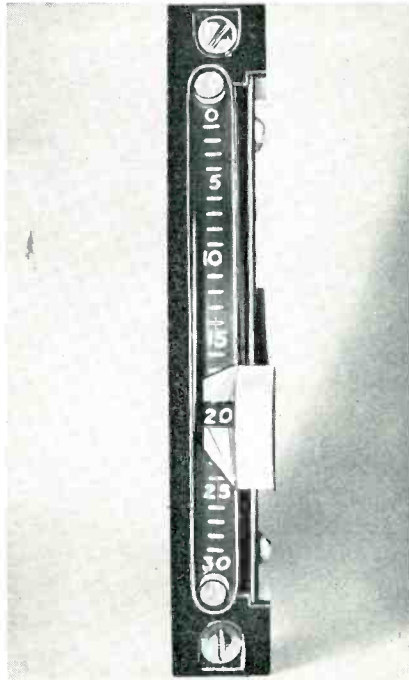

Curved-Front Attenuators

Painton & Co., Ltd., Northampton, England, has established an American subsidiary, Painton, Inc., to sell its line of audio and video faders to American broadcasting stations and recording companies. According to the American company, a large quantity of Painton's curved-front attenuators have been purchased by CBS for their new broadcast center in New York City. Other substantial orders have been received from various broadcasting stations and recording companies, including 200 faders for Columbia Records. Most popular in the line is Model EM-2 Edgewise Miniature Fader which was originally designed for BBC Studios at White City, London. The compact design allows adjacent mounting in minimum space on control desks. Two assemblies having inversely operating networks can be mounted side by side, and by coupling the knobs, complete two channel mixing can be effected in a single control. Easy removal of the plug-in instrument from its panel, and the clip-on dust cover, enable convenient periodic contact cleaning. Other EM2 features are: 3/4" mounting centers; edgelit, translucent scale; low-noise contacts, plug and socket connection.

Circle Item 46 on Tech Data Card

Desoldering Iron

The Endeco Model 100-A desoldering-resoldering iron, designed to reduce the time for electronic circuit repairs, is available from Enterprise Development Corp. The iron saves considerable of the time formerly required for removing soldered components. Requiring only one hand to operate, the iron features a vacuum pickup for melted solder that leaves terminals and mounting holes clean. Useful for compactly designed

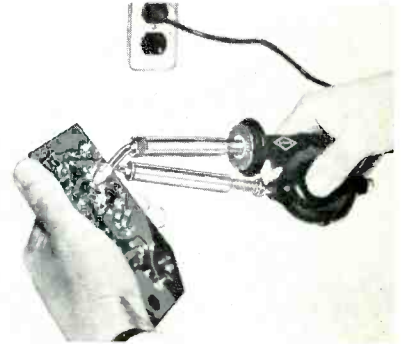

broadcast equipment — especially that employing printed boards — the iron reaches into corners and other areas normally inaccessible. Controlled heat is reached in about 2 minutes; clean desoldering requires two to three seconds per terminal. A temperature control prevents over-heating.

Circle Item 47 on Tech Data Card



Illuminated Push Button Switch

Dialight Corp. has announced the DIALCO Series V illuminated push button switch. It is designed for applications where miniaturization is a prime requirement—notably for use in control boards and switching equipment. The unit is of the momentary type, requiring light operating pressure. The circuit is completed by a flexible bridging member meeting two stationary contacts, giving a double break action. The contact arrangement is single pole, single throw, normally open. Switch ratings are: .1 amp, 125 volts AC; and .1 amp, 30 volts DC (noninductive); insulation, 1250 volts AC breakdown. The switch contact points are gold plated; life is at least one million operations at rated values. Illumination is from a replaceable T-1 3/4 midget flanged-base incandescent lamp, available in a range of voltages to 28 volts.

Circle Item 48 on Tech Data Card

TV Tape Machines

Three television tape machines, including the industry's first designed exclusively for playing back TV tape were announced recently by RCA. A transportable tape recorder, compatible with

BROADCAST ENGINEERING

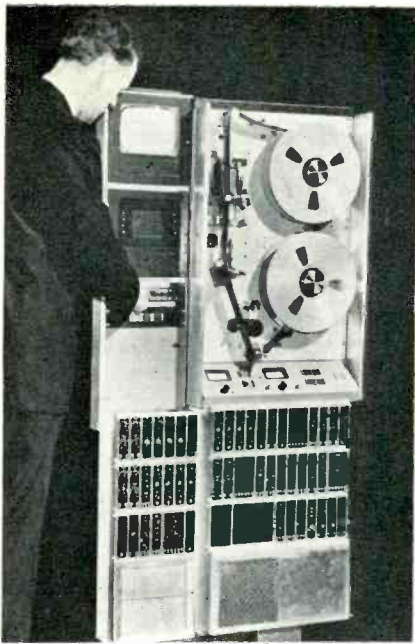

TV broadcast standards, and a compact recording-playback system round out the trio. The units are fully transistorized and designed for color operation as well as black-and-white. By using the quadruplex recording method, the machines are fully compatible with the approximately 2,000 professional TV tape recorders now in worldwide use. The playback machine, TR-3, provides a professional yet economical means for previewing tape-recorded programs and commercials. The transportable unit, TR-5, is contained in a small cabinet which can be wheeled into a station wagon or other vehicle for travel to a remote recording location. The third product is a compact TV tape recording-playback system, the TR-4. Each of the TV tape units is available in two models, one for U. S. line standards, and an international model that can be switched for operation on either of two standards.

Circle Item 49 on Tech Data Card



Turntable Combination

A complete turntable unit including an equalized turntable preamplifier, pickup cartridge, tone arm, and professional turntable, all packaged in an attractive functional cabinet, is announced by Sparta Electronic Corp. The cabinet is

constructed of wood, finished in dove grey bonded plastic laminate. A large access door at the front provides a service entrance and storage space. Leveling screws compensate for uneven floor surfaces. The turntables are available with a standard four-pole or a Bodine synchronous motor; both 12" and 16" models offer the "platter-dapter" for playing 45 rpm records. A single positive-indexed lever controls the selection of 33 $\frac{1}{3}$, 45, or 78 rpm speeds. Constructed of cast aluminum with a precision machined and balanced platter, the turntable boasts wow and flutter of less than .05% at any of the three speeds. The CT combination units are equipped with the Gray 12" 212TN or 16" 208 SG tone arms. Rek-O-Kut or other tone

arms of customer's choice are available on special order. Included is a Sparta TEP-2 for RIAA equalized preamplification. A selector switch is provided for high frequency roll off. Gain of the preamp is adjustable from -22 to +12 with 12 mv input. The TEP-2 is fully transistorized, includes a self-contained power supply and, as standard equipment has an output transformer for balanced or unbalanced 150/600-ohm output impedance. A GE VR11 variable reluctance turn-around cartridge (Model 4GD) is supplied with 1 mil diamond and 2 $\frac{1}{2}$ mil sapphire styli. Other equivalent units may be used if desired. Prices for the CT series range from \$315 to \$455.

Circle Item 50 on Tech Data Card

SECURE INVESTMENTS:

SCA MULTIPLEX RECEIVERS and TRANSISTOR AMPLIFIERS
from *McMartin*

Leading Equipment Supplier To The FM Background Music Industry

**TN-66CB
MULTIPLEX
TUNER**



**HIGH
SENSITIVITY**

- Sensitivity: 1 uv for 30 db quieting
- Crystal controlled
- Main or sub-channel switch
- Top chassis test points
- Stereo filter available.

**TN-77CB
TUNER and
5 WATT AMP**



**LOW
MAINTENANCE**

- All tuner functions plus full-rated 5 watt amplifier
- 8 ohm and 70.7 volt output
- Bass and treble controls
- Microphone input separately controlled.

**TN-88B
TUNER and
15 WATT AMP**



**CONTINUOUS
DUTY**

- All tuner functions plus full-rated 15 watt amplifier
- Paging, output, tone, and automatic muting circuits identical to the TN-77CB.

**TRANSISTOR
AUDIO AMPS
LT-80A LT-300**



**RELIABLE
QUALITY**

- Studio monitoring, cueing, utility
- Music distribution
- Temperature stable
- 19" Rack mount available
- Compact 8 and 32 watts rms.

Originality by

McMartin

McMartin Industries, Inc., 605 N. 13th St., Omaha, Nebr., Code 402 ■ 342-2753
In Canada Sold by: Canadian Marconi Company, Montreal 16, P.Q.

Circle Item 34 on Tech Data Card

NEW IMPROVED ATC 55 FROM AUTOMATIC TAPE CONTROL

See this newly engineered multiple cartridge handler at the NAB show, April 5-8. Built into a standard Cabtron rack cabinet, the improved ATC-55 may be made a part of your existing automatic broadcasting equipment or may be used as a cartridge library for live broadcasting.

Check these features :

- New positive indexing direct current braking system.
- New gravity lock cartridge loading stops.
- New element guided floating cartridge storage rack.
- New quieter operation.
- New ease of maintenance.
- Adaptable to existing automatic systems.
- Can be used with ATC Automatic Program Logging.
- Automatic Electric dual contact relays used throughout.
- Available in stereo.

Make it a point to stop in and see this new and improved cartridge handler at Booth 24-W at the 1964 NAB. Or, write ATC for literature and more information.

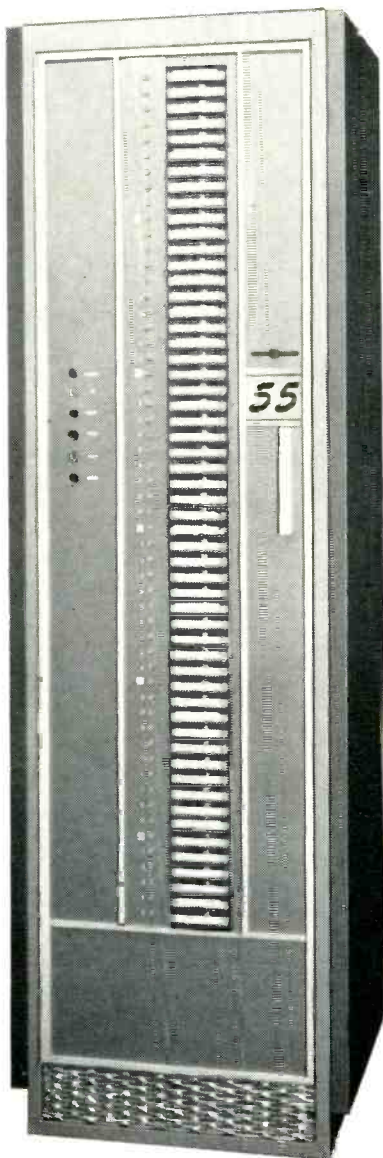

AUTOMATIC  **TAPE CONTROL**
1107 E. Croxton Ave. Bloomington, Illinois

Circle Item 35 on Tech Data Card

Silicon Rectifier

(Continued from page 17)

necting diodes in series. Three thousand volts represents no magical number with which to distinguish high from low voltage, but it does more or less mark the line which separates the problems of the two.

Design and construction of reliable high-voltage assemblies involves more than connecting a string of diodes in series. As a matter of fact, even if the individual diodes in such a string were of the highest possible reliability, the completed assembly could not be guaranteed. For one thing, when diodes are series connected, certain circuit and system phenomena develop that did not exist before. A good example is the hole-storage effect, more commonly known as diode recovery time. In an elementary circuit employing one or two diodes in series, the effect can be undetectable in a majority of applications. In high-voltage assemblies, it is one of the most important factors governing design.

Additionally, each diode in a series must be shunted with a capacitor and a resistor to optimize voltage distribution and to prevent overloading of individual units and consequent breakdown.

Finally, the reliability of a silicon-rectifier assembly cannot be separated from its electrical rating and its application. Diodes must be selected first for their overload capacity and second for the average current they are expected to carry. This is to insure they can handle short-circuit currents. The margin of safety results in the diode operating at lower than designed maximum junction temperature, which in turn increases voltage capability. The minimum voltage safety factor in high-voltage applications is 1.33 to 1.

In addition to this minimum voltage safety factor built into the individual diodes within a high-voltage assembly, the assembly itself is so constructed that performance is unaffected by the failure of a diode. If two out of fifty diodes fail, the other forty-eight will support the slightly increased load placed on them. Since 99.9% of diode failures are shorts, only a slim possibility of an open circuit exists. To insure

Does Your Station Have the

"BIG VOICE?"

Are you losing advertisers because you don't have the loudest signal in your area? Are they going to other stations because you don't have the "BIG VOICE?" Only DYNAMIC DIMENSION Control Equipment by FAIRCHILD, individually or integrated, can provide you with an easy-to-listen-to "BIG VOICE"—the loudest and cleanest signal in your area!

FAIRCHILD DYNALIZER Model 673

The newest approach for the creation of "apparent loudness"—the Dynalizer is an automatic dynamic audio spectrum equalizer which redistributes frequency response of the channel to compensate for listening response curves as developed by Fletcher-Munson. Adds fullness and body to program material. Completely automatic with flexible controls. Easily integrated into existing equipment.



FAIRCHILD CONAX Model 602

The world-acknowledged device that eliminates distortion problems caused by pre-emphasis curves. Allows higher average program levels through inaudible control of high frequencies. Invaluable in FM broadcast and disc recording. Eliminates stereo splatter problems in multiplex channels.



FAIRCHILD LIMITER Model 670

Fast attack stereo limiter (50 microseconds) with low distortion and absence of thumps. Sum and difference limiting position eliminates floating stereo image, despite amount of limiting used in one of the two channels. Also includes regular channel A and B limiting. Dual controls and dual meters provided. Now used throughout the world in recording studios. (Mono model available).

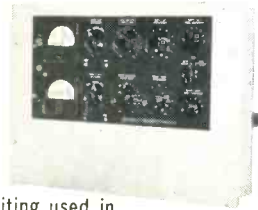

Write to Fairchild—the pacesetter in professional audio products—for complete details.

FAIRCHILD
RECORDING EQUIPMENT CORPORATION
10-40 45th Ave., Long Island City 1, N.Y.

Circle Item 36 on Tech Data Card

April, 1964

against even this, however, shunting capacitors have been designed to short circuit if a diode opens.

Current Installations

The first million-watt power supply was fitted with solid-state rectifiers in 1962. The supply feeds two 200-kw transmitters at Bethany, Ohio, which broadcast Voice of America programs to South America, Europe and Africa. Prior to the conversion, the rectifier cabinet (Fig. 2) housed equipment for three circuits. Two low-voltage bridge circuits, each employing four 872A tubes, provided bias voltages of 2 kv and 4 kv and plate voltages of 1 kv and 2 kv. The third rectifier, a high-voltage, six-phase, single-Y circuit, employed six 870A's to provide 15 kv plate voltage for the modulator and final amplifier. Two spare tubes, kept heated, brought the total number of 870A's in the cabinet to eight. Also housed in the cabinet were 16 filament transformers and many other components.

All of this equipment was removed during conversion. High voltage is provided by 12 silicon assemblies. These assemblies are shown on the shelves in Fig. 3. Two smaller silicon assemblies, mounted separately in the cabinet, each provide low voltage.

Economy realized by such a conversion is impressive; installation costs were equivalent to half the price of replacement tubes. Seven kilowatts of power, which had been dissipated in heat, were saved. The removal of old equipment in the rectifier cabinet—tubes, filament transformers, switching buses, heaters, and associated circuitry—has reduced maintenance costs.

Obviously, such large-scale savings are being enjoyed, for the most part, only at superpower transmitter sites. The fact that silicon-rectifier power supplies for transmitters of 50 kw and below provide the same degree of reliability, however, has resulted in many conversions now being made.

The combination—reliability and low price—may very well spell the passage of the mercury-vapor rectifier tube. And for the broadcast engineer, who is responsible for keeping the station on the air, this happy circumstance surely can't come too soon. ▲

INTRODUCING!

1 KW AM TRANSMITTER

Automatic Power Control and New Cabinet Styling. Exclusively offered as a "kit" or factory assembled.

1 KW FM TRANSMITTER

Featuring Automatic Power Control and the lowest tube investment in the industry.

5 KW AM TRANSMITTER

Offering Increased Reliability with a new twelve-phase high voltage Power Supply.

"LOG ALARM"

New . . . simple method to log transmitter readings with complete "remote control" features.

NAB BOOTH #52W

Bauer

ELECTRONICS
CORPORATION

1663 Industrial Road, San Carlos, California
Area Code 415 591-9466

Circle Item 44 on Tech Data Card

NEW BRIDGE SIMPLIFIES RF IMPEDANCE MATCHING

FROM
TRANSMITTER
COMMON POINT
OR
SIGNAL
GENERATOR

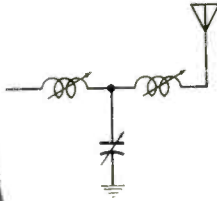

DELTA MODEL OIB-1 OPERATING IMPEDANCE BRIDGE

Connect in antenna lead, transmission line, common point, etc., turn on power (5 kw max.), adjust for null on meter and read R and X. Insertion does not upset directional parameters. Operating impedance is thus measured. In use by leading consultants and station engineers. (\$475.00)

DELTA ELECTRONICS



DELTA ELECTRONICS, INC.
4206 Wheeler Avenue, Alexandria, Virginia

Circle Item 37 on Tech Data Card

SPOTMASTER

RS-25



Tape Cartridge Racks

RM-100

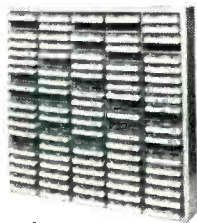

... from industry's most comprehensive line of cartridge tape equipment.

Enjoy finger-tip convenience with RM-100 wall-mount wood racks. Store 100 cartridges in minimum space (modular construction permits table-top mounting as well); \$40.00 per rack. SPOTMASTER Lazy Susan revolving cartridge wire rack holds 200 cartridges. Price \$145.50. Extra rack sections available at \$12.90.

Write or wire for complete details.

Spotmaster

BROADCAST ELECTRONICS, INC.
8500 Brookville Road
Silver Spring, Maryland

Circle Item 38 on Tech Data Card

ENGINEERS' TECH DATA SECTION

AUDIO & RECORDING EQUIPMENT

50. AUTOMATIC TAPE CONTROL—Brochure and spec sheet cover new solid state "Criterion" series cartridge tape equipment.
51. BROADCAST ELECTRONICS—Packet contains specs and prices for "Spotmaster" cartridge tape system.
52. CINE SONIC SOUND—Brochure details complete background music studio and library of prerecorded tapes.
53. CROWN—Line of tape recorders and players for professional applications is described in set of catalog sheets.
54. ERCONA CORP.—Brochure has engineering specs on miniature condenser microphones.
55. FAIRCHILD RECORDING EQUIP.—Handbook explains system for custom designing consoles; bulletins describe variety of audio level and frequency response devices.
56. RCA COMPONENTS & DEVICES—"Select-A-Guide" provides simple method for choosing microphones.
57. RCA VICTOR—Bulletin lists physical and magnetic properties of magnetic recording tape.
58. REEVES SOUNDCRAFT—Spec sheet with price list covers new video tape with long life characteristics.
59. RYE SOUND—Illustrated catalog presents line of Beyer microphones and audio components.
60. SPARTA—Product sheet has specs on battery operated portable cartridge tape playback unit.
61. SENNHEISER ELECTRONIC CORP.—Technical product booklet describes transistorized condenser microphone with integral RF circuitry.

COMPONENTS & MATERIALS

62. BRADY—Product data sheet describes Mylar-shielded wire markers for permanent identification of wires, cables, and harnesses.
63. ELECTRO-SEAL CORP.—Bulletin provides detailed circuitry of stepping switch driver, its applications and theory of operation.
64. KURMAN—Design aid, "Pick-A-Relay," enables user to select a stock readily by using four basic parameters: coil, contacts, rating, and physical configuration.
65. METALAB EQUIPMENT CO.—Catalog, "Laboratory Storage Assemblies and Specialized Equipment," includes fundamental and specialty times.
66. QUAM-NICHOLS—Catalog sheet includes coaxial, extended range, mid-range, and high frequency speakers.
67. SPRAGUE—70-page catalog lists electronic components for industrial, military, and commercial applications.
- SWITCHCRAFT—Product bulletin describes new stereo "Littel Jax," designed to switch 3-wire stereo input circuits.

MICROWAVE DEVICES

69. MICRO LINK—Bulletin describes portable microwave link; planning guide provides information on 2500 ETV service; data sheet details fixed link for the business band.
70. JERROLD—Case history brochure describes microwave control system installation for Philadelphia Water Works.

POWER DEVICES

71. ONAN—8-page catalog on standby generating plants and controls for radio and TV stations serves as guide to selection and installation.
72. TERADO—Product circular shows "Satellite" inverter for operating TV receivers in car, boat, and plane.

RADIO & CONTROL ROOM EQUIPMENT

73. KARG—Article reprint describes crystal-controlled 12-channel FM broadcast monitor; bulletin gives specs of stereo generator.
74. McMARTIN—Pamphlet describes selective programmer for operation of SCA storecast and background music service while simultaneously transmitting FM stereo.
75. ROTRON—Product bulletin fully covers "Sentinel" fan for commercial electronic cooling applications.

STUDIO & CAMERA EQUIPMENT

76. BOSTON INSULATED WIRE & CABLE—Connectors, connector accessories, and TV camera cable are listed in catalogs.
77. EASTMAN KODAK—Data bulletins describe 16mm TV projector, "Reflect Special" camera, "Viscomat" processor, and sound recording tapes.
78. TELEVISION ZOOMAR—Illustrated pamphlets cover lenses for image orthicon television cameras.

TELEVISION EQUIPMENT

79. AIR SPACE DEVICES—Safety device "Saf-T-Climb," which provides protection from falling when climbing any type of vertical structure, is described in brochure.
80. EIMAC—Brochures, data sheets, and bulletins give information on power tubes for UHF TV, klystrons, and vapor phase.

81. E. M. C.—Circular details transistorized low-noise preamplifier for CATV systems; product sheet outlines 2500 mc ETV system.
82. INTERNATIONAL NUCLEAR — Transistorized clamping/equalizing amplifier is described in spec sheet.
83. JERROLD—Case history is given in brochure on the installation of a video microwave system for educational station WHYY-TV.
84. RIKER—Bulletins describe custom built video switchers, transistor video modules, and vertical interval diode switches.

TEST EQUIPMENT & INSTRUMENTS

85. ALFORD—Instruments and components catalog illustrates and gives details of complete line of RF equipment.
86. AMPROBE—A line of portable DC recording wattmeters is described in bulletin.
87. BIRD—Periodical bulletin has helpful hints on RF measurements, solutions to RF problems, and applications of the company's products sent in by readers.
88. DELTA—Operation, and installation of common-point impedance bridge is explained in data sheet.
89. EICO—32-page catalog lists test instruments, audio products, tape decks, and communication equipment; special bulletin describes FM multiplex generator.
90. KARG—Data sheet and reprints of product reports provide information on stereo multiplex signal generator.
91. MARCONI—Tech data sheet discusses noise loading techniques in testing of wideband systems.
92. SECO—Data sheet covers details of "Caddy Pack" tube tester which carries over 200 tubes and tests all receiving tubes plus over 400 CRT's.
93. SPRAGUE—Illustrated bulletin describes latest model 500 interference locator for radio, television, and utilities.
94. WATERS—Catalog lists radio communications equipment for commercial and amateur service.

TOOLS & ACCESSORIES

95. ENTERPRISE DEVELOPMENT—Bulletin describes Endeco desoldering iron for removing components from printed boards quickly and without damage.
96. BUCHANAN ELECTRICAL PRODUCTS—Data sheets provide information on crimping tool kits containing crimping tool, positioners, plug gauges, application chart, and instructions.

TRANSMITTER & ANTENNA DEVICES

97. ALL PRODUCTS—Spec sheets describe an all-aluminum portable lightweight telescoping tower for site locating and field measurements.
98. ANTENNA PRODUCTS CO.—Technical data summary gives details of log periodic and conical log spiral antennas for communication systems.
99. BAUER—Bulletin provides full information on "Log Alarm" automatic transmitter logging system.
100. CO.EL.—Booklets cover broadband dipole TV antennas for VHF and UHF, multiguide slot antennas, directional antennas for 1 kw UHF, wideband FM antennas, VHF and UHF notch duplexers, and filter-plexers.
101. COLLINS—Illustrated brochure shows new 10 kw FM transmitter, and brochures are available on full line of broadcast equipment.
102. CORNELL-DUBILIER—Bulletin lists antenna rotor systems and discusses how to improve TV-FM reception.
103. DRESSER-IDECO—Catalog covers broadcast antenna towers, TV, AM, FM, Microwave, in Guyed, Candelabra, and self supporting types.
104. JAMPRO—New FM antenna catalog describes line of horizontally polarized units, including some with digital tuning elements for low VSWR.
105. RUST—Pamphlet covers "Autolog" automatic chart recorder for all radio and TV transmitter parameters.
106. STAINLESS—Brochure illustrates world's tallest structure, a 1749' television tower.
107. TIMES WIRE & CABLE—Semiflexible coaxial cables with foam-polyethylene or air dielectric are detailed on data sheets covering 1/4" through 1 5/8" sizes.
108. UNITED STATES PLASTIC ROPE—Booklet discusses Mylar rope, pointing out advantages and characteristics.

SCHOOLS & REFERENCE MATERIAL

109. CLEVELAND INSTITUTE—Booklet describes course in electronics for broadcasting.
110. HAYDON BOOK CO.—Catalog lists books published by John F. Rider and Haydon Book Co.
111. INTERNATIONAL ELECTRONIC RESEARCH—25-page report is entitled, "Heat-Dissipating Electron Tube Shields and Their Relation to Tube Life and Equipment Reliability."
112. H. W. SAMS—Latest book list covers technical books for all phases of electronics and the associated fields.

Get a top job in broadcasting . . .

A First Class FCC License

...or Your Money Back!



Your key to future success in electronics is a First-Class FCC License. It will permit you to operate and maintain transmitting equipment used in aviation, broadcasting, marine, microwave, mobile communications, or Citizens-Band. Cleveland Institute home study is the ideal way to get your FCC License. Here's why:

Our training programs will *quickly* prepare you for a First-Class Commercial Radio Telephone License with a Radar Endorsement. Should you fail to pass the FCC examination after completing your course, you will get a *full refund* of all tuition payments. You get an FCC License . . . or your money back!

You owe it to yourself, your family, your future to get the complete details on our "proven effective" Cleveland Institute home study. Just send the coupon below TODAY. There's no obligation.

MAIL COUPON TODAY FOR FREE CATALOG

Cleveland Institute of Electronics

1776 E. 17th St., Dept. BE-14
Cleveland 14, Ohio

Please send FREE Career Information prepared to help me get ahead in Electronics, without further obligation.

How to Succeed in Electronics

CHECK AREA OF MOST INTEREST —

- | | |
|---|--|
| <input type="checkbox"/> Electronics Technology | <input type="checkbox"/> First-Class FCC License |
| <input type="checkbox"/> Industrial Electronics | <input type="checkbox"/> Electronic Communications |
| <input type="checkbox"/> Broadcast Engineering | <input type="checkbox"/> _____ other _____ |

Your present occupation _____

Name _____ Age _____
(please print)

Address _____

City _____ Zone _____ State _____

Accredited Member National Home Study Council

Professional Services

VIR JAMES

CONSULTING RADIO ENGINEERS

Applications and Field Engineering
345 Colorado Blvd.
Phone: (Area Code 303) 333-5562

DENVER, COLORADO 80206

Member AFCCE

JOHN H. BATTISON & ASSOCIATES CONSULTING RADIO ENGINEERS

TV-AM-FM & Microwave Applications and
Installations

Specializing in all forms of communications
engineering.

422 Washington Bldg. Washington 5, D. C.

Phone ST 3-3484

Established 1954

Classified

Advertising rates in the Classified Section are ten cents per word. Minimum charge is \$2.00. Blind box number is 50 cents extra. Check or money order must be enclosed with ad.

The classified columns are not open to the advertising of any broadcast equipment or supplies regularly produced by manufacturers unless the equipment is used and no longer owned by the manufacturer. Display advertising must be purchased in such cases.

EQUIPMENT FOR SALE

Commercial Crystals and new or replacement crystals for RCA, Gates, W. E., Bliley and J-K holders; regrinding, repair, etc. BC-604 crystals. Also A. M. monitor service. Nationwide unsolicited testimonials praise our products and fast service. Eidson Electronic Company, Box 96, Temple, Texas. 9-61 tf

Leeds Northrup Galvanometer shunt. New. Leeds Northrup Pointer Galvanometer. NEW. Daven Resistance Decade Box. Four dials. Slide wire 0-1.3 ohms. In case. National NPW-0 dial. New. F. D. Fallain, 224 E. Court St., Flint Mich. 48503 4-64 1t

Will buy or trade used tape and disc recording equipment—Ampex, Concertone, Magnecord, Presto, etc. Audio equipment for sale. Boynton Studio, 295 Main St., Tuckahoe, N. Y. 1-64 tf

Ampex Head Assemblies for 300 and 400 series recorders reconditioned. Service includes lapping and polishing all three head stacks, cleaning entire assembly, readjusting and replacement of guides and realignment of stacks as to azimuth and zenith. Full track assemblies—\$60.00. Taber Manufacturing & Engineering Co., 2619 Lincoln Ave., Alameda, California. 8-63 5t

Trim 504 Audio Patch Cords \$4.00—Audio Jack Panels for 19" racks, 12 pair \$9.95—10 pair \$8.95. Repeat coils 500-500 ohm flat to 20 kc, \$4.00—relay racks and equipment cabinets—write for list. Gulf Electro Sales, Inc., 7031 Burkett, Houston, Texas. 4-64 3t

RCA PYLON FM ANTENNA. State model number, frequency, condition and other information. KBCA, Suite 617, 6505 Wilshire Blvd., Los Angeles 48, Calif. 4-64 1t

Gray Model—216 tone arms. Two, good condition, \$20 each. One, fair condition, \$15. Station KBRZ, Freeport, Texas. 4-64 1t

Two Motorola mobile remote pick-up units for 12 volts; one base unit for 115 V-AC. Rebuilt by Communications Service Inc. of Dallas. Broadcast quality frequency response. Make offer or inquire by mail. KOLS, Pryor, Okla. 4-64 2t

PERSONNEL

TV Engineer needed. Must be thoroughly experienced in maintenance and trouble shooting of RCA studio, VTR, micro-wave, and transmitting equipment. This job requires competent, reliable man who can be depended on to keep equipment in excellent condition. Top salary with chance for advancement to Chief Engineer. If qualified call collect 512-TU. 3-6511, Jerry E. Smith, KRIS-TV, Corpus Christi, Texas. 4-64 1t

MANAGER - SALES - CHIEF ENGINEER. Background college, 20 years chief, new construction, directionals, field measurements, AM-FM. Ten years management, sales, specialty low-cost high profit operation, record 30% net profit daytime. Stable, family man, civic minded. Prefer percentage net profit or lease. Interview NAB Chicago, April. Manager, Box 6782, Jackson, Mississippi. 4-64 1t

- SYNCHRONOUS MAGNETIC FILM RECORDER/REPRODUCER
- MAGNETIC TAPE RECORDERS
- NEW—THE portable MINITAPE synchronous 13 lb., battery operated magnetic tape recorder for field recording.

THE STANCIL-HOFFMAN CORP.
845 N. Highland, Hollywood 38, Calif.
Dept. B HO 4-7461

Audio Equipment bought, sold, traded. Ampex, Fairchild, Crown, McIntosh, Viking, F. T. C. Brewer Company, 2400 West Mayes Street, Pensacola, Florida. 3-64 tf

BEHIND THIS DOOR



—IN THIS CABINET JUST 42" HIGH IS A DUAL STL THAT MEETS AND SURPASSES THE DEMANDS OF FM STEREO, TV AURAL, INTER-CITY RELAY AND OTHER AM OR FM STEREO OR MONAURAL REQUIREMENTS.

—FOR FURTHER INFORMATION ON WHAT'S BEHIND THE DOOR WRITE

MOSELEY ASSOCIATES INC.

P.O. Box 3192, SANTA BARBARA, CALIF.
TELEPHONE—AREA CODE 805
967-1469 OR 967-8119

Circle Item 39 on Tech Data Card

Advertisers' Index

Altec Lansing Corp.	6
Automatic Tape Control, Inc.	52
Bauer Electronics Corp.	53
Boston Insulated Wire & Cable Co.	38
Broadcast Electronics	43, 46, 54
CBS Labs, Inc.	30, 31
Cleveland Institute of Electronics	55
Conrac Div., Giannini Controls Corp.	8
Continental Electronics	40
Crown International	4
Delta Electronics, Inc.	54
Eastman Kodak Co.	39
Electronics, Missiles & Communications, Inc.	36
Fairchild Recording Co.	53
Gamma Scientific, Inc.	48
Gates Radio Co.	5, 12
General Electric Co.	3
ITA Electronics Corp.	Cover 2
ITT - Cannon	22
International Nuclear Corp.	41
Lang Electronics, Inc.	50
McMartin Industries	51
Minnesota Mining & Mfg. Co.	10, 11
Moseley Associates	56
Norton Associates, Inc.	46
Penta Laboratories	45
RCA Electronic Components and Devices	32, 33, Cover 4
RCA Victor Record Div.	29
Reeves Industries	25
Rohn Mfg. Co.	42
Russco Electronics Mfg.	26
Rust Corp. of America	47
Sams, Howard W. & Co., Inc.	42
Sarkes Tarzian Broadcast Equipment Div.	35, 37
Saxitone Tape Sales	56
Scala Radio Co.	38
Sony Corp. of America	7
Sparta Electronics Corp.	48
Stainless, Inc.	26
Tektronix, Inc.	9
Telemet Corp.	Cover 3
University Loudspeakers, Inc.	23
Visual Electronics Corp.	49

REMOTE THERMOMETER (Electronic)

Outside temperature from mike position. Installed in less than 1 hour. Ask about our other weather equipment. Send for Brochure. P. O. Box 6111, 1246 Shafter St., San Diego 6, Calif. 2-64 1t



WOLLENSAK Tape Recorders

Besides being pretty, I pack a bigger output than many recorders twice my size... I AM THE GREATEST!

New models include: 524, 1400, 1440, 1500, 1515-4, 1570, 1780, 1580, 1980, 1981 and 422, & SA-421 speaker/amplifiers. Whether you order 1 or 1000 units, your order receives prompt attention.

Free! Complete Tape Recorder Discount Sheet.

SAXITONE RECORDING TAPE

275' Acetate (plastic), 3" reel	35¢
600' Acetate (plastic), 5" reel	70¢
600' MYLAR 5" reel	75¢
900' MYLAR (polyester), 5" reel	89¢
1200' Acetate (plastic) 7" reel	99¢
1200' MYLAR, 1/2-mil. (strong 7" reel)	1.09
1200' MYLAR, 1/2-mil., 5" reel	1.18
1800' Acetate (plastic) 7" reel	1.19
1800' MYLAR 1-mil. thick, 7" reel	1.59
2400' MYLAR, untensitized, 7" reel	2.49
2400' MYLAR, tensitized, 7" reel	2.79
3600' MYLAR, tensitized, 7" reel	3.89

Greater discounts to quantity buyers.

Plus Postage

Save 30-60%
4-track Stereo music on tape.
FREE
50-page catalog

SAXITONE

dit: Commission Electronics, Inc.
1776 Columbia Rd. N.W., Wash. 9, D. C.

Circle Item 40 on Tech Data Card

BROADCAST ENGINEERING

*New from Telechrome**

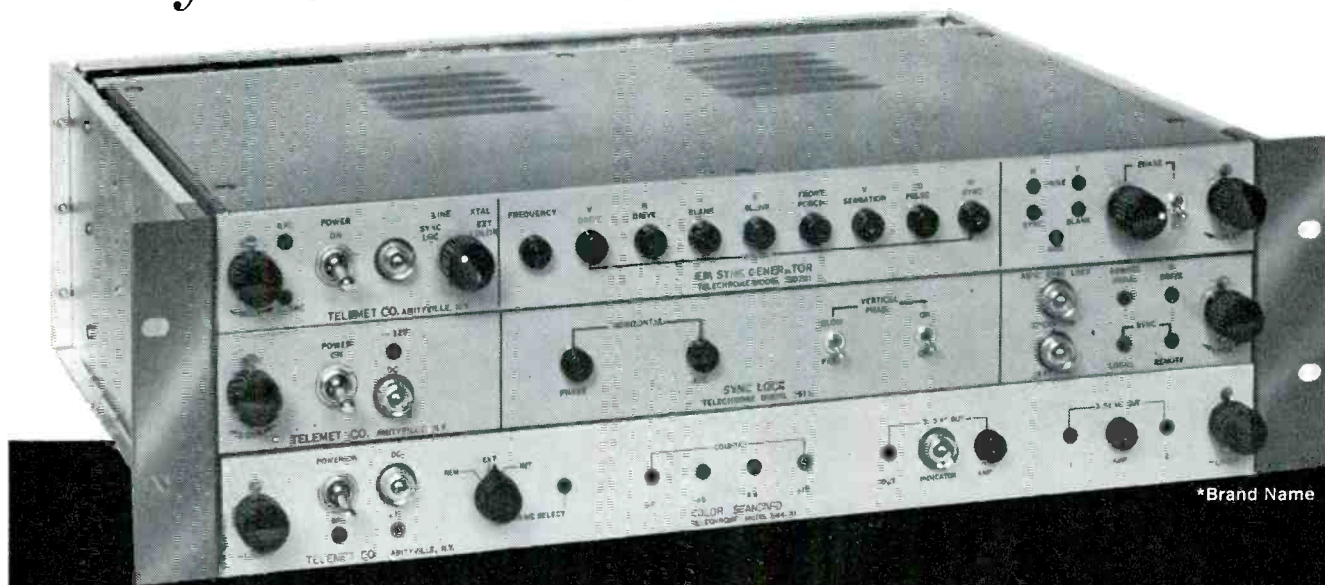

"ADD-ON" STUDIO SYNC GENERATING EQUIPMENT

**COMPACT / FLEXIBLE / STABLE / SOLID STATE
MEETS ALL RS-170 REQUIREMENTS**

in any combination of:

**3507C1 SYNCHRONIZING WAVEFORM GENERATOR
3513A1 SYNC LOCK • 3514A1 COLOR STANDARD
3509A1 SYNC CHANGEOVER • COMING-COLOR SYNC LOCK**

Pictured above is new multi-unit frame with internal blower cooling—available in various heights to hold any combination of 2 or more Telechrome 1 $\frac{3}{4}$ " modules.

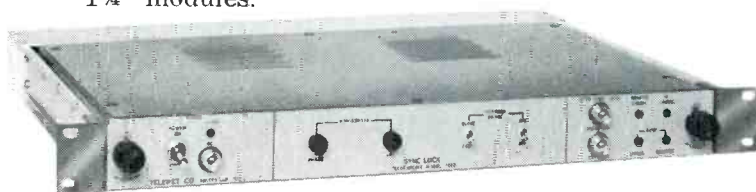

Units also available in individual mounting frames.

For Multiple Studio Distribution: Model 3202A1 Regenerative Pulse Distribution Amplifier.

TELEMET COMPANY

a division of

GIANNINI SCIENTIFIC CORPORATION

AMITYVILLE, N.Y.: 185 DIXON AVENUE • PHONE (516) 541-3600
SANTA ANA, CAL.: 3841 S. MAIN STREET • PHONE (714) 545-7171

FEATURES

SYNC GENERATOR

Internal Crystal, Line, Color or Sync Lock. ■ Auto-changeover to internal lock when remote sync fails.

SYNC LOCK

Advance counter reduces lock-in time. Composite or non-composite remote sync input.

COLOR STANDARD

Temperature controlled crystal oven. Binary Dividers.

SEE US AT NAB SHOW, BOOTH 2E



Circle Item 41 on Tech Data Card

Created by the hand of experience



RCA-7295B 4 1/2-INCH IMAGE ORTHICON

Unmatched picture quality in black-and-white pickup

- **NEW MICRODAMP CONSTRUCTION.** Reduces microphonic noise in the output signal by isolating the target-to-mesh assembly from the effects of external acoustical noise and camera vibration, and by damping out internally induced vibration on the target.
- **REDUCED CHANCE OF "WASHED OUT" PICTURES.** Opaque black coating on lower part of tube prevents "washed out" pictures due to extraneous light.
- **HIGH AMPLITUDE RESPONSE FOR SHARP RESOLUTION** (800 TV lines).

- **HIGH SIGNAL-TO-NOISE RATIO** (75:1 at 4.5 Mc)
- **IMPROVED BACKGROUND UNIFORMITY**, with very good half-tone signal reproduction.
- **FIELD-MESH CONSTRUCTION.** Produces uniform signal output and focus. Reduces unwanted bright edges and geometric distortion.
- **HIGHER SIGNAL OUTPUT LEVELS** with lower microphonics.
- **MORE STABLE SENSITIVITY CHARACTERISTICS.**

RCA ELECTRONIC COMPONENTS AND DEVICES, HARRISON, N. J.



The Most Trusted Name in Electronics

AVAILABLE THROUGH YOUR AUTHORIZED RCA BROADCAST TUBE DISTRIBUTOR FOR NAME AND ADDRESS OF YOUR LOCAL DISTRIBUTOR WRITE OR CALL YOUR NEAREST RCA DISTRIBUTOR PRODUCTS SALES OFFICE—NEW YORK, NEW YORK: 35 W. 49th St., (212) MU 9-7200; NEEDHAM HEIGHTS 94, MASSACHUSETTS: 80 "A" St., (617) HI 4-8430; WASHINGTON 6, D. C.: 1725 "K" St., N.W., (202) FE 7-8500; ATLANTA, GA.: 134 Peachtree St., N.W., (404) JA 4-7703; CLEVELAND, OHIO: 1621 Euclid Ave., (216) CH 1-3450; CHICAGO, ILL.: Merchandise Mart, (312) 467-5900; DALLAS 7, TEXAS: 7901 Carpenter Freeway, (214) ME 1-3050; KANSAS CITY 14, MO.: 7711 State Line, (816) EM 1-6462; HOLLYWOOD, CALIFORNIA: 6363 Sunset Boulevard, (213) 461-9171; SAN FRANCISCO 2, CALIFORNIA: 420 Taylor St., (415) PR 5-5135-6-7.