

JULY, 1959

Covering all
phases of...



BROADCAST ENGINEERING

THE TECHNICAL JOURNAL OF THE BROADCAST INDUSTRY

In this issue . . .

FM Serrasoid Modulator in
Multiplex Transmitters

Television Broadcast
Translators

Weather Radar

New Dimmer Controls

How to Choose the
Correct Connector

Tower Vibration Problems

Looking Over AM
Transmitters

●
F.C.C. Regulations
TV Technical Standards

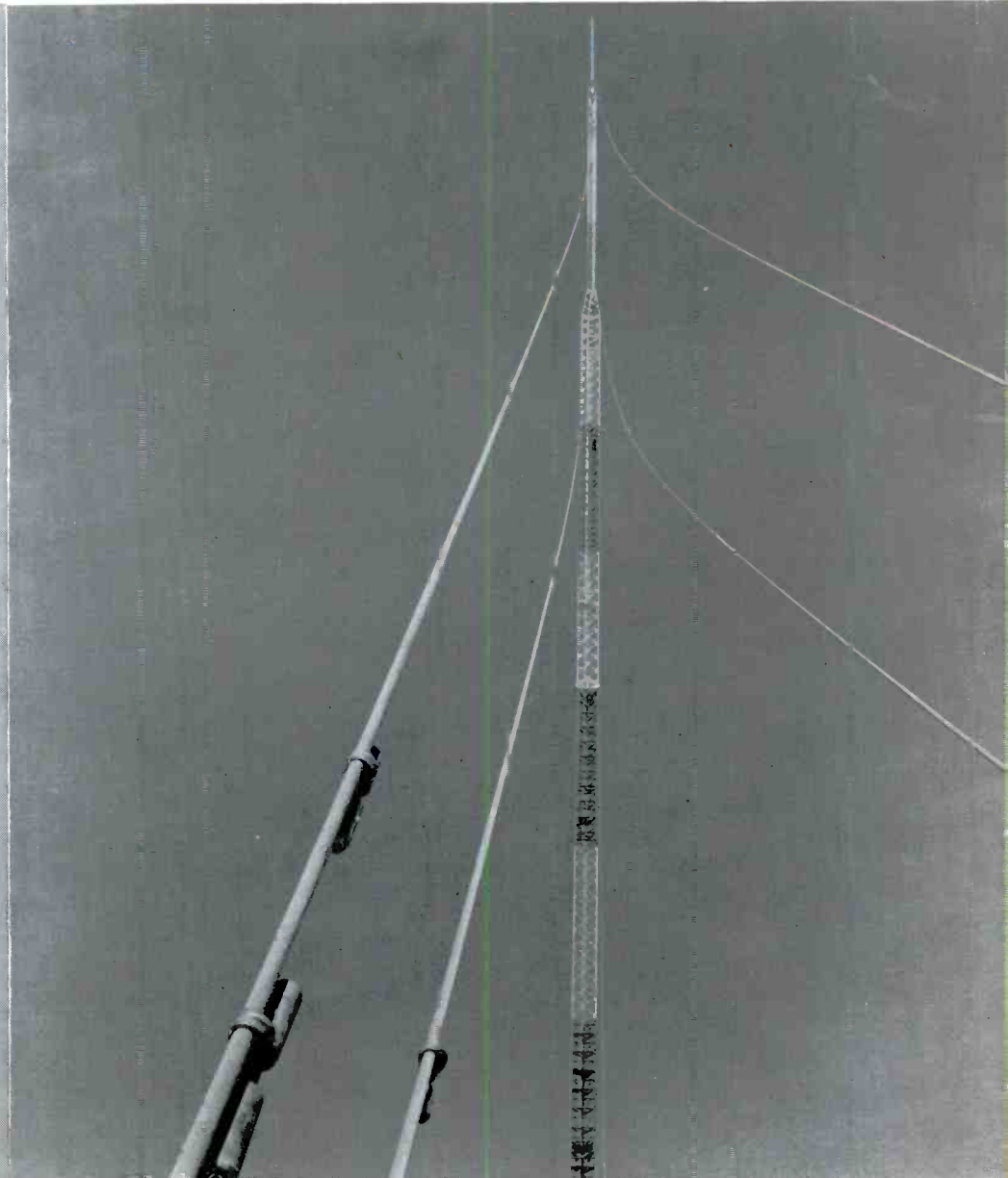

TOOLS OF THE TRADE

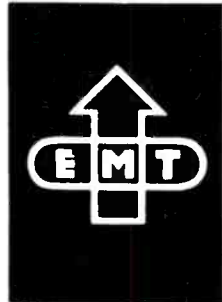

Problem: R_x

SOLUTION:



EMT 321

DIRECT-READING OHMMETER

For measuring resistances between 10 milliohms and 100 megohms, with the smallest possible loading of the test object.

For more information:

In Chicago: Ray R. Hutmacher Associates
In Dallas: Audio Acoustics Company
In Los Angeles: Ralph Auf Der Heide

In Miami: Dukoff Int., Sound Corporation
In New York Area: Harry Reizes, Eastmeadow, L. I.
In San Francisco: Ron Marco, San Bruno

In Canada, E M T Products, VIDITON CORP., OTTOWA

Electronic Applications

194 Richmond Hill Avenue, Stamford Conn.

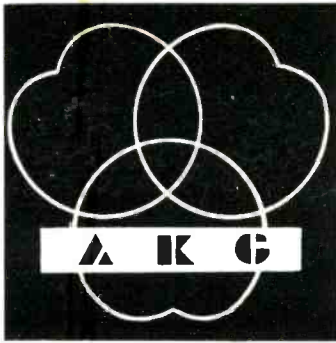

FOR TV, FILM AND
BROADCASTING

STUDIO

EMT D 24 Dynamic Directional Microphone

Professional studio microphone, moving coil design, cardioid characteristic. Minimum visual obstruction (TV and stage) due to small dimensions. Equipped with windscreen, switch for acoustical high-pass filter (-10 db) against rumble and effective shielding against stray fields.

Range:	30 ... 16,000 c/s
Ratio of front to rear sensitivity	20 to 25 db
Sensitivity:	0.2 millivolt/microbar

Head diameter 39 mm (1 17/32 inches) and 157 mm (6 3/16 inches) long.

Weight: 190 grams (7 ounces) Gold with umber grey finish.

Accessories as mounting floor stand adapters type Sa 1, Sa 2, Sa 3 available.



REMOTE

D 15 DYNAMIC DIRECTIONAL MICROPHONE Close-talking hand microphone with cardioid characteristic. Can also be supplied with harness for reporters. Especially suitable for radio and television reporting on portable tape recording equipment under conditions where the background noise ratio is high.

For more Information:

- In Chicago: Ray R. Hutmacher Associates
- In Dallas: Audio Acoustics Company
- In Los Angeles: Ralph Auf Der Heide
- In Miami: Dukoff Int., Sound Corporation
- In New York Area: Harry Reizes, Eastmeadow, L. I.
- In San Francisco: Ron Marco, San Bruno

In Canada, E M T Products, VIDITON CORP., OTTOWA
In USA, Exclusive Representatives & Service:

Electronic Applications

194 Richmond Hill Avenue, Stamford Conn.



BROADCAST ENGINEERING

THE TECHNICAL JOURNAL OF THE BROADCAST INDUSTRY

Volume One

July, 1959

Number 3

CONTENTS

Pulse Technique for FM Broadcast Transmitters	Dwight Harkins	4
The third article in this exclusive multiplex series explains the operation of the Serrasoid modulator and its use with FM multiplex circuits.		
Television Broadcast Translators	C. J. Auditore, P.E.	10
The installation and circuit requirements of UHF Television Translators are described along with economic considerations.		
Weather Radar	R. Craig Christie	16
The application of radar for television weather forecasting is described and the operation of the equipment is explained.		
The SCR Dimmer	Herbert R. More	22
Answers to the many questions concerning this new type of lighting control are answered in this paper which was presented at this year's NAB Engineering Conference.		
Are You a Dibber?	Oscar von der Snikrah, Ph.B. Dec.	27
For the first time anywhere is told the story of the unsung heroes of the broadcast engineering fraternity. The use and application of the widely used transmission unit RCH is explained.		
A New Look at Portability—The Multi-Contact Plug	Don A. Drake	30
Reliability of equipment depends upon the use of proper connectors. Factors to be considered in the choice of connectors are pointed out and examples of the use of various plugs and receptacles are illustrated.		
Vibration Problems in Tall Tower Construction	J. Roger Hayden	34
The different types of vibration problems are explained and the methods which have been developed to control or minimize these problems are described.		
One Kilowatt AM Transmitters		37
Some of the features of current models are pointed out.		

DEPARTMENTS

Sounding Board	3
Technical Hints	48
Industry News	44
Product News	46
Amendments and Proposed Changes of Regulations	39
F.C.C. Regulations	40

COVER STORY

Dampeners are shown installed on the guy wires of a tall TV tower to prevent vibrations. These problems and their preventative measures are described in the article beginning on page 34.

Editor and Publisher — D. E. Mehl

COPYRIGHT 1959 BROADCAST ENGINEERING

BROADCAST ENGINEERING is published monthly in Kansas City, Missouri
Subscription rates; U. S. and Possessions, \$6 per year.
Other Countries, \$7. Single Copies, 75 cents.

BROADCAST ENGINEERING, P. O. Box 93, Kansas City 41, Missouri



Sounding Board

EDITOR:

This concerns the possible use of the multiplex sub-carrier spectrum for a broadcast service involving stereo. Stereo requires the precise physical placement of equipment and listeners in order to achieve the spatial effect and is, therefore, directed to a captive audience and commands complete aural attention. Based on this premise, it is my thought that stereo broadcasting will not have as wide acceptance as some believe. Furthermore, I have yet to discover among multiplex operators an open declaration of interest in stereo. It is not my wish to deprive the public of stereo if they really want it. I do feel, however, that the methods by which we broadcast this service should be carefully considered. It is my opinion that broadcasters should object to any broadcast service designed for the public which appears in the multiplex channels.

W. H. COLLINS
President
Electro-Plex Corp.

EDITOR:

HURRAH! WHOOPEE! A Technical Journal such as yours has been the hope for a long time for those of us in the broadcast industry. Congratulations! May you have success in your new venture. Even at this early stage, I'm sure the industry is looking forward to a rapidly expanding journal.

Maybe I'm a little partial, but many articles on the long-lived medium, AM, are appreciated.

LEON C. OSBECK
W K O W
Madison, Wis.

EDITOR:

Our radio station received your new magazine, BROADCAST ENGINEERING. The contents were certainly worthwhile and your future plans even more interesting. And may I add a personal word? There are a lot of us yet engaged in radio work, so please don't swing over to TV to the extent of excluding radio almost entirely, as so many other magazines have done.

J. ROGER FLANAGAN
Station Manager
W I V V
Box 338
Vieques, Puerto Rico

Federal Communications
Commisson
Washington, D. C.

Our recommendation for the new channel allocations is a band of frequencies starting at channel 7 and going upwards for 30 channels to be used by commercial TV stations for entertainment. TV manufacturers would be encouraged to build receivers for this range. The present translator channels of 70 to 83 would be reserved for educational TV and high-power fringe area translators and received on the TV set with the use of a converter. As a leading manufacturer of UHF converters, we could produce a quality converter that would cost \$20.00 to the customer.

Boosters or repeaters on an off-channel basis could be authorized by the FCC on any channel for use in difficult reception areas. This would provide 44 channels with maximum flexibility and low cost to the public.

ISAAC S. BLONDER, President
Blonder-Tongue Laboratories, Inc.
Newark 2, N. J.

New TransMagnemite[®] Professional Transistorized Battery-Operated Spring-Motor PORTABLE FIELD RECORDER

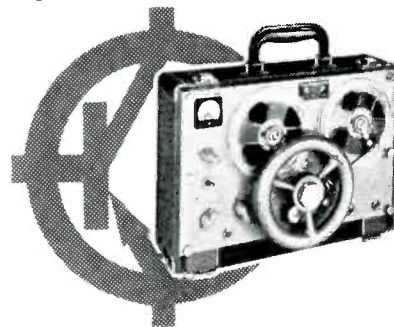

Check These Unusual Features:

- ✓ Low noise input stage (0.25 microvolts).
- ✓ Overall Gain 110 db.
- ✓ No Microphonics or motor noises.
- ✓ Uses Dry Rechargeable batteries.
- ✓ Batteries last 125 hours.
- ✓ Modular plug-in construction.
- ✓ Exceeds NARTB Broadcast standards.
- ✓ Size: 11 x 10 x 7 inches—Weight: 15 lbs.
- ✓ Full unconditional Two Year Guarantee.

Write for complete information and direct factory prices to Dept. RB:

AMPLIFIER CORP. of AMERICA
398 Broadway, N. Y. 13, N. Y.

EDITOR:

This is a great magazine. Keep up the good work.

DUTCH MEYER
K X L L
Missoula, Mont.

EDITOR:

Enjoying your informative book very much.

CHARLES E. SLIGH
Chief Engineer
W O L S
151 South Dargan St.
Florence, S. C.

JAMPRO ANTENNA COMPANY

7500 14TH AVENUE • BUILDING 9
SACRAMENTO • CALIFORNIA

ANTENNA EQUIPMENT FOR
TELEVISION AND FM BROADCASTING

- ★ SALES
- ★ SPECIAL DESIGNS
- ★ ENGINEERING
- ★ FABRICATION

JAMPRO . . . a complete source for all
your antenna requirements!

MULTIPLEX INSTRUMENTS for THE FM BROADCASTER

- MODULATION MONITOR
- SUB-CARRIER FREQUENCY MONITOR
- SELECTIVE MUTING GENERATOR
- RELAY RECEIVER

ELECTRO-PLEX CORP.

P. O. Box 52
Westfield, New Jersey
Adams 3-3464



PULSE TECHNIQUE for FM BROADCAST TRANSMITTERS

The methods whereby modern pulse techniques are used to provide the modulation for FM broadcast transmitters that makes possible high carrier stability together with extremely low distortion and noise.

By DWIGHT "RED" HARKINS*
Harkins Radio, Inc.

COMMERCIAL broadcast transmitters have used two methods of obtaining frequency modulation. The general groups fall into either the reactance modulated oscillator type or the phase shift type. With the reactance tube type, the frequency of an oscillator is caused to vary directly in proportion to audio modulation. This reactance controlled oscillator is the frequency determining oscillator of the transmitter. Through the use of automatic frequency control circuits of various types the center frequency of the oscillator is kept within broadcast standards. When using the phase shift type of modulation process the center frequency of the carrier oscillator is not varied and therefore a

crystal can be used to obtain the desired stability.

Known as indirect FM, the frequency of the carrier will be deviated from its crystal controlled point only during the instant that the phase is changing. The deviation that is produced is proportional to the rate of change of phase.

Small amounts of phase shift modulation can be easily obtained by applying to any crystal controlled circuit a variable reactance that is controlled by audio voltages. The amount of phase shift or deviation produced is so small that an awkward number of multiplication stages would be needed to produce the full plus or minus 75 Kc. required for 100 per cent modula-

tion of the FM broadcast transmitter. The most widely used circuit in present day FM broadcast transmitters for the generation of the PM consists of a circuit developed in this country by Mr. J. R. Day. This circuit which uses pulse techniques is most commonly known as the "Serrasoid." However, it is now appearing under other names, such as "angle modulator" or "pulse position modulator" or a "truncated sawtooth modulation," to mention a few. The word *Serrasoid* is Greek for describing a sawtooth. Since this circuit depends upon the production of a linear sawtooth and obtains the phase modulation by causing the audio voltage to clip the linear slope of the formed sawtooth, the name *Serrasoid* is very descriptive.

*4444 East Washington, Phoenix, Ariz.

This method of obtaining crystal controlled frequency modulation is capable of producing a peak phase shift of plus or minus 90 degrees while preserving absolute linearity. This is equivalent to one and one-half radians and when computed mathematically it can be shown will produce a deviation of plus or minus 75 cycles with an audio tone of 50 cycles. In order to deviate sufficiently to meet the standards of the FM broadcast service, a deviation of plus or minus 75,000 cycles is required, which simply means that the product of the simple process we are describing must undergo a frequency multiplication of 1,000. In actual practice, a multiplication

factor of 972 is used since this can be realized with an assortment of doublers and triplers.

For example, with a crystal of 100 Kc. and a multiplication of 972, the output frequency would be 97.2 Mc. which appears in the FM broadcast band.

All indirect FM or PM processes differ from FM obtained by direct reactance tube modulators in respect that the amount of deviation is not directly related to modulating frequency. In the PM circuits such as we are describing, the amount of phase shift necessary to deviate a given amount decreases at the rate of 6 db per octave increase

in frequency. The phase shift modulator such as the type we are describing therefore is called upon to exert its greatest effort at the lowest transmitted audio frequency, which is generally 50 cycles. As the frequency rises to 15,000 cycles the amount of audio required to produce the same modulation level as at 50 cycles will be found to be 6 db less each time we move up another octave. Or, to put it another way, each time we double the audio frequency applied, half as much will be necessary to obtain the same deviation, thus converting the PM signal into the same characteristics discussed later in this paper.

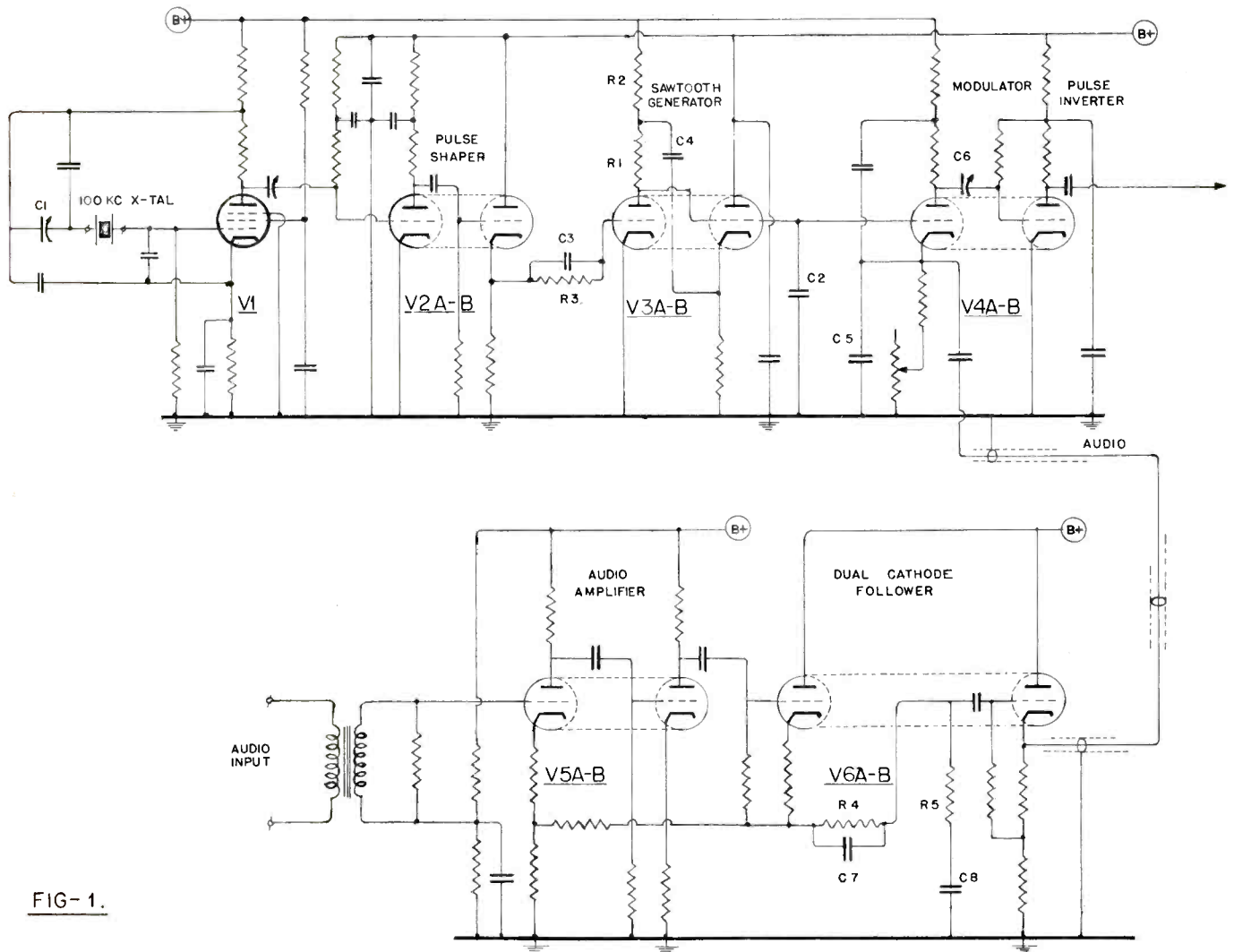

FIG- 1.

The Serrasoid Frequency Modulation Circuit

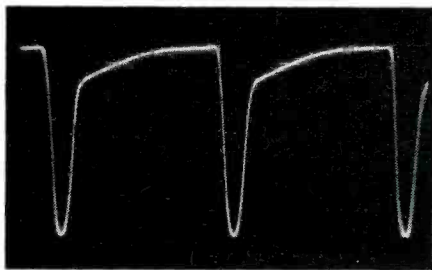

Figure 2
Waveform observed at plate of crystal oscillator V-1.

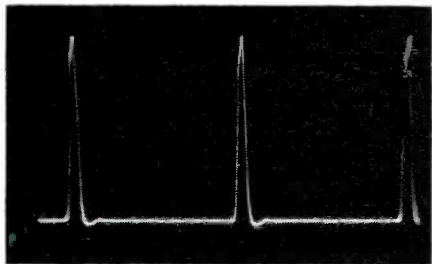

Figure 3
Positive spikes spaced 10 microseconds that initiate the generation of each linear sawtooth wave. Scope connected to grid of V2-B.

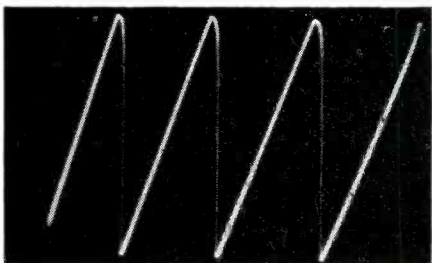

Figure 4
Complete sawtooth wave observed at grid pin of V-4A with V-4A removed from socket to prevent grid conduction and clipping.

In describing the circuit which appears in Figure 1, the crystal of a frequency which is one over 972 of the transmitting frequency is part of the oscillator circuit with V-1. The oscillating frequency may be adjusted for fine frequency by tuning a variable series capacitor, C-1. In an oven this will give a carrier stability of plus or minus .0001 per cent. The grid of V-1 is blocked during the greater part of the modulating cycle so that a healthy negative pulse is produced on Plate V-1. These negative pulses appear at an evenly spaced rate of 100,000 per second or at a rate of one every 10 microseconds in the case of the 100 Kc. crystal. Figure 2 shows the negative going pulses at the plate of V-1 as they appear on an oscilloscope.

After being differentiated by the coupling condenser to the following grid circuit the pulses become quite short and are at an amplitude several times the cutoff voltage of V-2A. This causes short positive pulses to appear at the plate of V-2A. These positive pulses overdrive the grid of V-2B and cause sharp well-defined spikes to appear at the relatively low impedance of the cathode. These spikes appear on the oscilloscope screen in Figure 3.

These sharp pulses are used to time a one shot non-oscillating sawtooth generator. In the case of the 100 Kc. crystal these pulses are 10 microseconds apart. The dual triode V-3-A-B is the linear sawtooth generator. The linear rise of the sawtooth has a slope that corresponds to the charging of condenser C-2 through R-1 as it approaches the steady voltage of the junction of the plate load resistors, R-2 and R-1. The charging time of this network coincides with the time between pulses at the grid of V-3A. The combination of R-3 and C-3 has developed cutoff bias for the grid of V-3A from previous pulses. The

charging of the slope of the sawtooth wave would have too much exponential curvature to be useful for our purposes unless a bootstrap connection is used from the output of the cathode follower V-3B through C-4 to the junction of the rising voltage developed across C-2. This compensates for the falling voltage on R-1, thus maintaining a constant charging current.

The linear sawtooth wave formed at the plate of V-3A which is also connected to the grid of V-3B and the grid of V-4A can be observed with V-4A-B tube removed from its socket as shown in Figure 4.

Now by plugging V-4A-B we can proceed to use this linear sawtooth wave for producing phase modulation. The wave is directly coupled to the grid of V-4A whose cathode bias caused by plate current is adjusted in such a manner with a variable cathode resistor that the grid goes into conduction when the sawtooth wave rises about half way up. The condenser C-5 across the cathode resistor is large enough to hold the bias constant during the sawtooth period and therefore when the grid current causes C-2 to stop charging the latter half of the sawtooth rise is clipped or truncated. The action is quite rapid since the passage from beginning of plate current flow to a grid current takes much less than one microsecond. Figure 5 shows the wave form as observed on the grid of V-4A.

It is important at this time to realize that the plate current of V-4A is passing only during the latter half of the sawtooth wave after the grid has conducted. If the bias for V-4A is adjusted, the leading edge of the plate current pulse will vary in time and its position can be seen to shift either forward or backward as the bias is lowered or raised. By differentiating this pulse through condenser C-6 a pulse is produced

Photos taken by Frank Wildeboor at WMAL, Washington, D.C.

which changes its leading edge relative to the portion of the sawtooth slope from which it was formed.

If the bias on the cathode developed across the cathode has superimposed upon it the voltage from the audio program this rise and fall of bias which is following the complex audio wave will cause the pulses in turn to vary in position and actually form what could be called pulse position modulation.

V-5 and V-6 are audio amplifying tubes to supply the audio voltage to the cathode of the modulator tube. The modulating voltages are applied at a relatively low impedance from the cathode follower and the audio amplifier in addition to having low noise and very low distortion must also perform two very important functions. It must correct the audio response curve to compensate for the 6 db increase in sensitivity as the audio rises in frequency that all phase shift modulators have. In addition to this predistortion it must also provide pre-emphasis in order that the transmitter signal will meet the FCC requirements of the 75 microsecond pre-emphasis scheme. This is done by R-4-5-C-7-C-8.

After the differentiated pulses which appear at the grid of V-4B pass through this tube, they are fed from the plate in the form of positive pulses to the grid of the first multiplier tube. These pulses are shown in Figure 6. These pulses will be frequency modulated as much as plus or minus 75 cycles at 100 per cent modulation. In the plate of the first multiplier tube the pulses convert to a sine wave since it is a resonant L-C circuit at this point.

By using five triplers and two doublers a total multiplication factor of 972 times will produce the carrier that will be further amplified to apply to the transmitting antenna.

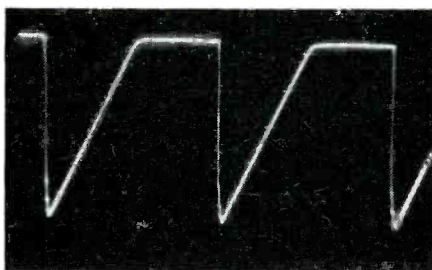

Figure 5

Waveform at grid of V-4A with V-4A plugged into socket showing normal operation with cathode bias adjusted to allow grid to conduct at the half-way point of the slope. No modulation is being applied.

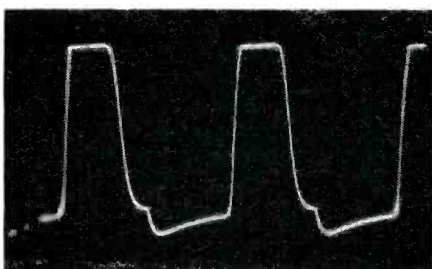

Figure 6

Pulses formed at plate of V-4B. Audio voltage superimposed on the cathode of V-4A will cause the leading edge of this pulse to vary in position or phase. It moves forwards and backwards as much as 90 degrees when 50 cps modulates 100%.

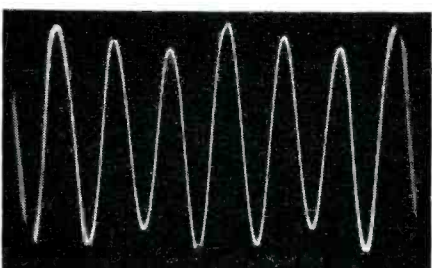

Figure 7

"Stair step" waveform seen at plate of first tripler (V-7) showing tripling action. This is 300 Kc. with a 100 Kc. component appearing as AM. This effect is removed by coils L-1 through L-6.

At this time I would like to mention the results of using well over 100 of these modulation units throughout the United States. As used in both the Harkins Multiplex exciters and the subcarrier generators to form frequency modulated subcarriers, this circuit has proven itself beyond a doubt. Since the carrier frequency control is absolutely crystal controlled the center frequency of the transmitter is ultra stable. The four tubes used in the basic circuit excluding the audio tubes operate under cut-off conditions or cathode follower conditions. As a result the whole system is independent of tube changes or aging and there are no resonant circuits to drift. Many units have been in operation now for four years without adjustment, a single tube failure, or a shift in operating performance. Very few electronic circuits have shown themselves to be this reliable.

Now let us discuss some of the design problems that arose when this excellent process of obtaining frequency modulation was applied to a transmitter that was going to have the multiplex subcarriers added at one of the multiplier stages later on.

The first problem confronted was that of eliminating the basic crystal frequency from phase modulating the early multiplier tubes to such an extent that it followed all the way through the whole chain to appear at the carrier output as an unwanted subcarrier in the range of 100 Kc. depending upon the actual crystal used. This peculiarity was observed at the time spectrum analysis was being conducted to satisfy the engineering department of the FCC. Without taking precautions the 100 Kc. component was quite apparent at the transmitter output on the final operating frequency. It measured less than 20 db down from the center carrier on

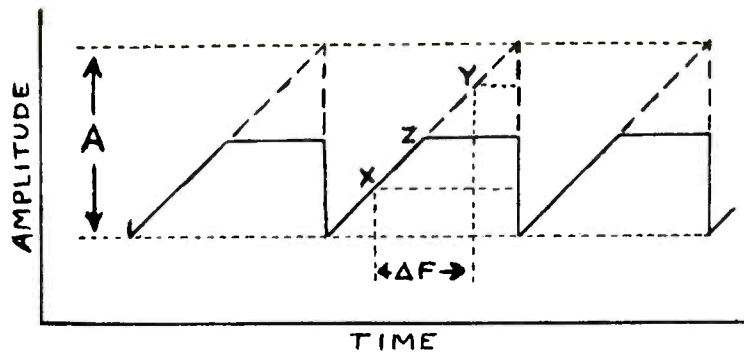

Figure 8

Dashed lines represent waveform of sawtooth without V-4A in the circuit. Points X and Y show points of clipping under normal use caused by audio peaks of modulation voltage Delta F. Point Z is point of grid current clipping when no modulating voltage is present.

either side in the form of unwanted sidebands. The circuitry of Figure 9 was developed to eliminate this condition. All six coils are tuned to the third harmonic of the crystal frequency. They represent the tuned circuit through which the tripled oscillator frequency must pass before going on. This was necessary in order to obtain a 70 db rejection of the fundamental 100 Kc. pulses that appear on the grid of V-7. This procedure caused an unwanted result in restricting the sidebands generated during the modulation process to such an extent that the frequency response above 6 Kc. dropped off to such a degree that it would not meet the Commission's standards. Rather than attempt equalization of the audio itself in order to compensate for this peculiarity a staggered tuning procedure was developed that enabled us to obtain the flat

response up to 15,000 cycles. Above 15,000 cycles the response drops very rapidly due to the Q and pass band characteristics of the six coils all tuned at the 300 Kc. range. This feature is quite desirable if we are going to keep audio harmonics from interfering with the multiplex subcarriers that are going to be added later in the multiplier chain.

Another design problem presented itself in keeping the unmodulated crystal driven pulses appearing in V-1 and V-2 and V-3 from entering the grid of V-4B or V-7. By experimenting with grounding of the individual stages together with adequate power supply filtering, decoupling, and shielding, this effect was overcome. Although the unmodulated pulses interfering with the modulated pulses did not create noise or distortion that could be measured with a distortion meter, it

produced a peculiar swishing sound in the modulation that was especially offensive on the lower frequencies.

Still another peculiarity of this circuit was discovered in the field and probably would not have been unearthed except for the fact that many of our excitors and subcarrier generators are called upon to operate in close proximity to AM transmitters as well as TV transmitters.

The condition made itself apparent in the form of a heterodyne whistle appearing in the modulation of the transmitter which disappeared when the AM transmitter was turned off. This was disconcerting when first observed because it appeared at a time when the FM units had been completely checked out and everybody was ready to go to bed, only to find that when the AM transmitter was signed on the

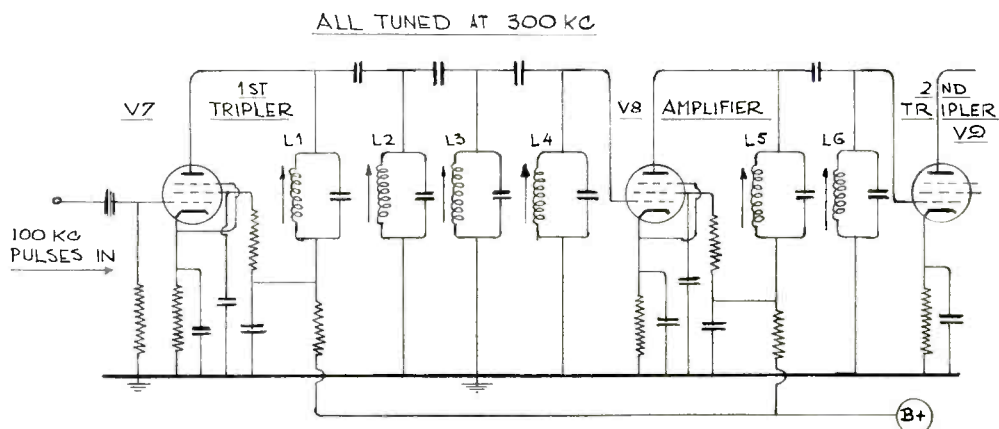

Figure 9

Tuned circuits for eliminating 100 Kc. component.

whistle came roaring out of the FM unit.

This condition was caused by the existence of many, many harmonics caused by the sharp pulses created in this modulation circuit. For example, the 9th or 10th harmonic of pulses appearing at the plate of V-4A will beat with a strong R.F. signal in the broadcast band. At one installation, the 11th harmonic of the crystal frequency was beating with the AM station carrier frequency to form a 22 Kc. beat note—which was then transmitted over the system in the form of an unwanted third subcarrier. This made a mysterious whistle in the 26 Kc. subcarrier. The harmonic content of the pulses can be varied by changing the pulse width and for this reason we include a variable condenser between the plate of V-4A and the grid of V-4B. Also by using extra shielding and R.F. chokes the condition has been cured.

In actual use for providing commercial service the performance has been uniform in all units built. The distortion and noise measurements obtained in the field depend entirely upon the inherent noise that is present in the station monitor being used. In other words, the actual distortion generated by this unit, together with its noise figure cannot be truly stated because of the variation in monitors that are used to make the measurements. Since the Commission requires a minimum of a 60 db ratio of 100 per cent modulation to noise, you would expect it to be satisfactory if this figure is achieved. In all cases this has not only been achieved but in many instances measurements have been observed consistently in the 75-80 db range, in which case you are getting down to the noise around the sta-

tion caused by the blinking of tower lights and other surges on the AC line which go into the noise measuring equipment rather than the modulator itself.

In regard to distortion, it is not unusual to get distortion measurements of .2 per cent at the 100 per cent modulation at 50 cycles. Then measuring the oscillator direct without going through the transmitter also produces .2 per cent reading on the distortion analyzer. This would lead you to believe that the process is distortionless. At 20 cycles modulation it is not possible to deviate the full 75 Kc. without distortion since the amount of phase shift required is more than the slope of the sawtooth will permit. However, this feature could be overcome if it was necessary by using a larger multiplication factor which could be obtained by starting out at a lower crystal frequency.

The distortion measurements obtained at frequencies higher up in the audio spectrum usually depend once again upon the condition of the station monitor. With a well adjusted monitor the distortion from 50-15,000 cycles at 100 per cent modulation usually falls below .25 per cent. Installations that number in the hundreds throughout the country have proven that the pulse technique is ideal for many reasons: (1) In the use of FM stations for rebroadcast and relay purposes there are no ill effects of rebroadcasting the signal. Since the noise and distortion are kept so low there is no cumulative effect. (2) The noise, distortion, and frequency response are solely controlled by the originating audio equipment such as microphones, tapes, reproducers and pickups. (3) Non-critical components and tubes allow for carefree

operation, especially important in this age of remote control. (4) The ultra stability gains from direct crystal control cannot be equalled by mechanical or electronic means of automatic frequency control. (5) The ease of adjustment makes possible uniform results from unskilled technicians. (6) As quantity production of these units progresses, the cost to the broadcaster will be considerably lower than any other possible system. These modulators also lend themselves to the production of a highly stable low distortion subcarrier. For this purpose, the frequency modulated pulses obtained at the 100 Kc. frequency go through a smaller string of multipliers to a frequency in the 20 Mc. range and are beat with a crystal oscillator to form the desired subcarrier such as 26 Kc. or 65 Kc. In the HARKINS two channel subcarrier generator a master crystal oscillator and pulse shaper operating at 100 Kc. is used to drive two different sawtooth generators and modulators. The output of each one then goes its separate route through a doubler string of multipliers to produce two different subcarriers, each with separate modulation but all driven by the master crystal. By using different multiplication factors in the two chains it is possible to avoid beat notes and heterodynes that would occur. This method of producing subcarriers has proven itself over the past four years to be reliable and consistent in results. It has permitted 100 per cent crystal control of all functions.

Since this modulation process is also being used in several manufacturers' TV-Aural transmitters it is hoped that this article will prove useful to the TV engineers as well as to those interested in FM broadcasting.

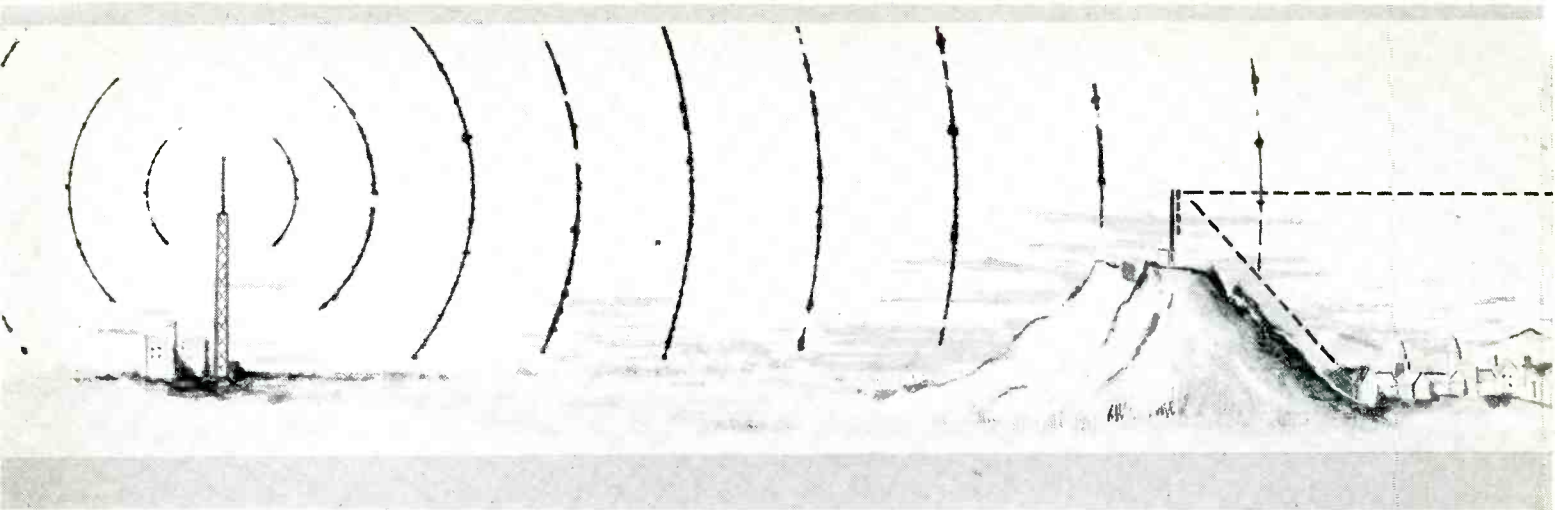

TELEVISION BROADCAST TRANSLATORS

By
C. J. AUDITORE, P.E.
Chief Engineer
Adler Electronics, Inc.

THOUSANDS of Americans have been hopelessly underprivileged insofar as television is concerned, because of natural terrain barriers and the poor economic feasibility of establishing a local television broadcasting station. These potential viewers reside in widely scattered communities, in sparsely populated areas of the country, considerably removed from a major marketing area, oftentimes nestled in valleys and barricaded by lofty mountains. As a means for extending television service to this important segment of the nation's population, the Federal Communications Commission has authorized the establishment of television broadcast translator stations.

The rules governing this service are contained in Part 4, Sub-part G of the Commission's Rules, obtainable from the Superintendent of Documents, Government Printing Office, Washington 25, D. C., at a nominal cost of 15¢ per copy.

Television broadcast translators have the capability of providing the same television programming and choice of channels enjoyed in adjoining major cities to every community deprived of direct reception by distance ("fringe" signals) and natural terrain barriers ("shadowed" signal areas). The isolated community may also resort to on-channel VHF boosters, and subscriber community antenna systems.

All of these systems contrive to bring programs into homes which otherwise would not have television service. The FCC policy is to encourage the extension of free, technically foolproof and lawful television service to all communities without distinction. The television broadcast translator, pioneered by Adler Electronics, is the only approved high-power equipment meeting *all* of these requirements.†

The Adler Translator is designed for unattended operation, employing high-level heterodyne conversion to "translate" any input VHF TV channel 2 to 13 to any output

†The Adler Type RA-7 100 Watt Television Translator Amplifier is the only FCC approved equipment in this power range, at this time.

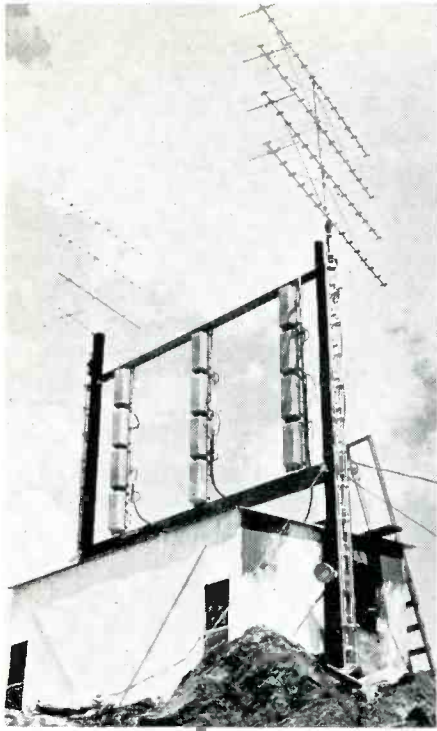

Three Adler Translators bring ABC, CBS and NBC Television programs to Palo Verde Valley, an area 50 miles wide by 35 miles deep. (Photo courtesy of Industrial Television, 7940 Fareholm Dr., Los Angeles 46, Calif.)

UHF TV channel 70 to 83. The UHF output signal is amplified to ten watts true peak visual power, plus five watts aural power in the basic type UST-10 unit, for re-broadcasting. A separate Translator is required for each channel desired. The output signal is identical, except for frequency and amplitude, and equal in quality to the input signal. Additionally, a 100-watt Translator Amplifier type RA-7 is now available to boost the output power to 100 watts true peak visual plus aural.

Suitable receiving and transmitting antennas are required to complete the television broadcast translator system. The receiving or input antenna operates on VHF and does not represent a problem. Any one of a large number of standard VHF TV home-type receiving antennas may be used. A mountain top or otherwise elevated location is selected for most effective use of both the receiving and transmitting antennas. The care with which the

VHF receiving antenna is installed is a decisive factor in the performance of the system. Fortunately, good signals are available over considerable distances when line-of-sight propagation paths are provided. A low-loss 75 ohm coaxial cable completes the input signal circuit.

The transmitting antenna is a more specialized unit. In order to obtain the bandwidth necessary for a UHF TV channel with minimum signal distortion, these antennas must be tailor made. The antenna design is further complicated by the economic necessity for obtaining a power gain without sacrifice in horizontal coverage. The Adler type USTA-4 unitized UHF transmitting antenna was developed specifically for this application.

The unitized antenna consists of four dipole radiating elements mounted on a common reflector plate, housed in a weatherproof fiberglass case. A phasing and power dividing network provides a single type N connector input terminal. When tuned to any specified UHF TV Channel 70 to 83, a gain of 9 db is obtained, with a VSWR of 1.1 over the 6 mc channel bandwidth and a horizontal beam width of 100° . The impedance is 52 ohms and the recommended input power rating is 200 watts. Its light weight (12½ lbs.) and compact size (10½ inches wide by 27 inches high) presents a windload of only 88 lbs. at velocities of 100 mph. It is designed for mounting to pipe antenna masts.

The USTA-4 unitized antennas may be stacked vertically and horizontally to provide increased gain at

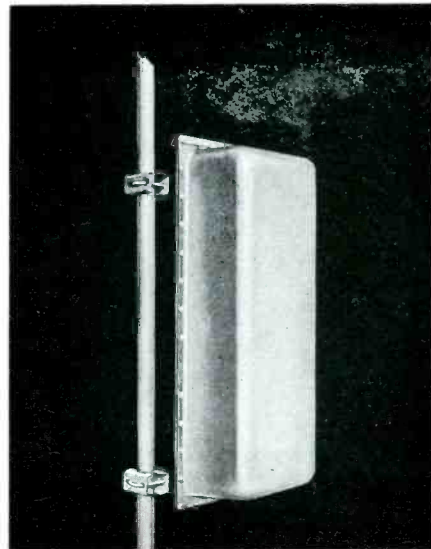

The USTA-4 Unitized Translator Transmitting Antenna.

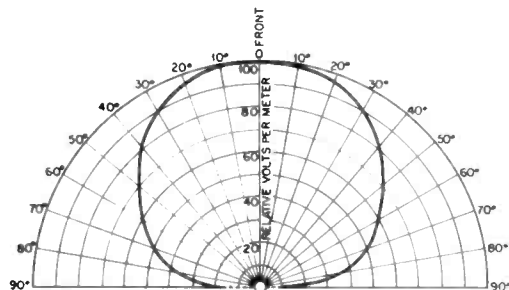

USTA-4 UHF Antenna Horizontal Radiation Pattern.

any practical coverage pattern. The power gain is increased in 3 db steps each time the number of USTA-4 antennas stacked is doubled. Standard Adler USTAT-50 matching transformers are used to combine units, maintaining the 52 ohm impedance with a 1.1 VSWR, and at the same time insuring equal power distribution between the elements of the array. Omnidirectional horizontal radiation patterns are also obtainable by stacking USTA-4 units horizontally in quadrature.

The basic type UST-10 Translator is housed in a standard cabinet rack, 42 inches high. Primary power requirements are 420 watts at 117 volts, single phase, 60 cycles, ± 5 per cent regulation. A weatherproof shack of simple construction is required at the base of the antenna supporting mast. Translators are usually located at the highest point

near the community to be served. This provides good antenna coverage with a short mast, at the same time reducing transmission losses due to excessive cable runs. The site is usually selected so that the more efficient unidirectional transmitting antennas may be used to provide community coverage.

Provision should also be made in the shack for the addition of the type RA-7 100-watt Translator Amplifier. This unit is housed in a standard cabinet rack 66 inches high. A pedestal is available to bring the UST-10 unit up to the RA-7 height. The additional input power requirements for the 100-watt Amplifier are 720 watts. Some reserve power should be available for lighting and test equipment. A 20-ampere circuit is normally installed, to meet all requirements for a single channel translator system.

A word of caution is advisable at this point. A low-resistance ground rod installation must be provided in order to comply with safe operating practice. The power source and the equipment should be tied into this ground. In addition, a lightning arrester is sometimes desirable in difficult weather areas.

Sufficient VHF amplification is provided in the Translator to operate from a 1000 uv/m input signal. This may be augmented by an external low-noise preamplifier to build up the signal in borderline receiving areas. The output from the VHF preamplifiers in the UST-10 is one of the input signals for the high-level mixer. Instantaneous variations in VHF signal level, due to fading and other quirks of propagation, are compensated by the 20 db automatic gain control circuit in these amplifiers. Input signal variations of

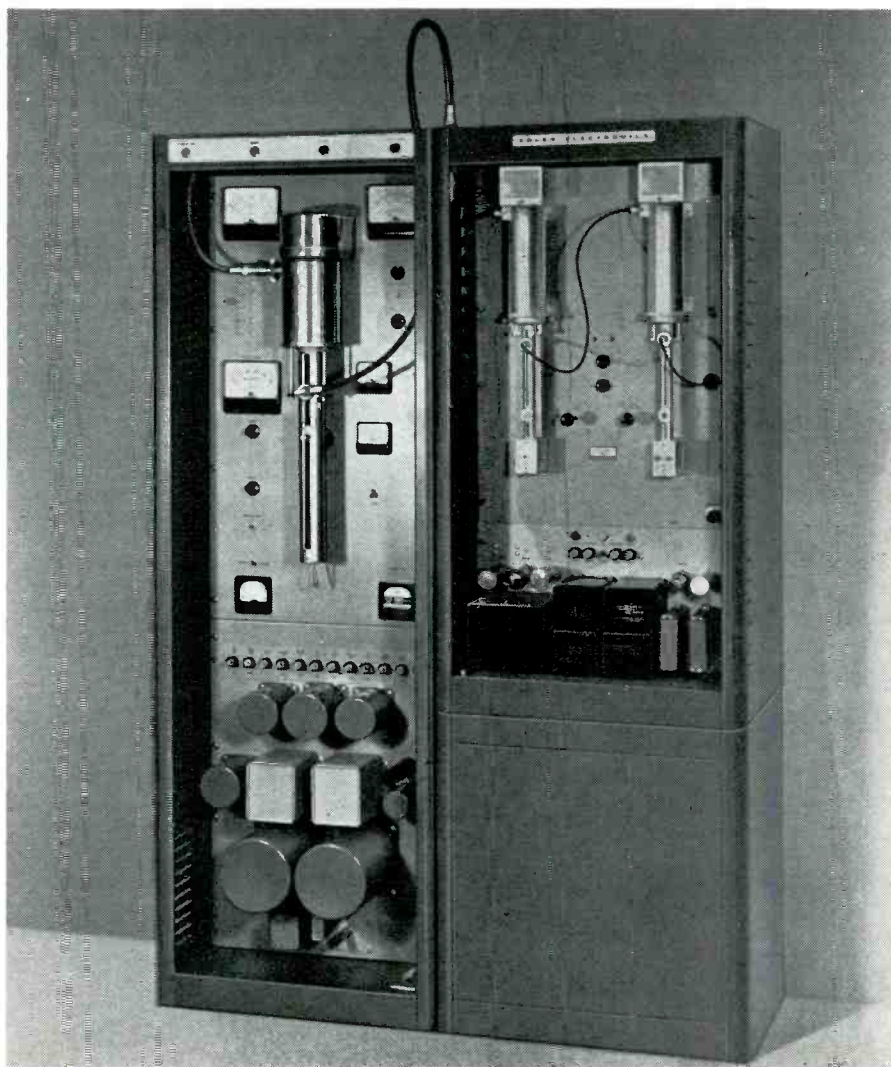

The UST-10 Translator (right) and RA-7 Amplifier (left) combined to form a 100-watt Translator-Transmitter.

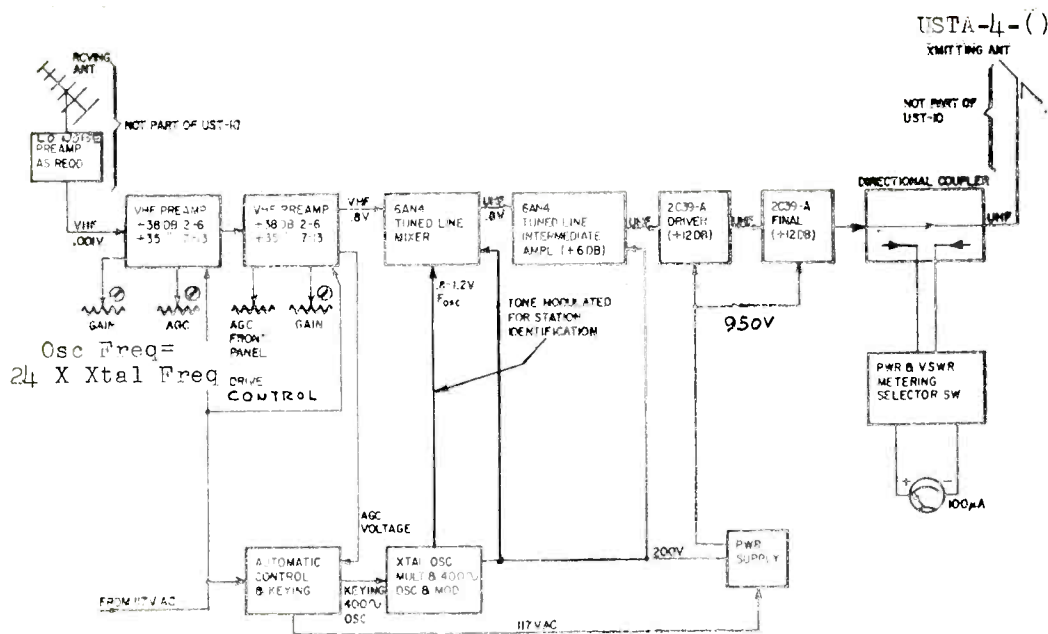

Block Diagram of the Adler UST-10 Translator.

1000 uv/m \pm 10 db have no discernible effect on the UST-10 if output power. When properly set up, the AGC control on the second VHF preamplifier also controls the drive and rf output power.

The Translator is designed to turn itself on and off with the pick up of a signal from the "mother" station, while in a standby operating condition, only the VHF preamplifiers and automatic control chassis are activated. The incoming signal produces a dc voltage in the AGC circuit, which is used to operate a relay, turning the UST-10 on. A fail-safe remote control circuit is also required by the FCC. This circuit consists of a field wire pair run down the mountain to a roadside control box. A simple toggle switch and selenium rectifier determine whether or not the UST-10 carrier may be placed on-the-air. The circuit is a combination of ac and dc operation, so that a short or open circuit field wire pair will fail safe, disabling the Translator. This additional manual remote control available roadside satisfies the requirement for removing the carrier under emergency conditions.

The second input signal to the high-level mixer originates in the

crystal oscillator-multiplier chassis. A crystal oscillator operating on a frequency of approximately 30 mc is multiplied up to a frequency 24 times greater. This oscillator signal and the input VHF signal was heterodyned in the high-level mixer, the sum frequency resulting in the UST-10 UHF carrier frequency. All of the original video and aural modulation components on the VHF signal are transferred without change to the UHF carrier. Because of the high level of operation, the mixer output is noise-free. Furthermore, there is no conversion loss.

The FCC requires that the Translator Carrier be identified on-the-air every half hour. The oscillator signal into the mixer is amplitude modulated with 400 cps tone for this purpose. The international Morse code station call letters may be read on a monitor receiver, while at the same time resulting in only minor disturbances in the picture and sound program. A synchronous clock motor drives a timer wheel, which in turn controls a code wheel. The timer wheel may be set to start the code wheel cycle 30 seconds before the half-hour. The code wheel completes one revolution in approximately 20 seconds, always starting

and stopping at the same place. A soft copper ribbon 1/4-inch wide and 15 mils thick is threaded into slots milled in the code wheel. This ribbon provides continuity for the keying circuit producing the station call in Morse code. In addition, the keying control circuit is arranged to transmit the station call letters immediately upon placing the carrier on-the-air at the beginning of the broadcast day.

The mixer and intermediate amplifiers employ 6AN4 tubes in a grounded grid circuit, with a trough line construction output configuration. Mixing is accomplished in the cathode circuit, with suitable VHF and UHF isolation provided. The output is tuned by varying the plate plunger, which is the center conductor of the trough line. Adjustable capacity output coupling is employed in these and the succeeding 2C39A amplifier stages.

The 2C39A driver and final stages are of coaxial cavity construction, employing a grounded grid circuit. Both circuits are identical, although one operates as a small signal amplifier while the other is a power amplifier. Linear operation is required to avoid intermodulation of the visual and sound

carriers and the chrominance sub-carrier in the case of color. The input circuit for these cavities is of special interest, since it represents an advance in the state of the art. The cathode circuit is formed into a coaxial transmission line. Two adjustments are provided on this cathode line, a sliding short, and a sliding inner conductor tap. The circuit is equivalent to an autotransformer with both the primary and secondary impedances adjustable. Between the two adjustments, a perfect impedance match is obtainable at any operating frequency. The plate output circuit is an adjustable cavity, with capacitive output coupling.

A directional coupler in the output transmission line completes the signal circuit. Rf power output and VSWR are monitored with an external service type 100 ua meter (5000 ohms internal impedance—Simpson Model 260 or equal). VSWR is very important in determining the effective transfer of power from the power amplifier to the antenna.

The power supply is of conservative design, producing both the high voltage and the low voltage. Safety interlocks, air-flow switches and features usually found in commercial transmitters are also provided, for

a well rounded reliable operating equipment.

The type RA-7 100-watt Translator Amplifier uses the basic UST-10 Translator for a driver. Existing installations require the reconnection of the antenna to the RA-7 output and the addition of a jumper cable between the UST-10 output and the RA-7 input. A control circuit pair between the RA-7 and the UST-10 provides automatic on/off operation of the RA-7 along with the UST-10.

The RA-7 amplifier employs a 4CX250K low cost ceramic tetrode in a coaxial cavity configuration. The screen grid is grounded directly, while the control grid is rf grounded only, to allow for the application of bias potential. The plate is operated at +1200 volts and the cathode is at -300 volts, effectively placing the screen grid at +300 volts with respect to the cathode. The coaxial cavity amplifier is similar to the time proven 2C39A coaxial cavity in every other respect.

The UST-10 directional coupler is used to match the RA-7 input circuit. An additional directional coupler in the RA-7 is used to monitor the rf output power and to match the antenna. The Adler USTA-4 antenna configuration in use will also handle the RA-7 power output. The amplifier is completely instrument-

ed, designed for ease of operation and maintenance in unattended installations.

Most translator systems are supported by popular subscription. Others are supported by municipalities, private commercial interests and TV broadcast stations. Of interest is the use of Translators by the Springfield Television Broadcasting Corp., WWLP—Channel 22 and WRLP—Channel 32. Using 10-watt type UST-10 Translators, W79AA serves approximately 14,000 people in Claremont, N. H., and W81AA serves roughly 25,000 people in the White River, Vt., vicinity.

The following statistics are based on a report from William L. Putnam, president of the corporation:

Conversion to UHF in the W79AA service area is about 35 per cent, with strong competition from an established local community antenna system. At W81AA conversion runs to 80 per cent, with a high degree of community recognition and acceptance, since this is the only good television service in that area.

The total cost for equipment and installation at W79AA was about \$4,200, including the tower, building, transmission lines, power service, monitor receiver, translator and antennas. The cost at W81AA was a few hundred dollars higher be-

TO KEEP UP-TO-DATE ON THE
LATEST DEVELOPMENTS IN
BROADCASTING BE SURE
YOU ARE A SUBSCRIBER
TO

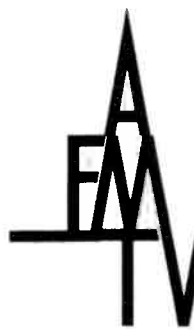

BROADCAST
THE TECHNICAL JOURNAL OF THE BROADCAST INDUSTRY
ENGINEERING

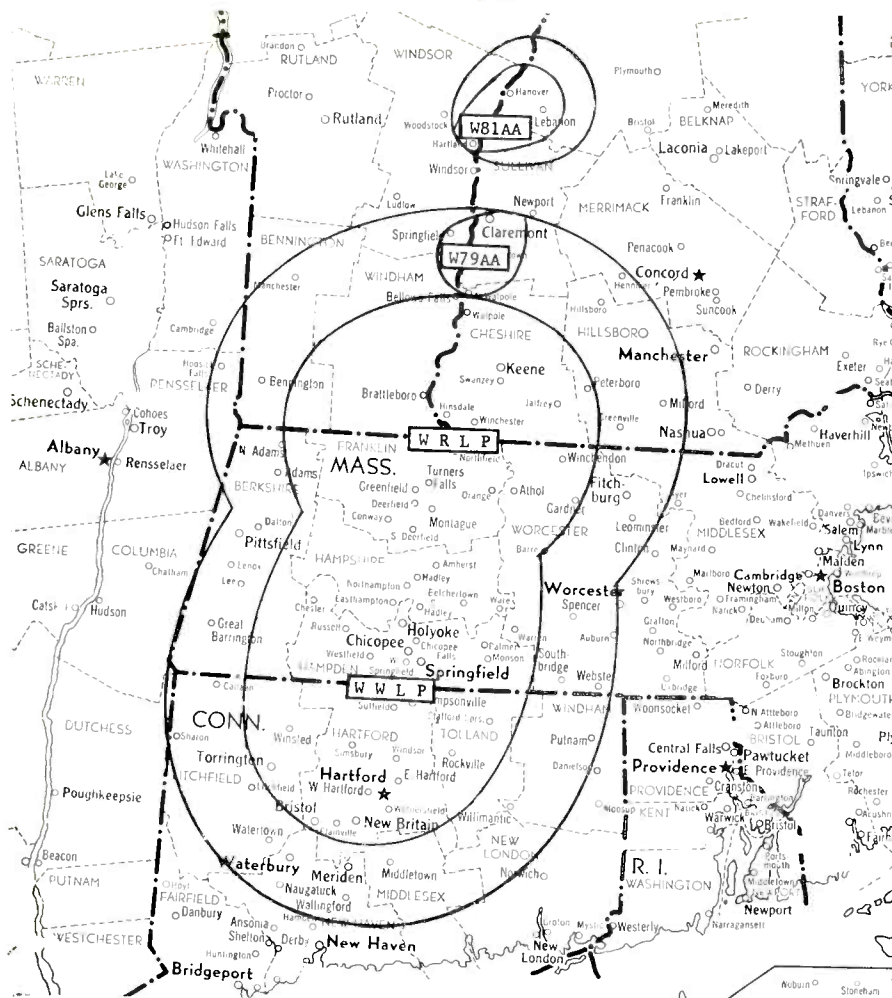

WWLP-CHANNEL 22 Springfield - Holyoke, Mass.

WRLP-CHANNEL 32 (Satellite Station)

Battleboro, Vt. — Greenfield, Mass. — Keene, N. H.

CHANNEL 79 - Claremont, N. H.

CHANNEL 81 — Hanover, N. H. — Lebanon, N. H. — White River Junction, Vt. (Translator Stations)

cause a higher gain transmitting antenna was used. Add about \$5,500 to this for a 100-watt Translator installation. Maintenance at each site is done by local people at no cost to the station. Occasionally, WRLP personnel check the equipment for tuning and extraordinary adjustment.

The entire operation has been pitched as a package bonus, with WWLP, so the additional coverage has not meant a great deal for national advertisers. Regional advertisers, on the other hand, are familiar with the communities served by the Translators and are very interested. Local advertisers gained by these Translators have spent many thousands of dollars with WWLP since the inception of this service.

These Translators have meant considerable in revenue to the station, and although they have not been used specifically as an excuse for higher rates they have done much to gain acceptance for the current rates. The station is now planning for additional Translators to serve the towns of Athol and Orange, and the cities of Pittsfield and Shelburne. It is planned to make two of these 100-watt Translators. It is also planned to convert W81AA from a 10-watt to a 100-watt Translator.

Mr. Putnam writes: "Very early in the game we came to the conclusion that increases in power output at WRLP would be of very little help in getting us greater population coverage in an area of rela-

tively mountainous terrain. It was obvious that Translators were the answer to providing service to distant and valley area."

Television Broadcast Translator Stations are creating their own niche in the pages of broadcasting history. With increased power authorized by the FCC and now available, increasing use of this service is already indicated. The addition of a relatively simple audio-video modulator opens the way for local origination on Translator Stations, when approved by the FCC. In the meantime, Low Power Standard UHF Television Broadcast Stations for educational TV and economy commercial stations are a reality. There no longer is an underprivileged television minority in this country.

WEATHER

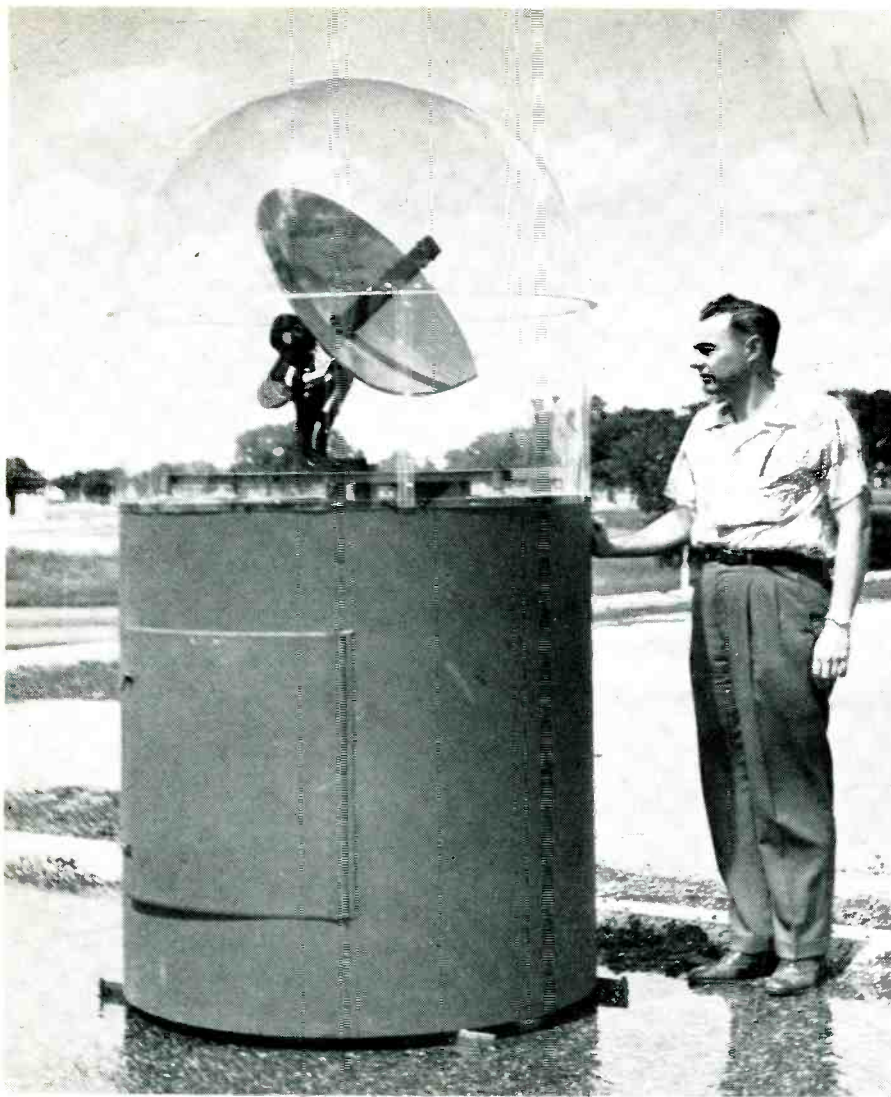

Radar Antenna Enclosed in Plexiglas Dome.

APPROXIMATELY a year ago a weather radar system was installed at WFAA-TV in Dallas, Tex., for the purpose of showing the viewing audience an actual picture of the current weather. This weather presentation enjoyed rather wide acceptance by the Dallas viewing public. Because of this acceptance many other television broadcasting organizations have looked into and are installing weather radar systems.

This growing interest in weather radar aroused many questions among broadcast engineers. Some of these questions concerned theory of operation and associated installation problems. Other questions were in regard to weather radar interpretation and how this could be effectively presented to the viewing audience. This article will endeavor to answer these questions.

The primary function of a weather radar system is to present a weather map of the general sky area 360 degrees around the base of the antenna and at distances up to 150 miles. The weather map is displayed as a PPI visual presentation on a range azimuth indicator unit, which shows the location of cloud formations in terms of distance and azimuth with respect to the antenna location. Cloud formations which have heavy rainfall gradient or hail will appear as bright returns as compared to harmless formations which will appear much less bright.

The Collins WP-101, Weather Radar System, consists of five components (see Fig. 1). These are the 374A-1 R-T Unit, 776C-2 Synchronizer Unit, 493A-1 Range Azimuth Indicator, 537F-3 Antenna and 561G-1 Control Unit. In addition to

the above units a 1 kw source of 115v, 400 cps power and a 1 amp. 27.5 volt dc power supply is required.

Specifications

Careful consideration was given to all system parameters in the design of the WP-101 system. Important parameters such as frequency, power output, pulse width, pulse repetition frequency and beam width have been optimized to give maximum interpretation to thunderstorms and other frontal conditions. A short summary of these parameters follows:

CHARACTERISTIC	DESCRIPTION
Frequency band	C band
Transmitting and receiving frequency	5400 mc \pm 30 mc
Power output	75 kw peak, minimum
Pulse width	2.1 microseconds
Pulse repetition frequency	400 cps (nominal)
Intermediate frequency	60 mc

RADAR

By
R. CRAIG CHRISTIE,
Collins Radio Co.

*The following paper was presented at
the 13th NAB Engineering Conference.*

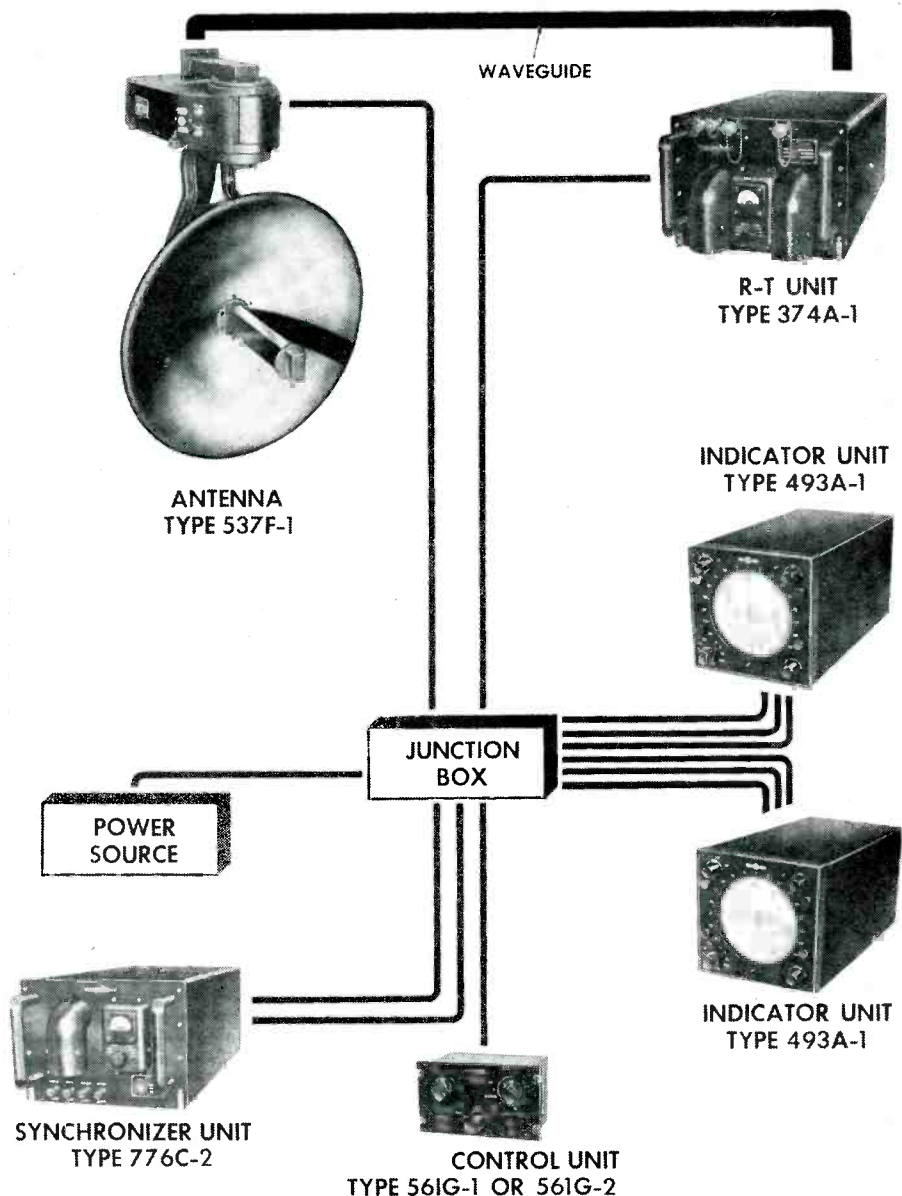

Figure 1
Complete Weather Radar System.

IF bandwidth	2 mc at 3 db, 60 mc center frequency
Over-all video bandwidth	200 cps to 2 mc at 3 db points
Antenna scan	15 rpm, 360 degrees (nominal)
Antenna manual tilt	+ 10 degrees, - 15 degrees
Antenna beam width	5½ degrees
Sweep ranges	20, 50, 150 miles
Range mark intervals	5, 10, 25 miles
Power input requirements	115v ac ± 5%, 380-420 cps, 665va for a two indicator system; ± 28v dc at 1.0 amps.
Presentation	PPI type range—azimuth information on a 5-inch cathode ray tube.
STC (Sensitivity time control)	Continuously effective up to 25 miles
Iso-echo (contour) operation	Optional operation from 561G-1 control unit.
Magnetron protection	Load isolator 16 db isolation; insertion loss less than 1 db.

Theory of Operation

Your attention is invited to the block diagram (see Fig. 8). It will be noted that the 400 cycle source previously mentioned is used to establish the pulse repetition frequency of the system. Using a non-resonant a-c charging scheme, a thyatron switch tube and a pulse forming network, a 2.1 microsecond pulse of large amplitude is generated and applied to the magnetron. The magnetron is a high-powered type of oscillator, and operates at approximately 5400 mc. Energy is coupled from the magnetron to the antenna via the load isolator, duplexer-mixer and interconnecting waveguide.

The load isolator is a device which transmits r-f energy with little attenuation in one direction, and a

maximum attenuation in the opposite direction. The duplexer is an r-f energy switch which prevents the high energy of the transmitted pulse from entering the receiver (mixer), and directs the returned echo signal into the mixer. In the mixer the received echo signal is heterodyned with the local oscillator producing an i-f signal which is amplified and detected. The transmitted r-f energy is fed to the antenna through waveguide and is disbursed from slots in the antenna feed at the focal point of the parabolic antenna directs the energy into a 5½ degree beam.

The antenna rotates at 15 rpm, scanning 360 degrees. Cloud formations, rain storms and solid objects reflect a portion of the transmitted

energy. This returned energy (or echo) is received at the antenna and travels through the waveguide to the duplexer-mixer. Here the received signal is mixed with a signal from the local oscillator which is operating 60 mc above the magnetron frequency. A difference frequency of 60 mc is detected by the crystal rectifier and this signal is fed into the i-f amplifier. The i-f amplifier is highly selective and is tuned to a frequency of 60 mc with a bandwidth of 2 mc. After several stages of amplification, the signal is detected by a crystal detector. The output video signal is amplified in the indicator unit and impressed on the control grid of the indicator CRT, thereby causing the echo signals to be displayed as bright spots or areas on the face of the tube.

A pulse is derived from the thyratron switch tube and is used to synchronize sweep traces and range marks for the indicator. This gives the viewer a means of measuring distances of received echoes. Selector modules provide the appropriate sweep and range markers for each of the three ranges (20, 50, and 150 miles). The sweep currents are applied to the magnetic deflection coils (yoke) which encircles the neck of the CRT. Range markers (along with the video signals) are applied to the control grid of the CRT.

The azimuth drive system consists of a closed loop servo and an open loop servo. The closed loop servo includes a servo amplifier in the synchronizer unit, and a servo motor and synchro transformer in the range-azimuth indicator unit. The open loop includes an azimuth synchro transmitter which is geared to the azimuth gear drive of the antenna. The open loop transmits a signal to the closed loop, causing the servo motor (in the indicator unit) to rotate the deflection coils around the neck of the CRT in synchronism with the antenna.

Two sources of power are required for the operation of the radar system. These are 28v dc for relay operation and 115v ac primary power source. The power requirements of the radar system are divided into three loads. These loads are supplied from the three phases of a three-phase generator, or they may be supplied from the same source if single phase power is used.

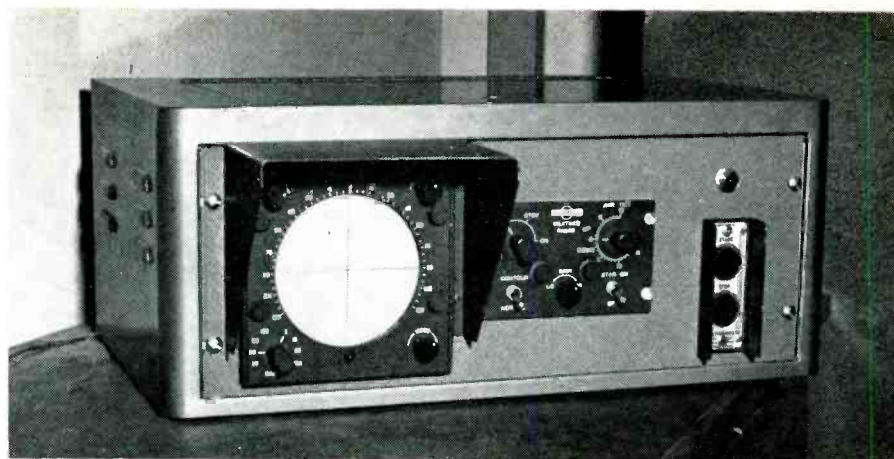

Figure 2
Radar Indicator and Control Unit.

Control

Operation of the system is accomplished by various controls located on both the 561G-1 Control Unit, and 493A-1 Indicator (see Fig. 2). These controls and their function are as follows:

561G-1 CONTROL

Control	Function
OFF-STBY-ON	System power control switch.
OFF	Turns equipment off.
STBY	Holds system in standby condition.
ON	Operating position after four minute time delay (high voltage applied).
ANT TILT	Varies tilt of the antenna 10 degrees up and 15 degrees down.
LO-HI GAIN	Controls rf amplification of received signals.
CONTOUR-NORMAL	Controls iso-echo circuit.
NORMAL	Signal returns from targets are displayed as bright areas on the indicator.
CONTOUR	Signal returns above the contour threshold are displayed as shaded or dark configurations surrounded by brighter areas.

493A-1 INDICATOR UNIT

Control	Function
DIM	Varies the panel illumination of the indicator unit.
INT	Adjusts the brightness of the sweep trace and range marks.
VIDEO	Adjusts the contrast between the echo return and screen background.
RANGE	Selects range of operation and the corresponding range marks.
20 MI	Selects 20-mile sweep and 5-mile range marks.
50 MI	Selects 50-mile sweep and 10-mile range marks.
150 MI	Selects 150-mile sweep and 25-mile range marks.

Interpretation

After proper adjustment of the controls has produced the most readable scope image, the task of interpretation of the weather front still exists. As an example (see Figure 3) let us look at a front on the

150-mile scale which extends in azimuth from 30 degrees right to 120 degrees left of the 0 degree reference. Bright returns within the shaded area denote the presence of rainfall in the weather front. The echoes are very intense and sharp-edged, indicating active, turbulent areas. Note that the farthest return is displayed approximately 25 degrees right of the 0 degree reference at a distance of 100 miles.

Next let us look at this same front on the 50-mile scale (see Figure 4). Notice that the closest portion of the front is displayed approximately 85 degrees left of the 0 degree reference at a distance of 20 miles. The display shows the extent in azimuth of an active turbulent storm but gives us no information relative to areas of heavy rainfall or degree of turbulence.

Let us now operate the contour switch on the control unit to the contour position (see Figure 5). Notice the difference between this display and the previous one. An area of heavy rainfall is displayed at 0 degrees/35 miles. Smaller areas of lighter rainfall are shown 15 degrees left of the 0 degree reference at a range of 30 miles and at 85 degrees left of the 0 degree reference at a range of 22 miles. The rainfall gradient changes rapidly from bright to dark at the 0 degree position indicating extreme turbulence around the contour of the black hole. The gradients at the 15 degree and 85 degree position do not change as rapidly; turbulence may exist but is not so extreme as at the 0 degree position.

Let us now look at this same front on the 20-mile scale with the nominal contour switch in the nom-

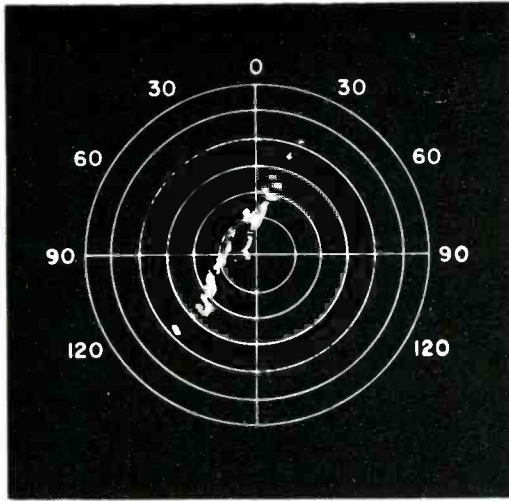

Figure 3. Indicator Display, 150 Mile Range, Initial Detection

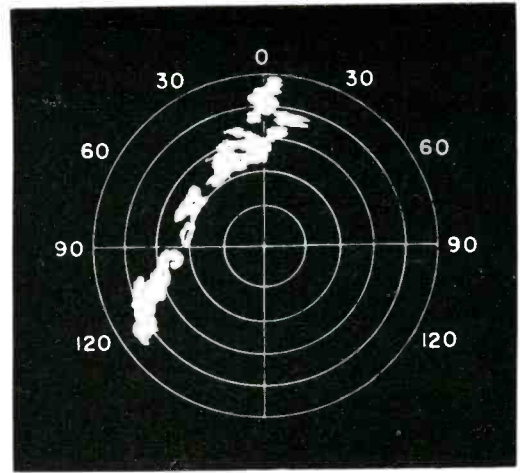

Figure 5. Indicator Display, 50 Mile Range, Contour

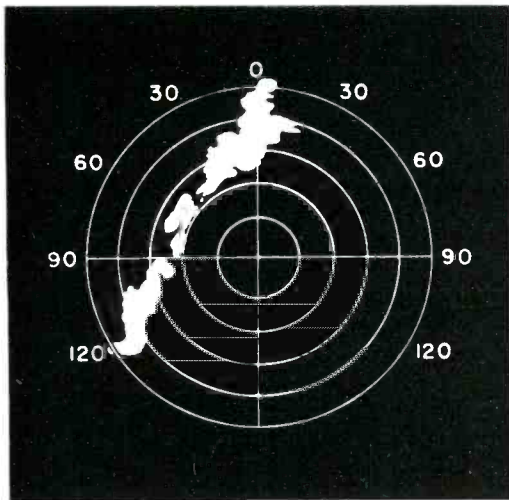

Figure 4. Indicator Display, 50 Mile Range, Normal

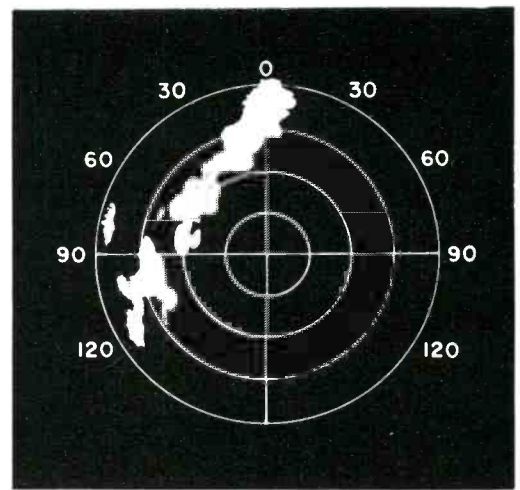

Figure 6. Indicator Display, 20 Mile Range, Normal

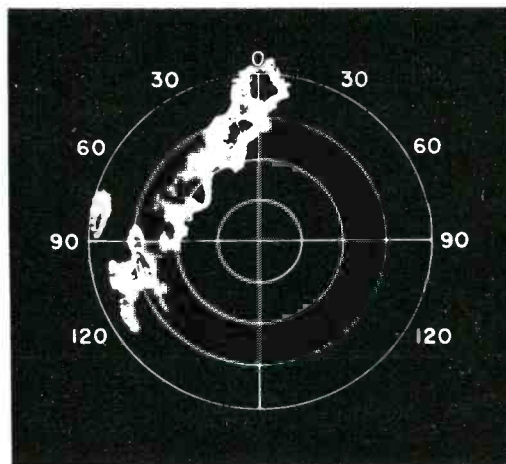

Figure 7. Indicator Display, 20 Mile Range, Contour

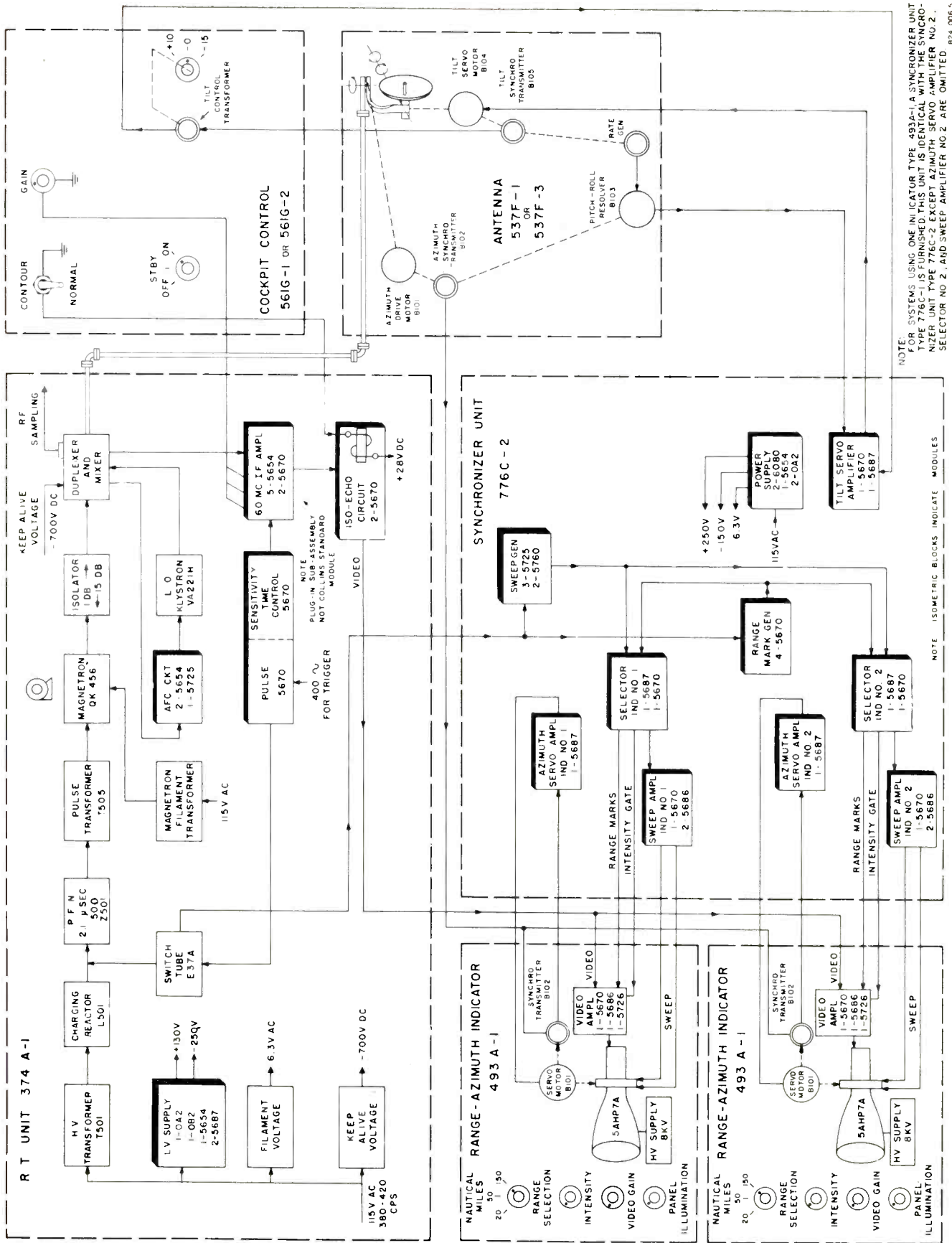

Figure 8. WP-101 Weather Radar System, Block Diagram



Figure 9
RT Unit, Synchronizer and
Junction Box.

inal position (see Figure 6). The bright intense echoes indicate active turbulent areas. No information is presented, however, relative to areas of rainfall and degree of turbulence. The closest portion of the front has advanced to approximately 8 miles at an azimuth of 45 and 80 degrees left of the 0 degree reference.

With the contour-nominal switch placed in the contour position the display changes (see Figure 7.) Heavy rainfall is now denoted by black areas within the bright return at 0 degree/18 miles; 15 degrees left of the 0 degree reference at a distance of 13 miles; 60 degrees left/8 miles; 85 degrees left/12 miles; 90 degrees left/15 miles; and 105 degrees left/15 miles. Extreme turbu-

lence exists in the areas surrounding the contour of the black holes at 0 degrees and at 15, 60, and 85 degrees left of the 0 degree reference. The portion of the front extending in azimuth from 90 to 120 degrees left of the 0 degree reference produces a light fuzzy return thus indicating little turbulence exists.

Installation

Installing a weather radar system at a television station can be accomplished with ordinary station personnel at minimum expense. As an example some pictures of the weather radar installation at WMT-TV, Cedar Rapids, Iowa, are shown.

In coordinating the weather radar installation with their operational requirements WMT chose to mount the control unit and one indicator in a console in the news room. This allowed the news forecaster to adjust and view the indicator continuously during thunderstorm periods. Another indicator was mounted in the studio in front of a fixed camera. This made possible the transmission of the actual weather to the viewing audience. Although some users place a weather map overlay over the indicator, WMT has adopted the practice of superimposing the radar picture on a false indicator which has been enlarged (see Figure 10).

The antenna is mounted on a circular pedestal located on the roof. The height of the pedestal was chosen so that the protrusions from the studio building would not be in the beam width when scanning in a horizontal plane. A plexiglass ra-

dome was placed over the antenna to protect it against weather.

The wave guide and power-control cable are fed through the roof to the RT Unit, Synchronizer and junction box which are located directly below the antenna (see Figure 9). Notice that the RT Unit, Synchronizer and junction box are mounted on a table for ease of installation and maintenance. Both the RT Unit and Synchronizer are mounted on shock mounts which allows easy removal when maintenance is required. The wave guide is coupled to the shock mount through a 3-foot length of flexible wave guide.

Notice that all the cables from the system components are terminated in a common junction box. This allows interconnection between units to be accomplished at a common place in addition greatly simplifying initial testing and routine servicing.

The 115-volt, 400 cps power for this system is supplied by an American Electronics 1.8 kva single phase motor generator. The 27.5 volt dc is obtained from a 6 amp transformer-rectifier power supply located on the second shelf of the table. The power input circuits are remotely controlled from the news room for convenience.

It is believed that the installation of weather radar system in television stations has greatly increased the interest in the "weather show." In addition TV weather radar allows the television industry to provide a great public service in offering actual first hand weather reports on approaching dangerous weather.

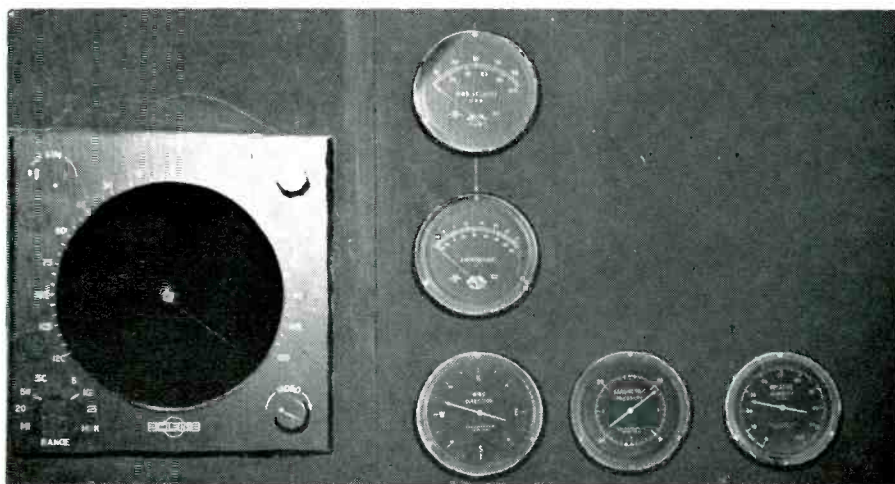

Figure 10
Weather Forecasting Indicator at WMT.

THE SCR DIMMER

SILICON CONTROLLED RECTIFIER GREATLY REDUCES SIZE AND WEIGHT

HERE ARE THE ANSWERS TO THE MOST ASKED QUESTIONS

By

HERBERT R. MORE

Manager, TV Division, Kleigl Bros.

What is the SCR Dimmer?

The SCR Dimmer is a revolutionary form of light dimming control employing two silicon controlled rectifiers as the basic dimming elements. The dimmer is equally adaptable for use in directly or remotely controlled dimming installations. These double rectifier dimmers may be used individually or when grouped in banks are fully adaptable to presetting and mastering systems.

What is a silicon controlled rectifier?

A silicon controlled rectifier is a four element semiconductor, physically having a great resemblance to a 1/4"-20 nut and bolt to which some wires have been attached. (Figure 1) In its off or non-conducting state the device represents essentially an open circuit or open switch. However, when the proper control signal is supplied to a control "gate" on the

rectifier, the device switches to a conducting state completing the lighting circuit.

What is the general principle of operation of the SCR Dimmer?

The SCR Dimmer may be thought of as a valve placed in the line ahead of the lighting load. The control setting governs the period of flow of current through the dimmer in each cycle and thus causes the lamps to operate at any desired brightness.

How large a unit is the SCR Dimmer?

Two basic units are available: One, (Figure 2) occupies only 1/8 of a cubic foot, a six-inch cube; the other, (Figure 3) plug-in style equipped with primary circuit protection, measures approximately 3 1/2 x 8 x 14 inches. Figure 4 shows how the physical size of a 32 circuit auto-transformer dimmer board (measuring 97 x 68 x 24 inches) would be cut down to a size of 48 x 32 x 12 inches by the use of SCR Dimmers.

How much does the SCR Dimmer weigh?

The basic unit weighs only 4 1/2 pounds. Housed complete in 16-gauge sheet metal and including the weight of the primary circuit breaker the SCR Dimmer still weighs only 9 pounds. This compares with 76 to 168 pounds for similarly rated dimmers of other types now on the market.

What is the rating of the SCR Dimmer?

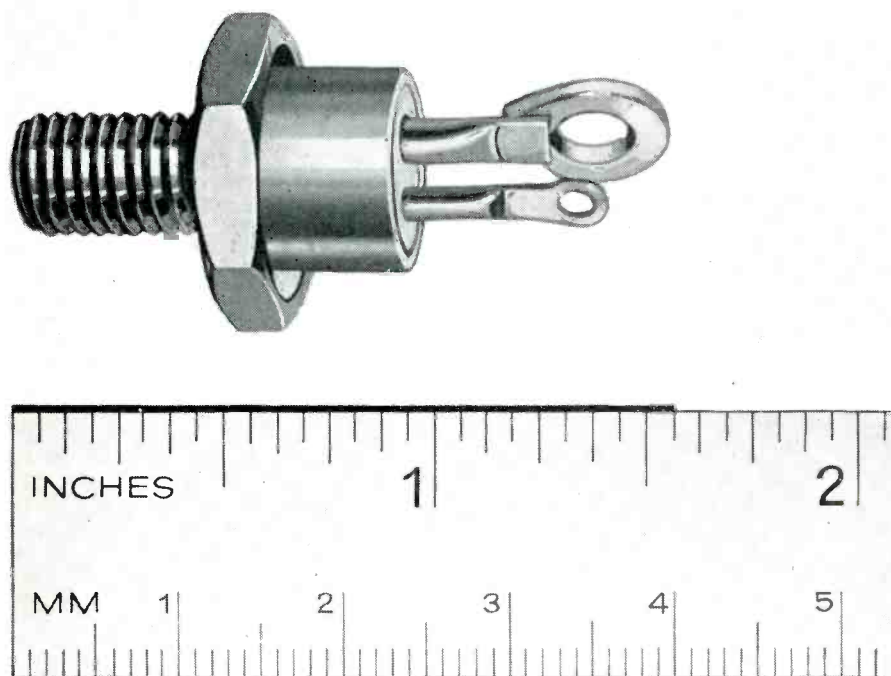

Figure 1
The Silicon Controlled Rectifier.

The present model of the SCR Dimmer is rated at 4000 watts. Before July a 10,000-watt unit will be introduced. A 2500-watt SCR Dimmer using two rectifiers is available at somewhat lower cost, the price differential being in the rectifiers. However, in view of a steadily declining price for the rectifiers this price differential will soon cease to be significant. At present, therefore, the basic SCR unit is the 4000 watt size.

What voltage supply is required?

The SCR Dimmer operates directly off the standard 120-volt 60 cps single phase alternating current service. (Figure 5) Thus it may be used with 120-208 volt three phase, four wire; 120-240 volt single phase, three wire; 120 volt single phase, two wire or any other service from which a nominal 120 volts a.c. is obtainable. The SCR Dimmer will not become unstable with poor input voltage regulation. It has been tested for input from 105 to 130 volts and has proved equally satisfactory for all.

What is the full load drop across the SCR Dimmer?

The maximum voltage drop across the unit when operating at its rated load is approximately three volts.

What is the output voltage waveform from the SCR Dimmer?

The electrical circuit of the SCR Dimmer consists of two silicon controlled rectifiers in a so-called "back-to-back" assembly. (Figure 6) Each element will permit a controlled amount of current to pass during its half of the applied voltage cycle. Thus, the full output of the SCR Dimmer is a 60 cps sine wave completely symmetrical with the zero voltage axis. At lower voltages (Figure 6) the output resembles that of a back-to-back thyatron. In no case is there any circulating d.c. component.

What practical considerations led to the decision to use a "back-to-back" or two rectifier circuit?

To be a true silicon controlled rectifier dimmer, the load currents must flow through both rectifiers. When a single rectifier is used to control the current in a saturable reactor it is no longer an SCR Dimmer as it is only a new control unit for a saturable reactor.

While at the present time this single rectifier method would result

in a unit of slightly lower cost, the resultant dimmer would have several undesirable characteristics. Its loading ratio would be decreased from infinite to only 10 to 1. Considerable output "noise" would be introduced which would require the use of additional components under certain circumstances such as its use in a TV studio. The fact that its type control curve, as well as its voltage output, changes under load are further disadvantages. Also, the weight of the unit will be increased more than two-fold.

In view of the compromise with quality and of the only temporary price advantage, this circuit was firmly rejected.

What about linearity of output control?

The light output versus control setting has been designed to be nearly linear from 0 to 10. (Figure 7) Control settings therefore indicate rather directly the percentage of light output. Thus actual illumination control is distributed evenly throughout the entire control scale, unlike previous systems, based on voltage linearity, which placed 90

per cent of the actual dimming in the top half of the control range. In this way subtlety of dimming control has been reintroduced to the dimming field.

What is the difference between the "Off" and "O" points on the control potentiometer?

At "Off" the output voltage of the SCR Dimmer is zero volts. At "O" the output is approximately 11-12 volts, barely enough to bring a glow to an incandescent lamp filament. This dual arrangement is a desirable feature, since it allows both complete blackout without extra switching and pre-heating of lamp filaments.

What is the loading range of the SCR Dimmer?

The loading range is infinite being better than 1000 to one. The dimmer may be loaded from the smallest available 3 watt lamp size to its rated load with no change either in the light output curve or the time of response.

What is the time of response?

The SCR Dimmer can be made to respond instantaneously to the control. Its response time is much faster than that of the incandescent

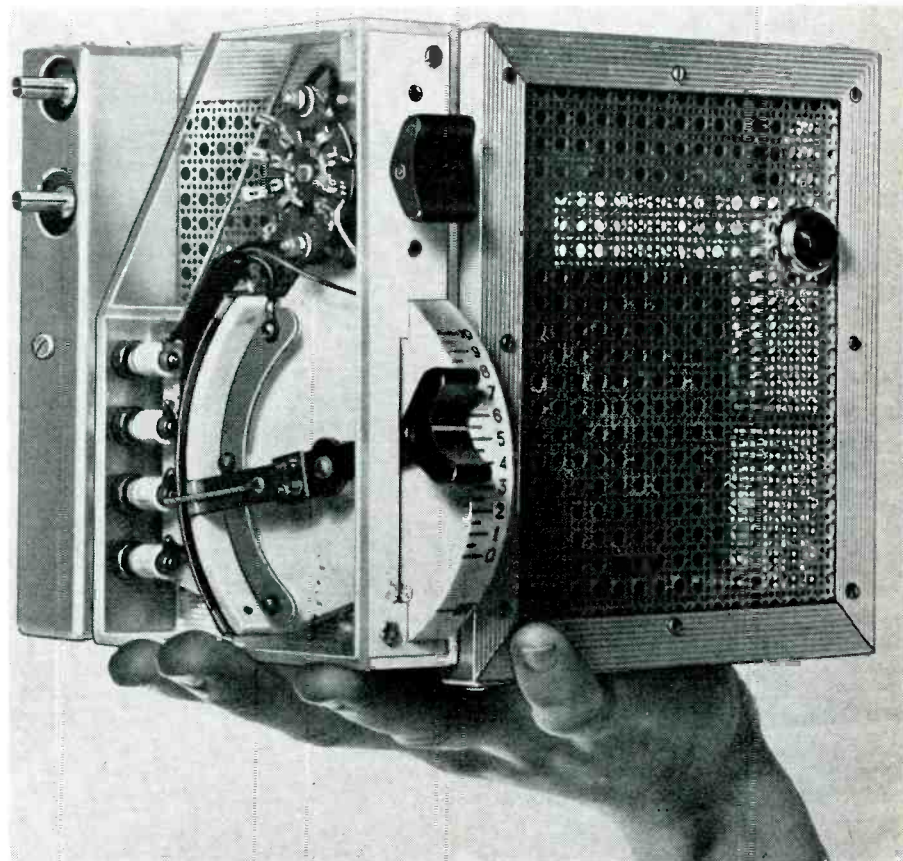

Figure 2

The basic dimmer is a six-inch cube.

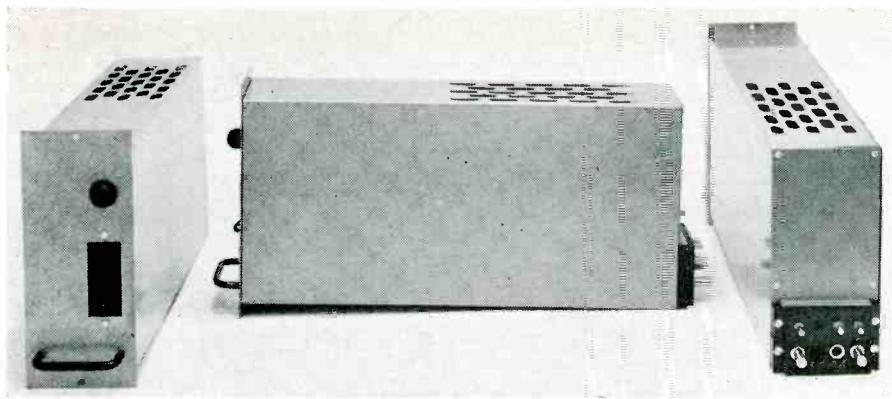

Figure 3

Plug-in style dimmers are equipped with primary circuit protection.

loads. To guard against short circuits a pair of quick acting silver sand fuses are provided. Also a special fast-acting circuit breaker protects the circuit against overloads.

What are the control voltage and current?

The control current is less than 5 milliamperes at 28 volts d.c.

What control wiring is necessary?

For ordinary dimming, one wire per dimmer plus a common wire are all that are needed. If the system includes a two or more scene preset device, then two control wires per dimmer plus one common wire are all that are necessary. The wire size will vary from #16 to #20 depending on the distance between the control and the dimmer and upon local codes. Lighter wiring is not

lamp filament and under any load condition for both "on" and "off" does not exceed 0.1 to 0.2 seconds.

What are the losses?

The efficiency of the SCR Dimmer is a remarkable 98 per cent plus. Full load losses are only 50 watts per dimmer. Figure 8 gives a great deal of comparative data on the four leading types of dimmers.

Will primary disconnect contactors and other disconnect devices be required in an SCR Dimmer System?

Because of the high efficiency of the individual SCR Dimmer units it will be possible to allow the SCR Dimming Bank to remain "on the line" if this is desired. However, in most instances the use of a primary contactor system is probably desirable. Good electrical practice will, in any case, dictate the use of at least a manual disconnect switch if a primary contactor or circuit breaker is not included in the installation.

Is any ventilation required for the SCR Dimmer?

In most installations ventilation will be desirable, and will normally be provided by the manufacturer in the form of a small silent blower designed to keep the air circulating in the dimmer rack assembly.

What provisions have been made for short circuit and overload protection?

Double protection is built into every SCR Dimmer. Careful research has shown that no single device will adequately take care of both short circuits and simple over-

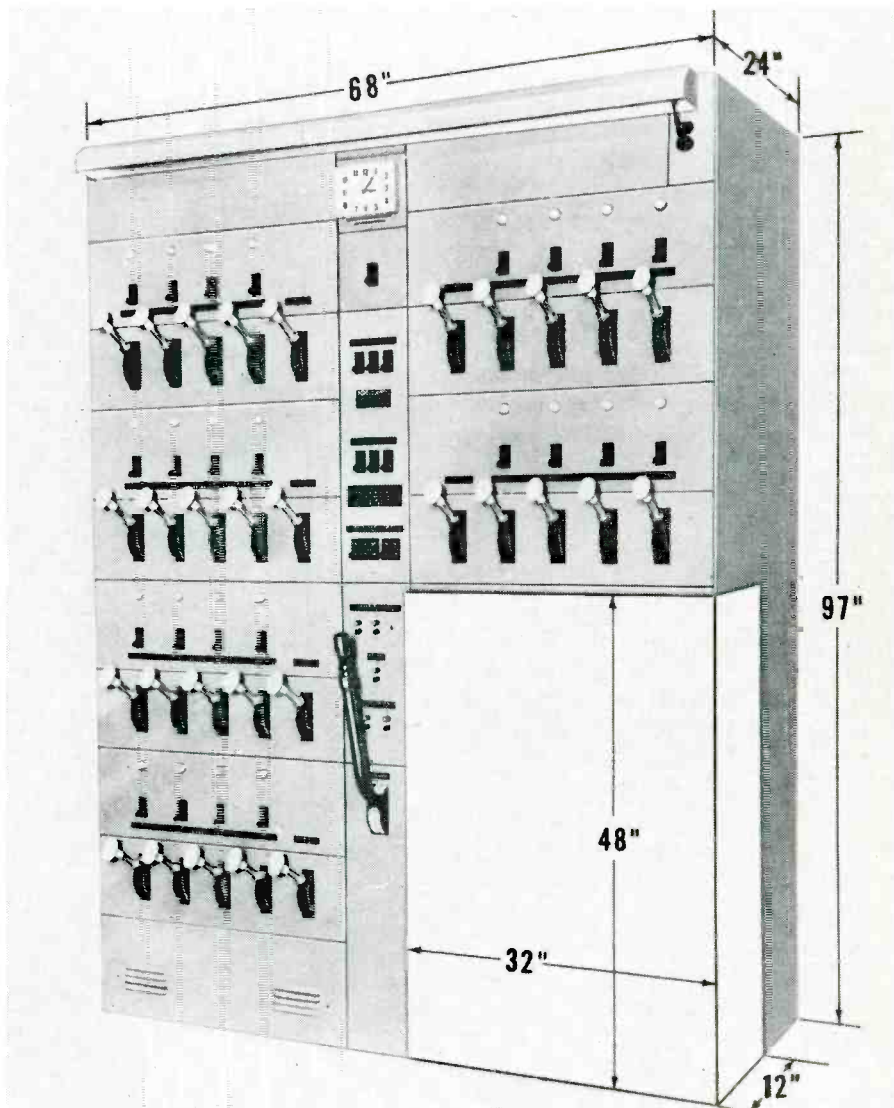

Figure 4

The above thirty-two circuit autotransformer dimmer board would be reduced to the size of the cutout section by using SCR Dimmers.

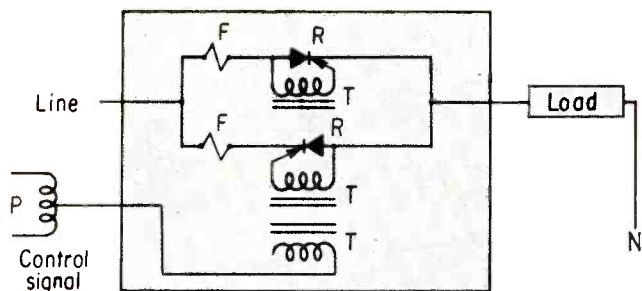

Figure 5

Schematic diagram of SCR Dimmer.

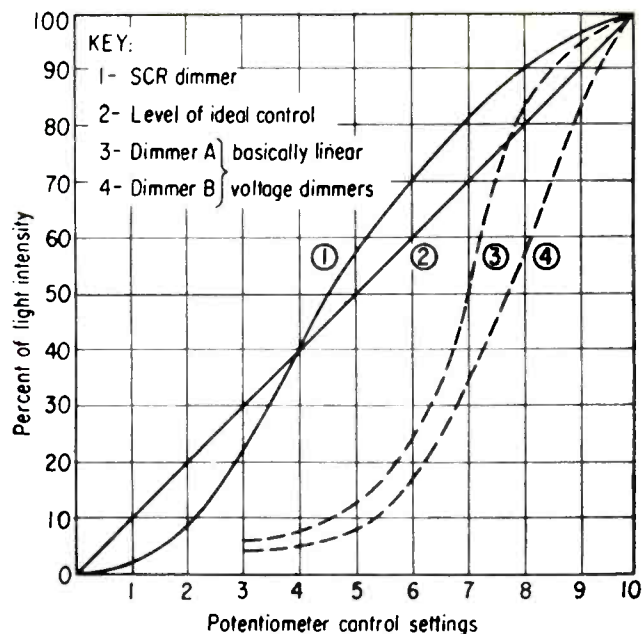

Figure 7

Linearity of SCR Dimmer is shown by above curves.

recommended for mechanical reasons.

Is electrical mastering possible?

Yes, the SCR Dimmer is capable of fully proportional mastering, submastering, fading, etc. This adds nothing to the interwiring between control station and dimmer.

What about the various forms of presetting?

The SCR Dimmer is adaptable to any of the forms of presetting including fading, infinite preset, pile-on, etc.

What modifications are required with present remote-control dimming systems to make them compatible with the SCR Dimmer?

Almost any modern remote control system can, with modification, be used with the SCR Dimmer. It is fully expected that many present thyatron, magnetic amplifier, and motor-operated auto-transformer units will be replaced with SCR

Dimmers when maintenance is indicated. The Engineering Division of Kliegl Bros. will furnish details regarding any installation upon receipt of information concerning the installation in question.

Is the SCR Dimmer suitable for use in television studios?

Yes. Tests by two separate groups of network engineers show that the SCR Dimmer causes no more video or audio interference than other systems presently in use. No filters or chokes are necessary.

What are some of the ways in which the SCR Dimmer may be used?

The SCR Dimmer makes possible an almost unlimited number of imaginative lighting system designs. Among them are:

a. The combination of dimmer rack and cross-connecting panel into one panel. Primary feeders are brought into the panel, secondary

circuits taken out of the panel. The control console can also be incorporated into the same panel or located remotely.

b. The combination of dimmer rack and control console. Primary feeders are brought into this combined panel. Dimmer feeds are taken from the panel to the cross-connecting panel located elsewhere or directly to the various lighting loads as desired.

c. Individual dimmers may be located on the light pipes alongside the individual lighting units. The main feeder for any individual lighting pipe is brought directly to the battens saving on the secondary distribution system. In this system the cross-connecting panel would be eliminated. Control wires only would have to be run from the light pipes back to the control console.

d. Small lightweight portable dimmer groups or banks may be made into traveling portable switchboards. In this event, the reduction in weight and size from a conventional professional theatre roadboard would be in the order of 90 to 95 per cent.

Is shock and vibration from handling or near-by machinery a problem?

No. The SCR Dimmer is made up of static elements which are not susceptible to shock damage.

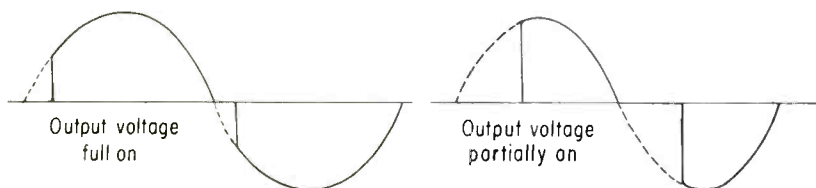

Figure 6

Each rectifier permits a controlled amount of current to pass.

Relative Performance Characteristics of Available Dimmer Systems

	Autotransformer (Motor Driven)	Magnetic Amplifier	Electronic (Thyratron)	SCR Dimmer
Weight of Dimmer Component Per Kw of Load Capacity	10 to 15 lbs.	15 to 25 lbs.	8 to 10 lbs.	2 lbs.
Size of Dimmer Component Per Kw of Load Capacity	¼ to ½ cu. ft.	¼ to ½ cu. ft.	¼ to ½ cu. ft.	1/20 cu. ft.
Efficiency	95 to 97 %	90 to 95 %	90 %	98.5 %
Response, on-off	Selected speeds available from 6 to 45 seconds	0.4 to 1 ¼ sec. lag, depending on loading	Virtually instantaneous	Virtually instantaneous
Loading	Essentially infinite	from 30 to 1 to 100 to 1	Infinite	Infinite
Auxiliary Apparatus	None	Booster transformer	Auxiliary or booster transformer	None
Noise	60-cycle hum	60-cycle and 120-cycle hum	Tube conduction	None

Figure 8

Is the SCR Dimmer noisy?

The SCR Dimmer is extremely quiet and does not need to be placed in a sound-proofed room.

What is the life of the SCR Dimmer?

It is a solid state device and contains only components such as semiconductors, diodes, resistors, capacitors, inductors, etc., which are conservatively rated for the circuitry employed. While only estimates of life expectancy can be made at the present time, experience with the above components indicates that many years of trouble free operation should be expected.

What maintenance requirements may be expected?

Virtually no maintenance will be necessary. The SCR is delivered as a factory adjusted and sealed unit, and all circuit components except the contactors and potentiometers are mechanically static elements.

Can an SCR Dimmer System be purchased and added to in the future?

Yes, the SCR is ideal for this pur-

pose. It is only necessary to insure that sufficient service and control wiring is installed initially to serve the contemplated system. Mounting racks and a minimum of units are first installed; then more plug-in units are added as they are needed. No expensive additional work is necessary.

What is the cost of the SCR Dimmer?

The cost is basically dependent upon the form in which the SCR is used and the complexity of the system desired. At present SCR Dimmer Systems are lower in price than other types of remote-control dimming systems, such as thyratron or magnetic amplifier dimmers. SCR Dimming Systems are presently only slightly higher than autotransformer systems.

What about U.L. approval?

The SCR Dimmer is presently being submitted for U.L. approval. Testing of the dimmer by the U.L. is a time-consuming procedure. It is fully expected through past experience with U.L. requirements that the complete SCR Dimming

System will receive U.L. approval.

What about guarantee?

The individual SCR Dimmer will be sold as a factory-sealed module. Providing that the unit has not been unsealed, a blanket one-year guarantee will be in effect upon the unit. The complete system will likewise receive a material warranty of one year.

Why does the SCR Dimmer offer advantages over all other types of dimming control?

First of all, the physical factors: less weight, less bulk, less heat, less noise, less maintenance.

Second, the operational factor: immediate response, infinite loading, excellent dimming curve, higher efficiency, subtlety of control.

Third, its adaptability: Its module construction and ability to combine into flexible arrangements with all system elements, its affluency with mastering, submastering, presetting, fading, pile-on, etc.

In all of these ways it may be established that the SCR Dimmer equals or exceeds the performance of any dimming system heretofore.

ARE YOU A DIBBER?

Revealed for the first time are the secrets of the unsung heroes of the broadcast engineering fraternity.

An introduction to RCH—the unit of transmission which may replace the decibel.

By OSCAR VON DER SNIKRAH, PhB. DSC.

Haywire Radio Mfg. Co.

Petrified Lake, Arizona

A DIBBER is a broadcast engineer who dabble-dabbles with decibels. His main tools of trade include a distortion and noise analyzer, together with an audio oscillator and assorted meters, clip leads and other well known arrangements for making haywire connections.

The fraternity is composed of two levels of dibbers. The associate dibbers are those who perform proof of performance measurements at least once every three years, while the pro-level dibbers are those who make proof of performance measurements at least once a week. Station managers who occasionally digest proof of performance reports are unofficial dibbers and maintain an amateur standing only.

The associate members are usually called into action at some odd time by the station manager who calls them and says he is filling out an application for renewal of the station license (which was due last week). He wants to know "has the proof of performance been made recently?" This starts the ball rolling and by midnight everybody is all ready to go and a real session is in store.

Both the associate dibbers and the professionals never go to work before 1:00 A.M. The standard working hours are 1:00 A.M. to 6:00 A.M. However, it is not un-

usual for the working hours to extend up towards noon, as occasionally the transmitter doesn't get together in time for the normal morning sign off.

By 1:00 A.M. it is discovered that three or four pieces of vital gear were taken home by someone and the whole project is called off. Since the transmitter hasn't been dusted out for three years the night wasn't wasted. It then takes the rest of the night to get the rig back on the air after being thoroughly cleaned.

Sooner or later the actual measurements take place. Despite the article in the May issue of BROADCAST ENGINEERING, there is many a slip between the plate and the lip. Certain unpublicized techniques will now be brought to light for the first time to encourage the growth of the nation wide organization of dibbers.

The well known practice of "fudging" need not be analyzed critically since it is standard procedure. For example, if you are looking for a 50 db signal to noise ratio and the meter reads 47, turning the transmitter off for two or three seconds will give you time enough to make a quick reading and write it down. This is known as "fudging" and is standard procedure used by both the pros and the associate members.

When the measurements really get going in earnest and the preliminary "fudging" trials show that

the old rig really is in a sad mess, the first procedure is to frantically substitute new tubes for the old faithfuls that have been in there for three years. Since new tubes are seldom on hand, the used ones are tried one by one until the best measurements are obtained. (If a good set of tubes is discovered among the spares, be sure to remove them immediately after making the proof of performance measurements and lock them away some place for future proof of performance measurements during the coming years.)

During the process of adjusting various gain controls for ideal distortion and noise measurements and the wiggling of test wires and placing of various pieces of metal around tube to cut down hum, the engineers' vocabulary has been very limited in the past towards fast expediting of these movements. This then brought about the development of a new transmission unit known as the RCH. The RCH was invented by some unknown engineer but this author has done everything possible to spread across the nation its use in making proof of performance measurements.

To define an RCH—it is a unit which is a fraction of a decibel. Ten RCH's equal one decibel, although there is some difference of opinion as to whether this is valid since



Author shown using "Kentucky Windage" system at his secluded transmitter site atop Stony Cloud Mountain. Note protective measure used on wrist to prevent "Dibbers Disease" usually often resulting from manipulating distortion meter controls.

some meters are mounted on magnetic panels and others are mounted on aluminum panels. In spite of this, the term has become endeared to the broadcast fraternity and it is not uncommon to hear such remarks between engineers busy at the process of the dibble-dabbling with the decibels, as "Give me a couple RCH more gain" or "Back off the tone an RCH." Or when a two man team is working it is advised that the man taking the readings dictate them to his partner (who cannot see the meters) to write them down. He can call out a reading such as "Just an RCH above 50." This will be written down as 55.

These examples are given to cite the flexibility of this important transmission unit. It is also highly recommended for use in adjusting remote antenna indicating ammeters, when it is necessary to yell across the field to the back door of the transmitter, such as is often done.

Both the pro group and the associate dibbers have one thing in common, namely, one of these night sessions seldom passes without some emergency rising. As a result of changing tubes, or over modulating, or some other accidental maneuver, something usually blows up. If the replacement part or tube is on hand, that's pure luck and is seldom en-

countered in the field.

It is considered wise advice to have an alarm clock set to go off at a safe time that will allow the transmitter to be reassembled in time for morning sign on. Even the old pros get caught with their pants down in this respect, however, and it is nothing to be ashamed of if the old rig can't get in operation until noon.

It usually takes several hours to find which mike channel has the lowest noise and best frequency response. However, once again the RCH comes in very handy and it is often necessary to make the noise measurements in the mike channel with the good frequency response to record the frequency response measurements (or vice versa).

Another method that is not widely known is to use the Kentucky windage approach on all measurements. For this purpose a telescope is mounted to one side of the distortion meter so that the observation through the telescope and its resulting parallax allows you to write down observed readings that are quite a few RCH's to your benefit. The telescope should be mounted towards the right side of the meter for both the distortion and noise measurements. It can be mounted on a swivel bracket when making frequency response measurements to allow you to attack the

problem from either side.

The professional group are the real unsung heroes because they become very proficient at the art. They don't waste time on experimental "fudging" procedures as they are well known from the previous week. The casual bystander or uninitiated observer, such as a visiting radio inspector, will always be amazed by the perspicacity of the old pro.

The old pro has also become well steeled to the casual remarks from the management who in their amateur status, sluff off the measurements even though they represent several nights of sweat. A special manual is being prepared for the management group entitled "Hints On Preventing Frustration With Your Staff Dibber." Much greater management - engineering cooperation is expected from the widespread distribution of this manual.

Here then is a salute to all the members of the royal fraternity of dibbers (wherever they might be) and may they truly become the leaders of the "Night People."

Ed. Note: The origin of the term RCH is unknown. However, our research has uncovered the fact that RCH stands for "Red Chaffinch Hair." The male chaffinch bird has bright red plumage on its breast which is made up of extremely fine hairs that can't be split. Approximately 10 of these hairs laid side by side would equal one division on a db meter representing one db. The popularity of the transmission unit far exceeds the question of its origin. Hair splitting is forever ended.

MODERNIZE NOW

with a new

BAUER

CUSTOM AM TRANSMITTER

THE ULTIMATE IN ECONOMY AND DEPENDABILITY

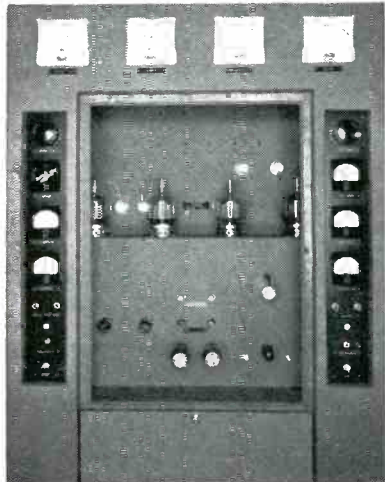

All audio and R.F. tubes are removable from upper door. Each critical circuit is separately metered.

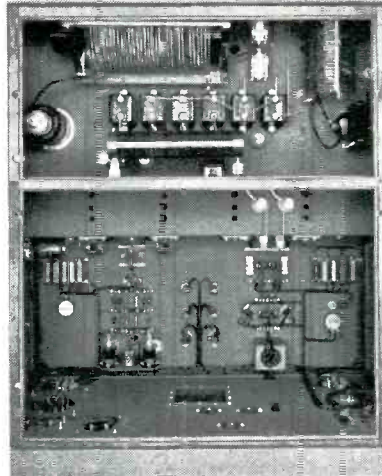

Vacuum variable tank condenser, output circuitry, and accessibility of components are shown.



Relays are in a dust-free location. All components and circuit terminals are in convenient locations.



Heavy-duty rectifier components, constant voltage filament transformer, and modulation transformer are mounted in lower compartment.

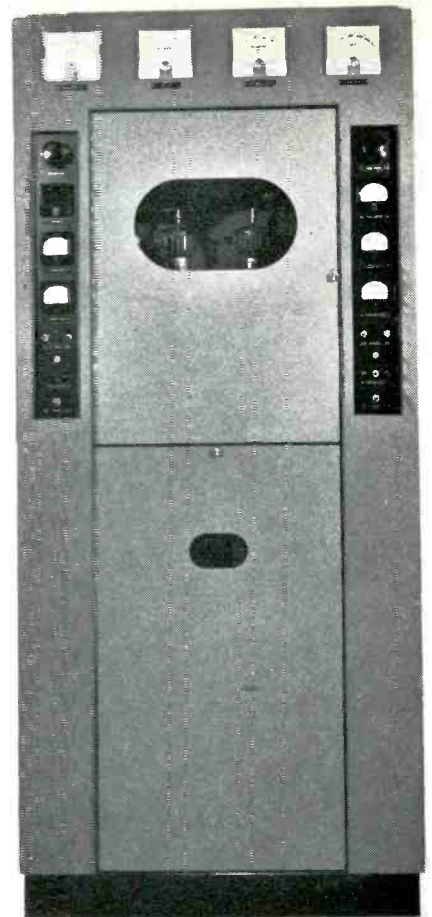

FB-1000-J

FEATURES:

- TETRODE CIRCUITRY
- ONE TUNING CONTROL
- DUMMY ANTENNA
- NINE METERS
- UNATTENDED OPERATION
- COMPLETE ACCESSABILITY
- POWER CUTBACK

A Few of the Stations Using BAUER Transmitters

WMAX—Grand Rapids, Mich.
 EOSI—Denver, Colo.
 ELIK—Jefferson City, Mo.
 EFWB—Los Angeles, Calif.
 KEWB—Oakland, Calif.
 KUTY—Palmdale, Calif.
 KCVL—Colville, Wash.
 KMYC—Marysville, Calif.
 KTYM—Los Angeles, Calif.
 KWSD—Mt. Shasta, Calif.
 KOHU—Hermiston, Ore.
 KAGR—Yuba City, Calif.

AVAILABLE FROM ONE TO TEN KILOWATTS

FOR FURTHER INFORMATION WRITE OR CALL

BAUER

ELECTRONIC MANUFACTURING CO.

P. O. Box 1101

SAN MATEO, CALIF.
 PHONE: FIRESIDE 5-0897

A NEW LOOK AT PORTABILITY

THE MULTI-CONTACT PLUG

By DON A. DRAKE
Cannon Electric Co.

TERMINATING most multi-conductor cables used on audio and video equipment is a multi-contact plug. Its function: To permit a fast, easy means of connecting and disconnecting electrical circuits, thus making broadcast equipment more flexible in the studio as well as on field locations. There are innumerable basic types of plugs available today for such applications. Presented here is a summary of these specialized plugs; their functions and their uses. A comprehensive check-list of selection factors is included to assist the broadcast engineer in choosing the most suitable plug for his particular application.

Plugs specifically designed for low-level signal or power transmission generally have the following characteristics in common: Two or more mating pin and socket contacts; an insulating dielectric; a protective shell; and a convenient method of coupling. They differ in size; configuration of contact insert; insulation material; and shell design.

Multi-Contact Plugs for Audio Equipment

Three series of plugs for audio circuits have become recognized standards in the broadcast industry: Type P Series, Type UA Series, and Type XLR Series. Their design features and electrical characteristics are detailed here with a discussion of plugs for video equipment presented in the second section of this article.

Type P Series—Principal feature of the Type P Series is the wide variety of contact-insert arrangements available. Six different inserts with

2, 3, 4, 5, and 6 contacts are interchangeable within eight different shell styles; a larger plug with 8 contacts is also available. Thus, practically any audio application requirement can be met by a combination of the required number of contacts and a plug shell, the size and shape of which best fits the application.

Insert-dielectric material used in the P Series is molded from phenolic, a thermosetting substance which exhibits excellent insulation properties: Low resistance—100 megs minimum, long service life, and prolonged resistance to electrical breakdown.

Shell material is steel for greater protection of the contacts and insulator in areas where extreme abuse is anticipated. Finish is satin chrome.

Contacts used in Type P Cannon plugs are silver-plated brass—giving high conductivity and minimum wear from frequent engaging and disengaging action. Those used in the 2, 3, 4, 5, and 6 contact-layouts are rated at 30 amperes, while those in the 8 contact-layout are rated at 15 amperes. Utilizing a “full-floating” principle originated by Cannon Electric Co., Type P contacts relieve any stress or twisting acquired in the conductors during the soldering process. Full-floating contacts also enable the avoidance of variations in contact resistance when the mated plugs are moved while the circuit is closed.

Type P plugs, as well as the UA and XLR Series, feature spring-actuated, snap-lock coupling devices and integral cable clamps. These unique

snap-lock latches offer the advantage of a strong, secure connection which cannot be disengaged accidentally. Only a slight downward pressure on the thumb-latch is required to effect a quick and easy disconnect. The integral cable clamps — tightened by set screws at the cable entry — provide ample safeguard against loosening or possibly breaking the conductors away from their solder joints. Generally, Type P plugs are used on microphones, rack equipment, interconnecting portable equipment, amplifiers, test equipment and master control consoles.

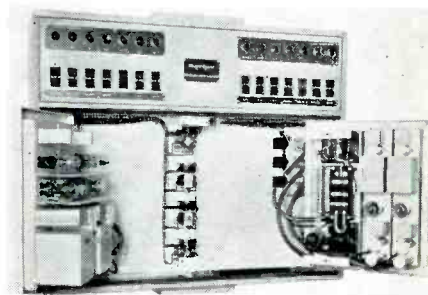

Figure 1

Accessibility and ease of servicing are keynotes in the design of the control room equipment exhibited in Fig. 1. It was custom-built by the Western Electric Co. Rectifiers in the power control cabinet are mounted on hinged panels, permitting them to be swung out for inspection and maintenance. The Type P plugs which connect the input and output circuits further amplify the keynote of easy servicing. Fig. 2 shows how the Type P plug can be designed within the body of a micro-

phone. This Altec-Lansing microphone utilizes the eight 15-amp contact layout. Such a built-in feature helps keep the design of the microphone simple and symmetrical. A Type P plug is used as an input connection to the Altec power sup-



Figure 2

ply. The two Type P plugs in Fig. 3 connect the two main amplifiers and the reverberation amplifier on a control room console, also custom-built by Western Electric.

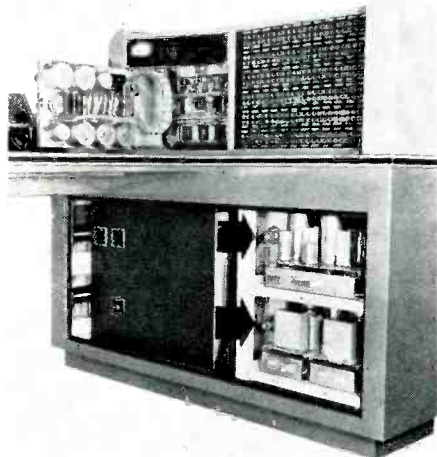

Figure 3

Type UA Series—Type UA Series plugs were developed as a result of RETMA (Radio-Electronics-Television Manufacturers' Assn.) recom-

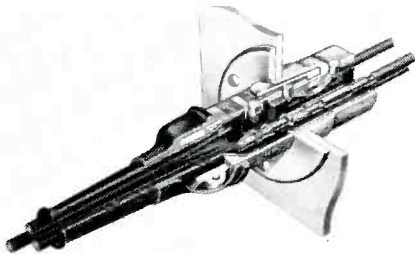

Figure 4

mendations. Used primarily for microphones and microphone extension cables, the UA (Ultimate Audio) series consists of one mating straight-cord plug with round and rectangular flush-mounted wall, panel, and chassis receptacles. A double rubber bushing over the cable clamp and cable entry provides splash-proof protection and a safeguard against shock.

The flat-top design of the UA Series facilitates quick polarization;

that is, the flat surfaces indicate the correct alignment of male and female contacts for proper connection. Contacts in the UA Series are gold-plated brass according to RETMA standards for protection against corrosion. Internal construction of the UA plug and wall receptacle is shown in Fig. 4.

A typical microphone application for the UA plugs is pictured in Fig. 5. The stand, by Electro-Voice, permits the microphone to be completely suspended to eliminate interference from vibration.



Figure 5

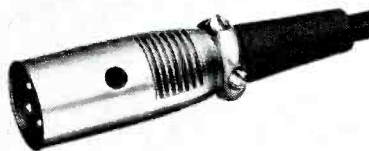

XLR Plugs

Type XLR Series—Featuring resilient polychloroprene contact-inserts in all socket assemblies, Type XLR Cannon plugs have been especially designed to attenuate objectionable noise created by the movement of the plugs or cables during transmission. Type XLR plugs are available in the following contact arrangements: Three 15-amp, four 10-amp, and five 7.5-amp contacts. The cable clamp provides two clamping positions, accommodating cable sizes 7/32-inch to 5/16-inch. Standard shells are furnished in either zinc or steel, finished in satin nickel plate. Because of its design simplicity, its snap-lock latch, its resilient insula-

tor, and its compact size, the XLR has found wide use on microphones, tape recorders, control panels, amplifiers, turntables, test equipment, and a multitude of low-level power applications where a fast, separable connection is desired.

Multi-Contact Plugs for Video Equipment

Separable plugs for video equipment, especially television cameras and interconnecting cables, may be contrasted with the plugs designated "Audio" in the following respects:

(1) **Size**—Generally, video plugs are larger than audio plugs because of the number of contacts used. Audio plugs usually require only three or four contacts; video plugs contain from 24 to 82 contacts, including coaxials and twinaxials.

(2) **Size and Type of Contacts**—Video plugs utilize several different types and ratings of contacts within a single insert. Audio plugs use from 3 to 8 contacts, usually the same type and size for any one insert.

Heavy-duty video plugs greatly facilitate the interconnection of remotely operated TV broadcasting equipment. They are grouped in four standard series: LK, LKT, RLKL, and AK.

The LK, LKT, and RLKL series feature 34 contact arrangements with from 24 to 53 contacts. These arrangements are interchangeable within the different shell styles of the three series. Series AK consists of 12 different layouts, with from 9 to 82 contacts. Because of the spacing required for the high-voltage coaxials and twinaxials, AK plugs are larger in size. Therefore, a greater separation force is necessary to effect a quick disconnect. For this purpose a handle is designed on the endbell.

Available within the four series is a wide variety of shell styles, coupling methods, and accessory parts. Straight and 90-degree endbells are available in the LK, LKT series; AK series feature 90-degree endbells only; and Type RLKL utilize a 60-degree endbell with thumb-actuated latch lock. The RLKL design is used principally for switching panels. Their endbells can be rotated a full 360 degrees in 30-degree increments. The latch lock insures a secure connection and the curved handle design provides an excellent hand-grip for easier disconnect.

Types LK and LKT incorporate Acme-thread coupling nuts for quick connect and disconnect. The AK series utilizes standard NC-2 coupling threads. These coupling nuts or rings are available on either the plug or the receptacle half. The RCA television camera control panel, Fig. 6, uses three LKT receptacles with coupling rings attached for added cable support. These plugs incorpo-

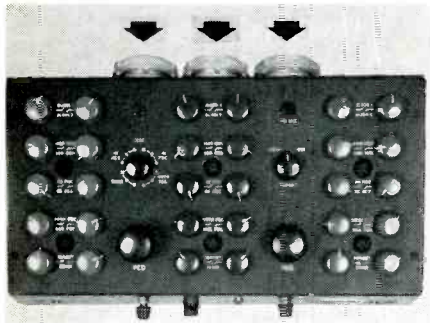

Figure 6

rate insert arrangements of 21 No. 14 contacts and 3 No. 16 Coaxial contacts. The plug engaged on the junction box in the foreground features a specially designed endbell currently used by RCA on their color equipment. The contact layout for this special plug is shown in Fig. 7 and Fig. 8 shows the plug as a straight cable connection.

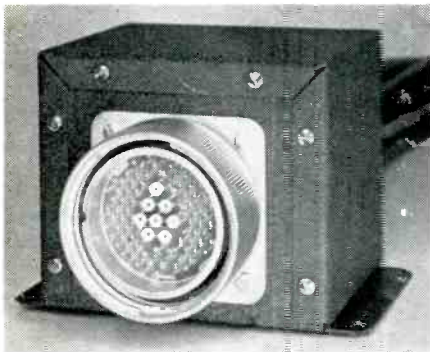

Figure 7



Figure 8

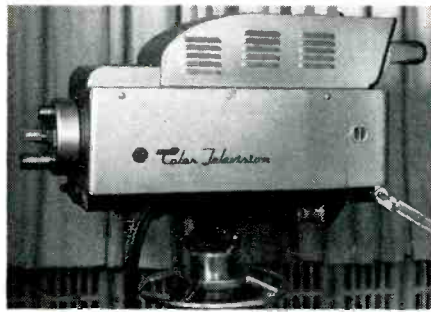

Figure 9

Connecting video signals from the TK-41 Color Camera Chain by RCA, Fig. 9, is one of the three type LKT plugs. The signals are fed directly to the camera control panel on which both operating and selected set-up controls are located. These signals are in turn fed to the processing amplifier which performs functions of cable compensation, video amplification, blanking and shading insertion, feedback clamping, linear clipping, gamma correction and output amplification, as well as providing auxiliary switching for the master monitor kinescope.

Other Broadcast Equipment Plugs—To say that the plugs previously described are the only types used in the field of broadcasting would be a gross understatement. This article has narrowed the great expanse of plugs to cover only those developed specifically for audio and video applications. Many situations and applications will require MS type plugs, RF coaxials, rack-panel-chassis plugs, and many special configurations not currently in existence.

As an example, the Philco Corp.'s Direct Contact Crossbar Switch utilizes 10 Type DP (Dual Panel) Cannon plugs for its input and output circuits. This unit provides an excellent RGB color or monochrome switching system which can be DC remote controlled from a multiplicity of control points. Special DP triple coax plugs are provided at the switch inputs to permit simultaneous insertion of RGB video and tally light circuits. Similar plugs are used on the switching output. Pins are provided on the output plugs to accommodate external cabling of the tally circuits.

Type DP plugs are available with from 2 to 156 contacts in rectangular inserts ranging in sizes from 9/32 by 19/32-inch up to 2 3/4 by 4 1/4 inches. Both halves of the plug can be rigidly mounted, or one-half can be mounted and the other half cord connected.

Plug Selection Check-List

Specifying multi-contact plugs for specific applications means careful consideration of several important factors. A quick check of the following eight points before specifying a particular plug series will aid in choosing the best plug for your particular application.

1. *Number of Contacts*—One of the major restricting elements in the selection of electrical plugs is the number of circuits it must connect. Before any other consideration, decide how many circuits are to be terminated by separable plugs.

2. *Size of Contacts*—Size of contacts, and the resultant spacing is highly critical in the selection of plugs. The controlling factor is the amperage a particular contact or a set of contacts is to carry. Be sure to note the number of contacts required; their amperage and wire size.

3. *Style of Contacts*—The third factor to be considered in selecting plugs is to choose the type of contact that best meets your requirement. Many are available: Solder-pot terminals, crimp-type terminals, coaxial and twinaxial contacts, thermocouple types, high-voltage types, and taper pin types. Solder-pot Contact, are standard for audio and video plugs.

4. *Mounting Space*—Another important factor that must be considered when selecting plugs is the mounting space available. Dimensional limitations are often the determining selection factor. Normally, the receptacle is the portion to be mounted, although in several plug series the plug half is mounted. In some rack-panel-chassis installations both the plug on the instrument or equipment, the other half on the rack.

The fourth step then in determining a suitable plug for your application is to find out how much mounting area you have to work with.

5. *Coupling Method*—After establishing the number of contacts; size and style of contacts; and mounting space required; then, decide the coupling method to be used. Keep in mind there are almost as many different coupling methods as there are plug styles. You will find standard MS-type coupling nuts, reverse Acme-thread coupling nuts, quick Acme-thread coupling nuts, bayonet locks, snap-locks, quick disconnects, contact-friction types, ball-and-gear types, and center post screw type.

6. *Insulation Material*—Many installations require critical consideration of the type of insulation material to be used. A wide variety of insulation material has been developed with varying electrical properties. Standard materials include melamine, phenolic, and synthetic rubber.

7. *Shell Style*—Many shell styles are available to meet any special re-

quirement. These include straight, 60-degree, 45-degree, and 90-degree types; split-shell types, round and rectangular types; and flush-mounted wall, panel and chassis receptacle shell types. Determining factor for the type of shell used is the amount of space available for connect and disconnect, and inspection and servicing.

8. *Shell Material*—The plug shell performs several important functions. First, as a housing for the contacts and insulation, the shell integrates the plug component parts into one unit. Second, it protects the component parts from dust, moisture, and abuse. Third, it protects the operator from the high voltages carried through the plug. Standard audio plugs are provided with steel and zinc shells, while video plugs are usually aluminum with cadmium plating.

After these eight factors have been carefully considered and definite requirements established for each, the composite will indicate a plug series

from which to choose the particular plug that best meets your requirements.

The best general criterion to use in selecting multi-contact plugs is to select plugs as you would your most critical components! Only then will you feel you've done everything possible to achieve the high reliability required in audio and video equipment.

In summary, familiarize yourself with the different types of standard multi-contact plugs available. Considerable savings in both time and costs will result from specifying existing shell styles, contact layouts, and coupling methods. Redesigns and custom-designs cost money! In addition, replacement parts may be hard to find if you specify designs too varied from standard.

Whenever frequent portability, mobility, or easy accessibility is required in audio and video circuitry, a separable multi-contact plug will eliminate much soldering and re-soldering . . . wiring and rewiring.

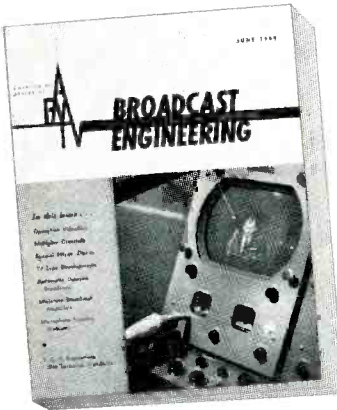

**Enter Your
Subscription
Today**

**Keep Informed of the Latest Developments
Stay Up to Date on F. C. C. Regulations
Become Familiar With All Phases of Broadcasting
Learn Ways to Improve Your Station**

**By Subscribing To
BROADCAST ENGINEERING
P. O. BOX 93
KANSAS CITY 41, MISSOURI**

SUBSCRIPTION ORDER
BROADCAST ENGINEERING
"The Technical Journal of the Broadcast Industry"

NAME..... TITLE.....
FIRM.....
ADDRESS.....
CITY..... STATE.....

RATE \$6 PER YEAR — 12 ISSUES

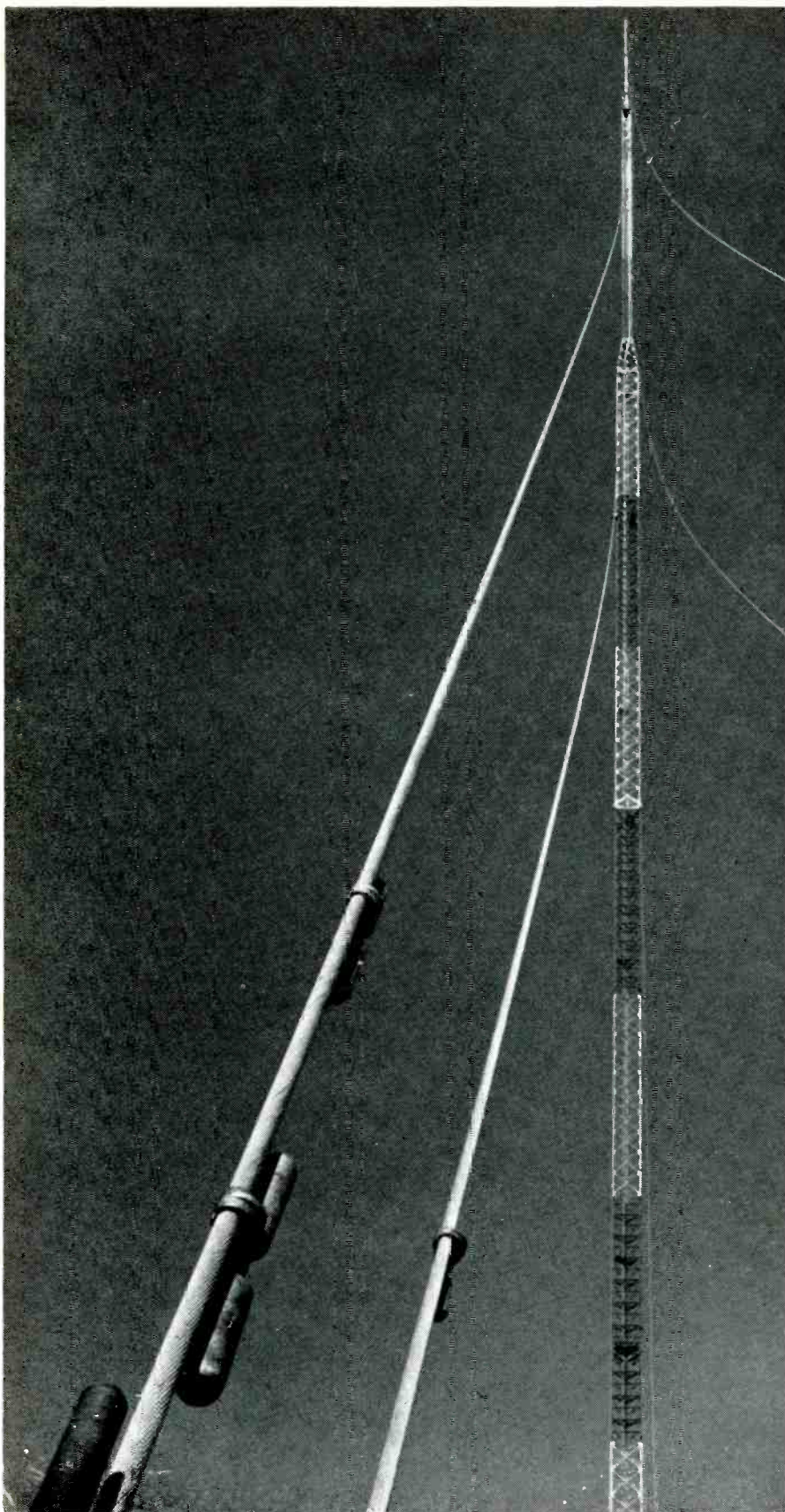

Vibration Dampeners in Lower Guy Assembly

VIBRATION

ALMOST every structure designed by a structural engineer today is calculated to resist a static load with the structure being stationary with respect to the load. However, many loads today are dynamic in nature instead of static. Very simply, a dynamic load is one applied to a moving structure causing the rate of movement to change. An engineer today transforms a dynamic load into a static load by applying an impact factor to a load and using the result or static load in the design. For example: a gusty wind is treated as a static load by multiplying the design load by a factor which is usually 1.3. This product then becomes the true design load and is considered as a static load. The moving load is transformed into a stationary load so that the structural problem may be solved.

However, this type of treatment may not always do the job. If the gusty style loading is repeated at a constant rate and is in tune with the natural vibration of the structure in question, the movement may

*Mr. Hayden presented this paper at the NAB Engineering Conference this year.

PROBLEMS IN TALL TOWER CONSTRUCTION

By
J. ROGER HAYDEN*
Dresser-Ideco Co.

tend to build up into dangerous or at least disturbing movements.

In tower construction the greatest movement has been observed in long guys having the same area throughout their length although some vibration has been observed in fairly long members in self-supporting structures. Any vibration in a member of a self-supporting tower is difficult if not impossible to predict but is easy to control by the use of additional members which shorten the span of the member so that the vibration is stopped. Shortening the span simply changes the period of the member as well as increasing the stiffeners of the member.

Many times the rapid movements of a long slender member in a self-supporting tower are annoying because of the noise generated. A long steel member can sound like a parade of garbage cans with the right conditions of wind and member length.

This style vibration is not difficult to handle and as a general rule is not dangerous.

The vibration in a long guy must be handled in a different manner. The stiffness of a bridge cable cannot be increased by additional members nor can the span be changed very simply. The one thing that can be changed fairly easily is the load in the guy. This change in loading will prevent any constant increase in guy movements. Vibration in a guy will change the direction of any portion of the guy. If a device is attached to any portion of the guy which will resist a change in direction of the guy, this has the effect of adding a load to the guy wire.

Two different types of movement have been observed in tower guys. The most common is a high-frequency oscillation of about 30 cycles per second which has been observed in guy cables under a steady wind of 35 miles per hour or less. This style movement may be felt by placing a hand on a guy wire. As a general rule this type oscillation cannot be seen by the eye.

The second style movement is a fairly slow galloping of one cycle

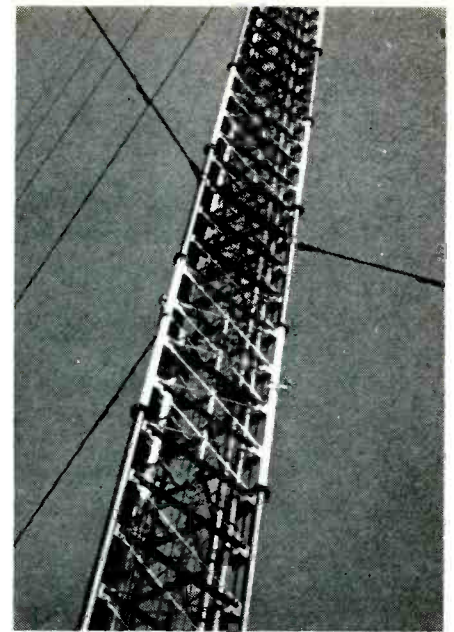

Upper Guy Dampeners

per second or less under a wind of 15 to 25 miles per hour. This style movement has only been observed in guy wires which have been coated with ice forming a different style shape and which has a different characteristic under a wind than the normal circular cable. This style movement is infrequent and is not regarded as dangerous by the structural engineer. However, this rather slow ponderous motion is disturbing to watch and should not be allowed to continue for any length of time.

A high-frequency vibration which continues over a long period of time can well cause fatigue in the metals and lead to failure. In a guy cable the failure can start in the small wires which make up the finished cable. Sometimes the vibrations from the guy wires cause movement in the tower proper with damage to equipment mounted on the tower. Since this style oscillation happens frequently, some means of controlling the movement should be used.

In order to control high-frequency vibration in the guys a number of different methods have been used but in general the principal was exactly the same. A weight having an inertia against any movement out of line with the guy wire is inserted in the guy assembly.

The first style dampeners used in the guy wires of a tower were not regarded or designed as dampeners. They were AM tower guy insulators. The weight of the insulators plus the slight change in the stiffness of the insulator assembly over the guy wire stiffness added an inertia to the assembly which resisted any change in position along the guy wires. As a result of this secondary feature of guy insulators, the cables in an AM tower have not been inclined to oscillate to any great degree.

The first television tower over 1,000 feet in height was constructed for WSB at Atlanta, Ga., and the guy wires were not insulated. The oscillation in the guys was considered in the design and rather long, heavy loads were attached to the guys at intervals to provide an inertia load which would resist movement.

At a later date another style inertia device was adopted. This device is known as a stockbridge dampener and consists of a pair of weights suspended from a guy cable by an arm giving the weight quite a bit of leverage to act against any oscillation of the guy. Once again, this is an inertia device resisting movement from a straight line.

All of the above style dampeners are used to reduce a high-frequency oscillation to a minimum. Since this style movement is fairly constant, this type control should be used on large guyed structures.

Some AM towers in the past have had guy wires that oscillate in a

rotary or twisting fashion. This has never been objectionable nor has any record of failure of material developed from this style movement. However, if this were to develop, a stockbridge dampener would be suspended at right angles to the guy wire which would effectively resist a twisting motion.

A high-frequency oscillation in the tower bracing where the bracing is long and slender has been observed in a few instances. This is usually shown by a flutter in the member and is best controlled by increasing the stiffness of the member through the use of additional bracing. Brace rods used in pairs have been affected by wind turbulence or vortexes spilling off of the front or windward rod and causing vibration. This has been observed with rod or circular members only. The solution in this case is to tie the members together so that turbulence from one will not affect the other.

A low frequency galloping of the guy wires is a different style problem. The only records of this style of movement show that this occurs when guys are covered with ice and a moderate, even wind flows across the guys. A lift develops and the guys move in a rather large arc.

Fortunately, this happens at infrequent intervals when the ice coating and the wind velocities combine to produce this effect. Since the movements are slow and ponderous, the loads in the guy cables are not great and the tendency for fatigue stresses developing is slight.

To date, this problem has not been solved, although the movement can be controlled by a number of different mechanical methods of attaching a heavy weight to the galloping cable.

We have found that a fairly heavy weight could be attached to

the guy cable about 15 feet above the anchor and the movement could be stopped. However, it is not desirable to have this weight on the guy cables when a heavy wind storm is encountered. So the only recommendations to date are to control the movement when trouble appears.

In some instances the weight of a man has been sufficient to stop the movement of the guys. A tractor has also been attached to the guy wires and has stopped the movement.

A tower in Texas, built for WFAA-KRLD, has a permanent means of controlling this style movement although this is mechanical and is not automatic. A concrete block was installed below each guy cable and a steel cable was attached to a chain hoist which was attached to the concrete block. This steel cable is slack at all times until icing occurs and the wind starts a movement in the guy cables. Then a man tightens the hoist until the movement is stopped.

Another method which has been tried consists of suspending a weight which increases when an upward motion is applied. This has consisted of a spring loaded device and has not been completely successful.

Still another suggestion is a suspended weight moving on an inclined plane with the incline increasing so that the force increases with an upward movement. This method is extremely expensive and has not been tried. The principle is the same.

This style movement is being studied by the American Institute of Electrical Engineers and further improvements in the art may be expected in the future.

LOOKING OVER ONE KILOWATT AM TRANSMITTERS

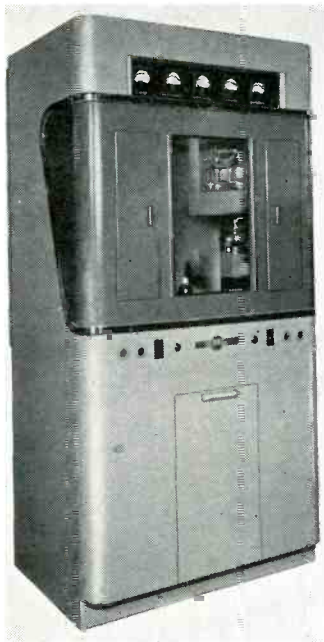

COLLINS 20-V

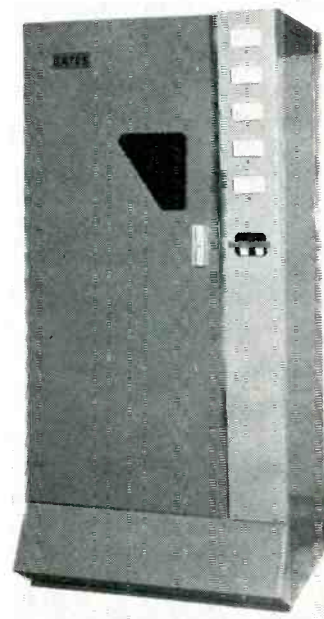

GATES BC-1T



RCA BTA-1R

THE RECENT F.C.C. ruling which now permits most Class IV Stations to increase their daytime power to one kilowatt has caused a great increase in interest among broadcasters in new transmitters which will enable them to take advantage of this opportunity.

Transmitters now manufactured have better frequency response, lower distortion and noise, and, in many cases, higher modulation capability than older transmitters and the change in quality usually is noticeable to most listeners.

Transmitter requirements have changed during the years since many existing transmitters were built and former necessary modifications and makeshift arrangements can now be obtained as standard factory features. In addition, developments in electronic components and transmitter circuitry enable the manufacturer to offer a transmitter which is simpler to operate, more economical, and more trouble-free than older models.

Since the approval of remote operation of transmitters, provisions have been made to perform control functions and make circuit measurements from a remote point. The modification of older transmitters for remote control was often a difficult job. Most manufacturers now deliver the transmitter with complete remote control provisions, making detailed modifications unnecessary.



BAUER FB100J

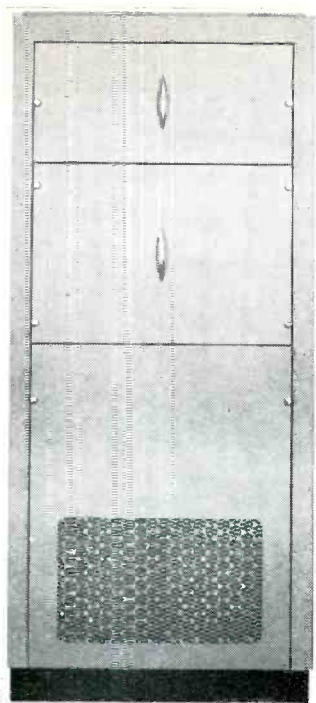

BAUER FB1000J

Eliminating rear door reduces required installation area.

An additional requirement for new Class IV equipment is to switch from one KW to 250 watts for night operation. Even though the older transmitter could be used at night, new equipment can be obtained with this feature and will provide a more versatile and useful transmitter.

Stations which are in the Conelrad system may also obtain a transmitter equipped for quick change to the Conelrad frequency.

Vacuum variable tuning condensers, printed wiring and tetrode circuitry all contribute to simplified operation and maintenance. With the vacuum tank condenser, the size of the tank circuit is reduced and accumulated dust cannot reduce the efficiency of the circuit. Tetrode circuitry eliminates the necessity for neutralization.

Built-in dummy antennas are provided on several transmitters to facilitate testing.

For the broadcaster who has been wanting to justify the purchase of a new modern transmitter, the change in Class IV power limitation is the opportunity to increase range, quality and dependability.

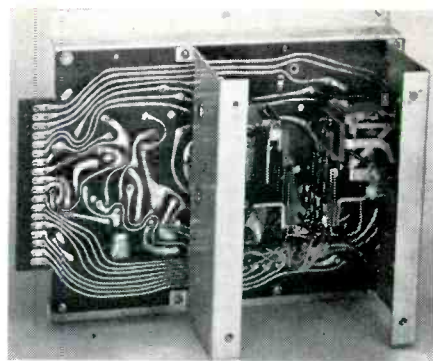

OSCILLATOR CIRCUIT OF
RCA BTA-1R

Printed wiring simplifies servicing.

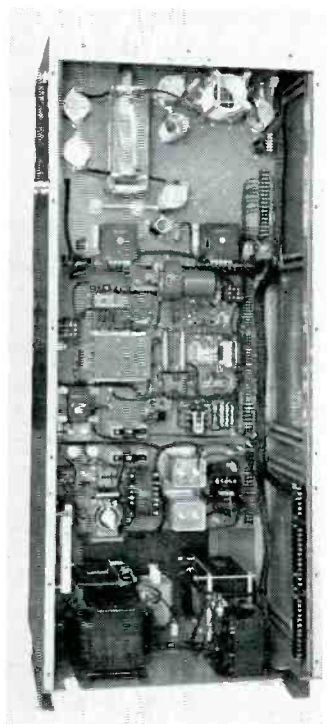

RCA BTA-1R

Vertical construction provides accessibility.

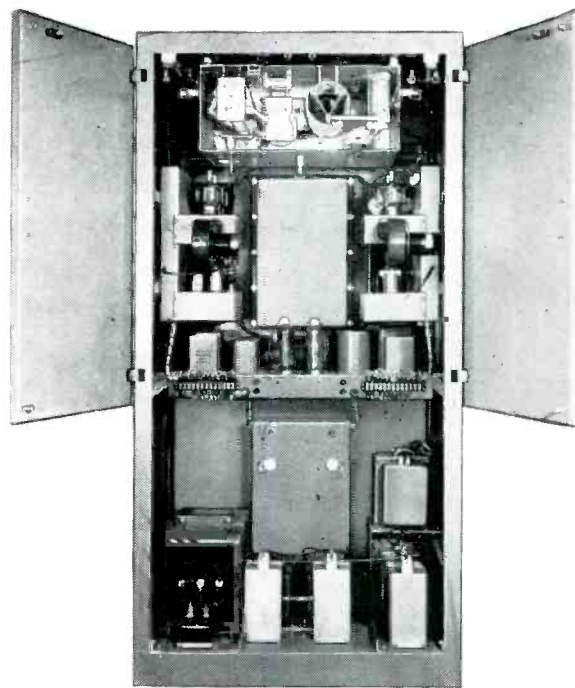

COLLINS 20-V

Separate RF and AF blowers. Components accessible from back.

AMENDMENTS AND PROPOSED CHANGES OF REGULATIONS

TV Frequency and Modulation Monitor Requirements Relaxed for Another Year

The Commission having under consideration the provisions of §§ 3.690 (a) and 3.691 (a) of its rules, which require that television broadcast stations have type-approved frequency and modulation monitors at the station whenever the transmitter is in operation.

It appearing that the time specified for compliance with the requirements of §§ 3.690 (a) and 3.691 (a) was last extended to June 1, 1959; and

It further appearing that with the continued development of more stable frequency control circuits in all types of broadcast transmitters (AM, FM and TV), the Commission is considering a review of its requirements regarding continuously operating frequency monitors to ascertain whether such apparatus is still needed or is adequate to ensure that the operating frequencies of broadcast stations are maintained within the prescribed frequency tolerances; and that should it appear that the rules relating to such monitors should be amended, an appropriate rule making proceedings will be initiated; and

It further appearing that since the requirements of §§ 3.690 (a) and 3.691 (a) have not, as yet, been placed in effect and in view of the possibility that these rules may be amended in the near future, the Commission deems it desirable to postpone the effective date of these sections of the rules for an additional period of one year; and

It further appearing that the amendment herein ordered is procedural in nature and effects a relaxation of the rules; therefore, compliance with the requirements of section 4 of the Administrative Procedure Act is not required;

And it further appearing that authority for the amendments adopted herein is contained in sections 303 (e), (f), and (r) and 4(i) of the Communications Act of 1934, as amended;

It is ordered, That, effective June 1, 1959, §§ 3.690 (a) and 3.691 (a) are amended by substituting the date "June 1, 1960", in the parenthetical sentence to each of these sections.

These sections now read as follows:

3.690 Frequency monitors. (a) The licensee of each television broadcast station shall have in operation at the transmitter approved frequency monitors independent of the frequency control of the transmitters. (The requirement of this paragraph is postponed until June 1, 1960.)

3.691 Modulation monitors. (a) The licensee of each television broadcast station shall have in operation at the transmitter an approved modulation monitor for the aural transmitter. There shall also be employed sufficient monitoring equipment for the visual signal to determine that the signal complies with the requirements of this subpart. (The requirement for use of type-approved aural modulation monitors is postponed until June 1, 1960.)

Time Extended to Dec. 11, 1959, for Filing Comments on Multiplex and Stereo Inquiry

In the matter of inquiry into Amendment of Parts 2, 3, and 4 of the Commission's rules and regulations and the Standards of Good Engineering Practice concerning FM broadcast stations to permit FM broadcast stations to engage in specified nonbroadcast activities on a multiplex basis; Docket No. 12517.

1. The Commission has before it a "Request for Extension of Time" filed May 18, 1959, by the Electronic Industries Association (EIA) directed to the Commission's Further Notice of Inquiry released March 12, 1959, which enlarged

the scope of the above-captioned proceeding to afford interested persons an opportunity to submit additional data and views dealing specifically with the matter of stereophonic programming. The EIA requests that the closing date for submission of comments be extended from June 10, 1959, to December 11, 1959.

2. In support of its request for extension of time, EIA states that it has established the National Stereophonic Radio Committee (NSRC) for the purpose of making detailed technical studies of several possible methods of providing compatible stereophonic transmission; that six panels have been established within the NSRC to facilitate these studies, which studies will not be completed for some months; and that the NSRC studies represent an industry-wide effort to resolve the technical problems involved in FM stereophonic multiplexing.

3. In view of the foregoing representations, it appears that the public interest would be served by extending the closing date for the submission of comments in the manner requested.

4. *Accordingly, it is ordered*, That the aforementioned request for extension of time is granted; and the closing date for the submission of comments on the Further Notice of Inquiry in this proceeding is extended from June 10, 1959, to December 11, 1959.

SUBSCRIPTION ORDER

Please place us on your subscription list.

NAME..... TITLE.....

FIRM.....

ADDRESS.....

CITY..... STATE.....

RATE \$6 PER YEAR

PAYMENT ENCLOSED

BILL LATER

BROADCAST ENGINEERING P. O. Box 93 Kansas City 41, Mo.

"The Technical Journal of the Broadcast Industry"

F.C.C. REGULATIONS

REVISED UP TO PUBLISHING TIME.

TV TECHNICAL STANDARDS

§ 3.681 Definitions.

Amplitude modulation (AM). A system of modulation in which the envelope of the transmitted wave contains a component similar to the wave form of the signal to be transmitted.

Antenna height above average terrain. The average of the antenna heights above the terrain from two to ten miles from the antenna for the eight directions spaced evenly for each 45 degrees of azimuth starting with True North. (In general, a different antenna height will be determined in each direction from the antenna. The average of these various heights is considered the antenna height above the average terrain. In some cases less than 8 directions may be used. See § 3.694 (d).)

Antenna power gain. The square of the ratio of the root-mean-square free space field intensity produced at one mile in the horizontal plane, in millivolts per meter for one kilowatt antenna input power to 137.6 mv/m. This ratio should be expressed in decibels (db). (If specified for a particular direction, antenna power gain is based on the field strength in that direction only.)

Aspect ratio. The ratio of picture width to picture height as transmitted.

Aural transmitter. The radio equipment for the transmission of the aural signal only.

Aural center frequency. (1) The average frequency of the emitted wave when modulated by a sinusoidal signal; (2) the frequency of the emitted wave without modulation.

Blanking level. The level of the signal during the blanking interval, except the interval during the scanning synchronizing pulse and the chrominance sub-carrier synchronizing burst.

Chrominance. The colorimetric difference between any color and a reference color of equal luminance, the reference color having specific chromaticity.

Chrominance subcarrier. The carrier which is modulated by the chrominance information.

Color transmission. The transmission of color television signals which can be reproduced with different values of hue, saturation, and luminance.

Effective radiated power. The product of the antenna input power and the antenna power gain. This product should be expressed in kilowatts and in decibels above one kilowatt (dbk). (If specified for a particular direction, effective radiated power is based on the antenna power gain in that direction only. The licensed effective radiated power is based on the average antenna power gain for each horizontal plane direction.)

Field. Scanning through the picture area once in the chosen scanning pattern. In the line interlaced scanning pattern of two to one, the scanning of the alternate lines of the picture area once.

Frame. Scanning all of the picture area once. In the line interlaced scanning pattern of two to one, a frame consists of two fields.

Free space field intensity. The field intensity that would exist at a point in the absence of waves reflected from the earth or other reflecting objects.

Frequency modulation (FM).—A system of modulation where the instantaneous radio frequency varies in proportion to the instantaneous amplitude of the modulating signal (amplitude of modulating signal to be measured after pre-emphasis, if used) and the instantaneous radio frequency is independent

of the frequency of the modulating signal.

Frequency swing. The instantaneous departure of the frequency of the emitted wave from the center frequency resulting from modulation.

Interlaced scanning. A scanning process in which successively scanned lines are spaced an integral number of line widths, and in which the adjacent lines are scanned during successive cycles of the field frequency.

Luminance. Luminous flux emitted, reflected, or transmitted per unit solid angle per unit projected area of the source.

Monochrome transmission. The transmission of television signals which can be reproduced in gradations of a single color only.

Negative transmission. Where a decrease in initial light intensity causes an increase in the transmitted power.

Peak power. The power over a radio frequency cycle corresponding in amplitude to synchronizing peaks.

Percentage modulation. As applied to frequency modulation, the ratio of the actual frequency swing to the frequency swing defined as 100 per cent modulation, expressed in percentage. For the aural transmitter of television broadcast stations a frequency swing of ± 25 kilocycles is defined as 100 per cent modulation.

Polarization. The direction of the electric field as radiated from the transmitting antenna.

Reference black level. The level corresponding to the specified maximum excursion of the luminance signal in the black direction.

Reference white level of the luminance signal. The level corresponding to the specified maximum excursion of the luminance signal in the white direction.

Scanning. The process of analyzing successively, according to a predetermined method, the light values of picture elements constituting the total picture area.

Scanning line. A single continuous narrow strip of the picture area containing highlights, shadows, and half-tones, determined by the process of scanning.

Standard television signal. A signal which conforms to the television transmission standards.

Synchronization. The maintenance of one operation in step with another.

Television broadcast band. The frequencies in the band extending from 54 to 890 megacycles which are assignable to television broadcast stations. These frequencies are 54 to 72 megacycles (channels 2 through 4), 76 to 88 megacycles (channels 5 and 6), 174 to 216 megacycles (channels 7 through 13), and 470 to 890 megacycles (channels 14 through 83).

Television broadcast station. A station in the television broadcast band transmitting simultaneous visual and aural signals intended to be received by the general public.

Television channel. A band of frequencies 6 megacycles wide in the television broadcast band and designated either by number or by the extreme lower and upper frequencies.

Television transmission standards. The standards which determine the characteristics of a television signal as radiated by a television broadcast station.

Television transmitter. The radio transmitter or transmitters for the transmission of both visual and aural signals.

Vestigial sideband transmission. A system of transmission wherein one of the generated sidebands is partially attenuated at the transmitter and radiated only in part.

Visual carrier frequency. The frequency of the carrier which is modulated by the picture information.

Visual transmitter. The radio equipment for the transmission of the visual signal only.

Visual transmitter power. The peak power output when transmitting a standard television signal.

§ 3.682 **Transmission standards and changes**—(a) **Transmission standards.** (1) The width of the television broadcast channel shall be six megacycles per second.

(2) The visual carrier frequency shall be nominally 1.25 mc above the lower boundary of the channel.

(3) The aural center frequency shall be 4.5 mc higher than the visual carrier frequency.

(4) The visual transmission amplitude characteristic shall be in accordance with the chart designated as Fig. 5 of § 3.699.

(5) The chrominance subcarrier frequency shall be 3.579545 mc \pm 10 cycles per second with a maximum rate of change not to exceed one tenth cycle per second per second.

(6) For monochrome and color transmissions the number of scanning lines per frame shall be 525, interlaced two to one in successive fields. The horizontal scanning frequency shall be 2/455 times the chrominance subcarrier frequency; this corresponds nominally to 15,750 cycles per second (with an actual value of $15,734.264 \pm 0.044$ cycles per second). The vertical scanning frequency is 2/525 times the horizontal scanning frequency; this corresponds nominally to 60 cycles per second (the actual value is 59.94 cycles per second). For monochrome transmissions only, the nominal values of line and field frequencies may be used.

(7) The aspect ratio of the transmitted television picture shall be 4 units horizontally to 3 units vertically.

(8) During active scanning intervals, the scene shall be scanned from left to right horizontally and from top to bottom vertically, at uniform velocities.

(9) A carrier shall be modulated within a single television channel for both picture and synchronizing signals. For monochrome transmission, the two signals comprise different modulation ranges in amplitude, in accordance with the charts designated as Figures 5 and 7 of § 3.699. For color transmission, the two signals comprise different modulation ranges in amplitude except where the chrominance penetrates the synchronizing region and the burst penetrates the picture region, in accordance with the charts designated as Figures 5 and 6 of § 3.699.

(10) A decrease in initial light intensity shall cause an increase in radiated power (negative transmission).

(11) The reference black level shall be represented by a definite carrier level, independent of light and shade in the picture.

(12) The blanking level shall be transmitted at 75 ± 2.5 per cent of the peak carrier level.

(13) The reference white level of the luminance signal shall be 12.5 ± 2.5 per cent of the peak carrier level.

(14) The signals radiated shall have horizontal polarization.

(15) An effective radiated power of the aural transmitter not less than 50 per cent

nor more than 70 per cent of the peak radiated power of the visual transmitter shall be employed.

(16) The peak-to-peak variation of transmitter output within one frame of video signal due to all causes, including hum, noise, and low-frequency response, measured at both scanning synchronizing peak and blanking level, shall not exceed 5 per cent of the average scanning synchronizing peak signal amplitude. This provision is subject to change but is considered the best practice under the present state of the art. It will not be enforced pending a further determination thereof.

(17) The reference black level shall be separated from the blanking level by the setup interval, which shall be 7.5 ± 2.5 per cent of the video range from blanking level to the reference white level.

(18) For monochrome transmission, the transmitter output shall vary in substantially inverse logarithmic relation to the brightness of the subject. No tolerances are set at this time. This provision is subject to change but is considered the best practice under the present state of the art. It will not be enforced pending a further determination thereof.

(19) The color picture signal shall correspond to a luminance component transmitted as amplitude modulation of the picture carrier and a simultaneous pair of chrominance components transmitted as the amplitude modulation sidebands of a pair of suppressed subcarrier in quadrature.

(20) Equation of complete color signal.

(i) The color picture signal has the following composition:

$$E_M = EY' + \{ E_Q' \sin(\omega t + 33^\circ) + E_I' \cos(\omega t + 33^\circ) \}$$

Where:

$$E_Q' = 0.41(E_B' - EY') + 0.48(E_R' - EY')$$

$$E_I' = -0.27(E_B' - EY') + 0.74(E_R' - EY')$$

$$EY' = 0.30E_R' + 0.59E_G' + 0.11E_B'$$

For color-difference frequencies below 500 kc (see (iii) below), the signal can be represented by:

$$E_M = EY' + \left\{ \frac{1}{1.14} \left[\frac{1}{1.78} (E_B' - EY') \sin \omega t + (E_R' - EY') \cos \omega t \right] \right\}$$

(ii) The symbols in subdivision (i) of this subparagraph have the following significance:

E_M is the total video voltage, corresponding to the scanning of a particular picture element, applied to the modulator of the picture transmitter.

EY' is the gamma-corrected voltage of the monochrome (black-and-white) portion of the color picture signal, corresponding to the given picture element.

Note: *Forming of the high frequency portion of the monochrome signal in a different manner is permissible and may in fact be desirable in order to improve the sharpness on saturated colors.*

E_Q' and E_I' are the amplitudes of two orthogonal components of the chrominance signal corresponding respectively to narrow-band and wide-band axes.

E_R' , E_G' , and E_B' are the gamma-corrected voltages corresponding to red, green, and blue signals during the scanning of the given picture element.

ω is the angular frequency and is 2π times the frequency of the chrominance subcarrier.

The portion of each expression between brackets in (i) represents the chrominance subcarrier signal which carries the chrominance information.

The phase reference in the E_M equation in (i) is the phase of the burst $+180^\circ$, as shown in Figure 8 of § 3.699. The burst corresponds to amplitude modulation of a continuous sine wave.

(iii) The equivalent bandwidth assigned prior to modulation to the color difference signals E_Q' and E_I' are as follows:

Q—channel bandwidth:

At 400 kc less than 2 db down.

At 500 kc less than 6 db down.

At 600 kc at least 6 db down.

I—channel bandwidth:

At 1.3 mc less than 2 db down.

At 3.6 mc at least 20 db down.

(iv) The gamma corrected voltages E_R' , E_G' , and E_B' are suitable for a color picture tube having primary colors with the following chromaticities in the CIE system of specification:

	x	y
Red (R)	0.67	0.33
Green (G)	0.21	0.71
Blue (B)	0.14	0.08

and having a transfer gradient (gamma exponent) of 2.2 associated with each primary color. The voltages E_R' , E_G' , and E_B' may be respectively of the form $E_R^{1/2}$, $E_G^{1/2}$, and $E_B^{1/2}$ although other forms may be used with advances in the state of the art.

Note: *At the present state of the art it is considered inadvisable to set a tolerance on the value of gamma and correspondingly this portion of the specification will not be enforced.*

(v) The radiated chrominance subcarrier shall vanish on the reference white of the scene.

Note: *The numerical values of the signal specification assume that this condition will be reproduced as CIE Illuminant C ($x=0.310$, $y=0.316$).*

(vi) EY' , E_Q' , E_I' , and the components of these signals shall match each other in time to 0.05 μ secs.

(vii) The angles of the subcarrier measured with respect to the burst phase, when

proposed change or modification would be in the public interest, convenience, and necessity.

Should a change or modification in the transmission standards be adopted by the Commission, the effective date thereof will be determined in the light of the considerations mentioned in subparagraph (4) of this paragraph.

§ 3.683 *Field intensity contours.* (a) In the authorization of television broadcast stations, two field intensity contours are considered. These are specified as Grade A and Grade B and indicate the approximate extent of coverage over average terrain in the absence of interference from other television stations. Under actual conditions, the true coverage may vary greatly from these estimates because the terrain over any specific path is expected to be different from the average terrain on which the field strength charts were based. The required field intensities, F (50, 50), in decibels above one microvolt per meter (dbu) for the Grade A and Grade B contours are as follows:

Note: It should be realized that the F (50, 50) curves when used for Channels 14-83 are not based on measured data at distances beyond about 30 miles. Theory would indicate that the field intensities for Channels 14-83 should decrease more rapidly with distance beyond the horizon than for Channels 2-6, and modification of the curves for Channels 14-83 may be expected as a result of measurements to be made at a later date. For these reasons, the curves should be used with appreciation of their limitations in estimating levels of field intensity. Further, the actual extent of service will usually be less than indicated by these estimates due to interference from other stations. Because of these factors, the predicted field intensity contours are no assurance of service to any specific percentage of receiver locations within the distances indicated. In licensing proceedings these variations will not be considered.

	(dbu) Grade A	(dbu) Grade B
Channels 2-6	68	47
Channels 7-13	71	56
Channels 14-83	74	64

(b) The field intensity contours provided for herein shall be considered for the following purposes only:

(1) In the estimation of coverage resulting from the selection of a particular transmitter site by an applicant for a television station.

(2) In connection with problems of coverage arising out of application of § 3.636.

(3) Reserved.

(4) In determining compliance with § 3.685 (a) concerning the minimum field intensity to be provided over the principal community to be served.

§ 3.684 *Prediction of coverage.* (a) All predictions of coverage made pursuant to this paragraph shall be made without regard to interference and shall be made only on the basis of estimated field intensities. The peak power of the visual signal is used in making predictions of coverage.

(b) Predictions of coverage shall be made only for the same purposes as relate to the use of field intensity contours as specified in § 3.683 (b).

(c) In predicting the distance to the field intensity contours, the F (50, 50) field intensity charts (Figures 10 and 11 of § 3.699) shall be used. If the 50 percent field intensity is defined as that value exceeded for 50 percent of the time, these F (50, 50) charts give the estimated 50 percent field intensities exceeded at 50 percent of the locations in decibels above one microvolt per meter. The charts are based on an effective power of one kilowatt radiated from a half-wave dipole in free space, which produces an unattenuated field strength at one mile of

about 103 db above one microvolt per meter (137.6 millivolts per meter). To use the charts for other powers, the sliding scale associated with the charts should be trimmed and used as the ordinate scale. This sliding scale is placed on the charts with the appropriate gradation for power in line with the horizontal 40 db line on the charts. The right edge of the scale is placed in line with the appropriate antenna height gradations, and the charts then become direct reading (in uv/m and in db above 1 uv/m) for this power and antenna height. Where the antenna height is not one of those for which a scale is provided, the signal strength or distance is determined by interpolation between the curves connecting the equi-distant points. Dividers may be used in lieu of the sliding scale. In predicting the distance to the Grade A and Grade B field intensity contours, the effective radiated power to be used is that in the horizontal plane in the pertinent direction. In predicting other field intensities over areas not in the horizontal plane, the effective radiated power to be used is the power in the direction of such areas; the appropriate vertical plane radiation pattern must, of course, be considered in determining this power.

(d) The antenna height to be used with these charts is the height of the radiation center of the antenna above the average terrain along the radial in question. In determining the average elevation of the terrain, the elevations between 2 and 10 miles from the antenna site are employed. Profile graphs shall be drawn for 8 radials beginning at the antenna site and extending 10 miles therefrom. The radials should be drawn for each 45 degrees of azimuth starting with True North. At least one radial must include the principal community to be served even though such community may be more than 10 miles from the antenna site. However, in the event none of the evenly spaced radials include the principal community to be served and one or more such radials are drawn in addition to the 8 evenly spaced radials, such additional radials shall not be employed in computing the antenna height above average terrain. Where the 2 to 10 mile portion of a radial extends in whole or in part over large bodies of water as specified in paragraph (e) of this section or extends over foreign territory but the Grade B intensity contour encompasses land area within the United States beyond the 10 mile portion of the radial, the entire 2 to 10 mile portion of the radial shall be included in the computation of antenna height above average terrain. However, where the Grade B contour does not so encompass United States land area and (1) the entire 2 to 10 mile portion of the radial extends over large bodies of water or foreign territory, such radial shall be completely omitted from the computation of antenna height above average terrain, and (2) where a part of the 2 to 10 mile portion of a radial extends over large bodies of water or over foreign territory, only that part of the radial extending from the 2 mile sector to the outermost portion of land area within the United States covered by the radial shall be employed in the computation of antenna height above average terrain. The profile graph for each radial should be plotted by contour intervals of from 40 to 100 feet and, where the data permits, at least 50 points of elevation (generally uniformly spaced) should be used for each radial. In instances of very rugged terrain where the use of contour intervals of 100 feet would result in several points in a short distance, 200- or 400-foot contour intervals may be used for such distances. On the other hand, where the terrain is uni-

form or gently sloping the smallest contour interval indicated on the topographic map (see paragraph (g) of this section) should be used, although only relatively few points may be available. The profile graphs should indicate the topography accurately for each radial, and the graphs should be plotted with the distance in miles as the abscissa and the elevation in feet above mean sea level as the ordinate. The profile graphs should indicate the source of the topographical data employed. The graph should also show the elevation of the center of the radiating system. The graph may be plotted either on rectangular coordinate paper or on special paper which shows the curvature of the earth. It is not necessary to take the curvature of the earth into consideration in this procedure, as this factor is taken care of in the charts showing signal intensities. The average elevation of the 8-mile distance between 2 and 10 miles from the antenna site should then be determined from the profile graph for each radial. This may be obtained by averaging a large number of equally spaced points, by using a planimeter, or by obtaining the median elevation (that exceeded for 50 percent of the distance) in sectors and averaging those values.

Note 1: This paragraph does not apply to any application designated for hearing in which the engineering portions have been heard or the engineering exhibits exchanged prior to June 1, 1953, the effective date of the amendment of this subsection unless the subsection as amended would materially affect the outcome of the hearing.

Note 2: The Commission will, upon a proper showing by an existing station that the application of this rule will result in an unreasonable power reduction in relation to other stations in close proximity, consider requests for adjustment in power on the basis of a common average terrain figure for the stations in question as determined by the Commission.

(e) In instances where it is desired to determine the area in square miles within the Grade A and Grade B field intensity contours, the area may be determined from the coverage map by planimeter or other approximate means; in computing such areas, exclude (1) areas beyond the borders of the United States, and (2) large bodies of water, such as ocean areas, gulfs, sounds, bays, large lakes, etc., but not rivers.

(f) In cases where the terrain in one or more directions from the antenna site departs widely from the average elevation of the 2 to 10 mile sector, the prediction method may indicate contour distances that are different from what may be expected in practice. For example, a mountain ridge may indicate the practical limit of service although the prediction method may indicate otherwise. In such cases the prediction method should be followed, but a supplemental showing may be made concerning the contour distances as determined by other means. Such supplemental showing should describe the procedure employed and should include sample calculations. Maps of predicted coverage should include both the coverage as predicted by the regular method and as predicted by a supplemental method. When measurements of area are required, these should include the area obtained by the regular prediction method and the area obtained by the supplemental method. In directions where the terrain is such that negative antenna heights or heights below 100 feet for the 2 to 10 mile sector are obtained, a supplemental showing of expected coverage must be included together with a description of the method employed in predicting such coverage. In

special cases, the Commission may require additional information as to terrain and coverage.

(g) In the preparation of the profile graphs previously described, and in determining the location and height above sea level of the antenna site, the elevation or contour intervals shall be taken from the United States Geological Survey Topographic Quadrangle Maps, United States Army Corps of Engineers maps or Tennessee Valley Authority maps, whichever is the latest, for all areas for which such maps are available. If such maps are not published for the area in question, the next best topographic information should be used. Topographic data may sometimes be obtained from State and municipal agencies. Data from Sectional Aeronautical Charts (including bench marks) or railroad depot elevations and highway elevations from road maps may be used where no better information is available. In cases where limited topographic data is available, use may be made of an altimeter in a car driven along roads extending generally radially from the transmitter site. Ordinarily the Commission will not require the submission of topographical maps for areas beyond 15 miles from the antenna site, but the maps must include the principal community to be served. If it appears necessary, additional data may be requested. United States Geological Survey Topographical Quadrangle Maps may be obtained from the Department of the Interior, Geological Survey, Washington, D. C. Sectional Aeronautical Charts are available from the Department of Commerce, Coast and Geodetic Survey, Washington, D. C.

§ 3.685 *Transmitter location and antenna system.* (a) The transmitter location shall be chosen so that, on the basis of the effective radiated power and antenna height above average terrain employed, the following minimum field intensity in decibels above one microvolt per meter (dbu) will be provided over the entire principal community to be served:

Channels 2-6	Channels 7-13	Channels 14-83
74 dbu	77 dbu	80 dbu

(b) Location of the antenna at a point of high elevation is necessary to reduce to a minimum the shadow effect on propagation due to hills and buildings which may reduce materially the intensity of the station's signals. In general, the transmitting antenna of a station should be located at the most central point at the highest elevation available. To provide the best degree of service to an area, it is usually preferable to use a high antenna rather than a low antenna with increased transmitter power. The location should be so chosen that line-of-sight can be obtained from the antenna over the principal community to be served; in no event should there be a major obstruction in this path. The antenna must be constructed so that it is as clear as possible of surrounding buildings or objects that would cause shadow problems. It is recognized that topography, shape of the desired service area, and population distribution may make the choice of a transmitter location difficult. In such cases, consideration may be given to the use of a directional antenna system, although it is generally preferable to choose a site where a non-directional antenna may be employed.

(c) In cases of questionable antenna locations it is desirable to conduct propagation tests to indicate the field intensity expected in the principal community to be served and in other areas, particularly where severe shadow problems may be expected. In considering applications proposing the use of such locations, the com-

mission may require site tests to be made. Such tests should be made in accordance with the measurement procedure hereafter described, and full data thereon must be supplied to the Commission. Test transmitters should employ an antenna having a height as close as possible to the proposed antenna height, using a balloon or other support if necessary and feasible. Information concerning the authorization of site tests may be obtained from the Commission upon request.

(d) Present information is not sufficiently complete to establish "blanket areas" of television broadcast stations. A "blanket area" is that area adjacent to a transmitter in which the reception of other stations is subject to interference due to the strong signal from this station. The authorization of station construction in areas where blanketing is found to be excessive will be on the basis that the applicant will assume full responsibility for the adjustment of reasonable complaints arising from excessively strong signals of the applicant's station or take other corrective action.

(e) A directional antenna is considered to be an antenna that is designed or altered for the purpose of obtaining a noncircular radiation pattern. Directional antennas may not be used for the purpose of reducing minimum mileage separation requirements but may be employed for the purpose of using a particular site; however, directional antennas with a ratio of minimum to maximum radiation in the horizontal plane of more than 10 decibels will not be permitted.

(f) Applications proposing the use of directional antenna systems must be accompanied by the following:

(1) Complete description of the proposed antenna system.

(2) Orientation of array with respect to true north; time phasing of fields from elements (degrees leading or lagging); space phasing of elements (in feet and degrees); and ratio of fields from elements.

(3) Horizontal and vertical plane radiation patterns showing the free space field intensity in millivolts per meter at 1 mile and the effective radiated power, in dbk, for each direction. The method by which the radiation patterns were computed or measured shall be fully described, including formulas used, equipment employed, sample calculations and tabulations of data. Sufficient vertical plane patterns shall be included to indicate clearly the radiation characteristics of the antenna above and below the horizontal plane. The horizontal plane pattern shall be plotted on polar coordinate paper with reference to true north. The vertical plane patterns shall be plotted on rectangular coordinate paper with reference to the horizontal plane.

(4) Name, address, and qualifications of the engineer making the calculations.

(g) Applications proposing the use of television broadcast antennas within 200 feet of other television broadcast antennas operating on a channel within 20 percent in frequency of the proposed channel, or proposing the use of television broadcast antennas on Channels 5 or 6 within 200 feet of FM broadcast antennas, must include a showing as to the expected effect, if any, of such proximate operation.

(h) Where simultaneous use of antennas or antenna structures is proposed, the following provisions shall apply:

(1) In cases where it is proposed to use a tower of a standard broadcast station as a supporting structure for a television broadcast antenna, an appropriate application for changes in the radiating system of the standard broadcast station must be filed by the licensee thereof. A formal application (FCC Form 301) will be required if the

proposal involves substantial change in the physical height or radiation characteristics of the standard broadcast antennas; otherwise an informal application will be acceptable. (In case of doubt, an informal application (letter) together with complete engineering data should be submitted.) An application may be required for other classes of stations when the tower is to be used in connection with a television station.

(2) When the proposed television antenna is to be mounted on a tower in the vicinity of a standard broadcast directional array and it appears that the operation of the directional antenna system may be affected, an engineering study must be filed with the television application concerning the effect of the television antenna on the directional pattern. Readjustment and field intensity measurements of the standard broadcast station may be required following construction of the television antenna.

(i) The provisions of Part 17 of this chapter shall govern the construction, marking and lighting requirements of antenna structures used by television broadcast stations. In the event a common tower is used by two or more licensees or permittees for antenna and/or antenna supporting purposes, the licensee or permittee who is owner of the tower shall assume full responsibility for the installation and maintenance of any painting and/or lighting requirements. In the event of shared ownership, one licensee or permittee shall assume such responsibility and advise the Commission accordingly.

§ 3.686 *Measurements for rule making purposes and upon request of the Commission.* (a) Except as provided for in § 3.612, television broadcast stations shall not be protected against any type of interference or propagation effect. Persons desiring to submit testimony, evidence, or data to the Commission for the purpose of showing that the technical standards contained in this subpart do not properly reflect any given types of interference or propagation effects may do so only in appropriate rule making proceedings to amend such technical standards. Persons making field intensity measurements for formal submission to the Commission in rule making proceedings, or making such measurements upon the request of the Commission, should comply with the procedure for making such measurements as outlined below.

(b) Measurements made to determine field intensities of television broadcast stations should be made with mobile equipment along roads which are as close and similar as possible to the radials showing topography which were submitted with the application for construction permit. Cluster and spot measurements may also be submitted, if accompanied by a complete showing of the procedures employed. Suitable measuring equipment and a continuous recording device must be employed, the chart of which is either directly driven from the speedometer of the automobile in which the equipment is mounted or so arranged that distances and identifying landmarks can be readily noted. The measuring equipment must be calibrated against recognized standards of field intensity and so constructed that it will maintain an acceptable accuracy of measurement while in motion or when stationary. The equipment should be so operated that the recorder chart can be calibrated directly in field intensity in order to facilitate analysis of the chart. The receiving antenna must be horizontally polarized and should be non-directional.

(c) Mobile measurements should be made with a minimum chart speed of 3 inches per mile and preferably 5 or 6 inches per

mile. Locations shall be noted on the recorder chart as frequently as necessary to fix definitely the relation between the measured field intensity and the location. The time constant of the equipment should be such as to permit adequate analysis of the charts, and the time constant employed shall be shown. Measurements should be made to a point on each radial well beyond the particular contour under investigation.

(d) While making field intensity measurements either the visual or the aural transmitter may be used. If the visual transmitter is used, it is recommended that a black picture be transmitted or that the transmitter be operated at black level without synchronization peaks. Operation at a power somewhat less than black level is permissible but too great a reduction in power is not recommended due to the difficulty of recording weak signals. In any event, an appropriate factor shall be used to convert the readings obtained to the field strength that would exist on synchronization peaks while operating at the authorized power.

(e) After the measurements are completed, the recorder chart should be divided into not less than 15 sections on each equivalent radial from the station. The field intensity in each section of the chart should be analyzed to determine the field intensity received 50 percent of the distance (median field) throughout the section, and this median field intensity associated with the corresponding sector of the radial. The field intensity figures must be corrected for a receiving antenna elevation of 30 feet and for any directional effects of the automobile and receiving antenna not otherwise compensated. This data should be plotted for each radial, using log-log coordinate paper with distance as the abscissa and field intensity as the ordinate. A smooth curve should be drawn through these points (of median fields for all sectors) and this curve used to determine the distance to the desired contour. The distances obtained for each radial may then be plotted on the map of predicted coverage or on polar coordinate paper (excluding water areas, etc.) to determine the service and interference areas of a station.

(f) In certain cases the Commission may desire more information or recordings and in these instances special instructions will be issued.

(g) Data obtained in conjunction with field intensity measurements shall be submitted to the Commission in affidavit form in triplicate, including the following:

(1) Map or maps showing the roads or points where measurements were made, the service and/or interference areas determined by the prediction method and by the measurements, and any unusual terrain characteristics existing in these areas. The maps, preferably of a type showing topography in the area, should show the Grade A and Grade B field intensity contours.

(2) If a directional transmitting antenna is employed, a diagram on polar coordinate paper showing the predicted free space field intensity in millivolts per meter at 1 mile in all directions.

(3) A full description of the procedures and methods employed, including the type of equipment, the method of installation and operation, and calibration procedures.

(4) Complete data obtained during the survey, including calibration. (Only the original or one photostatic copy of the recording tapes, or representative samples, need be submitted.)

(5) Antenna system and power employed during the survey.

(6) Name, address, and qualifications of the engineer or engineers making the measurements.

INDUSTRY NEWS

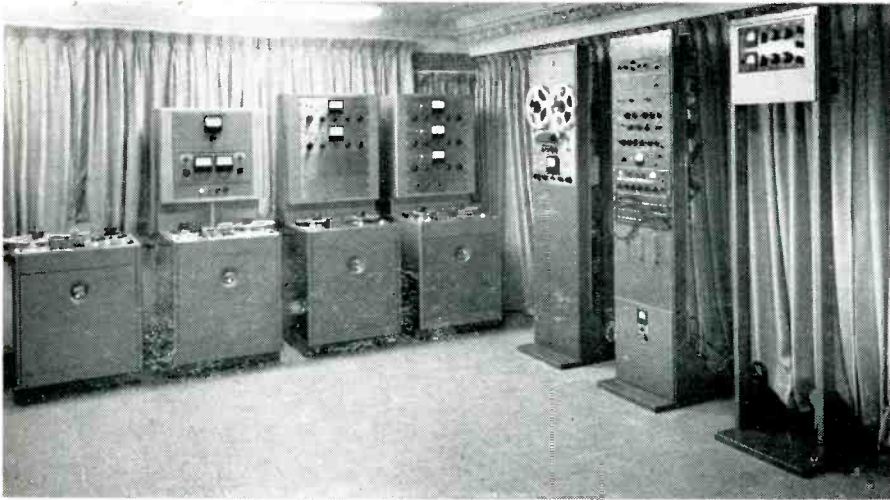

NEW PROFESSIONAL SHOWROOM AT HARVEY RADIO

The first showroom of professional sound equipment for the broadcasting and recording industry was opened June 10th by Harvey Radio Co., Inc., 103 West 43rd St., New York City. The new room, the first of its kind in the country, will offer the professional an opportunity to see and test the latest audio equipment.

General Electric Co.

Appointment of Robert L. Casselberry as acting manager of the Technical Products Operation of the General Electric Co.'s communication products department here was announced by Harrison Van Aken, general manager of the department. The announcement was made from department headquarters, Lynchburg, Va.

Mr. Casselberry was formerly manager of product planning and marketing-research at the department's Lynchburg headquarters. In his new position, he will be responsible for all phases of administration, engineering, finance, manufacturing, marketing and related activities for the technical products operation. He will make his headquarters at Electronics Park.

General Electric's technical products operation makes a complete line of radio and television broadcast equipment, including antennas, transmitters and studio gear; closed-circuit television for the military, commercial, industrial and educational fields; advanced communications systems for the military; and high-frequency heating equipment for industry.



H. ERNEST AMMAN

H. Ernest Amman, recently of Western Electric Co., has joined Foto-Video Laboratories, Inc., as production manager.

Mr. Amman was with the engineer-of-manufacture organization of Western Electric for eleven years, following his graduation from Newark College of Engineering in 1947 with a Bachelor of Science degree in Mechanical Engineering.

Rosenthal Named Director of Quality Control at Adler

Bradley Rosenthal has been appointed director of quality control of Adler Electronics, Inc., New Rochelle, N. Y. He was formerly with the Ford Instrument Co.

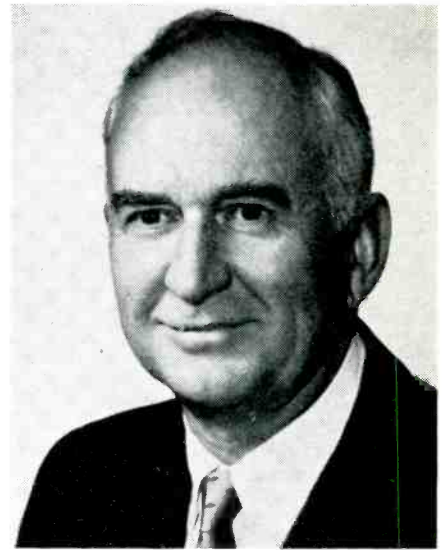

DONALD R. FOYER

Donald R. Foyer, formerly sales manager of one of the world's largest manufacturers of piezoelectric crystals, the Hunt Corp. of Carlisle, Pa., has been appointed Foto-Video Laboratories' sales representative for the Middle-Atlantic area centered at Washington, D. C.

Rohde & Schwarz Sales Co.

Rohde & Schwarz, German electronics manufacturing company, will henceforth market its line of precision measuring instruments in the United States through the recently formed Rohde & Schwarz Sales Co. (U.S.A.), it has been jointly announced by the Industrial Products Division of International Telephone & Telegraph Corp., former distributor, and Rohde & Schwarz (U.S.A.).

The agreement allows the ITT division to expand its instrument manufacture into areas covered by Rohde & Schwarz equipment while allowing Rohde & Schwarz to market its complete line of electronic products in areas competitive with other ITT system companies.

The Industrial Products Division will continue to market other imported instrument lines, as well as domestically engineered and manufactured large-screen oscilloscopes and related equipment, from its west coast facilities at 15191 Bledsoe St., San Fernando, Calif.

Headquarters for Rohde & Schwarz (U.S.A.) is located at 111 Lexington Ave., Passaic, N. J.



JAMES R. PALMERE

James R. Palmere has been appointed electronic fabrication group sales manager of Foto-Video Laboratories, Inc., as the current step in the company's amplification of its sales force for full nation-wide coverage.

Mr. Palmere formerly was the Foto-Video purchasing agent. Announcement was made by Albert J. Barackett, president.

New Executives Appointed At ITT Federal Division

Reassignment of two executives of ITT Federal Division, which operates manufacturing plants at Clifton, N. J., and Ft. Wayne, Ind., has been announced by D. L. Mills, president. Vernon L. Haag, who has been general manager of the division's operation at Ft. Wayne, will report to Mr. Mills on special assignment at Clifton headquarters, effective immediately. Edward J. McGrath, deputy director of the Weapons System Management Group, Clifton, has been named to succeed Mr. Haag. ITT Federal is a division of International Telephone & Telegraph Corp.

JOHN ESAU

John Esau has been named national sales manager of Programatic Broadcasting Service, it has been announced by Joseph W. Roberts, vice-president. Esau had been eastern sales manager for the firm. Norman J. Ostby will continue to operate as western sales manager for Programatic in Beverly Hills, Calif.

Rohn Manufacturing Co.

Rohn Manufacturing Co., Peoria, Ill., manufacturer of television, communications and amateur radio towers and accessories, recently acquired additional manufacturing facilities of approximately 20,000 square feet. This additional manufacturing space is in a building next to the main plant at Bellevue near Peoria.

Just a few months ago a huge new galvanizing plant was put into operation so as to be able to contain hot-dip galvanizing on all Rohn products. Together with the new addition, the Rohn company now has seven plants with a total space of approximately 90,000 square feet devoted exclusively to manufacturing the complete line of Rohn products.



JEROME G. FRIEDMAN

Jerome G. Friedman has been appointed director of customer relations of Adler Electronics, Inc., New Rochelle, N. Y. His responsibilities include all government and industrial contract sales activities. Mr. Friedman holds a Master of Science Degree from the Stevens Institute of Technology and a Bachelor of Science in Electrical Engineering Degree from Newark College of Engineering. Prior to joining Adler, he was a key sales and engineering executive with Design Service Co., R.C.A. and Westinghouse.



C. ROBERT LANE

C. Robert Lane was recently promoted to the position of sales manager of Andrew Corp., designers and manufacturers of antenna systems. He has been associated with the company four years as eastern regional manager, with offices in Westwood, Mass., and had extensive engineering experience in antenna systems prior to joining Andrew. Lane will direct the company's expanding national and international sales activities from their Chicago offices.

In announcing Mr. Lane's new position, Robert P. Lamons, director of marketing, also states that Robert C. Bickel has been named marketing manager and will assume responsibility for the company's product planning and all other marketing activities, except sales. Each man's activities will be under the direction of Mr. Lamons.

Schneiderman Named Customer Engineering Manager at Adler

Sol Schneiderman has been appointed manager of customer engineering of Adler Electronics, Inc., New Rochelle, N. Y. Prior to joining Adler, he was with Instruments for Industry, Inc. and Radio Receptor Co. Mr. Schneiderman holds a Bachelor of Electrical Engineering Degree from Polytechnic Institute of Brooklyn and is a licensed Professional Engineer. He is a member of the Institute of Radio Engineers (IRE).

PRODUCT NEWS



MODEL 524D COUNTER

Hewlett-Packard Co.
275 Page Mill Rd., Palo Alto, Calif.

The new electronic counter features a uniform eight-decade numerical readout. The instrument has a crystal oscillator stability of three parts in 10^8 short term; five parts in 10^6 per week. Frequency measurements from ten cps to ten MC and period measurements from zero cps to ten KC. Plug-in units extend the frequency measurement range to 220MC, permit period measurements over 10,000 period. The unit features direct, instantaneous, and automatic readings. Display time is variable and an automatic illuminated decimal point is included.

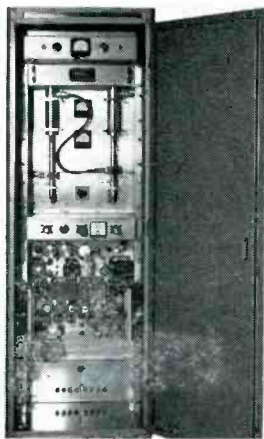

TEXAN TYPE A TRANSLATOR

Texan Translator & TV Network, Inc.
San Antonio, Texas

The Texan Translator is contained in a six-foot equipment rack, front and rear doors have interlocks, with gray hammertone finish. The oscillator is a 12AT7 tube and the crystal is temperature controlled. The crystal frequency is in the 20-40 megacycle range. The frequency multipliers up to the final injection voltage multiplier/amplifier are 6AK5 tubes. The final injection voltage amplifier is a 587A pencil tube, as is the Mixer and first UHF amplifier. The driver cavity and final output cavity use 3CX100A5 tubes. The receiving antenna recommended is a cluster of full wave loops. Each cluster of four loops and reflectors has a power gain of 24 db, and is supplied with a balun to match RG-11/U cable.

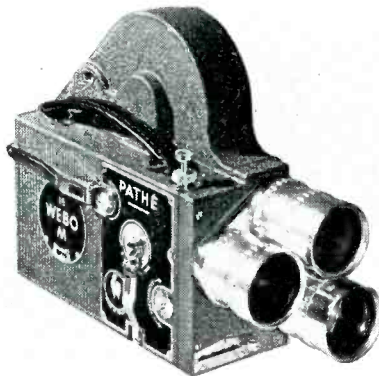

16MM PATHE CAMERA

Burke & James, Inc.
321 S. Wabash Ave., Chicago 4, Ill.

The 16mm Webo-M Pathe camera is now being distributed by Burke & James, Inc. The camera offers continuous reflex viewing, six speeds, eight to eighty frames per second and variable shutter. The camera takes all 16mm lenses with standard C mount threads.

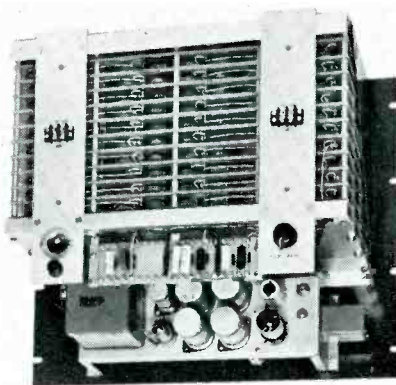

SPEC. 7251 AUDIO DELAY LINE

The Daven Co.
Livingston, N. J.

A new audio delay line is being produced for use in a compatible stereo broadcasting system developed by F. K. Becker of Bell Laboratories. The Bell system is based upon the "precedence" effect which operates in such a way that when sound is reproduced through two separate channels, with one of the channels delayed by several milliseconds, the stereo listener hears the sound as if it comes from only one speaker. The monophonic listener gets full reception on either channel. The delay line has a delay of ten milliseconds; phase linearity of X plus or minus one per cent, 100 cps to 10 kc, plus or minus three per cent below 100 cps; and frequency response plus or minus two db 30 cps to 10 kc.

AUTOMATIC PROGRAM EQUIPMENT

Programatic Broadcasting Service, 229 Park Ave. South, New York 22, N. Y., offers a program service and automatic broadcasting equipment. The Programatic machine is a double deck electronically-controlled, time-synchronized tape playback. One deck plays back the programming and the other injects announcements and time signals.



TRANSISTORIZED SECRET RECORDER

Amplifier Corp. of America
398 Broadway, New York 13, N. Y.

The electric-motor, battery-operated recorder is installed in an average sized leather brief case. The recorder is started or stopped by pressing the patented slide-lock and switch. A built-in microphone is hidden in the upper folds of the briefcase. The unit measures 16 inches long by 12½ inches high by 4½ inches wide and weighs 12 pounds. Single-speed and two-speed models are available.



SP 58-1A SYMMETRA-PEAK

Kahn Research Laboratories, Inc.
22 Pine St., Freeport, L. I., N. Y.

The Model SP 58-1A Symmetra-peak is being widely used by AM, FM and TV stations to increase their voice coverage range because it equally distributes unequal positive or negative peak energy contained in voice waves. Thus, non-symmetry resulting from certain voice characteristics, improperly phased microphones or switching between local and network voice program sources is eliminated. With peak energy lowered, average audio level can be increased, permitting modulation to be raised by as much as 4 db. A symmetrical input also provides better over-all performance of limiters and AGC amplifiers. No power source is needed and there is nothing to wear out or replace in normal service.

WRITE

**Manufacturers
for further
Information**

**Please Mention
BROADCAST ENGINEERING**

BROADCAST ENGINEERING

LONG LIFE POWER TUBES

ITT Components Division, Clifton, N. J., has started production of a line of high temperature, long-life power tubes that achieve extra reliability through a vapor cooling technique. The tubes which dissipate more heat than conventional air or water cooled tubes can be adapted to existing tube designs, according to Frank M. Viles, Jr., vice-president and director of marketing. Under normal operating conditions anode dissipation exceeds 800 watts per square inch. In tests on specific models, anode dissipation of 2500 watts per square inch has been maintained for several minutes without damage to the tubes. Cooling equipment for the tube consists of a boiler filled to a definite level with distilled water and cooling coils immersed in the water.

The tube sets in the boiler and is sealed by its own weight. Steam that develops is recondensed in the boiler by the transfer of heat to water in the cooling coils. The tubes may be used in modulators, amplifiers and oscillators in communication equipment and industrial equipment.

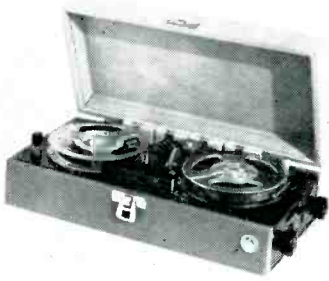

NO. 1A TAPE RECORDER

Kingdom Products Ltd.

514 Broadway, New York 12, N. Y.

The 1A Fi-Cord is a two-speed transistorized tape recorder. Frequency response is 50 to 12,000 cycles cps plus or minus 3 db. The unit is completely battery operated and the batteries can be recharged. A loudspeaker is included.

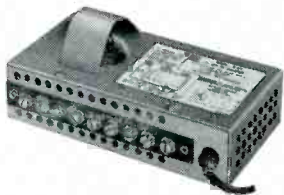

MODEL B-24 POW-R BOOSTER

Blonder-Tongue Laboratories, Inc.

9 Alling St., Newark 2, N. J.

The booster serves as a single-set booster or as a two-set booster-coupler. The straight through circuit provides up to ten db gain on one TV or FM set and five db gain when used to feed two sets.

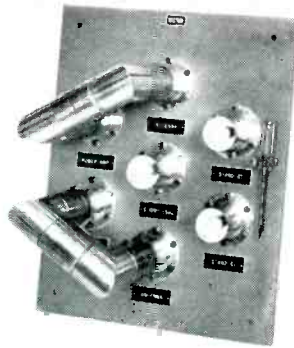

COAXIAL PATCH PANEL

The Mectron Co.

166 Ridge Ave., North Plainfield, N. J.

A standard Coaxial Patch Panel is manually operated for 1 $\frac{3}{8}$ -inch, 3 $\frac{3}{8}$ -inch and 6 $\frac{1}{8}$ -inch air dielectric coaxial lines in 50, 51.5 and 75 ohm impedances. VSWR is 1.02 or better with no loss in power handling capabilities. Standard three-pole and seven-pole circuits furnish flexibility.



SM-1 STEREO CARTRIDGE

Fairchild Recording Equipment Corp.

10-40—45th Ave., Long Island, N. Y.

The SM-1 has an output of 11 mvs at 5 cm at 1 kc. The cartridge case is made of mu metal and is not affected by magnetic interference. It will track 30 cm/sec sinusoidal at approximately three grams. It has more than 20 db separation over the greater part of the audio spectrum and has a frequency response of better than plus or minus two db from 20 cycles to 15,000 cycles on each channel.

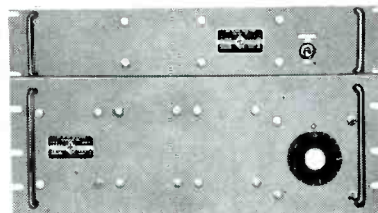

LINE VOLTAGE REGULATOR

General Radio Co.

West Concord, Mass.

A line-voltage regulator designed to meet military environmental requirements of shock, vibration, temperature and humidity. The unit is servo-controlled and can be used for three-phase service. It employs a three-gang Variac and a thyatron-controlled servo-motor.

MOBILE RF LOAD

Mobile, RF loads and wattmeters for use with aural or visual transmitters operating on any frequency from 54 to 216 mc are offered by Standard Electronics Division of Radio Engineering Laboratories, 29-01 Borden Ave., Long Island City, N. Y.

The 25 and 50 kw RF loads are housed in dolly mounted cabinets which may be wheeled to the equipment to be tested. A coaxial transmission line input is adjustable in height from six feet, 11 $\frac{1}{2}$ inches to seven feet, 10 $\frac{1}{2}$ inches above floor level and may be rotated through 360 degrees. Power output is indicated directly in watts on a portable meter which may be placed at the front of the transmitter under test while the dummy load is at the back. The wattmeter is actuated by a sealed differential thermocouple which senses the difference between water input and output temperatures, so that supply water temperature is non-critical.

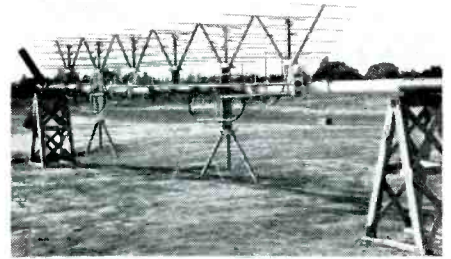

JA-500-7 TV ANTENNA

Jampro Antenna Co.

7500—14th Ave., Building 9
Sacramento, Calif.

A new type of TV directional antenna permits gains of up to 20. Consisting of six bays, the picture shows a Jampro Channel 7 antenna, with a modified figure eight pattern. Weighing 2300 pounds, the antenna is 47 feet long. Power input rating is 50 KW, with two line input feed system.

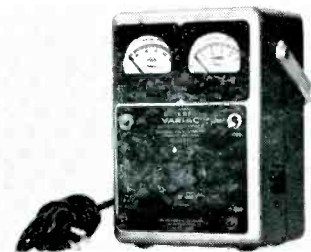

W5MT3A METERED VARIAC

General Radio Co.

West Concord, Mass.

A five-ampere Variac with meters in the load circuit to measure voltage and current. Meter shielding is included which reduces the stray field so that an overall accuracy of three per cent can be obtained with two per cent meters. A make-before-break range switch permits switching of the meters under load.

FOR COMPLETE COVERAGE OF BROADCAST BUYING POWER

ADVERTISE IN

BROADCAST ENGINEERING

THE TECHNICAL JOURNAL OF THE BROADCAST INDUSTRY

TECHNICAL HINTS

Stabilizing Outside Tuning Units

During early morning hours, or following a rain, antenna currents have a tendency to "wander" a bit. This effect can be held to a minimum by placing, in each tuning box, a 40, 60 or larger wattage bulb and letting it burn continuously. The size of the bulb is determined by the size of the tuning box and the relative dampness expected each morning.

JOSEPH KISH, JR.
Chief Engineer
WTIG
Massillon, Ohio

An Inexpensive Filter Mike

We had occasion to require a filter mike for a special effects recording we were to make. Not having either the filter mike or the necessary time to investigate and figure out the filter and order the parts, we hit upon this scheme.

By gluing two surplus earphones together face to face, feeding one through a point oh-oh-four-seven microfarad capacitor from a cheap public address mike and amplifier, and connecting the second earphone to one of our console mike pre-amplifiers, we obtained the desired effect.

Our setup used the above mentioned device as one channel (filter) and a second normally connected studio mike for the regular channel. We connected a foot button operated relay to alternately short out either of the two channels. The mikes were placed side-by-side, and by use of the button, the announcer was able to select either normal or filter. By-the-way, the value of the above mentioned capacitor can be varied to suit the amount of filtering required.

GEORGE JENNINGS,
Chief Engineer
WCBG
Chambersburg, Pa.

How to Prolong the Life Of Transmitter Tubes

Tubes used in the high power stages of most transmitters employ directly heated thoriated tungsten cathodes. This type of filament draws a heavy current to bring it

JACK STRIPS

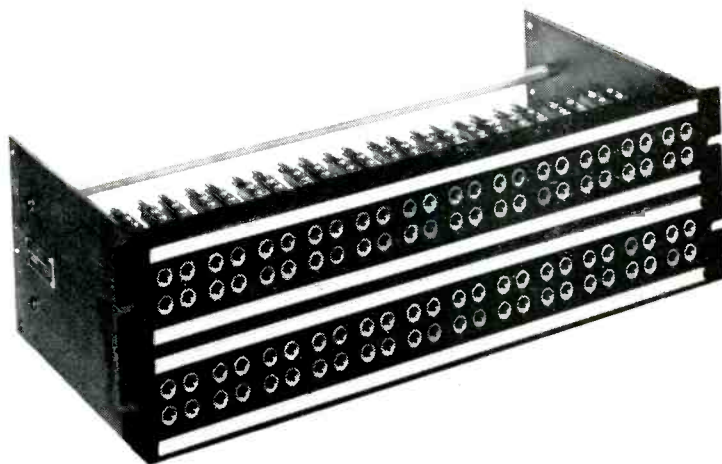

- ★ PROFESSIONAL TYPE MOUNTING
- ★ 96 ADC CLOSED CIRCUIT JACKS
- ★ STANDARD 19-INCH WIDTH
- ★ DESIGNATION STRIPS
- ★ NEW! \$100 VALUE

ONLY \$39.50

Cash or C.O.D. . . . Cash Orders Shipped Prepaid.

CENTURY DISTRIBUTING COMPANY
1238 Pennsylvania Avenue
KANSAS CITY 5, MISSOURI

up to the high temperature at which it operates. When the filament is cold its resistance is very low, and if full voltage is applied immediately an excessive current flow results before operating temperature is reached. During this period of excessive current flow the weakest point of the filament will become overheated and may cause the filament to open. To further aggravate the situation most stations turn on their transmitters early in the morning, when the line voltage is higher than normal due to the light consumer load at that early hour. To prevent premature failure of these expensive tubes the transmitter filament control should be adjusted to minimum voltage before applying power. After the power has been applied the filament voltage should be readjusted to the normal value. This simple procedure will greatly extend the life of these costly tubes by limiting the filament current surge.

ALBERT J. KRUKOWSKI,
Transmitter Engineer
WSPR,
West Springfield, Mass.

SEND YOUR IDEAS
to
TECHNICAL HINTS

★
FIVE DOLLARS
IS PAID
FOR ALL SUGGESTIONS
PUBLISHED!

BROADCAST ENGINEERING
P. O. Box 93
Kansas City 41, Missouri

PERSONNEL

Wise station managers and chief engineers insist on RERB registration of all new personnel. RERB investigation before hiring reduces hiring hazards. Radio-TV Employee Reference Bureau, P. O. Box 333, Tacoma, Wash.

BROADCAST ENGINEERING

72 different wipes, at your fingertips

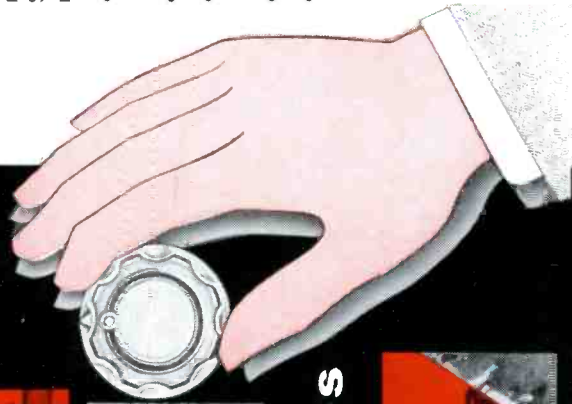

Telechrome brings to TV broadcasters a vastly improved system for producing a wide variety of dramatic wipes, inserts, keying and other special effects. The superb engineering of the Telechrome Special Effects System provides outstanding reliability and technical performance when used for either color or monochrome TV. Simplicity of pattern selection and wipe speed is provided by manual switches on the remote control unit.

- Unusual compactness and portability make possible the creation of special effects even in field locations.
- Simplest to operate. All 72 wipes available at all times.
- Stabilized black balance between pictures. Millimicrosecond transition time eliminates edge effects.
- Additional camera input allows keying from camera signal.
- Its versatility permits use in live, video-tape or film programming.

TELECHROME SPECIAL EFFECTS GENERATOR FOR WIPES & MATTING, MODEL 490A

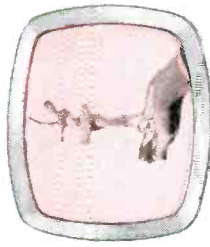

Insert Keying with Super Stability

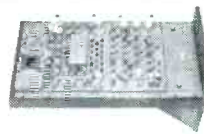

Rack Mounted

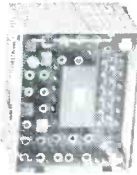

490W1 Waveform Generator. Generates keying signals for the 72 different wipes.



490S1 Switching Amplifier. Combines two picture signals in accordance with applied keying waveform.



490R1 Remote Control Unit. Selects and controls desired effect. Designed for console or desk mounting. Easily modified for integration into existing studio facilities. Complete with power supply—512CR.

Designed for 19" rack mounting, or portable cases. Full specifications and details available on request.

AVAILABLE FOR IMMEDIATE DELIVERY.

COLOR TV • INDUSTRIAL INSTRUMENTATION • TELEMETRY



TELECHROME MFG. CORP.

28 RANICK DRIVE, AMITYVILLE, N. Y., LINCOLN 1-3600
CABLE ADDRESS: COLORTV • TWX, AMITYVILLE NY2314

AT THE FRONTIERS OF ELECTRONICS

WESTERN ENGINEERING DIVISION • 13635 Victory Blvd., Van Nuys, Calif., State 2-7479
MIDWESTERN ENGINEERING DIVISION • 106 W. St. Charles Rd., Lombard, Ill., MAYfair 7-6026
SOUTHWESTERN ENGINEERING DIVISION • 4207 Gaston Ave., Dallas, Tex., Taylor 3-3291

Demonstrated at
N.A.B. SHOW
& I.R.E. SHOW

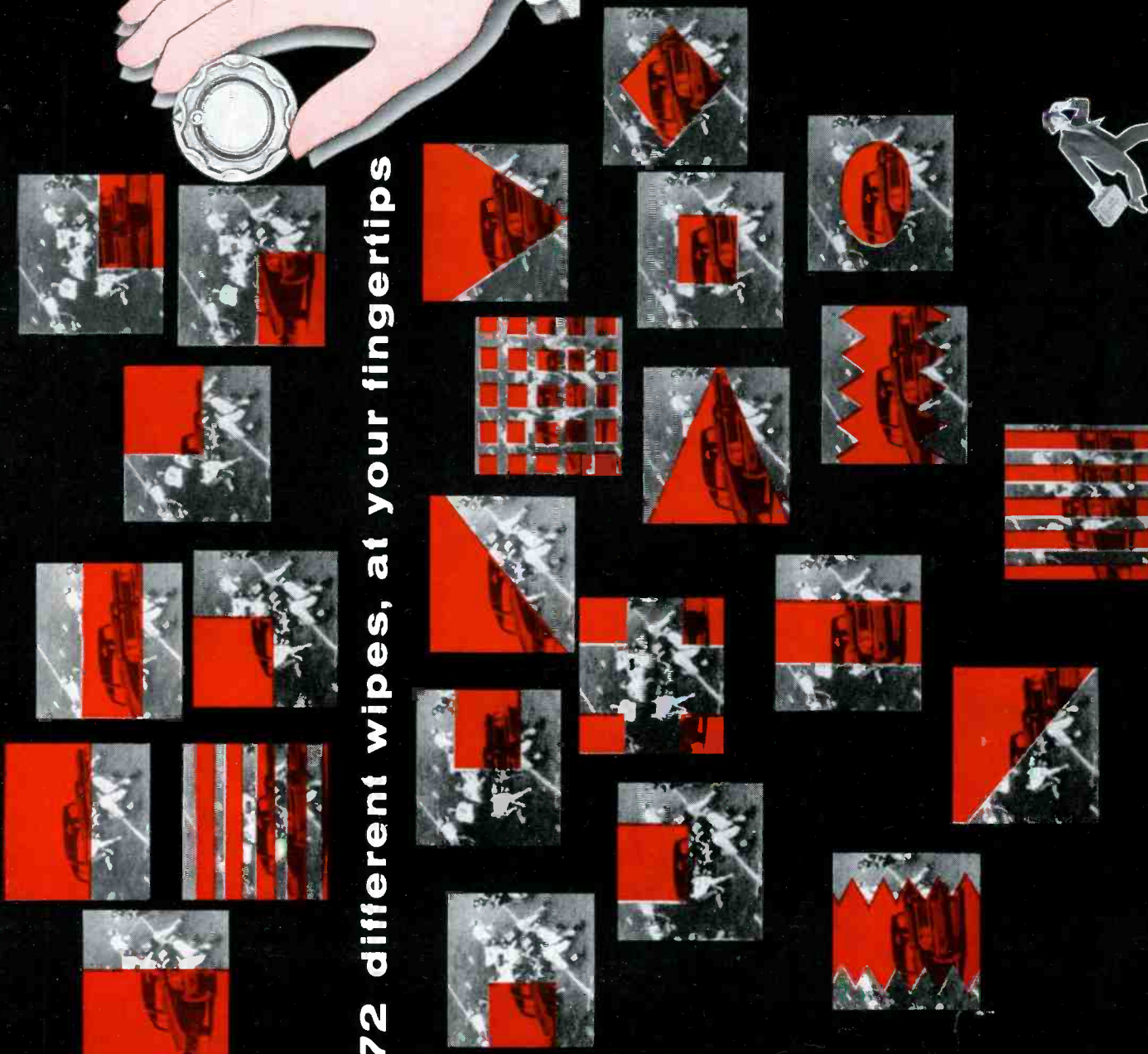

TELEVISION ENGINEERS THE WORLD OVER

will tell you the

Super Studio and Super Universal

ZOOMARS

are the finest precision lenses for
both live and taped productions
... color or monochrome

"WE USE YOUR SUPER STUDIO ZOOMAR LENS ON ALL OUR
LOCAL SHOWS. AN INVALUABLE HELP ON OUR SIX TO SEVEN PM

COLOR PROGRAMS WEEK DAYS AND OUR WEEKEND SHOWS.

WE WOULD RATHER GIVE UP ONE CAMERA

THAN GIVE UP THIS LENS."



SUPER UNIVERSAL

Color Corrected
Speed f/3.9
Zoom Range 2½ to 40 inches
Two converters.
Zoom Ratio 6 to 1



SUPER STUDIO

Color Corrected
Speed f/2.7
Zoom Range 2¼ to 7¼ inches
Converter—5 to 15 inches
Zoom Ratio 3½ to 1

No counterbalancing necessary
Self Supporting
Change Zoom Range in a minute
Interchangeable all American I. O. cameras
Zoomars serviced by the Engineers who build them
Use other fixed-focus lenses on same turret
Zoomars change from camera to camera in a minute
One year guarantee and maintenance contract

For a
demonstration of
ZOOMAR LENSES
on your cameras,
write or call



JACK A. PEGLER • BILL PEGLER

TELEVISION ZOOMAR COMPANY

500 Fifth Avenue, Room 2223 • New York 36, New York • BRyart 9-5835

The originator — 12 years specializing in the manufacturer of ZOOMAR LENSES for Television