

The Bell System Technical Journal

Vol. XVI

January, 1937

No. 1

A Million-Cycle Telephone System *

By M. E. STRIEBY

ABOUT two years ago a new wide-band system for multi-channel telephone transmission over coaxial cables was described.¹ An experimental system has now been installed between New York and Philadelphia. The various tests and trials which are planned for this system have not been carried far enough to justify a formal technical paper. Meanwhile, the considerable interest that has been aroused in the system has led to this brief statement of its principal features and its general technical performance as so far measured.

The coaxial cable itself has been installed between the long distance telephone buildings in New York and Philadelphia, a distance of 94.5 miles. It has been equipped with repeaters, at intervals of about 10 miles, capable of handling a frequency band of about 1,000,000 cycles.

This million-cycle system is designed to handle 240 simultaneous two-way telephone conversations. Only a part of the terminal apparatus has been installed, sufficient in this case to enable adequate tests to be made of the performance of the entire system. A general view of the New York terminal is shown in Fig. 2. Some preliminary test conversations have been held over the system, both in its normal arrangement for providing New York-Philadelphia circuits, and with certain special arrangements whereby the circuit is looped back and forth many times to provide an approximate equivalent of a very long cable circuit. The performance has been up to expectations, and no important technical difficulties have arisen to cast doubt upon the future usefulness of such systems. Much work remains to be done, however, before coaxial systems suitable for general commercial service can be produced.

THE COAXIAL CABLE

Figure 1 shows a photograph of the particular cable used in this installation. It contains two coaxial units, each having a 0.265-inch inside diameter, together with four pairs of 19-gauge paper insulated wires, the whole enclosed in a lead sheath of 7/8-inch outside diameter.

* Published in *Electrical Engineering* for January, 1937.

¹ "Systems for Wide-Band Transmission Over Coaxial Lines" by L. Espenschied and M. E. Strieby, *Bell Sys. Tech. Jour.*, October, 1934; *Elec. Engg. (A. I. E. E. Transactions)*, Vol. 53, 1934, pages 1371-80.

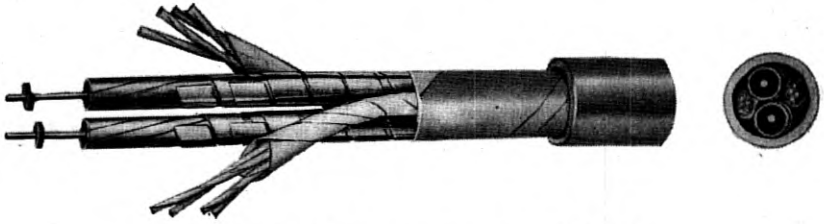

Fig. 1—View showing structure of coaxial cable.



Fig. 2—The New York terminal of the coaxial system.

The central conductor of the coaxial units is a 13-gauge copper wire insulated with hard rubber discs at intervals of $3/4$ inch. The outer conductor is made up of nine overlapping copper tapes which form a tube 0.02-inch thick; this is held together with a double wrapping of iron tape.

The transmission losses of this coaxial conductor at various frequencies are shown in Fig. 3. This attenuation is about 4 per cent higher than is calculated for a solid tube of the same dimensions and material. Another matter of importance is the shielding obtained from one conductor to the other or to outside interference. Inasmuch as the most severe requirement is that of crosstalk from one coaxial unit to another, this has been used as a criterion of design. Figure 4

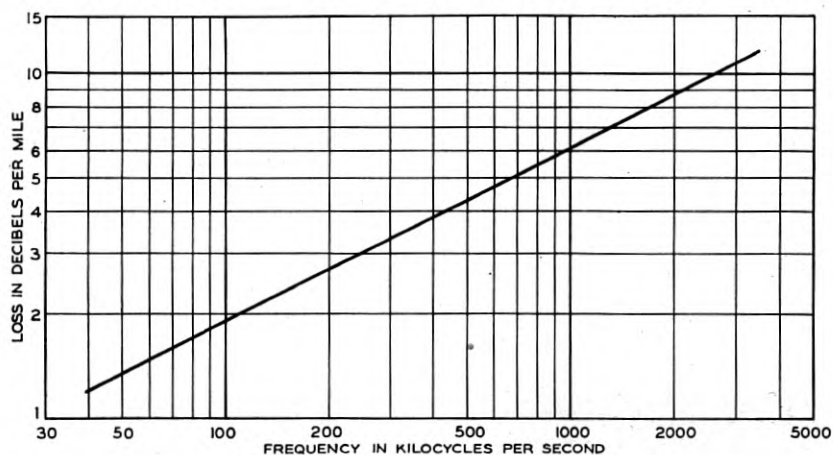

Fig. 3—Attenuation of the coaxial conductor.

shows the average measured high-frequency crosstalk in this particular cable on a 10-mile length without repeaters, both near-end and far-end.

REPEATERS

The amplifiers used in this system were designed for a 10.5-mile spacing and a frequency range of 60 to 1024 kc. A total of 10 complete two-way repeaters has been provided including those at the terminals. Two of the intermediate repeaters are at existing repeater stations along the route, the other six being at unattended locations along the line. Four of these are in existing manholes, while the other two are placed above ground for a test of such operation. Figure 5 shows a manhole repeater with the cover removed for routine replacement of vacuum tubes. Figure 6 shows one of the installations above ground.

The measured gain of a typical repeater is shown by the points on the curve of Fig. 7. The curve itself is the line loss that the repeater

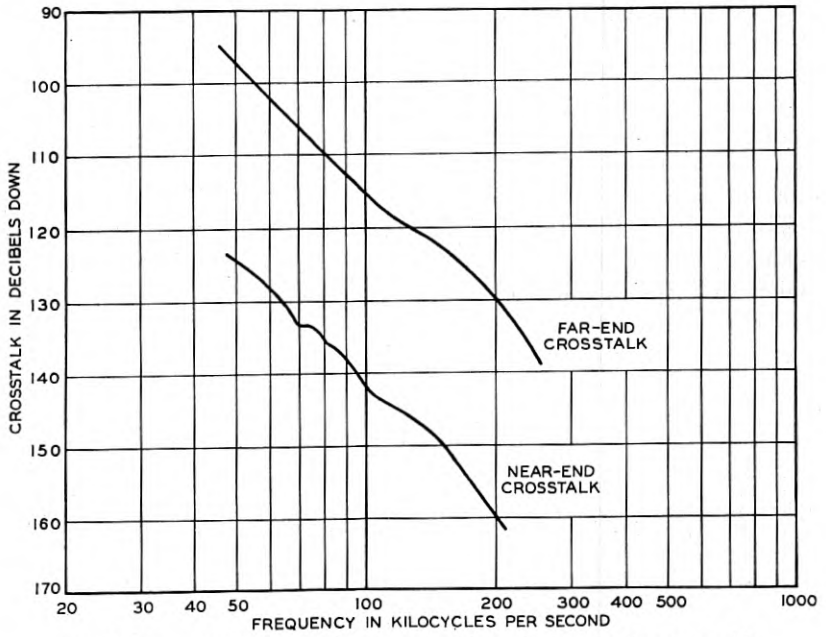

Fig. 4—Crosstalk between the two coaxial conductors in the new cable.



Fig. 5—Million-cycle repeater mounted in a manhole.

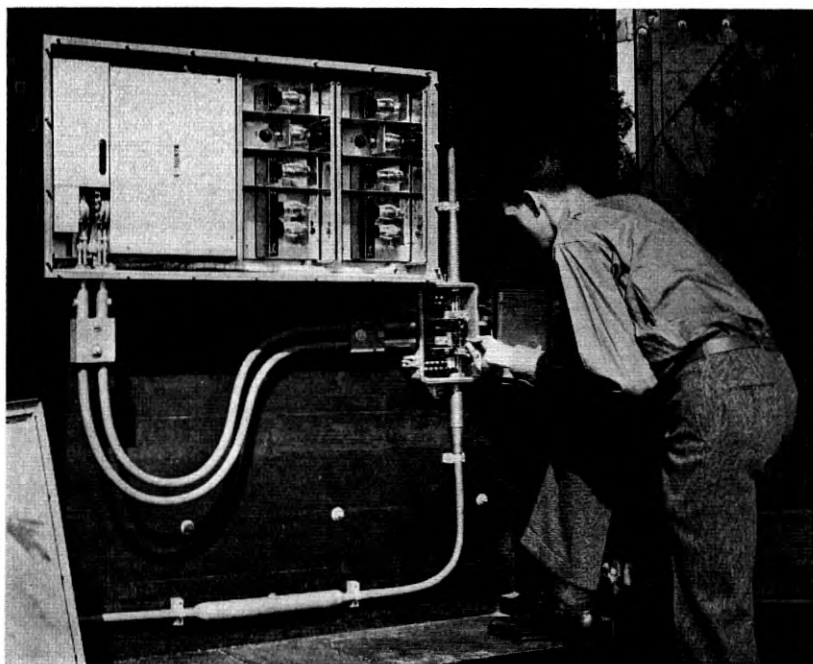

Fig. 6—Installation of coaxial repeater above ground.

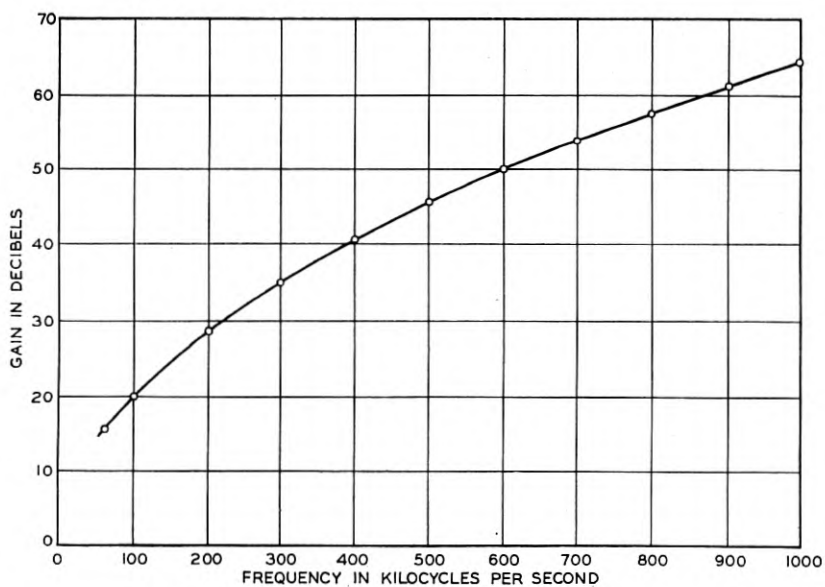

Fig. 7—Gain-frequency characteristic of coaxial repeater.

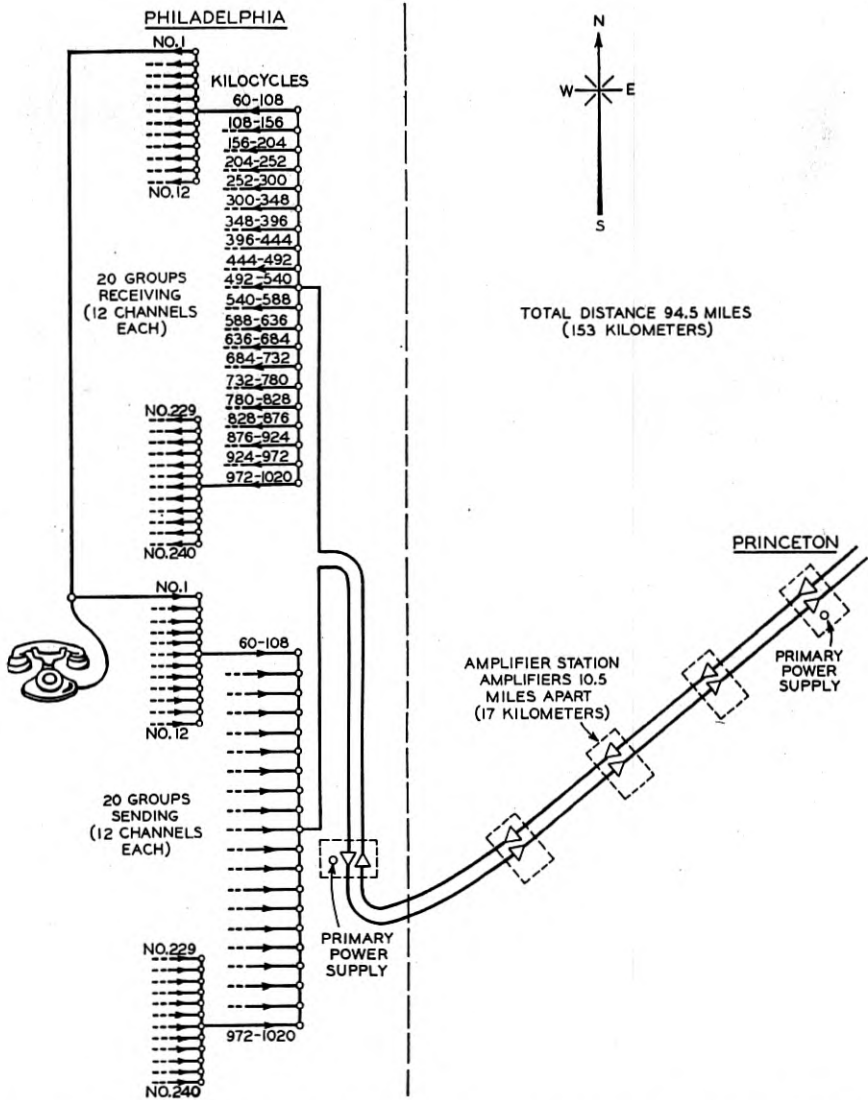

Fig. 8—Frequency characteristic allocation assignments of a typical speech channel. Broad-band system over coaxial cables (240 telephone circuits).—*Continued on page 7.*

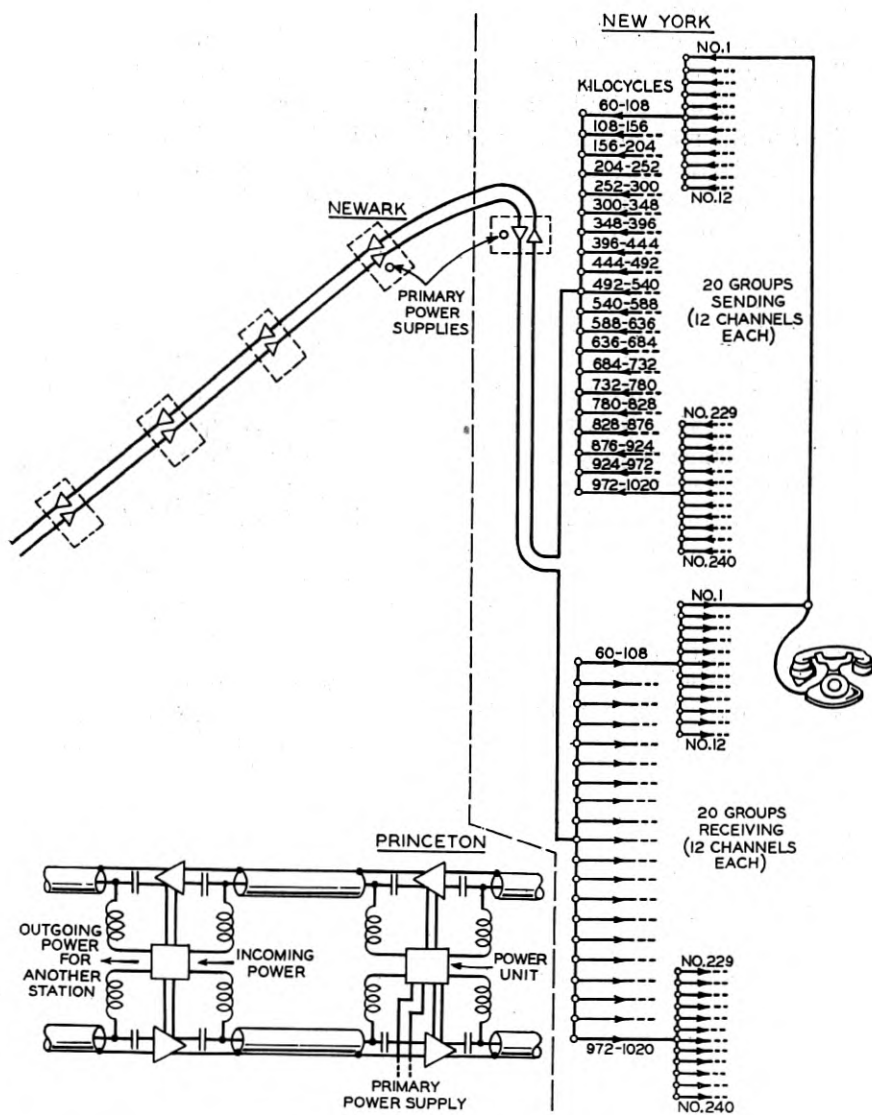

Fig. 8—Continued from page 6.

is designed to compensate. Three stages of pentodes are used with negative feedback² around the last two stages. Attenuation changes due to temperature of the line are compensated automatically by a pilot channel device which has been installed at every second or third repeater. The regulating mechanism uses four small tubes and is added to the normal repeater when desired. The amplifiers shown in Figs. 5 and 6 are regulating. As the cable is underground, the temperature changes are very slow and but meagre data on the accuracy of compensation are yet available.

TERMINALS

A schematic diagram of the terminal arrangements for a 240-channel million-cycle system is shown on Fig. 8. In this installation the New York and Philadelphia terminals have each been equipped to handle only 36 two-way telephone conversations. As has been pointed out, the scheme employed involves two steps of modulation, the first of which is used to set up a 12-channel group in the frequency range from 60 to 108 kc. Three such groups have been provided in this installation. In order to transmit at the higher frequencies, a second step of modulation is used in which an entire 12-channel group is moved to the desired frequency location by a "group" modulator. Six such group modulators have been provided at various frequencies throughout the range, including both the top and bottom. Patching facilities have been provided so that any 12-channel group may be transmitted over any one of the high-frequency paths. A typical frequency characteristic of one of the channels is shown in Fig. 9. It may be observed that relatively high quality has been obtained, due largely to the use of quartz crystal electric wave filters, even though the channels are spaced throughout the frequency range at 4000-cycle intervals.

PRELIMINARY TESTS

As already noted, various long circuits have been built up by looping back and forth through the coaxial system. One setup over which conversations were successfully carried out consisted of five voice-frequency links in tandem, each link being 760 miles long, giving a total circuit length of 3800 miles. This setup included, in each direction, seventy stages of modulation and the equivalent of 400 line amplifiers, the transmission passing twenty times through each one of the twenty one-way line amplifiers constituting the ten two-way repeaters.

² "Stabilized Feedback Amplifiers" by H. S. Black, *Bell Sys. Tech. Jour.*, January, 1934.

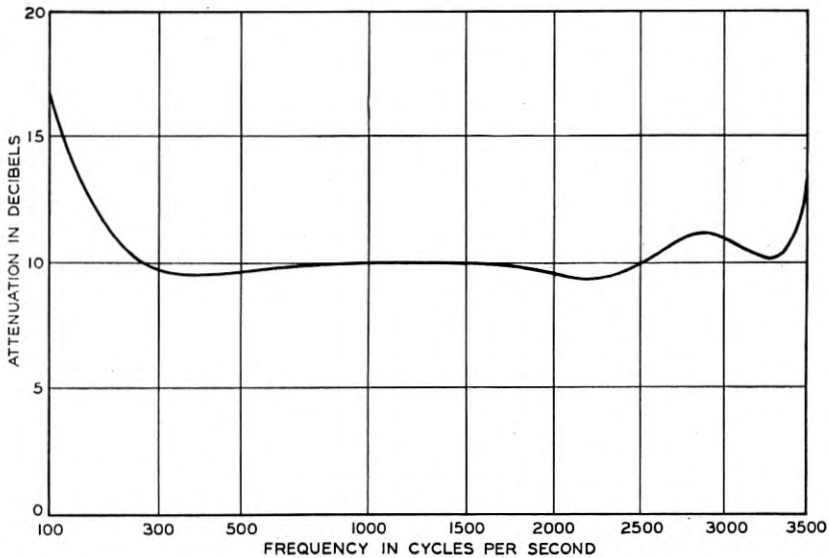

Fig. 9—Schematic diagram of a coaxial million-cycle system showing frequencies assigned to the different channels.

This demonstrated that the complete assemblage of parts, including filters which divide the frequency range into the required bands, modulators which produce the necessary frequency transformations, and amplifiers which counteract the line attenuation, introduced very little distortion. Many problems require further consideration, however, before these systems will be ready for design and production for general use. The final systems must have such refinement that they are suitable for transcontinental distances; the tremendous amplifications needed for such distances must have very precisely designed regulation systems, particularly where aerial construction is involved; noise and crosstalk must not accumulate over the long distances; the repeaters must have such stability and reliability that continuity of service will be assured with hundreds of repeaters operating in series and each repeater handling several hundred different communications simultaneously.

A Power Amplifier for Ultra-High Frequencies *

By A. L. SAMUEL and N. E. SOWERS

A consideration of the special problems encountered at ultra-high frequencies has led to the design of a push-pull power pentode, useful as an amplifier, frequency multiplier, and modulator at frequencies of 300 megacycles per second and below. Unusual construction features include the mounting of two pentodes in the same envelope with interconnected screen and suppressor grids, complete shielding between the input and output circuits with no common leads, and provision for cooling all grids while maintaining extremely small inter-electrode spacings. The electrical characteristics depart from the conventional mainly in the low value of lead inductances and the high value of the grid input resistance at ultra-high frequencies.

The second part of the paper describes a single stage amplifier unit built for testing the tube at frequencies between eighty and 300 megacycles, and the associated apparatus for measuring input impedance, gain, and harmonic distortion. The results given indicate that by using this new tube it is possible to construct stable amplifiers at ultra-high frequencies up to 300 megacycles, having gains of twelve to twenty-five decibels per stage and delivering several watts of useful power. Stability and distortion compare favorably with those obtained from conventional tubes at much lower frequencies.

PART I—THE VACUUM TUBE

By A. L. SAMUEL

WE ARE witnessing a rapid expansion and extension in the use of radio communication. A corresponding extension in the usable portion of the radio-frequency spectrum is highly desirable. With this in mind, special forms of vacuum tubes have already been developed for use as oscillators at frequencies above 100 megacycles.^{1, 2} Except at low power levels,³ amplifier tubes have not been available.

* Presented at Institute of Radio Engineers meeting, New York City, October 7, 1936. Published in *Proceedings I.R.E.*, November, 1936.

¹ M. J. Kelly and A. L. Samuel, "Vacuum Tubes as High-Frequency Oscillators," *Elec. Eng.*, vol. 53, pp. 1504-1517, November, 1934; *Bell Sys. Tech. Jour.*, vol. 14, pp. 97-134, January, 1935.

² C. E. Fay and A. L. Samuel, "Vacuum Tubes for Generating Frequencies Above One Hundred Megacycles," *Proc. I.R.E.*, vol. 23, pp. 199-212, March, 1935.

³ B. J. Thompson and G. M. Rose, "Vacuum Tubes of Small Dimensions for Use at Extremely High Frequencies," *Proc. I.R.E.*, vol. 21, pp. 1707-1721, December, 1933.

It is the purpose of this paper to discuss the problem of amplification at ultra-high frequencies and to describe one form of amplifier tube designed for moderate power in that frequency range.

THE TRIODE AS AN AMPLIFIER AT ULTRA-HIGH FREQUENCIES

A simple triode amplifier as used at low frequencies becomes unstable as the operating frequency is increased, exhibiting a tendency to oscillate or "sing" because of the interaction between the input and output circuits. This interaction or "feedback" is, in the main, produced by the grid-plate capacitance of the tube. It may be overcome either by the introduction of a compensating capacitance somewhere in the circuit or by the introduction of an electrostatic shield or screen within the tube envelope. The first expedient, known as neutralization, is employed in the case of a triode. The second expedient results in the screen-grid tetrode. At moderately high frequencies either arrangement may be used.

The conventional triode is unsatisfactory at very high frequencies. The usual capacitance neutralization scheme fails, partly because of the inductance of the tube leads which makes difficult the correct location of the neutralizing capacitance. The appreciable time required for the electrons to traverse the interelectrode spaces within the tube structure makes neutralization more difficult by introducing a shift in the phase of the necessary compensation.

A more serious effect of electron transit time is the marked increase at high frequencies in the input conductance of a tube over the value observed at low frequencies. This effect has been the subject of considerable study.^{4, 5, 6, 7} Theory and experiment both agree in relating the input conductance loss to the tube geometry and the applied electrode potentials. The conductance depends upon the electron transit time and increases rapidly with increasing frequency. The transit time may be reduced either by decreasing the electron paths or by increasing the electron velocities. Decreasing the path calls for smaller interelectrode spacings, and increasing the velocity calls for higher electrode potentials. On the other hand, practical considerations limit both the dimensions and the potentials. An optimum design may utilize special mechanical arrangements to combine both expedients.

⁴ J. G. Chaffee, "The Determination of Dielectric Properties at Very High Frequencies," *Proc. I.R.E.*, vol. 22, pp. 1009-1020, August, 1934.

⁵ F. B. Llewellyn, "Operation of Ultra-High-Frequency Vacuum Tubes," *Bell Sys. Tech. Jour.*, vol. 14, pp. 632-665, October, 1935.

⁶ W. R. Ferris, "Input Resistance of Vacuum Tubes as Ultra-High-Frequency Amplifiers," *Proc. I.R.E.*, vol. 24, pp. 82-104, January, 1936.

⁷ D. O. North, "Analysis of the Effects of Space Charge on Grid Impedance," *Proc. I.R.E.*, vol. 24, pp. 108-136, January, 1936.

The electron transit time limitation becomes of particular importance at frequencies above one hundred megacycles and sets an upper frequency limit on the useful operation of the usual triode as an amplifier just as it sets the limit at which the tube will operate as an oscillator. Because of the similarity in the special high-frequency requirements, negative grid tubes designed for use primarily as ultra-high-frequency oscillators are good amplifiers at somewhat lower frequencies. The necessity for very careful circuit design and for critical adjustment of the neutralization becomes particularly pronounced when triodes are used as ultra-high-frequency amplifiers.

THE MULTI-ELEMENT TUBE AS AN AMPLIFIER AT ULTRA-HIGH FREQUENCIES

Conventional screen-grid tetrodes and pentodes are also unsatisfactory at very high frequencies. Two factors are again primarily responsible, the one set by the circuit requirements, the other set by the electron transit time. These limitations will be considered in detail.

In the usual radio-frequency amplifiers using tetrodes or pentodes the input and output circuits are tuned to the desired frequency. For most practical purposes the upper limit to the frequency for which these circuits may be tuned is set by the natural period of the circuits formed by the corresponding lead inductances and interelectrode capacitances. Even before this limit is reached the major portions of the tuned circuits are within the tube envelope. Their inaccessibility makes it difficult to obtain effective coupling between amplifier stages.

Interaction between the input and output circuits if excessive may cause "singing." Such interaction is usually due to the residual value of the grid-plate capacitance. Not only must this capacitance be made very low by the proper design of the screen and suppressor grids, but its effective value must remain low at the operating frequency. This latter is realizable only if the screen and suppressor grids can be coupled to the cathode by leads having extremely small inductances. A further desirable feature is that there be no appreciable circuit impedance in the form of lead inductance common to both input and output circuits. The use of short leads is thus seen to be just as important in the design and use of the multi-element tube as it is in the design of the triode.

As in the case of the triode, the electron transit time is effective in limiting the useful frequency range of the multi-element tube. The increase in the input conductance which it introduces is again primarily responsible.

In considering the design of an amplifier tube for ultra-high frequencies, it appeared desirable to select frequency and power levels

such that a break from conventional design was inevitable, leaving for future work the satisfactory coverage of the transition region. Since triodes had already been studied as oscillators it was decided to design and construct a pentode. A tentative rating of fifteen watts anode dissipation (per tube) with an operating range up to 300 megacycles was chosen. It was further thought desirable to limit the sum of the grid-to-ground and plate-to-ground capacitances to a value less than eight micromicrofarads in order to facilitate the design of the accompanying circuits.

Preliminary considerations led to the conclusion that the desired results could be best obtained by push-pull operation. In view of the required shortness of leads it seemed logical, if not essential, to inclose both sets of tube elements within one envelope and to provide an internal by-pass condenser between the screen and suppressor grids. It also appeared desirable to design the structure so that a simple extension of the screen-grid element would form a partition separating the input portion of the tube from the output portion. By mounting the tube so that the internal partition forms a continuation of the external partition separating the input and output circuits, quite adequate shielding should be possible. From previous experience, it was concluded that the special frequency requirements for a 300-megacycle amplifying tube would be satisfied by a design patterned after a 600-megacycle oscillator tube.²

To summarize, the following construction features were considered desirable:

- (1) The mounting of two sets of elements in the same envelope.
- (2) A method of interconnecting the two screen grids by a low impedance conductor.
- (3) A method of grounding the screen and suppressor grids inside the tube envelope.
- (4) Complete shielding between input and output sides of the tube.
- (5) The use of extremely short leads.
- (6) Means for maintaining very small spacings between the elements.
- (7) Provision for adequate cooling of all grids.
- (8) Adequate insulation paths to permit a high anode potential.
- (9) The absence of any leads common to both input and output circuits.

The first of the experimental tubes designed to have a fifteen-watt dissipation per anode is shown in Fig. 1. It will be noted that a partition divides the envelope into two parts. This partition is in reality double, being made up of two sheets, one being connected to the sup-

pressor grids and the mid-point of the filament circuit and the other being connected to the screen grids. Slots in these sheets provide space to mount the tube elements. The capacitance between the two closely

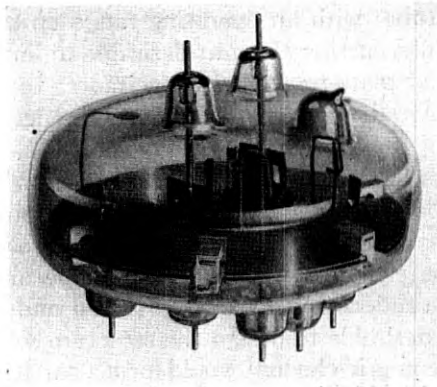

Fig. 1—An early experimental type tube.

spaced sheets forms an effective radio-frequency by-pass condenser between the screen grids and the filaments. Fig. 2 is a section view

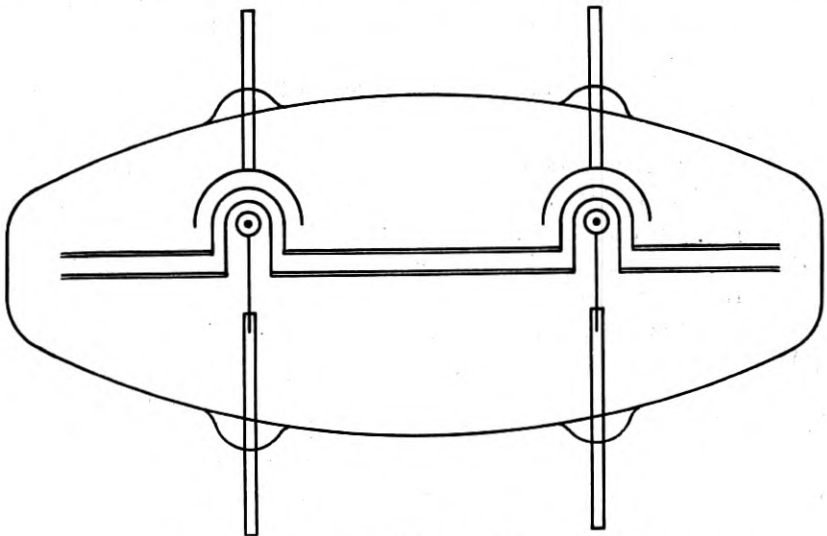

Fig. 2—Section view of the tube shown in Fig. 1.

through the middle of the tube showing the disposition of the elements. While entirely satisfactory from an operating viewpoint, this design proved to be rather difficult to fabricate.

THE ULTRA-HIGH-FREQUENCY DOUBLE PENTODE TUBE

The successful operation of the experimental models described above indicated the desirability of continuing this line of attack. A complete mechanical redesign to facilitate the fabrication and pumping was undertaken. Fig. 3 is a photograph of this design. Section views are shown in Fig. 4. The large capacitance between the screen and suppressor which characterized previous models was retained in the form of concentric cylinders instead of parallel plates. These cylinders and the flange at one end effectively shield the input and output sides of the tube. The low impedance connection between the two screens provided by these cylinders is an important feature of the design. Adequate cooling of the screen grid is provided by mounting it directly

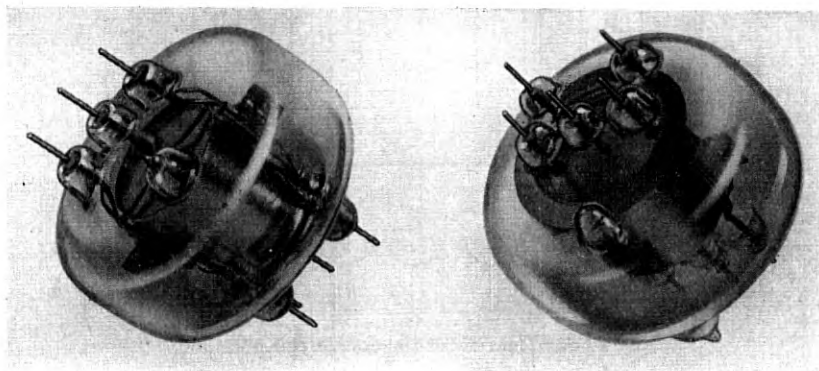

Fig. 3—The ultra-high-frequency double pentode vacuum tube.

in a slot in one of the cylinders. The control grids are of the so-called fin type of construction already employed with considerable success in triode oscillators. They consist of a series of tungsten loops attached to a common cooling fin. This construction makes feasible the use of extremely small dimensions, so that the grid-filament spacing is comparable with the filament diameter. One of these grids is illustrated in Fig. 5. The length of leads has been kept as small as is consistent with mechanical requirements. The longest lead, measured from the mid-point of its attached element to the outside of the envelope, is about three centimeters. Other details of the design are evident from the photograph and the diagram.

Operating characteristics and constants are listed in Table I.

Special attention is directed to the values of interelectrode capacitances and lead inductances. It will be observed that while the inter-

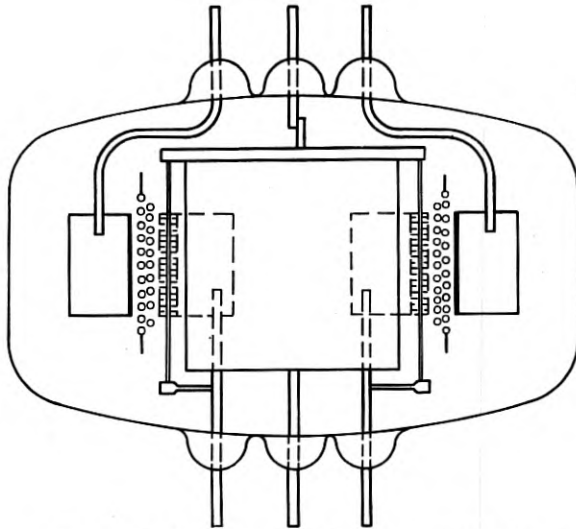
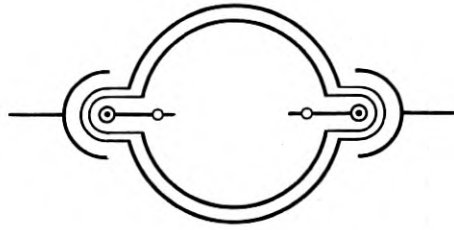

Fig. 4—Section view of the double pentode tube.

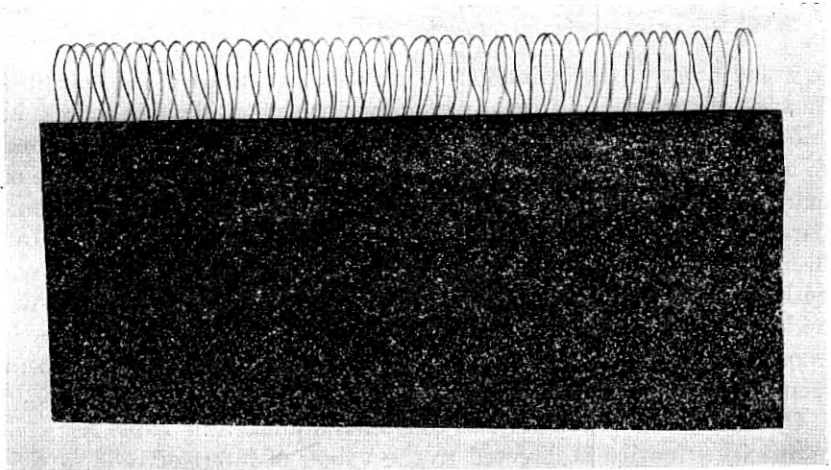

Fig. 5—One of the control grids used in the double pentode tube.

TABLE I

OPERATING CHARACTERISTICS AND CONSTANTS OF THE DOUBLE PENTODE TUBE

Filament current (each side).....	5.0 amperes
Filament potential (each side).....	1.5 volts
Rated anode dissipation (each anode).....	15 watts
Rated screen dissipation (each side).....	5 watts
<i>At anode and screen potentials of 500 volts and anode current of 0.030 ampere—characteristics of each side</i>	
Transconductance.....	1250 micromhos
Anode resistance.....	200,000 ohms
Normal control grid potential.....	-45 volts
<i>Interelectrode capacitances (when properly mounted)</i>	
Direct control grid to control grid.....	0.02 micromicrofarad
Direct plate to plate.....	0.06 micromicrofarad
Total control grid to ground (each side).....	3.8 micromicrofarads
Total plate to ground (each side).....	3.0 micromicrofarads
Control grid to plate (each side).....	0.01 micromicrofarad
<i>Lead inductances</i>	
Total grid to grid.....	0.07 microhenry
Total plate to plate.....	0.08 microhenry
<i>Rating as class A amplifier</i>	
Maximum direct plate potential.....	500 volts
Maximum direct screen potential.....	500 volts
Maximum continuous plate dissipation (each).....	15 watts
Maximum continuous screen dissipation (total).....	10 watts
Maximum output at 150 megacycles with distortion down 40 decibels.....	1 watt
Nominal stage gain at 150 megacycles.....	20 decibels
Nominal control grid potential.....	-45 volts
<i>Rating as class B amplifier</i>	
Maximum direct plate potential.....	500 volts
Maximum direct screen potential.....	500 volts
Maximum space current (total).....	150 milliamperes
Maximum continuous plate dissipation (each).....	15 watts
Maximum continuous screen dissipation (total).....	10 watts
Maximum output at 150 megacycles.....	10 watts

electrode capacitances are low they have not been reduced in proportion to the reduction in operating wave length. The more important feature is the reduction of the lead inductances. Tabulation of the value of these inductances represents a departure from the conventional practice and is made desirable by their relative importance.

A feature of the design not directly measurable under actual operating conditions but nevertheless responsible for some of the improvement over the more conventional designs is the reduction of an auxiliary dielectric material and the attending dielectric losses that occur at ultra-high frequencies.

The usual static characteristics given in Figs. 6 and 7 are seen to resemble those of the conventional pentode. For a tube which is to be used at ultra-high frequencies, certain other characteristics have a much greater significance. One of the most important of these is the

active grid loss which as already mentioned comes about because of the appreciable electron transit time. Fig. 8 gives a plot of the push-pull input shunting resistance of this tube as a function of frequency. The

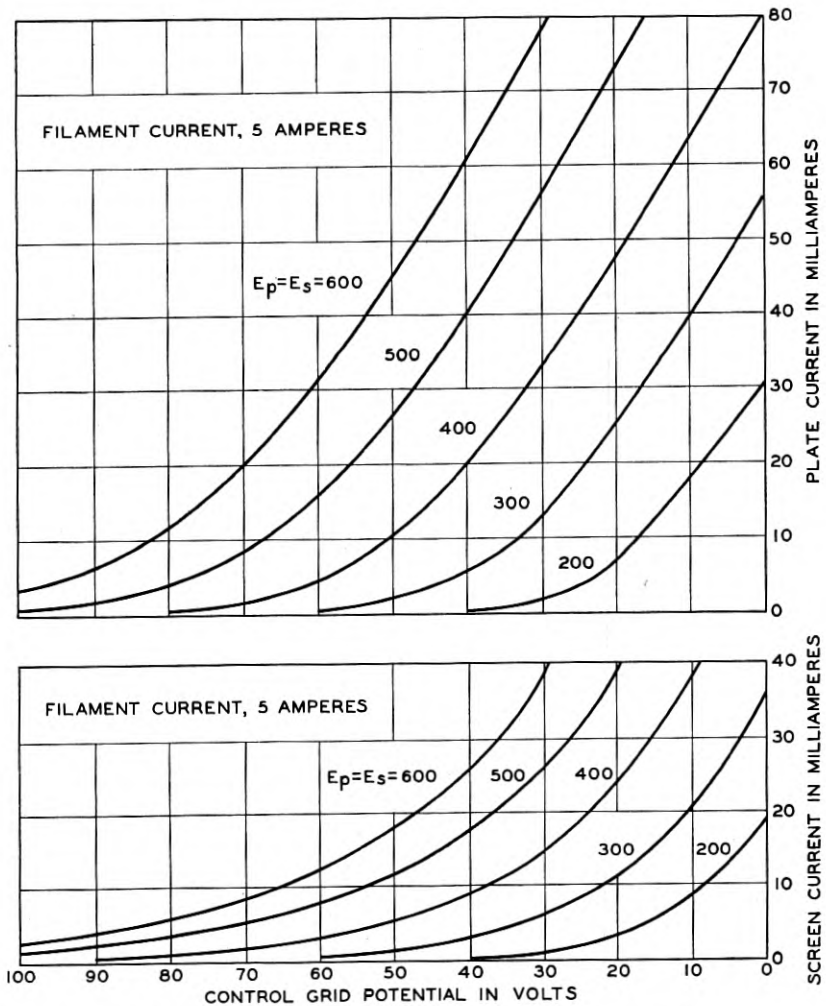

Fig. 6—Mutual characteristics of the double pentode tube.

value of 30,000 ohms at 150 megacycles is to be compared with 2000 ohms, a typical value for two conventional tubes in push-pull. At 300 megacycles the input resistance of the twin pentode is still above 5000 ohms while for conventional tubes it is so low as to make them com-

pletely inoperative. The variation in the input resistance with the operating conditions of the tube for a constant frequency of 150 megacycles is shown in Fig. 9. It is evident that if a high value of input resistance is to be realized, high anode potentials with low space cur-

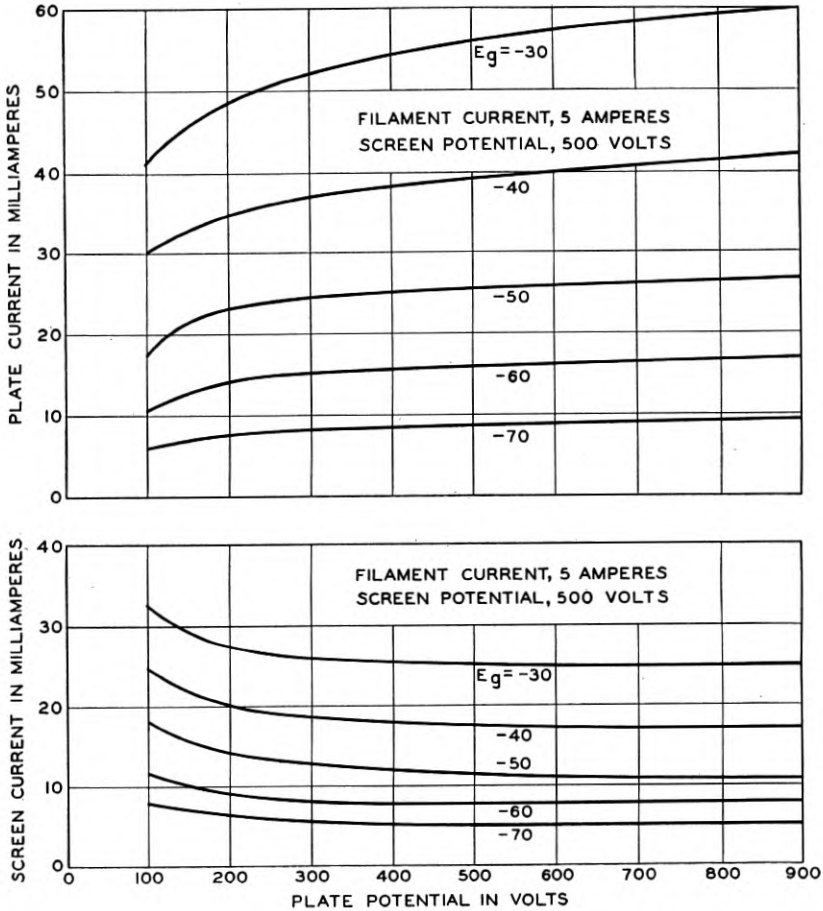

Fig. 7—Anode characteristics of the double pentode tube.

rents must be used. The reduction in the filament grid spacing made possible by the unusual construction is in a large measure responsible for the improvement in the input resistance just noted.

A characteristic measurable only at the operating frequency is the interaction between the input and output circuits which results from

the residual value of the grid-plate capacitance. This reaction differs from that predicted from the low-frequency capacitance measured on a cold tube because of the inductance of the screen-grid lead and because of the electron space charge. The reaction can be measured by observing the variation in the input impedance resulting from a variation in the tuning and loading of the output circuit. Experimentally determined values are given in Fig. 10.

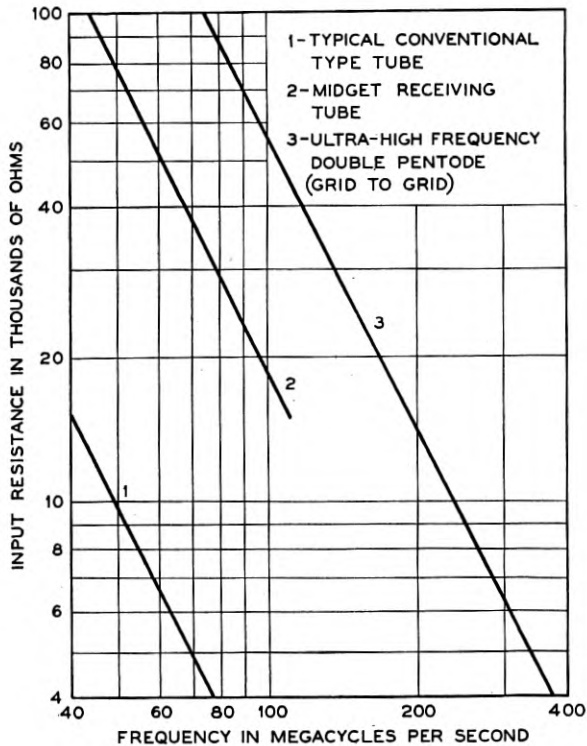

Fig. 8—The input resistance as a function of frequency.

The double pentode tube has been found useful as a high quality class A amplifier, a class B amplifier, a frequency multiplier, and as a modulator at frequencies of 300 megacycles per second and below. Its performance in these various modes of operation is quite comparable to the performance of conventional pentodes of similar ratings at much lower frequencies. Stable operation with some gain has been obtained at frequencies as high as 500 megacycles. Because of the increased im-

portance at ultra-high frequencies of circuit design in the over-all performance of an amplifier or modulator, such tests cannot be considered as a definite measure of the capabilities and limitations of the tube but they indicate what has already been accomplished.

When operating as a class A amplifier at 150 megacycles an output of one watt is obtained with the distortion forty decibels below the fun-

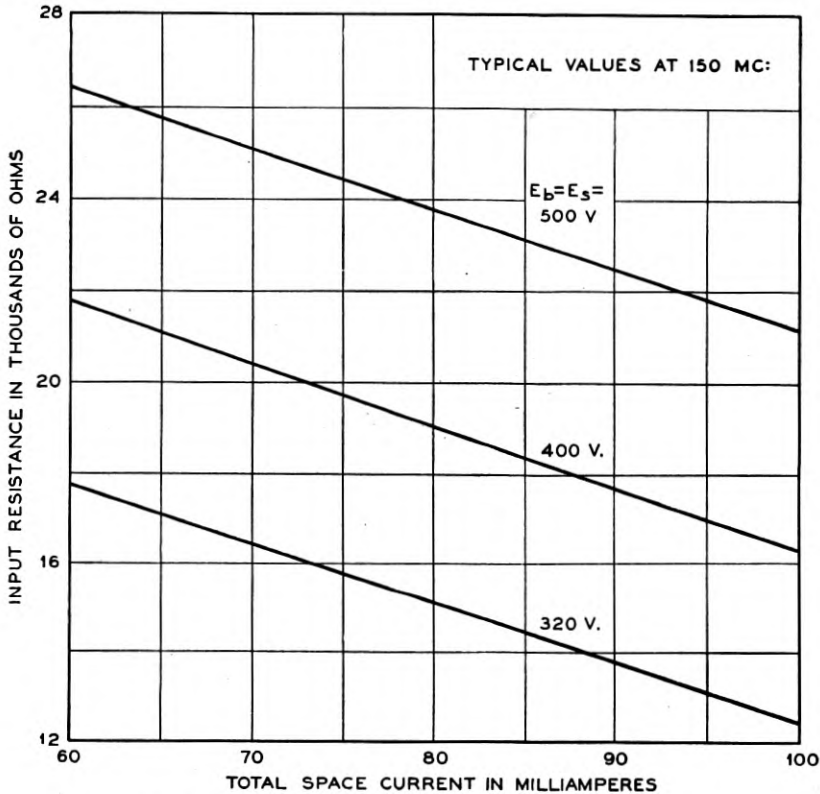

Fig. 9—The variation in input resistance with operating conditions at 150 megacycles.

damental. Under these conditions the stage gain is twenty decibels. Outputs of ten watts with a plate efficiency of sixty to seventy per cent and a gain of ten decibels are secured with class B operation. Experimental results confirming these statements together with a discussion of the principles of circuit design and the technique of measurements are given in the accompanying paper by N. E. Sowers.

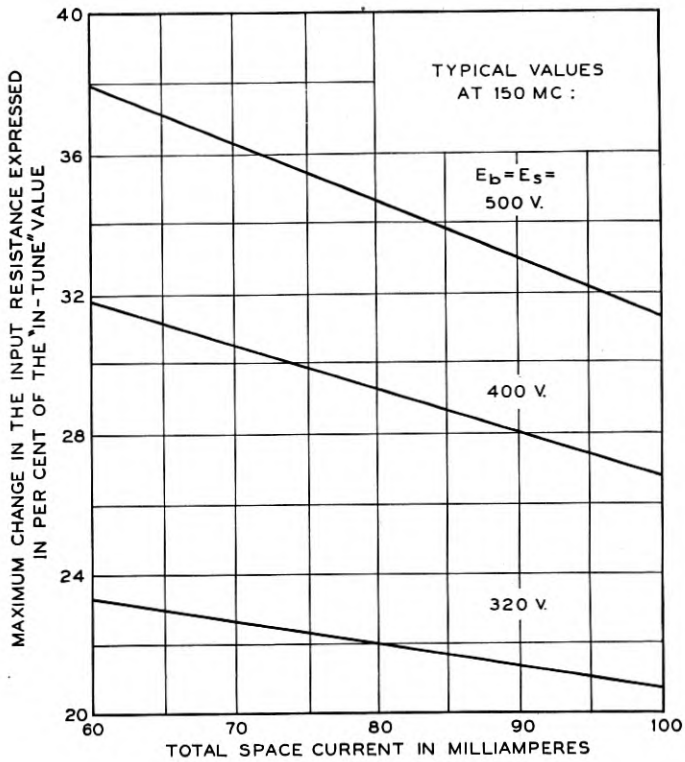

Fig. 10—The input-output reaction at 150 megacycles.

CONCLUSION

The development of this ultra-high-frequency pentode demonstrates that amplifier tubes of the negative grid type are usable at higher power levels and frequencies than have been reported previously. The extension of the principles underlying the design of this tube to the design of a tube with approximately ten times the output is now being considered. This type of development removes a practical barrier which has, up to the present, prevented the successful utilization of this frequency range.

PART II—THE CIRCUIT

By N. E. SOWERS

INTRODUCTION

In the first section of this paper A. L. Samuel has described the development of a push-pull pentode designed to function as a stable

amplifier at frequencies up to at least 300 megacycles. It is the purpose of the present section to describe the methods and apparatus used in testing this tube and to set forth the results of some of the tests.

An attempt to study the operating characteristics of an amplifier tube at ultra-high frequencies brings up many new problems. Such fundamental properties of the tube as amplification factor, transconductance, and plate impedance do not convey as much information about the behavior of the tube at these frequencies as they do at lower frequencies. The presence of unavoidable stray inductances and capacities makes it much more difficult to separate tube problems from circuit problems. Consequently, at ultra-high frequencies we are virtually forced to consider the tube and its associated circuits as comprising a single piece of apparatus. If the circuit design is carefully made the stray inductances and capacitances can be greatly reduced in magnitude and so localized that their effects upon the over-all performance of such a piece of apparatus can, to a certain extent, be computed.

CIRCUIT DESIGN

Some idea of the extreme attention to detail required in designing amplifier circuits for use at ultra-high frequencies may be gained from the following considerations. Computations indicate that even with the tuned plate and grid circuits placed as close as physically possible to one of these push-pull pentodes, at 300 megacycles, the radio-frequency voltage actually applied to the grids of the tube may be as much as twenty-five per cent greater than the voltage developed across the tuned grid circuit. At the same time the load presented to the tube plates may be as much as twice the load actually present across the tuned plate circuit. These discrepancies are a direct result of the inductance of grid and plate leads which, in the case of this new tube, have already been reduced well nigh to the minimum possible.

In studying the performance of these tubes we wished to be able to check experimental results against theory at every possible point. Consequently the simplest auxiliary circuits were chosen, namely, shunt-tuned antiresonant circuits from grid to grid and from plate to plate, with screens and filaments by-passed as directly as possible to ground. In their mechanical design these circuits embody a number of features intended to reduce and localize stray inductances and capacities, into the details of which it is not possible to go at present. A simple arrangement was evolved to provide a maximum of convenience and flexibility for experimental work. The single stage amplifier unit consists of three sections, an input circuit section, a tube housing section, and an output circuit section. This arrangement permits

tubes to be changed with a minimum of disturbance to the circuits. During experimental work it is almost inevitable that circumstances will arise calling for major changes in the nature of the circuits, or the size, shape, and lead arrangement of the tubes. This sectional construction provides the necessary flexibility to take care of such needs, as the construction and substitution of appropriate new sections would permit the experimental work to proceed with a minimum of delay. To facilitate the operation of several units in tandem for tests on a multistage amplifier, each section is provided with its own power supply jacks so that the only longitudinal connections required

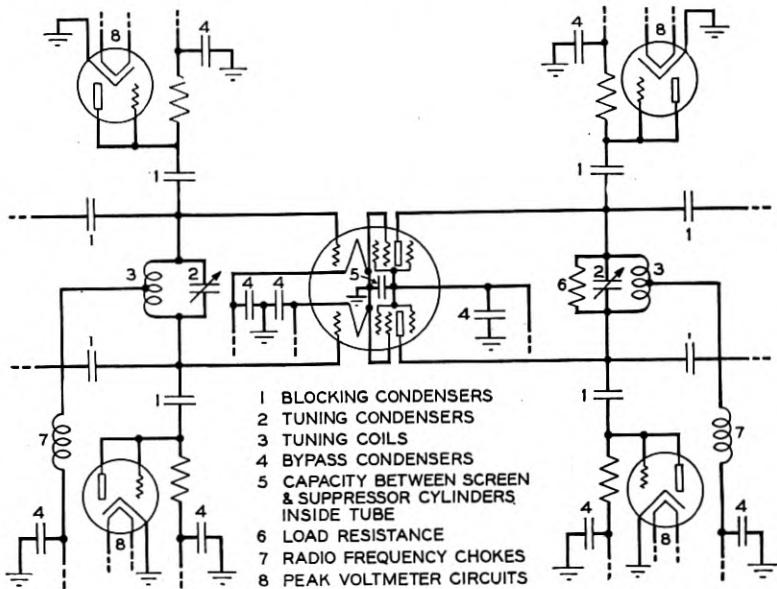

Fig. 11—Circuit diagram of single stage test amplifier.

within the sections are those between tube leads and the circuits. These connections are so arranged as to be very easily broken when sections are to be separated. Each circuit section has built into it a pair of peak voltmeters for indicating the radio-frequency voltage developed across the tuned circuit. These voltmeters consist of RCA type 955 tubes used as diode rectifiers in the familiar self-biased peak voltmeter circuit. Fig. 11 shows the circuit in schematic form. Fig. 12 shows an experimental two-stage amplifier constructed in substantially the same fashion as the test circuit, but without the sectionalizing feature.

The desire to reduce the length of all leads to a minimum has naturally resulted in bringing the tuned circuits rather close to the sides of the circuit housings. Nevertheless care and attention to

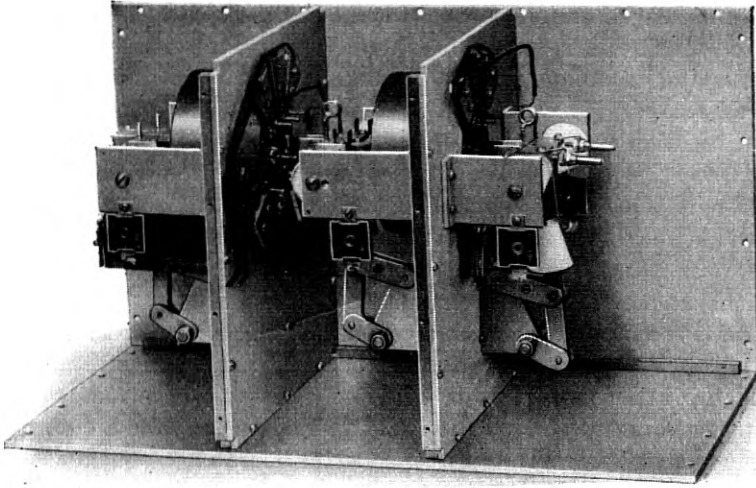

Fig. 12—An experimental two-stage one-meter amplifier using two of the earlier type push-pull pentode tubes.

detail in the circuit design have enabled the stray capacities to be kept down to satisfactory values. Fig. 13 shows in schematic form one of

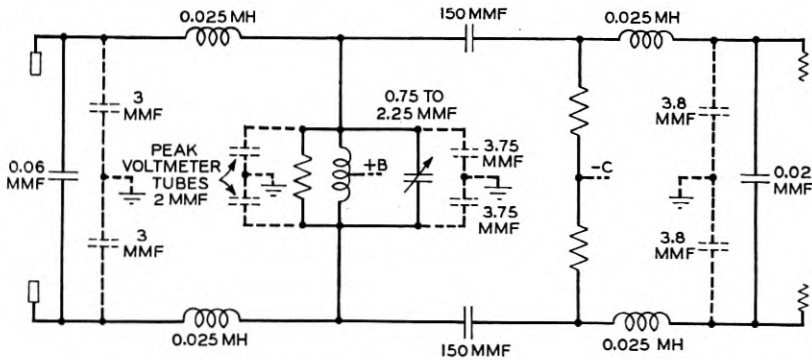

Fig. 13—Diagram of interstage circuit.

these circuits employed as the interstage circuit between two of these push-pull pentodes, all of the important inductances and capacities being included.

INPUT IMPEDANCE MEASUREMENT

One of the factors which effectually limits the performance of a vacuum tube at ultra-high frequencies is the internal grid resistance or active grid loss. Consequently, this factor is of extreme interest in the development of amplifier tubes for use in the ultra-high-frequency range and much of this work has centered around the development of apparatus and technique for rapidly and accurately measuring these input resistances. The method employed has been the simple resistance substitution method used by Crawford.⁸

An adjustable quarter-wave Lecher frame is provided with suitable means for inducing a radio-frequency voltage across it and a suitable detector for indicating the current flowing at the short-circuited end. A calibration is made by noting the detector indication corresponding to various known resistances connected across the open end of the frame, with the input voltage held constant. The input circuit of the tube under test is then connected to the end of the Lecher frame in place of the calibrating resistors and the detector indications corresponding to various voltages and loads applied to the tube are noted. Since the Lecher frame is initially tuned to the operating frequency, and when the tube input circuit is attached the circuit itself is retuned for resonance, it follows that the quantity actually measured is the effective resistance across the tuned circuit, including both the circuit losses and the active grid loss of the tube. It is of course possible to determine the circuit losses separately and to compute the contribution to the total resistance offered by the tube losses, and also to compute the active grid loss existing directly at the grids of the tube, taking into account the impedance transformation existing between the tube grids and the tuned circuit, brought about by the lead inductances. Practically, however, the total effective shunt resistance across the tuned circuit as actually measured is a more significant quantity, as this quantity determines more or less directly the gain which can be obtained from a multistage amplifier. It frequently happens that changes in the voltages applied to the tube produce small changes in the reactive component of the input impedance. These may be taken into account by noting the changes in grid circuit tuning required to maintain resonance. These changes are usually so small as to be of only minor interest.

The Lecher frame used in these measurements is shown in Fig. 14. The plate bridging the frame nearest the open end carries the detector, an RCA type 955 tube set into the plate. The grid of this tube is

⁸ A. B. Crawford, "Input Impedance of Vacuum Tube Detectors at Ultra-Short Waves" (Abstract), *Proc. I.R.E.*, vol. 22, pp. 684-685, June, 1934.

coupled to the frame by means of a small rectangular single turn loop mounted just beneath and quite close to the bars at the short-circuited end. The second plate bridging the bars, in conjunction with the electrostatic screen between the bars and the input coupling coil, aids in

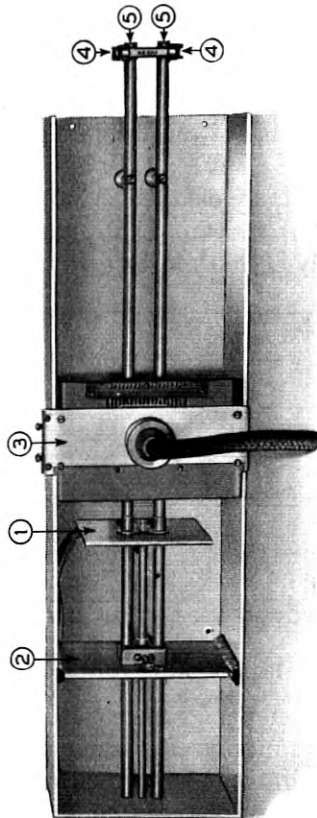

Fig. 14—Photograph of impedance measuring Lecher frame.

1. Short-circuiting bridge carrying detector tube and detector coupling coil.
2. Auxiliary bridge for breaking up unbalance currents flowing on the frame.
3. Input circuit. Note electrostatic screen between frame and input coil mounted on end of flexible transmission line leading to driving oscillator.
4. Clips carrying calibrating resistors.
5. Jacks into which plugs on amplifier input circuit fit.

eliminating any unbalance of the currents flowing in the two sides of the frame. The aluminum trough surrounding the frame provides sufficient shielding to render the apparatus virtually immune to the operator's body capacity effects. The whole resistance measuring

setup is remarkably stable and satisfactory to operate. Resistance measurements on a given tube at specified operating points can be repeated with a precision of two or three per cent even when weeks elapse between measurements.

In addition to being a function of frequency, the input resistance of one of these tubes is also a function of all of the operating conditions, that is, applied voltages, plate circuit tuning, and load. In Table II are shown values of this input resistance for a typical tube at several frequencies and over a considerable range of operating conditions. Because of the large number of variables which affect this input resistance it is difficult to devise any way of plotting up these data so as to give a comprehensive picture of tube performance.

The variation of input resistance with plate circuit tuning has, for this design, consistently been of the form illustrated in Fig. 15. How-

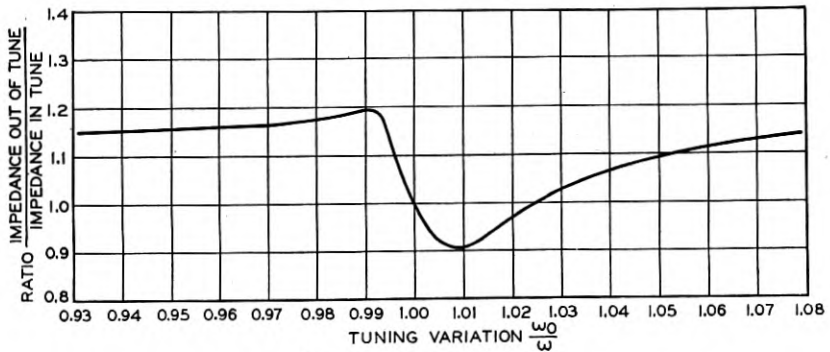

Fig. 15—Reaction curve.

ever, the relations between maximum, minimum, and "in-tune" values vary somewhat with frequency, operating conditions, and plate load. Also, as may be expected, they vary somewhat in different tubes which have been made up with various grid and screen spacing, etc. A convenient numerical measure of the magnitude of this reaction is obtained by taking the difference between the maximum and minimum values at any specified operating point and dividing this difference by the "in-tune" value. This reaction ratio will also be found listed in Table II for various operating conditions.

GAIN MEASUREMENTS

The measurement of the voltage gain of an amplifier stage containing one of these tubes is a relatively simple matter. As stated in the description of the circuit, provision is made for connecting a peak voltmeter directly to each tuning condenser plate in both plate and

TABLE II
 INPUT RESISTANCE AND REACTION RATIO AS A FUNCTION OF FREQUENCY AND APPLIED VOLTAGES AND CURRENTS
 PLATE CIRCUIT LOAD 15,000 OHMS

	$f = 150$ megacycles			$f = 200$ megacycles			$f = 250$ megacycles			$f = 300$ megacycles		
	64	80	100	64	80	100	64	80	100	64	80	100
$I_P + I_S$ mils	17200	15050	13500	9900	8650	7750	6600	5800	5200	4900	4300	3850
$E_P = E_S$ { = 320 volts { reaction ratio	0.230	0.220	0.207	0.197	0.185	0.174	0.159	0.147	0.144	0.133	0.128	0.177
$E_P = E_S$ { = 400 volts { reaction ratio	21100	19050	16250	12150	10950	9350	8150	7350	6250	6000	5450	4600
	0.311	0.289	0.271	0.267	0.251	0.241	0.227	0.211	0.192	0.175	0.174	0.163
$E_P = E_S$ { = 500 volts { reaction ratio	26000	23700	21300	14950	13600	12250	10000	9150	8250	7400	6750	6050
	0.373	0.346	0.314	0.324	0.298	0.273	0.270	0.257	0.232	0.216	0.207	0.190

$$\text{Reaction Ratio} = \frac{\text{(maximum resistance—minimum resistance)}}{\text{resistance with plate circuit in tune}}$$

grid circuits so that the applied grid drive and developed plate voltages may be read directly. Of course, the gain figure arrived at in this manner is an over-all factor, a function both of tube conditions and circuit construction and loading. Nevertheless, it is a satisfactory figure of merit for the stage. In Table III are shown these gain figures for a typical tube under various conditions.

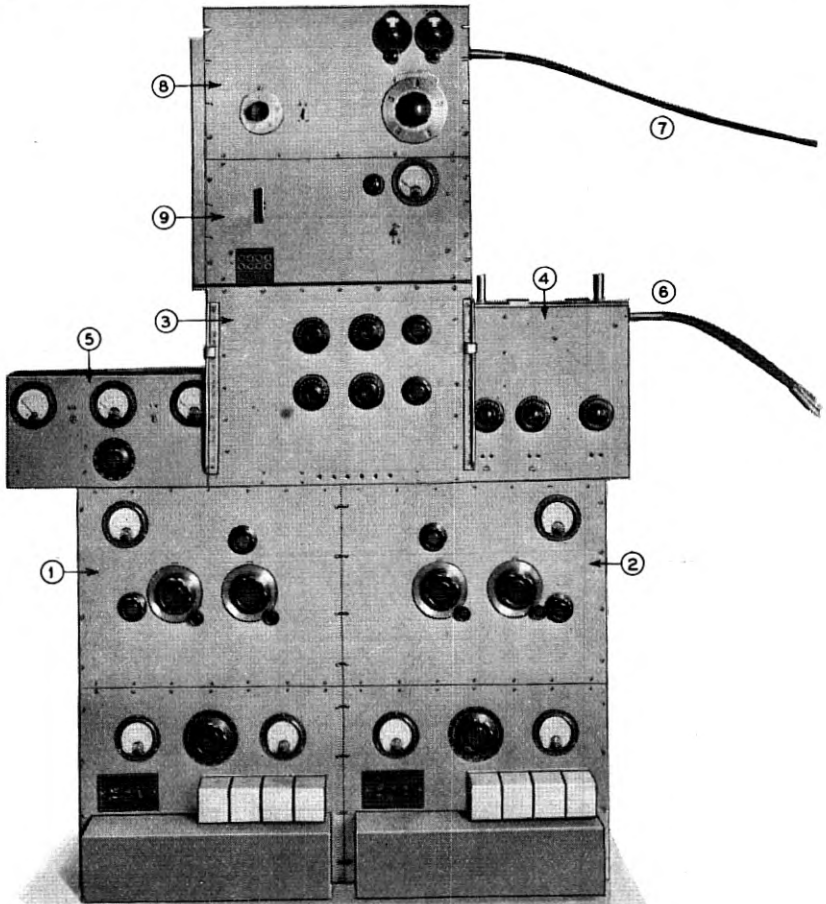

Fig. 16—Distortion measuring equipment.

Nos. 1 and 2—Signal oscillators.

3—Capacitance bridge.

4—Auxiliary amplifier.

5—Power supply unit for auxiliary amplifier.

6—Transmission lines to tube under test.

7—Transmission line from tube under test to radio receiver.

8—Beating oscillator, first detector and attenuator.

9—Intermediate amplifier and second detector of receiver.

TABLE III
STAGE GAIN IN DECIBELS AS A FUNCTION OF CURRENT, VOLTAGE, PLATE CIRCUIT LOAD, AND FREQUENCY

$I_P + I_S$	Mils Plate Cct. Load, Ohms	$f = 150$ megacycles			$f = 200$ megacycles			$f = 250$ megacycles			$f = 300$ megacycles		
		64	80	100	64	80	100	64	80	100	64	80	100
$E_P = E_S$ = 320 volts	unloaded*	25.2	26.1	26.5	23.6	24.5	24.9	23.0	23.9	24.3	23.1	24.0	24.3
	15000†	18.2	19.1	19.5	17.7	18.6	19.0	18.0	18.9	19.3	18.7	19.6	20.0
	5000†	11.8	12.7	13.1	11.6	12.5	12.9	12.5	13.4	13.8	13.6	14.5	14.9
$E_P = E_S$ = 400 volts	unloaded*	24.6	25.5	25.6	23.0	23.9	24.0	22.4	23.3	23.4	22.5	23.4	23.5
	15000†	17.6	18.5	18.6	17.1	18.0	18.1	17.4	18.3	18.4	18.1	19.0	19.1
	5000†	11.2	12.1	12.2	11.0	11.9	12.0	11.9	12.8	12.9	13.0	13.9	14.0
$E_P = E_S$ = 500 volts	unloaded*	23.9	24.7	25.2	22.3	23.1	23.6	21.7	22.5	23.0	21.8	22.6	23.1
	15000†	16.9	17.7	18.2	16.4	17.2	17.7	16.7	17.5	18.0	17.4	18.2	18.7
	5000†	10.5	11.2	11.8	10.3	11.0	11.6	11.2	11.9	12.5	12.3	13.0	13.6

* Except for peak voltmeters.
† In addition to peak voltmeters.

DISTORTION MEASUREMENTS

One of the quantities of fundamental interest in studying class A amplifiers is the amount of distortion to the applied signal generated in the tube. The technique of making distortion measurements at audio and carrier frequencies is well understood and presents no outstanding problems. However we would not expect distortion measurements made at low frequencies to have any significant application to ultra-high-frequency operation. Since the input resistance of a tube at these frequencies is obviously a function of the various voltages and currents we should expect this input resistance to vary throughout the radio-frequency cycle, that is, to be essentially nonlinear. The question of whether or not this nonlinearity is of sufficient magnitude to cause trouble can best be answered by making direct distortion measurements at the ultra-high frequencies. After some consideration of the various methods of measuring distortion we have chosen the two-tone method as being the most promising. In this method two independent frequencies suitably chosen in the transmission band of the amplifier are fed into the amplifier and the amplitudes of these two tones and such of their modulation products as are of interest are measured in the output of the amplifier by means of a suitable voltage analyzer. In the present case the "tones" are actually a pair of ultra-high-frequency signals. The principal precaution which must be taken in this method is to prevent the oscillators which supply the driving frequencies from reacting on each other and producing distortion products ahead of the amplifier under test. In the present case we have taken care of this requirement by using relatively high powered driving oscillators, very well shielded, from which only very small amounts of power are taken by means of very loosely coupled and electrostatically screened coupling coils. The outputs of the two oscillators are still further isolated from each other by connecting each across opposite diagonals of a balanced capacity bridge and taking off the voltage to drive the circuit under test across one arm of the bridge. A small amount of the voltage developed in the output circuit of the amplifier under test is picked up by a small coupling coil and fed into a voltage analyzer by means of which the relative amplitudes of the testing frequencies and their modulation products may be measured. This voltage analyzer consists of a high gain superheterodyne receiver having a rather sharply tuned, intermediate-frequency amplifier and an extremely precise tuning arrangement on the beating oscillator. The intermediate-frequency amplifier contains an attenuator which, in conjunction with the second detector current meter, permits the relative amplitude of signals to be measured.

The oscillators are push-pull tuned-plate—tuned-grid oscillators employing Western Electric type 304-A tubes with about 900 volts on their plates. These oscillators each deliver about twenty-five watts of radio-frequency power, nearly all of which is dissipated in a resistance load inside the shielding compartments. The receiver (voltage analyzer) has approximately one hundred decibels gain and a ninety-three-decibel attenuator adjustable in one-decibel steps so that measurements over a very wide range of amplitudes are possible. It was found desirable to interpose an additional amplifier (also using these push-pull pentodes) between the output of the bridge and the tube and circuits under test. Of course this amplifier introduces a possible source of distortion ahead of the circuit under test and care must be taken to operate it under such conditions that an adequate margin exists between distortion level measured at its output and distortion level existing at the output of the tube under test.

In Table IV are shown the results of distortion measurements made under several typical sets of operating conditions.

TABLE IV

RATIO OF AMPLITUDE OF THIRD ORDER MODULATION PRODUCTS TO AMPLITUDE OF ONE OF TWO EQUAL TEST FREQUENCIES

Frequency = 80 megacycles

E_P, E_S Volts	E_G Volts	I_P Mils	I_S Mils	Distortion ratio, decibels at 0.33 watt * output	Distortion ratio, decibels at 0.75 watt * output
320	-27.4	43.5	19.5	-52	-44
320	-23.8	54.0	26.0	-54	-46
320	-19.0	66.5	33.5	-56	-48
400	-38.3	44.0	22.0	-53	-44
400	-34.5	55.0	25.0	-54	-45
400	-29.5	68.5	31.5	-57	-49
500	-53.5	45.5	19.5	-57	-50
500	-49.0	56.0	24.0	-58	-50
500	-44.2	70.0	30.0	-56	-48

* For single frequency whose amplitude is the sum of the amplitudes of the two test frequencies.

OTHER APPLICATIONS

A study of the performance of these tubes as class B amplifiers, as harmonic generators, and as modulators apparently presents no serious additional problems and requires very little in the way of additional new technique. Tests indicate that in the neighborhood of 150 megacycles the performance of these tubes in such modes of operation is comparable to that of conventional pentodes in the ordinary short-wave range. In a two-stage amplifier using these tubes, with the first

tube working as a class A amplifier and the second tube under class B conditions an output of over ten watts has been obtained with a second stage plate efficiency of around seventy per cent and with an over-all voltage gain for the two stages of twenty-four decibels. Using the first tube as a harmonic generator, driven at fifty megacycles, and the second tube as a class B amplifier, over six watts of 150-megacycle power have been obtained with an over-all voltage gain from fifty-megacycle input to 150-megacycle output of about four decibels.

CONCLUSIONS

It is often little realized how completely our present highly developed technique of making communications measurements depends upon our ability to set up stable and reliable amplifiers at the frequencies we wish to use. We are now in a position to set up such amplifiers in the ultra-short-wave range; amplifiers of sufficient gain, stability, and most important, of sufficient power handling capacity to enable us to make many of the measurements we may wish, at low enough impedance levels to minimize some of the effects of unavoidable stray inductances and capacitances in our circuits and at high enough power levels to make practicable the use of simple and reliable, and almost necessarily rather insensitive measuring apparatus. Furthermore, our experience in this work indicates that it is not necessary to modify drastically our experimental procedures when we move into the ultra-short wave field. Much more care in circuit design is required, but with more attention to details formerly unimportant, much of the background of electrical measuring technique becomes, with the advent of this new tool, available in the ultra-short-wave range.

•

The Physical Reality of Zenneck's Surface Wave

By W. HOWARD WISE

The first part of the paper shows that a vertical dipole does not generate a surface wave which at great distances behaves like Zenneck's plane surface wave. In Parts Two and Three it is shown that it is not necessary to call upon the Zenneck wave to explain the success of the wave antennas.

IN 1907¹ Zenneck showed that a plane interface between two semi-infinite media could support, or guide, an electromagnetic wave which is exponentially attenuated in the direction of propagation along the interface and vertically upwards and downwards from the interface. Zenneck did not show that an antenna could generate such a wave but, because this "surface wave" seemed to be a plausible explanation of the propagation of radio waves to great distances, it was commonly accepted as one of the components of the radiation from an antenna.

After Sommerfeld² formulated the wave function for a vertical infinitesimal dipole as an infinite integral and noted that the integral around the pole of the integrand is the wave function for a surface wave, which at great distances is identical with the Zenneck wave, no one questioned the reality of Zenneck's surface wave.

There has been recently pointed out by C. R. Burrows¹⁰ the lack of agreement between various formulas and curves of radio attenuation over land when the dielectric constant of the ground must be taken into account. The values of Sommerfeld² and Rolf⁵ are stated to differ from those of Weyl⁷ and Norton⁹ by an amount just equal to the surface wave of Zenneck. Burrows¹⁰ presents experimental data supporting the correctness of the Weyl-Norton values and raises a question as to whether a surface wave really is set up by a radio antenna. A vertical current dipole does not generate a surface wave which at great distances behaves like Zenneck's plane surface wave. Theoretical and numerical evidence leading to this conclusion is presented in Part One of this paper. A contemporary theoretical investigation by S. O. Rice* leads to the same conclusion.

The reader familiar with wave antennas will at once ask why the wave antennas seem to justify the Zenneck surface wave theory by means of which they were conceived and designed if there is no surface

* "Series for the Wave Function of a Radiating Dipole at the Earth's Surface," this issue of the *Bell Sys. Tech. Jour.*

wave. In Part Two of this paper it is shown that a plane electromagnetic wave, polarized with the electric vector in the plane of incidence and in the wave front, impinging on a plane solid at nearly grazing incidence produces a total field in which the horizontal electric field near the solid has very nearly the same ratio to the vertical electric field as in the Zenneck surface wave. In Part Three of this paper it is shown that the wave tilt near the ground at a great distance from a vertical dipole is almost the same as that found for the plane wave at nearly grazing incidence.

PART ONE—THE EVIDENCE AGAINST THE SURFACE WAVE

The following discussion centers around the surface wave wavefunction P and the series (5), (6), (8) and (9) of paper 3 in the bibliography.* These series and P follow

$$P = -\frac{\pi s \tau}{1 - \tau^2} H_0^{(2)}(sr) e^{i\tau s z}, \dagger \quad (12)$$

$$Q_1 + P/2 = \frac{1}{r} \frac{e^x}{1 - \tau^2} \sum_{n=0}^{\infty} A_n (-x)^n, \quad (5)$$

$$Q_2 + P/2 = \frac{1}{r} \frac{e^{x_2}}{1 - \tau^2} \sum_{n=0}^{\infty} B_n (-x_2)^n, \quad (6)$$

$$Q_0 = Q_1 + P \sim \frac{1}{r} \frac{e^x}{1 - \tau^2} \sum_{n=1}^{\infty} C_n x^{-n}, \quad (8)$$

$$Q_1 \sim \frac{1}{r} \frac{e^{x_2}}{1 - \tau^2} \sum_{n=1}^{\infty} D_n x_2^{-n}, \quad (9)$$

where r = horizontal distance, $x = -ik_1 r$, $x_2 = -ik_2 r$, $\tau = k_1/k_2$, $s = k_1/\sqrt{1 + \tau^2}$, $k^2 = \epsilon\mu\omega^2 - 4\pi\sigma\mu i\omega$, $k_2^2 = k_1^2 (\epsilon - i2c\lambda\sigma)$, $k_1 \approx 2\pi/\lambda$ in air, $a = \tau^2/(1 + \tau^2)$, $a_2 = 1/(1 + \tau^2)$,

$$\begin{aligned} A_0 &= 1, & A_1 &= \sqrt{a} \tanh^{-1} \sqrt{a}, & A_2 &= A_1 - a, \\ A_n &= [(2n - 3)A_{n-1} - aA_{n-2}]/(n - 1)^2, \\ B_0 &= 1, & B_1 &= \sqrt{a_2} \tanh^{-1} \sqrt{a_2}, & B_2 &= B_1 - a_2, \\ B_n &= [(2n - 3)B_{n-1} - a_2B_{n-2}]/(n - 1)^2, \\ C_1 &= -1/a, & C_2 &= -3/a^2 + 1/a, \\ C_n &= [(2n - 1)C_{n-1} - (n - 1)^2C_{n-2}]/a, \\ D_1 &= -1/a_2, & D_2 &= -3/a_2^2 + 1/a_2, \\ D_n &= [(2n - 1)D_{n-1} - (n - 1)^2D_{n-2}]/a_2. \end{aligned}$$

* Sommerfeld's time factor $e^{-i\omega t}$ which was used in paper 3 has been replaced by $e^{i\omega t}$.

† z , the height above ground, is zero in paper 3.

The left hand side of (8) has been altered to correspond with the facts as now known.

P is the wave-function for a surface wave which at great distances behaves like Zenneck's plane surface wave.

The series (5) and (6) constitute the complete wave-function for a unit vertical dipole centered on the interface between air and ground.

The series (8) and (9) are the asymptotic expansions of (5) + $P/2$ and (6) - $P/2$.

The series (5), (6), (8) and (9) are exact and it is from them that the attenuation charts in a paper by C. R. Burrows in this issue of the *Bell System Technical Journal* were computed.

Since interchanging k_1 and k_2 in (5) gives (6) and interchanging k_1 and k_2 in (8) gives (9) but interchanging k_1 and k_2 in P changes its sign it follows that if (6) \sim (9) + $P/2$ then (5) \sim (8) - $P/2$. Hence the complete wave-function $\Pi_z = (5) + (6) \sim [(8) - P/2] + [(9) + P/2] = (8) + (9)$ and P does not appear in the asymptotic expansion of the wave-function.

The series (5) and (6) have been computed and found to be respectively equal to (8) - $P/2$ and (9) + $P/2$.* These computations show again that $\Pi_z = (5) + (6) \sim (8) + (9)$ or putting it in words, that there is no surface wave wave-function P in the asymptotic expansion of the complete wave-function.

As a further check S. O. Rice has derived the series (5) and (6) in an entirely different manner and verified that their asymptotic expansions are indeed $Q_0 - P/2$ and $Q_2 + P/2$.

In order to get a direct numerical check on the series the wave-function integral was computed by mechanical quadrature for two cases. Van der Pol's transformation of the wave-function integral with the path of integration deformed upward along the lines $Im(ihru)$ constant was used.⁶

1. With $r/\lambda = 1/4\pi$ and $\epsilon - i2c\lambda\sigma = 12.5 - i 12.5$ mechanical quadrature gave $\Pi_z = (.800 - i .578)/r$ while the series (5) and (6) gave $(.9247 - i .4334)/r$ and $(-.1242 - i .1438)/r$ respectively which add up to $(.8005 - i .5772)/r$. This is a good check on the series (5) and (6).

2. With $r/\lambda = 50$ and $\epsilon - i2c\lambda\sigma = 80 - i .7512$ mechanical quadrature gave $\Pi_z = (.094 - i .178)/r$ while the series (8) and (9) gave $Q_0 \approx (.086 - i .187)/r$ and $Q_2 \approx 1.2 \times 10^{-11} \sqrt{13^0}/r$. Since $P = (4.47 - i 1.92)/r$ there can be no doubt that it must be omitted in computing Π_z asymptotically. This is a good check on the above stated relation $\Pi_z = (5) + (6) \sim (8) + (9)$ or $\Pi_z \sim Q_0 + Q_2$. Because the asymptotic series Q_0 here starts to diverge at the third term

* Eq. (1) in paper 4 says that (5) \sim (8) - $P/2$.

it is not possible to determine Q_0 with an accuracy better than the discrepancy between the values given for Q_0 and Π_z .

The above cited facts prove that on the ground the wave-function for a vertical dipole centered on the interface between air and ground is

$$\Pi_z = (5) + (6) \sim [(8) - P/2] + [(9) + P/2] = (8) + (9)$$

or

$$\Pi_z = (Q_1 + P/2) + (Q_2 + P/2) \sim Q_1 + Q_2 + P = Q_0 + Q_2.$$

The function P can only be thought of as follows. The convergent series (5) and (6) comprising the wave function can not be directly expressed as inverse power series; but if the function $P/2$ is respectively added and subtracted the resulting sum and difference do have the asymptotic inverse power series expansions (8) and (9).

PART TWO—SUPERSEDING THE SURFACE WAVE

It has now been shown by theory, by numerical studies and by crucial experiment that Zenneck's surface wave is not a component in the asymptotic expansion of the wave-function for a vertical dipole.

Since the wave antennas were designed to utilize the horizontal component of the Zenneck wave electric field and do pick up radio signals it is desirable that we explain the success of the wave antennas in some other way at the same time that we throw away the Zenneck wave.

The object of this part of the paper is to show that the success of the wave antennas can be well accounted for by means of a plane wave theory. It will be shown that if a plane electromagnetic wave polarized with the electric vector in the plane of incidence and in the wave front impinges on a plane solid at a large angle with the normal to the surface then near the surface the ratio of the horizontal to the vertical component of the total electric field is very nearly the same as though the total field were that of a Zenneck surface wave.

Since the electric and magnetic fields of an antenna ultimately lie in the wave front and since the wave front at any considerable distance is effectively plane for a structure the size of a wave antenna and since the radiation coming down from the ionosphere consists chiefly of that which has been subjected to the minimum number of reflections and the angle at which the radiation arrives at the receiving wave antenna is usually rather low this plane wave theory easily accounts for the success of the wave antennas.

A plane electromagnetic wave polarized with its electric vector in the plane of incidence falls upon a plane semi-conducting surface. We are interested in the total field.

Let the incident electric field be

$$\begin{aligned} E_{xi} &= e^{i\omega t - ik_1(x \sin \theta - z \cos \theta)} \cos \theta, \\ E_{zi} &= e^{i\omega t - ik_1(x \sin \theta - z \cos \theta)} \sin \theta. \end{aligned}$$

The reflected field is

$$\begin{aligned} E_{xr} &= - e^{i\omega t - ik_1(x \sin \theta + z \cos \theta)} \cos \theta \cdot R, \\ E_{zr} &= e^{i\omega t - ik_1(x \sin \theta + z \cos \theta)} \sin \theta \cdot R, \end{aligned}$$

where

$$\begin{aligned} R &= \frac{\cos \theta - \tau \sqrt{1 - \tau^2 \sin^2 \theta}}{\cos \theta + \tau \sqrt{1 - \tau^2 \sin^2 \theta}}, \\ \tau &= k_1/k_2 = 1/(\epsilon - i2c\lambda\sigma)^{1/2}. \end{aligned}$$

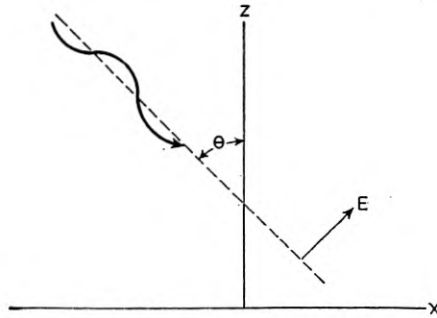

Fig. 1

Then the total field is

$$\begin{aligned} E_x &= e^{i\omega t - ik_1z \sin \theta} \cos \theta (e^{i\eta} - R e^{-i\eta}), \\ E_z &= e^{i\omega t - ik_1z \sin \theta} \sin \theta (e^{i\eta} + R e^{-i\eta}), \end{aligned}$$

where $\eta = k_1z \cos \theta$.

$$E_x = e^{i\omega t - ik_1z \sin \theta} 2 \cos \theta \frac{i \cos \theta \sin \eta + \tau \sqrt{1 - \tau^2 \sin^2 \theta} \cos \eta}{\cos \theta + \tau \sqrt{1 - \tau^2 \sin^2 \theta}},$$

$$E_z = e^{i\omega t - ik_1z \sin \theta} 2 \sin \theta \frac{\cos \theta \cos \eta + i\tau \sqrt{1 - \tau^2 \sin^2 \theta} \sin \eta}{\cos \theta + \tau \sqrt{1 - \tau^2 \sin^2 \theta}}.$$

In order to see better the significance of these formulas it is necessary to write $\theta = \pi/2 - \delta$ where δ is small, say less than 20° , and suppose that $k_1z \cos \theta$ is small. Then we may use the expansions

$$\begin{aligned} \cos \theta &= \sin \delta = \delta - \delta^3/3! + \dots, \\ \sin \theta &= \cos \delta = 1 - \delta^2/2! + \dots, \\ \tan \eta &= \cos \theta \cdot k_1z (1 + k_1^2z^2\delta^2/3 + \dots), \\ \cos \eta &= 1 - k_1^2z^2\delta^2/2 + \dots. \end{aligned}$$

If terms of third and higher order in δ are dropped we have left

$$E_x = e^{i\omega t - ik_1 z \sin \theta} 2\delta \left(1 - \frac{\delta^2}{6}\right) \left(1 - k_1^2 z^2 \frac{\delta^2}{2}\right) \\ \left(\tau\sqrt{1-\tau^2} + \frac{\tau^3\delta^2}{2\sqrt{1-\tau^2}} + ik_1 z \delta^2\right) / \left(\tau\sqrt{1-\tau^2} + \delta + \frac{\tau^3\delta^2}{2\sqrt{1-\tau^2}}\right), \\ = e^{i\omega t - ik_1 z \sin \theta} \frac{\tau\sqrt{1-\tau^2}}{\delta + \tau\sqrt{1-\tau^2} + \tau^3\delta^2/2\sqrt{1-\tau^2}} 2\delta^* \\ [1 - \delta^2(\frac{1}{6} + k_1^2 z^2/2 - \tau^2/2(1-\tau^2) - ik_1 z/\tau\sqrt{1-\tau^2})],$$

$$E_z = e^{i\omega t - ik_1 z \sin \theta} 2 \left(1 - \frac{\delta^2}{2}\right) \delta \left(1 - \frac{\delta^2}{6}\right) \left(1 - k_1^2 z^2 \frac{\delta^2}{2}\right) \\ \left[1 + \left(\tau\sqrt{1-\tau^2} + \frac{\tau^3\delta^2}{2\sqrt{1-\tau^2}}\right) ik_1 z (1 + k_1^2 z^2 \delta^2/3)\right] / \\ \left(\tau\sqrt{1-\tau^2} + \delta + \frac{\tau^3\delta^2}{2\sqrt{1-\tau^2}}\right), \\ = e^{i\omega t - ik_1 z \sin \theta} \frac{1 + \tau\sqrt{1-\tau^2} k_1 z i}{\delta + \tau\sqrt{1-\tau^2} + \tau^3\delta^2/2\sqrt{1-\tau^2}} 2\delta \\ \left[1 - \delta^2 \left(\frac{2}{3} + k_1^2 \frac{z^2}{2} - i \frac{\tau^3 k_1 z/2 + \tau(1-\tau^2) k_1^3 z^3/3}{(1 + \tau\sqrt{1-\tau^2} k_1 z)\sqrt{1-\tau^2}}\right)\right].$$

The wave tilt is then

$$\frac{E_x}{E_z} = \frac{\tau\sqrt{1-\tau^2}}{1 + \tau\sqrt{1-\tau^2} k_1 z i} \left\{ 1 + \delta^2 \left[\frac{1}{2} + \frac{ik_1 z}{\tau\sqrt{1-\tau^2}} + \frac{\tau^2}{2(1-\tau^2)} \right. \right. \\ \left. \left. - i \frac{\tau^3 k_1 z/2 + \tau(1-\tau^2) k_1^3 z^3/3}{(1 + \tau\sqrt{1-\tau^2} k_1 z)\sqrt{1-\tau^2}} \right] \right\}.$$

The wave tilt in the Zenneck wave is just τ .

As a particular and probably typical case we may take $\epsilon = 9$, $\sigma = 2 \times 10^{-14}$ and $f = 60,000$ and then $\tau = k_1/k_2 = 1/\sqrt{\epsilon - i2c\lambda\sigma} = 1/\sqrt{9 - i600} = .04082 \angle 44.570^\circ$. If $z = 30$ ft. then

$$k_1 z = 2\pi 30 \times 30.48/5 \times 10^5 = .01149.$$

If $\delta = 10^\circ = .1745$ radian then $\delta^2 = .03045$. The coefficient of τ in E_x/E_z then turns out to differ from unity by only about 1 per cent.

These figures show that if we retain only the principal terms in our formulæ we have

$$E_x = e^{i\omega t - ik_1 z \sin \theta} \frac{\tau\sqrt{1-\tau^2}}{\delta + \tau\sqrt{1-\tau^2}} 2\delta \left[1 - \delta^2 \left(\frac{1}{6} - \frac{ik_1 z}{\tau} \right) \right],$$

$$E_z = e^{i\omega t - ik_1 z \sin \theta} \frac{1 + \tau\sqrt{1-\tau^2} ik_1 z}{\delta + \tau\sqrt{1-\tau^2}} 2\delta \left[1 - \frac{2}{3}\delta^2 \right],$$

$$\frac{E_x}{E_z} = \frac{\tau\sqrt{1-\tau^2}}{1 + \tau\sqrt{1-\tau^2} ik_1 z} \left[1 + \delta^2 \left(\frac{1}{2} + ik_1 z / \tau \right) \right].$$

As a rule the wave tilt is so nearly equal to the value τ predicted by Zenneck that present day wave tilt measurements do not distinguish between the two.

PART THREE—THE WAVE TILT OF THE Q_0 -WAVE

It would be but natural for a reader to ask what wave tilt would be observed at the surface of a flat earth if there were no Heaviside layer. It was shown in Part One that the asymptotic expansion of the complete wave function is $Q_0 + Q_2$, of which Q_2 is negligible. The function Q_0 there considered is the surface value of a detached wave that carries energy to infinity in all directions. One would therefore expect that at the surface of the earth the Q_0 -wave would act like the detached plane wave employed in Part Two. It will now be shown that it does.

It was shown in paper 8 that in the air

$$Q_0 \sim \frac{e^{-ikr}}{r} + \frac{e^{-ikr_2}}{r_2} \left\{ g_{01}(c) - \frac{g_{02}(c)}{ikr_2} + \frac{g_{03}(c)}{(ikr_2)^2} + \dots \right\},$$

where

$$g_{01}(c) = \frac{c - \tau\sqrt{1-\tau^2 + \tau^2 c^2}}{c + \tau\sqrt{1-\tau^2 + \tau^2 c^2}},$$

$$g_{0(n+1)}(c) = \frac{n-1}{2} g_{0n}(c) - \frac{c}{n} g_{0n}'(c) + \frac{1-c^2}{2n} g_{0n}''(c),$$

$c = \cos \theta$ and r_2 and θ are shown in Fig. 2,

$$r_2 = \sqrt{\rho^2 + w^2}, \quad c = w/r_2, \quad w = z + a.$$

We need to compute (elm. units are employed, $\mu = 1$)

$$E_\rho = \frac{-\mu i \omega}{k^2} \frac{\partial^2 Q_0}{\partial \rho \partial z},$$

$$= \frac{-i\omega}{k^2} \left(\sqrt{1-c^2} \frac{\partial}{\partial r_2} - \frac{c\sqrt{1-c^2}}{r_2} \frac{\partial}{\partial c} \right) \left(c \frac{\partial}{\partial r_2} + \frac{1-c^2}{r_2} \frac{\partial}{\partial c} \right) Q_0$$

and

$$\begin{aligned} E_z &= -\mu i\omega \left[1 + \frac{1}{k^2} \frac{\partial^2}{\partial z^2} \right] Q_0, \\ &= -i\omega \left[1 + \frac{1}{k^2} \left(c \frac{\partial}{\partial r_2} + \frac{1-c^2}{r_2} \frac{\partial}{\partial c} \right)^2 \right] Q_0 \end{aligned}$$

at a great distance near the interface; that is to say, retaining only the leading terms in c/r_2 and $1/r_2^2$.

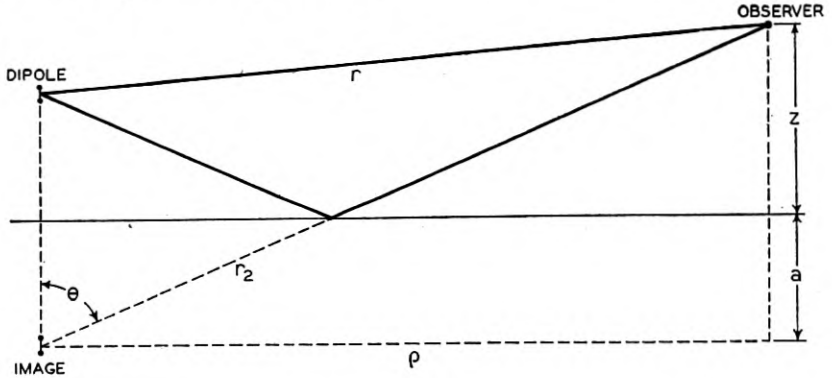

Fig. 2

The complete calculation of E_p and E_z is too long to be included. If $a = 0$ so that $r = r_2$

$$\begin{aligned} E_p &= -i\omega \frac{e^{-ikr_2}}{r_2} \left\{ -c\sqrt{1-c^2}(1+g_{01}(c)) + \frac{\sqrt{1-c^2}}{ikr_2} [(1-2c^2)g_{01}'(c) \right. \\ &\quad - 3c(1+g_{01}(c)) + cg_{02}(c)] - \frac{\sqrt{1-c^2}}{(ikr_2)^2} [-(2-5c^2)g_{01}'(c) \\ &\quad - c(1-c^2)g_{01}''(c) + (1-2c^2)g_{02}'(c) + 3c(1+g_{01}(c)) \\ &\quad \left. - 5cg_{02}(c) + cg_{03}(c)] + \dots \right\}, \\ E_z &= -i\omega \frac{e^{-ikr_2}}{r_2} \left\{ (1-c^2)(1+g_{01}(c)) - \frac{1}{ikr_2} [(1-c^2)g_{02}(c) \right. \\ &\quad - (1-3c^2)(1+g_{01}(c)) - 2c(1-c^2)g_{01}'(c)] \\ &\quad + \frac{1}{(ikr_2)^2} [-(1-5c^2)g_{02}(c) + (1-c^2)g_{03}(c) - (1-c^2)^2g_{01}''(c) \\ &\quad \left. + (1-3c^2)(1+g_{01}(c)) + c(1-c^2)(5g_{01}'(c) - 2g_{02}'(c))] + \dots \right\}. \end{aligned}$$

Since c is to be very small it is best to expand $g_{01}(c)$ into an ascending power series in c .

$$g_{01}(c) = -1 + \frac{2c}{\tau\sqrt{1-\tau^2}} - \frac{2c^2}{\tau^2(1-\tau^2)} + \frac{(2-\tau^4)c^3}{\tau^3(1-\tau^2)^{3/2}} \\ - \frac{2(1+\tau^2)c^4}{\tau^4(1-\tau^2)} + \frac{(8-12\tau^4+3\tau^8)c^5}{4\tau^5(1-\tau^2)^{5/2}} - \frac{2(1+\tau^2)^2c^6}{\tau^6(1-\tau^2)} + \dots$$

The recurrence relation then gives us

$$g_{02}(c) = \frac{-2}{\tau^2(1-\tau^2)} + \frac{(6-2\tau^2-\tau^4)c}{\tau^3(1-\tau^2)^{3/2}} - \frac{(12+6\tau^2)c^2}{\tau^4(1-\tau^2)} \\ + \frac{(40-24\tau^2-36\tau^4+12\tau^6+3\tau^8)c^3}{2\tau^5(1-\tau^2)^{5/2}} + \dots,$$

$$g_{03}(c) = \frac{-6-4\tau^2}{\tau^4(1-\tau^2)} + \frac{(120-72\tau^2-108\tau^4+36\tau^6+9\tau^8)c}{4\tau^5(1-\tau^2)^{5/2}} + \dots$$

After dropping all but the leading terms there is left

$$E_p = -i\omega \frac{e^{-ikr_2}}{r_2} \left\{ \frac{1}{ik_2 r_2} \left[\frac{2}{\tau\sqrt{1-\tau^2}} \right] \right\}, \\ E_z = -i\omega \frac{e^{-ikr_2}}{r_2} \left\{ \frac{2(1+\tau\sqrt{1-\tau^2}ikw)}{ikr_2\tau^2(1-\tau^2)} \right\}.$$

The wave tilt near the surface of the ground is then

$$\frac{E_p}{E_z} = \frac{\tau\sqrt{1-\tau^2}}{1+\tau\sqrt{1-\tau^2}ikz}.$$

This is the wave tilt in the asymptotic field of a quarter wave antenna or flat top antenna.

If a is not zero but c is small the final field expressions are

$$E_p = -i\omega \frac{e^{-ikr_2}}{r_2} \left\{ \frac{2+\tau\sqrt{1-\tau^2}ik[w+(2a-w)e^{ik2az/r_2}]}{ikr_2\tau\sqrt{1-\tau^2}} \right. \\ - \frac{3}{ikr_2^2} [(w-2a)e^{ik2az/r_2} - w] \\ \left. - \frac{6-6\tau^2-3\tau^4+6\tau\sqrt{1-\tau^2}ikw+2\tau^2(1-\tau^2)(ikw)^2}{(ikr_2)^2\tau^3(1-\tau^2)^{3/2}} + \dots \right\},$$

$$E_z = -i\omega \frac{e^{-ikr_2}}{r_2} \left\{ (e^{ik2az/r_2} - 1) \left(1 + \frac{1}{ikr_2} \right) + \frac{2(1 + \tau\sqrt{1 - \tau^2}ikw)}{ikr_2\tau^2(1 - \tau^2)} \right. \\ \left. + \frac{(e^{ik2az/r_2} - 1)(1 + k^2w^2) - 6k^2a(w - a)e^{ik2az/r_2}}{(ikr_2)^2} \right. \\ \left. + \frac{2 - 6/\tau^2 - (6 - 8\tau^2 + 5\tau^4)ikw/\tau\sqrt{1 - \tau^2} - 2(ikw)^2}{(ikr_2)^2\tau^2(1 - \tau^2)} \right\}.$$

If $k2az/r_2 \ll 1$ the leading terms give

$$E_p = -i\omega \frac{e^{-ikr_2}}{r_2} \cdot \frac{2(1 + \tau\sqrt{1 - \tau^2}ika)}{ikr_2\tau\sqrt{1 - \tau^2}}, \\ E_z = -i\omega \frac{e^{-ikr_2}}{r_2} \cdot \frac{2(1 + \tau\sqrt{1 - \tau^2}ikz)(1 + \tau\sqrt{1 - \tau^2}ika)}{ikr_2\tau^2(1 - \tau^2)}$$

and E_p/E_z is the same as obtained above with $a = 0$.

BIBLIOGRAPHY

1. J. Zenneck: *Ann. der Physik*, Bd. 23, page 846, 1907.
2. A. Sommerfeld: *Ann. der Physik*, Bd. 28, page 705, 1909. *Jahrb. d. drahtl. Tel.*, Bd. 4, page 157, 1911.
3. W. H. Wise: *Proc. I. R. E.*, Vol. 19, page 1684, 1931.
4. W. H. Wise: *Bulletin Amer. Math. Soc.*, Vol. XLI, pp. 700-706, October, 1935.
5. Bruno Rolf: *Ingeniörs Vetenskaps Akademien, Handlingar*, Nr 96, 1929.
6. Balth. van der Pol: *Zeitschrift für Hochfrequenztechnik*, Bd. 37, page 152, 1931.
7. H. Weyl: *Ann. der Physik*, Bd. 60, page 481, 1919.
8. W. H. Wise: *Physics*, Vol. 4, page 354, 1933.
9. K. A. Norton: *Proc. I. R. E.*, Vol. 24, page 1367, 1936.
10. C. R. Burrows, *Nature*, Aug. 15, 1936. A more complete description will appear in the February issue of the *Proc. I. R. E.*

Radio Propagation Over Plane Earth—Field Strength Curves

By CHARLES R. BURROWS

Curves are presented to facilitate the calculation of radio propagation over plane earth. The magnitude and phase of the reflection coefficient for all conductivities of interest and for four values of the dielectric constant are presented in the form of curves from which the significant quantities may be read with the same degree of accuracy for all conditions. Simple equations, from which the effect of raising the antennas above the earth's surface may be readily calculated, are presented.

INTRODUCTION

THIS paper is intended to facilitate the calculation of radio propagation over plane earth. In Part I curves are presented that show the decrease of field strength with distance for antennas on the surface of the earth. In these curves the results obtained by Sommerfeld¹ and Rolf² are corrected and certain approximations³ introduced by Rolf to reduce the number of variables to a workable number are eliminated. For a discussion of the Sommerfeld-Rolf curves, the reader is referred to a companion paper.⁴

Part II is concerned with the more general case of antennas above the surface of the earth. The complete equation that gives the field strength for antennas at any height above the earth is reduced to a simple equation which allows the calculation of the field under conditions of practical interest.

To facilitate field strength calculations, the values of the reflection coefficient are presented in the form of curves from which the significant quantities may be read with the required degree of accuracy for all angles of incidence.

PRELIMINARY REMARKS

A rectilinear antenna in free space generates an electric field whose effective value in the equatorial plane of the antenna at a distance large compared with the wave-length and the antenna length is

$$E_0 = \frac{60\pi HI}{\lambda d}, \quad (1)$$

where HI is equal to the line integral of the current taken over the

¹ Numbers refer to bibliography at end.

antenna.* If the antenna is placed above and perpendicular to a perfectly conducting plane and the antenna current is maintained the same, the electric field will be twice as great † or

$$E = 2E_0 = \frac{120\pi HI}{\lambda d}. \quad (2)$$

To maintain the current constant, however, it is now necessary to deliver more power to the antenna.

For a short doublet antenna in free space the radiation resistance is $R_0 = 80\pi^2 H^2/\lambda^2$ and hence the effective value of the received field strength is given as a function of the radiated power by ‡

$$E = \frac{3\sqrt{5}\sqrt{P}}{d}. \quad (3)$$

If this antenna is placed perpendicular to and very near a perfectly conducting plane the field strength pattern will be unchanged in the upper hemisphere but there will be no field below the perfectly conducting plane. The power that was required to produce the field in the lower hemisphere, which because of symmetry is half the total, is no longer radiated so that the same field strength will be produced by half the power, †† or

$$E = \frac{3\sqrt{10}\sqrt{P}}{d}. \quad (4)$$

If the transmitting antenna is removed so far from the ground that the reaction of the currents in the ground on the antenna current is negligible its radiation resistance is the same as if the ground were not present. The receiving antenna, however, still "sees" the image of the transmitting antenna in the ground. At a distance large compared with the height above ground, the transmitting antenna and

* The units are volts, amperes, meters and watts. H is the effective height of the antenna as defined in the most recent "Report of the Standards Committee" of the I.R.E. (1933).

† Under the hypothetical conditions taken by Sommerfeld, namely the antenna half in the ground and half in the air, the field is the same above a perfectly conducting plane as in free space. When the antenna is entirely above a perfectly conducting plane the field is the same as it would be if the plane were replaced by the image of the antenna in it. That is, the field is the sum of two equal components, one due to the antenna itself and the other due to its image. At distances large compared with the height of the antenna above the plane these two components are in phase and their sum is equal to twice either of them.

‡ For half-wave antennas the numerical factors in equations (3), (4) and (5) are respectively 7.0, 9.9 and 14.0.

†† Let E_1 be the received field strength in free space produced by a power P_1 and let E_2 be the field strength for an antenna perpendicular to and very near a perfectly conducting plane produced by a power P_2 . Then $E_2 = E_1$ when $P_2 = P_1/2$, and by equation (3), $E_2 = E_1 = 3\sqrt{5}\sqrt{P_1}/d = 3\sqrt{5}\sqrt{2P_2}/d$, which is equivalent to equation (4).

its image are substantially the same distance from the receiver so that

$$E = \frac{6\sqrt{5}\sqrt{P}}{d} \tag{5}$$

The way in which the ground currents affect the antenna resistance is given by the following equations which follow directly from more general cases considered by Sterba.⁵

$$\frac{R_V}{R_0} = \left[1 - 3 \left(\frac{\cos v}{v^2} - \frac{\sin v}{v^3} \right) \right] = 2 - \frac{v^2}{10} + \frac{v^4}{280} - \dots, \tag{6}$$

$$\frac{R_H}{R_0} = \left[1 - \frac{3}{2} \left(\frac{\sin v}{v} + \frac{\cos v}{v^2} - \frac{\sin v}{v^3} \right) \right] = \frac{v^2}{5} - \frac{3v^4}{280} + \dots, \tag{7}$$

where v is equal to 4π times the height of the antenna above the ground in wave-lengths, and R_V and R_H are the radiation resistances of

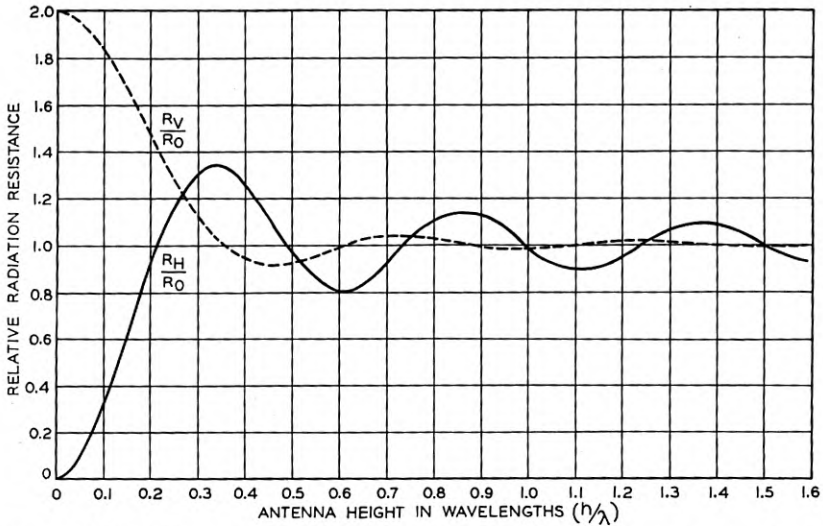

Fig. 1—Ratio of the radiation resistance of a short doublet antenna above perfectly conducting ground to that of the same antenna in free space.

short vertical and horizontal doublets above perfectly conducting earth respectively, and R_0 is the radiation resistance of the same antenna in free space. For the same input power the received field is inversely proportional to the square root of these ratios which are plotted in Fig. 1.

It is sometimes convenient to express the results in terms of the ratio of transmitted power to useful received power. The useful re-

ceived power is the maximum power that can be transferred from the receiving antenna to the first circuit of the receiver. This is

$$P_r = \left(\frac{E\lambda}{8\pi\sqrt{5}} \right)^2 \quad (8)$$

for a short doublet. From equation (3) it follows that the ratio of transmitted to useful received powers for antennas in free space is *

$$\frac{P_t}{P_r} = \left(\frac{8\pi d}{3\lambda} \right)^2. \quad (9)$$

For short vertical doublets above the surface of a perfectly conducting plane this becomes,

$$\frac{P_t}{P_r} = \left(\frac{4\pi d}{3\lambda} \right)^2 \left(\frac{R_{V_1}}{R_0} \right) \left(\frac{R_{V_2}}{R_0} \right) \quad (10)$$

at distances that are large compared with the antenna heights. Here R_{V_1}/R_0 and R_{V_2}/R_0 are the ratios given by equation (6) and Fig. 1 for the transmitting and the receiving antenna respectively. When the antennas are more than a wave-length above the ground these ratios are substantially unity, and only one-fourth as much transmitted power is required as would be if the antennas were in free space. When both antennas are very near the surface of the earth, $R_V/R_0 = 2$ and the same transmitted power is required as in free space.

PART I—VERTICAL ANTENNAS ON THE SURFACE OF THE EARTH

In this section transmission between two short vertical antennas above and very near to the surface of plane earth will be considered. The attenuation factor will be taken as the ratio of the received field strength to that which would result if this plane surface had perfect conductivity.

In evaluating the electromagnetic field generated by a short vertical antenna on the surface of an imperfectly conducting plane it is convenient to first determine the auxiliary function $\mathbf{\Pi}$, called the Hertzian potential, from which the vertical component of the electric field may be obtained by means of the relationship,†

$$E = - \frac{240i\pi^2}{\lambda} \left(1 + \frac{\lambda^2}{4\pi^2} \frac{\partial^2}{\partial z^2} \right) \mathbf{\Pi} \quad \text{volts per meter.} \quad (11)$$

* For half-wave antennas the right-hand side of equation (9) must be multiplied by $(73.2/80)^2 = 0.837$.

† Bold face type is used to indicate a complex quantity. The same character in light face type represents its magnitude with which the radio engineer is concerned. The imaginary unit, $\sqrt{-1}$, is represented by i .

For an antenna on the surface of a perfectly conducting plane this function may be written *

$$\Pi = 2\Pi_0 = 2 \frac{HIe^{-2\pi iR_1/\lambda}}{4\pi R_1} \text{ amperes,} \quad (12)$$

where $R_1 = \sqrt{d^2 + z^2}$ is the distance. For an antenna on an imperfectly conducting plane

$$\Pi = 2W\Pi_0, \quad (13)$$

where W is the ratio of the Hertzian potential due to an antenna on an imperfectly conducting plane to that on a perfectly conducting plane. W may be expressed as the sum of two infinite convergent series, A and D , which are defined in Appendix I (page 70).

$$W = A + D. \quad (14)$$

The series D becomes unwieldy for distances greater than the order of a wave-length. In order to facilitate computation, D may be transformed into an asymptotic expansion to which it is equivalent at large distances, so that

$$W = A - B/2 + F. \quad (15)$$

At still greater distances A also becomes unwieldy and it may in turn be replaced by its asymptotic expansion, which contains the term $B/2$, so that

$$W = C + F. \quad (16)$$

When the impedance of the ground is very different from that of the air,† F is small compared with $A - B/2 \approx C$. If the conductivity of the ground is not zero, F is exponentially attenuated so that it may be neglected in comparison with C in equation (16). Even if the conductivity is zero and the relative dielectric constant is as small as 4, the only effect of F in equation (16) is to produce oscillations in W of approximately 3 per cent from the magnitude of C . Even under these extreme conditions the received field strength may be calculated from equation (15) neglecting F without introducing an error greater than 3 per cent. As the transmitting antenna is approached, the approximations involved in equation (15) become poorer and poorer but at the same time the field strength becomes independent of W so that at no distance is there an appreciable error introduced

* The factor 2 occurs in equation (12) since Π_0 and E_0 refer to transmission in free space.

† This is true when the so-called "complex dielectric constant," $\epsilon - 2i\sigma/f$, differs sufficiently from unity.

by using equation (15) to calculate the field strength. This is fortunate since series D requires laborious calculations.

The attenuation factor may be obtained from W by means of the relation,*

$$\frac{E}{2E_0} = \frac{W}{1 + \tau^2} + \frac{1}{1 - \tau^4} \left[\frac{1}{2\pi id/\lambda} + \frac{1}{(2\pi id/\lambda)^2} \right], \quad (17)$$

where

$$\frac{1}{\tau^2} = \epsilon - 2i\sigma/f = \epsilon(1 - i/Q). \quad (18)$$

In this equation $2E_0$ is the inverse distance, or radiation, component of the field that would result from transmission over a perfectly conducting plane, and Q is the ratio of the imaginary component to the real component of the admittance of the ground. In other words, Q is the ratio of the dielectric current to the conduction current.† The parameter ϵ occurring in equation (18) is the relative dielectric constant (with respect to vacuum), a pure numeric that is numerically equal to the dielectric constant measured in electrostatic units.

If the value of W from equation (16) is substituted in equation (17) and terms which involve $(1/d)$ to powers higher than the first are neglected as may be done at the greater distances, we have

$$E \rightarrow \left[\frac{1}{1 - \tau^4} \frac{1 + \tau^2}{2\pi\tau^2 id/\lambda} \right] \left[1 - \frac{\tau^5}{(1 + \tau^2)} e^{\frac{2\pi id}{\lambda} (1 - \frac{1}{\tau})} \right] 2E_0. \quad (19)$$

The magnitude of the second factor on the right differs from unity

* This expression may be obtained as follows. Π satisfies the wave equation which in cylindrical coordinates (z, θ, d) is

$$\left(\frac{1}{d} \frac{\partial}{\partial d} d \frac{\partial}{\partial d} + \frac{1}{d^2} \frac{\partial^2}{\partial \theta^2} + \frac{\partial^2}{\partial z^2} + \frac{4\pi^2}{\lambda^2} \right) \Pi = 0.$$

Because of symmetry the second term is zero. Solving for the value of the last two terms and substituting it in equation (11) yields

$$E = 60i\lambda \left[\frac{\partial^2}{\partial d^2} + \frac{1}{d} \frac{\partial}{\partial d} \right] \Pi.$$

The differential equation given by Wise¹¹ for Π becomes

$$-\frac{\lambda^2}{4\pi^2} \left(\frac{\partial^2 \Pi}{\partial d^2} + \frac{1}{d} \frac{\partial \Pi}{\partial d} \right) = \frac{\Pi}{1 + \tau^2} + \frac{2}{1 - \tau^4} \left[\frac{1}{2\pi id/\lambda} + \frac{1}{(2\pi id/\lambda)^2} \right] \Pi_0$$

when the value of $y = (1 + \tau^2)\Pi/2$ is substituted in his equation (7), and the result multiplied by $2/(1 + \tau^2)$. Substitution of this relation in the preceding equation and division by $E_0 = -240i\pi^2\Pi_0/\lambda$ gives equation (17) of the text. Since E_0 is the inverse distance component of the free space field, this relation follows from equation (11).

† In practical units $Q = 2\pi f\epsilon'/g$, where ϵ' is the dielectric constant in farads per meter and g is the conductivity in mhos per meter. On frequent occasions, the constants of the dielectric are expressed in electrostatic units; then $Q = f\epsilon/2\sigma$.

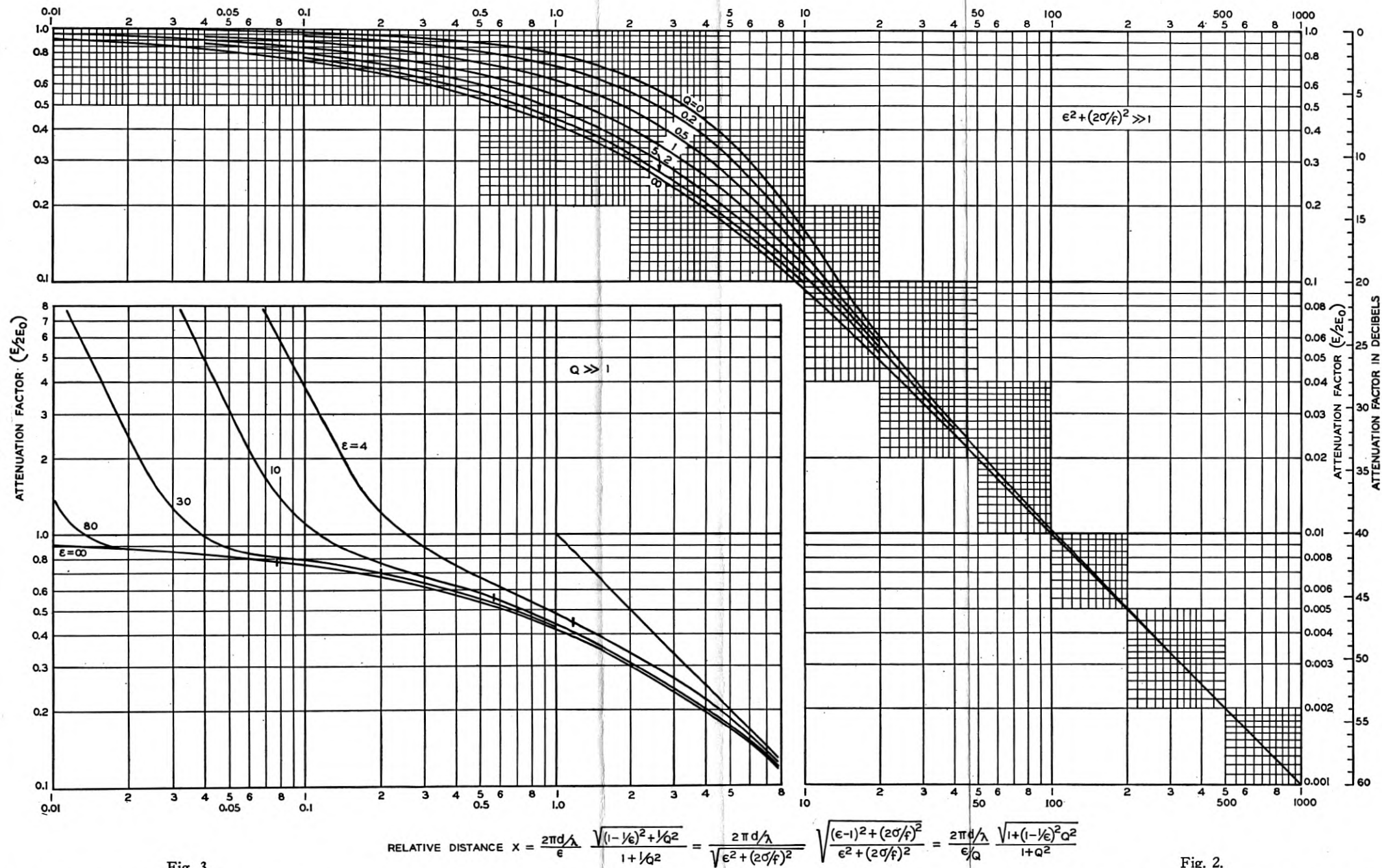

Fig. 3.

Fig. 2.

Fig. 2—Attenuation factor for radio propagation over plane earth. The number on each curve gives the value of the Q ($= \epsilon f/2\sigma$) to which it applies; σ is the conductivity and ϵ the dielectric constant in electrostatic units; f is the frequency in cycles per second; d/λ is the ratio of the distance to the wave-length.

Fig. 3—Attenuation factor for radio propagation over a dielectric plane. The number on each curve gives the value of the dielectric constant to which it applies.

by less than $2\frac{1}{2}$ per cent for values of ϵ greater than 4. Accordingly the magnitude of the first factor (which is equal to the first term of C) gives the attenuation factor at great distances with a degree of accuracy sufficient for all practical purposes. If we choose our unit of distance such that

$$x = |2\pi\tau^2(1 - \tau^2)d/\lambda|$$

$$= \frac{2\pi d/\lambda}{\epsilon/Q} \frac{\sqrt{1 + (1 - 1/\epsilon)^2 Q^2}}{1 + Q^2} = \frac{2\pi d/\lambda}{\epsilon} \frac{\sqrt{(1 - 1/\epsilon)^2 + 1/Q^2}}{1 + 1/Q^2} \quad (20)$$

all of the attenuation curves will tend to coincide at the greater distances. This is done in Figs. 2 and 3. Figure 2 shows the variation of received field strength with distance for seven values of Q for the case where the impedance of the ground is very different from that of the air.* These curves give the correct attenuation factor for arbitrary ground constants at the greater distances. At any distance the above assumption introduces a significant error only when Q is large. Accordingly the curves of Fig. 3 have been calculated for various values of the relative dielectric constant when Q is large.† The short vertical line on each curve indicates the abscissa corresponding to a distance of one wave-length. The curves do not depart appreciably from that for an infinite dielectric constant except for distances less than this.‡ Since the error introduced in applying the curves of Fig. 2 to the general case is greatest for the conditions represented in Fig. 3, the curves of Fig. 2 may be used with confidence.

It should be emphasized that the curves of Fig. 2 give the ratio of the received field strength to that which would result from the same current in the same antenna on the surface of a plane earth of perfect conductivity. The antenna is assumed at the earth's surface so that the curves are strictly true only for short antennas. The error for half-wave doublets whose mid-points are not more than a half wave-length above the surface of the earth is negligible except in the immediate vicinity of the transmitter. The effect of height above the surface of the earth is taken up more fully in the next section.

* Since the writing of this paper, Part I of a paper by K. A. Norton on "The Propagation of Radio Waves Over the Surface of the Earth and in the Upper Atmosphere" has appeared in *Proc. I.R.E.*, 24, 1367-1387, October, 1936. The curves of Fig. 2 in this paper are similar to those of Norton's Fig. 1, but by presenting the curves as a function of x their validity is extended to include a wider range of ground constants.

† The writer is indebted to Miss Clara L. Froelich for making these calculations.

‡ The ratio $E/2E_0$ is greater than unity at the shorter distances because E_0 is the inverse distance or radiation component of the free space field while E is the total field. At distances that are small compared with a wave-length, $E/2E_0$ is given by the second and third terms on the right of equation (17) and the effect of the ground is to increase the field by the factor $2/(1 - \tau^4)$.

The calculation of the field strength as a function of the radiated power requires a knowledge of the effect of imperfect conductivity on the resistance of the antenna. The reader is referred to papers by Barrow⁶ and Niessen⁷ on this subject. In the wave-length range where these curves are of greatest applicability, the practice is to minimize the ground losses by a ground system consisting of a counterpoise or a network of buried wires. When this is done the ground losses are properly part of the antenna losses and the radiated power may rightfully be taken as the rate of flow of energy past a hemisphere large enough to include the antenna and ground system. If this is done, the field strength is given by

$$E = \frac{3\sqrt{10}\sqrt{P}}{d} F(x), \quad (20a)$$

where $F(x)$ is the ratio plotted in Fig. 2.*

PART II—ANTENNAS ABOVE THE SURFACE OF THE EARTH

It is well known^{8, 9} that calculations based on the physical optics of plane waves give the first approximation to the received field for radio propagation over plane earth. This approximation is accurate enough for all practical purposes if the antennas are sufficiently removed from the surface of the earth.† Under these conditions, the ratio of the received field strength to that which would be received in free space is given by ‡

$$E/E_0 = \sqrt{(1 - K)^2 + 4K \sin^2(\gamma/2)}, \quad (21)$$

* In estimating the fraction of the total power input that is radiated the following papers may be helpful: George H. Brown, "The phase and magnitude of earth currents near radio transmitting antennas," *Proc. I.R.E.*, 23, 168-182, February, 1935; and H. E. Gihring and G. H. Brown, "General considerations of tower antennas for broadcast use," *Proc. I.R.E.*, 23, 311-356, April, 1935.

† This height depends upon the distance, wave-length and ground constants. The range of validity of this approximation is discussed more fully in connection with equation (27).

‡ Equation (21) gives the received field strength for either polarization for transmission along the ground. In this case the direct and reflected components are oriented in the same direction in space. It may also be used to calculate the effect of the ground for signals arriving at large angles by taking into consideration the space orientation of the components.

For horizontal antennas the orientation of the electric vector is horizontal for all angles of incidence so that equation (21) applies directly. For vertical antennas the electric vector makes the angle ξ_2 with the vertical, both in the direct and reflected wave. Hence if the ratio given in equation (21) is taken as the ratio of the vertical component of the received field to the total incident field it must be multiplied by $\cos \xi_2$. Even if the ground were not present, however, the vertical component would be reduced by this factor so that the effect of the presence of the ground on the field received by a vertical antenna is given by equation (21) as written without the $\cos \xi_2$ factor.

where K is the ratio of the amplitude of the reflected wave to that of the direct wave and $\gamma + \pi$ is their phase difference.

$$\gamma = \psi - \Delta, \tag{22}$$

where Δ is 2π times the path difference in wave-lengths and

$$\varphi = \psi \pm \pi \tag{23}$$

is the phase advance at reflection. The geometry is shown in Fig. 4. Δ may be calculated from the geometry by means of equation (47) of Appendix II (page 72).

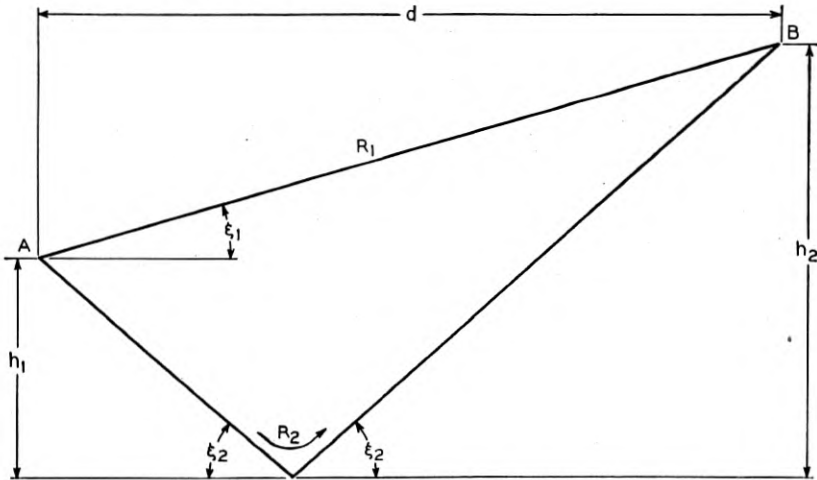

Fig. 4

The magnitude and phase of the reflection coefficient, $R = -Ke^{i\psi}$, for both polarizations are plotted in Figs. 5-12 for $\epsilon = 4, 10, 30$ and 80 and a series of values of $\epsilon/Q = 2\sigma/f$ differing by factors that are multiples of 10. The coordinate system has been chosen so that the quantities $1 - K$ and ψ that enter into the equation for the resultant field strength may be read with the same degree of accuracy for the entire range of the curves. To obtain values of $1 - K$ and ψ for smaller values of ξ_2 than shown on Figs. 5-12 use is made of the fact that both of these quantities are proportional to ξ_2 for small values of ξ_2 . This linear relationship holds for the lowest cycle* of the curves so that the parts

* An exception to this occurs for large Q in the ψ -curves for vertical polarization. Under these conditions the difference between ψ and zero for values not shown on the chart is relatively unimportant. When Q is large and K is different from zero ψ is substantially 0° or 180° . For horizontal polarization ψ may be taken equal to zero for most practical purposes.

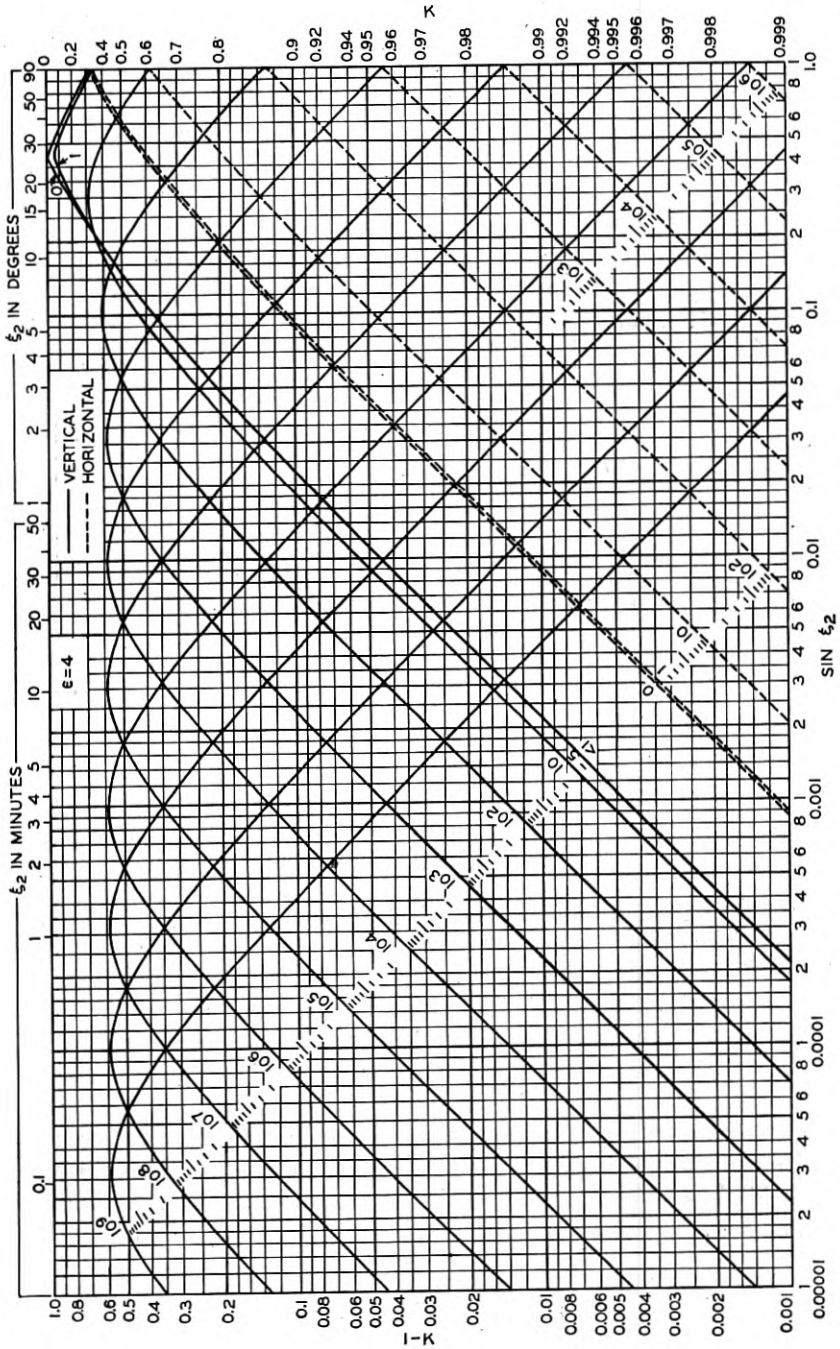

Fig. 5—Magnitude of reflection coefficient for $\epsilon = 4$. The number on each curve gives the value of q ($= 2\sigma f$) to which it applies. Vertical polarization is shown by solid lines, horizontal polarization by broken lines.

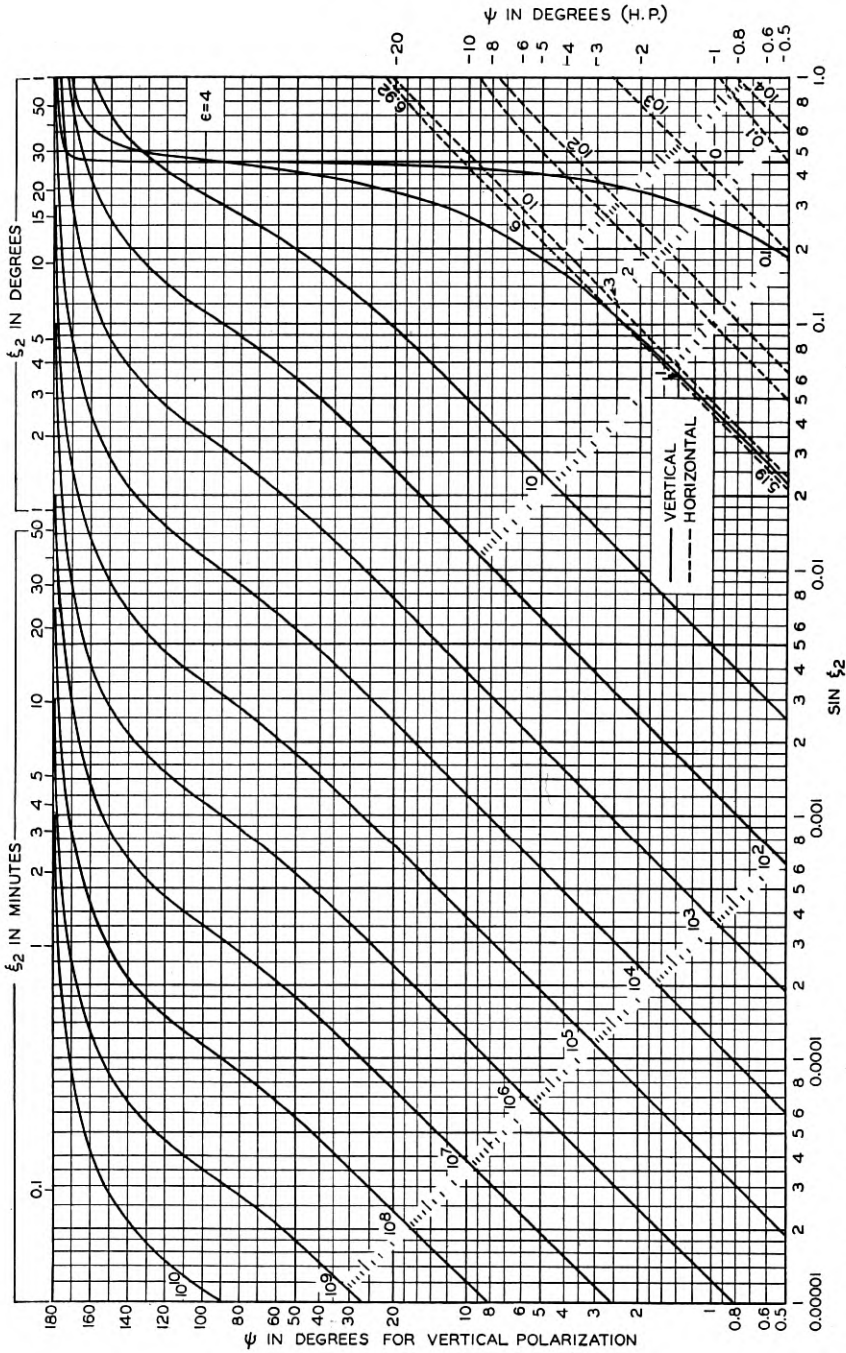

Fig. 6—Phase shift at reflection for $\epsilon = 4$. The number on each curve gives the value of g ($= 2\sigma f$) to which it applies. Vertical polarization is shown by solid lines, horizontal polarization by broken lines.

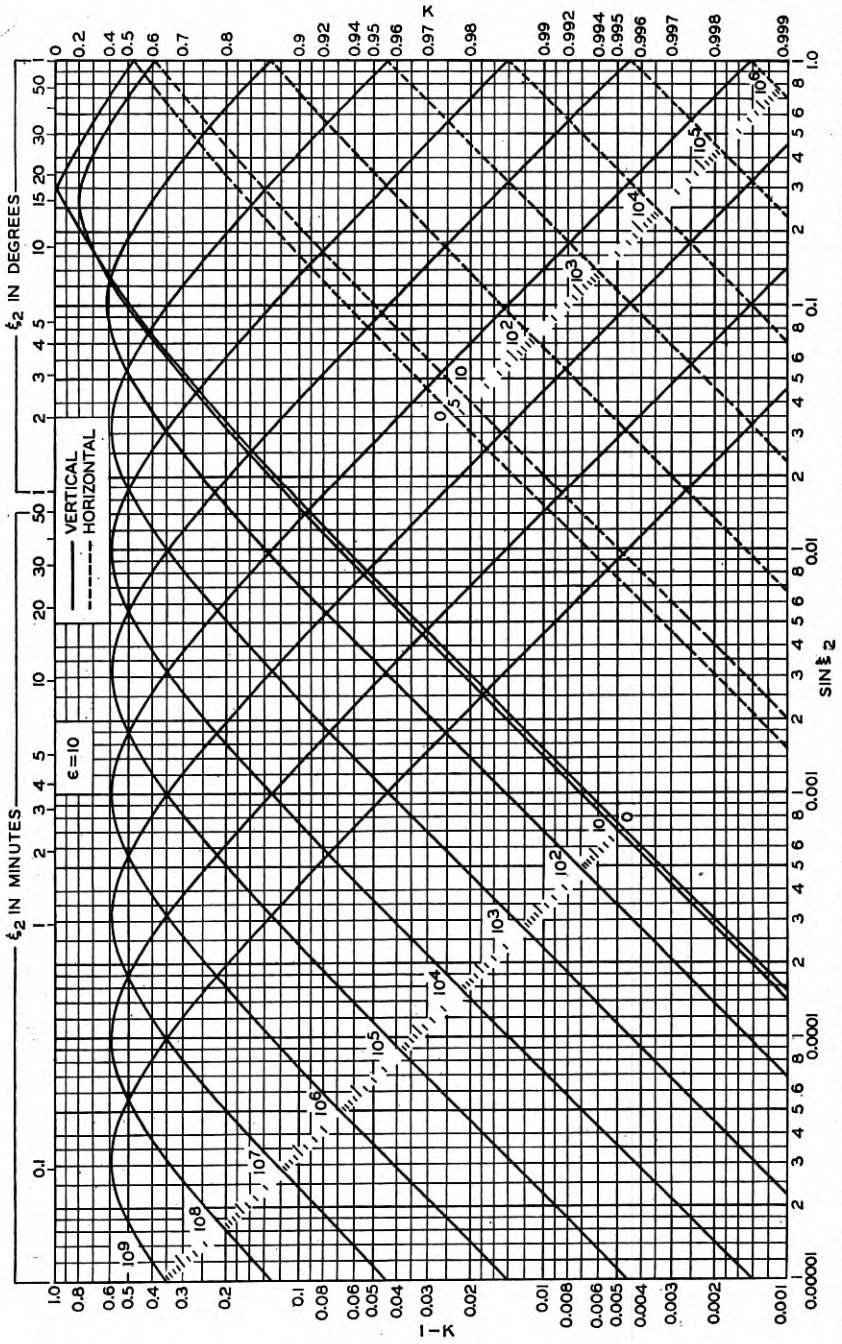

Fig. 7—Magnitude of reflection coefficient for $\epsilon = 10$. The number on each curve gives the value of q ($= 2\sigma/f$) to which it applies. Vertical polarization is shown by solid lines, horizontal polarization by broken lines.

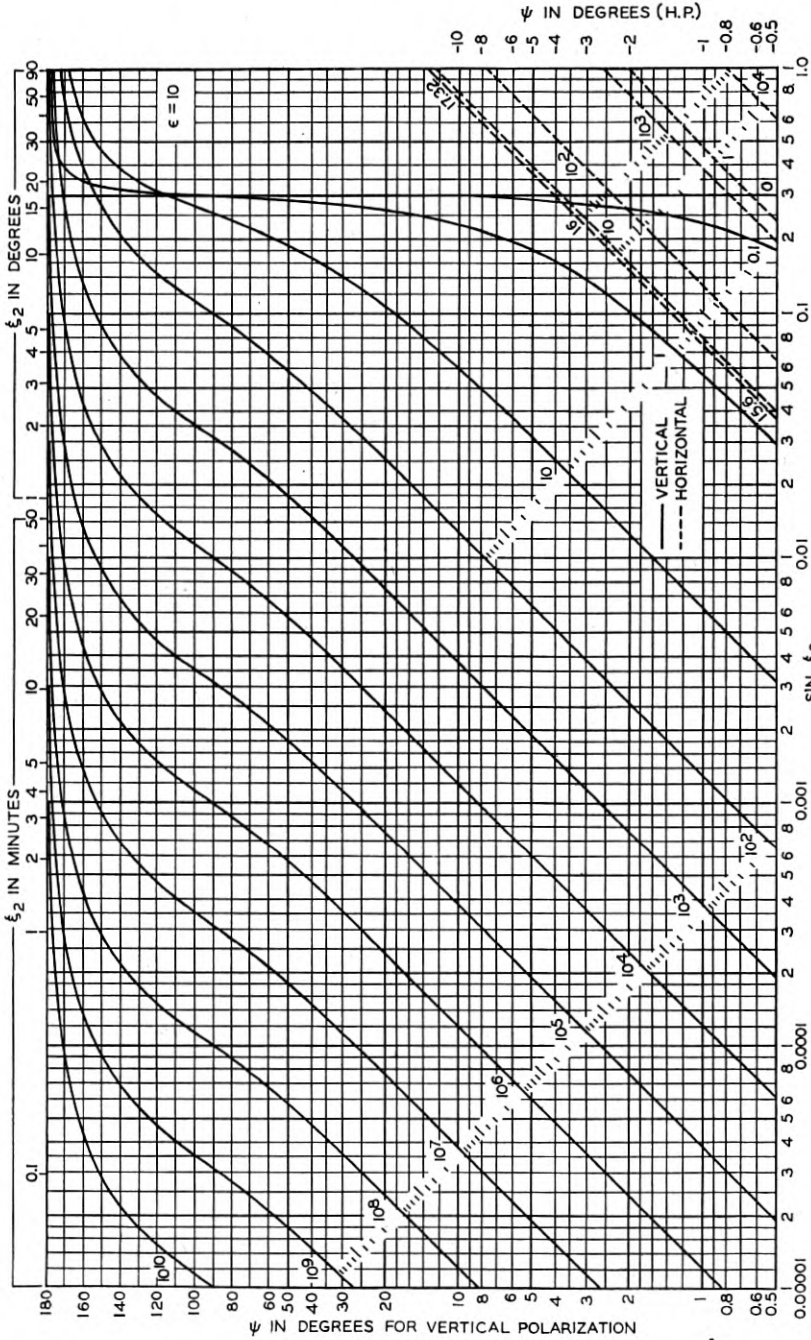

Fig. 8—Phase shift at reflection for $\epsilon = 10$. The number on each curve gives the value of $q (= 2\sigma f)$ to which it applies. Vertical polarization is shown by solid lines, horizontal polarization by broken lines.

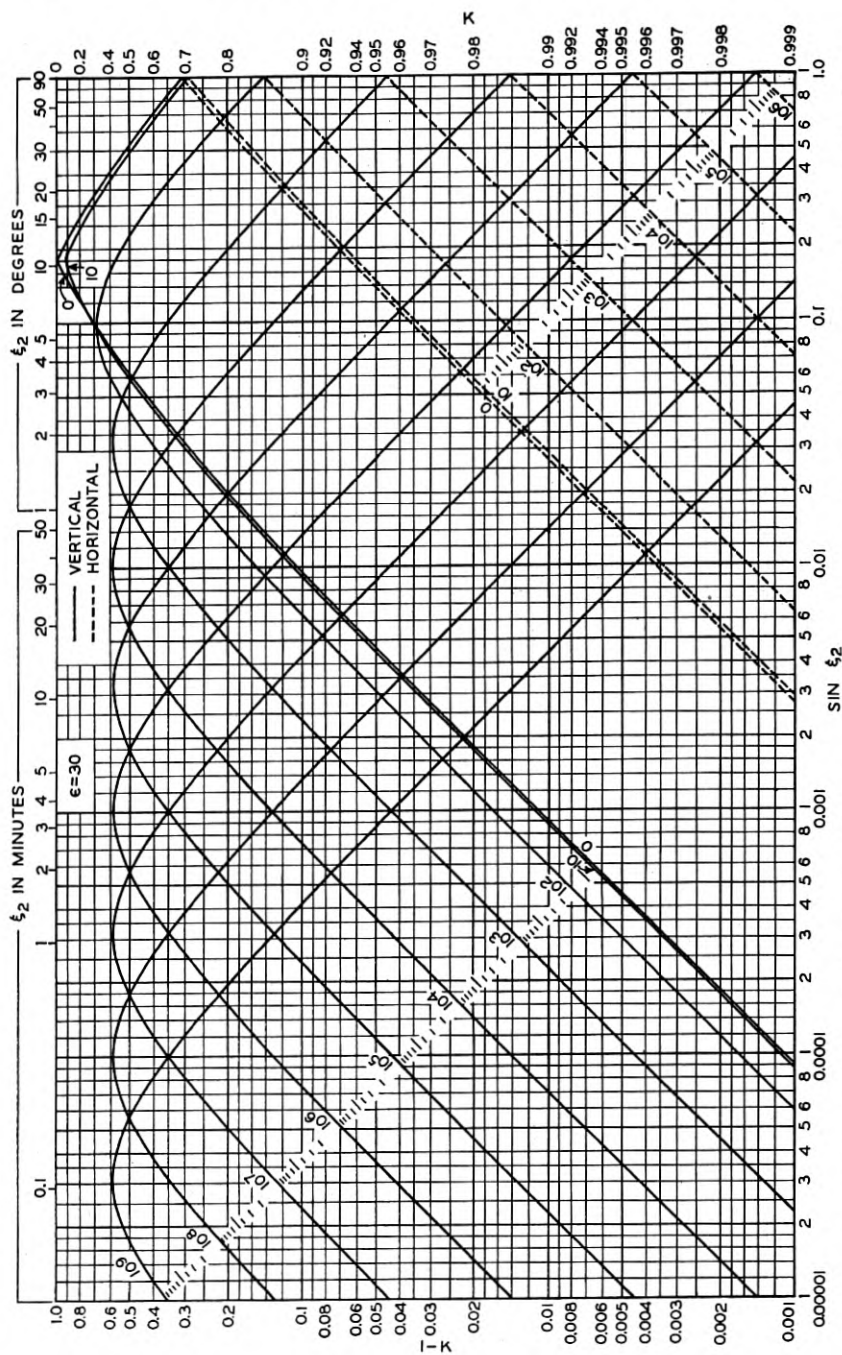

Fig. 9—Magnitude of reflection coefficient for $\epsilon = 30$. The number on each curve gives the value of q ($= 2\sigma f$) to which it applies. Vertical polarization is shown by solid lines, horizontal polarization by broken lines.

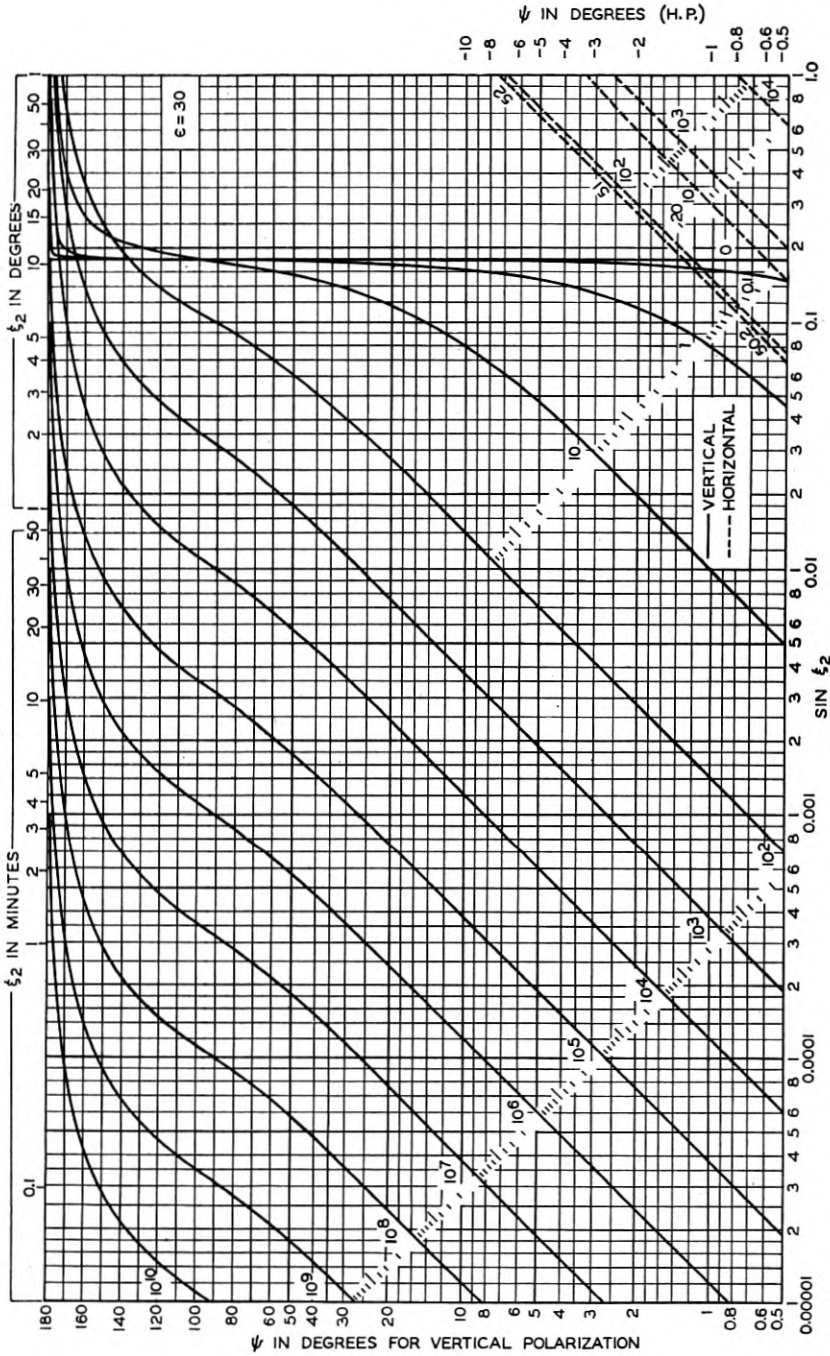

Fig. 10—Phase shift at reflection for $\epsilon = 30$. The number on each curve gives the value of g ($= 2\sigma/f$) to which it applies. Vertical polarization is shown by solid lines, horizontal polarization by broken lines.

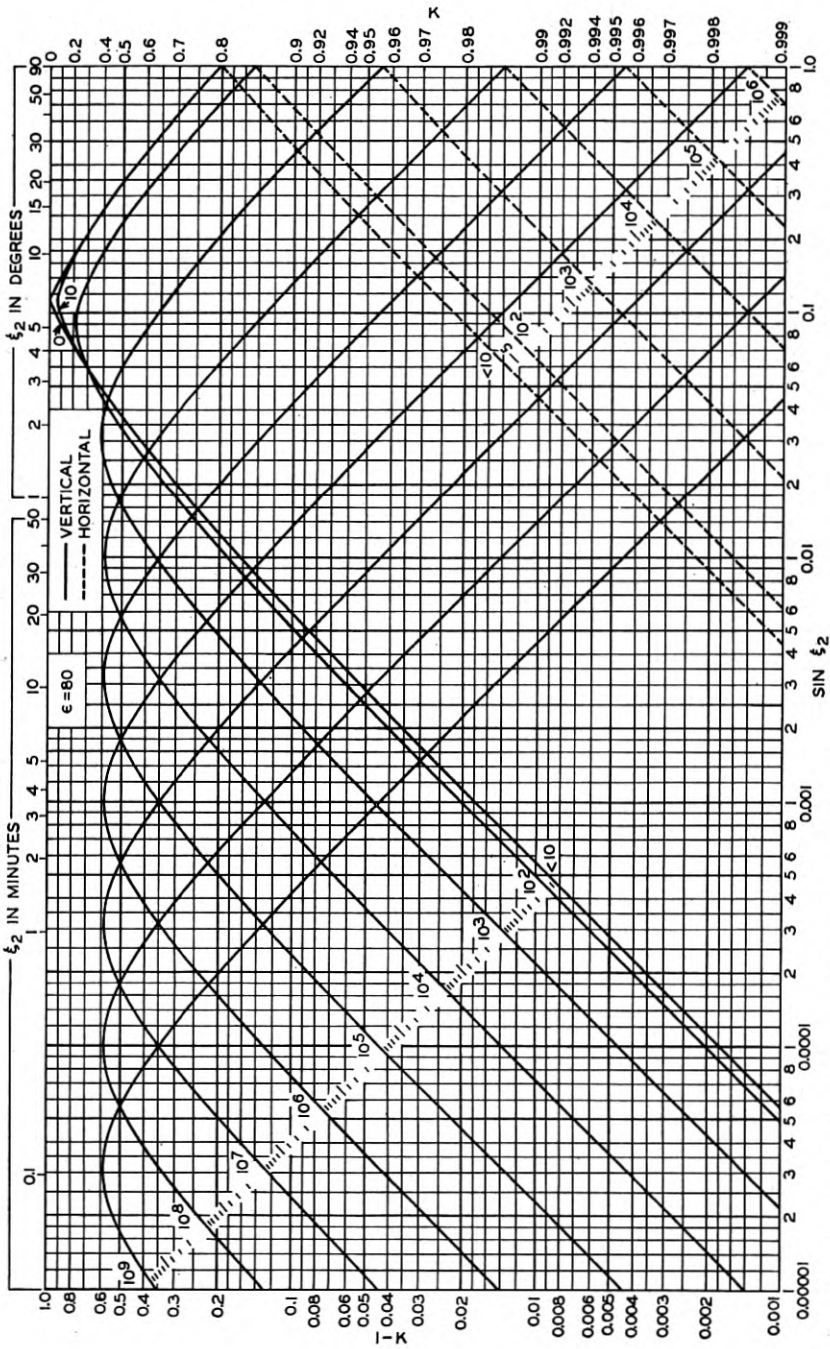

Fig. 11—Magnitude of reflection coefficient for $\epsilon = 80$. The number on each curve gives the value of $q (= 2\sigma f)$ to which it applies. Vertical polarization is shown by solid lines, horizontal polarization by broken lines.

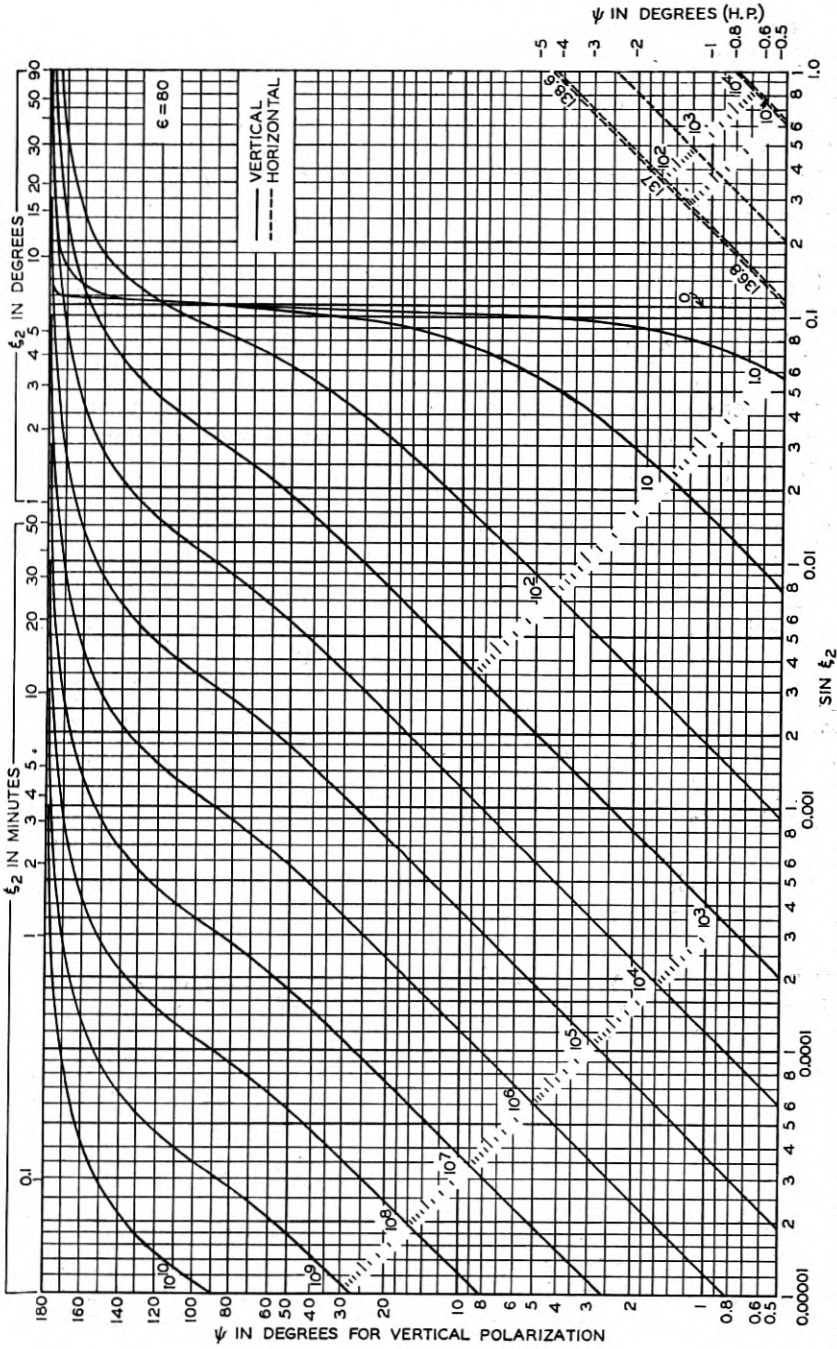

Fig. 12—Phase shift at reflection for $\epsilon = 80$. The number on each curve gives the value of q ($= 2\pi/f$) to which it applies. Vertical polarization is shown by solid lines, horizontal polarization by broken lines.

of the curves in this cycle may be used to obtain the values of $1 - K$ and ψ for any value of ξ_2 for which the curves go below the edge of the charts, as follows. Multiply ξ_2 by the smallest power of ten that will give a value on the chart, read the value of $1 - K$ or ψ corresponding to this new ξ_2 and divide this value of $1 - K$ or ψ by this power of ten to obtain the desired value of $1 - K$ or ψ . To obtain values of $1 - K$ and ψ for larger values of $q = 2\sigma/f$ than shown on Figs. 5-12 use is made of the fact that both of these quantities may be expressed as functions of the parameter $\sqrt{q} \sin \xi_2$ for large values of q , ($Q \ll 1$). That is, the shape of all the curves for values of Q that are small compared with unity is the same. Hence to obtain values of $1 - K$ and ψ for values of q greater than those for which curves are shown, divide the given q by some power of one hundred that gives a value of q for which a curve is drawn, and read the desired value of $1 - K$ or ψ opposite the value of $\sin \xi_2$ that is the same power of ten times the given $\sin \xi_2$ as the power of one hundred by which q was divided.

If the following characteristics of the curves are taken into consideration, interpolation is simplified. The similarity of the K -curves suggests relabelling the abscissa so that the value of K for some intermediate value of q may be read from one of the curves that is drawn. Any curve for a large value of q , ($Q \ll 1$), such as for $q = 10^n$ may be relabelled $q = x \times 10^n$ if the value of the abscissa is divided by \sqrt{x} . The same method is useful for small values of q but in this case the quantity by which the abscissa must be divided depends on the value of Q . Also in this case the shape of the curves changes with Q so that it is desirable to read the values from the curves drawn for the nearest values of q on either side of the desired value. The factor by which the abscissa must be multiplied to obtain the desired result may be inferred from the interpolation scale on the curves. When q is large the same method of interpolation may be employed for the ψ -curves as for the K -curves. When q is small, ($Q \gg 1$), the fact that ψ is proportional to q suggests the method of interpolation. (On vertical polarization when ξ_2 is greater than the Brewster angle, $\pi - \psi$ is proportional to q .) If the value of ψ for $q = x \times 10^{-n}$ is required, read the value of ψ from the curve for $q = 10^{-n}$ and multiply by x to obtain the desired value of ψ . If greater accuracy is required the values may be calculated from the equations and Table III of Appendix II without prohibitive labor.

When the antennas approach the ground, the ratio given in equation (21) approaches zero so that more terms of the complete solution must be taken into consideration. Wise¹⁰ has derived an expression for the effect of the ground on the Hertzian potential which when

added to the primary disturbance gives the following expression. Since it is now known⁴ that no exponential term must be added to this expression, it may be used to calculate the received field.

$$\Pi = \frac{HI}{4\pi} \left[\frac{e^{-2\pi i R_1/\lambda}}{R_1} + \frac{e^{-2\pi i R_2/\lambda}}{R_2} \sum_{n=1}^{\infty} \frac{g_n}{(-2\pi i R_2/\lambda)^{n-1}} \right], \quad (24)$$

where the geometry and nomenclature are given in Fig. 4.

$g_1 = R = -Ke^{i\psi}$ is the reflection coefficient and

$$g_{n+1} = \frac{n-1}{2} g_n - \frac{\sin \xi_2}{n} g_n' + \frac{\cos^2 \xi_2}{2n} g_n'', \quad (25)$$

where $\pi/2 - \xi_2$ is the angle of incidence and the primes denote differentiation with respect to $\sin \xi_2$. Performing the operation indicated in (11) on (24) the complete expression for the received field strength on vertical polarization is found to be

$$\begin{aligned} E = & -\frac{60\pi i HI}{\lambda} \left\{ \frac{e^{-2\pi i R_1/\lambda}}{R_1} \cos^2 \xi_1 + \frac{e^{-2\pi i R_2/\lambda}}{R_2} g_1 \cos^2 \xi_2 + \frac{e^{-2\pi i R_1/\lambda}}{R_1} \frac{1-3\sin^2 \xi_1}{2\pi i R_1/\lambda} \right. \\ & + \frac{e^{-2\pi i R_2/\lambda}}{R_2} \frac{g_1(1-3\sin^2 \xi_2) + 2g_1' \sin \xi_2 \cos^2 \xi_2 - g_2 \cos^2 \xi_2}{2\pi i R_2/\lambda} \\ & + \frac{e^{-2\pi i R_1/\lambda}}{R_1} \frac{1-3\sin^2 \xi_1}{(2\pi i R_1/\lambda)^2} + \frac{e^{-2\pi i R_2/\lambda}}{R_2} \left[\frac{g_1(1-3\sin^2 \xi_2) + 5g_1' \sin \xi_2 \cos^2 \xi_2}{(2\pi i R_2/\lambda)^2} \right. \\ & \left. + \frac{-g_1'' \cos^4 \xi_2 - g_2(1-5\sin^2 \xi_2) - 2g_2' \sin \xi_2 \cos^2 \xi_2 + g_3 \cos^2 \xi_2}{(2\pi i R_2/\lambda)^2} \right] \\ & + \sum_{n=3}^{\infty} \frac{e^{-2\pi i R_2/\lambda}}{R_2} \left[\frac{g_{n-1}(n-1)(1-[n+1]\sin^2 \xi_2)}{(-2\pi i R_2/\lambda)^n} \right. \\ & + \frac{(2n+1)g_{n-1}' \sin \xi_2 \cos^2 \xi_2 - g_{n-1}'' \cos^4 \xi_2}{(-2\pi i R_2/\lambda)^n} \\ & \left. + \frac{-g_n(1-[2n+1]\sin \xi_2) - 2g_n' \sin \xi_2 \cos^2 \xi_2 + g_{n+1} \cos^2 \xi_2}{(-2\pi i R_2/\lambda)^n} \right] \left. \right\}. \quad (26) \end{aligned}$$

The first term on the right of equation (26) is the vertical component of the electric field radiated by a vertical electric doublet in free space. The second term is the corresponding component reflected from the earth. The third and fifth terms are sometimes referred to as the induction and electrostatic components respectively. The remaining terms complete the effect of the ground. When the antennas approach the ground $R_1 \rightarrow R_2$, $\cos \xi_1 \rightarrow \cos \xi_2 \rightarrow 1$ and $g_1 \rightarrow -1$ so

that the first two terms tend to cancel. Under these conditions the sum of the first four terms of equation (26) may be written *

$$\frac{E}{E_0} = 1 + \left[R + \frac{(R+1)^2 \lambda d}{4\pi i (h_1 + h_2)^2} \right] e^{-4\pi i h_1 h_2 / \lambda d}. \quad (27)$$

At the greater antenna heights this expression also gives the correct result provided the distance, d , is large compared with the sum of the antenna heights, $h_1 + h_2$. For smaller antenna heights this expression is limited to distances for which the magnitude of the second term within the bracket is small (say less than 0.1). If this term is not small more terms of equation (26) must be taken into consideration. While equation (26) applies to vertical polarization only, equation (27) applies to both polarizations within the region for which it is valid provided the appropriate reflection coefficient is employed.

For antenna heights sufficiently small that the exponential factor of equation (27) may be replaced by the first two terms of its series expansion,

$$\frac{E}{E_0} = \frac{4\pi i h_1 h_2}{\lambda d} \left[1 + \frac{(a - ib)\lambda}{4\pi i h_1} \right] \left[1 + \frac{(a - ib)\lambda}{4\pi i h_2} \right], \quad (28)$$

where a and b are given in Table III of Appendix II (page 72). The first factor gives the well known expression for ultra-short-wave propagation over level land. The second two factors are important for antennas near the ground. When $h_1 \rightarrow h_2 \rightarrow 0$ this becomes

$$\frac{E}{E_0} = \frac{(a - ib)^2 \lambda}{4\pi i d}, \quad (29)$$

which is equivalent to the first term of the asymptotic expansion of the attenuation factor given in Part I.

A more useful form of equation (28) is

$$\frac{E}{E_0} = \frac{4\pi h_1 h_2}{\lambda d} \left[1 + a_1 \left(\frac{1}{h_1} + \frac{1}{h_2} \right) + a_2 \left(\frac{1}{h_1} + \frac{1}{h_2} \right)^2 + a_3 \frac{1}{h_1 h_2} + a_4 \frac{1}{h_1 h_2} \left(\frac{1}{h_1} + \frac{1}{h_2} \right) + a_5 \frac{1}{h_1^2 h_2^2} \right]^{1/2}, \quad (30)$$

* Equation (27) differs from equation (26) only in the dropping of terms in $1/d^3$. By leaving the exponential factor and the coefficient of reflection unexpanded the useful range of this formula is increased. The term

$$\frac{1}{2\pi i d / \lambda} \left[1 + R e^{-4\pi i h_1 h_2 / \lambda d} \right]$$

has been omitted from the right side of equation (27) since it can be shown that this term is always small compared with the remaining terms when $2\pi d / \lambda \gg 1$. In order to facilitate calculations by means of the reflection coefficient curves, $-g_2$ is replaced by $(R + 1)^2 d^2 / 2(h_1 + h_2)^2$ to which it is equal to the required order of approximation. Another form of equation (27) that may be preferred in some cases is given as equation (35) in the conclusions. This form results from substituting for $-g_2$ its value $(a - ib)^2 / 2$.

TABLE I

	a_1	a_2	a_3	$a_4 = a_1 a_2$	$a_5 = a_1^2$
1. Both V.P. and H.P.	$-\frac{b}{2\pi\lambda}$	$\frac{a^2 + b^2}{4(2\pi\lambda)^2}$	$-\frac{a^2 - b^2}{2(2\pi\lambda)^2}$	$-\frac{a^2 b + b^3}{4(2\pi\lambda)^3}$	$\frac{(a^2 + b^2)^2}{(4\pi\lambda)^4}$
2. V.P. in general	$-\frac{\sqrt{2}[q\sqrt{s} + r - \epsilon\sqrt{s-r}]}{s(2\pi\lambda)}$	$\frac{\epsilon^2 + q^2}{s(2\pi\lambda)^2}$	$-\frac{2[r\epsilon^2 + (2\epsilon - r)q^2]}{s^2(2\pi\lambda)^2}$	—	$\frac{(\epsilon^2 + q^2)^2}{s^2(2\pi\lambda)^4}$
3. V.P. $Q \ll 1$	$-\frac{\sqrt{2}q}{2\pi\lambda}$	$\frac{q}{(2\pi\lambda)^2}$	$-\frac{2(\epsilon + 1)}{(2\pi\lambda)^2} \rightarrow 0$	$-\frac{q\sqrt{2}q}{(2\pi\lambda)^3}$	$\frac{q^2}{(2\pi\lambda)^4}$
4. V.P. $Q \gg 1$	$-\frac{2q\sqrt{\epsilon-1}}{2\pi\lambda} \rightarrow 0$	$\frac{\epsilon^2/(\epsilon-1)}{(2\pi\lambda)^2}$	$-\frac{2\epsilon^2/(\epsilon-1)}{(2\pi\lambda)^2}$	$-\frac{2q\epsilon^2/(\epsilon-1)^{3/2}}{(2\pi\lambda)^3} \rightarrow 0$	$\frac{\epsilon^4/(\epsilon-1)^2}{(2\pi\lambda)^4}$
5. H.P. in general	$\frac{\sqrt{2}\sqrt{s-r}}{s(2\pi\lambda)}$	$\frac{1/s}{(2\pi\lambda)^2}$	$-\frac{2r/s^2}{(2\pi\lambda)^2}$	$\frac{\sqrt{2}\sqrt{s-r}/s^2}{(2\pi\lambda)^3}$	$\frac{1/s^2}{(2\pi\lambda)^4}$
6. H.P. $Q \ll 1$	$\frac{\sqrt{2}q}{2\pi\lambda}$	$\frac{1/q}{(2\pi\lambda)^2}$	$-\frac{2(\epsilon-1)/q^2}{(2\pi\lambda)^2} \rightarrow 0$	$\frac{\sqrt{2}q^2}{(2\pi\lambda)^3}$	$\frac{1/q^2}{(2\pi\lambda)^4}$
7. H.P. $Q \gg 1$	$\frac{q/(\epsilon-1)^{3/2}}{2\pi\lambda} \rightarrow 0$	$\frac{1/(\epsilon-1)}{(2\pi\lambda)^2}$	$-\frac{2/(\epsilon-1)}{(2\pi\lambda)^2}$	$\frac{q/(\epsilon-1)^{5/2}}{(2\pi\lambda)^3} \rightarrow 0$	$\frac{1/(\epsilon-1)^2}{(2\pi\lambda)^4}$

Where $Q = \epsilon f/2\sigma$, $q = 2\sigma f = \epsilon/Q$, $r = \epsilon - 1 + \sin^2 \xi_2$ and $s = \sqrt{r^2 + q^2}$. See Appendix II for further evaluations of a and b .

where the values of the a 's are given in Table I. A similar expression results for horizontal polarization so that the a 's are also evaluated for this case.

With the aid of equation (9) this may be expressed as a power ratio between short doublets:

$$\sqrt{\frac{P_r}{P_t}} = \frac{3h_1h_2}{2d^2} \left[1 + a_1 \left(\frac{1}{h_1} + \frac{1}{h_2} \right) + a_2 \left(\frac{1}{h_1} + \frac{1}{h_2} \right)^2 + a_3 \frac{1}{h_1h_2} + a_4 \frac{1}{h_1h_2} \left(\frac{1}{h_1} + \frac{1}{h_2} \right) + a_5 \frac{1}{h_1^2h_2^2} \right]^{1/2}. \quad (31)$$

For antennas at the heights above the ground that are usual in the ultra-short-wave range, the bracket in equation (31) is unity so we have the useful result that within certain limitations the ratio of received to transmitted power with simple antennas is independent of the wave-length.

When the Q of the ground is large in comparison with unity, equation (30) reduces to the somewhat simpler expression

$$\frac{E}{E_0} = \frac{4\pi h_1h_2}{\lambda d} \sqrt{\left[1 + \frac{a_0^2}{h_1^2} \right] \left[1 + \frac{a_0^2}{h_2^2} \right]}, \quad (32)$$

where $a_0^2 = \epsilon^2\lambda^2/4\pi^2(\epsilon - 1)$ for vertical polarization and $a_0^2 = \lambda^2/4\pi^2(\epsilon - 1)$ for horizontal polarization. Likewise when the Q of the ground is small in comparison with unity, equation (30) reduces to

$$\frac{E}{E_0} = \frac{4\pi h_1h_2}{\lambda d} \sqrt{\left[1 + \frac{b_0}{h_1} + \frac{b_0^2}{2h_1^2} \right] \left[1 + \frac{b_0}{h_2} + \frac{b_0^2}{2h_2^2} \right]}, \quad (33)$$

where $b_0 = -\sqrt{2q}\lambda/2\pi$ for vertical polarization and $b_0 = \sqrt{2/q}\lambda/2\pi$ for horizontal polarization.

Equations (28), (30), (31), (32) and (33) are valid for all distances beyond those for which the received field strength begins to vary inversely with the square of the distance provided the antennas are not too high. This range of validity contains all practical distances for ultra-short-wave propagation over land and fresh water and the longer distances for ultra-short-wave propagation over sea water. For antennas at greater heights above the ground, equation (27) is required; but usually the range of antenna heights between those for which equation (21) and those for which equation (30) are valid, is small.

The applicability of the approximate equations to the problem in hand may be ascertained as follows. First calculate the parameter x of Fig. 2 to determine if the distance is sufficient for the field strength

to be inversely proportional to the square of the distance. The deviation of the attenuation curve from the straight line $E/2E_0 = 1/x$ shows the degree of this approximation for antennas on the ground. If this is satisfactory then equation (27) applies.* An evaluation of the parameters in equation (27) for the greatest antenna height allows a determination of whether equations (28) and (30) apply. If R is within the range where it is a linear function of ξ_2 , that is if the curves for $1 - K \text{ vs } \sin \xi_2$ (Figs. 5, 7, 9 and 11) are straight lines for this value of ξ_2 , and if $\sin 4\pi h_1 h_2 / \lambda d$ is approximately equal to $4\pi h_1 h_2 / \lambda d$, then equations (28) and (30) apply. If also Q is very different from unity then either equation (32) or equation (33) applies.

An evaluation of the parameters in equation (27) for the lowest height will allow a determination of whether equation (21) applies. If the second term within the brackets is small compared with the first term, equation (21) applies.

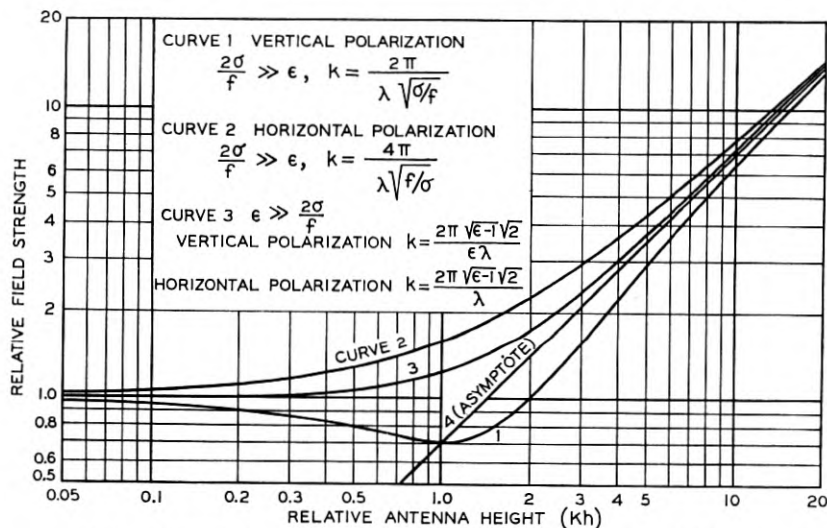

Fig. 13—Variation of received field strength with antenna height.

The variations of the received field strength with antenna height for the four cases of especial interest given by equations (32) and (33) are plotted in Fig. 13. The ordinate gives the ratio of the field strength at the height corresponding to the abscissa to that for zero height. If both antennas are off the ground the product of the ratios corresponding to the antenna heights gives the ratio of the field strength to

* As the antennas are removed from the earth's surface the error introduced because of this deviation is less.

that for both antennas on the ground. The distances between the curves and the straight line labelled "asymptote" give the magnitudes of the factors in equations (32) and (33) by which $(4\pi h_1 h_2 / \lambda d) E_0$ must be multiplied to give the field strength.

For transmission over a ground of good conductivity ($Q \ll 1$) with vertical antennas there is a least favorable height for the antennas as indicated by curve 1 of Fig. 13. With both antennas at this height, which is about $1.7\lambda^{3/2}$ meters for ocean water, the received field is one-half what it would be if both antennas were on the ground.

Curve 2 for transmission on horizontal polarization over ground of good conductivity ($Q \ll 1$) shows a steady increase in the received field with increase in antenna height. If curves 1 and 2 were plotted against antenna height in meters for any given ground conditions ($Q \ll 1$), curve 2 for horizontal polarization would not depart appreciably from its asymptote until such small antenna heights were reached that curve 1 for vertical polarization would be substantially independent of antenna height. Hence curves 1 and 4 give a comparison of the received field strength at any height on the two polarizations. At the height for which the field strength is minimum on vertical polarization, the field strength is independent of polarization. For lower antennas vertical polarization gives the greater fields, while for higher antennas horizontal polarization gives the greater fields. The maximum advantage of horizontal polarization over vertical polarization occurs at twice this height and is a factor of two.

As Q increases curves 1 and 2 merge into curve 3 for transmission over a perfect dielectric. While the shape of the curves for the two polarizations is identical and the received field strength is independent of polarization at the greater antenna heights, the field strength is ϵ^2 times as great on vertical polarization as on horizontal polarization with antennas on the ground.

As an example of the use of the curves for the reflection coefficient the relative advantages of different types of ground for low-angle reception (or transmission) on vertical polarization has been calculated. With vertical antennas both the direct and the reflected components are reduced by the factor $\cos \xi_2$ so that the right-hand side of equation (21) must be multiplied by $\cos \xi_2$. The receiving antenna will be assumed to be on the ground.* Figure 14 gives the resulting curves for the indicated ground constants. For very low angles the curves are parallel, indicating that the relative advantages of different types of ground are independent of the angle at these angles. The gain in

* For higher angles of reception the relative advantages of different types of ground may be made approximately the same by properly adjusting the antenna height.

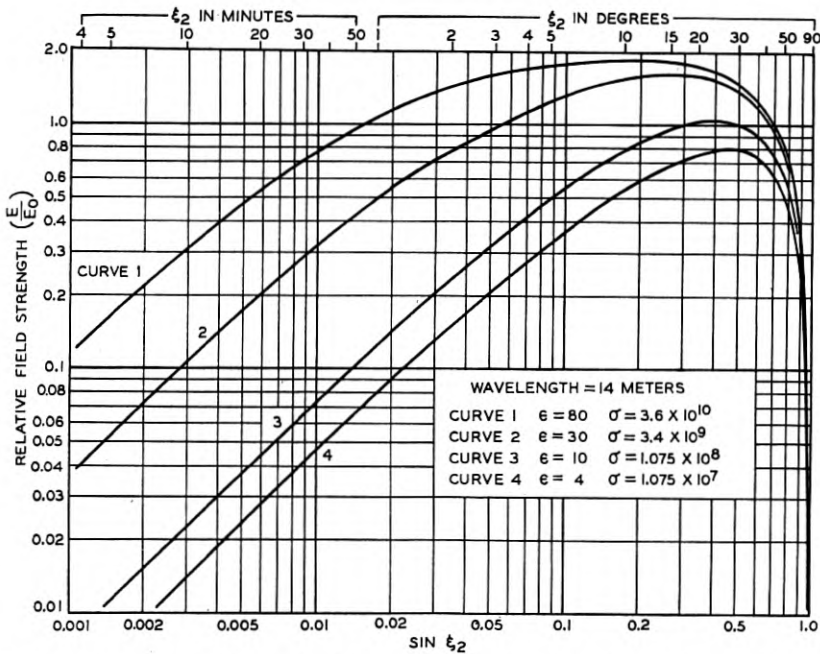

Fig. 14—Relative advantage of different types of ground for low-angle reception on 14 meters with vertical polarization.

locating an antenna above sea water instead of above the following grounds on a wave-length of 14 meters is given in Table II.

TABLE II

	Ground Constants		Gain in db for reception at			
	Dielectric Constant - ϵ	Conductivity - σ	Small Angles	1°	2°	5°
	Electro-static Units	Electro-static Units				
1. Sea Water . . .	80	3.6×10^{10}	0	0	0	0
2. Salt Marsh . . .	30	3.4×10^9	10	7	5	3
3. Dry Ground . .	10	1.075×10^8	24	19	15	11
4. Rocky Ground.	4	1.075×10^7	28	23	20	14

ACKNOWLEDGMENT

The value of a paper of this type depends to a large degree upon its freedom from errors. With this thought in mind the equations and tables have been checked by my associate, Mr. Loyd E. Hunt, whose cooperation is hereby acknowledged.

CONCLUSIONS

For transmission over plane earth with antennas on the ground the received field strength in volts per meter is given by the formula,

$$E = \frac{120\pi HI}{\lambda d} F(x) = \frac{3\sqrt{10}\sqrt{P}}{d} F(x), \quad (34)$$

where HI is the transmitting ampere-meters, P is the radiated power in watts exclusive of ground losses, d the distance in meters, λ the wave-length in meters and $F(x)$ is the factor plotted in Fig. 2. When the Q of the ground is large compared with unity, the factor plotted in Fig. 3 is to be preferred to that plotted in Fig. 2.

When the antennas are not on the ground the received field strength may be calculated by means of equation (27) or its equivalent,

$$\frac{E}{E_0} = 1 + \left[R + \frac{(a - ib)^2 \lambda}{4\pi id} \right] e^{-4\pi i h_1 h_2 / \lambda d}, \quad (35)$$

where the reflection coefficient,

$$R = -Ke^{\psi} = -1 + (a - ib) \sin \xi_2 + \dots \quad (36)$$

The quantities K and ψ are plotted in Figs. 5-12.

When the antennas are sufficiently removed from the ground that the second term within the bracket of equation (35) may be neglected the simpler expression given in equation (21) applies.

$$E/E_0 = \sqrt{(1 - K)^2 + 4K \sin^2(\gamma/2)}. \quad (21)$$

When the distance between antennas is sufficiently great that the exponential factor in equation (35) may be replaced by the first two terms in its series expansion, the received field strength may be calculated by equation (30) and Table I. Four special cases are given by equations (32) and (33) and Fig. 13.

APPENDIX I

The values of the components of

$$W = A + D \approx A - B/2 + F \approx C + F$$

are:

$$A = \frac{1}{1 - \tau^4} \left[1 + \sum_{n=1}^{\infty} \left(\frac{2\pi i \tau^2 d / \lambda}{1 + \tau^2} \right)^n \frac{a_n}{1 \cdot 3 \cdot 5 \cdots (2n - 1)} \right], \quad (37)$$

$$B = \frac{1}{1 - \tau^4} \sqrt{2\pi \sqrt{1 + \tau^2}} \sqrt{\frac{2\pi i \tau^2 d / \lambda}{1 + \tau^2}} e^{(2\pi d / \lambda)(1 - 1/\sqrt{1 + \tau^2})}, \quad (38)$$

$$C = -\frac{1}{1 - \tau^4} \sum_{n=1}^{\infty} \left(\frac{1 + \tau^2}{-2\pi\tau^2 id/\lambda} \right)^n [1 \cdot 3 \cdot 5 \cdots (2n - 1)] c_n, \quad (39)$$

$$D = -\frac{\tau^2}{1 - \tau^4} e^{(2\pi id/\lambda)(1-1/\tau)} \sum_{n=0}^{\infty} D_n \left(\frac{2\pi id}{\lambda\tau} \right)^n, \quad (40)$$

$$F = \frac{\tau^2}{1 - \tau^4} e^{(2\pi id/\lambda)(1-1/\tau)} \sum_{n=1}^{\infty} \left(\frac{1 + \tau^2}{-2\pi id/\lambda\tau} \right)^n [1 \cdot 3 \cdot 5 \cdots (2n - 1)] f_n, \quad (41)$$

where

$$\frac{1}{\tau^2} = \epsilon - 2i\sigma/f \quad (42)$$

and τ is in the first quadrant. The positive square root of i is to be taken in equation (38).

These expressions follow from those given by Wise ¹¹ when the sign of i is changed so that the implied time factor is $e^{i\omega t}$ in accordance with engineering practice instead of the $e^{-i\omega t}$ employed by Sommerfeld and Wise. Their expressions were derived for an antenna half in air and half in the earth. To obtain the above expressions which apply to antennas on the surface of the earth, Wise's expressions have been multiplied by $2/(1 + \tau^2)$. A corresponds to his expression (5), B to his (12), C to his (8) and D to his (6). The quantities, a_n and c_n are substantially unity except when τ is not small.

$$\left. \begin{aligned} a_1 &= \frac{\tanh^{-1}\sqrt{k}}{\sqrt{k}} = \sum_{n=1}^{\infty} \frac{k^{n-1}}{(2n-1)}, & a_2 &= \frac{3(a_1 - 1)}{k}, \\ a_n &= \frac{(2n-1)(2n-3)(a_{n-1} - a_{n-2})}{(n-1)^2 k}, \end{aligned} \right\} \quad (43)$$

$$\left. \begin{aligned} c_1 &= 1, & c_2 &= 1 - \frac{k}{3}, \\ c_n &= c_{n-1} - \frac{(n-1)^2 k}{(2n-1)(2n-3)} c_{n-2}, \end{aligned} \right\} \quad (44)$$

$$\left. \begin{aligned} D_0 &= 1, & D_1 &= \sqrt{l} \tanh^{-1} \sqrt{l} = \sum_{n=1}^{\infty} \frac{l^n}{(2n-1)}, \\ D_2 &= D_1 - l, & D_n &= \frac{(2n-3)D_{n-1} - lD_{n-2}}{(n-1)^2}, \end{aligned} \right\} \quad (45)$$

where

$$k = \frac{\tau^2}{1 + \tau^2} = \frac{1}{\epsilon + 1 - 2i\sigma/f}, \quad (46)$$

$$l = \frac{1}{1 + \tau^2} = \frac{\epsilon - 2i\sigma/f}{\epsilon + 1 - 2i\sigma/f}, \quad (47)$$

The f_n 's are the same functions of l that the c_n 's are of k .

APPENDIX II

The phase angle introduced by the path difference is:

$$\begin{aligned} \Delta &= \frac{2\pi}{\lambda} \left[\sqrt{d^2 + (h_1 + h_2)^2} - \sqrt{d^2 + (h_1 - h_2)^2} \right] \\ &= \frac{4\pi h_1 h_2}{\lambda d} \left[1 - \frac{h_1^2 + h_2^2}{2d^2} + \frac{3h_1^4 + 10h_1^2 h_2^2 + 3h_2^4}{8d^4} - \dots \right]. \quad (48) \end{aligned}$$

The magnitude and phase of the reflection coefficient are given by the following equations.

$$R = -Ke^{i\psi}$$

$$K = \sqrt{\frac{1-\alpha}{1+\alpha}} = 1 - \alpha + \frac{1}{2}\alpha^2 - \frac{1}{2}\alpha^3 + \frac{3}{8}\alpha^4 + \dots,$$

$$\alpha = \frac{mx}{1+x^2}, \quad \tan \psi = \frac{nx}{1-x^2}, \quad \sin \xi_2 = x/\sqrt{c},$$

$$m = a/\sqrt{c}, \quad n = b/\sqrt{c}, \quad \xi_2 = \frac{\pi}{2} - \theta,$$

where θ is the angle of incidence.

$$\begin{aligned} q &= 2\sigma/f = \epsilon/Q, \quad r = \epsilon - 1 + \sin^2 \xi_2, \\ s &= \sqrt{r^2 + q^2}, \quad \frac{r}{s} = \left[1 + \left(\frac{q}{r} \right)^2 \right]^{-1/2}, \end{aligned}$$

where ϵ and σ are respectively the dielectric constant and conductivity of the ground in electrostatic units and f is the frequency in cycles per second. The values a , b and c depend on the polarization and ground constants as shown in Table III below.

For grazing incidence, $\xi_2 \rightarrow 0$, $1 - K \rightarrow a\xi_2$ and $\psi \rightarrow b\xi_2$. On vertical polarization near normal incidence for $\epsilon^2 + q^2 \gg 1$, $x \gg 1$ and the approximations $1 - K \rightarrow a/c \sin \xi_2$ and $\psi \rightarrow \pi - b/c \sin \xi_2$ are useful. These coefficients are given in Table III.

For normal incidence, $\sin \xi_2 = 1$, $\alpha = \frac{\sqrt{2}\sqrt{s+\epsilon}}{s+1}$ and $\tan \psi = \frac{\sqrt{2}\sqrt{s-\epsilon}}{1-s}$.

At Brewster's angle, $\cot \xi_2 = \sqrt{\epsilon}$ and $K = 0$ when $q = 0$ for vertical polarization. For vertical polarization the minimum value of K is $\sqrt{\frac{2-m}{2+m}}$ and occurs when $x = 1$ and $\sin \xi_2 = \sqrt{\frac{s}{\epsilon^2 + q^2}}$. For horizontal polarization the maximum value of b occurs when $q = \sqrt{3}r$ and is equal to $-1/\sqrt{2}r$. Under these conditions $s = 2r$ and $n = -1$.

TABLE III

	m	n	$\frac{1}{\sqrt{c}}$	$a = m\sqrt{c}$	$b = n\sqrt{c}$	$\frac{a}{c} = \frac{m}{\sqrt{c}}$	$\frac{b}{c} = \frac{n}{\sqrt{c}}$
1. Vertical Polarization in General	$\sqrt{2} \left[\sqrt{1 + \left(\frac{r}{s}\right)^2} + \sqrt{1 + \left(\frac{r}{\epsilon}\right)^2} \right]$	$\sqrt{2} \left[\sqrt{1 + \left(\frac{r}{s}\right)^2} - \sqrt{1 + \left(\frac{r}{\epsilon}\right)^2} \right]$	$\sqrt{\frac{s}{\epsilon^2 + q^2}}$	$\frac{\sqrt{2}}{s} [\epsilon\sqrt{s+r} + q\sqrt{s-r}]$	$\frac{\sqrt{2}}{s} [q\sqrt{s+r} - \epsilon\sqrt{s-r}]$		
2. V. P., $Q \ll 1$	$\sqrt{2}$	$\sqrt{2}$	$\frac{1}{\sqrt{q}}$	$\sqrt{2q}$ *	$\sqrt{2q}$ *	$\sqrt{\frac{2}{q}}$	$-\sqrt{\frac{2}{q}}$
3. V. P., $Q \gg 1$	2	$\frac{2r - \epsilon}{\epsilon r} q$	$\frac{\sqrt{r}}{\epsilon} = \sqrt{\frac{\epsilon - 1}{\epsilon^2 - x^2}}$	$\frac{2\epsilon}{\sqrt{\epsilon - 1}}$ *	$\frac{(\epsilon - 2)q}{(\epsilon - 1)^{3/2}}$ *	$\frac{2\sqrt{\epsilon - 1 + \sin^2 \xi_2}}{\epsilon}$	$\frac{7\epsilon - 8 + 8 \sin^2 \xi}{(\epsilon - 1 + \sin^2 \xi)} \frac{\sqrt{\epsilon - 1 + \sin^2 \xi_2}}{4\epsilon^2} q$
4. Horizontal Polarization in General	$\sqrt{2} \sqrt{1 + \frac{r}{s}}$	$-\sqrt{2} \sqrt{1 - \frac{r}{s}}$	\sqrt{s}	$\frac{\sqrt{2}\sqrt{s+r}}{s}$	$-\frac{\sqrt{2}\sqrt{s-r}}{s}$		
5. H. P., $Q \ll 1$	$\sqrt{2}$	$-\sqrt{2}$	\sqrt{q}	$\sqrt{\frac{2}{q}}$	$-\sqrt{\frac{2}{q}}$		
6. H. P., $Q \gg 1$	2	$-\frac{q}{r}$	$\sqrt{r} = \frac{\epsilon - 1}{1 - x^2}$	$\frac{2}{\sqrt{\epsilon - 1 + \sin^2 \xi_2}}$	$\frac{q}{[\epsilon - 1 + \sin^2 \xi_2]^{3/2}}$		

* For vertical polarization, $x \rightarrow 0$ requires $\xi_2 \rightarrow 0$. The tabulated values of a and b in rows 2 and 3 are true only for $\xi_2 \rightarrow 0$. For horizontal polarization x is never large.

APPENDIX III

In using the equations and curves of this paper to calculate the field, the ground constants appropriate to the location of interest should be employed. The literature on ground constants is already large and is continually increasing. An exhaustive summary of this literature would be out of place here, but as an aid to those who do not have available the ground constants of the locality in which they are interested, the following table is presented.

The first four sets of values have been widely used. The conductivities of grounds 1 and 5 have been accepted by the Madrid Conference as representative of ocean water and average ground. The conductivities of grounds 5 to 8 were obtained from field strength surveys.¹² The conductivities of water 9 to 11 were obtained from sample measurements by Mr. L. A. Wooten of these laboratories at a temperature of 25° C. Both the conductivity and dielectric constant of water vary appreciably with the temperature, approximately in accordance with the relationships

$$\begin{aligned}\sigma &= \sigma_{25}(1 + 0.02t), \\ \epsilon &= 80 - 0.4(t - 20),\end{aligned}$$

where t is the temperature in degrees centigrade.* The conductivity also varies from place to place in the ocean due to changes in its composition. The constants of grounds 12 to 15 were obtained from measurements on samples by Mr. C. B. Feldman of these laboratories. The constants of grounds 16 and 17 are typical of measurements made by Dr. R. L. Smith-Rose on English soil.¹⁴

In general, both the conductivity and dielectric constant of the ground vary with temperature, moisture content and frequency as well as location. For a more complete treatment and extensive bibliographies see C. B. Feldman¹³ and R. L. Smith-Rose.¹⁴

Column 6 of Table IV gives the frequency for which $Q = 1$ for each type of ground. At higher frequencies $Q > 1$ and the ground tends to resemble a dielectric; at lower frequencies it tends to resemble a conductor.

Columns 7, 8, 9 and 10 give the values of the parameter x of Fig. 2 for a distance of 1 km. and the indicated frequency. For any other distance, x is equal to these values times the distance in kilometers. When $Q \ll 1$, x is proportional to the distance and to the square of the frequency. When the frequency is small compared with that

* The first equation was obtained from the values given for sodium chloride in the International Critical Tables. The second equation is given in the same source for pure water.

given in Column 6 these conditions are fulfilled and the proportionality factor is given in Columns 7, 8 and 9 for three frequencies. When the frequency is large compared with that given in Column 6, $Q \gg 1$ and the parameter x of Fig. 2 is proportional to the distance and the first power of the frequency. This proportionality factor is given in Column 10 for a frequency of 50 mc.

The parameter $q = 2\sigma/f$ of Figs. 5-12 is given in Columns 10, 11 and 12 for three frequencies.

BIBLIOGRAPHY

1. Arnold Sommerfeld, "Ausbreitung der Wellen in der drahtlosen Telegraphie. Einfluss der Bodenbeschaffenheit auf gerichtete und ungerichtete Wellenzüge," *Jahrb. d. drahtl. T. u. T.* **4**, 157-176, December, 1910.
2. Bruno Rolf, "Numerical Discussion of Prof. Sommerfeld's Attenuation Formula for Radio Waves," Ingeniörs Vetenskaps Akademien, Stockholm, 1929 and "Graphs to Prof. Sommerfeld's Attenuation Formula for Radio Waves," *Proc. I.R.E.*, **18**, 391-402, March, 1930.
3. W. Howard Wise, "Note on the Accuracy of Rolf's Graphs of Sommerfeld's Attenuation Formula," *Proc. I.R.E.*, **18**, 1971-1972, November, 1930.
4. Chas. R. Burrows, "The Surface Wave in Radio Propagation over Plane Earth," *Proc. I.R.E.*, **25**, February, 1937.
5. E. J. Sterba, "Theoretical and Practical Aspects of Directional Transmitting Systems," *Proc. I.R.E.*, **19**, 1184-1215, July, 1931.
6. W. L. Barrow, "On the Impedance of a Vertical Half-Wave Antenna above an Earth of Finite Conductivity," *Proc. I.R.E.*, **22**, 150-167, February, 1935.
7. K. F. Niessen, "Erdabsorption bei vertikalen Dipolantennen in grosser Höhe über ebener Erde," *Ann. d. Phys.* **5**, **25**, 673-687, March, 1936.
8. M. J. O. Strutt, "Strahlung von Antennen unter dem Einfluss der Erdbodeneigenschaften; (a) elektrische Antennen, (b) magnetische Antennen, (c) Rechnung in zweiter Näherung, (d) Strahlungsmessungen mit Antennen," *Ann. d. Phys.*, **5**, **1**, 721-772; **4**, 1-16; **9**, 67-91, 1929-1931.
9. W. Howard Wise, "Asymptotic Dipole Radiation Formulas," *Bell. Sys. Tech. Jour.*, **8**, 662-671, October, 1929.
10. W. Howard Wise, "Note on Dipole Radiation Theory," *Physics*, **4**, 354-358, October, 1933.
11. W. Howard Wise, "The Grounded Condenser Antenna Radiation Formula," *Proc. I. R. E.*, **19**, 1684-1689, September, 1931.
12. Glenn D. Gillett and Marcy Eager, "Some Engineering and Economic Aspects of Radio Broadcast Coverage," *Proc. I.R.E.*, **24**, 190-206, February, 1936.
13. C. B. Feldman, "The Optical Behavior of the Ground for Short Radio Waves," *Proc. I.R.E.*, **21**, 764-801, June, 1933.
14. R. L. Smith-Rose, "Electrical Measurements on Soil with Alternating Currents," *I.E.E. Jour.* (London) **75**, 221-237, August, 1934.

The Inductive Coordination of Common-Neutral Power Distribution Systems and Telephone Circuits *

By J. O'R. COLEMAN† and R. F. DAVIS

Early installations of three-phase, four-wire power distribution systems of the multi-grounded or common-neutral type in some cases created noise problems involving neighboring telephone circuits. Operating experience, studies of specific situations and comprehensive cooperative research over a period of years have developed means of largely avoiding difficulties of this character. The relative importance of various features of the power and telephone systems which have been found to affect the noise induction problems involved is discussed and the general cooperative procedures, most helpful in conversions to or extensions of these types of power distribution systems, are outlined.

INTRODUCTION

PRIOR to about 1915, delta-connected 2300-volt, three-phase, primary circuits were used extensively for the distribution of electric current. While some distribution networks throughout the country still operate in this manner, the marked increase in load densities, starting about 1915, often made the retention of the 2300-volt delta system impracticable. In a few instances the development of the particular network was at a point where it was feasible to change from the 2300-volt delta to a 4600-volt delta arrangement but in other cases the existing equipment represented too great an investment for a complete change of this character.

From studies of various methods of caring for the augmented load densities it was found that the existing equipment could largely be saved and the capacity of the distributing networks substantially increased by converting them to a 2300/4000-volt, star-connected, four-wire primary system. By about 1925 this system had extended to most of the larger cities and most power companies had found it economical for use in at least some parts of their territories.

In using the 2300-volt equipment on the 4000-volt, four-wire system it was necessary to stabilize the neutral conductor in some way. Most of the four-wire systems had the neutral conductor grounded at the

* Published in *Electrical Engineering*, January, 1937.

† Mr. J. O'R. Coleman, joint author of this paper, is an engineer on the staff of the Edison Electric Institute, New York City.

substation only although sometimes low-voltage lightning arresters were placed on it at various points in the distribution network to aid in its stabilization in case of a break in it. In some instances, at the time of the installation of the four-wire system, the primary neutral was connected at various points in the network to driven ground rods thus resulting in a multi-grounded neutral system. In at least one instance the neutral conductor was not solidly grounded even at the substation, it being connected to ground through lightning arresters.

The experiences of the power companies with the multi-grounded neutral were generally favorable. It was found to be more reliable and to embrace some simplifications over other distribution methods. While the early multi-grounded neutral arrangements were obtained by making connections to ground along the primary neutral conductor and interconnecting it, at service transformers, to well-grounded secondary neutrals a further simplification in the arrangement was readily apparent.

It will be noted in Fig. 1 that this interconnection of the primary and secondary neutrals resulted in two grounded neutrals on the pole line in all sections where the secondary neutral existed. In extending the multi-grounded neutral arrangement or in reconstructing existing portions of the network, these two neutrals were combined into a single well-grounded conductor continuous in all portions of a feeder area and often continuous in all parts of a substation area or of several contiguous substation areas. This arrangement, called the "common-neutral," which was first extensively applied in Minneapolis* by Mr. S. B. Hood, resulted in certain savings in equipment and relief of congested pole heads and in a neutral network most effectively grounded since all secondary neutral grounds were thus made available, in addition to any driven grounds along the pole line.

The operation of this system in Minneapolis showed many advantages in the protection of secondary networks from the effects of voltage rises under abnormal conditions. In addition a paper presented in 1925 by Mr. Hood¹ pointed out that over a period of three years the rate of transformer failure was reduced to 8/10 of 1 per cent per annum. This excellent performance in transformers arose undoubtedly from the fact that with the "common-neutral" or interconnected neutral arrangements the lightning arresters are connected directly around the transformers. Later studies showed that the connection of the lightning arresters directly between the primary conductors and secondary neutral provides a degree of protection which cannot readily be obtained in any other way.^{2, 3, 4, 5, 6, 7}

* Prior to applying this system in Minneapolis, Mr. Hood introduced it at Toronto, Canada.

In urban areas, the multi-grounded or common-neutral method of distribution introduced, in some instances, noise induction in nearby telephone circuits. In view of this fact an extensive cooperative investigation was undertaken by Project Committee No. 6 of the

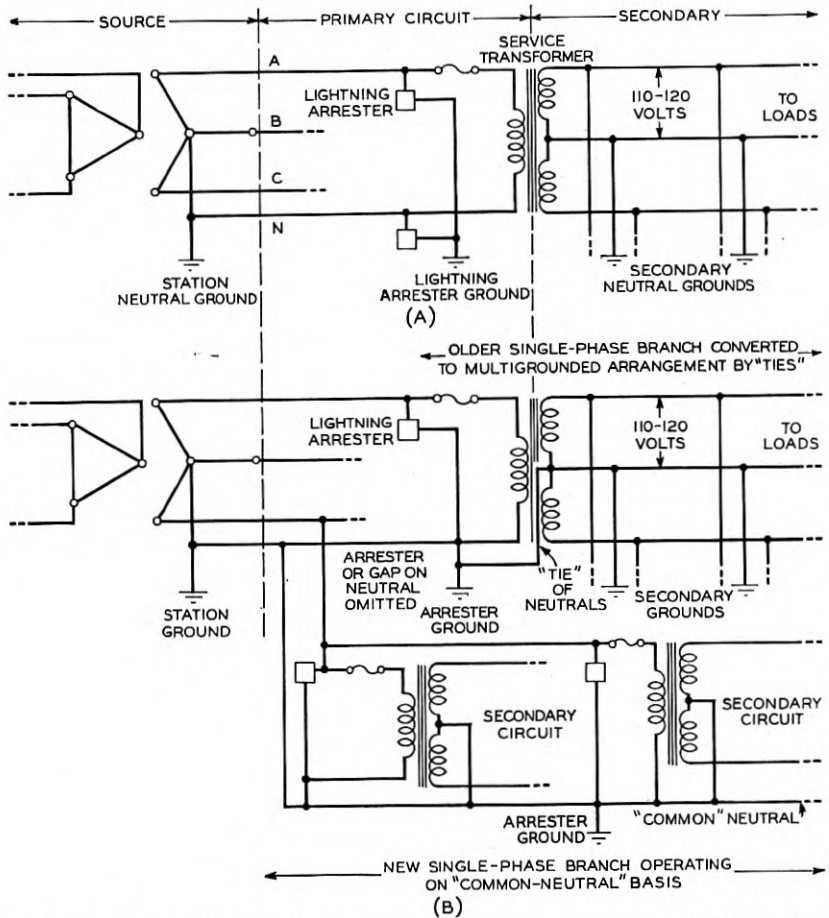

Fig. 1—A. Simplified feeder operating with primary neutral grounded at source only. B. Simplified feeder operating with multiple grounds on primary neutral—older part of feeder having ties between primary and secondary and new extensions being of common-neutral arrangement.

Joint Subcommittee on Development and Research of the National Electric Light Association and Bell Telephone System to determine the factors involved in the coordination of local power distribution systems and telephone systems. A study was carried out in Minneapolis during the years 1924 to 1926 having as its primary objective the determination of the factors involved where the telephone distribution

was largely in aerial cable. The investigation was continued in Elmira, New York in 1926 to 1929 to embrace the factors introduced when the exchange telephone plant was of open-wire construction.⁸ Supplementing these detailed technical studies, an investigation of certain economic features of various arrangements of power and telephone distributing methods and of their practical application under varying conditions was carried out in California in 1928 and 1929. As a result of these investigations the various factors involved in the coordination of multi-grounded or common-neutral power systems and telephone distribution systems were determined and certain practices developed for the coordination of these systems under various conditions in urban areas.⁹

The purpose of this paper is that of briefly outlining a few of the more important features of power and telephone circuits affecting noise coordination. Following such a review there is presented a list of measures which extended experience has shown will, where given proper consideration by both parties, enable multi-grounded or common-neutral power circuits and telephone circuits to live harmoniously. No attempt is made, however, to reiterate the extensive technical information obtained from the investigations outlined above as these are adequately covered in the references cited.

RECENT TRENDS

During the past few years there has been extensive conversion from other types of urban power distribution to the multi-grounded or common-neutral system of primary distribution. Where there exists a three-phase, three-wire delta circuit the system is converted by making the secondary neutral network continuous, reinforcing it where necessary, and making the required changes in transformer connections. Where there is a three-phase, four-wire uni-grounded primary system the conversion is, as previously mentioned, made by interconnecting the primary and the secondary neutral at each load transformer generally removing the primary neutral only at the time of major rebuilding. In either case extensions are usually made using a single neutral in the secondary position.

In the urban areas most of the multi-grounded or common-neutral systems are of the 2300/4000-volt class, although there are a few instances where 4600-volt systems have been converted. At the present time there is being constructed a 6900/12,000-volt common-neutral distribution system at Wichita, Kansas.

The distinct trend in power distribution practice has been, in no small measure, influenced by the improved overall protection features

readily obtained by the multi-grounded neutral arrangement as well as by certain equipment savings. The recent emphasis placed on the electrification of rural areas and the distinct need for maximum service continuity on rural power circuits has increased the interest in the use of the multi-grounded or common-neutral method of distribution in rural areas. The rural systems are generally of the 7600/13,200-volt class, although 4600/8000-volt circuits have been used to some extent.

The factors affecting inductive coordination involved in the use of the common-neutral method of distribution in rural areas, are somewhat different from those encountered in urban areas. This is largely due to the lower load densities, the greater lengths of circuits, higher operating voltages and to the somewhat different types of equipment employed in rural telephone distribution. These factors were investigated by the Joint Subcommittee on Development and Research during the summers of 1935 and 1936 and the more important considerations determined.¹⁰

FACTORS INFLUENCING INDUCTIVE COORDINATION

In any problem of inductive coordination it is convenient to subdivide the factors influencing coordination into those relating to the inductive influence of the power circuit, the inductive susceptiveness of the telephone circuit and the inductive coupling between the two types of circuits. As far as urban distribution circuits are concerned the load current unbalance of the power circuit is usually the controlling influence factor. For rural distribution circuits the unbalanced charging currents are generally more important than the unbalanced load currents. Likewise, in an exchange telephone circuit the admittance and impedance unbalances of the two sides of the circuit are usually the controlling factors in its inductive susceptiveness. As far as coupling between the power and telephone circuits is concerned this is largely controlled by their relative positions and the lengths of the exposure. For urban areas their relative positions are largely fixed by the normal arrangement of conductors and cables on jointly-used poles. In rural areas power and telephone circuits are generally at roadway separation although some joint use exists. In urban areas considerable control can often be exercised over the coupling by planning the routes of the main feeds of the two services so as to avoid long sections of close exposure. In rural areas where there are no paralleling routes close together it is generally necessary for both services to use the same roads and therefore the opportunity to control the coupling by the cooperative planning of routes is much reduced.

Certain quantitative indications of the extent to which this measure of coordination is applicable in the two types of areas are shown in the illustrative examples in the Appendix.

POWER CIRCUITS

Power systems operate, for the most part, at frequencies of 60 cycles and below. Telephone circuits, on the other hand depend mainly upon frequencies above about 200 cycles for the transmission of speech. Ordinarily, therefore, the effects of induction from the fundamental frequency currents and voltages in neighboring power lines are negligible as far as telephone circuit noise is concerned. It is quite generally recognized, however, that it is impracticable commercially to build rotating machinery and transformers which are entirely free from harmonics. There are, therefore, harmonics present on all operating power systems and it is the harmonic-frequency components induced into telephone circuits from these power system harmonics that are of major importance from the noise standpoint.¹¹

In any distribution circuit the harmonic currents present will fall within the following classes:—load currents, transformer-exciting currents and line-charging currents. With a uni-grounded neutral the load currents and the transformer-exciting currents are practically entirely confined to the wires of the circuit. Where the neutral is multi-grounded, the vector sum of the currents in the phase conductors (residual current) will divide between the neutral conductor and the paralleling earth path as determined by the relative impedances of these two paths. While there is some variation in the division of the return current between the neutral and ground paths, for most practical purposes this division may be assumed to be about half in each path at all the frequencies of interest.

As pointed out above, in the case of a line operating with uni-grounded neutral, the earth-return components of the load and transformer-exciting currents are ordinarily negligibly small. However, this is not true of the line-charging current which is chiefly a function of the magnitude and frequency of the impressed voltage, the circuit length, and, at non-triple harmonic frequencies, of the balance of the admittances to ground of the various phase conductors. While multi-grounding the neutral ordinarily increases the earth-return components of the load and transformer-exciting currents, it has been found, due to the parallel path provided by the neutral wire, on an average to decrease slightly the amount of charging current in the earth.

In an urban distribution system where the load density is relatively

high, the load currents and transformer-exciting currents are relatively large and the line-charging currents are usually negligible. In such a system multi-grounding the neutral results in an increase in the current returning through the earth and a consequent increase in the inductive influence of the power distribution system.

In rural areas, however, where the load density is low and the load currents and transformer-exciting currents are relatively small, the line-charging currents become significant. In general, under such conditions the multi-grounding of the neutral does not increase the magnitude of the ground-return current at frequencies of interest from the noise induction viewpoint. Under certain conditions the magnitude of this ground-return current may actually be substantially decreased by the multi-grounding of the neutral. This effect is more marked for the higher voltage circuits.

The harmonics present in a distribution circuit may be divided into (1) triple harmonics, that is, the third harmonic and odd multiples of it, and (2) non-triple harmonics, that is, the odd harmonics, starting with and including the fifth, which are not multiples of three. The triple harmonics in a three-phase system are in phase in the three line conductors so that their residual value (vector sum) is the arithmetic sum of their magnitudes in the three-phase wires. The non-triple harmonics are spaced, in time phase, the same as the 60-cycle fundamental and the magnitude of the residual current (vector sum) for these harmonics is usually much less than their arithmetic sum. If these harmonics were perfectly balanced the residual current for these frequencies would be zero. In exposures involving three-phase sections of line the balance of the non-triple harmonics between phases is influenced by the degree of balance of the loads and single-phase branches and therefore has an important effect in reducing the overall influence of the power system. In exposures involving single-phase extensions, or extensions consisting only of two-phase wires and a neutral wire this advantage of the balancing of the non-triple harmonics is, of course, not obtainable.

The extent to which induction from the non-triple harmonic voltages and currents in power distribution circuits can be controlled by power circuit transpositions is ordinarily very limited. Usually, due to the large number of exposure discontinuities arising from changes in the power or telephone circuits, the power circuit transpositions are quite ineffective. This is particularly true in cases where the induction from the ground-return current is controlling. In specific cases where considerable wave shape distortion exists and the induction from the balanced voltages and currents may therefore be relatively important, transpositions in power distribution circuits may be found helpful.

Table A shows the average harmonics present on three-phase, four-wire industrial and residential feeders under light and heavy load conditions. The reduced magnitudes of the non-triple frequencies in the residual current (neutral and ground-return) are evident. The importance of this as regards noise induction is further indicated in the illustrative examples of the Appendix.

TABLE A *
AVERAGE CURRENT AND VOLTAGE WAVE SHAPES OF 2300/4000-VOLT,
3-PHASE, 4-WIRE DISTRIBUTION CIRCUITS

Frequency	Order of Harmonic	Phase-to-Neutral Voltage at Bus.	Current in Industrial Feeder (In Amperes)				Current in Residential Feeder (In Amperes)			
			Light Load		Heavy Load		Light Load		Heavy Load	
			Phase	Residual	Phase	Residual	Phase	Residual	Phase	Residual
60	—	2380	65.		130		53		99	
180	3	16	<i>1.1</i>	<i>2.6</i>	<i>1.1</i>	<i>2.9</i>	<i>1.8</i>	<i>5.2</i>	<i>1.9</i>	<i>6.0</i>
300	5	21	1.0	.15	1.3	.16	.43	.21	.75	.29
420	7	6.4	.3	.03	.3	.05	.13	.06	.17	.08
540	9	1.7	<i>.04</i>	<i>.08</i>	<i>.04</i>	<i>.13</i>	<i>.04</i>	<i>.09</i>	<i>.04</i>	<i>.09</i>
660	11	1.9	.07	.01	.09	.01	.04	.01	.06	.02
780	13	1.8	.08	.01	.05	.01	.02	.01	.04	.01
900	15	.42	<i>.01</i>	<i>.01</i>	<i>.01</i>	<i>.03</i>	<i>.01</i>	<i>.01</i>	<i>.01</i>	<i>.01</i>
1020	17	.90	.03	.01	.07	.01	.02	.01	.03	.01
1140	19	.87	.02	—	.04	—	.01	.01	.02	.01
1260	21	.16	—	—	—	<i>.01</i>	—	—	<i>.01</i>	<i>.01</i>
1380	23	1.4	.05	—	.06	—	.01	—	.03	.01
1500	25	2.1	.06	.01	.09	.01	.01	.01	.03	.01
1620	27	.79	—	<i>.01</i>	<i>.01</i>	<i>.02</i>	—	—	<i>.01</i>	<i>.01</i>
1740	29	1.5	.02	—	.03	.01	.01	—	.02	.01
1860	31	1.4	.01	—	.02	—	—	—	.01	—
TIF †		9.7	11.2	—	8.9	—	6.6	—	5.8	—
Kv. T or I.T.		23.2	733	193	1160	330	346	238	571	283

Note: Triple harmonics are italicized.

* Tables 31 & 32—pp. 235 & 236 of Vol. II of Eng'g Reports of Joint Subcommittee.

† New weighting—see Engineering Report No. 33 of Joint Subcommittee.

The triple-harmonic currents present on a feeder supplied from a delta-wye substation transformer bank are generally due to the exciting currents of the single-phase load transformers. Under this condition no excessive triples are impressed on the feeder at its source as is sometimes the case where the source is a wye-connected, grounded-neutral generator directly connected to the feeder. The exciting currents flow from the individual single-phase transformers toward the delta-wye transformer in the substation. The presence on the feeder of a large three-phase wye-delta load transformer with its neutral connected to the system neutral, provides a parallel path for supplying

part of these triple-harmonic exciting currents as well as part of the unbalanced non-triple and fundamental currents and under certain conditions may substantially decrease the overall inductive influence of a feeder by reducing the ground-return current flowing through an exposure. The effect of such a connection in reducing the noise is dependent upon the location of the bank with respect to the exposure and its relative impedance to the various harmonics as compared to that of the path back to the substation. From the power operating standpoint such a bank tends to supply part of the unbalanced load and also, in case of the interruption of one phase between it and the substation, tends to supply the power to that portion of the phase still connected to it. Under certain conditions, the action of such a bank may prove detrimental to the operation of the power feeder due to its action in attempting to balance the voltages at the point of its connection to the feeder. Under other conditions the neutral of an existing bank can readily be connected to the feeder neutral with distinctly beneficial effects on the inductive influence and with little or no adverse effects on the power-system operation. The tendency of such banks toward noise reduction and towards unbalanced load supply is shown in two of the illustrative examples in the Appendix.

TELEPHONE CIRCUITS

The voltages induced into a telephone circuit may be divided into (1) metallic-circuit induction, that is, a voltage induced between the two sides of the circuit with a resultant current flowing around the circuit, and (2) longitudinal-circuit induction, that is, a voltage induced along the conductors such that the resultant current flows in a circuit having the telephone conductors as one side and the earth as the other. This latter voltage may also result in noise, due to its action upon telephone circuit unbalances, setting up currents in the voice channel (metallic-circuit). For either type of voltage, the induction may be "electric," that is, from the voltage on the power circuit, or "magnetic" from the current in the power circuit.

The local telephone circuit may be divided into three parts: (a) the central office equipment, (b) the line conductors and (c) the subscriber equipment. Inter-office circuits include only the first two items.

(a) *Central Offices Equipment*

The central office equipment associated with a subscriber circuit consists essentially of two elements: (1) line signaling equipment connected to the circuit for indicating to the operator, or to the dial equipment, the desire of a subscriber to start a call and (2) a linking or switching circuit or circuits for interconnecting two subscriber cir-

cuits either directly or through intervening trunk circuits and providing supervision during the call.

The line signaling equipment with its associated relay is either bridged across the line or arranged so that, when two subscriber circuits are interconnected, any ground connections on the line relays are automatically opened. The line signaling equipment is not, therefore, ordinarily a factor in noise considerations. Occasionally, however, the effect on noise of the ground connection on the line signaling equipment requires specific treatment when the longitudinal-circuit induction is sufficiently high. The noise in such instances occurs either during the pre-answering period before the line relay is "cut-off" or, in certain types of switchboards, on conversations between two persons on the same line (party-line) where the use of a switching circuit in the office is unnecessary.

The linking or switching equipment in the central office may consist of a pair of wires with bridged supervisory relays as in the case of a magneto office or may be a complicated arrangement of relays, repeating coils, condensers, etc., as in the case of common-battery offices of the manual or dial type. The necessary ground connections of the latter type of apparatus introduce the possibility of the unbalances in the equipment contributing to the overall noise when the longitudinal-circuit induction on the outside conductors is impressed on the switching circuits. Ordinarily in urban areas, due either to the frequency make-up of the longitudinal-circuit induction or to the relationships of the various impedances-to-ground, the amount of noise contributed by the central office equipment is relatively low. This is readily evident from Table B which shows, at 500 and 1000 cycles, the relative proportions of overall noise due to the action of induced voltages on station, cable and central office unbalances:

TABLE B *
RELATIVE IMPORTANCE OF CIRCUIT UNBALANCES

Type of Service	500 Cycles			1000 Cycles		
	Contribution from:			Contribution from:		
	Station	Cable	Office	Station	Cable	Office
Individual (bridged ringers)	Negligible	3	3	Negligible	20	20
Party-line (grounded 8-A ringers)	100	3	3	100	20	20

* See p. 72 of Vol. I of Eng'g Reports.

Cases arise, however, quite frequently where the relative circuit impedances or the frequency make-up of the induction or both are such that the noise contribution from the unbalances in the central office equipment becomes important. Such cases usually involve long subscriber or inter-office trunk circuits and particularly where sections of open-wire construction are present. Values of the unbalances in certain types of central office equipment are given on page 91 of Volume I of the Engineering Reports of the Joint Subcommittee on Development and Research.

(b) *Line Conductors*

Where the telephone line conductors are in open-wire, the induced voltage between conductors (metallic-circuit) as well as along these conductors (longitudinal-circuit) must be considered. The direct metallic-circuit induction can be greatly reduced by systematic transpositions in the telephone circuit. Due to the physical limitations in a practical layout of telephone transpositions, the reduction in metallic-circuit induction is, on the average, from 60 to 80 per cent on non-pole pairs and about 90 per cent on pole-pairs. Transpositions also tend to lessen the capacitance and inductance unbalances of the two sides to ground and to other circuits, thereby reducing the effect of the longitudinal-circuit induction on such unbalances. The improved balance of the mutual impedances between the various telephone conductors is, of course, distinctly beneficial in reducing crosstalk and transpositions are generally used for limiting the crosstalk where open-wire telephone circuits extend for substantial distances.

The construction of telephone cables is such that there is inherently very close spacing between the conductors and they are frequently transposed due to the continuous twisting of the pairs in manufacture. Due to this close spacing and frequent transposing there is practically no voltage induced between the wires of a cable pair or quad (group of four conductors). The unbalance to ground of the conductors of the present type of cable is so small that it is not ordinarily a contributing factor to noise induction. It may be noted, however, from Table *B* that in cases where the central office unbalances are of importance, the effect of shunt or series unbalances in the cables also needs consideration.

The lead sheath of a telephone cable provides practically perfect shielding against induction from power system voltages when it is grounded at one or more points. The sheath likewise provides substantial magnetic shielding when it is grounded more or less continuously as in underground construction or is grounded at both ends of the aerial section or near both ends of an exposure. The degree of magnetic shielding effected varies, depending on the size of the cable

TABLE C
 MAGNETIC SHIELDING FOR VARIOUS FREQUENCIES
 SIZES AND LENGTHS OF TELEPHONE CABLES AND VARIOUS GROUNDING RESISTANCES
 (Calculated Values of ϵ_r/ϵ_t)
 (ϵ_r = Voltage remaining after shielding)
 (ϵ_t = Voltage present with sheath grounded at one point only)

Frequency	Full-Sized Cable (2.61" Outside Dia.)						101 Pair 24 Ga. (0.85" Outside Dia.)						51 Pair 24 Ga. (0.64" Outside Dia.)					
	1 Mile*		3 Miles*		1/2 Mile*		1 Mile*		1/2 Mile*		1 Mile*		1/2 Mile*		1 Mile*		1/2 Mile*	
	0w†	5w†	10w†	0w	5w	10w	0w	5w	10w	0w	5w	10w	0w	5w	10w	0w	5w	10w
180 Cycles	14%	82%	94%	14%	50%	71%	60%	95%	99%	71%	89%	95%	71%	96%	99%	71%	92%	96%
300 "	8.5	65	85	8.5	33	52	42	89	96	57	89	89	57	91	96.5	57	82	91
420 "		52	76	6	24	40	31.5	81	93	44.5	65	81	37	84	93.5	44.5	71	84
540 "		43.5	71	5	19	32	25	73	88	37	55.5	73	37	77	90	37	63	77
660 "		37	64	4	16	27	21	66	84	31	47.5	66	31	71	86	31	55	71
1000 "		25.5	44.5	3	11	18	15	51	72	22	35	51	22	56	74.5	22	41	56

* Refers to distances along cable sheath between the two grounding points.

† Refers to total grounding impedance (approx. d.c. resistance) of the two ground connections—expressed in ohms.

and the resistance of the ground connections, reaching optimum values of over 90 per cent. Table C gives the magnitude of this shielding for various selected sizes and lengths of cable. Table C brings out distinctly the variation in the magnetic shielding due to the factors mentioned above. The effect of cable sheath shielding in several typical cases is further indicated in the Appendix.

TABLE D

RELATIVE SUSCEPTIVENESS OF SEVERAL TYPES OF STATION SETS

General Description of Station Set	Noise in Receiver Branch for 100 Noise Units to Ground—Average Power Wave Shape (One Station on Line-Effect of Set Only)
<i>Class 1—Types of sets in most common use today</i>	
a. Sidetone type of party-line set using 8A ringers or equivalents (one end of ringer grounded). (Common-battery talking and signaling)	350 Noise Units Approximately
b. Same type—local-battery talking	120 Noise Units Approximately
c. Magneto party-line set (52A Ringer or equivalent)	120 Noise Units Approximately
d. Individual-line set—any type	Negligible
<i>Class 2—Types of sets frequently encountered</i>	
a. Sidetone type of 4-party full-selective or 8-party semi-selective set (using relay or cathode tube to connect ringer to circuit during ringing period)	Negligible
b. Four-party selective or 8-party semi-selective sets employing high impedance ringers or relays connected to ground	About 30
c. Eight-party selective (harmonic ringing) sets employing ringers connected to ground and tuned to 4 different ringing frequencies	Limited data indicate that, depending on frequency for which ringer is tuned, noise will range from about 100 to about 400 units
d. Ground-return rural circuits (usually of magneto type and having code ringing)	3500 or more noise units
<i>Class 3—Special types of sets</i>	
a. Sidetone type of party-line set using split-condenser and higher impedance ringer (one end of ringer grounded)	About 20 noise units
b. Type of party-line set using split condenser arrangement with 8A ringer or equivalents (one end of ringer grounded).	About 90 noise units

(c) Station Apparatus

Individual-line stations employ a "bridged" ringer connection, i.e., the ringer is, in effect, connected between the two line conductors.

However, for selective signaling purposes party-line stations frequently have the ringer connected, in effect, between one of the line conductors and ground. The unbalance of the party-line station equipment is therefore affected by the impedance of the ringer and its point of connection in the station equipment. The relative susceptiveness of several types of station sets to noise-frequency induction is shown in Table *D*.

Table *D* shows that, with advance planning in areas where noise induction is or may likely become a matter of importance, much can be accomplished by the use of station sets of decreased inductive susceptiveness. Where such types of apparatus are substituted in existing plant, except in gradual replacements or in connection with general rearrangement programs, the expense is, naturally, increased.

INDUCTIVE COUPLING

As stated above, the inductive coupling between exchange telephone plant and power distribution circuits in urban areas is largely controlled by such factors as the street layouts and the joint use of poles.

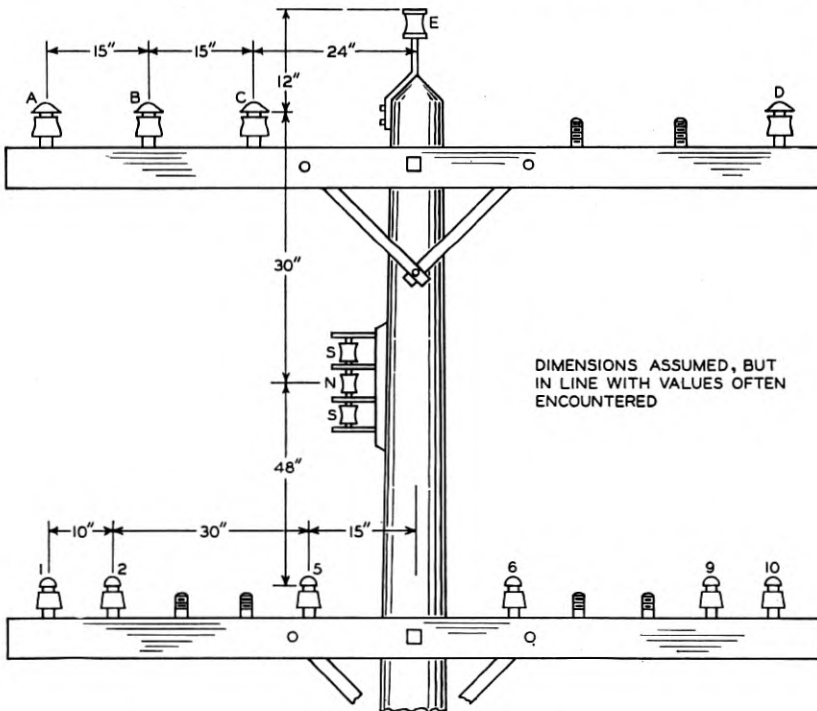

(See following page)

DIRECT METALLIC CIRCUIT INDUCTION IN UNTRANSPOSED TELEPHONE CIRCUITS

Magnetic Induction, 1000 Cycles

Volts Metallic per Ampere of Power Circuit Current per 1000 Feet of Exposure

Type Power Circuit	Induction Component	Power Conductors*	Pair 1-2	Pair 5-6	Pair 9-10	Avg.
Single Phase	Residual	A & N	.021	.043	.0044	.022
“ “	“	C & N	.0044	.018	.0053	.0092
“ “	“	E & N	.0002	.023	.0013	.0082
Two Phase Wires & Neut.	Residual	A, C, & N	.013	.031	.005	.016
	“	A, D, & N	.008	.018	.009	.012
Three Phase	Residual	A, B, C, & N	.012	.033	.005	.017
	“	A, C, D, & N	.007	.01	.004	.007
Two Phase Wires & Neut.	Balanced	A, C, & N	.017	.026	.0009	.015
	“	A, D, & N	.026	.13	.026	.061
Three Phase	Balanced	A, B, C, & N	.015	.023	.012	.017
	“	A, C, D, & N	.023	.123	.026	.057

* In each case, conductor "N" is a multi-grounded neutral, the other wires being phase conductors. Assumed 50% of the residual current in the neutral and 50% in the ground.

*Electric Induction*Volts per Kilovolt V_m/Kv

Type Power Circuit	Induction Component	Power Conductors†	Pair 1-2	Pair 5-6	Pair 9-10	Avg.
Single Phase	Residual	A & N	7	19	3	9.7
“ “	“	C & N	2	7.3	2.3	3.9
“ “	“	E & N	.4	9	.2	3.2
Two Phase Wires & Neut.	Residual	A, C, & N	5	13	2.6	6.9
	“	A, D, & N	2	7	2	3.7
Three Phase	Residual	A, B, C, & N	2.8	10	2	5.0
	“	A, C, D, & N	1.4	2.2	.7	1.4
Two Phase Wires & Neut.	Balanced	A, C, & N	3	7	.4	3.5
	“	A, D, & N	6	30	5	13.7
Three Phase	Balanced	A, B, C, & N	2.7	5.8	.4	3.0
	“	A, C, D, & N	5.6	27	5.4	12.7

† Wires S & S assumed continuous through exposure and grounded.

Fig. 2—Effect of relative positions on joint-use pole of power and telephone conductors on coefficients of induction for voltages and currents.

However, by cooperative planning of routes it is frequently practicable to secure lower coupling by avoiding long exposures between the main feeds of the two plants. As shown by the illustrative examples this procedure is, where applicable, very beneficial.

In rural areas where both distribution services must ordinarily be carried along the highways the opportunity for controlling the coupling between the two classes of circuits by cooperative planning of routes is much reduced.

Some benefit may be gained, however, in the case of open-wire construction particularly at joint-use separations, by arrangements of the conductors on the pole so as to avoid excessive spacings. As shown on Fig. 2 certain arrangements tend to minimize the amount of noise induction arising from the power circuit voltages and currents. This beneficial effect is, however, much less noticeable at roadway separations.

SUMMARY AND CONCLUSIONS

Since about 1915 there has been a continued increase in the use of the multi-grounded or common-neutral arrangement of power distribution in this country. At the present time, approximately half of the distribution is by 4000-volt multi-grounded or common-neutral circuits. A large part of the higher-voltage rural distribution is also operating with this arrangement.

In general it may be said that for the lower-voltage 2300/4000-volt distribution circuits, the use of the multi-grounded or common-neutral arrangement may be expected to increase the inductive influence of the power circuits. Unless attention is given to cooperative planning to secure features beneficial from the inductive coordination standpoint, noise problems may result either in restricted or extensive areas. With proper attention to the coordination features⁹ such noise situations as develop are largely in the nature of isolated cases and can usually be cared for by relatively minor changes or adjustments in either or both plants.

For the higher voltage (11–13 kv.) rural distribution circuits, there seems to be little difference, from the noise induction standpoint, between the uni-grounded four-wire system and the multi-grounded or common-neutral arrangement.¹⁰ Under many conditions the placing of multiple grounds on the neutral will result in noise reductions due to the effect, previously mentioned, of the multi-grounded neutral on the line charging currents. It is interesting to note that experience to date with the multi-grounded or common-neutral in rural areas has shown that many of the measures of coordination applicable in urban areas will prove similarly helpful in rural communities.

The measures of coordination which investigations and operating experience have shown to be practicable and effective include:

1. Cooperative planning by both parties to avoid not only severe exposure conditions but also types of equipment likely to aggravate the possible noise induction situation.

2. A reasonable degree of balance of the loads between the three phases of the power circuit. In the higher-voltage rural circuits this also includes the lengths of branches consisting of one or two phase wires and neutral.
3. The avoidance of unnecessarily heavily loaded branches consisting of one or two phase wires and neutral.
4. The prevention of excessive over-excitation of transformers.
5. The grounding, where necessary, of aerial telephone cables at or near both ends of an exposure to obtain the benefits of magnetic shielding.
6. The use of adequately coordinated telephone transpositions on open-wire extensions and the avoidance of severe unbalances in the open-wire conductors.
7. The correction of badly distorted voltage or current wave shape on the power system.
8. The connection of the neutral point of three-phase wye-delta load banks to the system neutral conductor.
9. The use of telephone station apparatus, on party-line service, of lower susceptiveness.
10. Occasionally the use of arrangements or apparatus to minimize the effects from unbalances in central office equipment.

It is, of course, essential in successfully coordinating the power distribution and telephone circuits that, as in other coordination situations, the power and telephone people view the matter as a mutual responsibility and fully cooperate in the application of the tools available. Experience over a period of years has now shown that where this is done adequate overall coordination can be readily secured.¹²

The authors wish to acknowledge their indebtedness to their many coworkers who aided in carrying on the various investigations on which this paper is based.

BIBLIOGRAPHY

1. "Improvement in Distribution Methods," S. B. Hood—p. 1038 of 1925 *Trans. A.I.E.E.*
2. "Interconnection of Primary Lightning Arrester Ground and the Grounded Neutral of the Secondary Main," C. F. Harding and C. S. Sprague—p. 234 of 1932 *Trans. A.I.E.E.*
3. "Lightning Protection for Distribution Transformers," K. B. McEachron and L. Saxon—p. 239 of 1932 *Trans. A.I.E.E.*
4. "Lightning Protection for Distribution Transformers," A. M. Opsahl, A. S. Brooks and R. N. Southgate—p. 245 of 1932 *Trans. A.I.E.E.*
5. "Studies of Lightning Protection on 4000-volt Circuits—III," D. W. Roper—p. 252 of 1932 *Trans. A.I.E.E.*
6. "Lightning Protection for Distribution Transformers," T. H. Haines & C. A. Corney—p. 259 of 1932 *Trans. A.I.E.E.*

7. "Distribution System Lightning Studies by Philadelphia Electric Company," H. A. Dambly, H. N. Ekvall, and H. S. Phelps—p. 265 of 1932 *Trans. A.I.E.E.*
8. Engineering Reports 6, 9, 13 and 15—Vols. I and II of Engineering Reports of Joint Subcommittee on Development and Research of National Electric Light Association and Bell Telephone System.
9. Common-Neutral Practice Confirmed in California—p. 980—June 4, 1932 issue of *Electrical World*—(See also May 15, 1932 issue of *Electrical West*.)
10. Provisional Report No. 18 of Joint Subcommittee on Development and Research of Edison Electrical Institute and Bell Telephone System.
11. "Measurement of Telephone Noise and Power Wave Shape," J. M. Barstow, P. W. Blye and H. E. Kent—p. 1307 of 1935 *Trans. A.I.E.E.*
12. Reports of Joint General Committee of National Electric Light Association and Bell Telephone Systems on Physical Relations between Electrical Supply and Signal Systems—Edition of Dec. 9, 1922.

APPENDIX

For the sake of brevity, the detailed calculations and some of the minor assumptions for the following examples have been omitted.

Illustrative Example 1

The purpose of this example is to show, for average power system wave shapes:

1. The noise induction problem that might be created by the exposure of a reasonably long aerial telephone cable in an urban area with a heavily loaded single-phase feeder. It features:
 - a. The relative importance of triple and non-triple harmonic induction, and
 - b. The extent to which planning of routes, grounding of cable sheaths, etc. might improve the situation.
2. The changes in the noise magnitudes for the same situation with the various single-phase loads well distributed among all three phases. Under this condition, attention is directed to:
 - a. The change in the relative importance of the triple and non-triple harmonic induction.
 - b. The amount of reduction obtained by the same remedial measures tried in 1-b above.

Figure 3 shows a possible method of supplying the single-phase loads in a rather extensive part of an urban area. The general layout shown on Fig. 3 is such that all of the current for the feeder area traverses a considerable part of the exposure. Under this quite extreme condition—essentially single-phase supply for a relatively large area—the noise at location C under heavy load conditions would be about as shown on Table I.

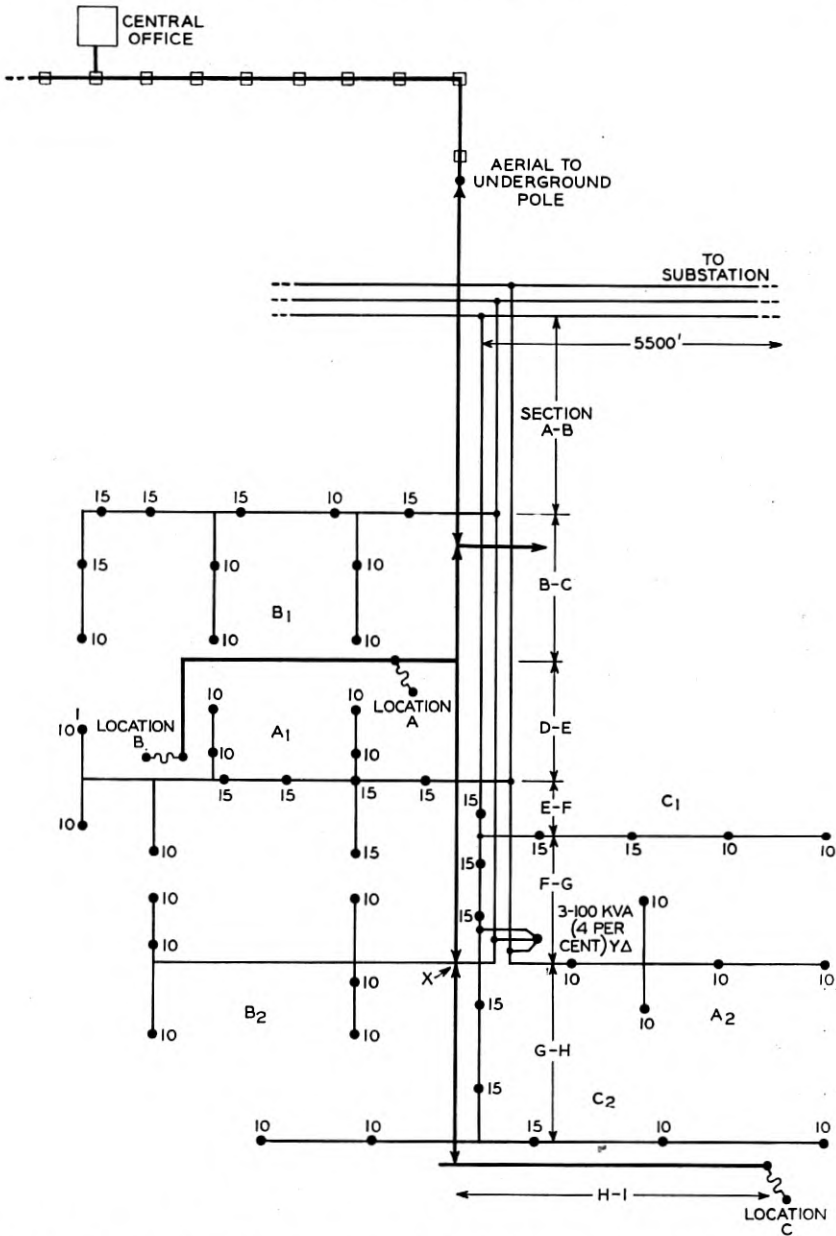

Fig. 4—Example of possible rearrangement of feeder layout shown in Fig. 3 to reduce magnitudes of "ground-return" currents.

TABLE I
NOISE CONTRIBUTIONS (FIG. 3) OF VARIOUS HARMONICS AND
SECTIONS OF EXPOSURE

Section of Exposure	RMS Magnitude of Residual Current	Approximate Total Noise Contribution *	Approximate Noise Contribution From:	
			180 Cycles	300 Cycles and Higher Frequencies
A-B.....	210 amperes	1240 noise units	270 noise units	1215 noise units
B-E.....	157 "	1130 " "	250 " "	1100 " "
E-I.....	30-107 "	500 " "	100 " "	490 " "
	Total	2870 " "	620 " "	2800 " "

* Location C—For party-line service using 8A ringers, during heavy power loads.

It is evident from Table I that most of the party-line stations fed by the aerial telephone cable would need treatment. It will be noted from Table II that completely replacing the existing party-line stations with special station apparatus will, to a large extent, care for the situation since, in this case, the amount of noise contributed by the cable and central office unbalances would aggregate less than 150 units. Other measures either singly or in combination, probably more economical in their application, would provide substantial reductions in noise but would not be adequate for the more severely exposed stations.

TABLE II
COMPARISON OF EFFECTIVENESS OF VARIOUS REMEDIAL MEASURES
(Fig. 3 Conditions)

Type of Remedial Measure	Approximate Noise on Party-Line Stations (Heavy Power Loads)	
	Location A or B	Location C
1. Before applying remedial measures.....	1800 noise units	2870 noise units
2. Using special telephone station sets.....	75 " "	125 " "
3. Avoiding exposure in section A-B by cooperative planning of routes.....	560 " "	1630 " "
4. Cable sheath shielding by tying aerial and underground telephone cables at junction pole and connecting aerial sheath to 1 ohm ground at point X.	1160 " "	1700 " "
5. Interconnecting 300 kva wye-delta bank with system neutral	1430 " "	1600 " "
6. Combination of measures 3, 4, and 5.....	365 " "	420 " "

(170 kva of unbalanced load)

Assume, however, that instead of supplying the single-phase loads in the area shown on Fig. 3 from one phase only, the single-phase loads were distributed reasonably uniformly among the phases. This would be advantageous not only by the noise reduction possibilities, which will be more fully discussed but also by the improved regulation attainable on the feeder. Figure 4 shows a possible rearrangement of Fig. 3 along these lines and Table III shows the noise conditions with the feeder arrangements of Fig. 4.

TABLE III
NOISE CONTRIBUTIONS (FIG. 4) OF VARIOUS HARMONICS AND SECTIONS OF EXPOSURE

Section of Exposure	RMS Magnitude of Residual Current	Total Noise Contribution *	Noise Contribution From:	
			180 Cycles	300 Cycles and Higher
A-B.....	6 amperes	280 noise units	270 noise units	75 noise units
B-E.....	45 "	370 " "	250 " "	275 " "
E-I.....	5-45 "	150 " "	100 " "	115 " "
	Total	735 " "	620 " "	375 " "

* Location C—For party-line service using 8A ringers, during heavy power loads.

A comparison of Tables I and III shows that the noise from the non-triple harmonics has been very materially reduced by the balancing of loads made possible by the more favorable feeder arrangement of Fig.

TABLE IV
COMPARISON OF EFFECTIVENESS OF VARIOUS REMEDIAL MEASURES (Fig. 4)

Type of Remedial Measure	Approximate Noise on Party-Line Stations (Heavy Power Loads)	
	Location A or B	Location C
1. Before applying remedial measures.....	480 noise units	735 noise units
2. Using special telephone station sets.....	25-30 " "	40-50 " "
3. Avoiding exposure in section a-b by cooperative planning of routes.....	190 " "	460 " "
4. Interconnecting 300 kva wye-delta bank with system neutral	330 " "	535 " "
5. Cable sheath shielding—grounding at jct. pole and to 1 ohm ground at X.....	325 " "	420 " "
6. Combinations of measure 3, 4, and 5.....	85 " "	245 " "

(26 kv. of unbalanced load)

4, although that from the triple harmonics has been inappreciably changed. The net effect has been a reduction of nearly 75 per cent in the noise on the party line stations served by the telephone cable. The reductions afforded by various remedial measures are shown in Table IV.

It is evident from Table IV that, by the application of various of the measures of coordination, the need for an extensive rearrangement of either plant is avoided.

Illustrative Example 2

The purpose of this example is to show the extent to which remedial measures of the type generally applicable in urban areas (see Example 1), may be applied in a less thickly settled area where exposures to 2.3/4 kv. multi-grounded neutral arrangements are encountered under average conditions of power system wave shape. In detail the example covers:

- a. The extent to which such measures as cooperative planning of routes and use of wye-delta load banks may be ineffective.

TABLE V
NOISE AT VARIOUS LOCATIONS (FIG. 5) AND FOR VARIOUS TYPES
OF TELEPHONE SERVICE

Location	Type of Telephone Service	Total Noise	Contribution From:		Remarks
			Cable Exposures	Open Wire Exposures	
A	1. Common-Battery Party-line stations (Class 1-a Table D)	225-345	220-270	45-215	Open-wire noise dependent on effectiveness of telephone transpositions.
	2. Magneto party-lines (Class 1-c Table D)	85-225	75 app	40-215	
	3. Individual Line (Class 1-d Table D)	40-210	25-35*	About 10-210	Lower values of noise on circuits controlled by effects of station sets—higher values by effectiveness of telephone transpositions.
B	1.	170-1200	10-100	170-1190	
	2.	75-1175	20-35	70-1175	
	3.	60-1175	About 20*	55-1175	
C	1.	400-975	285-325	275-925	*Noise in cable section due to office and cable unbalances.
	2.	150-870	110-125	110-860	
	3.	100-860	60*	75-860	

The extent to which various measures of coordination could be applied to reduce the noise induction or to restrict the extent of special arrangements is shown in Table VI.

TABLE VI
COMPARISON OF EFFECTIVENESS OF VARIOUS REMEDIAL MEASURES

Type of Remedial Measure	Approximate Noise at:								
	Location A			Location B			Location C		
	1*	2	3	1	2	3	1	2	3
1. Before applying measures	225-345	85-225	40-210	170-1200	75-1175	60-1175	400-975	150-870	100-860
2. Using special tel. sets	40-210	40-210	Neg. Change	60-1175	60-1175	Neg. Change	100-860	100-860	Neg. Change
3. Avoiding exposure section B-C by cooperating planning	130-250	65-220	Neg. Change	Neg. Change			350-950	115-860	Neg. Change
4. Interconnecting neutral of 150 kva wye-delta bank	180-310	Neg.	Change	150-1175	Neg.	Change	370-950	Neg.	Change
5. Average degree of coordinated tel. transpositions	250	80	50	200	175	175	340	175	130
6. Tel. transpositions + cable sheath shielding †	210	70	50	180	175	175	320	165	130
7. Combination of 4, 5 and 6	185	65	50	160	155	155	310	160	125

* Type of station apparatus shown on Table V.

† Cable was assumed to be grounded at junction pole at end of Section F-G to 2.5 ohm ground; at other junction poles to grounds exceeding 10 ohms.

It is evident from this table that, for the conditions assumed, the use of reasonably coordinated telephone circuit transpositions will be necessary to care for the stations served by open-wire. Ordinarily the use of such transpositions in combination with such other measures as are reasonably effective would serve to take care of the stations served by telephone cable and would limit the extent to which special telephone station apparatus might be needed for the stations served by the longer open-wire extensions.

Series for the Wave Function of a Radiating Dipole at the Earth's Surface

By S. O. RICE

In this paper three series expansions are derived for the wave function of a vertical dipole placed at the surface of a plane earth. Two convergent series and one asymptotic series are obtained. A remainder term for the latter series is given which enables one to set an upper limit to the amount of error obtained by stopping at any particular stage in the series.

INTRODUCTION

THE wave function above the earth of a vertical dipole placed at the surface of a plane earth is ¹

$$\Pi_1(r, z) = (k_1^2 + k_2^2) \int_0^\infty \frac{J_0(\xi r) e^{-z\sqrt{\xi^2 - k_1^2}} \xi d\xi}{k_2^2 \sqrt{\xi^2 - k_1^2} + k_1^2 \sqrt{\xi^2 - k_2^2}}, \quad (1)$$

where r and z are the horizontal and vertical distances from the dipole. k_1 and k_2 are constants depending upon the electrical properties of the air and ground, respectively.² We shall be concerned with the value of this function at the surface of the earth. Setting $z = 0$ gives us an integral for $\Pi_1(r, 0)$ which is the function of r to be investigated here.

Although the electric and magnetic intensities are the properties of an electromagnetic field which have the greatest physical significance, writers on this subject often deal with the wave function because of its simpler form and because in many cases of practical interest it is nearly proportional to the electric intensity. However, the electromagnetic field may be obtained from the wave function by differentiation. If the real parts of $He^{-i\omega t}$ and $Ee^{-i\omega t}$ represent the electric and magnetic intensities the field above the earth produced by the dipole is

$$H_r = H_z = 0, \quad H_\phi = -\frac{\partial \Pi_1(r, z)}{\partial r},$$

$$E_r = \frac{ic^2}{\omega} \frac{\partial^2 \Pi_1(r, z)}{\partial r \partial z}, \quad E_\phi = 0, \quad E_z = -\frac{ic^2}{\omega} \frac{1}{r} \frac{\partial}{\partial r} \left(r \frac{\partial \Pi_1(r, z)}{\partial r} \right).$$

¹ A. Sommerfeld, *Ann. der Physik*, vol. 28, pp. 665-736, No. 4 (1909).

² The symbols used here are defined in a list at the end of the paper.

From these expressions it will be observed that if we obtain expressions for $\Pi_1(r, 0)$ we shall be able to compute the field at the earth's surface except for the radial component E_r , which is small compared to E_z .

STATEMENT OF RESULTS

The asymptotic expression for $\Pi_1(r, 0)$ is

$$\Pi_1(r, 0) = -\frac{1}{(1-\tau^2)r} \left[e^{ik_1 r} \sum_{n=1}^N \frac{n! P_n(k_2/s)}{(i\tau s r)^n} + R_{1N} - \tau^2 R_{20} \right], \quad (9)$$

where R_{1N} and R_{20} satisfy the inequalities

$$|R_{1N}| < \left| \frac{(N+1)! e^{ik_1 r \sqrt{\csc \theta}}}{[r(k_1 - s) \sin \theta]^{N+1}} \right|, \quad |R_{20}| < \left| \frac{e^{ik_2 r}}{rk_2 - rs} \right|,$$

$\theta = \pi/2 - \arg(k_1 - s)$ being an angle slightly greater than $\pi/2$.

The convergent series for $\Pi_1(r, 0)$ are³

$$\Pi_1(r, 0) = \frac{1}{(1-\tau^2)r} \sqrt{\frac{\pi\tau}{2}} \left[e^{ik_1 r} \sum_{n=0}^{\infty} (-i s \tau r)^n P_{-1/2}^{-n}(k_1/s) - \tau e^{ik_2 r} \sum_{n=0}^{\infty} \left(\frac{s r}{i \tau} \right)^n P_{-1/2}^{-n}(k_2/s) \right] \quad (14)$$

and

$$\Pi_1(r, 0) = \frac{1}{(1-\tau^2)r} \left[\sum_{n=0}^{\infty} \frac{(ik_1 r)^n}{n!} F(1, -n/2; 1/2; s^2/k_2^2) - \tau^2 \sum_{n=0}^{\infty} \frac{(ik_2 r)^n}{n!} F(1, -n/2; 1/2; s^2/k_1^2) \right]. \quad (19)$$

The quantities τ and s are defined by $\tau = k_1/k_2$ and $1/s^2 = 1/k_1^2 + 1/k_2^2$, and the numbers on the right are the equation numbers in the text. W. H. Wise⁴ has obtained series which are equivalent to those appearing in (9) and (14).

PROCEDURE

The results given here depend upon a transformation of the integral obtained by setting $z = 0$ in equation (1). This integral can be expressed in the following way as has been shown by B. van der Pol:⁵

$$\Pi_1(r, 0) = -\frac{\tau}{1-\tau^2} \int_{k_1/s}^{k_2/s} \frac{e^{i\tau w}}{r} d(w^2 - 1)^{-1/2}, \quad (2)$$

³ The Legendre functions are discussed by E. W. Hobson, "Th. of Spherical and Ellipsoidal Harmonics." Hypergeometric functions are discussed in Chap. XIV, "Modern Analysis," by Whittaker and Watson.

⁴ W. H. Wise, *Proc. I.R.E.*, vol. 19, pp. 1684-1689, September 1931.

⁵ *Jahrbuch der drahtlosen Telegraphie Zeitschr. f. Hochfrequenz Techn.*, 37 (1931), p. 152.

which becomes, after integration by parts,

$$= + \frac{\tau}{1 - \tau^2} \left\{ \left[\frac{-e^{isrw}}{r\sqrt{w^2 - 1}} \right]_{k_1/s}^{k_2/s} + is \int_{k_1/s}^{k_2/s} \frac{e^{isrw} dw}{\sqrt{w^2 - 1}} \right\}. \quad (3)$$

The path of integration is the straight line in the complex w plane joining the points k_1/s and k_2/s . $\text{Arg}(w - 1)$ and $\text{arg}(w + 1)$ are taken to be zero at the point this contour crosses the real axis. The Argand diagram for a typical case is shown in Fig. 1. From the definitions of k_1 , k_2 , and s it follows that $|s| < |k_1| < |k_2|$, and $0 = \arg k_1 < \arg s < \arg k_2 < \pi/4$.

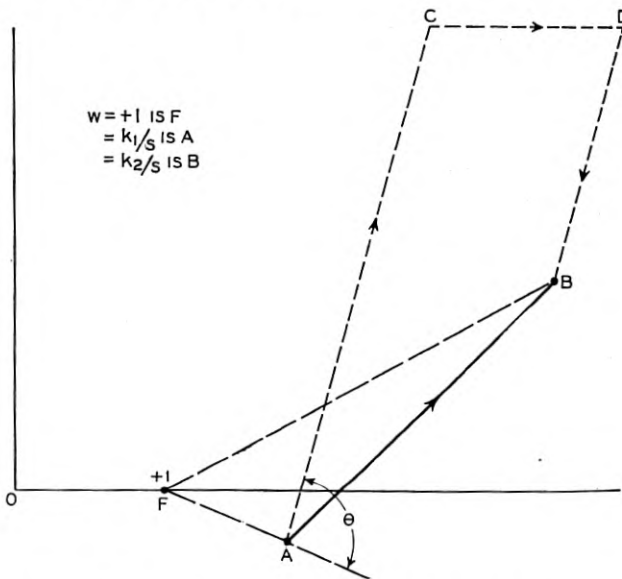

Fig. 1—Paths of integration in the w plane.

ASYMPTOTIC EXPANSION

To obtain an asymptotic expansion for $\Pi_1(r, 0)$ we deform the linear path joining A and B into the path $ACDB$ as is shown in Fig. 1. The lines AC and BD are both inclined to the real axis at the angle $\arg(is^*)$ where s^* is the conjugate of s . This is the direction in which the exponential term e^{isrw} decreases most rapidly since along it the variable part of the exponent is real and negative.⁶ The section CD may be displaced to infinity where its contribution to the value of the integral becomes zero because of this exponential decrease.

⁶ To show this for the line AC we set $w = k_1/s + is^*u$. As w goes from A to C u is real and increases from zero. The exponent then becomes $isrw = ik_1r - |s|^2ru$ since $ss^* = |s|^2$.

The integral $\Pi_1(r, 0)$ is then composed of two components consisting of the integrals along AC and DB , respectively, and we may write

$$\Pi_1(r, 0) = -\frac{\tau}{(1-\tau^2)r} [I(k_1) - I(k_2)], \quad (4)$$

where

$$I(k) = \int_{k/s}^{\infty is^*} e^{isr w} d(w^2 - 1)^{-1/2}. \quad (5)$$

We integrate (5) by parts N times and find

$$I(k) = \left[-e^{isr w} \sum_{n=1}^N \frac{(-)^n}{(isr)^n} \frac{d^n}{dw^n} (w^2 - 1)^{-1/2} \right]_{k/s}^{\infty is^*} + (-)^N \int_{k/s}^{\infty is^*} \frac{e^{isr w}}{(isr)^N} \frac{d^{N+1}}{dw^{N+1}} (w^2 - 1)^{-1/2} dw.$$

The derivatives may be expressed in terms of Legendre polynomials by means of the relation

$$(-)^n \frac{d^n}{dw^n} (w^2 - 1)^{-1/2} = n! (w^2 - 1)^{-n/2 - 1/2} P_n \left(\frac{w}{\sqrt{w^2 - 1}} \right).$$

When the limits in the integrated portion are inserted and the definition of s used we see that

$$I(k_1) = \frac{k_2 e^{ik_1 r}}{k_1} \sum_{n=1}^N \left(\frac{k_2}{ik_1 s r} \right)^n n! P_n(k_2/s) + R_{1N} \frac{k_2}{k_1}, \quad (6)$$

where

$$R_{1N} = -\frac{k_1(N+1)!}{k_2(isr)^N} \int_{k_1/s}^{\infty is^*} P_{N+1} \left[\frac{w}{\sqrt{w^2 - 1}} \right] \frac{e^{isr w}}{(w^2 - 1)^{N/2+1}} dw. \quad (7)$$

An inequality for R_{1N} may be obtained by using ³

$$|P_{N+1}(t)| \leq |t + \sqrt{t^2 - 1}|^{N+1}$$

which holds for all values of t in the t plane cut from -1 to $+1$, if $\arg \sqrt{t^2 - 1} = 0$ when t is real and greater than $+1$. For then the absolute value of the Legendre polynomial in the integrand is seen to be less than $|(w+1)/(w-1)|^{(N+1)/2}$ when $R(w) > 0$, and R_{1N} may be compared with an integral having $|e^{isr w}|$ and powers of the factors $|w+1|$ and $|w-1|$ in the integrand. On the path AC we

³ E. W. Hobson, loc. cit., p. 60.

have $|w - 1| \geq |(k_1/s - 1) \sin \theta|$ where

$$\theta = \arg is^* - \arg \left(\frac{k_1}{s} - 1 \right) = \frac{\pi}{2} - \arg(k_1 - s) > \frac{\pi}{2}.$$

Similarly we have $|w + 1| \geq |k_1/s + 1|$. These inequalities enable us to deal with the integral of $|e^{isr w}|$ which may be integrated to show that

$$|R_{1N}| < \left| \frac{(N + 1)! e^{ik_1 r} \sqrt{\csc \theta}}{[r(k_1 - s) \sin \theta]^{N+1}} \right|. \tag{8}$$

By interchanging k_1 and k_2 in (6) and (7) we obtain expressions for $I(k_2)$ and R_{2N} . An inequality for $|R_{2N}|$ is obtained from (8) by setting $\theta = \pi/2$ and interchanging k_1 and k_2 . By combining these expressions in accordance with equation (4) we obtain an asymptotic expansion for $\Pi_1(r, 0)$.

In general, $I(k_2)$ is negligible in comparison with $I(k_1)$ because k_2 has a positive imaginary part which causes $e^{ik_2 r}$ to decrease rapidly. Since $I(k_2) = R_{20}$, R_{20} being the remainder after zero terms, we may obtain an inequality for $I(k_2)$ by setting $N = 0$, $\theta = \pi/2$, and interchanging k_1 and k_2 in (8). Then from (4) we have the result

$$\Pi_1(r, 0) = -\frac{1}{(1 - \tau^2)r} \left[e^{ik_1 r} \sum_{n=1}^N \frac{n! P_n(k_2/s)}{(i\tau sr)^n} + R_{1N} - \tau^2 R_{20} \right], \tag{9}$$

where R_{1N} satisfies the inequality (8) and $|R_{20}| < |e^{ik_2 r}/(rk_2 - rs)|$.

SERIES FOR $\Pi_1(r, 0)$ IN ASCENDING POWERS OF r

Put

$$K(k_1) = e^{ik_1 r} - i \frac{k_1 sr}{k_2} \int_1^{k_1/s} \frac{e^{isr w} dw}{\sqrt{w^2 - 1}} \tag{10}$$

and define $K(k_2)$ as being obtained from (10) by interchanging k_1 and k_2 . By referring to equation (3) we see that I may be written in the form

$$\Pi_1(r, 0) = \frac{1}{(1 - \tau^2)r} [K(k_1) - \tau^2 K(k_2)]. \tag{11}$$

We write

$$\begin{aligned} K(k_1) &= e^{ik_1 r} \left[1 - \frac{ik_1 sr}{k_2} \int_1^{k_1/s} \frac{e^{irs(w - k_1/s)} dw}{\sqrt{w^2 - 1}} \right] \\ &= e^{ik_1 r} \left[1 - \frac{ik_1 sr}{k_2} \sum_{n=1}^{\infty} \frac{(irs)^{n-1}}{(n-1)!} \int_1^{k_1/s} \frac{(w - k_1/s)^{n-1} dw}{\sqrt{w^2 - 1}} \right], \tag{12} \end{aligned}$$

the infinite series being uniformly convergent.

From Hobson's contour integral definition³ of $P_n^m(t)$ it can be shown that if $R(m) < 1/2$

$$P_{-1/2}^m(t) = \sqrt{\frac{2}{\pi}} \frac{e^{-\pi i(m+1/2)}(t^2 - 1)^{m/2}}{\Gamma(1/2 - m)} \int_1^t \frac{(w - t)^{-m-1/2}}{\sqrt{w^2 - 1}} dw,$$

where $\arg(w - 1) = \varphi$, $\arg(w - t) = -\pi + \varphi$, where φ is the angle measured counter-clockwise from the positive direction of the real axis to the line directed from $w = 1$ to $w = t$. Setting $m = +1/2 - n$ where n is a positive integer we obtain

$$\int_1^t \frac{(w - t)^{n-1}}{\sqrt{w^2 - 1}} dw = (-)^{n-1} (n - 1)! \sqrt{\frac{\pi}{2}} (t^2 - 1)^{n/2-1/4} P_{-1/2}^{1/2-n}(t).$$

Thus Equation (12) becomes

$$\begin{aligned} K(k_1) &= e^{ik_1 r} \left[1 + \sum_{n=1}^{\infty} \left(\frac{srk_1}{ik_2} \right)^n \cdot \sqrt{\frac{\pi k_1}{2k_2}} P_{-1/2}^{1/2-n}(k_1/s) \right] \\ &= e^{ik_1 r} \sqrt{\frac{\pi k_1}{2k_2}} \sum_{n=0}^{\infty} \left(\frac{srk_1}{ik_2} \right)^n P_{-1/2}^{1/2-n}(k_1/s), \end{aligned} \quad (13)$$

where in passing from the first to the second line we have set $n = 0$ in³

$$P_{-1/2}^{1/2-n}(t) = \frac{1}{\Gamma(1/2 + n)} \left(\frac{t - 1}{t + 1} \right)^{n/2-1/4} F\left(1/2, 1/2; n + 1/2; \frac{1 - t}{2}\right),$$

and have summed the resulting series to show that $P_{-1/2}^{1/2}(k_1/s) = \sqrt{2/\pi\tau}$. The function $K(k_2)$ may be obtained from (13) by interchanging k_1 and k_2 .

Combining (13) and (11), and using $\tau = k_1/k_2$ gives the convergent series for $\Pi_1(r, 0)$ given in the statement of results as equation (14).

ANOTHER POWER SERIES FOR I

Here we obtain an expression for I somewhat similar to the one obtained in the previous section. The first step is to deform the contour joining the points A and B ($w = k_1/s$ and $w = k_2/s$). The deformation is carried out in two steps shown in Figs. 2a and 2b, respectively.

In Fig. 2(a) the contour joining A to B has been pulled around the point $+1$ and looped over itself. The point H is destined to move

³ E. W. Hobson, loc. cit., p. 188.

over to B and G is to move over to A . This deformation of the contour does not alter the value of the integral as long as we pay attention to the arguments of $w - 1$ and $w + 1$. In Fig. 2(b) the deformation is almost completed; all that remains is for G to coincide with A and H to coincide with B .

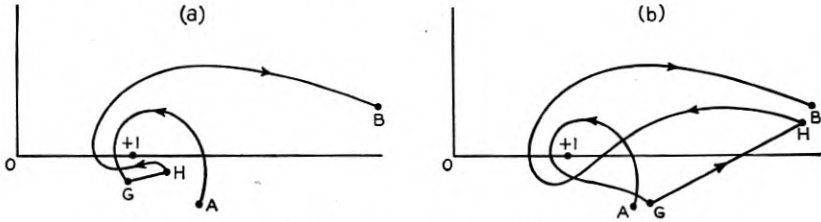

Fig. 2—Deformation of contour in w plane.

Using this deformation of the contour we may write equation (2) as follows:

$$\begin{aligned} \Pi_1(r, 0) &= + \frac{\tau}{1 - \tau^2} \left[\int_A^G + \int_G^H + \int_H^B \frac{e^{isr\tau w} w dw}{r(w^2 - 1)^{3/2}} \right] \\ &= \frac{\tau}{(1 - \tau^2)r} \left[\int_{k_1/s}^{(1+)} - \int_{k_1/s}^{k_2/s} - \int_{k_2/s}^{(1+)} \frac{e^{isr\tau w} w dw}{(w^2 - 1)^{3/2}} \right] \end{aligned}$$

with the understanding that $\arg w - 1$ and $\arg w + 1$ have their principal values at the beginning of each integration. Upon referring to (2) we see that the middle integral is $-\Pi_1(r, 0)$ and hence

$$\Pi_1(r, 0) = \frac{\tau}{2r(1 - \tau^2)} [L(k_1) - L(k_2)], \tag{15}$$

where

$$L(k_1) = \int_{k_1/s}^{(1+)} \frac{e^{isr\tau w} w dw}{(w^2 - 1)^{3/2}} = \sum_{n=0}^{\infty} \frac{(isr)^n}{n!} \int_{k_1/s}^{(1+)} \frac{w^{n+1} dw}{(w^2 - 1)^{3/2}} \tag{16}$$

and $L(k_2)$ is obtained from $L(k_1)$ by interchanging k_1 and k_2 .

Let $w^2 - 1 = \tau^2(1 - t)$, or $sw = k_1\sqrt{1 - ts^2/k_2^2}$, then

$$\begin{aligned} \int_{k_1/s}^{(1+)} \frac{w^{n+1} dw}{(w^2 - 1)^{3/2}} &= - \frac{k_2}{2k_1} \left(\frac{k_1}{s} \right)^n \int_0^{(1+)} \frac{[1 - (s^2 t/k_2^2)]^{n/2}}{(1 - t)^{3/2}} dt \\ &= 2 \frac{k_2}{k_1} \left(\frac{k_1}{s} \right)^n F(1, -n/2; 1/2; s^2/k_2^2), \end{aligned} \tag{17}$$

where it is understood that at the initial point of the contour

$\arg(1-t) = 0$, $\arg(1 - (s^2/k_2^2)t) = 0$. This may be verified by expanding the numerator of the integrand and using

$$\int_0^{(1+)} t^m (1-t)^{\nu} dt = (1 - e^{2\pi i \nu}) \frac{\Gamma(m+1)\Gamma(\nu+1)}{\Gamma(m+\nu+2)},$$

where m is a positive integer or zero, with $\nu = -3/2$.

Expression (16) now becomes

$$L(k_1) = 2 \frac{k_2}{k_1} \sum_{n=0}^{\infty} \frac{(ik_1 r)^n}{n!} F(1, -n/2; 1/2; s^2/k_2^2) \quad (18)$$

and the series converges for all finite values of r since the series integrated termwise in Equation (16) is uniformly convergent.

We obtain the series for $\Pi_1(r, 0)$ given in statement of results as equation (19) by putting (18) and the corresponding expression for $L(k_2)$ in equation (15).

NOTATION

The following symbols are used. C.G.S. electromagnetic units are used throughout the paper.

c = velocity of light, 3×10^{10} cm./sec.

$F(a, b; c; x)$ = The hypergeometric function

$$1 + \frac{ab}{1!c} x + \frac{a(a+1)b(b+1)}{2!c(c+1)} x^2 + \dots$$

$J_0(\xi r)$ = Bessel function of the first kind, zero order.

$k_1 = \omega/c$.

$k_2 = \sqrt{\epsilon\omega^2 + i4\pi\sigma\omega}$. The real and imaginary parts are positive.

$P_n(t)$, $P_{-1/2}^{-n}(t)$ = Legendre's polynomial, and associated Legendre's function of the first kind.

R_{1N} , R_{20} = Remainder terms in asymptotic series.

r = horizontal distance of representative point from dipole.

$s = k_1 k_2 / \sqrt{k_1^2 + k_2^2}$ or $1/s^2 = 1/k_1^2 + 1/k_2^2$. The real and imaginary parts of s are positive.

s^* = The complex conjugate of s .

t = time in the introduction, otherwise a complex variable.

w = complex variable.

z = height of representative point above ground.

ϵ = dielectric constant of the ground in e.m.u. The dielectric constant of air in e.m.u. is $1/c^2$. If the dielectric constant in e.s.u. is ϵ' , then $\epsilon = \epsilon'/c^2$. The dielectric constant of air in e.s.u. is 1.

$\Pi_1(r, z)$ = Wave function for $z \geq 0$ for a vertical unit dipole centered at the interface between air and ground. The wave function for a unit dipole wholly in air is obtained by multiplying the wave function given here by $2/(1 + \tau^2)$. By a unit dipole is meant the system obtained by letting the length l of a conductor approach zero while the current in the conductor approaches infinity in such a way that $Il = \text{unity}$, where the current equals the real part of $Ie^{-i\omega t}$ and does not vary with position along the conductor.

$\Pi_1(r, 0)$ = Value of wave function at earth's surface.

σ = conductivity of the ground in e.m.u. If the conductivity is σ' mhos per meter cube then $\sigma = 10^{-11}\sigma'$.

$\tau = k_1/k_2$.

ω = angular velocity, radians/sec.

Currents and Potentials along Leaky Ground-Return Conductors *

By E. D. SUNDE

THE problem of current and potential propagation for long conductors having large leakance to ground arises in connection with certain railway electrification problems, such as inductive effects in exposed communication lines, and voltages to ground of the tracks and of nearby underground cables. Impressed voltages in exposed lines are due partly to induction and partly to earth potential differences, and the latter in particular depend to a considerable extent on the mode of propagation of the track current. Voltages to ground of underground telephone cables depend on the mode of propagation along the cables of current produced in these by nearby railway electrification. These voltages may under certain conditions raise questions as to the possibility of hazard or, in case of direct current, give rise to electrolytic effects.

In considering propagation along earth-return conductors of the above kind, it is necessary to include certain effects which can be neglected in circuits having small leakance. One of the quantities involved in the differential equation for the current at a point of a ground-return conductor is the axial electric force produced in the ground adjacent to the conductor. For a given frequency and earth resistivity, this electric force at the point under consideration depends partly on the axial current distribution and partly on the leakage current distribution along the entire length of the conductor. The component depending on the axial current distribution is the vector potential multiplied by $-i\omega$, ω being the radian frequency, while the other component is the negative gradient of the earth potential, which depends on the leakage current distribution along the conductor. In the customary treatment, applying to conductors of small leakance, the axial current is assumed practically constant for great distances along the conductor, so that the first component becomes the negative product of axial conductor current at the point under consideration and the external earth-return impedance of the conductor. Furthermore, the earth potential is neglected or assumed constant along the conductor, so that the second component vanishes.

* Digest of a paper to be presented at the Winter Convention of the American Institute of Electrical Engineers, New York, January 25-29, 1937, and published in full in *Electrical Engineering*, Vol. 55, No. 12, pp. 1338-1346, December, 1936.

For conductors with large leakance, these simplifying assumptions are not justified. When the earth resistivity is uniform or varies with depth only, the electric force may be formulated in terms of the current along the entire length of the conductor, in which case the usual differential equation for the current is replaced by an integro-differential equation. A general solution of this equation and for conductor and earth potentials has been obtained. For homogeneous earth, rigorous as well as approximate solutions of special cases of interest in connection with the railway electrification problems mentioned above have also been derived.

One of these cases is of general interest since it may be regarded as fundamental to the solution of the general case of an arbitrary impressed electric force along the conductor. In this case a voltage $2V(0)$ is impressed across a break in the conductor at a certain point, which may be taken as the origin. The conductor current and potential are given by rather complicated integrals, which, in order to obtain practical formulas, may be expanded in series as:

$$I(x) = I_1(x) + I_2(x); \quad I_2(x) = I_{21}(x) + I_{22}(x), \quad (1)$$

$$V(x) = V_1(x) + V_2(x); \quad V_2(x) = V_{21}(x) + V_{22}(x), \quad (2)$$

where $I_{22}(x)$ and $V_{22}(x)$ may again be written as the sum of two terms, etc. The first terms in these expansions are:

$$I_1(x) = I_1(-x) = V(0) \frac{G(\Gamma)}{\Gamma} e^{-\Gamma x} = I(0) e^{-\Gamma x}, \quad (3)$$

$$V_1(x) = -V_1(-x) = V(0) e^{-\Gamma x} = I(0) \frac{\Gamma}{G(\Gamma)} e^{-\Gamma x}, \quad (4)$$

where $x \geq 0$ and:

$$\Gamma = \sqrt{Z(\Gamma)G(\Gamma)}.$$

x = distance from origin, in meters.

$$Z(\Gamma) = z + \frac{i\omega\nu}{2\pi} \log_e \frac{1.85 \dots}{a\alpha}$$

a = conductor radius, in meters.

$$G(\Gamma) = \left[g^{-1} + \frac{\rho}{\pi} \log_e \frac{1.12 \dots}{a\Gamma} \right]^{-1}$$

z = internal impedance in ohms per meter.

$$\alpha = (i\omega\nu\rho^{-1} + \Gamma^2)^{1/2}$$

g = leakage conductance in ohms per meter.

$$\omega = 2\pi f.$$

ρ = earth resistivity in meter-ohms.

f = frequency in cycles per second.

$\nu = 4\pi \cdot 10^{-7}$ henries per meter.

The transcendental equation defining the propagation constant Γ may be solved by successive approximations; a convenient first approximation is $\Gamma = \Gamma_1 = \sqrt{gZ(0)}$, $Z(0)$ being the earth-return self-impedance of the conductor. Equations (3) and (4) are of the same form as the solution for conductors of small leakance, except that the propagation constant for the latter is taken equal to Γ_1 above. The effect of the earth potential appears in a first approximation as the second term in the expression for $G(\Gamma)$.

For earth resistivities within the usual range and for electric railway tracks or underground cables the two terms in the expression for $G(\Gamma)$ are frequently of the same order of magnitude. Appreciable errors may therefore be obtained by neglecting the second term, and in correlating the results of measurements this must be kept in mind.

The second terms in the expansions are given below, but may be neglected in the range of most practical applications.

$$I_{21}(x) = I_{21}(-x) = -I(0) \frac{G(\Gamma)\rho}{4\pi} \{ (1 + \Gamma x)e^{\Gamma x} Ei(\Gamma x) - (1 - \Gamma x)e^{-\Gamma x} [Ei(-\Gamma x) + i\pi] \}, \quad (5)$$

$$V_{21}(x) = -V_{21}(-x) = I(0) \frac{\Gamma\rho}{4\pi} \{ \Gamma x e^{\Gamma x} Ei(\Gamma x) - \Gamma x e^{-\Gamma x} [Ei(-\Gamma x) + i\pi] - 2 \}, \quad (6)$$

where $Ei(u) = \int_u^\infty \frac{e^{-u}}{u} du$ is the exponential integral.

For sufficiently large values of Γx the bracket terms of expressions (5) and (6) vanish as $-8/(\Gamma x)^3$ and $4/(\Gamma x)^2$, respectively, so that in this case the second terms in the expansions predominate.

Abstracts of Technical Articles from Bell System Sources

*Electricity in Gases.*¹ KARL K. DARROW. The material in this paper was presented as the Joseph W. Richards Memorial Lecture delivered before the Electrochemical Society at Cincinnati, April 23, 1936. This lecture presents in a vividly descriptive manner some of the material published in past issues of the *Bell System Technical Journal*.

*Electron Diffraction Experiments Upon Crystals of Galena.*² L. H. GERMER. Cleaved surfaces of galena crystals yield electron diffraction patterns made up of Kikuchi lines, and spots which are drawn out into streaks by refraction. After etching, the spot pattern predominates and the individual spots are sharp. The lines are then rather diffuse and ill-defined. Rocking curves upon various Bragg reflections from the surface plane prove that the imperfection of a certain crystal does not exceed about 15 minutes, and that the projections through which the electrons pass are relatively thick. Estimates of imperfection and thickness made from rocking curves are in approximate agreement with those obtained from widths of Kikuchi lines.

A galena crystal which has been filed or ground parallel to a cube face exhibits two different sorts of surfaces. There are smooth "mirror" surfaces from which large blocks of the crystal have been mechanically torn, and there are very deeply scratched portions of the surface. The "mirror" surfaces give diffraction patterns which are qualitatively similar to patterns from cleaved surfaces, although there are notable differences. From mirror surfaces produced by filing, Kikuchi lines are very diffuse or are entirely missing, and diffraction spots form an extended array. The diffuseness of the lines and the extent of the array of spots correspond to great crystal imperfection, or to exceedingly thin projections. Reasons are advanced for believing in imperfection rather than extreme thinness.

The deeply scratched portions of the surface of a galena crystal give diffraction patterns which are entirely unlike patterns from cleaved surfaces. Before etching, Debye-Scherrer rings are produced. After a light or moderate etch a complex pattern appears, the nature of which is related to the angle between primary beam and direction of filing.

¹ *Transactions Electrochemical Society*, Vol. LXIX, 1936.

² *Phys. Rev.*, October 1, 1936.

The pattern is that of a mass of minute crystallites which have been rotated about an axis in the surface normal to the direction of filing, and in the sense determined by imaginary rollers which would be turned by slipping on the (0 1 0) plane. The magnitude of the rotation varies for different crystallites over a range from 5 to about 35 degrees. By alternate etching and examination by electron diffraction it is found that this layer of rotated crystallites extends beneath the surface to a depth of 0.003 mm.

Rotation of crystallites accompanying slip along slip planes is the mechanism reported to account for strain hardening in metals. This same rotation is observed in the present experiments on galena. It seems altogether possible that the simple technique of these experiments can be applied directly to study the disturbance in surface layers of metal crystals produced by abrasion. It may thus be a useful way of studying strain hardening in metals.

*The Photoelectric Cell and Its Method of Operation.*³ M. F. JAMIESON, T. E. SHEA, and P. H. PIERCE. This paper gives a simple description of the laws governing the release of electrons from photoelectric surfaces, their collection at anodes, and the creation of ions in photoelectric cell gases by the "ionization" process, and discusses questions of spectral selectivity of various photoelectric surfaces, the influence of spectral characteristics of illumination, and the dynamic characteristics of vacuum and gas-filled cells.

*Modified Sommerfeld's Integral and Its Applications.*⁴ S. A. SCHELKUNOFF. The purpose of this paper is to obtain a certain integral expressing the fundamental wave function and with the aid of this integral to calculate the radiation resistances of small doublets and small loops placed inside an infinite hollow cylinder. Some applications of this integral to calculation of radiation from parallel wires in free space are also discussed.

*Diffusion of Water Through Insulating Materials.*⁵ R. L. TAYLOR, D. B. HERRMANN, and A. R. KEMP. Data are presented on the rate of water diffusion through various organic materials. A diffusion constant based on Fick's linear diffusion law is calculated for each material. Several equations are derived from Fick's law to show how valuable information can be obtained in connection with practical problems.

³ *Jour. S. M. P. E.*, October, 1936.

⁴ *Proc. I. R. E.*, October, 1936.

⁵ *Indus. and Engg. Chem.*, November, 1936.

The effect of variations in methods and conditions of test is studied. The rate of diffusion through a water-sorbing material such as rubber does not obey Fick's law when under diffusion conditions favoring high water sorption.

Various concepts involving sorption and diffusion processes are discussed as bearing upon the mechanism of the diffusion of water through organic substances.

Contributors to this Issue

CHARLES R. BURROWS, B.S. in Electrical Engineering, University of Michigan, 1924; A.M., Columbia University, 1927; E.E., University of Michigan, 1935. Research Assistant, University of Michigan, 1922-23. Western Electric Company, Engineering Department, 1924-25; Bell Telephone Laboratories, Research Department, 1925-. Mr. Burrows has been associated continuously with radio research and is now in charge of a group investigating the propagation of ultra-short waves.

R. F. DAVIS, B.E.E., Cornell University, 1921. American Telephone and Telegraph Company, Department of Operation and Engineering, 1921-. Mr. Davis' work has been largely concerned with the electrical protection of communications circuits and with the electrical coordination of such circuits with power transmission and distribution circuits.

S. O. RICE, B.S. in Electrical Engineering, Oregon State College, 1929; California Institute of Technology, 1929-30, 1934-35; Bell Telephone Laboratories, 1930-. Mr. Rice has been concerned with various theoretical investigations relating to telephone transmission theory.

A. L. SAMUEL, A.B., College of Emporia (Kansas), 1923; S.B. and S.M. in Electrical Engineering, Massachusetts Institute of Technology, 1926. Instructor in Electrical Engineering, Massachusetts Institute of Technology, 1926-28. Bell Telephone Laboratories, 1928-. Mr. Samuel has been engaged in research and development work on vacuum tubes.

NELSON E. SOWERS, B.S. in Engineering Physics, 1924, University of Illinois; M.A., Columbia University, 1927; Engineer-Physicist (Professional), University of Illinois, 1936. Engineering Department, Western Electric Company, 1924-25. Bell Telephone Laboratories, Inc., 1925-. Since 1931, Mr. Sowers has been engaged in studies pertaining to amplifiers for ultra-high radio frequencies.

M. E. STRIEBY, A.B., Colorado College, 1914; B.S., Harvard, 1916; B.S. in E.E., Massachusetts Institute of Technology, 1916; New York

Telephone Company, Engineering Department, 1916-17; Captain, Signal Corps, U. S. Army, A. E. F., 1917-19. American Telephone and Telegraph Company, Department of Development and Research, 1919-29; Bell Telephone Laboratories, 1929-. Mr. Strieby has been associated with various phases of transmission work, more particularly with the development of long toll circuits. At the present time, in his capacity as Carrier Transmission Research Engineer, he directs studies of new and improved methods of carrier frequency transmission over existing or new facilities.

ERLING D. SUNDE, E. E., Technische Hochschule Darmstadt, 1926. American Telephone and Telegraph Company, Department of Development and Research, 1927-34; Bell Telephone Laboratories, 1934-. Mr. Sunde's work has been mainly concerned with inductive effects of electric railways.

W. HOWARD WISE, B.S., Montana State College, 1921; M.A., University of Oregon, 1923; Ph.D., California Institute of Technology, 1926. American Telephone and Telegraph Company, Department of Development and Research, 1926-34; Bell Telephone Laboratories, 1934-. Dr. Wise has been engaged in various theoretical investigations relating to transmission theory and telegraphy.