

*The*  
*Electrical Discoveries of*  
**JOSEPH HENRY**

*By*

H. S. OSBORNE AND A. M. DOWLING

AMERICAN TELEPHONE AND TELEGRAPH COMPANY  
NEW YORK, U. S. A.

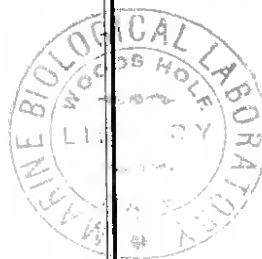

*A Supplement to*  
*The Bell System Technical Journal*  
*July, 1932*

## The Electrical Discoveries of Joseph Henry

By H. S. OSBORNE and A. M. DOWLING

AN historical research into the accomplishments of a great scientist, such as Henry, includes two main parts. There is first the proof, based upon the record, that he accomplished certain things. This being an affirmative proof can be quite definite. There is a second step, however, which is of interest in the appraisal of his work, namely, showing in respect to what items he was first. This means in effect proving that in respect to these items no one anticipated him. Such an assertion, being a universal negative, cannot be absolutely proved, but can, of course, by sufficient work be shown to be probable in a high degree.

The student of Joseph Henry's work is hampered in the number of items which can be included in the affirmative proof by the fact that no adequate record has been preserved. Henry was slow and fragmentary in publication and most of his personal records were destroyed in a fire at the Smithsonian Institution in 1865. While his publications and the testimony of others who saw his experiments show a prodigious accomplishment, it is probable that a more complete record would have added other important contributions made by Henry to electrical science, and in other fields of scientific work.

When one attempts to appraise Henry's work in comparison with that of his contemporaries, and particularly to determine in what cases Henry's discoveries were prior to those of others, the difficulty is multiplied. There was a complete lack of means for rapid communication one hundred years ago. As a result scattered scientists working in the same field often independently made similar discoveries and the scientific journals in which their results were published were neither rapidly nor widely distributed. The result is illustrated by the fact that so fundamental an advance as Ohm's law, published in full in 1827, was little known or accepted even in Europe for a decade.

The original notes of the scientific investigators are for the most part, with the outstanding exception of Michael Faraday, not available, and credit for priority of discovery has generally, by common consent, been associated with priority of publication. Even at the time there were some interesting cases in Europe where conflicting claims of priority were made and the implication is made in some cases that the scientific

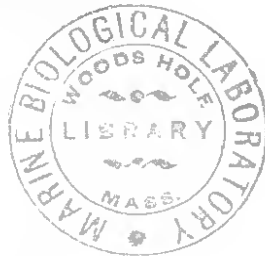

accuracy even of the scientists themselves is open to question where matters of priority are concerned. As stated by Arago,

"Those who discover a new fact in the sciences of observation must expect, first, to have its correctness denied,—next its importance and utility contested,—and afterwards will come the chapter of priority,—then, passages, obscure, insignificant, and previously unnoticed, will be brought forward in crowds as affording evident proofs of the discovery not being new."<sup>1</sup>

One hundred years later the determination of questions of priority is still difficult and it is small wonder the different writers on the subject of Joseph Henry's electrical discoveries have not always been in complete agreement as to the items for which priority should be assigned to Henry. In an attempt to resolve these uncertainties a study has been made of the published accounts of the more important discoveries of Joseph Henry in the electrical field and of the work of his contemporaries in that field. Reference has been made to the original of the publications cited by earlier investigators to indicate priority or lack of priority for Henry's work.

The results of this study are given below. It is naturally not a complete review of this complicated situation, relating as it does only to selected items of Henry's electrical work and, furthermore, other references may be found which affect the conclusions reached. It is believed, however, that this study is a contribution towards a more exact appraisal of Joseph Henry's work, and if it is of assistance to others who may in the future wish to carry this review still further, it will doubly have served a useful purpose.

In the selection of material for this review it is the intention to include in it the discoveries of Joseph Henry which are the more important from the standpoint of subsequent practical applications of electricity. The following summary indicates briefly what these discoveries were, and the conclusions in each case resulting from this study. The somewhat voluminous reference material on which the conclusions are based is given in the appendix to this paper, arranged under the same numbered headings as the summary.

#### SUMMARY OF HENRY'S DISCOVERIES INCLUDED IN THIS STUDY

##### *1. Construction of Electromagnets (1829 and 1830)*

Henry used insulated wire for the winding of electromagnets instead of the single spiral of non-insulated wire which had previously been used, and devised windings with more than one layer. By this means he was able to increase very greatly the strength of electromagnets and to make them practicable for general use. His form of construc-

<sup>1</sup> *Meteorological Essays* by Francois Arago, London, 1855, p. 291.

tion is universal for electromagnets today. Insulated wire had previously been applied to other uses, including galvanometer coils, but not to magnets.

### 2. *Proportioning of Magnet and Battery for Maximum Effect (1830)*

Henry pointed out that the coils of the magnets constructed by his method could be made up either of one very long wire or several shorter ones, showed the proper relative proportioning of magnet and battery for maximum effect in these two cases and pointed out that the intensity magnet and battery were suitable for operating over line wires of considerable resistance, while the quantity magnet and battery were suitable for local circuits. This result was arrived at experimentally before Henry had any knowledge of Ohm's law, and is the first recognition of the necessity for properly proportioning the impedance of different parts of an electric circuit which has become an important quantitative requirement in the design of all forms of electric circuit, particularly in communication circuits.

### 3. *Electromagnetic Motor (1831)*

Henry was the first to publish a description of an electric motor using electromagnets and a commutator. This motor was a reciprocating device, therefore quite different in form from the commercial motors developed later. It did, however, contribute these two fundamental elements of permanent value and also served to rouse interest in and stimulate work on the problem of obtaining mechanical power from electricity.

The question has been raised whether Henry was not anticipated by Salvatore dal Negro of Padua, who made a similar motor apparently in the same year. While the evidence on this point is somewhat circumstantial, it seems to indicate clearly that Henry was first in publication. It is probable that dal Negro's work was done without knowledge of Henry's, but there is no evidence to indicate that his motor was constructed earlier than Henry's.

### 4. *Telegraphy (1831 and 1832)*

By the application of his principles of proper proportioning of magnet winding, battery and external circuit resistance, Henry produced the first telegraph using electromagnets as a receiving device. The idea of using galvanic current for telegraphy at a distance had previously been investigated by Barlow and later the control of electromagnets at a distance by transmitting current over a line wire was investigated by Wheatstone without knowledge of Henry's work done five years earlier. In both cases the project was rejected as impractic-



able because of their lack of appreciation of this principle of proper proportioning.

Henry's telegraph included an "intensity" battery, a line wire of more than one mile in length and a receiving device consisting of an electromagnet with polarized armature so arranged as to strike a bell when reversals of current were sent. The use of the electromagnet made rapid signaling possible and has formed the basis of practically all subsequent commercial telegraph development. He was also the first to employ audible reception, which has played a very important part, particularly in American telegraph practice.

In Henry's later telegraph experiments he used a grounded circuit which has played a very important part in telegraph development. Grounded circuits had, however, been used before Henry in experiments with electric telegraphs of other types.

In 1850 in a Morse patent suit a claim was made that in 1830 Abraham Booth from Dublin had demonstrated a similar electromagnetic telegraph. A search of important contemporary publications, however, reveals no evidence to support this claim.

#### 5. *Electromagnetic Induction (1832)*

Faraday and Henry both independently discovered the phenomena of mutual induction and of self induction. On the basis of date of publication the discovery of mutual induction is properly credited to Faraday (1831, published 1832) and the discovery of self induction to Henry (1832). The determination of this question is recognized in the official adoption by the International Electrical Congress of 1893 of the name "henry" for the practical unit of inductance.

It is interesting to note that in 1804 Vassali-Eandi observed that the shock obtained in opening a long circuit was greater than that received by merely touching the battery terminals. While this fact was due to the self inductance of a circuit this observation did not constitute an anticipation of Henry, as no thought of induction, either self or mutual, was in the mind of the investigator. Also, in connection with his investigations of mutual induction in 1831, Faraday conceived that conductors might have the property of self inductance, and carried on experiments designed to detect this property. His experiments, however, showed a negative result.

#### 6. *Electromagnetic Relay (1835)*

Henry first discovered and demonstrated the principle of the electromagnetic relay. The relay was used by him at the end of his telegraph line to open the local circuit of a large magnet and to demonstrate

the possibility of producing a great mechanical effect at a distance. This invention is, of course, fundamental to the operation of electrical systems of all kinds: telephone, telegraph and electric power.

#### *7. Non-Inductive Winding (1835)*

Both Henry and Faraday devised non-inductive windings in connection with their experiments on self induction. Henry's publication was, however, slightly earlier than Faraday's. The non-inductive windings so described are fundamentally the same in principle as those now used for resistance coils and other apparatus where self inductance is reduced to a minimum.

It is interesting to note that before the discovery of self induction Faraday constructed for use in certain experiments on mutual induction an apparatus closely parallel to the non-inductive winding, namely, two closely associated secondary windings connected in series opposing.

#### *8. Transformer (1838)*

While both Faraday and Henry used a transformer structure in their first mutual induction experiments, it was only later (1838, published 1839) that it was discovered by Henry that by the proper proportioning of the coils the voltage could be stepped up or stepped down with this structure. This is fundamentally the basis of modern electrical transformers.

#### *9. Electromagnetic Shielding (1838)*

Henry discovered the screening effect of all good conducting substances interposed between two coils, i.e. the primary and secondary of a transformer. After publishing his results Henry learned of Faraday's results published at about the same time purporting to show that this screening effect did not exist except with magnetic materials. Henry thereupon explained the reason for this apparent discrepancy and reaffirmed his own results.

He also pointed out that this principle has an important bearing on the improvement of electrical machinery, and explained the advantage which had been found by using bundles of wires instead of solid pieces of iron, i.e. lamination.

#### *10. Discoveries Bearing Particularly on Radio Telegraphy and Telephony (1838 to 1842)*

Henry (1838, published 1839) showed the variation in current induced in a secondary circuit as the separation between primary and secondary is varied. This is the principle of the variometer widely used in radio work.

Henry then (1842) carried his investigations to considerable distances, producing high frequency oscillating currents in a primary circuit by the discharge of a battery of Leyden jars, and detecting the result in secondary circuits at a distance first of 30 feet and then of several hundred feet. He concluded that every spark of electricity in motion exerts inductive effects at distances indefinitely great and likened the propagation of this effect to the propagation of light which he surmised was merely another kind of wave in the same medium. It is an extraordinary fact that in these experiments Henry had what would now be considered a form of radio transmitter and receiver, and that he believed the results to be produced by an electromagnetic radiation comparable with light. This was 25 years before the work of Maxwell and more than 40 years before the work of Hertz.

Henry is sometimes credited with having discovered the oscillatory nature of the discharge of the Leyden jar (1842). Felix Savary, however, in 1827 had advanced the hypothesis that this discharge is oscillatory in order to explain his experimental results. Henry repeated Savary's investigations and brought about the acceptance of Savary's hypothesis as a result of his authoritative affirmation that this hypothesis was correct.

The above record of the achievements of Joseph Henry, partial though it be, is the more impressive in consideration of the difficulties under which Joseph Henry labored. He worked in a frontier country far from the current of European scientific thought and with only occasional information regarding the results achieved by others. Furthermore, in his early years his work was limited largely to summer vacations, his time being fully occupied by teaching during the school year. His financial limitations were serious. His results were achieved by great industry in the application of his genius for practical experimentation, his inventive insight, his power for exact observation and his sense of perspective and proportion.

## APPENDIX

### REFERENCES BEARING ON HENRY'S ELECTRICAL DISCOVERIES

#### 1. *Construction of Electromagnets*

##### a. *Use of Insulated Wire*

Insulated wire was used before Henry's work for various purposes including electrostatic telegraphs and galvanometers. For example, the wire of the coil in Schweigger's galvanometer as made by Oersted was:

"... wrapped or wound round throughout its whole length, in silk thread. Thus all electric communication is avoided between the different parts of this wire, the turns of which are wound one over or above the other, as it is placed in the groove of the frame."<sup>2</sup>

Insulated wire had not been applied to magnets, they being constructed by insulating the magnet core and winding on it a single spiral of uninsulated wire. The following is Henry's first description of the application of insulated wire to magnets:

"In a paper, published in the *Transactions of the Albany Institute*, June, 1828, I described some modifications of apparatus, intended to supply this deficiency of Mr. Sturgeon [weak magnetic effects], by introducing the spiral coil on the principle of the galvanic multiplier of Prof. Schweigger, and this I think is applicable in every case where strong magnets cannot be used. . . . Shortly after the publication mentioned, several other applications of the coil, besides those described in that paper, were made in order to increase the size of electro-magnetic apparatus, and to diminish the necessary galvanic power. The most interesting of these, was its application to a development of magnetism in soft iron, much more extensively, than to my knowledge had been previously effected by a small galvanic element.

"A round piece of iron, about 1/4 of an inch in diameter, was bent into the usual form of a horse-shoe, and instead of loosely coiling around it a few feet of wire, as is usually described, it was tightly wound with 35 feet of wire, covered with silk, so as to form about 400 turns; . . ."<sup>3</sup>

The nearest approach which has been found to a contemporary statement indicating possible anticipation by others is the following published by Silliman in his journal for July, 1837:

"Prof. Moll, of Utrecht, by winding insulated wire around soft iron, imparted to it prodigious magnetic power, so that a horse shoe bar, thus provided, and connected with a galvanic battery, would lift over one hundred pounds. About the same time, Mr. Joseph Henry, of Albany, now Prof. Henry, of Princeton College, by a new method of winding the wire, obtained an almost incredible magnetic force. . . ."

However, reference to Moll's own account of his work published in the *Edinburgh Journal of Science* April-October, 1830, and copied in *Silliman's Journal* for January, 1831, and to another contemporary account of Moll's work gives no indication of his having used insulated wire.

Henry also used other insulating materials. In SW, Vol. 1, p. 48 (1831), he acknowledged Dr. Beck's suggestion for using well waxed cotton instead of silk thread and also mentioned Dr. Beck's experiments with iron bonnet wire "which, being found in commerce already wound, might possibly be substituted in place of copper. . . ."

In 1832 he described winding the armature of a magnet with "A piece of copper wire, about thirty feet long and covered with elastic varnish. . . ."<sup>4</sup> In this, however, he was anticipated as to publication

<sup>2</sup> *Electro-Magnetism etc.*, Jacob Green, 1827, pp. 81-83.

<sup>3</sup> SW, \* Vol. 1, pp. 37-38; paper published January, 1831.

<sup>4</sup> SW, Vol. 1 p. 75.

\* *Scientific Writings of Joseph Henry*, published by the Smithsonian Institution in 1886.



at least by Professor Hare of the University of Pennsylvania, who in a letter of February 24, 1831, published in *Silliman's Journal* of July 1831, stated with reference to wire for magnets, "I used no wrapping, but merely shell lac varnish, applied in winding. . . ." The same issue of *Silliman's Journal* quotes a letter from Professor J. W. Webster of Harvard of February 7, 1831, stating, "In constructing the magnetic apparatus, there is considerable economy in using sealing wax instead of silk."

b. *Multiple Layer Windings*

In 1831 Henry wrote as follows:

"At the same time [1829 or 1830], a very material improvement in the formation of the coil suggested itself to me, on reading a more detailed account of Prof. Schweigger's galvanometer, and which was also tested with complete success upon the same horse-shoe; it consisted in using several strands of wire, each covered with silk, instead of one:—agreeably to this construction, a second wire, of the same length as the first, was wound over it, and the ends soldered to the zinc and copper in such a manner that the galvanic current might circulate in the same direction in both. . . ."<sup>5</sup>

This is generally acknowledged to be the first publication of the use of this important improvement in magnet construction.

In Henry's early work the windings were wound directly on the magnet core. It is not clear whether he later wound up coils separately intended to be applied to the magnet cores after winding. This form of construction, however, was used by Professor Hare as early as 1831 in making the Henry type magnets. In a letter of March 4, 1831, he described in detail the process of winding the coil on a mandril and later slipping it over the core, apparently as an improvement in construction detail.<sup>6</sup>

2. *Proportioning of Magnet and Battery for Maximum Effect*

Henry, in a paper published January, 1831, described a series of experiments instituted jointly with Dr. Philip Ten Eyck for the purpose of determining how the type of magnet and battery and the length of the interconnecting wires affected the magnetic force produced. From the results he concluded that:

"From these experiments, it is evident that in forming the coil we may either use one very long wire or several shorter ones as the circumstances may require: in the first case, our galvanic combinations must consist of a number of plates so as to give 'projectile force'; in the second, it must be formed of a single pair."<sup>7</sup>

3. *Electromagnetic Motor*

In 1821 Faraday made the first electric motor, the action of which was the rotation of a current-carrying wire around the pole of a perma-

<sup>5</sup> SW, Vol. 1, p. 39.

<sup>6</sup> *Silliman's Journal*, July, 1831.

<sup>7</sup> SW, Vol. 1, p. 42.

nent magnet. This was followed by Barlow's motor in which a spur-shaped wheel, with current flowing through it radially, rotated between the poles of a permanent horse-shoe magnet. Henry, in an undated letter published in *Silliman's Journal* in July, 1831,<sup>8</sup> described in detail and illustrated an electro-magnetic rocker arm machine, provided with a commutator. This letter commences with the following statement:

"Sir:—I have lately succeeded in producing motion in a little machine by a power, which, I believe, has never before been applied in mechanics—by magnetic attraction and repulsion.

"Not much importance, however, is attached to the invention, since the article, in its present state, can only be considered a philosophical toy; although, in the progress of discovery and invention, it is not impossible that the same principle, or some modification of it on a more extended scale, may hereafter be applied to some useful purpose. But without reference to its practical utility, and only viewed as a new effect produced by one of the most mysterious agents of nature, you will not, perhaps, think the following account of it unworthy of a place in the *Journal of Science*."

The question is sometimes raised whether Henry's motor was not anticipated by a similar one made by Salvatore dal Negro of Padua. A review of the original publications of dal Negro, while indicating that he independently invented a motor similar to Henry's, seems to indicate clearly that his dates of publication were later. The facts are these:

The first brief description of dal Negro's motor is given in a memoir entitled, "New Electro-magnetic Experiments and Observations," published in *Nuovi Saggi della Imperiale Regia Accademia di Scienze Lettere ed Arti in Padova*, Volume III, 1831. This volume is a collection of papers covering the years 1825–31, inclusive, and is one of a series of volumes issued at irregular intervals of 3 to 8 years, apparently for the purpose of providing a permanent record. This volume includes the statement that the dal Negro paper was presented before the Academy of Padua on June 21 and July 10, 1831. There is no indication how much later than this the volume was published, although the character of the volume and the other evidence in this case suggest that it may well have been published at the end of 1831 or later.

In this memoir, parts 1 to 3 inclusive, comprising 16 pages and a plate of illustrative figures, describe batteries and magnets. Part 4, only one page in length, with no figures, describes the motor very briefly as follows:

"Part 4—A New Electro-magnetic Motor

Having succeeded in building temporary magnets capable of holding up considerable weights by means of electromotors [batteries] of very moderate size and therefore of very small cost, I have engaged myself in the study of the way of employing this new force towards setting in motion a machine of any sort, and now I am about to

<sup>8</sup> SW, Vol. 1, p. 54.

outline briefly to you, illustrious members of the Academy, the various manners which I have devised for putting a lever into motion.

1. The first lever I have set in motion consists of a magnetized steel bar, set vertically between the ends of a temporary magnet. The bar oscillates in response to succeeding magnetic attractions and repulsions which take place between the S pole of the bar and the S and N poles of the temporary magnet, which poles are continually reversed by the same lever. By means of the same contrivance the lever can be made to oscillate in a horizontal plane.

2. . . . ."

The rest of part 4 deals in a general way with other methods of producing motion by the use of electro-magnets and is not of interest in this discussion.

A bi-monthly publication entitled *Annali delle Scienze del Regno Lombardo-Veneto, Padova*, in its issue of July-August 1831, gives a review of the presentation of the dal Negro paper before the Academy of Padua. This review, which is more than a thousand words long, covers very completely the subject matter of the first three parts of dal Negro's paper. It makes no mention whatever of the new electro-magnetic motor. Since the description of the motor appears to be the most novel and interesting part of the paper as finally published, the omission of any mention of it in the published review naturally raises a question whether the description of the motor was a part of the paper as originally presented.

Furthermore, in the November-December 1831 issue of *Annali delle Scienze* the first three parts of dal Negro's paper are published, but not the fourth part. In this there is no reference to the electro-magnetic motor except the following statement in the introductory part, given as one of the reasons for presenting the paper:

"4. Finally, because I hope to have enriched physics with a new motor, having succeeded in putting into motion in various manners a lever, taking advantage of the strength of temporary magnets."

The article is marked "to be continued," which suggests that it was the intention to add in a later issue a description of the electro-magnetic motor mentioned in the introduction. However, a review of subsequent issues fails to reveal any publication of part 4.

The above evidence indicates that the brief description of dal Negro's motor mentioned above probably was not published before the end of 1831, and raises considerable doubt whether it was included in the original draft of dal Negro's paper presented before the Academy in June and July, particularly in view of the lack of any mention of this part of the paper in the very full report of the meeting published in August.

The first full description of dal Negro's machine was published in the *Annali delle Scienze* for March and April 1834. This paper includes the following footnote:

"This new instrument was made by me in the year 1831 and I have already mentioned this in the fourth part of my first memoir on temporary magnetism which I published in volume VI of the *Atti dell' Accademia di Scienze, Lettere ed Arti di Padova*." [The volume number appears to be an inaccurate reference to volume III of *Nuovi Saggi*, etc. as indicated above.]

#### 4. Telegraphy

In 1831, following the description of the experiments which led to his discovery of the proper proportioning of the battery and the magnet, Henry stated:

"But be this as it may, the fact, that the magnetic action of a current from a trough is, *at least*, not sensibly diminished by passing through a long wire, is directly applicable to Mr. Barlow's project of forming an electro-magnetic telegraph. . . ."<sup>9</sup>

Henry later corrected this reference to Barlow since Barlow's investigation merely tended to disprove the possibility of the telegraph. Barlow's statement regarding the telegraph was:

"In a very early stage of electro-magnetic experiments, it had been suggested, that an instantaneous telegraph might be established by means of conducting wires and compasses. The details of this contrivance are so obvious, and the principles on which it is founded so well understood, that there was only one question which could render the result doubtful, and this was, Is there any diminution of effect by lengthening the conducting wire? . . . I was, therefore, induced to make the trial, but I found such a sensible diminution with only 200 feet of wire, as at once to convince me of the impracticability of the scheme."<sup>10</sup>

Even as late as 1837, Wheatstone in England had satisfied himself by experiment that the development of electro-magnetism in soft iron at a distance was impracticable. Cooke had sought to develop magnetism at a distance for the purpose of sounding an alarm. His experiments were unsatisfactory and on asking advice of Faraday and Roget was referred by the latter to Wheatstone. Wheatstone's statement was:

"I believe, but am not quite sure, that it was on the 1st of March 1837, that Mr. Cooke introduced himself to me. . . . Mr. Cooke [later] showed me some of his drawings and models, and though I could not fully comprehend the full scope of them at the time, I saw and understood enough to assure me that his instrument was a massive complicated piece of machinery, intended to be set in action by the attractive power of an electro-magnet. On seeing this, and relying on my former experience, I at once told Mr. Cooke that it would not and could not act as a telegraph, because sufficient attractive power could not be imparted to an electro-magnet interposed in a long circuit; and to convince him of the truth of this assertion, I invited him to King's College, to see the repetition of the experiments on which my conclusion was founded. He came, and after seeing a variety of voltaic magnets, which even with powerful batteries exhibited only slight adhesive attraction, he expressed his disappointment in these words, which I well remember, 'Here is two years' labour wasted.'"<sup>11</sup>

Henry in 1831 or 1832 at Albany acted on his own suggestion as to

<sup>9</sup> SW, Vol. 1, p. 42.

<sup>10</sup> *Edinburgh Philosophical Journal*, Jan.-Apr. 1825.

<sup>11</sup> *The Electric Telegraph: Was It Invented by Professor Wheatstone?*, by W. F. Cooke, Part 2, pp. 86-87.



the applicability of his discovery to the electro-magnetic telegraph. At that time he published no description of his experiments, but did so a number of years later. There are also accounts of several eye-witnesses to them, the following from a letter of James Hall to Henry, January 19, 1856.

"While a student of the Rensselaer School, in Troy, New York, in August, 1832, I visited Albany with a friend, having a letter of introduction to you from Professor Eaton. Our principal object was to see your electro-magnetic apparatus, of which we had heard much, and at the same time the library and collections of the Albany Institute.

"You showed us your laboratory in a lower story or basement of the building, and in a larger room in an upper story some electric and galvanic apparatus, with various philosophical instruments. In this room, and extending around the same, was a circuit of wire stretched along the wall, and at one termination of this, in the recess of a window, a bell was fixed, while the other extremity was connected with a galvanic apparatus.

"You showed us the manner in which the bell could be made to ring by a current of electricity, transmitted through this wire, and you remarked that this method might be adopted for giving signals, by the ringing of a bell at the distance of many miles from the point of its connexion with the galvanic apparatus."<sup>12</sup>

And Dr. Orlando Meads, a former student of the Albany Academy, in 1863 in a discourse commemorating an anniversary of the Academy, thus referred to the scenes he had witnessed one-third of a century before:

"The older students of the Academy in the years 1830, 1831, and 1832, and others who witnessed his experiments which at that time excited so much interest in this city, will remember the long coils of wire which ran circuit upon circuit for more than a mile in length around one of the upper rooms in the Academy, for the purpose of illustrating the fact that a galvanic current could be transmitted through its whole length so as to excite a magnet at the farther end of the line, and thus move a steel bar which struck a bell."<sup>13</sup>

Henry had two applications of his electro-magnets in mind: first, the production of a machine to be moved by electro-magnetism and, second, the transmission of or calling into action power at a distance.

"... for the purpose of experimenting in regard to the second, I arranged around one of the upper rooms in the Albany Academy a wire of more than a mile in length, through which I was enabled to make signals by sounding a bell."<sup>14</sup>

Henry later used the grounded circuit, another close parallel to the form taken in the practical development of the telegraph. This principle, however, had been used years earlier in electrostatic telegraphs and in firing gun powder at a distance, e.g., by Cavallo in 1794-5 and Salva in 1798.<sup>15</sup>

<sup>12</sup> *Annual Report Smithsonian Institution* 1857, p. 96.

<sup>13</sup> *A Memorial of Joseph Henry*, published by Order of Congress, 1880, p. 380.

<sup>14</sup> SW, Vol. 2, p. 434, 1857.

<sup>15</sup> *A History of Electric Telegraphy to the Year 1837*, by J. J. Fahie, 1884, pp. 99 and 108.

In the case of Smith vs. Downing, a telegraph infringement suit tried at Boston in 1850, a witness, Oliver Byrne by name, made the following statement.

"In the year 1830, I attended the public lectures of Abraham Booth (afterward scientific reporter for the *Times* newspaper, and who became Dr. Booth), delivered in Dublin, among other subjects, on electricity and electro-magnetism. In said lectures, the said Booth, in my presence, used in combination a long circuit of insulated wire conductors, or galvanic battery, an electro-magnet with an armature and mercury cups to join and disjoin the circuit, with which he magnetized and demagnetized the iron of the electro-magnet, causing it to attract the armature when the circuit was joined, and to recede from it when disjoined. Mr. Booth, at that time, stated to his audiences that that power could be produced and used at distant places, as signs of information; and he repeatedly illustrated what he meant, by causing the armature to approach the magnet, and then to fall from it on the floor, stating at the same time that it made marks by so falling."<sup>16</sup>

A search was made of various indices and publications, including *The Royal Society Catalogue of Scientific Papers, 1800-1863*; *Transactions of Royal Irish Academy, 1786-1886*; *Royal Dublin Society Catalogue, 1731-1839*, by J. F. Jones; *British Museum Catalogue*; Glazebrook's *Dictionary of Applied Physics*; J. J. Fahie's *History of the Telegraph*, previously referred to; and William B. Taylor's *An Historical Sketch of Henry's Contribution to the Electro-Magnetic Telegraph, 1879*. No further report or particulars of Abraham Booth's work, aside from the same quotation in Fahie's book, was found to support the statement and it is not therefore considered to constitute adequate evidence of anticipation of Henry.

##### 5. Electromagnetic Induction

Henry's first description of his experiments on self-induction is included in his paper in *Silliman's Journal* of July, 1832. After describing experiments on mutual induction he proceeded with the following:

"I have made several other experiments in relation to the same subject, but which more important duties will not permit me to verify in time for this paper. I may however mention one fact which I have not seen noticed in any work, and which appears to me to belong to the same class of phenomena as those before described; it is this: when a small battery is moderately excited by diluted acid, and its poles which should be terminated by cups of mercury, are connected by a copper wire not more than a foot in length, no spark is perceived when the connection is either formed or broken; but if a wire thirty or forty feet long be used instead of the short wire, though no spark will be perceptible when the connection is made, yet when it is broken by drawing one end of the wire from its cup of mercury, a vivid spark is produced. If the action of the battery be very intense, a spark will be given by the short wire; in this case it is only necessary to wait a few minutes until the action partially subsides, and until no more sparks are given from the short wire; if the long wire be now substituted a spark will again be obtained. The effect appears somewhat increased by coiling the wire into a helix; it seems also to depend in some measure on the length and thickness of the wire. I can account for these phenomena only by supposing the long wire to become charged with electricity, which by its re-action on itself projects a spark when the connection is broken."<sup>17</sup>

<sup>16</sup> *Historical Sketch of the Electric Telegraph*, by Alexander Jones, 1852, p. 32.

<sup>17</sup> SW, Vol. 1, p. 79.

Faraday's first communication on self-induction, in the *Philosophical Magazine* of November, 1834, does not state the matter very clearly. A more detailed paper read before the Royal Society on January 29, 1835, clearly presents the matter, including the following quotation:

"The case, therefore, of the bright spark and shock on disjunction may now be stated thus: If a current be established in a wire, and another wire, forming a complete circuit, be placed parallel to the first, at the moment the current in the first is stopped it induces a current in the *same* direction in the second, the first exhibiting then but a feeble spark; but if the second wire be away, disjunction of the first wire induces a current in itself in the same direction, producing a strong spark. The strong spark in the single long wire or helix, at the moment of disjunction, is therefore the equivalent of the current which would be produced in a neighbouring wire if such second current were permitted."<sup>18</sup>

It is interesting to note that Faraday ascribed the momentary character of the induced current in a secondary conductor to the development in that conductor of an "electro-tonic" state, which tended to oppose the flow of current. The following interesting statement is made in a paper read on November 24, 1831:

"The current of electricity which induces the electro-tonic state in a neighbouring wire, probably induces that state also in its own wire; for when by a current in one wire a collateral wire is made electro-tonic, the latter state is not rendered any way incompatible or interfering with a current of electricity passing through it (62). If, therefore, the current were sent through the second wire instead of the first, it does not seem probable that its inducing action upon the second would be less, but on the contrary more, because the distance between the agent and the matter acted upon would be very greatly diminished."<sup>19</sup>

Faraday then quoted experiments on an electrical conductor designed to detect "a return current . . . due to the discharge of its supposed electro-tonic state." These experiments were, however, unsuccessful. In view of the failure of the experiments, these speculations are not considered to constitute an anticipation of the discovery of self-induction made by both Henry and Faraday at a later date.

Another reference which is of interest regarding early observations of self-induction is the following published in the *Philosophical Magazine* in 1804 under the heading "Intelligence and Miscellaneous Articles."

*"Velocity of the Galvanic Fluid"*

"Vassali-Eandi has lately made some experiments on this subject, as Beccaria did in regard to the velocity of the electric fluid. The fluid of a pile of twenty-five pairs of plates traversed in a second thirteen metres (forty-two feet and a half) of gold cord. In another experiment with a pile of fifty pairs, the fluid passed along a copper wire plated with silver, three hundred and fifty-four metres (1151 feet) in length, in a time incommensurable: the shock in this case was three times as strong as that experienced by immediately touching the two extremities of the pile."<sup>20</sup>

<sup>18</sup> *Experimental Researches in Electricity* by Michael Faraday, Volume 1, paragraph 1092.

<sup>19</sup> *Experimental Researches*, Volume 1, paragraph 74.

<sup>20</sup> Volume 18, p. 374.

It appears that the experimenter observed the phenomenon of momentary high voltage produced by the "extra current" later observed by Henry, but that it was in no sense an anticipation of the discovery of self-induction since it was not so interpreted, no thought of induction, self or mutual, being in the mind of the experimenter.

Henry's first publication on mutual induction was in *Silliman's Journal*, July, 1832. He mentioned having seen a short account of Faraday's work and the method he used, saying:

"Before having any knowledge of the method given in the above account, I had succeeded in producing electrical effects in the following manner, which differs from that employed by Mr. Faraday, and which appears to me to develop some new and interesting facts."<sup>21</sup>

He then described his experiment, which consisted in opening and closing the circuit of an electro-magnet and noting the effect on a galvanometer connected to a coil wound around the armature of the magnet.

Faraday read a detailed paper November 24, 1831, on mutual induction, this appearing in *Philosophical Transactions*, 1832. The account Henry saw was the proceedings of the Royal Institution as reported in the *Philosophical Magazine* for April 1832, as follows:

"Feb. 17.—Mr. Faraday gave an account of the first two parts of his recent researches in electricity; namely, volta-electric induction, and magneto-electric induction.

If two wires, A and B, be placed side by side, but not in contact, and a voltaic current be passed through A, there is instantly a current produced, by induction, in B, in the opposite direction. . . . If a wire connected at both extremities with a galvanometer be coiled, in the form of a helix, around a magnet, *no current* of electricity takes place in it. . . . But if the magnet be withdrawn from or introduced into such a helix, a current of electricity is produced *whilst the magnet is in motion*, and is rendered evident by the deflection of the galvanometer. . . . Thus is obtained the result so long sought after,—the conversion of magnetism into electricity."<sup>22</sup>

#### 6. Electromagnetic Relay

The date of Henry's first electro-magnetic relay is generally given as 1835. It was made at Princeton (where he went towards the end of 1832) after he became settled in his duties there, and before he went to England in 1837. Edward N. Dickerson,<sup>23</sup> a Princeton student in 1839, said that Henry put his relay in operation at Princeton in 1835. Henry's earliest description of the relay, from a deposition of 1849, is as follows:

"In February, 1837, I went to Europe; and early in April of that year Prof. Wheatstone, of London, in the course of a visit to him in King's College, London, with Prof. Bache, now of the Coast Survey, explained to us his plans of an electro-magnetic telegraph; and, among other things, exhibited to us his method of bringing

<sup>21</sup> SW, Vol. 1, p. 75.

<sup>22</sup> *Philosophical Magazine*, April, 1832, pp. 300-301.

<sup>23</sup> *Joseph Henry and the Magnetic Telegraph: An Address by Edward N. Dickerson*, LL.D., 1885.



into action a second galvanic circuit. . . . I informed him that I had devised another method of producing effects somewhat similar. This consisted in opening the circuit of my large quantity magnet at Princeton, when loaded with many hundred pounds weight, by attracting upward a small piece of moveable wire, with a small intensity magnet, connected with a long wire circuit. When the circuit of the large battery was thus broken by an action from a distance, the weights would fall, and great mechanical effect could thus be produced, such as the ringing of church bells at a distance of a hundred miles or more, an illustration which I had previously given to my class at Princeton. . . . The object of Prof. Wheatstone, as I understood it, in bringing into action a second circuit, was to provide a remedy for the diminution of force in a long circuit. My object, in the process described by me, was to bring into operation a large quantity magnet, connected with a quantity battery in a local circuit, by means of a small intensity magnet, and an intensity battery at a distance."<sup>24</sup>

Under date of March 16, 1857, Henry transmitted to the Board of Regents of the Smithsonian Institution a "statement in relation to the history of the electro-magnetic telegraph" for the investigation of their special committee. Referring in his letter to his 1849 deposition he stated:

"My testimony was given with the statement that I was not a willing witness, and that I labored under the disadvantage of not having access to my notes and papers, which were in Washington. The testimony, however, I now reaffirm to be true in every essential particular."<sup>25</sup>

As a result of its investigations the Committee reported as follows:

"We have shown . . . that Mr. Henry's deposition of 1849 . . . is strictly correct in all the historical details, and that, so far as it relates to Mr. Henry's own claim as a discoverer, it is within what he might have claimed with entire justice. . . ."<sup>26</sup>

#### 7. *Non-Inductive Winding*

The earliest reference to the use of the non-inductive winding by Henry was in a verbal communication made by him January 16, 1835, before the American Philosophical Society, a report on which was published March, 1835. He described it in more detail in a paper read February 6, 1835, as follows:

"One of these ribbons was next doubled into two equal strands, and then rolled into a double spiral with the point of doubling at the centre. By this arrangement the electricity, in passing through the spiral, would move in opposite directions in each contiguous spire, and it was supposed that in this case the opposite actions which might be produced would neutralize each other. The result was in accordance with the anticipation; the double spiral gave no spark whatever, while the other ribbon coiled into a single spiral produced as before a loud snap. Lest the effect might be due to some accidental touching of the different spires, the double spiral was covered with an additional coating of silk, and also the other ribbon was coiled in the same manner; the effect with both was the same."<sup>27</sup>

Faraday, in his paper read before the Royal Society January 29,

<sup>24</sup> *Annual Report of Smithsonian Institution*, 1857, pp. 111-112.

<sup>25</sup> *Annual Report of Smithsonian Institution* 1857, p. 87.

<sup>26</sup> *Annual Report of Smithsonian Institution* 1857, p. 98.

<sup>27</sup> SW, Vol. 1, p. 94.

1835, and published in the Philosophical Transactions of that year, described the non-inductive winding as follows:

"Thus, if a long wire be doubled, so that the current in the two halves shall have opposite actions, it ought not to give a sensible spark at the moment of disjunction: and this proved to be the case, for a wire forty feet long, covered with silk, being doubled and tied closely together to within four inches of the extremities, when used in that state, gave scarcely a perceptible spark; . . . ." <sup>28</sup>

Prior to this discovery Faraday in 1832 had constructed for use in certain experiments on mutual induction an apparatus closely parallel to the non-inductive winding, namely, two secondary windings twisted about each other to associate them as closely as possible and then wound in the form of a helix. With these windings connected in series opposing, he found no mutual inductive effect. <sup>29</sup>

#### 8. Transformer

In Henry's article, "On Electro-Dynamic Induction," read November 2, 1838, and published the following year, after referring to Faraday's discovery of mutual induction he stated:

"Since then however attention has been almost exclusively directed to one part of the subject, namely, the induction from magnetism, and the perfection of the magneto-electrical machine: and I know of no attempts, except my own, to review and extend the purely electrical part of Dr. Faraday's admirable discovery." <sup>30</sup>

The experiments bearing on the transformer he partially summarized as follows:

"This experiment was considered of so much importance, that it was varied and repeated many times, but always with the same result; it therefore establishes the fact that an 'intensity' current can induce one of 'quantity,' and, by the preceding experiments, the converse has also been shown, that a 'quantity' current can induce one of 'intensity.'" <sup>31</sup>

#### 9. Electromagnetic Shielding

Both Henry and Faraday made extensive experiments of the effect of non-magnetic shields on induction between primary and secondary coils. That the important screening effect was observed by Henry seems to have been due to his method of observation which indicated instantaneous or peak voltages, in contrast to Faraday's which gave only a measure of the total quantity of induced electric displacement.

Prior to his work on electro-magnetic shielding, Henry knew of the discovery of magnetic rotation by Arago and of the various experiments by Herschel, Babbage and Harris. These experiments had shown that a revolving magnet gives rotation to metallic discs or needles suspended

<sup>28</sup> *Experimental Researches in Electricity* by Michael Faraday, Vol. 1, paragraph 1096.

<sup>29</sup> *Experimental Researches*, Vol. 1, paragraph 194.

<sup>30</sup> SW, Vol. 1, p. 114.

<sup>31</sup> SW, Vol. 1, p. 118.

above it and that this action is stopped by an interposed screen of magnetic material or thick plates of copper, silver, or zinc. Also, Faraday had shown that the rotation is due to inductive rather than magnetic action, the rotating magnet causing induced currents in the suspended body.

Henry did not know of the experiments on screening which Faraday had made and which were the subject of a paper read June 21, 1838, and published in the *Philosophical Transactions* for that year.<sup>32</sup> In this work Faraday found that a copper plate interposed between a primary and a secondary coil had no effect on the induction as indicated by a galvanometer, apparently of the slow-period type. Under this condition of measuring, the induced currents in the shields, which set up a flux opposing that of the primary coil, die out before the galvanometer response is well under way, so that the deflection is dependent only on the total change of flux in the secondary coil and hence substantially independent of the screen.

Henry, on the other hand, using shocks, which are indicative of instantaneous or peak voltages, as the measure of induction, observed the important principle of shielding, namely, that an interposed non-magnetic metallic conducting screen prevents sudden changes of flux through the screen. The "measuring instrument" in this case being instantaneous, the opposing effect of the currents induced in the shield is observed. Henry communicated these results to the American Philosophical Society November 2, 1838, a report of which, published in 1839, stated that a part of the paper:

"relates to the effect of interposing different substances between the conductor which transmits the current from the battery, and that which is arranged to receive the induced current. All good conducting substances are found to screen the inducing action, and this screening effect is shown, by the detail of a variety of experiments, to be the result of the neutralizing action of a current induced in the interposed body."<sup>33</sup>

Henry, on later learning of Faraday's results and of the then apparent discrepancy between those and his own, investigated the subject further with additional experiments, and from the experimental data and theoretical reasoning arrived at a fair reconciliation of the various observations.<sup>34</sup>

Speaking of the phenomena of circulating currents induced in an interposed shield, Henry said:

"Also the same principle appears to have an important bearing on the improvement of the magneto-electrical machine: since the plates of metal which sometimes form the ends of the spool containing the wire, must necessarily diminish the action,

<sup>32</sup> *Experimental Researches in Electricity* by Michael Faraday, Vol. 1, paragraphs 1709-1736.

<sup>33</sup> SW, Vol. 1, p. 106.

<sup>34</sup> SW, Vol. 1, pp. 169-188.

and also from experiment of paragraph 72 the armature itself may circulate a closed current which will interfere with the intensity of the induction in the surrounding wire. I am inclined to believe that the increased effect observed by Sturgeon and Calland, when a bundle of wire is substituted for a solid piece of iron, is at least in part due to the interruption of these currents. I hope to resume this part of the subject, in connection with several other points, in another communication to the Society."<sup>35</sup>

At the end of the meeting in which this communication was presented, Dr. Bache gave an account of investigations of Professor Ettingshausen of Vienna, in which he had been led to suspect the development of a current in the metal of the keeper of the magneto-electrical machine, which diminished the effect of the current in the coil about the keeper. Mentioning this communication, Henry said:

"It gives me pleasure to learn that the improvements, which I have merely suggested as deductions from the principles of the interference of induced currents (76), should be in accordance with the experimental conclusions of the above named philosopher."<sup>36</sup>

Under date of November 13, 1838, a few days after Henry's communication to the American Philosophical Society, a communication bearing on this subject was sent to *Silliman's Journal* by Charles G. Page and published in that *Journal* in January, 1839. Mr. Page states:

". . . I would not say that a very careful insulation [of the iron wires forming a magnet core] might not improve their operation. For I apprehend that in the development and return of magnetic forces, electrical currents are excited in the body of the magnet at right angles to its axis, as well as in the wires surrounding the magnet."

The work of Foucault, whose name is often associated with this type of induced current, was published in *Comptes Rendus*, 1855. Foucault was familiar with the work of Arago and Faraday, but did not mention the work of Henry.

#### 10. Discoveries Bearing Particularly on Radio Telegraphy and Telephony

##### a. Variation of Induction Between Coils with Separation

Henry, in his extensive investigations of induction, as presented in a paper in 1838 and published in 1839,<sup>37</sup> showed that the current induced in the secondary of two helical coils could be varied or regulated by changing the relation in space of the coils. The following from several of Henry's applications of this principle gives a partial summary of the results of his investigations:

"The action at a distance affords a simple method of graduating the intensity of the shock in the case of its application to medical purposes. The helix may be sus-

<sup>35</sup> SW, Vol. 1, p. 126.

<sup>36</sup> SW, Vol. 1, p. 145.

<sup>37</sup> SW, Vol. 1, pp. 119-122.

pended by a string passing over a pulley, and then gradually lowered down towards the plane of the coil, until the shocks are of the required intensity."<sup>38</sup>

*b. Action of Induction at a Distance*

Henry investigated the action of the discharge of a Leyden jar through a primary circuit in inducing currents in distant secondary circuits. For example, the following report of a paper read in 1842 was published the following year:

"... a single spark . . . thrown on the end of a circuit of wire in an upper room, produced an induction sufficiently powerful to magnetize needles in a parallel circuit of wire placed in the cellar beneath, at a perpendicular distance of thirty feet with two floors and ceilings . . . intervening. . . . when it is considered that the magnetism of the needle is the result of the difference of two actions, it may be further inferred that the diffusion of motion in this case is almost comparable with that of a spark from a flint and steel in the case of light."<sup>39</sup>

These experiments were carried to greater distances as is illustrated by the following excerpt from the proceedings of the meeting of the American Philosophical Society, October 21, 1842:

"Prof. Henry communicated, orally, an extension of the experiments, which he had previously brought before the Society, on electro-dynamic induction. He had succeeded in magnetizing needles by the secondary current in a wire more than two hundred and twenty feet distant from the wire through which the primary current was passing, excited by a single spark from an electrical machine."<sup>40</sup>

Also, in the notes on "Lectures on Natural Philosophy by Professor Henry" made by William J. Gibson, a student, February 28, 1844, after a description of experiments on induction at a distance in which inductive effects were noted several hundred feet away, it is stated:

"Hence the conclusion that every spark of electricity in motion exerts these inductive effects at distances indefinitely great (effects *apparent* at distances of one-half a mile or more); and another ground for the supposition that electricity pervades all space. Each spark sent off from the Electrical Machine in the College Hall sensibly affects the surrounding electricity through the whole village. A fact no more improbable than that light from a candle (probably merely another kind of wave or vibration of the same medium), should produce a sensible effect on the eye at the same distance."<sup>41</sup>

This is also referred to in Henry's letter to Rev. S. B. Dod, written in 1876 as follows:

"As another illustration of this, it may be mentioned that when a discharge of a battery of several Leyden jars was sent through the wire before mentioned, stretched across the campus in front of Nassau Hall, an inductive effect was produced in a parallel wire, the ends of which terminated in the plates of metal in the ground in the back campus, at a distance of several hundred feet from the primary current, the building of Nassau Hall intervening. The effect produced consisted in the magnetization of steel needles."<sup>42</sup>

<sup>38</sup> SW, Vol. 1, p. 121.

<sup>39</sup> SW, Vol. 1, p. 203.

<sup>40</sup> *Proceedings of the American Philosophical Society*, Vol. 2, Jan., 1841–May, 1843.

<sup>41</sup> Manuscript in Princeton Library, p. 135.

<sup>42</sup> *A Memorial of Joseph Henry*, published by order of Congress, 1880, pp. 151–152.

The effect of lightning on an electroscope had been observed prior to Henry's work. In extending this work, Henry connected a wire to the metallic roof of his study, carried this wire through a magnetizing spiral and to ground, by means of which arrangement needles were magnetized in his study "even when the flash is at a distance of seven or eight miles, and when the thunder is scarcely audible."<sup>43</sup> William J. Gibson, in 1844, in his notes on Henry's lectures, states that needles were magnetized by lightning 20 miles away.

*c. Oscillatory Nature of Discharge of Leyden Jar*

Anomalies in the polarity of small steel needles magnetized by the discharge from the Leyden jar had been observed prior to Henry's work notably by Felix Savary, who in 1827 advanced in the following words the hypothesis that these results were due to the oscillatory discharge of the Leyden jar:

"An electric discharge is a phenomenon of movement. Is this movement a continuous translation of matter in a determined direction? Then the opposite polarity of magnetism observed at different distances from a straight conductor, or in a helix with gradually increasing discharges, would be due entirely to the mutual reactions of the magnetic particles in the steel needles. The manner in which the action of a wire changes with its length appears to me to exclude this supposition.

"Is the electric movement during the discharge, on the other hand, a series of oscillations transmitted from the wire to the surrounding medium and soon attenuated by resistances which increase rapidly with the absolute velocity of the moving particles?

"All the phenomena lead to this hypothesis which makes not only the intensity but the polarity of the magnetism depend on the laws in accordance with which the small movements die out in the wire in the surrounding medium and in the substance which receives and conserves the magnetism."<sup>44</sup>

Henry repeated and extended Savary's investigations and confirmed Savary's hypothesis by a clear and authoritative statement of the phenomenon as follows:

"The discharge, whatever may be its nature, is not correctly represented (employing for simplicity the theory of Franklin) by the single transfer of an imponderable fluid from one side of the jar to the other; the phenomena require us to admit the existence of a principal discharge in one direction, and then several reflex actions backward and forward, each more feeble than the preceding, until the equilibrium is obtained. All the facts are shown to be in accordance with this hypothesis, and a ready explanation is afforded by it of a number of phenomena which are to be found in the older works on electricity, but which have until this time remained unexplained."<sup>45</sup>

*References*

For convenience there is given below a list of the principal publications referred to in connection with the study as original sources. Many of the references cover the general field of electrical discovery contemporary with Henry; others relate to specific items of the work.

<sup>43</sup> SW, Vol. 1, p. 203—Paper presented in 1842 and published the following year.

<sup>44</sup> *Annales de Chimie et de Physique*, 1827.

<sup>45</sup> SW, Vol. 1, p. 201, 1842.

A number of these references are mentioned in the discussion of specific items. The list does not include thirty or forty present day publications relating to Henry's work, which were reviewed, from many of which valuable suggestions were obtained as to where to look for source material, but which were not themselves used as sources.

- Scientific Writings of Joseph Henry*, published by the Smithsonian Institution, 1886.  
*Experimental Researches in Electricity*, by Michael Faraday, D.C.L., F.R.S., 1839.  
*A Memorial of Joseph Henry*, published by Order of Congress, 1880.  
*Annual Report of the Smithsonian Institution for 1857*.  
*Students' Notes on Henry's Princeton Lectures*, MSS. in Princeton Library.  
*The Electric Telegraph: Was It Invented by Professor Wheatstone?*, by William Fothergill Cooke, London, 1857.  
*Historical Sketch of the Electric Telegraph*, by Alexander Jones, New York, 1852.  
*A History of Electric Telegraphy to the Year 1837*, by J. J. Fahie, London, 1884.  
*An Historical Sketch of Henry's Contribution to the Electro-Magnetic Telegraph*, by William B. Taylor, 1879.  
*Joseph Henry and the Magnetic Telegraph: An Address*, by Edward N. Dickerson, LL.D., 1885.  
*The Annals of Electricity, Magnetism, etc.*, by William Sturgeon, 1836-1843, London.  
*Scientific Memoirs*, Edited by Richard Taylor, F.S.A., London, 1837-1852.  
*Electro-Magnetism, etc.*, by Jacob Green, M.D., Philadelphia, 1827.  
*Meteorological Essays* by Francois Arago, London, 1855.  
*Glazebrook's Dictionary of Applied Physics*.  
*Annali delle Scienze del Regno Lombardo-Veneto, Padova*, 1831-1834.  
*Nuovi Saggi della Imperiale Regia Accademia di Scienze Lettere ed Arti, in Padova*, Vols. I-VI, 1817-1847.  
*American Journal of Science (Silliman's Journal)*, 1822 and 1827-1842.  
*Proceedings of American Philosophical Society*, Vols. 1-3, and Vol. for 1744-1838.  
*Transactions of American Philosophical Society*, Vols. VI-VIII (1834-1842).  
*Philosophical Transactions, London*, 1831, 1832, 1834, 1835, and 1838.  
*Philosophical Magazine, London*, 1803, 1804, 1828-1832 and 1834.  
*Edinburgh Philosophical Journal*, 1825.  
*Edinburgh Journal of Science*, 1830.  
*Annales de Chimie et de Physique*, 1827.  
*Comptes Rendus*, 1855.  
*Royal Society Catalogue of Scientific Papers, 1800-1863*.  
*Transactions of Royal Irish Academy*, 1786-1886.  
*Royal Dublin Society Catalogue of the Library, 1731-1839*, by J. F. Jones.  
*British Museum Catalogue*.

# The Bell System Technical Journal

July, 1932

---

## Henry as an Electrical Pioneer

By BANCROFT GHERARDI

An address presented at the Meeting of the National Academy of Sciences, April 25, 1932, at Washington, D. C. in commemoration of the Hundredth Anniversary of the Electrical Discoveries of Joseph Henry.

The author expresses his appreciation of the researches of Dr. Harold S. Osborne and Mr. A. M. Dowling in establishing many of the facts upon which this address is based, and of other assistance in its preparation. This research developed many facts of interest and its results are separately published as a supplement to this issue of the *Bell System Technical Journal*.

THIS evening we are gathered together to celebrate the hundredth anniversary of the electrical discoveries of Joseph Henry. I have been assigned the honorable and pleasant duty of speaking of Henry's work as an electrical pioneer. According to the Century Dictionary, a pioneer is one who goes before and leads or prepares the way for others coming after, specifically, the first or early explorer or experimenter in any department of human enterprise. Surely no one is better entitled to the honorable title of pioneer than is Joseph Henry.

Let us look a bit at what this country was about 100 years ago. The population of the United States in 1830 was 12,900,000. The largest city in the country, New York, had a population of 203,000. Philadelphia was the next largest city with 80,000. Washington, the capital of the nation, had a population of 18,800, which included 2,330 slaves. There were twenty-four states in the Union and of these the most westerly was Missouri. Chicago, now the second city of the country, was just being laid out near Fort Dearborn and was not organized as a village until 1833. Detroit, now the fourth city, had a population of 2,222 and Cleveland had 1,076.

Highways were largely trails or unpaved roads. Canals played an important part in the transportation system of the country. The first railroad in the United States began operation by steam in 1830. In 1836 trains between Albany and Schenectady were still pulled by horses. The first steamship, equipped with both sails and steam, had crossed the ocean in 1819, but it was not until 1838 that a ship depending primarily upon steam for its propelling power made the transatlantic trip. Communications were solely dependent upon transportation and subject to all of its uncertainties and lack of speed.



Mills and factories were just beginning to be operated by steam power, having previously been dependent upon water power or man power with occasional use of horses or windmills. Lighting was done principally by sperm oil lamps or by candles. Baltimore was the first American city to adopt gas lighting on a large scale in 1817. Gas was introduced in New York City in 1823, but even after 1830 many large cities went for years without a gas system. In 1833 a petition was addressed to the Common Council of Philadelphia protesting against the use of gas "as ignitable as gunpowder and as nearly fatal in its effects as regards the immense destruction of property."<sup>1</sup> There was no commercial application of electricity. At that time electricity was a matter of Leyden jars and of pith balls, of galvanic batteries and of twitching frogs' legs, of crude galvanometers, and of feeble magnets.

Such was the condition of this country when Joseph Henry was Professor of Mathematics and Natural Philosophy at the Albany Academy about 1830.

But "The old order changeth, yielding place to the new," and Joseph Henry was one of those who made major contributions to this change. Just what did Henry do that contributed to the development of the electric art of today? As you have heard from Professor Magie, we may properly claim priority for Henry for the following among his many electrical contributions:

Henry constructed powerful electromagnets by the use of insulated wire on the magnet core and by using more than one layer of winding. (1829 and 1830)

Henry indicated the proper proportioning of magnet windings, external circuit resistance and electrical battery arrangement for effective operation. (1830)

Henry constructed the first motor embodying an electromagnet and a commutator. (1831)

Henry constructed the first telegraph using an electromagnet as the receiving element and demonstrated its operation with a line wire over one mile long. (1831 and 1832)

Henry discovered the property of self-induction of electrical circuits. (1832)

Henry constructed and operated the first electromagnetic relay. (1835)

Henry determined that by the proportioning of the windings of two coils in inductive relationship the voltage in the secondary circuit could be stepped up or stepped down. (1838)

<sup>1</sup>"A Popular History of American Invention," W. Kaempfert, 1924, Vol. 1, p. 554.

Henry produced currents in distant circuits by oscillatory discharges and detected them when the two circuits were separated by several hundred feet. (1842)

These contributions by Henry to our electrical knowledge have been essential to the development of practically every commercial application of electricity. Let us now consider some of these.

The idea of the electric telegraph was not new when Henry did his work. It had been considered by others and in January, 1825, Barlow, an English scientist, wrote as follows: "In a very early stage of electro-magnetic experiments, it had been suggested, that an instantaneous telegraph might be established by means of conducting wires and compasses. The details of this contrivance are so obvious, and the principles on which it is founded so well understood, that there was only one question which could render the result doubtful, and this was, Is there any diminution of effect by lengthening the conducting wire? . . . I was, therefore, induced to make the trial, but I found such a sensible diminution with only 200 feet of wire, as at once to convince me of the impracticability of the scheme."<sup>2</sup> Even as late as 1837 Wheatstone, another distinguished British scientist, satisfied himself by experiment and convinced others that the development of electro-magnetism in soft iron at a distance was impracticable. This was six years after Henry's work on the proportioning of magnet windings and battery arrangement for maximum effect with line wires of substantial resistance had shown him the solution of the telegraph problem, and five years after he himself had constructed and demonstrated his electromagnetic telegraph over a line wire more than a mile long.

Henry's contributions to the telegraph were three in number. He demonstrated that magnetic action and magnetic control could be exercised at considerable distances if the battery and the magnet windings were suitably proportioned and this is the basis of all electric telegraphs of today. He abandoned the galvanometer or compass needle as a receiving device for the electrical impulses and substituted therefor a magnet operating a movable armature, this making possible rapid signaling and audible receiving. This has continued as the basic form of the telegraph circuit, even with the modern printing telegraph systems, in which electric typewriters are controlled by magnets of Henry's type. He constructed and operated the first electromagnetic relay, a device by which the current in the line circuit controls an armature which carries the contact of a local circuit so that the feeble line current, instead of directly controlling the receiving

<sup>2</sup> "On the laws of electro-magnetic action," *Edinburgh Philosophical Journal*, Jan., 1825, Vol. XII, p. 105.

mechanism, merely opens and closes a local circuit and a strong local current performs whatever functions may be necessary in the receiving mechanism.

These constitute the fundamentals of a complete magnetic telegraph system and left only its perfection in detail, the development of an alphabetical code in dots and dashes, and its commercial exploitation. In 1844 Morse opened his first telegraph line between Baltimore and Washington and in this line utilized the features referred to above, contributed by Henry. From this start the telegraph rapidly grew to a nation-wide and world-wide communication system.

The next important commercial application of electricity came about 30 years later when Bell invented the telephone. As in the case of the telegraph, important use was made of Henry's contributions to the art.

Bell's telephone makes use of Henry's work on magnets, as does every telephone receiver today. The telephone bell, with which each telephone is equipped to give an audible signal so as to attract the attention of the called party, consists essentially of a polarized ringer directly suggested by the receiving device employed by Henry in his first telegraph demonstration. But a telephone by itself, even equipped with a call bell, is merely an interesting scientific toy. The telephone is useful only as there are a number of them at the ends of telephone lines, these lines centering on telephone switchboards for the purposes of interconnection. In all telephone switchboards, whether of the manual or of the automatic type, there are multitudes of relays for the purpose of controlling circuits and signaling apparatus. There are perhaps seventy million telephone relays in the United States today and the prototype of all of these is Henry's electromagnetic relay, dating back to 1835.

Telephony owes still another debt to Henry and to his work. He discovered the characteristic of electrical circuits known as self-induction. This is a property of all electrical circuits unless especially designed to avoid it and self-induction must be taken into account in many phases of electrical design. In long telephone lines it was found to exercise a favorable effect upon telephonic transmission and about 1900 Dr. Michael I. Pupin, a distinguished member of the National Academy of Sciences, showed how self-induction could be added to long telephone lines so as to improve their talking efficiency. Today his invention is very generally used, not only in the lines of this country but throughout the world, and has been an important factor in the extension of long distance telephony and in making possible long telephone cables.

The start of commercial electric light and power systems and of electric traction came shortly after the beginnings of the telephone about 1880. These, likewise, built upon Henry's work. Powerful electromagnets are the basis of every generator and of every electric motor and it would be difficult for any one today to construct either a generator or a motor and avoid the ideas which were contributed by Henry. Commutators which appear first in Henry's motor are essential parts of every direct current generator or motor.

Henry's electric motor was not the first one to be built. Faraday built the first electric motor and it was interesting because it was a continuously rotating device. However, it had no commutator and did not employ electromagnets. Henry's motor was interesting because, while it was a reciprocating device, it was the first to employ a commutator and an electromagnet. A combination of these principles, that is, a rotating motor, electromagnets and commutation gives the basis of the modern electric motor of today.

Henry's comments in 1831 on his electric motor are interesting. "Not much importance, however, is attached to the invention, since the article, in its present state, can only be considered a philosophical toy; although, in the progress of discovery and invention, it is not impossible that the same principle, or some modification of it on a more extended scale, may hereafter be applied to some useful purpose."<sup>3</sup> Much later, in 1876, he writes: "I soon saw, however, that the application of this power was but an indirect method of employing the energy derived from the combustion of coal, and, therefore, could never compete, on the score of expense, with that agent as a means of propelling machinery, but that it might be used in some cases in which expense of power was not a consideration to be weighed against the value of certain objects to be attained."<sup>4</sup> Certainly a prophecy, when we consider today the extent to which this "indirect method of employing the energy derived from the combustion of coal" is utilized because of its convenience for lighting and because of its flexibility for the operation of power units through electric motors.

Modern electrical systems for power and light would be inoperative without the use of auxiliary circuits and equipment for their proper control. In these, extensive use is made of relays and also of other electromagnetic devices using Henry's magnet principle.

While every branch of the electric power art is indebted to Henry, the alternating current system now in such general use and universal for long distance power distribution owes him a peculiar obligation.

<sup>3</sup> "Scientific Writings of Joseph Henry," 1886, Vol. I, p. 54.

<sup>4</sup> "A Memorial of Joseph Henry," 1880, p. 149.

In his work in 1838 he demonstrated that through the proportioning of the windings of two coils in inductive relationship, the voltage in the secondary circuit could be stepped up or stepped down and here we find the genesis of the modern transformer. The transformer, a device without moving parts, is fundamental to every alternating current system, and it is the principal reason why alternating currents are so generally employed today. Through its use, it is possible to design dynamos for operation at the most effective generator voltage and then step up the voltage by means of a transformer to the most efficient level for use on the transmission lines and then at the distant end of these lines by means of other transformers step down the potential to the most efficient and convenient voltage for use on distributing systems.

So fundamental was Henry's work that in it we find contributions even to the youngest child of the electrical family, the radio communication art. Not only does it use his general contributions to the art because of the fact that radio communication is simply a specialized form of telephony or telegraphy employing a particular method of transmission, but Henry's work in detecting the discharges of Leyden jars at a distance of 30 feet and later at distances of several hundred feet certainly foreshadows radio transmission. In 1842 Henry wrote as follows in regard to his experiment in which he observed the inductive effects of a discharge of Leyden jars at a distance of 30 feet: ". . . when it is considered that the magnetism of the needle [his receiving device] is the result of the difference of two actions, it may be further inferred that the diffusion of motion in this case is almost comparable with that of a spark from a flint and steel in the case of light."<sup>5</sup> In the notes made early in 1844 by a student recording Henry's lectures on natural philosophy the following occurs: "Hence the conclusion that every spark of electricity in motion exerts these inductive effects at distances indefinitely great (effects *apparent* at distances of one-half a mile or more); and another ground for the supposition that electricity pervades all space. Each spark sent off from the Electrical Machine in the College Hall sensibly affects the surrounding electricity through the whole village. A fact no more improbable than that light from a candle (probably merely another kind of wave or vibration of the same medium), should produce a sensible effect on the eye at the same distance."<sup>6</sup>

It is certainly a far cry from Henry's observations of inductive effects at distances of a few hundred feet to the present use of radio for broad-

<sup>5</sup> "Scientific Writings of Joseph Henry," 1886, Vol. 1, p. 203.

<sup>6</sup> Notes of Wm. J. Gibson, entitled "Lectures on Natural Philosophy by Professor Henry," Feb. 28, 1844, p. 135.

casting and for transoceanic telegraph and telephone service, but a consideration of what he himself says about this and of the notes of his student, quoted above, indicates clearly that in his work is the germ of radio transmission.

Had not a fire in the Smithsonian Institution in 1865 destroyed so many of Henry's original records, there is but little doubt that in these records there would have been preserved many other interesting and suggestive things which he did and many significant comments on them. But the record as it is now known to us is sufficient to establish Henry's contributions as outstanding, and to more than justify this distinguished gathering tonight for the purpose of reminding us of our obligation to him.

Before Joseph Henry died in May, 1878, he had seen an extensive commercial application of telegraphy. He had seen the invention of the telephone but not its commercial application. As years have gone by since that date, a greater and greater superstructure of commercial application has been reared upon the foundations laid by Joseph Henry and the other distinguished scientific workers of his time. When writing as early as 1849, he said: "The only reward I ever expected was the consciousness of advancing science, the pleasure of discovering new truths, and the scientific reputation to which these labors would entitle me."<sup>7</sup> This he surely attained. Joseph Henry died with a national and international scientific reputation, Secretary of the Smithsonian Institution, President of the National Academy of Sciences, a friend of Abraham Lincoln and loaded with honors, both at home and abroad. Since then, as time has gone by, it has but added to his greatness, to the esteem in which he is held and to the value of the services which he has rendered to mankind through his work as an electrical pioneer.

<sup>7</sup> *Annual Report of the Smithsonian Institution for 1857*, p. 117.

# The Cæsium-Oxygen-Silver Photoelectric Cell

## An Investigation of the Relations in a Composite Photoelectric Surface

By C. H. PRESCOTT, Jr., and M. J. KELLY

Technique is described permitting the formation of cæsium-oxygen-silver photoelectric cells under controlled conditions. It is shown that the essential conditions are a quantitative control of the degree of oxidation of the silver cathode base and the amount of cæsium generated together with a regulation of the amount of chemical interaction by a control of the time and temperature of the heat treatment.

Variations in sensitivity to integral light at 2,710° K. color temperature are shown as a function of the initial amounts of oxygen and cæsium and the time of heat treatment.

Small amounts of oxygen were permitted to react with the standard cathode surface. The sensitivity of the cathode fell but recovered due to the diffusion of free cæsium to the surface from the underlying material. The effects are shown in relation to the integral sensitivity and the spectral response from 6,000 Å. to 10,000 Å.

The effects of depositing minute amounts of free cæsium upon the standard cathode surface are also shown in relation to the spectral response.

The active surface of the cathode appears to be a film of free cæsium of atomic dimensions adsorbed upon a matrix of cæsium oxide and silver containing free cæsium and a small amount of silver oxide. The spectral characteristics of the photoelectric response appear to depend largely upon the thickness of the surface film of free cæsium. This film thickness is determined by the cæsium concentration in the underlying matrix and is maintained by a diffusion equilibrium.

### INTRODUCTION

EARLY studies of the photoelectric effect were made on pure metals, eliminating, in so far as possible, the effects of absorbed gases. But since the alkali metals alone respond appreciably to visible light, and these only to light at the blue end of the spectrum, the development of photoelectric cells of greater response to ordinary light sources has led to the study of thin films of the alkali metals and of various composite surfaces. The enhanced photoelectric activity of the thin films of the alkali metals was first brought out by Ives<sup>1</sup> who also noted that the maximum response and the greatest extension of sensitivity toward the red end of the spectrum were obtained when the film thickness was of the order of one molecular diameter. Later work<sup>2</sup> has shown that the maximum excursion of the photoelectric threshold of an alkali metal film on a metallic base

<sup>1</sup> H. E. Ives, *Astrophys. J.*, **60**, 4 (1924).

<sup>2</sup> Ives and Olpin, *Phys. Rev.*, **34**, 117 (1929).

corresponds with the wave-length of the first line of the principal series of the atomic spectrum of the alkali metal.

The first composite surface to attain practical importance was the so-called potassium hydride cell discovered by Elster and Geitel<sup>3</sup> in which a potassium surface is sensitized by a glow discharge in hydrogen. This cell has its maximum response at 4,350 Å. and its photoelectric threshold at 5,900 Å. The response of a good potassium hydride (vacuum) cell to a light source at a color temperature of 2,710° K. is about one microampere per lumen, which is eighty times that obtainable with pure potassium surfaces.

This sensitivity is still below that required for many technological applications. Also, the potassium hydride surface is unstable even at ordinary temperatures and may deteriorate rapidly in use or in storage. So there has been a great demand in engineering applications for both a more stable device, and a cell more sensitive to the red and infra-red light which constitutes the major part of the emission from common incandescent light sources.

The photoelectric threshold is a direct measure of the work necessary to liberate an electron from a surface, i.e., the "work function" which also figures in the thermionic effect. That is, both red sensitive photoelectric cells and active thermionic filaments possess low values of the work function. The study of the thermionic effect in adsorbed films of caesium on tungsten and on oxidized tungsten by Langmuir and Kingdon<sup>4</sup> and by Becker<sup>5</sup> have indicated surprisingly low values of the electron work function. It was to be expected that some similar surface should possess a high order of photoelectric response to red light. Research along these lines has resulted in this and other laboratories in the development of the caesium-oxygen-silver photoelectric cell. Early work on cells of this type is reported by Koller<sup>6</sup> and by Campbell.<sup>7</sup>

For the cells discussed in this paper the active photoelectric surface is formed on a roughened silver sheet. This is slightly oxidized by making it the cathode in a glow discharge in oxygen. Caesium is then generated by chemical reaction in a pellet enclosed within the photoelectric cell bulb. Finally, by a proper temperature cycle the caesium is condensed on the silver oxide surface of the cathode and allowed to react with it to form the active photoelectric surface.

<sup>3</sup> Elster and Geitel, *Phys. Zeit.*, **11**, 257 (1910).

<sup>4</sup> Langmuir and Kingdon, *Phys. Rev.*, **21**, 380 (1923) abstr.

K. H. Kingdon, *Phys. Rev.*, **24**, 510 (1924).

Langmuir and Kingdon, *Proc. Roy. Soc.*, 107-A, 61 (1925).

<sup>5</sup> J. A. Becker, *Phys. Rev.*, **28**, 341 (1926).

<sup>6</sup> L. R. Koller, *Phys. Rev.*, **33**, 1082 (1929) abstr. *Phys. Rev.*, **36**, 1639 (1930).

<sup>7</sup> N. R. Campbell, *Phil. Mag.*, **12**, 173 (1931). "Photoelectric Cells and Their Applications" (Phys. Soc. London, 1930), p. 10.



The cells thus obtained are highly sensitive to red and infra-red light. The maximum response is at 8,000 Å., the response is one third as great at 10,000 Å., and the photoelectric threshold is somewhere in the neighborhood of 12,000 Å. Cells are frequently obtained with a vacuum sensitivity of 35 microamperes per lumen to a light at 2,710° K. color temperature, and their useful life is indefinitely long, even at a temperature of 50° C. But such results obtain only if the cells be produced under controlled and definitely specified conditions. It appears that the product is definitely affected by variations in the quantities of caesium and oxygen. Also, the course of the chemical reactions (still obscure) and the thickness of the final caesium thin film are very sensitive to slight variations in the process conditions. In the early stages of this work the results were highly erratic; only occasionally was a useful cell obtained. A large amount of development time has been devoted in these laboratories to the isolation and correlation of the various factors which determine the sensitivity of a finished cell. With the technique now available, caesium-oxygen-silver photoelectric cells are prepared under conditions of quantity production with sensitivities varying within a factor of two and with a process shrinkage no greater than obtained in the production of high quality thermionic vacuum tubes.

#### THE STRUCTURAL DETAILS AND METHOD OF PREPARATION OF THE CELLS

The structure of the cells used in this study is shown in Fig. 1. The cathode is a semicylinder of silver 99.9 per cent pure. The anode is a nickel wire mounted in the axis of the cylinder. These are mounted on a stem which is sealed into a spherical bulb of soda-lime glass. Around the stem is suspended an open ring of heavy copper wire between the ends of which is crimped a tube rolled from thin sheet molybdenum which carries the caesium pellet. This structure is adapted to the initiation of the chemical reaction by induced high-frequency currents with a minimum heating of the oxidized cathode. A nickel shield is placed between the pellet sheath and the cathode to protect the latter from radiation and to deflect the hot caesium vapor evolved by the pellet.

The essential steps in the process of formation of the active cathode surface are:

1. Formation of a silver oxide film on surface of cathode.
2. Preparation of caesium.
3. Combination of caesium with silver oxide surface.

### 1. Formation of a Silver Oxide Film on Surface of Cathode

The cells are sealed to a high vacuum exhaust system and baked out at 400° C. The next step is the oxidation of the surface. It was found that oxidation by a glow discharge in oxygen was the most suitable method. This oxidation could not be done quantitatively and uniformly over the front surface of the cathode because of surface irregularities in the silver and because of variations in the physical conditions of the surface. Means were therefore sought to obtain a

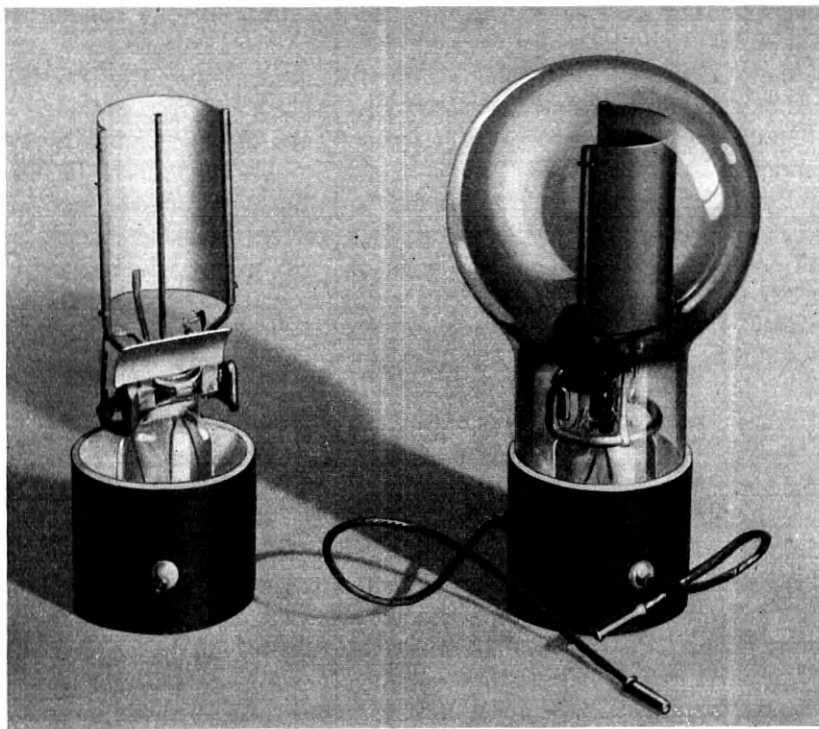

Fig. 1—Western Electric 3A photoelectric cell.

uniform surface and one that would be the same in all cells, independent of irregularities that could not be avoided, which were due to past history.

To accomplish this, electrolytic oxygen is admitted to the exhaust system and the cathode is oxidized by a glow discharge until completely black. Then the circuit is held closed while the cathode is heated by ion bombardment until the silver oxide is decomposed, leaving a bright matte surface. After cooling, this process is repeated.

It is repeated a sufficient number of times to establish a cathode surface that is uniformly rough over its entire front surface and is substantially the same for all cells. The exhaust system is then evacuated and pure oxygen admitted to the optimum pressure for quantitative oxidation.

The quantitative oxidation is accomplished by charging a condenser of known capacity to a definite voltage and then discharging it through the cell in series with a suitable resistance. The discharge is in the proper direction for oxidation of the cathode. A double contact telegraph key is used for charge and discharge of the condenser. The number of taps given to the key is then a quantitative measure of the oxidation of the cathode. After the requisite oxidation of each cathode, the system is again evacuated.

As the oxidation proceeds, the surface goes through characteristic changes in color. At 25 "taps" it is yellow, at 50 red, at 75 blue and at 100 a greenish yellow. If the oxidation is continued, the color goes through another cycle becoming a golden yellow, a deep rose red and an olive green. From then on it is quite dark, but under strong light shows several alternations of red and green before ending in black. As will be seen later an oxide thickness corresponding to about 100 taps is the most suitable for use.

## 2. Preparation of Cæsium

The early work demonstrated the necessity of a close control of the amount of cæsium made available for the cathode in each cell. After an examination of a number of chemical systems for preparation of cæsium by a high temperature chemical reaction, a pellet composed of a mixture of cæsium chromate, chromic oxide and powdered aluminum was adopted. These materials are thoroughly mixed in quantitative proportions and ground in an agate mortar. A suitable weight of the mixture is compressed in a die. A slight but uniform loss of material is entailed in the pellet making process. Any desired quantity of pellets differing in weight by not more than ten per cent can be made by this process. This pellet is placed in the molybdenum housing described above and after the quantitative oxidation of the surface and removal of excess oxygen the pellet is heated by high-frequency induction to its kindling temperature.

Sufficient aluminum is supplied to completely reduce the cæsium chromate and chromic oxide. Besides permitting a pellet of convenient size, the chromic oxide is instrumental in furnishing, by its reduction, a large amount of heat. The high-frequency heating serves only to initiate the reaction. The exothermic reaction involves a

great rise in temperature and causes the immediate and complete expulsion of all cæsium. This allows the high-frequency heating with the attendant hazard of heating the cathode and reducing a part of the silver oxide to be a minimum. The cæsium travels in straight lines from the pellet housing and is condensed on the glass wall of the bulb. A shield above the housing prevents any cæsium, as it is expelled from the pellet, from impinging on the cathode surface.

### 3. *Transfer of Cæsium to the Cathode Surface*

The transfer of the cæsium to the cathode surface and its reaction with the silver oxide film to the proper extent is probably the most difficult process to control. The ideal process requires the transfer of the cæsium from the glass wall of the envelope to the cathode surface without the reduction of any of the silver oxide by the heat required to bring about this cæsium transfer, the reaction of the silver oxide with the greater portion of the cæsium and the leaving of a sufficient amount of uncombined cæsium to supply the required volume concentration of cæsium and to cover the entire cathode surface with an equilibrium thin film of cæsium. The practical difficulties in carrying out this process are due to the fact that, at the temperatures required to transfer in a reasonably short time the cæsium from the glass wall to the cathode, the silver oxide has an appreciable rate of decomposition. This difficulty was overcome so far as is possible by heating the glass wall selectively at a controlled temperature. There is a material lag in the cathode temperature in this process. Thus the cathode is kept at as low a temperature as possible while the cæsium is transferred to it at a sufficiently rapid rate.

This is accomplished by surrounding the cell with a stream of hot air for approximately 30 minutes. A glass chimney is placed around the cell. The chimney fits into a transite manifold containing heating coils through which compressed air is fed at the rate of 0.5 liter per second per chimney. The temperature of the air stream is controlled to within 5° C.

If this process is carried on in the usual electric oven where a portion of the winding is exposed, the cathode is heated preferentially due to the radiant heat and it is almost impossible to obtain an active surface due to silver oxide reduction by temperature, as well as to the fact that with the cathode the hottest surface, the cæsium will tend to condense elsewhere. Even with all windings of the oven covered by asbestos sheet so that substantially all heat is due to convection, the process is infinitely more difficult of control than with the hot air stream oven.

It was not found practicable, even with such exact control of the silver oxide film, the amount of caesium and of the temperatures of the photo-cell parts, to give the cell a definite time-temperature cycle in the transfer process. It is necessary to follow the growth of the photo and thermionic currents as the heating continues. A small tungsten lamp is mounted in a fixed position with respect to the cell and after the heating has progressed for some 20 minutes, observations are made each minute on the total thermionic and photoelectric currents. These currents rise in value as the surface is built up and, by experience, a definite point on the growth curve is found where the hot air stream should be discontinued in order to obtain the optimum surface.

After the cell has cooled it is sealed from the exhaust system if a vacuum cell is desired, or filled to the required pressure with an inert gas, usually argon, if a gass filled cell is desired.

#### SURFACE STRUCTURE

In the study of the photosensitive cathode surface some information regarding the physical structure and chemical nature of the surface has been gained by direct examination and analysis. The physical nature of the roughened silver may be seen from microphotographs of the cathode taken following the roughening oxidation and reduction which precedes the quantitative oxidation.

Fig. 2*a* is a plan view taken at 1,530 diameters magnification. Fig. 2*b* is a transverse section of the cathode supported in a heavy nickel plate taken at 200 diameters. Fig. 2*c* is a detail view of the front surface of the transverse section taken at 2,450 diameters. It would appear that the effect of the oxidation and reduction is to etch out the polished silver sheet, giving the surface elements a random orientation but not causing any great increase in surface area. If we judge the length of a line element to be doubled, this indicates a four-fold increase in area.

To determine the amount of oxygen entering into combination at each discharge of the condenser, three cells were given 50, 75 and 100 taps respectively of the key controlling the condenser discharge. The excess oxygen was removed and the exhaust manifold trapped off by a mercury seal. Each cathode in turn was then heated by induced high-frequency current till the silver oxide decomposed, and the pressure developed in the exhaust system was measured. The pressures and amounts of oxygen as microgram-molecules of  $O_2$  are given in Table 1.

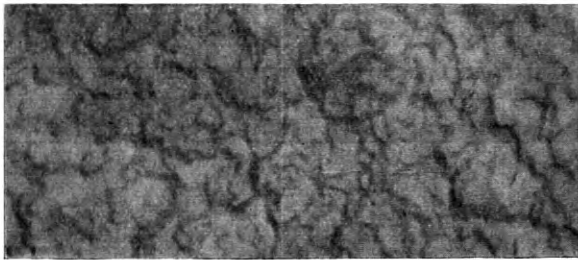

(a)

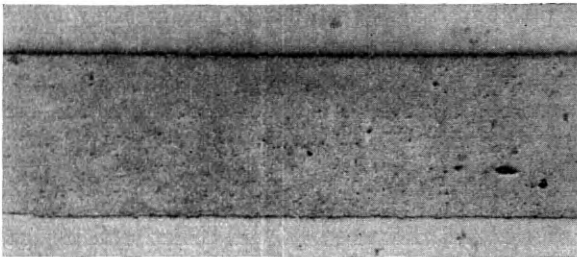

(b)



(c)

Fig. 2—Microphotographs of roughened silver cathode base. (a) Plan view, 1530 diameters. (b) Transverse section, 200 diameters. (c) Transverse section, 2450 diameters.

TABLE 1

No. of Taps	Pressure	Micro-moles of O <sub>2</sub>	Micro-moles per 100 Taps
50	0.0179 mm.	2.24	4.48
75	0.0256	3.20	4.27
100	0.0369	4.62	4.62
Weighted average			4.45

This value of 4.45 micro-moles of oxygen per 100 taps corresponds to 1.32 molecules of  $O_2$  or 2.64 atoms per electron equivalent of the charge transported in the glow discharge, assuming complete discharge of the condenser. This value entails a high efficiency in the combination of positive ions with the surface, and also predominantly poly-atomic ions at least as complex as  $O_3^+$ .

Microchemical analyses were performed on several cells to determine the cathode composition and the final distribution of the caesium. With an accuracy of about 3 per cent all the initial caesium was recovered, 68 per cent being recovered from the silver cathode and the rest from the inner surface of the glass bulb. No caesium was found in the pellet residue. In the cathode surface was also found an average of 0.13 milligram of undecomposed silver oxide. But the actual amount may be greater for we have later evidence that at least 7 per cent of the caesium on the cathode occurs as the free metal which would reduce silver oxide when the cathode is extracted with water and dilute acid prior to the analysis.

The optimum conditions, as shown later, are obtained with 4.1 milligrams of caesium chromate in the pellet and a "ratio" of 19 condenser discharges per milligram of caesium chromate. These are equivalent to 83 micrograms of caesium and 3.2 micrograms of oxygen (using the factor from Table 1) per square centimeter of the cathode and a ratio of 3.1 atoms of caesium per atom of oxygen. With 68 per cent retention of the caesium in the cathode, we obtain 56 micrograms of caesium per square centimeter and an atomic ratio of 2.1. If we neglect the free caesium and residual silver oxide in the cathode surface and assume that no oxygen has been lost from the cathode, which implies that the caesium on the bulb has been oxidized by reaction with water or other constituents of the glass—the atomic ratio of 2.1 suggests that  $Cs_2O$  is the main caesium constituent of the cathode surface. But however probable it may seem, it is not possible to demonstrate this by ordinary analytical means in the presence of free caesium and residual silver oxide.

These initial and retained amounts of caesium are equivalent respectively to 910 and 620 atomic layers on the plane cathode surface. If we assume the surface to be increased by a factor of four in roughening, we find the caesium retained in the cathode surface to be equivalent to roughly 155 atomic layers of free caesium. This caesium will, of course, occur mainly as caesium oxide and be mixed with the finely divided silver from the reduced silver oxide. It would comprise about 50 layers of  $Cs_2O$  molecules.

L. R. Koller<sup>6</sup> has given quantitative data on surfaces which were

<sup>6</sup> Loc. cit.

formed by admitting oxygen to a cathode surface covered with a thick adsorbed layer of metallic caesium. He finds a maximum activity at a caesium-oxygen weight ratio of 110, which corresponds to 13.2 atoms of caesium per atom of oxygen. This high value may be due in part to an incomplete yield from his caesium pellets, but we doubt that the surface structure so obtained can be closely compared with that which we have described. The cells described elsewhere in his paper have much more closely analogous surfaces.

N. R. Campbell<sup>7</sup> has performed experiments in which caesium is diffused slowly into a cell containing an oxidized silver cathode, all held at 184° C. in an aniline bath. He finds the completion of the reaction corresponds to the formation of Cs<sub>2</sub>O, or an atomic ratio of 2.

Kingdon and Thompson<sup>8</sup> also report their cathode surfaces, presumably the same as in the cells described by Koller, to consist of Cs<sub>2</sub>O.

#### A SURVEY OF MACROSCOPE PARAMETERS

With uncertainty as to the microscopic physical structure of this surface, and no adequate theoretical basis for the correlation of photoelectric response to such a detailed structure, a macroscopic frame of reference has been essential to the correlation of data. This has been particularly important in the development phases of the project so that the results obtained should be self-sufficient and the systematic investigation of substances and processes should not be conditioned by the anticipated interpretations. From a thermodynamic standpoint, the surface may be considered as a two-dimensional phase or system with two variable components, caesium and oxygen. If this system were in equilibrium, its properties would depend only on its temperature and the amounts of the components. Since it is far from equilibrium the specification of its condition or "state" requires also its past history, the most vital part of which is the heat treatment.

As the activity of a completed cell is definitely affected by each of the factors controlled in the quantitative technique, it will be seen that the state of the cathode surface is a function of (at least) five parameters, viz: the amount of caesium, the amount of oxygen, the surface roughness of the silver, and the temperature and time of the heat treatment. Some qualitative experience seems to indicate that variation in surface roughness shows itself chiefly by affecting the efficiency of the glow discharge in the quantitative deposition of oxygen, and to a limited extent involves a greater or less extension

<sup>7</sup> Loc. cit.

<sup>8</sup> Kingdon and Thompson, *Physics*, 1, 343 (1931).



of the surface. Also, the temperature and time of heat treatment are to a limited extent compensatory. So a more fundamental specification of the active surface would involve the surface concentrations of caesium and oxygen, and a degree of interaction which is commensurate with the heating time.

The best known thin film phenomena in the past have been of the type of caesium adsorbed on tungsten, a single component film under essentially equilibrium conditions. At least the film is reversibly adsorbed for it may be condensed or evaporated at will by varying the tungsten temperature or the caesium vapor pressure. Caesium on oxidized tungsten is again a two-component film. The caesium is reversibly adsorbed and, after the caesium is removed, it appears that the adsorption of the oxygen is reversible at a considerably higher temperature.

Langmuir and Villars<sup>9</sup> have published curves showing the thermionic activity of tungsten filaments with varying amounts of adsorbed caesium and oxygen. Due to the lack of an independent measure of the amount of adsorbed oxygen the data have been presented from a different point of view, resulting in a determination of the heat of adsorption of the oxygen. But we may point out the obvious though tacit assumption that the thermionic and other properties of the surface are uniquely determined in terms of the amounts of adsorbed oxygen and caesium (and the temperature). This is equivalent to the presumption that the filament is under equilibrium conditions.

In contrast, the two-component film of caesium and oxygen on silver which comprises the photoelectric cathode is formed by essentially irreversible processes. No caesium atom which has combined with oxygen can be released, and no oxygen atom split off from the silver surface may be recombined. And the reaction is stopped long before any equilibrium is reached.

To obtain definite knowledge of the relations in the neighborhood of the optimum conditions we have prepared cathode surfaces under carefully controlled conditions. Two different amounts of caesium were used and the oxygen-caesium ratio (the number of "taps" per milligram of caesium chromate) and the time of hot air heating were systematically varied. The first series of cells was made with pellets containing approximately 5 milligrams of caesium chromate. The oxygen-caesium ratio was varied from 15 to 30, and three groups heated for 15, 30 and 60 minutes respectively at 220–225° C. In each case, as shown in Fig. 3, the activity as measured with a light source at a color temperature of 2,710° K. goes through a maximum

<sup>9</sup> Langmuir and Villars, *J. Amer. Chem. Soc.*, **53**, 486 (1931).

in the neighborhood of the 20 ratio. Also, the maximum activity is significantly higher for the 30-minute heat treatment than for either 15 or 60 minutes. The second series of cells was made with pellets containing 3 milligrams of caesium chromate. The oxygen-caesium ratio was varied from 10 to 30 and three groups baked for 7.5, 15 and 30 minutes, respectively. In this series the maximum activity occurs

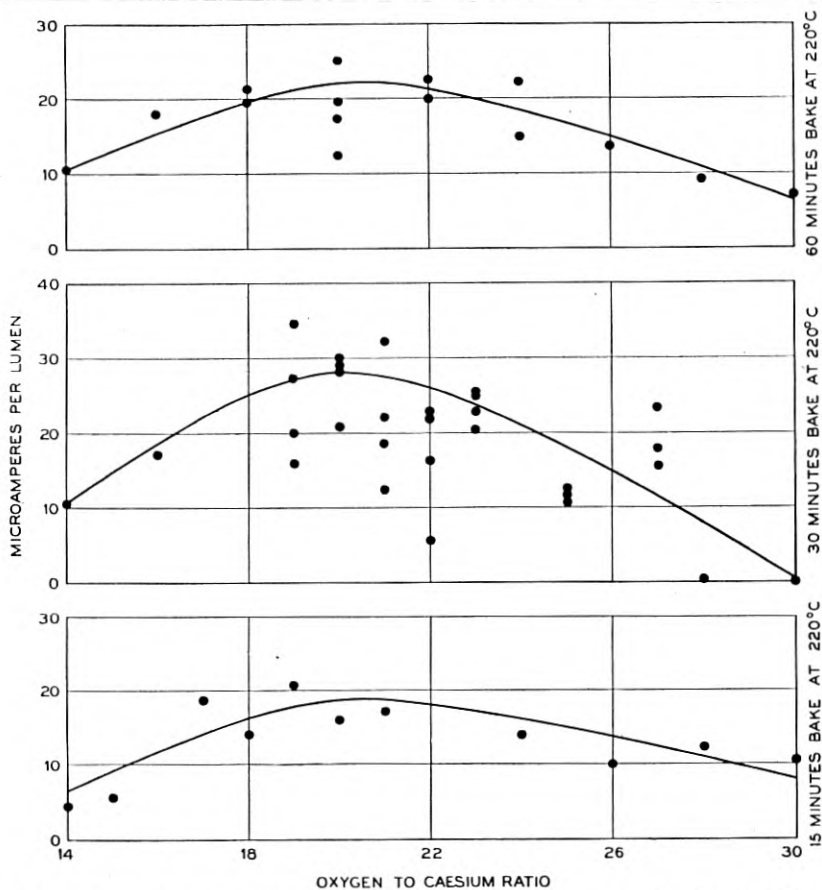

Fig. 3—Integral sensitivity as a function of oxygen-caesium ratio for 5 mg. pellets.

at a ratio of 17 and with a heat treatment of 15 minutes as shown in Fig. 4. One additional point of interest is that with the light pellets the cells have still fair activities at the high ratios for the short heat treatments but are destroyed by the 30-minute heating. This is most probably due to the oxidation of free caesium by residual silver oxide.

It is also significant to compare the coordinate effects of both oxygen-cæsium ratio and weight of cæsium chromate upon the activity. To this end in Figs. 5 and 6 for the 15 and 30-minute heat treatments, the ratio is plotted as abscissa, the weight of cæsium chromate as ordinate, and a circle is drawn about each point whose diameter is proportional to the observed activity. It is apparent that the 3-milligram pellets give superior results for the 15-minute heat treatment, and the 5-milligram pellets for the 30-minute treatment. Also the 5-milligram pellets seem to be the better, each considered under

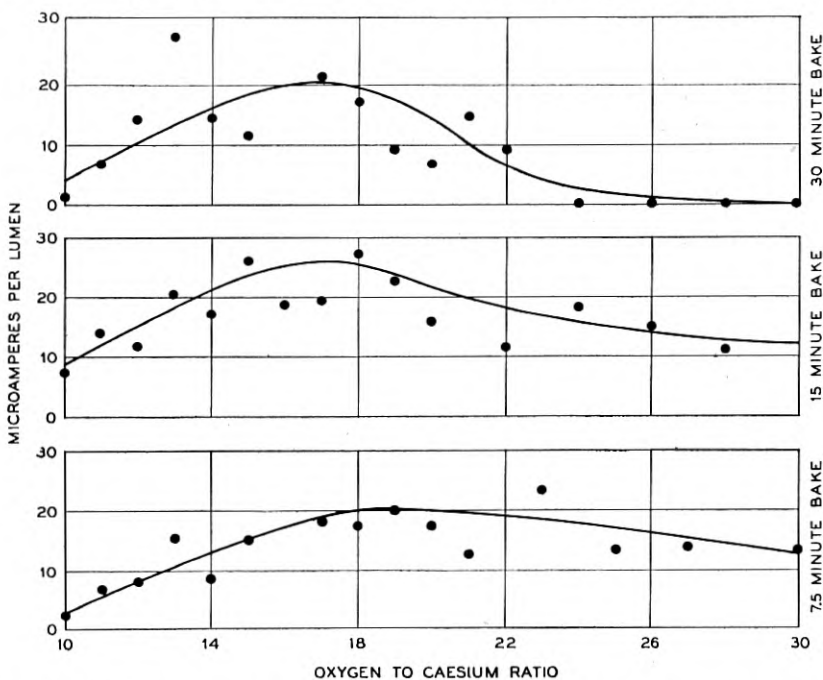

Fig. 4—Integral sensitivity as a function of oxygen-cæsium ratio for 3 mg. pellets.

its optimum conditions. The 5-milligram pellets also seem to yield cells more stable with respect to excessive heating, cf. Figs. 3 and 4. The pellet weights were in general quite uniform, but due to temporary difficulties the weights of the 5-milligram pellets used in the 30-minute heat treatment scattered considerably as is shown in Fig. 6. Fortunately, this scattering furnishes some detailed evidence as to the relation between activity and pellet weight. The locus of highest activity appears to be an oblique line as expressed in the coordinates of Fig. 6. One might predict that the highest activities would be

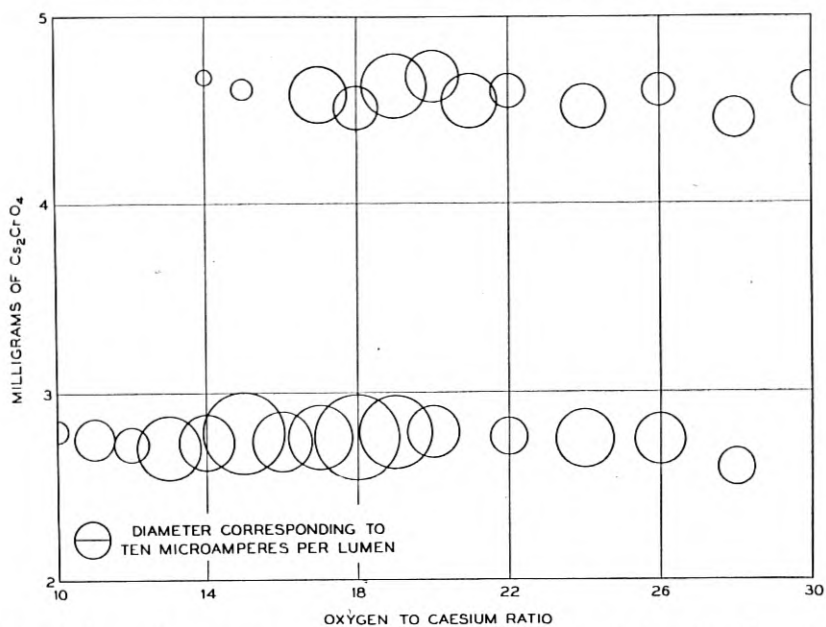

Fig. 5—Integral sensitivity as a function of ratio and weight of caesium chromate for a 15-minute heat treatment.

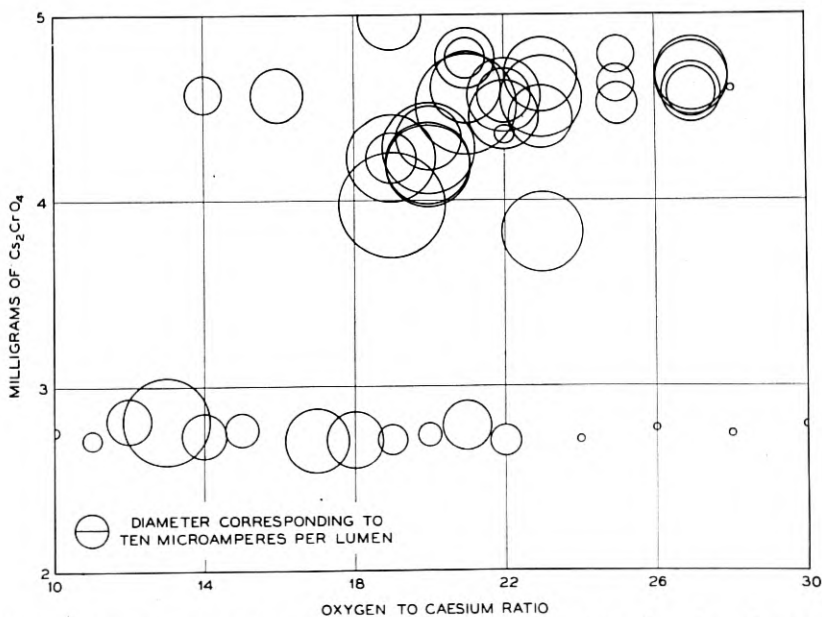

Fig. 6—Integral sensitivity as a function of ratio and weight of caesium chromate for a 30-minute heat treatment.

obtained by specifying a pellet containing 4.0 to 4.2 milligrams of caesium chromate, an oxygen-caesium ratio of 19, and a heat treatment at 220° C. for 25 to 30 minutes. It should be noted, of course, that the above are initial specifications. Two thirds of the caesium goes to form the matrix and active film of the cathode surface, while the remainder is deposited upon the inner surface of the glass bulb.

#### STUDIES OF THE CAESIUM THIN FILM

These cells show small fluctuations in sensitivity and shifts in spectral response with time and with the temperature of the surroundings. Even cells prepared under the optimum conditions take several days to stabilize. The integral sensitivity often changes by 5 or 10 per cent, usually to higher values. But further changes occur with changes in temperature. A number of cells aged at 50° C. increased in sensitivity by about 10 per cent in a few days, and then fell to their former stable values after operation for a few days at room temperature. In particular, cells made with large ratios of caesium to oxygen and short heat treatments, which should be conducive to the presence of small residual amounts of free caesium, tend to be the least stable, and to decrease rather than gain in integral sensitivity. Such cells are apt also to have low insulation resistance which tends to be unstable in value as compared to the normal cell which has a high and relatively stable insulation resistance.

Since the changes in sensitivity at 50° C. or below are generally reversible, they can not be due to chemical reactions of the irreversible type by which the cells are prepared. These changes seem most easily explicable as due to changes in thickness of a thin film of free caesium reversibly adsorbed upon the matrix of gross material, many molecules thick, which has been formed upon the silver cathode surface. According to this view it should be possible to correlate the observed fluctuations in sensitivity with variations in film thickness as the free caesium diffuses in and out of the underlying matrix, or evaporates and recondenses upon the various surfaces of the photoelectric cell interior.

Now it is impossible to differentiate between caesium adsorbed on the surface, absorbed in the matrix, or in chemical combination, by the type of quantitative data considered in the previous section, for all are placed simultaneously in their appropriate places and in proper amounts by the processes described. Neither is it possible to build up a matrix alone and subsequently place the film upon it with any assurance that the final state shall be comparable to that found in the cells already described. So resort has been had to a variational method of studying the surface film.

We have wished to obtain information regarding the amount of caesium in the surface film, the amount of free caesium in the underlying body of the matrix, to check up on the possibility of the diffusion of free caesium between the surface and body of the matrix and to study the relation between film thickness and the spectral response of the cathode surface. To this end we conducted one series of experiments in which known quantities of oxygen were admitted to cathode surfaces prepared in the standard fashion, following the course of recovery in response with time at various temperatures. In further experiments caesium vapor was allowed to deposit continuously upon the active surfaces of several cathodes of the same type, while observations were made of the resulting changes in spectral response.

Special cells were made and pumped under as nearly as possible the optimum conditions. The first series of cells were similar in structure to that shown in Fig. 1, except that to the upper end of the bulb was sealed a short glass tube. Within this tube and attached to its upper end was a thin-walled glass bulb containing oxygen at reduced pressure. A steel ball was also included within the tube which could be made to break the glass bulb of oxygen by agitation of the cell. The second series of cells were constructed as shown in Fig. 7. In each cell was supported a glass cylinder closed except for a small orifice pointing obliquely towards the cathode surface. Within this cylinder were a thin-walled bulb of soda-lime glass containing free caesium and a steel ball with which the bulb could be broken as before.

Monochromatic light was obtained from a Bausch and Lomb No. 2700 glass spectrometer fitted with two slits and calibrated by the makers to 10,000 Å. The light source was a lamp with a helical tungsten filament operated at a color temperature of 2,710° K. Readings were corrected to an equal energy scale using the relative energy curve for tungsten and the dispersion curve of the spectrometer. At the blue end of the spectrum readings were very small due to the low intensity of the light, the low response of the cell, and the wide dispersion of the spectrometer. The values presented are from 6,000 Å to 10,000 Å. The measurements were made with 90 volts across the cells and the photoelectric currents were amplified on a vacuum tube bridge circuit so as to be rapidly readable on a microammeter.

In Table 2 are presented data from four cells to which oxygen was admitted, giving the amounts of oxygen, the equivalent number of atomic layers of caesium oxidized, the various aging and heat treatments, and the integral sensitivities obtained after the several treat-

ments. In the second row of Table 2 the equivalent layers of caesium are computed as upon a smooth cathode surface. To obtain actual layers upon the roughened cathode these values must be divided by a factor which we have judged to be approximately four. In addition, since the oxygen flowed freely into the whole structure of the cell,

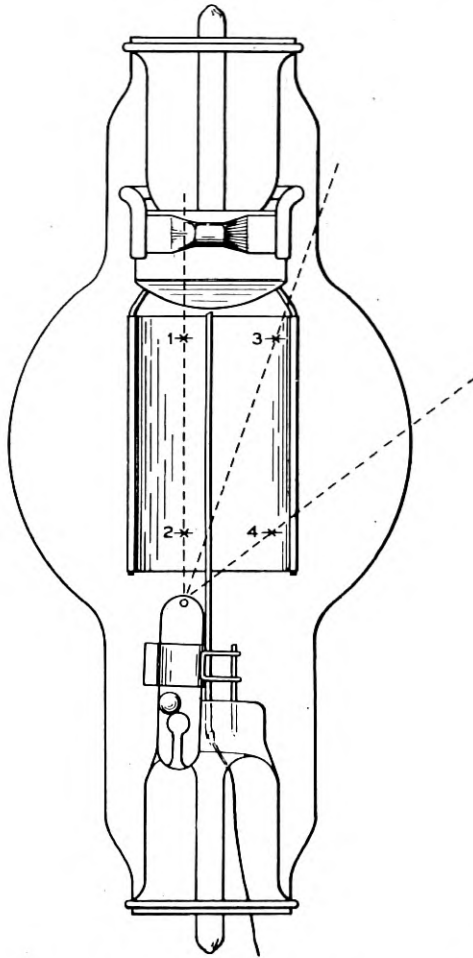

Fig. 7—Cell design for the deposition of caesium on a cathode surface.

we must consider a film (probably monatomic) of free caesium adsorbed on the inner surface of the glass bulb which has about four times the area of the cathode. This film must be present since the bulb itself is appreciably photosensitive. In cell *A* the oxygen, calculated as

TABLE 2

	Cell A		Cell B		Cell C		Cell D	
	Time of Treatment	Integral Sensitivity	Time of Treatment	Integral Sensitivity	Time of Treatment	Integral Sensitivity	Time of Treatment	Integral Sensitivity
Moles of O <sub>2</sub> . . . . .		2.36 · 10 <sup>-8</sup>		5.27 · 10 <sup>-8</sup>		17.5 · 10 <sup>-8</sup>		29.2 · 10 <sup>-8</sup>
Equivalent layers of caesium on smooth cathode . . . . .		4.01		8.95		29.7		49.7
Estimated layers of free caesium oxidized on roughened cathode . . . . .		0.5		1		6		11
Initial sensitivity . . . . .		34.7 μ amps. lumen		25.4		26.4		29.1
After releasing oxygen . . . . .		16.2		4.20		0.25		0.10
After aging at 22° C. . . . .	48 hours	20.3	68 hours	6.83			3 hours	0.41
After aging at 75° C. . . . .	1.7	28.8	8.7	14.3	0.5 hours	1.22	1.0	0.91
After further aging at 75° C. . . . .	3.0	30.8	5.0	15.3	11.5	0.93	5.0	0.82
After aging at 200° C. . . . .			5 minutes	13.1	5 minutes	23.4	5 minutes	1.00
After further aging at 200° C. . . . .			10	21.1	10		5	1.00
							10	19.9



equivalent to four layers of caesium upon a smooth cathode, would be sufficient to oxidize either the monatomic film of caesium on the bulb, or one atomic layer upon the cathode. We have therefore supposed that about half an atomic layer upon the surface of the cathode was actually oxidized. With the other three cells we have subtracted four "layers" for the bulb and divided the remainder by four to obtain a rough estimate of the actual number of atomic layers of free caesium upon the cathode surface which were oxidized. These values are shown in the third row of Table 2.

Each cell was first baked for 30 minutes at 75° C. to insure that the surface was in substantial equilibrium. No integral sensitivity changed by more than 10 per cent, and changes in the distribution of spectral response were inappreciable. These results are in agreement with our general experience that these cathodes are stable at 75° C.

All four cells were radically affected by the introduction of oxygen, but none were made entirely inactive. All recovered somewhat at room temperature but the rate of recovery slowed down rapidly. After the recovery had flattened out at room temperature the cells were baked at 75° C. The process of recovery was much accelerated so that cell *A* recovered most of its initial sensitivity, but cells *B*, *C* and *D* did not recover a high sensitivity until after a short heat treatment in an oven at 200° C. Cell *A* losing half a layer of caesium upon the introduction of oxygen fell to 47 per cent of its initial sensitivity. It recovered to 59 per cent after 48 hours at room temperature, and to 89 per cent after 3 hours at 75° C. Cell *B* losing one layer fell to 16.5 per cent, recovered to 27 per cent after 68 hours at room temperature, to 60 per cent after 14 hours at 75° C., and to 83 per cent after 15 minutes total at 200° C. Cell *C* losing six layers fell to 0.95 per cent, recovered to 3.5 per cent after 12 hours at 75° C., and to 89 per cent after 5 minutes at 200° C. Cell *D* losing eleven layers fell to 0.3 per cent, recovered to 1.4 per cent after 7 hours at room temperature, to 2.8 per cent after 6 hours at 75° C., and to 68 per cent after 20 minutes total at 200° C.

The heat treatment at 200° C. was kept short as reaction between free caesium and silver oxide and evaporation of caesium oxide both occur at this temperature and in time would destroy even a normal cathode surface. In the five-minute heat treatments the maximum cathode temperature was doubtless considerably less than 200° C. and the increased effects of the ten-minute treatments which followed are probably due more to the enhanced cathode temperature than to the longer time. The observed recovery must be due to the migration of free caesium already present as there is no chemical reaction possible

under these conditions by which free cæsium could be obtained from the cæsium oxide present.

This recovery of sensitivity has every appearance of accompanying a diffusion process by which cæsium in the matrix is brought to the surface of the cathode. Initially the concentration is uniform throughout the matrix. As soon as the oxygen is released it oxidizes the cæsium on and near the surface until the oxygen is exhausted. The cæsium oxide formed is identical with that already present. The resulting condition will be a matrix with a very sharp gradient from outer surface inward in cæsium concentration. This will cause a rapid initial rate of outward diffusion. But as soon as diffusion occurs the concentration gradient is decreased and the rate of transfer is less rapid since the cæsium is transported over a constantly greater distance under a decreasing diffusion pressure. As the temperature is raised the mobility of the cæsium is greatly increased but the essential nature of the process is the same.

It does not appear that any conclusion can be drawn from these data as to the thickness of the surface film of cæsium. Even in cell *D* with oxygen equivalent to eleven atomic layers of cæsium there was still a finite residual activity immediately after the oxygen reacted, which was not far different in value from that obtained with the six equivalent layers in cell *C*. It seems probable that the matrix is sufficiently spongy that there is a rapid diffusion of oxygen into it and immediate interaction of oxygen with the absorbed cæsium, preventing a complete clean-up of all cæsium on the surface with the amounts of oxygen used. Cell *D* is also noteworthy in that the oxygen used was equivalent to 7 per cent of the total cæsium found on such a cathode. And after the oxidation of this amount of free cæsium it was still possible to develop from this surface a high sensitivity equal to two thirds that of the initial state. So the initial amount of free cæsium must be still greater than 7 per cent of the total cæsium on the surface.

But it is not necessary to suppose a much greater amount since it is known that monomolecular films have a great tendency to form. This may resolve the difficulty in understanding why, after the equilibrium is reestablished, so large a change in volume concentration involves so slight a change in the surface condition. While the thickness of a surface film in equilibrium with a gas or vapor is a definite function of the pressure, the film thickness changes much less rapidly than the pressure when the film is in the neighborhood of one molecule thick. The same type of functional relationship may also obtain when the surface concentration is determined as a function

of an underlying volume concentration. Langmuir<sup>10</sup> has shown by the use of the Gibbs adsorption isotherm that in the case of solutions where the solute greatly lowers the surface tension, there is a layer of solute at the surface which is approximately a monomolecular film under a wide range of concentrations in the body of the solution. The same type of relationship may well obtain in the system under discussion, and the concept of a surface film merges into that of a limiting concentration at the surface of the matrix.

Measurements of spectral response were taken with the light

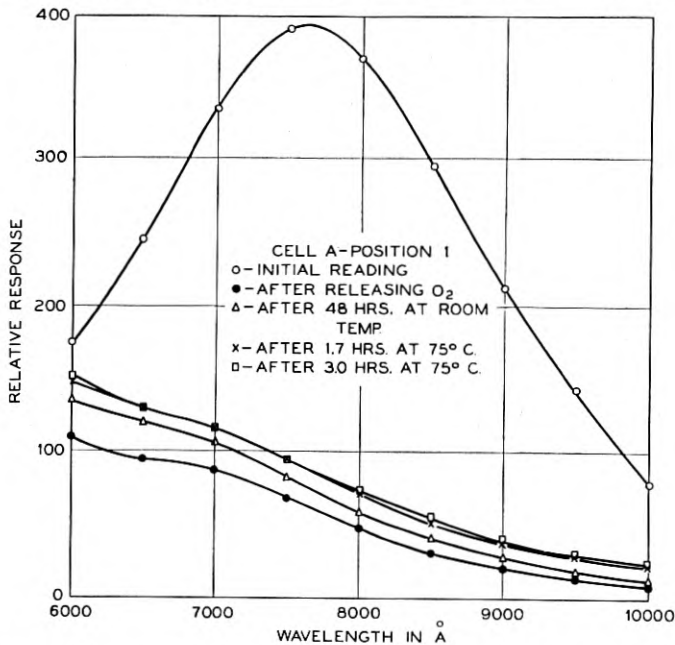

Fig. 8—Relative spectral response to equal energy for cell A, position 1.

incident upon four different positions on the cathode surface. The relative positions are the same as shown in Fig. 7. The effects were quite similar for positions 1 and 3 and again for positions 2 and 4, so curves are shown only for positions 1 and 2 for cells A and B to illustrate the effects at opposite ends of the cathode. In cells C and D the results were so similar for all four positions that curves are shown only for position 1.

In Figs. 8 and 9 are shown the effects upon cell A of the admission of oxygen equivalent to half an atomic layer of free caesium. Position

<sup>10</sup> Irving Langmuir, *Proc. Nat. Acad. Sci.*, 3, 251 (1917).

1 was nearer the end of the bulb at which the oxygen was introduced and was apparently more oxidized than was position 2. The characteristic spectral maximum for position 1, Fig. 8, is completely suppressed and has not reappeared after 4.7 hours of baking at 75° C. At position 2, Fig. 9, the height of the spectral maximum is greatly reduced but recovers considerably on baking, moving towards the longer wave-lengths, and accompanied by an increase in response at 10,000 Å. till it exceeds that of the initial state. In this final state

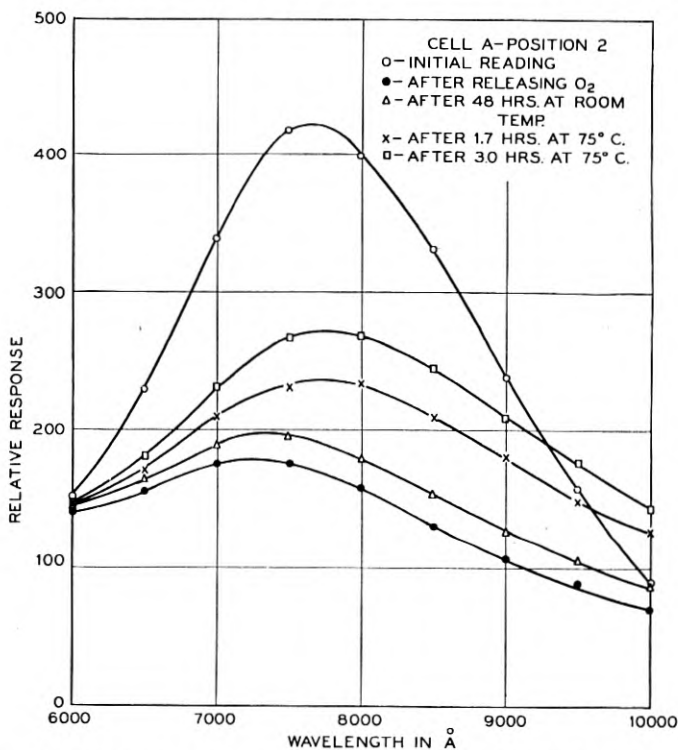

Fig. 9—Relative spectral response to equal energy for cell *A*, position 2.

the integral sensitivity of the cell as a whole had nearly recovered its initial value. The large difference in behavior of the two ends of the cathode is doubtless due to the fact that the oxygen was insufficient to oxidize even the superficial layer of free caesium and reacted wherever it first struck the cathode. The difference between opposite ends of the cathode is less pronounced in the other cells treated with more oxygen.

In cell *B*, Figs. 10 and 11, which we have estimated to be treated

with enough oxygen to oxidize a complete atomic layer of cesium, the selective maximum disappeared at both ends of the cathode and only reappeared as a slight indication in Fig. 11 after prolonged heating at 75° C. On baking for five minutes at 200° C. the selective response reappeared prominently with a maximum at 7,330 Å. but with a loss in response at 9,000 Å. and 10,000 Å. sufficient to involve a decrease in integral sensitivity as shown in Table 2. Further baking

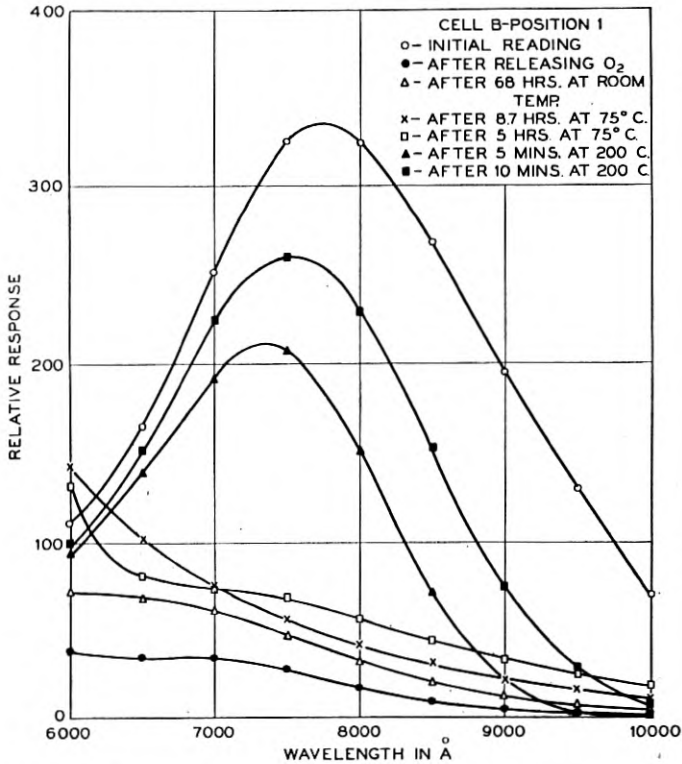

Fig. 10—Relative spectral response to equal energy for cell B, position 1.

involved a further rise in the maximum and a considerable increase in response at 9,000 Å.

In cells C and D, Figs. 12 and 13, which were treated with large amounts of oxygen, the response fell to very low values, rising only slightly on baking at 75° C. But on baking at 200° C. the selective maximum reappeared but at a longer wave-length than in the initial state, and the spectral response at 10,000 Å. was higher than it was at the beginning.

In all cases the recovery is easily interpreted as attendant upon a diffusion of free cæsium from the matrix to the surface film, furnishing a sequence of states with increasing film thickness, and approaching the initial state of each cell, but we can not estimate the quantitative differences in film thickness from state to state on account of the uncertain nature of the oxidation and diffusion processes.

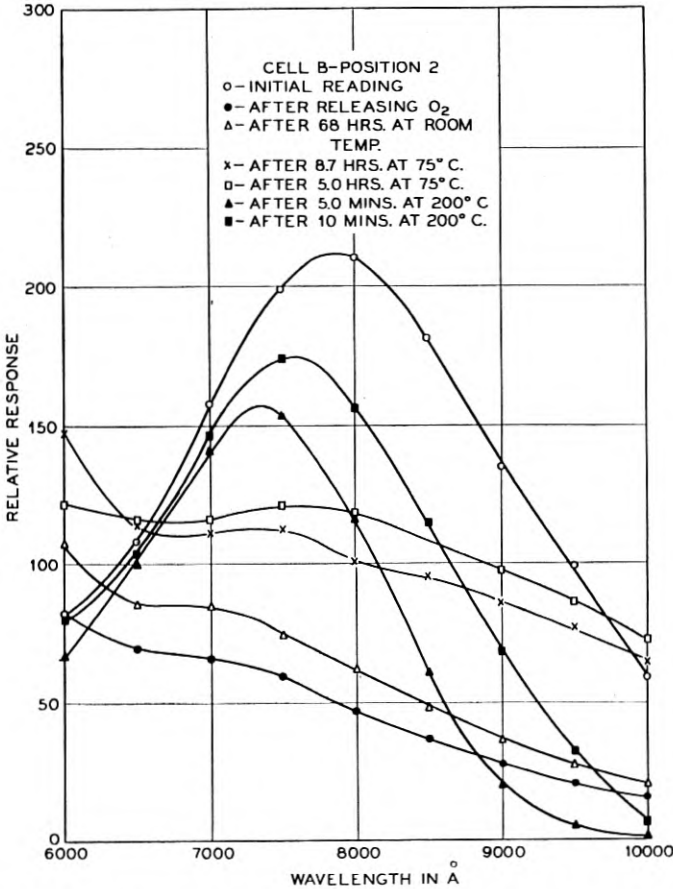

Fig. 11—Relative spectral response to equal energy for cell B, position 2.

The extension of this sequence of states to those with film thicknesses greater than that of the initial state was made by the deposition of cæsium upon the cathode surfaces of cells constructed as already shown in Fig. 7. When the cell was shaken and the steel ball made to break the glass bulb containing cæsium, cæsium vapor filled the glass cylinder and diffused slowly through the orifice. Data on three

cells are presented in which rates of deposition of free caesium differing by a factor of 700 were obtained. The sizes of the orifices differed and positions on each cathode at different distances from the orifice were observed. Measurements of spectral response were made with the light incident upon each of the four positions on the cathode shown in Fig. 7.

From simple kinetic considerations we may derive a formula for

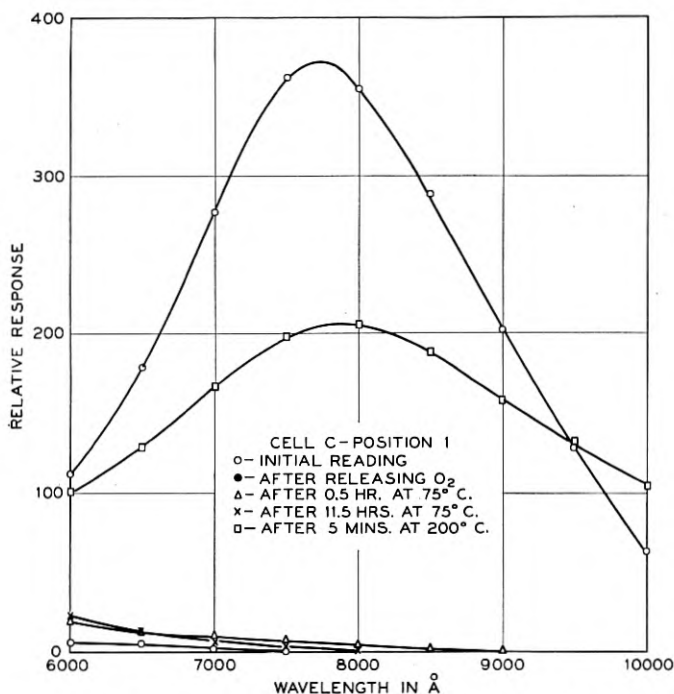

Fig. 12—Relative spectral response to equal energy for cell *C*, position 1.

the rate of deposition upon a surface of the vapor effusing from the orifice:

$$W = 0.01857 \sqrt{M/T} \frac{\sigma p_{\text{mm.}}}{r^2} \cos \theta \cos \Psi,$$

where  $W$  is the weight deposited per cm.<sup>2</sup> per second (in grams),  $M$  is the molecular weight of the vapor,  $\sigma$  is the area of the orifice,  $p_{\text{mm.}}$  is the pressure within the cylinder in millimeters of mercury (i.e. the vapor pressure of caesium<sup>11</sup>),  $r$  is the distance from the orifice to the surface,  $\theta$  is the angle between  $r$  and the normal to the plane

<sup>11</sup> Int. Crit. Tables III, 205.

TABLE 3

Cell Number	$\sigma$	$t$	Position	$W_{Cs}$	Layers/Hour
<i>E</i>	0.0107cm. <sup>2</sup>	29.0° C.	2	0.285 $\mu$ gm. cm. <sup>-2</sup> hr. <sup>-1</sup>	3.15
<i>F</i>	0.000396	28.0	1	0.000407	0.00450
			2	0.0082	0.0906
<i>G</i>	0.00155	31.0	1	0.00218	0.0242
			2	0.044	0.487

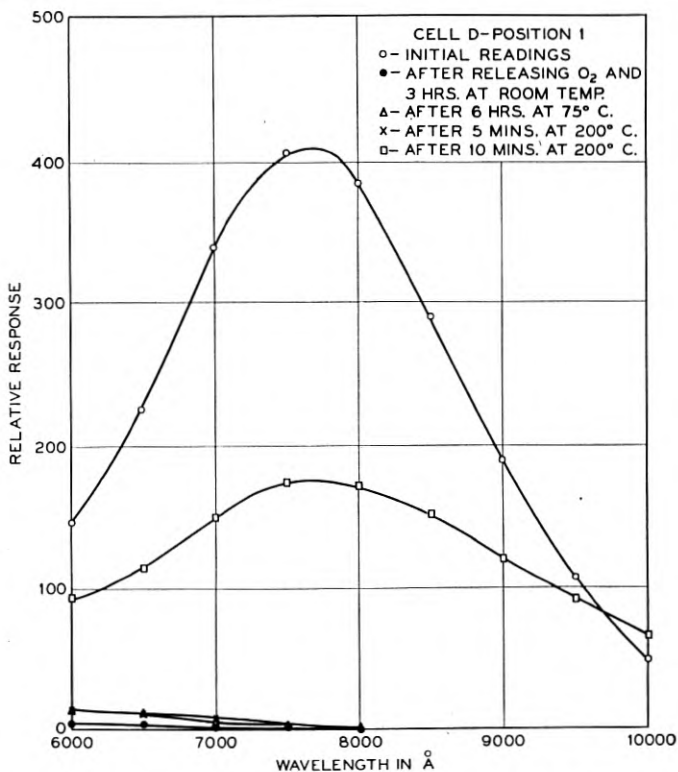

Fig. 13—Relative spectral response to equal energy for cell *D*, position 1.

of the orifice, and  $\Psi$  is the angle between  $r$  and the normal to the surface. The constants for the three cells presented and the rates of deposition of caesium at the various positions are shown in Table 3, where  $t$  is the mean temperature during the time of observation, and  $W_{Cs}$  is the rate of deposition of caesium in micrograms per square centimeter per hour. In the last column are shown the equivalent number of atomic layers of caesium that would be deposited per hour upon a plane surface. As before, these values must be divided by



approximately four to correct for the increase in surface on roughening, but it seems preferable to present the experimental results in terms of measured rather than estimated quantities, so numbers of layers of caesium deposited will be presented as upon a smooth surface.

In cell *E*, which had the largest orifice, the changes were so rapid that only one position could be followed. In Fig. 14 the response at each wave-length is plotted against the time on a logarithmic scale.

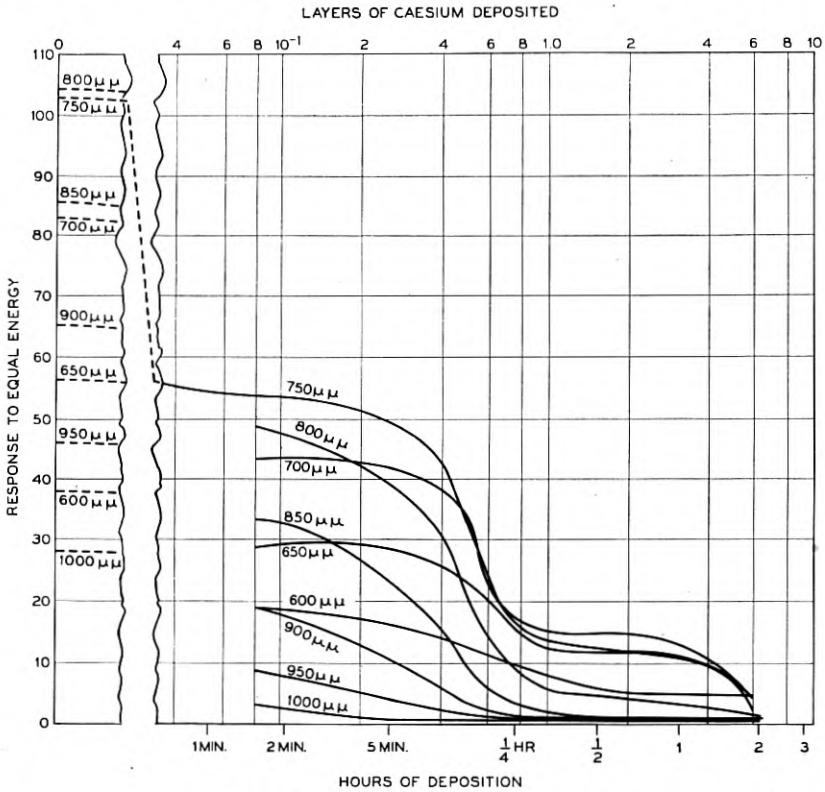

Fig. 14—Spectral response changes in cell *E*.

The response decreased at all wave-lengths, but the effect increased progressively with increasing wave-length. After two hours the wave-length of maximum response had shifted from 7,750 Å. to 6,000 Å.

With slower rates of deposition, initial effects become apparent. In Fig. 15 are shown the results for position 1 of cell *F* which involved the slowest rate of deposition. For wave-lengths shorter than 9,000 Å. there is first a rise in response to a maximum at between 10 and 20

hours of deposition which is most pronounced at 7,500 Å. This is followed by a decay which is again most rapid for the longer wave-lengths. The responses for 9,500 Å. and 10,000 Å. show no rise and decrease steadily after 10 hours. The responses at these wave-lengths were probably at their maxima initially, while the responses at all shorter wave-lengths reach their maxima with increasing time in the order of a progression of wave-lengths from infra-red to visible light. Calculation from the constants in Table 3 shows the maximum

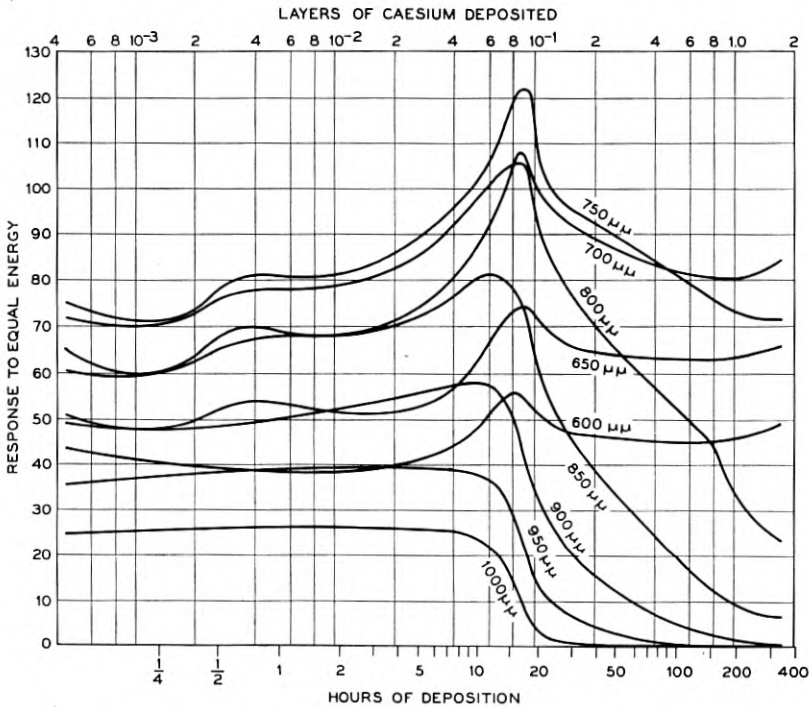

Fig. 15—Spectral response changes in cell *F*, position 1.

response at 7,500 Å. to correspond to the deposition of approximately one tenth of an atomic layer, as may be seen from the scale of abscissæ at the top of the figure.

For position 2 of this same cell, where the deposition was 20 times as rapid, the curves show a great similarity in every respect including the proportionality of the time scales up to the point corresponding to one tenth of a layer, as may be seen in Fig. 16. Then the maxima spread out and the falling off of response is relatively slower than that found in Fig. 15 as expressed in terms of layers deposited. In

fact the two sets of curves become more comparable as expressed in terms of the time scale until after 400 hours the two distributions of spectral response are nearly identical. This final identity may be interpreted in view of the fact that position 2 has received roughly 30 atomic layers of caesium. For such a thickness the vapor pressure would be expected to approach that of bulk caesium. At this temperature the rate of vaporization from a bulk caesium surface would

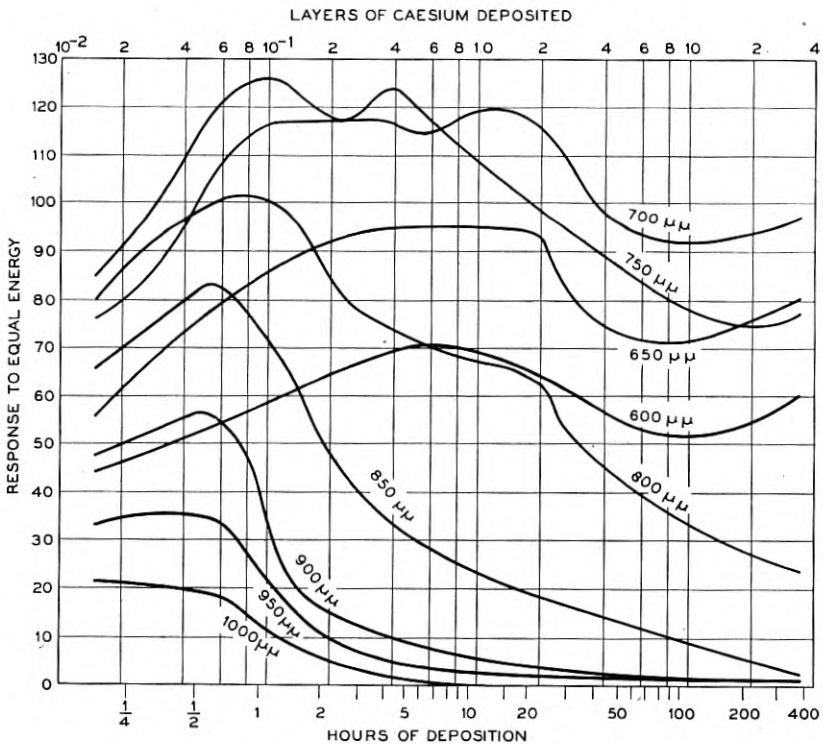

Fig. 16—Spectral response changes in cell *F*, position 2.

exceed the rate of deposition at this point from the orifice. So caesium should obviously evaporate from position 2 and condense on the less saturated areas such as position 1. Eventually the thickness of the deposited layer should be equalized over the entire surface.

The same qualitative description covers the phenomena observed at the other two positions of the same cell which are not shown. The rate of deposition was slow at position 3 and rapid at position 4. The behavior of all four positions fits into a coherent scheme where the initial sections of the four groups of curves are similar with respect

to the amount of cæsium deposited and the final sections approach similarity with respect to the elapsed time.

In cell *G* similar qualitative results are apparent. The cell was not as active initially as cell *F*, and the rises in response are not so prominent. For the slow position 1, Fig. 17, the maxima in the response curves are lower and broader than for the slow position of cell *F*, Fig. 15. But the maximum response for a wave-length of 7,500 Å. occurs again after the deposition of approximately one tenth of a layer of cæsium, though in Fig. 17 the maximum response at 8,000 Å.

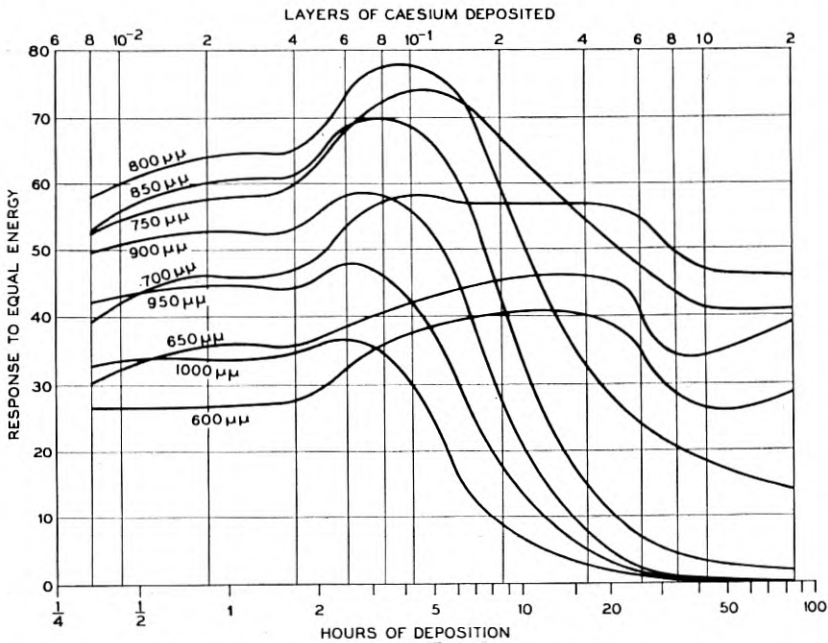

Fig. 17—Spectral response changes in cell *G*, position 1.

is greater than the maximum response at 7,500 Å. In position 2, Fig. 18, which had the fastest rate of deposition the maxima are either entirely absent or else displaced to a position corresponding to about 0.5 of an atomic layer where there are slight indications of maxima for the wave-lengths 7,500 Å. to 6,000 Å.

If we again refer to Fig. 14, which shows curves for the very rapid deposition of cæsium, it appears in this case that after the deposition of one tenth of a layer the response has decreased markedly for light of all wave-lengths. There appears to be a systematic variation of behavior in that the maxima are very sharp for the slow rates of

deposition and are progressively wider and less prominent as the rate of deposition is increased until for very rapid deposition the response for all wave-lengths decreases rapidly from the beginning. In this connection we may recall from the oxidation experiments that a slight amount of diffusion or surface rearrangement may occur in such time intervals as are available in the experiments involving slow deposition of caesium.

But the behavior of the different cells and even different positions in the same cell may not be closely compared, for their initial states were by no means identical. In each of these cells there was a difference in the colors of the two ends of the cathode due to a distortion of the glow discharge in the quantitative oxidation step of their preparation which was due to the special geometry of these cells

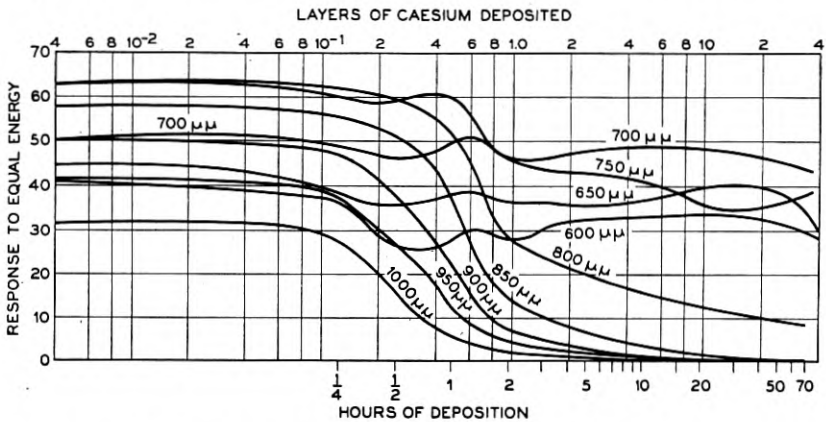

Fig. 18—Spectral response changes in cell G, position 2.

But certain gross conclusions may be drawn. In all cases the addition of a few tenths of a layer of free caesium caused profound modification in the spectral response characteristics. If we regard the results for the slower rates of deposition as more typical of steady state conditions of the cathode surface, it appears that we may increase the response in the region about 7,500 Å. at the expense of the response at and beyond 10,000 Å. by the addition of a few tenths of a layer of free caesium. It should be remarked again, however, that in view of the roughness of the surface these quantities should be reduced by a factor of four, and the critical amount of caesium may well be less than even a tenth of a layer on the actual surface. Further addition of caesium causes a decrease in sensitivity at all wave-lengths, and this effect is increasingly pronounced towards the infra-red end of the spectrum.

In Fig. 19 are shown spectral distribution curves of the response to equal energy with different amounts of deposited cæsium selected from the data shown in Fig. 15. These curves show in more conventional fashion the shift in the position and height of the spectral maximum. This illustrates the general behavior of the equilibrium surface upon the addition of further cæsium. There is an increase in response at the spectral maximum upon the addition of approximately

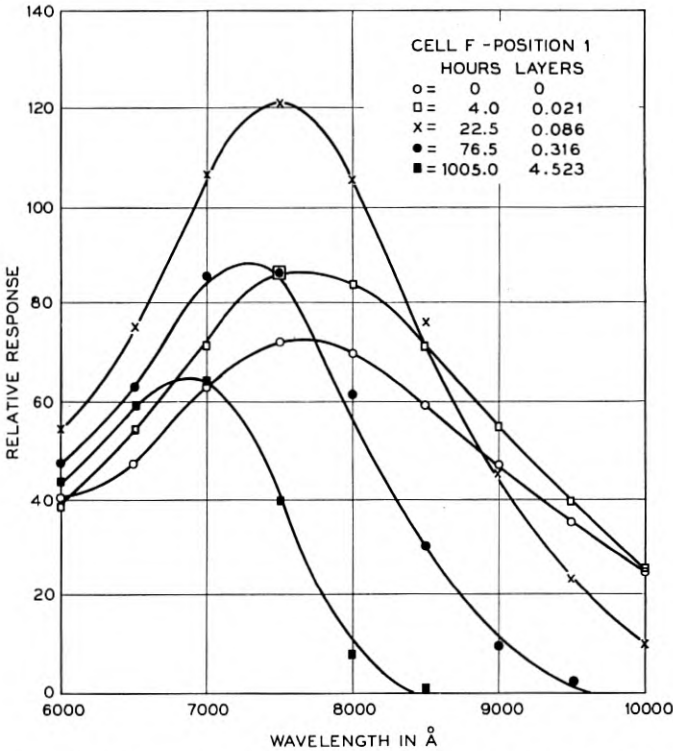

Fig. 19—Relative spectral response to equal energy for cell *F*, position 1.

one tenth of a layer of cæsium. As further cæsium is added the height of the spectral maximum progressively decreases. The wavelength of the maximum spectral response and the wavelength of the photoelectric threshold both recede progressively toward the ultra-violet upon the addition of free cæsium to the normal surface.

Combining the results from the experiments where oxygen was admitted to the cells and those where additional cæsium was deposited upon the cathode, we have a sequence of states with increasing thickness of the cæsium thin film upon the cathode surface. If we take

curves for the spectral response of various states obtained by oxidation followed by diffusion at room temperature and at 75° C., and then include curves for the spectral response of various states obtained by the slow deposition of caesium we may obtain a composite family of curves such as are sketched in Fig. 20 to show the whole sequence of response characteristics whose parameter is the thickness of the surface film of free caesium. In obtaining curves for this composite progression of states we have not considered surfaces after they were

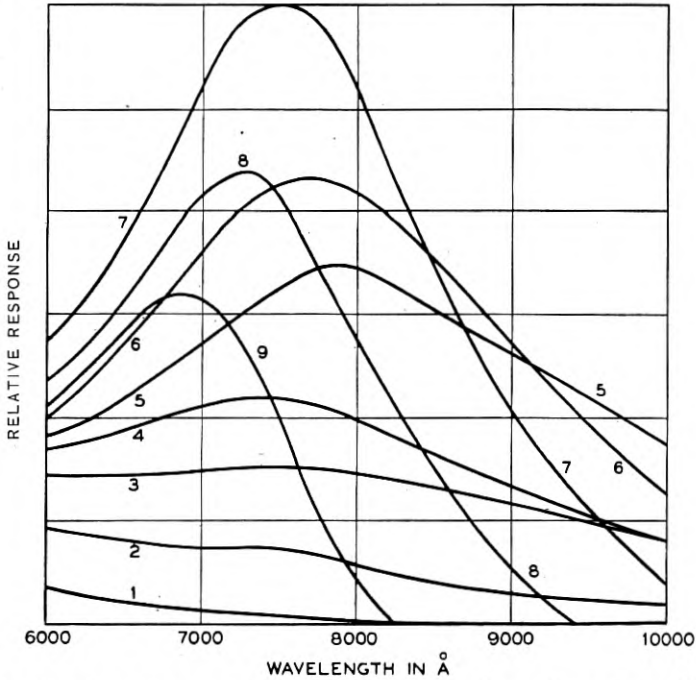

Fig. 20—Relative spectral response to equal energy of a caesium-oxygen-silver cell as an idealized function of film thickness.

baked at 200° C. because of the likelihood at this temperature of surface changes other than in caesium concentration alone.

When the amount of caesium in the surface is far below the normal (as after admitting oxygen equivalent to six layers of caesium) we have a spectral response which decreases continuously with increasing wave-length, as shown in curve 1 of Fig. 20. This is the same type of response as obtained by Koller<sup>6</sup> from cells prepared by treating with caesium a silvered bulb with an adsorbed film of oxygen which gave a type of surface designated by him as "Cs-O-Ag." With increasing film thickness the response increases at all wave-lengths

<sup>6</sup> Loc. cit.

and a selective maximum appears as in curves 3 and 4. Then its height rises and its position moves to longer wave-lengths until the maximum occurs at 8,000 Å. as in curve 5, and the response at 10,000 Å. attains its highest value. From a consideration of prevalent concepts of thin-film effects in thermionic and photoelectric phenomena one should expect the surface in this state, which has apparently the maximum value of the photoelectric threshold, to be covered with a monatomic film of free caesium. As we continue increasing the amount of caesium in the film, the height of the maximum still rises but its position recedes to 7,500 Å. and the response at 10,000 Å. falls as represented in curves 6 and 7. In the transition from curve 5 to curve 7 the gain in response at 7,500 Å. is offset by the loss in response at and beyond 10,000 Å. As a result the integral sensitivity to tungsten light is sensibly constant and the optimum states for maximum integral sensitivity lie within this range. With further increase in caesium film thickness the height of the maximum drops, and the positions of both the selective maximum and the photoelectric threshold recede towards shorter wave-lengths as in curves 8 and 9. Eventually we should doubtless approach the spectral response curve for bulk caesium<sup>12</sup> with the selective maximum at 5,400 Å. and the photoelectric threshold at 7,100 Å.

The large changes in spectral response following the deposition of minute amounts of caesium upon the cathode surface are further evidence that the photoelectric effect is a phenomenon of the superficial surface only and is conditioned mainly by the thickness of the surface film of free caesium. Although the cathode surface as a whole is prepared by irreversible chemical reactions which are arrested before their completion, the film thickness of the standard surface is determined by the concentration of free caesium in the underlying matrix and is maintained by a diffusion equilibrium. In the preparation of the standard surface this partition is first determined at 220° C. in the heat treatment. Stabilization involves a readjustment of the surface to equilibrium with the adjacent portion of the matrix at room temperature. But the attainment of complete equilibrium at room temperature takes so long that many fluctuations of the ambient temperature intervene and the actual history of such a photoelectric surface involves a long series of diffusion waves accompanied by small fluctuations in the thickness of the surface film which determines its photoelectric behavior.

We wish to express our appreciation of the assistance of Mr. M. F. Jameson in these experiments. Acknowledgment is also due to Mr. H. W. Hermance for the chemical analyses, and to Miss A. K. Marshall for the microphotographs.

<sup>12</sup> Miss Seiler, *Astrophys. J.*, **52**, 129 (1920).



## Two-Way Radio Telephone Circuits \*

By S. B. WRIGHT and D. MITCHELL

This paper deals with the problems of joining long-distance radio telephone transmission paths to the ordinary telephone plant. It gives the possibilities and limitations of various methods of two-way operation of such circuits where the radio channels employ either long or short waves. It also describes the special terminal apparatus for switching the transmission paths under control of voice currents and lists the advantages of using voice-operated devices.

**R**ADIO telephone circuits are now in regular use between New York and London, New York and Buenos Aires, San Francisco and Honolulu, and many other points. At each end of such a circuit there are a transmitting radio station and a receiving radio station, usually geographically separated. The radio provides two one-way transmission paths. The circuit is completed by means of one-way wire lines which connect the radio sending and receiving stations to a common point. At this common point some rather intricate apparatus is called for in order to permit switching of the circuit to the wire telephone plants at the two terminals. This paper explains why this intricate apparatus is necessary even for the comparatively simple case of short-wave radio circuits which use different frequency bands to transmit in opposite directions. It also describes the latest form of this terminal apparatus in which provision is made for certain switching of privacy apparatus by means of which an important saving is made in the amount of privacy apparatus required. The original form of this apparatus is described in an earlier paper.<sup>1</sup>

### TRANSMISSION PATHS

Radio telephone circuits may employ the same frequency band for transmission in the two directions or they may employ separate bands. The present long-wave telephone circuit between New York and London is of the first type, while most existing short-wave circuits are of the second.

A short-wave circuit, using separate frequency bands, is shown in its simplest form in Fig. 1. It is formed of two sets of terminal appara-

\* Presented at I. R. E. Convention, Pittsburgh, Pa., April 7-9, 1932. Published in *Proc. I. R. E.*, July, 1932.

<sup>1</sup> S. B. Wright and H. C. Silent, "New York-London Telephone Circuit," *Bell Sys. Tech. Jour.*, 6, 736-749; October, 1927.

tus connected by two one-way channels, each of which consists of a transmitting wire line, a radio link and a receiving wire line. The function of the terminal or "combining" apparatus is to tie together these two one-way paths in such a manner that they may be connected at the switching centers to various telephone subscribers via the usual telephone circuits.

When the United States subscriber, designated as *A* in Fig. 1, talks, electrical waves set up by his voice pass over a wire line to a toll office. They then divide in a hybrid set. Part of the energy is dissipated in the output of a receiving repeater, and part is amplified by a transmitting repeater and passes over a wire line to a radio transmitter, as indicated in the upper transmission path of Fig. 1.

The waves are then amplified and transformed into radio-frequency energy and radiated. Some energy is picked up by a distant radio receiver, amplified, and transformed back into voice-frequency energy which passes over a wire line to the overseas terminal. The receiving repeater at this point makes up for the loss of the receiving wire line. From its output the waves pass into a hybrid set, part being dissipated in the network and the other part going through the toll office to the overseas subscriber *B*. Due to the imperfect balance between the subscriber's line and the network, a portion of this energy will be returned over the lower transmission path to the United States subscriber *A* as echo.

The action when the overseas subscriber *B* talks is substantially the same as that described above except that the useful speech waves pass over the lower transmission path.

In long-wave radio circuits the scarcity of suitable radio channels makes it highly desirable to use the same frequency band for transmission in both directions. This results in two additional radio paths becoming important, namely, those between the radio transmitter and the radio receiver at each end of the circuit. By using specially directive antenna arrangements, transmission over these paths may be partly balanced out. In practice, this balance cannot be made very effective in reducing the relative importance of these paths without sacrificing materially the receiving directivity against natural radio noise. The effect of these added transmission paths is to make the transmission problem more difficult, as will be explained.

#### TRANSMISSION CHARACTERISTICS

Returning to consideration of the simple four-wire set-up involved in short-wave operation, the transmission characteristics of the circuit evidently depend on the sum of the effects of the radio and wire line

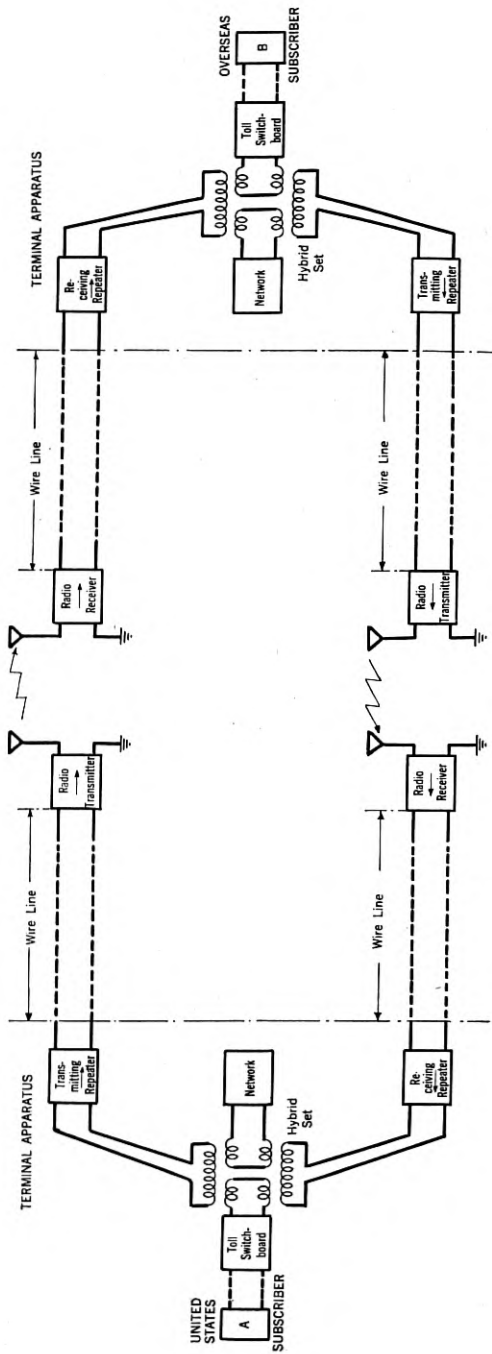

Fig. 1—Two separate radio links connected as a four-wire circuit.

portions. In view of the relatively higher cost and greater length of the radio links, the highest grade wire circuits available are usually justified so that, in general, they should not be allowed to contribute much transmission impairment. In general, the added delay introduced by these wire lines is their most important effect.

If the radio links are quite stable and fairly free from atmospheric disturbance, the circuit may be operated like four-wire land telephone circuits. That is, the total amplification in the circuit may be kept at such a value that it never exceeds the total attenuation, and over-all singing will not occur. Four-wire terminating sets or hybrid sets placed at the ends of the circuit, as shown in Fig. 1, are adequate to prevent singing and minimize echo effects in four-wire circuits which have over-all transmission times less than about 0.02 second, provided the net loss from switchboard to switchboard does not become lower than about 5 db.

If the radio links or wire lines are long, the circuit will produce annoying echoes exactly as a four-wire cable circuit will, due to delay or instability, or both. Also, as in the case of four-wire cable circuits, echo effects may be reduced appreciably by voice-operated echo suppressors which block the path of the delayed echoes while the other path is transmitting speech. The possibilities and limitations of this type of device are discussed elsewhere.<sup>2</sup>

When the radio channels are more noisy and/or less stable, the transmission may be greatly improved through more efficient use of the radio links. The noise may be minimized by bringing the speech waves of all talkers, strong or weak, to the same "electrical volume" or strength at the input to the radio transmitter. Thus, practically full modulation may be maintained on the radio transmitter at all times and the ratio of the desired signal to the radio noise kept a maximum. Large changes in gain between the two-wire line and the radio transmitter are necessary to accomplish this result. These changes are made by technical operators who make the adjustments with variable loss devices. An indication of the volume is obtained through the aid of electrical meters called "volume indicators." In practice, the over-all transmission of a long radio circuit may be varied by the technical operators from a 30-db loss to a 30-db gain within a few minutes.

In short-wave circuits, the phenomenon known as "fading" introduces an effect which is of great importance in two-way operation. Where fading results in variations of the entire transmitted band of frequencies, automatic gain control at the radio receiver is effective in

<sup>2</sup> A. B. Clark and R. C. Mathes, "Echo suppressors for long telephone circuits," *Jour. A. I. E. E.*, **44**, 618-626; June, 1925.

maintaining the received volume at a substantially constant value. The gain control is operated by the incoming carrier. When the fading is of the type in which the different frequencies in the transmitted band do not fade simultaneously, the automatic gain control is not so effective and considerable variations in volume out of the receiver may occur in a short time.

In the long-wave circuit, the variations are too slow to be classed as fading, and occasional manual adjustments of receiver gain result in keeping the volume at the receiving end within about  $\pm 5$  db.

Because of the gain adjustments to reduce noise, combined with changes in radio receiver gain to compensate for fading or for variations in radio attenuation, "singing" would occur if the hybrid coils and echo suppressor were not augmented by additional means of singing prevention. One way of preventing singing would be to reduce gain in the receiving leg whenever gain was introduced in the transmitting leg of the circuit. Volume penalties to the listener as great as 25 db would frequently be encountered if this were done, and, in addition, considerable agility would be required on the part of the technical operators to keep the circuit adjusted. However, this method would not compensate for gain changes in the radio receivers, so that singing might still occur under unfavorable conditions.

Also, in the case of a long-wave transatlantic circuit, singing could occur over transmission paths between the local radio transmitter and receiver. The volume received from the local transmitter may occasionally be as much as 40 db stronger than that from the distant station if the transmitter and receiver are about 90 miles apart, even though antenna directivity were used at both the transmitters and the receivers. In general, if the receiver gain is adjusted to give the proper volume on the distant station, the amplification in the local radio path is entirely out of reason.

It is therefore necessary to provide other means of preventing singing to maintain optimum transmission conditions.

#### VODAS

There has been developed for meeting these difficulties an anti-singing voice-operated device known as a "vodas."<sup>3</sup> Fig. 6 shows a radio telephone circuit arranged with a vodas in its simplest form at each end of the circuit. The vodas consists of a transmitting delay circuit, detector, and certain relays, and a receiving delay circuit, detector, and relay. These devices are operated by the voice currents in the circuit so as to keep all singing paths blocked at all times.

<sup>3</sup> Taken from initials of the words "Voice-Operated Device Anti-Singing."

The vodases in Fig. 6 are shown for the condition when no speech is being transmitted. Relay 1 keeps the transmitting circuit blocked so that singing cannot occur around the complete circuit or through a local radio path and terminal. Transmission is free to pass the contacts of relay 2. When the United States subscriber speaks, voice currents go into the transmitting detector and delay circuit. While they are traversing the delay circuit, relays 1 and 2 become operated provided relay 3 has not been operated previously. The operation of relay 1 permits the voice currents to travel on to the radio transmitter. The operation of relay 2 blocks the receiving path and prevents echoes and singing that might otherwise occur when relay 1 is operated.

Upon being received at the distant end, the voice currents operate relay 3 from the receiving detector, thus protecting the transmitting detector and relays against operation by echoes of received speech currents. These echoes are returned from unbalances in the two-wire portion of the connection beyond the terminal. The receiving delay circuit delays the speech long enough to insure complete operation of relay 3 before the echoes return. When the subscriber stops speaking, the relays return to normal.

By adding two more relays to the transmitting side of the vodas, it is possible to save part of the apparatus which is used to increase privacy on the circuit. This saving is made by using the same privacy device for both transmitting and receiving. This is possible provided the action of the privacy device is the same for distorting the voice waves at the transmitting end as it is for restoring them at the receiving end of the circuit. An arrangement of the vodas having this feature, which is now in general use, is illustrated in Fig. 2. The apparatus additional to the simple vodas consists of relays 4 and 5, the privacy device, a hybrid set, and two one-way repeaters. In Fig. 2 this apparatus is labeled "Privacy Switching Circuit."

The action of the device shown in Fig. 2 on transmitting speech waves is as follows: Useful waves from subscriber *A* are impressed on a potentiometer ahead of the transmitting repeater, which is kept adjusted by the technical operator to maintain constant volume at the output of the transmitting repeater. The waves then pass into the vodas where they first reach the transmitting delay circuit and are stored for a short interval. A small part of these waves enters the transmitting detector and operates relays 1, 2, 4, and 5, provided relay 3 has not been operated by the receiving detector previously. The interval of the transmitting delay circuit is several times as great as the operating time of relays 1, 2, 4, and 5 so that initial weak parts of speech syllables may be stored in this delay circuit until stronger parts arriving later have had a chance to operate the relays.

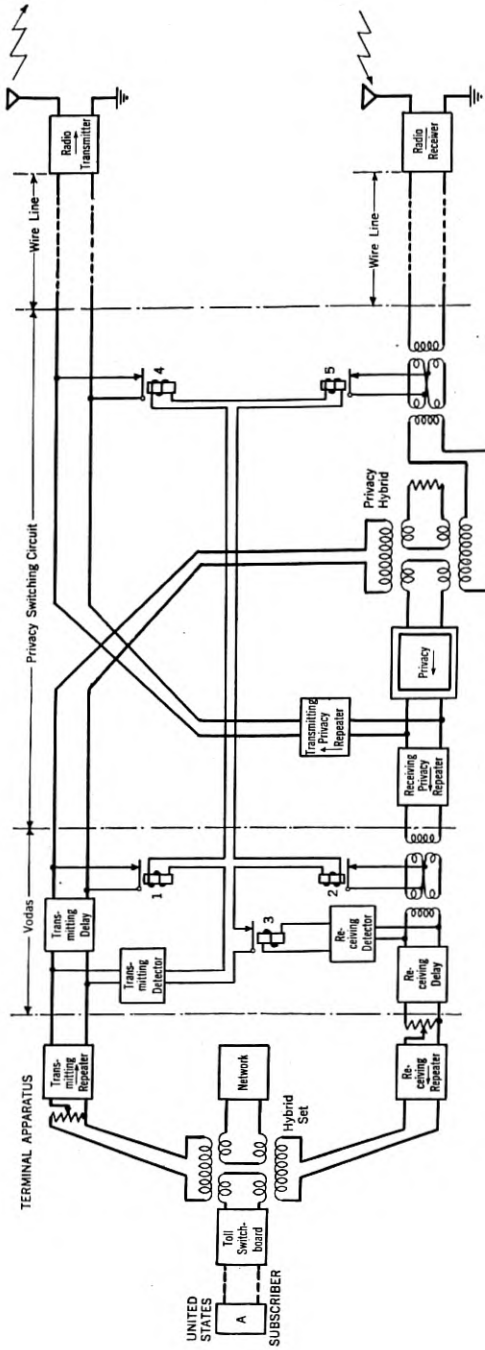

Fig. 2—Voice-operated device used on New York-Buenos Aires and other radiotelephone circuits.

Operation of relay 1 clears a path for the speech waves after they pass through the transmitting delay circuit. From there they pass into the privacy switching circuit traveling downward to the privacy hybrid set. Here they divide and the useful portion travels through the privacy device. At its output the waves divide, part being amplified by the transmitting and part by the receiving privacy repeater. The subscriber at *A* is prevented from hearing echo by the operation of relay 2 which disables the receiving transmission path in a way to be described later. The portion of the waves which travels upward through the transmitting privacy repeater, however, is now free to pass on to the wire line and radio link due to the operation of relay 4. Operation of relay 5 prevents any echo due to direct transmission from the local radio transmitter to the radio receiver from being passed into the privacy device and thus causing distortion of the outgoing waves.

Action of this device on incoming speech waves is as follows: The waves after being detected by the radio receiver travel over the wire line and, provided the transmitting relays have not been previously operated, pass through the first repeating coil combination and into the lower side of the privacy hybrid. There they divide and the useful part passes through the privacy device where it is restored to an intelligible form. At the output of the privacy device, the waves are amplified by both transmitting and receiving privacy repeaters. Any retransmission of these waves from the local transmitter is prevented by relay 4 which is now released. At the output of the receiving privacy repeater the waves pass through the second repeating coil combination and thence to the receiving delay circuit. A part of these waves, if they are strong enough, may operate the receiving detector and thus, relay 3.

After passing through the receiving delay circuit the speech waves travel on through a receiving potentiometer, receiving repeater, hybrid set, and to the subscriber at *A*.

A small part of these waves may be reflected due to the difference in impedance between the subscriber's line and the network and return over the transmitting branch of the circuit. However, if these waves are strong enough to operate relay 3, they are prevented from operating the transmitting relays. If they are too weak to operate relay 3, an adjustment of receiving volume is made so that they will be too weak to operate the transmitting relays. This adjustment is accomplished by the potentiometer ahead of the receiving repeater. The waves are prevented from passing through the privacy device by relay 1 which is released.

In practice, it is necessary to protect the vodas against operation



from noise. This is done by frequency discrimination as well as by amplitude discrimination and the use of artificial delay. The detectors have their input circuits arranged to keep out frequencies that are not essential for speech operation. In addition, their sensitivity is made adjustable. The transmitting detector is generally worked at a value which results in no perceptible loss of intelligibility due to failure of the transmitting relays to operate, at the same time allowing a maximum amount of line noise to be applied without operating the relays falsely. The receiving detector is adjusted frequently by the technical operator so as to obtain the best operation on incoming speech without false

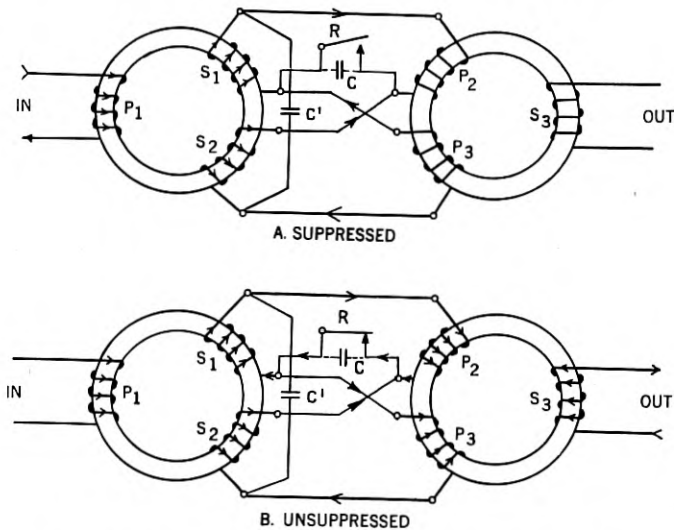

Fig. 3—Repeating coil arrangement for suppressing echoes.

operation from radio noise. When the incoming noise is low, relay 3 may be made very sensitive. Any incoming speech which does not operate relay 3 is thus weak, and the receiving volume may be kept high without danger of echoes operating the transmitting relays. When the noise is high, relay 3 is made insensitive, requiring more loss in the echo path and, consequently, lower volume to the listener.

The method of suppressing transmission by opening a single relay contact is illustrated in detail by Fig. 3. In A of this figure, the relay ( $R$  on the figure) is assumed to be operated so that transmission is suppressed. The voltages induced in windings  $S_1$  and  $S_2$  of the first coil are opposed to each other in a circuit including  $P_2$  and  $P_3$  of the second coil, the resulting flux in the core of this coil being very small. Losses

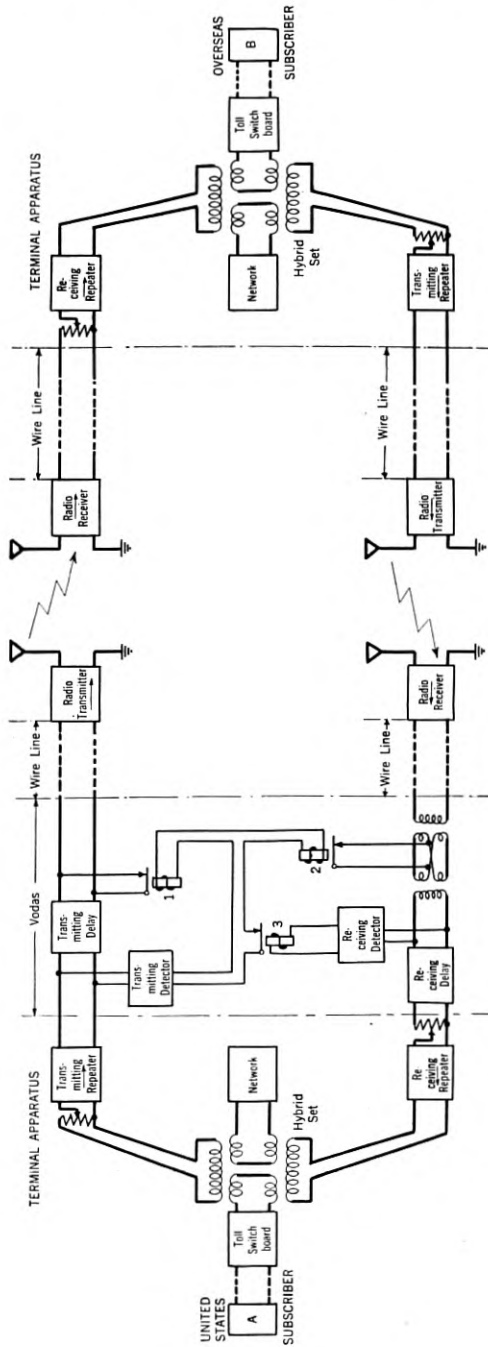

Fig. 4—Radio telephone circuit with vodas at one end only.

as high as 75 db are produced by this arrangement by proper design of coils and adding a small condenser ( $C'$ ) to balance the capacity ( $C$ ) of the leads to the relay contacts. In practice, a pair of wires is cut off to give the right capacity, and then laced into the cable form. In B of the figure, the circuit is shown in the normal condition. Transmission through the coils is affected only by their normal transition loss. While the windings  $S_1$  and  $S_2$  in A are effectively in series opposing, in B they are connected by separate circuits to the corresponding windings  $P_2$  and  $P_3$ , due to the extra path through the relay contact.

#### OPERATION OF A RADIO TELEPHONE CIRCUIT

Having in the vodas a means for suppressing echoes and singing under extreme conditions (with the additional advantages of suppressing intermediate "cross-transmission" paths), it is important to consider the broader application of such a device to radio telephone circuits. Three cases of operation with anti-singing devices are of interest:

1. Vodas at one end, plain hybrid set at the other.
2. Vodas at one end, echo suppressor (without anti-singing relay) at the other.
3. Vodases at both ends.

##### *1. Vodas at One End, Plain Hybrid Set at the Other*

This arrangement is shown in Fig. 4. In this and the next figures, the privacy switching circuit has been omitted for simplicity. The vodas prevents singing and echo effects from unbalances at the  $A$  end and also prevents the  $A$  subscriber from hearing echoes.

The disadvantages of these arrangements may be understood by considering the transmission received at the  $B$  end which has no voice-operated relays. Speech received over the circuit would be returned to the local radio transmitter as an echo or echoes. If a weak talker were connected at the  $B$  end, the volume control device would amplify these echoes to an appreciable extent. In addition to overloading the radio transmitter, such echo would permit both sides of the conversations to be broadcast from the same station, thus reducing privacy. Radio noise might also be received at  $B$  and transmitted as echoes to the  $A$  end of the circuit. In addition, line noise from a two-wire circuit at the  $B$  end would be freely transmitted to the  $A$  end, causing a limitation of the sensitivity of relay 3 and consequently a reduction of volume at the  $A$  end.

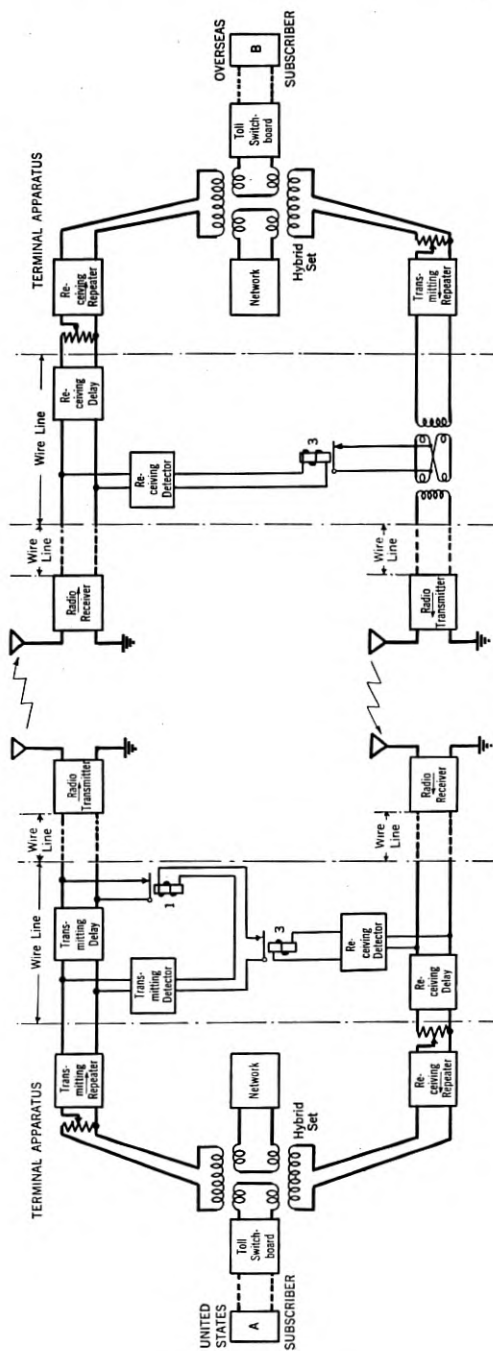

Fig. 5—Radio telephone circuit with vodas at one end and echo suppressor at opposite end.

### 2. *Vodas at One End, Echo Suppressor at the Other*

The above possibilities of transmitter overloading and speech reradiation due to echoes might be prevented by adding a voice-operated echo suppressor at the *B* end as shown in Fig. 5. This device would be operated by received speech so as to disable the transmitting branch of the circuit. Its sensitivity would be limited as would also the received volume at one or both ends. It should be noted that if no cross transmission paths existed, relay 2 of the vodas at the *A* end could be omitted when this device is used.

The echo suppressor would not suppress echoes of radio noise or direct transmission of line noise from the *B* end to the receiving relay 3 at the *A* end. Relay 3 would therefore need to have its sensitivity reduced so as not to be operated by these noises. This gives rise to an additional limitation of received volume at the *A* end. The amount of the penalty would, of course, depend on the noise conditions, the talker volume and the echoes in two-wire circuits at the *B* end. Under extreme conditions, the necessary reduction in receiving volume at the *A* end might be as much as 25 db. This is considered to be an important disadvantage inasmuch as conditions at the two ends are not independent and lack of an anti-singing device at one end penalizes the received volume at the other.

Another solution would be to limit the transmitting gain at the *B* end so that the noise transmitted past the echo suppressor would never limit the sensitivity of relay 3 at the *A* end. This would mean that the received signal-to-noise ratio at the *A* end would be reduced, particularly if the taker at the *B* end were weak.

### 3. *Vodases at Both Ends*

To summarize, it may be said that anything short of anti-singing devices at both ends does not make the two ends of the circuit independent and may penalize the transmission at the vodas end when there is radio noise or line noise at the end without an anti-singing device. The preferred arrangement is shown in Fig. 6.

## RESULTS OF VODAS OPERATION

In general, the results of operation with the vodas have been good and, when radio conditions are favorable, the circuits are not appreciably different from land circuits of comparable length.

Occasionally, the vodases introduce minor difficulties. False operation by noise and simultaneous talking by the two subscribers both tend to cause speech mutilation. The large transmission advantages

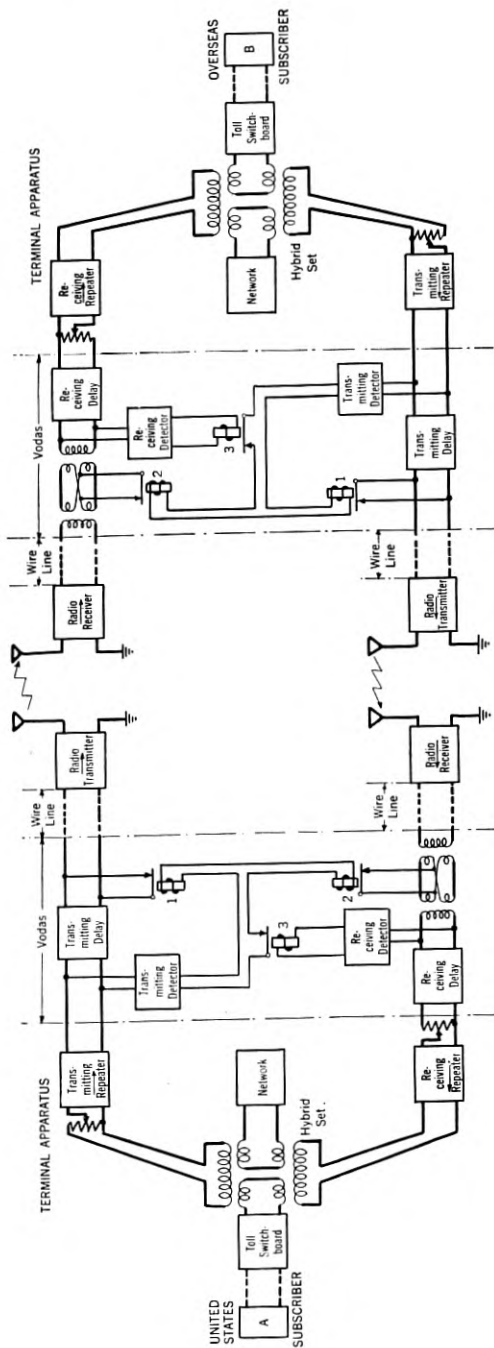

Fig. 6—Radio telephone circuit with vodases at both ends.

afforded by their use greatly outweigh any such troubles. These advantages may be summarized as follows:

1. Suppress echoes and singing which would otherwise be heard due to adjustments to reduce radio noise, instability and cross-transmission paths.
2. Prevent retransmission of echoes which would cause overloading and two-way broadcasting at the radio transmitters.
3. Save privacy apparatus.
4. Permit the telephone listeners to hear louder speech waves.
5. Afford independent technical operation of the two ends of the circuit.

# Magnet Steels and Permanent Magnets—Relationships Among Their Magnetic Properties\*

By K. L. SCOTT

## INTRODUCTION

A GENERAL study of the magnetic properties of magnet steels and permanent magnets embraces a number of related problems. Of chief interest to the designer of magnets is the problem of determining the relationship between the open-circuit remanence of a permanent magnet and the various factors which determine its value. These factors include the magnetic characteristics or properties of the steel, as displayed by its hysteresis loop, and the shape and dimensions of the magnet. Of interest to the manufacturer of magnet steel are the questions of how chemical composition, melting practise, and rolling practise affect the magnetic and mechanical properties of the steel. The manufacturer of magnets is interested in the effect of the necessary manufacturing operations, such as heating for hot forming and annealing to increase machinability, upon the flux obtainable in the finished magnet; on the tendency of the steel to warp and crack upon quenching; and on the proper hardening treatment to use.

These interests overlap, of course, and include many special subjects, among which may be listed the manner in which various influences may affect the state of magnetization of a magnet, the correlation of the microstructure and mechanical properties of a magnet steel with its magnetic properties, the determination of a suitable criterion of magnetic quality, the development of accurate and convenient testing equipment, and various other matters of greater or less importance.

It is the purpose of this paper to present data relating to some of the above topics, which have been collected by the writer during the course of several years connection with the manufacture of permanent magnets, both in the laboratory and in the shop.

## SYMBOLS AND NOTATIONS

The following symbols and notations will be used. See Fig. 1. All values of  $B$  are intrinsic or ferric induction.

$B_{max}$  = The value of magnetic induction corresponding to the tip of a given hysteresis loop, in gauss.

\* Presented before A. I. E. E. in New York City, Jan. 26, 1932. Published in abridged form in *Elec. Engg.*, May, 1932.



- $H_{max}$  = The value of  $H$  corresponding to  $B_{max}$ , in oersteds.  
 $B_s$  = The saturation value of flux density corresponding to an infinite magnetizing force.  
 $B_r$  = Residual induction, the magnetic induction in a ring or infinitely long straight bar after the value of  $H$  has been reduced from  $H_{max}$  to  $O$ . The value of  $B$  at the intersection of the hysteresis loop with the  $B$  axis, in gauss.  
 $H_c$  = Coercive force, the value of  $H$  required to reduce  $B$  from  $B_r$  to  $O$  in a ring or infinitely long bar. The value of  $H$  at the intersection of the hysteresis loop with the  $H$  axis, in oersteds.  
 $B_{rem}$  = Remanence, the magnetic induction at the magnetic equator of a permanent magnet with no external magnetizing or demagnetizing force. Values of  $B_{rem}$  given in this paper are without pole pieces on the magnets, in gauss.  
 $L$  = The actual developed length of a magnet.  
 $A$  = The area of cross section of a magnet.  
 $D$  = The equivalent diameter of a magnet  
 $= 2\sqrt{A}/\sqrt{\pi}$   
 $L/D$  = The dimension ratio of a permanent magnet.  
 $(BH)_{max}$  = The maximum value of the product of the coordinates of the demagnetization curve for a given steel. The demagnetization curve is the portion of the hysteresis loop between  $B_r$  and  $H_c$ .  
 $T$  = Hardening temperature, absolute scale.  
 $T_0$  = Optimum hardening temperature, absolute scale.

#### FACTORS THAT DETERMINE THE REMANENCE OF A PERMANENT MAGNET

Of the subjects enumerated in the introduction, the first is the one that has been of greatest technical interest to the writer. During the course of several laboratory investigations connected with shop problems, advantage was taken of the opportunity to secure data which might be used for the purpose of making generalizations regarding relations among magnetic properties of magnet steels and permanent magnets.

The specific problem was to find out exactly the way in which the remanence of a magnet is related to its shape and dimensions as well as to the magnetic properties of the material of which it is made. Although it requires the complete family of hysteresis loops for a given piece of magnet steel to portray all of its various magnetic characteristics, it was felt that possibly the combined influence upon the reman-

ence of a magnet of the sum of these characteristics could be expressed in terms of the values of  $B_r$  and  $H_c$  for the material. Such an assumption, if valid, would simplify the problem considerably.

It is true that in the literature on the subject there are several papers<sup>1, 5, 6</sup> describing more or less accurate methods by means of which a designer may predict the flux of a given magnet provided the demagnetization curve for the steel is known. But these methods are laborious, and unless a complete redesign is worked out for each case,

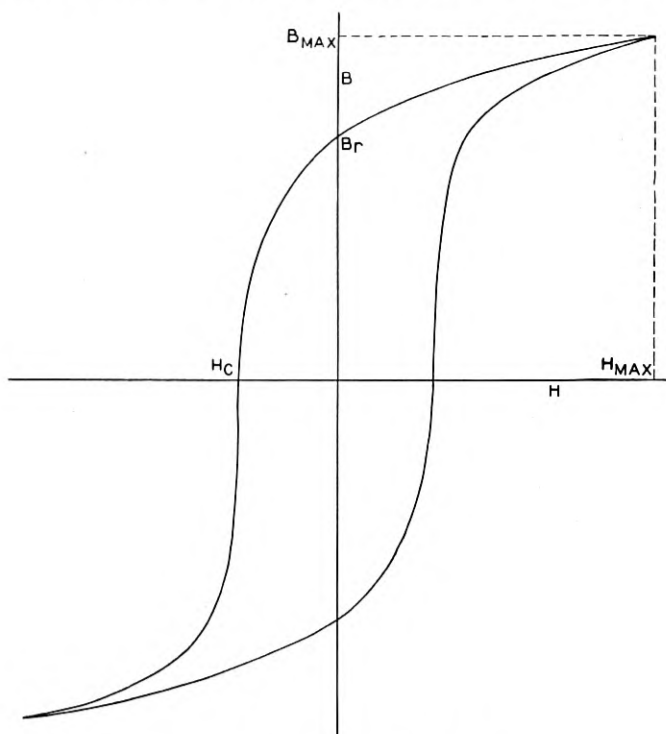

Fig. 1—Hysteresis loop of magnet steel.

they do not answer such questions, for example, as how much a certain change in  $B_r$  or  $H_c$  will affect the remanence of a given magnet, other factors remaining constant.

Because the flux value of a magnet is affected by shape as well as other factors, and because magnets are made in a bewildering variety of shapes, it was decided to confine the investigations to straight bar magnets and leave the matter of the effect of shape on flux for a later study.

<sup>1</sup>For references see end of paper.

*Test Specimens.* Accordingly, a large number of straight bars of magnet steel were used for test specimens. Each of the bars was 12 inches in length. In the lot were bars of  $\frac{1}{8}$  by  $1\frac{1}{2}$  in.,  $\frac{1}{4}$  by  $\frac{1}{4}$  in.,  $\frac{3}{16}$  by  $\frac{3}{4}$  in.,  $\frac{1}{4}$  by  $1\frac{1}{4}$  in.,  $\frac{3}{4}$  by  $\frac{5}{8}$  in., and  $\frac{3}{8}$  by  $\frac{1}{2}$  in. cross sections. All of the types of steel available were used, including 0.9 to 3.5 per cent chromium steel, 0.85 per cent manganese steel, 5 per cent tungsten steel, and 20, 25 and 36 per cent cobalt steels. Along with this range in composition a range in coercive force of from 40 oersteds to 260 oersteds was available, accompanied by a variation in residual induction of from 6,000 gauss to 11,000 gauss.

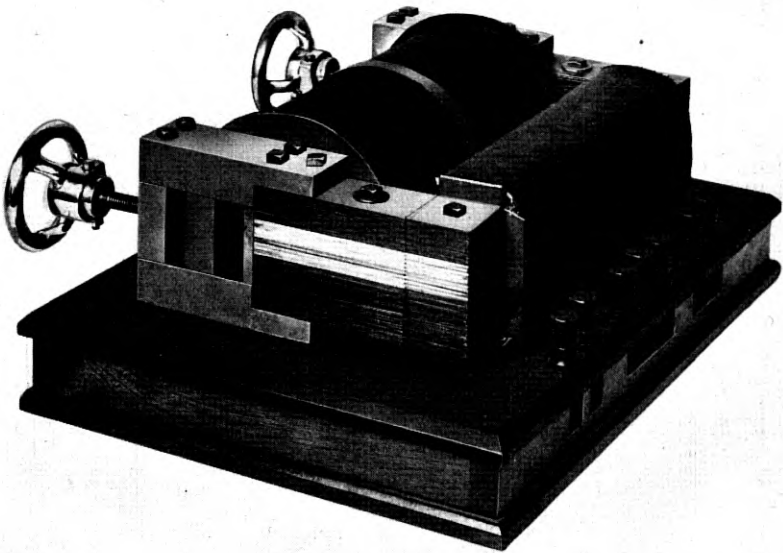

Fig. 2—The Babbitt permeameter. Used for making magnetic measurements on any kind of magnet steel.

*Experimental Procedure.* The test bars were hardened in the manner appropriate to each type of steel, except that some bars were purposely quenched from a high temperature in order to secure low values of  $B_r$ . After hardening, the demagnetization curve for each bar was determined by means of permeameter measurements, using the Babbitt<sup>7</sup> permeameter and a Grassot fluxmeter with lamp and scale. The control circuit of this permeameter is the conventional circuit for a ring test, as shown in Fig. 3. The magnetic data are all comparable since accurate measurements may be made with this permeameter on all of the above mentioned types of magnet steel.

Following the permeameter measurements, each bar was magnetized as a straight bar magnet in an air core solenoid. Field strengths of over 1,000 oersteds were applied to each bar. Upon removal from the solenoid the flux density at the middle of the bar was measured by means of a search coil and the Grassot fluxmeter with lamp and scale. It is the flux density measured in this way that is referred to in this discussion as the remanence of a magnet, or  $B_{rem}$ .

After the measurements at 12-in. lengths were completed, each bar was cut in succession to 10, 8, 6, 4, and 2-in. lengths by removing 1 inch of material from each end except that in the case of some of the bars of larger cross-section the lengths of 10, 6, and 2 inches were omitted.

Remanence measurements were made at each of the above lengths.

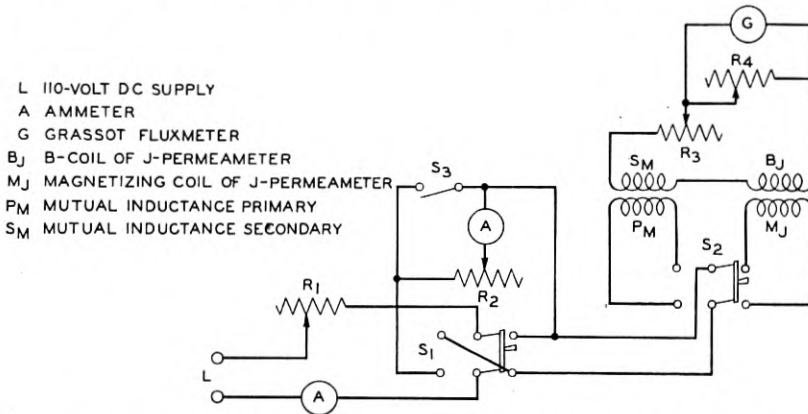

Fig. 3—Control circuit of the Babbitt permeameter. Note that the connections are those of a simple ring test.

The bars were remagnetized for each new measurement of  $B_{rem}$ .

The foregoing experiments made available for analysis a wide range of values of the associated variables  $B_{rem}$ ,  $B_r$ ,  $H_c$ , length  $L$ , and cross-sectional area  $A$ .

*Analysis of Data.* The values of remanence *versus* length for a number of the straight bar magnets are plotted in Fig. 4 to show the range of values existing in different bar magnets of the same length, when fully magnetized. The differences in  $B_{rem}$  for a particular length of bar are due to the differences in  $B_r$ ,  $H_c$ , and cross-section of the various samples.

The chief characteristic that the curves of Fig. 4 have in common is a resemblance in shape to a normal induction curve and an asymptotic approach to limiting values of  $B_{rem}$  as the lengths increase.

In Fig. 5 is shown the result of plotting  $B_{rem}/B_r$  vs.  $(L/D)\sqrt{H_c}(T/T_0)^2$  for the same set of bars. This combination of variables was arrived at purely by a cut and try method, but as shown, a surprisingly good correlation is obtained.

It should be mentioned in connection with Fig. 4 that it was found that the data relating to some of the bars did not fit the curve satisfactorily if  $B_{rem}/B_r$  was plotted against  $L\sqrt{H_c}/D$ , but in each case

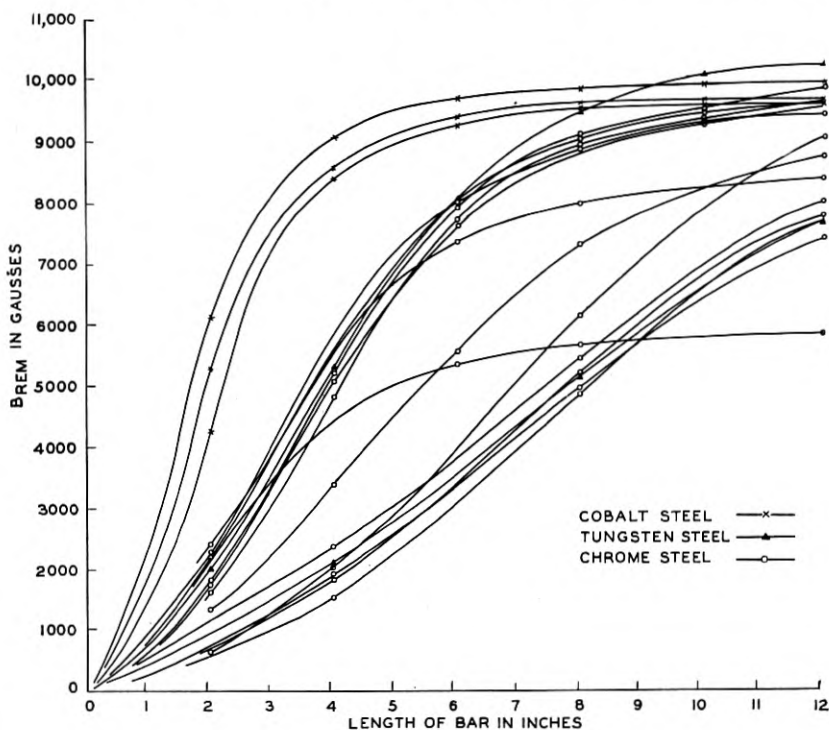

Fig. 4—Curves of remanence vs. length for straight bar magnets of different cross-sections and materials.

where this was so the bar had been quenched from above or below the optimum hardening temperature. It was found, however, that the data from these bars could be correlated with those from the properly hardened bars if  $B_{rem}/B_r$  were plotted against  $(L/D)\sqrt{H_c}(T/T_0)^2$  in which  $T$  is the actual, and  $T_0$  is the optimum hardening temperature on the absolute scale. The ratio  $T/T_0$  is, of course, equal to unity for bars properly hardened. The definition of the optimum hardening temperature will be given later.

After this empirical correlation was obtained, it was suggested that  $B_{rem}/B_r$  vs.  $L\sqrt{H_c}/D\sqrt{B_r}$  would be preferable as a choice of variables, from theoretical considerations based upon the assumption of uniform magnetization in the magnets. Although it can be shown that this assumption is not fulfilled in the actual case of straight bar magnets, this method of plotting gives as good a correlation as is shown in Fig. 5. Such a result might be expected, since the values of  $B_r$  commonly

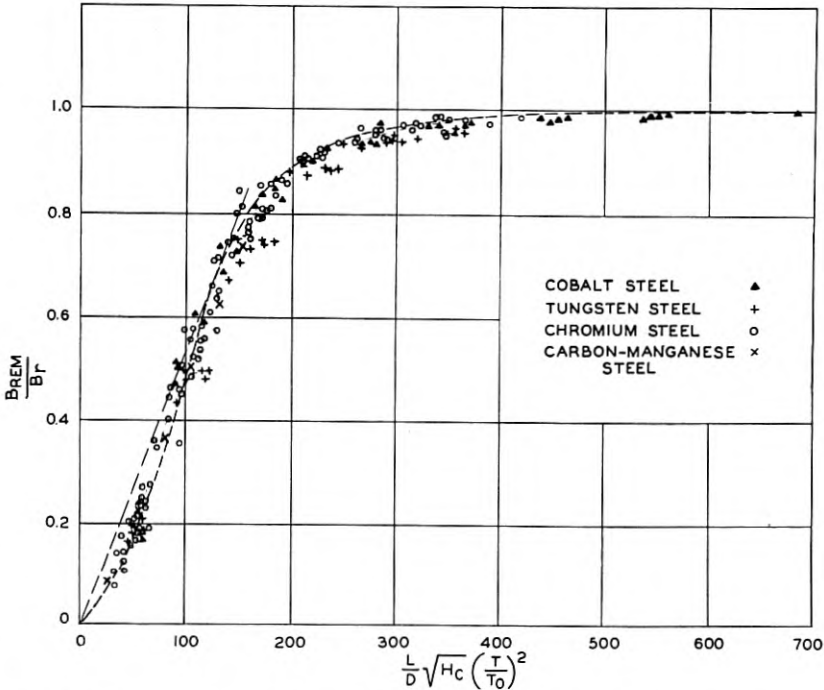

Fig. 5—The same data as in Fig. 4. Showing the correlation between  $B_{rem}/B_r$  and  $(L/D)\sqrt{H_c}$  for bars of any kind of material, magnetic properties, length or cross-section.

encountered range from 9,000 gauss to 11,000 gauss, thus differing from 10,000 gauss by 10 per cent at most. The square root of  $B_r$ , therefore, differs from 100 by not more than 5 per cent in most cases, whence it follows that dividing  $L\sqrt{H_c}/D$  by  $\sqrt{B_r}$  shifts the relative position of the abscissas of the points in Fig. 5 by not more than 5 per cent in most cases. Fig. 6 illustrates the results obtained by the second method of plotting.

Dimensional considerations favor the use of the quantity  $L\sqrt{H_c}/$

$D\sqrt{B_r}$ , however, since this quantity, like  $B_{rem}/B_r$ , is dimensionless, whereas  $L\sqrt{H_c}/D$  is not. For this reason it is felt that the method of plotting shown in Fig. 6 is to be preferred to that of Fig. 5 although the correlation obtained in Fig. 5 appears to be as good as that shown in Fig. 6. Further, the necessity for injecting the variable of temperature into the picture is done away with.

Inasmuch as the data from a large number of bars of widely different compositions, magnetic properties, dimensions and heat treatment are

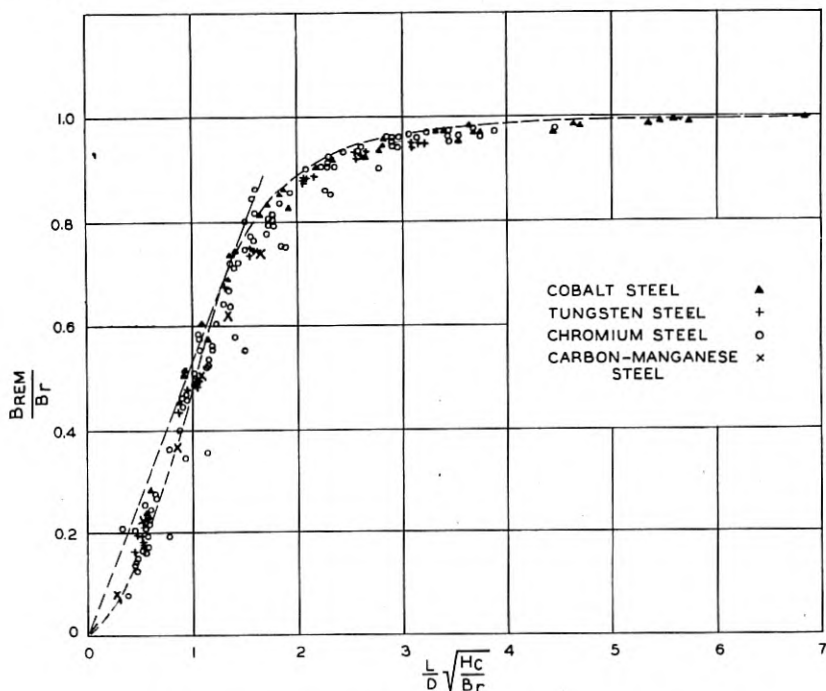

Fig 6.—The data of Fig. 4 with  $B_{rem}/B_r$  plotted against  $L\sqrt{H_c}/D\sqrt{B_r}$ .

all found to cluster quite closely along a single curve, it is felt that it is legitimate to use the curve as a basis for some generalizations, even though the curve was arrived at largely by empirical processes.

The type of curve that is obtained when  $B_{rem}/B_r$  is plotted against  $L\sqrt{H_c}/D\sqrt{B_r}$ , indicates that other factors being constant, the remanence of a magnet is roughly proportional to  $\sqrt{B_r}$  and, for large values of  $L\sqrt{H_c}/D\sqrt{B_r}$ , in other words, for large values of dimension ratio or coercive force, the remanence is practically equal to  $B_r$ . This fact is of interest from a design standpoint.

It was to be expected, of course, that the values of  $B_{rem}$  would approach  $B_r$  as a limit for high values of length of bar, since the end effect diminishes as the length increases and the condition of an infinitely long bar or a closed ring is simulated. The functional relationship which the quantity  $L\sqrt{H_c}/D\sqrt{B_r}$  bears to the ratio  $B_{rem}/B_r$  is not known. A fairly good fit of the observed data is given by the expressions:

$$r = \frac{q^{1.5}}{2.15} \quad q = 0 \text{ to } q = 1.25 \text{ and}$$

$$r = e^{-\frac{0.8}{q^{2.75}}} \quad q = 1.25 \text{ to } q = \infty$$

in which  $r = B_{rem}/B_r$  and  $q = L\sqrt{H_c}/D\sqrt{B_r}$ , but aside from the direct proportionality of  $B_{rem}$  and  $B_r$ , the equations appear to have little meaning. However, they do indicate that for a given dimension ratio, there is a practical upper limit to  $H_c$ , beyond which very large increases in  $H_c$  are necessary to produce small increases in the ratio of  $B_{rem}$  to  $B_r$ . Considerable interest attaches to the fact that the dimension ratio  $L/D$  and  $\sqrt{H_c}/\sqrt{B_r}$  are of equal weight in affecting the remanence of a magnet. It is also worth noting that the value of  $B_{rem}$  is independent of the contour of the cross-sectional area. It is possible that this would not hold for dimension ratios less than one, but it does appear to hold for dimension ratios of practical importance. As shown in Fig. 5, a line drawn through the origin and tangent to the dotted curve of that figure has its point of tangency at values of  $B_{rem}/B_r$  and  $L\sqrt{H_c}/D\sqrt{B_r}$  of approximately 0.65 and 1.25 respectively. It will be shown later that this is the point of maximum efficiency, *i.e.*, the point at which are obtained the highest values of  $B_{rem}$  or external magnetic energy per unit volume of steel.

It follows, if this is true, that magnets should be designed so that  $L\sqrt{H_c}/D\sqrt{B_r} = 1.25$ , and with this as a basis, the nomogram of Fig. 7 was laid out. The use of this chart to design a magnet for maximum efficiency, is illustrated by the dotted lines of the figure. In the case shown a total flux in the magnet of 3,000 maxwells is desired, and a steel with a  $B_r$  of 10,000 gauss and a coercive force of 54 oersteds is assumed. The correct values of  $A$  and  $L$  are found to be 0.461 cm.<sup>2</sup> and 13 cm., respectively, and the dimension ratio is 17.

It should be borne in mind throughout this discussion that Figs. 4, 5, 6 and 7 apply directly only to straight bar magnets. Formed magnets with short air-gaps with or without pole pieces, will have higher remanence values than are shown by the curve of Fig. 6. This



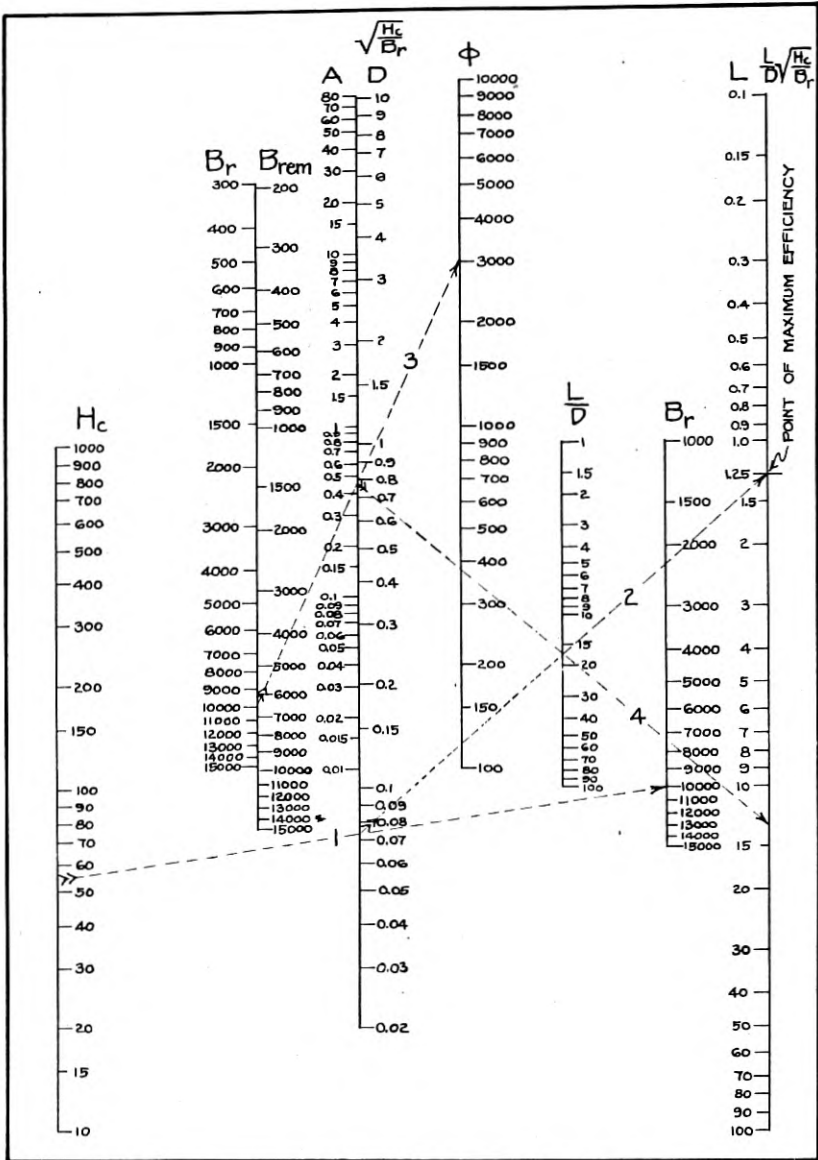

Fig. 7—Nomogram chart for permanent magnet design for maximum efficiency. Based on the curves of Figs. 6 and 10.

is because, compared with straight magnets, their effective lengths are greater than their actual lengths. The difference between effective and actual lengths is negligible, however, except for magnets whose poles are brought quite close together, either actually or by means of pole pieces of soft iron. Watt-hour meter damping magnets are good examples of magnets whose poles are brought thus closely together without the aid of pole pieces.

On the other hand, the general conclusions drawn from the curve of Fig. 6 are applicable to magnets of any shape if  $L$  is assumed to stand for the effective length of the magnet. Fig. 7 also is perfectly general on the same basis. By effective length is meant the length of a straight bar magnet of equal cross-section and magnetic properties, having the same remanance as the given magnet.

#### CORRELATION BETWEEN STRAIGHT AND BENT MAGNETS

Subsequent to the establishment of the relationships shown in Fig. 6, a limited amount of data were secured which have a bearing upon the effect on  $B_{rem}$  of departure from the form of a straight bar magnet.

To get these data, one  $\frac{1}{4}$  by  $\frac{1}{4}$  in. rod each of cobalt steel and tungsten steel were formed into rings of 2-in. inside diameter, with the ends touching. Companion test bars were cut adjacent to each end of the rods used in forming the rings. All three pieces of each kind of steel received as nearly identical heat treatments as possible, even to heating and cooling the straight test bars at the time of forming the rings. After hardening, demagnetization curves were obtained on each of the two test bars of tungsten steel and of cobalt steel. Then data for  $B_{rem}$  vs. length curves were obtained from both the test bars and rings by the process of cutting off the ends and remeasuring  $B_{rem}$  already described.

The demagnetization curves and the  $B_{rem}$  vs. length curves, for the two straight cobalt steel bars are practically identical. Inasmuch as these bars were cut adjacent to the ends of the bar from which the ring was formed, and heat treated with it, it is safe to assume that the material in all three samples is alike magnetically, and that the demagnetization curve for the ring is the same as for the straight bars. The same conclusions hold for the tungsten steel, as shown in Fig. 9.

It follows then that it is valid to compare the  $B_{rem}$  vs. length curves for the straight bars with those for the rings, and conclude that all differences in the curves are due to differences in shape. It is interesting to note that the ring for cobalt steel yields the same curve for  $B_{rem}$  vs. length as the straight bar, but that, in the case of the tungsten steel, the proximity of the ends of the ring has an appreciable

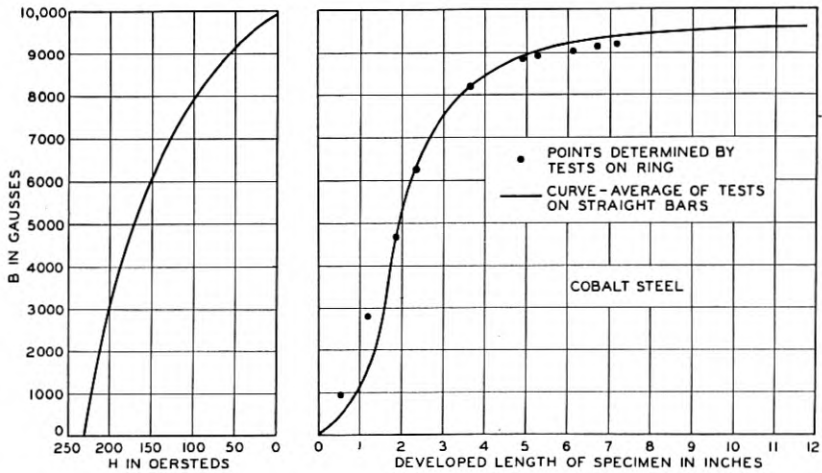

Fig. 8—Comparison of  $B_{rem}$  vs. length curves for straight bar and 2-in. I.D. ring of  $\frac{1}{4}$ -in. x  $\frac{1}{4}$ -in. cobalt steel in which  $B_r = 9,980$  gauss and  $H_c = 230$  oersteds.

effect on the value of  $B_{rem}$ , causing the curve for  $B_{rem}$  vs. length to turn upwards for those lengths corresponding to short air gaps.

Additional data along these lines would be very useful, and should include measurements on magnets with pole structures having well defined air gaps.

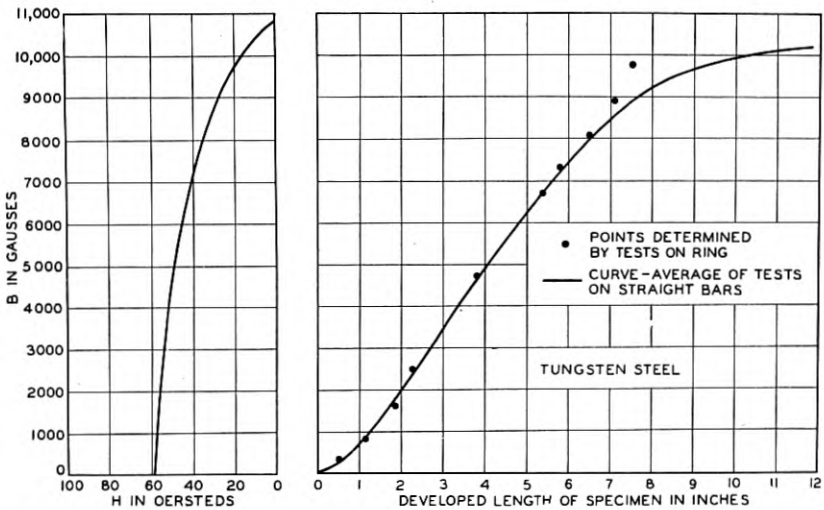

Fig. 9—Comparison of  $B_{rem}$  vs. length curves for straight bar and 2-in. I.D. ring of  $\frac{1}{4}$ -in. x  $\frac{1}{4}$ -in. tungsten steel in which  $B_r = 10,830$  gauss and  $H_c = 59$  oersteds.

## CRITERIA OF MAGNETIC QUALITY OF PERMANENT MAGNET STEELS

A number of quantities determinable by magnetic measurement have been proposed at various times by different investigators for use as criteria of magnetic quality of magnet steels. Among these quantities may be listed  $(BH)_{max}^{(1)}$ , the maximum product of the coordinates of the demagnetization curve; and the quantities  $B_r H_c^{(2)}$ ,  $B_r/B_{max}$ ,  $B_r H_c/B_{max}$  and  $B_r/H_c^{(3)}$ . High values of all of the proposed criteria except the last were considered desirable.

The form  $B_r/H_c$  has decided disadvantages, since a low value of the criterion is obtained when  $B_r$  is small as well as when  $H_c$  is large, and low values of  $B_r$  are distinctly undesirable in view of the fact that  $B_{rem}$  is directly proportional to  $B_r$ . The ratio  $B_r/B_{max}$  was found to be practically constant for some types of steel, regardless of the value of  $H_c$ , and thus was of no value as a criterion. The quantity  $B_r H_c/B_{max}$  would accordingly amount to a constant times  $H_c$  and would give no actual weight to the value of  $B_r$ . These three criteria would therefore fail either to indicate a choice between different types of magnet steel or to aid in the selection of an optimum heat treatment for a given kind of steel.

This leaves the quantities  $(BH)_{max}$  and  $B_r H_c$  as the only ones not obviously faulty. The first was proposed by S. Evershed in a noteworthy paper in the *Journal* of the Institution of Electrical Engineers for September 1920, in which he showed that the quantity  $(BH)_{max}$  is a measure of the maximum amount of external magnetic energy which can be supported per unit volume of a given magnet steel, and that this in turn defines the term "magnetic quality" as applied to magnet steel.

Evershed's derivation of his criterion of magnetic quality, given in the article noted above, is complete and convincing, but it was thought desirable to obtain experimental verification. The data from the bars of Fig. 4 were used to this end. In Fig. 10 are shown a number of curves each corresponding to a different type of magnet steel. The demagnetization curves for the bars are shown plotted in the usual way, and to the right of these are plotted the curves of  $(BH)$  vs.  $B$ . To the right of these are plotted further the experimentally determined curves of  $B_{rem}$  vs. length for the bars in question.

Fig. 10 shows that if tangents to the curves of  $B_{rem}$  vs. length are drawn through the origin the point of tangency in each case indicates the value of  $B_{rem}$  and length at which the ratio of  $B_{rem}$  per unit length or volume of steel is a maximum, and it is clearly demonstrated that in each case these values of  $B_{rem}$  coincide closely with the values of  $B$  for which the product  $(BH)$  is a maximum. The writer feels that this

constitutes a sufficiently convincing verification of the correctness of Evershed's criterion.

The chief objection to the use of Evershed's criterion is that a number of points on the demagnetization curve for a piece of magnet steel must be known before the numerical value of the product  $(BH)_{max}$  can be determined. The quantity  $B_r H_c$  is more easily obtained than

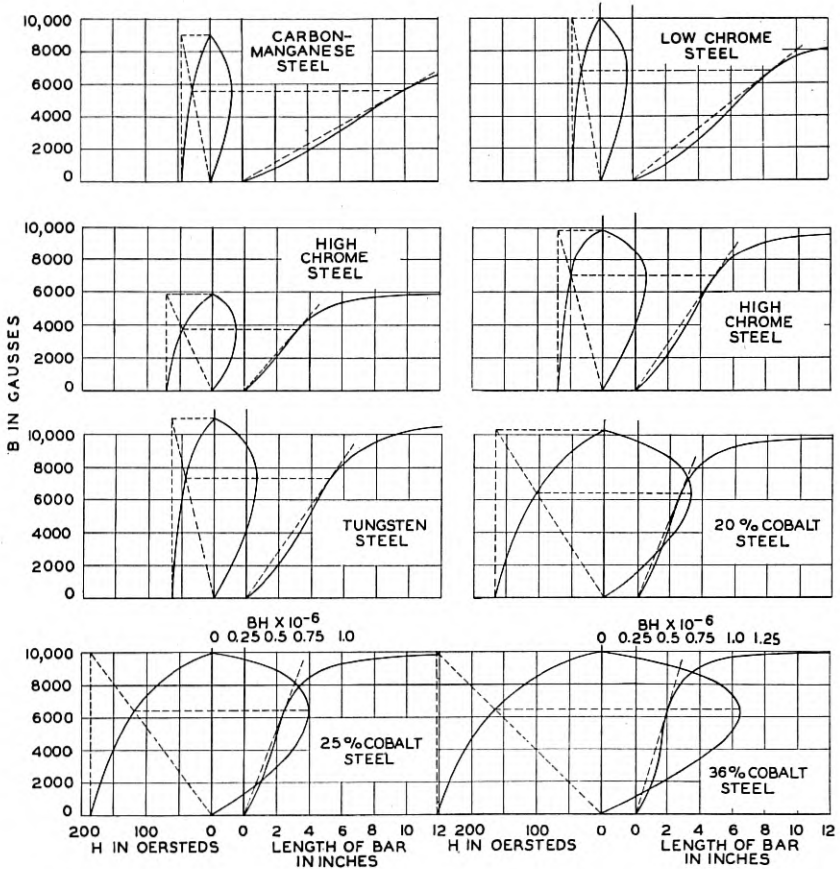

Fig. 10—Curves showing experimental verification of validity of Evershed's criterion for magnetic quality of permanent magnet steels.

$(BH)_{max}$  but its validity as a criterion cannot be established from theoretical considerations. Accordingly, the values of  $(BH)_{max}$  and  $B_r H_c$  were determined by actual measurement for a large number of bars of different kinds of magnet steel. In Fig. 11 are shown the values of  $B_r H_c$  plotted against the corresponding values of  $(BH)_{max}$ .

It is felt that these points lie closely enough along the straight line in that figure to warrant the use of  $B_r H_c$  as a criterion of magnetic quality of magnet steel for all practical purposes. In cases where very accurate comparisons are required, it may be necessary to go to the greater trouble of determining  $(BH)_{max}$ .

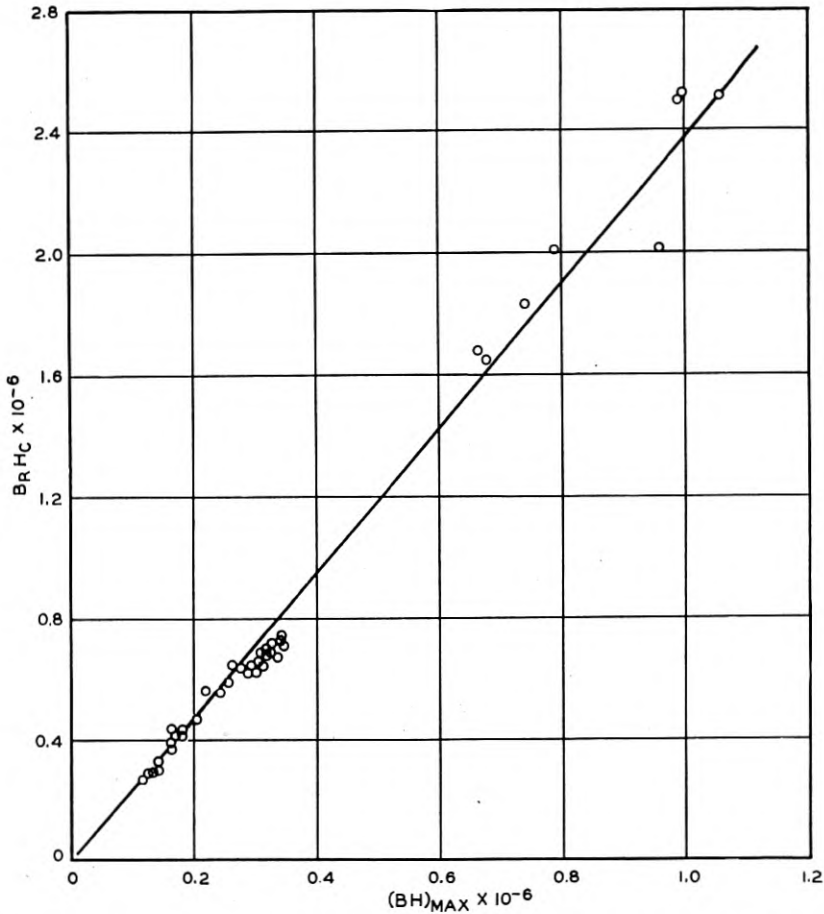

Fig. 11—Relation between the quantity  $B_r \times H_c$  and Evershed's criterion,  $(BH)_{max}$ .

Referring to a previous mention of optimum hardening temperatures, it will be understandable now to state that the optimum hardening temperature for a given type of steel is that temperature at which a maximum value of  $(BH)_{max}$  is obtained, or practically speaking, a maximum value of  $B_r H_c$ .

## FIT OF DEMAGNETIZATION CURVE BY HYPERBOLA

It will be noted that the points on the demagnetization curves for which the product ( $BH$ ) is a maximum are given quite accurately in each case by the intersection of the demagnetization curve with a line through the origin having the slope  $B_r/H_c$ . That this should be so follows from the fact that any demagnetization curve for magnet steel may be closely approximated by a rectangular hyperbola whose equation is  $B = a - k/(H + b)$  in which  $a$ ,  $b$ , and  $k$  are parameters of each particular curve. It is a mathematical property of the foregoing rectangular hyperbola that the coordinates whose product is a maximum are located by a line through the origin having a slope equal to the ratio of the intercepts of the hyperbola. This property of the

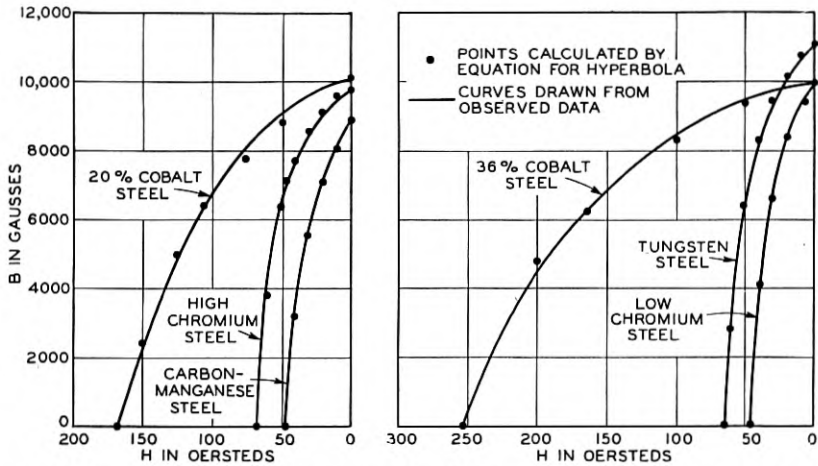

Fig. 12—Curves showing approximation of actual demagnetization curves by points on the general hyperbola,  $B = a - k/(H + b)$ .

hyperbola is a property of the demagnetization curves for magnet steel in so far as these curves can be closely fitted by appropriate hyperbolas. That the fit is quite good in all cases is shown by Fig. 12 in which hyperbolas calculated for each demagnetization curve are shown by dots and the observed points by a full line. The graphical method of Fig. 10 for determining the point on each demagnetization curve the product of whose coordinates is a maximum is more accurate than the method of plotting the curve of  $(BH)$  vs.  $B$ , because the latter curve is usually quite flat-topped and its maximum is hard to locate exactly. The fact that the curve is flat-topped explains why many methods of magnet design give good results. It is because about equal efficiencies are obtained in any case over a fairly wide range of values of  $B_{rem}$ .

A further application of the idea that the demagnetization curve can be represented by a hyperbola is made by Mr. E. A. Watson.<sup>4</sup> Watson applies a graphical construction for a hyperbola to the demagnetization curve and extends the construction into the region of positive values of  $H$ , thus providing a means of extrapolating the hysteresis loop to the saturation value of  $B$ . It has been the writer's experience that Watson's graphical construction cannot be legitimately extended into the first quadrant because the curve thus predetermined almost always lies considerably under the true curve, and yields too low a value for the saturation flux density. Fig. 13 illustrates the case in point.

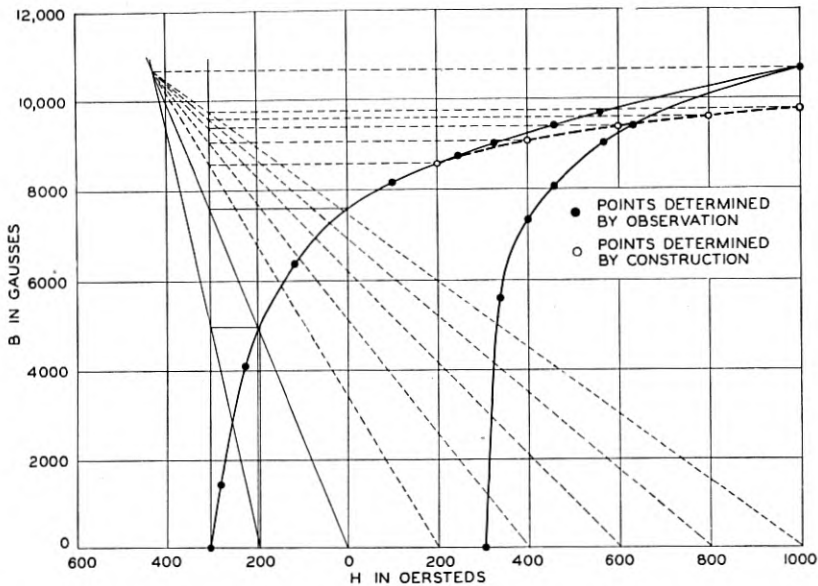

Fig. 13—Comparison of graphical construction of the descending portion of the hysteresis loop with actual measured data. Note the lack of agreement for positive values of  $H$ .

If, instead of plotting  $B$  vs.  $H$  for the points of the demagnetization curve, we plot  $B/B_r$  vs.  $H/H_c$ , it is found that all test specimens yield points fitting fairly well the single curve represented by the equation  $y = A(x + 1)/(x + A)$ , in which  $y = B/B_r$ ,  $x = H/H_c$  and  $A = \sqrt{2}$  approximately. It is possible to derive from this equation the relationship that  $(BH)_{max} = 0.423 B_r H_c$  which checks very well with the line drawn in Fig. 11. It can also be seen from the equation  $y = A(x + 1)/(x + A)$  that the representation of the demagnetization curve by a hyperbola cannot be extrapolated to give the correct



value for  $B_s$  since for values of  $H$  approaching infinity, the equation yields the result that  $y = B_s/B_r = A = \sqrt{2}$  whence  $B_s = \sqrt{2} B_r$ , while values of  $B$  in excess of  $\sqrt{2} B_r$  are commonly encountered at ordinary values of  $H$ .

#### CHARACTERISTIC CURVES FOR MAGNET STEEL

In Fig. 14 are shown demagnetization curves and  $(BH)$  curves for the various types of magnet steel with which the writer has had experience. It should be remembered that while these curves are more

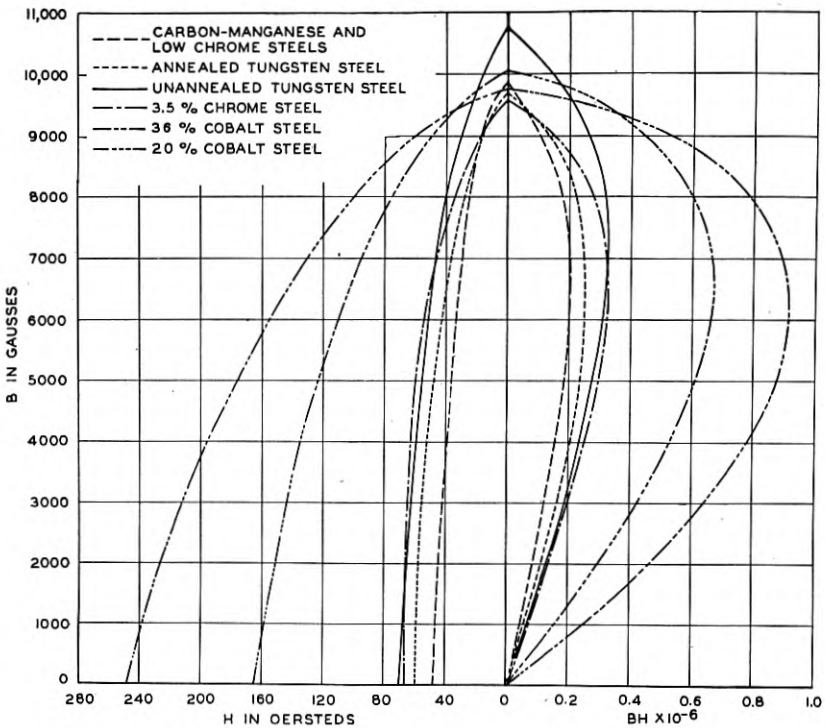

Fig. 14—Typical demagnetization curves and curves of  $BH$  vs.  $B$  for various kinds of magnet steel.

or less typical of the steels in question, there is no one curve which can be given as the curve for the material. There will be as many curves as there are samples tested, because magnetic characteristics of a piece of magnet steel, or any other magnetic material depend upon the whole previous thermal history of the sample from the time of melting to the time of testing, the amount of hot and cold working the sample has received, and the conditions of stress in the material

at the time of testing. The relation of all of these variables to the remanence of a permanent magnet, fortunately, is focussed, as it were, in the values of  $B_r$  and  $H_c$  for the material, and the relation of these variables to  $B_{rem}$  is as shown by Fig. 6.

## REFERENCES

1. "Permanent Magnets in Theory and Practise," Evershed, S., *Journ. Inst. Elect. Eng.* **58**, 780 (1920); **63**, 725 (1925).
2. "Ein neues Material für permanente Magnete," Gumlich, E., *Elektrot. Zeits.* **44**, 147 (1923).
3. "Magnetic Habits of Alloy Steels," Mathews, J. A., *Proc. Amer. Soc. Testing Mat.* **14**, 50 (1914).
4. In discussion, *loc. cit.*<sup>(1)</sup>, *Journ. Inst. Elect. Eng.* **58**, 829 (1920), also *ibid.* **61**, 641 (1923).
5. "Calcul des appareils magnétiques, Diagramme généralé," Picou, R. V., *Rev. gén. de l'élect.*, **22**, 259 (1928).
6. "Une solution sans fiction du problème de l'attraction magnétique," Lehmann, T., *Rev. gén. de l'élect.* **20**, 433 (1926).
7. "An Improved Permeameter for Testing Magnet Steel," Babbitt, B. J., *Jour. Opt. Soc. Amer.* **17**, 47 (1928).

## A Method of Measuring Acoustic Impedance \*

By P. B. FLANDERS

An apparatus is described whereby acoustic impedances may be measured in terms of a known acoustic impedance and the complex ratios of two electrical potentiometer readings to a third. As a known impedance, there is chosen the reactance of a closed tube of uniform bore which is an eighth wave-length long. The electrical readings are obtained by balancing the amplified output of a condenser transmitter against the electrical input of the source of sound. The condenser transmitter picks up the acoustic pressure at the junction of the sound-source and the attached impedance. A balance is made for each of three successively attached impedances: (1) a closed tube an eighth wave-length long, (2) a rigid closure of the sound-source, and (3) the impedance to be measured. The unknown acoustic impedance  $Z$  is then calculated in terms of the known acoustic impedance  $Z_0$  by means of the equation  $Z = Z_0 \frac{z_1 - z_2}{z_3 - z_2}$ , where  $z_1$ ,  $z_2$  and  $z_3$  are, respectively, the three electrical impedance settings of the potentiometer. As indicated by this equation, the constants of the electrical circuit are involved only as ratios, so that the response characteristics of the source of the sound, condenser transmitter and amplifiers (provided they are invariable) do not affect the measurement.

Illustrations are given of impedance measurements on a closed tube of uniform bore, a conical horn, an exponential horn, an "infinite" tube, and a hole in an "infinite" wall.

THE progress in acoustics during the past few years has caused acoustic impedance measurement to have the same relative importance that impedance measurement in electrical work has had for many years. The concept of acoustic impedance is derived from the analogy<sup>1</sup> that exists between electrical and acoustic devices, as shown by the analogous differential equations describing their action. Acoustic impedance is usually defined as the complex ratio of pressure to volume velocity (or flux) but it is sometimes more convenient to deal with ratios of pressure to linear velocity or force to linear velocity. The magnitudes of these are interrelated, of course, by powers of the area involved.

The earliest efforts to measure acoustic impedance seem to have been made by Kennelly and Kurokawa.<sup>2</sup> In their method, electrical measurements were made of the motional impedance of a telephone receiver, with and without an attached acoustic impedance. Except for frequencies near resonance, the method was inaccurate because the acoustic impedance was associated with a relatively large mechanical impedance.

\* Presented before Acous. Soc. Amer., New York City, May 3, 1932.

<sup>1</sup> This analogy was first pointed out by A. G. Webster in *Nat. Acad. of Science*, 5, 275 (1919).

<sup>2</sup> *Proc. Am. Ac. Arts and Sc.*, 56, 1 (1921).

Later, a direct method was described by Stewart<sup>3</sup> who measured the change in acoustic transmission through a long uniform tube when the unknown impedance was inserted as a branch.

The apparatus to be described in this paper measures acoustic impedance directly in terms of a known acoustic impedance and three balance readings of an electrical potentiometer. The only assumptions involved in the method are that the elements of the apparatus be invariable during a measurement, and that the value of the comparison acoustic impedance be known accurately.

APPARATUS

Fig. 1 shows the general arrangement of the apparatus. An oscillator feeds electrical energy into a loud speaker where a portion is converted into acoustic energy which travels along the tube and into an

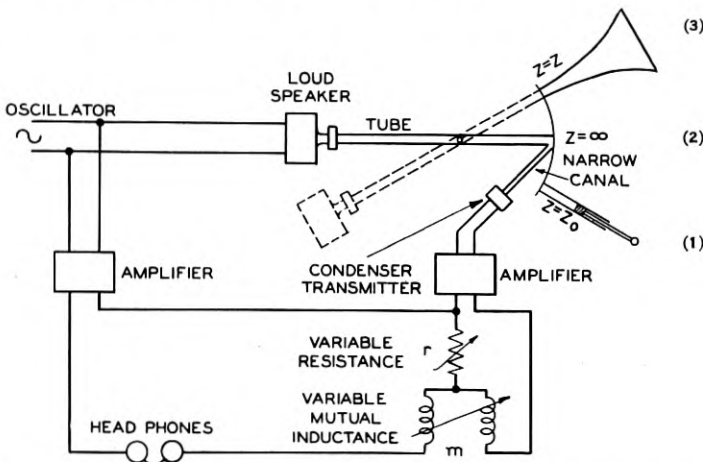

Fig. 1—Schematic circuit of acoustic impedance measuring apparatus.

attached impedance. A canal about 0.06 inches in diameter picks up the sound pressure at the junction of the tube and the attached impedance, and passes it along to a small condenser transmitter. A corresponding voltage, generated by the transmitter, is amplified and the current output of the amplifier passed through a variable resistance in series with the primary of a variable mutual inductance.

The same oscillator also feeds energy through a second amplifier at the output of which the voltage is balanced (by the null method) against the voltage drop across the variable resistance and the secondary of the mutual inductance.

<sup>3</sup> *Phys. Rev.*, 28, 1038 (1926).

At the end of the tube from the loud speaker are three different impedances. One is the reactance offered by a closed tube of uniform bore. The closure is formed by a well-fitting plunger whose position in the tube may be adjusted. The second is the infinite impedance offered by a rigid wall closing the end of the tube from the loud speaker. The third is the impedance to be measured. All three impedance elements are fixed in position. The loud speaker, tube, condenser transmitter and associated amplifiers are, however, mounted together on a carriage which can be rotated so as to bring any one of these impedances into alignment with the tube. For brevity, reference to these three positions will hereinafter be to positions 1, 2, and 3.

For any one frequency a balance is obtained for each of the three positions. These three electrical readings and the reactance value of the closed tube are sufficient to determine the impedance being measured.

A photograph of the apparatus is shown in Fig. 2.

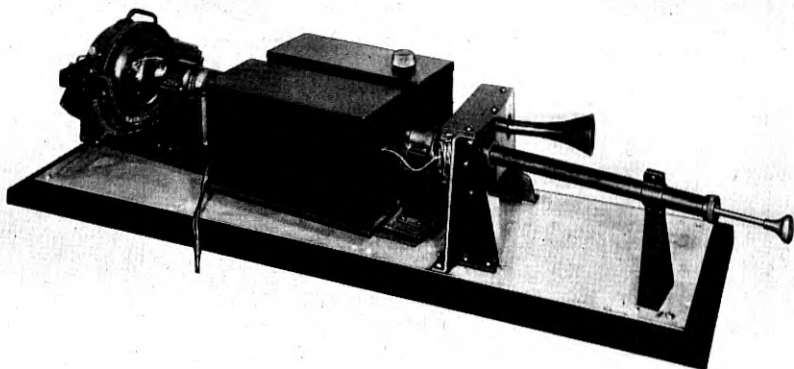

Fig. 2—View of acoustic impedance equipment, showing loud speaker, tubes, condenser transmitter amplifiers and small horn in position for measurement.

#### THEORY

Thevenin's theorem<sup>4</sup> states that, in an invariable electrical network, the current in any branch is equal to the current that would flow in a simple series circuit composed of an electromotive force and two impedances. The electromotive force is the voltage that would obtain at the branch terminals on open circuit. The impedances are the impedance at the terminals looking back into the source of power, and the impedance of the branch.

<sup>4</sup>K. S. Johnson's "Transmission Circuits for Telephone Communication," Ch VIII.

Since the differential equations of acoustics are analogous to those of electrical lines and networks, the theorem may be applied to the action of this apparatus with a considerable saving in labor.<sup>5</sup>

By Thevenin's theorem then, the tube, loud speaker, oscillator, etc. may be replaced by one pressure and one impedance. The pressure is the "open-circuit" pressure at the end of the tube, or in other words the pressure that would be exerted on a rigid wall if placed there. The impedance is the complex ratio of pressure to velocity at the end of the tube which would exist if acoustic energy were sent into it toward the loud speaker, the oscillator being shut off. In electrical terms, this would be called the impedance looking into the source. The velocity or acoustic current that flows into an impedance attached to the end is then the current that would flow in an analogous circuit composed of this vibromotive force or pressure and the two impedances in series. This impedance diagram is given in Fig. 3.

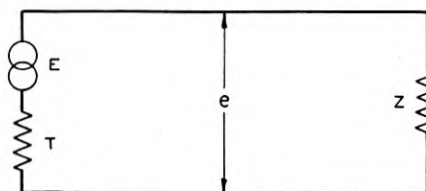

Fig. 3—Impedance diagram for Thevenin's theorem.

$E$  is the open-circuit voltage or pressure,  $T$  the impedance looking into the source of sound at the junction, and  $Z$  the attached impedance. The pressure  $e$  at the junction of  $T$  and  $Z$  is, of course, the velocity-current  $\frac{E}{T + Z}$  in the loop, multiplied by  $Z$ . The three equations for three values of attached impedance are

$$\begin{aligned} Z = Z_0, & \quad e_1 = \frac{EZ_0}{T + Z_0}, \\ Z = \infty, & \quad e_2 = E, \\ Z = Z, & \quad e_3 = \frac{EZ}{T + Z}. \end{aligned}$$

The two unknown quantities,  $E$  and  $T$ , can be eliminated giving one equation

$$\frac{Z}{Z_0} = \frac{\frac{e_2}{e_1} - 1}{\frac{e_2}{e_3} - 1},$$

<sup>5</sup> A more direct proof of Thevenin's theorem as applied to acoustics is given by W. P. Mason in *B. S. T. J.*, 6, 291 (1927).

whereby  $Z$  may be calculated in terms of  $Z_0$  and two ratios of pressures at the junction.

Referring now to Fig. 1 it will be seen that the current through the resistance and mutual primary is proportional to the pressure at the junction. The drop in voltage across the secondary and the resistance is equal in magnitude and opposite in phase to a voltage proportional to  $E$ , when no current passes through the head-phones. If  $k$  signifies the circuit constant and if  $z$  be the impedance value of the resistance and the mutual inductance, then  $ez = kE$ ; and the above equation becomes

$$\frac{Z}{Z_0} = \frac{\frac{z_1}{z_2} - 1}{\frac{z_3}{z_2} - 1} = \frac{z_1 - z_2}{z_3 - z_2} = \frac{(r_1 - r_2) + j\omega(m_1 - m_2)}{(r_3 - r_2) + j\omega(m_3 - m_2)},$$

where  $r$  is the resistance component of  $z$  and  $m$  is the mutual inductance.

The reactance of a closed tube of uniform bore whose length is one-eighth the wave length of sound for the measuring frequency is chosen as the known impedance. If dissipation in the tube be neglected, the impedance is readily calculated<sup>6</sup> to be a pure negative reactance of 41 mechanical ohms per square centimeter<sup>7</sup> at a temperature of 20° C. This value is chosen because it is of the same order of magnitude as most acoustic impedances. By mechanical ohms per square centimeter is meant the complex ratio of pressure to the linear velocity of the air. The justification for assuming negligible dissipation will be apparent when measurements made on a closed tube, several wavelengths long, are described.

In making measurements, the three impedance values necessary for balance are read for the three impedance conditions in the 2-1-3 or 2-3-1 order. Afterwards, as a check to ensure that the circuit constant has not changed during the measurement, condition 2 is measured again. This series of four measurements is repeated for each frequency.

#### APPLICATION

Fig. 4 shows the results of measuring the reactance of a closed tube. The tube was 2.4 inches long and 0.7 inch in diameter. The comparison impedance was the calculated reactance of this same tube in the one-eighth wave-length condition, assuming no dissipation. The impedance was also calculated,<sup>8</sup> taking into account viscosity and

<sup>6</sup> See I. B. Crandall's "Theory of Vibrating Systems and Sound," p. 104.

<sup>7</sup> See definitions 8007 and 8011 in "Standardization Report of I. R. E." in "Year Book of I. R. E.," 1931.

<sup>8</sup> See Rayleigh, "Theory of Sound," Vol. II, pp. 318 and 325.

losses through heat conduction, for frequencies near the half wavelength anti-resonance, where dissipative effects are most pronounced. It will be seen from Fig. 5 that there is a close agreement between the theoretical curve and the measured points. It seems reasonable, therefore, to assume that the value chosen for the comparison impedance is quite accurate.

Fig. 6 shows the impedance of a conical horn and Fig. 7 that of an exponential horn. In both cases, the mouth of the horn projected through a window into open air, so as to minimize reflection effects

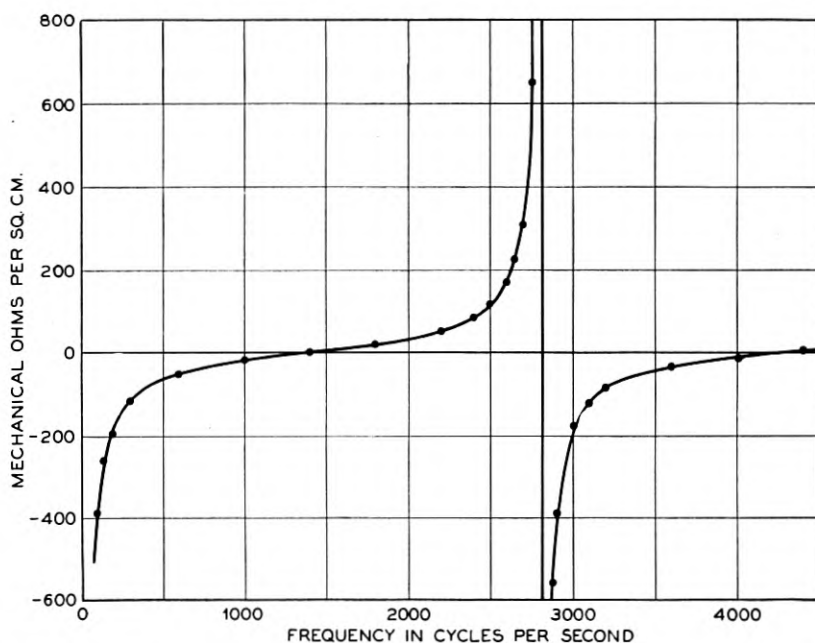

Fig. 4—Acoustic reactance of closed cylindrical tube, 2.4 inches long and 0.7 inch in diameter.

from external objects. Reflection effects from the mouth, where there is a change in impedance, are present, however, and these appear as oscillations of the impedance about a mean which is the characteristic impedance of the horn. By characteristic impedance is meant the impedance that would obtain looking into the throat of the horn were it infinite in length.

Fig. 8 is the impedance of an "infinite" tube. The tube was actually 112 feet long and coiled into a helix. At low frequencies, where the dissipative losses are small, reflection effects from the open end are



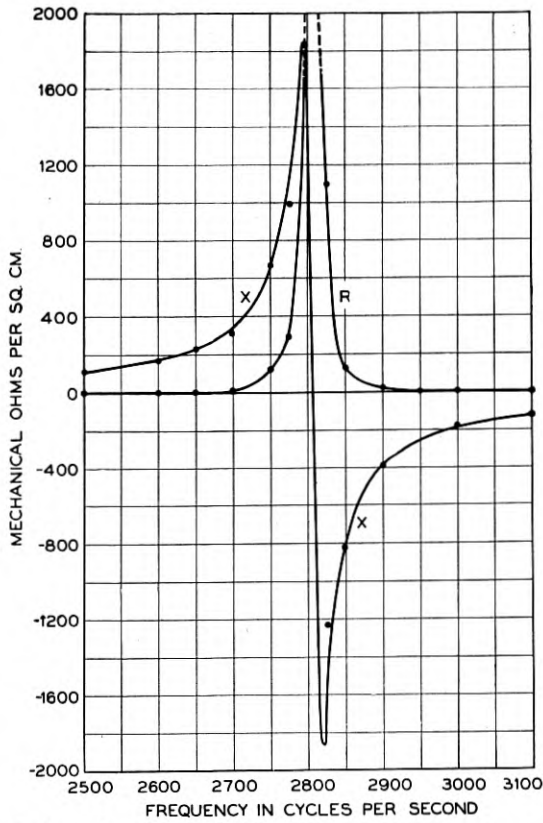

Fig. 5—Acoustic impedance of closed cylindrical tube, 2.4 inches long and 0.7 inch in diameter, showing agreement between measured and calculated values.

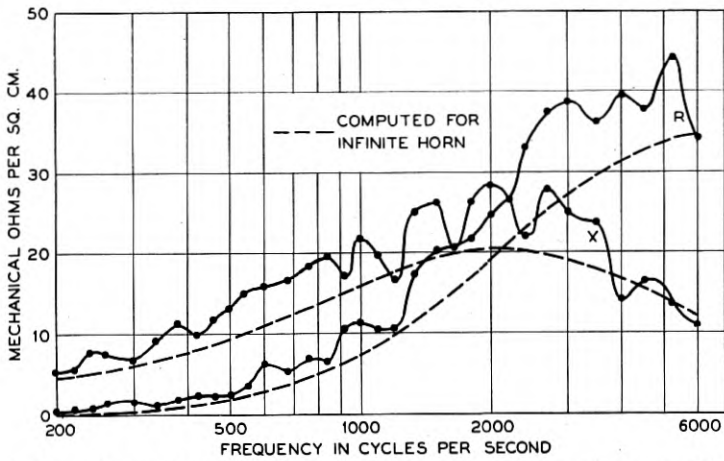

Fig. 6—Acoustic impedance of 38 inch conical horn, having end diameters of 0.7 inch and 28 inches.

observed as oscillations of the impedance at about 5-cycle intervals. An examination of the measurements in this oscillatory region (Fig. 9) will make evident the precision of the apparatus.

Fig. 10 shows the radiation impedance of a hole, 0.7 inch in diameter and surrounded by a flange which approximates an infinite wall for

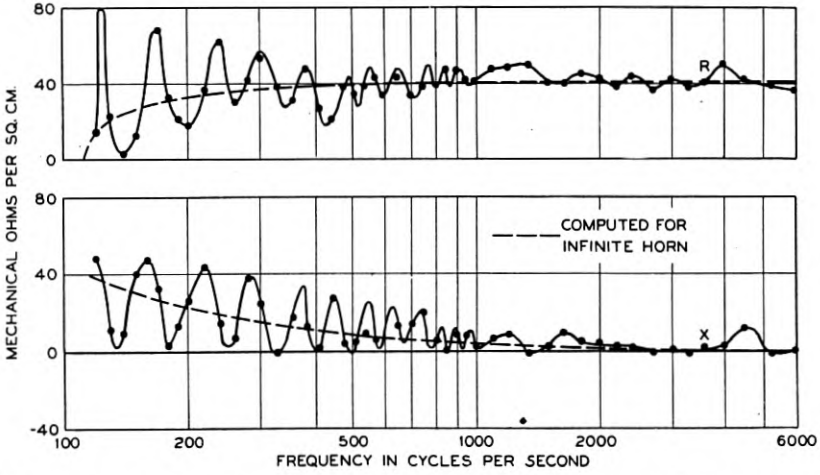

Fig. 7—Acoustic impedance of 6 foot exponential horn, having end diameters of 0.7 inch and 30 inches.

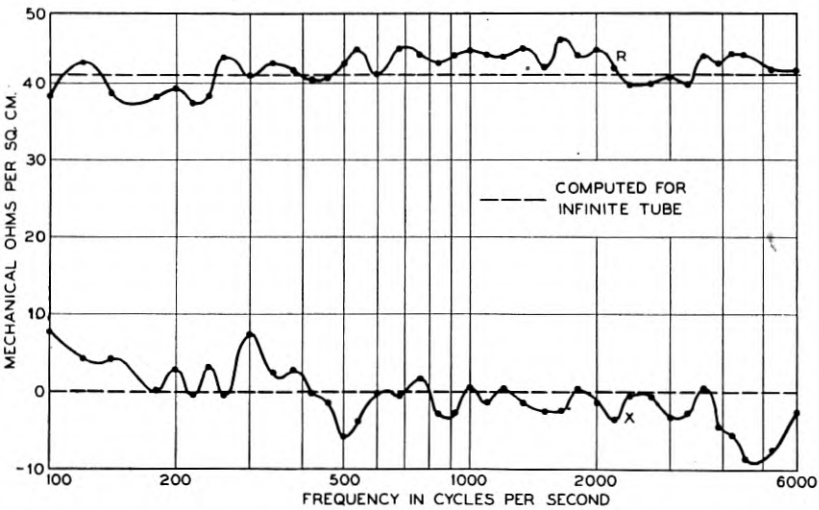

Fig. 8—Acoustic impedance of 112 foot open tube, 0.7 inch in diameter, coiled into helix. Measuring frequencies chosen at random.

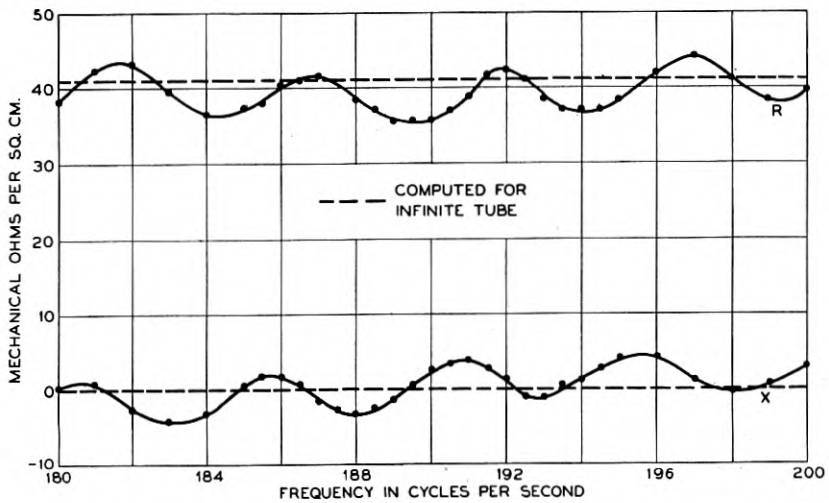

Fig. 9—Acoustic impedance of 112 foot open tube, 0.7 inch in diameter, coiled into helix. Measuring frequencies chosen at half and one cycle intervals to show oscillatory character of impedance.

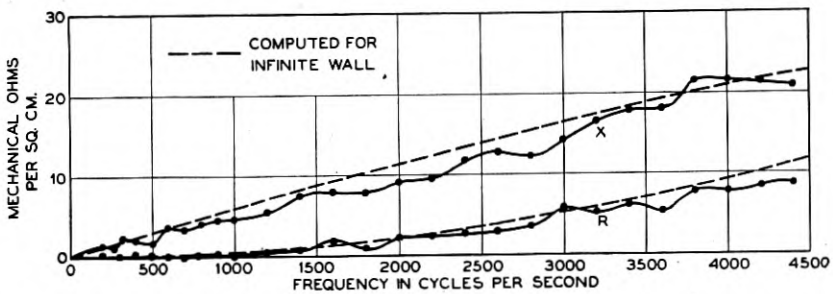

Fig. 10—Acoustic radiation impedance of hole, 0.7 inch in diameter, in flange having diameter of 6 inches.

the frequencies of interest. The dotted lines are the resistance and reactance as calculated by the equations of Rayleigh.<sup>9</sup>

<sup>9</sup> "Theory of Sound," Vol. II, p. 164.

# Transmission Lines for Short-Wave Radio Systems\*

By E. J. STERBA AND C. B. FELDMAN

The requirements imposed on transmission lines by short-wave radio systems are discussed, and the difference in the requirements for transmitting and receiving purposes is emphasized. Various line types are discussed, particular attention being given to concentric tube lines and balanced two-wire lines. The concentric tube line is particularly valuable in receiving stations where great directional discrimination is involved and low noise and static pick-up is required.

Excellent agreement between calculations and measurements is found for the high-frequency resistance of concentric lines, using the asymptotic skin effect formula of Russell. Other losses in correctly designed concentric tube lines are found to be negligible. Measured losses in two-wire lines are found to be greater than losses predicted by the asymptotic skin effect formula owing, in part, to losses brought about by unbalanced currents.

Practical aspects of line construction such as joints, insulation, and provision for expansion with increasing temperature are discussed.

Some difficulties encountered in transmission line practice, such as losses due to radiation, reflections from irregularities, effects of weather, and spurious couplings between antenna and line are discussed.

## I. GENERAL REQUIREMENTS

THE transmission line systems employed for the purpose of transferring energy between radio units and antennas are fundamentally no different from line systems used in power or telephone work. Owing, however, to the high frequencies employed in radio transmission an operating technique differing from that found economical in low-frequency practice is necessary. An important consideration in 60-cycle power practice is that the voltage at the far end of the line be maintained constant irrespective of load variations. At radio frequencies a transmission line may be many wave-lengths long and the reflections from a load other than one equal to the characteristic impedance of the line produce standing waves. Transmission losses in radio-frequency lines are appreciably augmented when the currents and voltages on the line appear in the form of standing waves. The operation of the radio unit connected to the line is sometimes affected by the presence of standing waves.

Induction and cross-talk problems familiar to every telephone engineer are increasingly important as line operation approaches radio frequencies. Owing to the high sensitivity of radio receiving equipment as compared with that of telephone equipment the difficulties

\* Presented at I. R. E. Convention Pittsburgh, Pa., April 7-9, 1932. Published in *Proc. I. R. E.*, July, 1932.

arising from static and noise pick-up are more marked at radio frequencies. Spurious radiations from lines operated at radio frequencies may completely destroy the directional characteristics of an antenna and in addition may cause interference to other radio stations. Under certain conditions the spurious power radiated by a transmission line may be an appreciable fraction of that radiated by the antenna connected to the line.

It follows that although the primary purpose of a transmission line in a radio station is to provide a means for transferring energy between an antenna and the radio unit, a consideration of great importance is the degree of isolation from its associated antenna, from other antennas and lines, and from extraneous sources of signals. This is particularly true in receiving stations where discrimination against undesired signals is oftentimes of greater importance than the over-all sensitivity to the desired signal. Extraneous pick-up on a line to the receiving unit may not only destroy the directional pattern of the antenna but it may also introduce a noise level into the receiver output comparable to the desired signal and so destroy the utility of the apparatus. As compared with transmitters, receivers are generally small units. It is economical to house several units in one building. The lines not only to one receiver but those to other receivers must of necessity be in close proximity. Thus the possibilities for cross-talk with ensuing increase in noise levels, loss of circuit gain, and loss of discrimination are greatly augmented.

Of course, cross-talk possibilities between lines of adjacent transmitters cannot be ignored. Transmitters, however, usually occupy sufficient space so that a desirable degree of line separation is obtained. With the exception of local lightning storms static pick-up is of no great importance. High voltage surges due to lightning may be drained by means of properly placed horn gaps and grounds.

Insulation for high voltages at radio frequencies is an important consideration for the case of lines connected to transmitters. Insulators for balanced open-wire construction may be selected from materials designed for high voltage power transmission. However, insulators for concentric tube lines capable of transmitting several kilowatts of modulated radio-frequency power require special consideration.

The lines commonly employed in radio stations may be divided into four classes: single-wire lines, balanced open-wire lines, multiple-wire lines, and concentric-tube lines.

Single-wire lines are of limited utility owing to the low efficiencies arising from the marked radiation characteristics of such wires. The power radiated by a single-wire line several wave-lengths long may be

equal to that radiated by the antenna to which it is connected.<sup>1</sup> In fact, single-wire lines, particularly when terminated, are for certain services desirable radiating elements. Diamond-shaped arrays of such elements are employed in some of the radio facilities of the Bell System.<sup>2</sup>

It is generally appreciated that the power losses due to radiation may be reduced by employing two conductors in a go-and-return circuit, the wires being separated a small fraction of a wave-length. A necessary requirement is that the two wires carry equal currents exactly opposite in phase. Otherwise, there will appear current components which employ the two conductors in parallel. In the latter event the radiation losses ascribed to single-wire conductors occur.

Although there is a very great reduction in radiated power in balanced two-wire lines as compared with single-wire lines there are many practical cases where the radiation from two-wire lines produces cross-talk and loss of signal discrimination. Multiple-wire lines comprising several pairs of conductors in go-and-return circuits may be employed to reduce the undesired radiation couplings. As in the two-wire case, care must be exercised in maintaining the required current amplitudes and phases since otherwise the radiation losses ascribed to single-wire lines may destroy the utility of the multiple-wire system. Multiple-wire lines, of course, reduce static and noise interference.

From the standpoint of isolation an ideal electrical connection between antennas and radio apparatus is approached when one conductor completely encloses the other conductor. A concentric-tube line comprising an outer sheath and an inner conductor is the practical form of this construction. Long transmission lines often pick up a large amount of static and other electrical disturbances. Spurious couplings may introduce these disturbances into the radio circuit. Electrical disturbances so introduced are greatly reduced when the outer sheath of a line may be grounded at frequent intervals. In fact, concentric-tube lines may be buried in the ground.

The effect of weather is a factor which in some instances may determine the type of construction to be employed in radio-frequency lines. It is generally appreciated that rain and sleet storms may materially lower the insulation of a line. The velocity of propagation and characteristic impedance also are affected by a coating of water or sleet upon the wires. Concentric-tube lines may be constructed so as to be weather proof.

This paper will be confined entirely to concentric-tube lines, to

<sup>1</sup> See calculations in the appendix.

<sup>2</sup> E. Bruce, *Proc. I. R. E.*, p. 1406, August, 1931.

balanced two-wire lines, and to the apparatus associated with these two line types.

## II. CONCENTRIC-TUBE LINES

A shielded line comprising an inner tubular conductor and an outer concentric shield is the form most commonly employed in radio practice. Owing to the circular symmetry of the line the case is capable of rather exact mathematical analysis. At radio frequencies the results are surprisingly simple. This simplicity is very evident for the two important parameters of a transmission line, the propagation constant  $P$  and the characteristic impedance  $Z_0$ .

The propagation constant of a line is defined by:

$$P = \sqrt{R + j\omega L} \cdot \sqrt{G + j\omega C}, \quad (1)$$

in which

$(R + j\omega L)$  is the complex impedance and

$(G + j\omega C)$  is the complex admittance, both per unit length. It is well known that the propagation constant is a complex number and that at radio frequencies (1) reduces to:<sup>3</sup>

$$P = \alpha + j\beta = \frac{R}{2Z_0} + \frac{GZ_0}{2} + \frac{j2\pi}{\lambda}, \quad (1a)$$

in which  $R$  is the resistance and  $G$  is the leakage conductance, both per unit length and at the wave-length  $\lambda$ .

The characteristic impedance  $Z_0$  is defined by the ratio:

$$Z_0 = \frac{\sqrt{R + j\omega L}}{\sqrt{G + j\omega C}}. \quad (2)$$

The characteristic impedance also is a complex quantity, but at radio frequencies it is for most practical purposes the real quantity:

$$Z_0 = \sqrt{\frac{L}{C}}. \quad (2a)$$

In the case of concentric-tube lines the expression for the capacity  $C$  per unit length is the familiar relation:

$$C = \frac{1}{2 \log_e \frac{b}{a}} \text{ e.s.u.}, \quad (2b)$$

in which  $a$  is the outer radius of the inner conductor and  $b$  is the inner radius of the outer conductor. The inductance  $L$  per unit length may

<sup>3</sup> J. A. Fleming, "The Propagation of Electric Currents."

be obtained from an expression derived by Lord Rayleigh upon assuming that the two tubes comprising the line are of negligible thickness. This is permissible because at radio frequencies the conduction of currents is essentially a skin effect. Upon this basis the inductance per unit length of a concentric-tube line becomes:

$$L = 2 \log_e \frac{b}{a} \text{ e.m.u.} \quad (2c)$$

Upon substituting (2b) and (2c) into (2a) with proper regard of units a simple expression for the characteristic impedance at radio frequencies is obtained:

$$Z_0 = 138 \log_{10} \frac{b}{a} \text{ ohms.} \quad (2d)$$

The high-frequency resistance of concentric-tube lines has been treated by a number of investigators, notably by A. Russell.<sup>4</sup> The asymptotic formula for resistance as the frequency is increased without limit is:

$$R = \sqrt{\rho\mu f} \left( \frac{1}{a} + \frac{1}{b} \right) 10^{-9} \text{ ohms/cm,} \quad (3)$$

in which:

$\rho$  is the resistivity in e.m.u. (for pure copper  $\rho$  is about 1730 e.m.u.),

$\mu$  is the magnetic permeability,

$f$  is the frequency, c.p.s.,

$a$  is the outer radius of the inner conductor,

and

$b$  is the inner radius of the outer conductor, the two latter being in centimeters.

It is of interest to note that the wall thickness of the conductor is not involved. At radio frequencies the current is confined to a very thin layer on the outside of the inner conductor and on the inside of the outer conductor.<sup>5</sup> The skin effect is, of course, not so pronounced at low frequencies and more complicated formulas involving wall thickness must be employed.

Some typical experimental data are submitted to show that for frequencies higher than one megacycle and for several practical line constructions the foregoing equation (3) holds with a very useful degree of accuracy. The physical dimensions and construction details of

<sup>4</sup> A. Russell, *Phil. Mag.*, April 1909; and "Alternating Currents," Vol. I, p. 222, 1914, Cambridge Press.

<sup>5</sup> Frequency is not the sole criterion, resistivity, wall thickness, and diameter also being involved.



the lines for which the observations were made appear in Fig. 1. With the exception of one rubber insulated line all inner conductors were supported on porcelain insulators. The latter were attached to the inner conductor by means of spring clips, extruded metal ears or by means of soldered rings. Some measurements were made on lines assembled with soldered joints and some on lines connected by means

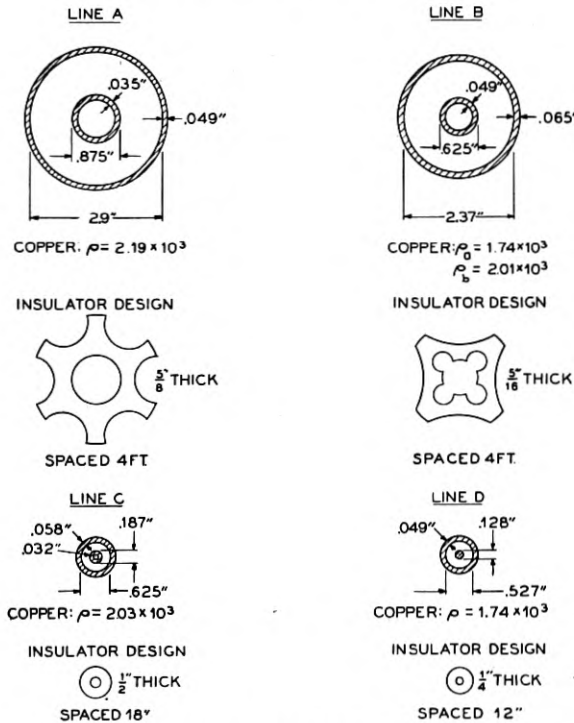

Fig. 1—Principal dimensions of the concentric tube lines upon which the experimental resistance measurements shown in Fig. 2 were made.

Line E—Same dimensions as "C." Brass ( $\rho = 6.6 \times 10^3$ ) outer pipe.

Line F—Same dimensions as "C." All brass ( $\rho = 6.6 \times 10^3$ ), insulators spaced 22 inches.

Line G—Same as "C" but filled with insulators.

Line H—Lead sheath cable, No. 18 B & S copper ( $\rho = 1.7 \times 10^3$ ), rubber insulation, lead ( $\rho = 17 \times 10^3$ )  $\frac{1}{8}$ -inch inside diameter.

Line I—Same as "C" but insulators spaced 9 inches.

Line J—Same as "F" but insulators spaced 18 inches.

of pipe unions with miniature plug and jack connections for the inner pipe. Various line lengths were employed. Most of the observations comprised measurements of the quantity  $(R/2 + GZ_o^2/2)$ . The measurement procedure will be described later.

The results of these measurements appear on Fig. 2. The solid curves were computed by means of (3), neglecting the conductance term. The points are the experimental observations. Note that, excepting lines *G* and *H*, the small margin between measured and calculated values shows that the leakage losses are very small. It is believed that the scattering of the observed points could have been reduced appreciably if corrections for variations of resistivity with temperature had been made.

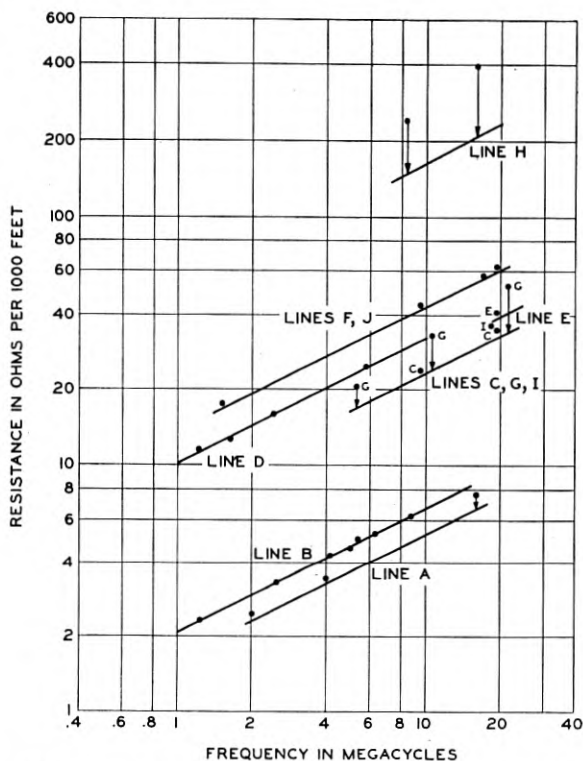

Fig. 2—Radio-frequency resistance measurements upon concentric tube lines. The curves are based upon computations and the points are experimental observations. See Fig. 1 for line details.

In lines *B*, *E*, and *H* the sheath and the inner conductor comprised materials of different resistivities. Calculations for these cases were made with the assistance of a modified form of (3):

$$R = \frac{1}{a} \sqrt{\rho_a f} + \frac{1}{b} \sqrt{\rho_b f}, \quad (3a)$$

in which the subscripts denote the inner and the outer conductors.

Line *G* was completely filled with porcelain insulators and line *H* was a rubber insulated, lead sheathed, cable. The curves of Fig. 3 were derived from the difference between the observed and calculated resistance in these two cases. The results so obtained are a fair approximation of the leakage losses. Note that the curves are nearly proportional to the frequency which is to be expected if for a constant voltage the dielectric absorbs a fixed amount of energy each cycle.

As may be expected the velocity of propagation for both lines *G*

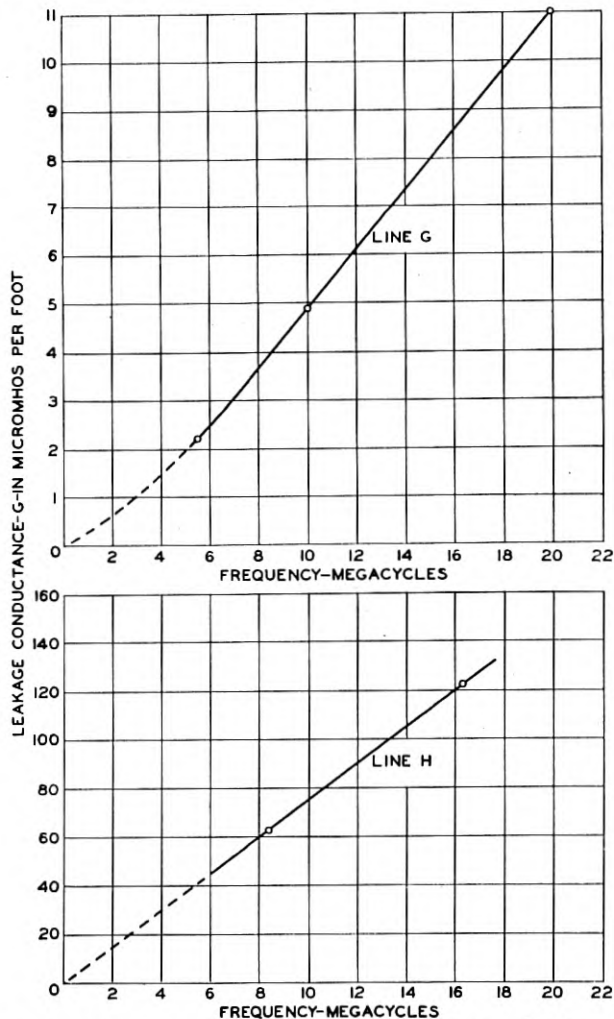

Fig. 3—Derived leakage conductance for the concentric tube lines *G* and *H* of Fig. 1. Line *G* was completely filled with porcelain insulators. Line *H* comprised a No. 18 B & S conductor with rubber insulation and lead sheath.

and  $H$  was reduced by a factor of approximately 1.8 which corresponds to a dielectric constant of about 3.2. Line  $I$  which was made with insulators spaced at 9-inch intervals was the only other line which showed a pronounced reduction in the velocity of propagation, the factor in this case being 1.18.

It is of interest to observe that if for economic reasons the diameter of the outer conductor is fixed there is an optimum inner conductor size for minimum attenuation. Employing (1a), (2d), and (3) the real part of the propagation constant may be written as:

$$\alpha = \frac{\sqrt{\rho\mu f}}{276} \frac{\left(\frac{1}{a} + \frac{1}{b}\right)}{\log_{10} \frac{b}{a}} \times 10^{-9}. \tag{4}$$

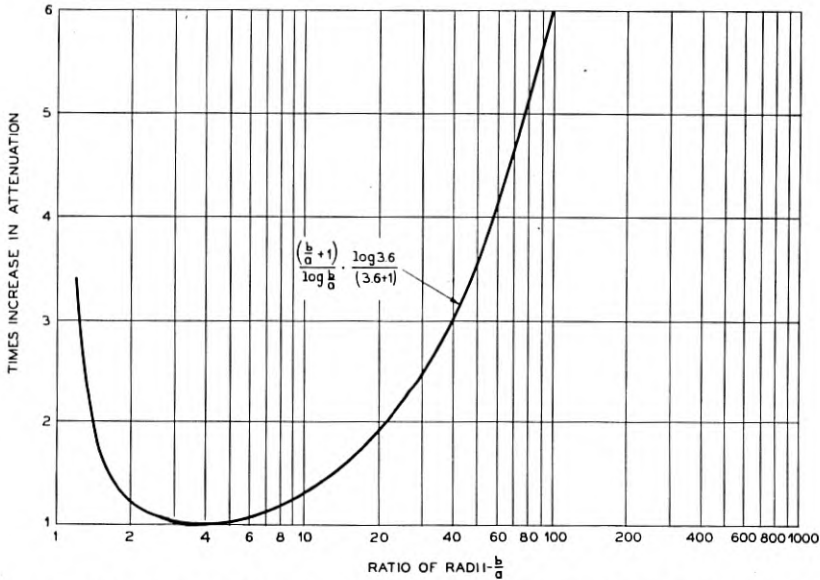

Fig. 4.—The most desirable ratio (36) of outer to inner conductor and the penalty incurred in departing from this value.

This neglects leakage loss and assumes that both conductors are made of the same material. Upon minimizing with respect to  $a$ , the optimum ratio:<sup>6</sup>

$$\frac{b}{a} = 3.6 \tag{4a}$$

is readily obtained. This ratio corresponds to a characteristic impedance of 77 ohms. Fig. 4 gives the manner in which the attenuation

<sup>6</sup> An experimental figure for the optimum ratio was given by C. S. Franklin in a British Patent, No. 284005. The above derivation for the optimum ratio was disclosed to the writers by E. I. Green and F. A. Leibe, American Telephone and Telegraph Company, New York City.

varies as a function of  $b/a$ . Note that a moderate departure from the optimum ratio does not greatly increase the line losses.

So far it has been tacitly assumed that the conductors were exactly concentric. Eccentricity affects all of the line constants.<sup>7</sup> However, experience has shown that the departures from concentricity usually encountered in practice produce no appreciable increase in the attenuation constant of the line.

At commercial installations the actual power loss in the terminated line is measured directly in decibels and has invariably been found to

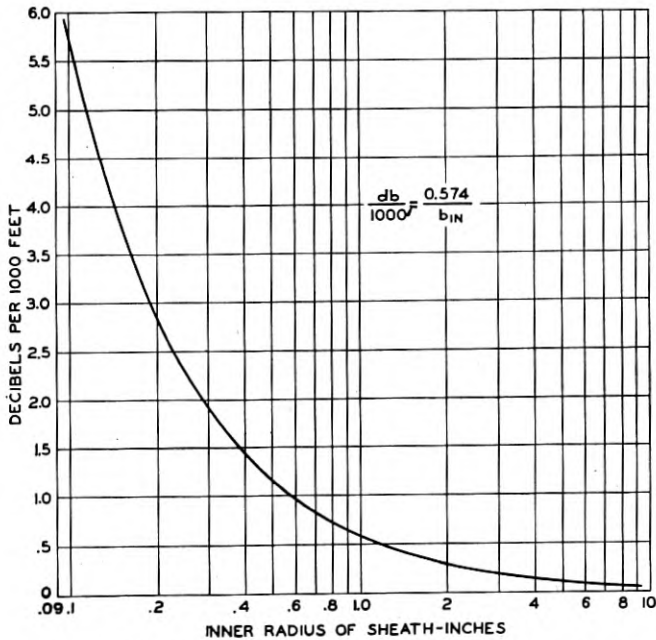

Fig. 5—Calculated losses at 20 megacycles expressed in decibels for concentric-tube lines constructed from copper and employing the optimum ratio (3.6) of outer to inner conductor.

agree with the predictions within the precision of such measurements which is about 0.5 db, in field work. Certain of the lines referred to in this paper have been similarly tested in the laboratory under more favorable conditions and yielded agreements within 0.3 db where the total loss was of the order of 4 to 6 db.

Briefly summarizing it may be said that the attenuation in well constructed concentric lines is proportional to the square root of frequency, inversely proportional to the diameters (optimum ratio) and

<sup>7</sup> A. Russell, "Alternating Currents," Vol. 1, p. 166, Cambridge Press.

proportional to the square root of resistivity. Numerically, the loss for copper lines of optimum ratio, neglecting leakage, is:

$$\frac{db}{1000 \text{ ft.}} = \frac{0.128 \sqrt{f_{\text{mc.}}}}{b_{\text{in.}}} \quad (5)$$

A plot of (5) for one particular frequency ( $f = 20$  mc.) is shown in Fig. 5.

It is important to emphasize one precaution in the use of concentric lines. The high degree of isolation afforded by concentric-tube lines may be easily destroyed. Owing to pick-up from near-by antennas or from other sources, currents of appreciable magnitude may be flowing upon the exterior of the sheath. Spurious couplings between the antenna and the line or between the equipment and the line may introduce these currents into the shielded circuit. In this manner the discrimination of a receiving circuit against undesired signals may be destroyed. Also, the currents flowing upon the exterior of the sheath may destroy the directional characteristic of the antenna to which the line is connected. Grounds placed at frequent intervals are useful in reducing these currents. Sometimes it is both desirable and convenient to bury the line in the earth. Additional improvement is obtained by constructing the circuits which transform the antenna impedance to the line impedance so as to obtain rigorous symmetry to ground.

### III. OPEN-WIRE LINES

The losses in open-wire lines may not be determined in as simple a manner or with the degree of certainty that is possible with concentric-tube lines owing to the complex nature of the electromagnetic field about open-wire lines. The high-frequency resistance of one conductor may be obtained from the foregoing equation (3) by assuming that the radius of the outer pipe is infinite. The characteristic impedance of balanced open-wire lines is obtained with sufficient accuracy from:

$$Z_0 = 276 \log_{10} \frac{2D}{d} \text{ ohms,} \quad (2e)$$

in which  $D$  is the axial spacing and  $d$  is the wire diameter. Some typical results for the resistance of a single conductor appear in Fig. 6.

At first thought it would appear that, owing to the high resistance of a single conductor, the losses in open-wire lines are higher than in concentric-tube lines. In practical constructions, however, open-wire characteristic impedances 5 to 10 times greater than those for concentric-tube lines are easily obtained. For example, the loss of

a 77-ohm concentric-tube line is 6.38 times as great as that for a 770-ohm open-wire line in which the wire diameter is equal to that of the inner conductor of the concentric-tube line. Thus, the attenuation constant for a practical open-wire line may be approximately the same as that for the larger practical sizes of concentric-tube lines. Some typical computations appear in Fig. 7. A balanced two-wire line of 600-ohm characteristic impedance was chosen for the computations.

In Fig. 7 it was assumed that the proximity effect, that is, the redistribution of currents owing to the presence of the second conductor, is a correction of negligible magnitude. Only in the case of large con-

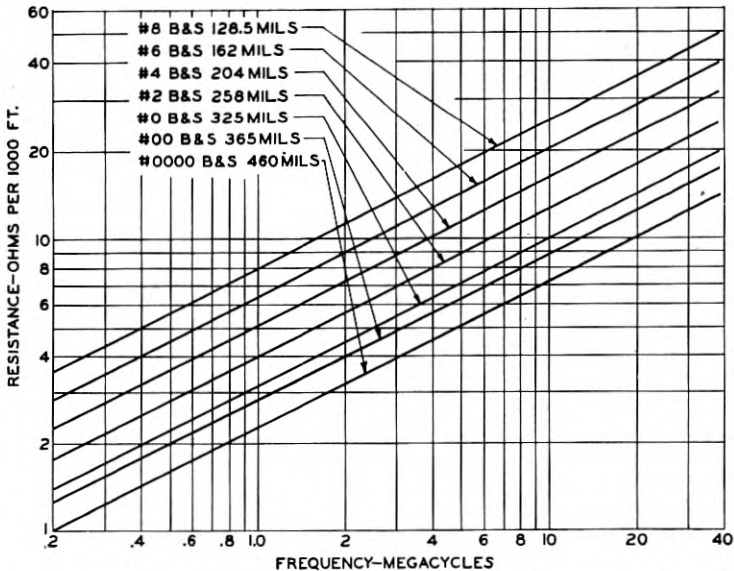

Fig. 6—Calculated radio-frequency resistance for several common sizes of solid copper conductors. Values are for one conductor only.

ductors closely spaced does the proximity effect perceptibly increase the resistance. This may be seen from Fig. 8 which shows the increase in resistance due to the proximity of the conductors. There are several excellent published articles upon this subject.<sup>8,9,10,11</sup>

The foregoing results give, of course, only the power dissipated in copper losses and tell nothing about radiation losses. If the line spacing is less than 1/10 of a wave-length and if the line length is more

<sup>8</sup> J. R. Carson, *Phil. Mag.*, Ser. 6, Vol. 41, p. 607, April, 1921.

<sup>9</sup> H. B. Dwight, *Jour. A. I. E. E.*, p. 203, March, 1922.

<sup>10</sup> H. B. Dwight, *Jour. A. I. E. E.*, p. 827, September, 1923.

<sup>11</sup> S. Pero Meade, *Bell Sys. Tech. Jour.*, Vol. 4, No. 2, April, 1925. The equations given in this reference were employed in computing Fig. 8.

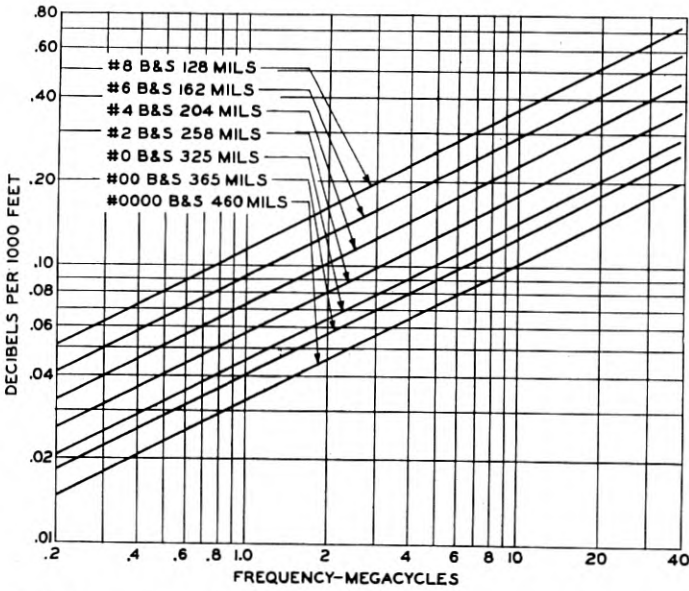

Fig. 7—Calculated attenuation expressed in decibels for copper losses in 600-ohm lines made up from common sizes of solid conductors.

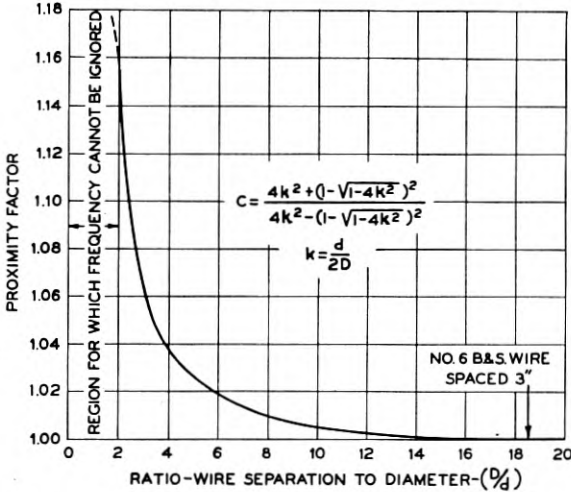

Fig. 8—Calculated values for the increase in copper losses due to the redistribution of current at close conductor spacings in balanced two-wire lines.



than 20 times the line spacing, the power radiated by a two-wire line terminated in its characteristic impedance is approximately:

$$\frac{P}{I^2} = 160 \left[ \frac{\pi D}{\lambda} \right]^2 \text{ watts}/(\text{amperes})^2, \quad (6)$$

in which:

$D/\lambda$  is the line spacing and

$I$  is the r.m.s. value of the current in the line.

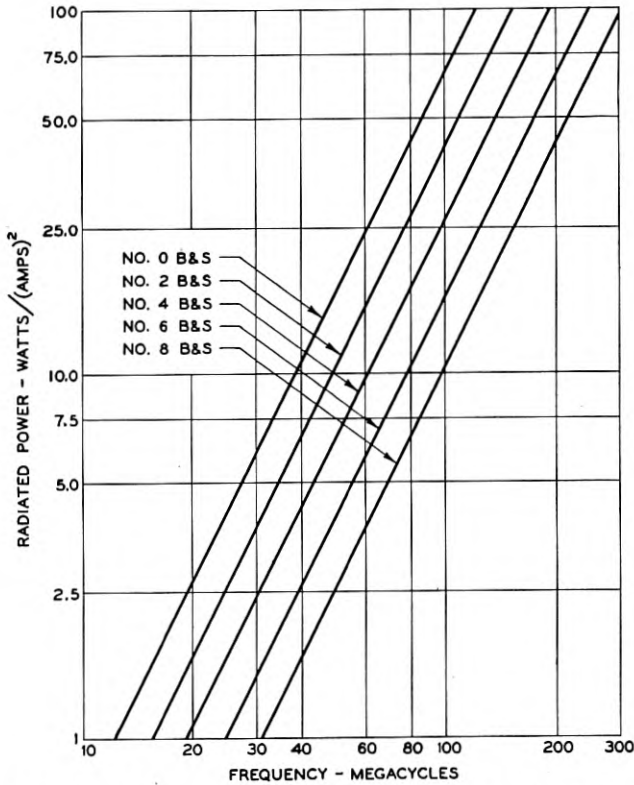

Fig. 9—Calculated power radiated by 600-ohm lines terminated in the characteristic impedance for several common conductor sizes. Note that line length is not involved.

Under these conditions the radiated power is independent of line length. More accurate equations appear in an appendix to this paper. It may be concluded from (6) that the power radiated by a terminated line is, in magnitude, approximately twice that radiated by a doublet antenna of length equal to the line spacing. Thus, the most simple circuit with which it is possible to terminate an open-wire line, a resistance of

length equal to the line spacing, will radiate approximately one half as much power as the line. Therefore, considering both load and generator terminations, the total power dissipated in radiation may be approximately twice that given in (6). The equation is plotted on Fig. 9 for the cases of several 600-ohm lines constructed from practical conductor sizes. It may be seen from this figure that the power radiated by a practical terminated line is negligible as compared to the power transmitted by the line provided that operations are confined to wave-lengths other than those in the ultra-short-wave region.

If the currents in the two wires are unequal or are not exactly 180 degrees out of phase there is an appreciable amount of power radiated by a two-wire line. Unbalances of this kind become evident when the driving voltages, measured to neutral, are incorrectly balanced and phased. Such unbalances also arise if the voltages induced by the antenna set up currents in the line which employ the two conductors in parallel.

For the purpose of computation unbalanced currents may be considered as flowing in a single conductor parallel to a perfectly reflecting earth. The amplitude of the current in the single wire may be assumed to be the vector sum of the current values in the two conductors. This procedure ignores the mutual interactions of the balanced and unbalanced currents flowing in the two-wire line and hence, the results so obtained are not strictly correct. It is believed, however, that the error is small.

Based upon these assumptions the power radiated by unbalanced currents is approximately:<sup>12</sup>

$$\frac{P}{I^2} = 30 \left[ 0.5772 + \log_e (2L) - \sin^2 (L) \left( 1 - \frac{\sin H}{H} \right) - Ci(2L) - 2Ci(H) + Ci(\sqrt{L^2 + H^2} - L) + Ci(\sqrt{L^2 + H^2} + L) \right], \quad (7)$$

in which:

$P/I^2$  is expressed in watts/(amps)<sup>2</sup>

$I$  = r.m.s. value of current at a position along the line of maximum current,

$H = \frac{4\pi h}{\lambda}$ ,  $\frac{h}{\lambda}$  being the height of the wires above ground

in wave-lengths,

and

$L = \frac{2\pi l}{\lambda}$ ,  $\frac{l}{\lambda}$  being the length of the line in wave-lengths.

<sup>12</sup> See appendix.

The equation is plotted on Fig. 10 for two specific heights above ground and for various line lengths. Upon examining Figs. 9 and 10 it may be concluded that in practical constructions a thirty per cent unbalance in line currents radiates an amount of power roughly equal to that radiated by the balanced currents in the line.

It is our experience that losses due to current unbalances are appreciably greater and somewhat different in character from those indicated by (7). The discrepancy may reside in the assumptions employed in deriving the equation. In particular, the losses in the earth have been ignored. It may well be that the soil over which the line is erected introduces large losses in the line, particularly when the currents are unbalanced. Such losses would augment the attenuation constant

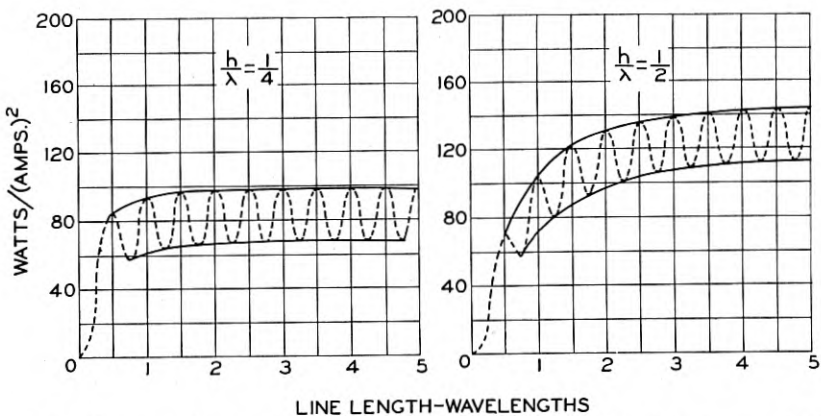

Fig. 10—Approximate power in watts radiated by an unbalanced current of 1.0 r.m.s. amperes in a long two-wire line. Also, the power radiated by a single wire parallel to the earth for 1.0 r.m.s. ampere line current. Two cases,  $\frac{1}{2}$  and  $\frac{1}{4}$  wavelengths above ground are illustrated.

of the line.<sup>13</sup> At least, the computations indicate the desirability of maintaining careful line current balances.

Some remarks upon the proper procedure for inserting the power losses due to radiation into the equations for the line may be of interest. Carson<sup>14</sup> has shown that the conventional solution of the transmission equation for guided waves on wires is incomplete and does not explain the phenomena of radiation. He shows that a "principal wave," and hence the currents in the conductor associated with this wave, travel along the conductors without sensible attenuation due to radiation. Radiation from the line results in the attenuation of an infinite number of "complementary waves." These are highly attenuated so that the

<sup>13</sup> John R. Carson, *Bell Sys. Tech. Jour.*, Vol. V, No. 4, October, 1926.

<sup>14</sup> John R. Carson, *Jour. A. I. E. E.*, p. 908, October, 1924.

radiation of energy is a phenomenon essentially associated with the terminals of the line or points of discontinuity which set up reflected waves.

It may be concluded from Carson's mathematical investigation that the radiation resistance is a term to be added to the impedance of the line at the terminals or points of discontinuity and that it does not appear in the propagation constant. On this basis, the power radiated by a practical balanced transmission line is negligibly small when compared to the power being transmitted by the line except perhaps for operation at the very short wave-lengths.

Experimental data for the attenuation in open-wire lines which are as complete as those already shown for concentric-tube lines are not

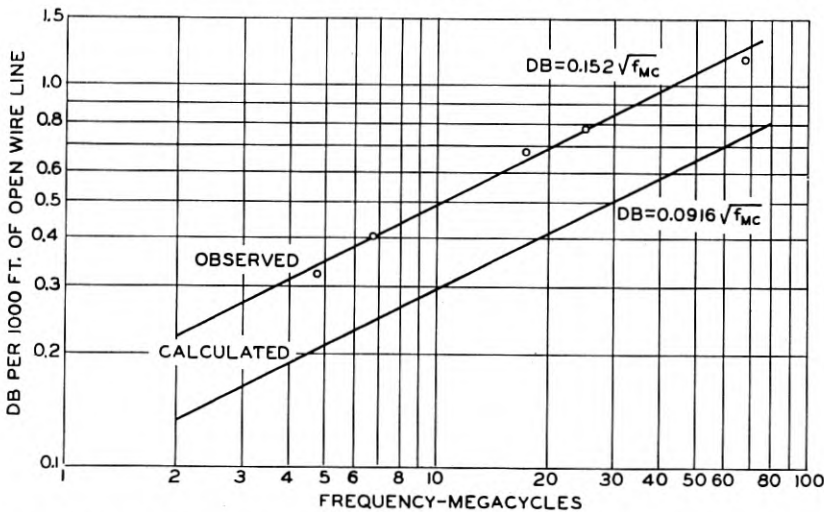

Fig. 11—Experimental observations of attenuation in a 600-ohm line comprising 0.162-inch copper conductors. The points are observed values. The lower curve is calculated only on the basis of copper losses.

available for this paper. Some typical observations for 600-ohm lines constructed with No. 6 B & S semi-hard drawn copper wire appear in Fig. 11. The points are experimental observations. The lower curve was computed for the case 1830 e.m.u. copper resistivity. The observed values are about 66 per cent higher than the computed values.

The experimental procedure was as follows. A line 2000 feet long was carefully balanced and terminated by an iron wire line<sup>15</sup> for each of the experimental observations. By means of a portable calibrated indicating device the average currents for the one-half wave-length of

<sup>15</sup> See Section VII.

line at the near end and at the far end were obtained. The attenuation in decibels was computed from average near end and far end current ratios.

It is difficult to explain the discrepancy between observed and computed values. If the resistivity employed in the computations were to be increased from 1830 to 5030 e.m.u. (a multiplication factor of 2.75) the computed curve so obtained would be in good agreement with the observed results. It is true that the wires were somewhat weathered. There is, however, little reason to believe that an appreciable amount of current flows in the oxide layer covering the wires. Effects of this kind would have been evident in the measurements upon concentric-tube lines. It already has been mentioned that small current unbalances in the line may produce losses in the earth which increase the real part of the propagation constant. Possibly, losses of this kind may explain the discrepancy.

#### IV. NOTES ON MATCHING IMPEDANCES

It already has been mentioned that standing waves on a transmission line augment line losses. The penalty which is imposed by improper impedance matches may be seen from Fig. 12. This figure plots line loss as a function of the degree of matching for several attenuation factors. The line loss is computed from the ratio of the power dissipated in the load to the total power obtainable from the generator. The curves were obtained from conventional transmission line theory. For the purpose of simplifying calculations the line length is assumed to be an integral number of one-quarter wave-lengths, thereby eliminating complex impedances. Otherwise the length of the line is immaterial, the product of length and attenuation per unit length being the criterion of loss.

In the diagrams of Fig. 12A and Fig. 12B the circuit  $M$  is an adjustable ideal transformer. For every value of the resistance  $R$  the transformer  $M$  is assumed to be adjusted so as to maximize the load power. This process is equivalent to matching impedances at the terminals of the line adjacent to the transformers. It is of interest to observe that where  $R$  is not equal to the characteristic impedance  $Z_0$ , this adjustment does not yield an impedance match at the line terminals remote from the transformers. It is of further interest to observe that in the case where the load impedance is variable (Fig. 12B) the optimum adjustment is a compromise between a non-reflecting termination and an impedance match at the generator end.

Conventional tuned transformers may be employed to match the line impedance to the antenna and radio equipment impedances. In

the transmitting case, tuned circuits are often found to be both bulky and costly. There are a number of schemes which employ a short section of line as a transformer element. These are feasible only at fre-

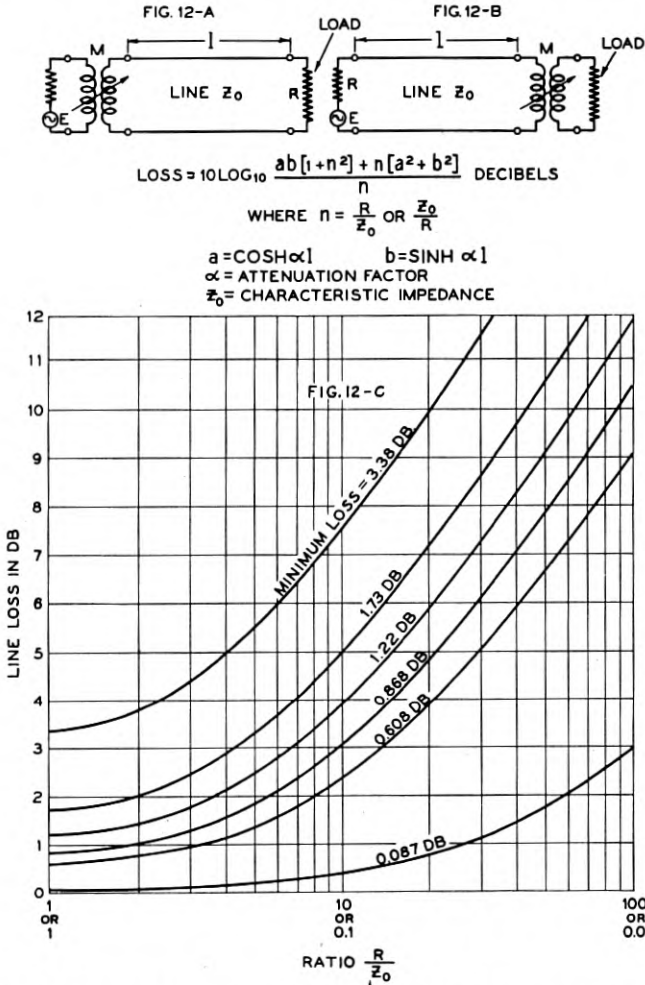

Fig. 12—Line loss as a function of the degree of matching. The several curves are designated in terms of the minimum line loss obtained for the case of a perfect match with the line characteristic impedance.

quencies for which the wave-length is short. The circuits so provided are extremely simple and cheap.

In another paper<sup>16</sup> a scheme for employing a one-quarter wave-

<sup>16</sup> E. J. Sterba, *Proc. I. R. E.*, p. 1184, July, 1931.

length section of line as a step-up or step-down transformer was described. Briefly the principle of operation is the fact that the sending end impedance  $Z_s$  and the receiving end impedance  $Z_r$  are related to the characteristic impedance  $Z_0$  by the simple expression:

$$Z_s Z_r = Z_0^2. \quad (8)$$

Thus, by choosing the proper characteristic impedance any two real impedances may be matched provided these do not differ too greatly.

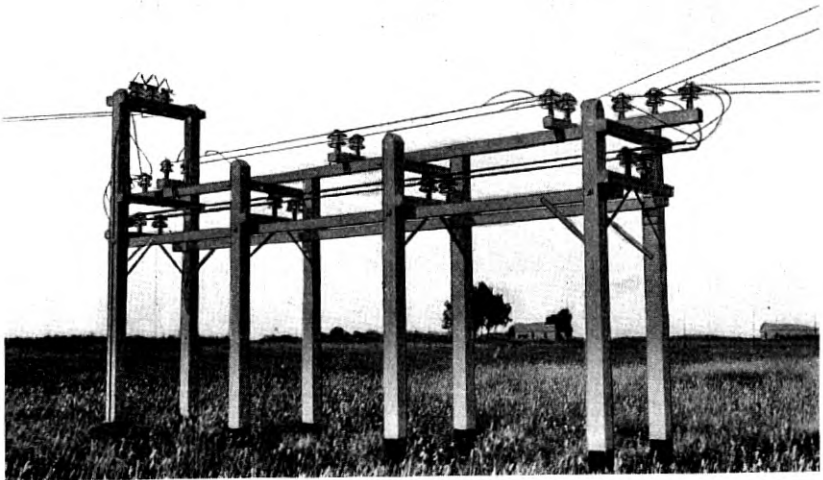
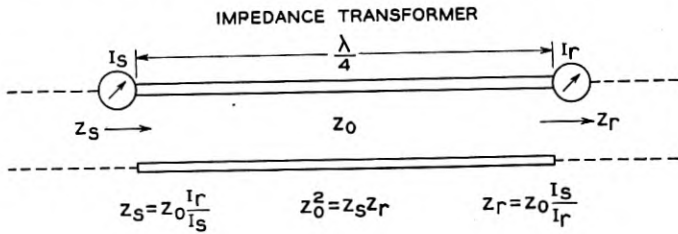

Fig. 13—The principles underlying the use of one quarter wave-length bars as a transformer are shown in the upper diagram. The lower illustration depicts a commercial installation.

Often the scheme is made workable by constricting the line spacing for a one-quarter wave-length section. Where a large difference in transformer line and transmission line spacing is undesirable the transformer line may comprise conductors of large diameter. A transformer set-up of this type is shown in Fig. 13.

There is another effective way for transforming line impedances by

means of short line devices.<sup>17</sup> A complex impedance at the proper position along a partially terminated line is selected such that a shunt reactance at this position transforms the real part of the impedance to the surge impedance of the line at essentially unity power factor. The shunt could, of course, be a lumped reactance. It is found convenient to employ a short section of line for this reactance. A position along the line for the shunt reactance of either leading or lagging power factor may be chosen. In the former case the shunt reactance must be inductive and in the latter case capacitive. Computed shunt impedance positions for the two cases and the values of the shunt impedance in terms of line length for 600-ohm lines and various standing wave amplitudes on the unterminated section appear in Fig. 14. Actual settings correspond very well with the calculated settings.

#### V. RESISTANCE AND ATTENUATION MEASUREMENTS ON TRANSMISSION LINES

The following is a description of some of the measurement methods which have been found useful in the study of transmission lines. The schemes may not be applicable to every phase of the transmission line problem. However, it is hoped that they may suggest precautions to be observed in performing transmission line studies.

One scheme, very commonly employed, is to measure the attenuation along a transmission line by actual current measurements. This method is particularly suited to measurements upon a long line terminated in its characteristic impedance. It has been found desirable to measure the current amplitudes at close intervals for at least a one-half wave-length section at the near end and the far end of the line. In this manner an average result which reduces observational errors and errors arising from standing waves of small amplitudes is obtained. From the ratio of the average sending end current  $I_s$  and the average receiving end current  $I_r$  and the average distance  $l$  between the two sections of line the attenuation per unit length is obtained from the definition:

$$\text{db} = 20 \log_{10} \frac{I_s}{I_r}, \quad (9)$$

and since

$$\frac{I_s}{I_r} = e^{Rl/2Z_0}, \quad (10)$$

$$\frac{\text{db}}{l} = 4.343 \frac{R}{Z_0}, \quad (11)$$

<sup>17</sup> Disclosed to the writers by P. H. Smith, Bell Telephone Laboratories, Inc., New York, N. Y.



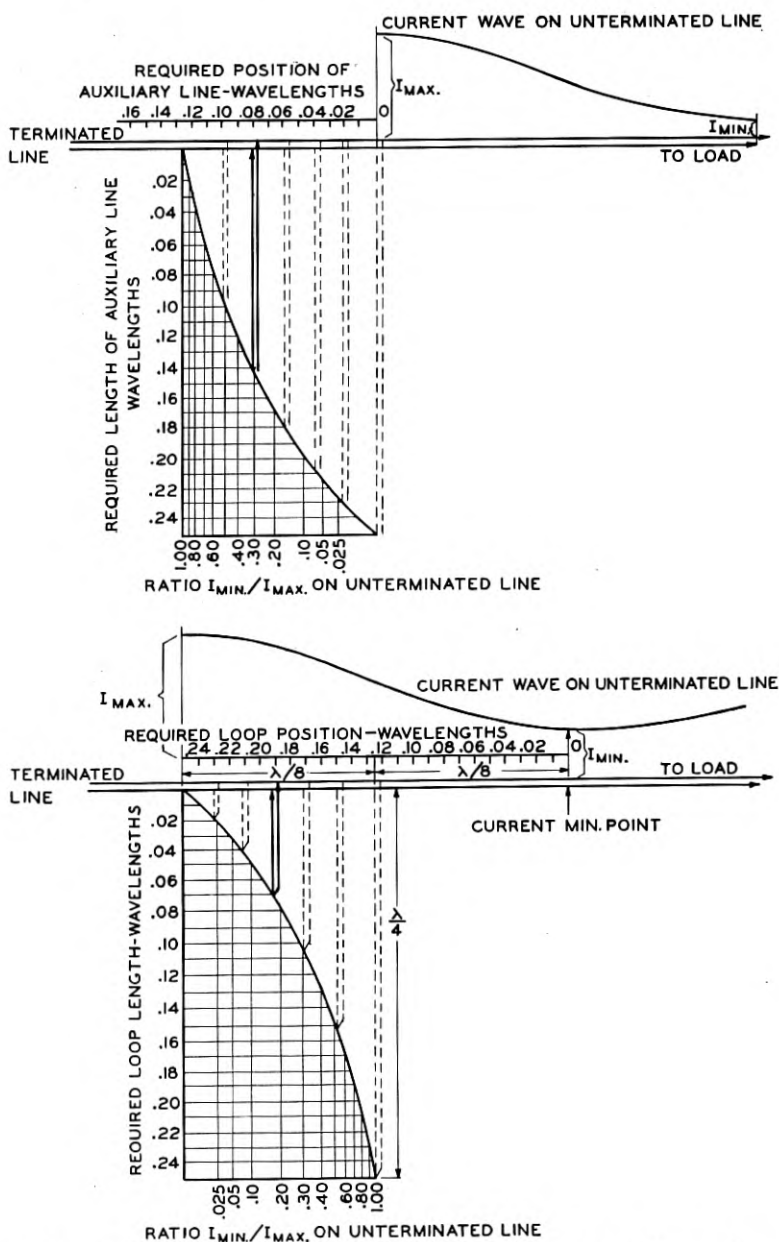

Fig. 14—The use and adjustment of an auxiliary line as a transformer element. The settings are computed for the case of 600-ohm lines. The position and length of the auxiliary line may be obtained from the curves for any given ratio of minimum to maximum currents on the unterminated portion of the line.

from which the resistance  $R$  per unit length may be obtained with a degree of accuracy depending chiefly on how accurately the characteristic impedance  $Z_0$  is known.

The current distribution along the line is most conveniently obtained by means of a portable indicating device. Three designs which have been found useful are shown in the following figures. The indicator to the left of Fig. 15 is used for measurements upon open-wire lines. The manner in which it operates is evident from the figure. Note that

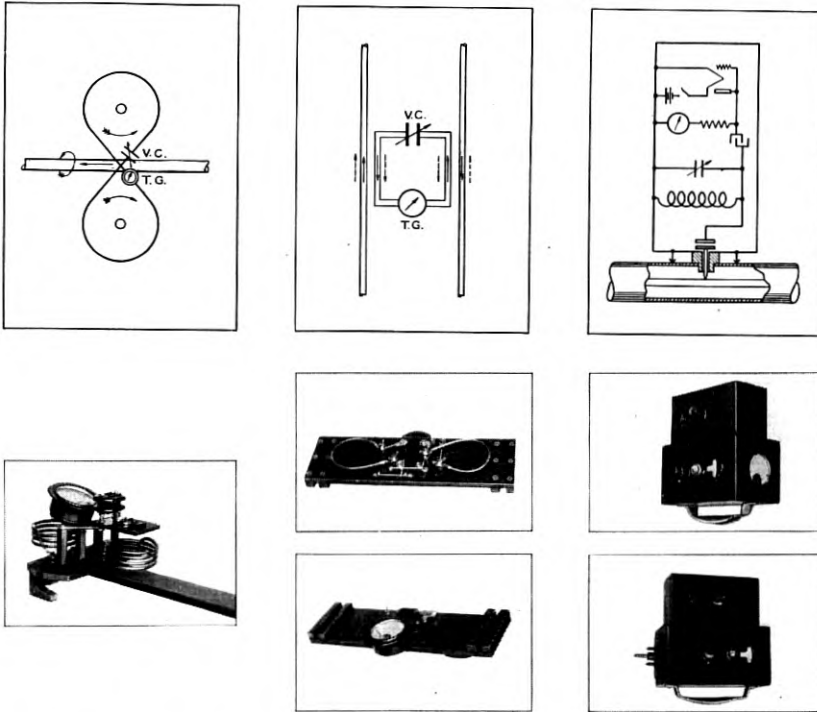

Fig. 15—Three types of portable indicating devices for observing the current distribution on transmission lines. The device to the left is sensitive chiefly to the current flowing in one conductor. The device in the center responds chiefly to balanced currents and is not sensitive to unbalanced currents. The device to the right is suitable for observing the voltage amplitudes on concentric tube lines.

except for closely spaced wires the device is sensitive only to the current in one side of the line. When this device is used the currents in both sides should be measured to assure that there are no large current unbalances and for the purpose of averaging out any small unbalances. The device in the center of Fig. 15 is coupled to both sides of the line and is not sensitive to currents which employ the two-line conductors

in parallel. It is useful where for other reasons the unbalanced currents cannot be reduced to a desirably low value. The device shown to the right of Fig. 15 is suitable for measurements on concentric lines. In order to employ this device openings at regular intervals are required in the outer sheath. An important precaution to be observed in employing this last device is that the shielding be sufficiently thorough to assure no pick-up from stray currents flowing upon the outside of the sheath.

It is of course essential that all portable devices of this kind extract a very small proportion of the power in the line; otherwise, the device becomes a source of reflection and spurious results are obtained.

Another method of measuring the attenuation of a line which is particularly useful in studying the effects of current unbalances is to employ a small portable horizontal antenna the impedance of which matches the characteristic impedance of the line. The antenna is connected in a short section and then in a long section of the line. It is essential that the height of the antenna above ground be equal for the two positions. Also, the location for the experiment should be such that the same ground losses are present for the two positions. The ratio of the antenna currents for the two positions and for the condition of equal power input is a measure of the total line losses.

One of the most satisfactory schemes for measuring line attenuation is the direct measurement of the line sending end impedance by means of the familiar resistance substitution method. It has been used extensively in measurements of concentric lines. For this purpose it is necessary to employ lines either open- or short-circuited at the far end and to restrict the measurements to lines which contain an integral number of quarter wave-lengths.

Conventional transmission line theory indicates that under these conditions the impedance is either:

$$Z_1 = Z_0 \tanh \left( \alpha \frac{n\lambda}{4} \right), \quad (12)$$

or:

$$Z_2 = Z_0 \coth \left( \alpha \frac{n\lambda}{4} \right), \quad (13)$$

where:

$Z_0$  = characteristic impedance,

$\alpha$  = attenuation factor; i.e., the real part of the propagation constant,

$\lambda$  = wave-length, and

$n$  = an integer denoting the number of quarter wave-lengths.

If  $n$  is even and the termination is a short circuit or if  $n$  is odd and the termination is an open circuit, (12) is employed. If  $n$  is odd and the termination is a short circuit or if  $n$  is even and the termination is an open circuit, (13) is employed. The attenuation factor is given by:

$$\alpha = \frac{1}{2} \frac{R}{Z_0} + \frac{1}{2} GZ_0 \text{ nepiers per foot,} \quad (14)$$

$$= 4.34 \left( \frac{R}{Z_0} + GZ_0 \right) \text{ decibels per foot,} \quad (14a)$$

where:

$R$  = resistance in ohms per foot,  
 $G$  = conductance in ohms per foot, and  
 $Z_0$  = characteristic impedance in ohms.

For all the lines concerned with here  $\tanh [\alpha(n\lambda/4)]$  may be replaced by  $[\alpha(n\lambda/4)]$  without more than 1.5 per cent error. Thus, (12) and (13) reduce to

$$Z_1 = \frac{R}{2} \frac{n\lambda}{4} \left( 1 + \frac{GZ_0^2}{R} \right), \quad (12a)$$

$${}^{18}Z_2 = \frac{2Z_0^2}{n\lambda} \frac{1}{R} \left( 1 - \frac{GZ_0^2}{R} \right). \quad (13a)$$

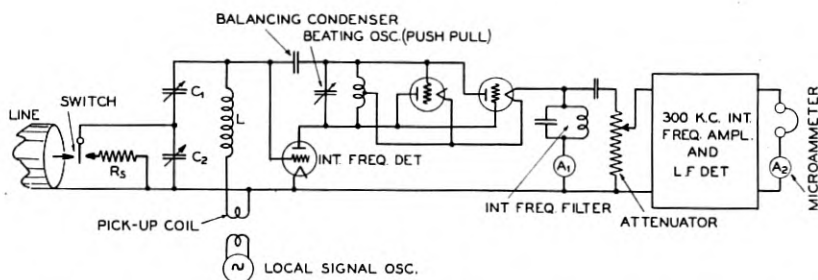

Fig. 16—Schematic diagram of apparatus for measuring line loss by means of a resistance substitution method.

Therefore, except for the small contribution of shunt conductance,  $Z_1$  is independent of  $Z_0$ . In cases where  $G$  is negligible, the measurement of  $Z_1$  gives directly the high-frequency resistance.

The method of measurement is shown schematically in Fig. 16 and an experimental set-up appears in Fig. 17. The modified high-fre-

<sup>18</sup> It is assumed here that the conductance term in (14) is small compared with the resistance term.

quency field intensity measuring unit<sup>19</sup> is a convenient indicating device and source of signal. The intermediate-frequency amplifier with its adjustable gain is very useful in maintaining a desirable level in the last detector which is the indicator. Returning to Fig. 16, the local signal oscillator is the source of voltage actuating the tuned circuit  $LC_1C_2$  in which the substitutions are made. Loose coupling is desirable between the pick-up coil and oscillator. In measuring  $Z_1$ , which is a low impedance, the condenser  $C_2$  is set at minimum capacity thus effectively

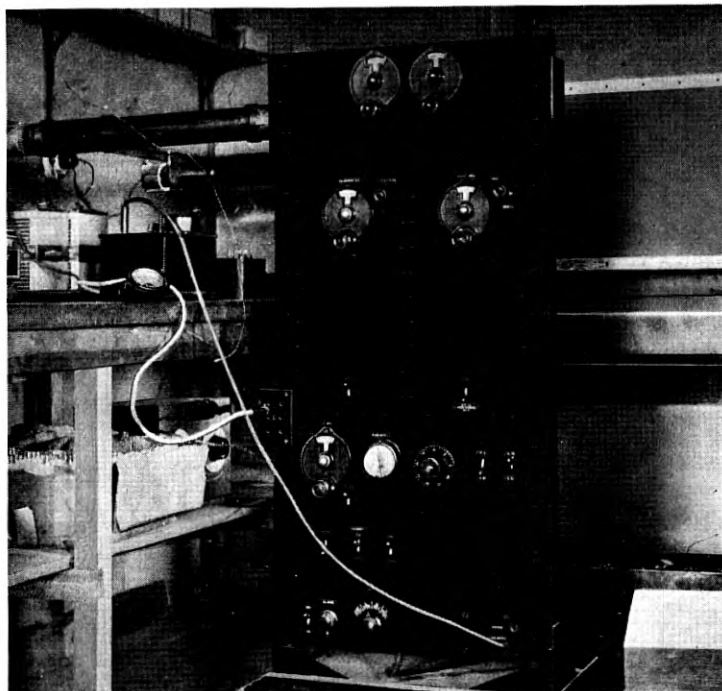

Fig. 17—Experimental set-up of apparatus for measuring line loss.

making the comparison in a series circuit. In measuring  $Z_2$ , which is of the order of hundreds of ohms,  $C_2$  is used to transform  $Z_2$  into an appropriate series value consistent with selectivity and sensitivity.

The comparison resistances used for measuring ( $Z_1$ ) may be fixed units and the line impedance obtained by interpolation. These comprise straight lengths of high-resistance wire and range from a few tenths of an ohm to ten ohms. The wire size is chosen so that skin

<sup>19</sup> Readers not familiar with this measuring unit may refer to a paper by Friis and Bruce, *Proc. I. R. E.*, August, 1926.

effect is negligible. Although these resistances possess appreciable inductive reactance at the higher frequencies the reactance usually may be safely tuned out.

It has been found practicable to employ continuously variable resistances made from hard drawing pencil lead equipped with spring clip contacts for measurements of high resistances such as ( $Z_2$ ). The high resistivity of graphite makes it possible to obtain several thousand ohms in 5 or 6 inches, free of skin effect and with but little inductance.

The foregoing resistance substitution method has been found satisfactory for the purpose of measuring the characteristic impedance of lines. Two methods have been employed. One of these is the familiar procedure in which the sending end impedance is measured for the case of the line open and short circuited at the far end. The geometric mean of the two impedances so obtained is the characteristic impedance of the line.

Another scheme producing more precise results is also adapted to the foregoing resistance measuring method in that it requires that the line be some odd number of one-quarter wave-lengths long. Such a line transforms to a different value a terminating impedance which is other than the characteristic impedance. By comparing a variable terminating resistance directly with the value to which it is transformed by the line a setting may be found for which the line functions as a one-to-one transformer. For this condition the value of the variable terminating resistance is the characteristic impedance of the line. Here again drawing pencil leads have been found to be satisfactory termination resistances when set by direct-current measurement methods.

In practice the foregoing resistance substitution method brings to light many slight irregularities. Variations of apparent characteristic impedance with frequency as much as 5 to 10 per cent have been found for concentric-tube lines equipped with elbows, couplings, and similar fittings. It is believed that impedance variations of this order are to be expected from some such irregularities unless particular care is taken in the construction of the fittings. On the other hand, it has been found that a short straight length of carefully constructed concentric-tube line is so smooth that its characteristic impedance may be employed as a calculable standard.

## VI. PRACTICAL CONSTRUCTION DETAILS

Open-wire radio-frequency line construction is not very different from that employed in power practice. One outstanding difference is that line supports and insulators must be considered as individual ir-

regularities spaced at intervals often greater than one wave-length. The effect of one such irregularity may be small. The total effect in a long line, however, is sometimes appreciable.

The body of the insulator, since it has a dielectric constant appreciably different from air and since its dimensions are comparable with the line spacing, is in itself a line irregularity. Tie wires or conductor clamps augment this effect. Cross arms and pins employed for mounting pin-type insulators also add to the effect, particularly during wet weather.

From the standpoint of line irregularities suspension-type insulators are more desirable than pin-type insulators. The latter construction, however, appears to be more practical because the lines are more rigid, sway less during wind storms, and because no intermediate spreaders are required to maintain the desired line spacing.

One other difficulty with open wire lines is the drift in velocity of propagation and surge impedance during rain and sleet storms.<sup>16</sup> Since a similar effect occurs in the elements of the antenna there is a decided drop in the efficiency of the combined antenna and line during rain and sleet storms. The effects of sleet may be reduced by heating the wires with sleet melting currents. The conductor size may be increased to reduce the effects of wet weather but this makes sleet melting more difficult.

There is an appreciable pick-up between balanced open wire lines on common supports. It appears desirable to separate lines to a common transmitter by at least 10 times the conductor spacing. Spacings greater than this may be required if two lines are to be operated simultaneously and in some cases it is more desirable to employ separate line supports in order to reduce the possibility of cross-talk difficulties. Of course any current unbalances in two parallel lines greatly increase the danger of cross-talk.

Concentric tube line construction is not as simple as open wire construction. Considering the transmitting case, there is a smaller safety factor for voltage overloads. Insulators are required to withstand high voltage gradients. Temperature changes with ensuing line expansions and contractions must be given consideration. It is these factors in addition to the added expenditure for copper which make concentric line construction more costly than open wire construction.

The first consideration in the design of a concentric line is the weight of the outer sheath. If the line is to be employed for high power transmitting purposes the voltage safety factor may be so low that accidental dents in the sheath may lead to breakdown. Obviously, there is a choice between a large diameter, lightweight sheath

and more rugged small diameter sheath without an appreciable difference in copper expenditure. Other factors which involve the remainder of the radio plant often determine the size of the outer sheath. We have found that for outer sheaths a diameter of 2.5 inches and a radial thickness of 0.0875 to 0.10 inch provides lines which are sufficiently rugged for transmitting 15 kw of modulated power at 16 meters wave-length.

Careful consideration needs to be given to the problem of protecting concentric lines from voltage overloads which may be brought about by accidental open or short circuits or by flashovers. Voltages of the order of 30,000 to 90,000 volts may easily be built up in this manner at the shorter wave-lengths. Horn gaps are useful if located in the proper way. It is fortunate that conventional line input circuits are apt to be detuned in the event of an accidental open or short circuit on the line and that very little power may then be transmitted to the line.

Beads of high grade porcelain in diameters up to one inch are satisfactory insulators for low power and receiving lines. However, such simple insulators are not suitable for high power work. Owing to the volume of dielectric in large annular insulators sufficient heating may occur at the higher voltages to destroy the insulator. Insulators such as those described for line *B* Fig. 1 have been found suitable at the higher voltages.

The air film between the insulator and the inner conductor lies in a region of steep voltage gradient. Even under what is considered normal operating voltage there may be enough corona in this region to produce heating of the insulator. It may be of interest to mention that a line approximately as described in *B* Fig. 1 has been found satisfactory for normal operation at 16 meters for a carrier power of 15 kw. The line breaks down in the region of the insulator at 9000 r.m.s. volts.

For transmitting purposes it has been found desirable to employ glazed insulators in concentric tube lines because dirt, soldering fluxes, etc. acquired in assembly operations are more readily removed from glazed insulators.

There are a number of simple ways in which insulators may be held in place in concentric tube lines. For low power work and receiving purposes wire clips, rivets or even extruded metal ears upon the inner conductor, are satisfactory. As a rule these do not prove satisfactory at higher powers owing to high potential gradients at points and sharp edges. Small rings riveted or soldered upon either side of the insulator have proven satisfactory. Lines with soldered rings are more



easily repaired. Care must be exercised, however, to prevent condensation of metal and fluxes in the pores of the insulator.

In open wire construction it is customary to accommodate line variations brought about by temperature changes by adjusting the sag of the conductors. Provisions for temperature variations in concentric tube lines are not so simple. The first obvious remedy is to employ lines buried at sufficient depth so that temperature changes are reduced to a slow seasonal variation. At the present time a buried 3/8-inch line has been in service for more than one year without developing faults. Without longer experience with concentric lines we would question the advisability of burying larger lines which are to be

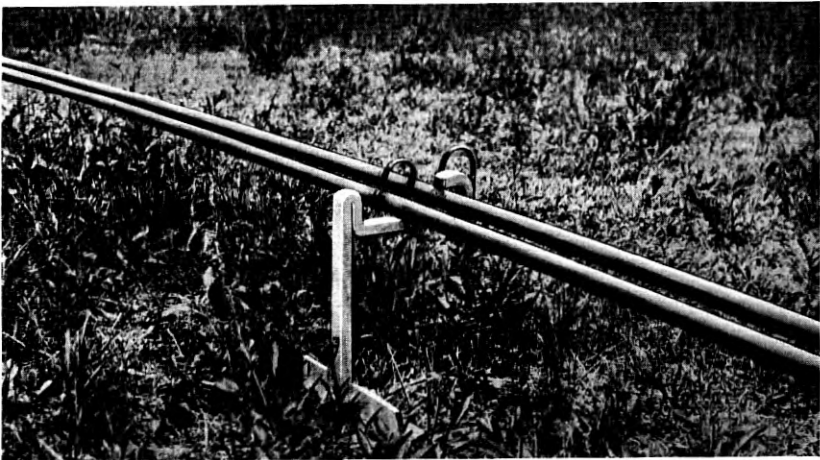

Fig. 18—A short section of three-quarter inch diameter line showing support for holding line in a sinuous form.

employed at high voltages due to the difficulty of finding faults should these occur.

A very simple scheme, suitable for small lines, is to reduce the effects of temperature variations by laying the line in a sinuous path as shown in Fig. 18. This construction permits the line to buckle slightly at the curves as the length varies and cumulative changes in length do not appear at the line terminals. The inner conductor is held loosely within the sheath so that it may buckle independently of the sheath. The outer conductor changes its length both at a different rate and at a different time from the inner conductor. With increasing temperature the sheath is at a higher temperature than the inner conductor. There is an appreciable time lag in heating of the inner conductor due

to the heat insulation of the air space between the conductors. Small lines laid in a sinuous manner have been found remarkably free from mechanical breakdowns brought about by temperature variations of length.

Sliding joints may be employed to accommodate variations in line length brought about by temperature changes. It is very difficult to make such joints water-tight without recourse to expensive fittings. There is also the possibility of microphonic contacts which are particularly objectionable in receiving work.

The expansion joints shown to the right of Fig. 19 have been em-

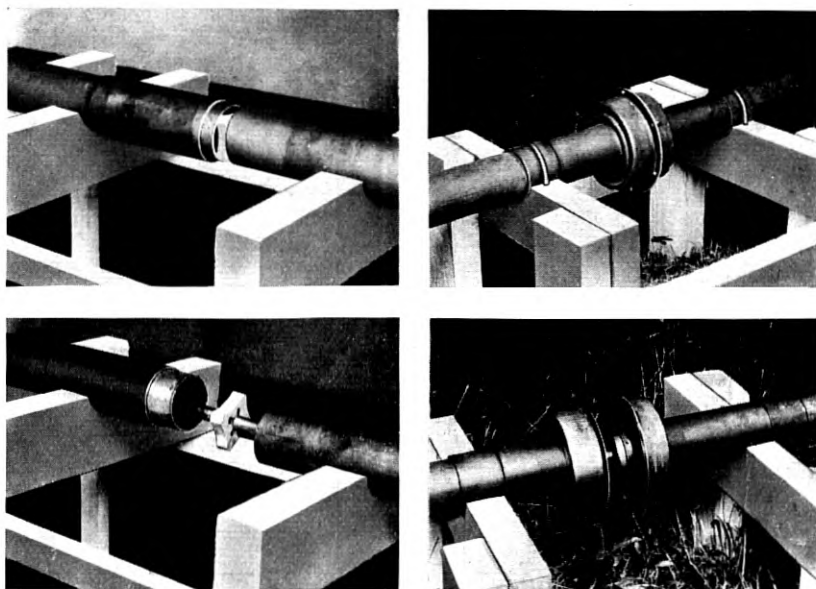

Fig. 19—Experimental expansion and lock joints for large sizes of concentric tube line.

ployed with some success. Dimensions and shapes should be chosen to minimize the irregularities in line impedance caused by expansion joints. It is a step in the right direction to maintain constant the ratio of conductor diameters at the joint. Even then, it has been found that the irregularities caused by 10 such joints in a 600-foot line are observable (approximately 10 per cent standing waves).

It is necessary that expansion joints be employed in conjunction with lock joints so arranged that no one joint is required to take more than a predetermined portion of the line expansion. One lock joint with an expansion joint 25 feet in either direction has been found to be

a satisfactory length within which line variations are corrected. The lock joint proper, Fig. 19, comprises an insulator of the same design as the intermediate insulators but made with an outer diameter equal to that of the outer sheath. It is held in place by a sleeve sweated to the sheath, the sleeve continuing the electric circuit. The insulator is also fixed to the inner conductor by means of rings. Since the lock joint is in a position symmetrical with respect to the two expansion

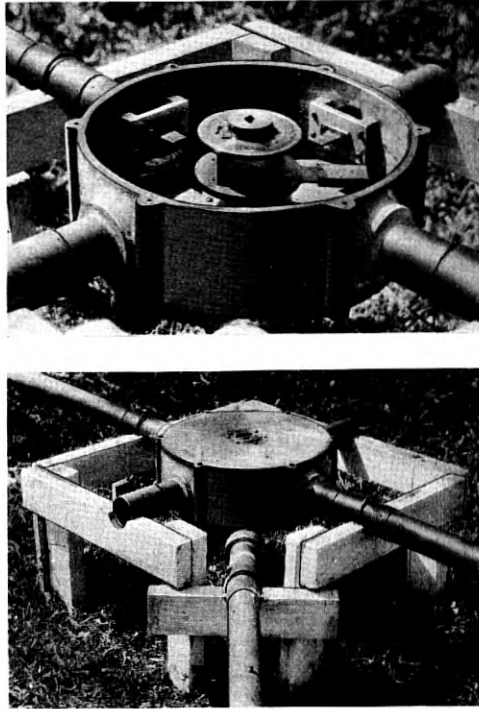

Fig. 20—An experimental selector switch for connecting several antenna lines to one transmitter line. The small coil antiresonates the capacity of the switch for the operating frequency associated with the particular contact to which it is connected.

joints it is required to withstand a shearing load brought about only by inequalities in the expansion of the conductors. In order to distribute the line expansion uniformly among the expansion joints it is necessary to clamp the outer sheath of the lock joint to a substantially braced support.

The joints described above are required to accommodate a total annual variation of 0.5 inches. After one year's period of experimental operation the few faults found in a line containing these joints were

nearly all traced to faulty construction at the braced support which clamps the lock joint.

Copper pipe lines may be too costly to permit the installation of more than one line per transmitter. In such cases a selector switch is required if several antennas are to be associated with one transmitter. Some of the details of such a switch may be obtained from the experimental arrangement shown in Fig. 20.

The switch is an irregularity on the line and a source of undesired reflections. This difficulty may be corrected by making the design such that capacitive reactance of the switch predominates and then anti-resonating this reactance with a suitable inductance. This scheme is effective provided the irregularity is not too great. In the latter event the corrective coil transforms the load impedance to a value different from the surge impedance so that the reflections arising from the mismatch are more serious than from the switch alone.

## VII. OTHER APPLICATIONS OF TRANSMISSION LINES

In this section are described a number of transmission line applications to radio work some of which are feasible only at high frequencies because the wave-length is short.

Small concentric lines approximately  $3/8$ -inch in diameter may be employed as radio-frequency wiring in radio stations. Such lines owing to the flexibility of the tubing may be snaked behind partitions in very much the same manner that armored or leaded conductors are installed. For this purpose refrigerator tubing has been found desirable because it is flexible and because it may be procured in long lengths. The inner conductor is insulated from the sheath by means of small porcelain beads spaced at intervals of approximately one inch. The beads are held in position by small metal ears extruded from the inner conductor. The beads fit loosely in the inner conductor so that the line may be bent into arcs as small as six inches radius. Construction details for small concentric lines may be obtained from Fig. 21.

Lines constructed from refrigerator tubing may be buried in the ground. Since only a few splices are necessary the possibility of faults arising from water seeping into the line are correspondingly small. A buried line constructed in this manner has been in service for more than a year without developing faults.

A number of the above-described lines may be terminated upon a jack board and circuits set up with patch cords as in telephone practice. Of course, the beads in the patch cords may be more closely spaced to assure flexibility and freedom from short circuits. The

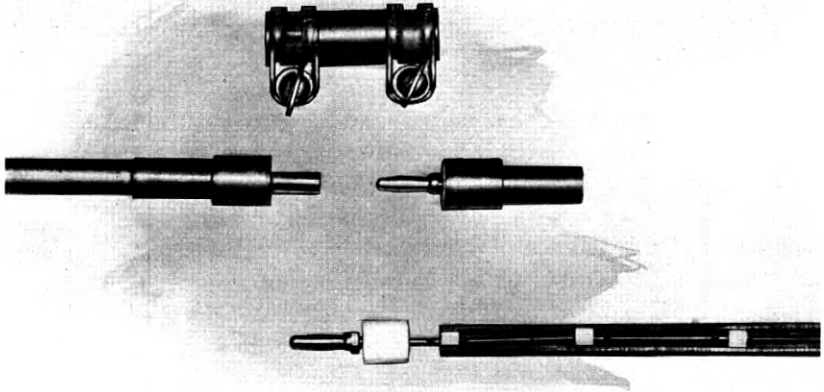

Fig. 21—Details of construction for small concentric lines suitable for station wiring and for patch cords. The plug-and-jack union is an effective scheme for temporarily connecting two small lines.

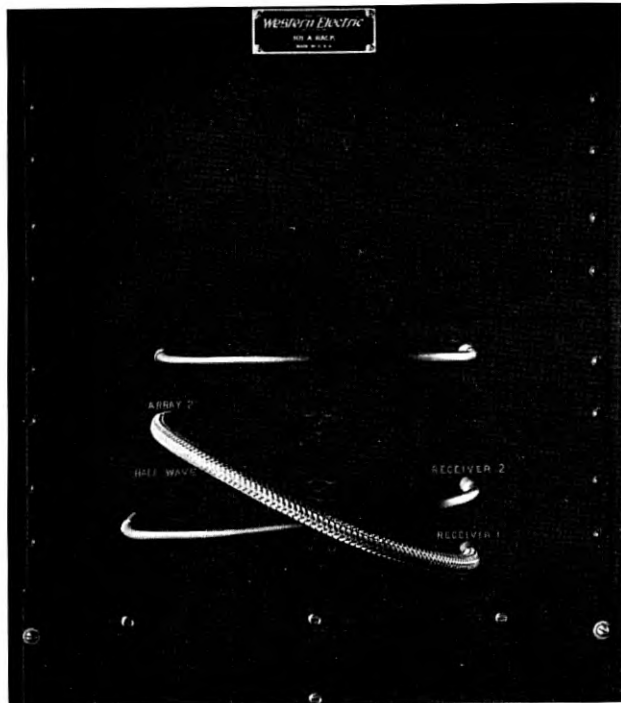

Fig. 22—An experimental radio-frequency jack board terminal for small concentric-tube lines. Path cords are constructed in the manner depicted in Fig. 21.

scheme is particularly advantageous where for operating reasons it is useful to connect any station antenna to a particular receiving unit. A board set up for this purpose is shown in Fig. 22.

Concentric-tube lines may be employed as standards of resistance when other standards become questionable. Since the agreement be-

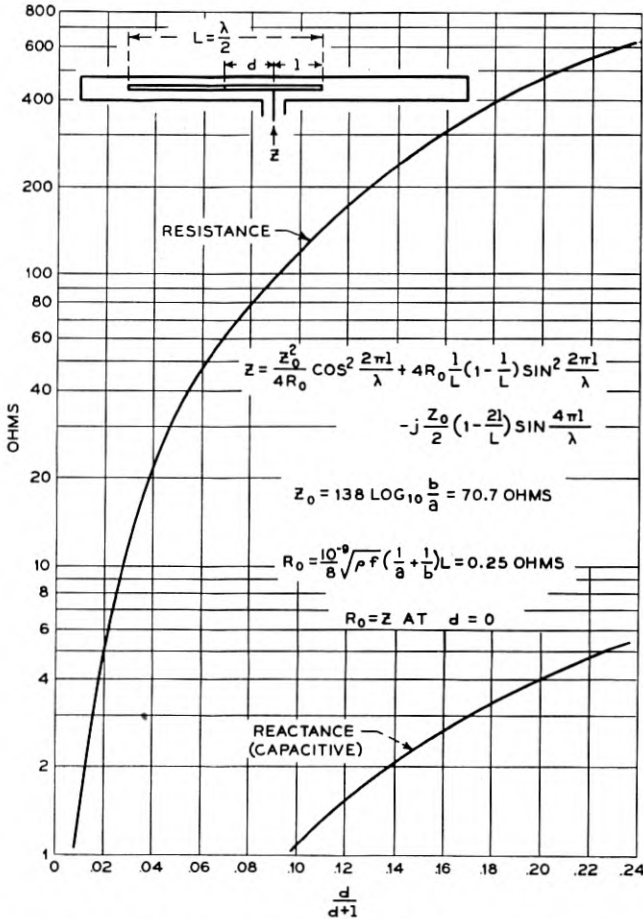

Fig. 23—A scheme for obtaining a calculable radio-frequency resistance standard which is essentially nonreactive and which is adjustable over wide limits of resistance.

tween theoretical and experimental values of radio-frequency resistance has been found very good at frequencies as high as 20 megacycles the theory may be considered adequate for much higher frequencies. One scheme for utilizing this situation so as to obtain an adjustable

radio-frequency resistance will be described. The scheme utilizes the resonant properties of a section of concentric-tube line of which the inner conductor is one-half wave-length long. The required resistance is obtained by a connection to the proper position on the inner conductor. The device is illustrated schematically on Fig. 23. It may be seen from the curves on this figure that the device is a means for obtaining a variable resistance which for most practical purposes is non-reactive. Additional advantages are that the device is rugged and that it may be designed to dissipate an appreciable amount of power.

For the purpose of testing transmitters and for other purposes in which the terminating network is required to dissipate several kilo-

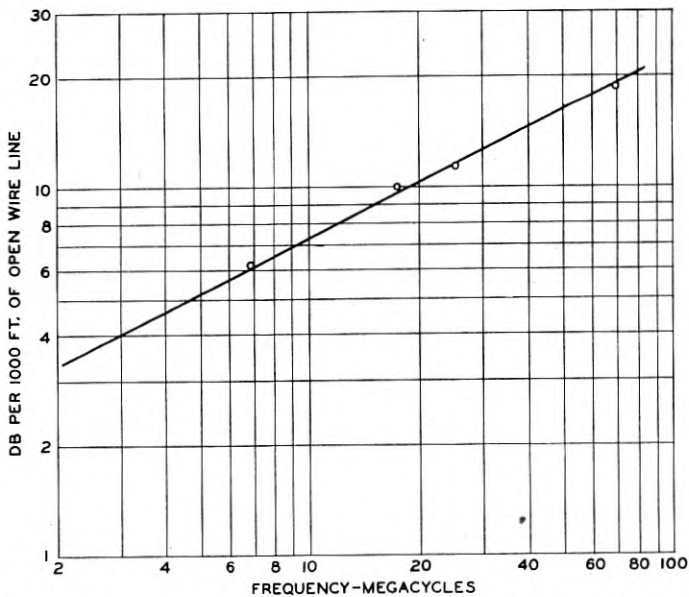

Fig. 24—The curve gives the attenuation in decibels for a balanced 600-ohm line constructed from No. 6 B & S iron wire.

watts, an iron wire line has been found to be of considerable utility. An iron wire line has the advantage that its impedance is almost independent of the frequency provided that the length of the line is sufficient. This impedance is very closely the characteristic impedance of the line. The far end of the line may be left either opened or closed. For operation at some one frequency the input impedance may be made more nearly equal to the characteristic impedance by means of a termination at the far end. For this purpose the scheme employing a short length of line as a parallel transforming impedance has been found very convenient.

An experimental attenuation curve for a 600-ohm line comprising 0.162-inch iron wire conductors is given in Fig. 24. The current entering the line was approximately one ampere. The measured resistivity for the iron is 12,300 e.m.u. The attenuation could be explained upon the basis that the permeability is 92.<sup>20</sup> This is not an unreasonable value. In fact it may be very desirable to obtain the permeability of iron at radio frequencies by forming the material into a transmission line and observing the line attenuation and direct-current resistance.

An iron wire line 1600 feet long has been in use at the Deal Laboratories for several years for the purpose of testing transmitters. This line successfully dissipates 15 kw. at 20 megacycles.

### VIII. CONCLUSION

In conclusion a few remarks on the relative utility of open-wire and concentric-tube lines may assist in selecting the most desirable construction for a particular service. A definite discrimination between the two is not readily made because the economics of the entire radio plant are involved.

Concentric lines are more costly than open-wire lines. On the other hand, concentric lines permit the installation of a number of radio units within a single structure without incurring difficulties from crosstalk. The first cost and annual charges upon a compact installation may more than offset the cost of the lines when compared with an installation comprising several widely separated structures. Also, concentric lines may be constructed so as to be weatherproof.

There is little choice between the losses in open and concentric lines provided that a reasonable degree of current balance in the open-wire lines is maintained. In order to obtain balances the open-wire line terminal equipment both at the antenna and at the radio unit ends of the line must be carefully designed. The chief source of current unbalance difficulties resides in couplings between the antenna and an open-wire line. These may be materially reduced but cannot be completely eliminated. Another source may be unbalances with respect to neutral at the radio unit.

Complete isolation of the antenna from the line can only be obtained with shielded lines. Similarly, complete isolation from static and other noise sources for which discrimination by the antenna is obtained can only be effected by shielded lines. This is particularly important in reception. In this case small concentric-tube lines with losses as much as 2 db per 1,000 feet may be used provided that the noise level is reduced by a corresponding amount.

<sup>20</sup> P. P. Cioffi, Bell Telephone Laboratories, New York City, found an initial permeability of 95 for a sample of the above wire.



We wish to acknowledge the helpful suggestions which have been received in the course of this work from Messrs. H. T. Friis, J. C. Schelleng, and M. E. Strieby. Valuable advice on some of the mathematical questions encountered has been received from Mr. T. C. Fry.

#### APPENDIX

The following formulas for the power radiated by transmission lines were obtained by the conventional method of postulating the current distribution, calculating the electromagnetic fields and from the fields, the associated radiation by means of Poynting's theorem. As an independent check the same current distribution was postulated and the radiated power calculated following the methods of Pistolcors<sup>21</sup> and Bechman.<sup>22</sup>

##### Case I

An approximation for a line terminated in its characteristic impedance is a balanced two-wire line carrying a non-attenuated traveling wave. For this case the power radiated is:

$$P_1 = 120I^2 \left[ \log_e (2L) - Ci(2L) + \frac{\sin (2L)}{(2L)} + 0.5772 - 1 \right. \\ \left. - 2Ci(A) + \frac{\sin A}{A} - \frac{\sin (\sqrt{L^2 + A^2} - L) + \sin (\sqrt{L^2 + A^2} + L)}{2\sqrt{L^2 + A^2}} \right. \\ \left. + Ci(\sqrt{L^2 + A^2} - L) + Ci(\sqrt{L^2 + A^2} + L) \right] \text{ watts,} \quad (1)$$

in which

$$A = \frac{2\pi a}{\lambda},$$

$$L = \frac{2\pi l}{\lambda},$$

$$\frac{a}{\lambda} = \text{line spacing in wave-lengths,}$$

$$\frac{l}{\lambda} = \text{line length in wave-lengths,}$$

$$I = \text{r.m.s. value of current in each wire, and}$$

$$Ci( ) = \text{cosine integral.}^{23}$$

The equation simplifies considerably if it is assumed that  $a/\lambda$  is small so that:

$$\sin A \approx A \text{ and } L \gg A,$$

<sup>21</sup> A. A. Pistolcors, *Proc. I. R. E.*, p. 562, March, 1929.

<sup>22</sup> R. Bechman, *Proc. I. R. E.*, p. 461, March, 1931.

<sup>23</sup> See Jahnke und Emde, "Funktionentafeln."

under which condition:

$$P_1 = 160I^2 \left( \frac{\pi a}{\lambda} \right)^2 \text{ watts.} \quad (1a)$$

The numerical constant in (1a) differs somewhat from a result published some time ago by Carson.<sup>24</sup>

### Case II

An approximation for an unterminated line is a balanced two-wire line bearing standing waves of the form:

$$I_x = I \cos \left[ \frac{2\pi x}{\lambda} + \frac{2\pi m}{\lambda} \right].$$

For this case the power radiated is:

$$\begin{aligned} P_2 = 60I^2 \left[ \log_e(2L) - Ci(2L) + 2 \cos M \cos(L - M) \frac{\sin L}{L} + 0.5772 \right. \\ \left. - 2Ci(A) + \frac{\sin A}{A} [\cos^2 M + \cos^2(L - M)] \right. \\ \left. - \cos^2 M - \cos^2(L - M) - 2 \cos M \cos(L - M) \frac{\sin \sqrt{L^2 + A^2}}{\sqrt{L^2 + A^2}} \right. \\ \left. + Ci(\sqrt{L^2 + A^2} - L) + Ci(\sqrt{L^2 + A^2} + L) \right] \text{ watts,} \quad (2) \end{aligned}$$

in which  $M = 2\pi m/\lambda$ .

If as before it is assumed that the spacing is small and the line long the equation reduces to the following cases:

### Case II-A

When the current is zero at both ends of the line, then,

$$\sin L = 0 \quad \text{and} \quad \sin M = \pm 1$$

and the radiated power is:

$$P_2 = 120I^2 \left( \frac{\pi a}{\lambda} \right)^2 \text{ watts.} \quad (2a)$$

This agrees with a result published by Manneback.<sup>25</sup>

<sup>24</sup> John R. Carson, *Jour. A. I. E. E.*, p. 789, October, 1921.

<sup>25</sup> Charles Manneback, *Jour. A. I. E. E.*, p. 95, February, 1923.

*Case II-B*

When the current is zero at one end and maximum at the other end of the line, then,

$$\begin{aligned} \sin M &= \pm 1 \text{ and } \cos L = 0 \\ \text{or } \cos M &= 1 \text{ and } \sin L = \pm 1 \end{aligned}$$

and the radiated power is:

$$P_2 = 80I^2 \left( \frac{\pi a}{\lambda} \right)^2 \text{ watts.} \quad (2b)$$

*Case II-C*

When the current is maximum at each end of the line, then,

$$\sin M = 0 \quad \text{and} \quad \cos L = \pm 1$$

and the radiated power is:

$$P_2 = 40I^2 \left( \frac{\pi a}{\lambda} \right)^2 \text{ watts.} \quad (2c)$$

The approximation for the power radiated by unbalanced currents is essentially the case of a long wire parallel to a perfect earth. The approximation may be obtained from (2) by assuming that power is radiated only in one hemisphere, which divides the numerical constant by a factor of two and by writing for  $a$  the quantity  $2h$ ,  $h$  being the height of the wire above ground. Equation (7) of the paper is written on the basis that ( $\sin M = \pm 1$ ).

It is of interest to compare some of the above results with those for the case of a single conductor far removed from reflecting surfaces. If the wire is excited so as to bear standing waves of  $I$  r.m.s. amperes maximum value the radiated power is:

$$\begin{aligned} P_3 = 30I^2 \left[ 0.5772 + \log_e (2L) - Ci(2L) - \cos^2 M - \cos^2 (L - M) \right. \\ \left. + 2 \cos M \cos (L - M) \frac{\sin (L)}{(L)} \right] \text{ watts.} \quad (3) \end{aligned}$$

If the wire is "terminated" so that there are no reflections from the ends a uniform current of  $I$  r.m.s. amperes may be assumed to exist along the wire. In this case the power radiated is:

$$P_4 = 60I^2 \left[ 0.5772 - 1 + \log_e (2L) - Ci(2L) + \frac{\sin 2L}{2L} \right] \text{ watts.} \quad (4)$$

## An Efficient Miniature Condenser Microphone System\*

By H. C. HARRISON and P. B. FLANDERS

It has been shown recently that microphones and contiguous amplifiers distort the sound field in which they are placed by reason of their size and the cavity external to the diaphragm of the microphone. For frequencies such that the size is large compared to the wave-length of perpendicularly incident sound, reflection causes the actuating pressure to be double that which would exist in the undisturbed field. If the direction of the incident sound be along the plane of the diaphragm, the increase of pressure due to reflection is not as great; but there may be a substantial reduction in effective pressure due to differences in phase across the diaphragm. In addition, cavity resonance produces an increase of pressure at frequencies usually within the working range of the microphone.

This paper describes a laboratory model of a Wentz-type condenser microphone of high efficiency and an associated coupling amplifier which are of such small size that reflection and phase-difference effects are of negligible importance within the audible frequency range; while the cavity is so proportioned that its resonance effect is an aid rather than a detriment to uniformity of response in a constant sound field.

SEVERAL writers<sup>1</sup> have recently called attention to the fact that a microphone distorts the sound field in which it is placed by reason of its size and the cavity external to the diaphragm. The distortion due to size was first mentioned by I. B. Crandall and D. MacKenzie in 1922.<sup>2</sup> It is a function of the direction of the sound with respect to the diaphragm.<sup>3</sup> The distortion due to cavity resonance is substantially independent of direction and depends mainly on the relation between the dimensions of the cavity and the wave-length of sound.

If a microphone were to be designed so that it would respond uniformly to sound coming from any direction, it is apparent that first the size would have to be diminished to such an extent that reflection and phase-difference effects became negligible. Secondly, the cavity would either have to be eliminated entirely<sup>4</sup> or else be so proportioned that resonance occurred at frequencies above the resonance frequency of the diaphragm, where the response of the latter was diminishing. Such mutual compensation is possible in a small microphone and the effect is substantially independent of the direction of sound.

\* Presented before Acous. Soc. Amer., New York, N. Y., May 3, 1932.

<sup>1</sup> A. J. Aldridge in *P. O. E. E. Jour.*, Oct., 1928, pp. 223-225; S. Ballantine in *Phys. Rev.*, Dec., 1928, pp. 988-992; W. West in *I. E. E. Jour.*, 1929, pp. 1137-1142.

<sup>2</sup> *Phys. Rev.*, March, 1922.

<sup>3</sup> L. J. Sivian in *B. S. T. J.*, Jan., 1931, pp. 96-116.

<sup>4</sup> S. Ballantine in "Contributions from the Radio Frequency Laboratories," No. 18, April 15, 1930.

This paper will discuss the factors relating the dimensions of a condenser-type microphone system with the several types of field distortion, and will describe a miniature system designed to practically eliminate such distortions over a wide frequency range.

DIFFRACTION OF SOUND AROUND AN OBSTACLE

The shapes of condenser microphones alone or in association with amplifiers are so irregular that it is impossible to calculate their effect as diffractors of sound waves. It will suffice, however, to assume some regular shape approximating actuality, for which calculations can be made. The diffraction effects so obtained for the regular shape will be substantially the same as those caused by the actual irregular shape, provided their areas projected on the plane of the incident sound-waves be equal. Cavity resonances, of course, may be quite different in the two cases. But these can be treated as separate effects, and will be so considered in a later section of the paper. In this section, only those disturbances of the sound field, caused by the smooth envelope of the microphone alone or with its amplifier, will be considered.

The case of diffraction of plane sound waves around a spherical

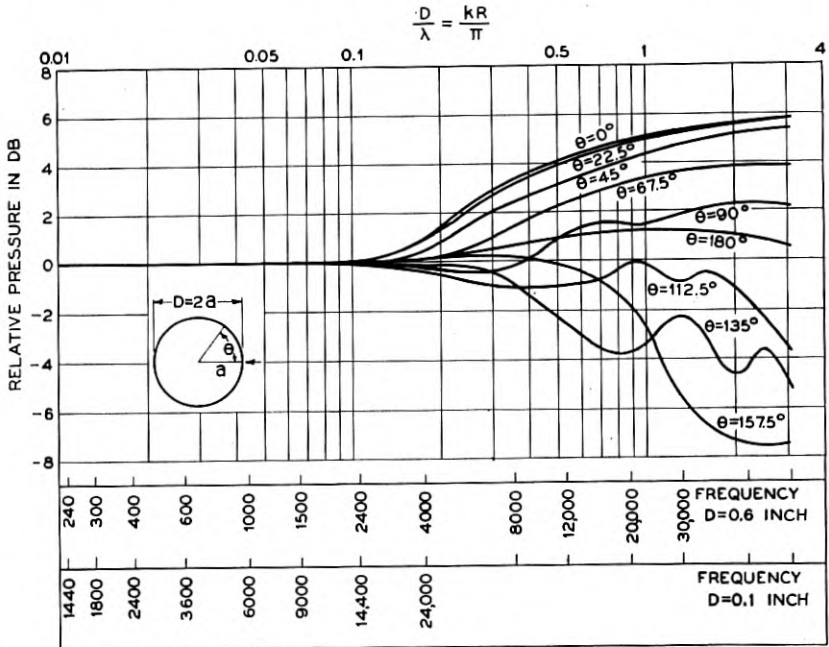

Fig. 1—Variation in pressure on rigid sphere due to diffraction of plane sound waves.

obstacle is amenable to mathematical treatment, and was considered theoretically by Raleigh. Quantitative consideration of the effect at a point on a sphere directly in line with the oncoming sound has been given by S. Ballantine.<sup>1</sup> Fig. 1 shows the effect for other polar angles around the sphere, as computed from Ballantine's equation. Of particular theoretical interest is the curve for a polar angle of  $180^\circ$ ; that is, the point that should be most completely "shadowed" from the sound. Actually, no shadowing effect appears, the pressure remaining substantially equal to that of the undisturbed field. This case is analogous to that where diffraction of light causes a bright spot to appear in the center of the shadow of a circular disk. The area of this acoustic bright spot is small, as may be seen by the pronounced shadowing of a point only  $22\frac{1}{2}^\circ$  away. Because of its small area, it is impractical to make use of the effect in microphone design.

#### EFFECT OF PHASE-SHIFT IN A PLANE SOUND WAVE TRAVELING ALONG THE PLANE OF THE DIAPHRAGM

In Appendix I is given an approximate calculation of the reduction in effective pressure on a circular diaphragm, due to the change in

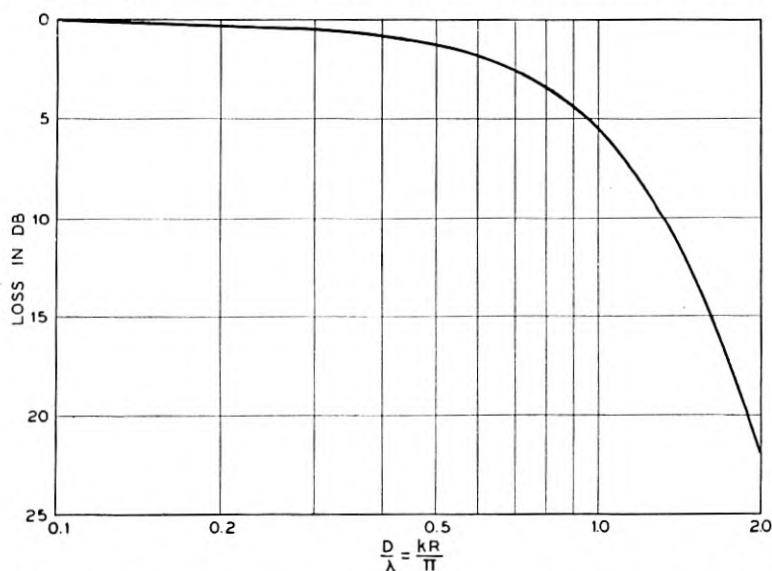

Fig. 2—Loss in effective pressure due to phase-shift in plane sound waves traveling across circular diaphragm.

phase of a progressive plane wave traveling across it. The effect is plotted in Fig. 2. As might be expected, the reduction becomes

<sup>1</sup> Loc. cit.

considerable when the diameter of the diaphragm exceeds the wavelength. Since in normal use, a large proportion of the sound actuating the microphone comes in a transverse direction, the distortion due to this phase-cancellation effect may often be more serious than the distortion due to diffraction.

#### CAVITY RESONANCE

The effect of a cylindrical cavity on the pressure actuating a diaphragm is given by equation (5) in Appendix II and is shown graphically in Fig. 3. It is apparent that the larger the ratio of diameter

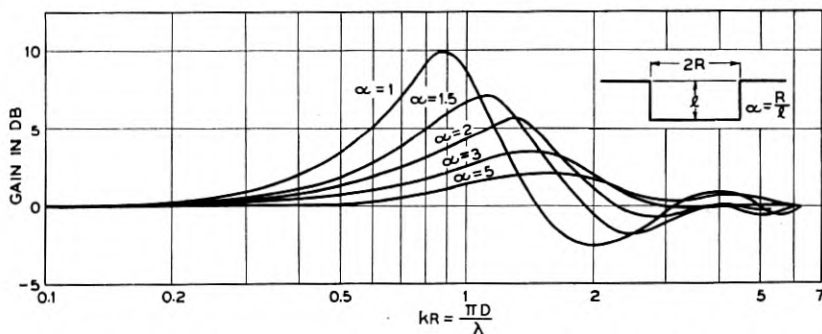

Fig. 3—Gain in effective pressure on circular diaphragm due to cavity resonance.

to wave-length, the smaller is the resonance effect; and that the greater the ratio of a given diameter to the depth of the cavity, the higher the frequency at which such resonance occurs. There is, of course, more than one resonance. However, for the higher resonances there is a greater ratio of diameter to wave-length with a consequent increase in damping; so that the resonance effect is less pronounced. Compared to the primary resonance, the secondary resonances are, as a rule, of negligible importance.

#### ACOUSTIC AND ELECTRICAL CONSIDERATIONS AFFECTING THE SIZE OF A CONDENSER MICROPHONE

If diffraction effects for all angles of incidence are to be negligible in a frequency range extending, for example, to 15,000 c.p.s., it is apparent from Fig. 1 that the diameter of the microphone should not be greater than about a tenth of an inch. Assuming that all other dimensions and characteristics remain fixed, including the resonance frequency of the diaphragm and the ratio of dead to active capacity, it can be shown that as the diameter of a condenser microphone diaphragm is decreased, the ratio of generated voltage to actuating

pressure remains constant. The diameter can not be decreased indefinitely, however, because of the limitations of amplifiers with which the condenser microphone must of necessity be closely associated. The resistor for feeding the polarizing voltage and the grid biasing resistor must be increased as the diameter of the diaphragm (and consequently the active capacity) is reduced, in order that, at low frequencies, the same proportion of generated voltage may get to the grid of the amplifier tube. They must not be made too large, however, for then the voltages due to thermal agitation<sup>5</sup> in the resistors will become comparable to the signal voltage. Similarly, the capacity of the input leads, vacuum tube and resistors will become comparable to the lowered capacity of the microphone, with a consequent reduction in signal voltage at the grid, over the whole frequency range. The actual limit in reducing microphone size can not be defined accurately; but it is definitely greater than one-tenth of an inch.

Further consideration of the diffraction problem, however, shows that such an extremely small size is not really necessary in order to practically eliminate sound-field distortion. When sound is picked up indoors at some distance from the source, the directly incident sound contributes much less to the microphone output than does the reflected sound arriving from other angles of incidence.<sup>3</sup> The greater part of the effective actuating pressure comes then at polar angles in the vicinity of  $90^\circ$ , where the diffraction effect is much less pronounced. If  $90^\circ$  be taken as an effective average angle, it is seen from Fig. 1 that the diameter of a microphone need only be reduced to about six-tenths of an inch in order to make this type of distortion negligibly small.

If sound is picked up out-of-doors, or indoors near the source, the directly incident waves predominate over the reflected waves. For this case it will suffice to place the microphone so that the sound arrives at a polar angle of  $90^\circ$ ; and a six-tenths inch diameter is still sufficiently small.

Inspection of Fig. 2 shows that the phase-difference loss is about 1 db at 10,000 c.p.s. for this diameter; so that six-tenths of an inch can safely be chosen as an acceptable design value.

#### THE AMPLIFIER

Consideration has now been given to the problem of reducing the size of a microphone to such an extent that it would not appreciably disturb the sound-field. But all such labor is in vain if the size of

<sup>5</sup> J. B. Johnson, *Phys. Rev.*, July, 1928, pp. 97-109.

<sup>3</sup> Loc. cit.



the coupling amplifier be not correspondingly decreased, since, for efficient operation, the high impedance of the microphone necessitates a close spacial coupling between the two.

Use of a special miniature type vacuum tube affords the possibility of materially reducing the size of the coupling amplifier. It is but slightly greater in diameter than the microphone just described, the inter-electrode capacities are quite low, and the plate resistance is not too high. This tube, with the necessary coupling resistors and a small stoppage condenser are placed within a cylindrical metal tube of about 0.8 inch diameter, to one end of which is attached the condenser microphone. From the other end of the cylinder extends a shielded cable along the axis of which runs the plate lead from the vacuum tube. This cable is constructed so that the capacity of the lead to ground is small. Surrounding the lead are two filament supply conductors and a conductor for supplying polarizing voltage to the microphone. The impedance between these and ground being very small, their capacity to ground may be as large as desired. Of course, the longer the connecting cable, the lower must be the capacity of the plate lead per unit length. The second stage, to which the cable runs, may be large, and as distant from the miniature first stage as is consistent with these lead capacity requirements.

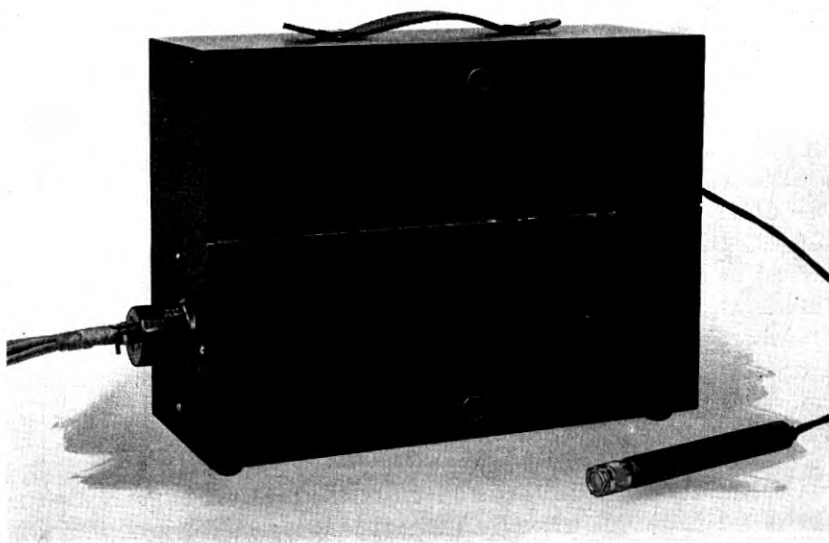

Fig. 4—View of miniature microphone and attached miniature coupling amplifier, together with second amplifier stage.

The miniature microphone and the miniature vacuum tube with necessary coupling resistors and a stoppage condenser are contained in the metal tube shown in the right foreground of Fig. 4. The dimensions of the container tube are about 7.5 inches long and 0.8 inch in diameter. The carrying case houses the second stage amplifier together with other accessories.

#### CONCLUSION

For the same frequency range, the efficiency of this miniature microphone as determined by a thermophone calibration is about 2.5 db greater than that of the 394W type, because of a lower proportion of dead to active capacity. In combination with a well designed amplifier, the efficiencies as determined by the voltages on the grid of the tube are about equal, most of the proportional contribution to dead capacity in the one case coming from the amplifier, and in the other case from the microphone.

In this miniature condenser microphone, the diaphragm is tuned higher than is the 394W, so that the efficiency in association with the amplifier is about 3 db lower than that of the 394W. The resonance of the external cavity gives a maximum lift in response of about 3 db. The microphone as a whole responds uniformly up to 10,000 c.p.s. The diffraction and phase-difference effects are negligible up to that frequency.

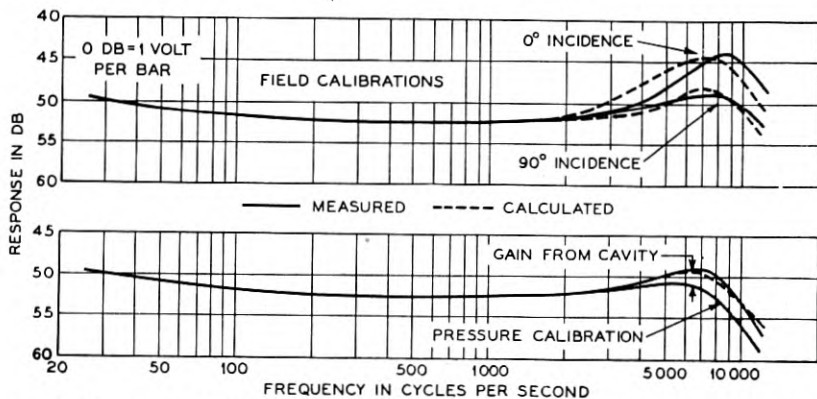

Fig. 5—Pressure and field calibrations of miniature condenser microphone, showing cavity effect.

Curves showing the constant pressure and constant field<sup>3</sup> calibrations of this microphone are given in Fig. 5.

The work on this miniature microphone system has so far been essentially of a research nature, and its use has been directed primarily

<sup>3</sup> Loc. cit.

to fundamental laboratory problems in the field of sound measurements. The necessary work toward commercialization has not been effected, in view of the high quality performance and certain practical advantages of available types of microphones.

## APPENDIX I

For a stretched membrane, the equation expressing the statical deflection  $\xi$  as a function of the radius  $r$ , for a symmetrical distribution of pressure  $p$ , is <sup>6</sup>

$$(1) \quad p = -\frac{\tau}{r} \frac{d}{dr} \left( r \frac{d\xi}{dr} \right),$$

where  $\tau$  is the tension coefficient. Two integrations give

$$(2) \quad \xi = \frac{1}{\tau} \int_r^R \left[ \frac{1}{r} \int_0^r p r dr \right] dr,$$

where  $R$  is the bounding radius. The central displacement is evidently

$$(3) \quad \xi_0 = \frac{1}{\tau} \int_0^R \left[ \frac{1}{r} \int_0^r p r dr \right] dr.$$

Now, considering the case of a progressive plane wave

$$p = P \cos (\omega t - kx)$$

(where  $k = \frac{2\pi}{\text{wave-length}}$ ) traveling across this membrane, an expression can be computed for the average pressure on the boundary of the circle of radius  $r$ . From Fig. 6 it is clear that

$$x = R - r \cos \theta$$

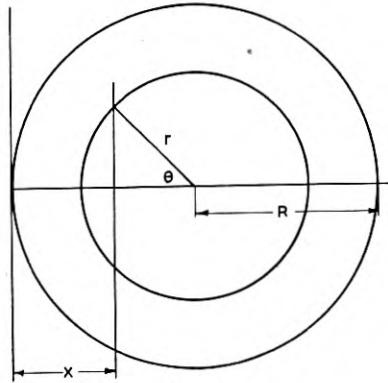

Fig. 6—

<sup>6</sup> See Lamb's "Dynamical Theory of Sound," § 54.

and hence that

$$\begin{aligned} p &= P \cos [(\omega t - kR) + kr \cos \theta] \\ &= P[\cos (\omega t - kR) \cos (kr \cos \theta) - \sin (\omega t - kR) \sin (kr \cos \theta)]. \end{aligned}$$

The average pressure is

$$\begin{aligned} p_{av} &= \frac{1}{\pi} \int_0^{\pi} p d\theta \\ &= \frac{P \cos (\omega t - kR)}{\pi} \int_0^{\pi} \cos (kr \cos \theta) d\theta \\ &\quad - \frac{P \sin (\omega t - kR)}{\pi} \int_0^{\pi} \sin (kr \cos \theta) d\theta. \end{aligned}$$

Here the second integral is zero, while the first may be written

$$\begin{aligned} p_{av} &= \frac{2P}{\pi} \cos (\omega t - kR) \int_0^{\pi/2} \cos (kr \cos \theta) d\theta \\ &= \frac{2P}{\pi} \cos (\omega t - kR) \int_0^{\pi/2} \cos (kr \sin \theta) d\theta \end{aligned}$$

and is readily identified as a Bessel function.

$$(4) \quad p_{av} = P \cos (\omega t - kR) J_0(kr).$$

Substitution of (4) in (3) gives an approximation to the total effect (on the central displacement) of these average pressures acting over the whole diaphragm.

$$(5) \quad \xi_0 = \frac{P \cos (\omega t - kR)}{\tau} \int_0^R \left[ \frac{1}{r} \int_0^r J_0(kr) r dr \right] dr.$$

Now

$$\int_0^r J_0(kr) r dr = \frac{r}{k} J_1(kr)$$

and

$$\int_0^R \frac{1}{k} J_1(kr) dr = \frac{1}{k^2} [1 - J_0(kR)]$$

so that

$$(6) \quad \xi_0 = \frac{P \cos (\omega t - kR)}{k^2 \tau} [1 - J_0(kR)].$$

The displacement when  $R$  is small compared to the wave-length, i.e.  $k = 0$  is

$$(7) \quad \xi_0' = \frac{PR^2 \cos \omega t}{4\tau}.$$

The ratio of (6) to (7) in amplitude is

$$(8) \quad \left| \frac{\xi_0}{\xi_0'} \right| = \frac{4[1 - J_0(kR)]}{(kR)^2},$$

which is plotted as db loss vs.  $kR$  in Fig. 2.

There are two approximations involved in this analysis, both involving equation (3). One is that for  $p$  (which should be constant for a given  $r$ ), can be taken the average of the actual pressures around the circle of radius  $r$ . The other is that the shape of the static deflection curve represents the actual shape up to the highest frequencies of interest in (8).

#### APPENDIX II

Assuming (1) that the air particles, in the plane of the entrance to the cavity, all move in phase with equal velocities  $v_1$  which are normal to that plane, and (2) that the impedance per unit area of the microphone diaphragm is large compared to  $\rho c$ , where  $\rho$  is the density of air and  $c$  is the velocity of sound, the following three relations hold: From the theory of plane wave propagation in a tube,

$$(1) \quad p_2 = p_1 \cos kl - i\rho c v_1 \sin kl$$

where  $p_1$  is the pressure in the plane of the entrance to the cavity of depth  $l$  and  $p_2$  is the pressure at the diaphragm. Also, the input impedance per unit area of this closed cylindrical tube is

$$(2) \quad \frac{p_1}{v_1} = -i\rho c \cot kl.$$

Now  $p_1$  is equal to the pressure  $P$  that would exist at the opening if the air particles were held stationary, diminished by the drop in pressure due to their motion and the consequent radiation from the opening. In symbols,

$$(3) \quad p_1 = P - \rho c(a + ib)v_1,$$

where  $(a + ib)$  is the radiation impedance coefficient given by Raleigh<sup>7</sup> for the case of a circular piston in an infinite wall:

$$(4) \quad a = 1 - \frac{J_1(2kR)}{kR},$$

$$b = \frac{8kR}{\pi} \sum_{n=1}^{n=\infty} (2n+1) \left( \frac{2^n |n|}{|2n+1|} \right)^2 (-4k^2 R^2)^{n-1}.$$

<sup>7</sup> "Theory of Sound," Vol. II, § 302.

Elimination of  $p_1$  and  $v_1$  from the first three equations gives

$$(5) \quad \left| \frac{P}{p_2} \right| = \sqrt{(\cos kl - b \sin kl)^2 + a^2 \sin^2 kl}$$

as the expression for the change in acoustic pressure on a diaphragm, caused by the entrance cavity.<sup>8</sup> It is plotted as db gain in Fig. 3.

Similar calculations have been given by other writers.<sup>3, 9</sup>

<sup>8</sup> Numerical values of the functions  $a(kR)$  and  $b(kR)$  are given in Crandall's "Theory of Vibrating Systems and Sound," Fig. 19, p. 172.

<sup>3</sup> Loc. cit.

<sup>9</sup> W. West, in *Jour. I. E. E.*, April, 1930.

## Wire Communication Aids to Air Transportation \*

By H. H. NANCE

**R**APID development of air transportation in this country has continued through the past few years and today established routes connect nearly all important cities. The route mileage of the airways in the United States as shown in Fig. 1 totals over 30,000 miles. Regularly scheduled transport service is given on practically all of these routes and considerable use of them is also made by military and private planes. Statistics relating to service of air transport companies seem particularly significant. The United States Department of Commerce reported approximately 42,800,000 miles flown in passenger, mail and express service on domestic scheduled lines in 1931, an increase of 35 per cent over the preceding year and more than a fourfold increase since 1928. In the same three-year period passengers carried increased ninefold, reaching a total of around 470,000 in 1931. Along with this growth safety has been increased as indicated by the respective 1928 and 1931 reports of 250,000 and 750,000 miles flown per accident. Reasonable regularity of schedules on air transport lines also has been maintained, the ratio of miles actually flown to scheduled miles last year being in the order of 92 per cent.

Communication facilities have been an important contributing factor to all this development and improvement. It was recognized early that fast and reliable communication would be needed in connection with any extensive development of air transportation. Communication with planes in flight was an obvious requirement and this could be provided only by radio. For land service, however, experience has indicated that wire facilities best meet the general requirements. This paper describes the wire communication facilities in general use today, both by the Government and by transport companies, as aids to air transportation.

Principal airways have been established largely through Federal aid. In addition to marking and lighting airways the Airways Division of the Department of Commerce had provided up to April 1, 1932, 67 radio telephone stations at approximately 200-mile intervals as indicated in Fig. 1, to be used for broadcasting weather reports and similar

\* Presented at Summer Convention of A. I. E. E., Cleveland, Ohio, June 20-24, 1932. Published in abridged form in *Elec. Engg.*, July, 1932.

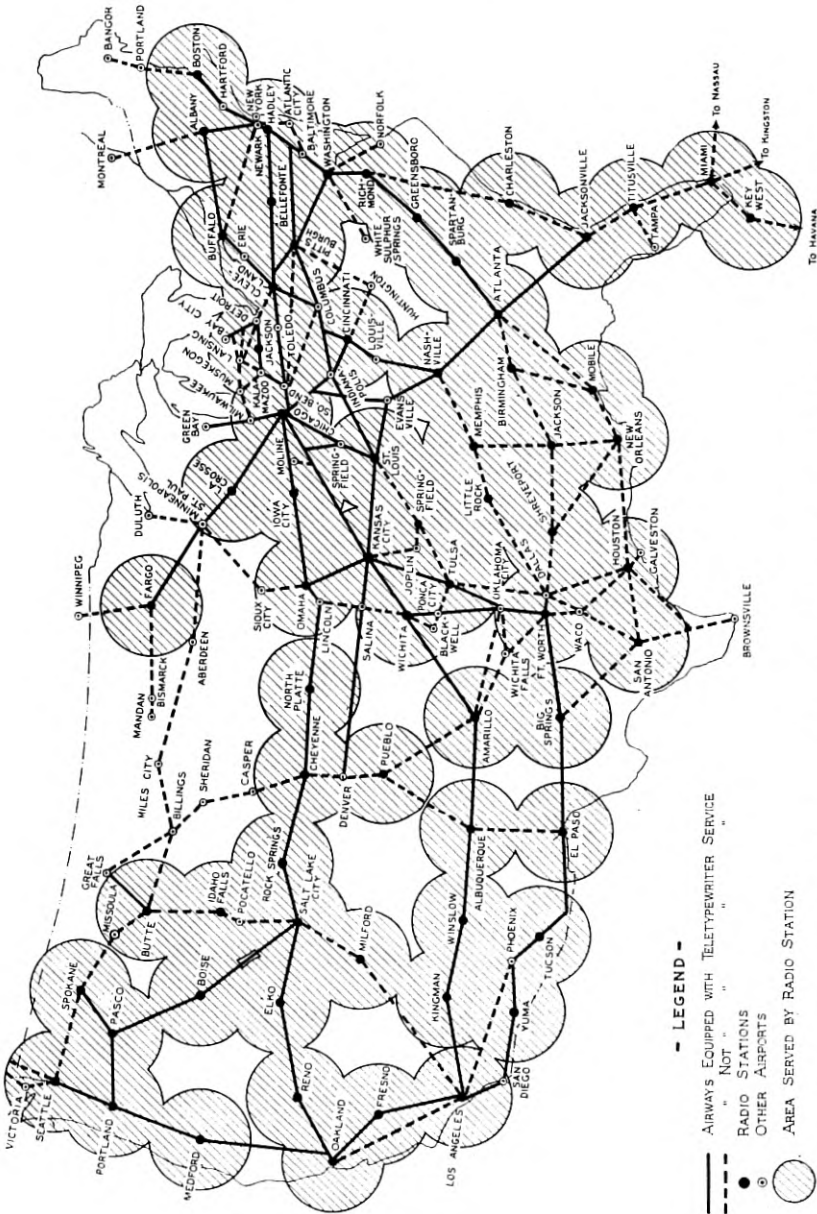

Fig. 1—Airway map of the United States showing routes equipped with teletypewriter service.



information to planes in flight and for transmitting directive radio beacon signals for enabling planes to keep on the course. In conjunction with these services it had contracted for 24-hour teletypewriter service along 13,000 miles of main airways connecting some 250 stations, principally for the purpose of transmitting weather reports and to assist in dispatching the planes. All of these facilities have been made available without cost to aircraft operating companies and others using the airways.

In addition to this communication service contracted for by the Government, approximately 5,000 miles of teletypewriter circuit are used daily in furnishing private wire communication service to a number of transport companies for transmitting information pertaining to the operation of their own lines. Routes on which these facilities are furnished to the Government and transport companies are indicated by heavy lines in Fig. 1.

When the first air mail service was established, radio telegraph was introduced as a means of point-to-point communication along the New York-Chicago-San Francisco airway route. At each radio station meteorological data were collected from surrounding points by means of long distance telephone and telegraph and these data were exchanged periodically through the day with the other stations over the radio telegraph.

With a rapid expansion in air transport service foreseen it was apparent there would be a large increase in communication requirements not only to equip new routes but to handle increased volume on existing routes. There was the definite requirement for radio telephone communication with planes which would need a number of the radio channels allotted to this service. Considering these factors and the geographic and other conditions applying to probable development of air transportation in the United States, it seemed that regular point-to-point service served by radio telegraph could be provided more satisfactorily in another way.

Arrangements were made in 1928 for teletypewriter communication services at several points connecting radio stations with their local weather bureau offices in order to expedite the delivery of weather reports and other traffic handled by radio telegraph. Shortly afterward, a teletypewriter system was installed on the New York-Cleveland route connecting the Department of Commerce and Weather Bureau stations at Hadley Field, Stelton, N. J., and Cleveland, Ohio, and a number of intermediate points. This type of service seemed ideally fitted for use in weather reporting and plane dispatching and has been extended not only to replace the service furnished by the radio telegraph system but also to provide for communication requirements on other routes.

Teletypewriter service offers the advantages of simultaneous communication with any desired number of stations, the communications being automatically recorded on machines at each point. A message using code or abbreviations, if desired, can be sent instantly without the necessity of calling in or checking with the receiving stations; thus the immediate attention of only the sending operator is required. Automatic recording reduces the possibility of human error and permits the most efficient use of operating personnel with resulting savings in labor. Furthermore, as contrasted with radio, this system, utilizing wire transmission, is not so subject to variations in meteorological conditions; it is thus more dependable, and has the advantage that it can be readily extended to handle large volumes of business. This system also is well adapted for carrying on administrative and other work as well as for weather reporting and plane dispatching.

#### TRANSMISSION OF WEATHER REPORTS

Material progress has been made in reducing the effect of weather hazards to air transportation, through the service rendered by the Department of Commerce and United States Weather Bureau in the collection and dissemination of weather reports supplemented by other reports collected by individual transport companies from planes in flight. For this service a system of practically continuous reporting and forecasting for areas along air routes has been developed and weather observations have been extended to include data of particular benefit to air navigation.

The teletypewriter networks furnished the Department of Commerce are devoted largely to this purpose and in conjunction with its radio telephone broadcasting service are the means for providing to pilots information relating to existing conditions and forecasts for both general and local areas.

Twelve selected Weather Bureau airport stations located at strategic points in the country's airway network prepare summaries of weather conditions in their own areas and make area forecasts every three hours based on data collected over the Department of Commerce circuits from connected airway stations and over commercial telegraph lines from other reporting points. These summaries and forecasts are then transmitted over the teletypewriter circuits and made available to all airway stations.

While the forecasts include predictions as to storm developments or movements, conditions in specific localities are often likely to change rapidly and it has been necessary to provide additional reports along the air routes on an hourly basis in order to keep pilots continuously

advised of conditions likely to be encountered. Consequently, the airway keepers and Weather Bureau observers at the various teletypewriter stations make local observations of general weather conditions, ceiling height, visibility, wind direction and velocity, temperature, and barometric pressure, every hour. These data are then sent by teletypewriter and automatically recorded at all points in accordance with a predetermined schedule, which is coordinated with the broadcast schedule of radio stations. Since pilots will tune in on particular stations at definite times to obtain reports in accordance with the broadcast schedule, it is important that the schedules be closely adhered to. The following is an illustration of scheduled weather reporting along the Newark-Cleveland route.

At 42 minutes past the hour the observers will begin typing their observations on the circuit beginning with the Newark station, followed successively by Hadley, Allentown, Park Place, Numidia, Sunbury, Winkleblech, Bellefonte, Kylertown, Greenwood Club, Brookville, Mercer, Parkman and Cleveland, with practically no interval between the completion of the report from one station and the beginning of a report from the next. When the Cleveland weather observer has completed typing his report a complete record of weather conditions at all points on the circuit will appear on the teletypewriter tape at each individual station and in the radio broadcasting stations located at Hadley, Bellefonte and Cleveland. Fig. 2 shows a portion of an

```

NK CV 0642ES
NK OVC LWR BRKN CLDS OCNL SPRKG ETD 6 HND 2 1/2 NE 8 42 40 3010
HW OVC LWR BRKN CLDS SPRKG HAZY 1 THSD 3 NE 5 42 3006
AL OVC LT RAIN LT FOG ETD 6 HND 2 E 10 41 3006
PL DENSE FOG LT RAIN ZERO ZERO ESE 15 37 3006
NU OVC LT RAIN HAZY ETD 1 THSD 3 E 12 41
SV OVC LT RAIN LT FOG ETD 12 HND 1 NE 9 43
WK DENSE FOG LT RAIN ZERO ZERO E 18 37 3004
BF OVC LT RAIN 8 HND 6 NE 6 43 43 2998

```

Fig. 2—Teletypewriter tape with portion of weather sequence report.

actual tape record of an hourly report along the Newark-Cleveland route which includes the stations between Newark and Bellefonte, Pa. For convenience the tape has been cut to show one station report on

each line. First the starting time, 0642 E. S., which is 6:42 a.m. Eastern Standard Time, is shown. Each reporting station in sequence then gives its code letter or letters and follows with a report of its observations. An interpretation of the report from the first station is "Newark, overcast, lower broken clouds, occasional sprinkling, estimated ceiling height 600 feet, visibility  $2\frac{1}{2}$  miles, wind velocity 8 miles per hour, direction northeast, temperature  $42^{\circ}$ , dew point  $40^{\circ}$ , barometric pressure 30.10 in." The time of actual transmission for all 14 stations, Newark to Cleveland, is generally about four minutes.

At 50 minutes past the hour the three radio stations will interrupt the beacon signals and broadcast the reports just received. Hadley station transmits the weather sequence received from stations between Newark and Bellefonte; simultaneously, the Bellefonte radio station transmits the entire sequence received from all points between Newark and Cleveland, and the Cleveland radio station broadcasts reports from points between Bellefonte and Cleveland. All three radio stations include in the sequence, reports of weather at Cleveland and New York. The range beacons are not interrupted for these reports for longer than two minutes, and if the reports require a longer period the beacon signals are restored for one minute and again interrupted to complete the reports.

Based upon the information obtained through the sequence collections, the airway weather reporting station retransmits, generally by teletypewriter, hourly weather reports to the various airway operating companies' offices in that vicinity. Airway companies maintain various arrangements for posting the weather information for the convenience to pilots. Some companies post the information on a series of boards of different color arranged in geographic sequence to represent different airway routes, each board indicating a particular point on that route.

An experimental service involving the transmission of weather summaries in map form has been tried out recently at Kansas City, Chicago, Cleveland, Newark and Washington. A separate circuit equipped with page teletypewriters at each of these points was provided for this purpose. The weather maps were prepared at Kansas City and Cleveland every three hours. A typical map, the notations of which were transmitted over the circuit and directly printed by the teletypewriter, is shown in Fig. 3, and the following describes briefly the methods used.

Two special airways maps, ordinary letter width, have been printed, one map covering the section of the country east of the Mississippi River and another the section west to the Rocky Mountains. The maps are printed in ink which permits hectographic reproduction. The

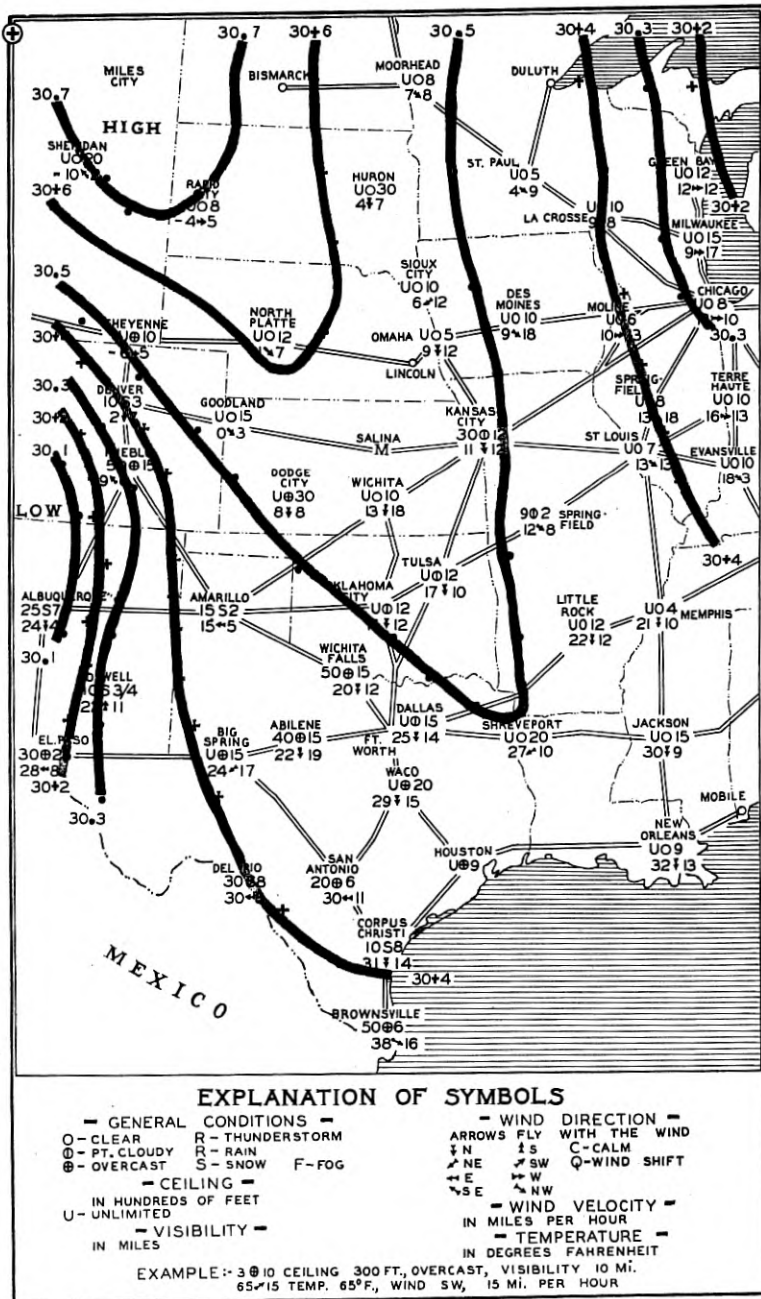

Fig. 3—Weather map, the notations of which were transmitted and directly printed by the teletypewriter system.

airways, principal airports, and cities are shown on the map and in the upper left corner is a small circle used as a coordinating point.

At a scheduled time the operator at Kansas City or Cleveland inserts in a teletypewriter equipped for perforating tape a copy of the map on which the latest weather information has already been typed including general state of weather, ceiling height, visibility, temperature, wind direction and velocity and barometric pressure for each point and isobars connecting points of equal pressure. The sending operator then types the identical symbols, letters, and figures directly over the corresponding ones on the map inserted in his machine, thus making a complete record on perforated tape. On schedule a blank map is inserted in the teletypewriter at each receiving point and positioned so that a type bar will strike the map within the small coordinating circle. The sending operator then releases the tape and the signals transmitted over the circuit reproduce on the map at the receiving stations data similar to those on the original map at the sending station.

The map data are sent in sequence from the two transmitting stations and after they have been received on the map forms a number of duplicate copies can be run off immediately and the two maps fitted together if desired. The maps are then available to pilots at each of the respective airports.

Complete reports of weather are generally maintained by transport companies in dispatching offices. On some lines two-way short-wave radio telephone equipment has been provided for communicating with planes and periodic contact is maintained during flight. In this way pilots report their positions directly to dispatchers and in addition supplementary weather data are usually exchanged, particularly in respect to local ceiling heights and conditions in the upper air strata.

#### PLANE DISPATCHING AND OTHER SERVICE

Teletypewriter circuits furnished to air transport companies are used principally for dispatching planes and handling the many traffic matters usual to this type of service. Plane movements including reports of position in flight are transmitted over the teletypewriter system and recorded at various offices. The reports of positions, in many cases, are given by pilots over short-wave radio telephone where this type of equipment has been provided.

To facilitate position reporting some of the companies have superimposed a system of rectangular coordinates over a map of the course cutting the territory into squares or rectangles 10 to 20 miles on a side. The coordinates are numbered so that the pilots and dispatchers can

readily establish the location of the plane. The dispatchers generally maintain a typewritten, chronological log of position reports from each plane in the air. Bulletin boards are also used, marked with the stations along the route and with spaces for filling in data such as plane number and license, name of pilot, time of arrival and departure at each station and final destination.

A considerable volume of information is required to be transmitted in connection with the handling of traffic on large lines. This usually consists of data as to reservations, number of passengers and amount of mail and express carried, connections to be made, and arrangements at terminals. Supplementary instructions to pilots and many administrative matters requiring prompt handling are also transmitted.

Although the airways teletypewriter circuits furnished the Department of Commerce are used mostly for handling weather reports, considerable information is also transmitted over them relating to departure and arrival of planes and their position in flight. Upon request the Department of Commerce will send over its teletypewriter system the license number of a plane, the station from which the plane is departing, its time of departure, and its destination, to stations along the route of the flight. Stations on the route knowing approximately the time the plane will be due watch for it and record the actual time the plane passes so that other stations may be informed.

#### TELETYPEWRITER CIRCUIT LAYOUT

Teletypewriter networks furnished by the Bell System for service along airways are composed of some 30 separate circuits. Circuit mileage of the longest is about 2,000 miles and of the shortest, 200 miles. The longer circuits generally connect 15 to 20 intermediate stations. Since airways naturally follow direct air lines the intermediate airway stations are often located at points considerable distances from main communication lines, which, generally, are constructed along routes connecting the industrial and more populous centers, due regard being given to topographic and other conditions. At the larger airports such as Newark and Cleveland, local teletypewriter circuits are also provided to connect the Department of Commerce station with the offices of the various transport companies, the post office, and weather bureau. Automatic transmission equipment is provided so that information received on one circuit can be retransmitted over one or more other circuits if desired.

A layout diagram of a typical circuit is shown in Fig. 4. Facilities in the New York-Cleveland long distance cable are used for establishing the main links totaling 515 miles. Repeater stations on the cable

route located approximately every 50 miles afford convenient points from which branch circuits are extended to the intermediate airway stations. The several branch circuits are of the grounded open-wire

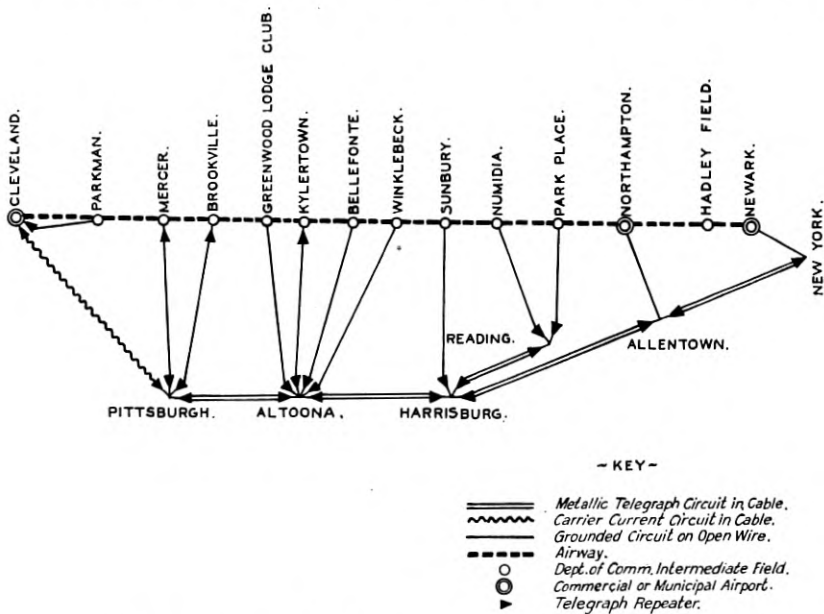

Fig. 4—Layout of typical teletypewriter circuit along airway.

type and total 331 miles. A total circuit mileage, therefore, of 846 miles is required in this case for connecting all stations along an air route a little over 400 miles long.

The Newark-Pittsburgh section of the main circuit is operated on metallic telegraph cable facilities, a type particularly adapted to use where stations to be connected to the circuit are spaced at frequent intervals. Between Pittsburgh and Cleveland a channel of a voice frequency carrier telegraph system on cable facilities is used. This type of facility is generally used where stations are located 150 or more miles apart. The longer branch circuits on open wire employ polar transmission with repeaters at both the repeater station and terminal and use two wires, one for each direction of transmission. The shorter branch circuits use one wire with a grounded duplex repeater at the repeater station and a constant d.c. potential at the outlying terminal. Detail descriptions of these various telegraph systems have been given in previous papers.

Cable circuits are less susceptible than open-wire circuits to inter-



ference and storm trouble, and where they are available they have been used generally for establishing teletypewriter circuits furnished both the Department of Commerce and the transport companies. At present, over one third of the mileage of these circuits is in cable. Facilities on alternate routes are available to be substituted for the regular circuit in the event circuit trouble develops.

#### TELETYPEWRITER EQUIPMENT

The theory of teletypewriter operation and descriptions of the machines generally used in this country have been given in other papers but are briefly reviewed here in order to describe some of the specific equipment arrangements used in airways service.

The teletypewriter is designed to perform the functions of an ordinary typewriter with added features that permit the typing units of a number of similar machines located at distant points to be controlled by the operation of the keyboard of any one of them. This is accomplished by the translation of the mechanical action of any key in the keyboard unit to electrical impulses arranged in a code and transmitting them over an electrical circuit to the distant machines where the impulses are translated back to the mechanical action of a type bar in the typing unit corresponding to the key struck in the distant keyboard. Electric motors and electro-magnets provide the mechanical power and the means of translation of electrical impulses to mechanical action. It is necessary, of course, that the mechanical action of all of the machines be synchronized. This is provided for by the use of synchronous motors or governed motors regulated to the same speed and a start-stop rather than a continuously rotating system. By the use of the start-stop system the effect of variations in motor speeds is minimized, accurate synchronization being required only during the interval of typing of one letter after which a clutch releases and stops the receiving mechanism momentarily to permit it again to start in synchronism with the sending mechanism. To provide the start-stop feature and sufficient code combinations for the letters and symbols required a seven-impulse code is used consisting of a start pulse, five selecting pulses, and a stop pulse.

Teletypewriters are available to print on an ordinary page or on a narrow strip of tape. Tape machines are generally used in airways service because they are particularly adapted to the handling of short messages and weather sequences where it is generally desirable to rearrange the messages received by cutting and pasting the tape on separate pages to form a continuous weather record for each point. This is preferable to a chronological message record requiring a search

through all of the information to obtain the trend of weather at a particular point. The tape machines are also somewhat smaller, less expensive, and more efficient, not requiring the transmission of carriage return and paper feeding signals.

In addition to the ordinary sending and receiving machines supplementary apparatus units may be used so that operators can work at maximum efficiency and the line circuit can be used to its maximum capacity. These units are the perforator, tape transmitter, and reperforator.

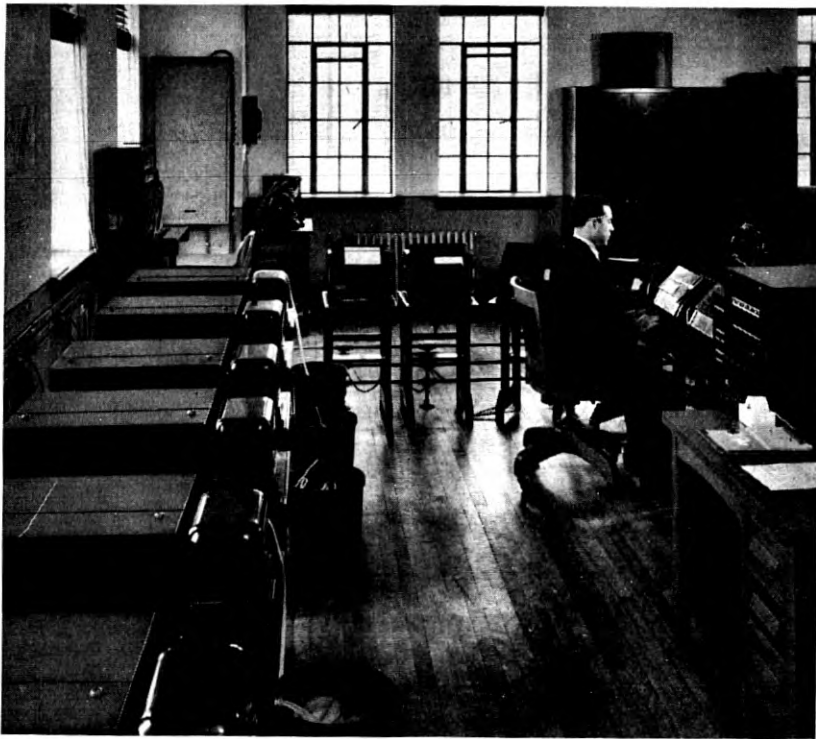

Fig. 5—Department of Commerce airport teletypewriter station.

The perforator is associated with a keyboard and perforates a tape with one to five perforations for each key struck. The tape is run through a tape transmitter which automatically sends electrical impulses to the circuit corresponding to the perforations in the tape and identical to those that would have been sent from the keyboard direct had it been connected to the circuit for normal keyboard sending. The use of the perforator and tape transmitter permits the circuit to be

operated at its maximum speed at all times and permits the operator to do other work while the accumulated tape is running through the transmitter. Also the same tape can be run through several tape transmitters and thus be used for sending the message over several circuits.

The reperforator is a receiving device which records the message on a perforated tape similar to that produced by a perforator unit. This permits storing a received message for immediate or subsequent retransmission to other circuits without retyping it.

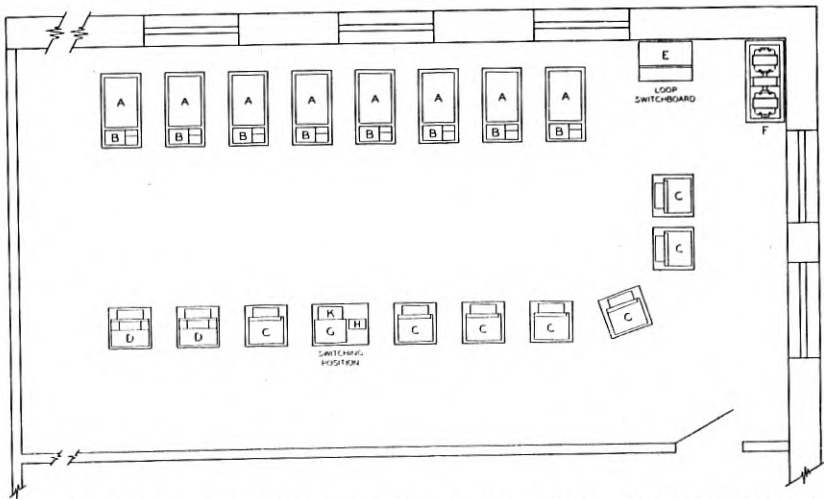

Fig. 6—Teletypewriter equipment layout in large office. A, Reperforator; B, Transmitter distributor; C, Tape teletypewriter; D, Page teletypewriter; E, Loop switchboard; F, Motor generator set; G, Radial transmitting board; H, Remote control box; K, Perforator.

The smaller teletypewriter stations of the Department of Commerce and those of the various transport companies are generally provided with one or two teletypewriters. At the larger teletypewriter stations of the Department of Commerce a special arrangement of the equipment has been provided to permit efficient operation of the teletypewriter circuits from the standpoints of requiring the fewest operators and of obtaining rapid retransmission of messages received on one circuit to one or more of the other circuits as required. A view of an installation is given in Fig. 5 and a typical floor plan arrangement is illustrated in Fig. 6. The apparatus is mounted on tables specially designed for the purpose, and these are usually arranged on the floor in the shape of a U, the units facing inward so that the operators work inside the U.

A separate reperforator (*A*) and tape transmitter (*B*) in addition to a tape teletypewriter (*C*) are provided for each circuit. Messages are received simultaneously on a printed tape by the tape teletypewriter and on a perforated tape by the reperforator. Mounted adjacent to the reperforators are the tape transmitters through which the perforated tape can be run to retransmit immediately a received message to another circuit. The reperforators and tape transmitters can be started and stopped individually from the remote control box (*H*).

A tape perforator (*K*) is provided to perforate tape for messages originating at the local station. The messages can then be sent automatically over the circuit or circuits desired by running the tape through the proper tape transmitters.

All of these units are terminated on cords and plugs at a loop switchboard (*E*) and any unit or combination of units may be connected to any of the teletypewriter circuits which are wired through a number of series jacks in the loop switchboard. A supplementary switching arrangement is provided by radial transmitting board (*G*) equipped with keys and repeating relays. By operating one or more of the keys one of the tape transmitters can be connected quickly to two or more of the teletypewriter circuits through the repeating relays to obtain simultaneous transmission to the circuits connected.

At certain stations page teletypewriters (*D*) are provided for the transmission of weather maps as described previously. This type of machine employs a fixed paper carriage and movable type basket, and accommodates paper up to  $8\frac{1}{2}$  inches wide. It has been equipped with a number of special type characters to provide the symbols required on the maps. These symbols, which are shown in Fig. 3, are provided as upper case characters on the teletypewriters in place of fractions and punctuation marks.

The arrangement of equipment described generally permits one operator to attend all of the circuits. The teletypewriters are all located in a fairly small space, which permits one man to observe the incoming messages and operate the control boards, to start and stop the proper transmitter and to relay the messages as required.

#### RADIO INTERFERENCE

The establishment of teletypewriter stations along the airways brought about the installation of teletypewriter equipment in the same room or in close proximity to short-wave radio receivers, and introduced the problem in specific cases of radio interference caused by the operation of the teletypewriter.

Remedial measures have been designed effectively to reduce this

interference, and consist of the use of synchronous motors, rectifiers and specially designed filters, together with the locating of the apparatus and wiring in such a way as to effect a minimum coupling between the teletypewriter and its associated loop and the radio antenna system.

#### CONCLUSION

History of air transportation in the past few years indicates that continued growth may be expected, particularly as hazards to flying are mitigated and safety and dependability are recognized by the public. The Government is continuing the extension of airways and weather reporting and other services, and air transport companies are progressing in developing transport business. Fast and reliable communication service has proved the backbone of weather and position reporting and has been a valuable aid in the handling of traffic and other matters relating to air transportation. Teletypewriter circuits used for land service have been found particularly suited to meeting the various requirements involving simultaneous communication with many stations at remote distances. Other wire communication services such as long distance telephone and commercial telegraph have also aided, particularly in reaching points not served by teletypewriter circuits. It is expected wire communication service will continue to be used extensively in connection with air transportation and will be of considerable aid in its future development.

#### BIBLIOGRAPHY

1. *Airway Bulletin* No. 1, September, 1931, issued by the U. S. Department of Commerce.
2. *Air Commerce Bulletin* March 1, 1932, issued by U. S. Department of Commerce.
3. "Metallic Polar-Duplex Telegraph System for Long Small-Gauge Cables," by Bell, Shanck, and Branson, *A. I. E. E. Trans.*, Vol. 44, 1925, p. 316.
4. "Voice Frequency Carrier Telegraph System for Cables," by Hamilton, Nyquist, Long, and Phelps, *A. I. E. E. Trans.*, Vol. 44, 1925, p. 327.
5. "Modern Practices in Private Wire Telegraph Service," by R. E. Pierce, *A. I. E. E. Trans.*, Vol. 50, 1931, p. 426.
6. "Police Teletypewriter Communication," by R. E. Pierce, presented at Great Lakes District Meeting, A. I. E. E., Milwaukee, Wis., March, 1932.
7. "Printing Telegraph Systems," by John H. Bell, *A. I. E. E. Trans.*, Vol. 39, Part 2, 1920.
8. "Air Transport Communication," by R. L. Jones and F. M. Ryan, *A. I. E. E. Trans.*, Vol. 49, p. 187.
9. "Aeronautical Communication," by E. Sibley, *Jour. A. I. E. E.*, p. 918, November, 1930.
10. "Airplane Flight Aided by Electricity," by C. F. Green, *Electrical Engineering*, August, 1931, p. 654.
11. "Telephone Typewriters and Auxiliary Arrangements," by R. D. Parker, *Bell Telephone Quarterly*, July, 1929.
12. "Teletypewriter Service and Its Present Day Uses," by W. L. Dusenberry, *Bell Telephone Quarterly*, April, 1931.

## Abstracts of Technical Articles from Bell System Sources

In January, 1932, a series of seven lectures by representatives of the Bell Telephone System was given before the Lowell Institute of Boston, Massachusetts. The general title of the series was "The Application of Science in Electrical Communication."

The lectures were as follows:

- "An Introduction to Research in the Communication Field," by H. D. Arnold, Ph.D., Sc.D., Director of Research, Bell Telephone Laboratories.\*
- "Research in Speech and Hearing," by Harvey Fletcher, Ph.D., Acoustical Research Director, Bell Telephone Laboratories.
- "Transoceanic Radio Telephony," by Ralph Bown, Ph.D., Department of Development and Research, American Telephone and Telegraph Company.\*
- "Picture Transmission and Television," by Herbert E. Ives, Ph.D., Sc.D., Electro-Optical Research Director, Bell Telephone Laboratories.\*
- "Talking Motion Pictures and Other By-Products of Communication Research," by John E. Otterson, President, Electrical Research Products, Inc.
- "Utilizing the Results of Fundamental Research in the Communication Field," by Frank B. Jewett, Ph.D., D.Sc., Vice President, American Telephone and Telegraph Company, President, Bell Telephone Laboratories.\*
- "Social Aspects of Communication Development," by Arthur W. Page, A.B., Vice President, American Telephone and Telegraph Company.\*

*Further Notes on the Detection of Two Modulated Waves Which Differ Slightly in Carrier Frequency.*<sup>1</sup> C. B. AIKEN. The present paper deals with the analysis of the detection of two modulated waves of slightly different carrier frequency under the conditions that the carrier amplitude of one wave is much smaller than that of the other and that the modulation of the larger wave is low. These conditions apply in determining the interference which arises during the operation of two broadcast stations on the same frequency assignment when the

\* Published in the April 1932 *Bell Telephone Quarterly*.

<sup>1</sup> *Proc. I. R. E.*, March, 1932.

stations are nonisochronous and transmit different programs. A discussion of the characteristics of shared channel interference is given, and it is shown that there are only two important components of this interference, one being the carrier beat note and the other being what has been designated as side band noise. This latter consists of two frequency spectra, one of which is similar to the spectrum of the modulating frequencies of the undesired station but is shifted upward by a constant amount equal to the difference between the carrier frequencies. The other spectrum is of a similar type but is shifted downward in frequency by the same amount.

*The Use of Thermionics in the Study of Adsorption of Vapours and Gases.*<sup>2</sup> JOSEPH A. BECKER Thermionic emission can be very useful in the study of adsorption phenomena. The primary reason is that very minute amounts of electropositive elements, such as caesium, barium, or thorium, or electronegative gases, such as oxygen, change the thermionic emission from surfaces of tungsten, platinum, molybdenum, etc., by very large factors and in a characteristic manner. They do this by changing the work function of the surface. This effect, as well as other surface effects, can be best explained by the adion grid theory: The adsorbed particles can exist on the surface either as adions (adsorbed ions) or as adatoms; the adions act like a positively charged, open meshed grid placed very close to the surface. From this theory and the experimental facts it follows: (1) That the ratio of adions to adatoms decreases as the surface concentration increases (Table I); (2) that the work required to remove an adion from the surface increases while the work to remove an adatom decreases as the surface concentration increases; (3) the mean life of an adsorbed particle depends on the surface concentration as well as on the temperature (Table II); (4) the rate of diffusion from the surface into the interior depends upon the temperature and on the amount by which the surface concentration exceeds its equilibrium value. Thermionic experiments show the existence of surface migration and can be used to make a quantitative study of this phenomenon. The techniques involved in these various experiments are described and references given to previous publications.

*Electrical Phenomena in Gases.*<sup>3</sup> KARL K. DARROW. This treatise of 500 pages is concerned with one of the most important, instructive, and intensively studied fields of modern physics. Its scope embraces, first of all, the elementary processes through the action of which a gas

<sup>2</sup> *Transactions of the Faraday Society*, March, 1932.

<sup>3</sup> Published by Williams and Wilkins Company, Baltimore, Maryland, 1932.

becomes and remains capable of conducting electricity, and acquires and retains other interesting qualities. Such are: "ionization," the detachment of electrons from atoms and molecules by electron-impact, light, impact of positive ions, and other agencies; "excitation," the transfer of atoms and molecules, by these same agencies, into abnormal or excited states in which they possess extra energy and various peculiar powers—the return of excited atoms to their normal condition, with emission of light or with other modes of energy-surrender; "interception," the deflection and slowing-down of electrons and positive ions by collisions with molecules and atoms. After the four chapters devoted to these elementary processes, come four concerned with the drift and diffusion of electrons and more massive ions through dense gases, and with allied topics: material often classified under such names as "mobility," "diffusion," "recombination" and "capture of electrons." The following chapter is assigned to the drifting of ions through dense gases under fields so strong that these ions themselves produce extra ionization, and to the phenomena of "breakdown" which is sometimes sparkover, sometimes the establishment of a discharge such as a glow or an arc. After a chapter on the distortion of electric fields by space-charge, essential to what follows, there comes a treatment of the properties of highly ionized and luminous gases such as the mercury-vapor arc exemplifies, and of space-charge sheaths, as clarified of recent years by newly developed probe-methods. The final chapters are descriptions of the important types of discharge known as self-sustaining glow and self-sustaining arc. The book is thus so arranged as to proceed from the fundamental atomic phenomena, through the intermediate topics of drift and diffusion of ions through gases, to the most intricate discharges. In the later parts, especial attention has been paid to such phenomena as have been made at least partially intelligible in terms of the processes described in the earlier; nevertheless, those which have not been interpreted are given due place and emphasis.

*Electrical Phenomena in Gases* is Dr. Darrow's second book. *Introduction to Contemporary Physics* was published by D. Van Nostrand Company in 1926.

*Application of Quartz Plates to Radio Transmitters.*<sup>4</sup> O. M. HOGGAARD. This paper discusses the disturbing elements encountered in the application of quartz plates to broadcast and aircraft radio transmitters. A general procedure for minimizing such effects is considered from a circuit standpoint as well as in the light of practical experience.

<sup>4</sup> *Proc. I. R. E.*, May, 1932.



The degree to which maintenance may affect performance and the necessity for automatic equipment are shown by data obtained in the field. Apparatus and systems which enable the operating staff to meet modern frequency stability requirements by monitoring the emitted carrier are also described.

*Tape Armored Telephone Toll Cable.*<sup>5</sup> C. W. NYSTROM. Toll cables buried directly in the earth are coming into increased use. Such cables are not installed in the usual clay conduit but are protected by layers of paper, jute, and steel tapes. Complete equipment for laying this cable has been developed.

*Some Effects of Topography and Ground on Short-Wave Reception.*<sup>6</sup> R. K. POTTER and H. T. FRIIS. This paper contains some results of an experimental study of the effects which ground and ground irregularities have upon short-wave signal reception. The results illustrate the signal strength advantage to be gained in the selection of suitable ground or topographical conditions and show the influence of antenna types, and vertical angle of signal arrival, upon such an advantage. Although the tests were confined to reception, the conclusions are probably applicable in general to the case of transmission. The agreement between measurement data and theory seems to justify the application of plane wave optical theory to the calculation of vertical plane directivity of antennas. Such an application suggests, according to the data obtained, that signals from South America are normally received at much lower vertical angles than those from England.

*Western Electric Noiseless Recording.*<sup>7</sup> H. C. SILENT and J. G. FRAYNE. The Western Electric method of noiseless recording with the light valve is described. The general principles are discussed, the circuit diagram is explained, and the method of adjusting the device for service described. The photographic characteristics of film are considered, and their application in noiseless recording is shown in some detail.

*The Acoustics of Large Auditoriums.*<sup>8</sup> S. K. WOLF. Extremely large auditoriums present acoustical difficulties which do not readily yield to the customary methods of analysis and correction. This is illustrated by measurements of the time of reverberation, made in

<sup>5</sup> *Electrical Engineering*, March, 1932.

<sup>6</sup> *Proc. I. R. E.*, April, 1932.

<sup>7</sup> *Jour. S. M. P. E.*, May, 1932.

<sup>8</sup> *Jour. S. M. P. E.*, April, 1932.

the Madison Square Garden, New York, N. Y., which revealed a considerable discrepancy between theoretical expectations and the times actually measured throughout the frequency range. At 500 cycles, for example, analysis of the auditorium indicated a decay period of 35.5 seconds, whereas the time actually measured by the spark chronograph reverberation meter was only 7.6 seconds. On the basis of the measured time, 47,000 square feet of one-inch rock wool were installed. This material was distributed in a manner calculated to suppress undesirable discrete reflections as well as to reduce the general reverberation time. The result was a reduction in the measured time to 3.5 seconds and the complete elimination of acoustic difficulties. Present reverberation formulas do not possess sufficient generality to justify application to enclosures which are extremely atypical in size or shape. Until such formulas are developed, reliance must be placed on actual measurements.

## Contributors to this Issue

C. B. H. FELDMAN, B.Sc., University of Minnesota, 1926; Teaching Fellow, University of Minnesota, 1926-28; M.Sc., University of Minnesota, 1928. Bell Telephone Laboratories, 1928-. Mr. Feldman has been engaged in short-wave radio receiving. His work has been mainly on transmission lines, antennas, and wave propagation problems.

P. B. FLANDERS, A.B., Harvard University, 1920; S.B. in Electrical Engineering, 1922. Engineering Department, Western Electric Company, 1922-25; Bell Telephone Laboratories, 1925-. Mr. Flanders has worked principally on acoustic devices and on the development of acoustic measuring methods.

BANCROFT GHERARDI, B.Sc., Polytechnic Institute, Brooklyn, N. Y., 1891; M.E., Cornell University, 1893; M.M.E., Cornell University, 1894. New York Telephone Company, Engineering Assistant, 1895-99; Traffic Engineer, 1899-1900. New York and New Jersey Telephone Company, Chief Engineer, 1900-06. New York Telephone Company, and New York and New Jersey Telephone Company, Assistant Chief Engineer, 1906-07. American Telephone and Telegraph Company, Equipment Engineer, 1907-09; Engineer of Plant, 1909-18; Acting Chief Engineer, 1918-19; Chief Engineer, 1919-20; Vice President and Chief Engineer, 1920-. Mr. Gherardi is a Past President of the American Institute of Electrical Engineers and is now President of the American Standards Association.

H. C. HARRISON, A.B., Colorado College, 1910; S.B., Massachusetts Institute of Technology, 1913; Instructor in Electrical Engineering, Massachusetts Institute of Technology, 1913-14. Western Electric Company, 1914-24; Bell Telephone Laboratories, 1925-. As Special Transmission Instruments Research Engineer, Mr. Harrison has been instrumental in applying the principles of electric transmission theory to sound recording and reproducing equipment.

M. J. KELLY, B.S., Missouri University, 1914; M.S., University of Kentucky, 1915; Ph.D., University of Chicago, 1919; Instructor of Physics, University of Kentucky, 1914-15; Research Assistant, University of Chicago, 1915-18. Western Electric Company, 1918-25; Bell Telephone Laboratories, 1925-. As Vacuum Tube Development

Engineer, Dr. Kelly has worked on the development of thermionic and photoelectric devices.

D. MITCHELL, B.S., Princeton University, 1925. Department of Development and Research, American Telephone and Telegraph Company, 1925-. Mr. Mitchell has been engaged in transmission development work on voice-operated devices and problems of interconnecting wire and radio telephone systems.

H. H. NANCE, Washington University, 1906-10. American Telephone and Telegraph Company, Long Lines Plant Department, 1910-23; Long Lines Engineering Department, Acting Engineer of Transmission, 1923; Engineer of Transmission, 1924-1928; Plant Extension Engineer, 1928-.

C. H. PRESCOTT, JR., B.A., Yale University, 1922; Ph.D., California Institute of Technology, 1926; Research Fellow, California Institute of Technology, 1926-27; National Research Fellow in Chemistry, 1927-28. Bell Telephone Laboratories, 1928-. Dr. Prescott has been engaged in development and research on photoelectric and thermionic vacuum tubes.

K. L. SCOTT, B.S. in Electrical Engineering, University of Wisconsin, 1921; M.S. in E.E., 1928; Instructor in Electrical Engineering, University of Wisconsin, 1921-24. Engineer, Western Electric Company, 1926-. Mr. Scott has been engaged in laboratory investigations of magnet steels and permanent magnets, and the development of manufacturing processes and equipment in connection with magnet manufacture.

E. J. STERBA, B.E. in Electrical Engineering, State University of Iowa, 1920. Engineering Department, Western Electric Company, 1920-25; Bell Telephone Laboratories, 1925-. Mr. Sterba has been engaged chiefly in the development of transmitting antennas and apparatus related to antennas.

S. B. WRIGHT, M.E., M.E.E., Cornell University, 1919. Department of Development and Research, American Telephone and Telegraph Company, 1919-. Mr. Wright has been engaged in transmission development work on voice-operated devices and problems of interconnecting wire and radio telephone systems.