

The Bell System Technical Journal

July, 1924

Electrical Tests and Their Applications in the Maintenance of Telephone Transmission

By W. H. HARDEN

INTRODUCTION

THE installation and maintenance of the circuits in a telephone plant employed for the transmission of speech require the use of various testing schemes to insure a high grade of commercial service. Circuits are engineered and installed to meet the established standards of transmission in the most economical manner and this having been done the next step is to provide an adequate testing program. A number of the electrical tests required in this program include well known laboratory methods adapted so that they can be readily applied in the field, while others have been developed for particular use in telephone maintenance work.

Standard types of test boards and portable testing arrangements are as a rule made up of simple circuits designed electrically and mechanically in a manner to facilitate ready connection to the operating circuits in the plant. It has been found by experience that many of the transmission maintenance requirements can be taken care of by direct current testing methods and the simpler alternating current tests. With the advent of vacuum tubes, some of the more complex circuits such as repeaters and carrier called for the development of testing apparatus to meet the additional maintenance requirements. Fortunately, the vacuum tube furnished the means whereby new testing devices have been provided which can be applied as quickly and readily to maintenance work as the simpler methods.

In what follows is given a discussion of the more important electrical testing methods together with the application of these methods in maintaining the transmission efficiency of the various types of telephone circuits now in general use. Direct current testing methods are covered first and later alternating current methods are considered. A typical toll connection is used to illustrate the general scheme of applying the various electrical tests in everyday installation and maintenance work.

DIRECT CURRENT TESTS

The tests involving the use of direct currents and voltages provide means for checking some of the electrical characteristics of telephone circuits and insuring to a certain extent that these circuits will give satisfactory speech transmission. The application of these tests to the telephone plant reduces to a minimum the amount of alternating current testing required and lengthens the interval at which alternating current tests need be made.

Wheatstone Bridge Measurements. The various arrangements of the Wheatstone bridge for direct current measurements and the principles involved are well known and are therefore not discussed in any detail in this paper. However, due to the importance of such measurements in the maintenance of telephone circuits and in trouble location work a brief discussion of the general applications of the bridge is given.

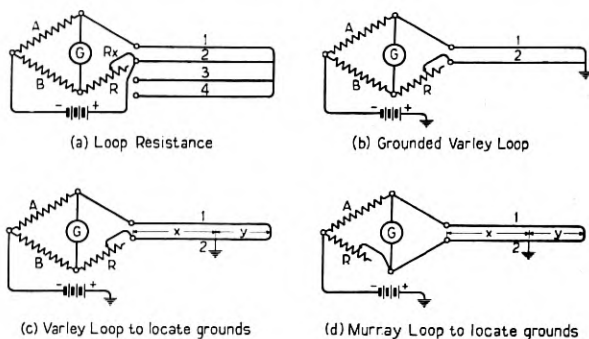

Fig. 1

Fig. 1 shows four arrangements commonly employed in routine testing and trouble location. Diagram (a) of this figure gives the bridge circuit for obtaining loop and single wire resistance measurements. Diagram (b) shows the circuit for Varley loop measurements to determine resistance unbalances in a pair when a third wire is not available, while Diagrams (c) and (d) show the Varley and Murray bridge circuits used in locating grounds. Various other arrangements of the bridge circuit are, of course, used where such arrangements will facilitate the testing work. For a condition of bridge balance indicated by no deflection of the galvanometer the value of the resistance being measured is given by the well known bridge ratio formulae. In diagram (a) of Fig. 1, for example, $R_x = \frac{A}{B} R$.

The testing circuits shown in Fig. 1 are commonly used in the day by day maintenance of the telephone plant. Resistance and resistance balance measurements are made periodically on toll circuits to guard against series resistance unbalances such as might be caused by high resistance joints. The Varley and Murray tests are constantly employed in directing linemen in clearing trouble such as crosses and grounds. The Wheatstone bridge is therefore an important feature of toll test boards where keys are provided to furnish a means for quickly setting up the different bridge test circuit arrangements desired.

The Varley or Murray tests used in connection with pole line diagrams in locating troubles provide a means whereby the test board men can direct the movements of linemen to the best advantage. Unit resistance values with temperature corrections are available for different types of circuits. If a good circuit of the same type and gauge over the same route is available, the unit resistance can be determined directly by a loop measurement of this circuit. The resistance values obtained by measurements on circuits having crosses or grounds can then be used to determine the distance to the trouble and the lineman sent to this point. By making measurements carefully and using the most accurate unit resistances available, troubles can be located and cleared in the minimum amount of time. In trouble location work on cables where the cable needs to be opened to repair the trouble, bridge measurements are made to give the approximate distance to the fault. More exact locations can then often be made by using an exploring coil test set by means of which the cable repairman listens by induction to a tone sent out from the cable terminal and determines in this way when he passes the point of trouble.

Leakage or Insulation Resistance Measurements. An important factor in the maintenance of telephone circuits is to insure that there are no resistance leaks between conductors or between conductors and ground. It is also important to insure that insulated conductors will not have the insulation broken down by the voltages which are met with under service conditions. Two types of tests now used extensively in the plant are described below:

(1) *Voltmeter Method.* This method is the one commonly used in determining the leakage between wires and to ground particularly on toll circuits involving open wire and on subscribers' circuits. As shown in Fig. 2 the testing arrangement consists of a voltmeter in series with a battery connected to the conductors under test. Diagram (a) shows the connection for testing the leakage between wires and

Diagram (b) the connection for ground leakage tests. Since the leakage resistance measured is relatively high, the most accurate results are obtained by using a high resistance voltmeter and a fairly high test voltage. In practice, a 100,000-ohm voltmeter is generally used with a test battery of from 100 to 150 volts. A test voltage of 200 is also provided in circuit with a milli-ammeter and protective resistance for use in checking the strength of insulation of central office wiring and subscriber's lines.

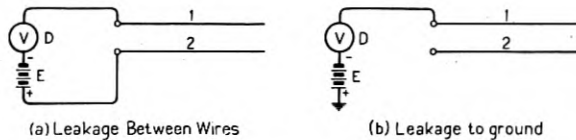

Fig. 2

Considering the circuits shown in Fig. 2, the voltage of the battery E is equal to the IR drop over the voltmeter plus the IR drop or the drop due to leakage over the remainder of the circuit back to the battery. Designating the insulation resistance being measured by X , the voltage of the test battery by E , the deflection in volts of the 100,000-ohm voltmeter by D and the current flowing by I , then

$$E = D + XI,$$

$$D = 100,000 I,$$

and

$$X = 100,000 \left(\frac{E - D}{D} \right).$$

In practice, tables are provided from which the insulation resistance or leakage can be read directly for various deflections of the voltmeter. When expressed in terms of insulation resistance, the most convenient unit of measurement is the megohm. If expressed in terms of leakage, the unit used is a reciprocal function of the megohm known as the millimicromho. The results of measurements for complete circuits are generally reduced to apply to a unit length of circuit such as a mile so that the testing results on circuits of different lengths will be comparable.

The open wire toll circuits in the telephone plant are tested periodically by the method just described. The leakage of circuits is materially increased by defective or broken insulators and by contact of the wires with foreign objects such as trees, particularly under damp weather conditions. Troubles of this kind are detected by careful

leakage measurements and routine tests, therefore, become very useful in indicating when remedial measures, such as line inspections and tree trimming work, should be undertaken.

If open wire telephone circuits are so situated that contact with foliage growth will occur during the growing season low values of insulation resistance are certain to result even under dry weather conditions. This is illustrated by the curve of Fig. 3 which shows

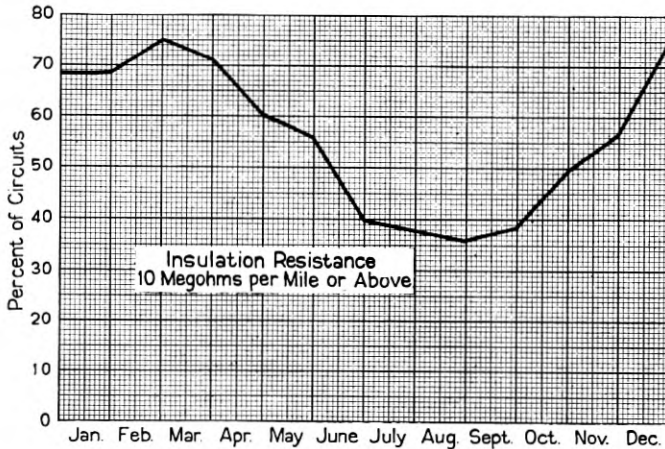

Fig. 3

results of monthly day time dry weather insulation measurements on a number of toll circuits over a period of a year under conditions of this kind. The monthly testing periods are plotted as the abscissa while the ordinates show the percentage of circuits which measure 10 megohms per mile or more during these monthly testing periods. This curve indicates the need for periodic insulation resistance tests and the use which can be made of such tests in instigating clean-up work.

(2) *Megger Method.* The voltmeter method is not applicable for accurately testing the higher values of insulation resistance such as are encountered in telephone cables. Conductors in cables require a very high insulation and in practice values of 500 megohms or more per mile are specified. The laboratory galvanometer method of testing very high resistances, which is the same in principle as the voltmeter method, can, of course, be used, but is not sufficiently rugged for field testing. To take care of cable testing work in the plant a method known as the Megger method is employed. Fig. 4 gives the

schematic circuit arrangement of the "Evershed" megger which is the commercial form of instrument now used for this work. This circuit is contained in a small portable box so that it can be readily used at office frames or carried out on the line.

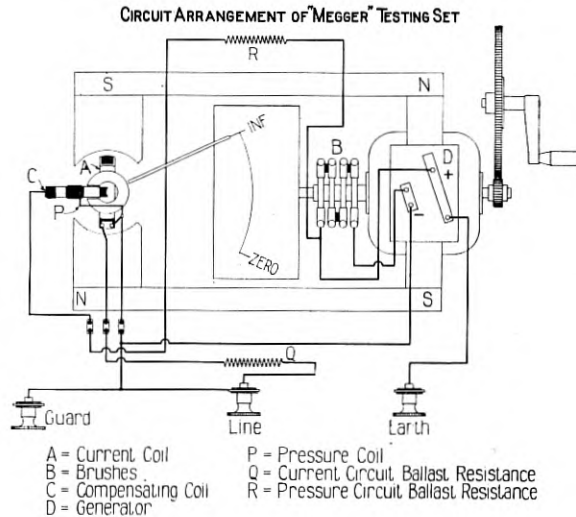

Fig. 4

The circuit of Fig. 4 consists of a high potential direct current generator, hand driven by means of a crank handle. This generator is arranged to provide a maximum potential of 400 volts which is the potential now employed in measuring insulation resistance on cable conductors. The potential furnished by the generator is impressed on two coils in an indicating device, one of these coils being in series with a fixed resistance and the other in series with the circuit under test. When the circuit under test is not connected to the megger the full current from the generator flows thru the first coil of the indicating device which for this condition causes the pointer to go to the "Infinite" position. When a circuit is connected to the megger "Line" and "Earth" terminals some current flows through this circuit due to its leakage and through the second coil of the indicating device. This causes the indicating device to move the pointer toward the "Zero" position, the amount of the movement depending on the leakage in the circuit under test. The indicating device is calibrated in megohms so that the results of insulation tests can be read directly.

Current Flow and Voltage Measurements. Tests to determine the amount of direct current flowing in telephone circuits involve the simple arrangement of an ammeter or milli-ammeter in series with a d.c. generator or battery and the circuit under test. The amount of current flowing is, of course, a function of the resistance of the circuit and the voltage applied. In testing arrangements where it is neces-

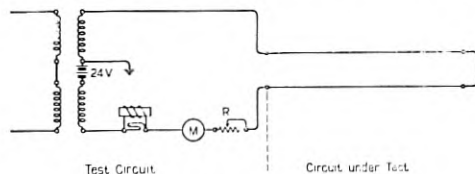

Fig. 5

sary to know the battery or generator potential, voltage readings are made by using ordinary voltmeters having the proper range and resistance. Direct current and voltage measurements can best be described by considering two of their applications in the telephone plant.

Fig. 5 shows a simple test circuit provided in the local test desk whereby central office battery is supplied through a regulating rheostat, a standard cord circuit and a meter. Knowing the voltage of the central office battery and the resistance in the test circuit, the reading of the meter when circuits such as a subscriber's loop or trunk conductors are connected and shorted at the distant end gives a means for determining the direct current resistance of these. Tables are generally provided for use at the test desks by means of which different readings of the meter for different conditions of measurement can be converted directly into resistance values. The rheostat in the test circuit is provided primarily for adjusting the current supplied to subscribers' loops and instruments to the same value for different lengths of loop. Talking tests as mentioned later in connection with substation maintenance can then be made from the instruments to the test man in the central office under the same current supply conditions for different lengths of loop at the time substations are installed or when these are reported in trouble. The arrangement shown in Fig. 5 is useful in detecting high resistances in circuits when a Wheatstone bridge is not available. High resistances in the main frame protector springs and heat coils of both subscribers' lines and toll circuits are also determined by a current flow method, a special portable testing set, however, being designed particularly for this purpose.

Direct currents and voltages are very important factors in the operation and maintenance of amplifier circuits such as telephone repeater and carrier apparatus. The battery supply arrangements for a single tube amplifier are shown in Fig. 6.

It is necessary in order to insure efficient amplification without distortion to regulate the currents and voltages to fairly close limits. In practice provision is made for quickly reading the voltages of grid, filament and plate batteries as shown by the voltmeter connection (V) in the figure. The plate current is read by the milli-ammeter M and the filament current by the ammeter A. The filament current

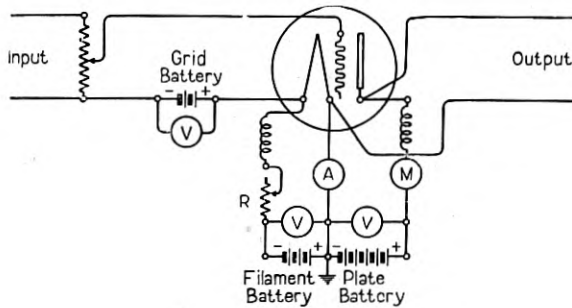

Fig. 6

is regulated to meet the operating limits by cutting resistance in or out of the circuit with the rheostat R. The same applications of current and voltage readings apply to the more complicated amplifier circuits, although wherever practicable automatic regulating devices are provided which reduce the amount of manual testing work to a minimum.

Capacity Measurements. There is little occasion in transmission maintenance work to make accurate direct current measurements of capacity. A simple d.c. test, however, has been provided for use primarily on subscribers' loops for checking the condensers in the sets.

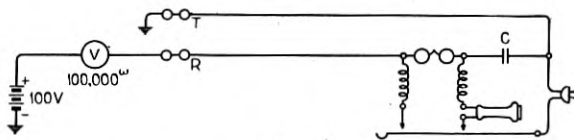

Fig. 7

As shown in Fig. 7 the circuit consists of a 100,000-ohm voltmeter in series with a grounded 100-volt battery connected to one conductor of a subscribers' loop, the other conductor of the loop being grounded.

When the battery is connected a current will flow momentarily in the circuit charging the condenser C. This will produce a throw of the voltmeter needle, the amount of the deflection depending upon the capacity of the condenser C and the capacity between conductors. If the tip and ring connections of the loop are reversed the volt-

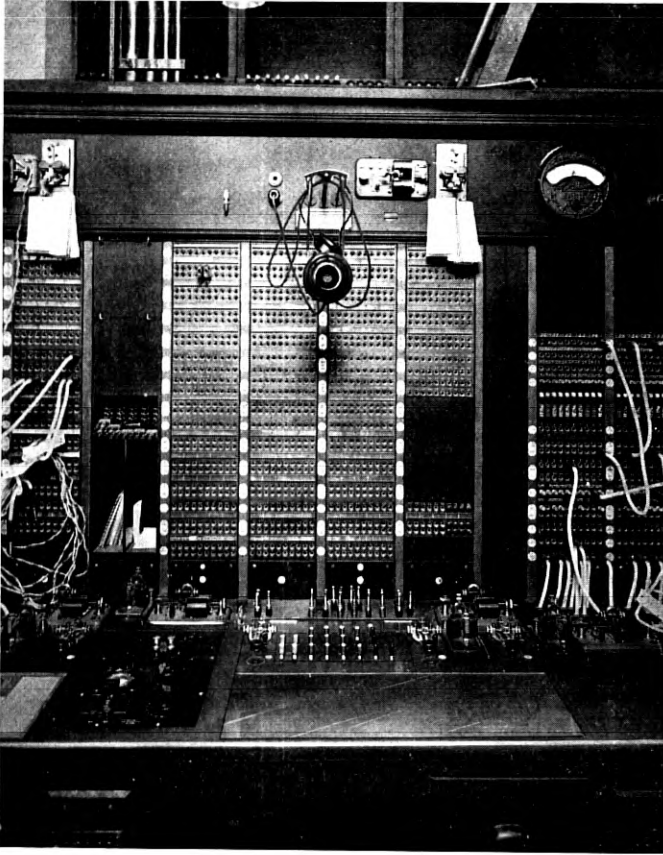

Fig. 8

meter needle throw will be in the opposite direction from that obtained in the first condition. The capacity of the conductors in the loop is relatively small as compared to that of the condenser C so that by knowing the throw which should be obtained under the test conditions for known values of capacity a fairly good check of the condensers in subscribers' sets is provided by this method of measure-

ment. Different deflections of the voltmeter needle will, of course, be obtained depending on whether the loop tested is a single party, two-party or four-party line and also on whether $1 \mu f.$ or $2 \mu f.$ condensers are provided in the substation sets. These conditions must be known by the testman if he is to properly interpret the testing results and detect missing or defective condensers.

Standard Types of Testboards. Pictures of two of the latest types of toll and local testboards are shown in Figs. 8 and 9. These boards provide circuit arrangements for making most of the direct current

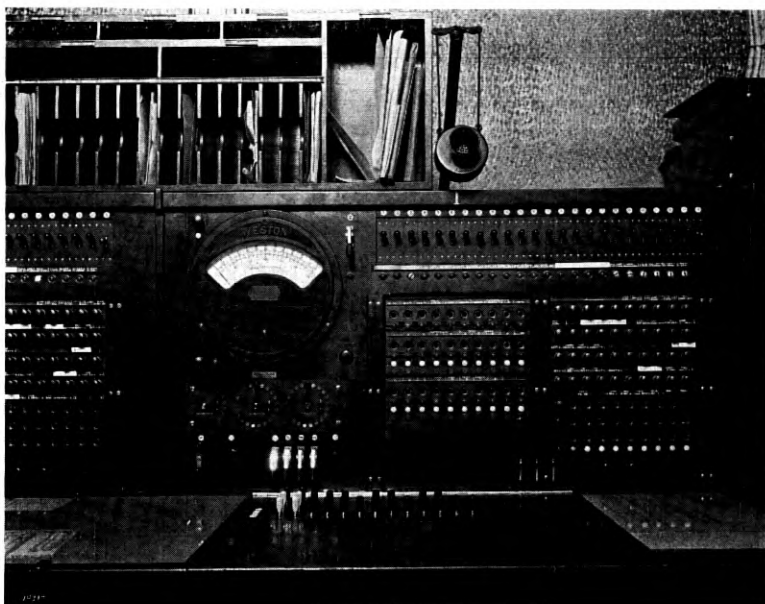

Fig. 9

tests which have just been described and also some of the alternating current tests described below. The wiring of the test circuits to keys, jacks and plugs and the provisions made for picking up various telephone circuits for test greatly facilitate routine maintenance work and the location of troubles which occur in service. Modifications and various arrangements of the tests described above have been provided for in these boards to meet different operating conditions which may arise.

The test board shown in Fig. 8 is designed primarily for testing toll circuits. The vertical section of the board provides jacks for

terminating the toll circuits and the apparatus associated with them, such as phantom and simplex coils, composite sets, etc. The 100,000-ohm voltmeter and the Wheatstone bridge and keys for obtaining various testing arrangements are mounted in the horizontal shelf and connections are made to the toll circuit and equipment jacks by means of the cords and plugs located at the back of the shelf. The telegraph instruments are used on order wires to distant test boards and the meter shown in the vertical section of the board is for measuring the voltage and current in telegraph circuits.

The test board shown in Fig. 9 is designed primarily for testing the local plant, although tests on toll circuits can also be made from this board. One transmission feature provided in the board is an artificial line which when cut in circuit with a 500 ohm subscriber's loop, gives an overall equivalent of approximately 30 TU. This line is terminated on keys by means of which it can be connected as a trunk circuit and used in talking tests on subscribers' loops at the time of their installation or when subscribers' stations are visited in connection with trouble complaints. Jacks are provided in the vertical section of the board for terminating certain test trunks and other test trunks are terminated on keys. A Wheatstone bridge is not normally mounted in this type of test board, but where required, a portable bridge is supplied which is generally kept in one of the drawers of the board when not in use.

ALTERNATING CURRENT TESTS

While the direct current tests just described tell a great deal about the physical and electrical condition of telephone circuits, it is very necessary in maintenance work to consider also the alternating current characteristics. The transmission of speech is, of course, fundamentally a problem of the transmission of alternating currents of very small values. The inductance and capacity as well as the resistance and leakage of circuits, therefore, become important items in determining the efficiency of telephone circuits and means must be provided for testing these characteristics under operating conditions. In principle, alternating current testing methods do not differ materially from direct current methods and their application in the telephone plant is not difficult.

Alternating Current Bridge Measurements. These measurements employ Wheatstone bridge arrangements, the direct current source of power being replaced by an alternating current source and the condition of bridge balance being obtained by some alternating

current detecting device, generally an ordinary telephone receiver. Four important bridge measuring methods are used extensively in telephone testing work as described below:

(1) *Alternating Current Capacity Tests.* The bridge circuit arrangement for measuring a.c. capacity is shown in Fig. 10.

Two arms of the bridge consist of fixed and equal resistances A and B connected by a slide wire resistance, the position of the contactor on this slide wire determining the total amount of resistance

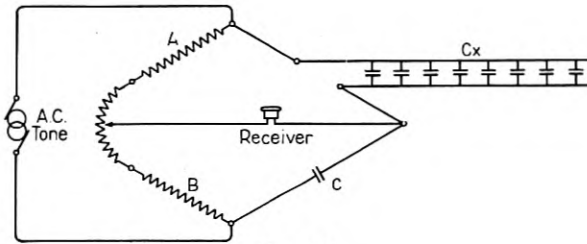

Fig. 10

in each of the two arms. The fixed resistances in A and B are simply extensions of the slide wire and can be cut out of the circuit when not required. The third arm of the bridge consists of standard condensers C , and the fourth arm the circuit whose capacity C_x is to be measured. A source of alternating current generally an 800 or 1,000 cycle oscillator is connected to the terminals of the arms A and B while the telephone receiver is connected to the slide wire contactor and to the junction of the standard condenser and circuit under test. A balance of the bridge is obtained when there is minimum tone in the receiver, for which condition the common bridge formula $C_x = \frac{B}{A} C$ applies. The slide wire is calibrated to read the ratio B/A directly.

For field testing work the above circuit arrangement is made up in a portable box and a portable oscillator is used so that the apparatus can be readily carried about as required. The commercial form of bridge provides three values of standard condensers which can be used to cover measurements from about 500 micro-microfarads up to 1.5 microfarads. This bridge finds its application in the plant in measuring the capacity of short lengths of non-loaded cable, bridge wire, switchboard wire, etc. Such measurements are of particular importance in connection with the installation of 22 type telephone repeaters to determine the proper values of building out condensers to use in the line and balancing circuits.

Another use which is made of alternating current capacity measurements is in connection with the open location test provided at toll test boards. The essential features of the circuit arrangement are shown in Fig. 11.

The ordinary Murray connection of the test board bridge is used, the four arms of the bridge consisting of one fixed 1,000-ohm resistance A , a variable resistance R , a standard 1 $\mu f.$ condenser C and the open

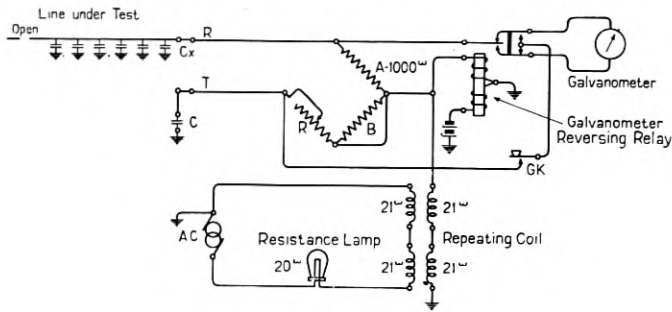

Fig. 11

condenser under test C_x . Ordinary 20 cycle ringing current is used as the measuring current and the galvanometer or voltmeter connected through a reversing relay so that it will always read in one direction. For the balanced condition of the bridge as indicated on the galvanometer the relation $C_x = \frac{R}{A} C$ holds. Substituting the numerical values for A and C in the above formula C_x then equals $\frac{R}{1000}$.

The above test provides a means for determining the approximate distributed capacity of a circuit up to the point where it is open. With previous measurements on known lengths and similar types of circuits available and assuming the distributed capacity proportional to the length of circuit, this test provides a simple means for determining the approximate distance out to the open. In practice fairly good results are obtained on loaded or non-loaded open wire circuits up to 200 miles in length and on loaded or non-loaded cable up to 40 miles in length. The degree of accuracy with which opens can be located by this method depends, of course, on having good unit capacity measurements for the different types of circuits involved in the testing work.

(2) *Capacity Unbalance Tests.* If the electrostatic capacities between wires and between wires and ground in telephone circuits are not

properly balanced crosstalk between circuits will result. The effects of capacity unbalances of this kind are particularly serious in producing side to side and phantom to side crosstalk in quadded cable circuits unless great care is taken in splicing the various pairs and quads in consecutive lengths so that the resultant unbalances will be a minimum. This is to be expected since in cables the electrostatic capacities between conductors and between conductors and sheath

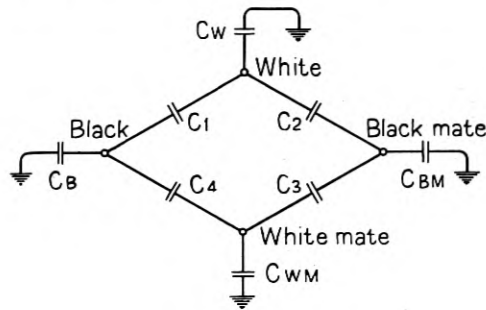

Fig. 12

are high as compared to open wire circuits and any irregularities in construction may produce very appreciable unbalance conditions between these capacities.

Fig. 12 shows the direct electrostatic capacities in a quad which, if they do not have the proper balance relations will produce excessive crosstalk. The conductors of one pair are designated "white" and "white mate" and of the other pair "black" and "black mate." The particular arrangement of the conductors in the figure to form the arms of a Wheatstone bridge is used since this arrangement is employed in the capacity unbalance measuring circuit described later.

Neglecting second order effects, side to side crosstalk is produced by unbalances in the direct capacities between conductors in accordance with the following relation.

$$\text{Capacity unbalance} = C_1 + C_3 - (C_2 + C_4).$$

In phantom to side crosstalk the unbalance relations of the direct capacities of the conductors to ground (sheath and "bunch") in addition to the direct capacities between conductors become important. Again neglecting second order effects, the unbalance relations producing crosstalk between the phantom and the "white" side is

$$\text{Capacity unbalance} = 2 [C_1 + C_2 - (C_3 + C_4) + \frac{1}{2}(C_w - C_{wm})].$$

Similarly the unbalance relations producing crosstalk between the phantom and the "black" side is

$$\text{Capacity unbalance} = 2 [C_1 + C_4 - (C_2 + C_3) + \frac{1}{2}(C_B - C_{BM})].$$

The factor 2 enters into the last two formulæ since the difference in direct capacities have about twice the effect on phantom to side crosstalk as they do on side to side crosstalk.

The capacity unbalances given above are measured on each quad in every loading section and give a measure of the side to side and phantom to side crosstalk due to capacity unbalance in the cable. Such measurements are usually made at three points in every loading section and the quads are spliced at these points in such a way that the capacity unbalances in the two directions will tend to neutralize. In this connection particular care is taken to neutralize the phantom to side unbalances since these are usually higher.

For making capacity unbalance tests a special portable bridge known as the capacity unbalance test set was developed which has been in general use since the introduction of quadded cables in the telephone plant. Fig. 13 shows the schematic circuit arrangement of this bridge for measuring the capacity unbalance as indicated above between sides of a quad.

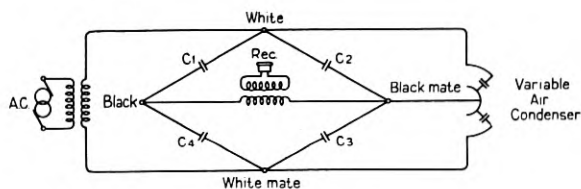

Fig. 13

The two conductors of each side circuit of the quad are connected to opposite corners of the bridge, these being designated as "white" and "white mate" and "black" and "black mate." The direct capacities between these conductors then become the arms of the bridge. An oscillator is connected through a transformer to the "white" and "white mate" terminals of the bridge and a variable air condenser is connected to these same terminals. A telephone receiver is connected through a transformer to the "black" and "black mate" terminals. The variable air condenser is adjusted until a minimum tone is observed in the receiver, this adjustment adding capacity to one side or the other of the bridge. The variable condenser is calibrated to read the unbalances directly in micro micro-

farads, the direction of the unbalances being indicated by red and black scales and arbitrarily designated as (+) and (-).

Fig. 14 shows the circuit arrangement of the bridge for measuring the capacity unbalance between the phantom and "white" pair. The oscillator, variable condenser and receiver are connected as before, the "black" conductor and its mate however, being strapped together at one of the remaining bridge terminals and ratio arms R_1 and R_2 each consisting of 2,000 ohms resistance, being connected as shown to the fourth bridge terminal. For the condition of minimum tone the variable condenser reading then gives a measure of the capacity unbalance between the phantom and the "white" pair, that

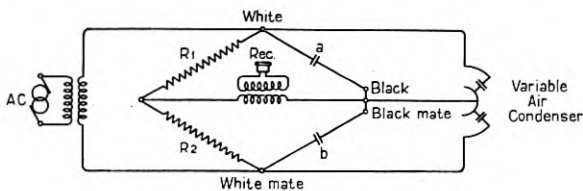

Fig. 14

is $a-b$. The capacities a and b take into account in this case the capacities of the "white" and "white mate" conductors to ground in addition to the direct capacities between wires shown in Fig. 13. The unbalance between the phantom and "black" pair is obtained in the same manner as shown by interchanging the "white" and "black" conductor connections to the bridge. The test set reads only half the capacity unbalance as defined in the above formulæ for phantom to side unbalance.

In practice the testing arrangement just described is used to test unbalances of all quads in a cable in each direction. At any splicing point where the tests are made the three unbalance measurements in each direction for each quad are carefully recorded and the splices then made by combining (+) and (-) values so as to neutralize each other as much as possible thereby reducing the resulting capacity unbalances and the crosstalk in each direction to a minimum. Both the bridge and oscillator are readily portable and designed for outdoor use. The bridge is equipped with keys, binding posts and leads to allow connections to be quickly made to the cable conductors and the various conditions of unbalance measured.

(3) *Impedance Tests.* The various bridge arrangements for capacity measurements are essentially impedance measuring devices, the im-

pedance of condensers being negative reactance. In telephone circuits and equipment where inductance is involved such as in loading coils, transformers, retardation coils, etc., the effective resistance as well as the inductance becomes a factor which must be taken account of in bridge testing work. For measuring effective resistance, inductance and impedance, bridges have been developed which are similar to capacity bridges except that standard condensers in the balancing arm are replaced by standard inductances and resistances.

There are two general types of bridges in use in the telephone plant designed to measure impedance; one type for testing equipment made up mostly of inductance, such as loading coils, and the other for testing the impedance characteristics of various types of equipment and circuits generally within the operating range of frequencies.

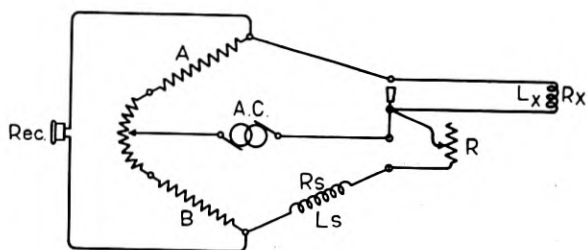

Fig. 15

The circuit arrangement shown in Fig. 15 is for an impedance bridge designed primarily for measuring impedance of equipment having positive reactance characteristics. As in the capacity bridges two arms are made up of fixed resistances A and B , connected by a slide wire resistance. The impedance to be measured makes up the third arm of the bridge and the standard impedance consisting of known values of inductance and resistance is the fourth arm. To obtain accurate measurements requires that the standard impedance be approximately the same order of magnitude as the impedance measured and the phase angles of the two must be very nearly the same. Values of standard inductance are, therefore, chosen which are known to be fairly near the values of the unknown inductances and a variable resistance R is provided which can be switched in series with either arm of the bridge and adjusted until the resistance components in the two arms are equal. The bridge is balanced by adjusting the slide wire resistance and the resistance R until a mini-

mum tone is heard in the receiver. For the condition shown in Fig. 15 when the bridge is balanced $L_x = \frac{A}{B} L_s$ and $R_x = \frac{A}{B} (R + R_s)$. The slide wire is calibrated to read the ratio $\frac{A}{B}$ directly and tables of values for L_s and R_s at various frequencies are supplied for use with the commercial form of bridges. The value of R is read directly from the dial rheostats on the bridge.

In practice this form of bridge finds its principal application in measuring the inductance and resistance of cable loading coils when trouble is experienced which necessitates opening up the cable and loading coil pots. It is also used to measure the unbalance between windings of coils as, for example, between the line windings or the drop windings of repeating coils. For measurements of the latter kind one winding is connected in place of L_x and the other in place of L_s and the unbalance between the two windings is then given by the slide wire ratio. A further use of this scheme is in checking the correctness of loading of short cable circuits and a special bridge has been designed for this purpose. A pair which is known to be properly loaded is used as the standard and all other pairs of the same length and loading are checked by connecting them one at a time into the unknown arm of the bridge.

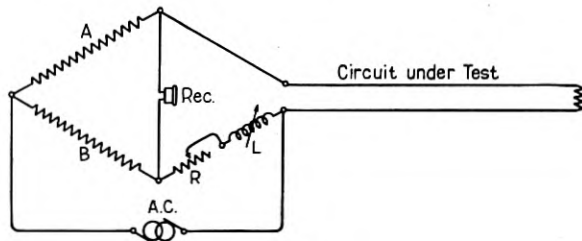

Fig. 16

The form of bridge designed to measure the impedance characteristics of circuits and equipment at any desired frequency or at a number of frequencies is shown in Fig. 16.

The fixed resistances A and B , generally of 1,000 ohms each, make up two arms of the bridge, the circuit under test the third arm and a variable resistance and a variable inductance standard the fourth arm. The variable inductance L is arranged so that it can be switched in series with the circuit under test when the characteristics of this circuit are such that its capacitive reactance predominates. For a

condition of balance indicated by minimum tone in the receiver, the effective resistance of the circuit is given directly by the value of the variable resistance R , and the inductance by the value of L . For any particular frequency f at which a measurement is made, the reactance of the circuit can be computed from the value of L and expressed in ohms by the formula

$$\text{Reactance} = 2\pi fL.$$

The impedance of the circuit expressed in ohms is equal to the vectorial sum of the effective resistance R and the reactance. This relation is made use of in practice when it is desired to express the impedance of circuits in round numbers without reference to its component parts. Generally, however, in the practical applications of impedance measuring in maintenance work, the resistance and inductance components can be used directly to the best advantage without combining them or expressing the inductance readings in terms of reactance.

One of the most important applications of impedance measurements is the determination of the characteristic impedance of telephone circuits at the various frequencies involved in the transmission of telephone currents. Measurements of this kind, when applied to equipment circuits such as telephone repeaters, balancing networks, etc., and to the line circuits themselves, tell a great deal in regard to the efficiency of these circuits for the transmission of speech. They are very important, therefore, in checking up the installation of certain circuits in the plant and making sure that the proper impedance relations are obtained.

Fig. 17 shows the results of impedance measurements on a loaded 19 gauge cable circuit within a range of frequencies from 300 cycles to 2,300 cycles. The effective resistance values and the values of the reactance components are indicated by the curves. The inductance values are negative which means that the circuit tested had capacitive reactance throughout the range of frequencies used. When the measurements were made the distant terminal of the circuit was terminated by an impedance approximating the characteristic impedance of the circuit in order to give the effect of an infinite length of line. If the above circuit is used for 2-way telephone repeater operation it is necessary that the repeater balancing networks have impedance characteristics similar to the lines which they balance in order that the maximum repeater gain with good quality be obtained.

Measurements such as described above, in addition to giving a picture of the effective resistance and reactance of circuits at different frequencies, also provide a means for locating the irregularities and

troubles which tend to change the normal impedance characteristics. The omission of loading coils or the reversal of one loading coil winding, the installation of intermediate apparatus or of emergency cable, etc., cause impedance irregularities which are very detrimental to telephone repeater operation. The effect of these irregularities on an alternating current is to reflect some of the current back towards the sending end, this reflected current either adding to or subtracting

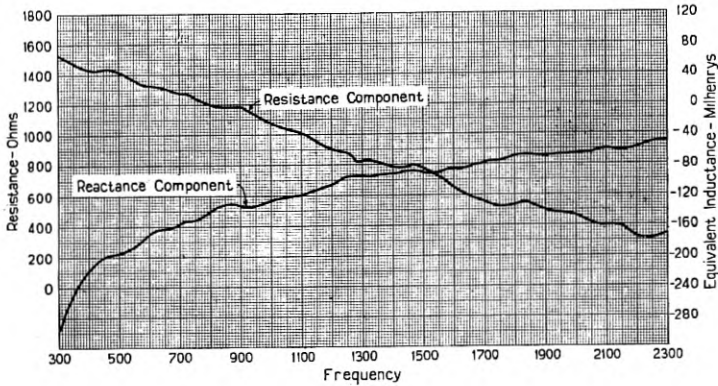

Fig. 17

from the current entering the line. This effect can be observed in impedance measurements by peaks and hollows in the effective resistance and inductance curves.

Fig. 18 shows two resistance curves of measurements made on a loaded No. 104 copper circuit (No. 12 N. B. S.), Curve *A* being for a condition where two consecutive loading coils were missing and Curve *B* for the condition after these coils were connected back in the circuit. The small irregularity in Curve *B* was due principally to the irregularity introduced by the use of a 1,500 ohm termination when making the measurement. The distance in miles from the end of the circuit at which the measurements were made to the irregularity caused by the missing loading coils is given fairly accurately by the formula:

$$\text{Distance} = \frac{V}{2(f_2 - f_1)},$$

where V is the velocity of the measuring current in miles per second for the particular type of circuit tested and $(f_2 - f_1)$ the average difference in frequencies between successive peaks of Curve *A*. For the type of circuit on which the measurements shown on Fig. 18 were

made, the velocity of propagation is approximately 54,700 miles per second. The average difference in frequencies between peaks on the curve is about 380 cycles. Applying these figures in the above formula gives the distance out to the irregularity as 70 miles. In this case the ninth and tenth loading coils were missing, which gave a very close check to the computed 70 mile figure. A great deal of use is

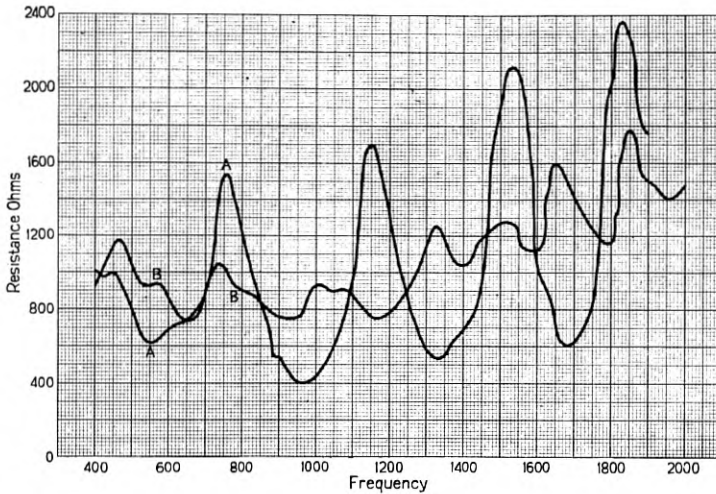

Fig. 18

made of measurements of this kind in locating troubles which affect telephone repeater operation and in directing the work of linemen in clearing these troubles.

A further use which can be made of a bridge similar to the one just described is in the location of impedance unbalance conditions which tend to increase crosstalk and noise between circuits. This is a fairly recent development and a description of it will be included in a paper to be published later.

(4) *Tests of Balance of Apparatus.* Certain types of equipment associated with telephone circuits are made up of apparatus which has to be closely balanced with respect to the various parts in order that the equipment when connected to telephone circuits will not cause unbalances in these circuits. Any unbalances introduced in this way will increase noise and crosstalk in the same manner as impedance unbalances in the line circuits themselves. Cord circuits, phantom repeating coils, composite sets, etc., are examples of the types of equipment in which unbalances in the apparatus may affect noise and

crosstalk conditions in the telephone circuits to which they are connected. The capacity bridge and the impedance bridge previously described can be used to test apparatus unbalances.

Composite sets for superposing telegraph on telephone circuits are particularly important in respect to balance and in order to provide a means for quickly checking the balance conditions in these a special form of bridge has been designed. This testing apparatus is known as the composite set bridge and is of particular advantage in that it provides for quickly testing the balance conditions of various parts

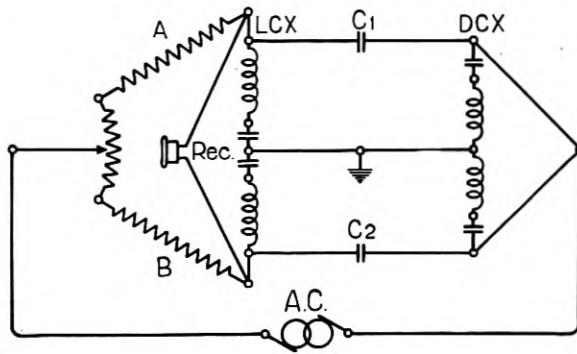

Fig. 19

of the set as well as complete sets. Tests can be made for example of the balance of the telegraph branches complete or of the condensers and coils in these branches separately. Tests can also be made of the balance of the grounded branches or of the series line condensers of the set.

To illustrate the operation of this bridge, Fig. 19 shows the arrangement for testing the balance of the series condensers in a composite set. Two arms of the bridge *A* and *B* consist of fixed resistances connected together by a slide wire resistance. The series line condensers of the composite set, C_1 and C_2 , then become the other two arms of the bridge. When a source of alternating current is connected as shown, a condition of minimum tone in the receiver obtained by adjusting the position of the contactor on the slide wire indicates when the bridge is balanced. The slide wire is calibrated to read the percentage unbalance of the condensers C_1 and C_2 directly.

Crosstalk and Noise Measurements. Circuit unbalance conditions, such as described in some of the previous tests, are often very detrimental to telephone transmission in that they cause crosstalk between

circuits. Also foreign currents, induced from supply lines, produce noise which has much the same effect as inserting a transmission loss. The magnitude of noise produced in this way is dependent among other things, on the balance conditions of both the supply and telephone circuits.

The determination of the magnitude of crosstalk and of noise currents can be made by relatively simple measurements. In practice crosstalk tests, which also give an indication of the balance conditions of circuits, can be made more quickly than impedance unbalance tests, although they do not give a location directly of any troubles which may exist. The usual procedure then is to make noise and crosstalk tests on circuits, and in those cases where the measurements indicate that improvement is desirable some of the direct current or alternating current methods previously described are applied to locate the cause. The simplified circuit arrangement of the test set commonly used for measuring crosstalk between two circuits is shown in Fig. 20.

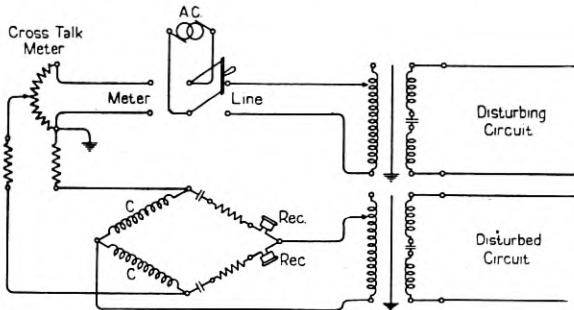

Fig. 20

An alternating current source generally of complex wave shape to simulate voice currents is connected to a switch in the set so arranged that its voltage can be impressed either on a telephone circuit known as the "Disturbing Circuit" or on a measuring shunt known as a "Crosstalk Meter." The other side of the shunt is connected through a Wheatstone bridge arrangement to a second telephone circuit known as a "Disturbed Circuit." Shielded transformers are used in the set as shown for connection to the circuits under test, these transformers being designed to give the proper impedance relations required by the different types of circuits met with in practice. The Wheatstone bridge arrangement is primarily for the purpose of allowing any noise currents which may be present in the disturbed circuit to be impressed on the observing receivers either when these are used to listen to the

cross-talk through the shunt or directly to the crosstalk from the disturbed line. Errors which might be introduced should line noise be present for only one condition of the test are in this way eliminated.

Measurements are made by first impressing the alternating current tone on the disturbing circuit and then on the meter and adjusting the shunt until the annoying effect of the tone heard in the disturbed circuit is judged to be the same as that heard on the meter. The crosstalk meter is calibrated in crosstalk units, one unit being defined as the ratio of one millionth between the current at the terminal of the disturbed circuit and the current at the terminal of the disturbing circuit, providing these currents are transmitted into like impedances and distortion of the speech sounds is not involved.

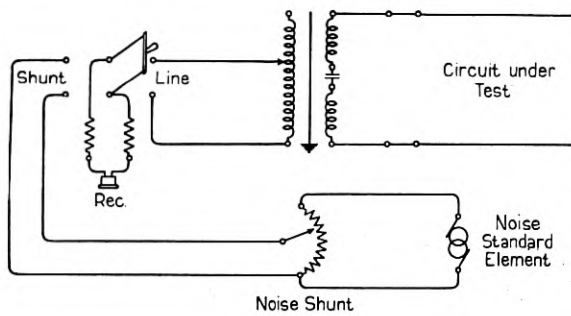

Fig. 21

Fig. 21 shows the simplified circuit of a noise measuring set arranged to measure metallic noise on a telephone circuit. As in the case of the crosstalk set, a shielded transformer is used to connect the set to the circuit under test which can be adjusted to give the proper impedance relations. With the switch thrown towards "line" the receiver is connected to the circuit under test and any noise on this circuit observed. When the switch is thrown towards "shunt" an artificial noise current produced by a vibrator is impressed on the receiver through a shunt. By alternately throwing the switch from the line under test to the shunt circuit, the shunt is adjusted until the interfering effect of the noise on the line and from the shunt are judged to be equal. The reading of the shunt which is calibrated in noise units gives a measure of the amount of noise in the circuit under test. In the commercial form of instrument used in the plant, the circuit is arranged so that both metallic noise and noise to ground can be readily measured. Where noise is present on circuits, instruments are also available for analyzing the wave shape, that is, de-

terminating which frequencies making up the noise currents predominate. For both noise and crosstalk measurements, definite rules must be followed in terminating the distant ends of the circuits under test in order to reduce terminal impedance irregularities.

21-Circuit Balance Tests. In describing the use of the bridge for locating impedance irregularities, mention was made of the effect of such irregularities on telephone repeater operation. Since the making of impedance runs on circuits involves a considerable amount of time and expense, a simple and quick balance test, known as the 21-circuit test, was devised in which the telephone repeater is made to function as the testing set. The gain which can be obtained from a 21 or 22 type telephone repeater with good quality depends to a large extent on the degree of balance, within the frequency range involved, between the impedances of the telephone circuits and the impedances of the corresponding balancing networks. The use of this balance relation is illustrated in the simplified circuit of Fig. 22 which shows a 22 type repeater connected to make a 21-circuit balance test between the "East" line and its balancing network.

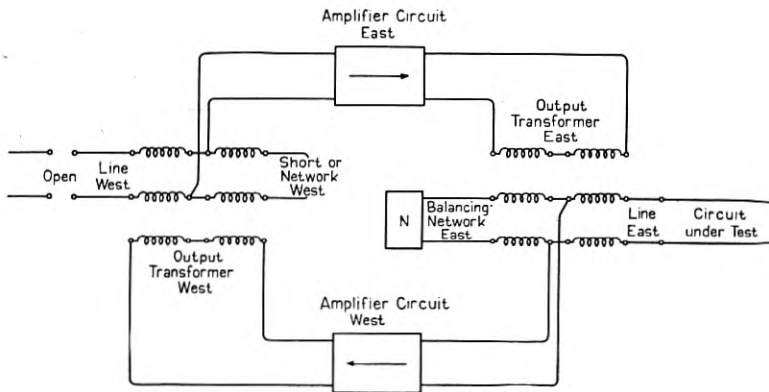

Fig. 22

The line under test and its balancing network are connected as for normal repeater operation, while the "West" line is opened. The "West" line network terminals are either shorted or the network left connected, the principle of the test being the same in either case. The 3-winding transformer, when connected for normal repeater operation, as shown for the "East" transformer in Fig. 22, simply gives a Wheatstone bridge relation, the input of the "West" amplifier being connected to the balanced points of the bridge. The proportion

of the current delivered to the transformer from the "East" amplifier which gets to the input of the "West" amplifier depends, therefore, on the degree of bridge balance furnished by the line under test and its network. When the 3-winding transformer is opened on the line side with either the network terminals shorted or with the network connected, as shown for the "West" transformer its action is the same as a repeating coil.

An internal path for currents which may produce repeater "singing" or a sustained tone, is established if the gain of the two amplifiers is just greater than the sum of the losses within the repeater circuit, that is, the losses through the transformers and any other equipment in the circuit. Theoretically, if the line and network were perfectly balanced and there were no internal unbalances in the repeater, it could not be made to sing since, due to the balance relations of the "East" 3-winding transformer, there would be infinite loss from the output of the "East" amplifier to the input of the "West" amplifier. This ideal condition is, of course, not met with in practice, since it is not practicable to design repeater circuits for perfect balance or to construct artificial networks which will exactly balance the working lines at all frequencies involved. The amplification which can be obtained in any instance without singing, then depends to a large extent on the balance between the lines and networks. In the test circuit shown in Fig. 22 the gains of the two amplifier elements are increased until singing or a sustained tone is observed and the total gain required for this gives an indication of the balance between the "East" line and its balancing network. In the same way the balance between the "West" line and its network can be determined by connecting this in the regular way to the "West" 3-winding transformer and disconnecting the "East" line. In making the tests in either direction the "poling" of the repeater circuit is reversed in order to give the lowest value of singing point which might occur under service conditions.

In practice the tests described above have become of considerable use and importance in the installation and maintenance of telephone repeaters and the circuits associated with them. Methods are available for computing the estimated singing points which circuits and equipment should give with telephone repeaters under operating conditions. These computations allow toll circuits and equipment to be engineered intelligently with respect to the gains which the repeaters may be expected to give with good quality. After installation, the 21-circuit tests furnish a means for checking computed or estimated singing points. When the estimated singing points cannot be obtained

with the 21-circuit tests, this is an indication of balance trouble which must be located either by an inspection of the circuits or balancing equipment or by resorting to impedance measurements as described previously.

Another method of determining impedance irregularities which is made use of in some of the larger offices is to measure the transmission loss through the 3-winding transformer with the lines and networks connected as for normal repeater operation. As stated previously the loss through the transformer to currents from the output of one amplifier to the input of the other gives a measure of the balance conditions of the line and network, the loss increasing as the balance becomes more perfect. By this scheme the losses through the 3-winding transformers can be measured over a range of frequencies as in line impedance measurements and a loss curve obtained which can be used to locate irregularities in the same manner as described for line impedance curves.

Transmission Efficiency Measurements. If all or a part of the tests already described were applied to the various transmission circuits in the telephone plant, most troubles which might effect speech transmission could be detected and assurance given that the circuits were properly installed. Such a procedure would be costly and impracticable and for this reason it is necessary that means be provided whereby a measurement of a circuit's efficiency for the transmission of voice currents can be quickly made.

The transmission of voice currents can be measured in terms of a standard and expressed in units in much the same manner as the transmission of any electrical currents. A telephone circuit, for example, extending between any two offices is said to have an equivalent of so many units of transmission, the number of these units depending on the electrical characteristics of the component parts of the circuit.¹ Transmission measurements, as far as volume efficiency is concerned, involve determining by means of suitable testing apparatus the number of transmission units of loss or gain which a particular circuit or piece of equipment causes. As it is desired to obtain a measure of efficiency at a frequency comparable with the combined frequencies of the voice, a frequency of 1,000 cycles for the testing current has been chosen which experience has shown gives results approximating fairly closely those obtained by using a combination of the frequencies within the voice range. Measurements can also be made at other frequencies within the voice range or at

¹ See the article in this issue, The Transmission Unit and Telephone Transmission Reference Systems, by W. H. Martin.

frequencies outside of this range where desired, for example, at ringing current frequencies or carrier current frequencies.

Efficiency tests of transmitters and receivers present a somewhat different problem and for these it has been found most convenient to make direct comparisons between the instruments under test and standard instruments.

A discussion of the application of transmission testing apparatus in maintenance work for measuring losses and gains is given below.

(1) *Measurements of Transmission Losses.* In its simplest form a transmission measuring set involves an arrangement of apparatus whereby a volume comparison can be made between voice currents transmitted over a circuit of unknown efficiency and then over a standard circuit of known efficiency.

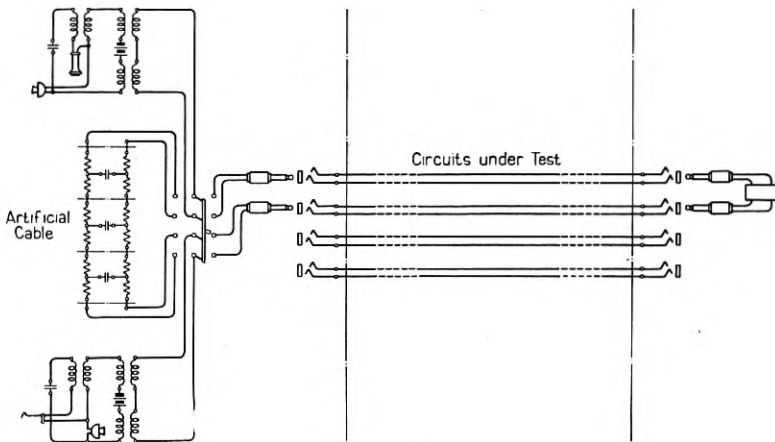

Fig. 23

Such an arrangement is illustrated in Fig. 23 in which the amount of artificial cable required to give a volume of transmission equal to that obtained over the circuit under test is a measure of the circuit's efficiency in terms of the artificial cable units. Prior to the development of the present types of transmission measuring sets the arrangement shown in Fig. 23 was used to a limited extent, principally in making measurements on important types of toll circuits and in determining fundamental transmission data such as unit equivalents, reflection losses, etc.

To meet the practical requirements of field testing work two general types of testing apparatus have been developed, one involving "ear

balance" methods and the other "visual" methods, that is, an amplifier and detector arrangement.

Fig. 24 shows the schematic circuit arrangement for an ear balance test set and Fig. 25, that for a set employing visual methods.

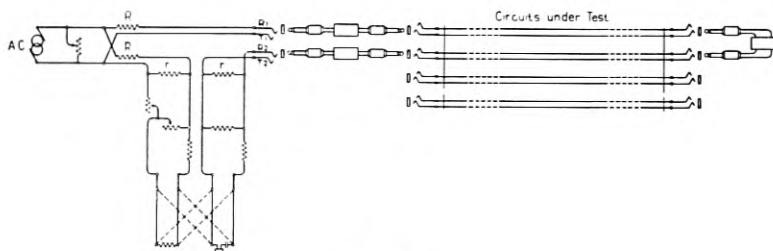

Fig. 24

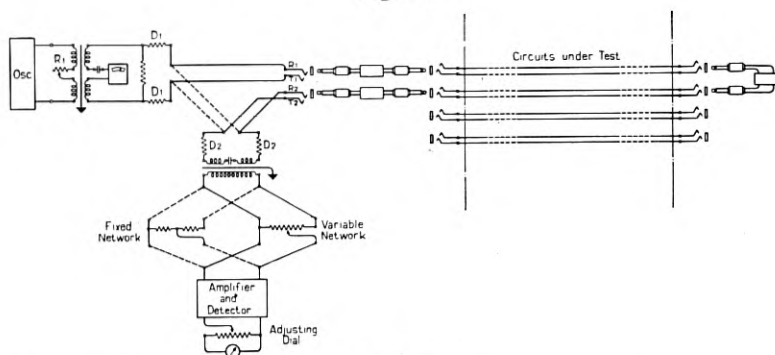

Fig. 25

A description of this apparatus and its development has been given in a paper by Best.² In brief, one subscriber's set of the circuit in Fig. 23 has been replaced by an oscillator while the other subscriber's set has been replaced by a receiver and resistance arrangement in the circuit of Fig. 24 and by an amplifier and detector in the circuit of Fig. 25. The artificial cable of Fig. 23 has also been replaced by distortionless resistance network standards in Figs. 24 and 25. Various resistances and coils are also provided to meet practical testing requirements such as adjusting the measuring current, and reducing reflection losses.

For field testing work, the circuits shown in Figs. 24 and 25 are mounted in compact form in portable boxes which can be readily carried from office to office or wherever required. Portable oscillators for supplying the measuring current are also provided so that com-

² F. H. Best, *Jour. A. I. E. E.*, Vol. XLIII, No. 2., Feb., 1924.

plete testing equipment is available, by means of which, a large volume of transmission testing in central offices and private branch exchanges can be done in the most convenient manner. Tests using these instruments can be made as readily on the transmission circuits in machine switching offices of both the step by step and panel types as in manual offices. The ear balance set of Fig. 24 requires no external source of direct current power and only a three dry cell battery is required for operating the oscillator. It is, therefore, used to the best advantage in testing private branch exchange switchboards and magneto switchboards where the power necessary to operate visual types of sets is not readily available.

The visual type of set of Fig. 25 is particularly suited for testing in the larger common battery central offices since it permits measurements to be made more quickly and accurately than in the case of the

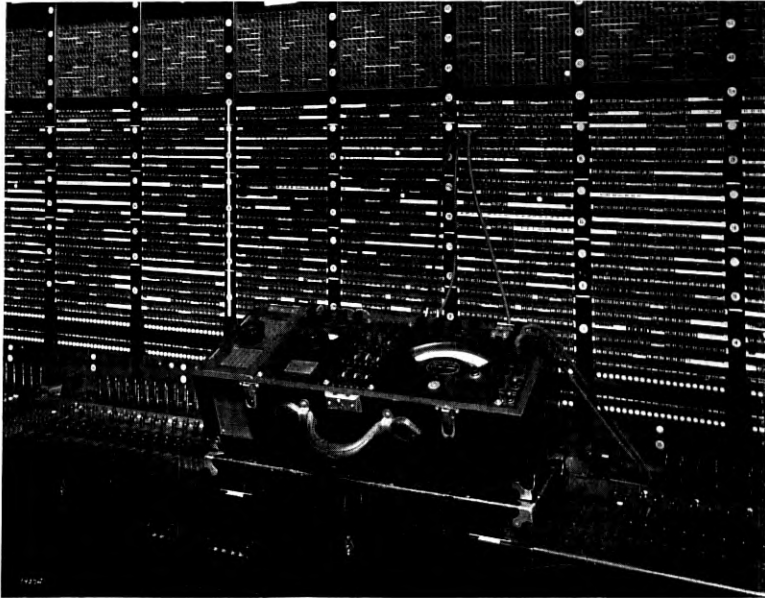

Fig. 26

ear balance sets. These larger offices also have readily available the 24-volt batteries required to operate the visual reading sets. Fig. 26 shows a picture of one of the latest types of portable visual reading measuring sets, set up ready for operation at a central office switchboard position.

In order to give a general picture of the kinds of trouble found with this transmission testing equipment the following table shows a trouble classification which is particularly useful in analyzing testing results and instigating any required remedial measures.

Classification of Troubles Found

Physical defects.	Wrong type of equipment or circuit.
Opens.	Missing equipment.
Grounds.	High resistance.
Crosses.	Low insulation.
Cut Outs.	Wrong routing.
Electrical defects.	Bridged conductors.
Incorrect wiring.	

The above classification includes all of the common types of troubles which, if not kept out of the plant, will be detrimental to service. The item of physical defects is a class of trouble which is not determined directly by transmission tests but is discovered by the maintenance forces during the course of their testing work. It represents any unsatisfactory conditions found in the circuits which, while not causing trouble at the time, may very likely do so later and should, therefore, be corrected. The next four kinds of trouble shown in the table viz: opens, grounds, crosses and cut-outs while detected by transmission tests can also be found and cleared by the everyday maintenance work without the use of transmission testing apparatus. The remaining classes of trouble listed can, it has been found, be detected and eliminated most efficiently by the use of transmission testing sets. Classifying troubles and identifying them with the important circuits in the exchange area plant such as cord circuits, operators' circuits, trunks, etc., has proved very valuable in transmission maintenance work. The results of the work when analyzed in this way are a very great aid in supervision and assist materially in keeping the plant in good condition.

The visual reading circuit of Fig. 25 is also designed in a form for permanent installation particularly for use in testing toll circuits. A picture of a typical installation of one of the latest types of sets and its associated oscillator is shown in Fig. 27.

From 40 to 50 instruments of the general type shown in the picture are now located at important toll centers throughout the country. They are constantly used to check the overall transmission efficiency

of toll circuits and in locating and clearing any transmission troubles which occur in service. Tests are made either by looping two circuits together at the distant terminals and measuring the loop loss or by testing single circuits straight-away between toll centers equipped with measuring instruments of this type.

In general, transmission testing apparatus quickly locates kinds of troubles which cannot be readily detected by other routine testing methods. Transmission tests also serve as a means for checking

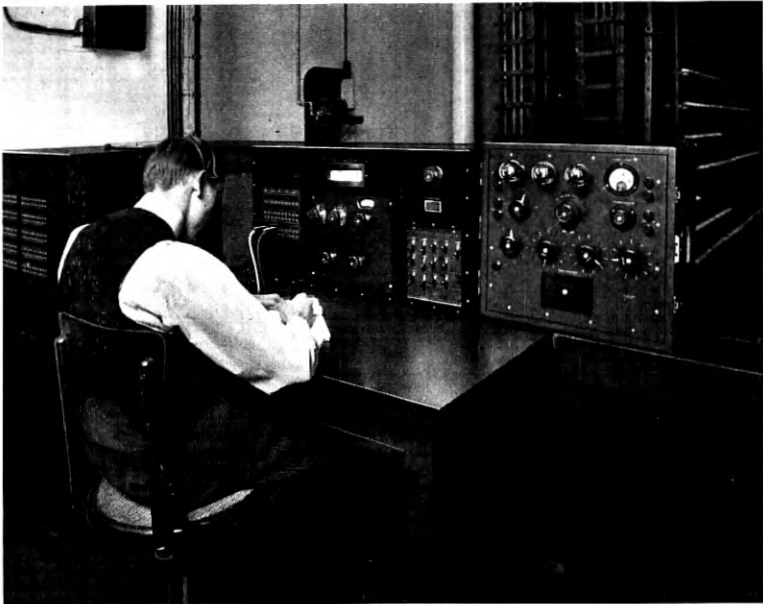

Fig. 27

general maintenance conditions and for insuring that other routine testing work is carried on in an effective manner.

As an illustration of the effect of some of the kinds of troubles which transmission tests detect, Fig. 28 shows the transmission circuit arrangement for a typical toll connection and below transmission level diagrams are given for the normal transmission condition and for conditions where common kinds of troubles are present. The level diagrams show how the normal overall transmission equivalent is increased when one or a number of transmission troubles are present in the various circuits going to make up the connection between subscribers. As indicated some troubles are more severe than others,

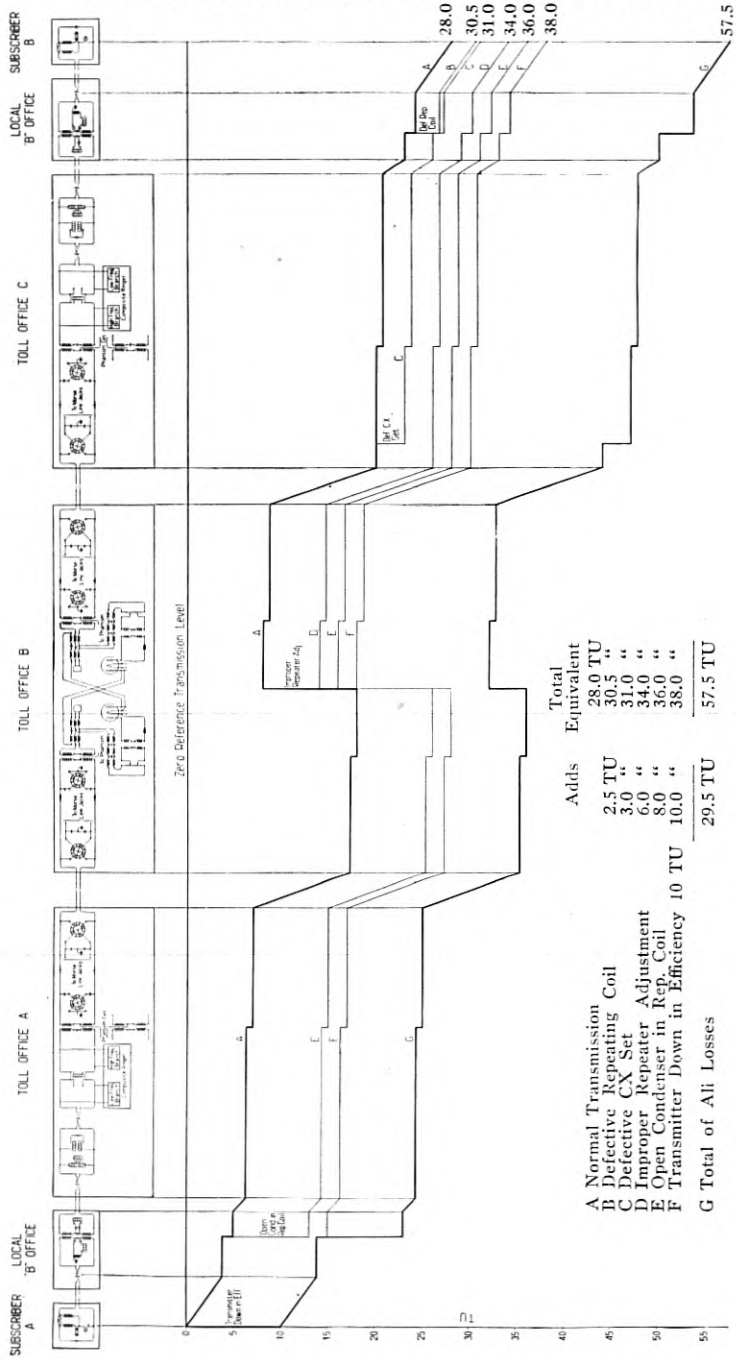

Fig. 28

but any of them tend to produce conditions which may be very detrimental to service. These diagrams illustrate therefore, how important it is to maintain the telephone plant so that troubles of this nature will not be present.

(2) *Measurements of Transmission Gains.* The transmission gains of amplifier circuits are measured in much the same way as transmission losses. A gain may be considered as a negative loss and is expressed in the same transmission units. In measuring the gains of amplifier circuits designed for two way operation, it is necessary to provide the proper balancing conditions in order to prevent "singing." This is done by connecting the amplifier circuit between two artificial lines of the proper impedances and balancing these lines by networks. The simplest measuring circuit now in use consists of an arrangement whereby the repeater or amplifier under test is connected between two artificial lines with balancing networks and tone is supplied by an oscillator at the terminal of one line while the terminal of the other line is equipped with a receiver and a measuring shunt calibrated in transmission units. The repeater and the shunt are then alternately cut in and out of the circuit and the shunt adjusted until equal volume of tone is observed in the receiver, for which condition the shunt reading gives the gain of the repeater.

A visual method for measuring repeater gains is provided by substituting an amplifier detector circuit for the shunt and receiver. This is essentially what is done in the transmission measuring circuit shown in Fig. 25. The type of set designed for permanent installation which employs this circuit is arranged so that amplifier gains up to about 20 TU can be measured when a repeater is connected in place of the lines under test and the necessary repeater balancing requirements taken care of. The gains of repeaters connected in toll circuits are often checked in this way when overall transmission tests are made on these circuits.

To meet practical testing requirements at the larger repeater and carrier stations where a considerable amount of gain testing work is done, a visual reading measuring set especially designed for testing amplifier gains has been developed. The measuring circuit employed in this gain testing set has been described.³ The equipment going to make up these sets, that is, the measuring shunts, artificial lines, amplifiers, meters, etc., is mounted in compact form on standard panels which can be installed at convenient locations near repeater and carrier equipment. A panel mounted 1,000 cycle oscillator is also

³ A. B. Clark, *Bell System Technical Journal*, Volume II. No. 1, January, 1923.

provided to supply measuring current, although other types of oscillators giving the necessary output and proper wave shape can be used if desired.

In practice, it is necessary to maintain the gains of the amplifiers in repeater and carrier circuits to fairly close limits since these amplifiers form an integral part of toll circuits. Measurements of gains are also made in connection with the 21 circuit balance tests previously described. Another important application of gain tests is to check the gain frequency characteristics of repeaters to determine that all frequencies within the voice range are being properly amplified. By varying the filament current between limits, a test of the vacuum tubes for filament activity is obtained by gain measurements.

(3) *Measurements of Transmitter and Receiver Efficiencies.* Transmitters and receivers are used in the telephone plant principally in operators' sets and subscribers' sets. In the former, the transmitters, receivers and operators' circuits are readily available to the maintenance forces and therefore can be inspected and tested in a routine manner. In the case of subscribers' sets, however, the equipment in service is not accessible and tests must be made on the instruments before installation or at times when they are removed from service. Talking tests can also be made from the instruments at the time installations are made and any particularly unsatisfactory conditions found in this way.

The difficulties incident to testing transmitters and receivers are due to the fact that in transmitters, the efficiency depends on the ability to convert sound energy into electrical energy and in receivers, the ability to convert electrical energy into sound energy. Obviously, a simple form of transmitter test and one which has until recently been generally used is to talk alternately into the transmitter under test and then into a standard transmitter and observe the difference in volumes at a receiving set. In the same manner, a simple receiver test is to listen alternately to a receiver under test and then to a standard receiver connected to a talking station. This method is slow and also of limited accuracy due to inherent changes in a speaker's voice and to the possibility of the distance of the speaker's lips from the transmitter varying. To take the place of this method transmitter and receiver testing machines have been developed which will be described in a paper to be published later.

Oscillators. Practically all alternating current testing work requires the provision of an external source of measuring current. For this purpose oscillators of various types have been developed which are designed electrically and mechanically to meet various test circuit

requirements as to wave shape, volume of current, etc. One of the earliest forms of oscillators known as the "substation howler" was made by coupling the receiver and transmitter of a subscriber's set together mechanically and taking off the alternating current generated by means of an induction coil in the howling circuit. This type of oscillator, which was subject to large variations in volume and produced a very poor wave form, has now been replaced by other and improved types.

Oscillators now in use in the field can be divided into three general classes, those employing vibrators, those employing motor generator equipment and those employing vacuum tubes. The principles of these oscillators are briefly described below by considering one commercial type in each class:

(1) *Oscillators Employing Vibrators.* Fig. 29 shows the circuit arrangement of an oscillator of this type which is designed for producing a single frequency alternating current.

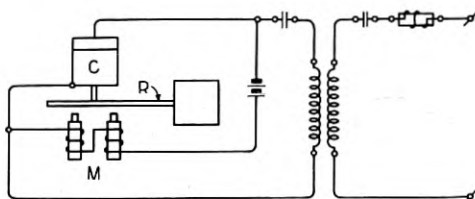

Fig. 29

The current generating element consists of a metal reed R , resting against the diaphragm associated with the carbon button C . The receiver spools M , are so arranged that when they are energized by the battery an attractive force is exerted upon the reed which draws it away from the carbon button. This action decreases the pressure in the carbon button with a corresponding decrease in the current from the battery, which in turn decreases the attractive force of the receiver so that the pressure of the reed against the carbon button is again increased. This cycle of change in current and pressure is repeated at the natural frequency of vibration of the reed so long as direct current flows from the battery. The alternating currents set up in this way are passed through a circuit resonant at the natural period of vibration of the reed, thereby giving a current of good wave form.

This particular form of vibrator oscillator is used principally in transmission testing work where portable "ear balance" methods

are employed. It may, however, be used for other kinds of measurements where single frequency currents of fairly good wave form are required. Other forms of vibrator oscillators are available, particularly for use in capacity and capacity unbalance tests and cross-talk and noise tests.

(2) *Oscillators Employing Motor Generator Equipment.* This type of oscillator is illustrated by ordinary ringing and trouble tone machines and the low frequency alternating currents generated by these machines are often used in testboard work. The circuit for an oscillator of this type, particularly designed for producing 1,000-cycle alternating current with good wave form, is shown in Fig. 30.

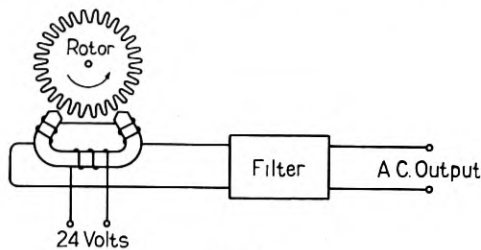

Fig. 30

In this circuit the field of an electromagnet is varied by a laminated core or rotor resembling a spur gear driven by a small 24-volt d.c. motor. The speed of the motor is automatically regulated and the electromagnet and rotor so designed that a 1,000-cycle current is generated. Harmonics which are inherent in the oscillator are eliminated by the use of a filter. This oscillator can be operated on the regular 24-volt central office battery and is compactly mounted to make it readily portable. It is particularly adaptable, therefore, for supplying the measuring current required to operate portable visual transmission measuring sets and is now generally used for this purpose in the telephone plant.

(3) *Oscillators Employing Vacuum Tubes.* Fig. 31 shows the simplified circuit arrangement of a vacuum tube oscillator.

The oscillating vacuum tube in this generator has its plate and grid inductively connected together in a tuned circuit. Closing the filament battery circuit starts this tube oscillating, the frequency of the oscillations being controlled by the inductance of the plate and grid coupling and the variable condenser *C*. The current thus generated is amplified by other vacuum tubes to the values which are required in the alternating current testing work. The circuit of Fig. 31 shows

only one amplifying vacuum tube, but additional amplifiers may be added to meet the requirements of particular kinds of testing work. One of the latest forms of oscillators of this type is shown in Fig. 27 set up for use with one of the permanent types of transmission measuring sets.

Vacuum tube oscillators have been developed which will generate measuring currents of any desired frequency within the range of 100 cycles to 50,000 cycles, thus covering both the voice and carrier

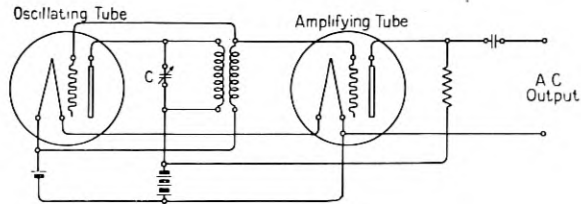

Fig. 31

range. These oscillators have become indispensable in testing and maintenance work. They are used extensively in making both single frequency transmission tests and transmission loss and gain tests within the range of frequencies mentioned above. They are also used in making line impedance and impedance unbalance tests and in determining the characteristics of telephone repeater and carrier circuits.

Specific Applications of Electrical Testing Methods. In describing the various electrical tests above, considerable has been said regarding the applications which are made of them to insure satisfactory telephone transmission. In order to give an overall picture of these applications the toll connection for which transmission level diagrams are given in Fig. 28, is shown in simplified form in Fig. 32, with various tests listed underneath the different sections of the circuit layout. Only the sections of the circuit making up the first part of the connection are shown since corresponding tests will apply to the circuits making up the second.

The tests listed in Fig. 32 are not intended to give a testing program but rather to show the various electrical testing means which are available for use in installation and maintenance work. Just what tests should be made, the frequency of making the tests and the limits to work to, to insure a high grade of transmission depend on the types of circuits and equipment involved and their relative im-

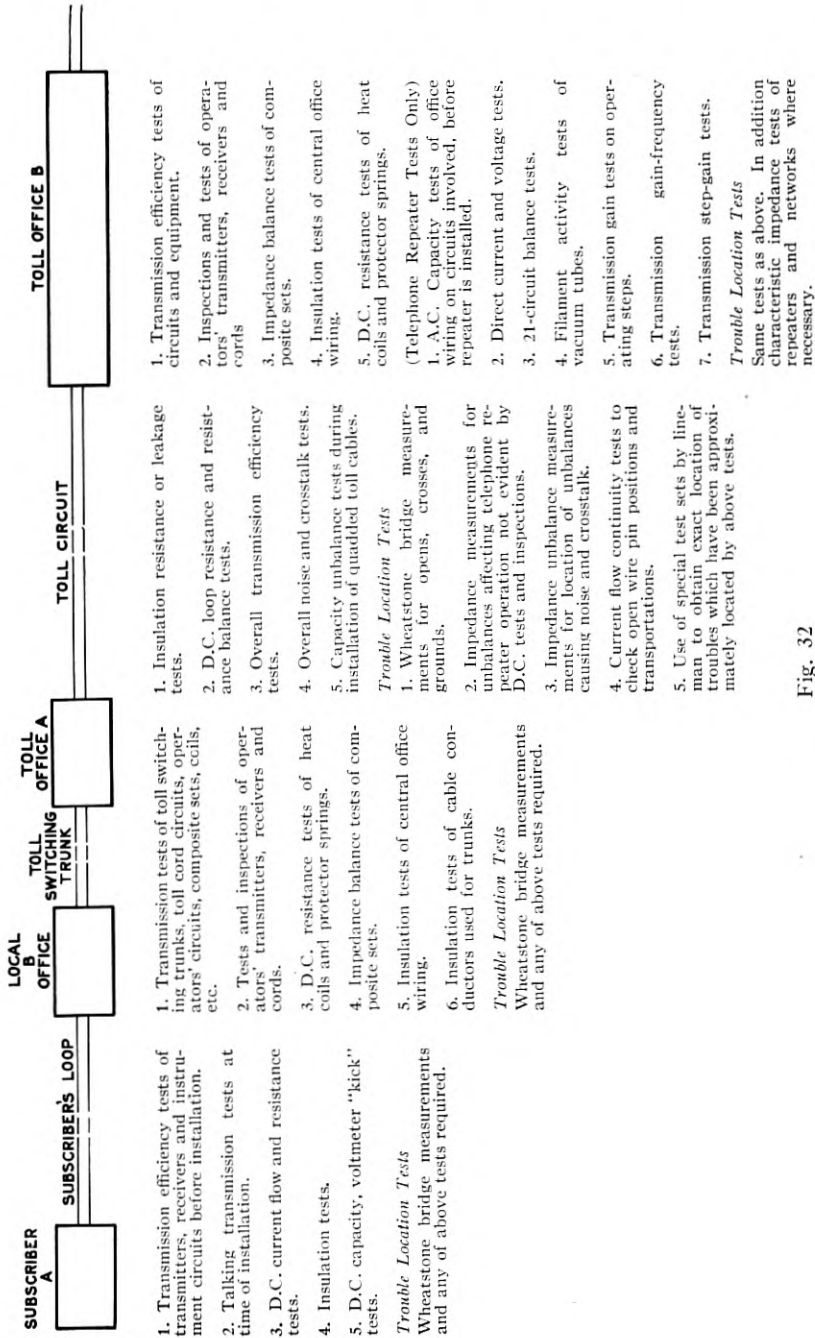

Fig. 32

portance in the system as a whole. These matters are covered in routine instructions which are developed by experience and which take into account local conditions and service requirements.

In conclusion, it may be stated that telephone systems in their present development have at their disposal means for carrying on an adequate transmission maintenance program in an economical manner. Furthermore, studies and trials of new methods are continually being carried on with a view to obtaining further improvements and increased economies in transmission testing and maintenance work.

A Generalization of the Reciprocal Theorem

By JOHN R. CARSON

THE Reciprocal Theorem, an interesting and extremely important relation of wide applicability, which was discovered by Lord Rayleigh, is stated by him in the language of electric circuit theory as follows:

"Let there be two circuits of insulated wire A and B, and in their neighborhood any combination of wire circuits or solid conductors in communication with condensers. A periodic electromotive force in the circuit A will give rise to the same current in B as would be excited in A if the electromotive force operated in B."¹

Before proceeding with the generalization which is the subject of this paper, Rayleigh's theorem, in the following modified form, will first be stated and proved:

I. *Let a set of electromotive forces $V_1' \dots V_n'$, all of the same frequency, acting in the n branches of an invariable network, produce a current distribution $I_1' \dots I_n'$, and let a second set of electromotive forces $V_1'' \dots V_n''$ of the same frequency produce a second current distribution $I_1'' \dots I_n''$. Then*

$$\sum_{j=1}^n V_j' I_j'' = \sum_{j=1}^n V_j'' I_j'. \quad (1)$$

To prove this theorem we start with the equations of the network

$$\sum_{k=1}^n Z_{jk} I_k = V_j, \quad j = 1, 2, \dots, n, \quad (2)$$

and observe that, provided the network is invariable, contains no internal source of energy or unilateral device, and provided that the applied electromotive forces $V_1 \dots V_n$ are all of the same frequency, say $\omega/2\pi$, the mutual impedances satisfy the reciprocal relations $Z_{jk} = Z_{kj}$. Consequently if (2) is solved for the currents, we get

$$I_j = \sum_{k=1}^n A_{jk} V_k, \quad j = 1, 2, \dots, n, \quad (3)$$

and the coefficients also obey the reciprocal relations $A_{jk} = A_{kj}$.

Now consider two independent and arbitrary sets of equi-periodic applied electromotive forces, $V_1' \dots V_n'$ and $V_1'' \dots V_n''$: then

¹ Rayleigh, Theory of Sound, Vol. I, p. 155.

in accordance with (3), the corresponding distributions of network currents $I_1' \dots I_n'$ and $I_1'' \dots I_n''$ are given by

$$I_j' = \sum_{k=1}^n A_{jk} V_k', \quad j=1, 2 \dots n, \quad (4)$$

$$I_j'' = \sum_{k=1}^n A_{jk} V_k''. \quad (5)$$

Now form the product sum $\sum V_j'' I_j'$; by means of (4) it is easy to show that, since $A_{jk} = A_{kj}$,

$$\sum_{j=1}^n V_j'' I_j' = \sum_{j=1}^n \sum_{k=1}^n A_{jk} (V_j' V_k'' + V_j'' V_j') - \sum A_{jj} V_j' V_j''.$$

Since this is symmetrical in the two sets of applied forces $V_1' \dots V_n'$ and $V_1'' \dots V_n''$, it follows at once that

$$\sum V_j'' I_j' = \sum V_j' I_j'',$$

which proves the theorem.

Now if we analyze the foregoing proof it is seen to depend on the assumption, first that the network can be described in terms of a set of simultaneous equations with constant coefficients, and secondly on the reciprocal relation in the coefficients, $Z_{jk} = Z_{kj}$. In other words, it is assumed that the currents flow in linear, invariable circuits, and that the system is what is called quasi-stationary.² What this means is that the network may be treated as a dynamical system defined by n coordinates, the n currents $I_1 \dots I_n$ being the velocities of the n coordinates. More precisely stated, the underlying assumption is that the magnetic energy, the electric energy, and the dissipation function can be expressed as homogeneous quadratic functions of the following form

$$T = \frac{1}{2} \sum \sum L_{jk} I_j I_k,$$

$$W = \frac{1}{2} \sum \sum S_{jk} Q_j Q_k, \quad I_j = d/dt Q_j,$$

and

$$D = \frac{1}{2} \sum \sum R_{jk} I_j I_k,$$

where the coefficients L_{jk} , S_{jk} , R_{jk} are constants. Subject to these assumptions, which, it may be remarked, underlie the whole of electric circuit theory, the direct application of Lagrange's equations to the quadratic functions T , W , D leads at once to the circuit equations (1) and the reciprocal relation $Z_{jk} = Z_{kj}$. This is merely a very brief outline of Maxwell's dynamical theory of quasi-stationary systems or networks.

² See *Theorie der Electricitat*, Abraham u. Foppl, Vol. I, p. 254.

Now in view of the foregoing assumptions and restrictions which underlie all the proofs of the Reciprocal Theorem, known to the writer, it is by no means obvious that the theorem is valid when we have to do with currents in continuous media as well as in linear circuits, and when, furthermore we have to take account of radiation phenomena.³ The proof or disproof of the theorem in the electromagnetic case is, however, extremely important. The writer therefore, offers the following generalized Reciprocal Theorem, subject to the restriction noted below.

II. *Let a distribution of impressed periodic electric intensity $\mathbf{F}' = \mathbf{F}'(x, y, z)$ produce a corresponding distribution of current intensity $\mathbf{u}' = \mathbf{u}'(x, y, z)$, and let a second distribution of equi-periodic impressed electric intensity $\mathbf{F}'' = \mathbf{F}''(x, y, z)$ produce a second distribution of current intensity $\mathbf{u}'' = \mathbf{u}''(x, y, z)$, then*

$$\int (\mathbf{F}' \cdot \mathbf{u}'') dv = \int (\mathbf{F}'' \cdot \mathbf{u}') dv, \quad (6)$$

the volume integration being extended over all conducting and dielectric media. \mathbf{F} and \mathbf{u} are vectors and the expression $(\mathbf{F} \cdot \mathbf{u})$ denotes the scalar product of the two vectors.

The only serious restriction on the generality of this theorem, as proved below, is that magnetic matter is excluded: in other words it is assumed that all conducting and dielectric media in the field have unit permeability. This restriction is theoretically to be regretted, but is not of serious consequence in important practical applications.

PROOF OF GENERALIZED RECIPROCAL THEOREM⁴

In order to prove the generalized theorem stated above it is necessary to discard the special assumption of quasi-stationary systems underlying Rayleigh's theorem, and start with the fundamental equations of electromagnetic theory. These may be formulated as follows:

$$\begin{aligned} \operatorname{div} \mathbf{B} &= 0, \\ \operatorname{div} \mathbf{E} &= 4\pi\rho, \\ \operatorname{curl} \mathbf{E} &= -\frac{1}{c} \frac{\partial}{\partial t} \mathbf{B}, \\ \operatorname{curl} \mathbf{B} &= 4\pi\mathbf{u} + \frac{1}{c} \frac{\partial}{\partial t} \mathbf{E}, \end{aligned}$$

where c is the velocity of light.

³ The theory of quasi-stationary systems expressly excludes radiation.

⁴ In the following proof it is necessary to assume a knowledge on the part of the reader of the elements of vector analysis; the notation is that employed by Abraham.

It will be noted that there are only two field vectors, \mathbf{E} and \mathbf{B} , instead of the usual four vectors \mathbf{E} , \mathbf{D} , \mathbf{B} , \mathbf{H} , where $\mathbf{D} = k\mathbf{E}$ and $\mathbf{B} = \mu\mathbf{H}$, and that the constants of the medium k and μ do not explicitly appear. This formal simplification is effected by taking as the current density

$$\mathbf{u} = \bar{\mathbf{u}} + \frac{1}{c} \frac{\partial \mathbf{P}}{\partial t} + \text{curl } \mathbf{M}$$

where $\bar{\mathbf{u}}$ is the conduction current density, \mathbf{P} is the polarization,* defined as

$$\mathbf{P} = \frac{k-1}{4\pi} \mathbf{E},$$

and \mathbf{M} is defined as

$$\mathbf{M} = \frac{1}{4\pi} \frac{\mu-1}{\mu} \mathbf{B}.$$

The equation of continuity

$$\text{div } \mathbf{u} = -\frac{1}{c} \frac{\partial \rho}{\partial t}$$

then determines the charge density ρ .

The advantage of this formulation is that \mathbf{E} and \mathbf{B} can now be expressed in terms of the retarded scalar and vector potentials Φ and \mathbf{A} , as follows:

$$\mathbf{E} = -\frac{1}{c} \frac{\partial \mathbf{A}}{\partial t} - \nabla \Phi,$$

$$\mathbf{B} = \text{curl } \mathbf{A},$$

where

$$\Phi = \int \frac{\rho(t-r/c)}{r} dv,$$

$$\mathbf{A} = \int \frac{\mathbf{u}(t-r/c)}{r} dv.$$

The notation $\rho(t-r/c)$ and $\mathbf{u}(t-r/c)$ indicates that ρ and \mathbf{u} are taken not at time t but at time $t-r/c$ in evaluating the integrals. It will be observed that with ρ and \mathbf{u} defined as above, all effects are transmitted with the velocity of light, independently of the characteristics of the medium, a point of view in accordance with the modern development of electromagnetic theory.

In the application of the preceding equations to our problem, it will be assumed that \mathbf{M} is everywhere zero, so that

$$\mathbf{u} = \bar{\mathbf{u}} + \frac{1}{c} \frac{\partial \mathbf{P}}{\partial t}.$$

It will be assumed further that $\bar{\mathbf{u}} = \sigma \mathbf{E}$ and, since $\mathbf{P} = \frac{k-1}{4\pi} \mathbf{E}$,

$$\mathbf{u} = \left(\sigma + \frac{k-1}{4\pi} \frac{1}{c} \frac{\partial}{\partial t} \right) \mathbf{E}$$

and is therefore a linear function of \mathbf{E} . σ and k are in general point functions of the medium. The reason for setting $\mathbf{M}=0$, is that it appears essential to the following proof that \mathbf{u} shall be linear in \mathbf{E} ; that is, that the current density at any point be proportional to the electric intensity.⁵

With the foregoing very brief review of the fundamental equations, we are now prepared to prove the generalized reciprocal theorem. Assuming a periodic steady state, so that $\partial/\partial t = i\omega$, we start with the vector equation

$$\mathbf{E} = \mathbf{F} - \frac{i\omega}{c} \mathbf{A} - \nabla\Phi \tag{7}$$

where

$$\mathbf{A} = \int \frac{1}{r} \exp\left(-\frac{i\omega}{c} r\right) \mathbf{u} \, dv,$$

$$\Phi = \int \frac{1}{r} \exp\left(-\frac{i\omega}{c} r\right) \rho \, dv.$$

Here \mathbf{F} is the impressed intensity: that is, the electric intensity which is not due to the currents and charges of the system itself. Also by virtue of the assumption $\mathbf{M}=0$,

$$\mathbf{u} = \left(\sigma + \frac{k-1}{4\pi} \frac{i\omega}{c} \right) \mathbf{E} = \lambda \mathbf{E},$$

whence (7) can be written as

$$\frac{1}{\lambda} \mathbf{u} + \frac{i\omega}{c} \int \frac{1}{r} \exp\left(-\frac{i\omega}{c} r\right) \mathbf{u} \, dv = \mathcal{F}, \tag{8}$$

where $\mathbf{G} = \mathbf{F} - \nabla\Phi$.

⁵ The question as to whether the generalized theorem itself, and not merely the foregoing proof, is restricted in general to the case where \mathbf{M} is everywhere zero has not as yet received a conclusive answer. There are reasons, however, which cannot be fully entered into here, which make it appear probable that the theorem itself is in general restricted to the case where the current density contributing to the retarded vector potential is linear in the electric intensity and the two vectors are parallel. Subject to the hypothesis and assumptions of quasi-stationary systems, however, the restriction $\mathbf{M}=0$ is not necessary. The writer hopes to deal with these questions in a future paper.

Equation (8) is a vector integral equation ⁶ in \mathbf{u} . The nucleus or kernel of the equation, $\exp\left(\frac{i\omega}{c}r\right)/r$, is symmetrical with respect to any two points $(x_1y_1z_1)$ and $(x_2y_2z_2)$, the distance between which is r . By virtue of this symmetry the following reciprocal relation is easily established.⁷

If $\mathbf{u}' = \mathbf{u}'(x, y, z)$ is a function satisfying equation (8) when $\mathbf{G} = \mathbf{G}' = \mathbf{G}'(x, y, z)$ and $\mathbf{u}'' = \mathbf{u}''(x, y, z)$ a second function satisfying (8) when $\mathbf{G} = \mathbf{G}'' = \mathbf{G}''(x, y, z)$, then

$$\int (\mathbf{u}' \cdot \mathbf{G}'') dv = \int (\mathbf{u}'' \cdot \mathbf{G}') dv. \quad (9)$$

Consequently since $\mathbf{G} = \mathbf{F} - \nabla\Phi$

$$\int (\mathbf{u}' \cdot \mathbf{F}'') dv - \int (\mathbf{u}'' \cdot \mathbf{F}') dv = \int \left\{ (\mathbf{u}' \cdot \nabla\Phi'') - (\mathbf{u}'' \cdot \nabla\Phi') \right\} dv. \quad (10)$$

The proof of the theorem is now reduced to showing that

$$\int \left\{ (\mathbf{u}' \cdot \nabla\Phi'') - (\mathbf{u}'' \cdot \nabla\Phi') \right\} dv = 0.$$

Now integrating by parts

$$\begin{aligned} \int (\mathbf{u}' \cdot \nabla\Phi'') dv &= - \int \Phi'' \operatorname{div} \mathbf{u}' dv, \\ &= \frac{i\omega}{c} \int \Phi'' \rho' dv, \end{aligned}$$

since, from the equations of continuity, $\operatorname{div} \mathbf{u} = -\frac{i\omega}{c}\rho$. But from the fundamental field equations:

$$4\pi\rho' = -\nabla^2\Phi' + \left(\frac{i\omega}{c}\right)^2\Phi'$$

whence

$$\int \left\{ (\mathbf{u}' \cdot \nabla\Phi'') - (\mathbf{u}'' \cdot \nabla\Phi') \right\} dv = \frac{1}{4\pi} \left(\frac{i\omega}{c}\right) \int \left\{ \Phi' \nabla^2\Phi'' - \Phi'' \nabla^2\Phi' \right\} dv,$$

and by Greens Theorem, the right hand volume integral is equal to the surface integral

$$\frac{1}{4\pi} \left(\frac{i\omega}{c}\right) \int \left\{ \Phi' \frac{\partial}{\partial n} \Phi'' - \Phi'' \frac{\partial}{\partial n} \Phi' \right\} dS,$$

the surface being any surface which totally encloses the volume, and $\partial/\partial n$ denoting differentiation along the normal to the surface.

⁶ The formulation of the electromagnetic field equations in this form is of considerable importance. The integral equation furnishes a basis for developing electric circuit theory from the fundamental field equations. In addition it leads to the solution of problems in wave propagation which can not be directly solved from the wave equation itself.

⁷ Perhaps the easiest way to prove this proposition is to regard the integral equation as the limit of a set of simultaneous equations, a point of view which forms the basis of Fredholm's researches on integral equations.

Now if the surface be taken as a sphere of radius R , centered at or near the system, it is easily shown that if R is taken sufficiently large

$$\frac{\partial}{\partial n}\Phi' = \frac{\partial}{\partial R}\Phi' = -\frac{i\omega}{c}\Phi',$$

$$\frac{\partial}{\partial n}\Phi'' = -\frac{i\omega}{c}\Phi'',$$

and the surface integral vanishes. Consequently we have established the *generalized reciprocal theorem*

$$\int(\mathbf{u}' \cdot \mathbf{F}'')dv = \int(\mathbf{u}'' \cdot \mathbf{F}')dv.$$

The Reciprocal Theorem I has long been employed in electric circuit theory, and has proved extremely useful. As an example of the practical utility of the generalized theorem II it may be remarked that it enables us to deduce the transmitting properties of an antenna system from its receiving properties. The latter may sometimes be approximately deduced quite simply, as in the case of the wave antenna, whereas a direct theoretical determination of the former presents enormous difficulties.

The Transmission Unit and Telephone Transmission Reference Systems¹

By W. H. MARTIN

SYNOPSIS: Consideration is given to the method of determining and expressing the transmission efficiencies of telephone circuits and apparatus, and of the desirable qualifications for a unit in which to express these efficiencies. The "transmission unit" described in this paper has been selected as being much more suitable for this purpose under present conditions than the "mile of standard cable" which has been generally used in the past.

THE "mile of standard cable" has been used in telephone engineering in this country for over twenty years, and during that time has been adopted in other countries, as the unit for expressing the transmission efficiency of telephone circuits and apparatus. In the present state of the telephone art, this unit has been found, however, to be not entirely suitable and it has recently been replaced in the Bell System by another unit which for the present, at least, has been called simply the "transmission unit." Before considering the reasons for such a fundamental change and the relative merits of the two units, it may be well to review briefly the general method of determining the efficiency of such circuits and the apparatus associated with them.

The function of a telephone circuit is to reproduce at one terminal the speech sounds which are impressed upon it at the other terminal. The input and output of the circuit are in the form of sound and its efficiency as a transmission system may be expressed as the ratio of the sound power output to the sound power input. For commercial circuits, this ratio may be of the order of 0.01 to 0.001.

In the operation of the system, the sound power input is converted by the transmitter into electrical power, which is transmitted over the line to the receiver and there reconverted into sound power. The effect of inserting a section of line or piece of apparatus or of making any change in the circuit can be determined in terms of the variation which it produces in the ratio of the sound power output to the sound power input, or, if this latter is kept constant, in terms of the ratio of sound power output after the change to that obtained before the change was made. It should be noted particularly that the change in the output power of the system is the real measure of the effect of any part of the circuit on the efficiency of the system and that the ratio of the power leaving any part to that entering it is not necessarily the measure of this effect. For example, a pure

¹ Reprinted from the *Journ. A. I. E. E.*, for June, 1924.

reactance placed in series between the transmitter and the line, may change the power delivered to the line by the transmitter and hence the output of the receiver, the magnitude and direction of the change being determined by the impedance relations at the point of insertion. The ratio of the power leaving the reactance to that entering it is, of course, unity, as no power is dissipated in a pure reactance. In other words, the transmission efficiency of any part of a circuit cannot be considered solely from the standpoint of the ratio of output to input power for that part, or the power dissipated in that part, but must be defined in terms of its effect on the ratio of output to input power for the whole system.

By determining the effect of separately inserting the many pieces of apparatus that may form parts of typical telephone circuits, an index can be established for each of these parts of its effect on the efficiency of the circuit for the conditions of which the circuit tested is typical. Similarly, the power dissipated in unit lengths of the various types of line can be determined by noting the change in power output of the receiver caused by increasing any line by a unit length. Such indices of the transmission efficiencies of the various parts of a circuit obviously have many applications in designing and engineering telephone circuits. These indices could be taken as the ratios expressing the change in the output power of the system. This, however, has certain disadvantages. For example, the combined effect of a number of parts would then be expressed as a product of a number of ratios. Likewise, for the case of a number of parts n of the same type in series, such as a line n miles in length, the effect would be expressed as the ratio for one part or one mile of the line, raised to the n th power. In many cases, these ratios and the powers to which they would need to be raised would be such as to make their handling cumbersome. If, however, these indices are expressed in terms of a logarithmic function of a ratio selected as a unit, the sum of any number of such indices for the parts of a circuit is the corresponding index for the power ratio giving the effect of the combination of these parts.

The "mile of standard cable" is such a logarithmic function of a power ratio. The new unit also meets this important requirement.

DEFINITION OF THE TRANSMISSION UNIT

The "transmission unit" (abbreviated *TU*) has been chosen so that two amounts of power differ by one transmission unit when they are in the ratio of $10^{0.1}$ and any two amounts of power differ by N units when they are in the ratio of $10^{N(0.1)}$. The number of trans-

mission units corresponding to the ratio of any two powers P_1 and P_2 , is then the common logarithm (logarithm to the base 10) of the ratio P_1/P_2 , divided by 0.1. This may be written $N = 10 \log_{10} P_1/P_2$. Since N is a logarithmic function of the power ratio, any two numbers of units, N_1 and N_2 , corresponding respectively to two ratios, P_a/P_b

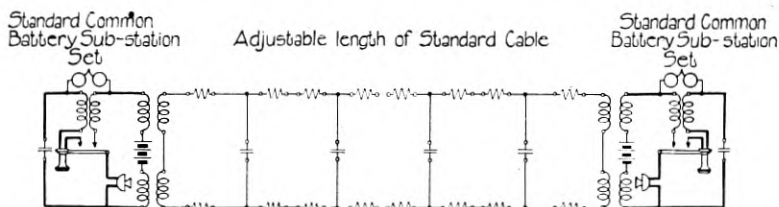

Fig. 1

and P_c/P_d , may be added and the result $N_1 + N_2$, will correspond to the product of the ratios, $P_a/P_b \times P_c/P_d$.

From the above it is seen that the measure in transmission units of the ratio of two amounts of power P_1 and P_2 is N , where

$$N = \frac{\log \frac{P_1}{P_2}}{\log 10^{0.1}}$$

In other words, the transmission unit is a logarithmic measure of power ratio and is numerically equal to $\log 10^{0.1}$.

The reasons for the selection of this unit and the method of applying it, can probably be best brought out by a consideration of the practise which has been followed in determining, and expressing the efficiencies of telephone circuits and apparatus in terms of "miles of standard cable."

STANDARD REFERENCE CIRCUIT

Fig. 1 shows what has been designated the "standard reference circuit." It consists of two common battery telephone sets of the type standard in the Bell System at the time this circuit was adopted, connected through repeating coils or transformers to a variable length of "standard cable." This cable is an artificial line having a resistance of 88 ohms and a capacity of 0.054 microfarad per loop mile which is representative of the type of telephone cable then generally used in this country.

For a given loudness of speech sounds entering the transmitter at one end of the circuit, the loudness of the reproduced sounds given out by the receiver at the other end can be varied by changing the amount of standard cable in the circuit. Also, the amount of cable in the circuit can be used to express the ratio of the power of the reproduced sounds to that of the impressed sounds. Due to the dissipation of electrical power in the cable, this ratio and consequently the loudness of the reproduced sounds become less as the amount of cable is increased and greater as the length of cable is decreased.

This circuit then became the measuring or reference system for engineering the telephone plant and the "mile of standard cable" became the unit in which the measurements were expressed. This circuit was used to set the service standards in designing and laying out the telephone plant. Thus, the reproduction obtained over this circuit with a length of cable of about twenty miles was found suitable and practicable for local exchange, that is, intra-city service, and that corresponding to about thirty miles for toll or intercity service.

Any telephone circuit was rated by its comparison with the standard circuit. This comparison was on the basis of a speaker talking alternately over the circuit to be measured and the standard circuit and a listener switching similarly at the receiving ends, the amount of cable in the standard circuit being adjusted until the listener judged the volume of the sounds reproduced by the two systems to be equal. The number of miles of cable in the standard circuit was then used as the "transmission equivalent" of the circuit under test. The effect of any change in the circuit under test on the efficiency of that circuit could then be measured by determining the variation in the amount of standard cable required to make the sounds reproduced by the two systems again equal and the number of miles of standard cable required to compensate for this change was used as the index of this effect. In this way the relative efficiencies of two transmitters or receivers could be determined. Likewise, the power dissipation per unit length or the attenuation, of the trunk in the circuit under test could be equated to miles of standard cable. Since in each case, the standard cable is used to adjust the volume of the reproduced sound, "the mile of standard cable" corresponds to the ratio of two amounts of sound power, or as this change in sound power is produced by changing the power delivered to the telephone receiver, to a ratio of two amounts of electrical power.

If the addition of a mile of standard cable to a long trunk of the standard circuit causes the power reaching the end of the trunk to decrease by a ratio r , then the insertion of two miles will decrease

the received power by a ratio of r^2 of that obtained before the two miles were inserted. A number of miles of cable, n , inserted will reduce the received power to a ratio r^n . Thus the power ratio corresponding to any given number of miles of cable is an exponential function of the ratio corresponding to one mile, the exponent being the length in miles. The length in miles is, therefore, a logarithmic function of the power ratio.

In an infinite length of uniform line having resistance, inductance, capacity and conductance of R , L , C and G per unit length, the attenuation a per unit length, of a current of frequency f flowing along the line can be shown to be equal to the real part of the expression

$$a + j b = \sqrt{(R + j 2 \pi f L)(G + j 2 \pi f C)}.$$

For the standard cable line, since L and G are zero

$$a = \sqrt{\pi f R C},$$

and since $R = 88$ ohms and $C = 0.054$ microfarad per mile the current attenuation per mile of standard cable is

$$a = 0.00386 \sqrt{f}.$$

If I_1' and I_2' are the currents, respectively, at the beginning and end of a mile of line, then

$$I_1'/I_2' = e^a \text{ or } a = \log_e I_1'/I_2'.$$

Similarly if I_1 and I_2 are the currents, at points 1 and 2, respectively, at the beginning and end of a section of l miles

$$I_1/I_2 = e^{la} \text{ and } la = \log_e I_1/I_2.$$

For this case, the effect of inserting the section of l miles into the line on the current at point 2, or at any point beyond 2, is that the currents at the point before and after the insertion are in the same ratio as I_1/I_2 . Furthermore, since the impedance of the line looking toward the receiving end is the same at points 1 and 2 (and at any other points), then the ratio of the powers at the two points is equal to the square of the current ratio.

Thus the power attenuation is represented by

$$P_1/P_2 = (I_1/I_2)^2 = e^{2la}.$$

Similarly for a line, terminated in a fixed impedance which may be different from the characteristic impedance of the line, the ratio of the powers received before and after a change in the length of the

line is equal to the square of the ratio of the corresponding currents. On the basis of this relation, and because it is in general more convenient to measure or compute currents than powers, the current ratio has often been used in determining the equivalent of any piece of apparatus or line in terms of standard cable. It should be noted, however, that such a current ratio can be properly used as an index of the transmission efficiency of a part of a circuit only when it is equal to the square root of the ratio of the corresponding powers. Also, of course, the voltage ratio can be similarly used when it meets the same requirement.

LIMITATIONS IN USE OF STANDARD CABLE UNIT

As has been shown above, the attenuation, either of current or power, corresponding to the mile of standard cable is directly proportional to the square root of the frequency of the current under consideration. This means that the standard cable mile corresponds not only to a certain volume change in the reproduced speech sounds, but also to a distortion change. For comparisons between the standard cable circuit and commercial circuits with talking tests and as long as most of the commercial circuits had distortion comparable to that of standard cable, this two-fold effect of standard cable was desirable. At present, however, many types of circuits are being used which have much less distortion than standard cable. Also, the use of voice testing has been largely given up in the plant and it is now the general practise to determine the efficiency of circuits and apparatus on the basis of measurements and computations for single-frequency currents, a correlation having been established between these latter results and those of voice tests. These factors have made it desirable to have a unit for expressing transmission efficiencies which is distortionless, that is, is not a function of frequency.

QUALIFICATIONS OF A NEW UNIT

The consideration of a new unit for measuring transmission efficiency brought out the following desirable qualifications:

1. *Logarithmic in Character.* Some of the reasons for this have already been discussed. In addition, the application of such a unit in measurements of sound make a logarithmic unit desirable, since the sensation of loudness in the ear is a logarithmic function of the energy of the sound.

2. *Distortionless.* The advantages of a unit which is independent of frequency have been referred to above. In expressing the effi-

ciency of the transmission of the high frequencies involved in carrier and radio circuits, such a unit is particularly desirable.

3. *Based on Power Ratio.* This is desirable because the power ratio is the real measure of transmission efficiency. As pointed out above, the current ratio can be used only when it is equal to the square root of the power ratio. Having the unit based on a power ratio does not, of course, require that measurements or computations be made on a power basis.

In considering the conversions between sound and electrical energy, it is obviously advantageous to have a unit based directly on a power ratio.

4. *Based on Some Simple Relation.* This is desirable in connection with the matter of getting a unit which may be widely used and may find applications in several fields.

5. *Approximately Equal in Effect on Volume to a "Mile of Standard Cable."* One reason for this is the practical one of avoiding material changes in the conceptions which have been built up regarding the magnitude of such things as transmission service standards. Also, the sound power changes which can be detected by an ear are of the order of that corresponding to a mile of standard cable. In measuring telephone lines and apparatus with single-frequency currents, it has been found that an accuracy of about one-tenth of a mile can be obtained readily and is sufficient practically.

6. *Convenient for Computations.* This refers to the matter of changing from computed or measured current or power ratios to transmission units or vice versa.

PROPERTIES OF THE TRANSMISSION UNIT

A consideration of the above qualifications and of the various units suggested, led to the adoption of the power ratio of $10^{0.1}$ as the most suitable ratio on which to base the unit of transmission efficiency. The transmission unit is logarithmic, distortionless, is based on a power ratio and its relation to that ratio is a simple one. Its effect on the transmission of telephonic power corresponding to speech sounds is about 6 per cent less than that of one mile of standard cable. Regarding its use in computations, it has the advantage that the number of units corresponding to any power ratio, or current ratio, can be determined from a table of common logarithms.

For a power ratio of 2, the logarithm is 0.301 and the corresponding number of units is, therefore, this logarithm multiplied by 10, which is 3.01 *T U*. For a power ratio of 0.5, the logarithm is $9.699 - 10 = -0.301$ and the number of units is -3.01 *T U*. A power ratio of 2

represents a gain of 3.01 units, and a power ratio of 0.5 corresponds to a loss of 3.01 units. If the above ratios were for current, the logarithms would be multiplied by 20. Thus a current ratio of 2 corresponds to a gain of 6.02 units and a current ratio of 0.5 corresponds to a loss of 6.02 units.

It will be noted that the $T U$ is based on the same ratio $10^{0.1}$ as the series of preferred numbers which has been used in some European countries and has been proposed here as the basis for size standardization in manufactured articles.² In common with this series, the $T U$ has the advantage that many of the whole numbers of units correspond approximately to easily remembered ratios as shown in the following table.

APPROXIMATE POWER RATIO

Transmission Units	For Losses		For Gains Decimal
	Fractional	Decimal	
1	4/5	0.8	1.25
2	2/3	0.63	1.6
3	1/2	0.5	2.
4	2/5	0.4	2.5
5	1/3	0.32	3.2
6	1/4	0.25	4.
7	1/5	0.2	5.
8	1/6	0.16	6.
9	1/8	0.125	8.
10	1/10	0.1	10.
20	1/100	0.01	100.
30	1/1000	0.001	1000.

It will be seen that the ratio for a gain of a given number of $T U$ is the reciprocal of the ratio for a loss of the same number of units. Also for an increase of 3 in the number of units, the loss ratio is approximately halved and the gain ratio doubled. If the approximate loss ratios corresponding to 1, 2 and 3 units are remembered, the others can be easily obtained.

From this consideration of the properties of the transmission unit, it is evident that there is much to commend its use in telephone transmission work. Furthermore, since its advantages are not peculiar to this work, such a unit may find applications in other fields. It is now being used in some of the work on sound.

² Size Standardization by Preferred Numbers, C. F. Hirshfeld and C. H. Berry, *Mechanical Engineering*, December, 1922.

NEW TELEPHONE TRANSMISSION REFERENCE SYSTEM

With the standardization of the distortionless unit of transmission it is desirable also to adopt for a transmission reference system a telephone circuit which will be distortionless from sound input to the transmitter to sound output from the receiver. This system will consist of three elements, a transmitter, a line and a receiver. Each will be designed to be practically distortionless and the operation of each will be capable of being defined in definite physical units so that it can be reproduced from these physical values. Thus the transmitter element will be specified in terms of the ratio, over the frequency range, of the electrical power output to the sound power input, this ratio being expressed in transmission units. The receiver element will be specified likewise in terms of the ratio of sound power output to electrical power input. The output impedance of the transmitter and the input impedance of the receiver elements will be 600 ohms resistance. The line will be distortionless with adjustments calibrated in transmission units and will have a characteristic impedance of 600 ohms resistance.

Such a reference system is now being constructed. The transmitter element consists of a condenser type transmitter and multi-stage vacuum tube amplifier. The receiver element consists of an amplifier and specially damped receiver. Each element is adjusted to give only negligible distortion over the frequency range.

It is proposed when this system is completed and adjusted that it will be adopted as the Transmission Reference System for telephone transmission work. Other secondary reference systems, employing commercial-type apparatus will be calibrated in terms of the primary system and used for field or laboratory tests when such commercial type systems are needed.

Practical Application of the Recently Adopted Transmission Unit

By C. W. SMITH

THE purpose of this paper is to outline the practical considerations involved in the use of the transmission unit (abbreviated *TU*), which was recently adopted by the Bell System to replace the mile of standard cable in transmission engineering work. A description of the *TU*, together with a discussion of the considerations which led to its adoption has been given by Mr. Martin in another article in this issue.

EFFECT OF ADOPTING THE *TU* AS REGARDS TRANSMISSION STANDARDS

The transmission standards in general use vary from 18 miles of standard cable to about 30 miles of standard cable, depending upon the locality and the class of service such as local and toll. It has become customary among telephone people interested in standards of service to associate certain figures for transmission standards with the corresponding standards of service which they represent. It is a distinct advantage, therefore, to retain the same figures for the same standards of service when changing to the new unit. The zero of reference was so selected, therefore, that 24 *TU* is equivalent to 24 miles of standard cable in volume reproduction. This means that if one talks with the same loudness over a circuit of 24 *TU* as over a circuit of 24 miles of standard cable, the volume received from each will be the same. As the attenuation corresponding to the *TU* is only about 6 per cent. less than the attenuation corresponding to the mile of standard cable and 24 miles represents the mean between the highest and lowest standards in common use, transmission standards on the new basis are very little different numerically from the same standards on the old basis. The former 18-mile standard is equivalent in transmission to 17.6 *TU* and the 30-mile standard is equivalent to 30.4 *TU*. The same numerical values can, therefore, generally be used for transmission standards in the new system, as in the old, since the greatest differences encountered will be 0.4 *TU*.

It is also true that a given transmission loss specified in miles will correspond very closely in numerical value to the same loss expressed in *TU*. People not directly engaged in transmission work, therefore, may generally disregard the slight difference which exists in considering transmission losses expressed in *TU* as compared with standard cable.

USE OF THE *TU* IN TRANSMISSION STUDIES

In making transmission studies it has previously been the practice to express the transmission efficiency of limiting subscribers' loops in terms of the resistance of a 22-gauge loop which would have the same total transmitting and receiving loss, thus a 400-ohm loop meant a loop which had the same total transmitting and receiving loss as a loop of 22-gauge ASA cable having a resistance of 400 ohms. At the time of changing from miles to *TU*, it was decided to abandon this method of expressing limiting loop losses in the Bell System and to express them directly in *TU*; thus a 5 *TU* loop means a loop whose total transmitting and receiving loss, taking into account the efficiency of the subscribers' set, is 5 *TU*. The following table gives a number of limiting loops expressed in *TU* and their equivalents in ohms of 22-gauge cable as defined above, assuming the use of the most efficient type of subscriber's set now available.

Limiting Loops Expressed in <i>TU</i>	Limiting Loops Expressed in Ohms
3	312
4	350
5	387
6	424
7	461
8	499
9	537
10	573
11	610

CONVERSION FROM MILES TO *TU* AND COMPUTATION
OF TRANSMISSION EQUIVALENTS

During the transition period in the adoption of the *TU* it will frequently be necessary to convert transmission data which are expressed in miles, to *TU*. This is easily accomplished by multiplying by a conversion factor and in the case of the transmission efficiencies of subscribers' sets by also correcting for the difference in the reference zero which was brought about for reasons referred to above. Two units both known as miles have been in common use as a measure of transmission; they are the standard cable mile and the 800-cycle mile. A different conversion factor is required for each.

The attenuation constant of standard cable for the complex currents used in the transmission of speech varies appreciably with the length of cable considered, since for long lengths the higher frequencies are attenuated to such low values as to have very little effect on the received volume. The best average figure is 0.122, although this value has yet to be determined more precisely by careful laboratory tests. The attenuation corresponding to one *TU* for currents of any

frequency is 0.115. The ratio of the effect on volume of the mile of standard cable to the *TU* is, therefore, $\frac{0.122}{0.115}$ or 1.06, and equivalents obtained by comparison with standard cable by means of talking tests can therefore be converted to *TU* by multiplying by this factor, as previously indicated.

The 800-cycle mile which has been commonly used in expressing computed transmission losses, has an attenuation of 0.109 to currents of any frequency, and therefore data expressed in 800-cycle miles are converted to *TU* by multiplying by $\frac{0.109}{0.115}$ or 0.95.

For making talking tests the field has been supplied with artificial cables which were slightly different from standard cable, having a capacity of .06 μ f. per mile instead of .054 μ f. Miles of this artificial cable may be converted to *TU* by multiplying by 1.12.

The conversion of subscribers' loop losses to *TU* is somewhat more complicated as the zero of reference for subscriber's set efficiencies is slightly different on the new basis. In the Bell System, therefore, complete data on subscribers' loop losses in terms of the new unit were made available for engineering work at the time the *TU* was adopted.

The transmission equivalent of a line per unit of length in *TU* may be obtained by multiplying the attenuation constant of the line computed in the usual manner by a conversion factor. Calling the computed attenuation constant of the line per unit of length α , the number of *TU* will be given by the expression: $TU = \frac{\alpha}{0.115} = 8.69\alpha$.

In finding the total loss which a short line or a piece of equipment, such as, for example, a repeating coil will cause when inserted in a given circuit, the current in the receiving apparatus is usually computed for a convenient voltage applied at the sending end of the circuit, first with the repeating coil in the circuit and then with it out, the applied voltage remaining constant. Calling these currents I_1 and I_2 respectively, the current ratio $\frac{I_1}{I_2}$ may be converted into *TU* by the expression

$$\text{Loss in } TU = 20 \log_{10} \frac{I_1}{I_2}.$$

TRANSMISSION MAINTENANCE

The transmission measuring sets used for checking up the maintenance¹ of the plant from a transmission standpoint, have previously

¹ See an article in this issue "Electrical Tests and Their Applications in the Maintenance of Telephone Transmission"—W. H. Harden.

been calibrated in 800-cycle miles, and as the TU is of the same nature as this unit, no difficulties are encountered in arranging the sets to read directly in TU .

New sets will be manufactured on this basis, but it will, of course, be desirable in order to avoid frequent conversion of data from one unit to the other, to arrange many of the sets which are already in use in the plant to read in TU . It is not planned to convert the sets which depend upon ear comparisons, such as the² 1-A and 1-B transmission measuring sets and the receiver shunts used in some cases for checking up repeater gains, as the difference when measuring small values is not great and these sets are generally used for a class of work where the required precision is not sufficient to warrant their conversion to the new basis. Visual reading sets, however, such as 2-A, 3-A and 4-A transmission measuring sets and the 2-A repeater gain set, give results which are accurate to about 0.1 TU and are usually used for work where a fairly high degree of precision is required. These sets can be changed to read directly in TU at a comparatively small expense as it is only necessary to change the calibration of the measuring dials and slide wire potentiometers and the values of certain of the resistances associated with them. The cost of making these changes will be reduced by the fact that it is planned to make certain other desirable changes which will effect improvements in the operation of the sets at the same time. Complete loss data in terms of TU which are necessary for checking measured equivalents, have been prepared and will replace the data formerly used.

In toll line maintenance work, record cards are kept which show the layout of toll circuits and the transmission losses of the component parts of each circuit together with the total loss which should be obtained by test if the circuit is not in trouble. In changing over from miles to TU these record cards will be revised to show losses in the new unit.

CROSSTALK COMPUTATIONS

In handling certain types of crosstalk problems, it has been found convenient to express crosstalk in terms of transmission units rather than crosstalk units. Miles of standard cable have previously been used in such problems. TU can be used for this purpose as well as miles and it is somewhat simpler to make the conversion from

² See a paper by F. H. Best, "Measuring Methods for Maintaining the Transmission Efficiency of Telephone Circuits." *Journ. A.I.E.E.*, Vol. XLIII, 1924.

crosstalk units to *TU* than from crosstalk units to miles. Crosstalk may be converted from crosstalk units to *TU* as follows:

$$\text{Crosstalk in } TU = 20 \log_{10} \left(\frac{\text{No. of Crosstalk Units}}{10^6} \right).$$

The number of *TU* corresponding to certain numbers of crosstalk units are whole numbers and are therefore, easy to remember as shown in the following table.

Crosstalk in Terms of <i>TU</i> Loss	Crosstalk Units
80	100
60	1,000
54 (Approx.)	2,000
40	10,000
20	100,000

CONCLUSION

From this discussion the conclusion may be drawn that the adoption of the *TU* in place of the mile as the unit of telephone transmission can be readily accomplished in its practical application in the plant. During the transition period, before complete lists of the new data have been compiled, and before the measuring apparatus in use has all been changed to the new basis, frequent conversions between miles and *TU* will be necessary. These conversions can easily be made by multiplying by the proper conversion factor.

Impedance of Loaded Lines, and Design of Simulating and Compensating Networks

By RAY S. HOYT

SYNOPSIS: A knowledge of the impedance characteristics of loaded lines is of considerable importance in telephone engineering, and particularly in the engineering of telephone repeaters. The first half of the present paper deals with the impedance of non-dissipative loaded lines as a function of the frequency and the line constants, by means of description accompanied by equations transformed to the most suitable forms and by graphs of those equations; and it outlines qualitatively the nature of the modifications produced by dissipation. The characteristics are correlated with those of the corresponding smooth line.

The somewhat complicated effects produced by the presence of distributed inductance are investigated rather fully. In the absence of distributed inductance a loaded line would have only one transmitting band, extending from zero frequency to the critical frequency. Actually, however, every line—even a cable—has some distributed inductance; and the effect of distributed inductance, besides altering the nominal impedance and the critical frequency, is to introduce into the attenuating range above the critical frequency a series of relatively narrow transmitting bands—here termed the "minor transmitting bands"—spaced at relatively wide intervals. The paper is concerned primarily with the impedance in the first or major transmitting band; but it investigates the minor transmitting bands sufficiently to determine how they depend on the distributed inductance, and to derive general formulas and graphical methods for finding their locations and widths—an investigation involving rather extensive analysis.

The latter half of the paper describes various networks devised for simulating and for compensating the impedance of loaded lines; it furnishes design-formulas and supplementary design-methods for all of the networks depicted; and outlines a considerable number of applications pertaining to lines and to repeaters.

INTRODUCTION

THE present paper on periodically loaded lines (of the series type) is to some extent a sequel to a previous paper on smooth lines.¹

The reader may be reminded that the transmission of alternating currents over any transmission line between specified terminal impedances depends only on the propagation constant and the characteristic impedance of the line. In this sense, then, the characteristics of transmission lines may be classed broadly as propagation characteristics and impedance characteristics. In telephony we are concerned primarily with the dependence of these characteristics on the frequency, over the telephonic frequency range.

Prior to the application of telephone repeaters to telephone lines the propagation characteristics of such lines were more important than

¹ "Impedance of Smooth Lines, and Design of Simulating Networks," this *Journal*, April, 1923. Two typographical errors in that article may here be noted: p. 37, formula for C_7/C_3 , affix an exponent ² to the last parenthesis; p. 39, value for C_1 , replace comma by decimal point.

their impedance characteristics, because the received energy depended much more on the former than on the latter. Indeed, the object of loading² was to improve the propagation characteristics of transmission lines; the effects on the impedance characteristics were incidental, and of quite secondary importance.

The application of the two-way telephone repeater greatly altered the relative importance of these two characteristics, decreasing the need for high transmitting efficiency of a line but greatly increasing the dependence of the results on the impedance of the line. As well known, this is because the amplification to which a two-way repeater can be set without singing, or even without serious injury to the intelligibility of the transmission, depends strictly on the degree of impedance-balance between the lines or between the lines and their balancing networks. In the case of the 21-type repeater the two lines must closely balance each other throughout the telephonic frequency range. In the case of the 22-type repeater, which for long lines requiring more than one repeater is superior to the 21-type, impedance-networks are required for closely balancing the impedances of the two lines throughout the telephonic frequency range. Such balancing networks are necessary also in connection with the so-called four-wire repeater circuit.³

In Parts I, II, and III of this paper there is presented in a simple yet fairly comprehensive manner the dependence of the characteristic impedance of periodically loaded lines (of the series type) on the frequency and on the line constants, by means of description accompanied by equations transformed to the most suitable forms and by graphs of those equations. Also, the dependence of the attenuation constant on the frequency is presented to the extent necessary for exhibiting the disposition of the transmitting and the attenuating bands and thus enabling the characteristic impedance to be described with reference to those bands, and the important correlation between the characteristic impedance and the attenuation constant thereby exhibited; for the characteristic impedance by itself is not fully significant.

Parts IV to VIII, inclusive, relate to the simulation and the compensation of the impedance of periodically loaded lines by means of

² For the fundamental theory of loaded lines, reference may be made to the original papers of Pupin and of Campbell (Pupin: *Trans. A. I. E. E.*, March 22, 1899 and May 19, 1900; *Electrical World*, October 12, 1901 and March 1, 1902. Campbell: *Phil. Mag.*, March, 1903).

³ Regarding the broad subject of repeaters and repeater circuits, reference may be made to the paper by Gherardi and Jewett: "Telephone Repeaters," *Trans. A. I. E. E.*, 1919, pp. 1287-1345.

the simulating and the compensating⁴ networks for loaded lines devised by the writer at various times within about the last twelve years. Of course, the impedance of any loaded line could be simulated, as closely as desired, by means of an artificial model constructed of many short sections each having lumped constants; but such structures would be very expensive and very cumbersome. Compared with them the networks described in this paper are very simple non-periodic structures that are relatively inexpensive and are quite compact; yet the most precise of them have proved to be adequate for simulating with high precision the characteristic impedance of any periodically loaded line, while even the least precise (which are the simplest) suffice for a good many applications. The compensating networks also are of simple form. Design-formulas are included for all of the networks depicted; and certain supplementary design-methods are indicated. Finally, a considerable number of practical applications are outlined (Part VIII).

PART I

IMPEDANCE OF LOADED LINES—GENERAL CONSIDERATIONS

Before proceeding to the more precise and detailed treatment of the impedance of periodically loaded lines in Parts II and III, it seems desirable to furnish a background by outlining broadly the salient facts. For this purpose the loaded line will be compared with its "corresponding smooth line," that is, the smooth line having the same total constants (inductance, capacity, resistance, leakance).

Comparison with the Corresponding Smooth Line

At sufficiently low frequencies the impedance of a periodically loaded line approximates to that of the corresponding smooth line;¹ but at higher frequencies departs widely. Moreover, the impedance of the loaded line depends very much on its relative termination—fractional end-section or end-load ("load" is here used with the same meaning as "load coil" or "loading coil").

To bring out simply and sharply the contrast between a periodically loaded line and the corresponding smooth line, the effects of dissipation will at first be ignored, although the contrast is somewhat heightened thereby.

It will be recalled that the attenuation constant, the phase velocity, and the characteristic impedance of a non-dissipative smooth line are

⁴ Defined in the second paragraph of Part IV.

independent⁵ of frequency; such a line having a transmitting band (that is, a non-attenuating band) extending from zero frequency to infinite frequencies, and a characteristic impedance which is a pure and constant resistance.

In contrast, the corresponding characteristics of a non-dissipative periodically loaded line depend very greatly on the frequency; such a line has an infinite sequence of alternate transmitting and attenuating bands* wherein the impedance varies enormously with frequency, while at the transition frequencies its nature undergoes a sudden change. In this connection it may be remarked that, because of its special practical importance in being the upper boundary frequency of the first or principal transmitting band, the lowest transition frequency is termed the "critical frequency" to distinguish it from the other transition frequencies; though in its essential nature each transition frequency is a "critical" frequency. In the ordinary case, where the distributed inductance is small compared with the load inductance, each transmitting band is very narrow compared with the succeeding attenuating band. In the limiting case of no distributed inductance there is only one transmitting band and one attenuating band, the former extending from zero frequency to the critical frequency and the latter from the critical frequency to infinite frequencies.

The characteristic impedance of any non-dissipative transmission line is or is not pure reactance according as the contemplated frequency is in an attenuating band or in a transmitting band. For in an attenuating band the line cannot receive energy, since it cannot dissipate any energy and cannot transmit any energy to an infinite distance; while in a transmitting band the line must receive energy, because it does transmit. Thus, at the transition frequency between an attenuating band and a transmitting band the characteristic impedance undergoes a sudden change in its nature; the frequency-derivative of the impedance (namely, the derivative of the impedance with respect to the frequency) is discontinuous, so that the graph of the impedance has a corner (salient point) at a transition frequency. Moreover, at certain of the transition frequencies of a non-dissipative periodically loaded line the impedance is zero, and at others is infinite. The mid-point impedances are pure resistances throughout every transmitting band. (The "mid-point" terminations are "mid-load" and "mid-section," that is, "half-load" and "half-section" respectively.)

⁵ Except for slight change of the inductance, and even of the capacity, with frequency.

* For distinction, the first (lowest) or principal transmitting band may be termed the "major" transmitting band; the others, the "minor" transmitting bands.

Clearly the characteristic impedance of any dissipative line cannot be pure reactance at any frequency; for the line receives at its sending end the energy dissipated within itself. Also, the presence of dissipation renders the frequency-derivative of the impedance continuous at all frequencies; that is, it rounds off the corners on the graph of the impedance. Dissipation prevents the impedance from becoming either zero or infinite at any frequency; and in general it prevents the mid-point impedances from being pure resistances in the transmitting bands.

In the neighborhood of the transition frequencies of the loaded line, the effects of even ordinary amounts of dissipation may be very large, thus preventing the impedance from attaining the very extreme values of the non-dissipative line; but with that exception it may be said that the contrast between a loaded line and the corresponding smooth line is merely softened or dulled by the presence of ordinary amounts of dissipation: The impedance of the smooth line is no longer pure resistance, and it varies somewhat or even considerably with the frequency.¹ The impedance of the loaded line no longer varies quite so rapidly with the frequency nor attains such extreme values; but, except at low frequencies, it continues to depart widely from the impedance of the corresponding smooth line, and to vary much more rapidly than the smooth line with frequency, besides varying greatly with its relative termination (fractional end-section or end-load).

Non-Dissipative Loaded Lines

Except in the neighborhood of zero frequency and of the transition frequencies, the characteristic impedance of an efficient loaded line is dependent mainly on the inductance and capacity, only relatively little on the wire resistance and load resistance, and very much less still on the leakage. The present paper is confined mainly to non-dissipative loaded lines; it deals first with the limiting case of no distributed inductance, and then with the case where distributed inductance is present. By the neglect of all dissipation the number of independent variables is sufficiently reduced to enable a comprehensive, though only approximate, view to be obtained of the characteristic impedance of loaded lines. Such a view is a valuable guide in engineering work even though in most cases it may be necessary, for final calculations or verifications, to resort to exact formulas (Appendix D) or graphs thereof.

Notation and Terminology

The meanings of the fundamental symbols employed in this paper can be readily seen from inspection of Fig. 1. Thus, C and L denote the capacity and the inductance of each whole section between loads, and L' the inductance of each whole load; the ratio L/L' is denoted by λ . Figs. 1a and 1b represent infinitely long loaded lines terminating

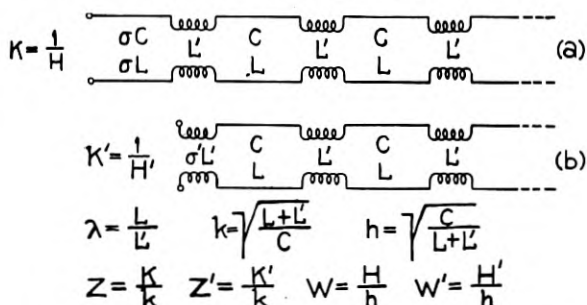

Fig. 1—A Non-Dissipative Infinitely Long Loaded Line Terminating at: (a) σ -Section, (b) σ' -Load

at σ -section and σ' -load respectively; the ratios σ and σ' will be termed the "relative terminations." K and K' denote the corresponding characteristic impedances, and H and H' the characteristic admittances. Stated more fully, K denotes the σ -section characteristic impedance, and K' the σ' -load characteristic impedance; similarly for the admittances H and H' . The "nominal impedance" and the "nominal admittance" are denoted by k and h , respectively; that is,

$$k = 1/h = \sqrt{(L+L')/C} = \sqrt{(1+\lambda)L'/C}, \tag{1}$$

the nominal impedance of a periodically loaded line being defined as equal to the nominal impedance of the corresponding smooth line.¹ $Z = X + iY$ and $Z' = X' + iY'$ denote relative impedances and $W = U + iV$ and $W' = U' + iV'$ the corresponding relative admittances, as defined by the equations

$$Z = K/k, \quad Z' = K'/k, \quad W = H/h, \quad W' = H'/h; \tag{2}$$

the real components being X, X', U, U' , and the imaginary components Y, Y', V, V' , respectively. By (2),

$$ZW = Z'W' = KH = K'H' = 1. \tag{2.1}$$

r denotes the relative frequency, namely, the ratio of any frequency $f = \omega/2\pi$ to the critical frequency f_c ; that is, $r = f/f_c = \omega/\omega_c$. i denotes the imaginary operator $\sqrt{-1}$.

Besides depending on the frequency f , the quantities K , H , Z , W and K' , H' , Z' , W' depend on the relative terminations σ and σ' respectively (Fig. 1). This dependence will not usually need to be indicated explicitly, but in case of such need the subscript notation will be found convenient. Thus, K_σ will denote the σ -section characteristic impedance (Fig. 1a); and $K_{1-\sigma}$ the "complementary characteristic impedance," that is, the characteristic impedance of the same loaded line if beginning at the "complementary termination"—namely, $(1-\sigma)$ -section. As an application of this notation we may note here the relations

$$K_0 = K_1', \quad H_0 = H_1', \quad K_1 = K_0', \quad H_1 = H_0'; \quad (2.2)$$

the first two relations subsisting because of the coincidence of the points σ -section and σ' -load for $\sigma=0$ and $\sigma'=1$, and the second two because of the coincidence for $\sigma=1$ and $\sigma'=0$.

PART II

IMPEDANCE OF NON-DISSIPATIVE LOADED LINES WITHOUT DISTRIBUTED INDUCTANCE

Transmitting Band and Attenuating Band

As already stated, a periodically loaded line without distributed inductance (Fig. 1, with $L=0$) has only one transmitting band and only one attenuating band; the former extending from zero frequency to the critical frequency f_c , and the latter from the critical frequency to infinite frequencies. The formula for f_c is

$$f_c = 1/\pi\sqrt{L'C}, \quad (3)$$

L' denoting the inductance of each load and C the capacity of each line-section between loads.

From the energy considerations already adduced, it is known that the characteristic impedance must be pure reactance throughout the attenuating band, but cannot be pure reactance anywhere in the transmitting band.

Formulas for the Relative Impedances

The impedance of even a loaded line without distributed inductance (Fig. 1, with $L=0$) depends on no less than four independent variables—namely, the frequency f , load inductance L' , section-capacity C , and one or the other of the relative terminations σ and σ' . But it is found that these quantities enter in such a way that the relative

impedances $Z=K/k$ and $Z'=K'/k$ and the relative admittances $W=H/h$ and $W'=H'/h$ depend on only two ratios,—namely, the relative frequency $r=f/f_c$, and the appropriate relative termination σ or σ' ,—as expressed by the equations⁶

$$Z = \frac{1}{W} = \frac{1}{\sqrt{1-r^2+i(2\sigma-1)r}} = \frac{\sqrt{1-r^2+i(1-2\sigma)r}}{1-4\sigma(1-\sigma)r^2}, \quad (4)$$

$$Z' = \frac{1}{W'} = \frac{1}{\sqrt{1-r^2+i(2\sigma'-1)r}} = \frac{1-4\sigma'(1-\sigma')r^2}{\sqrt{1-r^2+i(1-2\sigma')r}}. \quad (5)$$

In particular, for $\sigma=0.5$ and $\sigma'=0.5$, respectively,

$$Z_{.5} = 1/W_{.5} = 1/\sqrt{1-r^2}, \quad (6)$$

$$Z'_{.5} = 1/W'_{.5} = \sqrt{1-r^2}. \quad (7)$$

Equations (4) and (5) are not restricted to values of σ and σ' less than unity. On the contrary they are valid for any (real) values of these quantities—though values much exceeding unity are of infrequent occurrence in practice.

Miscellaneous Properties and Relations

Some of the most useful and interesting simple facts deducible from equations (4) and (5) are noted in the next five paragraphs:

In agreement with the general conclusion already reached from energy considerations, equations (4) and (5) show that each of the relative impedances and relative admittances is pure imaginary in the attenuating band ($r>1$). In the transmitting band ($0<r<1$), each is seen to be complex for all values of the relative terminations (σ and σ'), except that each degenerates to a real value when the relative termination becomes 0.5.

Throughout the transmitting band ($0<r<1$), a certain conjugate property is possessed by each of the quantities Z , W , Z' , W' —namely, each changes merely to its conjugate when σ is changed to $1-\sigma$, as is readily seen from (4) and (5); that is,

$$Z_\sigma = \overline{Z}_{1-\sigma}, \quad W_\sigma = \overline{W}_{1-\sigma}, \quad Z'_\sigma = \overline{Z}'_{1-\sigma}, \quad W'_\sigma = \overline{W}'_{1-\sigma}, \quad (8)$$

the bar over a symbol denoting the conjugate of the same symbol without the bar. Thus, complementary characteristic impedances are mutually conjugate throughout the transmitting band.

At all values of r ,

$$W_\sigma + W_{1-\sigma} = 2W_{.5}, \quad Z'_\sigma + Z'_{1-\sigma} = 2Z'_{.5}; \quad (9)$$

⁶ The equations were written in this sequence because, in practice, section-termination occurs much more frequently than load-termination.

although relations of this form do not hold for Z and for W' . Each of the relations (8) and (9) can be inferred also from simple physical considerations.

Equations (4) and (5) show that W and Z' are alike in form, and also W' and Z , when σ and σ' are regarded as corresponding to each other; in fact, when $\sigma = \sigma'$,

$$ZZ' = WW' = W/Z' = W'/Z = KK'/k^2 = HH'/h^2 = 1. \quad (10)$$

Besides, there is the set of perfectly general relations (2.1), which, of course, continue to hold when $\sigma = \sigma'$.

Equations (4) and (5) show also the existence of the following more special relations, holding when the relative terminations (σ and σ') have the values 0 and 1, as indicated by the subscripts:

$$Z_0 Z_1 = Z_0' Z_1' = W_0 W_1 = W_0' W_1' = 1, \quad (11)$$

$$|Z_0| = |Z_1| = |Z_0'| = |Z_1'| = |W_0| = |W_1| = |W_0'| = |W_1'| = 1. \quad (12)$$

Graphical Representations

Graphical representations of the relative impedances $Z = X + iY$ and $Z' = X' + iY'$, based on equations (4) and (5), will be taken up in the following paragraphs. Evidently it will not be necessary to consider also the relative admittances $W = U + iV$ and $W' = U' + iV'$ explicitly, since these are of the same functional forms as Z' and Z respectively—as noted in connection with equation (10).

One graphical method of representing the dependence of Z on r and σ is by means of a network of equi- r and equi- σ curves of Z in the Z -plane; likewise the dependence of Z' on r and σ' , by means of the equi- r and equi- σ' curves of Z' . The analytic-geometric properties of these curves, as deduced from equations (4) and (5), may be formulated as follows, for any (real) values of σ and σ' but for r restricted to the range 0 to 1:

(a) r fixed, σ varied: Z moves on the circle

$$(X - 1/2\sqrt{1-r^2})^2 + Y^2 = 1/4(1-r^2),$$

of radius $1/2\sqrt{1-r^2}$ with center at $Z = 1/2\sqrt{1-r^2}$.

(b) σ fixed, r varied: Z moves on the curve

$$(X^2 + Y^2)^2 - X^2 - Y^2 / (2\sigma - 1)^2 = 0.$$

(c) r fixed, σ' varied: Z' moves on the straight line

$$X' = \sqrt{1-r^2},$$

which is parallel to the X' -axis at a distance $\sqrt{1-r^2}$ therefrom.

(d) σ' fixed, r varied: Z' moves on the ellipse

$$(X'/1)^2 + (Y'/[2\sigma' - 1])^2 = 1,$$

whose center is at $Z'=0$ and whose semi-axes along the X' and Y' axes have the lengths 1 and $2\sigma' - 1$ respectively.

For values of r, σ, σ' each between 0 and 1, these facts are exhibited graphically in Fig. 2. This is a complex-plane chart of the equi- r

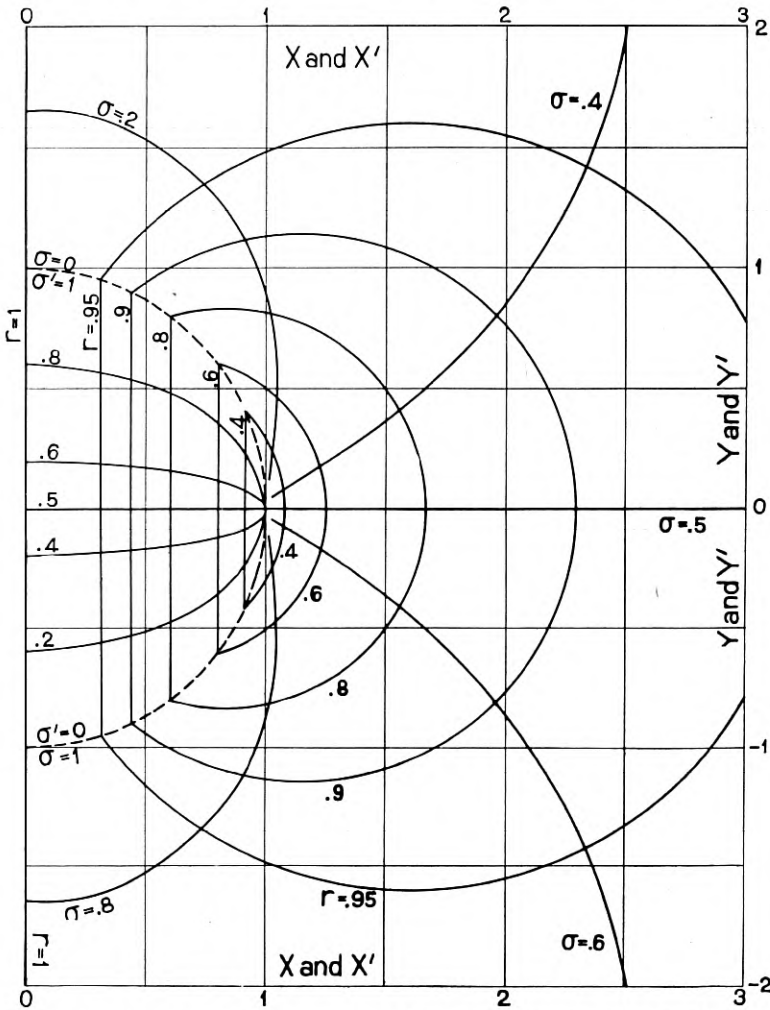

Fig. 2—Complex-Plane Chart of the σ -Section Relative Impedance $Z = X + iY$ and the σ' -Load Relative Impedance $Z' = X' + iY'$

and the equi- σ curves of Z , and the equi- r and the equi- σ' curves of Z' . The equi- r and the equi- σ curves constitute a curvilinear network superposed on the rectangular background of $Z=X+iY$; for any assigned pair of values of r and σ the value of Z can be obtained by finding the intersection of those particular curves of r and σ , and at that point reading off the value of Z on the rectangular background. Similarly for the evaluation of Z' by means of the network of equi- r and equi- σ' curves.

For the σ' -range and the σ -range contemplated in Fig. 2—namely, $0 < \sigma' < 1$ and $0 < \sigma < 1$ —the Z' -realm and the Z -realm are distinct; their mutual boundary (drawn dashed) is the unit semi-circle, that is, the semi-circle of unit radius having its center at the origin. The Z' -realm is the region inside; the Z -realm is all the region outside, extending to infinity in all directions through the positive real half of the complex-plane.

If the ranges of σ' and σ are extended to include values exceeding unity, the Z' -realm and the Z -realm will cease to be distinct but will overlap. The Z' -realm will expand upward, beyond the unit semi-circle, and ultimately will fill the region of unit width extending upward to infinity; the Z -realm will expand into and ultimately will fill the lower half of the unit semi-circle. Hence for values of σ' and σ exceeding unity it is preferable to employ individual charts in representing Z' and Z .

In the language of function-theory it may be said that, when $\sigma' = \sigma$, the Z' -realm and the Z -realm are inverse realms with respect to the unit semi-circle. The straight lines and the circles are inverse curves; the ellipses, and the curves characterized by the equation $(X^2 + Y^2)^2 - X^2 - Y^2 / (2\sigma - 1)^2 = 0$ are also inverse curves.

For $r=0$ it is seen that $Z' = Z = 1$ for all values of σ' and σ .

For values of r equal to or greater than unity, Z' and Z are pure imaginary, for all values of σ' and σ . For $r=1$, Z' lies somewhere on that part of the imaginary axis constituting the vertical diameter of the unit semi-circle, its position thereon depending on the particular value of σ' contemplated; while Z lies somewhere on the remainder of the imaginary axis. When r approaches infinity, Z' approaches infinity and Z approaches zero, along the imaginary axis.

Another graphical method of representing the relative impedances $Z=X+iY$ and $Z'=X'+iY'$, based on equations (4) and (5), is by means of the Cartesian curves of the components X , Y and X' , Y' , with the relative frequency r taken as the independent variable and the relative termination (σ or σ') as the parameter.

In this way, Fig. 3 represents X' and Y' , and Fig. 4 represents X and Y , all to the same scale. In each of these figures the r -range is 0 to 1.5, thus including the entire transmitting band and a portion of the attenuating band half as wide as the transmitting band. In the

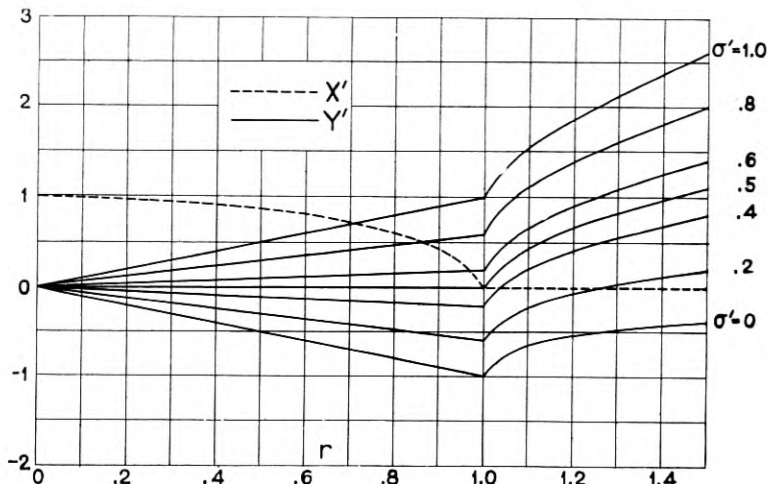

Fig. 3—Components of the σ' -Load Relative Impedance $Z' = X' + iY'$

attenuating band, Z' and Z are pure imaginary; in the transmitting band they are complex in general, though real for $\sigma' = 0.5$ and $\sigma = 0.5$.

Because in practical applications the transmitting band is much more important than the attenuating band, Fig. 5 has been supplied in order to represent X and Y in the transmitting band only, but to a considerably larger scale and for more values of σ .

If σ is read for σ' , Fig. 3 will represent U and V instead of X' and Y' respectively. If σ' is read for σ , Fig. 4 will represent U' and V' instead of X and Y ; so also will Fig. 5.

From Fig. 5 it will be observed that, in a certain range of σ , each curve of X has a maximum at some point within the transmitting band ($0 < r < 1$). For any fixed value of σ (in the range found below) the corresponding maximum of X and the particular value of r (critical value) at which the maximum occurs are expressed by the formulas

$$\text{Max. } X = |1/4(1 - 2\sigma)\sqrt{\sigma(1 - \sigma)}|,$$

$$\text{Crit. } r = \sqrt{\frac{8\sigma(1 - \sigma) - 1}{4\sigma(1 - \sigma)}},$$

as is readily found from the formula for X —namely, the real part of formula (4). The formula for Crit. r shows that the σ -range in which

X , regarded as a function of r , has a maximum within the transmitting band ($0 < r < 1$) is

$$(\sqrt{2}-1)/2\sqrt{2} < \sigma < (\sqrt{2}+1)/2\sqrt{2},$$

that is, approximately,

$$0.146 < \sigma < 0.854.$$

For values of σ outside of this range, X has no maximum within the transmitting band; but X has then its largest value at $r=0$, decreasing from 1 at $r=0$ to 0 at $r=1$. When $\sigma=1/2$, Crit. $r=1$;

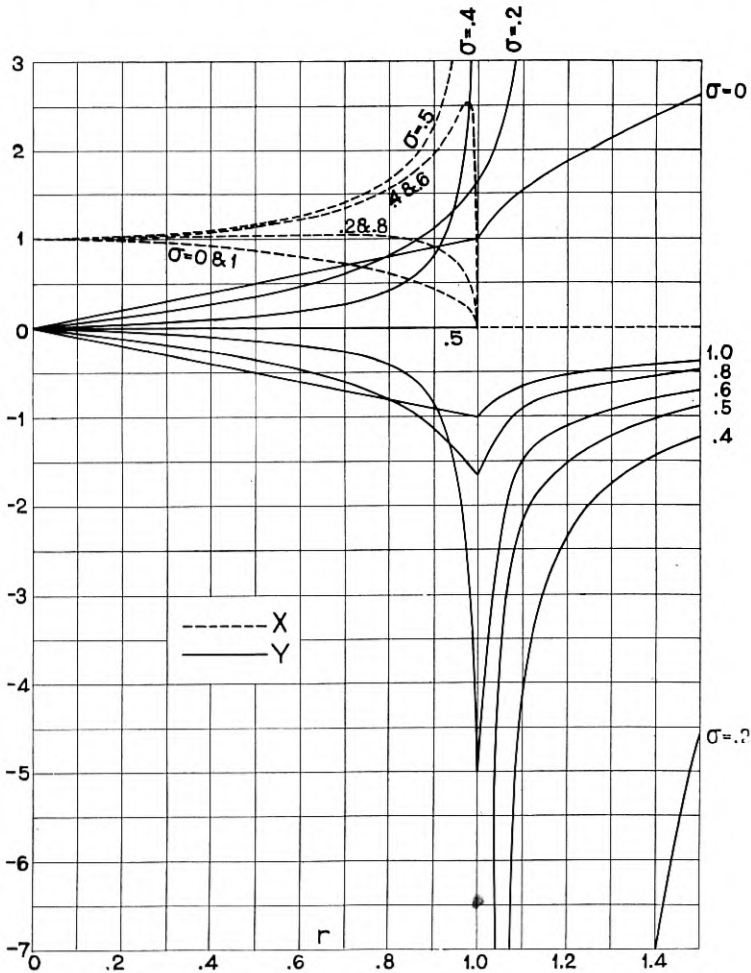

Fig. 4—Components of the σ -Section Relative Impedance $Z=X+iY$

when σ ranges from $1/2$ to either of its extreme values appearing in the foregoing inequality for σ , Crit. r decreases from 1 to 0.

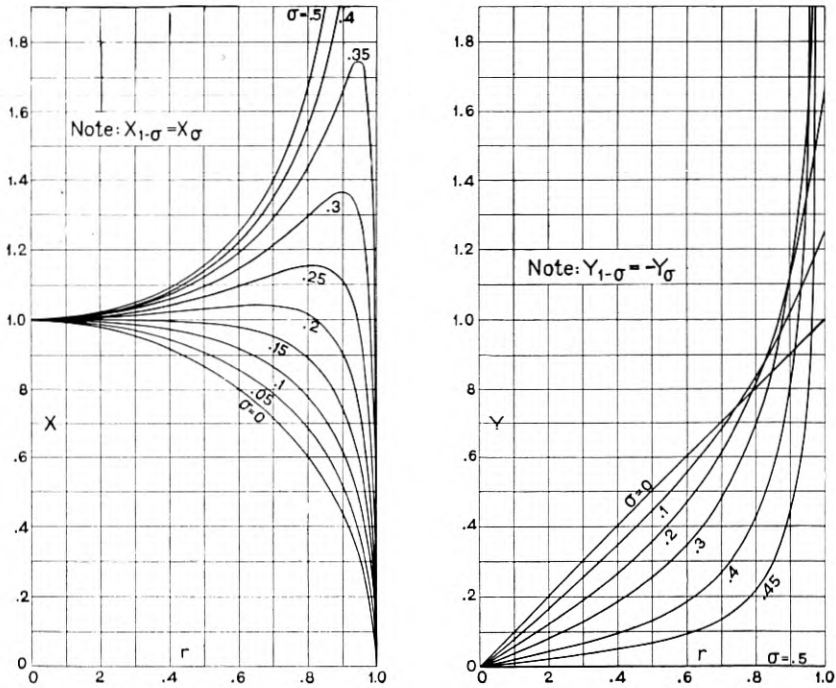

Fig. 5—Components of the σ -Section Relative Impedance $Z = X + iY$ in the Transmitting Band

PART III

IMPEDANCE OF NON-DISSIPATIVE LOADED LINES WITH DISTRIBUTED INDUCTANCE

Disposition of the Transmitting and the Attenuating Bands

It will be recalled that a loaded line without distributed inductance has only one transmitting band and only one attenuating band. In contrast, a loaded line (Fig. 1) with distributed inductance L has (as shown in Appendix A) an infinite sequence of alternate transmitting and attenuating bands; beginning with a transmitting band extending upward from zero frequency to the first transition frequency which, because of its special practical importance in being the upper boundary frequency of the first or principal transmitting band, is termed the "critical frequency" to distinguish it from the other transition fre-

quencies. The critical frequency will be denoted by f_c ; also by f_1 —particularly when regarded as the first transition frequency. The relative frequency will be denoted by r , that is,

$$r = f/f_c = f/f_1. \tag{13}$$

Evidently $r_1 = 1$. General formulas for all of the transition frequencies are furnished a little further on. For the case of no distributed inductance ($L=0$), there is only one transition frequency—the critical frequency—and it has the value expressed by equation (3). When necessary for distinction, the critical frequency for the case of no distributed inductance will be denoted by f'_c , also by f'_1 ; thus,

$$f'_c = f'_1 = 1/\pi\sqrt{L'C}. \tag{14}$$

The ratio of the critical frequency of any loaded line to the critical frequency of the same loaded line without distributed inductance ($L=0$) will be denoted by p ; that is,

$$p = f_c/f'_c = f_1/f'_1. \tag{15}$$

p can be evaluated by means of formula (22).

It is convenient to employ the term "compound band" to denote the band consisting of a transmitting band and the succeeding attenuating band. It is shown in Appendix A that, for any specific loaded line, the widths of all the compound bands are equal; though the transmitting bands become continually narrower with increasing

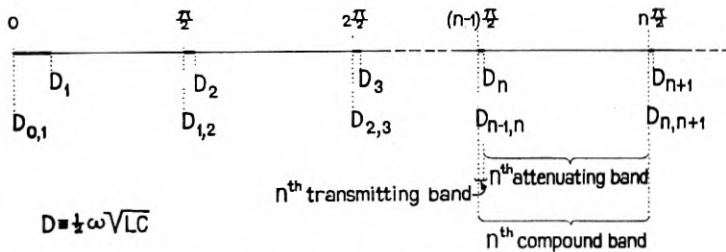

Fig. 6—Scale Showing the Disposition of the Transmitting and the Attenuating Bands of a Periodically Loaded Line (Fig. 1) with Distributed Inductance

frequency, while the attenuating bands become continually wider. These facts are represented on the D -scale in Fig. 6, D being proportional to the frequency f . Fundamentally D denotes the quantity $\frac{1}{2}\omega\sqrt{LC}$; but, by the substitution of $\lambda = L/L'$, and of r and p defined by (13) and (15), D can be written in the following four identically equivalent forms:

$$D = \frac{1}{2}\omega\sqrt{LC} = \frac{1}{2}\omega\sqrt{\lambda L'C} = rp\sqrt{\lambda} = rD_1. \tag{16}$$

It is of some interest to note that $D = \frac{1}{2}\omega\sqrt{LC}$ is equal to one-half the "phase constant" ("wave-length constant") of each section of line (L, C) between loads. In Fig. 6 the compound bands are numbered 1, 2, 3, . . . , n , . . . Thus D_n denotes the transition value of D within the n th compound band; that is, D_n is the value of D at the transition point between the n th transmitting band and the n th attenuating band. $D_{n,n+1}$ denotes the transition value of D between the n th and $(n+1)$ th compound bands; and hence the transition value of D between the n th attenuating band and the $(n+1)$ th transmitting band. The corresponding values of f and of ω would be correspondingly subscripted. By (16),

$$D_n = \frac{1}{2}\omega_n\sqrt{LC} = \frac{1}{2}\omega_n\sqrt{\lambda L'C} = r_n p\sqrt{\lambda} = r_n D_1; \quad (17)$$

and similarly for $D_{n-1,n}$ and $D_{n,n+1}$. In particular, $D_1 = p\sqrt{\lambda}$, since $r_1 = 1$. As shown in Appendix A,

$$D_{n-1,n} = (n-1)\pi/2, \quad D_{n,n+1} = n\pi/2. \quad (18)$$

Thus the D -width of each compound band is $\pi/2$, that is,

$$D_{n,n+1} - D_{n-1,n} = \pi/2; \quad (19)$$

and hence, by (16), the f -width has the value

$$f_{n,n+1} - f_{n-1,n} = 1/2\sqrt{LC} = 1/2\sqrt{\lambda L'C} = \pi f_1' / 2\sqrt{\lambda}. \quad (20)$$

If τ_n denotes the D -width of the n th transmitting band,—that is, $\tau_n = D_n - D_{n-1,n}$,—then the f -width has the value

$$f_n - f_{n-1,n} = \tau_n / \pi\sqrt{LC} = \tau_n / \pi\sqrt{\lambda L'C} = \tau_n f_1' / \sqrt{\lambda}. \quad (20.1)$$

With regard to the n th compound band it will be noted that there are two kinds of transition points—namely, the internal transition point D_n , and the boundary transition points $D_{n-1,n}$ and $D_{n,n+1}$. This distinguishing terminology will be found convenient in connection with the transition frequencies also.

As indicated by Fig. 6, the widths of all the compound bands are equal; but with increasing n the width of the n th transmitting band continually decreases toward a width of 0, while the n th attenuating band continually increases toward a D -width of $\pi/2$; so that the infinitely remote compound bands are pure attenuating bands, the infinitely remote transmitting bands being vanishingly narrow.

The situation of the critical value D_n of D within the n th compound band has no such simple expressions as have the boundary points $D_{n-1,n}$ and $D_{n,n+1}$; for D_n is a root of a transcendental equation and can be expressed only by an infinite series of terms or of opera-

tions. In Appendix A a power series formula has been derived for D_n in terms of $\lambda=L/L'$ and $D_{n-1,n}=(n-1)\pi/2$; if, for brevity, the somewhat cumbersome (though expressive) symbol $D_{n-1,n}$ is denoted by d_n , this power series is

$$D_n = d_n + \frac{\lambda}{d_n} - \frac{1}{d_n} \left(\frac{\lambda}{d_n} \right)^2 + \left(\frac{2}{d_n^2} - \frac{1}{3} \right) \left(\frac{\lambda}{d_n} \right)^3 - \left(\frac{5}{d_n^3} - \frac{4}{3d_n} \right) \left(\frac{\lambda}{d_n} \right)^4 \\ + \left(\frac{14}{d_n^4} - \frac{5}{d_n^2} + \frac{1}{5} \right) \left(\frac{\lambda}{d_n} \right)^5 - \left(\frac{42}{d_n^5} - \frac{56}{3d_n^3} + \frac{23}{15d_n} \right) \left(\frac{\lambda}{d_n} \right)^6 + \dots, \quad (21)$$

valid for $n=2,3,4, \dots$ but not for $n=1$. For $n=1$, so that $D_n=D_1$, it is shown in Appendix A that the appropriate formula is ⁷

$$D_1 = \sqrt{\lambda} \left(1 - \frac{\lambda}{6} + \frac{11\lambda^2}{360} - \frac{17\lambda^3}{5040} - \frac{281\lambda^4}{604800} + \frac{44029\lambda^5}{119750400} \dots \right). \quad (22)$$

Since, by (16), $p=D_1/\sqrt{\lambda}$, the series for p is the series in the parenthesis; see also (23-A) in Appendix A. Alternative series-formulas for evaluating D_1 and D_n are derived in Appendix A—formulas (23-A) and (23.1-A) for D_1 , and (20.2-A) for D_n . It may be observed that $D_n-d_n < \lambda/d_n$, that $D_1 < \sqrt{\lambda}$, and that $1-p < \lambda/6$.

The smaller λ , the more convergent are these formulas. Formula (22) is highly convergent, even when λ is as large as unity or even somewhat larger. The convergence of formula (21) depends very much on d_n and hence on n : when n is large, (21) is satisfactorily convergent even for fairly large values of λ ; but when n is small, (21) is satisfactorily convergent only for rather small values of λ .

As a supplement to or as an alternative to formulas (21) and (22) there will now be given a widely applicable formula of successive approximation for D_n , valid for all the values of n —including $n=1$ —and suitable even for large values of λ . With D_n-d_n (the D -width of the n th transmitting band) denoted by τ_n , this formula (derived by Newton's general method of approximation) is:

$$\tau_n'' = \frac{\lambda \tau_n' + \lambda \sin \tau_n' \cos \tau_n' - d_n \sin^2 \tau_n'}{\lambda + \sin^2 \tau_n'}, \quad (22.1)$$

wherein τ_n' is some approximate known value of τ_n , and τ_n'' is a more accurate approximate value yielded by the formula. τ_n'' , in turn, is to be used in the formula to compute a still more accurate approximate value τ_n''' ; and so on, through as many cycles as may be

⁷From the sequence of signs in this formula, namely $-+--+$, the sign of the next term is not evident. A similar remark applies to formulas (23-A) and (23.1-A) in Appendix A.

necessary—usually not more than two or three, though occasionally four. First-approximation values for τ_n are:

$$\tau_n' = \frac{\lambda}{d_n} \left(1 - \frac{\lambda}{d_n^2} \right) \text{ when } n \neq 1,$$

$$\tau_n' = \sqrt{\lambda} (1 - \lambda/6) \text{ when } n = 1,$$

as can be seen from (21) and (22) respectively. When $n = 1$, $\tau_n = D_1$, since $d_1 = 0$ by the first of (18).

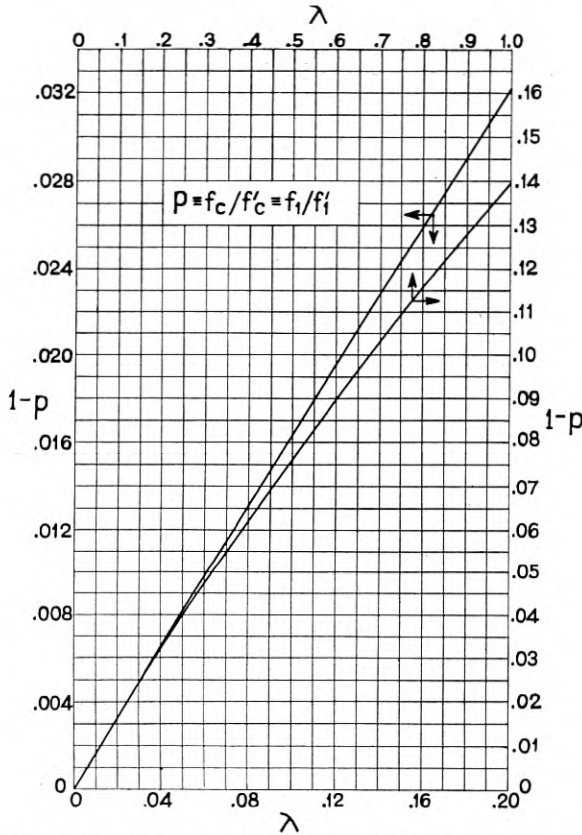

Fig. 7—Graphs of $1-p$ Representing the Fractional Lowering of the Critical Frequency by Distributed Inductance

D_n having been evaluated, the transition frequency f_n between the n th transmitting band and the n th attenuating band is calculable immediately from

$$f_n = \frac{D_n}{\pi\sqrt{LC}} = \frac{D_n}{\pi\sqrt{\lambda L'C}} = \frac{D_n f_1'}{\sqrt{\lambda}}, \tag{23}$$

derived from (17) supplemented by (14). Formula (23) is valid also when $n=1$, with D_1 evaluated from one of its appropriate formulas; the resulting formula for the critical frequency $f_1=f_c$ reduces to

$$f_1=f_c=p\sqrt{\lambda}/\pi\sqrt{LC}=p/\pi\sqrt{L'C}=pf'_c=pf'_1, \quad (24)$$

because $D_1=p\sqrt{\lambda}$, by (16); it is seen that (24) is consistent with (15).

For use in (24) and for certain other purposes to be met later, Fig. 7 gives graphs of $1-p$, calculated by (22) and also (22.1), for a wide range of λ . Up to the present time the largest value of λ occurring in practical applications in the Bell System is about 0.12; Fig. 7 covers

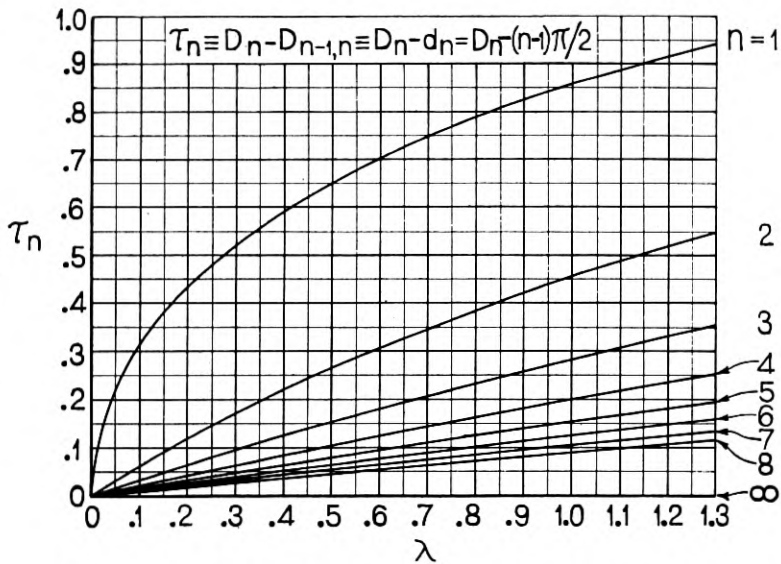

Fig. 7.1—Graphs for Finding the Widths of the Transmitting Bands

about eight times this range. Inspection of it shows that the graph of $1-p$ is sensibly a straight line up to values of r somewhat larger than even 0.12; and that $1-p$ is only slightly less than $\lambda/6$, which is merely the first term in the power series formula for $1-p$ obtained from (22).

The graphs in Fig. 7.1—constructed by means of formulas (22.1), (22), (21)—represent directly the dependence of the D -width $\tau_n = D_n - D_{n-1, n}$ of the n th transmitting band on λ and n , for a wide range of λ and the first eight values of n . The f -width is then obtainable

immediately from (20.1); and f_n from (23), since $D_n = \tau_n + (n-1)\pi/2$. In particular, the graph for $n=1$ is a graph of D_1 ; but D_1 —and hence f_1 —can be evaluated much more precisely by means of Fig. 7 described in the preceding paragraph.

The boundary transition frequencies $f_{n-1,n}$ and $f_{n,n+1}$ of the n th compound band (any compound band) depend on only one parameter (besides n)—namely, the product LC . The internal transition frequency f_n depends on two independent parameters (besides n)—namely, the product LC and the ratio $\lambda = L/L'$. Hence, fixing LC fixes all of the boundary frequencies of the compound bands; fixing LC and λ fixes all of the transition frequencies—boundary and internal. Fixing any one boundary frequency fixes LC and thereby fixes all of the remaining boundary frequencies; fixing any two transition frequencies of which at least one is an internal transition frequency fixes LC and λ and thereby fixes all of the remaining transition frequencies—boundary and internal.

The relative widths of all the transmitting and attenuating bands depend on only one parameter—namely, the ratio $\lambda = L/L'$. Hence, fixing λ fixes the relative widths of all these bands; fixing the ratio of the widths of any two bands not both of which are compound bands fixes λ and thereby fixes the relative widths of all the transmitting and attenuating bands.

The effect of increasing λ , when $L'C$ is fixed, is to lower the critical frequency $f_c = f_1$, the critical frequency approaching zero when λ approaches infinity. But for even the largest values of λ met in practice the critical frequency is not much lower than for $\lambda=0$; the fractional decrease $(f'_c - f_c)/f'_c$ produced in the critical frequency by increasing λ from 0 to any value λ is exactly equal to $1 - p$ and hence for any ordinary value of λ is, by (22), closely equal to $\lambda/6$ (which is only 0.02 for $\lambda=0.12$). It is interesting to note that the nominal impedance—defined by equation (1)—is increased about three times as much as the critical frequency is decreased; for the fractional increase in the nominal impedance is exactly $\sqrt{1+\lambda} - 1$, and hence approximately $\lambda/2$.

All the transition frequencies are reduced by increasing λ , when $L'C$ is fixed. The transition frequencies bounding the compound bands, and hence the widths of the compound bands, decrease in direct proportion to an increase of $\sqrt{\lambda}$. But the values of the internal transition frequencies do not decrease so rapidly; for the ratio of transmitting band width to attenuating band width increases with increasing λ .

The effect of adding distributed inductance L to a loaded line (L', C) having originally none is to replace the previous single compound band of infinite width by an infinite number of compound bands each of finite width. The larger L the narrower are the compound f -bands, and the further to the left they are situated. Although, as already noted, increasing L decreases the critical frequency, it increases the relative width of each transmitting band—namely, the ratio of the width of each transmitting band to the compound band of which it is a constituent. Thus, when L becomes very large (so that LC and λ become very large) there are within even a moderate frequency-range a very large number of compound bands whose transmitting constituents are very wide compared with the attenuating constituents.

The effect of applying lumped loading to a given smooth line (L, C) is to introduce into the previous transmitting band of infinite width an infinite number of attenuating bands whose upper boundary points are equidistant and whose widths continually decrease toward the lower frequencies. When the inductance L' of the loads is continually increased the attenuating bands continually increase in width as a consequence of their lower boundary points moving downward to lower frequencies, so that ultimately the attenuating bands fill the entire frequency scale from zero to infinity. An alternative but equivalent statement regarding the effect of applying lumped loading is that the previous pure transmitting bands, each of D -width equal to $\pi/2$, become compound bands whose attenuating constituents continually increase in width when L' is increased.

(The four preceding paragraphs are based on the last five paragraphs of Appendix A.)

In Fig. 6 the transmitting bands are represented as being relatively narrow compared with the attenuating bands. In existing loaded lines this is indeed the case, but it is not an inherent relation: for any number of the transmitting bands can be made wider than the associated attenuating bands by so designing the loading (lumped or smooth or both) as to secure a sufficiently large value of the ratio $\lambda = L/L'$. (However, for any fixed loading and hence a fixed value of λ , there is some frequency beyond which the transmitting bands are narrower than the associated attenuating bands.)

There will now be given two examples illustrating the relations represented in Fig. 6, and illustrating also the applications of certain of the foregoing formulas and graphs.

The first example pertains to a heavily loaded open-wire line of No. 12 N. B. S. gauge, having loading coils of inductance $L' = 0.241$

henry at a spacing of $s=7.88$ miles. The line has a capacity of $.00835 \times 10^{-6}$ farad and an inductance of .00367 henry, each per mile; whence, for each line-segment between loads, $C = .0658 \times 10^{-6}$ farad and $L = .0289$ henry. Therefore $\lambda = 0.12$. With λ known, the internal transition frequencies f_n (with $n = 1, 2, 3, 4, \dots$) can be readily evaluated from (23) through the values of D_n obtainable from Fig. 7.1. However, when particularly high accuracy is desired for the first transition frequency f_1 —the critical frequency—this can be attained by resort to formula (22) or to (22.1), or else to Fig. 7; it is thus found that $1 - p = .0196$, whence $p = 0.9804$, and then $f_1 = 2479$ cycles per second, by (24). The f -width of each compound band is 11464, by (20). The following table shows the locations and widths of the first five ($n = 1, 2, 3, 4, 5$) transmitting bands and associated attenuating bands of this loaded line. The numbers in the columns headed $f_{n-1,n}$ and f_n are the transition frequencies constituting, respectively, the lower and upper boundary points of the transmitting bands; and the numbers in the column headed $f_n - f_{n-1,n}$ are therefore the widths of the transmitting bands. The next to the last column shows the relative widths of the transmitting bands, referred to the first or principal transmitting band—whose width is $f_1 - 0 = f_1 = 2479$, the critical frequency being 2479. Similarly, the last column shows the relative widths of the attenuating bands.

n	τ_n	$f_{n-1,n}$	f_n	$f_n - f_{n-1,n}$	$(f_n - f_{n-1,n})/f_1$	$(f_{n,n+1} - f_n)/f_1$
1	.3396	0	2,479	2,479	1.000	3.625
2	.0729	11,464	11,996	532	.215	4.410
3	.0377	22,928	23,203	275	.111	4.514
4	.0253	34,392	34,577	185	.074	4.551
5	.0190	45,856	45,995	139	.056	4.569

It will be observed that the transmitting bands decrease rapidly in width at first, then more and more slowly; and that the associated attenuating bands are relatively very wide. For instance, the second transmitting band (0.215) is only about one-fifth the width of the first (1.000), and the second attenuating band (4.410) is more than twenty times the width of the second transmitting band (0.215).

The second example pertains to a hypothetical, though not necessarily impracticable, loaded line. Before loading, the line is the same as in the first example; but it is very lightly loaded—namely, with loading coils of inductance $L' = .0578$ henry at a spacing of $s = 15.76$ miles. Hence, $C = 0.1316 \times 10^{-6}$ farad and $L = .0578$ henry. Therefore

$\lambda = 1$. The following table shows the locations and widths of the first eight transmitting bands and attenuating bands. The critical frequency is $f_1 = 3140$, and the f -width of each compound band is 5732.

n	τ_n	$f_{n-1,n}$	f_n	$f_n - f_{n-1,n}$	$(f_n - f_{n-1,n})/f_1$	$(f_{n,n+1} - f_n)/f_1$
1	.8604	0	3,140	3,140	1.000	.826
2	.4579	5,732	7,403	1,671	.532	1.294
3	.2840	11,464	12,500	1,036	.330	1.496
4	.2008	17,196	17,929	733	.234	1.592
5	.1541	22,928	23,490	562	.179	1.647
6	.1247	28,660	29,115	455	.145	1.681
7	.1046	34,392	34,774	382	.122	1.704
8	.0900	40,124	40,452	328	.105	1.721

Comparison of this table with that of the first example brings out the great diversity between the two examples: the minor transmitting bands in the second example are relatively and absolutely much wider and situated at much lower frequencies than in the first example. In the second example the first or principal transmitting band is somewhat wider than the first attenuating band.

A further application of the foregoing formulas and graphs is to obtain a precise and explicit solution of the important practical problem of loading a given smooth line with lumped loading to secure specified values of the critical frequency f_1 and nominal impedance k . The design-problem consists in determining the requisite values of the load inductance L' and load spacing s in terms of f_1 and k and the known values of the inductance and capacity, L'' and C'' , per unit length of the given smooth line. Since $L = sL''$ and $C = sC''$, the solution can be obtained as follows: Substituting $L' = sL''/\lambda$ into (1) and solving for λ gives

$$\lambda = \frac{L''/C''}{k^2 - L''/C''}.$$

Then D_1 becomes known by means of Fig. 7 or Fig. 7.1 or formula (22) or (22.1). Next, s becomes known from (23) or (24):

$$s = D_1 / \pi f_1 \sqrt{L''C''}.$$

Finally, from these formulas for λ and s together with the relation $L' = sL''/\lambda$, it follows that

$$L' = \frac{D_1(k^2 - L''/C'')}{\pi f_1 \sqrt{L''/C''}}.$$

The Relative Impedances

The formulas for the impedances and admittances of a non-dissipative periodically loaded line (Fig. 1) with any amount of distributed inductance L will next be set down, and discussed somewhat, with particular regard to the transmitting and the attenuating bands of the loaded line.

As before, it is convenient to deal with the relative impedances Z, Z' and the relative admittances W, W' defined by equations (2). Special attention is given to the particular values $Z_{.5}, Z'_{.5}, W_{.5}, W'_{.5}$ corresponding to mid-point terminations.

It is found that Z, Z', W, W' can be expressed in terms of three independent quantities—namely, the relative frequency $r=f/f_c$, the inductance ratio $\lambda=L/L'$, and the relative termination σ or σ' . For most applications the quantity $r=f/f_c$ is more significant than any other quantity proportional to the frequency f , and on that score it would be desirable to employ it explicitly in the formulas for the impedances and admittances. However, the formulas are rendered considerably more compact by employing the quantity D defined by equation (16). Whenever desired, D can be expressed in terms of r, λ , and ρ by means of (16); and thence in terms of r and λ by means of (22).

Because of their special importance the formulas for the mid-point relative impedances and relative admittances will be set down first. From Appendix D these formulas are found to be

$$Z_{.5} = \frac{1}{W_{.5}} = \sqrt{\frac{\lambda}{\lambda+1}} \sqrt{\frac{\lambda+D \cot D}{\lambda-D \tan D}} \tag{25}$$

$$Z'_{.5} = \frac{1}{W'_{.5}} = \sqrt{\frac{(\lambda+D \cot D)(\lambda-D \tan D)}{\lambda(\lambda+1)}} \tag{26}$$

$$= \sqrt{\frac{\lambda^2 + 2\lambda D \cot 2D - D^2}{\lambda(\lambda+1)}} \tag{26.1}$$

From these formulas it can be verified that $Z_{.5}$ and $Z'_{.5}$ are pure imaginary throughout every attenuating band, and it can be seen that they are pure real throughout every transmitting band.

A study of equations (25) and (26) brings out also the following facts regarding the variation of $Z_{.5}$ and $Z'_{.5}$ in the transmitting and the attenuating bands, with increasing frequency:

In the first transmitting band, $Z_{.5}$ ranges from 1 to ∞ , but in all of the other odd transmitting bands it ranges from ∞ to ∞ , through finite intervening values; in the even transmitting bands it ranges

from 0 to 0, through finite intervening values. In the odd attenuating bands it ranges from $-i\infty$ to $-i0$; and in the even attenuating bands it ranges from $+i0$ to $+i\infty$.

In the first transmitting band, $Z'_{.5}$ ranges from 1 to 0, but in all of the other transmitting bands it ranges from ∞ to 0. In all of the attenuating bands it ranges from $+i0$ to $+i\infty$.

These facts are illustrated by Fig. 8, which gives graphs of $Z_{.5}$ and $Z'_{.5}$ over a range of three compound bands, as functions of $r = f/f_1 = D/D_1$, with $\lambda = 0.12$; also with $\lambda = 0$, for comparison. On the scale there used, the curves for the two values of λ are indistinguishable

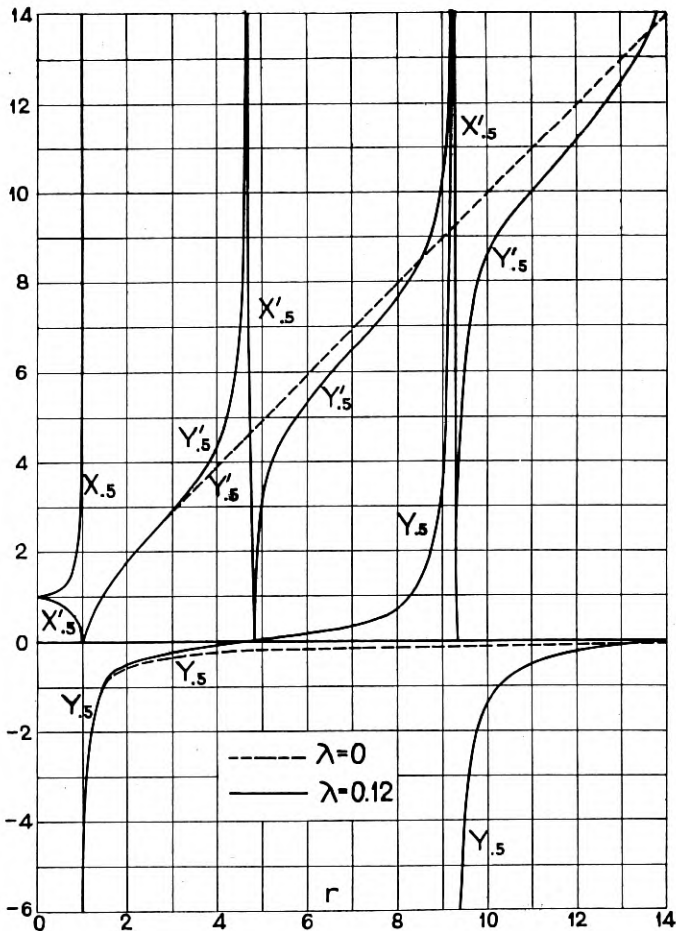

Fig. 8—Mid-Section Relative Impedance $Z_{.5} = X_{.5} + iY_{.5}$ and Mid-Load Relative Impedance $Z'_{.5} = X'_{.5} + iY'_{.5}$ Over a Range of Three Compound Bands

throughout the first transmitting band ($0 < r < 1$) and a considerable part of the succeeding attenuating band; but depart widely beyond.

The exact formulas for Z , W and Z' , W' for any terminations σ and σ' can be written in the forms

$$Z = \frac{1}{W} = \frac{Z_{.5} \cot (2\sigma - 1)D + i\sqrt{\lambda/(1+\lambda)}}{\cot (2\sigma - 1)D + iZ_{.5}\sqrt{(1+\lambda)/\lambda}}, \tag{27}$$

$$Z' = \frac{1}{W'} = Z'_{.5} + i\frac{(2\sigma' - 1)D}{\sqrt{\lambda(1+\lambda)}}. \tag{28}$$

These equations are not restricted to values of σ and σ' less than unity; they are valid for any (real) values of these quantities. When $\lambda = 0$, they reduce immediately to (4) and (5) respectively.

From (27) and (28) it is readily verified that Z and Z' are pure imaginary throughout every attenuating band, and it can be easily seen that they are complex throughout every transmitting band; because $Z_{.5}$ and $Z'_{.5}$ are pure imaginary throughout every attenuating band, and pure real throughout every transmitting band.

It is seen from (27) and (28) that, throughout every transmitting band, each of the quantities Z , W , Z' , W' changes merely to its conjugate when σ is changed to $1 - \sigma$. Thus the conjugate property expressed by equations (8) is not limited to loaded lines without distributed inductance but holds when there is any amount of distributed inductance. Thus it continues to be true that complementary characteristic impedances are mutually conjugate—throughout every transmitting band. For Z' and W' , these facts are readily seen from physical considerations also; though not so readily for Z and W .

From physical considerations, as well as from equation (28), it is readily seen that Z' continues to possess the property expressed by the second of equations (9); on the other hand, W no longer possesses the property expressed by the first of (9).

We shall now return to the important formulas (25) and (26) for the mid-point relative impedances in order to discuss them for small values of λ such as occur in practice, and particularly for a frequency-range not greatly exceeding that of the first transmitting band. For this purpose it is advantageous to write these formulas in the following forms, notwithstanding some sacrifice of compactness:

$$Z_{.5} = \frac{1}{W_{.5}} = \sqrt{\frac{\lambda + D \cot D}{\lambda + 1}} \bigg/ \sqrt{1 - \frac{D \tan D}{D_1 \tan D_1}}, \tag{29}$$

$$Z'_{.5} = \frac{1}{W'_{.5}} = \sqrt{\frac{\lambda + D \cot D}{\lambda + 1}} \sqrt{1 - \frac{D \tan D}{D_1 \tan D_1}}. \tag{30}$$

For the discussion of these it should be recalled that $D = \frac{1}{2}\omega\sqrt{\lambda L'C}$ and $r = D/D_1 = f/f_1 = f/f_c$; also that $D_1 \tan D_1 = \lambda$, whence D_1 is approximately equal to $\sqrt{\lambda}$ when λ is small.

Equations (29) and (30) are in such form as to exhibit the manner in which $Z_{.5}$ and $Z'_{.5}$ approach their simple limiting values for $\lambda = 0$, represented by equations (6) and (7) respectively. For when λ approaches 0, $D \cot D$ and $D \tan D$ approach 1 and D^2 respectively; and for values of λ even larger than the largest (about 0.12) occurring in practice, $D \cot D$ and $D \tan D$ respectively are at least roughly equal to 1 and to D^2 throughout even more than the first transmitting band.

The expression for $Z_{.5}$ reduces immediately to $1/\sqrt{1-r^2}$ when λ is zero. When λ is not zero, $Z_{.5}$ is less than $1/\sqrt{1-r^2}$ for all values of r in the first transmitting band ($0 < r < 1$); when r increases from 0 to 1, $Z_{.5}$ increases from 1 to ∞ .

The expression for $Z'_{.5}$ reduces immediately to $\sqrt{1-r^2}$ when λ is zero. Even when λ is several tenths, $Z'_{.5}$ is very closely equal to $\sqrt{1-r^2}$ for all values of r in the first transmitting band; when r increases from 0 to 1, $Z'_{.5}$ decreases from 1 to 0.

Effects of Distributed Inductance; the "Simulative Loaded Line"

The above-described relations are exemplified in Fig. 9, which gives graphs of $Z_{.5}$ and $Z'_{.5}$ over the first transmitting band and part of the succeeding attenuating band, as functions of r , with λ as parameter equal to 0.12 and to 0. It is seen that the curves of $Z_{.5}$ for the two values of λ do not differ much in the transmitting band ($0 < r < 1$); and that the curves of $Z'_{.5}$ for the two values of λ are indistinguishable—on the scale there used.

In order to indicate more precisely to what extent the forms of $Z_{.5}$ and $Z'_{.5}$ are affected by the presence of distributed inductance, as specified by $\lambda = L/L'$, Fig. 10 has been prepared. This gives a graph of the ratio of the values of $Z_{.5}$ for $\lambda = 0.12$ and $\lambda = 0$; and likewise of $Z'_{.5}$. That is, formulated in functional notation, it gives graphs of $Z_{.5}(r, \lambda)/Z_{.5}(r, 0)$ and $Z'_{.5}(r, \lambda)/Z'_{.5}(r, 0)$. From these it is seen that, in the transmitting band, the mid-section ratio (first ratio) and the mid-load ratio (second ratio) do not differ from unity by more than four per cent. and one-tenth of one per cent., respectively. These observations—particularly the second—suggest that, at least over the whole of the first transmitting band, the impedance of a non-dissipative periodically loaded line with small distributed inductance

can be rather closely simulated by a periodically loaded line without distributed inductance but with suitably chosen load-inductance L_0' and section-capacity C_0 . The utility of this observation resides

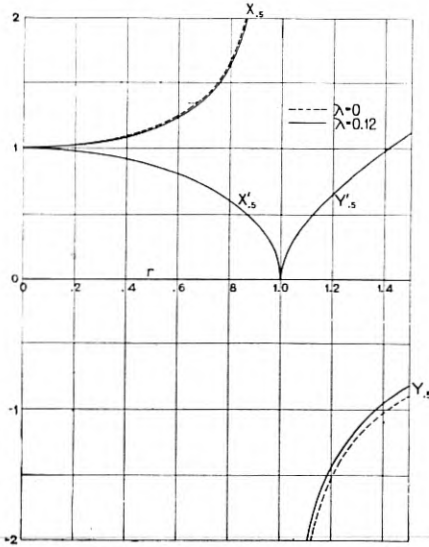

Fig. 9—Mid-Section and Mid-Load Relative Impedances $Z_{.5}$ and $Z'_{.5}$ Over the First Transmitting Band and Part of the Succeeding Attenuating Band

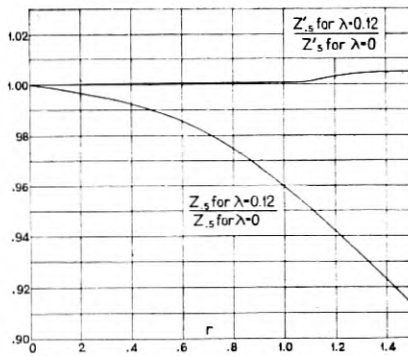

Fig. 10—Ratio Curves Showing Effects of Distributed Inductance on the Forms of the Curves of $Z_{.5}$ and $Z'_{.5}$

ultimately in the fact that the formulas for loaded lines without distributed inductance are much simpler than those for loaded lines with distributed inductance.

For mid-section or for mid-load termination the simulation of the effects of distributed inductance described in the preceding paragraph can be made exact at two different frequencies simultaneously, and the requisite values of the load-inductance L_0' and section-capacity C_0 of the simulating loaded line thereby determined. This simulating loaded line will be termed the "simulative loaded line" corresponding to the two particular frequencies contemplated.

In many applications a suitable simulation can be attained by imposing the conditions that the simulating loaded line (L_0' , C_0) shall have the same nominal impedance k and critical frequency f_c as the actual loaded line (L' , L , C). The particular simulating loaded line so determined will be called the "principal simulative loaded line"; evidently its load-inductance L_0' and section-capacity C_0 are determined in terms of k and f_c and also in terms of L' , L , C by the pair of equations

$$k = \sqrt{(L' + L)/C} = \sqrt{L_0'/C_0}, \quad (31)$$

$$f_c = p/\pi\sqrt{L'C} = 1/\pi\sqrt{L_0'C_0}, \quad (32)$$

of which (31) corresponds to (1), and (32) to (15) and (14) combined or to (24). The solution of the pair of equations (31) and (32) is the pair of values

$$L_0' = L'(\sqrt{1+\lambda})/p = k/\pi f_c, \quad (33)$$

$$C_0 = C/p\sqrt{1+\lambda} = 1/\pi f_c k. \quad (34)$$

In conjunction with (22), these formulas show that $L_0' > L'$ and $C_0 < C$; in fact they show that $L_0'/L' = 1 + 2\lambda/3$ and $C_0/C = 1 - \lambda/3$, as first approximations; precise values of these ratios can be readily calculated by substituting for p the power series contained in equation (22).

The simulative precision of the "principal simulative loaded line" depends on the value of the relative termination (σ or σ'). The simulation is far more precise for mid-load termination ($\sigma' = 0.5$) than for mid-section termination ($\sigma = 0.5$); this can be seen by developing in power series the functions involved; for $\lambda = 0.12$ the fact is illustrated by Fig. 10 already cited. The simulative precision for other terminations will not be discussed here, beyond remarking that the "principal simulative loaded line" terminating at σ' -load could not exactly simulate the actual loaded line terminating at σ' -load, even if the simulation were exact at 0.5-load; for the excess-inductances $(\sigma' - 0.5)L_0'$ and $(\sigma' - 0.5)L'$ are not exactly equal, the former being slightly the larger—as shown by equation (33). However, the smallness of the impedance-departure between the "principal simulative

loaded line" and the actual loaded line when both lines terminate at mid-load can be identically preserved for any other load-point termination of either line by so choosing the load-point termination of the other line that the excess inductance of its end-load beyond half load has the same value. This fact should be kept in mind when designing simulating and compensating networks, particularly such as pertain to a loaded line that terminates with a fractional load; also when choosing the relative termination σ' of the fractional load.

Some idea as to the simulative precision of the propagation constant $\Gamma = A + iB$ of the "principal simulative loaded line" can be obtained from Fig. 22 in Appendix A. For the present purpose the graphs for $\lambda = 0$ can be regarded as pertaining exactly to the "principal simulative loaded line" corresponding to any non-dissipative periodically loaded line having any amount of distributed inductance, while the graphs for $\lambda = 0.12$ are for any non-dissipative loaded line having the particular inductance ratio $\lambda = 0.12$. Of course, A is zero in the range $0 < r < 1$.

PART IV

NETWORKS FOR SIMULATING AND FOR COMPENSATING THE IMPEDANCE OF LOADED LINES—GENERAL CONSIDERATIONS

The remainder of the paper relates to the simulation and the compensation of the impedance of periodically loaded lines by means of the simulating and the compensating networks devised by the writer, as mentioned in the latter part of the Introduction.

The term "compensating network" requires at least a tentative definition. The compensating networks dealt with in the present paper are of two types: reactance-compensators, and susceptance-compensators. For the present they may be defined—rather narrowly—with reference to the first transmitting band of non-dissipative loaded lines, as follows: a reactance-compensator is a network that neutralizes the characteristic reactance of the line and hence simulates its complementary characteristic reactance; a susceptance-compensator is a network that neutralizes the characteristic susceptance of the line and hence simulates its complementary characteristic susceptance.

As actually worded, this division (Part IV) of the paper pertains mainly to the simulation of loaded lines; but with appropriate slight changes of wording most of it pertains also to compensation. Compensation is dealt with explicitly in portions of Parts V and VIII of the paper.

The simulating and the compensating networks were devised from purely theoretical studies of the characteristic impedance and admittance of periodically loaded lines as dependent on the frequency and on the relative termination, in somewhat the same way as the previously described¹ networks for smooth lines were devised from purely theoretical studies of the characteristic impedance of smooth lines as dependent on the frequency.

Building-out Structures, Basic Networks, and Excess-Simulators

Although the characteristic impedance of a periodically loaded line depends greatly on its relative termination (σ or σ'), yet there is no need of attempting to devise various independent networks corresponding to various relative terminations of the line. For any network that will simulate the line-impedance at any particular relative termination can be "extended" or "built-out" to simulate it at any other relative termination by merely supplementing the network with an "extension network" or "building-out structure" in the nature of an artificial line structure corresponding as closely as may be necessary to the portion of actual line structure included between the two relative terminations contemplated. Simulation can be attained also by building-out the line instead of the network, or by building-out both the line and the network to any common relative termination; but in practice these alternatives are not usually permissible, the usual requirement being the simulation of a given fixed line. (In present practice, the line is terminated usually at mid-section [$\sigma=0.5$], or as closely thereto as practicable.)

The term "basic network" will be used to denote a network which simulates the characteristic impedance of a non-dissipative periodically loaded line without the network's containing in its structure any building-out elements. Regarding the loaded line, the particular relative termination to which the basic network pertains will be termed the "basic relative termination" of the loaded line, and will be denoted by σ_b or σ_b' whenever a symbol is needed for it. (For the kinds of basic networks thus far devised, σ_b and σ_b' lie between about 0.1 and about 0.2, that range having been found to include the relative terminations most favorable to the design of those kinds of basic networks.) The foregoing terms, when used in connection with a dissipative loaded line, will be understood to refer to the corresponding non-dissipative loaded line. A considerable number of kinds of basic networks will be described in Part V supplemented by Part VI.

The amount by which the characteristic impedance of any periodically loaded line exceeds the impedance of the corresponding non-dissipative loaded line will be termed the "excess impedance" (or, more fully, the "excess characteristic impedance"); and a network for simulating it will be termed an "excess-simulator." Excess-simulators for loaded lines will be considered very briefly in Part VII.

(In passing, it may be noted that the foregoing definition of the "excess impedance" of a periodically loaded line properly includes the definition already given¹ of the excess impedance of a smooth

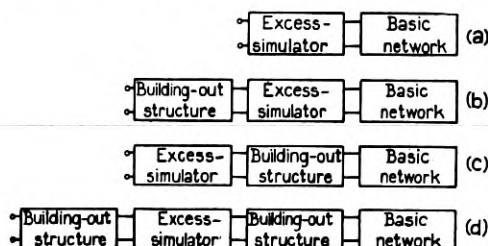

Fig. 11—Abstract Diagrams of Complete Networks for Simulating Characteristic Impedance of Loaded Line

line; for the "nominal impedance" of any smooth line was defined¹ as the impedance of the corresponding non-dissipative smooth line. A similar statement is applicable to the terms "excess simulator" and "basic network" previously defined¹ for smooth lines.)

The foregoing considerations and definitions have prepared the way for Fig. 11, which indicates in an abstract manner how the impedance of any loaded line having any relative termination can be simulated by combinations of basic networks, excess simulators, and building-out structures.

Fig. 11a corresponds to the simple but unusual case in which the loaded line has the basic relative termination: its impedance then can be simulated by the corresponding basic network and excess simulator, without any building-out structure.

When, as usual, the given line does not have the basic relative termination, there are available the two natural alternatives represented by Figs. 11b and 11c. Fig. 11b shows the whole network of Fig. 11a built-out to the relative termination of the given line by means of the requisite building-out structure, which for the highest precision must be dissipative to correspond to the actual line. In Fig. 11c the basic network is built-out to the relative termination of the given line with a non-dissipative building-out structure; and then the resulting network, which simulates the impedance that the actual

line would have if non-dissipative, is supplemented with an excess-simulator such as to simulate the excess impedance of the actual line.

Since the excess impedance depends somewhat on the relative termination it can be simulated more easily at certain relative terminations than at others. This fact is utilized in the arrangement represented by Fig. 11d. Here the basic network is built-out to some relative termination that is particularly favorable for the design of an excess-simulator; the excess-simulator is applied; and then is applied the building-out structure, which for the highest precision must be dissipative to correspond to the actual line.

The simulation-range of the basic networks described in this paper is a little less than the first transmitting band of the loaded line; but after a basic network has been built-out, its simulation-range may extend a little way into the succeeding attenuating band, omitting the immediate neighborhood of the critical frequency. The compensation-range of the compensating-networks is somewhat less than the first transmitting band of the loaded line.

PART V

NETWORKS FOR NON-DISSIPATIVE LOADED LINES WITHOUT DISTRIBUTED INDUCTANCE

In this Part will be described a considerable number of kinds of "basic networks" for simulating the characteristic impedance of non-dissipative loaded lines without distributed inductance; and two types of compensating networks for such lines. The modifications necessary when the lines have small distributed inductance will be indicated in Part VI.

The various kinds of basic networks here described may be regarded as of two different types corresponding to the terminations of the loaded lines to which they pertain; there may be several varieties of each type. The two types correspond to fractional-section and to fractional-load terminations respectively; that is, to the relative terminations σ_b and σ_b' respectively. (It has been stated already, in Part IV, that σ_b and σ_b' lie between about 0.1 and about 0.2.) It will appear below that these two types are inverse types, in the sense that the impedance of a network of one type is of the same functional form as the admittance of the corresponding network of the other type, when the frequency is regarded as the independent variable. In particular, for equal relative terminations ($\sigma_b = \sigma_b'$), the ratio of the impedance and the admittance of any two corresponding inverse networks is independent of frequency. This corresponds to the relations $Z/W' = 1$ and $Z'/W = 1$, holding for the loaded line

itself, according to equations (4) and (5). Hence the two types of networks will sometimes be distinguished as impedance type and admittance type. More specifically, the simulating networks of the two types will be distinguished as impedance-simulators and admittance-simulators, respectively; and the compensating networks as reactance-compensators and susceptance-compensators, respectively.

By being built out to the requisite extent, either type of network evidently can be employed with a loaded line terminating at any point in either a section or a load; but, depending on such termination, one type will require less building-out than the other, and hence will be somewhat preferable on that score. For instance, for simulating the impedance of a loaded line terminating at mid-section ($\sigma=0.5$), a basic network of the fractional-section type of termination will require less building-out than one of the fractional-load type of termination.

The Basic Networks

The various basic networks mentioned will now be described briefly, by aid of circuit diagrams which show the forms of the networks and which include explicit design-formulas for the proportioning. Mutually corresponding networks of inverse types will be described together or in sequence, in order to exhibit clearly their correlation.

In the design-formulas the requisite values for the network-elements will be expressed in terms of the load-inductance L' and the section-capacity C of the given loaded line; but when desired they can instead be readily expressed in terms of the nominal impedance k and critical frequency f_c , by means of the relations

$$L' = k / \pi f_c, \quad C = 1 / \pi k f_c.$$

Of course, the design-formulas involve also the relative terminations σ and σ' .

Figs. 12 and 13 show two rather simple networks which simulate very well, over most of the transmitting band, the σ -section character-

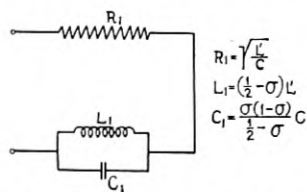

Fig. 12 — Impedance-Simulator for a Loaded Line Terminating at σ -Section, with σ in the Neighborhood of 0.2

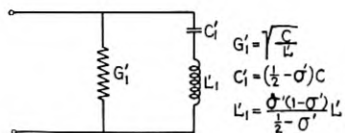

Fig. 13 — Admittance-Simulator for a Loaded Line Terminating at σ' -Load, with σ' in the Neighborhood of 0.2

istic impedance and the σ' -load characteristic admittance, respectively, of a non-dissipative loaded line, when σ and σ' are in the neighborhood of 0.2. The theoretical bases of these two networks and of their proportioning are outlined in Appendix B. (See also Patent No. 1124904 and No. 1437422, respectively.)

Figs. 14 and 15 show two networks which are considerably less simple than those of Figs. 12 and 13 but possess a substantially wider

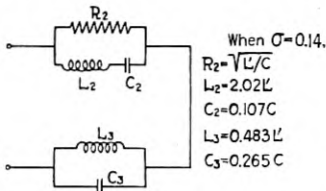

Fig. 14—Impedance-Simulator for a Loaded Line Terminating at σ -Section, with σ about 0.14

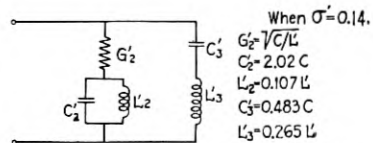

Fig. 15—Admittance-Simulator for a Loaded Line Terminating at σ' -Load, with σ' about 0.14.

frequency-range of simulation; for them the best value of σ and of σ' is about 0.14. The theoretical bases of these two networks are indicated below in the descriptions of the networks in Figs. 20 and 21, respectively. (See also Patent No. 1167693 and No. 1437422, respectively.)

Fig. 16 shows a network called a reactance-compensator, for a non-dissipative loaded line terminating at σ -section. When proportioned

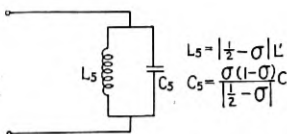

Fig. 16—Reactance-Compensator for a Loaded Line Terminating at σ -Section:
 Reactance-Simulator when $0 < \sigma < 1/2$
 Reactance-Neutralizer when $1/2 < \sigma < 1$

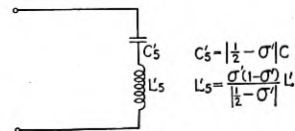

Fig. 17—Susceptance-Compensator for a Loaded Line Terminating at σ' -Load:
 Susceptance-Simulator when $0 < \sigma' < 1/2$
 Susceptance-Neutralizer when $1/2 < \sigma' < 1$

in accordance with the design-formulas there given, this network possesses the following two-fold property with reference to the σ -section characteristic reactance of the loaded line: When σ has any fixed value between 0 and 1/2, the network exactly simulates the σ -section reactance, and exactly neutralizes the $(1-\sigma)$ -section reactance; or, what is equivalent, when σ has any fixed value between 1/2 and 1, the network exactly neutralizes the σ -section reactance and exactly simulates the $(1-\sigma)$ -section reactance.

Fig. 17 shows a network called a susceptance-compensator, for a non-dissipative loaded line terminating at σ' -load. When proportioned in accordance with the design-formulas there given, this network possesses the following two-fold property with reference to the σ' -load characteristic susceptance of the loaded line: When σ' has any fixed value between 0 and 1/2, the network exactly simulates the σ' -load susceptance, and exactly neutralizes the $(1-\sigma')$ -load susceptance; or, what is equivalent, when σ' has any fixed value between 1/2 and 1, the network exactly neutralizes the σ' -load susceptance and exactly simulates the $(1-\sigma')$ -load susceptance.

It may be noted that the resonant frequency f_r of the compensators in Figs. 16 and 17 is never less than the resonant frequency f_c of the loaded line; for when $\sigma = \sigma'$ the two types of compensators have the same value of f_r , and

$$f_r/f_c = 1/2\sqrt{\sigma(1-\sigma)}.$$

This ratio has a minimum value of unity, when $\sigma = 1/2$; and becomes infinite when $\sigma = 0$ and when $\sigma = 1$. It is equal to 1.25 when $\sigma = 0.2$ and when $\sigma = 0.8$.

The compensators in Figs. 16 and 17 are evidently inverse networks; the theoretical principles underlying them are outlined together in Appendix C. (See also Patent No. 1243066 and No. 1475997, respectively.)

With σ and σ' each in the neighborhood of 0.2 or of 0.8, the σ -section characteristic reactance and the σ' -load characteristic conductance of a non-dissipative loaded line are simulated pretty well by the constant resistance R_1 and the constant conductance G_1' of Figs. 12 and 13, respectively, as pointed out in Appendix B.

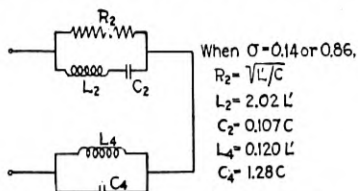

Fig. 18—Resistance-Simulator for a Loaded Line Terminating at σ -Section, with σ about 0.14 or about 0.86

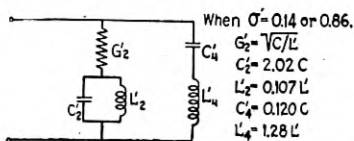

Fig. 19—Conductance-Simulator for a Loaded Line Terminating at σ' -load, with σ' about 0.14 or about 0.86

Simulation of the σ -section resistance and of the σ' -load conductance can be accomplished over a substantially wider frequency-range than in the foregoing paragraph, by means of the networks of Figs. 18 and 19, respectively; for them the best value of σ and of σ' is about 0.14.

These networks must not be confused with those of Figs. 14 and 15: they are like the latter in form but differ in the values of certain of their elements, as will be seen on close examination; they differ also in their functions, the networks of Figs. 14 and 15 simulating the σ -section impedance and the σ' -load admittance, respectively, whereas the networks of Figs. 18 and 19 simulate merely the resistance and the conductance components of these, respectively. In Fig. 18 the reactance of the L_4C_4 -portion neutralizes that of the $R_2L_2C_2$ -portion; and in Fig. 19 the susceptance of the $L_4'C_4'$ -portion neutralizes that of the $G_2'C_2'L_2'$ -portion. (See also Patent No. 1167693 and No. 1437422, respectively.)

By combining the resistance-simulator of Fig. 18 and the reactance-simulator of Fig. 16 there results the impedance-simulator of Fig. 20.

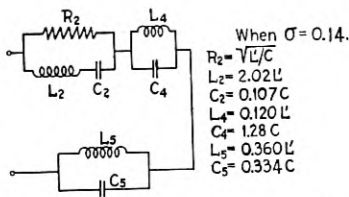

Fig. 20—Impedance-Simulator for a Loaded Line Terminating at σ -Section, with σ about 0.14. (This figure indicates the synthesis of the network in Fig. 14.)

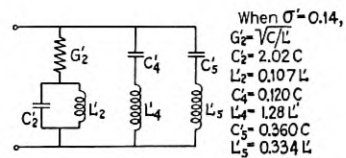

Fig. 21—Admittance-Simulator for a Loaded Line Terminating at σ' -Load, with σ' about 0.14. (This figure indicates the synthesis of the network in Fig. 15.)

But it is found that the L_4C_4 -portion and the L_5C_5 -portion can be combined, without appreciable sacrifice of simulative precision, into the single L_3C_3 -portion of Fig. 14—whose synthesis is thereby indicated. (See also Patent No. 1167693.)

By combining the conductance-simulator of Fig. 19 and the susceptance-simulator of Fig. 17 there results the admittance-simulator of Fig. 21. But it is found that the $L_4'C_4'$ -portion and the $L_5'C_5'$ -portion can be combined, without appreciable sacrifice of simulative precision, into the single $L_3'C_3'$ -portion of Fig. 15—whose synthesis is thereby indicated. (See also Patent No. 1437422.)

PART VI

NETWORKS FOR NON-DISSIPATIVE LOADED LINES WITH DISTRIBUTED INDUCTANCE

From the latter portion of Part III it will be recalled that the approximate effect of small distributed inductance is to alter slightly

the nominal impedance and the critical frequency of the loaded line without much affecting the relative impedance when expressed as a function of the relative frequency, over the first transmitting band and the lower part of the succeeding attenuating band. Thus an approximate way of taking account of the effects of small distributed inductance is to deal with the constants L_0' and C_0 of the corresponding "principal simulative loaded line"; since this line has no distributed inductance it is seen that the networks described in Part V for loaded lines without distributed inductance are adequate for loaded lines with small distributed inductance; the design-formulas remain unchanged beyond substituting L_0' for L' and C_0 for C ; however, the simulative precision of the networks is altered slightly.

A slightly better approximation may be secured by working not only with L_0' and C_0 but also with fictitious values of σ and σ' , say σ_0 and σ_0' , slightly different from those which would be best if there were no distributed inductance.

Owing to the presence of a certain amount of distributed inductance in all transmission lines (even in cables), simulation of the σ' -load impedance ($\sigma' > \sigma_b'$) by means of a fractional-load (σ_b') type of basic network built out to σ' -load is slightly more precise than simulation of the σ -section impedance ($\sigma = \sigma'$) by means of a fractional-section (σ_b) type of basic network built out to σ -section. This is evident from the latter portion of Part III of this paper.

(Regarding the effects of small distributed inductance in loaded lines, Patent No. 1167693 may be of some interest.)

PART VII

NETWORKS FOR DISSIPATIVE LOADED LINES

A natural first-approximation network for simulating the impedance of a dissipative loaded line is the network for the corresponding non-dissipative loaded line, the excess impedance thus being neglected; in the case of a high grade loaded line this is a good approximation except at very low frequencies. Various forms and types of networks for non-dissipative loaded lines having the basic relative terminations were described in Parts V and VI; those networks ("basic networks") can be built-out readily to any relative terminations by means of simple non-dissipative building-out structures.

When the excess impedance of the loaded line is not negligible an excess-simulator is required. A first-approximation excess-simulator for a loaded line is the excess-simulator for the corresponding

smooth line.¹ This is a good approximation over about the lower half or two-thirds of the transmitting band; but to be adequate in the upper part of the transmitting band it requires some modification in its proportioning or even in its form, according to several circumstances, such as the relative termination, the amount and distribution of the dissipation, and the ratio of the highest contemplated frequency to the critical frequency. The immediate neighborhood of the critical frequency is here disregarded, as having thus far been unimportant in practice; modification of the networks to extend their range of simulation right up to the critical frequency appears to present much greater difficulties.

PART VIII

APPLICATIONS OF THE SIMULATING AND THE COMPENSATING NETWORKS

In this Part a considerable number of applications of the above-described networks will be outlined. (For some details and further applications, reference may be made to the patents cited in Part V—namely, Patent No. 1124904, No. 1167693, and No. 1437422, pertaining to the simulating networks; and No. 1243066 and No. 1475997 pertaining to the compensating networks.)

Applications of the Simulating Networks

Foremost of the uses of the simulating networks is their employment for balancing purposes in connection with 22-type repeaters, already spoken of in the Introduction.

Another application of a simulating network is for terminating an actual loaded line in the field or an artificial loaded line in the laboratory in such a way as to avoid reflection effects. For this purpose the proper terminating impedance is evidently one equal to the complementary characteristic impedance of the loaded line. Such a terminating impedance is often needed in the making of electrical tests or electrical measurements on a loaded line.

Furthermore, in making certain tests on apparatus normally associated with a loaded line, such line may be represented conveniently by the appropriate simulating network.

Applications of the Compensating Networks

The compensating networks have a wide variety of uses as neutralizing networks and also as simulating networks. These uses depend

mainly on the fact that a compensating network when used as a neutralizer enables the impedance of a loaded line to simulate approximately the impedance of a smooth line and hence to simulate at least roughly a constant resistance, and when used as a simulator enables the impedance of a smooth line to simulate approximately the impedance of a loaded line.

Foremost of the uses of the compensating networks is their employment for properly connecting together a loaded line and a smooth line, to reduce reflection effects at the junction. This may be accomplished either by means of the reactance compensator (Fig. 16) or by means of the susceptance compensator (Fig. 17) by adopting a suitable relative termination for the loaded line in each method. In describing these two methods, it will be assumed at first that the loaded line and the smooth line are non-dissipative and have equal nominal impedances. In the first method of compensation the loaded line is terminated at σ -section with σ in the neighborhood of 0.8, where its curve of characteristic resistance is nearly flat; and a reactance-compensator (Fig. 16) is inserted in series between the two lines. This compensator, by neutralizing the reactance of the given loaded line, makes that line appear like a smooth line; while, by simulating the complementary characteristic reactance of the loaded line, it makes the smooth line appear complementary to the given loaded line. In the second method of compensation the loaded line is terminated at σ' -load with σ' in the neighborhood of 0.8, where its curve of characteristic conductance is nearly flat; and a susceptance-compensator (Fig. 17) is inserted in shunt between the two lines at their junction. This compensator, by neutralizing the susceptance of the given loaded line, makes that like appear like a smooth line; while, by simulating the characteristic susceptance of the complementary loaded line, it makes the smooth line appear complementary to the given loaded line.

When, as actually, the lines are dissipative, the compensator continues to make the loaded line appear approximately like a smooth line, and to make the smooth line appear approximately like a loaded line; but now, unless the lines happen to be about equally dissipative, there will exist at their junction an irregularity arising chiefly from inequality in their "excess-impedances." This irregularity can be largely prevented from occurring when the gage of either or both of the lines is at the disposal of the designer; when this is not the case and the irregularity is seriously large, resort may be had to special equalizers termed "excess-impedance equalizers."

When the nominal impedances of the two lines are unequal, adjustment in that respect can be made by means of a transformer of suitable ratio.

Some other uses for the compensators are as follows: (a) to properly connect a loaded line to a repeater system whose impedance is nearly constant resistance; (b) to connect a loaded line type of filter (low-pass filter) to an amplifying element whose impedance is nearly constant resistance; (c) to connect a loaded line to terminal apparatus whose impedance is nearly constant resistance; (d) to convert the impedance of a loaded line to that of the corresponding smooth line and thereby enable it to be simulated (or to be balanced) by a smooth-line type of simulating network; (e) to convert the impedance of a smooth line to that of a loaded line and thereby enable it to be simulated (or to be balanced) by a loaded-line type of simulating network; (f) to neutralize the characteristic reactance of an approximately non-dissipative loaded line, thereby enabling the resulting nearly pure resistance impedance to be closely simulated (or to be closely balanced) by the network (Fig. 18) simulating the characteristic resistance of the loaded line; or—though somewhat less closely—by a mere resistance element; (g) to neutralize the characteristic susceptance of an approximately non-dissipative loaded line, thereby enabling the resulting nearly pure conductance admittance to be closely simulated (or to be closely balanced) by the network (Fig. 19) simulating the characteristic conductance of the loaded line; or—though somewhat less closely—by a mere conductance element.

In applications (a), (b), (c) the irregularity at the junction can be still further reduced by the addition of an excess simulator for simulating the excess impedance of the loaded line.

APPENDIX A

THE TRANSMITTING AND THE ATTENUATING BANDS OF A NON-DISSIPATIVE LOADED LINE WITH DISTRIBUTED INDUCTANCE

This Appendix contains the derivations of the formulas in Part III pertaining to the disposition of the transmitting and the attenuating bands; and also several alternative formulas; it outlines six graphical methods for studying the bands; and it discusses, more comprehensively than in the body of the paper, the salient properties of the bands and the effects produced by varying certain of the parameters.

Disposition of the Transmitting and the Attenuating Bands

The propagation constant $\Gamma = A + iB$ of a non-dissipative loaded line (per periodic interval) can be expressed in terms of $\lambda = L/L'$ and the quantity D defined by equation (16). From Appendix D,

$$\cosh \Gamma = \cos 2D - \frac{D}{\lambda} \sin 2D, \tag{1-A}$$

$$\sinh^2 \Gamma = (\sin^2 2D)(D \tan D - \lambda)(D \cot D + \lambda)/\lambda^2 \tag{2-A}$$

$$= (\sin^2 2D)(D^2 - \lambda^2 - 2\lambda D \cot 2D)/\lambda^2 \tag{3-A}$$

$$= (-\sin^2 2D)(1 + 1/\lambda)Z_s'^2. \tag{3.1-A}$$

Thus, for a non-dissipative loaded line, $\cosh \Gamma$ and $\sinh^2 \Gamma$ are both pure real.

When $\cosh \Gamma$ is known, A and B can be evaluated by means of the identity

$$\cosh \Gamma = \cosh (A + iB) = \cosh A \cos B + i \sinh A \sin B. \tag{4-A}$$

In particular, when $\cosh \Gamma$ is pure real—as for a non-dissipative loaded line—the values of A and B must evidently be such as to satisfy the pair of equations

$$\sinh A \sin B = 0, \tag{5-A} \quad \cosh A \cos B = \cosh \Gamma; \tag{6-A}$$

with, of course, the added restriction that A must be real and positive, and B real. Thence it is readily found that:

$$\begin{aligned} \text{When } \cosh^2 \Gamma < 1, \text{ that is, } \sinh^2 \Gamma < 0, \\ \text{then } A = 0 \text{ and } B = \cos^{-1} \cosh \Gamma; \end{aligned} \tag{7-A}$$

$$\begin{aligned} \text{When } \cosh^2 \Gamma > 1, \text{ that is, } \sinh^2 \Gamma > 0, \\ \text{then } A = \cosh^{-1} |\cosh \Gamma| \text{ and } B = q\pi; \end{aligned} \tag{8-A}$$

$\cosh \Gamma$ being real, and q being an even or an odd integer according as $\cosh \Gamma$ is positive or negative, respectively.

Before continuing with the general case ($\lambda \neq 0$) it seems worth while to digress long enough to apply the preceding general formulas to the limiting case where $\lambda = 0$. For it, formula (1-A) reduces to

$$\cosh \Gamma = 1 - 2r^2, \tag{9-A}$$

where $r = f/f_c = D/D_c$, and f_c is given by (3). Application of (7-A) and (8-A) to (9-A) shows that:

$$\text{When } 0 < r < 1, \text{ then } A = 0 \text{ and } B = 2 \sin^{-1} r; \tag{10-A}$$

$$\text{When } r > 1, \text{ then } A = 2 \cosh^{-1} r \text{ and } B = q\pi, \tag{11-A}$$

where q is an odd integer.

For illustrative purposes, Fig. 22 gives graphs of A and B throughout the first transmitting band ($0 < r < 1$) and part of the succeeding attenuating band, for a non-dissipative loaded line, with $\lambda=0$ and with $\lambda=0.12$. Of course, A is zero in the range $0 < r < 1$.

Returning now to the general case ($\lambda \neq 0$), we see that the transmitting bands ($A=0$) are characterized by the inequality $\sinh^2 \Gamma < 0$,

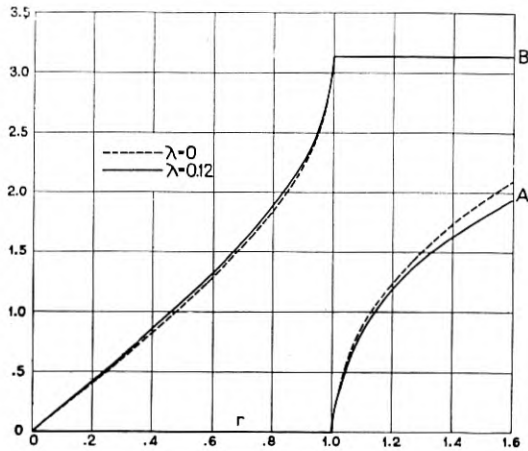

Fig. 22—Propagation Constant $\Gamma=A+iB$ in the First Transmitting Band ($0 < r < 1$) and in Part of the Succeeding Attenuating Band, of a Non-Dissipative Loaded Line with $\lambda=0$ and with $\lambda=0.12$

and the attenuating bands ($A \neq 0$) by the inequality $\sinh^2 \Gamma > 0$; and hence the transition points between the two kinds of bands are characterized by the equation $\sinh^2 \Gamma = 0$.

We seek the transition values of D , that is, the values of D where $\sinh^2 \Gamma = 0$; and we seek the transmitting and the attenuating ranges of D , that is, the ranges of D where $\sinh^2 \Gamma < 0$ and $\sinh^2 \Gamma > 0$, respectively.

The transition values of D are perhaps most readily found from the equation for $\sinh^2 \Gamma$ when written in the form (2-A). They are the zeros of the first three factors in the right-hand member of that equation. The zeros of the factor $\sin^2 2D$ are at $D = m\pi/2$, with $m=0, 1, 2, 3, \dots$; thus they subdivide the D -scale into segments of width $\pi/2$ each, as represented by Fig. 6; and they have the values represented by (18). The zeros of the factors $D \tan D - \lambda$ and $D \cot D + \lambda$ are situated in the odd and even numbered segments, respectively, because, λ is positive; there is one and only one zero in each

segment. Thus, if D_n denotes the zero of $\sinh^2\Gamma$ situated in the n th segment, then

$$(n-1)\frac{\pi}{2} < D_n < n\frac{\pi}{2}. \tag{12-A}$$

Either analytically or graphically it is readily seen that, when λ is small, D_n is only slightly greater than $(n-1)\pi/2$; it approaches that value as a limit when n approaches infinity, for all finite values of λ . The power series formula (21) for D_n is derived at a little later point in this Appendix.

Formulated analytically, with the arguments of the trigonometric functions reduced to the smallest positive values that preserve the values of the functions, the transition values of D are the values of $D_{n,n+1}$ and D_n satisfying the equations

$$\sin^2 2\left(D_{n,n+1} - n\frac{\pi}{2}\right) = 0, \tag{13-A}$$

$$D_n \tan\left(D_n - [n-1]\frac{\pi}{2}\right) = \lambda, \tag{14-A}$$

with $n=0, 1, 2, 3, \dots$ in (13-A) and $n=1, 2, 3, \dots$ in (14-A). Equation (13-A) is equivalent to $\sin^2 2D=0$. With n odd and with n even, (14-A) is equivalent respectively to $D \tan D - \lambda = 0$ and to $D \cot D + \lambda = 0$. An equivalent of (14-A) is obtainable from the second factor of (3-A). By (3.1-A), still another equivalent is $Z'_{.5} = 0$; that is, the values of D_n are the zeros of the mid-load relative impedance $Z'_{.5}$, and hence of the mid-load impedance $K'_{.5}$.

With $(n-1)\pi/2$ denoted by d_n , equation (14-A) shows that

$$D_n - d_n < \lambda/d_n, \quad (n=2, 3, 4, \dots) \qquad D_1 < \sqrt{\lambda}.$$

By inspection of (2-A) it can be readily verified that $\sinh^2\Gamma$ is negative when $D_{n-1,n} < D < D_n$ and positive when $D_n < D < D_{n,n+1}$; and hence that these two ranges of D are a transmitting band and an attenuating band, respectively, the corresponding compound band thus being the range $D_{n-1,n} < D < D_{n,n+1}$. In this connection it may be of some academic interest to note that, strictly speaking, $D=0$ is not a transition value of D between a transmitting and an attenuating band. For (2-A) shows that $\sinh^2\Gamma$ does not change sign when D passes through 0; on the contrary, $\sinh^2\Gamma$ is entirely unchanged when D is changed to $-D$. Thus, $D=0$ is a point of symmetry, but not a transition point.

The values of D_n , namely, the roots of (14-A), cannot be written down directly or expressed exactly. But they can be found to any

desired degree of approximation by first developing the left side of (14-A) into a power series involving D_n ; and then, by successive approximation or by undetermined coefficients, solving the resulting equation so as to express D_n as a power series in λ (that is, "reverting" the first series to obtain the second).

Digression on the Reversion of Power Series

Since there will be several occasions here for reverting a power series it seems worth while to digress sufficiently to furnish the requisite general formulas for the reversion of power series:⁸

Given $y = F(x)$ developed as a convergent power series in x ,

$$y = x + a_2x^2 + a_3x^3 + a_4x^4 + \dots \quad (15-A)$$

The coefficient of x has been assumed to be unity because the formulation of the reversion is much simplified thereby without any real sacrifice of generality; for, if the coefficient of x were a_1 , the equation could be reduced immediately to the form (15-A), either by treating a_1x as the independent variable, or by dividing through by a_1 and then treating y/a_1 as the dependent variable.

The given equation (15-A) expresses y as a power series in x . It is required to revert this relation, that is, to express x as a power series in y . In the present work this was done originally by successive approximation, and was verified later by the method of undetermined coefficients. Evidently the first approximation to the solution of (15-A) is merely $x_1 = y$, and thence the second approximation is $x_2 = y - a_2x_1^2 = y - a_2y^2$. But the higher approximations cannot be written down thus directly; indeed the labor of obtaining them increases rapidly. The work was carried through the sixth approximation, with the result:

$$\begin{aligned} x = & y + (-a_2)y^2 + (2a_2^2 - a_3)y^3 + (-5a_2^3 + 5a_2a_3 - a_4)y^4 \\ & + (14a_2^4 - 21a_2^2a_3 + 6a_2a_4 + 3a_3^2 - a_5)y^5 \\ & + (-42a_2^5 + 84a_2^3a_3 - 28a_2^2a_4 - 28a_2a_3^2 + 7a_2a_5 + 7a_3a_4 - a_6)y^6 + \dots \quad (16-A) \end{aligned}$$

⁸ Cf., for instance, Bromwich, "Theory of Infinite Series"; Goursat-Hedrick, "Mathematical Analysis"; Wilson, "Advanced Calculus"; Chrystal, "Text Book of Algebra." But in none of these references is the reversion carried far enough; moreover, the formulas there obtained do not apply directly to a series containing only even powers—one of the cases in the present application. At considerable labor, by two independent methods, I remedied both of these lacks. Somewhat later I came upon a valuable article by C. E. Van Orstrand, "The Reversion of Power Series" (*Phil. Mag.*, March, 1910), where the reversion is carried to no less than thirteen terms, but is not directly applicable to series containing only even powers.

This was verified by the method of undetermined coefficients, consisting in assuming

$$x = y + b_2y^2 + b_3y^3 + b_4y^4 + \dots$$

and then substituting this expression for x into (15-A) to evaluate the b 's by treating the resulting equation as an identity.

In the degenerate case where only even powers of x are present in (15-A) the formula (16-A) when applied directly does not correctly express the solution (for reasons appearing below). However, the given equation, containing only even powers of x , say

$$y = x^2 + c_2x^4 + c_3x^6 + c_4x^8 + \dots, \tag{17-A}$$

can be correctly solved for (x^2) by direct application of (16-A), with $a_s = c_s$; and then the value of x can be expressed as a power series in y by extracting the square root of the power series representing (x^2). In that way the solution of (17-A) was found to be

$$\begin{aligned} \frac{x}{\sqrt{y}} = & 1 + \left(-\frac{1}{2}c_2\right)y + \left(\frac{7}{8}c_2^2 - \frac{1}{2}c_3\right)y^2 + \left(-\frac{33}{16}c_2^3 + \frac{9}{4}c_2c_3 - \frac{1}{2}c_4\right)y^3 \\ & + \left(\frac{715}{128}c_2^4 - \frac{143}{16}c_2^2c_3 + \frac{11}{4}c_2c_4 + \frac{11}{8}c_3^2 - \frac{1}{2}c_5\right)y^4 + \left(-\frac{4199}{256}c_2^5 \right. \\ & \left. + \frac{1105}{32}c_2^3c_3 - \frac{195}{16}c_2^2c_4 - \frac{195}{16}c_2c_3^2 + \frac{13}{4}c_2c_5 + \frac{13}{4}c_3c_4 - \frac{1}{2}c_6\right)y^5 + \dots \tag{18-A} \end{aligned}$$

This result was verified by the method of undetermined coefficients, by writing x in the form

$$x = \sqrt{y} (1 + e_1y + e_2y^2 + e_3y^3 + \dots) \tag{18.1-A}$$

and then evaluating the e 's by substituting (18.1-A) into (17-A). Still another method would be to extract the square root of (17-A) as the first step, thereby expressing \sqrt{y} as a power series in x of the form (15-A); and then reverting by application of (16-A), thereby expressing x as a power series in \sqrt{y} and thence of the form (18.1-A).

For use in this connection it may be noted that the square root of a power series having the form

$$y^2 = 1 + h_1x + h_2x^2 + h_3x^3 + \dots$$

will be of the form

$$y = 1 + k_1x + k_2x^2 + k_3x^3 + \dots$$

The k 's can be evaluated by identifying the first equation with the square of the second; their values are found to be

$$\begin{aligned} k_1 = \frac{1}{2}h_1, \quad k_2 = \frac{1}{2}h_2 - \frac{1}{2}k_1^2, \quad k_3 = \frac{1}{2}h_3 - k_1k_2, \\ k_4 = \frac{1}{2}h_4 - \frac{1}{2}k_2^2 - k_1k_3, \quad k_5 = \frac{1}{2}h_5 - k_1k_4 - k_2k_3, \\ k_6 = \frac{1}{2}h_6 - \frac{1}{2}k_3^2 - k_1k_5 - k_2k_4. \end{aligned}$$

Derivations of Formulas for the Transition Points

The above general formulas for the reversion of power series will now be applied in the derivation of the formulas (21) and (22) for D_n and D_1 , in the body of the paper; and also in the derivation of certain other formulas, not included there.

To outline the derivation of the formula (21) for D_n , denote $(n-1)\pi/2$ by d_n and $D_n - d_n$ by τ_n , so that (14-A) becomes

$$(d_n + \tau_n) \tan \tau_n = \lambda. \quad (19-A)$$

Now replace $\tan \tau_n$ by its known power series expression, and divide both sides of the resulting equation by d_n ; thus (19-A) becomes

$$\frac{\lambda}{d_n} = \tau_n + \frac{1}{d_n} \tau_n^2 + \frac{1}{3} \tau_n^3 + \frac{1}{3d_n} \tau_n^4 + \frac{2}{15} \tau_n^5 + \frac{2}{15d_n} \tau_n^6 + \dots \quad (20-A)$$

This is of the form (15-A), and hence can be reverted by direct application of (16-A); the result is (21).

An alternative formula for D_n can be obtained by starting from Gregory's series,

$$v = \tan v - \frac{\tan^3 v}{3} + \frac{\tan^5 v}{5} - \frac{\tan^7 v}{7} + \dots \quad (20.1-A)$$

Application of this to (19-A) enables the left side of that equation to be expressed as a power series in $\tan \tau_n$; and when the resulting equation is reverted by means of (16-A) and then τ_n replaced by $D_n - d_n$ the result is

$$\begin{aligned} \tan (D_n - d_n) &= \frac{\lambda}{d_n} - \frac{1}{d_n} \left(\frac{\lambda}{d_n} \right)^2 + \frac{2}{d_n^2} \left(\frac{\lambda}{d_n} \right)^3 - \left(\frac{5}{d_n^3} - \frac{1}{3d_n} \right) \left(\frac{\lambda}{d_n} \right)^4 \\ &+ \left(\frac{14}{d_n^4} - \frac{2}{d_n^2} \right) \left(\frac{\lambda}{d_n} \right)^5 - \left(\frac{42}{d_n^5} - \frac{28}{3d_n^3} + \frac{1}{5d_n} \right) \left(\frac{\lambda}{d_n} \right)^6 + \dots \quad (20.2-A) \end{aligned}$$

It has already been noted that (21) is not valid for $n=1$ and hence does not include the formula (22) for D_1 . To obtain this formula for D_1 , start with the equation

$$D_1 \tan D_1 = \lambda, \quad (21-A)$$

obtained by setting $n=1$ in (14-A). Then replace $\tan D_1$ by its known power series expansion, thus obtaining the equation

$$\lambda = D_1^2 + \frac{1}{3} D_1^4 + \frac{2}{15} D_1^6 + \frac{17}{315} D_1^8 + \frac{62}{2835} D_1^{10} + \frac{1382}{155925} D_1^{12} + \dots \quad (22-A)$$

This is of the form (17-A), and hence can be reverted by direct application of (18-A); the result is (22).

It may be noted that (22-A), when regarded as a power series in (D_1^2), is of the form (15-A) and hence that (D_1^2) can be expressed as a power series in λ by direct application of (16-A); the result is⁷

$$D_1^2 = \lambda - \frac{\lambda^2}{3} + \frac{4\lambda^3}{45} - \frac{16\lambda^4}{945} + \frac{16\lambda^5}{14175} + \frac{64\lambda^6}{93555} \dots \dots \quad (23-A)$$

In certain applications this formula for D_1^2 is more useful than formula (22) for D_1 ; though the two are ultimately equivalent. A formula for p^2 is obtainable by dividing both sides of (23-A) by λ ; for $p^2 = D_1^2/\lambda$, by (16).

An alternative formula for D_1 can be obtained by starting from Gregory's series (20.1-A). Application of this to (21-A) enables the left side of that equation to be expressed as a power series in $\tan D_1$; and when the resulting equation is reverted by means of (18-A) the result is⁷

$$\tan D_1 = \sqrt{\lambda} \left(1 + \frac{\lambda}{6} - \frac{\lambda^2}{360} - \frac{11\lambda^3}{5040} + \frac{1357\lambda^4}{1814400} \dots \dots \right). \quad (23.1-A)$$

Series that are even more convergent than (21) and (22), though much less simple, can be obtained by expanding the original function in the neighborhood of a value of the variable known to be an approximate solution of the equation to be solved, and then reverting the resulting series. To formulate the procedure analytically and generally, let u denote the variable, and $\psi(u)$ the function; and let the equation to be solved for u be

$$\psi(u) = q. \quad (24-A)$$

Then, if U is an approximate solution of this equation, application of Taylor's theorem leads to the following implicit equation for $u - U$:

$$\frac{q - \psi(U)}{\psi'(U)} = (u - U) + \frac{(u - U)^2}{2!} \frac{\psi''(U)}{\psi'(U)} + \frac{(u - U)^3}{3!} \frac{\psi'''(U)}{\psi'(U)} + \dots \dots \quad (25-A)$$

The left side of this is known. The right side is a power series in $u - U$, with U known; the better the approximation represented by U , the more rapidly convergent is the series. This equation (25-A) in $u - U$ is of the form (15-A), with

$$y = \frac{q - \psi(U)}{\psi'(U)}, \quad x = u - U, \quad a_s = \frac{\psi^{(s)}(U)}{s! \psi'(U)}; \quad (26-A)$$

and thence (25-A) can be reverted by application of (16-A). so that $u - U$ will be expressed as a power series in $[q - \psi(U)]/\psi'(U)$.

To apply the above general method in order to obtain for D_n a series more convergent than (21), return to (19-A) and note that when λ is small a first approximation for τ_n is $\tau_n = \lambda/d_n$. Then apply (16-A), with y , x , and a_s having the values expressed by (26-A); and $q = \lambda$, $u = \tau_n$, $U = \lambda/d_n$, and $\psi(u) = (u + d_n) \tan u$. The formulas for the first few successive derivatives of $\psi(u)$ will be needed, of course.

Similarly, to obtain for D_1 a series more convergent than (22), return to (21-A) and note that when λ is small a first approximation for D_1 is $D_1 = \sqrt{\lambda}$. Then apply (16-A), with y , x , and a_s having the values expressed by (26-A); and $q = \lambda$, $u = D_1$, $U = \sqrt{\lambda}$, and $\psi(u) = u \tan u$.

Graphical Methods for Locating the Transition Points

The positions of the transition points D_n ($n = 1, 2, 3, \dots$) on the D -scale can be determined also graphically, in several different ways corresponding to several different ways of writing the function $(D \tan D - \lambda)(D \cot D + \lambda)$ whose zeros are the values of D_n . To formulate such graphical methods concisely, let E denote any function of the variable D , so that, geometrically, E is the ordinate corresponding to the abscissa D . Six of the various possible graphical methods are then briefly but completely indicated by the following respective statements that the points D_n are the abscissas of the points of intersection of:

1. The horizontal straight line $E = \lambda$ with the curves $E = D \tan D$; the horizontal straight line $E = -\lambda$ with the curves $E = D \cot D$.
2. The straight line $E = D$ with the curves $E = \lambda \cot D$; the straight line $E = -D$ with the curves $E = \lambda \tan D$.
3. The straight line $E = D/\lambda$ with the cotangent curves $E = \cot D$; the straight line $E = -D/\lambda$ with the tangent curves $E = \tan D$.
4. The hyperbola $E = \lambda/D$ with the tangent curves $E = \tan D$; the hyperbola $E = -\lambda/D$ with the cotangent curves $E = \cot D$.
5. The parabola $E = D^2/\lambda - \lambda$ with the curves $E = 2D \cot 2D$.
6. The curve $E = D/2\lambda - \lambda/2D$, compounded of the straight line $E = D/2\lambda$ and the hyperbola $E = -\lambda/2D$, with the cotangent curves $E = \cot 2D$.

In methods 1, 2, 3, 4, the first set of intersections is situated in the odd-numbered segments, the second set in the even numbered segments; each segment of width $\pi/2$.

Besides being susceptible of quantitative service, these graphical methods are useful for qualitative purposes. For instance, they show

clearly that: one and only one transition value of D lies within each segment of width $\pi/2$; $\sinh^2\Gamma < 0$ when $D_{n-1,n} < D < D_n$, and $\sinh^2\Gamma > 0$ when $D_n < D < D_{n,n+1}$; the zeros of $\lambda - D \tan D$ and of $\lambda + D \cot D$ are situated in the odd and even numbered segments, respectively; with increasing D , the transmitting bands continually decrease in width and the attenuating bands continually increase in width, the change taking place rapidly at first and then more and more slowly; the mid-point relative impedances are pure imaginary throughout every attenuating band and pure real throughout every transmitting band, and, they have the ranges stated in the third and fourth paragraphs following equation (26.1). The graphical methods are useful also for showing the nature of the effects produced by varying the parameter λ .

Discussion of the Disposition of the Bands

The rest of this Appendix will be devoted to a discussion of the most salient properties of the compound bands and their constituent transmitting and attenuating bands.

The ratio of transmitting band width to compound band width continually decreases with increasing D and becomes zero when D becomes infinite; that is, the transmitting bands vanish and the compound bands become pure attenuating bands. These facts can be seen graphically, or analytically from equation (14-A).

The ratio of transmitting band width to compound band width continually increases with increasing λ ; this ratio ranging from zero when λ is zero to unity when λ is infinite. These facts can be seen graphically, or from equation (14-A). When λ approaches zero the f -width of each compound band approaches infinity; the f -width of each transmitting band approaches zero, except for the first transmitting band, whose width approaches a value equal to $f'_1 = f'_c$ —for equation (14-A) shows that $D_n(D_n - D_{n-1,n})/\lambda$ approaches unity, and hence that $f_n(f_n - f_{n-1,n})$ approaches $1/\pi^2 L'C = f'_1{}^2$, whence $f_n - f_{n-1,n}$ approaches zero for $n \neq 1$ and approaches f'_1 for $n = 1$.

The effects of varying the parameter λ will now be outlined briefly, in the next two paragraphs, for the cases respectively of $L'C$ fixed and LC fixed. The conclusions reached depend partly on the equation $D = \frac{1}{2}\omega\sqrt{LC} = \frac{1}{2}\omega\sqrt{\lambda L'C}$ defining D ; partly on the fact already deduced that the D -width of each compound band is an absolute constant ($\pi/2$); and partly on equation (14-A).

When $L'C$ is fixed, increasing λ reduces all of the transition frequencies. The transition frequencies bounding the compound bands,

and hence the widths of the compound bands, decrease in direct proportion to increase of $\sqrt{\lambda}$. The internal transition frequencies, however, do not decrease so rapidly; for the ratio of transmitting band width to attenuating band width increases with increasing λ . When λ approaches infinity each compound band approaches a width of zero, but the ratio of transmitting band width to compound band width approaches unity; so that when λ becomes infinite there are within any finite frequency range an infinite number of compound bands which are pure transmitting bands. On the other hand, when λ approaches zero the compound bands approach infinite width and hence move out toward infinity, except that the left end-point of the first band is fixed at $f=0$. When λ has become zero the first compound band has expanded to an infinite width; and its critical value f_1 of f has become equal to the limiting value $f'_1=1/\pi\sqrt{L'C}$ —as can be seen from (14-A) by putting $n=1$ and then applying the relation $D/\sqrt{\lambda}=\frac{1}{2}\omega\sqrt{L'C}$.

When LC is fixed the f -widths and locations of the compound bands are independent of λ , but the widths of the constituent attenuating and transmitting bands depend on λ ; that is, the boundary points $f_{n-1,n}$ and $f_{n,n+1}$ of the n th compound band are independent of λ , but the internal transition point f_n depends on λ . With increasing λ the attenuating bands become continually narrower, and vanish when λ becomes infinite, the transmitting bands thereby coalescing to form a pure transmitting band extending from zero to infinity. With decreasing λ the transmitting bands become continually narrower, and vanish when λ becomes zero, the attenuating bands thereby coalescing to form a pure attenuating band extending from zero to infinity.

APPENDIX B

THEORETICAL BASES OF THE SIMULATING NETWORKS IN FIGS. 12 AND 13

The Impedance-Simulator in Fig. 12

This network takes advantage of the fact, depicted in Fig. 5, that the graph of the σ -section characteristic resistance of a loaded line, for values of σ in the neighborhood of 0.2, is nearly flat over most of the transmitting band and hence can be approximately simulated by a mere constant resistance chosen approximately equal to the nominal impedance $\sqrt{L'/C}$. This is the basis for the R_1 -portion of the network in Fig. 12. The basis for the L_1C_1 -portion is the fact (proved in Appendix C) that, in the transmitting band, the σ -section

characteristic reactance can be exactly simulated (for any fixed value of σ between 0 and 1/2) by the network in Fig. 16.

The Admittance-Simulator in Fig. 13

This network takes advantage of the fact, depicted in Fig. 5, that the graph of the σ' -load characteristic conductance of a loaded line, for values of σ' in the neighborhood of 0.2, is nearly flat over most of the transmitting band and hence can be approximately simulated by a mere constant conductance chosen approximately equal to the nominal admittance $\sqrt{C/L'}$. This is the basis for the G_1' -portion of the network in Fig. 13. The basis for the $L_1'C_1'$ -portion is the fact (proved in Appendix C) that, in the transmitting band, the σ' -load characteristic susceptance can be exactly simulated (for any fixed value of σ' between 0 and 1/2) by the network in Fig. 17.

APPENDIX C

DERIVATIONS OF THE DESIGN-FORMULAS FOR THE COMPENSATING NETWORKS IN FIGS. 16 AND 17

The Reactance-Compensator in Fig. 16

For any values of C_5 and L_5 the reactance T of this network is

$$T = \frac{\omega L_5}{1 - \omega^2 L_5 C_5}.$$

By equation (4) the characteristic reactance N of the loaded line within its transmitting band is

$$N = \frac{k(1 - 2\sigma)\omega/\omega_c}{1 - 4\sigma(1 - \sigma)\omega^2/\omega_c^2}.$$

Comparison of these two equations shows that T and N are of the same functional form in ω ; and that the conditions for T to be identically equal to $\pm N$ are

$$L_5 = \pm k(1 - 2\sigma)/\omega_c, \quad L_5 C_5 = 4\sigma(1 - \sigma)/\omega_c^2,$$

whence $C_5 = \pm 4\sigma(1 - \sigma)/(1 - 2\sigma)k\omega_c$,

the upper and the lower sign of \pm corresponding to the use of the compensator as a reactance-simulator and a reactance-neutralizer, respectively. These values of L_5 and C_5 are equivalent to those appearing in Fig. 16, because $k = \sqrt{L'/C}$ and $\omega_c = 2\pi f_c = 2/\sqrt{L'C}$.

For positive values of L_5 the equation for L_5 shows that $\sigma \lesssim 1/2$, corresponding to \pm ; and then the equation for C_5 shows that $\sigma \gtrsim 1$, corresponding to \pm . Hence $0 < \sigma < 1/2$ for $T = +N$, and $1/2 < \sigma < 1$ for $T = -N$.

The Susceptance-Compensator in Fig. 17

For any values of C_5' and L_5' the susceptance S' of this network is

$$S' = \frac{\omega C_5'}{1 - \omega^2 L_5' C_5'}$$

By equation (5) the characteristic susceptance Q' of the loaded line within its transmitting band is

$$Q' = \frac{h(1 - 2\sigma')\omega/\omega_c}{1 - 4\sigma'(1 - \sigma')\omega^2/\omega_c^2}$$

Thus S' and Q' are of the same functional form in ω ; and the conditions for S' to be identically equal to $\pm Q'$ are that

$$C_5' = \pm h(1 - 2\sigma')/\omega_c,$$

$$L_5' = \pm 4\sigma'(1 - \sigma')/(1 - 2\sigma')h\omega_c,$$

the upper and the lower sign of \pm corresponding to the use of the compensator as a susceptance-simulator and a susceptance-neutralizer respectively. These values of C_5' and L_5' are equivalent to those appearing in Fig. 17, because $h = \sqrt{C/L'}$ and $\omega_c = 2/\sqrt{L'C}$.

The equations for C_5' and L_5' show that $0 < \sigma' < 1/2$ for $S' = +Q'$, and that $1/2 < \sigma' < 1$ for $S' = -Q'$.

APPENDIX D

GENERAL FORMULAS FOR THE CHARACTERISTIC IMPEDANCES AND THE PROPAGATION CONSTANT OF LOADED LINES

For reference purposes this Appendix gives the general formulas for the mid-section ($\sigma = 0.5$) and mid-load ($\sigma' = 0.5$) characteristic impedances $K_{.5}$ and $K'_{.5}$ and the propagation constant Γ of a periodically loaded line (of the series type).

The symbols have the following meanings: d denotes the impedance of each load. g and γ pertain to the line before loading; g denotes the characteristic impedance, and γ denotes the propagation constant of a segment whose length is equal to the distance between adjacent loads after the line is loaded.

The formulas for the mid-section and mid-load characteristic impedances $K_{.5}$ and $K'_{.5}$ are ⁹

$$K_{.5} = g \sqrt{\frac{1 + \frac{d}{2g} \coth \frac{\gamma}{2}}{1 + \frac{d}{2g} \tanh \frac{\gamma}{2}}}, \tag{1-D}$$

$$K'_{.5} = g \sqrt{\left(1 + \frac{d}{2g} \coth \frac{\gamma}{2}\right) \left(1 + \frac{d}{2g} \tanh \frac{\gamma}{2}\right)} \tag{2-D}$$

$$= g \sqrt{1 + \frac{1}{4} \left(\frac{d}{g}\right)^2 + \frac{d}{g} \coth \gamma}. \tag{3-D}$$

Several mutually equivalent formulas for the propagation constant Γ (per periodic interval) are:

$$\cosh \Gamma = \cosh \gamma + \frac{d}{2g} \sinh \gamma, \tag{4-D}$$

$$\sinh \Gamma = \frac{K'_{.5}}{g} \sinh \gamma, \tag{5-D}$$

$$\tanh \frac{1}{2} \Gamma = \frac{K_{.5}}{g} \tanh \frac{1}{2} \gamma. \tag{6-D}$$

The sending-end impedance J of any smooth line, of characteristic impedance g_1 and total propagation constant γ_1 , whose distant end is closed through any impedance J_1 , has the formula

$$J = g_1 \frac{J_1/g_1 + \tanh \gamma_1}{1 + (J_1/g_1) \tanh \gamma_1}. \tag{7-D}$$

This enables the formula for the σ -section characteristic impedance K_σ of a loaded line to be established by starting with the formula (1-D) for the mid-section characteristic impedance $K_{.5}$.

⁹ Formulas (2-D) and (3-D) for $K'_{.5}$ and formula (4-D) for $\cosh \Gamma$ are given by G. A. Campbell in his paper on loaded lines (*Phil. Mag.*, March, 1903) cited in footnote 2.

Some Contemporary Advances in Physics—IV

By KARL K. DARROW

CLOSING THE SPECTRUM GAP BETWEEN THE INFRA-RED AND THE HERTZIAN REGIONS

AN electrical circuit having a natural oscillation-frequency anywhere below 10^8 can be constructed by anyone with suitable condensers, inductance-coils, and a few feet of wire at his disposal. It can be set into oscillation by abruptly closing it when the condenser is charged, by coupling it to an audion, or otherwise; and the waves which it radiates while oscillating can be detected and measured, at least when the frequency exceeds 10^4 . Thus it is possible to generate perceptible electromagnetic waves of frequencies up to 10^8 , and hence of wavelengths down to 3 metres, by methods that may be called *electrotechnical*. Waves shorter than 300 cm., frequencies higher than 10^8 cycles, are not easily produced by any such method; for if one uses excessively small condensers and inductance-coils in the hope of forcing the circuit-frequency much past 10^8 , or even omits coils and condensers altogether, it is found that the auxiliary apparatus, the audion, even the wires of the circuit themselves, possess capacities and inductances which can not be annulled and which hold the oscillation-frequency down. By devising oscillating systems which have scarcely any outward resemblance to the circuits of familiar experience (although a formal analogy can be established) Hertz and his successors generated electromagnetic waves of frequencies up to 10^{11} and wavelengths down to 3 mm. Beyond a certain gap there commences, near frequency 10^{12} and wavelength 0.3 mm., the far-flung spectrum of rays emitted by molecules and atoms. This interval is one of the two lacunae in the complete electromagnetic spectrum extending from 10^4 past 10^{20} cycles, which were mentioned in the preceding article of this series. Unlike the gap between the ultra-violet and the X-rays, it is not believed to be populated by rays resulting from important processes occurring within the atoms, nor do we know of any other peculiar type of radiation which should be sought within it; and perhaps the bridging of it, when finally and unquestionably achieved, will be held notable chiefly as a feat of experimental technique or a *tour de force*. On the other hand, so long as the gap remains unspanned, we can hardly dismiss the possibility that something in the order of nature may reserve one range of wavelengths for the "natural" rays resulting from atomic processes, and limit the "artificial" waves generable by electrotechnical

means to a distant range which never can be extended to overlap the other.

The advance into the lacuna from the direction of shorter waves, that is, from the spectrum of natural rays, came almost to a stop in 1911, at a wavelength between 0.3 and 0.4 mm. Rubens and von Baeyer examined the rays emitted by a mercury vapor arc in a quartz tube, operated with a comparatively high expenditure of power; they filtered the radiation through a succession of diaphragms and lenses which cut out a large fraction of the short-wave radiation, but not by any means all of it. At first they analyzed the radiation which came through with an interferometer, like the one which I shall describe in speaking of short artificial waves; the curves indicated that it consisted largely of two waves, one at 0.218 mm. and the other at 0.343 mm. Rubens in 1921 returned to the experiments, and diffracted the transmitted rays with a large-scale wire grating (the wires were a millimetre thick and a millimetre apart). This method of analyzing the radiation, in which it is spread out in a spectrum, is preferable to the other. The results were quite concordant with the earlier ones; the curves of intensity versus wavelength show maxima at 0.210 mm. and 0.325 mm., and extend out as far as 0.4 mm.¹ There is no sign that this is a definite physical limit; it is merely the point at which the rays become too feeble to produce an unmistakable deflection of the micro-radiometer. Nichols and Tear also have observed these long natural waves.

To advance into the lacuna from the region of artificial waves, it was found necessary first of all to remodel the oscillator or "doublet" by means of which Hertz had generated the first waves of this kind. The original oscillators of Hertz were rather large; some for example, consisted of pairs of metal plates 40 cm. square or pairs of spheres 30 cm. in diameter with arms projecting from each toward the other and carrying knobs several mm. or cm. in diameter; their natural frequencies were of the order 10^7 – 10^8 . Their successors were made progressively smaller, and the latest oscillators are comparatively minute—in dealing with a less exact science, one would describe them as microscopic; for Möbius before the war used a doublet of

¹ It is not necessarily to be assumed that the mercury arc is unique in sending out rays of so great a wavelength with so great an intensity; these rays may not be more intense than a black body of the same temperature as the arc would emit in this portion of its spectrum (although this interpretation would involve a rather high estimate of the arc temperature, many thousands of degrees). But if we had a black body of this temperature available, we might not be able to detect these rays because of the flood of light of higher frequencies which could not be completely deflected from the path of the long waves. Thus we are led to the paradoxical conclusion that the mercury arc may be unique not in furnishing these rays, but in not emitting so much radiation of lesser wavelengths that the rays desired cannot be isolated.

platinum cylinders each 1 mm. long² and 0.5 mm. thick, while Nichols and Tear in 1922 succeeded in making and using tungsten cylinders 0.2 mm. long and 0.2 mm. thick. To appreciate this feat it is necessary to realize that the cylinders must be sealed into a sheet of glass with both ends projecting; as they are shown in Fig. 1, which like the remaining figures (unless otherwise mentioned) comes from the work of Nichols and Tear.

In Fig. 1, the oscillator-cylinders are shown at c and c_1 ; they are sealed into the tips of hard-glass tubes T and T_1 , and project outwards

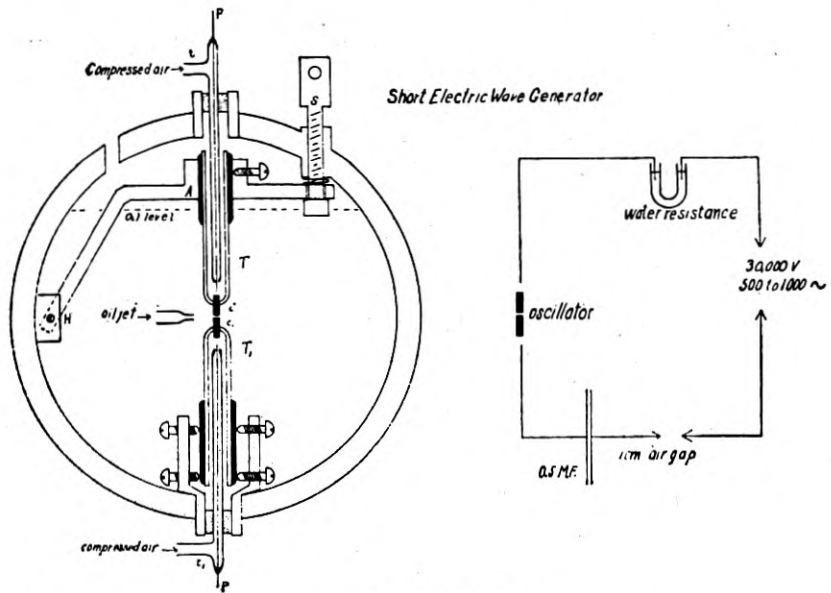

Sketch of oscillator.

Fig. 1—Diagrams of the Oscillator and the Circuit Used by Nichols and Tear. (*Physical Review*)

into kerosene oil which fills the entire cylindrical container up to the level indicated by the dashed line.³ The oscillator is excited by the voltage-impulses in the secondary of an induction-coil, resulting from

² The figure given by Möbius is 1.98 mm. (last column on p. 317, *l.c.infra*) which he says (on p. 302) applies to the *Gesamtlänge* of the doublet. Theory indicates that the wavelength of the fundamental oscillation is about twice the length of the cylinders, but the exact value of the factor is in doubt.

³ The kerosene, the "oil-jet" for keeping it circulating rapidly through the region between the cylinders and the blasts of compressed air into the tubes T and T_1 (note the spark-gaps in the leading in wires in these tubes) are all empirical devices for improving the efficiency of the apparatus.

abrupt breaks of the primary circuit produced by a mechanical interrupter at the rate of a thousand per second. Each of these voltage-impulses excites a spark between the doublet-cylinders, accompanied by a highly-damped oscillation which radiates what the authors describe as "a very short wave-train with from 60 to 80% of the energy concentrated in the first half-wavelength." This high damping is deplorable, as the waves are inconvenient to measure and must be regarded as mixtures of sine-waves of different frequencies. The gap between the cylinders is of the order 0.01–0.02 mm.; it changes rapidly and irregularly as the opposing surfaces are eaten away by

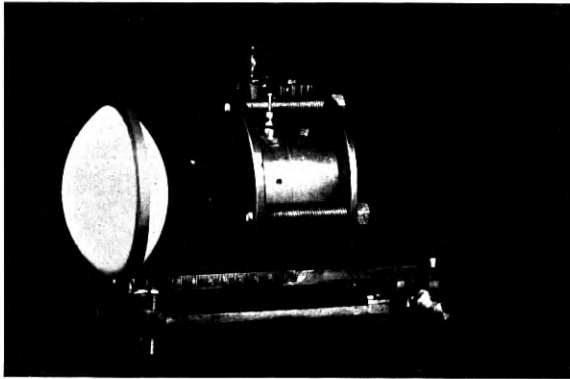

Fig. 2—Photograph of the Oscillator Used by Nichols and Tear. (*Physical Review*)

the sparks (tungsten was chosen by Nichols and Tear instead of platinum in the hope, justified by the event, of diminishing this trouble).

The rays issue through a mica window in the front of the containing-cylinder and are formed into a plane-parallel beam by an enormous double-convex paraffin lens (these objects are shown in the photograph, Fig. 2). Paraboloidal mirrors can be and have been used instead of the lens. In the sketch of Fig. 3, L_1 represents the lens; the plane-parallel beam proceeds to the mirror A and thence to the mirror B , which is really the pair of mirrors on the left-hand end of the apparatus of which Fig. 4 is a photograph. In this apparatus, the "Boltzmann interferometer," the upper mirror slides backward and forward (left to right and right to left, in the picture) along the guides, controlled by the screw; it remains always parallel to the lower and stationary mirror. Half of the plane-parallel beam falls upon each mirror, and the two reflected halves travel side by side

to the lens L_3 which merges them in a common focus at M , where the receiver stands.⁴

The intensity at M depends, by virtue of the principle of interference of periodic waves in its simplest conceivable application, on the ratio of the distance between the planes of the two mirrors to the

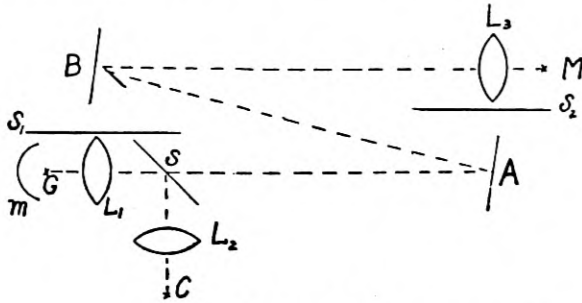

Diagram for wave-length measurements.

Fig. 3—Path of the Radiation from Oscillator to Receiver. (*Physical Review*)

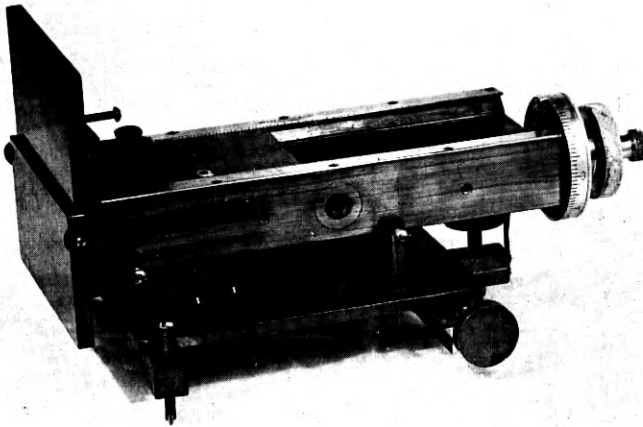

Fig. 4—Photograph of the Boltzmann Interferometer. (*Physical Review*)

wavelength of the rays. If at M there were a receiver of which the reading was perfectly proportional to the amplitude of the vibration at M and if the original wave-train were perfectly sinusoidal and

⁴ In the sketch S is a semi-transparent mirror (glass ebonite, or cardboard) which reflects a part of the beam to a lens L_2 and focus C where its intensity can be measured at the same moment as the intensity at M . The variability of the output of the source makes this control indispensable

very long, then the curve obtained by displacing the movable mirror step by step and plotting the receiver-reading against the mirror-displacement would be a perfect sine-curve; the distance between the positions of the mirror corresponding to two consecutive maxima of the curve would be half the wavelength of the wave-train. Unfortunately neither the receiver nor the wave-train is ever perfect. The wave-train is a heavily-damped sinusoid, and consequently the curve of receiver-reading versus mirror-displacement flattens out before the mirror has been moved very far. Even so, the interpretation might not be uncertain if the receiver gave a reading proportional to the time integral of the intensity of the wave-motion at M . This it rarely does.

The receiver, in this region of the spectrum, must be a thermal receiver—a short thin wire or a narrow band of sputtered metal upon a strip of insulating substance, or sometimes a wire loop. In this the

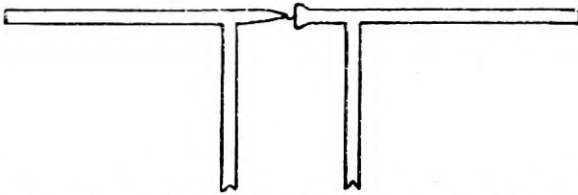

Fig. 5—Thermoelectric Receiver Used by Möbius. (*Annalen der Physik*)

incident waves induce a resonance-current, of which the Joule heat produces the directly-measured effect. A thermojunction may be intercalated in the resonant wire, as in Möbius' apparatus (Fig. 5; in the middle of the transverse piece, 14 mm. long and 0.3 mm. thick, a platinum tip is welded into a tellurium socket). Nichols and Tear, developing a method introduced by G. F. Hull, mounted the thin wire or the sputtered ribbon in front of a radiometer-vane; the Joule heat warmed the front face of the vane, and the rather mysterious agencies sometimes called "radiometer forces" came into play. Four of their receivers are shown in Fig. 6 at b , c , d , and e . In each of these sketches V_1 represents the edge of the radiometer vane; e in sketch b is a wire running from end to end of it, while e_1 , e_2 , etc., in sketches d and e are short wires mounted vertically or horizontally behind it. The mounting is shown in Fig. 6a; the vanes are seen front-face, one having its wire or wires in front and the other behind, so that the radiometer forces on both will produce torques acting in the same sense. The vanes with the cross-pieces c_1 and c_2 are mounted upon the rod q , which is suspended from a torsion-fibre;

and from the rod is suspended a mirror m to indicate the amount of twist. The air-pressure is adjusted to produce the maximum torque.

The outstanding defect of a receiver of this type is, that it imprints its own characteristics upon the data. It will not respond effectively to a wave-train not possessing a frequency agreeing closely with its

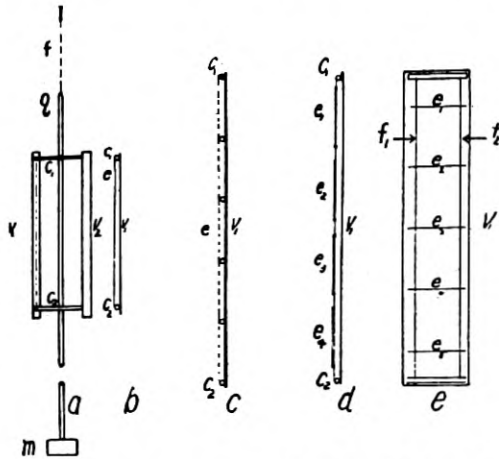

Fig. 6—Radiometer and Radiometer Vanes. Used by Nichols and Tear. (*Physical Review*)

own, or with some harmonic of its own; and has a tendency to exaggerate the apparent proportion of such frequencies in a beam which is a mixture of frequencies, as a damped wave-train is. In general, the curve of receiver-reading versus mirror-displacement is an unevenly wavy one which, when analyzed into components in Fourier's manner, is found to contain at least two frequencies, one of which is attributed to the receiver and the other to the radiation. On the other hand, if a receiver having its natural frequency far away from the expected periodicities of the waves is employed, it is found too insensitive.⁵ Worse yet, if the wave-train pursuing the path L_1ABM in Fig. 3 is a short heavily-damped one, while the natural oscillations of the receiver are of comparatively low frequency and slight decrement, the data will suggest that the wave-train is but slightly damped and has the frequency of the receiver.⁶

⁵ Thermal receivers having natural frequencies far below those of the incident beams have been employed in studying wave-trains of much greater wavelengths and much more intense than these.

⁶ This can be seen by considering an extreme case. Imagine that the wave is a single infinitely thin pulse, while the natural oscillations of the receiver are quite undamped. The pulse will be divided by the Boltzmann mirrors, so that two pulses

Clear smooth sine-like curves with the periodicity of the wave-train are obtained by using a receiver of which the natural frequency agrees with the fundamental frequency (or its octave) of the oscillator. Such curves are seen in Fig. 7; the two fundamental frequencies were

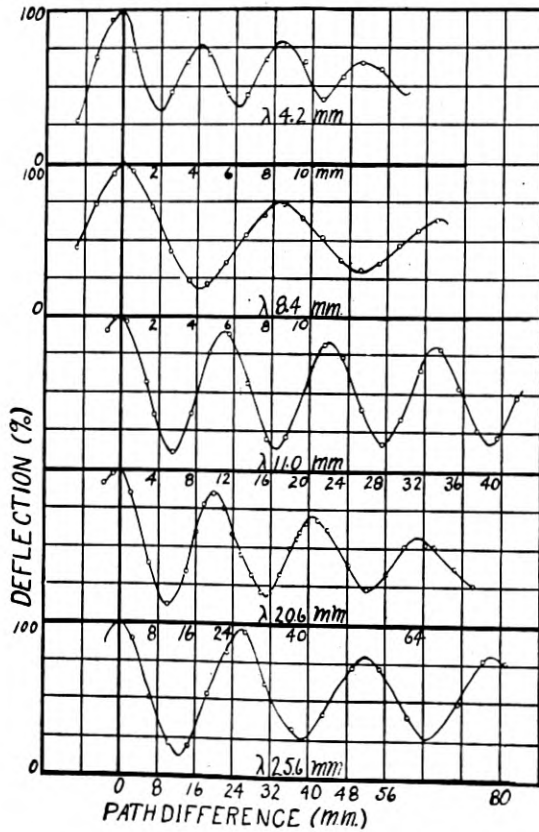

Set of curves, λ 4.2 to λ 27.

Fig. 7—Curves Obtained with a Receiver in Tune with the Oscillator (Topmost Curve with Receiver Tuned One Octave Below the Oscillator). (*Physical Review*)

will strike the receiver at a time-interval T ; there will be nothing of the nature of interference. But if T happens to be an even-integer multiple of the half-period of the receiver, the second pulse will reinforce the oscillations started by the first; if it is an odd-integer multiple of the half-period, the second pulse will annul the vibration started by the first. Thus as the Boltzmann mirror is moved along, the receiver-reading will pass through maxima and minima with a spacing imposed by the characteristics of the receiver. In actual experiment this might happen if the frequency and the damping of the wave-train were much higher than those of the natural vibration of the receiver. On the other hand it does not appear that a frequency much higher than that of the wave-train could be simulated by any effect due to the receiver—an important point, in view of what follows.

in close agreement for all except the topmost of the curves, for which the fundamental of the oscillator corresponded to wavelength 4.2 mm. and that of the receiver to wavelength 8.4 mm.

The lowest wavelength mentioned by Nichols and Tear as having been manifested and visualized in this lucid fashion is 4.2 mm.; while, replacing the two mirrors of the Boltzmann interferometer by a set of eight mirrors forming an evenly-rising staircase or echelon, they obtained curves which in one instance indicated a fundamental of

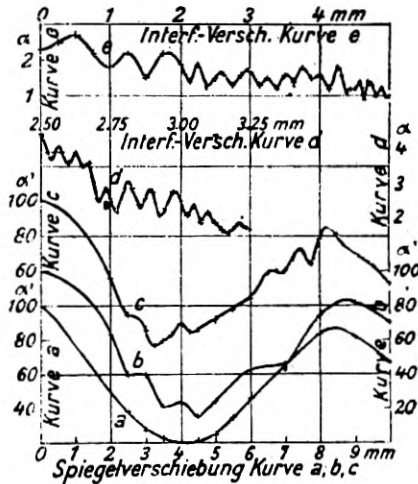
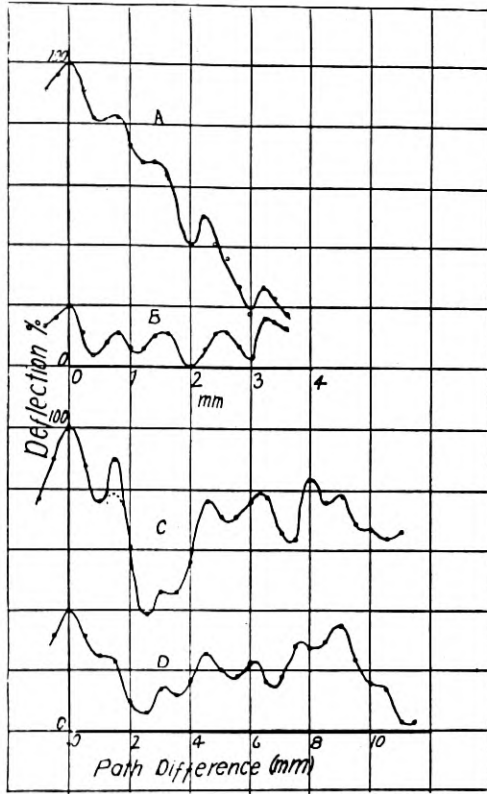

Fig. 8—Serrated Curves Indicating Very Short-Waved Components of the Wave Train. (*Annalen der Physik*)

1.8 mm. It would be a conservative, perhaps a too conservative, policy to regard this as the present limit of the spectrum of artificial electromagnetic waves.

Whether we may believe that rays lying beyond this limit have actually been generated depends upon the interpretation of certain narrow sharp serrations observed upon curves of the more uneven sort; for example, those of Fig. 8 (Möbius) and curves A and C of Fig. 9 (Nichols and Tear). If these are reliable indices of waves of corresponding wavelength in the mixed radiation from the oscillator, the frequencies in question must be considerably higher than the fundamental frequencies of the oscillators heretofore made; wavelengths ranging down to 0.1 mm., corresponding to frequencies ranging up to $3 \cdot 10^{12}$, have been inferred from such curves. If these are overtones emitted by the oscillator along with its fundamental, there would be little objection to extending the spectrum to cover them (although

it would be equivalent to considering a tenor's range as extending to the highest overtone which could be detected in any of his notes, which would certainly lead to astonishing results). Or they may be radiated by oscillations within particles of metal torn from the electrodes by the violence of the discharge—an idea suggested because



Harmonics.

Fig. 9—Serrated Curves (A and C) Indicating Very Short-Waved Components of the Wave Train. (*Physical Review*)

they are prone to appear after the spark-gap has been widened and the electrode-surfaces corroded by a succession of sparks. Or they might result from an excitation of molecules or atoms, in which case they should be regarded as belonging to the spectrum of natural rays, in the sense of my previous distinction.⁷ Even so, if the serra-

⁷ It is interesting to note that the opposite idea was put forward by Rubens—*i.e.*, that the rays of wavelengths 0.1 mm. and thereabouts emitted by the mercury arc might be due to oscillations in droplets of liquid mercury.

tions are truly due to waves issuing from the doublet and not to some unhappy peculiarity of the receiver—and the former alternative is considered the more probable one—then there is good reason for believing that the spectrum of artificial waves has been prolonged to overlap the spectrum of natural waves, and the lacuna is closed.⁸

THE DISCOVERY OF ISOTOPES

Thirteen additional elements having been analyzed into isotopes by Aston, the moment is opportune for restating the two great series of discoveries which have disclosed the hidden law and the underlying unity of the chemical elements. Twenty-five years ago, the labors of chemists had resulted in setting apart about seventy-five distinct, unchangeable, non-interconvertible substances as "the elements"; and the ancient ambition to describe all forms of matter as combinations or modifications of a single, truly fundamental element must have seemed to be definitely frustrated. It is true that there were undeniable signs of a family relationship among the elements. They could be classified into groups of elements more or less alike in their properties; and when they were arranged in the order of their combining weights, there was distinctly a periodic variation of chemical

⁸ Dr. Ernest Fox Nichols died suddenly on the twenty-ninth of April, 1924. A few days earlier he had very graciously offered to inform me of his latest work in extending the spectrum of artificial waves, hitherto unpublished except in brief reports before the Physical Society. He discussed the matter with his collaborator Dr. Tear, and to present his final formulation of his great achievement I can do no better than to quote verbatim a letter which Dr. Tear kindly wrote to me on April 29th:

"The most satisfactory data we have at present has been obtained with receivers whose fundamental wavelengths are long compared with those to be measured. The electrodes of our smallest oscillators are 0.1 mm. in diameter and 0.1 mm. long. The glass seal covers approximately one-half their length. The fundamental wavelength of such an oscillator is of the order of 1 mm. The distribution of the dielectric and the means of excitation are such however as to accent certain harmonics and to suppress the fundamental and other frequencies. The interference curves show then the presence of one high frequency, usually the second or fourth harmonic, plus the low frequency of the receiver. The interference persists for three or four cycles and is reproducible, although the construction of such minute seals introduces the element of chance, frequently making it necessary to construct several oscillators before finding one having the right proportions of bare and glass-covered electrode-surface to bring out one frequency and suppress the remainder.

"It is in a way perplexing that although chance proportions of glass and metal bring out one harmonic to a greater or less degree, the fundamentals of these smallest oscillators do not show up at all. It is of interest, too, to note that a sheet of glass 0.2 mm. thick, such as the seals are made of, transmits but 25% of the 0.32 mm.-radiation from the mercury arc. We have been led to the interpretation that the particular standing waves which can exist upon these small oscillators are determined by the location of the glass-oil boundary-surface, and that the predominant wavelength is the fundamental wavelength of that part of the oscillator which is in oil between the two glass-oil surfaces. *The wavelengths which we have isolated in this way extend to the 0.22 mm. limit which we reported at Boston.*" (That is, at the Boston meeting of the Physical Society, December, 1922. Italics mine.—K. K. D.)

and physical properties in passing along the line. Indeed the periodicity was so clear that in three instances when the order of two consecutive elements was such as to damage the periodic law, chemists simply reversed the order—putting argon before potassium, cobalt before nickel, tellurium before iodine, thus testifying to a faith that there must be something governing the nature of the chemical elements more fundamental than combining weights. Furthermore, in several instances where the periodic law implied that there ought to be an additional element between two apparently consecutive ones, chemists left a vacant space between the two for an element presumed to be existent but unknown; and some of these elements were subsequently discovered, thus justifying the faith in the most impressive way. But of the nature of this fundamental something, there was no inkling.

It had been suggested at one time that all atoms are built up of hydrogen atoms. But the most accurate measurements placed it beyond doubt that the chemical combining weights of the elements are not, in every case, integer multiples of the combining weight of hydrogen, nor of any other common divisor large enough to have a physical meaning. As it was universally assumed that the weight of the ultimate particles of an element is equal to its combining weight multiplied by some universal factor, this fact seemed to disprove the suggestion. Yet on the other hand the measurements established a rule that the combining weight of many of the elements—far too many to be explained as due merely to chance—are integer multiples of a common unit which is $\frac{1}{8}$ of the combining weight of oxygen. This can be illustrated from any group of elements, for example from the first ten of the periodic table:

H	He	Li	Be	B	C	N	O	F	Ne
1.008	4.00	6.94	9.02	10.83	12.00	14.01	16.00	19.0	20.20

out of which group of numbers eight are integer multiples of the unit 1.00, within observational error; while four—the combining weights of hydrogen, lithium, boron and neon—certainly are not. We are confronted with a manifest rule restricted by undeniable exceptions—the most stimulating situation which can arise in a science.

Suddenly the exceptions to the rule were all explained away, and the mystery vanished with a completeness which we hope that some of the other mysteries of physics will some day emulate. The trouble was simply that everyone has assumed, with an indifference to the other alternative which now seems strange,⁹ that all the atoms of an

⁹ Compare Aston's historical review (*Isotopes*, pp. 1-6). Crookes very definitely suggested a multiplicity of atomic weights in 1886.

element have the same weight, which (multiplied by the proper universal factor) is the combining weight of the element; whereas now it is known that some of the elements have two or several different kinds of atoms apiece, with different weights, of which the observed combining weight of the element is merely an average. The combining weight of an element as observed in ordinary chemical experiments has no general right to the title of *atomic weight*; only in special instances may the two be identified. The elements of which the combining weights are integers—meaning, integer multiples of $\frac{1}{16}$ of the combining weight of oxygen—consist of atoms of a single kind, the weight of which is truly and accurately given by the combining weight of the substance. The others, or those of them which have been analyzed, are mixtures of atoms of different kinds, the weight of no one of which is given by the combining weight of the element. Wherever it is actually the mass of an atom which is measured by the chemical method, the rule is verified; where the rule is apparently infringed, the quantity measured is merely a misleading average, and not the mass of an atom at all. When, therefore, the rule is restated to apply only to those combining weights which are truly atomic weights, the conspicuous exceptions no longer militate against it, and the supposition that all atoms may be built of hydrogen atoms is strongly reinforced.

When J. J. Thomson developed the technique of his "positive-ray analysis" by which he measured the masses of fast-flying charged atoms and molecules, he was unknowingly preparing the way for ascertaining how many different kinds of atoms belong to a single element. In these classical experiments the ionized particles were those existing in a rarefied gas traversed by an electrical discharge, and drawn to the cathode by the strong field maintaining the discharge; through a narrow perforation in the cathode, a thin pencil of the ions passed into a chamber where it was subject to crossed electric and magnetic fields. These fields resolved it into a number of separated and separately-directed pencils, each containing exclusively atoms (or molecules) of a single uniform mass, which could be deduced from the location of the trace made by the pencil upon a photographic plate.¹⁰ The method was designed by Thomson as a sensitive, indeed a supersensitive, method of chemical analysis, by

¹⁰ The actuality is somewhat more complex, as a distinct pencil is obtained for each value of the charge-mass ratio E/m , and it is this ratio which is deducible from the location of the pencil. However E is either the electron-charge e or a small integer multiple of it (occasionally, but rarely, as great as $8e$), and the multiplicity of pencils corresponding to different values of E and a single value of m seems to be an actual advantage to the experienced interpreter of such data.

which gases present even in small proportions in a discharge-tube could be detected and identified. The first trials were naturally made upon discharge-tubes containing the commoner gases, which as it happens nearly all consist of one kind of atom (or molecule) apiece—oxygen, nitrogen, hydrogen, carbon dioxide, carbon monoxide. This retarded the great discovery. But when neon, a gas of presumed atomic weight 20.2, was introduced into the tube in 1912, Thomson observed two pencils, of atoms of masses about 20 and 22, respectively, where he had expected to see but one consisting of atoms of mass about 20.2.¹¹

This observation was not immediately interpreted as we now interpret it. The mysterious pencil might have consisted of molecules of CO_2 of mass 44 bearing a double charge, or of molecules of a hitherto unknown compound NeH_2 . These possibilities were tested by appropriate experiments and discarded, and then for a time the gas of atomic mass 22 was apparently regarded as a new element distinct from neon and fortuitously mixed with it.

F. W. Aston undertook the attempt to separate the two gases, but they were so entirely alike in their properties that no success whatever was attained by fractional distillation and little by diffusion. This was Aston's entry into this field, and in a celebrated series of researches, soon interrupted by the war but resumed after six years and still continuing, he associated his name forever with the analysis of elements into the different kinds of atoms of which they consist.

Of the improvements which Aston made in the method of measuring the masses of charged particles, as of the details of Thomson's original method and of Dempster's method, it is hardly necessary to speak; for they have been admirably described, with reproductions of photographs, in several recent books.¹² The problem of generating ions of the elements to be analyzed became progressively harder to solve. The elements gaseous at room-temperature were easily investigated, and those of which a high vapor density could be produced either of the element or of one of its compounds, without overheating the tube, were also tractable; but when these elements had all been tested the resistance to further advance became formidable. Ions of the thirteen elements lately analyzed were formed as *anode rays*: that is, they were charged atoms expelled from the anode of a discharge-tube

¹¹ Neon by virtue of its well-known chemical inertness has no "combining" weight, but its average molecular weight was determined from its density by Watson, using Avogadro's principle, as 20.200. Thomson's earliest experiments were not delicate enough to distinguish whether the atoms in the former of the two pencils were of mass 20.0 or of mass 20.2, but the difference between either and 22 was unmistakable.

¹² Notably in Aston's own book *Isotopes* and in Andrade's *The Structure of the Atom*.

during the discharge—not ionized atoms of a gas sustaining the discharge, as previously—and drawn to and through the cathode by the entire voltage across the tube. The anode of the tube must be made in a special manner; in Aston's experiments it consists of a "paste" made of graphite, of lithium iodide, of a halogen salt of the metal to be analyzed, and sometimes of other salts as well. Ions of the other elements in the paste and from the gas in the discharge mingle with the desired ions in the pencil which shoots through the cathode perforation, but this is no inconvenience, quite the reverse, as the traces

	I	II	III	IV	V	VI	VII	VIII	O	
1	1 H 1.008								2 He 4	
2	3 Li 7, 6	4 Be 9	5 B 11, 10	6 C 12	7 N 14	8 O 16	9 F 19		10 Ne 20, 22	
3	11 Na 23	12 Mg 24, 25, 26	13 Al 27	14 Si 28, 29, 30	15 P 31	16 S 32	17 Cl 35, 37		18 A 40, 36	
4	19 K 39, 41	20 Ca 40, 44	21 Sc 45	22 Ti 48	23 V 51	24 Cr 52	25 Mn 55	26 Fe 56, 54	27 Co 59	28 Ni 58, 60
	29 Cu 63, 65	30 Zn 64, 66 68, 70	31 Ga 69, 71	32 Ge 74, 72, 70	33 As 75	34 Se 78, 76, 74 82, 77, 74	35 Br 79, 81		36 Kr 84, 86, 82 83, 80, 76	
	37 Rb 85, 87	38 Sr 88	39 Yt 89	40 Zr	41 Nb	42 Mo	43—	44 Ru 45 Rh 46 Pd		
5	47 Ag 107, 109	48 Cd	49 In 115	50 Sn 120, 118, 116, 114 119, 117, 122, 121	51 Sb 121, 123	52 Te	53 I 127		54 Xe 129, 132, 131 134 136, 128 130, 126, 124	

Additional elements: 55 Cs, one isotope at 133
80 Hg, isotopes at 202, 204, and in the range 197-200

Fig. 10—The First Six Rows of the Periodic Table of the Elements, Showing the Atomic Masses of the Isotopes of the Elements which Have Been Analyzed. The Data Come from Aston's Tabulations

which they leave on the plate are convenient *points de repère* for fixing the exact location of the traces left by the ions being analyzed. In this manner the elements scandium, titanium, vanadium, chromium, manganese, cobalt, copper, gallium, germanium, strontium, yttrium, silver and indium were studied—thirteen altogether, bringing up to forty-seven the number of elements which have been analyzed in the fourteen years since neon was first discovered to be multiple.

All of these forty-seven elements except two lie in the first five periods of the periodic table, and they have been written out in the tabular form in Fig. 10. The symbol of each element is preceded by its atomic number, and below the symbol lies not the combining weight of the element as in the tables one usually sees hanging on the walls of chemical lecture-rooms, but the ensemble of the atomic weights of its various kinds of atoms—the atomic masses of its *isotopes*, as the term is. Where no number or set of numbers is given, the analysis has not yet been made. Of the first fifty-five elements of

the table, all have been analyzed except nine; but of the next twenty-seven elements, only one (mercury) has been analyzed. These heavier elements and their compounds seem generally to be non-volatile and so impregnable by the original method; while they are difficult, if not impossible, to examine by Aston's new scheme, as the traces of the ions upon the plate become fainter with increasing mass, and are already extremely faint for the elements in the fifth row of the table.

Among the eight known elements beyond the eighty-second, every one has atoms of several different kinds, alike in physical and chemical properties but different, it is presumed, in mass; but they differ also in another quality, a much more striking quality—they differ in their degree of instability. Out of a great number of atoms of a radioactive substance, existing at a moment t , one-half will have disintegrated at a subsequent instant $t+T$; the interval T , which is called the *half-period* of the substance, is the measure of its instability. Like the atomic mass, this half-period may vary from one kind of atom to another, though both kinds have almost identical chemical and physical properties and belong to the same element. The three isotopes of the eighty-sixth element, "emanation," have three entirely distinct half-periods: 54 seconds, 3.85 days and 11.2 days. Moreover, not only the rate but the manner of disintegration may be different for different isotopes of a single element. The six kinds of atoms which share the ninetieth place in the periodic table display this diversity of properties:

Uranium X₁ has a half-period of 23.8 days and its atoms emit electrons and electromagnetic waves when breaking up;

Uranium Y has a half-period of 24.6 hours and emits electrons;

Ionium has a half-period of 9×10^4 years and emits helium nuclei;

Thorium has a half-period of 2.2×10^{10} years and emits helium nuclei;

Radiothorium has a half-period of 1.90 years and emits helium nuclei;

Radioactinium has a half-period of 19 days and emits helium nuclei.

Nor must it be supposed that if each of two isotopes is stated to emit helium nuclei, they are in that respect identical; for the energies of the emitted nuclei generally vary from one isotope to another, so that every one of the six kinds of atoms listed above differs from every other not only in the rate but also in the manner of its disintegration—and likewise in its ancestry and its posterity, in the

genealogical line to which it belongs. These are the conspicuous differences between the isotopes comprised in a single element, when the element is one of the eight final ones of the periodic table; and they are so conspicuous and impressive that the individual isotopes

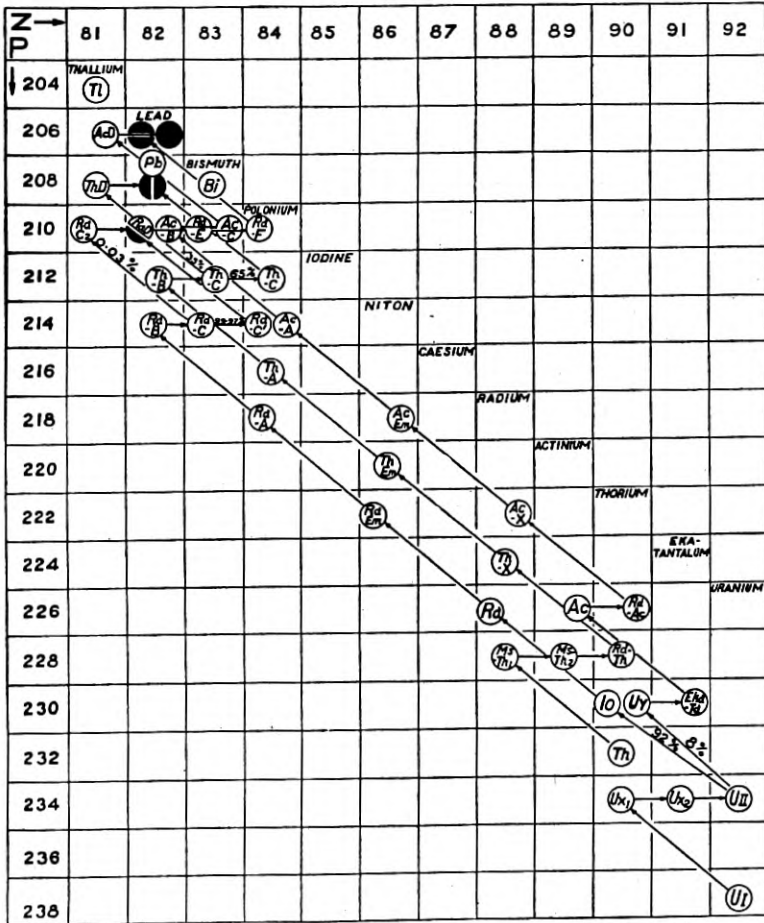

Fig. 11—Table of the Elements from the Eighty-Second to the Ninety-Second (Inclusive) Showing the Names and the Presumed Atomic Masses of Their Isotopes. (Andrade, *The Structure of the Atom*)

enjoy individual names, while the element to which they all belong usually has no all-embracing name of its own,—quite the opposite of the state of affairs among the stable elements, each of which has its own name while the isotopes composing it are known only by the numbers giving their atomic masses. Fig. 11 displays these last

eight elements and the preceding one (lead) each in a column of its own marked with its atomic number (and for identification the name of some element in the same column of the periodic table), while the mass of each kind of atom is given by its elevation above the bottom of the figure (the values are written along the vertical axis).¹³

In these tabulations of Fig. 10 and Fig. 11, all the numbers representing atomic masses are written as integers. The conspicuous post-decimal figures occurring in the sequence of combining weights are absent; the notorious 35.45 of chlorine, the 24.32 of magnesium, the 10.83 of boron have vanished from the scene. Are then the masses of all atoms really integer multiples of $\frac{1}{16}$ of the mass of the oxygen atom, using "really" in its only significant sense of "within the uncertainty of observation?" Or do some of them deviate appreciably from the rule? The trial can be made most exactly upon the lightest elements, as for these a given deviation from an integer value would bulk as a larger percentage of the total mass, which is the measured quantity, than it would for the heavy elements. It is performed by mingling the ions under test with ions of oxygen, or of some other element, preferably one which has previously been compared with oxygen; the locations of the traces of the two pencils of ions upon the photographic plate are compared. Mingling lithium ions with carbon ions, Aston finds that the masses of the two kinds of lithium atoms stand to the mass of the carbon atom as

$$(7.006 \pm .005) : 12.000 \text{ and } (6.008 \pm .005) : 12.000$$

and if the mass of the carbon atom is exactly $\frac{1}{12}$ that of the oxygen atom, then the masses of the lithium atoms are very slightly distinct from $\frac{7}{16}$ and $\frac{6}{16}$ of the oxygen mass (for, little as the difference exceeds the uncertainty of experiment, Aston regards it as real). Beryllium, however, yielded the values 9.003 and 9.001—indistinguishable experimentally from 9.000—in two separate experiments, in terms of the same assumed value 12.000 for carbon. Farther along in the

¹³ The atomic masses of these different kinds of atoms are largely hypothetical. They have been measured for four single isotopes belonging to four distinct elements; radium (number 88, mass 226), radium emanation or niton (number 86, mass 222), thorium (number 90, mass 232), and uranium (number 92, mass 238). Measurements have also been made upon samples of lead believed to be composed almost entirely of a single isotope, giving 206 for one kind of atom and 208 for another). Each of the other atoms is a descendant of one or two of the four first-named atoms, and its atomic mass is calculated by subtracting, from the atomic mass of its ancestor, the masses of all the fragments which dropped away from the earlier atom during its evolution. This procedure is confirmed by comparing the measured values for uranium, radium, radium emanation, and one sample of lead, which all belong to the same line of evolution; and the measured values for thorium and for another sample of lead which is descended from thorium.

procession of elements, comparisons with the oxygen atom become difficult; but adjacent elements can be intercompared. The eight sorts of tin atoms lie next to the nine sorts of xenon atoms, the most massive kind of tin agreeing closely in weight with the least massive kind of xenon. When atoms of gaseous xenon and molecules of a volatile compound of tin are mixed together in the discharge-tube, the beam of ions issuing through the cathode-perforation is resolved into seventeen pencils; and the seventeen traces upon the plate are so placed that the masses of the seventeen atoms cannot all be integer multiples of a common unit of the order of $\frac{1}{16}$ the oxygen mass.¹⁴ Either the tin atoms or the xenon atoms deviate appreciably from the rule, or possibly both do.

So the common history of great sweeping discoveries in science seems to repeat itself; the simplicity of the principle first announced is gradually marred, its sharp lines become a trifle hazy and vague, as experiments are multiplied and refined. Yet the principle does not for that lose its character or its importance; the deviations of the new group of values from integer numbers are small compared to those of the old one, and promise to amplify the physical meaning of the rule instead of restricting it. We should be less prepared to accept them, were there not one of them at the very root of the system of elements; for the mass of the hydrogen atom is not exactly the $\frac{1}{16}$ of the oxygen mass which was taken for the fundamental unit mass of the system of atoms, but is 1.008/16 of it. This seems embarrassing; the bricks of which we intended to say that the atomic structures are built turn out to be smaller than the sample brick. But the embarrassment can be removed; for it can be shown that of the mass of the hydrogen atom is altogether electromagnetic, then the total mass of a group of such atoms crowded closely together must be inferior to the sum of the masses of the individual atoms when far apart. Therefore, small deviations from the rule of integer masses are to be anticipated, and may be expected to serve as a most valuable contrôle of proposed models of atom-nuclei, when the epoch of quantitative spatial models arrives. This epoch may be distant; or we may be upon the verge of it.

We have admitted, then, that the combining weight of an element, being in general not its atomic mass but the average of the masses of several kinds of atoms, and a *weighted* average at that, does not have

¹⁴ The experiment was performed with a tube containing the gaseous compound tin tetramethide (SnCH_3)₄ and some xenon from a previous experiment. Eight pencils of SnCH_3 ions were observed, consisting of molecules comprising tin atoms of the eight different kinds; molecules containing tin atoms of mass 120 would have a total mass of 135, and hence a pencil containing them would have fallen just midway between the pencils of xenon atoms of masses 134 and 136, respectively; actually it fell distinctly off-centre.

the profound physical significance it once seemed to possess. But this is not all; we must further concede that even the mass of the atom—or the ensemble of masses of the atoms—of an element is not by any means so distinctive and important a quality of the element as one would expect. Not only may one element have atoms of several different masses, but two distinct elements may have atoms of, so far as we can distinguish, the same mass; argon and calcium, selenium and krypton, tin and xenon. Now if an atom of the gaseous and inert argon may have the same mass as an atom of the metallic and active calcium, we cannot evade the conclusion that the mass of an atom is, in the terms of logic, an *accidental* property of the atom rather than an essential one. There must be some fundamental and essential feature or quality of the atom, which determines its ensemble of physical and chemical properties, and which is not the atomic mass; perhaps this quality determines the atomic mass as well, but certainly not in so rigorous a manner that one value of atomic mass corresponds invariably to one set of chemical and physical properties, and vice versa. This fundamental feature of the atom we recognize as the charge upon its nucleus, which, expressed as a multiple of the electron-charge e (of which it must be an integer multiple¹⁵) is also the number of electrons accompanying the nucleus, and the *atomic number* of the element.

This nuclear charge, or (cardinal) electron-number, or (ordinal) atomic number, is the same for all the atoms of a single element, and never the same for two atoms of different elements. It is 50 for all of the eight kinds of atoms of tin, and 54 for all of the nine kinds of atoms of xenon. It is 18 for all atoms of argon and 20 for all atoms of calcium, though some atoms of the one have the same weight (within one part in a thousand, Aston says) as some atoms of the other. It is 26 for all atoms of cobalt and 27 for all atoms of nickel, though most of the atoms of nickel are lighter and a few heavier than the atoms of cobalt. It is the true basis for the ordering of the elements, of which the ordering of the atomic masses is but an imperfect and distorted (though not a badly distorted) imitation.

Five observations or assemblages of observations, made in fields of physics separated almost as widely as any five fields could be, sustain this principle; and, combined with its philosophical attractiveness for the idea of arranging the elements in a single procession and attaching consecutive integer numbers to their fundamental qualities is as irresistibly attractive as a scientific idea can be—make it about

¹⁵ Otherwise the nuclear charge could not be exactly balanced by the charges of the environing electrons.

as certain as any principle not dealing with things which can be seen and handled. I shall mention them briefly, in a nearly chronological order.

The direct measurement of the charge of the helium nucleus. Rutherford and Regener independently measured the charge on the alpha-particle in the simplest, most direct and most incontrovertible way; they counted the alpha-particles emitted from a sample of a radioactive element in a given time, and measured the total charge they carried away from it, and divided the one datum by the other. Rutherford obtained twice $4.65 \cdot 10^{-10}$ (electrostatic units) for the charge of the individual particles; Regener obtained twice $4.79 \cdot 10^{-10}$. The agreement of the latter value with twice Millikan's standard value of the electron-charge ($4.774 \cdot 10^{-10}$) is magical; the agreement of the former value is also good. Though this is an average value for a great number of particles, the fact that a beam of alpha-particles is not spread or split by a magnetic field proves that each has the same charge (at least, to be perfectly precise, the same charge-to-mass ratio). It is established that the alpha-particle is the bare helium nucleus.¹⁶

The determination of nuclear charges by the scattering of alpha-particles. When a beam of alpha-particles is played against a sheet of metal foil, the nuclei of the metal atoms deflect the alpha-particles passing very close to them, by virtue of the electrostatic repulsion between the charge $+2e$ on the alpha-particle and the charge $+Ne$ on the nucleus of the metal atom. The distribution-in-angle of the scattered alpha-particles can be calculated, assuming that the action of the metal nuclei is not complicated by any forces due to the electrons surrounding them. The distribution-in-angle actually observed agrees in form with the calculated one; this proves not that there are no electrons surrounding the metal nuclei, but that there is a vacant space around each nucleus, wide enough so that the major part of the deflection of an alpha-particle takes place within it. All this was discussed in the second article of this series. The form of the distribution-in-angle and its variation with the speed of the alpha-particles prove the existence of the atom-nuclei, of their positive

¹⁶ For helium gas, evinced by its spectrum, appears in a tube into which alpha-particles are fired through the wall, and is exuded from a piece of metal which is melted after alpha-particles have been shot into it (Rutherford's experiments); furthermore impacts between alpha-particles and atoms of helium gas show them to be of the same mass (Blackett's experiments), and the value of the e/m ratio is correct for doubly-ionized helium atoms but not for any other admissible variety of atom. And the radius of the alpha-particles, calculated from the experiments on scattering, is smaller by several orders of magnitude, than the effective radius of any known atom having electrons in addition to its nucleus.

charges, of the vacant space around them; and if the percentage of scattered particles is measured absolutely, the absolute value of the charge of the nucleus can be calculated. These values have actually been obtained:¹⁷

Platinum: nuclear charge	$(77.4 \pm 1)e$	(Chadwick)
Silver:	$(46.3 \pm 0.7)e$	(Chadwick)
Copper:	$(29.3 \pm 0.5)e$	(Chadwick)
Argon:	$19e$	(Auger and Perrin)
"Air"	$6.5e$	(C. T. R. Wilson)

Bohr's interpretation of the spectra of hydrogen and ionized helium. There is a complete and perfect agreement between the observed frequencies in the spectra of hydrogen and ionized helium, and the frequencies predicted by Bohr. An essential feature of Bohr's theory is that the charge on the nucleus of the hydrogen atom is assumed to be e , and the charge on the nucleus of the helium atom to be $2e$. As there is no other element of which the spectrum has been perfectly and completely explained by Bohr's theory (or any other) this affirmation cannot be extended beyond hydrogen and helium.

Thus we have excellent evidence from three distinct sources that the nuclear charge of helium, the second element of the periodic table, is $2e$; excellent evidence from two sources that the nuclear charge of the first element, hydrogen, is e ; and good evidence by the alpha-ray method that the nuclear charges of the 18th, 29th, 46th and 78th element are as close to $18e$, $29e$, $46e$, and $78e$ as to any other integer multiple of e . In addition, there is evidence from two more sources that, in passing from one element to the next along the procession of elements, one finds the nuclear charge augmented by the amount e at each step; thus completing the itemized evidences foregoing by a process somewhat like what is called "mathematical induction."

The displacement-law of Fajans and Soddy. When an atom-nucleus of a radioactive element disintegrates by shooting off an electron bearing a charge $-e$, the residuum is found to be a nucleus of an element one step farther up in the procession of elements. When an atom-nucleus disintegrates by shooting off an alpha-particle bearing a

¹⁷ The earliest experiments (discussed by Rutherford in 1911) demonstrated that for several metals the nuclear charge (measured in terms of e) was about one-half the atomic weight; and those of Geiger and Marsden (1913) were arranged primarily to demonstrate the validity of the concept of the nuclear atom, but confirmed that statement for gold. Chadwick repeated these experiments upon *Pt*, *Ag* and *Cu* with the object of determining the nuclear charge as accurately as possible. The values for argon and "air" were determined by what is in principle the same method though in a very different form; the former with alpha-particles, the latter with fast electrons.

charge $+2e$, the residuum is found to be a nucleus of an element two steps farther down in the procession of elements. Thus in passing from one element to the next above it, the nuclear charge is found to be augmented by e . This law is deduced from numerous observations on the elements beyond the eighty-first.

Moseley's law. The square root of the frequency of the $K\alpha$ -ray (a prominent and easily-identified member of the X-ray spectrum) increases by a constant amount in passing from one element to the next above it. This law is valid from the twelfth to the ninety-second element in the periodic table. The same law governs, though not with such entire accuracy, the other identifiable members of the X-ray spectrum.

Apart from all interpretation, Moseley's law means that there is a certain important measurable quantity which is very characteristic of the elements and increases uniformly and steadily from one to the next, over almost the entire procession. The mere existence of such a quantity inspires confidence that there is a true physical seriation of the elements, but by interpretation a great deal more can be added. Bohr's theory of the atoms of hydrogen and ionized helium lead to this result: when a single electron forms an atomic system with a nucleus of charge Ne , one of the frequencies which this system can radiate—and the frequency which, on the whole, it would oftenest and most intensely radiate—is equal to

$$v = \frac{3}{4}RN^2, \quad R = 2\pi^2m e^4/h^3. \quad (1)$$

This is verified for hydrogen and ionized helium, each of these atoms consisting of a nucleus and a single electron. No other such atom has yet been isolated and made to radiate. But we might imagine that in a massive atom containing many electrons, one lies deep down beneath the others, and revolves by itself in the field of the nucleus, undisturbed by the rest. In this case there would be an X-ray frequency emitted by the atom, given by (1). The difference between the values of the square root of this frequency for consecutive elements would be constant and equal to

$$\Delta = \sqrt{\frac{3}{4}}R. \quad (2)$$

Now the observed constant difference between the values of the square root of the $K\alpha$ frequency for consecutive elements does conform to (2). But the actual value of the frequency does not conform to (1)

unless we get the quantity N equal, not to the order-number of the element in the procession, but to the order-number minus one.

Does this mean that the nuclear charge of the n th element in the periodic table is $(n-1)e$ for all the values of n exceeding 11 (the values for which Moseley's law holds)? I fear this could not be contradicted from the direct experimental evidence, for Chadwick's values of the nuclear charges for the elements $n=78, 47, 29$ fall just short of being exact enough to prove that they are $78e, 47e, 29e$ instead of $77e, 46e, 28e$, respectively. However, we should do too much violence to the beauty of the principle if we admitted that there are only eight values between $2e$ and $11e$ to be distributed among the nuclear charges of the nine elements between helium and magnesium, and happily it is not necessary, for the apparent discordance can plausibly be blamed upon too simple a view of the internal economy of the atom which we took in deriving equation (1). Instead of assuming that the deepest-lying electron of the atom revolves in an otherwise vacant space surrounding the nucleus, wide enough to contain the first two of its permissible orbits, we should do better to assume that there are several deep-lying electrons similarly placed and interacting with one another, or at least that there is no single deepest-lying electron too far inward to be affected by the others. The effect of thus changing the assumption is to change the calculated value of the $K\alpha$ -frequency, for an atom of nuclear charge Ne , from the value (1) to a value $\frac{3}{4}R(N-k)^2$; in which k depends on the particular configuration assumed for the internal electrons. It is clear, therefore, that we are in no wise compelled by Moseley's law to conclude that the nuclear charge of the atom of the n th element is $(n-1)e$ when $n > 11$, and may continue to accept the much more satisfying principle that the nuclear charge of the n th element is ne .¹⁸

Before stating the conclusion let me restate the evidence in a briefer form and an altered order. Originally the elements were arranged in the order of their combining weights. It was seen that when they are arranged in this way, there is a periodic variation of the ensemble of chemical and physical properties from element to element. But to make the periodic variation quite smooth and unbroken, it was found necessary to violate the order of the combining weights at several places in the series; three pairs of con-

¹⁸ The agreement with experiment indeed becomes very good, at least over a certain range of elements, if we assume that there are normally 3 electrons in the innermost or one-quantum ring and nine in the second or two-quantum ring orbit (J. Kroo). But nobody wants to accept this particular repartition of electrons, and it is customary to assume that the inner orbits are mostly elliptical. But it would be gratifying to attain a quantitatively successful theory.

secutive elements had to be reversed, and at several points it was necessary to leave vacant spaces between apparently-adjacent elements, imagining undiscovered ones to separate them. Thus it became clear that the true arrangement of the elements was controlled by something deeper and more fundamental than the combining weights; yet there was no adequate reason for preferring one of the measurable physical or chemical properties above all the others as the fundamental one. Moseley then discovered that the square root of the most conspicuous X-ray frequency increased at a steady and even pace from one element to the next, throughout almost the entire list of elements. Where the order of combining weights disagreed with the order of physical and chemical properties, the order of X-ray frequencies agreed with the latter and not with the former; where the succession of chemical and physical properties suggested that an element was missing from the list, the excessive leap of the root of the X-ray frequency in passing from the element below to the element above the suspected gap gave a striking confirmation. This important quality of the elements, advancing by equal steps from one to the next, testified far more impressively than the periodic variations of the various chemical and physical qualities to the close affiliation among them.

Measurements of the deflections of alpha-particles by atoms had shown that the atom has a massive nucleus bearing a positive charge; as there are also electrons surrounding the nucleus, and as no one has proved the existence of negative electricity otherwise than in electrons, it was inevitable to believe that the positive nuclear charge is balanced by and balances the charges of the surrounding electrons, and so is an integer multiple of the electron-charge e . Moseley's law could be interpreted to mean that the nuclear charge increases by e in passing from one element to the next. Fajans and Soddy had already found that when one of the radioactive elements is transformed into another, the transformation is always such that an increase of e in nuclear charge goes with an advance of one step along the series of elements. Therefore, it would be possible to assign the nuclear charges of all the elements if the nuclear charge of one, or preferably of several, could be absolutely determined. The experiments upon scattered alpha-particles did show for several elements that the nuclear charge of the n th element is at least as close to ne as to any other integer multiple of e ; direct measurement of the nuclear charge of the second element showed that it is quite accurately $2e$; and Bohr's theory, of which the interpretation of Moseley's law was an offshoot, derived its own successes partly from the essential as-

sumption that the nuclear charges of the first and second element are e and $2e$, respectively.

Meanwhile the combining weights, without losing their practical utility, were slipping out of the prominence into which they had been forced. It was discovered that they were not always to be identified with the atomic weights; that an element might have several kinds of atoms; that even the masses of these atoms were not absolute characteristics of the elements, as two very different elements might have atoms of apparently identical mass. In Remy de Gourmont's phrase, there occurred a *dissociation of ideas*; the idea of atomic weight was dis-associated from the idea of element, and the idea of atomic number supplanted it. The eighty-seven (now the eighty-eight) known elements formed themselves into a procession, which is a procession of atoms bearing eighty-eight of the ninety-two admissible nuclear charges between e and $92e$, and possessing consecutively all except four of the possible electron-families ranging in number from one to ninety-two. That at least eighty-eight out of these ninety-two conceivable atoms should actually exist and have been discovered, may seem strange; one might perhaps have expected that a stable nucleus with a net charge of ne could be built only for an occasional value of n ; but among the first eighty-two integers there are certainly not more than two, perhaps none, which are not represented by durable nuclei; and among the next ten at least eight are represented by not-too-transient nuclei. We have also seen that nuclei with certain values of charge, $54e$ or $90e$ for example, can be constructed in several different ways. These problems of nuclear structure are, however, problems for the future. What does seem established at the present moment is, that if we could determine the properties of the system formed by n electrons and a nucleus of charge ne , we should know all the properties of the elements except a very few having to do with intra-nuclear events. As the only case thus far successfully dealt with is the case $n=1$, and we cannot even explain what happens when two such atoms combine, this is not meant as an augury of an early complete liquidation of the mysteries of physics. Nevertheless, we have good reason to believe that, though ours is doubtless not the generation which will complete the solution of the problem of the atom, it is the first to which the nature of the problem has been revealed.

REFERENCES

- F. W. Aston: *Phil. Mag.* 47, pp. 385-400 (1924); 45, pp. 934-945 (1923) *Isotopes* (London, 1922).
 P. Auger and F. Perrin: *Comptes Rendus*, 175, pp. 340-343 (1922).

- J. Chadwick: *Phil. Mag.* *40*, pp. 734-746 (1920).
- H. Geiger and E. Marsden: *Phil. Mag.* *25*, pp. 604-623 (1913).
- J. Kroo: *Physikal. ZS.* *19*, pp. 307-331 (1918).
- F. Möbius: *Ann. der Phys.* *62*, pp. 293-322 (1920).
- H. G. J. Moseley: *Phil. Mag.* *27*, pp. 703-713 (1914); *26*, pp. 1024-1034 (1913).
- E. F. Nichols and J. D. Tear: *Physical Review* *21*, p. 378 and pp. 587-610 (1923).
- E. Regener: *Sitzungsber. Berlin Academy*, 1909, pp. 948-965.
- E. Rutherford: *Phil. Mag.* *21*, pp. 669-688 (1911) (evidence that nuclear charge is about $\frac{1}{2}$ atomic weight). *Proc. Roy. Soc.* *81A*, pp. 162-173 (1908) (evidence that nuclear charge of He is $2e$). Article "Radioactivity," *Encyc. Brit.* *32*, pp. 219-223 (1922) (isotopes among the radioactive elements).
- C. T. R. Wilson: *Proc. Roy. Soc.* *104A*, pp. 192-212 (1923).

Some Very Long Telephone Circuits of the Bell System

By H. H. NANCE

RECENT papers¹ have discussed at length the use of toll cables for the handling of certain long distance traffic. These cables, which are being used in areas of dense traffic, have been made possible by many developments in cable design, repeaters and loading coils. Coincident with these developments have gone others which are finding their application in the extensive establishment of improved open wire circuits for use over very long distances. The purpose of the present paper is to discuss some of the considerations involved in the overall design and maintenance of these very long open wire circuits. These circuits are often referred to as "backbone" circuits and supply a network of trunk lines for the entire Bell System. The most important of these routes are shown in Fig. 1.

The first transcontinental line was completed in the summer of 1914 and early in the following year three transcontinental telephone circuits were placed in commercial service. These circuits were constructed of copper wire 165 mils in diameter loaded with 250 millihenry coils at intervals of 7.88 miles and had telephone repeaters located at points about 500 miles apart. The opening of these first circuits, while marking a most important stage in the progress of long distance telephony, has been followed by many developments which have made possible increased overall transmission efficiency and improved quality. A discussion of these developments is given in a paper on "Telephone Transmission Over Long Distances," by H. S. Osborne.²

Two outstanding characteristics of these new open wire circuits are that they are non-loaded and that the repeaters are of an improved type, the number being increased in consequence of the higher attenuation. With these long non-loaded circuits increased speed of propagation and smoother characteristics are obtained resulting in less echo effect and better volume. Better attenuation-frequency characteristics are obtained and the quality is further improved due to the elimination, to a large extent, of transients. Changes in line attenua-

¹ "Philadelphia-Pittsburgh Section of New York-Chicago Cable," by J. J. Pilliod, *Bell System Technical Journal*, Vol. I, No. 1, July, 1922; *Journal of A.I.E.E.*, August, 1922. "Telephone Transmission Over Long Cable Circuits," by A. B. Clark, *Journal A.I.E.E.*, January, 1923; *Bell System Technical Journal*, Vol. II, No. 1, January, 1923.

² For detail discussion see paper on "Telephone Transmission Over Long Distances," by H. S. Osborne, *Journal A.I.E.E.*, Vol. XLII, No. 10, October, 1923.

tion with weather conditions are also considerably reduced. Furthermore, the use of this type of circuit fits in with the application of carrier current systems for which it is advantageous to use non-loaded 165 mil circuits where these are available.³

With the improved repeaters and balancing networks it is possible to obtain a higher degree of balance at the various repeater points. The improved transmission characteristics of these repeaters also contribute toward better quality. Both of these improvements are important in view of the increased number of repeaters in the circuit.

The use of this improved type circuit has been extended during the last few years to connect a large number of the important cities in the United States. A few of the longer circuits are:

Circuit	Approximate Length of Circuit Statute Miles	No. of Through Line Repeaters
Boston-Chicago	1,180	4
Chicago-Denver	1,090	3
Chicago-Los Angeles	2,890	12
Chicago-San Francisco	2,440	8
Dallas-St. Louis	670	2
Denver-San Francisco	1,350	4
Jacksonville-Havana	640	3
New York-Chicago	940	3
New York-Havana	1,710	8
New York-New Orleans	1,400	6
New York-St. Louis	1,020	5
Kansas City-Denver	750	2

One of the most recently established of these circuits is the Chicago-Los Angeles circuit routed over the southern transcontinental line. This and other through circuits on this line from Denver via El Paso to Los Angeles were established last year in order to provide for the growth in transcontinental traffic and to make available a second route as protection for the through service to the Pacific Coast. A brief description of these circuits will be given as typical of the long open wire circuits on this and other routes.

In the following, certain data based on actual experience with circuits on the southern transcontinental route, and in certain instances on circuits on the central transcontinental route are given. These data, however, are in general representative of results obtained on circuits of the same type throughout the Bell System.

From Denver west, a phantom group of four 165 mil wires provides for a Chicago-Los Angeles circuit, a Denver-El Paso circuit,

³ Refer to paper entitled "Practical Application of Carrier Telephone and Telegraph in the Bell System," by Arthur F. Rose, *Technical Journal*, April, 1923.

an El Paso-Los Angeles circuit and another circuit between Denver and Los Angeles with stations at intermediate points along the line. East of Denver facilities of the same type on an existing through route via Kansas City to Chicago with four intermediate repeater stations are used for the Chicago-Denver portion of the Chicago-Los Angeles circuit. The facilities and equipment arrangements permit rapid changes at the various repeater stations so that the circuit layout may easily be changed to take care of temporary rearrangements necessitated by trouble and to set up different layouts for the evening and night loads which at present are heavier than the day load.

Duplex telegraph equipment has been installed at various stations along the new route from Denver to Los Angeles for operating four direct current telegraph circuits derived by compositing the open wire circuits. In addition, a 10-channel carrier current telegraph system has been installed. Thus a total of 17 circuits, 3 telephone and 14 telegraph, operating on four wires are at present available over the new route for the through service. This requires a considerable

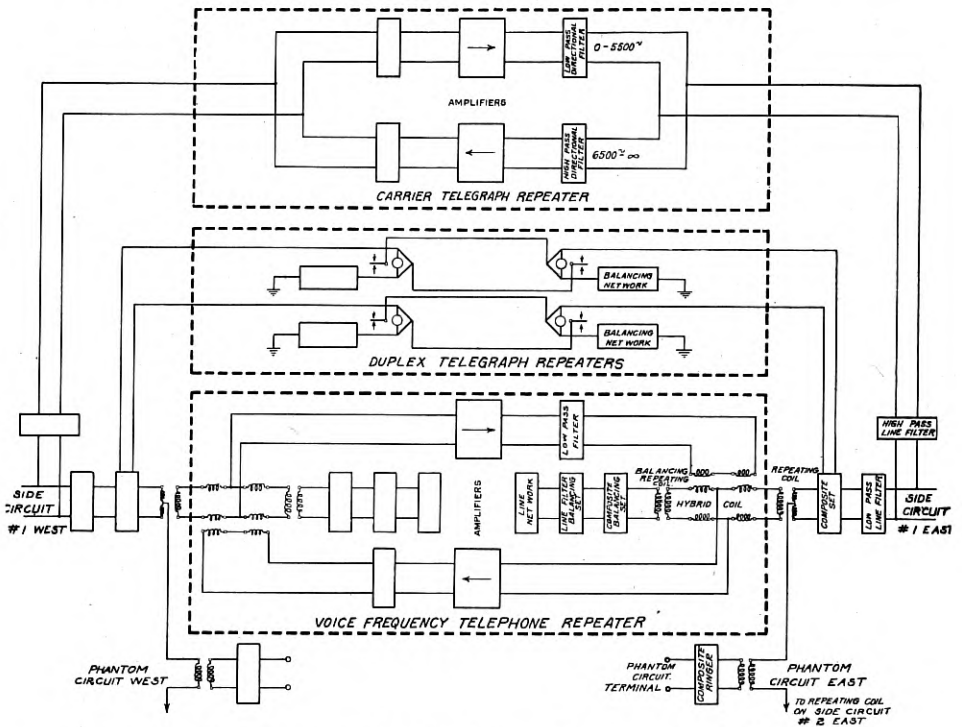

Fig. 2—Simplified Equipment Layout—Intermediate Repeater Station—Chicago-Los Angeles Circuit

amount of equipment at each of the repeater stations as illustrated by Fig. 2 which shows a simplified equipment layout at a typical repeater station. In addition to this number of circuits, a carrier current telephone system or an additional carrier current telegraph system can be provided and operated over these same wires at such time as traffic growth may warrant.

In view of the importance and number of services routed over the through wires, careful consideration was given to construction features. Copper line wire 165 mils in diameter affording high mechanical strength as well as low transmission loss was provided. For a

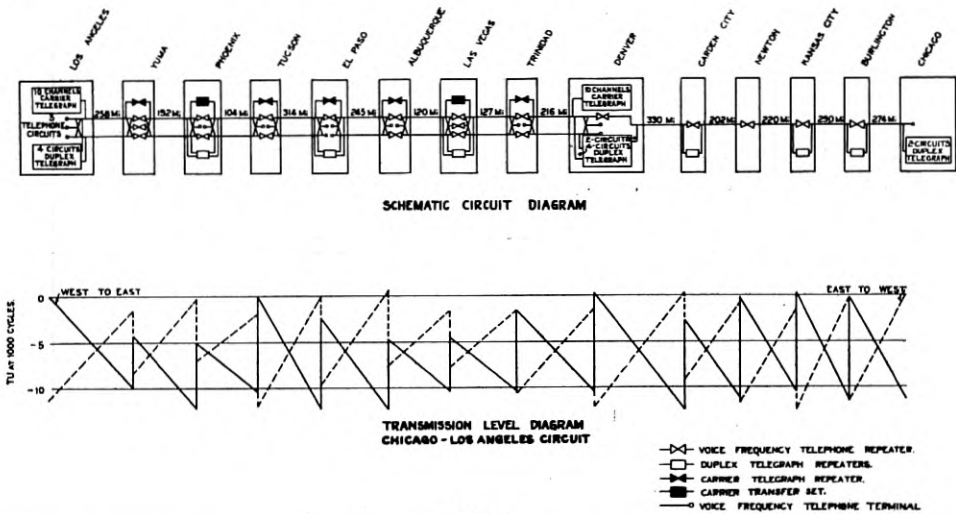

Fig. 3

large part of the distance an existing pole line over this route was used, but a new line was constructed in certain sections where the existing line was carrying full capacity load or was otherwise not suitable, and in other sections to avoid, as far as practicable, the use of intermediate or toll entrance cable. In a number of cases an important consideration in rerouting was the avoidance of exposures to electric light and power circuits. Considerable pole replacement work also was done in some of the existing pole line sections to strengthen the structure. The wires were transposed in accordance with a design⁴ providing low crosstalk values at the frequencies used in carrier operation as well as within the voice range.

In determining the location of repeater stations for the telephone circuits, direct current telegraph and carrier systems, it was neces-

⁴"Carrier Current Telephony and Telegraphy," E. H. Colpitts and O. B. Blackwell, *Journal A.I.E.E.*, Vol. XL, No. 5, May, 1921.

sary to consider the economical limit of attenuation loss in each repeater section, the degree of balance to be obtained between the line impedances of the different sections and the corresponding balancing network impedances, and the proper transmission levels, as well as the limited choice of points where it would be practicable to maintain these stations from an economy and maintenance force standpoint. Fig. 3 shows the layout of through circuits on the southern transcontinental line and a transmission level diagram of the Chicago-Los Angeles telephone circuit, indicating the location and spacing of repeater points, attenuation losses in the different sections and amplification of repeaters.

Impedance Characteristics. It has been practicable in the construction of the new facilities to avoid long sections of intermediate or entrance cable except at a few points and in general, very smooth impedance characteristics of the different repeater sections have been obtained. At the points where appreciable lengths of cable could not well be avoided, a special type of loading⁵ has been designed

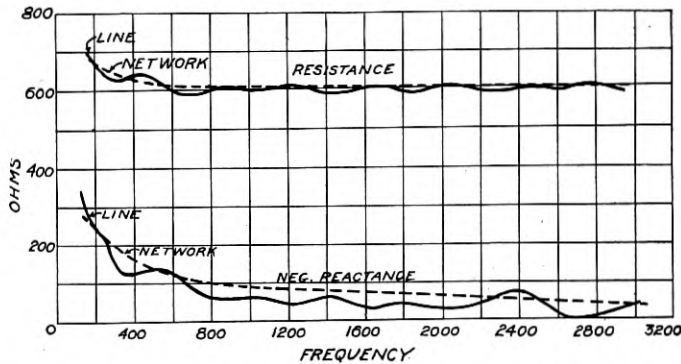

Fig. 4—Impedance Characteristic 216 Mile Repeater Section Non-Loaded 165 mil Physical Circuit (Circuit Terminated to Appear as Infinite Line)

for the purpose of raising the impedance of the cable circuits to values that match the impedance of the open wire at the carrier frequencies as well as at voice frequencies. This loading also is of particular benefit in reducing the attenuation loss at carrier frequencies which in non-loaded cable may be comparatively high.

The impedance characteristic of a typical repeater section 216 miles long is shown by the heavy lines in Fig. 4. The circuit in this case is terminated at the distant end by a network which makes it

⁵ Refer to paper on "Carrier Current Telephony and Telegraphy," by Colpitts and Blackwell, previously noted.

appear as an infinitely long line. The slight irregularity indicated by the humps in the impedance curve is due to a short section of non-loaded entrance cable at the distant end. Fig. 5 shows the same section of line terminated at the distant end by the impedance of the repeater into which it normally works. The impedance character-

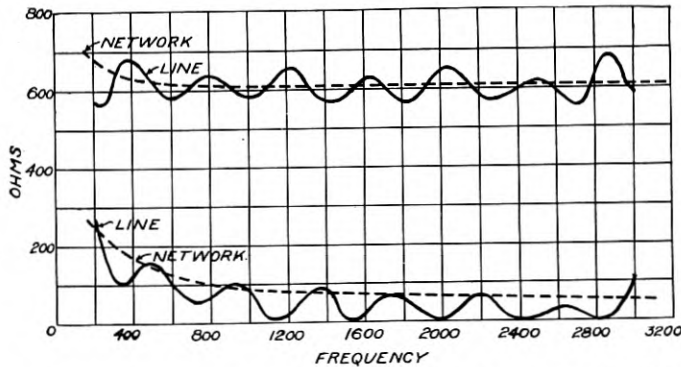

Fig. 5—Impedance Characteristic 216 Mile Repeater Section Non-Loaded 165 mil Physical Circuit (Terminated at Distant End by Passive Impedance of Adjacent Repeater)

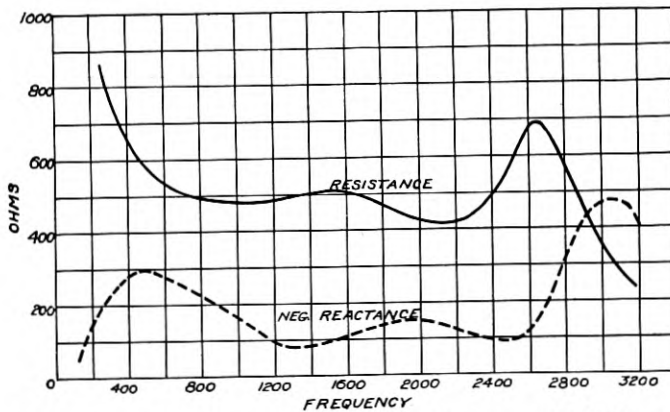

Fig. 6—Passive Input Impedance Characteristic of Improved "22" Type Repeater

istic of the repeater is shown in Fig. 6. The dotted curves in Figs. 4 and 5 are the impedance components of the network used to balance the line circuit. This network is of the precision type,⁶ designed for use in connection with long non-loaded open wire circuits which employ repeaters amplifying a wide band of frequencies.

⁶ "Telephone Repeaters," by B. Gherardi and F. B. Jewett, A.I.E.E. Transactions, Vol. XXXVIII, No. 11, November, 1919. See also "Impedance of Smooth Lines and Design of Simulating Networks," Ray S. Hoyt, *Technical Journal*, April, 1923.

Transmission Characteristics of Line and Repeater. Fig. 7 shows the attenuation frequency characteristic of a typical repeater section expressed in TU .⁷ The amplification frequency characteristic of the telephone repeater shown in Fig. 8 is such as to compensate for the inverse characteristic of the line circuit so that the over-all transmission characteristic of the circuit will be uniform over the important frequencies of the speech range as illustrated by Fig. 9.

Signaling. On the shorter of these circuits employing only a few repeaters, signaling current is relayed at each repeater point, new energy being sent into the adjacent section of the line by the operation of relays associated with the repeater. 135-cycle current is used for the signaling current sent over the line, this being the frequency commonly used for signaling over composited circuits. On longer circuits employing several repeaters, the time lag of the ring can be decreased by a system employing a combination of amplified and relayed ringing at alternate repeater stations. At points where the ring is amplified, it is necessary to increase the repeater amplification at 135 cycles in order that sufficient ringing energy may reach the relaying repeater point to operate the ringing relays. This is accomplished by making slight changes in the input circuit of the repeater to increase its efficiency at the lower frequencies as illustrated by the dotted curve in Fig. 8. Best results are obtained by relaying at alternate repeater points.

At each relayed ringing point a certain time interval is required for the operation of the relays and for this reason the length of time during which the ringing current is applied to the line may become less and less for each succeeding repeater. If the ring, therefore, is not of sufficient duration, it is likely that sufficient ringing energy to operate the line signal will not be received at the distant terminal. This has introduced some operating difficulties and made it necessary to exert great care in the maintenance of the apparatus at the intermediate as well as at the terminal stations involved and careful overall checking and lining up of the circuit as a whole.

There has been developed a system employing signaling currents of voice frequency which has largely overcome these difficulties. The signaling current is amplified by the repeaters with approximately the same efficiency as the voice currents so that relaying is unnecessary. Particular attention has been given in the design of the system to preventing false operation of the signals from voice or extraneous currents.

⁷ See article in this issue "The Transmission Unit and Telephone Transmission Reference System," by W. H. Martin.

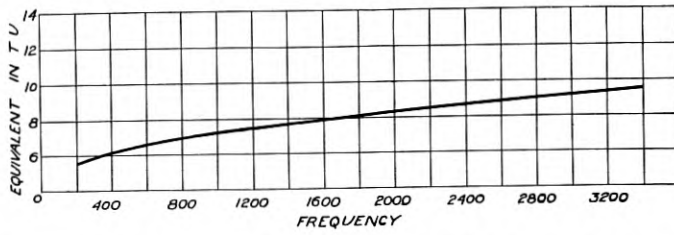

Fig. 7—Transmission-Frequency Characteristic 216 Mile Repeater Section of Non-Loaded 165 mil Physical Circuit

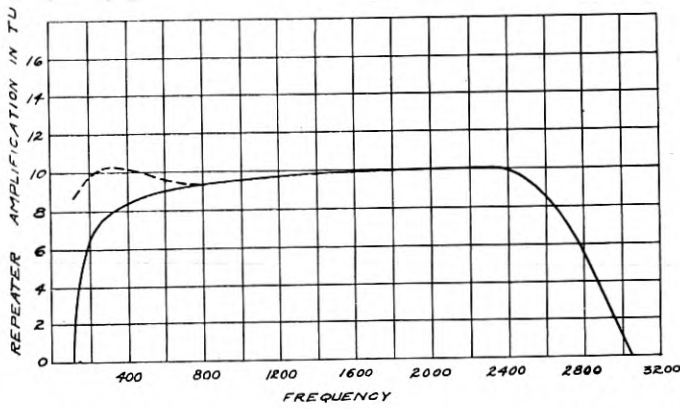

Fig. 8—Amplification-Frequency Characteristic of Improved "22" Type Repeater

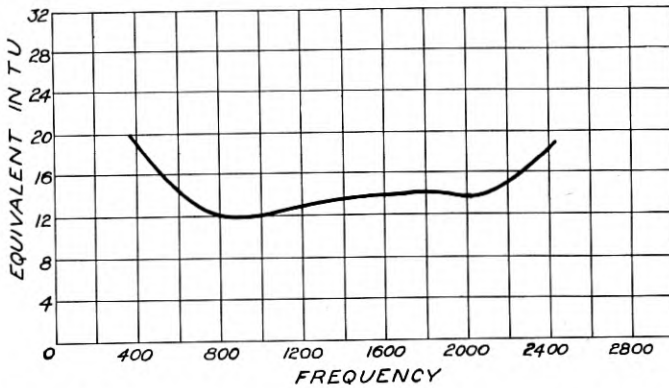

Fig. 9—Overall Transmission-Frequency Characteristic of Long Non-Loaded 165 mil Circuit Denver to Los Angeles

At the present time this system of voice frequency signaling is employed for regular use on the Chicago-Los Angeles circuit and a few others. The system employing 135-cycle current alternately relayed and amplified at repeater points also is installed on these circuits and probably will be retained for emergency use and to permit temporary changes in circuit layout.

Maintenance. The continuity of the many important services routed over the facilities used in making up these long circuits is dependent upon continuous and efficient maintenance methods and performance. Coordination of the work of the different offices is most essential in order to obtain best results, especially on the longer direct circuits and on those built up by the connecting together of several circuits, as there are a large number of variable factors. To assist in obtaining best results, accurate records of the circuit make-up

TOLL CIRCUIT LAYOUT RECORD														FORM 6-228	
CIRCUIT NO. 1		Chicago (MP)			Los Angeles			EQUIVALENT	CIRCUIT ORDER 5817		ITEM 3				
CONTROL OFFICE Chicago		CLASSIFICATION VI			COMPUTED 12.0		DATE IN SERVICE		MEASURED 12		CARD ISSUE NO. 1		DATE 4-17-24		
FROM	TO	CABLE OR LINE	PAIRS OR PINS	SIZE OF WIRE	LOADING	LENGTH	EQUIV.	ON SIDE	ON PWR. 10	ON PHAS. 11	FOR 12	CR 13	AMBA 14	OTHER 15	TOTAL LOSS (200-10) 16
C (Chicago)	Morl Pk.	1 Chgo-MP Ca	127	16	M	7.60	1.4								RL 80
D Morl. Pk.	P7415	Chicago-Omaha	9-10	165	N	175.3	6.1		55D			TS			KX .05
E P7415	P7445-1/2	" "	9-10	165	N	.7	.0								
F P7445-1/2	Davenport	Cable	7	13	N	.06	.0								KX .10
G Davenport	P7445-1/2	"	63	13	N	.06	.0								
H P7445-1/2	P7557	Chicago-Omaha	35-36	165	N	2.1	.1								
J P7557	P7741-1/2	" "	25-26	165	N	4.5	.2								
K P12976	P9047-1/2	St. L.-Dav.	5-6	165	N	83.4	2.9								
L P9047-1/2	Burlington	Cable	5	10	N	.51	.2	75A				TS			.90
M Burlington	P9047	"	15	13	N	1.03	.5	75A				TS			.90
N P9047	P7903-1/2	St. Louis-Dav.	15-16	165	N	29.5	1.0								
P P1	P612	Burl.-Kan. City	5-6	165	N	14.7	.5								
Q P612	P1578	" "	5-6	165	N	23.0	.8								
R P1578	P5634	" "	5-6	165	N	26.2	3.4								
TOTAL								Required Equ. 12.0		TOTAL					

STATION	CLASS	WIRING	IMP.	TELEPHONE REPEATER DATA								RINGING ON 2-W SIDE OF 4-W TERM. EQ.	DISTRIBUTION			
				CHAS. TO STEP	REPT.	R.O.D.	REPT.	CHAS. TO STEP	REPT.	R.O.D.	REPT.		OFFICES	BY	TER.	TRM. EQ.
T				Req.		Req.	Req.		Req.				Chicago	*	*	*
Morl. Pk.	CC		H				3	17F	25				Morl. Pk.	*	*	*
Burlgtn.	TL1	AMP.	N	11.8		17F	BL	25	11.8		17F	BZ	25			Burlingt.
Kans. City	TL1	135	N	11.9		17F	BU	25	11.9		17F	DQ	25			Omaha
Newton	TL1	AMP.	N	11.8		17F		21	11.8		17F		25			Kans. Cty
													(over)			

Fig. 10

from end to end, including a complete description of the types of equipment and transmission data are prepared and furnished to the terminal and repeater stations. These are made on cards of convenient size, as illustrated by Fig. 10, which is one of the five cards for the Chicago-Los Angeles circuit. To insure proper functioning of the circuit and satisfactory overall transmission and signaling one of the terminal offices of each circuit is designated as the controlling office for that circuit and is responsible for the direction and super-

vision of tests and adjustments required on the circuit as a whole. In addition to the duties in connection with the maintenance of the circuit as a whole each office along the circuit is responsible, of course, for the proper physical maintenance of the plant in its territory.

High grade maintenance is necessary to reduce to a minimum, service interruptions, noise and crosstalk and fluctuations in circuit characteristics and equivalents. An important part of this work consists of frequent periodic inspections, measurements⁸ of insulation resistance, loop resistance, resistance balance, transmission, noise and crosstalk and equipment parts which are subject to variation.

In order to make many of the measurements and tests it is necessary to remove the circuit from service. This would result in considerable lost circuit time if each of the stations made such measurements and tests independently. In order to minimize this lost circuit time, therefore, it has been found desirable in the case of long telephone circuits of this type to institute what is known as "co-ordinated testing" procedure. Under this procedure a definite time is set aside for the periodic tests and all repeater stations and both terminal stations co-ordinate their work under the direction of the controlling office. The success of this system is dependent upon each station doing its part of the work correctly and within a specified time allowed for each test. The method of conducting the tests is illustrated in the following description.

1. *Roll Call*—The tester at the controlling office first calls the roll, starting with the first station and proceeding through to the distant terminal, each station replying by name and giving the temperature and weather conditions.
2. *Repeater Amplification and Vacuum Tube Tests*—The tester at each station measures the amplification in both directions given by the telephone repeater at that point and checks the condition of the vacuum tubes.
3. *Balance Tests*—At each repeater station the degree of balance between the line circuit and the balancing network circuit is checked in both directions. Since it is necessary that each section of the circuit be terminated at the opposite end from the station making the balance tests, alternate repeater stations terminate the circuits and the other stations proceed with their balance measurements. The procedure is then reversed.

⁸ For description of these tests and their application see article in this issue "Electrical Tests and Their Applications in the Maintenance of Telephone Transmission," by W. H. Harden.

4. *Transmission Equivalent*—When the balance tests have been completed, a measurement of the overall transmission loss is made between the terminal stations.
5. *Talking Test*—In order that the quality and volume of transmission from a service standpoint may be determined, a talking test is made over the entire circuit using standard subscriber sets at each end.
6. *Signaling*—As a final check, ringing tests are made over the circuit in both directions to insure that satisfactory signaling is being obtained.

This testing routine has been perfected to such an extent that the circuit need not be kept out of service for more than about 15 minutes even in the case of the longest circuits. Results of measurements over the period of a year on the Chicago-San Francisco circuit are shown in Fig. 11. The overall transmission measurements, which

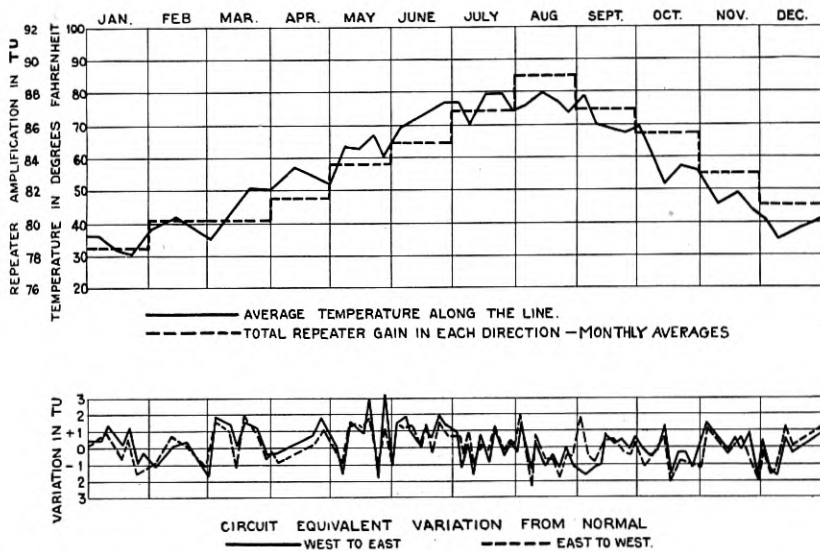

Fig. 11—Monthly Ranges in Temperature and Repeater Gain on the Chicago-San Francisco Circuit

are shown as variations from normal, were made at the conclusion of semi-weekly tests and after any necessary adjustment in repeater amplification had been made to compensate for changes in attenuation loss. The other curves show the average temperature along

the line at the time of tests and the average total repeater amplification from which can be noted the amount of amplification required to offset the variation in transmission equivalent due to seasonal temperature changes.

Conclusion—As mentioned earlier in this paper the data and results given in the foregoing, although applying particularly to circuits on the southern and central transcontinental routes, are also representative of the conditions on other long circuits of the same type. The establishment of these high quality circuits, which are also available for the application of carrier systems and which in certain cases have been so equipped, constitutes another important step in bringing together all sections of the country by telephone.

Vacuum Tube Oscillators—A Graphical Method of Analysis

By J. W. HORTON

INTRODUCTION

THE vacuum tube oscillator is fast becoming one of our most versatile circuits and the requirements which are being imposed upon it are constantly increasing in severity. In some cases it is asked to efficiently convert several kilowatts of direct current power to alternating current power. At other times, it may be called upon to deliver an alternating current having a frequency which shall remain constant within extremely narrow limits. It may be required to operate at a few cycles per second or at several million.

The question of frequency stability has recently taken on considerable importance. The need for currents of accurately known frequency is being felt in all branches of the electrical communication art, particularly in the field of multiplex transmission over wires by means of carrier currents and in radio broadcasting. The factors affecting the frequency of an oscillator will for this reason be given attention in the following discussion.

The operation of a vacuum tube oscillator or, in fact, of any system maintained in continuous oscillation, has certain unique features. In order for such a system to be in stable equilibrium its several elements must adjust themselves until certain necessary conditions are established. It is important, in an analytical study of oscillators, to know the manner in which this adjustment takes place.

If any operating condition may be defined by an equation made up of independent variables, it is a relatively simple matter to predict the result of changes in a single one. When, however, a change in one quantity is accompanied by a general readjustment of all the others, it is quite difficult to obtain a clear picture of what occurs from an equation. Graphical methods are better suited to a study of the manner in which a number of inter-dependent variables arrive at an equilibrium condition. Such a graphical treatment will be described in the following paragraphs and its application to the design of a circuit to perform certain specified duties will be discussed.

GRAPHICAL METHOD FOR DETERMINING CONDITIONS OF STABLE OPERATION

It is sometimes convenient to think of an electrical transmission system as being made up of a number of units, each delivering energy

to the next succeeding unit, and thereby controlling the energy which that unit, in turn, delivers to the next. In case such a unit is made up of a vacuum tube amplifier circuit with its associated power supply batteries, it will be capable of passing on to succeeding units a greater amount of energy in a given time than it receives from preceding units. If a transmission unit does not contain some source of energy, it will, in general, deliver less power than it receives. In many cases these units may be arranged so as to form a complicated network. Whenever in such a network, a group of units forms a closed loop, that particular group is said to constitute a regenerative system. If a regenerative system is capable of maintaining a continuous flow of energy around the loop without receiving energy from any unit

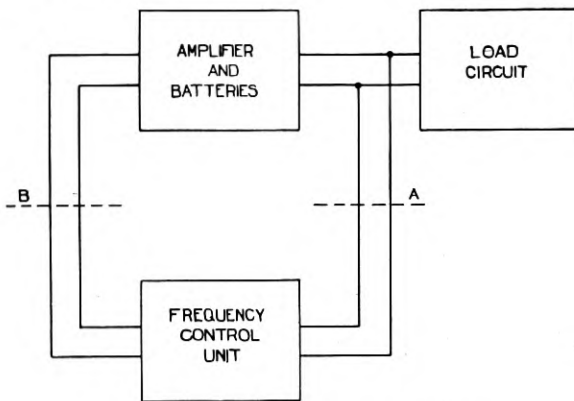

Fig. 1—Elements of an oscillating system

of the transmission network external to the loop, the system is said to be oscillatory.

For the purpose of this discussion let us think of an oscillatory system as made up of three units, the amplifier with its associated power supply source, a frequency control unit and an energy absorbing load unit. The arrangement of these units is as shown in Fig. 1. Now it is quite possible to determine the individual characteristics of the amplifier and of the frequency control units considered separately. The problem is to find the relation between these individual characteristics and the characteristics of the system.

In order that the regenerative circuit shall be in stable equilibrium, there are two conditions which must be met. The first of these is that the increase in power from the point *B* to the point *A*, through the amplifier unit, must be exactly equal to the decrease in power from the

point *A* to the point *B*, through the frequency control unit. Due account must be taken of any energy delivered to the load circuit. In other words, when a given amount of energy flows into the amplifier across the junction *B*, it must be transmitted around the regenerative loop and returned to this junction unchanged in amount. The second condition is that the phase displacement of the wave transmitted from *A* to *B* through the frequency control unit must be equal in amount and opposite in sign to the phase displacement of the wave transmitted from *B* to *A* through the amplifier. That is, a wave which enters the amplifier at the junction *B* must be transmitted through the regenerative system and returned to this junction with no resultant phase displacement.¹ The individual characteristics of the amplifier and of the frequency control unit which permit these two conditions to be satisfied fix the operating point of the system.

Although the reasoning to be used in the succeeding paragraphs may, in general, be applied to any oscillatory system, it will be easier to follow if described in terms of familiar electrical circuits. In Fig. 2

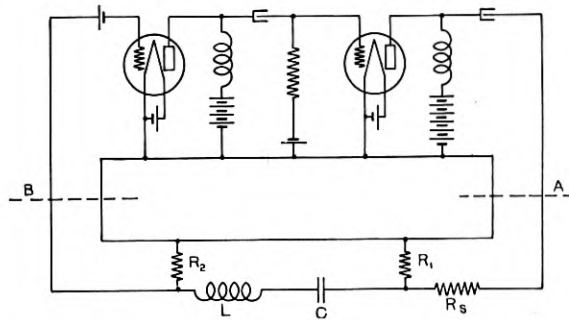

Fig. 2—Circuit of an elementary oscillator

the amplifier and associated batteries are shown in the form of an elementary vacuum tube circuit. It is necessary to use a two-stage circuit if the voltages at *A* and at *B* are to have the same sign. This is because the grid voltage, which is obtained as a potential drop due to current from an external source flowing through a resistance connected between the grid and the filament of the vacuum tube, reduces the current flowing from the filament of the tube to the plate, through a second external resistance, as the current flowing from the grid to the filament is reduced. That is, a change in the voltage drop across

¹ This condition for stable equilibrium will also be satisfied if the total phase shift around the loop is equal to $2\pi n$ where n may be any whole number.

the grid circuit resistance causes a change of opposite sign in the voltage drop across the plate circuit resistance, the two voltage drops being referred to the potential of the filament. The frequency control unit is in the form of a series circuit containing inductance, capacity, and resistance. Two resistance elements are used for coupling to the input and to the output of the amplifier.

Let us first consider the properties of the vacuum tube amplifier. In Fig. 3 the voltage developed across the junction *A* is plotted as a function of the voltage across the junction *B*. Let us assume, for the present at least, that this curve holds for all frequencies. Obviously

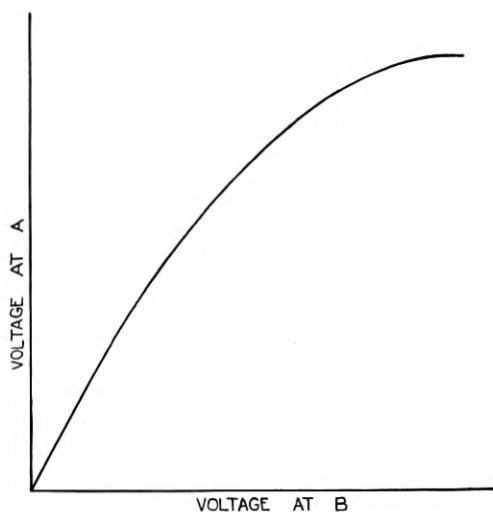

Fig. 3—Amplifier output characteristic

the voltage across the junction *A* depends upon the impedance looking into the frequency control unit, but if the resistance R_1 is small in comparison with the resistance R_s , the voltage will be practically independent of the frequency control unit. This curve represents a familiar characteristic of the vacuum tube amplifier. It shows that as the voltage upon the grid of the first tube is increased, a point is reached where the amplitude of the output is no longer proportional to the amplitude of the input. If this is carried far enough a point is ultimately reached where a continued increase in the voltage on the grid fails to produce any further increase in the voltage across the output. For our present purpose the data contained in this curve will be more useful if plotted in a less familiar form.

In Fig. 4 the ratio of the voltage across the junction *B* to the voltage across the junction *A* is plotted as a function of the voltage across the junction *A*. This curve is obtained from the same data as the curve of Fig. 3 and tells the same story. Assuming that this curve holds for all frequencies a family of curves may be plotted for the amplifier unit, as shown by the horizontal lines in Fig. 5. In these

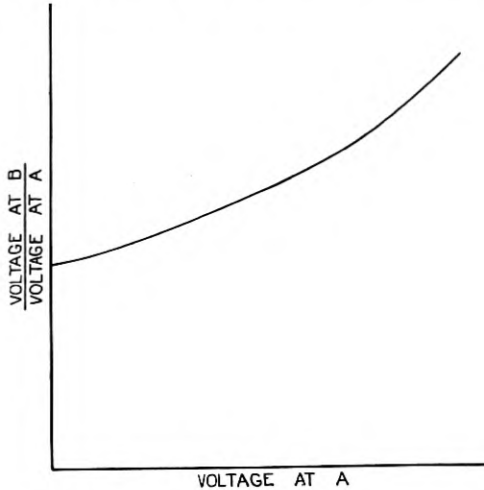

Fig. 4—Amplifier gain characteristic

curves the ratio of the voltage received by the unit to the voltage delivered by it is plotted against frequency. The numbers associated with each curve indicate the voltage at *A*, in arbitrary units, for which the curve holds.

A similar family of curves may be plotted for the frequency control unit. Since the impedance of the series resonance circuit varies with frequency from relatively high values above and below the resonance frequency to a minimum value at the resonance frequency, it follows that, for a fixed voltage across the junction *A*, the current through the inductance, the capacity and the resistance R_2 will vary with frequency. Consequently the voltage drop across the resistance, which is impressed across the junction *B*, will vary with frequency. The relation between this voltage and frequency, for a fixed voltage across the junction *A*, is given by the familiar resonance curve. As the voltage across the junction *A* is increased, currents of considerable magnitude may be caused to flow through the inductance, particularly in the neighborhood of the resonance point. If this

inductance has an iron core an increase in the current will result in increased damping which, at a fixed frequency, acts to reduce the ratio between the voltage set up across the resistance R_2 and the voltage impressed on the junction A . The resonance curves given

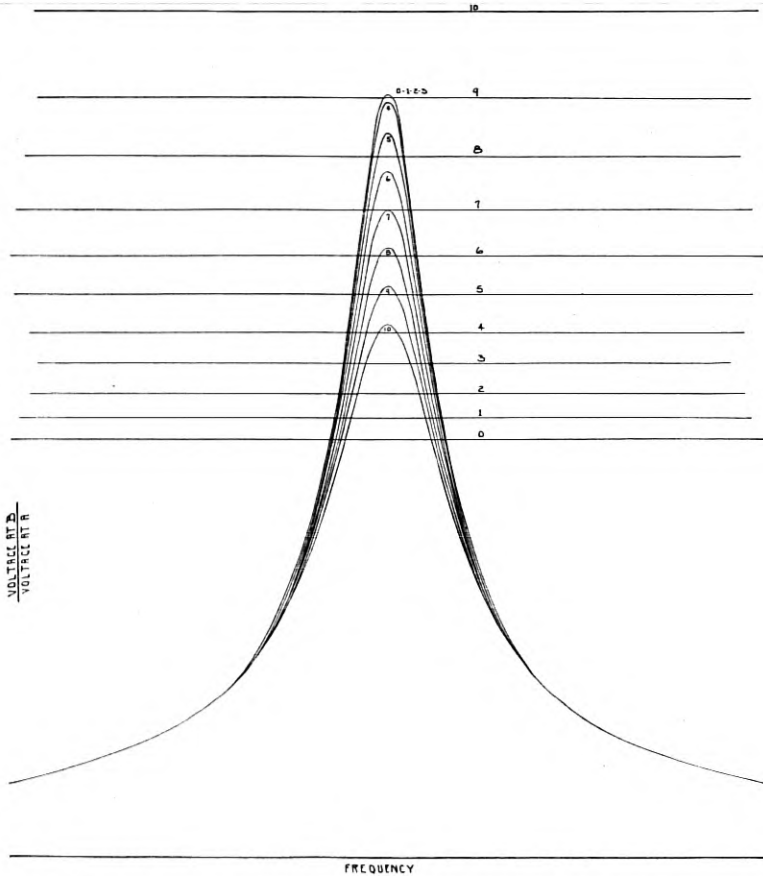

Fig. 5—Families showing relation between power gain, or loss and frequency for various power levels

in Fig. 5 show the relation between the ratio of the voltage across the junction B to the voltage impressed upon the junction A and frequency. The numbers again indicate the voltage at A , in the same arbitrary units as were used for the amplifier family.

Selecting any of the values given for the voltage across the junction A , it will be found that there are two curves showing the relation between the ratio of the voltage at the junction B to that at the

junction *A* and the frequency. One of these is a characteristic of the amplifier, the other of the frequency control unit. It is, of course, apparent that the voltage across any junction in a transmission system may be taken as a measure of the rate at which energy crosses this junction. Therefore, points of intersection of these lines satisfy the first condition which was imposed upon the oscillating system in order that it should be in stable equilibrium, namely, that the increase of power through one portion should be equal to the decrease in power through the remaining portion. Such points of intersection define values for the amplitude of the voltage at the junction *A* and of the frequency for which this condition is met. Similar pairs of lines, plotted for other values of the amplitude of the voltage at the junction *A*, have intersections indicating the corresponding frequency for which the energy relations are again satisfied. For each of these points, then, the amplitude of the voltage at *A*, the frequency and the ratio of the amplitude at *B* to the amplitude at *A* have the same values for the amplifier unit that they have for the frequency control unit. In the curve *A*, of Fig. 6, the first of these

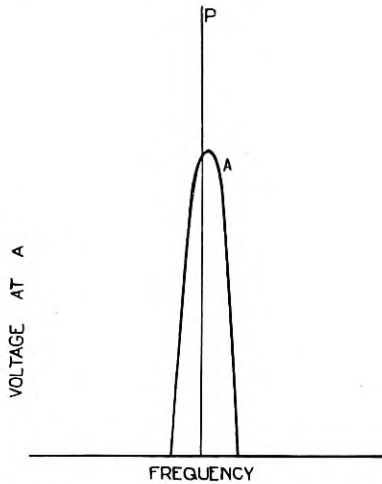

Fig. 6—Amplitude and phase equilibrium curves

variables is plotted against the second. The curve, therefore, shows the magnitude of the voltage delivered by the amplifier unit which, for a given frequency of the wave transmitted by the system, permits energy equilibrium to be maintained.

If energy considerations alone determined the stability of the oscillating system, it would appear that the operating point might be anywhere along this line. It is necessary, however, to consider the phase displacements occurring in the two units as well. The phase difference between the voltage across the output resistance of the frequency control unit and the voltage impressed across the junction *A* varies with frequency as indicated by the family of curves shown in Fig. 7. The assumption is made in drawing these curves

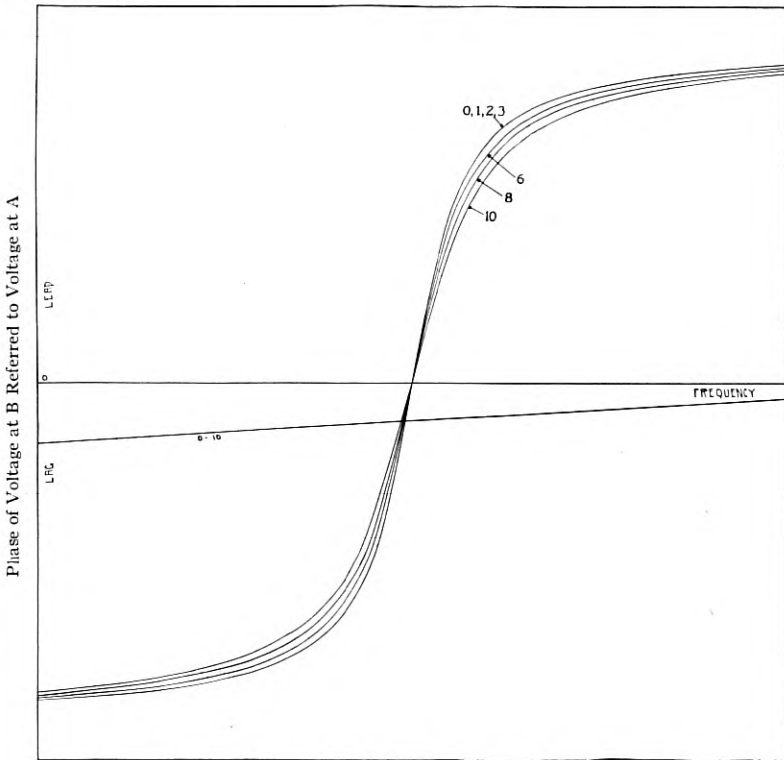

Fig. 7—Families showing relation between phase displacement and frequency for various power levels

that the change in damping is due entirely to a change in the resistance of the coil and that the inductance and the natural frequency of the circuit are unaltered as the load is increased. For low damping in the resonant circuit the phase shift changes rapidly with frequency in the neighborhood of the resonance point. As the amplitude of the voltage across the junction *A* is increased, thereby

increasing the damping, the rate of change of this phase shift is reduced. The several curves correspond to different values of the voltage amplitude at the point *A*.

The phase relation between the voltage wave impressed upon the input to the amplifier and the wave delivered by it is indicated in Fig. 7 by the single straight line. That is, we are assuming that the phase displacement of the wave transmitted through the amplifier varies but little over the frequency range covered by the diagram and that it is independent of the power which is being delivered by the amplifier. The numbers associated with the several curves have the same significance as those used with the power ratio families.

From these two sets of lines it is possible to determine a series of values of the voltage at the junction *A* and of the frequency for which the resultant phase displacement around the loop is zero; exactly as we determined a series of values for which the resultant power change was zero. These values are plotted in Fig. 6 as shown by the line *P*. If the condition for zero phase shift were the only one which the system had to satisfy, it is obvious that it would be in equilibrium at any point on this curve. Since, however, the system is called upon to satisfy two conditions, one defined by the curve *A* and the other by the curve *P*, any intersections which they may have are the only points at which the system can be in equilibrium.

This method of analyzing the relations between the characteristics of the several members of an oscillating system, and their mutual adjustment to an equilibrium condition may be summarized in general terms. The system is considered as a regenerative transmission circuit divided into two portions. For each of these portions a family of curves is plotted showing the relation between the rate at which energy crosses one of the junctions, which will be used as a reference point, the ratio between the rates at which energy crosses the two junctions and the frequency. Any two of these variables may be chosen as the coordinates for these families of curves, the remaining variable being the parameter. The intersections of a curve in one family with the curve of the same parameter in the other family define pairs of values of the frequency and of the power at the reference junction for which the system is in energy equilibrium.

For each portion of the regenerative system, a second family of curves is plotted showing the relation between the power at the reference junction, the phase displacement of the transmitted wave between the two junctions and frequency. Intersections of a curve in one of these families with the curve having the same parameter

in the other family define pairs of values of the frequency and of the power at the reference junction for which the system is in phase equilibrium.

The relations between these two quantities—frequency and power—may be expressed by two curves, one indicating the values necessary for energy equilibrium, the other indicating the values necessary for phase equilibrium. The intersections of these curves correspond to the only values meeting both conditions. The several elements must, therefore, adjust themselves to operate at the frequency and at the power indicated by such an intersection.

EFFECT OF VARIATIONS IN CIRCUIT ELEMENTS

In addition to determining the frequency and power at which a given system is in stable equilibrium, it is important to be able to predict the effect upon these quantities of such changes as may be expected to occur in the elements composing the system. It is then a relatively simple matter to so redesign these elements that some particular effect shall be reduced, or increased, as desired. The circuit which has already been described may be used for illustrating the application of the graphical method in answering some of the questions occurring most frequently in connection with vacuum tube oscillators.

One of the more important problems concerns the reaction on the oscillating circuit of the load absorbing system. Let us imagine that an impedance, to which energy is to be supplied, is connected across the junction *A*. If this impedance is a complex quantity it will alter both the amplitude and the phase of the voltage across the junction. This will affect both families of curves—Figs. 5 and 7—which define the operation of the amplifier. If, for simplicity in the present discussion, we assume the load impedance to be a pure resistance, the major change will be a reduction in the voltage across *A* for a given voltage across *B*. The ratio of the voltage at *B* to that at *A* will be increased and the family of curves defining the power ratio relations between frequency and power ratio in the amplifier will thus be moved upward. The reaction upon the energy equilibrium curve—curve *A*, Fig. 6—will be to decrease both its height and its breadth. Assuming that the phase equilibrium curve remains unchanged, it is apparent that the frequency at which the system is in stable equilibrium will be increased and that the power delivered to the junction *A* will be decreased. Any change affecting the amplification of the vacuum tube circuit would react in much the same way.

Another question concerns the effect upon the amplitude at which the system operates as its frequency is altered by readjustment of the frequency control elements. If, for example, the capacity in the series resonant circuit is increased, the resonance curves of Fig. 5 will move to the left. Their shape also will be altered very slightly. Since the power ratio curves defining the operation of the amplifier are horizontal straight lines there will be a correspondingly slight change in the shape of the curve indicating the possible conditions for energy equilibrium. It will, of course, be displaced to the left by the same amount as are the resonance curves. If, however, the resistance of the resonant circuit varies directly with frequency, as it might through changes in hysteresis and eddy-current losses, the current through the series resonant circuit and through the resistance, R_2 will be increased. This increases the ratio of the voltage across B to the voltage across A and consequently lengthens the ordinates of the resonance curves shown in Fig. 5. The shapes of the curves will also be changed due to the change in the ratio of the reactance to resistance. Under these conditions the energy equilibrium curve, in addition to being moved to the left, will be increased both in height and in breadth.

The phase curves of the frequency control unit—Fig. 7—will be moved to the left by the same amount as the resonance curves. Due to the slope of the phase family of the amplifier which we have assumed to be coincident straight lines, the intersections of the two phase families must move away from the point of zero phase displacement. The separation between the members of the phase family of the frequency control unit is greater here and consequently the phase equilibrium curve is less nearly vertical than before. The slope of the phase family of the amplifier also causes the phase equilibrium curve to move to the left by a slightly greater amount than the displacement of the resonance point of the tuned circuit. It is apparent, therefore, since the phase equilibrium curve moves farther than the amplitude equilibrium curve, that their intersection will move to a position corresponding to a lower value of the voltage at the junction A . This is true, of course, only if the change in the shape of the amplitude equilibrium curve due to the change in resistance of the inductance coil is small. It is also evident that the change in the frequency of the current delivered by the oscillator is greater than the change in the resonant frequency of the inductance and capacity.

These two examples are undoubtedly sufficient to demonstrate how a change in the constants of a single element of an oscillating system

necessitates a general readjustment of the other elements and how this readjustment reacts upon the operating point.

During the last few years the need for oscillating circuits of exceptionally high frequency stability has become more and more pressing. The requirements of multiplex telephony and telegraphy by means of carrier currents set particularly severe limits on the constancy of frequency of the alternating currents used. The efficient use of the ether in radio communication also places a very narrow tolerance upon any frequency variation in the carrier generators. It may be of interest, therefore, to consider some of the fundamental factors affecting the frequency stability of the vacuum tube oscillator.

Two lines of attack are open; we can design the several elements so as to reduce the possibility of a change in the value of their constants, or we can adjust the system so that unavoidable changes produce the least effect. It is in this latter connection that the graphical method of analysis is particularly helpful.

A change in the constants of any element of the oscillating system is going to result in a displacement or in a change in shape in at least one of the two equilibrium curves shown in Fig. 6. For a given change in either curve the horizontal displacement of their intersection will depend upon the slope of the other curve. The steeper one curve is, the less will be the frequency change resulting from any variation in the other. It, therefore, follows that we should make both curves as nearly vertical as possible.

Referring to the gain and loss families, Fig. 5, it will be seen that the slope of the amplitude equilibrium curve, and consequently the magnitude of the frequency change corresponding to a given change in the voltage at the reference junction, is determined by three things:

1. The separation between the lines defining the power gain in the amplifier; the less this separation, the less will be the frequency change accompanying a given change in the voltage.
2. The separation between the resonance curves defining the power loss in the frequency control unit; the less this separation, the less will be the frequency change accompanying a given change in the voltage.
3. The slope of the resonance curves; the steeper these curves, the less will be the frequency change accompanying a given change in voltage.

It appears then, that the change in frequency resulting from a given change in phase displacement, that is, accompanying any change in the phase equilibrium curve, may be reduced by operating

the vacuum tubes considerably below their overloading point, where the gain changes but little as the output is increased; by operating the tuned circuit at low power levels, where the damping, and consequently the loss, varies but little with changes in the input; and by keeping the damping as low as possible.

The slope of the amplifier gain family is, of course, a factor, but in practice it is found undesirable to permit the gain of the amplifier to vary with frequency. The slope of the phase equilibrium curve, which determines the change in frequency corresponding to a given change in transmission gain or loss, depends upon three things, as may be seen from Fig. 7. These are:

1. The distance from the point of zero phase displacement at which the phase family of the amplifier intersects the phase family of the frequency control unit; the less this distance, the less will be the frequency change accompanying a given voltage change.

2. The slope of the phase family of the frequency control unit; the more nearly vertical these curves are made, the less will be the frequency change accompanying a given voltage change.

3. The separation between the members of the phase family of the frequency control unit; the less this separation, the less will be the frequency change accompanying a given amplitude change.

If the phase family of the amplifier is not a single line, the separation between its members would be a factor. The slope of the curve also has a slight effect. The distance from the point of zero phase displacement, at which the two families intersect, may be reduced by reducing such reactive impedances as appear in the amplifier circuit. The slope of the frequency control unit family may be increased by reducing the damping of the tuned circuit. It may also be increased by reducing the phase displacement in the amplifier, thereby operating nearer the point of zero phase displacement where the rate of change of phase shift with frequency is greatest. The separation between the members of the phase family of the frequency control unit may be reduced by reducing the magnitude of such changes as occur in the damping. Moreover, since for various amounts of damping the several members of the phase family approach coincidence at the resonance point, it is again desirable to reduce any phase displacement of the amplifier in order to work as near this point as possible.

It has just been suggested that any reduction in the phase shift through the amplifier will make the phase equilibrium curve more nearly vertical. It will be noticed, however, that this causes the intersection between the phase equilibrium curve and the amplitude

equilibrium curve to occur in a portion of the latter where it approaches the horizontal. It would appear desirable, therefore, if frequency stability is to be pushed to the limit, to permit a slight phase displacement to occur in the amplifier in order that the intersection might be located at a place where the amplitude equilibrium curve is steeper. Any decrease in the slope of the phase equilibrium curve will be more than compensated for by the increase in slope of the amplitude curve. It will be apparent from the curves that such an adjustment reduces the amount of frequency change accompanying any change in phase displacement at the expense of amplitude stability. In practice, phase changes can be made smaller than transmission gain changes and we are consequently justified in placing most of the burden of holding the frequency to narrow limits on the phase equilibrium characteristic.

As a result of the foregoing analysis it appears that the amplifier should be designed so that, at the normal operating point, its gain varies but little with load and so that it introduces as small a phase shift as possible. The tuned circuit should have little damping and the variation in damping with load should be reduced to a minimum. Although these conclusions have been based upon the characteristics of a specific circuit, they apply equally well to other circuits of the same general form.

DESIGN OF CIRCUIT FOR HIGH FREQUENCY STABILITY

The arrangement of an oscillating circuit embodying the features which the preceding section has shown to be essential, if the generated current is to be maintained within narrow frequency limits, is given in Fig. 8. The frequency control unit is a shunt resonant

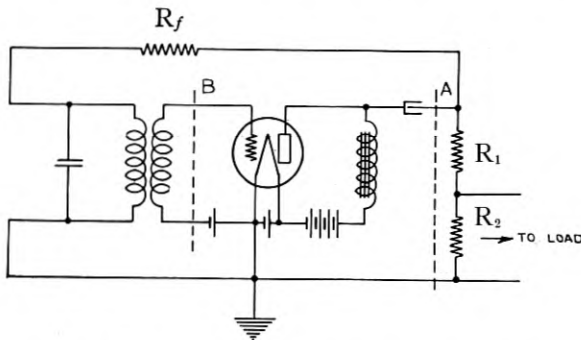

Fig. 8—Circuit of constant frequency oscillator

circuit coupled to the output of the amplifier, at the junction A , by a high series resistance, R_f , and to the input of the amplifier, at the junction B , through a winding coupled directly to the inductance.

The amplifier is designed to have ample load carrying capacity so that its gain varies but little with changes in load. This, as we have seen, is necessary in order to make the amplitude equilibrium curve steep and the frequency less subject to variation through unavoidable changes in phase displacement. Moreover, the voltage which appears at the junction A , as a result of a given voltage impressed upon the junction B , is stabilized by making the sum of the resistances R_1 and R_2 low as compared with the load impedance and with the impedance of the frequency control unit. In particular, R_2 , across which the load is connected, is so small in comparison with the impedance of the load that changes in the latter are entirely negligible. Such an arrangement does not, of course, lead to high efficiency, but we must be prepared to make concessions in one direction in order to secure benefits in another. By making the effective load applied to the tube largely resistance the phase displacement occurring in the amplifier is made very small.

In this circuit it is not necessary to use two tubes to obtain the proper phase relations. At resonance the apparent impedance of the shunt resonant circuit approaches a pure resistance and the voltage drop across it is consequently in phase with the e.m.f. acting in the plate circuit of the tube. The current through the inductance, however, lags 90° behind this voltage. The e.m.f. set up in the oscillator input winding is 90° out of phase with the current in the primary, thus making it possible to secure in the frequency control unit the necessary 180° phase reversal between the plate and grid circuits of the tube. Care must, of course, be exercised to connect the windings of the oscillating coil in the proper direction.

The damping of the resonant circuit may be made small by giving the primary winding of the oscillating coil a high time constant. The coupling impedances introduce additional damping which may be made small by making both the feed-back resistance, R_f , and the input impedance of the tube high. The tube impedance may be made very high by using sufficient negative grid bias to prevent the filament-grid circuit from becoming conductive. Of the two coupling impedances, the feed-back resistance, together with the other impedances associated with the tube output, introduces the greater damping. Now it can be shown that for the frequency control unit to have a given transmission efficiency, the total added damping due to coupling is a minimum when the damping due to the input coupling

is equal to that due to the output coupling. It is, therefore, desirable to make the coupling to the input of the tube as efficient as possible in order to permit the coupling to the output to be reduced. For this reason the mutual impedance of the oscillating coil has been kept as high as is practicable.

By increasing the feed-back resistance the ratio of the voltage at *B* to the voltage at *A* may be reduced, thereby decreasing the ordinates of the power loss family of the frequency control unit—Fig. 5. This affords a control by means of which the system may be adjusted so that both the amplifier and the frequency control unit are operated in regions where their power outputs are nearly proportional to the power inputs or, in other words, where the separation between the members in the gain and loss families is practically negligible.

There is another advantage in keeping the feed-back resistance high. In making it the major element in the network shunted across the resonant circuit, the effect of any variations in the output impedance of the tube or in the load impedance is reduced.

It is evident from an examination of the power ratio families which define the operation of the two elements of the regenerative system that before the system can come into equilibrium, at least one of these elements must enter a region where the relation between the power which it receives and the power which it delivers is non-linear. This means that the wave delivered by this element does not have the same form as the wave received by it. Distortion of this kind is manifest in the presence of harmonics of the fundamental frequencies in the current delivered by the oscillator. In most cases the amplifier is the distorting element and we find in the output all multiples of the fundamental. It has, however, been found advantageous in some instances to so adjust the system that the iron core of the inductance element in the frequency control unit overloads before the amplifier. In this case, the resulting distortion is such that only the odd multiples of the fundamental frequency are present.

By the proper choice of circuit elements, it has been found possible to design commercial oscillating circuits, covering the range of frequencies between 100 and 100,000 cycles per second, in which the frequency is but little affected by changes in elements external to the frequency control unit. In one such commercial oscillator it has been found, for example, that the average deviation in the frequency observed with any one tube from the mean frequency obtained with a number of tubes is approximately 0.02%. In this same circuit, as the plate potential changes from 100 to 150 volts, the frequency change does not exceed 0.04% at any portion of the fre-

quency range. Similarly, if the filament current is changed from 1.1 to 1.4 amperes, the average frequency change is 0.03%. Changes in the frequency resulting from changes in the load impedance are practically negligible.

Such frequency changes as occur in the oscillator referred to above, are due, to a large extent, to variations in the inductance consequent upon the variations in power level which accompany the particular circuit changes referred to. The stability of the system may, therefore, be increased considerably beyond the limits indicated if the electrical constants of the elements used in the frequency control unit are independent of the power level. The use of an air core coil in place of an iron core coil improves the stability to a very marked extent provided, of course, that the same time constant is obtained in both cases.

In oscillators which have been designed primarily for frequency stability, it is found that the largest frequency variation is due to the variation in the electrical constants of the frequency control unit with temperature. When iron core coils are used, the temperature coefficient of frequency of the oscillating system is approximately 0.01% for 1° C. Using suitably designed air core coils, the temperature coefficient of the oscillator becomes approximately 0.003% for 1° C. The change in frequency in this case is due almost entirely to the change in capacity of the mica condensers used in the frequency control unit.

Although the method of analysis which we have just considered has been discussed largely in terms of the relation of the frequency of an oscillating electrical system to the constants of the several members of the system, it is by no means limited to such consideration. It is, in fact, applicable to practically all types of oscillating systems, including those containing mechanically resonant devices. It should, however, be remembered that while an analytical study of this type may assist materially in furnishing a qualitative picture of the conditions existing in some piece of apparatus, it is by no means a substitute for a rigorous quantitative treatment.

Abstracts of Technical Papers¹

*Carrier Telephony on Power Lines.*² N. H. SLAUGHTER and W. V. WOLFE. The fundamental requirements of a telephone circuit are outlined briefly and translated into the terms of the power line carrier telephone problem. Considerable data on transmission line characteristics at carrier frequencies are presented, which clearly show the magnitude of the transmission problem and the best frequency values to employ. The advantages of using the "metallic circuit" arrangement rather than the commonly employed "ground return" arrangement are emphasized.

One of the chief problems in carrier telephony on power lines is to provide an efficient means of connecting the carrier equipment to the power line, and the various possibilities and preferred methods are discussed at some length.

The nature of the circuits and equipment employed are then described, together with an indication of their range of usefulness in power line telephone communication.

*The Nature of Language.*³ R. L. JONES. In introduction, the history of human language is outlined and the manner of speech production is briefly described with special reference to English. Following this is a summary treatment of available data on the subject of speech and hearing. Much of this is the result of investigations carried out during the past few years in the Research Laboratories of the American Telephone and Telegraph Company and the Western Electric Company, at New York.

Human speech employs frequencies from a little below 100 cycles per second to above 6,000 cycles, a range of about six octaves. The ear can perceive sound waves ranging in pressure amplitude from less than 0.001 of a dyne to over 1,000 dynes and in frequency of vibration from about 20 cycles per second to about 20,000, a range of about ten octaves.

The intensities and frequencies used most in conversation are those located in the central part of the area of audition. The energy of speech is carried largely by frequencies below 1,000, but the characteristics which make it intelligible, are carried largely by frequencies above 1,000. Under quiet conditions good understanding is possi-

¹ The purpose of these abstracts is to supplement the contents of the *Journal* by reviewing papers from Bell System sources which relate directly to electrical communication but which will not be reprinted in the *Journal*.

² *Journal A. I. E. E.*, Vol. XLIII, p. 377, Apr., 1924.

³ *Journal A. I. E. E.*, Vol. XLIII, p. 321, Apr., 1924.

ble with undistorted speech having an intensity anywhere from one hundred times greater, to a million times less than that at exit from the mouth. On the whole the sounds, *th*, *f*, *s*, and *v* are hardest to hear correctly and they account for over half the mistakes made in interpretation. Failure to perceive them correctly is principally due to their very weak energy although it is also to be noted that they have important components of very high frequency.

*The Physical Criterion for Determining the Pitch of a Musical Tone.*⁴ HARVEY FLETCHER. This paper describes experiments in which a high quality telephone system was used to reproduce musical sounds from the voice, the piano, the violin, the clarinet and the organ without any appreciable distortion. Into this telephone system electrical filters were introduced which made it possible to eliminate any desired frequency range. Results with this system show that only the quality and not the pitch of such musical sounds changes when a group of either the low or high frequency components is eliminated. Even when the fundamental and first seven overtones were eliminated from the vowel *ah* sung at an ordinary pitch for a baritone, the pitch remained the same. These results were checked by a study of synthesized musical tones produced by ten vacuum tube oscillators, with frequencies from 100 to 1,000 at intervals of 100. It was found that three consecutive component frequencies were sufficient to give a clear musical tone of definite pitch corresponding to 100, and that in general when the adjacent components had a constant difference which was a common factor to all components a single musical tone of pitch equal to this common difference was obtained, but not otherwise. Recent work on hearing has shown that the transmission mechanism between the air and the inner ear has a non-linear response which accounts for the so-called subjective tones. When the components of low frequency are eliminated from the externally impressed musical tone, they are again introduced as subjective tones before the sound reaches the nerve terminals. Calculation of the magnitude of these subjective tones from the non-linear constants of the ear shows that the results on pitch are what might be expected.

Sound spectra of ten typical musical sounds, obtained with an electrical automatic harmonic analyzer to be described by Wegel and Moore, are given for *ah* sung at pitch *d*, *a* sung at *a*, piano *c*₁, piano *c'*, violin *g'*, clarinet *c*, organ, pipe, *c*₁ for three pressures, and organ pipe *c'*.

*Ferromagnetism and Its Dependence Upon Chemical, Thermal and Mechanical Conditions.*⁵ L. W. MCKEEHAN. This review considers

⁴ Physical Review, Vol. XXIII, No. 3, March, 1924.

⁵ Journal of Franklin Institute, V. 196, pp. 583-601; 757-786, 1924.

first the general properties of ferromagnetic bodies and the particular forms of magnetization curves and hysteresis loops exhibited by iron, cobalt, nickel, and their alloys with each other and with other elements. The Heusler alloys are also described. The effects of temperature upon magnetization are then discussed in detail for the case of iron and the behavior of alloys is compared with this as a standard, both reversible and irreversible changes being discussed in some cases. The transient effects of mechanical strains within the elastic limit and the permanent effects of over-strain of the kinds usually met with in practice are considered. The review concludes with speculations in regard to the electronic groups in the atomic structure which are responsible for the occurrence of ferromagnetic properties. One hundred and forty references to recent periodical literature are intended to give starting points for more detailed study of any of the subjects discussed.

*Permeater for Alternating Current Measurements at Small Magnetizing Forces.*⁶ G. A. KELLSALL. This is a description of a permeameter for making alternating current measurements of permeability on toroidal specimens at small magnetizing forces and at telephonic frequencies. It is a special type of transformer with a single turn secondary. The primary consists of a suitable number of turns of insulated copper wire wound directly on a finely divided toroidal magnetic core made of one of the high permeability permalloys. The single turn secondary is an annular copper shell enclosing the primary with an additional space provided for the core to be tested. The copper shell is provided with convenient means for opening and closing. The sample whose permeability is to be determined is interlinked with the open secondary which is then closed. The inductance of the instrument connected as one arm of an inductance bridge is then measured at the primary terminals. From the value thus obtained, the constants of the transformer and the dimensions of the sample, the permeability is computed.

*Furnace Permeater for Alternating Current Measurements at Small Magnetizing Forces.*⁷ G. A. KELLSALL. This is an adaptation of the permeameter previously described for the measurement of permeability at elevated temperatures. It consists essentially of a permeameter with an addition of an annular electric furnace immediately surrounding the sample under test and suitably heat insulated from the other parts of the instrument. Like the simpler permeameter, it measures the permeability of ring samples for small magnetizing forces at

⁶ J. O. S. A. and R. S. I., 8, pp. 329-338, 1924.

⁷ J. O. S. A. and R. S. I., 8, pp. 669-674, 1924.

telephonic frequencies without the necessity of winding magnetizing coils upon them. The maximum temperature at which measurements can be made with this apparatus is about $1,000^{\circ}\text{C}$. By filling the unheated furnace with liquid air, a minimum temperature of -190°C is attainable making the whole range of the instrument about $1,200^{\circ}\text{C}$.

The changes introduced in order to adapt to permeameter for measurements at different temperatures do not impair its accuracy, the determination of permeability at both high and low temperature having the same precision as at room temperature.

Contributors to this Issue

W. H. HARDEN, B.E.E., University of Michigan, 1912; Engineering Department, American Telephone and Telegraph Company, 1912-1919; Department of Operation and Engineering, 1919—. Mr. Harden has been engaged in the development of transmission maintenance testing methods and in the preparation of routines and practices required for applying these methods in the telephone plant.

JOHN R. CARSON, B.S., Princeton, 1907; E.E., 1909; M.S., 1912; Research Department, Westinghouse Electric and Manufacturing Company; 1910-12; instructor of physics and electrical engineering, Princeton, 1912-14; American Telephone and Telegraph Company, Engineering Department, 1914-15; Patent Department, 1916-17; Engineering Department, 1918; Department of Development and Research, 1919—. Mr. Carson's work has been along theoretical lines and he has published several papers on theory of electric circuits and electric wave propagation.

W. H. MARTIN, A.B., Johns Hopkins University, 1909; S.B., Massachusetts Institute of Technology, 1911. American Telephone and Telegraph Company, Engineering Department, 1911-19; Department of Development and Research, 1919—. Mr. Martin's work has related particularly to loading, quality, and transmission of telephone sets and local circuits.

C. W. SMITH, B.S.E., University of Michigan, 1916; Chicago Telephone Company, 1916-20; American Telephone and Telegraph Company, Engineering Department and Department of Operation and Engineering, 1920—.

RAY S. HOYT, B.S. in electrical engineering, University of Wisconsin, 1905; Massachusetts Institute of Technology, 1906; M.S., Princeton, 1910. American Telephone and Telegraph Company, Engineering Department, 1906-07. Western Electric Company, Engineering Department, 1907-11; American Telephone and Telegraph Company, Engineering Department, 1911-19; Department of Development and Research, 1919—. Mr. Hoyt has made contributions to the theory of transmission lines and associated apparatus, and more recently to the theory of crosstalk and other interference.

KARL K. DARROW, S.B., University of Chicago, 1911; University of Paris, 1911-12; University of Berlin, 1912; Ph.D., in physics and mathematics, University of Chicago, 1917; Engineering Department, Western Electric Company, 1917—. At the Western Electric, Mr. Darrow has been engaged largely in preparing studies and analyses of published research in various fields of physics.

H. H. NANCE, Washington University, 1906-10; Long Lines Plant Department, 1910-23; district plant chief, 1917-18; division superintendent of equipment construction, 1919-20; division engineer, 1920-23; Long Lines Engineering Department, acting engineer of transmission, 1923; engineer of transmission, 1924.

J. W. HORTON, B.S., Massachusetts Institute of Technology, 1914; instructor in physics, 1914-16; Engineering Department of the Western Electric Company, 1916—. Mr. Horton has been closely connected with the development of apparatus for carrier current communication.