

APP 2 3 1957

Bell Laboratories

NAVY ELECTRONICS
LIBRARY
LABORATORY

RECORD

Volume XXXV

Number 4

April 1957



Television: 30 Years of Progress

CONTENTS

High-Speed Data Transmission, <i>W. A. Malthaner</i>	121
Certain Properties of Ferrites, <i>J. K. Galt</i>	126
A Wire-Spring Multicontact Relay, <i>R. Stearns</i>	131
E-Type Repeaters: San Francisco to Oakland Circuits, <i>W. J. Kopp</i>	135
Division of Telephone Numbers in the No. 5 Crossbar System, <i>R. C. Avery</i>	139
PI Rural Carrier: Equipment Features, <i>A. J. Wier and F. H. King</i>	143
Nike Hercules Undergoing Final Tests	147
Thermal Time-Delay Relays, <i>J. Jacobsen</i>	148
Television: 30 Years of Progress	150
"TJ"—A New Microwave Relay System	153
Smithsonian Institution Opens New Telephone Exhibit	154

THE COVER: TD2 microwave radio-relay tower in Cedar Mt., Utah. Radio-relay and coaxial cable form backbone of vast Bell System transmission facilities for long distance telephone and television service. See page 150 for story of 30th anniversary of TV transmission.

The BELL LABORATORIES RECORD is published monthly by Bell Telephone Laboratories, Incorporated, 463 West Street, New York 14, N. Y., M. J. KELLY, President; M. B. LONG, Secretary and Treasurer. Subscriptions: \$2.00 per year; Foreign, \$2.60 per year. Checks should be made payable to Bell Laboratories Record and addressed to the Circulation Manager. Printed in U. S. A.
© Bell Telephone Laboratories, Incorporated, 1957.

EDITORIAL BOARD

F. J. Singer, *Chairman*
J. A. Hornbeck
F. A. Korn
E. T. Mottram
R. J. Nossaman
W. E. Reichle
A. H. White

EDITORIAL STAFF

G. E. Schindler, Jr., *Editor*
W. W. Mines, *Assistant Editor*
A. G. Tressler, *Assistant Editor*
R. L. Shepherd, *Production Editor*
T. N. Pope, *Circulation Manager*

High-Speed Data Transmission

W. A. MALTHANER *Switching Research*

Today the Bell System has a growing list of new "customers" who are not people but electrical and electronic business machines. Such machines, like telephone users, must "talk" to each other, sometimes over long distances. An experimental Laboratories device, tentatively called a "data subset," has been designed with the needs of modern and future business practices in mind. It can transmit and receive large amounts of data at very high speed over telephone lines. Further, it is self checking to provide essentially error-free communication.

When we refer to the "machine age" we conjure up a mental picture of men using machines—to make steel, to move giant quantities of earth, and to transport men and material. Now, at least in the popular imagination, we are entering upon the "age of automation." This expression paints for most of us a picture of a *machine* using machines. Instead of operating a lathe, a man may now monitor a computing or control machine that operates a dozen or more lathes.

It is characteristic of all "automated" machinery—whether used in business offices or in production lines—that it must handle large amounts of data. Thus, concurrent with the increasing demand for the processing of data, there is naturally a need for its transmission. It would be somewhat archaic today, for example, to use a "giant brain" computer to assemble rapidly a large mass of information, and then to have a secretary laboriously type it all out and mail it to another part of the country. Ideally, the data should pass rapidly from the computer to the transmission line and then to another computer or receiver at a distant point, with a minimum of time-consuming "bottlenecks" in between.

This is not speed merely for the sake of speed, however. The people of the Bell System and others in the communications industry envision a time in the not-too-distant future when rapid transmittal



of huge masses of information will be an indispensable part of many business activities. This is true to a large degree even today. Many banks, stores, insurance companies, and manufacturing organizations with widely scattered branches depend for their efficient operation on an almost constant availability of the right information at the right time and place. A typical situation is that a branch office must have a very recent inventory, and must be able to place an order before the inventory goes out of date. We know that large collections of data, like inventories, are more and more being processed by automatic business machines and by high-speed computers. It is quite inevitable then that transmission systems must meet the pace set by electronic data processing. We have in mind future systems over which volumes of vital information can be sent to many places throughout the country in a matter of a few hours. Data accumulated during a day of business activity might be transmitted during an off-peak period overnight.

An experimental data transmission set recently built by Bell Laboratories is an important step in this direction. So long as a data-generating or data-

Above, J. E. Schwenker (left) and W. Kaminski testing experimental transmitting and receiving equipment of the high-speed data subset.

processing device can place its output on a magnetic tape in a properly encoded form, the transmission set will accept the tape and transmit the data at great speed over telephone lines to another magnetic tape at the receiving end. The system uses a band from about 700 to 1,700 cycles per second.

In discussing this transmission device, it is convenient to describe first some of its chief technical features with the aid of Figure 1, and then later to follow through an imaginary but possible application to a business procedure.

In Figure 1, the dotted lines between the two data transmissions represent a telephone channel used for voice conversations. The transmission sets could be in the same city, or one could be in New York and the other in San Francisco. The problem of

parallel code-group arrangement of punched paper tapes. In each of the seven positions there will be either a *zero* or a *one*, but in the entire series of seven there must *always* be either three or five *one's*. A *one* corresponds to a spot on the tape magnetized in one direction, and a *zero* corresponds to a spot magnetized in the reverse direction. As we shall see, if by error a code group does not have either three or five *one's*, a data subset will detect the error and will take steps so that it can be rectified. This code system is similar in principle to the self-checking "two-out-of-five" code commonly used in telephone switching equipment.

The output of the magnetic tape feeds into the amplifier and modulator section indicated in Figure 1. Here, an oscillator generates a 1,200-cycle

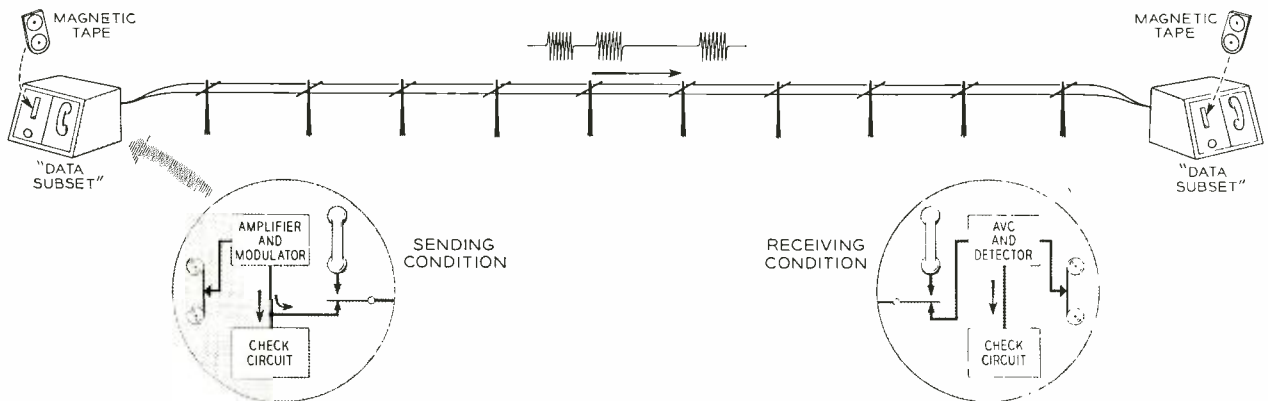

Fig. 1 — Experimental "data subsets" as used on the two ends of a telephone connection.

sending digital information at high speeds over voice channels has been studied for a number of years by the Switching Research Department at the Laboratories. Aside from the possibility of rapid data transmission, the work was directed toward the transmission of the digits and control signals required to set up a conventional telephone connection. This research has been described in a paper^o by A. W. Horton, Jr., and H. E. Vaughan of Bell Telephone Laboratories.

At the left in Figure 1 we have a magnetic tape input. For the moment we are not concerned with how the tape has been prepared. We know merely that the metallic oxide coating on the tape contains a series of magnetized spots arranged according to what is termed an "odd-parity check" code. The code for any unit of data — a digit, a letter of the alphabet, or any arbitrary symbol — will have seven positions. The information goes on the tape serially (one position after the other) in contrast to the

carrier which is amplitude modulated by the code signals. For example, a code like 1001010 would result in pulses of 1,200-cycle carrier in the three *one* positions, and no carrier would be present in the four *zero* positions. An amplifier raises the energy level sufficiently for transmission over the telephone connection, and a checking circuit verifies that the three-or-five-out-of-seven requirement has been met. If an encoding error is encountered, the set will send out a special symbol that will be recorded on the receiving tape.

To initiate the transmission of data, the person using the equipment could signal the party at the other end and talk to him. The calling party requests the called party to set a switch on the distant subset to the receiving condition, and then sets his switch to the transmitting condition. The data is then very rapidly transmitted and recorded on the distant magnetic tape.

At the receiving end, the switch setting has established the required rearrangement of the circuitry. An automatic volume control (AVC) cir-

^o Transmission of Digital Information over Telephone Circuits, B.S.T.J., 34, pp. 511-528, May, 1955.

circuit helps insure accuracy by evening out the energy levels of the incoming 1,200-cycle pulses. A detector circuit converts these to direct-current pulses that magnetize the appropriate spots on the receiving tape. Another check circuit is meanwhile verifying again the three-or-five-out-of-seven accuracy. This is necessary because an error might have been introduced along the transmission path. For instance, a flash of lightning from a thunderstorm might have induced a spurious voltage that smeared out one of the pulses. When the receiving check circuit discovers such an error, it signals the sending end that an incorrect code has been received. The sending data subset then backs up and repeats that portion of the message, and in all probability the data will this time come through correctly. Any incorrect data put on the receiving magnetic tape is labeled so that it can be ignored.

It should be mentioned here that such "error-free" communication is not always required. For routine transmission of text matter, an infrequent wrong character is usually tolerable. For this reason the data subset as presently conceived uses the check circuit as a separate module that can be incorporated or not as desired. It would be a necessity for transmission of such data as inventory lists, banking information, and the like.

The "data subset" we have been discussing is intended to be a fairly small and lightweight "box" that could be placed on an ordinary office desk. A small and convenient size is made possible by the use of transistors, semiconductor diodes and ferroelectric crystals. The data subset is completely transistorized; the functions of memory, logic, oscillation, modulation, and amplification — which would ordinarily be performed by bulky electron tubes and their associated components — are here performed by the minuscule products of solid-state electronics. A rather large and heavy cabinet of equipment would otherwise be required to do an equivalent job.

Until now, we have described a data transmission system with little thought given to other equipment on either side of the magnetic tapes. Yet consideration of this situation was one of the determining factors in the design. The aim was to provide a versatile instrument that would be easily adaptable to a wide variety of data-producing mechanisms. There is here a problem of compatibility something like the problem faced by the television industry a while ago in providing for color broadcasts. The hundreds of different types of data machines — typewriters, cash registers, card-punching



Fig. 2—W. Kaminski inspecting one "card" of printed circuitry. Final model can be much smaller than this experimental equipment.

machines, digital and analog computers — speak different languages. For efficient and economical transmission, however, the data they produce should preferably all be written in one common language. However, since a rigid standardization is not possible, at least not at the present time, the problem reduces to one of translating the different languages into the form that does least violence to the majority. Most machines can be modified to produce the magnetic tape used in this equipment.

There is a second important reason for using a magnetic tape input. In addition to the "language" translation, a "speed" translation is necessary. A telephone message channel can transmit information much faster than a human being can operate a typewriter keyboard, for example, but a message channel is slow compared with the ultra-fast speed of the modern electronic computer. Both the slow and fast speeds of data-producing mechanisms must therefore be translated into the fastest speed that telephone lines can handle. If this speed is exceeded, transmission becomes erratic, and if speed falls below the maximum, transmission becomes inefficient — the telephone circuit is in use longer than is really necessary to send the message. Magnetic tape is about the fastest and most adaptable medium yet found to satisfy this requirement of speed translation. The use of magnetic tape also has the incidental advantage of quiet operation.

We can now be a little more specific in describing what could be an operational setup using a data subset. It has already been mentioned that large digital computers could be "talking" to each other



Fig. 3—The author with automatic electric typewriter and experimental equipment for use of magnetic tapes to store data for transmission.

from the distant points. For an effective demonstration, however, electric typewriters were chosen as data-producing and data-receiving machines. A Flexowriter was obtained from the Commercial Controls Corporation. This is an automatic electric typewriter that punches a paper tape, and for use with the data subset it was adapted to provide magnetic tape.

Imagine now a secretary in the headquarters of a legal firm. She has a two-page, 1,000-word legal contract which must be delivered to an outlying office. The desk in front of her has an electric typewriter which produces both a typed copy of the text and a magnetic tape for use in the subset. As she types, the magnetized spots are placed on the tape. From her typescript, she checks the accuracy of each line after it is typed. On one occasion, she makes an error, so after this line she types a special "erroneous line" symbol. This symbol is duly recorded on the magnetic tape *after* the string of codes for the erroneous line. She then retypes the line correctly.

On her desk she also has a data subset. When she is through typing, she removes the magnetic tape from the typewriter and places it in the data subset. The legal firm has decided that transmission of legal documents requires a very high degree of accuracy, so this subset is provided with the error-checking module. To arrange for the transmission, the secretary removes the handset from the instrument and establishes a connection to the branch office. When the called party answers she converses in the normal manner until she is ready to transmit

the contract. She then tells the called party to switch the subset at the other end to the receiving condition. When this is done, she switches her own subset to the transmitting position. The entire 1,000-word contract is then transmitted and placed on the receiving magnetic tape in one minute.

Notice that the secretary did not rewind the tape before she placed it in the subset. She purposely used the tape just as it was wound up in the typewriter—that is, backwards. The tape information is thus sent backwards and received backwards. For the one erroneous line, the transmitter encounters the "erroneous line" symbol and does not transmit the line that follows. The erroneous line is thus rejected and only the correct line appears on the reproduced copy. In this manner, the problem of typing accuracy is largely taken care of. As mentioned before, electronic accuracy is provided by the checking circuits. If a malfunctioning tape-preparation mechanism or subset circuit causes an encoding error at the sending end, the sending checker will detect it. A code distorted over the transmission line will be discovered at the receiver, which will ask for a repeat. The successful transmission of the contract may complete the message, or the voice conversation may be resumed.

Two final matters require some additional explanation. First, it must be emphasized that the example of an operational situation used here is an imaginary one, though it is easy to see how useful such a transmission system could be in many fields of business activity. In some respects, however, it has been oversimplified. Typewriter preparation of the magnetic tape is only one of many methods of gathering data. More complex business machines would perhaps find even greater use for this type of transmission system. For instance, a banking establishment might employ a UNIVAC, an IBM 705, or some other electronic computer to compile such information as account numbers, deposits, with withdrawals, and balances. By placing the data on magnetic tape, the bank could quickly send it to a branch location. Also, it has been assumed in this example that there was only one receiving station. A more realistic situation might involve a central subset with a large number of outlying stations, to all of which the data would be transmitted.

Second, some of the significances of the very rapid transmission rate should be explained. We have stated that a thousand words of text would be transmitted tape-to-tape in about one minute. This of course is transmission speed, and the time consumed for the complete transaction would de-

pend on the methods of operation preceding and following the transmitting and receiving tapes. However, in terms of telephone communication channels, this very fast transmission offers great possibilities for increased efficiency and economy. A speed of 1,000 words per minute is about ten times the speed of teletypewriter communication. In many instances, there is no urgency requiring that a message be sent at 1,000 instead of 100 words per minute. But when we think of this speed in terms of the fact that for a given amount of information, a telephone line needs to be in use for only 1/10th the time, the potential economies of such data transmission systems are readily apparent. Further, because of the high degree of automatic

operation, equipment could be set up to function in off-peak traffic hours.

The Bell System believes that high speed data transmission is one direction in which the communication industry must turn to meet the challenge of the larger and larger amounts of information being processed by machines. The transistor and other solid-state devices have enabled us actually to reduce the sizes of equipment units even while their functions have been expanding. The Bell Laboratories experimental data subset demonstrates one sort of thing that can be accomplished in this field, and we believe that it represents one of a growing group of devices that will become commonplace in the new age of solid-state electronics.

THE AUTHOR

W. A. MALTHANER received a B.E.E. degree from Rensselaer Polytechnic Institute in 1937 and shortly thereafter joined the Laboratories. Initially, he was concerned with commercial development and research for automatic telephone central offices. During World War II, Mr. Malthaner worked on the development of fire-control systems and fire-control radar for the military. Following the war, he returned to research on new automatic telephone central office systems, customer dialing and supervisory arrangements, and inter-office signaling systems. More recently he has been in charge of a group concerned with digital data transmission and integrated data processing. He is an associate member of the A.I.E.E., a senior member of the I.R.E. and a member of the A.A.A.S., Sigma Xi, and Tau Beta Pi.



R. L. Helmreich Receives Distinguished Service Award

Kansas State College on March 12 presented its distinguished service award to Ralph L. Helmreich, Vice President and General Manager of the Laboratories. Presentation was made by James A. McCain, President of Kansas State College, on the occasion of the Engineering School's 33rd annual Open House. Similarly honored were Herbert M. Low, Vice President of J. F. Pritchard and Company, Charles W. Shaver, architect, and Murray A. Wilson of Wilson and Company. Kansas State has established the annual awards "to provide recognition to prominent persons . . . whose careers have contributed notably to the professions" represented by the schools from which they were graduated. The four recipients were the first engineering graduates to be so honored by the school.

Mr. Helmreich received a degree in mechanical

engineering from Kansas State College in 1928 and joined Southwestern Bell the same year. In 1932 he became Wire Chief in Sedalia, Missouri, and for the next sixteen years continued to work in the Plant Department in various cities in Kansas and Missouri. He moved to the General Department of the A.T.&T. Co. in 1949 as Supply Practices Engineer and in the following year returned to Southwestern Bell as General Manager in Kansas City. He was named Vice President in Charge of Personnel for the Mountain States Company in 1951 and was appointed Vice President-Operations a year later. In 1953 he returned to New York as Director of Operations, Long Lines, and assumed his present post at the Laboratories in 1956. Mr. Helmreich is a member of the American Society of Mechanical Engineers and of the Phi Delta Theta fraternity.

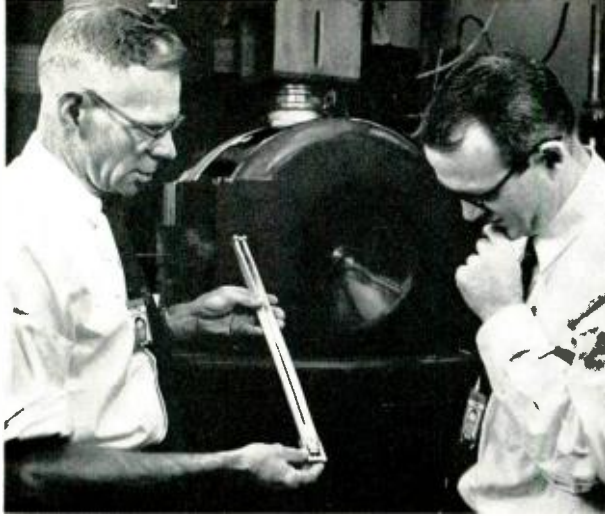

Certain Properties of Ferrites

J. K. GALT *Physical Research*

The new magnetic materials called ferrites have taken on a large and growing importance in communications technology. They are often better than ferromagnetic metals in standard components, and they have also made possible devices that were previously quite impractical. Although ferrites are broadly similar to the magnetic metals in many respects, the differences make them very valuable in a number of applications. Many components made of these materials are currently in use in the Bell System, with many more certain to come.

The ferrites are a class of ceramic magnetic materials formed by causing mixtures of various metallic oxides to react in the solid state at high temperatures. Electrically, their properties are broadly similar to those of semiconductors like silicon and germanium, but their magnetic properties are similar in many ways to those of iron, cobalt, nickel and other ferromagnetic metals. The most important similarity is that ferrites have spontaneous magnetic induction—that is, an induction present even in the absence of any applied field. However, because they also have several properties that are very different from those of the ferromagnetic metals, they have proved useful in many new applications since World War II, and they have been the subject of considerable research work at Bell Laboratories and elsewhere.

It is natural to begin by comparing the properties of the ferrites with those of the ferromagnetic metals. As we shall see, the dc magnetic properties are broadly comparable, but the ac characteristics of the two groups of materials are very different because of their different electrical properties, particularly resistivity.

Consider first the dc characteristics, the most important of which can be explained by referring to the familiar plots of hysteresis loops seen in Figure 2. Saturation induction and remanent induction (see values identified in Figure 2) are, in ferrites, typically about one-fourth the values for many

ferromagnetic metals. This difference does not seem large when we realize that in most materials these quantities are zero or very nearly so. The coercive force also has a broadly similar range of values in the two groups of materials. Further, we include under the dc characteristics the fact that some ferrites, like some ferromagnetic metals, have hysteresis loops which approximate the rectangle shown in Figure 2 (b). This is an important reason for their usefulness in magnetic-core memories and other electronic computer applications; the rectangularity means that there is a sharp discrimination between one direction of magnetization and the reverse, which is the property used in memory devices to switch between the “zero” and “one” (or “yes” and “no”) conditions.

One of the less familiar properties for which ferrites and ferromagnetic metals have similar values is the Curie point—the temperature above which the material is no longer ferromagnetic and where the saturation induction drops sharply to values near zero. Typical values of the Curie point for ferrites are 100° to 600°C. A second is the crystalline magnetic anisotropy—the energy required to turn the magnetization away from certain crystallographic directions along which it prefers to lie. Another is the magnetostriction, or strain that occurs in a magnetic material when the induction changes. This property is of interest for transducers which transform electromagnetic into mechanical

or acoustic energy. Cobalt ferrite is an example of a material with an extremely large magnetostriction, the largest known, in fact. Under suitable conditions, the dimensions of a sample of this material can change by as much as 0.08 per cent as a result of changes in its induction. Further, the elastic constants of many ferrites change relatively little with frequency, and the acoustical losses are not excessive. Recent investigations indicate that a ferrite can be fabricated with a combination of these properties, which would be very useful in an electromechanical transducer.

If we now turn our attention to ac properties, the differences between ferrites and the ferromagnetic metals become more apparent. When induction changes quickly, either in magnitude or direction, the speed of the change is limited by energy-loss mechanisms that tend to slow it down. In the ferromagnetic metals, the most important of these losses is the energy dissipated by "eddy currents" induced in a sample by any change in induction. The importance of the ferrites rests fundamentally on the fact that their electrical resistivity is so many orders of magnitude higher than that of metals that this mechanism is substantially absent. (Other loss mechanisms act in the ferrites, but as explained later, their effects are smaller.)

As a result, ferrites are useful up to much higher frequencies in such components as transformers and induction coils.⁹ Materials, to be useful in such components, must have a high permeability — that is, an applied field H at the operating frequency must cause the induction to change by many times H . Further, these large changes in induction must occur without dissipating excessive amounts of energy. If, as in Figure 1, we plot the typical behavior of permeability versus frequency, we see that it remains constant up to a certain frequency, after which it drops off rapidly. Also, energy losses reach a maximum where the fall-off in permeability occurs. As a result, a magnetic material is not very useful above the point at which the permeability starts to drop. If we compare a ferromagnetic

⁹ RECORD, May, 1951, page 203.

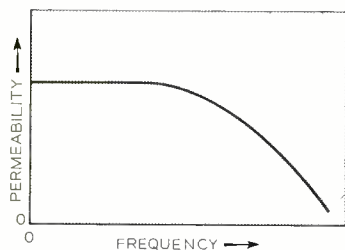

Fig. 1 — Typical permeability versus frequency curve; with ferrites, fall-off occurs at higher frequencies.

metal and a ferrite of the same permeability, the permeability of the ferrite does not drop off until a much higher frequency is reached (sometimes many megacycles). To say it another way, the ferrite has much lower losses at the higher frequencies in the useful range. For certain applications, in fact, the advantages of the ferrites are substantial even at frequencies as low as 10-50 kc.

Ferrites are also very useful in the microwave frequency range, from 1000 to 50,000 mc, an area in which both scientific understanding and technological development are expanding especially rapidly. Devices in this range have been described elsewhere in the RECORD¹⁰, but here we mention merely that in most cases, their operation depends on the fact that the ferrites in them have different characteristics for similar waves traveling in opposite directions — that is, they are nonreciprocal. Fer-

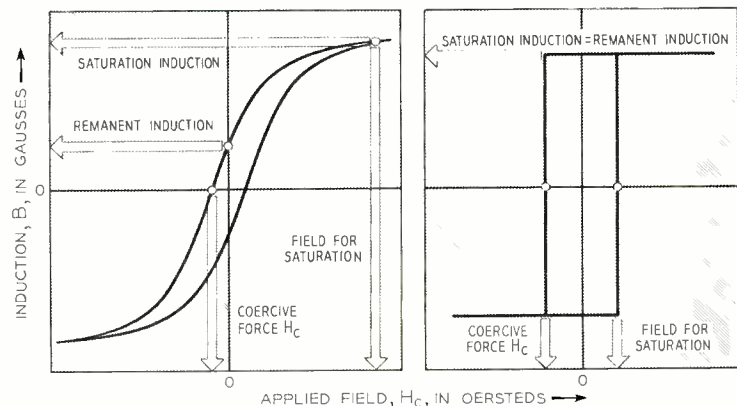

Fig. 2 — (a) Hysteresis loop identifying significant quantities used in studying properties of magnetic materials; (b) ideal rectangular loop for ferrite memory devices.

rites make such devices practicable because they perform the nonreciprocal function with only a small energy loss, which means a small attenuation of the electromagnetic wave.

Chemically, the ferrites are metal oxide compounds. Their basic chemical formula may be written MFe_2O_4 , where "M" represents a divalent metal ion (valence of +2) and the two iron ions are trivalent (valence of +3). This formula is often written $MOFe_2O_3$ to emphasize the valences of the different metal ions. If the divalent ion, "M", is iron, the ferrite may be called iron ferrite; it has been known throughout history as lodestone or in mineralogical circles as magnetite. Historically and chemically, this is the parent of all the ferrites.

¹⁰ RECORD, October, 1955, page 385; November, 1955, page 419.

Others of the "M" or divalent ions used to make different ferrites include nickel, cobalt, manganese, magnesium, mixtures of zinc and manganese, and mixtures of zinc and nickel. The mixtures of zinc and manganese, and of zinc and nickel, give ferrites that are especially important for applications.

Crystallographically, the ferrites may be described as a close-packed cubic array of oxygen atoms (see Figure 3) with the much smaller metal atoms tucked into various interstices; the details are the same as those in a common mineral structure called "spinel". The interstices are divided into two groups, in one of which the metal ion is at the center of an octahedron with an oxygen ion at each corner. In the other, the metal ion is at the center of a tetrahedron. The terminology "octa-

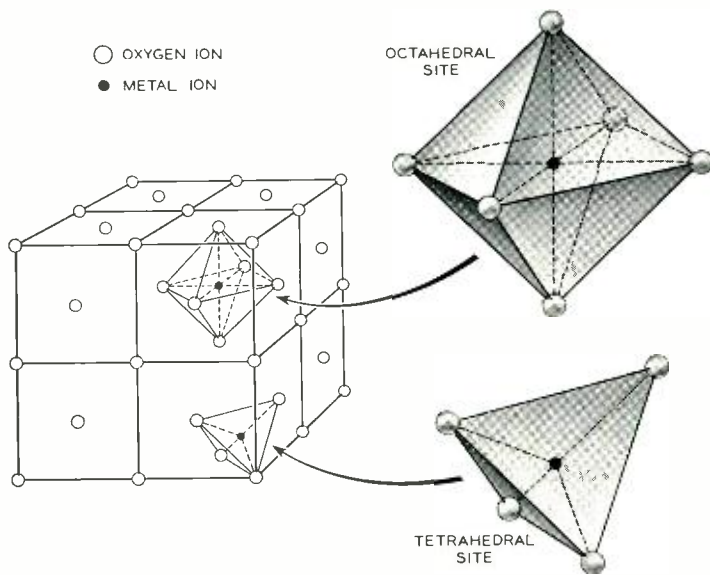

Fig. 3—Crystal structure of ferrites, with details showing how metal ions are situated at a tetrahedral (bottom right) and an octahedral site (upper right.)

hedral sites" and "tetrahedral sites" is therefore used in discussing the crystal structure of ferrites.

At temperatures below the Curie point, all the elemental "magnets" associated with metal ions at octahedral sites are lined up parallel with each other; similarly, all "magnets" associated with metal ions at tetrahedral sites are also lined up parallel with each other. But the two groups or sublattices" are oppositely directed—that is, they are anti-parallel—so that the magnitude of the net saturation induction in a ferrite is the *difference* between the saturation inductions of these two sublattices. This arrangement of dipole moments was first postulated by the French physicist L. Néel in 1948, and has since been confirmed experimentally. It

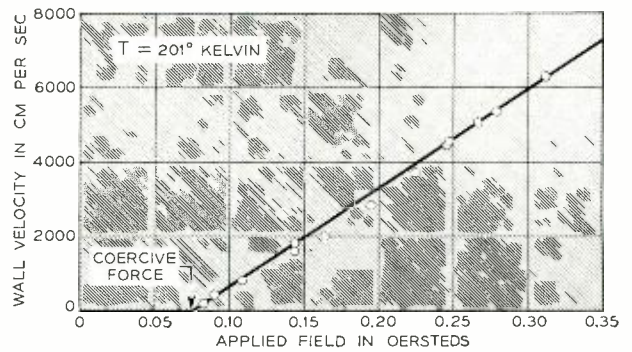

Fig. 4—Domain-wall velocity vs applied magnetic field in $(\text{NiO})_{0.75}(\text{FeO})_{0.25}\text{Fe}_2\text{O}_3$ at 201°K : viscous damping of wall is inversely proportional to steepness of the line.

is much more complicated than that in the ferromagnetic metals, where all the dipole moments are parallel and the saturation induction is simply the number of atoms times the contribution of each atom. The anti-parallel arrangement of the elemental magnets at octahedral and tetrahedral sites explains why saturation inductions in the ferrites do not in general exceed about one-third the values for the ferromagnetic metals. Néel has called the ferrites *ferrimagnetic* materials as distinct from *ferromagnetic*, and this is the terminology which is now widely used.

Aside from this and the other complexities in the atomic structure of ferrites, the materials are also complicated magnetically by the way in which they are produced. Usually, a mixture of dry powdered oxides is allowed to react at about $1,100^\circ\text{C}$; in this process nuclei of the ferrite reaction product are formed which grow together and join as the reaction proceeds. Sometimes pores are left in the final product, and these in turn introduce inhomogeneities in the direction of the magnetic induction and impediments to changes in it. The resultant effects

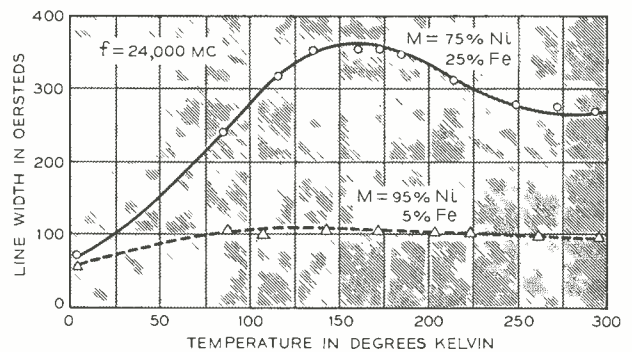

Fig. 5—Two curves show ferromagnetic resonance line width vs temperature for ferrites of different nickel-iron compositions.

on the ferrite material are very important, of course, and much development and research work has been done at Bell Laboratories and elsewhere to control and understand them. The more porous ferrites have low magnetic losses but tend to break easily.

We have mentioned earlier that in the ferrites, the energy loss that accompanies rapid changes in induction is small. Nevertheless, it is very important, and we shall discuss here work done in studying dynamical energy losses in ferrites. This work was done on single-crystal samples, rather than on the more complex polycrystalline ferrite structures, since it is easier to extract fundamental information from data taken on the more uniform single-crystal material.

We find in general that a ferromagnetic or ferrimagnetic sample is broken up into small units called domains, in each of which the induction uniformly points in one direction. The inductions in different domains, however, point in different



Fig. 7 — W. A. Yager adjusting the automatic frequency control of equipment used for ferromagnetic resonance experiments.

in early work on domain walls, have cut samples from single crystals of silicon iron which have just one movable domain wall. The author has used such samples cut from ferrite crystals to observe domain-wall motion in these materials. The details of this work will not be given here, but such experiments make it possible to plot domain-wall velocity against the magnitude of the steady applied field causing it to move. Such a plot, Figure 4, shows that as the applied magnetic field increases from zero, nothing happens until we reach a field comparable with the coercive force. This is because interaction of the domain wall with imperfections prevents it from moving. When the field exceeds the coercive force, however, the domain wall moves with a velocity that increases linearly with the strength of the field, and therefore with the pressure on the wall. We may therefore say that the domain wall motion is *viscously* damped in this range of fields and velocities. Figure 4 shows data for a sample of $(\text{NiO})_{0.75}(\text{FeO})_{0.25}\text{Fe}_2\text{O}_3$, where the "M" or divalent metal ion is 75 per cent nickel and 25 per cent iron. It has been found that domain walls in several ferrites show similar behavior to that indicated in this illustration.

In a graph like Figure 4, the slope of the line reflects the extent of damping — a steep line means that the loss mechanisms are ineffective, and a flatter line shows that damping is larger. For the material used in plotting this figure, the slope varies from about 30,000 cm/sec/oersted at room temperature down to about 150 cm/sec/oersted at

* RECORD, October, 1952, page 385.

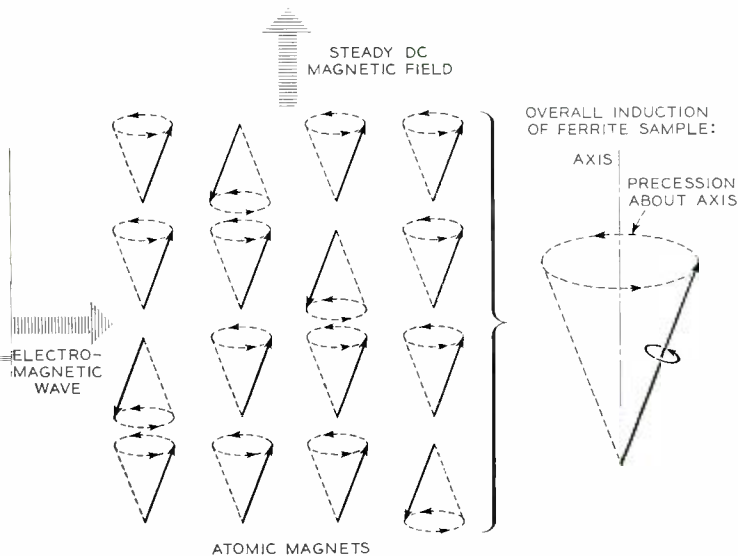

Fig. 6 — Rotational motion in ferrites: — induction precesses like a "wobbling" spinning top.

directions, and between the domains are thin sheets about 10^{-5} cm in thickness in which the direction of the induction changes. One way in which induction changes under the influence of a magnetic field is that these sheets, or "domain walls", move in such a manner as to enlarge domains whose induction is closest to the direction of the magnetic field, at the expense of the other domains. Rectangular hysteresis loops occur almost exclusively when the induction of a magnet sample changes by means of domain-wall motion.

H. J. Williams* and others at the Laboratories,

77°K. Thus, like most viscous damping mechanisms, those damping domain-wall motion in this ferrite become more effective at low temperatures. This is also true for other ferrites, but the change is often not so great. Clearly, ferrite devices that depend upon domain-wall motion will not work as fast at very low temperatures as they do at room temperatures.

We may also observe dynamical energy losses in connection with the other well-defined mode of motion of the induction in a magnetic material—a rotational motion in which the induction of a saturated sample changes its direction but not its magnitude. Such motion occurs in the nonreciprocal devices mentioned earlier which operate in the microwave range.

The motion of magnetization involved here is called a “rotational” motion because, as illustrated in Figure 6, it consists primarily of a precession of the induction of the sample about an applied steady field. This is just like the motion of a spinning top when its axis of rotation is not vertical—that is, when the axis itself is rotating. If the motion could occur without energy loss, it would occur at a single frequency for any given field applied to the sample, and once started would continue indefinitely. But, as we might expect, energy is dissipated during the motion, so it will not continue unless it is continuously excited. At the given frequency, such excitation is possible over a range of applied magnetic fields—a range which is termed the “ferromagnetic resonance line width.” Now this range of fields or line width will be larger or smaller according to whether the energy dissipated in the course of the precessional motion is large or small. Consequently, we can determine the losses associated with the rotational type of motion in ferrites by measuring line width.

Figure 5 shows line width as a function of temperature (solid curve) for the same material used

with Figure 4 to describe the domain-wall damping type of losses—the ferrite in which the “M” ingredient is 75 per cent nickel and 25 per cent iron. The impressed frequency is 24,000 mc. It is clear that the bulk of the energy loss over the whole temperature range is closely associated with the presence of a maximum in the loss at 160°K. The dashed curve in Figure 5 gives similar line-width data for a ferrite with “M” consisting of 95 per cent nickel and 5 per cent iron. Here the mechanism is much reduced in effectiveness, but it is not entirely absent, and the maximum, so far as it is detectable, seems to lie in about the same temperature region. Since the only apparent difference between the two materials is the difference in divalent iron content, we are led to the conclusion that the presence of divalent iron ions in the material gives rise to the loss mechanism we are considering. Experiments on polycrystalline ferrites at Philips Research Laboratories in Eindhoven, Holland, at frequencies below 10 mc suggested this conclusion also. It seems likely that the valence electrons on the divalent and trivalent iron ions rearrange as the saturation induction changes direction. Further experimentation and theoretical analysis have shown that broadly speaking, this mechanism fits the behavior observed experimentally.

The results of this work on domain-wall motion and rotational losses add much to our understanding of ferrites, but there is much that we do not yet know. For instance, we have no very satisfactory picture of the precise way the valence electrons rearrange geometrically or of their quantum-mechanical energy levels. The loss mechanisms discussed here are important in the materials for which we have given data, but there are other loss mechanisms acting in these materials, and probably still others in other materials. We are just beginning to understand this very important aspect of the behavior of ferrites.

THE AUTHOR



J. K. GALT received the A.B. degree from Reed College in 1941 and the Ph. D. in Physics from Massachusetts Institute of Technology in 1947. From 1943 to 1945, he was with the Office of Scientific Research and Development at MIT working on underwater sound and with the Radio Research Laboratory at Harvard working on radar counter-measures. Later he was a National Research Council Fellow in the Physics Department at Bristol University, England, during 1947-48. Dr. Galt joined Bell Telephone Laboratories in 1948, where he has been engaged in research on the properties of solids, with emphasis on their magnetic and electrical properties. More recently, he has been concerned with cyclotron resonance studies of metals. He is a Fellow of the American Physical Society and a member of Phi Beta Kappa.

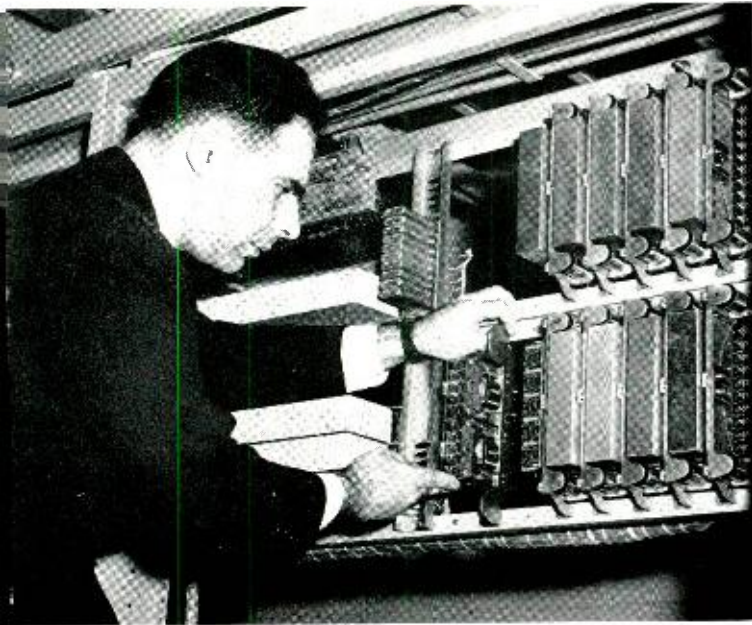

A Wire-Spring Multicontact Relay

R. STEARNS *Switching Apparatus Development*

Through adaptations and improvements in established principles, Laboratories engineers are frequently able to fulfill current Bell System needs. New wire-spring multicontact relays, for example, that perform better, require less maintenance and are easier to manufacture have been designed based on improved wire-spring technology. Innovations in this new design permit these new relays to be used as direct replacements for flat-spring multicontact relays on common control circuits in crossbar systems.

In a modern telephone office the common-control principle of switching permits one unit of equipment to serve many separate circuits because it is needed for only a fraction of a second on each call. A marker in a crossbar office, for example, might be connected to different crossbar frames several times in one second. To make these rapid interconnections, relays with large numbers of "make-contacts" are used. These are known as multicontact relays.

These relays present a difficult engineering problem because of the many conflicting requirements they must meet. They should have large numbers of contacts, yet operate at high speed and be easy to wire; they must operate as many as 200 million times during an anticipated 40-year life, yet show little wear and require a minimum of maintenance; most important, they must be economical to manufacture. The earlier flat-spring multicontact relay* met most of these requirements and performed satisfactorily for a number of years, although it did require appreciable maintenance.

* RECORD, May, 1939, page 301.

In recent years, intensive effort to increase the speed of common control circuits in modern crossbar offices has resulted in the use of wire-spring general-purpose relays and dry-reed switches. These components operate at higher speeds and require less maintenance than their predecessors. Taking advantage of this increased speed, the number of markers required to serve a given number of lines can be reduced, thereby saving considerable expense. Holding time can be further reduced if the connector circuits can also be speeded up. For this reason, experience in the wire-spring design was used to advantage, and a wire-spring multicontact relay was developed.

This relay, shown in Figure 1, embodies many features of the wire-spring general-purpose relay, such as operation by an insulating card, a flat magnetic structure, and pre-formed wire springs. All parts are either punched or molded, and the entire relay consists of only 18 parts or sub-assemblies. Four molded blocks contain all the wire springs to which the relay's 30 contacts are welded; relays are made by semi-automatic machinery designed by Western Electric engineers. Thus, the compli-

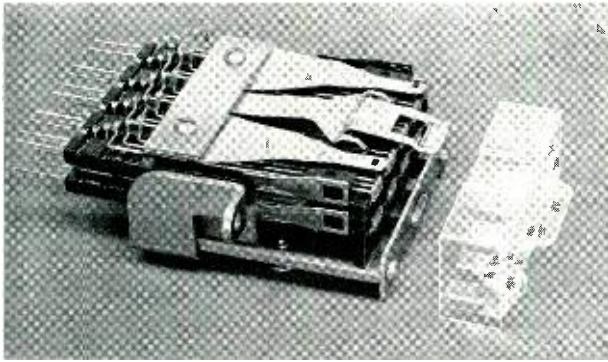

Fig. 1—The new high-speed multicontact relay with the lucite contact cover removed.

icated assembly operations and skillful adjustments necessary on the flat-spring multicontact relay have largely been eliminated in the present wire-spring version of the relay.

The older relays each used two coils and two magnet assemblies to actuate them. Most relays provided 60 contacts by having 30 on each half, while others provided fewer; in all cases, two assemblies were used on each relay. The wire-spring version has 30 contacts but uses only one coil and magnet assembly. It is equivalent to one-half the older relay, but is more flexible in mounting. Two of the new relays take less space than one older relay while providing an equivalent number of contacts.

To discontinue the manufacture of the older relay for additions and replacements in older offices, a replacement relay has been designed that consists of two 30-contact wire-spring relays mounted on a common bracket, Figure 2, and modified to make them slower to operate. The modifications consist of a special actuating card to provide a longer armature travel, coils with a larger number of turns to increase the relay inductance, and a special magnetic shunt to by-pass some of the magnetic flux. In other words, the magnetic structure of the high-speed relay has purposely been de-

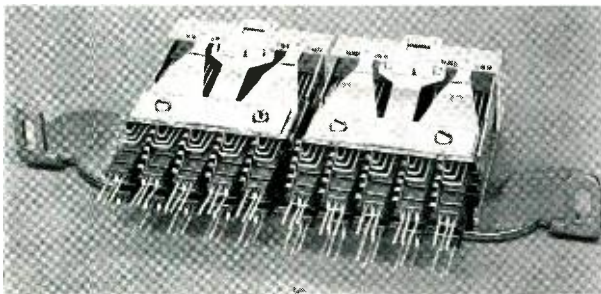

Fig. 2—The new replacement relay shown attached to a common mounting bracket.

graded for this application, to obtain a wire-spring replacement relay that is electrically and mechanically interchangeable with the flat-spring type.

Since the multicontact relay has so many contacts, considerable attention was given to the design of the terminal end of the relay so as to avoid wiring congestion and to speed installation. Connector circuits require a great many common leads, so arrangements were made for horizontal strapping of the single-wire terminals of the multicontact relay as shown in Figure 4. The twin-contact ter-

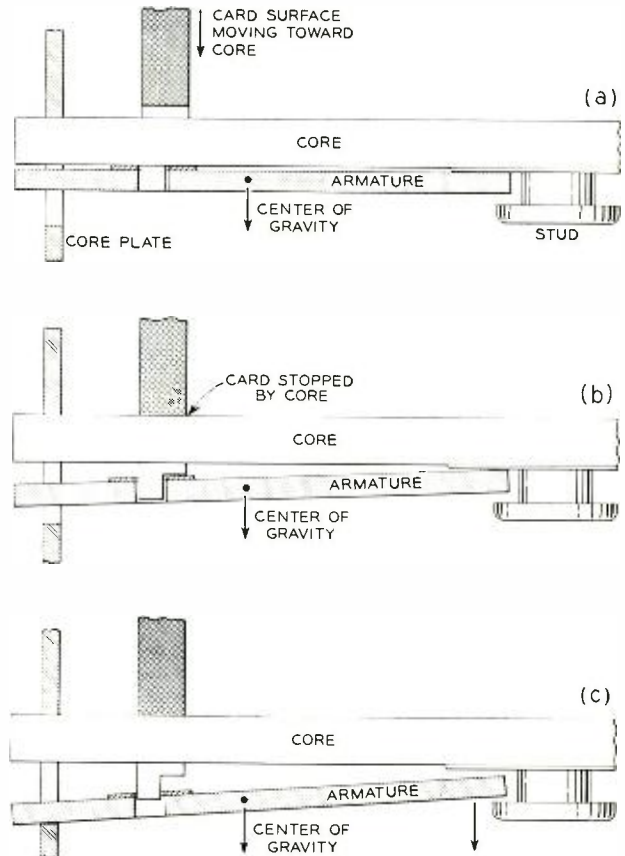

Fig. 3—The heel of the armature continues to move after the card is stopped by the core and the front of the armature is stopped by the core plate.

minals are specially formed by twisting each pair of wires together and coining them to a trapezoidal shape that is suitable for achieving reliable solderless wrapped connections.

Although the initial wiring of multicontact relays has been simplified, the replacement of a damaged relay is a time-consuming procedure because of the horizontal strapping and the numerous leads that must be changed. Under ordinary circumstances, very few of the new relays should require replacement or even extensive maintenance. However,

under very severe conditions, all parts subject to wear or damage can be replaced without removing the relay from the frame or disturbing the main portion of the wiring. Special tools have been developed to replace the coil and actuating card; should it be necessary, new contacts can be welded on with a specially-developed hand tool.

From a performance standpoint, the new relay has many significant advantages. In operate and release times it is at least twice as fast as the older flat-spring relay for the same input power. It has superior contact-chatter and rebound performance, is subject to much less wear, and is more stable than the earlier relay. The high operating speed is due principally to the use of a light and as short an armature travel as possible, consistent with allowances for wear of contacts in the operated position and adequate separation of contacts in the unoperated position.

Contact chatter, present to some extent in all relays, is the high-frequency vibration of the contact springs due to the sudden impact of the contacts when the relay operates. This vibration causes the contacts to "chatter" upon closure and may result in circuit failures if the duration of the chatter is too long. This is reduced to a minimum in wire-spring relays because the low stiffness and mass of wire springs result in a very rapid decay in the amplitude of vibrations. The use of independent twin moving contacts to mate with each single fixed contact helps to reduce the effect of chatter on circuit operation because the twin wires seldom vibrate exactly in phase; when one contact is open, the other is likely to be closed, and the effect of chatter is largely masked. As a result of this, most of the contact chatter on the wire-spring multicontact relay occurs in the first 100 microseconds of contact closure and has a negligible effect on circuit operation.

THE AUTHOR

R. STEARNS joined the Laboratories as a technical assistant in 1952 following his service in the Signal Corps. While in the service he was concerned with the development of high-powered public address systems at the Signal Corps Engineering Laboratory, Ft. Monmouth, N. J. Since coming to the Laboratories he has been principally concerned with the magnetic design of all types of wire spring relays, and related capability studies, and is currently engaged in the development of techniques for measuring the quality of welded connections between wires and terminals. Mr. Stearns, a senior technical associate, is attending evening sessions at the Polytechnic Institute of Brooklyn.

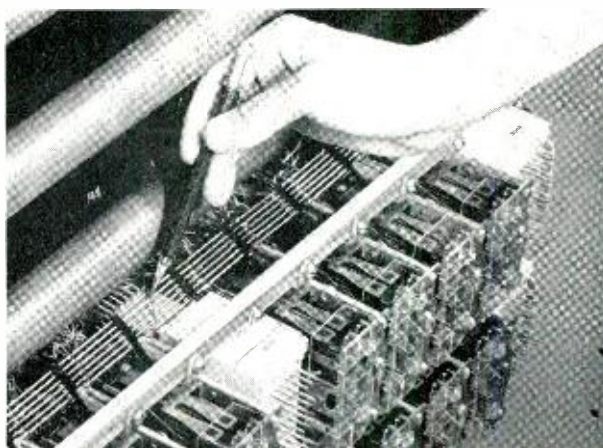

Fig. 4 — The new relays were designed to use strap wires molded into plastic separators, as shown here.

Armature rebound has also been reduced to a negligible amount. This has been accomplished by a special mechanical arrangement of the card, armature and core assembly. Figure 3 shows a cross-section of the moving system of the relay in various stages of release. The armature is on the side of the core opposite to that of the moving card, primarily to make the removal of the coil assembly easier, but also to provide a means of improving rebound performance.

When a relay of this size is operated, considerable energy is stored in the springs. Ordinarily, this energy would cause the armature to bounce off the backstop during release and would cause some of the contacts to reclose, resulting in undesirable pulses that could cause serious circuit trouble. The construction of the wire-spring multicontact relay is such that this energy is rapidly dissipated. When the relay is released, the restoring spring causes the card to accelerate towards the core, at the same time carrying the armature away from the core. When the card strikes the core, the armature has



gained considerable kinetic energy and keeps on traveling until it hits the backstop formed by the curved edge of the opening in the core plate. Since the armature loses only part of its energy upon hitting the backstop, there is a tendency for the armature to pivot about the backstop, causing the rear legs or "heels" of the armature to move away from the core and strike the heelstops. The front of the armature re-strikes the bearing surfaces of the card, but by this time most of the kinetic energy in the armature has been imparted to the core structure and is rapidly dissipated. The small amount of energy remaining in the low-mass armature is not sufficient to overcome the rather large force of the card against the core. Thus there is very little likelihood of false actuation of the contacts due to armature rebound under normal operating conditions.

To provide the proper wear characteristics, contacts have been made sufficiently large and all mating surfaces of moving parts have been made broad so that the wear is distributed over a large area. For example, the usual non-magnetic stop disc used on the armature of an ordinary relay to prevent sticking on release has been replaced with a large nickel-silver stop plate that has shown excellent wear characteristics. Stability of adjustment has been assured by the careful selection of molding compounds for the plastic parts of the relay so as to provide a minimum of deformation with variations in temperature and humidity.

As a result of these improvements, the new wire-spring multicontact relay will provide better performance, require less maintenance, and be easier to manufacture than the older flat-spring type.

Record Year in 1956 for Western Electric Company

Western Electric Company's Annual Report to Stockholders describes the year 1956 as outstanding in volume of production, in sales and in services rendered. Among highlights of the Annual Report, Western stated that commitments to all customers in 1956 were met, even though demand for nearly every product classification reached new peaks. Product quality and employee efficiency continued at high levels. Prices were maintained at essentially 1955 levels despite increases in wage rates and cost of materials.

Sales were \$2,372,726,000, about one-fourth greater than in the preceding year, the Report continued. Sales to Bell Companies totaled \$1,648,875,000. Equipment sufficient to serve 3,530,000 dial central office lines was shipped in 1956. This is about the combined total of lines now providing dial telephone service to the public in 10 large cities — Philadelphia, Washington, Columbus, Chicago, Milwaukee, Minneapolis, Dallas, Los Angeles, San Francisco and Seattle. Some 6,600,000 telephone instruments were produced and shipped — equal to one-seventh of all the Bell System telephones in service at the start of the year. In addition, 7,600,000 instruments were reconditioned and made available for further use in telephone service. The Government's requirements for electronic equipment and specialized services important in the nation's defense plans were higher than in any previous post-war year.

Activity in the installation organization increased sharply in 1956, keyed to the volume of central office equipment flowing from Western Electric factories. The number of dial lines installed and turned over to the telephone companies ready for service was almost 50 per cent greater than 1955. About one-quarter of the installers' work involved the expansion of many types of facilities for long distance telephone and television service.

Employees in the Company's distribution and repair centers shipped larger volumes of products and supplies to telephone companies and reconditioned more worn telephone equipment than in any previous year. An average of 12,000 items ordered by the Bell Telephone companies was shipped from local stocks every working hour throughout the year, 97.5 per cent of them on the date wanted.

An amount equal to nearly 60 cents of every sales dollar was paid last year by Western Electric to some 31,500 other businesses, suppliers and sub-contractors located in 3,200 U. S. cities and towns. More than 28,000 of these firms, or nearly 90 per cent of the total, were small businesses having fewer than 500 employees.

By the end of the year, the Report added, the number of the Company's employees had reached an all time high of 138,520. This, of course, meant a steady increase in training activities for those newly employed and for others who moved up to jobs of greater responsibility.

Sometimes the obvious solution to a problem is neither the best nor the most economical. This was true recently when the obvious answer to badly needed additional telephone service between San Francisco and Oakland was to follow the old cross-bay cable route with a second loaded cable. Instead, E-type repeaters were used on nonloaded cable following a new and longer route. The new route facilitated maintenance and resulted in a saving of nearly one-half million dollars.



E-Type Repeaters: San Francisco to Oakland Circuits

W. J. KOPP *Transmission Engineering*

To connect telephone customers with their own and other central offices, exchange-area transmission facilities in and around cities usually consist of underground or aerial cable. In locations such as the San Francisco Bay area, however, certain interoffice cables are under water. These cables are more expensive to build and install, and are often subject to unusual hazards—for example, dragging anchors of boats using the waterway. A need for more service between San Francisco and Oakland furnished an interesting plant and transmission problem in which the Laboratories participated. An unusual application of E-type repeaters provided a solution with savings of nearly one-half million dollars over alternative proposals.

E-type negative impedance repeaters^o are being used in exchange-area circuits in rapidly increasing numbers because they provide an economical method of reducing the transmission loss of existing circuits and permit the use of smaller gauge conductors for new layouts. Conventional repeaters require hybrid circuits, balancing networks, amplifiers and gain controls for each direction of transmission, as well as special bypassing circuits for

de signaling and supervision. E-type repeaters, however, are inherently two-way devices in which networks, adjusted by cross-connections on a terminal board, serve primarily to fix the gain and frequency response of the circuit. Instead of amplifying voice currents to overcome line loss, "E" repeaters act as "negative" impedances inserted in the line, effectively cancelling out some of the positive line impedance. No additional arrangements are necessary to handle de signaling, which passes through the repeater with a minimum of distortion.

A cable was laid across San Francisco Bay some years ago to provide telephone service between San Francisco and Oakland. The cable route, Figure 1, runs from the Main central office in San Francisco, touches Yerba Buena Island, and continues to the East Bay Main office in Oakland. The cable lies in shallow water and is brought to the surface every 6,000 feet where loading coils have been inserted to reduce the transmission losses. In a few places, man-made islands were built at considerable expense to accommodate the loading-coil vaults. The cable is subject to a certain amount of hazard from ship anchors. In addition, the route required digging a trench in the Oakland Harbor channel to clear dredging operations.

^o Record, February, 1952, page 56.

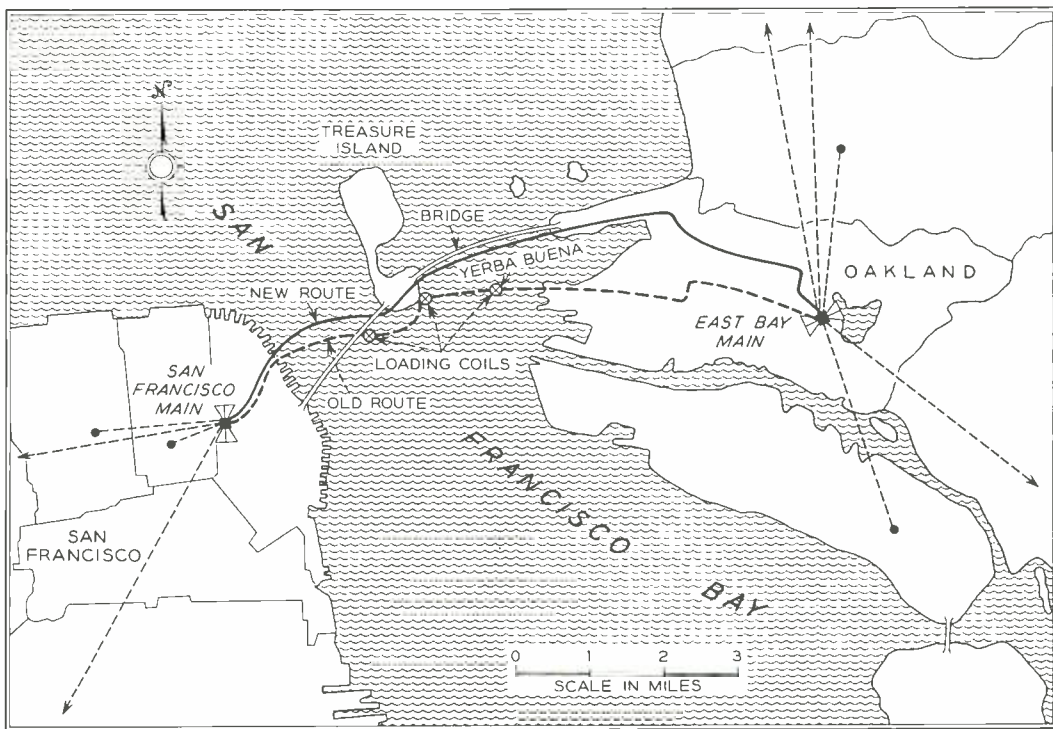

Fig. 1 — Map of San Francisco Bay showing the location of the old cable route (dashed line) and the location of the new route (solid line).

Telephone traffic between the two cities and surrounding areas has grown considerably since the cable was laid and an extended customer-dialing program employing CAMA was to be added to telephone services in the area. Both these conditions increased the requirements for more trunks between the cities, and an additional cable was necessary. Following the old route and using loading coils would have been very expensive. With E repeaters at both central offices, it was possible to consider a new cable without loading coils, following the longer route in Figure 1. The diversity provided by this route offered considerable advantage from the standpoint of service protection.

Savings were realized in several ways. Since the repeaters permitted a new route in deeper water that avoids the Oakland channel, no trench had to be dug. The gains possible by using the repeaters made it feasible to dispense with loading and to use smaller conductors. The new cable provides 1219 pairs — twice as many as was possible before in the same size cable — and is believed to have the largest capacity of any underwater cable of this length in the world. Eliminating the loading-coil construction alone saved over \$100,000.

The E1, and the electrically equivalent E2 plug-in repeater that was developed later, are series-type

repeaters. The E3, available only as a plug-in unit, is a shunt-type repeater. In each type, the useful negative impedance obtained is controlled by the elements of the network; these are connected to provide the desired characteristics. To produce low-loss transmission with the best possible impedance match, an E3 repeater is connected to the line coil of an E1 or E2 repeater to form an E13 or E23 repeater. The combination shown in Figure 2 is, in effect, a negative-impedance network

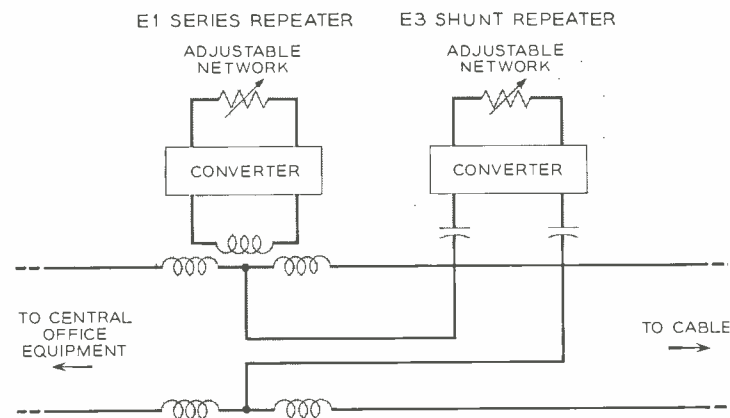

Fig. 2 — Block diagram of connections of a combination E13 repeater. The E1 is effectively in series with the line while the E3 is across the line.

that is inserted in the line to provide two-way gain and a good impedance match when connected to a loaded cable pair.

When E-type repeaters are applied to loaded facilities, the networks are connected by the Telephone Company to provide a given gain, using a series of charts. These connections are computed and checked initially at the Laboratories on artificial cable networks. No standard charts are available for cases involving appreciable lengths of non-loaded cable since the general problem would require data for many combinations of loaded and non-loaded cable facilities. The San Francisco cable project was therefore handled as a special problem requiring the help of the Laboratories.

Gain is difficult to achieve for nonloaded facilities since the repeater must, to a large extent, equalize the rising loss-with-frequency characteristic, and also provide a better impedance match than is obtained by direct connection of the non-loaded and connected facilities without gain. A poor impedance match results in echo effects* that are detrimental when the circuits are used in long toll connections. Accuracy of the impedance match

* RECORD, August, 1954, page 281.

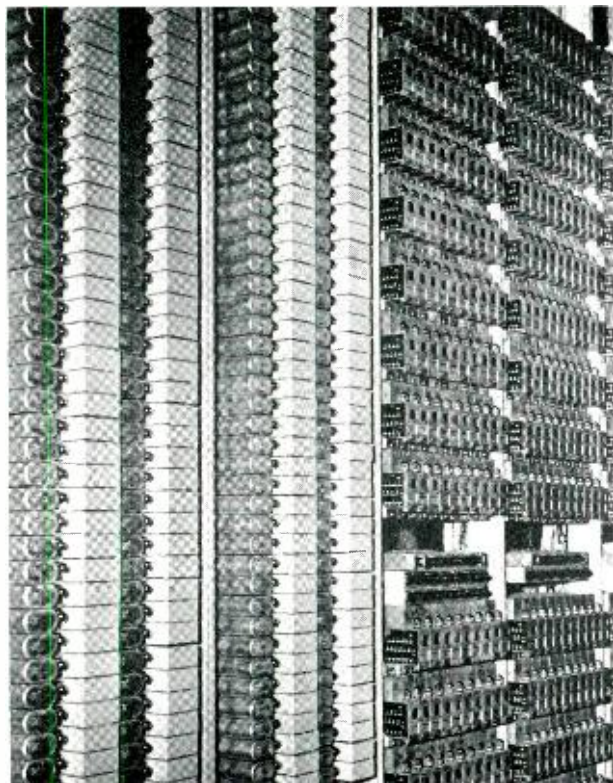

Fig. 3 — The Oakland installation, with E1 repeaters at the left and plug-in E3 repeaters at the right.

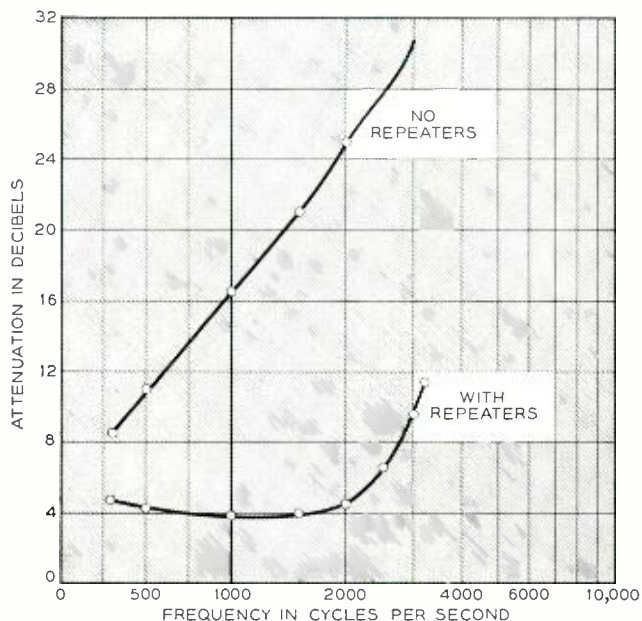

Fig. 4 — Loss-versus-frequency characteristic of repeatered and nonrepeatered nonloaded cable.

is measured by return loss, which indicates the ratio of energy returned as echo to the applied energy. Because of the difficulty in solving the general case, only special installations of non-loaded cables handling toll traffic, such as the San Francisco Bay cable, have been worked out.

E13 repeaters are connected at each end of the San Francisco Bay cable. E1 repeaters were used because E2 units were not available at the time of the cut-over. Figure 3 shows the installation at the Oakland Office, with the E1 repeaters at the left and the plug-in E3 units at the right. The result of applying repeaters to the 22-gauge nonloaded cable is shown graphically in Figure 4, which indicates the loss reduction and improved frequency response. The improved frequency characteristic approaches that of the older 19-gauge loaded cable.

Before the San Francisco installation, networks for the repeaters were worked out in the Laboratories to provide the desired gain-frequency characteristics and impedance transformation. In addition, stability margins against self-oscillation had to be obtained for both busy and idle circuit conditions. The network design for this project was further complicated since repeaters were required at both ends of the cable and it is not always apparent how the gain should be divided between repeaters to obtain the best result. These network arrangements were tried out and refined on artificial cable networks built up to represent as nearly as possible the Bay cable pairs.

On location, the networks were optimized after connection to the actual cable pairs to provide the best gain-frequency and return-loss characteristics. Gains of individual or combination repeaters at each location were measured with the repeater test set.^o In the usual case, the average gain of a repeater can be subtracted from the over-all computed net loss of the nonrepeated line to give the loss of the repeated line. In the case of the Bay cable, however, repeaters at each end made it difficult to calculate the over-all loss using measurements of repeater gain. End-to-end measurements were therefore substituted, using the test only to check the individual repeaters. A test of repeater stability (absence of singing or self-oscillation) in-

^o RECORD, January, 1956, page 17.

cludes checks with trunks in an idle condition—that is, disconnected from all other circuits—as well as trunks that are in a busy condition.

Many of the new cable circuits provide telephone communication between Oakland and the Main central office in San Francisco. Other circuits in the cable are extended at each end to other central offices within a seven-mile radius, forming permanently-connected cross-bay trunks. Repeaters on these pairs required slightly different gain adjustments from those on the Main to East Bay Main circuits to provide additional gain. Of the 1219 pairs available in the cable, 650 pairs were originally equipped with an EI3 repeater at each end, using a total of 2600 repeaters. Additional circuits with repeaters have been added since then, and by 1957 all pairs will be in service.

THE AUTHOR



WILLIAM J. KOPP joined the Laboratories in 1929, and was concerned with transmission measuring apparatus in connection with studies on transmission standards and effective transmission rating systems. Just prior to and after World War II, he investigated the transmission aspects of certain PBX's. During World War II he worked on wire and radio networks. Following the war, Mr. Kopp also worked on system aspects of the early mobile radio telephone equipment. Since 1947 he has been mainly concerned with negative impedance repeaters and their applications to telephone lines. Mr. Kopp received a B.S. in E.E. degree from New York University in 1937.

Editors Named for the Record and B. S. T. J.

George E. Schindler, Jr., Associate Editor of the RECORD, has been named Editor, effective with this issue. He succeeds William D. Bulloch, who has been named Editor of THE BELL SYSTEM TECHNICAL JOURNAL.

Mr. Schindler, who studied chemical engineering at Carnegie Institute of Technology, graduated from the University of Chicago and has a master's degree in English from the University of Pittsburgh. He taught technical writing at both the University

of Pittsburgh and Carnegie for several years, and did additional graduate work at Chicago before joining the Laboratories.

A graduate of Dartmouth College, with his master's degree in physics from the University of North Carolina, Mr. Bulloch taught courses in physics, mathematics and astronomy at the latter institution for a number of years. He was also Assistant to the Director of the Morehead Planetarium at Chapel Hill, North Carolina.

One major advantage of the No. 5 crossbar system is its flexibility. In some areas, for example, political or geographic boundaries influence the rate treatment on calls to and from various customers. A single No. 5 switching unit can serve up to 40,000 such customers divided among as many as six central office codes. With this arrangement, a customer's directory number can be used by the automatic switching equipment to insure that the proper rate treatment is applied. With the continuing growth of direct distance dialing, this flexibility makes the No. 5 crossbar system even more versatile in serving the operating telephone companies.



Divisions of Telephone Numbers in the No. 5 Crossbar System

R. C. AVERY *Switching Systems Development I*

The standard Bell System numbering plan consists of a group of digits used to identify the office in which the called customer line is located, and four additional digits for locating the line within that office. This latter condition limits the size of an office to 10,000 numbers — 0000 through 9999. In many cases, however, it is economical to build "wire centers" for more than 10,000 numbers. Such wire centers must therefore have more than one office name associated with them. Where common control switching systems are used, a single group of control circuits and test facilities may serve several offices in one center.

The telephones associated with the lines served by a No. 5 crossbar central office may be concentrated within a few blocks in the business section of a large city, or they may be spread out over a much larger area in the rural sections of the country. Sometimes rate boundaries may run through such an area, dividing it into sections which require different rate treatments for the calls to and from other central offices. Since the charges for these calls vary with the distances involved, and the political boundaries crossed, and since these charges are determined by identifying the office code involved, different codes must be assigned to the various

sections served by the telephone central office.

Also, in planning for future expansion of telephone facilities, it is sometimes desirable to assign more than one office code to a single central office. Projected growth in a particular area may indicate that an additional central office should be installed in the future, although immediate demands may be met by existing equipment. By assigning a new office code to the group of lines serving a particular area, and by providing the proper arrangement of switching equipment, this group of lines may be transferred when necessary to a new central office without the need for directory changes.

A switching unit (marker group) in the No. 5 crossbar system is designed to accommodate a maximum of 40,000 numbers, and these must be identified by not more than six office codes as shown in Figure 1. For identification within a switching unit, the numbers are divided into two major subdivisions known as number series groups A and B. Groups A and B consist of blocks of 30,000 or fewer numbers each, and each group can consist of from one to three series of 10,000 numbers. Although a number series may consist of the 10,000 numbers identified by an office code, a particular code may sometimes be used for less than

coming register link to the incoming register and then to the marker. Another signal, transferred through the trunk link connector, indicates the particular number series of the number series group. Together, these signals control the selection of the required number series. A signal from the trunk link frame also indicates whether the incoming trunk is restricted to reach only certain of the office codes within the number series group. This latter signal is compared with information returned by the number group and the call is completed only if these two signals match.

In certain cases a 10,000 number series may be divided into office subdivisions because of rate differences for calls from one locality while calls to these particular subdivisions from another locality will have the same rate. In the latter case, trunking efficiency can be increased by using one trunk group to reach all subdivisions with appropriate signaling arrangements.

On calls from revertive pulse offices such as panel and No. 1 crossbar which transmit the four-digit number in the form of five revertive pulse selections, a combination of directing signals and trunk grouping can be used. For these revertive pulse offices a trunk group can be provided for each office code in the No. 5 crossbar office, or the number of trunk groups can be reduced by employing a special signaling feature^o which effectively adds a central office designation. With this arrangement, a trunk group can be made to serve two offices, one of which will be in number series group A and the other in group B.

The possible divisions of numbers in the No. 5 crossbar system make this a very versatile system. Since a marker group can handle up to 40,000 numbers identified by as many as six office codes, it is suitable for application in any area, and ideal for rural and suburban areas.

^o The "High Five" incoming brush feature.

Laboratories Announces Tuition Aid Plan for College Study

A college tuition aid plan has been established by Bell Telephone Laboratories to assist employees in furthering their education. The plan provides a maximum of \$250 in tuition per school year for undergraduate studies which employees pursue on their own time.

Announced on March 13 by Dr. M. J. Kelly, the plan is available to all regular full-time employees. The courses elected under the program must be ones for which the college grants credit toward a degree and must be of benefit to the employee's work. The selected institution must be an accredited college or another institution approved by the Laboratories, and the employee must be acceptable to the college for undergraduate study. The maximum of \$250, which is to cover tuition but not registration or laboratory fees and other expenses, will be refunded by Bell Laboratories to each participating employee. One-half the tuition will be paid at the start of the course and the other upon its successful completion.

In his statement describing the plan, Dr. Kelly said, "We believe college educational training is beneficial both to the company and to the individual. The contributions of Bell Laboratories to the communication needs of the nation and to our na-

tional defense system depend upon the combined efforts of many well-trained people—people trained not only in scientific subjects but also many other disciplines of the mind.

"To solve the complex technical and human problems facing business today," Dr. Kelly said, "industry must direct greater attention than ever before to the development of its human resources. The individual, of course, must accept final responsibility for his own development, but his company can help him grow in many ways.

"At Bell Laboratories we have for many years provided employees with a variety of opportunities for education and training. Educational assistance for graduate study is available through tuition refunds and also through company training courses on a graduate level. At the undergraduate level we have already both in-hour and out-of-hour training programs covering a wide range of subject matter.

"Now we are extending tuition aid to those interested in outside undergraduate study wherever this promises to contribute to the employee's effectiveness on the job. I feel that this support of undergraduate study is a substantial step forward in developing to the maximum the capabilities of our people."

P1 Rural Carrier: Equipment Features

A. J. WIER

Transmission Systems Development I

F. H. KING

Merrimack Valley Laboratory



The new rural carrier telephone system, designed at the Laboratories, makes use of new transmission devices, novel assembly techniques and improved manufacturing facilities. Transmission devices include transistors, semiconductor diodes, dry tantalum capacitors, and newly designed transformers and inductors. Assembly techniques include the plug-in mounting of apparatus boards, the new wire-grid concept that makes such mounting practical, and the arrangement for quickly and easily replacing an entire terminal unit. Improved manufacturing facilities essentially consist of some mechanized units which automatically assemble the component apparatus onto the printed wiring boards.

Final development of a four-channel rural carrier system is now being completed at the Merrimack Valley Laboratory of Bell Telephone Laboratories. This new system, known as P1, was designed to fill the need for a rural carrier system that may in time be economically feasible for distances as short as five miles and as great as twenty miles. The new system transmits both sidebands and the carrier on each of four independent two-way channels. The additional carrier channels can be added to a given rural line pair, either one channel at a time or any number of channels up to four. The channel carriers are spaced about 12,000 cycles apart. The four channels may be applied to the line in two ways—"grouped" as to direction of transmission or "stacked" as to carrier frequency.

Transmission is over open-wire lines plus regular non-loaded entrance cables. Terminal equipment has been designed to take care of a line loss of approximately 30 db. Repeaters now being de-

veloped will make it possible to further extend the length of these lines by distances equivalent to 30 db per repeater, with a maximum of four repeaters.

Designed to serve all types of multi-party service, the system provides ringing options for four-party full-selective, and eight-party semi-selective, divided-code, or full-code ringing. Therefore, whenever the present 8-party service is considered adequate, this system can add up to thirty-two more customers on a single two-wire line, using semi-selective ringing. Moreover, with the new carrier system, it will be possible to carry on five simultaneous conversations over a rural open-wire circuit.

The P1 system uses transistorized circuitry and the new technique of printed wiring. These features have been introduced with a view toward providing the lowest possible first cost and simplified maintenance operations. The use of transistors also means lower power requirements and makes possible a reduction in the size of compo-

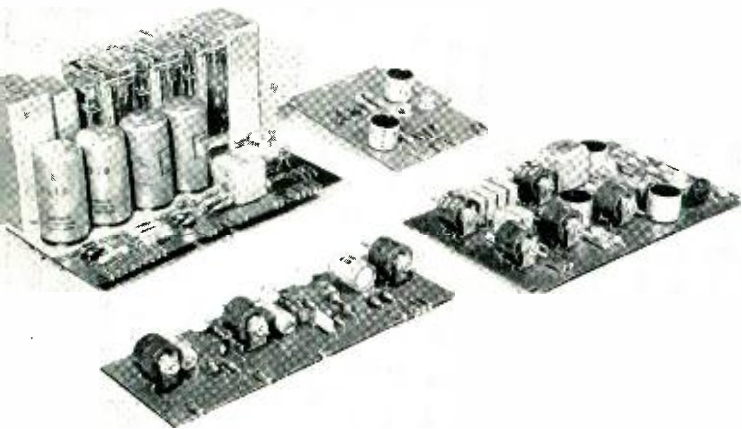

Fig. 1— Examples of equipment for terminal mounted on printed-wire boards.

nents such as inductors and capacitors; the result is a relatively small over-all size for the equipment.

All equipment for a terminal is mounted on eight printed wiring boards, approximately 5 inches by 8 inches in size, Figure 1. These in turn are located by self-aligning slides in an enclosed terminal box, Figure 2, that locks the boards in place and serves as a connector between the boards and the line. A wire grid arrangement within the box consists of thirty-six wires that interconnect the eight printed-wiring boards through small terminal connectors, overlaid with paladium on one side, mounted as required on each of the boards. The boards are

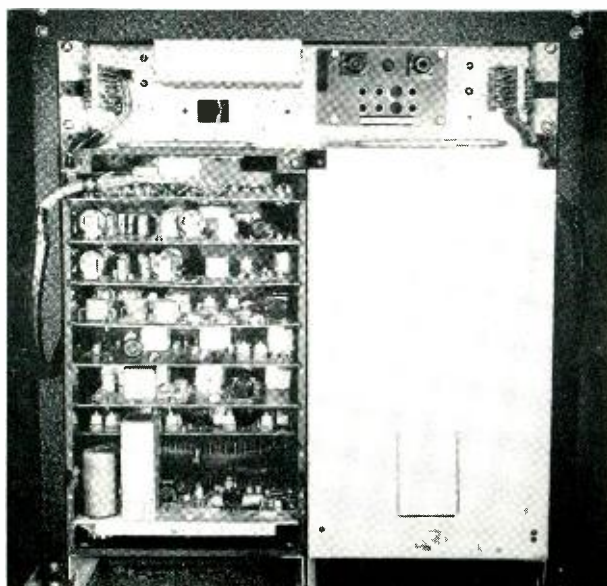

Fig. 2— Terminal box (laboratory set-up) includes boards illustrated in Figure 1.

assigned to positions A through J in the connector from the top down. All boards are coded as networks.

Each channel consists of two terminals — one at the central office and one at a remote location — both of which are the same except for the carrier frequency filters and the signaling-equipment boards. A complete terminal box can be easily fastened either to an office mounting bracket or to an outer weatherproof case by means of two screws near the top of the box. The “line connector” (the top printed wiring board), its associated cable, and

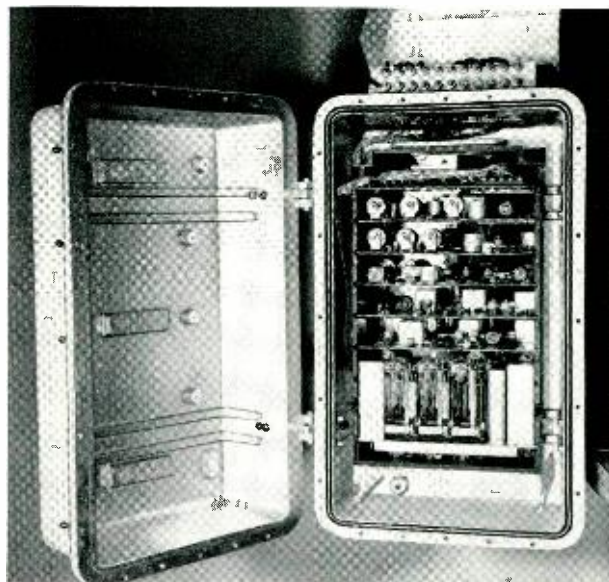

Fig. 3— The aircell power supply requires a much larger box than the terminal on the other side of the telephone pole.

an external terminal block connect the outside line to the terminal equipment at either location. Therefore, if trouble exists within a terminal unit at any time, it is only necessary to remove and temporarily relocate the line-connector board below the housing and then replace the entire terminal, box and all, with a good one. Service is automatically restored by replacing the line-connector board in its proper place in the new terminal.

Mounting brackets have been designed for use at a central-office location to mount the terminals for two channels side by side in a 19-inch rack. This mounting also includes the necessary line filters, and terminal blocks for transmission and power wiring to connect from either the 24-volt or 48-volt regulated office battery. With this mounting arrangement, one or two terminals will use the same 21 inches of vertical mounting space. These mount-

ings may be stacked to fill any standard size of rack.

In P1 carrier, except in long entrance cables, the same transmission lines will be used jointly for voice and carrier transmission, requiring an additional lowpass filter network at each voice drop to reduce carrier-frequency loss. The network, mounted on a pole at the point where the customer's drop wire connects to the carrier line, is cast as a small resin-block unit with tapered self-locking slots to fit an aluminum bracket. Screws are used to mount the bracket to the pole but no screws are necessary in mounting the block to the bracket. Lightning protection is provided by carbon-block protectors included as part of the network. A weather-protecting flexible rubber jacket covers the entire face and sides of the block.

The remote terminal, Figure 3, is designed to operate over an ambient temperature range of -40° to $+140^{\circ}$ Fahrenheit. To operate satisfactorily over this temperature range and not have the effects of humidity impair the system's performance, a hermetically-sealed outer case is used. Two similar die-cast aluminum shells, in conjunction with an O-ring gasket that fits between the shell flanges, are clamped together by sixteen captive screws along the flange, one for each four inches of periphery. A desiccant insures that air remaining in

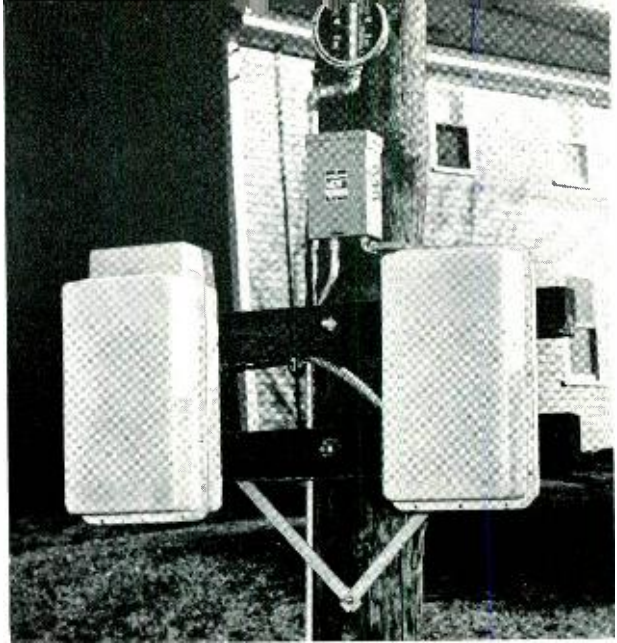

Fig. 4—Ac-operated supply and remote control housings mounted on pole.

the box is kept dry. Two special loose-pivot hinges allow ample freedom of movement in three directions for line-up purposes before the halves are clamped. The outer surfaces of the case are painted white for reflective purposes, to keep the inner temperature close to the ambient. In desert locations, the additional use of sunshades may be

THE AUTHORS



ANTHONY J. WIER joined the Western Electric Company Installation Department in 1911, and later transferred to the New York Telephone Company where he engaged in central office maintenance. After serving in France during World War I, and further service with both the New York Company and various engineering departments of Western Electric, he joined the Laboratories in 1928. Since that time he has been concerned chiefly with transmission development problems. Recently, he has spent most of his time on broadband carrier telephone systems and type-N and O carrier terminals. In 1935, Mr. Wier received the L.L.B. degree from the New Jersey Law School.

F. H. KING joined the Laboratories in 1929 and he became a technical assistant in the Transmission Systems Development Department, associated with transmission development laboratory test equipment in 1936. He was given responsibility for maintenance and repair of this equipment, in 1941. Mr. King became a Member of the Technical Staff in 1943. He was later assigned to N and O carrier development and in 1952 became involved with several government projects, including the NIKE missile. He is presently concerned with development of the P-1 carrier system at the Merrimac Valley Laboratory. Mr. King received an associate degree in electrical engineering from Newark College of Engineering in 1941. He is a member of the I.R.E.



necessary to realize the temperature requirements.

External wire connections — power, carrier, and voice — are brought to the outer side of a sealed terminal block, mounted on the top of the case. This terminal block provides both line protectors and through terminals to the inside of the case. A cover over the block for weather protection is hinged for ease of maintenance. Some of the through terminals of the block are used for test purposes to determine if the channel terminal contained within is in trouble. Because of this arrangement, it is believed that the outer sealed case will rarely have to be opened except to replace the terminal. The entire assembly is complete in itself and mounts on a pole usually within reach of the ground.

Each terminal at a remote location dissipates approximately 0.6 watt of power during idle (on-hook) periods. Nominal voltage for each terminal is 22.5 volts dc. Power at these remote locations will be supplied to each channel terminal individually by one of two methods:

1. An ac-operated supply using germanium di-

odes for rectification, a silicon junction diode as a voltage standard, and three transistors for voltage regulation. Two small lead-acid storage batteries will provide standby power for about six days.

2. Aircells where ac power is not available. These cells can be used within a temperature range of -40°F to $+140^{\circ}\text{F}$ and have a capacity of 1000 ampere-hours. The battery will supply a terminal for approximately three years.

The ac-operated supply contained in a die-cast aluminum case is practically identical with the remote terminal outer housing (both are made from the same basic die) and will mount on the same pole as the terminal, Figure 4. Connections between the cases and the transmission line are made by fourteen-gauge wire enclosed in flexible conduit. The aircell arrangement requires a special steel cabinet approximately three to four times the size of that required for the ac-operated supply and will be mounted near the base of the pole to make the cells easily accessible for periodic maintenance.

Program to Train Specialists in Digital Techniques

Plans for an educational program to train specialists in digital computer techniques and digital data processing have been announced by the Laboratories. The program calls for the establishment of a Digital Techniques Laboratory (DTL) which will take men with first year Communications Development Training or its equivalent and give them additional training in computer work. The level of training will be comparable to a graduate school thesis assignment. All men who are nominated for DTL are expected to meet standards that are required of candidates for graduate research in accredited colleges or universities.

The decision to establish DTL is a recognition of the increasingly apparent fact that future telephone switching and transmission systems will be based on digital techniques. The DTL program will qualify a number of Laboratories people to augment the limited supply of personnel from universities who are trained in this field.

General guidance of the program will be provided by an Advisory Committee made up of J. H. Felker, chairman, R. L. Dietzold and W. T. Rea. This group will function as a subcommittee of the Educational Policy Committee. The program will be conducted at the Whippany Laboratory under the direction of J. A. Baird. Professor R. E. Meagher, director of the Digital Computer Laboratory at the University of Illinois, will act as a consultant in planning research projects and organizing lectures and seminars.

The first group of trainees, expected to total 12 to 20 men, will be assigned to DTL on July 1, 1957. Enrollment in the program will be handled like a long rotational assignment. Credits will be granted toward a CDT certificate, and the DTL work will substitute for either the second or third year of the Communications Development Training program. At the end of the full year in DTL, the trainee will return to his sponsoring department.

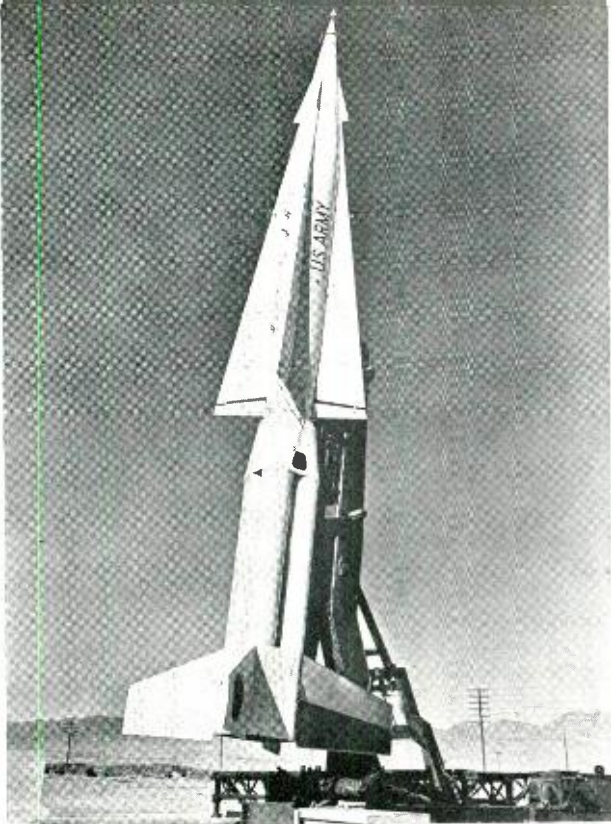

U. S. Army Photograph

Nike Hercules, more powerful and faster than the original Nike, is now undergoing final tests.

An improved version of the Nike missile, recently designated as Nike Hercules, with many times the destructive power of the original Nike, is undergoing final tests according to a recent announcement by the U. S. Army and Western Electric Company, prime contractor for the Nike System. Known as Nike B during its development stage, Nike Hercules is substantially faster and has a much greater range than Nike Ajax, which has guarded key cities and strategic areas of the nation for the past three years. It is expected that the new missile will be in the hands of operational Nike batteries strategically located around the country in the relatively near future.

Although longer, heavier and more than double the diameter of Nike Ajax, the Hercules model will have extreme maneuverability at altitudes far in excess of those capable of being reached by Ajax. Its higher velocity will permit swifter interception of the most advanced types of aircraft, and its increased lethality will make Nike Hercules one of the most effective weapons in America's defense arsenal of interceptor-type missiles.

Certain modifications in existing ground control equipment make it possible for Nike Hercules to be integrated into existing Nike batteries throughout the nation. Both Nike Ajax and Nike Hercules

Nike Hercules Undergoing Final Tests

can then be fired with the same system. The equipment changes also add to the effectiveness of Nike Ajax.

Research and development studies were begun on the improved version of Nike in 1953 by the same Army-Industry team which assumed responsibility for the original Nike missile. This included the U. S. Army Ordnance Corps, Bell Telephone Laboratories, Western Electric Company and Douglas Aircraft Company. The ground guidance and control equipment and missile guidance are being manufactured by the Western Electric Company at its Burlington and Winston-Salem plants in North Carolina, while Hercules missiles will be produced initially at the Douglas Aircraft Santa Monica plant and followed with additional production at the Douglas-operated Charlotte Ordnance Missile Plant at Charlotte, North Carolina. Components of the associated launching equipment are also the responsibility of Douglas.

The first prototype production model of ground equipment has been released for testing at the Army's White Sands Proving Ground in New Mexico. According to a special announcement by Secretary of Defense Charles E. Wilson, nuclear capability will be incorporated into the Nike-Hercules surface-to-air guided missile system.

A test firing of the Nike Hercules missile.

U. S. Army Photograph





Thermal Time-Delay Relays

A relay is generally thought of as a fast-acting device. The time between the application of power to a relay coil and the opening or closing of the contacts – the operate time – is ordinarily held to as low a value as possible. Sometimes, however, circuit requirements are such that the operate time of a relay must be comparatively long – from several seconds in some circuits to minutes in others. Relays that satisfy these conditions are known as time-delay relays. Many ingenious mechanisms have been used in time-delay relays but the simplest and most common is the thermal or heat-actuated type.

Probably the oldest thermal time-delay relay in the Bell System is the 235-type. It uses the mounting structure of an E-type relay to support the contact springs and heating element, but without the conventional coil and armature. The heating element is wound around a bi-metallic spring, and when heated, this spring bends toward its mating spring to close the contacts. This relay was first manufactured in 1935, but the first three codes (A, B, and C) saw little service and the use of these types has since been discontinued.

About 1950, a redesign resulted in several new 235-type relays. The 235E provides a single make contact and was originally used in the No. 5 cross-bar system to prevent a circuit from being held if either party failed to restore the handset after completing a call. The 235D relay provides two independent “make” contacts with different time delays.

One pair of springs performs a disconnect function similar to that of the 235E while the second pair, with a shorter delay time, prevents additional over-time charges on AMA^o calls if a disconnect entry is not made within the delay period. Both relays use a heating element wound on a flat mica bobbin which is wired to the bi-metallic spring instead of being wound around the spring itself. The 235D is supplied with a regular E-type relay cover to minimize time-delay variations due to air currents,

^o RECORD, September, 1951, page 401.



Photograph shows 235E-type relay with wound heating element wired to relay spring.

and to keep out dust. The G and H codes are similar respectively to the E and D codes but with different time-delay ranges. The J code is a single "break" instead of a "make" contact type. (The photograph at the top of the opposite page shows J. Jacobsen checking thermal time-delay relays to see if they meet "make" contact or "break" contact times specified for the various relays.)

Development of the key telephone equipment in the mid-thirties brought about another problem that was solved by the use of the 271A time-delay relay. In this system, when an incoming call rings the customer's bell, a lamp lights at the key equipment and remains lighted until the call is answered. If no one answers, the lamp could remain lighted for quite some time, possibly as long as an entire weekend. A switch is usually provided to disconnect the lamp when the telephone is expected to be unattended for any length of time, but office personnel sometimes forget to operate the switch. A time-delay relay is therefore provided to disconnect the lamp if the telephone is not answered within a given period. This time-delay relay not only saves frequent replacement of burned-out bulbs, but protects the battery power plant from depletion through needless lamp drain.

The 271A thermal relay was developed specifically for this purpose. To avoid extra space requirements, it is built as part of a U-type relay that is already included in the key equipment. A pair of bi-metallic springs is mounted in place of some of the regular U-type springs, and a heating element is mounted alongside one of the pair. The heating element is wound around a copper strip that makes mechanical contact with one of the bi-metallic springs in the relay (copper is used because of its high heat conductivity.) Heat is transferred to the spring through the copper strip and through the small air space between the spring and heating element. Some heat is also transferred to the second bi-metallic spring, but the amount is negligible.

Another thermal time-delay relay, coded 282A, has the same thermal element as the 271A relay except that the thermal element is built as part of a Y-type relay. Time delay in all these relays is set by adjusting the contact springs. On the "make" contact relays, the larger the contact separation the longer the time delay, and on the "break" contact relays, the greater the contact pressure the longer the time delay.

The operating voltage for the 271A and 282A

relays is usually supplied from the central office over various lengths of loop. The available voltage, which is nominally 24 volts, may vary from 16 to 26 volts dc. Most of the 235-type relays are designed to operate on a nominal voltage of 48 volts dc. In the central office this voltage may vary from 45 to 50 volts dc. The exception is the 235H relay which operates on a nominal 24 volts dc.

Thermal relays are always adjusted so that the minimum permissible time delay will occur with the highest available voltage. Lower voltages, as

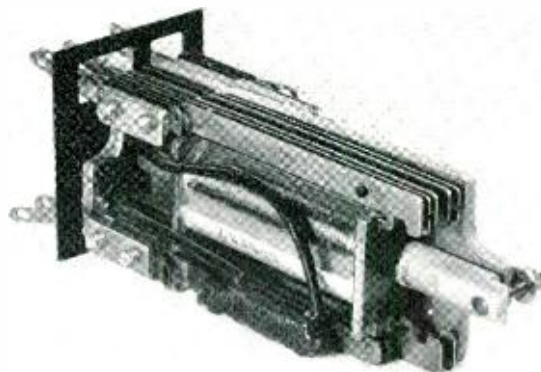

The 282 relay has the heating element mounted near pair of springs. Heat is transferred to the spring by contact and through airspace.

long as they are sufficient to eventually operate the relay, simply mean a somewhat longer time delay. Ambient temperature also has an effect on the delay, but this is minimized by making both springs of the same bi-metallic material, the same length, the same width and the same thickness. Ambient temperature changes cause both springs to bend in the same direction at the same rate, maintaining the desired contact spacing or pressure.

One problem with all thermal relays is the need for a "cooling-off" period or recycle time. After a relay has operated, the heated elements must cool off before being heated again or the time delay will be much too short. Two minutes is considered the minimum time permissible before reoperation of a 235-type relay and five minutes for a 271A or 282A relay.

J. JACOBSEN

Switching Apparatus Development

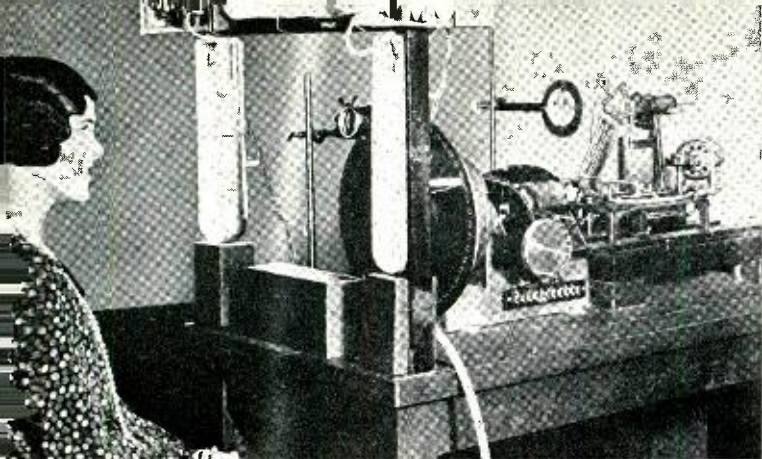

Television: 30 Years of Progress

The historic 1927 television transmitter. Light coming through holes in scanning disk was reflected from subject and picked up by highly sensitive photocells framing her face. As the scanning spot was detected, the signal was then transmitted to the receiving equipment and displayed.

Television was transmitted over a substantial distance for the first time thirty years ago this month using equipment developed by the Laboratories. Recognizable, moving images were sent by wire from Washington, D. C., and by radio from the Whippany, N. J., Laboratories location to a public demonstration in the West St. Auditorium in New York City on April 7, 1927. This event not only established the Bell System's vital part in the growth of television, but also helped significantly to establish Bell Telephone Laboratories as a center of basic scientific research.

Communications scientists had for some years dreamed of "ideal" personal communication, where the speaker could be seen and heard at the same time. In 1924, transmission of a still photograph from Cleveland to New York proved successful and the following year this system became commercial. Similar systems are in use today by the national press associations. The transmission of a transient visual image — *television* — seemed a logical next step in the program.

Dr. Herbert E. Ives, of the Electro-optical Research Department, who had directed the still picture transmission program, immediately proposed that a study pointed toward long distance television be undertaken. Basic to such a program in 1925 was the design and construction of terminal equipment to generate and transmit, and to receive and display, a television image. About a year later preliminary terminal equipment had been devised that was good enough to give room-to-room television. This was not the original intent of the program, however, and significant refinements and improvements were made in the terminal systems prior to the public demonstration.

Walter S. Gifford, then president of the A.T.&T. Co., was one of the many distinguished participants in the historic 1927 demonstration. Speaking of television, he said, "What its practical use may be I shall leave to your imagination. I am confident,

however, that in many ways and in due time it will be found to add substantially to human comfort and happiness."

Following this historic demonstration, the light gathering capacity of the original television equipment was greatly increased and daylight television was demonstrated in 1928. A two-way television circuit was set up between the West St. Laboratories and A.T.&T. headquarters at 195 Broadway in 1930, and was used by some 10,000 people before it was dismantled a year later.

During this period of exploring the possibilities of picture transmission, a system of color television was worked out and demonstrated in 1929. The light reflected from the image to be transmitted was broken down into red, green and blue light, the three signals transmitted simultaneously, and displayed as a full color picture.

Of even greater importance to television as we now know it have been the continuing advances made by the Bell System in broadband transmission systems. These broadband systems were originally developed to provide more telephone circuits at lower cost. The first coaxial cable was installed on a "field laboratory" basis between New York and Philadelphia in 1936, and through experimental television broadcasts was found to be suited to the broadband requirements of television.

Coaxial cable is laid by huge, 27-ton cable plows and cable reels as shown below. These machines plow a furrow and simultaneously lay the cable, sometimes burying it as deep as five feet into the ground.



Another system of broadband transmission — radio relay — has had an equally important effect on long distance television transmission. These line-of-sight radio links, based on the great advances made in microwave transmission during World War II at the Laboratories and elsewhere, had developed into an important communications tool by 1947. Laboratories engineers, through long experience in radio, were able to adapt the broadband advantages of microwave radio-relay for both multiplex telephony and television.

The interconnection of these two long-distance systems with local channels made inter-city television possible, and the original demand for long-distance television service built up rapidly. Concurrently, the need for a nationwide transmission sys-

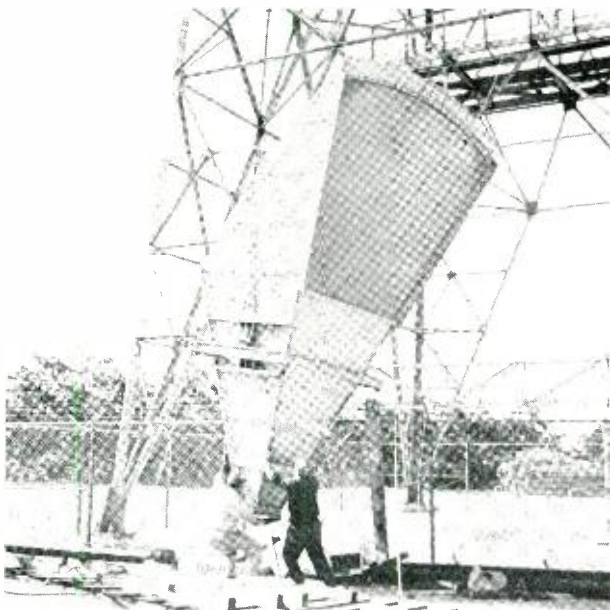

New, cornucopia type antenna on its way to the top of a radio-relay tower at Plainville, Long Island. Telephone and television transmission quality and capacity are constantly being increased through improvements in antenna design.

tem to accommodate the tremendous telephone expansion then under way was very apparent. A plan for a network of greatly increased telephone capacity, also capable of carrying high quality television, was worked out.

In 1948, the year the Bell System television network was first opened for commercial service, transmission was largely handled by coaxial lines, with only a relatively small proportion by microwave



Television operating center in Chicago. Standard operating center equipment was designed to coordinate program elements and monitor video quality for both incoming and outgoing television transmission.

radio-relay. By 1951, the year coast-to-coast television transmission was inaugurated, radio-relay had increased greatly in importance, and subsequently has exceeded coaxial cable in overall transmission capacity. During this same period, 1948-1951, the number of channel-miles of the television network had increased some twentyfold, and the number of stations and cities linked by the network had increased by a factor of ten.

Accompanying this tremendous growth in size have been important improvements in the transmission quality and versatility of this vast network. Long-life electron tubes developed at the Laboratories are now being used instead of tubes which formerly required frequent replacement. Since 1953, a large proportion of the network has been altered to handle the more exacting transmission requirements of color television. In addition, most of the radio-relay systems now in use have a capacity of six channels in each direction, compared with just two on the original, experimental Boston-to-New York link, so that most links now have a protection or emergency standby channel in each direction as part of the system. To make the fullest use of such protection, automatic switching techniques have been developed for radio-relay which can, in case of trouble, switch service to another channel in a fraction of a second. Many new transmission developments have also been designed specifically to improve local transmission. The latest of these is the A2A video transmission system for local, intracity television.

Several new systems embodying the latest developments in antenna design and waveguide technology are in the final stages of development at the Laboratories. These improved horn antenna systems will be installed on all new main routes and

will also ultimately replace many of the antennas now in use. This new equipment is designed to transmit and receive three wide ranges of wavelength instead of only one. New facilities of this type will enable the Bell System to furnish closed-circuit television with about a ten-megacycle bandwidth to theatres. Another recent development pointing toward maintaining better picture quality in transmission has been the introduction of new equipment in Television Operating Centers. Monitoring and maintaining high quality transmission have always been an important part of the Bell System transmission responsibility, but the development of standard TOC equipment permits increased



Motion picture film is frequently used as a source of picture signals for transmission studies. This continuous film scanner, developed in the Laboratories, provides signals of sufficiently high quality for advanced visual research. Left, to right, C. F. Matke, A. G. Jensen and R. E. Graham.

efficiency of both manual and electrical switching operations. This equipment was developed to standardize and facilitate the switching of video signals through centralized transmission facilities.

A television topic of much current interest and experimentation is educational television. The interest and support of the Bell System in this important field have been expressed through participation in educational television experiments now being conducted in Washington County, Maryland. This educational television program — the first attempt to furnish superior instruction in certain subjects on a county-wide basis — is being carried out by county education officials with the support and help

of the Ford Foundation, the Radio, Electronics and Television Manufacturers Association (RETMA), and the Bell System. As interest in this program grows and more definite information on the merits of such a program becomes available, additional work at the Laboratories may be required to develop special equipment and circuits for such closed circuit systems.

Closed circuit television has also received a great deal of recognition for the many and varied jobs it is performing in business and industry. Closely allied to closed circuit systems, and intimately related to both telephony and television, is the Picture-Phone. This exploratory voice-and-image transmission system operates through standard telephone circuits, and consequently appears to have possibilities not afforded by broadband visual systems. The Picture-Phone, however, is still very much a laboratory device, and considerable further investigation and evaluation will be required to determine where such a system will ultimately fit into the future of the Bell System.

But even more basic to the future of television transmission are the statistical and physiological foundations of sight and sound. How can signals of a given quality be transmitted more economically? What are the actual information-bearing aspects of speech and hearing? Is it possible that by encoding picture signals according to the tenets of Information Theory, the Bell System can furnish more and better picture information over a narrower band? What are the characteristics of picture quality and picture sharpness? These are some of the basic questions concerning sight and sound that the Audio and Visual Research Departments at the Laboratories are attempting to answer through subjective studies of speech and the visual process. Such studies have already yielded significant findings concerning the subjective sharpness of color television pictures — findings directly translatable into bandwidth problems. Digital computer studies of signal encoding systems, where the computer is programmed to represent the terminal equipment and the associated transmission system, have revealed at least some preliminary findings on the merits of various bandwidth compression schemes for picture signals. Similar studies in the field of speech and hearing are being conducted, and the data being gathered in this area also shows great promise of application. Undoubtedly somewhere in these basic studies of sight and sound lies the key to the telephone and television transmission systems of the future.

“TJ” — A New Microwave Relay System

To provide a highly reliable yet inexpensive short-haul microwave relay system, Bell Telephone Laboratories engineers have developed the “TJ” system. This system can provide up to six broadband radio-frequency channels on the same route in each direction of transmission. Each channel can be used for either telephone or television (monochrome or color) service. As many as nine repeaters can be connected in tandem. A single dual polarized antenna is used in each direction for simultaneous transmission and reception.

The equipment, developed under the direction of J. W. Fitzwilliam of the Laboratories, operates in the 11-kmc common-carrier band. Frequency modulation is employed, and is obtained by impressing the modulating signal on the reflector electrode of a klystron. Frequency stability is assured by a reference cavity system which, as part of a microwave discriminator, provides an error voltage when the frequency is incorrect. An electromechanical servo system, controlled by this error voltage, keeps the klystron mechanically tuned to the correct frequency.

Antenna Feed

Output of the klystron is fed to a dual polarized paraboloidal antenna. The rectangular waveguide from the klystron is connected to the circular waveguide of the antenna by means of a polarization separation network. Reflections due to slight irregularities in this guide or due to a mismatch at the antenna will give the klystron a nonlinear modulation characteristic. To avoid this possible source of trouble, a Laboratories development known as a ferrite isolator is included in the waveguide system. This isolator, consisting of two critically spaced slabs of magnetized ferrite installed inside the connecting waveguide, permits the direct signal to pass through with only a 15 per cent loss, while attenuating the reflected signal by a factor of one million.

In the receiver, the RF signal is passed through a channel separation network and mixed with the output of a klystron local oscillator in a balanced silicon diode mixer to produce an IF signal centered at 70 mc. This IF signal is then amplified, limited, and demodulated to baseband. The baseband intel-

ligence, after further amplification, may be used to modulate the transmitting klystron at an intermediate repeater station, or may be connected to the local carrier terminal or television link at the termination of a microwave link.

Channel Bandwidth and Separation

Each of the broadband channels is 20 mc wide, and channel separation in a particular direction is 80 mc. Channel allocations are such that there is a minimum of adjacent channel interference, and regeneration, which might occur if the same frequency were used for both transmission and reception, is eliminated.

To reduce adjacent-channel interference further, the RF signal associated with each channel is polarized in such a manner that the polarization vectors on adjacent channels are at 90 degrees with respect to each other. These individual polarized signals are then combined for transmission and separated out at the receiver. Discrimination between adjacent channels due to this technique alone may be as high as 25 db.

Alternative use of several types of antennas is planned, but the present system consists of a five-foot paraboloidal dish antenna pointed upward toward a plane reflector mounted at the top of the relay tower. This reflector, either six-by-eight feet or eight-by-twelve feet, depending on tower height and path length, is mounted at a 45-degree angle and reflects the signal horizontally toward the distant station. Such an arrangement eliminates the appreciable losses which would be encountered if a dish antenna were mounted at the top of the tower and fed by a long run of waveguide. Gain of the paraboloidal antenna itself is 42.1 db, and the use of a plane reflector provides an additional gain of about 1 db for tower heights of 200 feet or more. Beamwidth of the whole antenna system, including the reflector, is about 0.7 degree at -3 db points.

Normal signal level at the receiver is such that the system can operate through fades of as much as 40 db. This fading margin will take care of the attenuation in the 11 kmc band due to absorption and scattering of the signal by raindrops during severe rainstorms.



A view of the telephone exhibit area shows panel displays. Bust of Alexander Graham Bell stands at far end of corridor in front of historical section showing early transmission instruments and developments.

Smithsonian Institution Opens New Telephone Exhibit

The Smithsonian Institution in Washington, D.C., opened a new industrial exhibit on March 11. This exhibit features both a history of telephone development and a presentation of the most recent advances in communication technology. The opening ceremonies were planned to coincide with the eighty-first anniversary of the first successful telephone conversation carried over Alexander Graham Bell's basic instrument.

Dr. Melville Bell Grosvenor, president of the National Geographic Society and grandson of Alexander Graham Bell, formally opened the exhibit. Presentation was made by James B. Morrison, President of the Chesapeake and Potomac Telephone Companies, on behalf of the Bell System, and by L. F. Roberts, director of information for the United

States Independent Telephone Association, on behalf of the independent telephone industry. The exhibit was accepted by Dr. Leonard Carmichael, Secretary of the Smithsonian Institution. Present at the ceremonies were a number of Bell System representatives from the A.T.&T. Co. and the Chesapeake and Potomac Telephone Companies. Bell Telephone Laboratories representatives were R. K. Honaman, Director of Publication, and H. J. Kostkos, Exhibit Supervisor.

The exhibit is located on a balcony of the Arts and Industries building. Display panels, each depicting a different phase of telephone development, form a corridor on the balcony. One end of this corridor contains the early historical group and the sides are devoted to research and development

Participants in the ribbon cutting ceremonies included, left to right: R. V. Fleming, Chairman, Executive Committee of Board of Regents, Smithsonian Institution and Director of Chesapeake and Potomac Telephone Companies; Dr. Leonard Carmichael, Secretary of the Smithsonian; L. F. Roberts, Director of Information, U. S. Independent Telephone Association; J. B. Morrison, President of C. & P.; Dr. Melville Bell Grosvenor, President, National Geographic Society, Director of C. & P., and grandson of Mr. Bell.



demonstrations. A bust of Alexander Graham Bell stands at one end of the corridor.

Elementary transmission tools, such as the megaphone and tin-can and string telephone, and early sound transmission developments, such as those of Wheatstone and von Helmholtz, comprise the introductory panels of the exhibit. Alexander Graham Bell's development of the first practical telephone is shown in detail. A number of early commercial telephones are also shown in this area.

The principles of telephony are explained in a group of six panels which include several spectator-operated demonstrations. This portion of the exhibit is divided into four categories. The first features the concept of interconnecting telephones with manual and automatic switchboards, including both step-by-step and crossbar. The use of amplifiers in telephone lines comprises the second category. Following are displays devoted to carrier

1890. This group is followed by a panel of telephone instruments developed during the twentieth century. World-wide telephony, including both transoceanic radio-telephony and the underseas telephone cable, is the subject of the neighboring display. In the final two panels are demonstrated some refinements of telephony — the quartz crystal, miniaturization and printed circuit techniques.

Preparation of the exhibit was under the overall supervision of a Bell System committee including representatives of C.&P., A.T.&T., Long Lines, Western Electric and Bell Laboratories. Most of the exhibit was designed and constructed under the direction of the Laboratories exhibit group comprised of H. J. Kostkos, Exhibit Supervisor, E. A. Bowles and R. W. Smith. This group worked closely with R. P. Multhauf, acting head curator of Smithsonian's Department of Engineering and Industries. Considerable effort was made to enhance the dem-

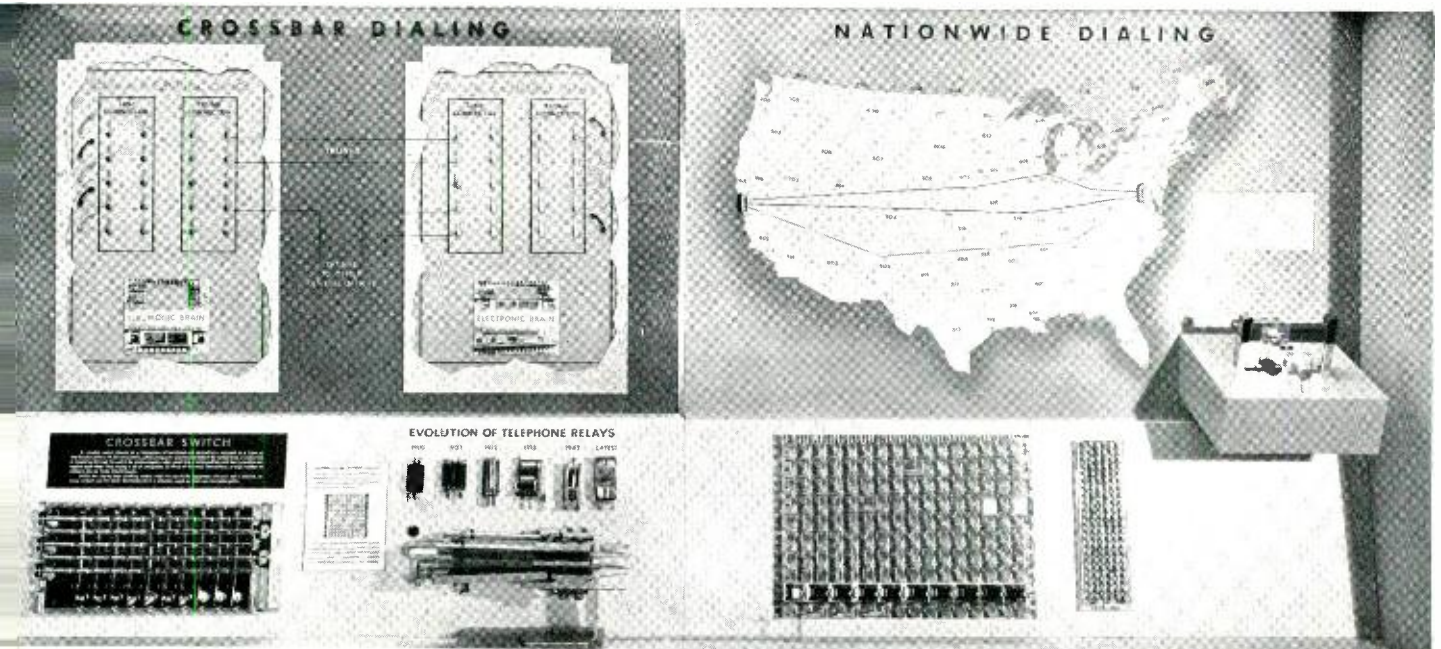

A typical display panel features demonstration of crossbar dialing at left and a demonstration of automatic alternate routing for selection of telephone conversations on the map at right.

systems and multiplexing as applied to the problem of carrying many voices over a single path. Recent developments by Bell Telephone Laboratories are shown in the concluding panel of this group. These include the use of solid state devices and the possible direct application of solar energy to new advances in telephony.

On the opposite side of the corridor is a group of four panels which depict development of the telephone instrument from its conception until

onstration nature of some of the displays by application of simple electrical and electronic controls. These devices will allow spectators to operate simple circuits and observe certain engineering concepts in action. N. C. Treadon of Ohio Bell, in addition to constructing part of the historical section, took charge of the necessary structural changes of the building in the exhibit area. Maintenance of the displays is to be undertaken by the Chesapeake and Potomac Companies.

Dr. Kelly Helps Formulate Plan for High School Science Majors

Dr. M. J. Kelly in his position as chairman of a New York City Board of Education subcommittee has been instrumental in developing a plan to interest high school students in careers in science, mathematics and engineering.

This subcommittee of the Board of Education's "Advisory Committee on Scientific Manpower" has recommended that industries in the New York area engaged in laboratory work undertake to provide suitable summer jobs for selected high school juniors and seniors. About 100 pupils who are majoring in science or mathematics will be selected for these laboratory-type summer jobs.

It is expected that this summer employment program will attract young men and women who have demonstrated a high order of ability in science and mathematics. The program is intended to widen the interests of the students in science and to encourage them to seek careers in the scientific, the mathematical or engineering fields.

New Directors Elected to Western Electric Company Board

At the regular meeting of Western Electric Company's Board of Directors on February 14, Florian J. Andre and Dr. John T. Rettaliata were elected members of the board. Their election brings Western Electric's board to a total of thirteen directors. Mr. Andre is president of Congoleum-Nairn Inc. of Kearny, New Jersey, and Dr. Rettaliata is president of the Illinois Institute of Technology in Chicago. Both men also are directors of several other companies and hold prominent positions in civic and industrial organizations.

H. G. Arlt Elected President of Standards Engineers Society

Herbert G. Arlt, Laboratories Materials Specifications Engineer, has been elected President of the Standards Engineers Society for 1957. The Standards Engineers Society is an organization which functions through local and national meetings in the United States and Canada to provide Standards Engineers with an opportunity to exchange information on techniques of standardization in different fields of endeavor and to promote the use of available standards.

Mr. Arlt joined the Bell System in 1923 and since that time, except for a period during World

War II, he has been engaged in materials engineering work. His primary concerns have been with finishes and organic materials, and he was in charge of finish development work for many years.

Contents of the March 1957 Bell System Technical Journal

The March, 1957, issue of THE BELL SYSTEM TECHNICAL JOURNAL contains the following articles:

A New Carrier System for Rural Service by R. C. Boyd, J. D. Howard, and L. Pedersen.

An Experimental Dual Polarization Antenna Feed for Three Radio Relay Bands by R. W. Dawson.

Sensitivity Considerations in Microwave Paramagnetic Resonance Absorption Techniques by G. Feher.

Measurement of Dielectric and Magnetic Properties of Semi-Conducting Ferromagnetic Materials at Microwave Frequencies by Wilhelm von Aulock and John H. Rowen.

The Character of Waveguide Modes in Gyromagnetic Media by H. Seidel.

The Determination of Pressure Coefficients of Capacitance for Certain Geometries by D. W. McCall.

Reading Rates and the Information Rate of a Human Channel by J. R. Pierce and J. E. Karlin.

Binary Block Coding by S. P. Lloyd.

Selecting the Best One of Several Binomial Populations by Milton Sobel and Marilyn J. Huyett.

50-Millionth Bell System Telephone Presented

The man who has been working for Bell longer than anyone else, James S. Russell of Salisbury, Md., received, on March 12, the 50-millionth Bell System telephone from Frederick R. Kappel, President of A. T. & T. Co. Mr. Russell began working for the Bell System as a boy telephone operator in Salisbury fifty-three years ago. He is now a district plant engineer of the Chesapeake and Potomac Telephone Company of Maryland.

In making the presentation at the A. T. & T. offices in New York, Mr. Kappel noted that the Bell System had not quite two million telephones in service when Mr. Russell started to work in 1904. "Then we had 77,000 employees," Mr. Kappel said, "and today we have nearly 800,000. In 1904, 17,000 people had invested savings in our business, while today we have a million and a half share owners. Our service progress has been brought about by all three groups — customers, employees and share

owners. But today we pay particular honor to telephone employees."

The 50-millionth telephone, in beige and with a suitably inscribed plaque, will later be installed in Mr. Russell's home in Salisbury.

Crossbar Equipment Plant Planned by Western Electric

Western Electric has announced plans to build a \$50,000,000 manufacturing plant on the outskirts of Columbus, Ohio, for the production of

crossbar switching equipment. Western has acquired options to purchase 250 acres of farmland for the proposed 1,500,000 square foot factory. If zoning and other problems are satisfactorily resolved, ground will be broken in May with initial occupancy early in 1959. Employment is expected to be about 4,000 when full production is reached.

In May, Western hopes to start a pilot shop in the area to train a nucleus of about 600 to 800 employees in manufacturing techniques. The new factory is needed because of the continuing heavy demand of the Bell telephone companies for crossbar switching equipment.

BELL SYSTEM TELEVISION NETWORK ROUTES

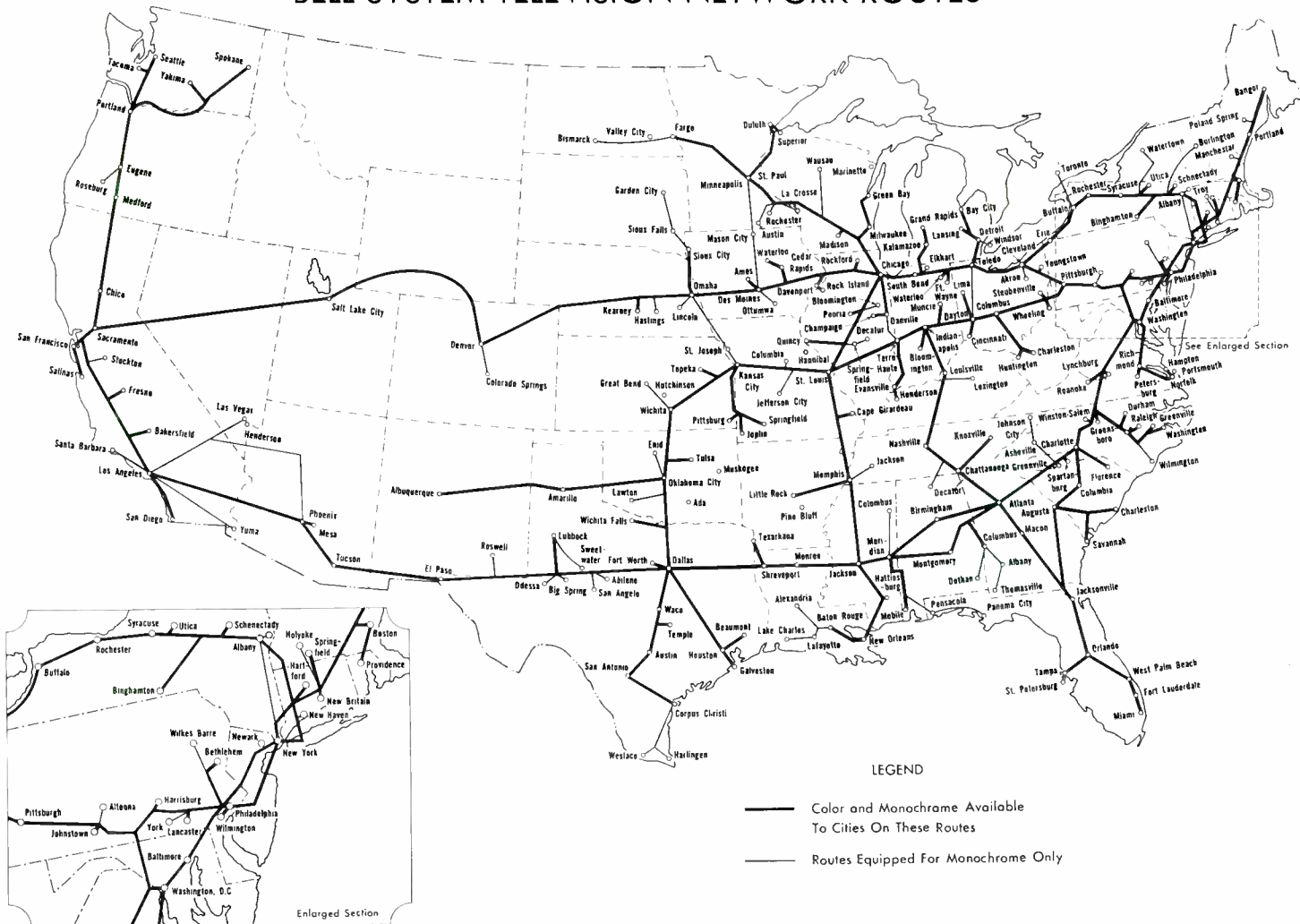

American Telephone & Telegraph Company • Long Lines Department

Talks by Members of the Laboratories

During February, a number of Laboratories people gave talks before professional and educational groups. Following is a list of speakers, titles, and places of presentation.

- Ahearn, A. J., *Mass Spectrographic Studies of Bulk Impurities and Surface Contaminants of Metals, Semiconductors and Insulators*, Cleveland Society of Spectroscopy, Cleveland, Ohio.
- Anderson, P. W., *Interactions of Donor Spins in Silicon*, Solid State Seminar, RCA Laboratories, Princeton, N. J.
- Bavelas, A., *Organizational Communication: Structure and Function*, Mid-Career Course on Foreign Affairs, Foreign Service Institute, Dept. of State, Washington, D. C.
- Becker, J. A., *Study of Surfaces by Using New Tools*, University of Maryland, College Park, Md., and Catholic University, Washington, D. C. Also, *Revelations of the Field Emission Microscope*, Bureau of Standards, Washington, D. C., and Stuyvesant High School, New York City.
- Benson, K. E., see Pfann, W. G.
- Booth, Dorothy P., *Programs for Crystal Structure Calculations on the IBM 650 Magnetic Drum Calculator*, Conference on the Use of the IBM 650 for Crystal Structure Analysis Computations, University of Pittsburgh.
- Bradley, W. W., *Metallic Coatings—Their Selection and Use*, Montreal Section of National Association Corrosion Engineers, Engineering Institute of Canada, Montreal.
- Brattain, W. H., *Demonstration-Lecture on Circuit Aspects of Transistors*, Chalmers Technical Institute, Göteborg, Sweden. This talk was given by Mr. Brattain while he was in Sweden to receive the Nobel Prize.
- Breidt, P., Jr., see Greiner, E. S.
- Brill, M. D., *Introduction to and Applications of Scattering Matrices*, Syracuse University, Syracuse, N. Y.
- Burgess, M. S., *Research and Development at Bell Telephone Laboratories*, Mineola High School Combined Science Classes, Mineola, Long Island.
- Chapin, D. M., *Direct Conversion of Solar Energy into Electrical Energy*, A.I.E.E., Oklahoma City, Okla., Oklahoma City Engineers' Club, Oklahoma City, Okla., and Tulsa A.I.E.E. Technical Discussion Group, Tulsa, Okla.
- Chase, L. E., *A Lead Engineer's Responsibilities in Performing Technical Writing Assignments*, Society of Technical Writers, Columbia University, N. Y. C.
- Dodge, H. F., *Sampling in Quality Control Work*, Montreal Chapter of the American Statistical Association, and *Chain and Skip-Lot Sampling Plans*, Montreal Section of the American Society for Quality Control, Montreal.
- Dorros, I., *Large Scale Testing of Switching Speeds of Junction Transistors*, 1957 I.R.E.-A.I.E.E. Conference on Transistor and Solid State Circuits, University of Pennsylvania, Philadelphia.
- Easley, J. W., and Dooley, J. A., *Irradiation of Germanium Alloy Transistors*, Nuclear Radiation Effects on Semiconductor Devices and Metals Symposium, N. Y. C.
- Eisinger, J., *Nuclear Experiments Employing Paramagnetic Substances*, Phys. Colloq., Rice Institute, Houston, Texas.
- Ellis, W. C., see Greiner, E. S.
- Ferrell, E. B., *Control Chart—Modifications and Extensions*, Mid-Hudson Section, American Society of Quality Control, Kingston, N. Y., and *Fundamental Concepts of Statistical Analysis*, Thirteenth Annual Quality-Control Clinic of the Rochester Society, Rochester, N. Y.
- Fleckenstein, W. O., *Trends in Communication Systems*, A.I.E.E., Communication Section, Massachusetts Institute of Technology, Cambridge, Mass.
- Ford, R. N., *Problems in the Use of Attitude Surveys*, Trenton State Teachers College, Trenton, N. J.
- Fox, A. G., *The New Field of Microwave Magnetics*, Dunworking Club, Montclair, N. J.
- Greiner, E. S., Breidt, P., Jr., Hobstetter, J. N., and Ellis, W. C., *Effects of Compression and Annealing on the Structure and Electrical Properties of Germanium*, Annual Meeting of American Institute of Mining, Metallurgical and Petroleum Engineers, New Orleans, La.
- Gupta, S. S., and Sobel, M., *On Selecting a Subset Which Contains all Populations Better Than a Standard*, University of North Carolina, Chapel Hill, N. C., and Columbia University, N. Y. C., (Presented by M. Sobel).
- Hansen, R. H., see Hawkins, W. L.
- Harvey, F. K., *Speech, Hearing and Music*, Joint Meeting Acoustical Society of America and I.R.E. Professional Group on Audio, W.C.A.U. Studios, Philadelphia, Pa.
- Hawkins, W. L., Hansen, R. H., Loeffler, B. B., Lanza, V. L., Matreyek, W., and Winslow, F. H., *New Thermal Antioxidants for Polyethylene Containing Carbon Black*, General Electric Company, Schenectady, N. Y.
- Hines, M. E., *General Principles of Traveling Wave Tube Operation*, Lehigh Valley Chapter, A.I.E.E., Western Electric Plant, Allentown, Pa.
- Hittinger, W. C., *Diffused Silicon Transistors*, Research Seminar, IBM Research Center, Poughkeepsie, N. Y.
- Hobstetter, J. N., see Greiner, E. S.
- Howard, B. T., *Semiconductor Developments*, Naval Reserve Headquarters, Stamford, Conn.
- Ingram, S. B., *Round Table Discussion on Engineers in Industry*, Engineering Night, Northern Valley Regional High School, Damarest, N. J.
- Katz, D., *Magnetic Regulated Power Supplies*, L. I. Lecture Series on Magnetic Devices, Stratford Ave. School, Garden City, L. I.
- Kruger, M. K., *Distribution Requirements in Terms of Quality Control Procedures*, Metropolitan Section, American Society for Quality Control, N. Y. C.
- Lanza, V. L., see Hawkins, W. L.
- Lax, M., *Trapping and Recombination Processes in Solids*, Physics Colloquium, Massachusetts Institute of Technology, Cambridge, Mass., Sylvania Electric Company, Bayside, N. Y., and Syracuse University, Syracuse, N. Y.
- Lebert, A. W., *Transatlantic Cable System*, West Hudson Kiwanis Club, Arlington, N. J.
- Loeffler, B. B., see Hawkins, W. L.
- Matreyek, W., see Hawkins, W. L.
- McMillan, B., *A Theory of Communication*, University of Pennsylvania, Philadelphia, Pa.
- Meszar, J., *Telephone Switching as Information Processing Technology*, I.R.E.-A.I.E.E. Student Branch, New York University, N. Y. C.
- Meszar, J., *Telephone Switching Today and Tomorrow*, A.I.E.E., Washington, D. C.

- Millman, S., *Careers in Physical Research*, Bronx High School of Sciences, Bronx, N. Y.
- Morin, F. J., *Interactions Among Defects in Semiconductors*, American Institute of Mining, Metallurgical and Petroleum Engineers, New Orleans, La.
- Pearson, G. L., *The Conversion of Solar to Electrical Energy*, American Association of Physics Teachers, N. Y. C., and *Electricity from the Sun*, Scientific Research Society of America, South Plainfield, N. J.
- Pfann, W. G., *Production and Removal of Imperfections in Semiconductor Crystals*, American Physical Society Symposium, N. Y. C.
- Pfann, W. G., Benson, K. E., and Wernick, J. H., *Some Aspects of Peltier Heating at Liquid – Solid Interfaces in Germanium*, Meeting of American Institute of Mining, Metallurgical and Petroleum Engineers, New Orleans, La.
- Phair, R. J., *Measurement of Adhesion of Organic Coatings*, New York Paint and Varnish Production Club, N. Y. C.
- Pierce, J. R., *Fancies and Fallacies of Space Travel*, Monmouth County Subsection I.R.E., Red Bank, N. J.
- Ralston, A., *Error Detection and Error Correction in Real Time Digital Computers*, 1957 Western Joint Computer Conference, Los Angeles, Calif.
- Read, W. T., *Dislocations in Semiconductors*, Metallurgy Colloquium, Massachusetts Institute of Technology, Cambridge, Mass.
- Ritchie, W. J., *Electronic Switching*, Joint I.R.E.-A.I.E.E. Student Branch, Michigan State University, East Lansing, Mich.
- Rutter, V. E., *The Traveling Wave Tube*, Western Electric Company, A.I.E.E. Study Group, Allentown, Pa.
- Schroeder, M. R., *Information Theory Aspects of Speech*, Joint Meeting I.R.E.-A.I.E.E., Pittsburgh, Pa.
- Smith, K. D., *A Status Report on Transistors*, A.I.E.E. New Jersey Section, Newark, N. J.
- Sobel, M., see Gupta, S. S.
- Talpey, T. E., *Development of 175 HQ Submarine Cable Tube*, Graduate Student Seminar Faculty, Cornell University, Ithaca, N. Y.
- Thorpe, G. A., *An Instrumentation Program for Guided Missiles*, I.R.E. Subsection, Winston-Salem, N. C.
- Thurston, M. O., *Diffusion in Semiconductors*, Metallurgical Symp., Ohio State University, Columbus, Ohio.
- Vogel, F. L., *Dislocations in Semiconductor Crystals*, Physics Colloquium Westinghouse Research Laboratories, East Pittsburgh, Pa.
- Waldhauer, F. D., *Wide Band Feedback Amplifiers*, 1957 I.R.E.-A.I.E.E. Conference on Transistor and Solid State Physics, University of Pennsylvania, Philadelphia.
- Wernick, J. H., see Pfann, W. G.
- Weinreich, G., *Acoustodynamic Effects in Semiconductors*, Phys. Colloq., Ohio State University, Columbus, Ohio.
- Winslow, F. H., see Hawkins, W. L.
- Wolfe, R. M., *Counting Circuits Using Ferroelectric Devices*, 1957 I.R.E.-A.I.E.E. Conference on Transistor and Solid State Physics, University of Pennsylvania, Philadelphia.
- Woolley, M. C., *Passive Components for Submarine Cable Telephone Repeaters*, I.R.E., Philadelphia Section.

Papers Published by Members of the Laboratories

Following is a list of the authors, titles, and places of publication of recent papers published by members of the Laboratories:

- Aaron, M. R., *The Use of Least Squares in Network Design*, Trans. I.R.E., **PGCT, CT-3** pp. 224-231, Dec., 1956.
- Andreatch, P., Jr., and Thurston, R. N., *Disk-Loaded Torsional Wave Delay Line. I – Construction and Test*, J. Acous. Soc. Am., **29**, pp. 16-19, Jan., 1957.
- Bond, W. L., see McSkimin, H. J.
- Bozorth, R. M., *Magnetic Properties of Materials*, Am. Inst. Phys. Handbook, Chapter **5**, pp. 206-244, Feb., 1957.
- Dillon, J. F., Jr., *Ferrimagnetic Resonance in Yttrium Iron Garnet*, Phys. Rev., Letter to the Editor, **105**, pp. 759-760, Jan. 15, 1957.
- Doba, S., Jr., *The Measurement and Specification of Non-linear Amplitude Response Characteristics in Television*, Proc. I.R.E., **45**, pp. 161-165, Feb., 1957.
- Evans, D. H., *A Positioning Servomechanism With A Finite Time Delay and A Signal Limiter*, Trans. I.R.E., **PGAC, AC-2**, pp. 17-28, Feb., 1957.
- Fuller, C. S., and Morin, F. J., *Diffusion and Electrical Behavior of Zinc in Silicon*, Phys. Rev., **105**, pp. 379-384, Jan. 15, 1957.
- Fuller, C. S., see Reiss, H.
- Geballe, T. H., see Kunzler, J. E.
- Gibbons, J. F., *A Simplified Procedure for Finding Fourier Coefficients*, Proc. I.R.E., Letter to the Editor, **45**, p. 243, Feb., 1957.
- Gross, W. A., *The Second Fundamental Problem of Elasticity Applied to a Plane Circular Ring*, J. Appl. Math. and Phys., **8**, pp. 71-73, 1957.
- Gould, H. L. B., and Wenny, D. H., *Supermendur – A New Rectangular-Loop Magnetic Material*, Elec. Engg., **76**, pp. 208-211, March, 1957.
- Hagstrum, H. D., *Effect of Monolayer Adsorption on the Ejection of Electrons from Metals by Ions*, Phys. Rev., **104**, pp. 1516-1527, Dec. 15, 1956.
- Hanning, R. W., *Harnessing the Digital Computers*, Columbia Engg. Quarterly, **10**, pp. 16-19, 54, March, 1957.
- Hanson, R. L., and Kock, W. E., *Interesting Effect Produced by Two Loudspeakers Under Free Space Conditions*, J. Acous. Soc. Am., Letter to the Editor, **29**, Jan., 1957.
- Herring, C., *Theoretical Ideas Pertaining to Traps or Centers*, Photoconductivity Conference (book), pp. 81-110, 1956. John Wiley & Sons, New York.
- Hull, G. W., see Kunzler, J. E.
- King, B. G., Discussion on "An Investigation into Some Fundamental Properties of Strip Transmission Lines with the Aid of an Electrolytic Tank", Proc. Inst. Elec. Engineers, **104**, p. 72, Jan., 1957.
- Kock, W. E., see Hanson, R. L.
- Kowalchik, M., see Thurmond, C. D.

Papers Published by Members of the Laboratories, Continued

- Kunzler, J. E., Geballe, T. H., and Hull, G. W., *Germanium Resistance Thermometers Suitable for Low-Temperature Calorimetry*, Rev. Sci. Instr., **28**, pp. 96-98, Feb., 1957.
- Lander, J. J., see Thomas, D. G.
- McSkimin, H. J., and Bond, W. L., *Elastic Moduli of Diamond*, Phys. Rev., **105**, pp. 116-121, Jan. 1, 1957.
- Mendizza, A., *The Standard Salt Spray Test - Is It A Valid Acceptance Test?* Plating, **44**, pp. 166-175, Feb., 1957.
- Mendizza, A., *The Standard Salt Spray Test - Is It A Valid Acceptance Test? Symposium on Properties, Tests and Performance of Electrodeposited Metallic Coatings*, A.S.T.M. Special Tech. Publication 197, pp. 107-117, 1957.
- Morin, F. J., see Fuller, C. S.
- Pietruszkiewicz, A. J., see Reiss, H.
- Read, M. H., see Van Uitert, L. G.
- Read, W. T., Jr., *Dislocation Theory of Plastic Bending*, Acta Met., **5**, pp. 83-88, Feb., 1957.
- Reiss, H., *Theory of the Ionization of Hydrogen and Lithium in Silicon and Germanium*, J. Chem. Phys., **25**, pp. 681-686, Oct., 1956.
- Reiss, H., Fuller, C. S., and Pietruszkiewicz, A. J., *Solubility of Lithium in Doped and Undoped Silicon, Evidence for Compound Formation*, J. Chem. Phys., **25**, pp. 650-655, Oct., 1956.
- Rose, D. J., *Microplasmas in Silicon*, Phys. Rev., **105**, pp. 413-418, Jan. 15, 1957.
- Schnettler, F. J., see Van Uitert, L. G.
- Seidel, H., *Ferrite Slabs in Transverse Electric Mode Wave Guide*, J. Appl. Phys., **28**, pp. 218-226, Feb., 1957.
- Suhl, H., *The Theory of Ferromagnetic Resonance at High Signal Powers*, J. Chem. and Phys. of Solids, **1**, pp. 209-227, Jan., 1957.
- Thomas, D. G., and Lander, J. J., *Hydrogen as a Donor in Zinc Oxide*, J. Chem. Phys., **25**, pp. 1136-1142, Dec., 1956.
- Thurmond, C. D., Trumbore, F. A., and Kowalechik, M., *Germanium Solidus Curves*, J. Chem. Phys., Letter to the Editor, **25**, pp. 799-800, Oct., 1956.
- Thurston, R. N., *Disk-Loaded Torsional Wave Delay Line, II - Theoretical Interpretation of Results and Design Information*, J. Acous. Soc. Am., **29**, pp. 20-25, Jan., 1957.
- Thurston, R. N., see Andreatch, P., Jr.
- Trumbore, F. A., see Thurmond, C. D.
- Van Uitert, L. G., Read, M. H., and Schnettler, F. J., *Permanent Magnet Oxides Containing Divalent Metal Ions (I)*, J. Appl. Phys., Letter to the Editor, **28**, pp. 280-281, Feb., 1957.
- Wenny, D. H., see Gould H. L. B.

Patents Issued to Members of Bell Telephone Laboratories During January

- Aaron, M. R. - *Distortion Correction in Repeated Carrier Transmission Systems* - 2,776,344.
- Albersheim, W. J. - *Spurious Mode Suppressing Wave Guides* - 2,779,006.
- Anderson, J. R. - *Delay Lines* - 2,776,411.
- Andrews, F. T., Jr. - *Electrical Circuits Employing Magnetic Cores* - 2,776,380.
- Baldwin, E. G. - *Multielectrode Semiconductor Circuit Element* - 2,776,381.
- Black, H. S. - *Magnetically Loaded Composite Conductors* - 2,777,896.
- Black, H. S. - *Composite Coaxial Resonator* - 2,779,925.
- Bowman, B. M. - *Method of Making Electrical Carbon-Film Resistors* - 2,778,743.
- Brattain, W. H., and Garrett, C. G. B. - *Protection of Semiconductor Devices by Gaseous Ambients* - 2,777,974.
- Buhendorf, F. G. - *Indexing Means for Signal Recording and Reproducing Apparatus* - 2,776,142.
- Clogston, A. M., and Harrison, C. W. - *Quantizing System Employing Cathode Ray Tube* - 2,776,371.
- Dacey, G. C., and Ross, I. M. - *Semiconductor Signal Translating Devices* - 2,778,956.
- Darlington, S. - *Multiple Code Wheel Analogue-Digital Translator* - 2,779,539.
- Doherty, W. H. - *Electrical Conductors Having Transposed Conducting Elements* - 2,779,814.
- Drew, G. G. - *Multivibrator Load Circuit* - 2,778,978.
- Flammer, H. A. - *Stapling Machine* - 2,775,763.
- Gammie, J., and Lovell, G. H. - *Distortion Correction in Repeated Carrier Transmission Systems* - 2,776,345.
- Garrett, C. G. B., see Brattain, W. H.
- Graham, R. E., and Mattke, C. F. - *Light Servo System for Non-Intermittent Projector* - 2,779,819.
- Harrison, C. W., see Clogston, A. M.
- Ketchledge, R. W. - *Communication Switching System Employing Gas Tubes* - 2,779,822.
- Kretzmer, E. R. - *Square Wave Generator* - 2,777,956.
- Liuwill, J. G. - *Branching Circuit* - 2,777,115.
- Lovell, G. H., see Gammie, J.
- Malthaner, W. A., and Vaughan, H. E. - *Repetition Telephone Dialing by Pulse Code Modulated Carrier* - 2,778,878.
- Mattke, C. F., see Graham, R. E.
- Minnick, R. C. - *Switching Circuits* - 2,779,934.
- Mischler, W. D. - *Frequency Conversion Circuits* - 2,776,373.
- Moore, E. F., and Shannon, C. E. - *Electrical Circuit Analyzer* - 2,776,405.
- Morton, J. A. - *High Frequency Amplifier* - 2,779,891.
- Remeika, J. P. - *Method and Apparatus for Processing Ferroelectric Crystal Elements* - 2,777,188.
- Ross, I. M., see Dacey, G. C.
- Shannon, C. E., see Moore, E. F.
- Shockley, W. - *Asymmetric Wave Guide Structure* - 2,777,906.
- Shockley, W. - *Semiconductor Signal Translating Devices* - 2,778,885.
- Vaughan, H. E., see Malthaner, W. A.
- Willard, G. W. - *Frequency Discriminator Employing Multiple Resonant Piezoelectric Vibrator* - 2,779,191.