

# *Miniature Metallized Lacquer-Film Capacitors*

H. G. WEHE *Transmission Apparatus Development*

**Bulky pre-World War II capacitors were miniaturized first by depositing metal on thin strips of lacquered paper. Now, by a process invented at Bell Telephone Laboratories, the paper can be removed to leave only a thin film of metallized lacquer. Besides their great conservation of space, these capacitors are particularly applicable to low-voltage circuits using transistors.**

A capacitor is a device for the storage of electricity. In its simplest form, it consists of two parallel plates close together but insulated from each other. The larger the plates and the closer they are placed without touching, the more electricity can be stored in them at a given voltage. The insulation between the plates may be a gas, a liquid, or a solid. Some materials when placed between the plates permit storage of more electricity than others. This property of a dielectric or insulator is known by several names including "k," "dielectric constant," and "specific inductive capacity."

Because of these basic facts, there are two approaches to miniaturization of capacitors. One consists of decreasing the thickness of the dielectric, and the other consists of increasing its dielectric constant. For capacitors larger than about one-tenth microfarad, reducing the thickness of the dielectric has been the more profitable approach. Two kinds of thin-film capacitor result, namely the lacquer-film capacitor herein discussed and the electrolytic capacitor using an electro-formed dielectric. The

properties of these latter capacitors make them complement rather than compete with lacquer-film capacitors.

But now, let us briefly consider the value and importance of miniaturization of capacitors. Miniaturization of electronic equipment has gained increasing importance in recent years. There are several factors contributing to this trend. One is the increasing complexity of electrical equipment, making it undesirably bulky when conventional components are used. Another is the desire for small size and weight in airborne equipment and guided missiles. Still another factor is the more frequent use of transistors. While each of these factors provides ample justification for effort aimed at miniaturization, the greatest stimulus comes from the transistor, whose small size challenges the designer of associated equipment, and whose small power requirements and low operating voltages open up new possibilities for miniaturization.

The value of miniaturization boils down to a saving of materials, space and money. With billions of

components, including many millions of capacitors in the Bell System, reduction in size of components eventually means fewer mounting racks and hence smaller space requirements.

Since miniature capacitors are to be used extensively with transistors, let us look at the transistor voltage requirements in order to determine the voltages to which the miniature capacitors will be subjected. It has been found that a capacitor that withstands only 10 volts will be very useful for some transistor circuits, and that a capacitor that withstands 50 volts will cover most of the ordinary transistor applications.

Dielectrics two- or three-tenths of a mil (0.0002 — 0.0003 inch) thick will withstand much more than the 50 volts required for most transistor applications. Hence, capacitors made from this thickness of material occupy much more space than is necessary. Yet, until the advent of the metallized lacquer-film capacitor, paper or plastic dielectrics thinner than about a quarter of a mil were not commercially available. Even if the dielectrics had been available, equipment to handle them was not because the thinner the films

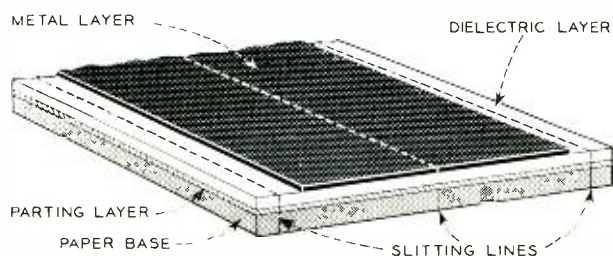
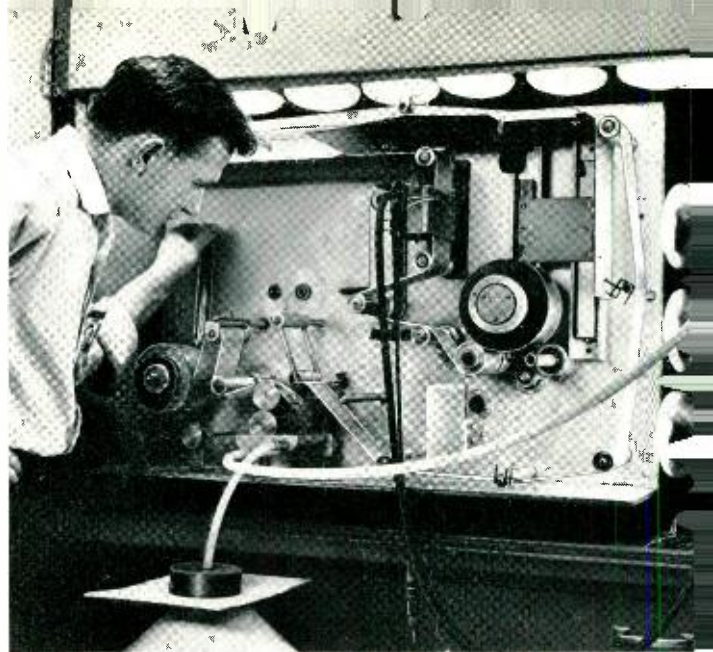

*Fig. 1—Pile-up of base, parting layer, lacquer film, and metal. Margins facilitate attaching leads.*

are, the more fragile they become. Hence, it was necessary to develop the procedures for both making and handling such thin films. The objective was set at about one-tenth of a mil (0.0001 inch) dielectric because experience indicated that this would easily withstand 50 volts.

The lacquer-film capacitor, therefore, is made of a very thin dielectric only a tenth of a mil thick, about 1/30 as thick as a sheet of ordinary writing paper. The dielectric (usually cellulose acetate) is metallized on one side by vapor deposition of zinc, which provides the electrode. Two strips of this material, when wound together, form a capacitor. The construction is similar to that used for metallized paper capacitors\* except the dielectric is much thinner. This makes possible capacitors one-seventh the volume of metallized paper capacitors and one

\* RECORD, September, 1949, page 317.



*Fig. 2—J. J. Jasinski operating "roller coater". Hoses lead to trough where rollers pick up lacquer for application*

five-hundredth the volume of paper and foil capacitors available at the turn of the century.

When the volume of a capacitor is reduced by a factor of seven (independent of housings), the voltage at which it may be used is reduced only by a factor of approximately three. This is due to the fact that for a given capacitance, volume is proportional to the square of the dielectric thickness. However, the voltage rating need be decreased only in direct proportion to the thickness of dielectric. Thus voltage rating has been traded for size reduction to an extent heretofore not feasible.

Further, the lacquer-film capacitor, like its predecessor, the metallized paper capacitor, is "self-healing". By this is meant that an internal short circuit, caused for example by an excessive voltage surge, is automatically cleared by the fuse-like action of the thin zinc electrode. In this way, the defective areas are isolated.

Because of its thinness and fragility it is essential that the plastic (lacquer film) be supported as much as possible throughout its manufacture. For this purpose a strip of ordinary kraft capacitor paper is normally used to serve as a web or belt on which the lacquer film will be placed. Figure 1 shows a pile-up of the materials on this belt. First is the paper, which is coated with a "parting layer". This is another plastic on which the dielectric layer will be placed and later removed. On top of the parting layer is placed the dielectric layer, whose uniformity and thickness must be carefully controlled. On top of the dielectric layer is placed a layer of metal (zinc) by vacuum vapor deposition. The pile-up of material on its supporting web is then slit to the desired width, as indicated by the dotted lines of

the illustration. It can be seen that two strips are thus formed side by side, with margins at the outer edges of the two strips. The metal extends completely to one edge of both strips, as indicated by the center dotted line.

A machine such as that shown in Figure 2 is used for applying two types of lacquer, one over the other, in making these capacitors. This machine is of the "roller-coater" type which applies lacquer by a kind of printing process.

Before the layers of lacquer are separated, and while they are both on the supporting web, the metal electrodes are vacuum vapor deposited on to the dielectric lacquer film in the machine shown in the illustration at the head of this article. The pile-up is then slit, as has been indicated, and the metallized lacquer film is removed from its support. This is done as shown in Figure 3.

At the top of Figure 3 is a roll of a pile-up of the web, the parting layer, the dielectric layer, and the metal film. At the bottom is a roll which winds up the waste material, consisting of the web and part-

ing layer. The metallized dielectric is wound up on the middle roll. The winding is started by means of a piece of pressure-sensitive tape, which will lift up the metallized dielectric and start it winding on the

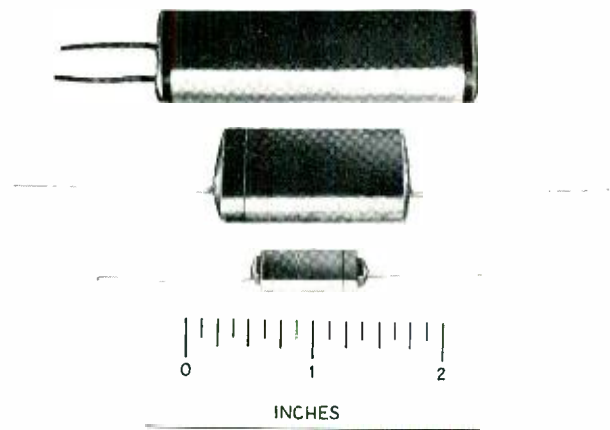

Fig. 1 — Three capacitors, each of two-microfarad rating, showing great reduction in size.

middle roll. A brake is applied to the supply roll to maintain tension in the web during the stripping process.

After the film is obtained in this manner, it is wound into a capacitor. Two rolls of film are placed in a machine which winds them together with an uncoated margin on opposite edges of each strip. When metal is sprayed on the ends of the unit, it strikes the exposed metal edge of one layer, but not the recessed metal of the other layer. Contact is thus made to the two sides, and the capacitor is complete except for attaching leads and providing a suitable housing. Despite the fragility of the film, surprisingly little difficulty has been experienced with the winding operation.

Figure 4 shows a size comparison of several two-microfarad capacitors without their containers. The upper capacitor is a conventional unit, consisting of two layers of 0.3-mil paper between each layer of 0.25-mil foil. This was the smallest capacitor of its type up to World War II. The middle capacitor is a metallized paper capacitor consisting of single-layer 0.3-mil kraft paper lacquered and metallized with alternate margins for each electrode. The smallest capacitor in Figure 4 is a two-microfarad metallized lacquer-film capacitor consisting of a single layer of stripped metallized 0.1-mil lacquer. Like the metallized paper capacitor, it has sprayed metal electrodes to which wire leads are soldered. In this capacitor, voltage rating has been traded for small size.

Figure 5 shows insulation resistance in megohms

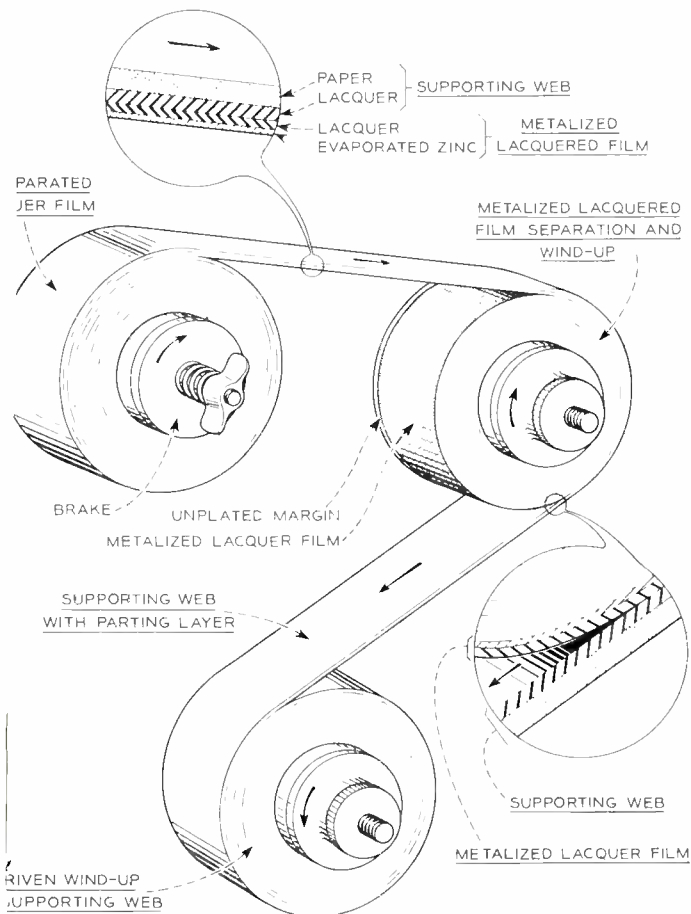

Fig. 3 — Method of separating metallized lacquer film from parting layer and supporting web.



times microfarads which gives a "figure of merit" by means of which metallized capacitors can be evaluated and compared. Capacitors with an initial insulation resistance of about 1,800 megohm-microfarads

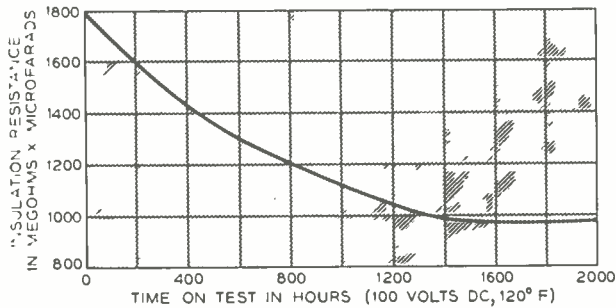

Fig. 5 — "Figure of merit" curve during life test showing good insulation resistance characteristic.

were placed on life test at double their rated voltage and at 120°F, which is probably near the upper limit of temperature to which the capacitors would be exposed in an ordinary room. It can be seen that after 2,000 hours the insulation resistance was still about 1,000 megohm-microfarads. This performance compares quite favorably with that of capacitors made by more conventional methods.

The ac electrical loss of such a capacitor is due partly to loss in the dielectric of which the film was constructed and partly to whatever series losses may be inherent in the vaporized metal electrode and the contact between the sprayed solder terminals and the vaporized zinc electrodes. It is relatively easy to achieve capacitors of one or two microfarads capacitance having power factors less than 4 per cent at 10 kc. and internal resistance of greater than 1,000 megohm-microfarads. The effective series resistance below 100 kc is about a tenth of an ohm. This resistance is found to increase directly as the dielectric is made thinner, and to decrease as the square of the width of the metallized electrode de-

creases. Thus, it is easy to maintain low series resistance in the capacitor for a given thickness of vaporized electrodes by making the width of the capacitor material narrower. Doing this makes the capacitor shorter, which would normally be done anyway when the capacitors are made smaller.

Under certain circumstances it is advantageous to leave the supporting web in the capacitor that is eventually made. Such is the case when a voltage rating of less than 15 volts is acceptable and also when the dielectric chosen (because of especially desirable electrical properties) might have poor mechanical properties, so that it could not be handled by the techniques described. Arrangements of such supporting lacquer films are shown in Figure 6.<sup>o</sup>

Hundreds of model capacitors have been made in the laboratory and supplied for trial in connection

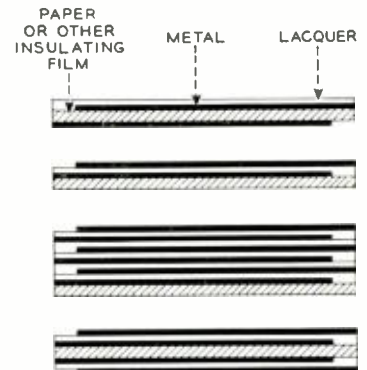

Fig. 6 — Cross-sections of multilayer capacitor films, showing retention of supporting web in some units.

with several different projects. Aging tests under voltage indicate good stability and long life. Work is continuing on lacquer-film capacitors directed toward improving the laboratory processes and the materials used in capacitor construction.

<sup>o</sup> For a comprehensive discussion of metallized lacquer-film capacitors, see an article by D. A. McLean and H. G. Wehe in the Proceedings of the Institute of Radio Engineers, December, 1954, pages 1779-1805.

#### THE AUTHOR

H. G. WEHE received an A.B. degree from Washburn College in 1922 and an M.A. degree from the University of Kansas in 1925. After spending one summer doing test board work with the Southwestern Bell Telephone Company, he joined the E. of M. Department of the Western Electric Company in 1926. In 1929, Mr. Wehe transferred to the Research Department of the Laboratories where his first work was in magnetics and the deposition of carbon films on ceramic materials. Except for a year during World War II developing radar tubes, he has been principally engaged since 1933 in studies of the vapor deposition of thin films. A considerable part of this work during these years has been on metallized paper capacitors.





# *Junction Phototransistors*

J. N. SHIVE AND P. ZUK

*Transistor Development*

Seventy-five years ago Alexander Graham Bell made one of the earliest recorded attempts to put the photoelectric properties of semiconductors to a practical use. The Bell photophone — a system for transmitting intelligence along a modulated ray of light — might be considered the forerunner of the beamed carrier transmission systems we have today. Since then, photoelectric devices have found many new applications in science, industry and the world of everyday affairs, and are appearing in increasing numbers in communications as well.

Until about two years ago the use of photoelectric cells in the Bell System was largely a single application in the transmission of wirephoto pictures. However, the recent successful employment of phototransistors in the card translator<sup>o</sup> unit of the nationwide direct distance dialing network is regarded by many as the portent of more widespread general use of semiconductor photocells in communication. The latest unit of this type, the 1N85 p-n junction phototransistor, appears to be one of the most likely candidates for introduction in such new applications, since it possesses high sensitivity, low noise, microsecond response, and a physical volume smaller than that of a 0.22 calibre bullet.

The term "photoelectric effect" is a generic designation which includes three different photoelectric phenomena in which the behavior of voltages or currents can be affected by light. Probably the earliest

<sup>o</sup> RECORD, October, 1953, page 369; March, 1955, page 93; and June, 1955, page 215.

known of these phenomena is the photoconductive effect, in which the conductance of a semiconductor element is increased when the surface of the element is illuminated.

Another photoelectric phenomenon is the photovoltaic effect. In a photovoltaic cell an electromotive force is generated when light falls on a semiconductor p-n junction or on a rectifying contact between a semiconductor and a metal. The Bell Solar Battery is an example of a photovoltaic device. Finally, the list of photoelectric phenomena is completed by adding the photoemissive effect, in which electrons are ejected from a sensitive surface when the surface is exposed to light. Ordinary vacuum phototubes operate on the photoemissive principle.

The 1N85 photoelectric cell to be described is nominally a photoconductive device. Because its structure includes a p-n junction, however, it can be used alternatively as a photovoltaic generator. Its active element consists simply of a p-n junction bar

with contacts to the ends of the p and n sections. Figure 1 shows a diagram of this basic element. In operation, a voltage bias is imposed between these terminals, with the p end negative and the n end positive. With this polarity, the junction becomes simply a reverse biased diode\* with very high impedance to current flow in the dark. When light falls on or near the junction, the junction impedance is

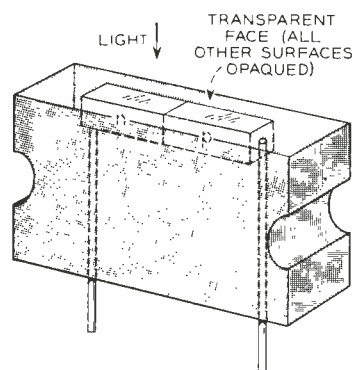

*Fig. 1 — Basic construction of the 1N85 p-n junction phototransistor. Dashed lines represent the lead wires and the shaded volume the plastic capsule.*

reduced and an increased current flow results, of magnitude approximately proportional to the incident light flux. This increased current then can be used to operate a sensitive relay, to give a reading on a meter, or to produce some other indication in the external circuit.

The basic device is thus as simple as could be desired by any circuit engineer, and fabrication principles are no more complex, although the actual techniques employed are quite demanding. The objectives are to form a p-n junction of appropriate size and shape, to make suitable electrical connections to the p and n sections, and then to enclose the element in a container which will both protect the assembly and permit mounting.

Fabrication of the element begins with germanium of phenomenal purity obtained by the process of successive melting and recrystallization known as zone refining.† With this material a junction is formed by the crystal “pulling” process,‡ with controlled resistivities of the p and n sections. These values of resistivity will predetermine the lowest dark current and the highest operating voltage attainable in a completed device. The central portion of the crystal which contains the junction is next cut into the elements as shown in Figure 1, and lead wires are soldered to the ends of each bar. An outer layer of germanium is then etched away to remove the surface debris left by the cutting operations and

\* RECORD, June, 1955, page 227. † RECORD, June, 1955, page 201. ‡ RECORD, February, 1955, page 41.

to expose the fresh undamaged crystal material beneath, after which the surface is protected from further contamination by coating with a thin film of transparent plastic. These last operations are performed under conditions of low humidity and extreme laboratory cleanliness.

The coated element is finally encased in a rectangular block of transparent plastic. Five faces of this block are painted black, leaving the sixth face as a window for access of light to the p-n junction element. As can be seen in Figure 1, and in the photograph, Figure 2, the plastic block has a semicylindrical notch in each of its two end faces. When the junction bar is molded into the block, the p-n junction itself is carefully located with respect to these notches. Thus, when the completed phototransistor is placed in equipment having locating pins which engage these notches, the p-n junction is precisely positioned in the equipment. In applications requiring several phototransistors in a linear assembly, the

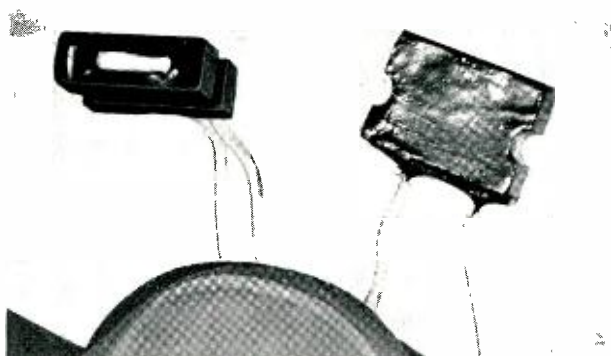

*Fig. 2 — 1N85 p-n junction phototransistors: junction bar can be seen inside unit on the left.*

notches facilitate the stacking of the required number of individual units between a pair of aligning pins so that all the p-n junctions will be arranged in a straight line.

The photoelectric behavior of a 1N85 phototransistor is described by the family of characteristics reproduced in Figure 3. Here are shown a number of current-voltage curves for the cell in the dark and for several different conditions of illumination. The voltages in the figure are given on a cube-root-of-voltage scale in order to present more detail in the region around zero voltage. For the light-response curves, the symbol L refers to an incident light flux of  $\frac{1}{2}$  milliwatt at 2870° absolute color temperature, focused onto a rectangular spot 0.010 x 0.020 inch on the center of the window face of the unit and aligned with the 0.020 inch dimension perpendicular to the p-n junction plane. Observe that



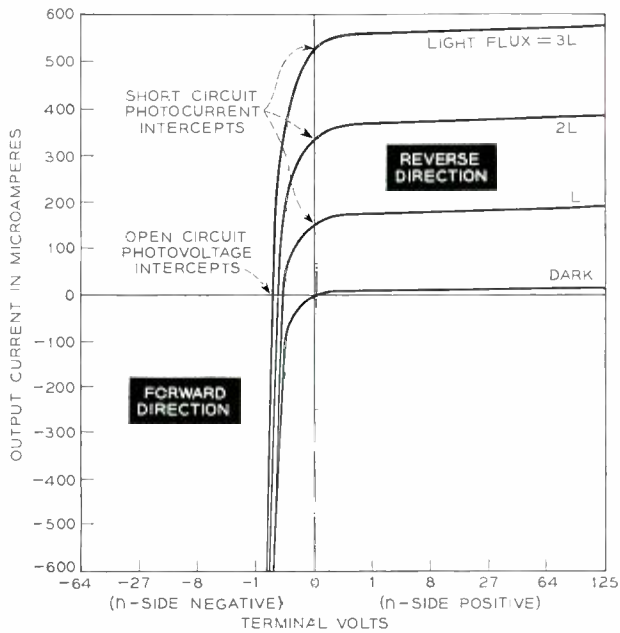

Fig. 3—Current-voltage characteristics of the 1N85 phototransistor. Intercepts on the diagram indicate open- and short-circuit conditions.

for applied voltages in the range above +1 volt the response is practically linear, in that equal increments of light flux result in equal increments of output current. This linearity is important if one is considering, for example, the high-fidelity reproduction of light signals.

Other interesting properties of the 1N85 can be developed from the curves of Figure 3. If the lead wires are short-circuited so that no terminal voltage can appear, for each level of illumination a short-circuit current will flow having magnitude almost as great as if the unit were biased several volts in the reverse bias direction. Observe also that if the photo-

transistor is left open circuited so that no current can flow, an EMF develops between the terminals when the cell is illuminated. This EMF biases the unit in the *forward* direction, and the magnitude of the EMF is the open-circuit voltage of the device when used as a photovoltaic cell. The highest voltage that can thus be developed is around half a volt per cell for germanium. The Bell Solar Battery, which employs silicon, puts out a somewhat higher open-circuit photovoltage.

As is the case for all photoelectric devices, the response of the 1N85 depends upon the wave length of the light to which it is exposed. Figure 4 presents a curve showing how the output current of the 1N85 responds to equal input flux powers at different wave lengths. This response extends all the way from a limiting region in the ultra-violet spectrum (left in the figure), where the encapsulating plastic becomes opaque, to another limit in the infra-red

Fig. 5—The response of a p-n junction phototransistor depends upon where it is illuminated.

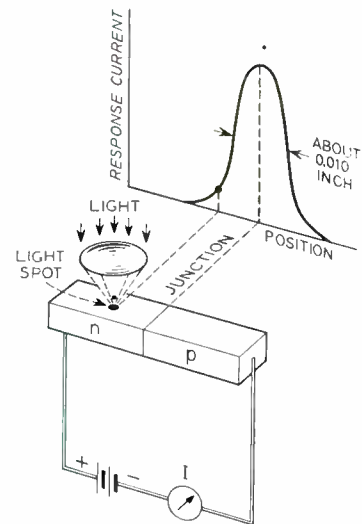

spectrum, beyond which the germanium itself becomes transparent and no longer absorbs radiant energy. The responsive range of the 1N85 is thus seen to encompass the entire range within which the human eye is sensitive, as well as most of the range of radiation from a high-temperature projection lamp. Curves for these latter relationships are shown in Figure 4, along with the photocell response curve.

The output response of the 1N85 depends not only on the intensity and wave length of the input light, but also on where the light is incident upon the germanium bar with relation to the junction. If a small spot of light is focused on the surface of the bar and is moved from one end of the bar to the other, the output current will vary with the position of the light spot as shown in Figure 5. The response is highest when the light is incident exactly on the

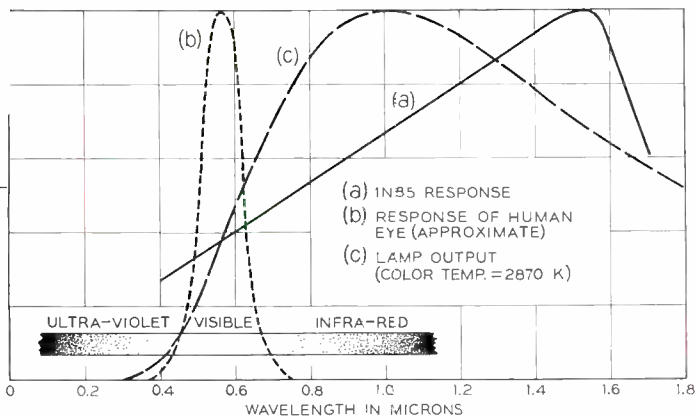

Fig. 4—(a) Response curve of 1N85 phototransistor; (b) output of lamp at color temperature of 2870°K; (c) approximate response of human eye. All curves referred to .0 as maximum.

junction, and falls off as the light spot is moved away from the junction in either direction.

The speed of the response of the 1N85 depends similarly on how far away from the junction the light is allowed to fall. If the light is incident exactly on the junction line and nowhere else, the speed of response should be more rapid than the best measuring technique can resolve. For light falling farther away from the junction, the response is more sluggish. In high-speed switching applications or high-frequency signal transmission applications, it is therefore necessary to mask the window surface of the photocell so that light can fall only in a restricted region at, and very near, the junction. In actual tests performed to determine practical masking slit widths, it is found that response times of about  $\frac{1}{2}$  microsecond can be achieved with a masking slit 0.007 inch wide, centered over the junction line.

The physics of these spatial-response and time-response effects is easily described. Wherever light of proper wave length falls on the surface of the element, electrons and positive holes are liberated in equal numbers as long as the light continues to shine. If the light is incident, for example, on the n-type side of the junction, the liberated electrons merely add a small fraction to the large number initially present. However, the positive holes, which in this case are the minority charge carriers, increase the total number of holes by large factors over the small number originally present in the dark. Figure

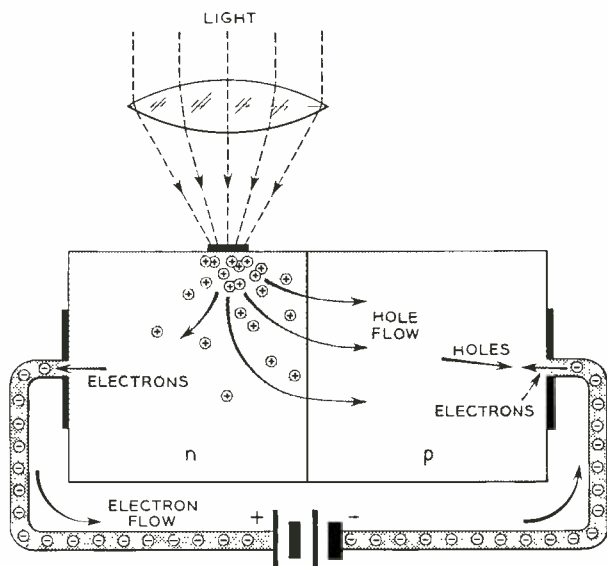

Fig. 6 — Creation of positive holes on n side of junction, causing electron flow into left contact and hole flow toward right contact. Increased current thus flows in external circuit.



Fig. 7 — D. R. McLennan (left) and J. V. Domaleski discuss the testing of an experimental 13-cell code-reading phototransistor assembly.

6 shows a diagram illustrating the generation of charge and flow of current when the n-type side of a p-n junction is illuminated by a small light spot. In the interest of simplicity, the majority carriers — the electrons on the n-type side and the holes on the p-type side — have been omitted from the drawing. Positive holes originating at the illuminated spot diffuse to the junction and cross over into the p-type section, while electrons are prevented from doing so by the opposing field at the junction. The p-type section thus acquires an excess positive charge that is continually neutralized by electrons which enter at the right-hand contact and recombine with some of the holes near this contact. The electrons are pumped around the external circuit by the battery, being continually replenished by electrons which leave the n-type section at the left-hand contact of the phototransistor.

It is only when minority charge particles diffuse to and cross the junction that current flows in the photocell circuit. They are said to be “collected” by the junction. If these particles are liberated far away from the junction, they must diffuse a long way to reach it, and many of them disappear by recombination with majority particles on the way. The collection efficiency thus decreases with increasing separation between the illuminated spot and the junction. Furthermore, the time required for the minority particles to diffuse this distance appears as a lag in the output response. A sharp, sudden flash



of light produces a sharp-edged cloud of liberated particles at the illuminated spot. However, as particles diffuse to the junction, the edges of the cloud become fuzzed out, so that the current pulse crossing the junction is not a sharp-cornered replica of the light flash, but rather a smeared-out distortion. This effect becomes worse the farther the particles have to travel. It is thus clear why limiting the window area of the photocell so that light can fall only at or very near to the junction results in higher response amplitude, shorter lag in response time, and more faithful electrical reproduction of the exact shape of the input light fluctuations.

One of the most obvious applications for phototransistors is in the reproduction of sound on film. The linearity of the 1N85 is comparable with that of a vacuum phototube, while the output current for a given light flux is from 10 to 20 times higher. A considerable improvement in the signal-to-noise ratio is obtainable by the use of the semiconductor cell, while with proper masking, the response can be rendered constant over the entire audible range.

Semiconductor photocells have been in operation in the Bell System card translator for about two years. On an experimental basis, phototransistors have demonstrated their potential usefulness in other systems as well. In an optical-mechanical position encoder, the angular position of a shaft can be "read"



*Fig. 8 — An experimental 4-cell code reader.*

by photoelectric means to within less than a minute of arc. Using these principles, electrical and mechanical "master-and-slave" systems may employ phototransistors to perform the reading and error-sensing functions. These devices may thus take over many of the control functions in the switching systems of the future. Coded information in the form of holes punched in tape can be read photoelectrically much faster than by mechanical means. In high-speed computers, arrays of phototransistors may operate on information presented as coded arrays of light spots on cathode ray tube screens.

Finally, if the continuing pressure for more and more bandwidth finds the transmission systems of the future pushing into the frequency ranges corresponding to optical wave lengths, phototransistors will undoubtedly be at the heart of these systems.

#### THE AUTHORS



J. N. SHIVE received his B.S. degree from Rutgers University in 1934, and a Ph.D. degree from Johns Hopkins University in 1939. That same year, he joined the Research Department where his first work was on thermistors and selenium rectifiers. During World War II, he was engaged in applying these components to military devices and systems. Following the war, he continued the study of selenium rectifiers, and more recently, has been engaged in various aspects of transistor development.



PAUL ZUK received a Bachelor of Engineering degree in Physics from Cornell in 1952. After doing summer work with the National Bureau of Standards, Cornell University on a Navy contract, and the General Electric Company, Mr. Zuk joined the staff of Bell Telephone Laboratories at Allentown in 1952. During his career at the Laboratories, he has worked as a device engineer on the final development stages of a number of semiconducting devices including diodes, phototransistors, and other transistors.

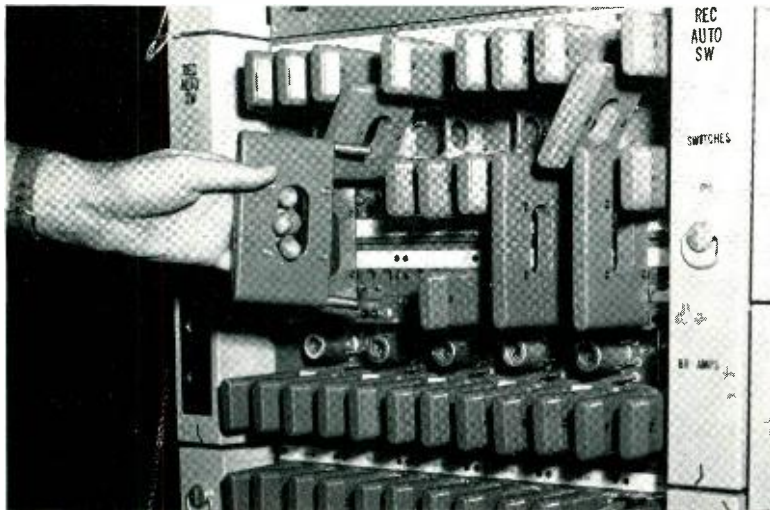

## *Coaxial Patch Plug for TD-2 Radio*

*At the left, molded plastic coaxial patch plugs are shown in use with the recently developed TD-2 automatic switching equipment.*

The development of program switching and automatic channel switching in TD-2 radio relay created the problem of rapidly and easily changing the connections between various parts of the equipment. Patching between equipment has been done in the past by patching cords, but the possibility of accidental disconnections causing service interruptions and also the possibility of incorrect connections made a better arrangement desirable. The result of a development program in this direction is a series of four new coaxial patch plugs, encased in molded plastic. These plugs have been in service in TD-2 radio relay equipment for some time.

Since switching in TD-2 radio is done at 70 mc, the plugs must maintain the characteristics of coaxial cable, yet be small and compact. The final design uses a short section of coaxial cable with coaxial plugs on each end. The plug fingers are gold-plated, attached to the cable by solderless shield connections.<sup>o</sup> The short section of cable is bent around a plastic core, and held in position by a plastic outer case. Screws hold the plug together. To assure accurate alignment with their mating jacks, the plug fingers are not clamped tightly but are allowed to "float." The cores and cases are of gray thermoplastic material to harmonize with the dark gray finish used on the surfaces of the patching area and to keep their weight to a minimum.

Patch plugs offer several advantages over the conventional patching cords in this application:

1. They present a much neater appearance, blending with the decor of the equipment.
2. They do not project into the aisle as do cords.

3. They do not obstruct the view of equipment and circuit designations.

4. The equipment is so designed that patch plugs fall into their correct positions almost automatically, and do not interfere with other patches.

This new series of coaxial plugs is another example of how the use of molded plastics is helping equipment designers make telephone equipment simpler to operate and more pleasing to the eye, while holding the cost to a minimum.

R. MORSE

*Switching Apparatus Development*



*A patch plug consists of a short coaxial cable with connections, a center piece, screws, and a cover.*

<sup>o</sup> RECORD, February, 1955, page 55.



# Differential Thermal Analysis

P. D. GARN *Analytical Chemistry*



The exacting specifications for components used in telephone communications frequently require the use of unusual methods to obtain information about the materials involved. By a technique of comparing unknown and reference samples in a carefully controlled furnace, individual temperature “profiles” of chemical compounds are obtained, and these are used for purposes of identification and for the comparison of commercial products. The method is both fast and accurate.

Many substances when heated undergo phase transitions—for example, they may melt, decompose, or change in crystallographic structure. All such processes result in a change in energy content, which is evidenced either by the evolution of heat (exothermic processes) or by the absorption of heat (endothermic processes). We can illustrate such a change in energy by the simple calorimetric experiment of freezing a certain volume of water. If we plot temperature against time, we notice that the temperature drops smoothly until the water begins to freeze, after which the curve flattens out until all the water has been converted into ice. Freezing is thus a heat-evolving or exothermic process. Enough heat is given off to maintain the temperature at a steady value (in this case  $0^{\circ}\text{C}$  or  $32^{\circ}\text{F}$ ) during the transition, instead of dropping smoothly as it did previously. Conversely, melting is a heat-absorbing or endothermic process.

Experiments similar in principle can be used to find melting points, temperatures at which atoms alter their spatial relationships in a crystal, temperatures at which molecules of water are driven out of a compound, and temperatures of other phase transitions. This calorimetric method, however, is rather tedious and requires very precise control of heating or cool-

ing rates. Also, since the apparatus containing the sample acts as a heat reservoir, a calibration must be performed by heating or cooling the apparatus without the sample. For these reasons, the method is used only in work requiring high quantitative accuracy. For qualitative and semiquantitative studies, these difficulties are lessened considerably by the use of a technique known as differential thermal analysis. By this method, we do not measure only

*Fig. 1—Placing specimen in sample well drilled into a platinum block. Entire ceramic holder is later enclosed by furnace.*

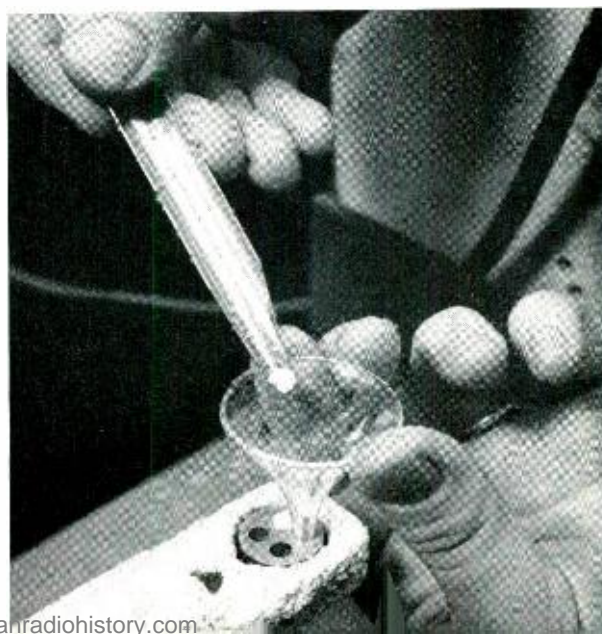



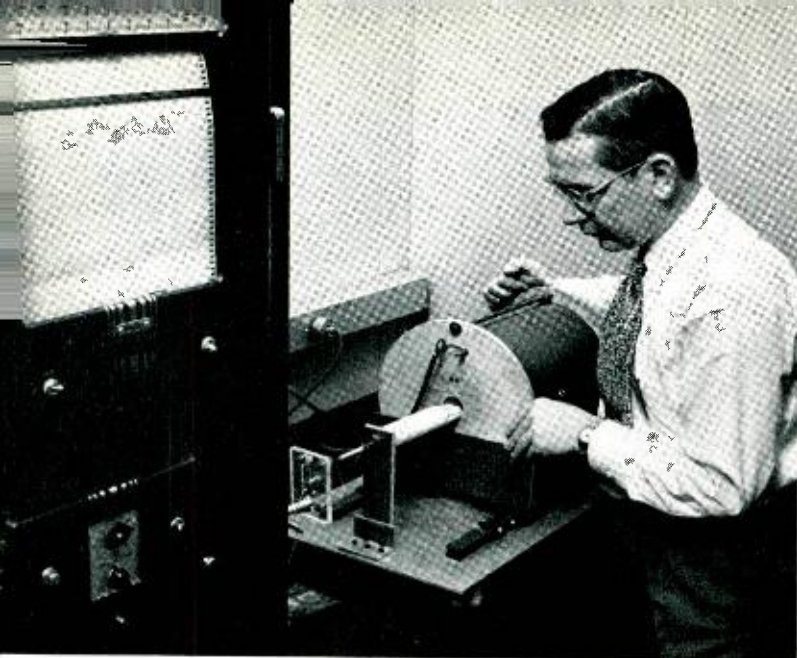

Fig. 2 — Furnace being moved over ceramic holder; control and recording apparatus is seen at left.

the temperature of the material in question; in addition, measurements are taken of the *difference* in temperature between the sample and a reference material.

Since the reference material is heated or cooled along with the sample, calibration of the apparatus is unnecessary, and small variations in the heating or cooling rate are insignificant, except for quantitative studies. These advantages result from the fact that we can now plot the *difference in temperature* against the temperature, rather than two sets of temperature data against time.

The main principles of differential thermal analysis are now generally known among chemists, but the construction of apparatus has presented a number of problems, particularly those of furnace temperature control, of mounting the sample, and of recording data. In the Bell Laboratories equipment, a high degree of accuracy was achieved by careful

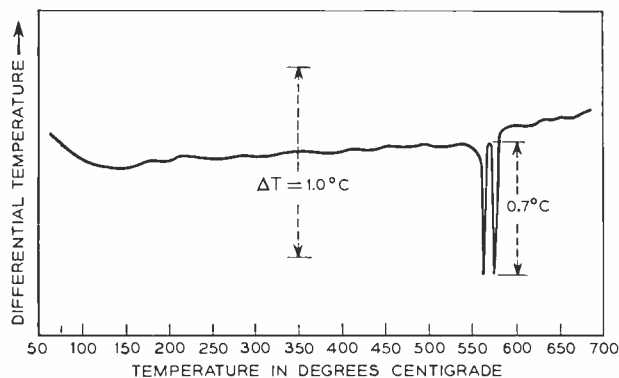

Fig. 3 — Thermogram showing separation of closely-spaced phase transitions in mixture of quartz and potassium sulphate.

design of the furnace and sample holder, and by incorporating an automatic, precisely-programmed method for temperature control and for plotting of data. Careful control of the heating and cooling rates enables us to obtain rather good quantitative data without the disadvantages of calorimetry.

Briefly, a portion of the sample is ground into a powder and is placed in a well drilled into a small block of platinum (Figure 1). A second or reference material, usually aluminum oxide, is similarly ground and placed in another well. Aluminum oxide is chosen as the reference material because of its freedom from phase transitions over the temperature range. The two junctions of a differential thermocouple are inserted into the two wells, so that any difference in temperature is determined by measuring the generated voltage. The platinum sample holder is supported in a ceramic core, so mounted that the furnace can be pushed into position to enclose the entire structure (Figure 2). The furnace temperature can be made to rise or fall at a constant rate of 10°C per minute in a range from 0°C to 1,500°C.

When the sample undergoes a phase transition, it will momentarily become hotter or colder than the reference material. This effect is transitory, for the temperature difference returns to a low value after the phase-change is completed. The phase transition will nevertheless be recorded on a continuously plotted curve as an exothermic "peak" or as an endothermic "depression." If the sample is a mixture of chemical compounds, the complete record may be a complicated curve showing many such peaks and depressions. From such a record, significant features may be found and used to identify the constituent materials. For example, magnesium carbonate may be detected in the presence of other magnesium compounds or other carbonates. Similarly, quartz can be

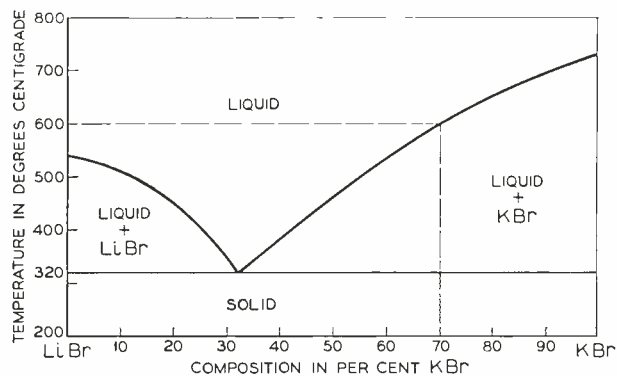

Fig. 4 — Phase diagram of lithium bromide — potassium bromide system that has been plotted from thermogram data.

detected in the presence of other forms of silicon dioxide.

A fairly simple thermogram is shown in Figure 3, which represents the thermal behavior of a mixture of quartz and potassium sulphate. The transition temperatures of these materials were already known, and the study was undertaken merely to become familiar with the range and sensitivity of the apparatus. We see from the graph that the mixture and the reference material (aluminum oxide) have nearly identical temperatures until the temperature approaches 571°C. Here, the temperature of the mixture suddenly becomes about 0.7°C cooler than the reference material. This depression in the curve is caused by a change in the crystallographic structure of the quartz, an endothermic or heat-absorbing process. (The heat is being supplied at a nearly constant rate, but at this temperature, some of the heat is used to change the crystal structure rather than to raise the temperature.) The temperature of the mixture then quickly recovers and becomes nearly identical to that of the reference material again. The graph then shows a second endothermic depression at 580°C, which indicates another crystallographic change, this time in the potassium sulphate. The closeness of these two transitions, which are still clearly separated on the thermogram, illustrates the high degree of resolution achieved by the equipment. Its great sensitivity is also shown by the fact that a temperature difference of only 0.7°C is easily noticeable; by calorimetric methods, such a small change would be difficult to detect.

Once the capabilities of the apparatus were known, differential thermal analysis was used for a number of chemical investigations. It is particularly useful, for example, in the preparation of phase diagrams. Such diagrams, an example of which is shown as Figure 4, are valuable in chemical analysis studies, since they define the state of mixtures of substances for any composition over a range of temperatures. In Figure 4, for instance, we can see that a mixture of 70 per cent potassium bromide (KBr) and 30 per cent lithium bromide (LiBr) will remain solid until a temperature of 320°C is reached, at which temperature the lithium bromide and a portion of the potassium bromide will melt. At higher temperatures, more potassium bromide dissolves in the liquid until the temperature reaches about 600°C. At this temperature the potassium bromide is completely dissolved and all material is liquid. To plot such a diagram, precise information must be obtained on the transition temperatures over the range of compositions, and these values are

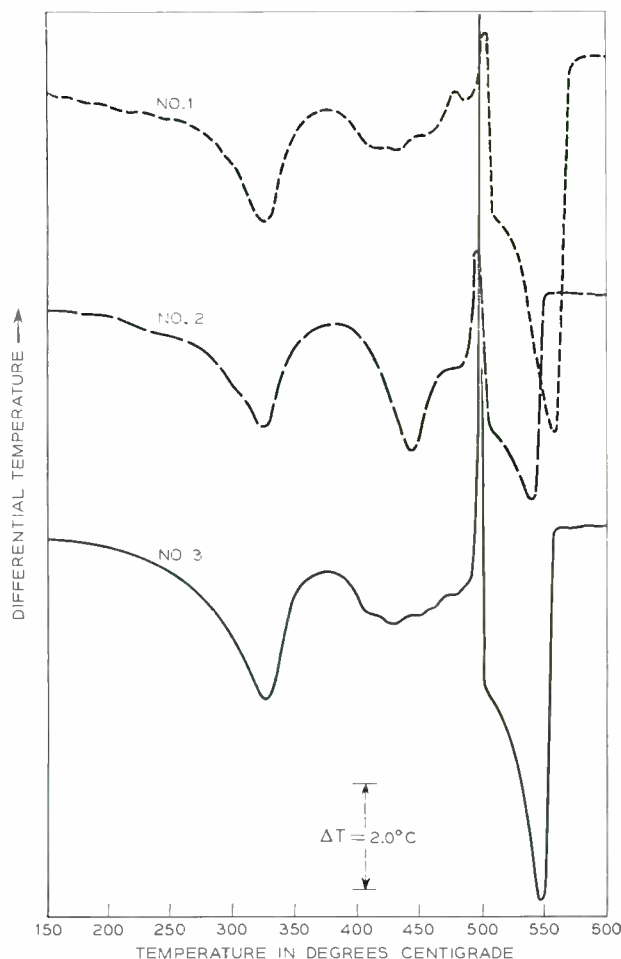

Fig. 5 — Comparative thermograms of three commercial brands of magnesium carbonate.

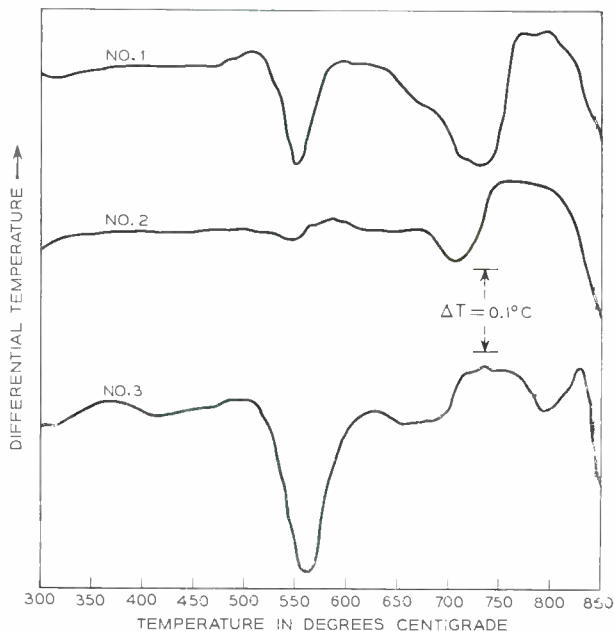

Fig. 6 — Comparative thermograms of three different types of commercial talc.

often most easily determined from differential thermograms by a simple procedure. Various mixtures of the substances are run through the heating cycle and the transition temperatures are picked off the thermograms for plotting the phase diagram.

Aside from such fundamental studies of the properties of chemical systems, differential thermal analysis data have been used in the investigation of the composition of various commercial products. One application of this type was concerned with the applicability of differential thermal analysis to the constituents used in the manufacture of steatite. This is a ceramic insulating material of recent interest because it shows good structural and dielectric properties at high temperatures and high frequencies, and is therefore being used in electron tubes.\*

Two of the constituent materials used for steatite ceramics are magnesium carbonate and talc. Since samples of these materials from various sources — such as from various natural deposits — will show somewhat different firing characteristics, it was desirable to have a precise method of analysis as an aid in the quality control of the final product.

Figures 5 and 6 show some typical comparisons obtained as a result of this work on steatite constituents. In Figure 5, thermograms of three commercial brands of similar grades of magnesium carbonate are plotted. Although the three graphs are closely similar, minor differences can be observed, and these could become significant in terms of the properties of the steatite produced. Curve number two, for example, is clearly different from numbers one and three in the second endothermic depression in the neighborhood of 450°C. Here, a molecule of water is driven out of the hydrated magnesium carbonate. The thermogram indicates that the water

\* RECORD, October, 1955, page 369.

#### THE AUTHOR

PAUL D. GARN received his B.Sc. degree from Ohio State University in 1948 and his M.Sc. and Ph.D. degrees from the same school in 1949 and 1952 respectively. He joined the Laboratories in 1952 and has been engaged in research in analytical chemistry with special interests in electroanalytical chemistry and in the detection of phase transformations in the solid state. Dr. Garn has completed problems in lubrication, low-temperature phase diagrams, and polarography. He is a member of Sigma Xi and Phi Lambda Upsilon.



Fig. 7 — Grinding sample prior to use; at left are sieves used to select correct particle size of material.

in the second sample is held in the compound by a somewhat different mechanism. Figure 6 shows thermograms for the identification of three commercial brands of talc. These graphs are also somewhat similar, but differences due to impurities make it possible to distinguish one from another by this method. Numbers one and three, for instance, show a broad endothermic depression at about 570°C, possibly due to the presence of quartz. Another impurity is identified in the first graph by the broad depression at about 700°C. This impurity is probably a carbonate, since an acid-washed sample did not show this depression.

Other studies of this sort have been performed, but the examples given here show the capabilities of the apparatus and the types of information it can yield. Because of its speed and accuracy, differential thermal analysis has become a useful addition to the numerous methods used in the investigation of materials of interest to telephone technology.



An apparently simple measurement problem is often complicated because the measuring device has a perceptible effect on the object being measured. A thermometer placed in a refrigerator, for example, will raise the temperature of the refrigerator slightly. Similarly, any ordinary device used to measure the surface temperature of a telephone pole will affect that temperature, and so result in a false reading. To overcome this difficulty, a special, fine-wire pyrometer has been developed at Bell Telephone Laboratories. In time this device may be valuable in helping to select poles that are clean, and will remain so, from those that are potential "bleeders".



## *Precise Temperature Measurements on Bleeding Poles*

G. Q. LUMSDEN *Outside Plant Development*

"Bleeding" has a special meaning in the telephone lineman's vocabulary — it refers to the sweating or exudation of oily material, such as creosote, that has been forced into wood fibers to preserve them. Bleeding occurs most frequently when the sun shines brightly on a freshly treated telephone pole. In a previous article \* the relationship between increasing temperature and increased creosote bleeding was established, but to determine this relationship precisely an accurate device for measuring pole surface temperature was needed. Existing measuring apparatus was relatively inaccurate and inconvenient for this purpose. Therefore, a fine-wire thermocouple was developed. This instrument is capable of measuring the temperature of pole surfaces accurately during normal field exposure involving surface temperatures from 80° to 170°F. The thermocouple was designed by the late L. H. Campbell and the tests described herein were conducted by him. The author has made liberal use of Mr. Campbell's memoranda and notes in preparing this article.

There are two properties of wood that make the measurement of surface temperature difficult: first, wood exposed to the sun may be chilled consider-

ably by the measuring device that comes in contact with it; and second, wood has a low rate of heat conductivity. It is this latter property that gives wood its excellent heat insulation properties.

These properties make it necessary to use very long contact times for accurate measurement of surface temperatures of wood. If shorter times are used, the temperatures registered by the instrument are considerably below the actual temperature. Then too, most commercial thermal devices cast shadows over the area being measured. Such a shadow can lower surface temperature in a very few seconds, and may lower the reading still further.

Three methods of measuring temperature by the use of a pyrometer were considered. The first involved a suitably mounted thermistor; the second, an auxiliary heating unit or pre-heater; and the third, a fine-wire thermocouple having a low heat capacity and a head so designed that it would not shade the irradiated surface. Although preliminary tests indicated that both the thermistor and the pre-heater showed considerable promise, the fine-wire thermocouple seemed best and was used throughout the remainder of the work.

As it is now used, the thermocouple consists of one-inch lengths of 10-mil constantan and chromel

\* RECORD, September, 1953 page 321.

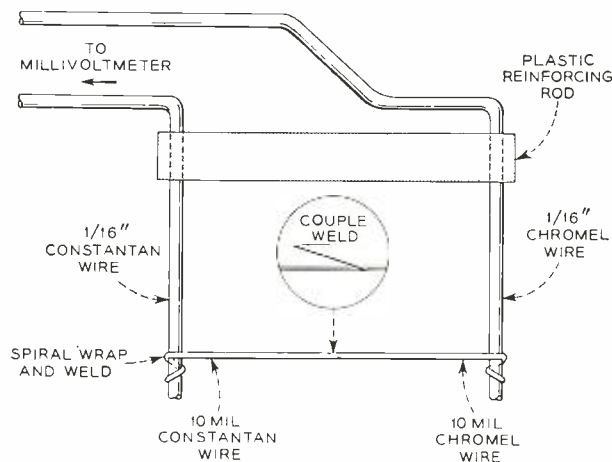

Fig. 1 — Details of the fine-wire thermocouple.

(chromium steel) wire, welded together in the center as shown in Figure 1. The resulting couple wire is then stretched taut and the ends are, in turn, welded to 1/16-inch wires of the same metals. These larger wires serve as leads to a millivoltmeter.

Welding the fine wires to each other and to the leads was a problem since care had to be exercised to avoid melting or "burning" the metals, particularly the constantan. A low-power, bench-model spot welder was used. To prevent tension on the weld between the fine wires and the leads, the wires were wrapped around the leads and welded at the end

TABLE I — TYPICAL SURFACE TEMPERATURE MEASUREMENTS MADE ON THREE POLES.

	ON SKIDS		SET IN GROUND
	Sunny Side	Sunny Side	Shady Side
Untreated, natural wood color	125°-130°F	110°-115°F	—
Creosoted, dark brown in color	115°-150°F	120°-125°F	90°-95°F
Creosoted, black in color, tarry	155°-160°F	135°-140°F	90°-95°F

TABLE II — LIQUID CONTENT OF CELLS IN THE OUTER FIBERS OF BLEEDING AND NON-BLEEDING POLES

Sample No.	Creosote Retention	Water Content	Total Liquid Content
Bleeder	(lbs./cu. ft.)	(lbs./cu. ft.)	(lbs./cu. ft.)
1	16.7	1.7	18.4
2	19.8	2.0	21.8
3	17.7	2.3	20.0
4	8.2	3.4	11.6
			Av. = 18.0
Non-Bleeder			
1	5.6	1.0	6.6
2	11.6	0.6	12.2
			Av. = 9.4

of the spiral. In addition, a flat area was filed on the lead ends to facilitate welding. Wire dimensions, structural details of the couple mounting, and the shape of the couple weld are included in Figure 1. The couple mounting is connected to a commercial, field-type millivoltmeter which is graduated to read in degrees Fahrenheit. The photograph of Figure 2 shows the whole pyrometer assembly as it is used on poles standing in line or in a test plot.

The pyrometer was standardized against a commercial laboratory potentiometer using a 10-mil iron-constantan wire thermocouple which had been standardized against National Bureau of Standards standard glass thermometers.

When using the fine-wire pyrometer in the field, the wire couple is placed against the wood with its mounting tilted so as not to cast a shadow on the spot being measured. To be sure that the couple will not remove too much heat from the wood in registering, it is placed first at an adjacent location for a few seconds to pre-heat it, and then moved

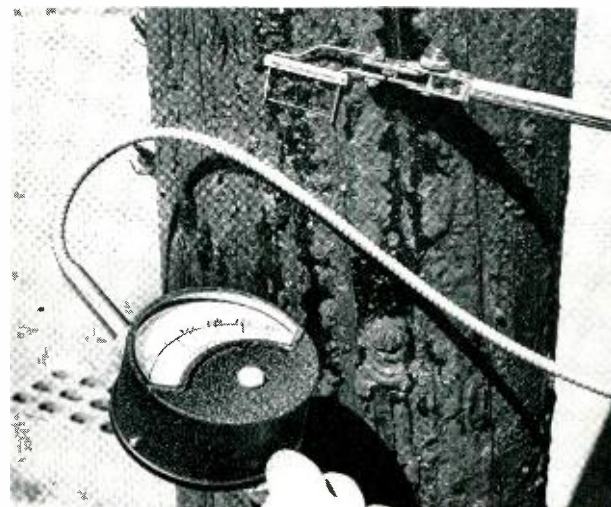

Fig. 2 — Close-up of pyrometer assembly in use to measure a pole temperature.

slowly to the desired position for the final measurement. A total contact time of one-half minute has been found adequate to assure that thermal equilibrium has been reached between the couple and the wood. The instrument registers well within the limits of  $\pm 2^\circ\text{F}$  in measuring the surface temperature of poles.

In field work, surface temperature measurements on many poles have shown that large variations occur. Table I gives some typical measurements on three poles under varying circumstances. The temperatures were taken on a sunny day within a period of ten minutes. Rapid measurement is essential be-

cause, even on a sunny day, a gust of wind may cause the surface temperature to fall 10° to 20°F in a few seconds. Likewise, a passing cloud may lower the surface temperature of a pole 20° to 30°F in the course of half a minute. The temperatures fluctuate widely depending on whether the color of the treated pole is light or dark, whether the temperature is taken on the sunny or shady side of the pole, and whether the pole is lying in a horizontal position or set vertically in the ground.

Once the reliability of the newly developed thermocouple had been demonstrated, it was possible to investigate the specific relationship between the surface temperatures prevailing at bleeding, and the liquid content of the surface cells of the wood. In Table II, figures are presented on two poles commercially treated at the same plant to the same retention level with the same preservative. One of the poles was bleeding badly while on the storage skids (i.e., lying horizontally) at the operating company's yard; the other was not. They are identified in the table as "Bleeder" and "Non-Bleeder." Using the new thermocouple, it was found that the preservative began to exude at a temperature of 140°F in the case of the "bleeder," although the non-bleeder was dry at 147°F, the maximum temperature under the atmospheric conditions then existing.

Six samples of wood about one inch long, one-half inch wide, and one-sixteenth inch thick were cut from the pole surfaces adjacent to the spots where the temperature was measured. The samples were analyzed in specially designed extraction apparatus shown in Figure 3. This apparatus is capable of handling such small amounts of wood to determine the amount of liquid (preservative and water) actually present. The average total liquid content of the bleeding pole, 18.0 pounds of liquid per cubic foot of wood, was almost twice that of the non-bleeder, 9.4 pounds per cubic foot. It is reasonable to assume that the exudation of the preservative

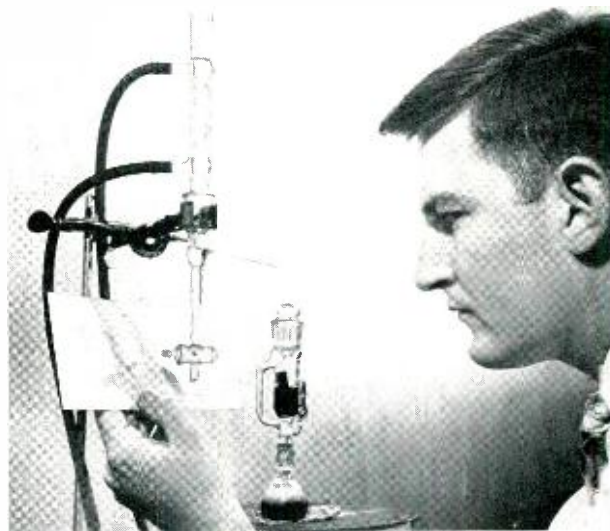

*Fig. 3—L. R. Snoke uses miniature extraction apparatus to determine the amount of liquid retained in wood samples.*

from the fuller surface cells would occur at a lower temperature than it would with the non-bleeding pole. It is also evident that high concentrations of creosote in the outer cells of the wood tend to bring about the bleeding sometimes found on commercial southern pine poles treated to high retentions. However, in considering any practical attempts to lower the concentration of the preservative, the resulting increased vulnerability of the wood to decay and insect attack must be recognized.

The new fine-wire thermocouple is now being used in development and research work. It is expected that it will also be of definite aid in future studies involving the determination of the critical preservative retentions for specified temperature conditions. With additional background of experience it may also develop into a valuable tool for use in separating poles that are clean and will remain so, from those that are potential bleeders.

#### THE AUTHOR

GEORGE Q. LUMSDEN received a B.S. degree from Cornell University in 1922, and a Master of Forestry degree from the same school in 1923. He joined the Engineering Inspection Department of the Western Electric Company in 1923 to work on timber products. Mr. Lumsden transferred to the Laboratories when the Outside Plant Development Department was established in 1927. Since then studies of timber products, and their preservation, especially new preservatives and field trials of them have occupied most of his time. In 1951, he was made Timber Products Engineer, a position he still holds. He is chairman of the "Wood Poles" sectional committee, American Standards Association, and a member of the Executive Committee, American Wood-Preservers' Association.





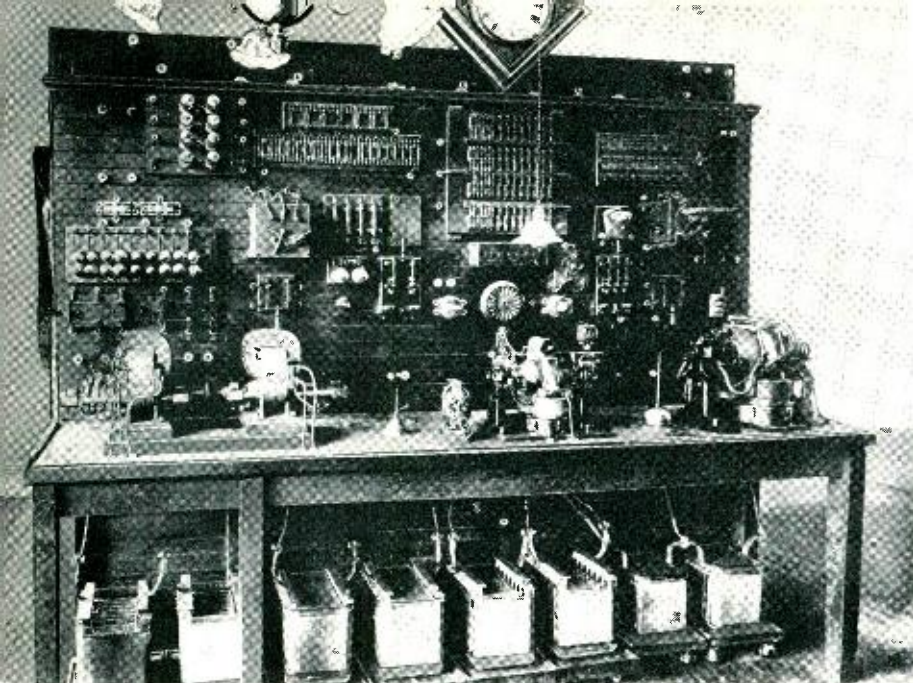

# *Why Storage Batteries?*

**R. D. de KAY**

*Facilities Development*

**It is understandable that the early telephone exchanges used storage batteries as a source of power, but it is not quite so apparent why they are used today. The reason is, of course, that no one has as yet devised a satisfactory substitute. Storage batteries are the most reliable source of emergency electric power and, as a bonus, they provide needed filtering that could otherwise be done only by large and costly filters.**

Behind every manifestation of the arts of telephone switching and transmission is the energy from the power supply. Generally purchased in bulk as 60-cycle current from the nearest power company, the energy must usually change its form before it is suitable to use for talking current, to energize a relay coil, or to power an electron-tube plate or filament, a motor winding, or other telephone apparatus. Most of these end uses call for direct current.

When a newcomer to the scene first begins to explore the practical business of furnishing this needed power he is often astonished to find a storage battery in almost every telephone power plant. Since this electrochemical reservoir of power has been with us from the earliest days of the telephone, and since nearly everything else has changed its form quite radically, the question naturally arises: "Why storage batteries?" They just sit there, apparently doing nothing, costing a lot, and occupying valuable space.

To answer this question, we must begin by thinking of the functions the storage battery performs and then endeavor to find another means to do these

---

*Above — This early telephone exchange used storage batteries as the chief source of power.*

things as well or better at an equivalent or lower cost. The primary function is, obviously, protection of the telephone system against power failures. The second function is that of a low-impedance filter for the reduction of noise and crosstalk.

Failures of commercial power are common in some places and almost unknown in others, depending on the normal hazards in each area, and the design of telephone power plants to some extent reflects past experience and future prospects of failures. Where failures occur frequently, a battery is provided even though the service to be protected is no more than a small PBX. For vital services, such as in a large central office, a battery is also provided even though power failures may be extremely rare.

The second function can, of course, be duplicated by sufficient filters. But, the storage battery affords a bonus in filtering and thereby saves considerable filter expense.

Primary cells such as the ordinary flashlight or doorbell cell were used a number of years ago for customer stations where the drains were very light. Centralizing the talking battery at the central office resulted in total office current drains far beyond the economic possibilities of primary cells. In addition to supplying all the talking currents previously supplied by individual batteries, the central office bat-

tery must supply operating current for relays, switches, and electronic devices. In the larger offices, this may be several thousand amperes.

One substitute for a storage battery might be a generator driven by a gasoline or diesel engine. This would be an acceptable alternative if an engine were available that would infallibly start when cold and produce its full rated speed and torque within a tiny fraction of a second after the regular power failed. In addition, momentary dips or surges in the outside power would have to be recognized as momentary or there would be many false starts.

To provide engine generators capable of supplying maximum "busy-hour" load and running continuously would be uneconomical; in a sense, it would duplicate part of the nearby commercial generating station. In a few places in the United States, it has been necessary to provide such primary power because no commercial source is available and there is no alternative except building long power transmission lines. Even in these offices, a storage battery is used as a safeguard against sudden failure of the engine, as well as for filtering and other reasons.

Many offices, while relying on a storage battery, also use engine generators to reduce the required capacity of the battery. For example, an office might be engineered for a battery with sufficient capacity to supply the office during a power failure lasting ten hours. If engine generators were installed, the

capacity of the battery could be cut so that it would supply the office for say, three hours, since an attendant could be alerted to start the engine within that time and take appropriate measures against any possible overload that the engine could not handle. The use of engines as an adjunct to storage batteries not only makes possible a reduction in the amount of stored energy but serves a further useful purpose in extending the period during which protection is furnished. Thus, while a normal storage battery might give protection for from ten hours to several days, an engine can extend the protection into weeks if necessary.

There have been other proposals for obtaining continuous power without the use of storage batteries. Chief among these is an ac motor and flywheel that is automatically coupled to an engine when the power to the motor fails. The engine is cranked and started almost instantly by the energy stored in the flywheel. The ac motor, already connected to the power lines, reverses its role and becomes an ac generator to continue supplying the office. This scheme may prove in some day, but many problems of cost and reliability have to be solved first.

One of the principal advantages of the storage battery is the fact that it is inert — there are no moving parts to wear out — and hence requires a minimum of maintenance. Because of the generally used method of "fully floating" the battery, failures of power, or even of individual charging rectifiers or motor generators, have no effect on its constant availability. "Fully floating" is accomplished by placing the charging rectifier or generator, the battery, and the load all in parallel and closely regulating the charging voltage to that of a fully charged battery. The load is actually supplied by the charging device, the fully charged battery simply "floating" across the line. The battery then draws only enough current to replace its internal losses and may last for as long as 25 years. In the event of a power failure, it is already across the line and automatically takes up the load. No complicated switching is involved, although during prolonged power failures a few extra cells may be added automatically or manually, to keep the office voltages up to their prescribed values as the battery voltage gradually falls off. When a battery fails at its end of life, it does so relatively slowly so that there is time to order and install a replacement.

While storage batteries have a relatively high first cost, their life is long and annual charges are low. This is especially true with the lead-calcium type batteries, which are estimated to have a 25-year or

Fig. 1 — Workmen installing a giant storage cell in a telephone office.

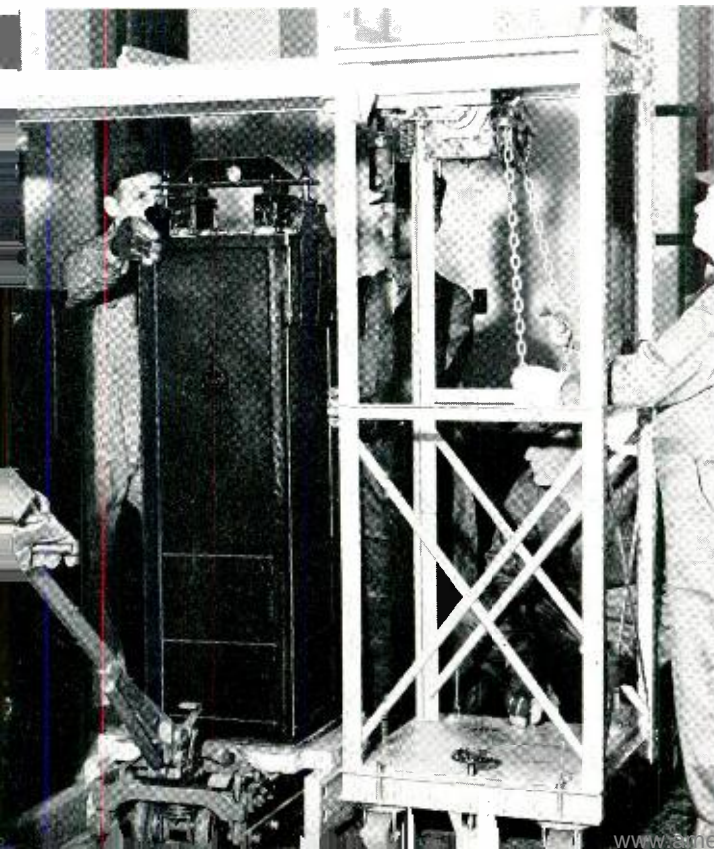



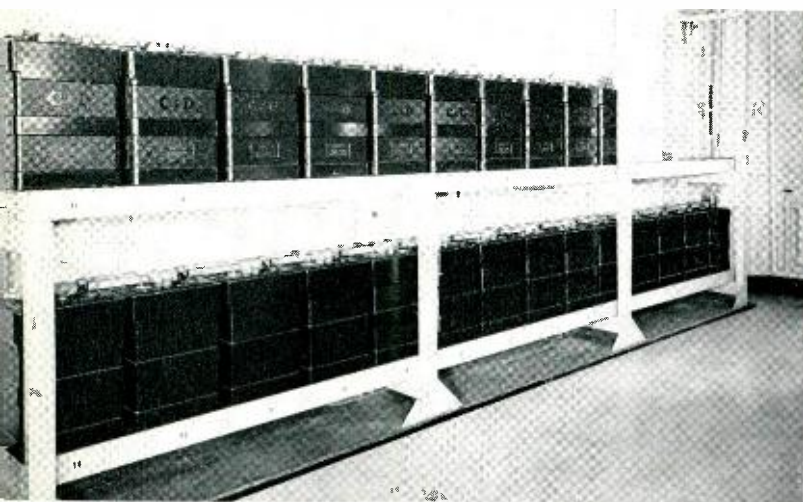

Fig. 2—Storage batteries used by the dial PBX at the Laboratories in New York City.

more life under full float conditions. Present anti-mony-type batteries have an average life of 14 years under the same operating conditions. Storage batteries of smaller sizes are generally only trickle charged; that is, operated by adjusting an unregulated rectifier to some average small value of charging current. These show considerably shorter life but, since their first cost is relatively low, they still prove economical.

A final question that is often asked is: "Why do we need batteries as large as the five-foot-high cells that can supply 875 amperes continuously for eight hours?" And, further, "Why do we even parallel such monsters?"

The answer is that very large centralized power plants supply current for thousands on thousands of switching relay coils and electron tubes. In type-L carrier offices, even large motor-generator sets must also be run from the battery whenever commercial power fails, since the coaxial carrier system requires reliable ac power that is isolated from temporary disturbances in commercial power.\* During normal conditions an ac motor drives an ac generator but, during periods of failure or low voltage of the outside ac power, a dc motor coupled to the generator takes over. Inertia of the rotating parts prevents any interruption of generated ac power during this transition. The dc motors, of course, get their power from the storage battery and some of these motors are as large as 30 horsepower.

Until such time as a satisfactory substitute is found, the storage battery will continue to be the bed-rock source of power in the telephone plant, to meet the standards for reliability in service that have been established by the telephone companies and to which the public has become accustomed.

\* RECORD, June, 1955, page 220.

#### THE AUTHOR



RODMAN DE KAY graduated from the U. S. Naval Academy in 1918 with a B.S. degree and served in the Navy until 1922. He joined the Laboratories, then the Engineering Department of Western Electric, in that year and has since been engaged in activities dealing with power equipment. His work has included the development of telephone power-plant equipment such as motor-generator sets, rectifiers, drive-motor equipment, and power converter apparatus. Mr. de Kay has also been involved in the development of motor-driven exhausters for pneumatic systems, special fans for telephone use, and mercury-tube-type interrupters for signaling purposes, and in the design of maintenance tools for charging generators.





# *Space Diversity Arrangement for Radio Teletypewriters*

E. N. SEPE *Telegraph Development*

**Military communications systems must be fast, accurate, reliable, and capable of operating in relatively inaccessible places. Teletypewriters provide accurate, reliable printed copies of messages transmitted over wire facilities, and their use was extended during World War II to include radio transmission. Six teletypewriter channels could be transmitted on a single-sideband telephone channel of a radio system, and the Laboratories included various circuits to assure continued accuracy and reliability. The earlier system has now been converted to double its original message capacity through the use of space diversity reception.**

As the activities of the Armed Forces increase in scope, so does the need for more channels of communication. In recent years, radio transmission has been used more and more frequently for teletypewriter communication. Radio can achieve instantaneous contact with remote or temporarily inaccessible locations, and teletypewriters provide printed copies of information transmitted. Other advantages of teletypewriters are that they are highly adaptable to automatic encipherment of messages and that, through the use of perforated paper tapes, they can readily relay messages from one circuit to another.

At the outbreak of World War II, the Army asked Western Electric to provide a system capable of simultaneously transmitting several teletypewriter signals over a single radio channel. Such a system was developed at the Laboratories by adapting the Bell System's 40C1 voice-frequency carrier telegraph equipment to provide six teletypewriter chan-

nels over Western Electric single-sideband radio facilities. This was accomplished through "frequency diversity," the use of two separate frequencies in the radio transmission path.

Teletypewriters require that transmitted signals be distorted as little as possible, to prevent inaccuracies in the received copy. Fading is frequently a problem when radio is used as a transmission medium, and one method of combating the effects of fading is to use automatic gain control (AGC). An AGC circuit uses the received signal level as a guide to how much gain is required in the amplifiers, and adjusts the gain automatically to provide a nearly constant output. Frequency diversity is another method of minimizing the effects of fading; in this case, the same information is transmitted over two separate radio frequencies. Since it is unlikely that both channels will fade at the same time, a useful signal is generally available. The system developed by the Laboratories included AGC in

both the radio receivers and in the telegraph terminal equipment, plus frequency diversity.

After a number of years of satisfactory operation of the six-channel equipment, the Armed Forces asked the Laboratories to design new telegraph equipment and to make certain necessary modifi-

cations of the old equipment whereby a greater number of teletypewriter channels could be used on the same radio facilities. To do this, the frequency diversity was replaced by another method of fading control—space diversity. Instead of transmission on two different frequencies, only one fre-

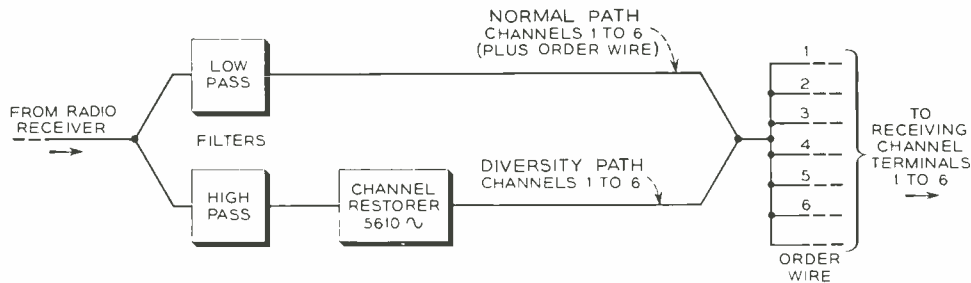

*Fig. 1—The six-channel receiving equipment sorts out the incoming signals with filters and a channel restorer.*

*Fig. 2—Each twelve-channel terminal uses one radio transmitter and two radio receivers to obtain space diversity.*

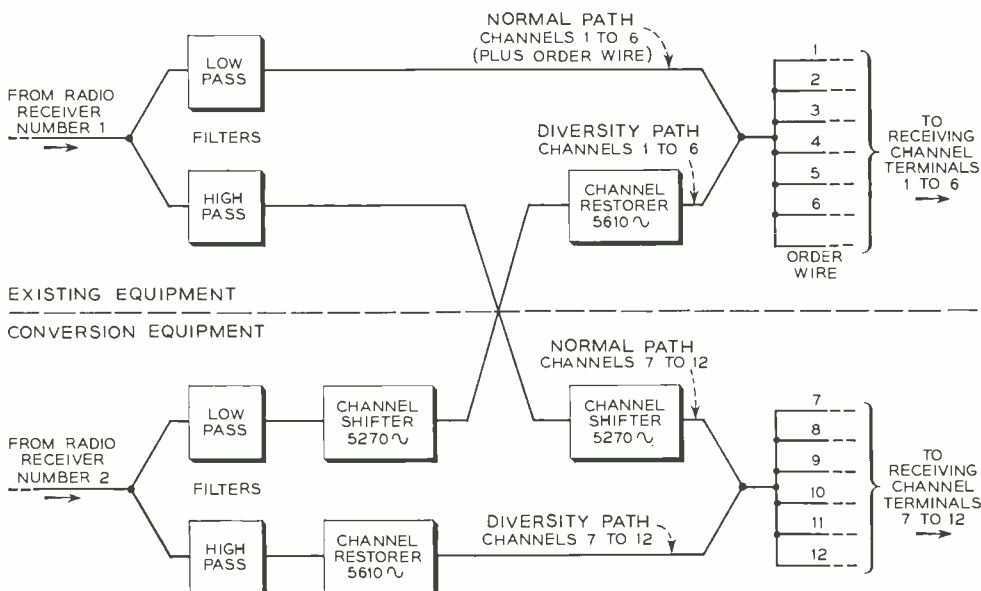
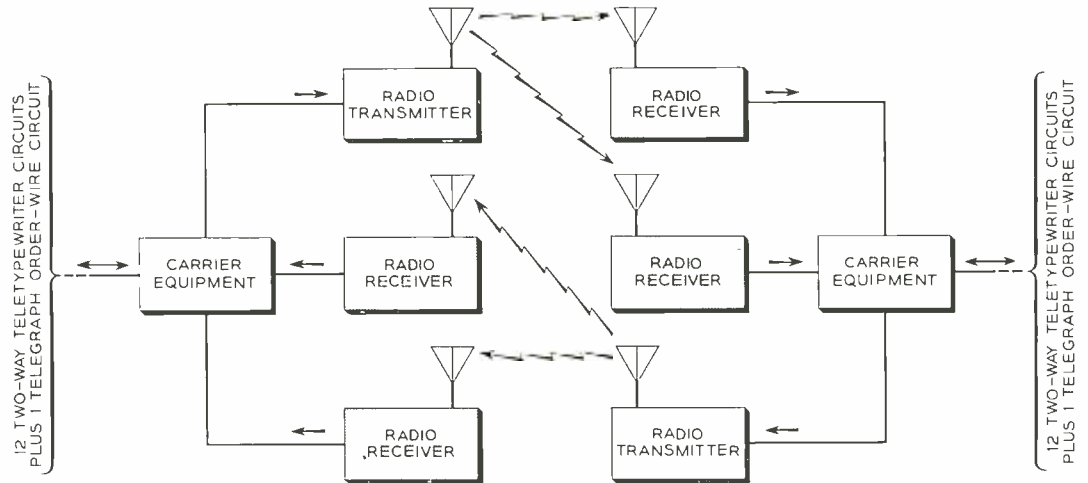

*Fig. 3—Twelve channels are sorted out by adding another radio receiver and some additional terminal equipment.*

quency is used but the signal is received on two different antennas at least ten wave-lengths apart. This, through appropriate modifications of the telegraph terminal equipment, permits transmission over the radio facilities of twelve instead of six teletypewriter channels.

The earlier six-channel telegraph equipment translated teletypewriter mark-space (on-off) code impulses into voice-frequency tones, which were then supplied to the radio system for modulation onto the radio carrier. Separate frequencies 170 cycles apart were used for marks and spaces for each channel, making a total of twelve individual tones for six channels. These twelve tones plus a thirteenth tone for manual telegraph order-wire service were supplied to the radio system in a voice-

ferent frequencies in the radio spectrum, one might be affected by selective fading while the other was not. Combining the two received tones provided a fairly constant output signal. This was accomplished by low- and high-pass filters and a 5,610-cycle "restorer". The low or unshifted group of tones was passed along to the receiving terminal equipment through a low-pass filter. The high or "diversity" group went through the high-pass filter and was then shifted to new frequencies by a restorer. Each high-group tone was thus shifted to a frequency 340 cycles higher than its unshifted counterpart. For example, channel 6 mark tones became 2,125 and 2,465 cycles. These tones were then combined in a detector to give a nearly constant output.

The new telegraph equipment uses a similar ar-

*Fig. 4—The left-hand three bays contain conversion equipment for six additional channels. The other bays are conversion and temporary power bays used at Laurence, Mass., to simulate an existing six-channel system.*



frequency band extending from 425 to 2,805 cycles per second.

In addition to the twelve tones (plus the order-wire), the *same* tones were shifted by a 5,270-cycle oscillator-modulator circuit to appear as tones in the band between 2,975 and 4,845 cycles. These new tones also were supplied to the radio system for modulation onto the radio carrier as another portion of the sideband. Thus the actual radio sideband transmitted extended from 425 to 4,845 cycles on one side of the radio carrier.

At the receiving terminal, *both* tones representing a particular mark or space condition for a given channel were combined in the telegraph equipment to provide a single output, Figure 1. Channel 6, for example, used tones of 2,125 and 3,145 to represent a mark condition. Since these tones produced dif-

ferent frequencies in the radio spectrum, one might be affected by selective fading while the other was not. This is space diversity as contrasted with frequency diversity. The advantage, of course, is that six teletypewriter channels now occupy only the unshifted band from 425 to 2,295 cycles, leaving room for six more channels.

The extra six channels, Figure 3, are handled in the telegraph equipment exactly as if they were the "shifted" duplicates of channels 1 to 6. That is, channels 7 to 12 are shifted by a 5,270-cycle oscillator-modulator to the band between 2,975 and



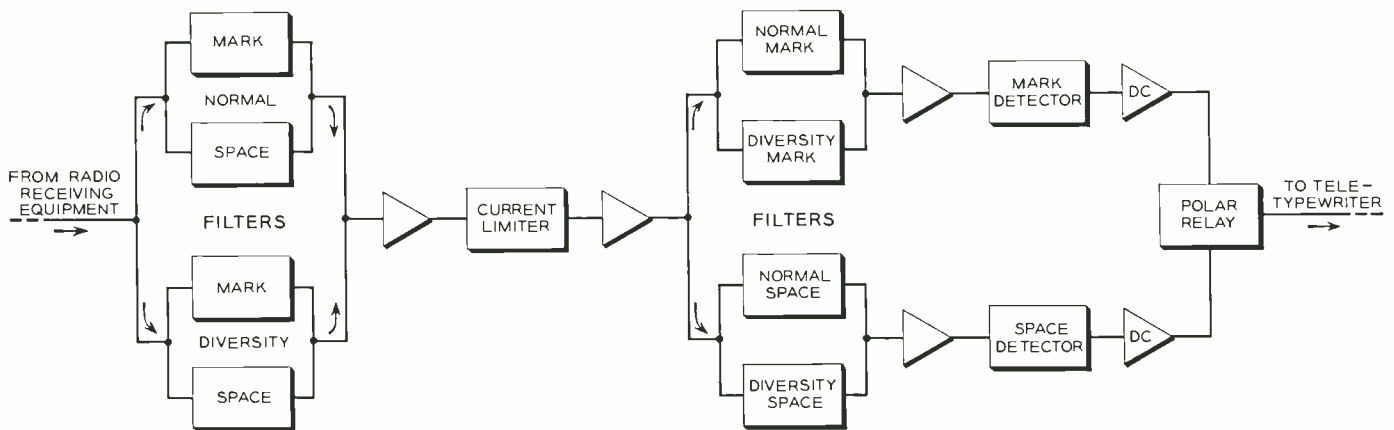

Fig. 5 — Block diagram of a channel receiving terminal.

4,845 cycles before being supplied to the radio system. Radio receiver No. 1 demodulates the radio signal back to voice-frequency tones. In the telegraph equipment, the unshifted channels (1 to 6) are passed along by a low-pass filter. The shifted channels (7 to 12) are passed by a high-pass filter to a 5,270-cycle oscillator-modulator where they are shifted back to their original individual frequencies between 425 and 2,295 cycles.

Radio receiver No. 2 produces exactly the same tones, but one extra step is necessary in the telegraph equipment. Each group of six channels is separately modulated by a 5,610-cycle restorer to shift the twelve tones to frequencies 340 cycles higher than their original values. These restored groups are then combined with their unrestored counterparts to provide the same frequencies as in the six-channel equipment. This arrangement permits the use of the original six-channel receiving terminal equipment.

The telegraph transmitting equipment is the same as in the six-channel system, except that channels 7 to 12 are shifted to form the high group. Each channel uses separate mark and space oscillators, control relays, and filters. The relays are controlled by the dc teletypewriter loop for that channel to transmit the appropriate tone as required.

In the new system, the six extra channels require six more channel receiving terminals. In each terminal, Figure 5, four filters select the four specific tones required by that channel from among the twenty-four presented to them. Channel 6, for example, uses 2,125 and 2,295 cycles in the low group for mark and space, and 2,465 and 2,635 cycles in the high group. An amplifier boosts them to a value sufficient to guarantee continuous operation of a limiter, and the limiter smooths out any variations

in their level. Again they are amplified and are then fed to four more filters. This time, the two tones representing a mark are selected and fed through an amplifier to a detector where they are combined into one dc output. The two space tones are similarly treated. The mark and space outputs are again boosted by dc amplifiers to values sufficient to operate a polar relay, which in turn controls the receiving teletypewriter.

Additional equipment required for the six extra

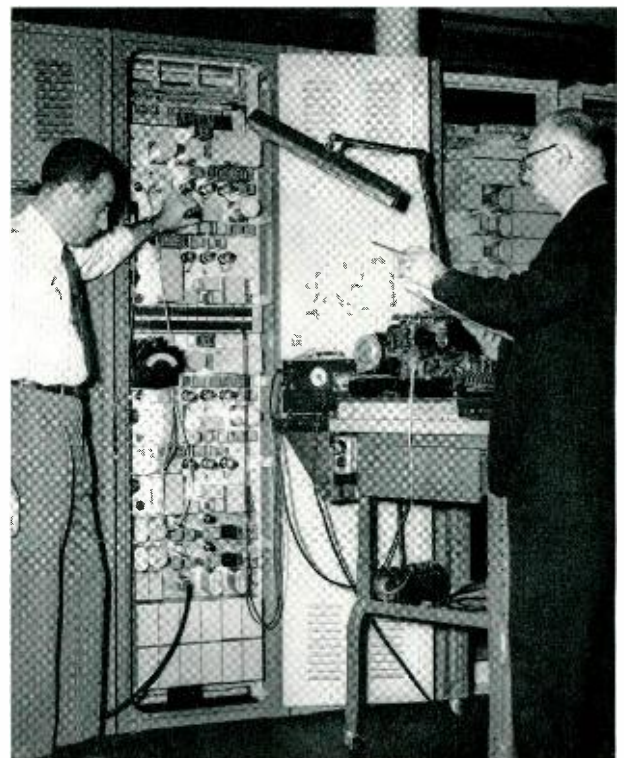

Fig. 6 — The author checks transmission while L. E. Melhuish takes data on the tests.

channels is housed in three steel cabinets, the same as those used for the existing equipment which uses ten cabinets. Two channel terminals mount in one cabinet, Figure 4. Part of the power supply for the additional channels is mounted in a fourth cabinet, the rest of the power supply and the channel carrier-frequency supply being taken from the existing equipment. Some of the units have been rearranged to provide room for the additional shifting and restoring equipment supplied as a single unit.

When the Armed Forces requested modification of the six-channel systems, little data was available

on their performance. Since they had been in use for several years with no reports of trouble, it was assumed that their performance was satisfactory. However, to insure that the converted systems would fulfill the requirements in the operating manuals of the older systems, a test set-up was arranged at the Lawrence, Massachusetts plant of Western Electric, Figures 4 and 6. Conversion units were arranged to simulate the original equipment, as well as being used for their normal function. Test results indicated that converted telegraph equipment fully met the design objectives.

---

#### THE AUTHOR



EDMUND N. SEPE attended Davis and Elkins College in West Virginia while working for radio stations WDNE-WDYK, and then transferred to St. John's University in Brooklyn. Upon joining the Laboratories in 1953, he began work in the Telegraph Department where he has since been concerned with carrier telegraph systems. Mr. Sepe is responsible for the writing of telegraph specifications including circuit descriptions, manufacturing requirements, and installation and testing procedures, and has just finished research and design for a noise alarm circuit for carrier telegraph. His experience includes two years instructing radio teletypewriter maintenance in the Army at Fort Monmouth and Camp Gordon.

---

### *Dr. Kelly Names Committee on Laboratories Fellowships*

A new committee, The Bell Telephone Laboratories Fellowship Committee, has been appointed by Dr. Mervin J. Kelly to administer the Laboratories Fellowships announced last June.\* The fellowships will be awarded to students who are now engaged in full-time graduate work and who expect to complete their doctorates within one or two years. They will be awarded for the first time in April of next year.

H. A. Affel has been named Chairman of the new Committee. Serving with him are R. L. Dietzold, K. E. Gould, J. A. Hornbeck, S. B. Ingram, W. D. Lewis, B. McMillan and S. Millman. M. B. Long will be Secretary.

\* RECORD, July, 1955, page 278.

Each fellowship carries a grant of \$2,000 to the fellow, and an additional \$2,000 to cover tuition, fees, and other costs to the institution at which he chooses to study. Fellows may choose any academic institution within the United States. These fellowships may run as a regular academic year or as an academic year plus a summer session. The field of study and research, while restricted to one having a direct bearing on electrical communications, is yet broad in the sense that relevance is not prejudged by detailed specification. The field of specialization, therefore, is not limited to electrical engineering but may, for example, include branches of mathematics, physics, chemistry, engineering mechanics, and mechanical engineering.

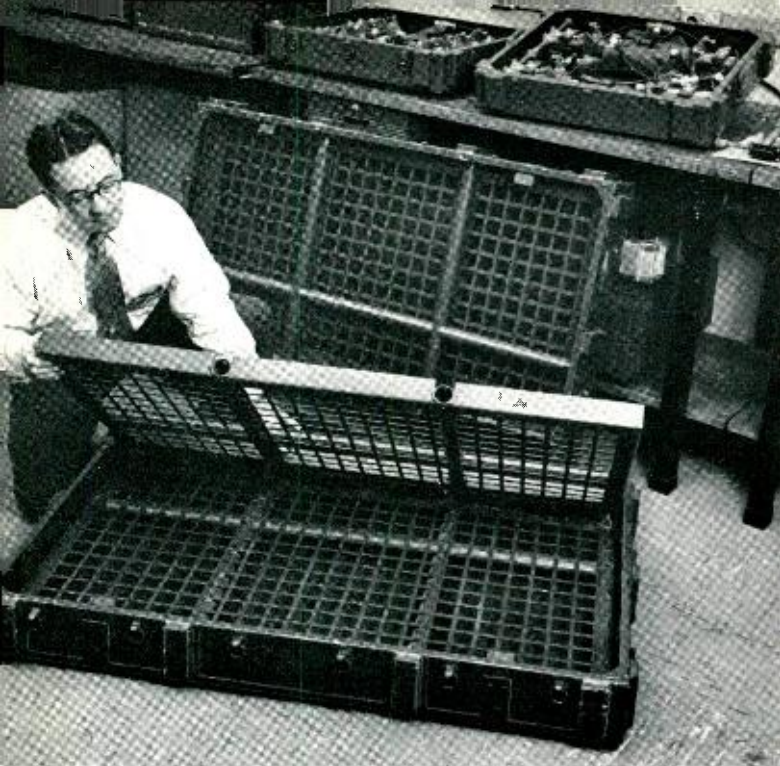

## *Radio Set*

### *AN TRC-24:*

### *Antenna*

The Army-Navy Transportable Radio Communications Model 24 (AN/TRC-24) Radio Set\* required that all components be exceptionally rugged and easily transportable. In the case of the antenna — usually a large piece of gear — these requirements presented some challenging electrical and mechanical problems. The final design weighs only 100 pounds and performs well over a 100- to 400-mc frequency range. This equipment makes possible a twelve-channel military radio-relay communication system, and when used with cable carrier,† provides an extensive network covering transmission distances as far as 1,000 miles and more.

Rigid Signal Corps specifications required that the antenna for this radio equipment be rugged, small, and easily transportable. One of the major problems was to meet these mechanical requirements without unduly compromising the electrical performance. The electrical principles involved in the designs were well known, but considerable development effort was necessary to adapt the designs for this particular military application.

As finally developed, the AN/TRC-24 antenna uses dipoles and plane reflectors to operate over the wide frequency range of 100 to 400 mc. The dipoles radiate a beam of radio energy in the desired direction, and this beam is reinforced by additional energy that bounces from the reflector. This arrangement meets the mechanical requirements and shows good gain and good impedance match over the entire frequency range. A transmitting and

a receiving antenna are assembled on a comparatively lightweight forty-five foot high mast, which is also furnished as part of the AN/TRC-24 Radio Set. Gin pole and block-and-tackle gear are provided as part of the equipment for raising the mast and antenna when changing adjustments or dipoles. Provisions are available for assembling a single antenna on the mast where one-way transmission is desired. The antenna may be oriented to provide either vertical or horizontal polarization of the radio energy.

The general design of the antenna can be seen in Figure 1, which shows a completely assembled antenna structure along with several possible arrangements of reflectors and dipoles. Each dipole consists of two radiating elements that are mounted in front of the reflector; two different sizes of dipoles are used to cover the frequency range. The reflectors are constructed of perforated sheet aluminum, reinforced with aluminum tubing to provide low weight, reduce wind loading, but retain high strength. When assembled, the reflectors are guyed for greater stability, and each is hinged in the center to fold like the pages of a book for packaging. The reflector may be mounted on any edge as required for proper polarization of the radio waves. The finish is olive drab to reduce light reflections, which might disclose the location of the equipment.

In service, the dipoles covering the desired operating frequency range are removed from their case and assembled on the reflector. For the 100- to 225-mc band, two dipoles are used per reflector. Each dipole element has two tubular members

\* RECORD, July, 1955, page 274 and November, 1955, page 428. † RECORD, August, 1955, page 290.



which form a junction at the antenna feed point and fan out to form a V-shaped element. Electrically, this configuration represents a dipole capable of operating over a wider frequency band than one made of single tubular members of the same size. A telescoping arrangement permits the length of the elements to be set at any one of three positions. For the 225- to 400-mc band, two single-element dipoles are mounted on each reflector, with two settings of length. Once the size and setting of the dipoles are selected, and the antenna is erected on the mast, the equipment can be operated within  $\pm 10$  per cent of the center frequency without lowering the mast for readjustment. The dipoles are constructed from metal tubing, finished with a dull gray chrome to reduce light reflections.

The dipole elements are attached to the reflector by metallic tubes that are adjusted to approximately

a quarter wavelength at the operating frequency. This places the dipole elements at a high-impedance point with respect to the reflector at operating frequencies, while at unused low frequencies the dipoles are effectively shortcircuited to the reflector. Lightning protection is therefore readily provided by attaching a suitable ground lead to the all-metal reflector, which in turn is connected to

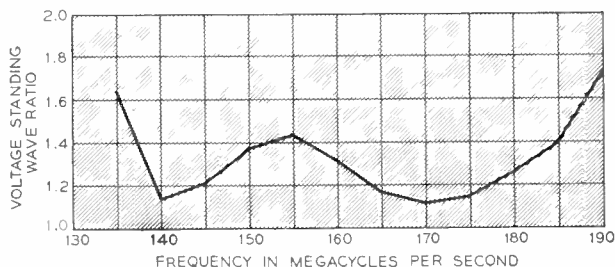

Fig. 2 — Standing-wave ratio characteristic, 135 to 190 megacycles.

the metal dipoles. Each dipole is fed with a phase-correcting coaxial harness, which is connected to the coaxial cable from the transmitter or receiver. A strain relief attachment removes the weight of the line from the connectors.

Examples of some of the more important of the antenna's electrical characteristics are shown in Figure 2. This illustration shows, for frequencies between 135 and 190 mc, the variation in "voltage standing wave ratio", which is a measure of the amount of impedance mismatch between the antenna and the 50-ohm coaxial transmission line. This ratio does not exceed 2.5 for the 100- to 400-mc range, and as seen from the graph, it is generally much lower than this.

When a transmitting and receiving antenna are mounted on the same mast, it is of interest to know what transmission loss exists between them. The higher the value of this loss, the less power is transmitted to the adjacent antenna. With a two-foot separation between antennas facing in the same direction, the transmission loss is in the 30- to 40-db range when the dipoles are parallel to each other. This represents the case when the antennas are installed for vertical polarization. When the dipoles are colinear, as is the case with horizontal polarization, the transmission loss is in the 40- to 50-db range.

W. C. BABCOCK,

*Transmission Engineering*

E. L. LeBRIGHT,

*Military Communication Development*

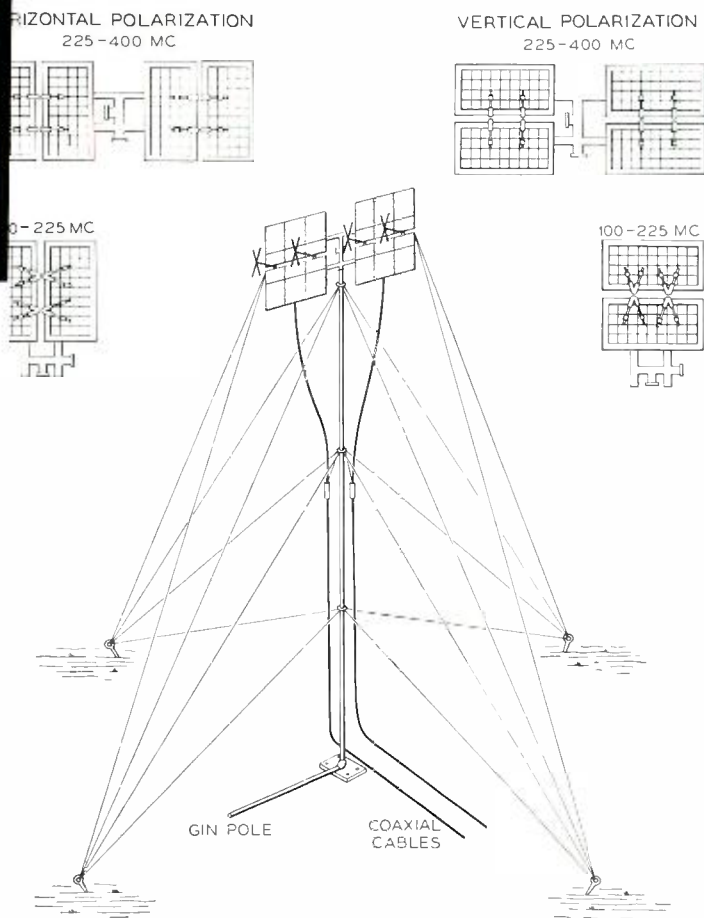

Fig. 1 — The AN/TRC-24 antenna. Insets show some of the possible combinations of frequency ranges and wave polarizations. In the illustration on the opposite page, E. L. LeBright is placing reflector in transit case. Cases of dipoles are on table in background.



In the past it has been necessary to install any new transmission system in the field and to study its characteristics before adequate equalizers could be designed and built. With the development of the L3 coaxial carrier system, however, a new type of equalizer, one with sufficient flexibility to accommodate any condition that might be encountered in the working system, was designed. This made it possible to install L3 lines with their equalizers already in place, adjust the equalizers and compensate for transmission deviations with no waiting period.

## *Adjustable Equalizers for the L3 Coaxial System*

R. S. GRAHAM AND J. P. KINZER *Transmission Systems Development*

The need for maintaining "flat transmission" characteristics within narrow limits over the 8-mc band in the L3 system has been described in previous RECORD articles. Stringent requirements must be met to assure satisfactory transmission of message and television signals over the long distances for which L3 was designed. The transmission characteristics of the system are measured periodically and the problem of maintaining satisfactory transmission is divided into two parts: that of maintaining substantially flat transmission in the period between measurements, and that of correcting for minor deviations at the line-up periods when transmission measurements are made. These periods occur about every three months.

The new adjustable equalizers, shown in the headpiece of this article, are provided to help solve the second part of this maintenance problem. These equalizers make it possible to compensate for any departure from an ideal transmission characteristic likely to be encountered in a working system.

Automatic control of the gain-frequency characteristic between line-up periods is achieved by networks whose loss-frequency characteristics vary under the control of single frequency tones called "pilots." However, it is impracticable to maintain the required transmission accuracy automatically over long periods. The pilot control networks cannot correct all the possible transmission variations. Some of these variations are due to differences in individual amplifier characteristics; others are caused

by small but significant differences between the actual system gain changes and the characteristics of the automatically controlled networks which compensate for them. The former gain changes occur when amplifiers are replaced and the latter when large temperature changes take place or when electron tubes or other components age appreciably. To compensate for these effects, a set of equalizers is required which can be adjusted to match any composite loss-frequency characteristic that may be encountered.

Use of a series of harmonics of sine and cosine functions to synthesize an arbitrary characteristic over an interval is a well known mathematical technique. The new equalizers, often called "cosine equalizers," utilize this technique by providing harmonically related loss-frequency characteristics. This application to provide a flexible adjustable equalizer was suggested some years ago by P. H. Richardson of the Laboratories, but networks designed for L3 are the first Bell System application of this concept.

To apply this principle to L3, the frequency band extending from zero to 8.5 mc can be considered as the abscissa of a graph. The ordinate of this graph is in decibels of loss. Further, assume a correspondence between frequency in megacycles and degrees of a cosine function by letting zero cycles correspond to zero degrees and 8.5 mc correspond to 180 degrees. In theory any characteristic over the chosen interval can be synthesized by harmonics of the

cosine function plotted on this set of coordinates.

To equalize any function perfectly, an infinite number of cosine harmonics would be required. For completely satisfactory equalization of the L3 system, however, 14 harmonics are sufficient and each of these is provided by an equalizer network. Since there is a large variety of transmission characteristics to be synthesized in practice, the amplitude of each of the 14 cosine harmonics must be adjustable.

The loss-characteristics of the first three networks used to provide these harmonics are illustrated in Figure 1. The amplitude of each term may be adjusted continuously between the maximum and minimum values indicated by the solid and dotted lines. An equalizer network assembly is shown in Figure 4. The rheostat at the end of this assembly controls the amplitude of the harmonic corresponding to that network. Each of these networks is made up of shunt and series arms as shown in the schematic diagram of Figure 3. The networks differ only in the number of such sections provided for each

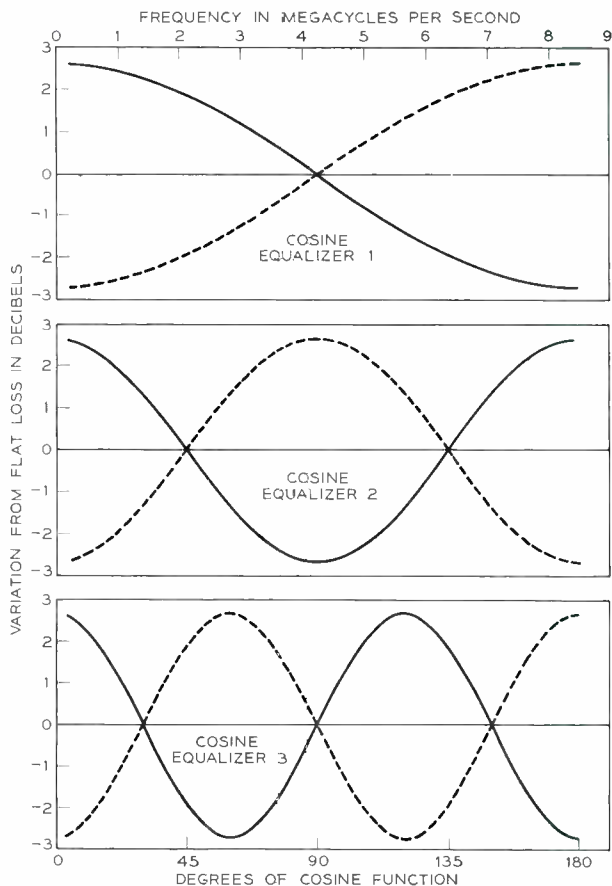

*Fig. 1 — Curves showing maximum and minimum variations from flat loss versus frequency for the first three networks in a cosine equalizer.*

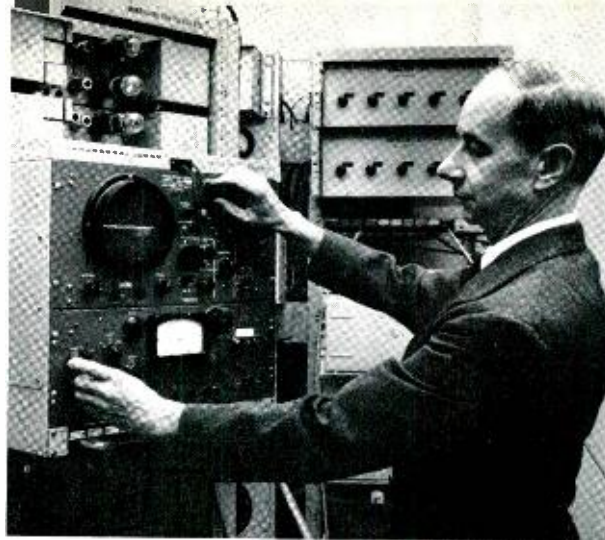

*Fig. 2 — J. P. Kinzer adjusts an equalizer test set. Two cosine equalizers are shown mounted at the top of the panel in the background.*

cosine harmonic; each higher harmonic requires an additional section in the series and shunt arms.

By using quality control in the manufacture of the fixed inductors, resistors, and capacitors, and by designing the mechanical assembly to maintain uniformity in the physical location of these components, only minor factory adjustments on the individual equalizers are required.

The use of cosines as equalizing functions has several advantages over other possible choices. These include the fact that improved equalization can be obtained by simply adding harmonics. Also, in providing adequate equalization, cosine equalizers introduce less loss into the system than other possible types. Since any characteristic that is likely to be encountered can be synthesized by a combination of harmonics, the equalizers can be designed, built, and installed with the initial system without the need for obtaining precise data on the performance of that system.

To make use of cosine equalizers, a practical method of adjusting the amplitude of these harmonics must be available. This is provided by a newly developed test set based on the use of sweep frequency techniques to convert the gain-frequency characteristic of the L3 line and cosine equalizers to a corresponding voltage-time characteristic. The amplitude of this voltage-time characteristic is a direct measure of the amount by which the gain-frequency characteristic of the system deviates from flatness. This test set is illustrated in Figure 2.

Any improvement in system equalization results in a reduction of the electrical power represented by the voltage-time characteristic and hence this power can be used as a measure of the degree of equalization. The set provides a means of minimizing the power in the voltage-time characteristic.



In equalizing the system, the test signal applied to an L3 line has a constant amplitude and a varying frequency sweeping back and forth between 0.35 and 8.25 mc at the rate of 37.5 cps. The signal is taken from the receiving end of the line after having passed through the cosine equalizer and is applied to an amplifier-detector circuit. In general, the amplitude of the received signal is no longer constant with frequency and therefore the output of the detector is a fluctuating direct voltage which contains components of 37.5 cps and its harmonics. The constant part of this voltage is blocked and the remaining fluctuating voltage is amplified and applied to a power measuring circuit, with a meter indication. The rheostats on each equalizer network are adjusted until a minimum reading is obtained on this meter. This minimum reading indicates that the gain-frequency characteristic has been adjusted to about as flat as possible. The fluctuating voltage is also applied to the vertical deflection circuits of an oscilloscope to give a visual presentation of the line characteristic.

The test set consists of a transmitter and receiver. In the transmitter a test signal is generated by oscillator-modulator circuits which consist of a fixed oscillator, a sweep-frequency oscillator, and a mod-

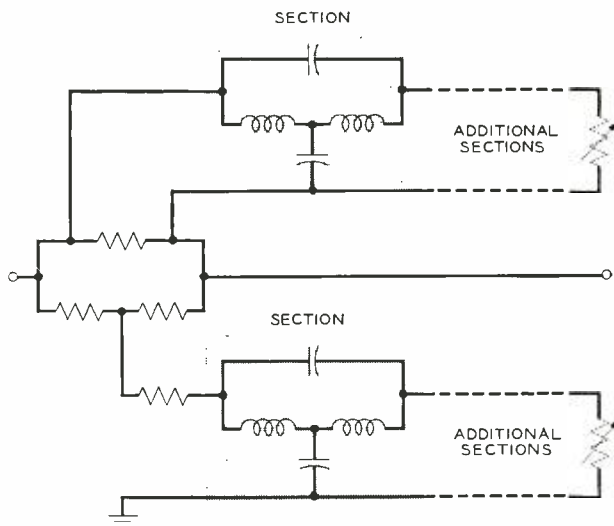

Fig. 3—Simplified schematic of an equalizer network showing shunt and series arms.

ulator as shown in Figure 5. The sweep-frequency oscillator swings between 71.75 and 79.65 mc. This signal, together with an 80-mc signal from the fixed oscillator is applied to the modulator. Its output is the test signal sweeping between 0.35 and 8.25 mc. The sweep oscillator is a reactance-tube



Fig. 4—R. Dempster makes wiring changes on an equalizer network unit.

device in which the frequency is varied up and down by a triangular voltage wave of 37.5 cycles per second obtained from the sweep generator. Feedback techniques are used to maintain the edges of the swept frequency band precisely. The band-edge setter is a circuit that monitors the test signal from the modulator. It applies corrective control voltages to the sweep generator to maintain the magnitude and direct component of the triangular sweep at values that will provide precisely the correct sweep range to the reactance-tube oscillator. In addition, a pilot skip circuit monitors the test signal and speeds up the rate of sweep 100-fold whenever the test signal comes within 100 kc of a pilot frequency, jumping the sweep to 100 kc on the other side of the pilot. This materially reduces the amount of test energy that gets into the pilot controlled regulators and might interfere with their correct operation.

The test signal, after transmission over the line, is applied to an amplifier detector in the receiver as shown in Figure 5. This circuit is of conventional broadband design and has an extremely flat response over the L3 frequency band. The detector output is constant at about 1 volt with the gain-frequency characteristic of the line appearing as a fluctuating voltage of a few hundredths of a volt superimposed on it. Any test signal appearing in the detector output is removed by a low-pass filter. A pulse is also generated in the amplifier-detector

each time the sweep passes through 5 mc. This pulse is used to synchronize the recurrent sweep circuit of the oscilloscope.

The test set is designed to be virtually complete

is done, the transmitter can be connected to its receiver and the flatness of the transmitter thereby checked. Marker-oscillators are provided at 0.35 and 8.25 mc to allow a check of the proper func-

Fig. 5—Block diagram of the cosine equalizer test set.

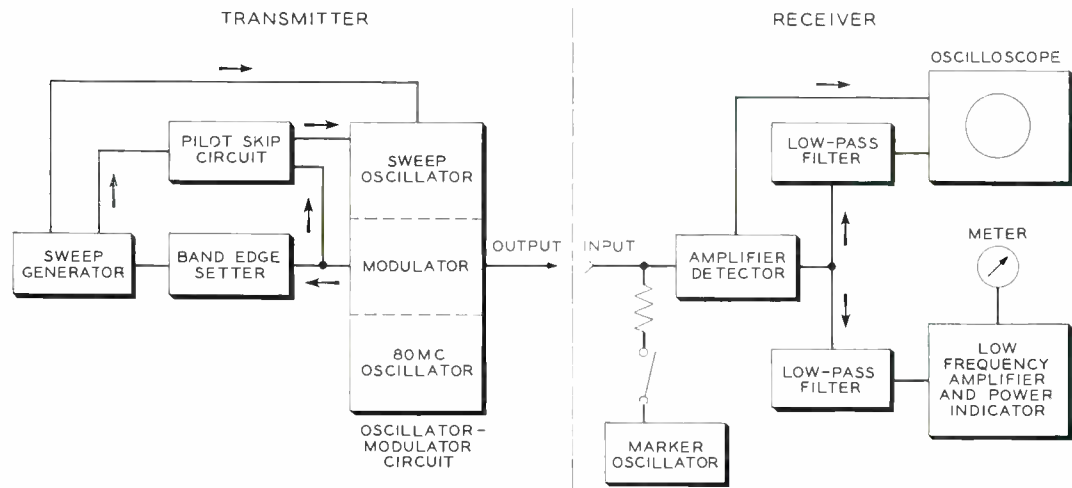

in itself and has numerous features to facilitate checking and maintenance. However, alignment of the receiver to obtain a flat transmission characteristic requires external precision equipment. Once this

tioning of the band edge setter.

In practice the test set has proved easy to use. An L3 line 100 to 200 miles long can be equalized to optimum flatness in a very few minutes.

#### THE AUTHORS

Since joining the Laboratories in 1937, R. SHIELDS GRAHAM has been principally concerned with the design of equalizers, electrical wave filters, and similar apparatus for use on long-distance coaxial cable circuits for both telephone and television transmission and is currently in charge of a group working on these problems. During World War II he designed circuits for electronic fire-control computers for military use, and later developed methods for computing network and similar problems on a digital relay computer. Mr. Graham received a B.S. degree in E.E. from the University of Pennsylvania in 1937. He is a member of the American Institute of Electrical Engineers and a senior member of the Institute of Radio Engineers.



J. P. KINZER joined the Laboratories in 1925, and after early work on the loudspeakers for the first sound pictures, he was engaged in the development of two-wire voice repeaters. In 1930 he transferred to the carrier group, and except for World War II work on microwave cavities for radar testing, he has since been concerned with the development and improvement of carrier systems for long-distance telephone and television cables. Mr. Kinzer received an M.E. degree from Stevens Institute of Technology in 1925, and in 1933 he received the degree of B. in C.E. from Brooklyn Polytechnic Institute. He is a senior member of the Institute of Radio Engineers.

# *Splicers and Pads for Coaxial and Balanced-Pair Cables*

Three new developments — promising savings in time, money and space — have grown out of the need for improved methods of splicing coaxial and balanced-pair transmission cables. The need for better splicing methods arose because of the manufacture of high-frequency apparatus using short lengths of these cables in place of regular terminals.

The first of the new developments is a solderless method of connecting cable shields, which permits splices to be made in a few minutes. A tin-plated copper sleeve is crimped at both ends to the conducting sheath of the cables being spliced. As shown in Figure 1, the splices made in this way require little space, in contrast to the awkward solder-

ing arrangements formerly employed. Another convenience is the rip tab provided on the outer connector to facilitate opening the splice. This tab can be peeled off easily with long-nose pliers, allowing the detail to fall away in two parts.

A second development based on the crimping process is the “pi” and square type attenuator pads (shown in Figure 2), which are furnished completely assembled in cylindrical cartridges. Used in coaxial or balanced circuits, the device effects considerable savings of panel mounting space. Removal of the pad can be accomplished quickly by use of the rip tab feature already described.

A third new development stems from an unusual

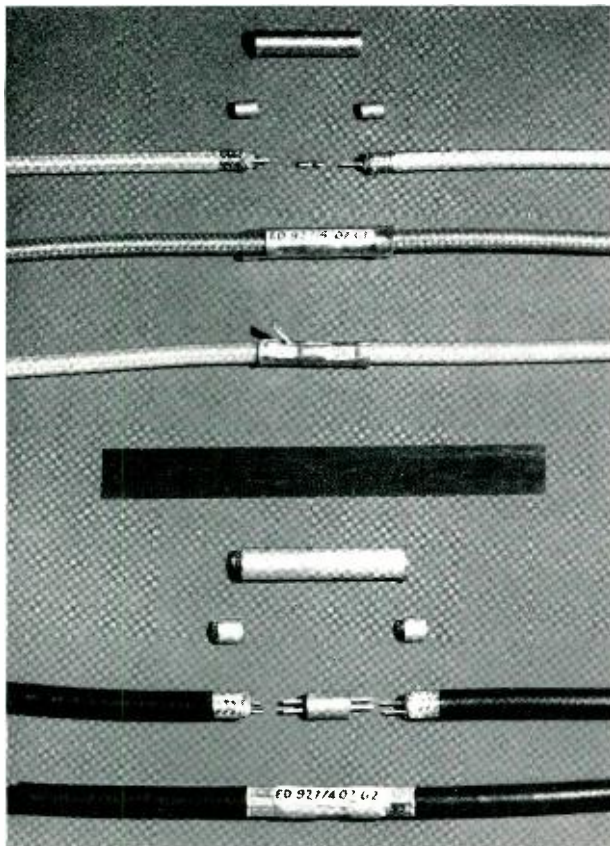

*Fig. 1—A coaxial splice (above), a balanced splice, and components for each.*

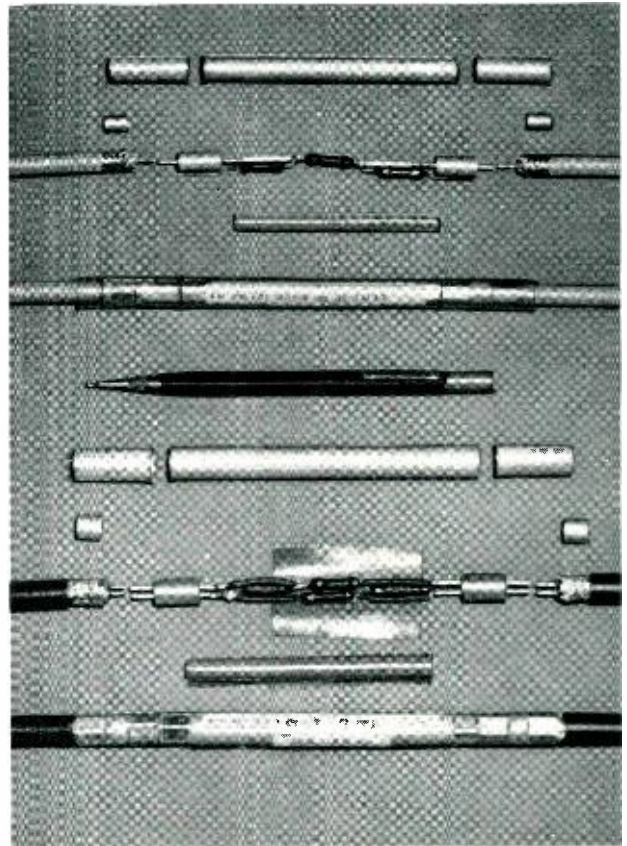

*Fig. 2—A “pi” pad (above), a square pad, and components for each.*





*Fig. 4 (left to right) — A. J. Uminowicz inspects a splice that is used in the L3 carrier terminal equipment, A. J. Weir examines an attenuator pad in a channel bank patching cord, and F. W. Koller illustrates the method of installing a pad, using a hand operated crimping tool.*

application of the cartridge-type pad. The Western Electric Company is now manufacturing patch cords containing pads of this general type for use in 4- or 6-wire voice-frequency patch bays. These cords are used for circuit interconnection and rearrangement, and for these purposes are more convenient and flexible, as well as cheaper, than the permanently mounted pads previously used.

Both pads and splices are cheap to produce be-

cause the mechanical components are made from tubing by a simple cut-off process. Many of these devices have been used in L3 systems already installed and numerous other applications are in the design stage. Assistance from the Western Electric Company in initial production runs aided materially in these applications.

F. W. KOLLER

*Transmission Systems Development*

---

## *Members of Laboratories Named Fellows of I.R.E.*

Several members of the Laboratories have been named Fellows of the Institute of Radio Engineers by the Board of Directors meeting in Kansas City, November 2. The grade of Fellow is the highest membership grade offered by the Institute and is bestowed only by invitation on those "who have made outstanding contributions to radio engineering or allied fields." The awards will be presented by local I.R.E. Sections, and recognition will be made at the 1956 I.R.E. National Convention.

Members of the Laboratories included in the list of recipients are: W. R. Bennett, "for contributions in the fields of circuit and transmission theory";

H. T. Budenbom, "for contributions to electronic navigation and to precision military radar systems"; The late A. B. Clark (former Vice President of Bell Telephone Laboratories, Inc.), "for early development and leadership in the field of telephonic transmission systems"; C. E. Fay, "for contributions to the development of high-power vacuum tubes"; A. G. Fox, "for research and invention in microwave waveguide techniques"; R. C. Newhouse, "for his work in the fields of terrain clearance indicators, airborne communications and military weapons systems"; and R. L. Wallace, Jr., "for contributions in the field of transistor technology and applications."

## *In Memoriam — Alva B. Clark*

Alva B. Clark, former Vice President of Bell Telephone Laboratories, died November 14 in New York City after a short illness. His age was 65. At the time of his death Mr. Clark was serving as Director of Research and Development in a sector of the Department of Defense in Washington. He retired



from Bell Laboratories last February, after more than forty-three years of Bell System service.

Mr. Clark's long Bell System career was marked by notable contributions to the expansion of long-distance telephone facilities. He led the planning and engineering of the transcontinental coaxial cable and microwave radio relay systems for telephone and television transmission, as well as the earlier systems employing "carrier" — the technique by which many messages can be carried simultaneously over one electrical pathway.

More recently he directed the development and engineering of the nationwide direct distance dialing system, already in operation in a number of localities, by which telephone customers will someday be able to dial any telephone in the country without the assistance of an operator. He also guided the development of the automatic message accounting system, now extensively used throughout the Bell System.

In addition to his achievements as a leader, Mr. Clark made important personal contributions to the nation's communications network through his in-

ventions, for which he was granted forty-four patents.

His telephone career began in 1911 when he joined the American Telephone & Telegraph Company, immediately after receiving the B.E.E. degree from the University of Michigan. He was a member of A. T. & T.'s Engineering Department from 1911 to 1919 and of its Department of Development and Research from 1919 to 1934, when that department was consolidated with Bell Laboratories.

After serving as toll transmission development engineer at A. T. & T., Mr. Clark was named Toll Transmission Development Director of Bell Laboratories in 1934 and Director of Transmission Development in 1935. In 1940 he became Director of Systems Development, assuming general direction of Bell Laboratories' work in telephone switching, transmission and equipment development.

When he became Vice President in 1944, his previous responsibilities were extended to include outside plant development. In 1947 he was placed in charge of switching research and in 1949 assumed direction of the development of apparatus for incorporation in switching and transmission systems. From June 1951 until his retirement Mr. Clark was in charge of coordinating all Bell System programs at Bell Laboratories, and was responsible for the Laboratories' relations with A. T. & T. and Western Electric on all programs for the Bell System.

During World War II he served as consultant or member of various divisions of the Office of Scientific Research and Development. In 1944 he was appointed consultant to the Secretary of War, and in connection with this work made trips to the European and Mediterranean theaters of operation.

From 1938 to 1955 Mr. Clark was Bell System chairman of the Joint Subcommittee on Development and Research of the Edison Electric Institute and the Bell System.

He was a Fellow of the American Institute of Electrical Engineers and the Acoustical Society of America, and a member of Tau Beta Pi, Sigma Xi, and the American Association for the Advancement of Science. He was recently named a Fellow of the Institute of Radio Engineers. In 1941 his alma mater, the University of Michigan, cited him as a Distinguished Alumnus.

### ***Cleo F. Craig Receives Wharton School Alumni Society Medal***

Cleo F. Craig, President of the American Telephone and Telegraph Company was selected to receive the 1955 Gold Medal of Merit of the University of Pennsylvania's Wharton School Alumni Society. The award, for "outstanding business leadership," was presented at the society's annual dinner November 14 in Philadelphia. Mr. Craig, who was the sixth recipient of the medal, gave the main address at the dinner.

Previous recipients of the Wharton Alumni Gold Medal have been Secretary of Defense Charles E. Wilson (then president of General Motors Corp.), 1950; Benjamin F. Fairless, chairman of the United States Steel Corp., 1951; Crawford H. Greenewalt, president of E. I. du Pont de Nemours & Co., Inc., 1952; Richard K. Mellon, Pittsburgh banker and industrialist, 1953, and Thomas B. McCabe, president of Scott Paper Co., 1954.

### ***G. N. Thayer, BTL Vice President, Named Chief Engineer of A. T. & T.***

Gordon N. Thayer, Vice President in charge of Switching and Transmission Development of the Laboratories, has been named Chief Engineer of A. T. & T., effective December 1. He succeeds H. I. Romnes who was recently elected Vice President



in charge of the O. and E. Department. In his new post Mr. Thayer will report to Mr. Romnes.

A native of Colorado, Mr. Thayer holds a degree in mechanical engineering from Stevens Institute of Technology. He joined Bell Laboratories in 1930, and for the next ten years his special interest was the development of mobile radio communication equipment and systems. In 1940 he turned to the

development of radar systems and, later, microwave radio relay systems.

In 1949 he became concerned with the development of communications systems, including the transcontinental radio relay system, the Key West-Havana submarine cable system, and overseas radio projects. He was appointed Assistant Director of Transmission Systems Development in 1949 and Director of Transmission Development in 1951.

In May, 1952, Mr. Thayer was named Vice President in charge of Military Development. He assumed his recent post in September, 1953. Mr. Thayer is a Fellow of the Institute of Radio Engineers.

### ***Dr. Kelly Named Chairman of Committee at M. I. T.***

Dr. Mervin J. Kelly has been appointed Chairman of the Visiting Committee for the Department of Physics at Massachusetts Institute of Technology. The appointment was announced by Dr. James R. Killian, Jr., M. I. T. President. Dr. Kelly had served on the Committee for two years as a nominee of the M. I. T. Corporation, of which he is a member. He is also a member of the Visiting Committee for the Division of Defense Laboratories at M. I. T.

Serving on the Visiting Committee for the Department of Physics are Alfred L. Loomis, Robert B. Lindsay, Harold B. Richmond, Henry A. Morss, Jr., Leonard I. Schiff, Edwin H. Land, I. I. Rabi and C. Guy Suits.

### ***Dr. J. B. Fisk Elected a Director***

Dr. James B. Fisk was elected to the Board of Directors on October 24. Dr. Fisk, who has been with the Laboratories since 1939, was appointed Director of Research in Physical Sciences in 1952, and in March of last year became Vice President in charge of Research. On June 1, Dr. Fisk was elected Executive Vice President of the Laboratories.

Other members of the Laboratories Board of Directors are Henry C. Beal, Vice President, Manufacturing Division of W. E. Co.; George L. Best, Vice President, Administration "B," A. T. & T. Co.; Joseph R. Bransford, Vice President, Telephone and Installation Division, W. E. Co.; Dr. Oliver E. Buckley, former President of the Laboratories; James E. Dingman, Vice President and General Manager of the Laboratories; Frederick R. Kappel, President, W. E. Co.; Dr. Mervin J. Kelly; H. Randolph Maddox, Vice President, Personnel Relations, A. T. & T. Co.; and Eugene J. McNeely, Executive Vice President, A. T. & T. Co.



### ***A. G. Jensen Serves in Two Posts***

Axel G. Jensen, Director of Television Research at Bell Laboratories, has been elected to serve a second two-year term as Engineering Vice President of The Society of Motion Picture and Television Engineers. He will serve in this capacity during 1956 and 1957. Mr. Jensen has also been appointed a member-at-large of the USA National Committee of the U.R.S.I. (International Scientific Radio Union), for a term extending until June 30, 1959.

Mr. Jensen in 1922 joined the Engineering Department of the Western Electric Company, which later became Bell Laboratories. At the Laboratories, Mr. Jensen was initially engaged in radio receiving studies, including work on transatlantic short wave service. In 1938 he was placed in charge of television research, and since 1952 has been Director of Television Research. Mr. Jensen is a Fellow of the SMPTE, and in recognition of his television work was awarded the David Sarnoff Gold Medal by the Society in 1952. Mr. Jensen is also a Fellow and Director of the Institute of Radio Engineers.

### ***Laboratories Men at First Solar Energy Conference and Symposium***

Several members of the Laboratories, including Vice-President Ralph Bown, D. M. Chapin, G. L. Pearson, M. B. Prince, and G. Raisbeck, took part in recent international meetings on the use of solar energy. These meetings were a Conference on the Use of Solar Energy – The Scientific Basis, held in Tucson, Arizona, on October 31 and November 1, and the first World Symposium on Applied Solar Energy, November 1 to 5, in Phoenix.

Mr. Pearson presided as Chairman of Section C of the Conference, dealing with the electrical processes for the conversion of solar energy. At this section of the Conference, the Bell Solar Battery and its characteristics were among the subjects discussed. D. M. Chapin delivered a talk entitled *Some Observations from a Year of Silicon Solar Battery Testing*, and M. B. Prince gave a talk entitled *Silicon p-n Junction Solar Energy Converter*. At the Symposium, Mr. Pearson gave a talk entitled *Electricity from the Sun*.

During the six days of discussions and exhibits, over 700 scientists from many countries were present by arrangement of the Association for Applied Solar Energy, the Stanford Research Institute and the University of Arizona. Exhibited at the Civic Center in Phoenix were about 100 solar energy displays, including several Bell Solar Battery operated

devices shown by the Laboratories and A.T.&T. Also exhibited was the Laboratories-developed zone refining process for the ultra-high purification of the silicon used in Bell Solar Batteries.

### ***W. A. Marrison Receives English Clockmakers' Gold Medal***

W. A. Marrison of the Transmission Research Department has been awarded the Tompion Gold Medal for 1955 by the Court of the Worshipful Company of Clockmakers of the City of London. Mr. Marrison received the medal at the Livery Dinner of the Clockmakers' Company on October 31.

Mr. Marrison was notified of the award in a letter from Sir Harold Spencer Jones, Astronomer Royal, who wrote that the award was being made in recognition of Mr. Marrison's "pioneer work on the development of quartz crystal oscillators as precision standards of time." The "quartz clock", developed originally at Bell Laboratories for the precise regulation of frequency standards, has become the basis of precise timing methods in most astronomical observatories and physical laboratories throughout the world.

The Tompion Gold Medal was instituted by the clockmakers last year for outstanding achievement in horology. The first award went to W. H. Shortt of London, England, for his contributions toward the development of the free pendulum clock.

### ***Members of Laboratories Serve as I.R.E. Chairmen***

Six members of the Laboratories were recently elected chairmen of Professional Groups in the Institute of Radio Engineers, and three others were appointed chairmen of I.R.E. Technical Committees. All offices are for the 1955-1956 term. The elections and appointments took place at organization meetings or by mail balloting held in recent weeks.

The six Professional Group chairmen include the following: *Audio, G1* – W. E. Kock, Director of Acoustics Research; *Communications Systems, G19* – A. C. Peterson, Jr., Radio Systems Engineer in Transmission Engineering II; *Electronic Computers, G16* – J. H. Felker, Director of Special Systems Engineering II; *Microwave Theory & Techniques, G17* – A. C. Beck of the Radio Research Department; *Ultrasonics Engineering, G20* – M. D. Fagen of Military Electronics Development II; and *Vehicular Communications, G6* – N. Monk of Special Systems Engineering I.

The following three Technical Committee chairmen were appointed by the I.R.E. Standards Committee and confirmed by the I.R.E. Board of Directors: *Circuits* – W. B. Bennett of the Transmission Research Department; *Information Theory and Modulation Systems* – J. G. Kreer of the Transmission Research Department; and *Television Systems* – W. T. Wintringham of the Television Research Department.

### **Switching Relay Design—New Book in Bell Laboratories Series**

An addition to the Bell Laboratories Series of Technical Books published is *Switching Relay Design*, by R. L. Peck, Jr. and H. N. Wagar.<sup>°</sup> This book has evolved from texts for training courses in relay design given at Bell Telephone Laboratories, and draws on the accumulated experience obtained in developing central-office switching apparatus. The presentation serves both as an engineering text and as a reference book and design manual for relay engineers.

Following a brief introduction describing the evolution of the switching relay and explaining the notations and units, the book is divided into two general parts – Part I, Fundamentals of Switching

<sup>°</sup> D. Van Nostrand, \$9.50.

Relay Design and Part II, Analytical Background for Switching Relay Design. Part I contains separate chapters that discuss the mechanical requirements for relays, static characteristics of electromagnets, and dynamic performance, and concludes with actual design techniques. Part II concerns procedures for designing contact springs, and includes a thorough analysis of the force-deflection and vibratory characteristics of spring systems and relay structures. An analysis of magnetization and pull relations, together with dynamics of electromagnets and magnet coil design, are also given.

Problems at the end of each chapter aid in developing an understanding of the text.

### **Members of Laboratories on New York Section A.I.E.E. Committees**

Several Laboratories people have been named to the New York Section A.I.E.E. Executive Committee and to the several divisions' executive committees. These are W. T. Rea, Treasurer New York Section; New Jersey Division, P. T. Sproul, Member-at-Large; Transportation Division, A. E. Ritchie, Vice Chairman; and Communication Division, A. E. Joel, Vice Chairman, W. O. Arnold, Secretary-Treasurer, M. A. Townsend, Junior Past Chairman, and R. S. Skinner, Chairman Educational Committee.

## **Patents Issued to Members of Bell Telephone Laboratories During the Month of September**

- Anderson, J. R. – *Ferroelectric Storage Device and Circuit* – 2,717,372.
- Anderson, J. R. – *Ferroelectric Storage Device and Circuit* – 2,717,373.
- Barstow, J. M., Jr. – *Electrical Conversion System with High and Low Voltage Alarm* – 2,719,289.
- Bennett, W. R., and Feldman, C. B. H. – *Prevention of Interpulse Interference in Pulse Multiplex Transmission* – 2,719,189.
- Eglin, J. M. – *Reduction of Quadrature Distortion* – 2,717,956.
- Feldman, C. B. H., see Bennett, W. R.
- Gannett, D. K. – *Reduction of Transient Effects in Wide Band Transmission Systems* – 2,719,272.
- Goddard, C. T. – *Electron Discharge Device* – 2,719,246.
- Hale, S. G., and Nuttman, C. W. – *Adjustable Inductance Device* – 2,717,984.
- Harkless, E. T. – *Attenuation Equalizer* – 2,718,622.
- Harris, J. R. – *Transistor Circuit for Operating a Relay* – 2,718,613.
- Ketchledge, R. W. – *Transmission Regulation* – 2,719,270.
- Lovell, C. A. – *Signaling or Dialing System* – 2,717,280.
- Matlack, R. C., and Metzger, F. W. – *Multiparty Selective Signaling and Identification System* – 2,717,279.
- Mattke, C. F. – *Continuous Film Motion Projector for Television Cameras and Film Recorders* – 2,718,549.
- Metzger, F. W., see Matlack, R. C.
- Nuttman, C. W., see Hale, S. G.
- Pfann, W. G. – *Semiconductor Translating Devices* – 2,717,342.
- Pierce, J. R. – *High Frequency Pulse Transmission* – 2,719,187.
- Pierce, J. R. – *Non-Synchronous Time Division Multiplex Telephone Transmission* – 2,719,188.
- Raisbeck, G. – *High-Efficiency Translating Circuit* – 2,719,190.
- Smith, P. H. – *Antenna* – 2,718,592.
- Staples, F. M. – *Radio Relay System* – 2,718,589.

## Talks by Members of the Laboratories

During October, a number of Laboratories people gave talks before professional and educational groups. Following is a list of the speakers, titles, and places of presentation:

### A.I.M.E. MEETING, RESEARCH IN PROGRESS SEMINAR, PHILADELPHIA

Arnold, S. M., and Koonce, Miss S. Eloise, Filamentary Growths on Metals at Elevated Temperatures.

Arnold, S. M., see Treuting, R. G.

Gibbons, D. F., Elastic Constants and Thermal Expansion of Silicon Between 1.7-300°K.

Greiner, E. S., and Hobstetter, J. N., The Generation of Dislocations in Rotational Slip.

Hobstetter, J. N., see Greiner, E. S.

Koonce, Miss S. Eloise, see Arnold, S. M.

Treuting, R. G., and Arnold, S. M., Growth and Deformation Studies on Filamentary Crystals.

### SEMICONDUCTOR SYMPOSIUM OF THE ELECTROCHEMICAL SOCIETY, PITTSBURGH

Kowalchik, M., see Thurmond, C. D.

Mason, D. R., A Useful Technique for Cleaning Semiconductor Surfaces.

McNamara, J. E., see Pudvin, J. F.

Pudvin, J. F., and McNamara, J. E., Plating Techniques in the Fabrication of Semiconductors.

Stansbury, E. J., The Role of Batteries in the Utilization of Solar Energy.

Sullivan, M. V., A New Method for Making Ohmic Contacts to Silicon at Low Temperatures.

Thomas, E. E., Metallographic Techniques.

Thurmond, C. D., Trumbore, F. A., and Kowalchik, M., On the Oxygen-Germanium System.

Trumbore, F. A., Some Properties of Germanium Doped with Tin.

Trumbore, F. A., see Thurmond, C. D.

Whelan, J. M., Special Techniques for Analyzing Semiconducting Materials.

### I.R.E. PROFESSIONAL GROUP ON ELECTRON DEVICES, WASHINGTON, D. C.

Becker, G. E., Dependence of Pulsed Magnetron Operation on the Centering of the Cathode.

Burcham, N. P., An Improved Point Contact Transistor Structure.

Burcham, N. P., and Miller, P., Vacuum-Baking Encapsulation Techniques and Improved Reliability of n-p-n Alloy Transistors.

Craft, W. H., see Koontz, D. E.

Danielson, W. E., see Watson, H. A.

Hittinger, W. C., see Warner, R. M., Jr.

Koontz, D. E., Olsen, E. G., and Craft, W. H., A System for Eliminating Physical and Water Soluble Contaminants from Electron Devices.

McDowell, H. L., A Medium Power Traveling Wave Tube for 6,000-Mc Radio Relay.

Miller, P., see Burcham, N. P.

Morton, J. A., Semiconductor Devices.

Olsen, E. G., see Koontz, D. E.

Robillard, T. R., Techniques Employed in the Fabrication of p-n-p Power Alloy Transistors.

Smith, K. D., Properties and Applications of Diffused Junction Silicon Rectifiers.

Uhlir, A., Jr., Frequency Conversion and Computation with p-n Junction Devices.

Warner, R. M., Jr., and Hittinger, W. C., A Developmental Intrinsic-Barrier Transistor.

Watson, H. A., and Danielson, W. E., Three Traveling-Wave Tubes for CW Use in the Common Carrier Band Centered at 11 Kmc.

### OTHER TALKS

Anderson, P. W., Some Aspects of the Theory of Perovskite Ferroelectrics, Seminar on Ferroelectrics, National Bureau of Standards, Washington, D. C.

Andrews, E. G., The Digital Computer and Its Components, Joint A.I.E.E. - I.R.E. Computer Lecture Series, New York City.

Beck, A. C., Waveguides for Long Distance Communication, Joint A.I.E.E. - I.R.E. Student Branch, Rensselaer Polytechnic Institute, Troy, N. Y.

Blecher, F. H., A Junction Transistor Integrator, National Electronics Conference, Chicago.

Boyle, W. S., see Germer, L. H.

Chynoweth, A. G., A Dynamic Technique for Studying the Pyroelectric Effect and Its Application to Ferroelectrics, Conference on Electrical Insulation, Pocono Manor, Pa.

Dacey, G. C., The Future of Transistors, National Security Agency Symposium on Transistors, Washington, D. C.

Desoer, C. A., The Iterative Solution of Networks of Resistors and Ideal Diodes, National Electronics Conference, Chicago.

Dodge, H. F., Some Experiences in Sampling, Joint Meeting, Cleveland Section, American Society for Quality Control and American Statistical Association.



- Dudley, H. W., *Fundamentals of Speech Synthesis*, Convention of the Audio Engineering Society, New York City.
- Early, J. M., *Semiconductor Physics, and Junction Transistor Physics*, New Jersey Section, I.R.E., Montclair.
- Felch, E. P., *Opportunities in Development Engineering*, Joint A.I.E.E. - I.R.E. Student Branch, Rutgers University, New Brunswick, N. J.
- Felker, J. H., *Transistors in Digital Computers*, I.B.M., Poughkeepsie; and I.B.M., Endicott, N. Y.
- Ferrell, E. B., *Elementary Statistical Concepts, and Applications of Control Charts*, Society for Advancement of Management, Elizabeth, N. J.
- Föllingstad, H. G., and Kummer, O., *Transistor Measurements from Low to Very High Frequencies*, I.R.E. Symposium on High Frequency Linear Transistor Circuitry, University of Connecticut.
- Foster, F. G., *The Microscopy of Opaque Materials*, New York Microscopical Society.
- Friis, R. W., and May, A. S., *A New Broadband Microwave Antenna System*, A.I.E.E. Fall General Meeting, Chicago.
- Fuller, C. S., *Some Analogies Between Semiconductors and Electrolyte Solutions*, *Frontiers of Chemistry Lecture*, Wayne University, Detroit.
- Germer, L. H., and Boyle, W. S., *Short Arcs*, American Physical Society Meeting, Schenectady, N. Y.
- Gohn, G. R., Guerard, J. P., and Freynik, H. S., *The Mechanical Properties of Wrought Phosphor Bronze Alloys*, A.S.T.M. Committee B5, Philadelphia.
- Groth, W. B., *Switching Circuit Design*, Bell Telephone Company of Pennsylvania Engineering School, Philadelphia.
- Guerard, J. P., see Gohn, G. R.
- Guldner, W. G., *Application of Vacuum Techniques to Analytical Chemistry*, Symposium on High Vacuum Technology, Mellon Institute, Pittsburgh.
- Hagstrum, H. D., *Formation of Metastable Ar<sup>+</sup>, Kr<sup>+</sup>, and Xe<sup>+</sup> by Electron Impact*, Gaseous Electronics Conference, Schenectady, N. Y.
- Harvey, F. K., *High Fidelity and the Hearing Process*, Joint A.I.E.E. - I.R.E. Student Branch, New York City.
- Heidenreich, R. D., *Problems in Interpretation of Thermionic Emission Images*, Electron Microscope Society of America, Pennsylvania State University.
- Herring, C., *Thermoelectricity and Thermal Conduction in Semi-conductors*, Seminar, Institute for Atomic Research, Iowa State College; Physics Colloquium, University of Chicago; Physics Colloquium, University of Notre Dame; and Physics Colloquium, Purdue University.
- Herring, C., *Piezoresistance and Mobility Theory*, Physics Colloquium, Iowa State College.
- Hershey, J. H., *A Modern Approach to the Maintenance Support of a Guided Missile System*, Working Conference on Reliability and Maintenance of Electronic Equipment, Aberdeen Proving Ground, Md.
- Hough, R. R., *The Bell Telephone Laboratories*, Rotary Club, Madison, N. J.
- Hoygaard, O. M., *Dry Reed Switches*, A.I.E.E. Fall General Meeting, Chicago.
- Ingram, S. B., *The Graduate Engineer - His Training and His Full Utilization in Industry*, A.I.E.E. Fall General Meeting, Chicago.
- Knapp, H. M., *The Bell System Wire Spring Relays - The Contribution of the Wire Springs and the Contact Actuation to Their Improved Performance*, A.I.E.E. Fall General Meeting, Chicago.
- Kock, W. E., *Speech, Music and Hearing*, I.R.E. Professional Group on Audio, Syracuse, N. Y.
- Kompfner, R., *Traveling Wave Tubes, Physical Society; and Some Recent Advances in Microwave Tubes*, British Institution of Radio Engineers, London, England.
- Kummer, O., see Föllingstad, H. G.
- Landgren, C. R., *Transistor Design from an Applications Viewpoint*, A.I.E.E., Louisville, and A.I.E.E., Lexington, Ky.
- Lewis, H. W., *The Intermediate State in Superconductors*, Physics Colloquium, Princeton University, N. J.
- Linville, J. G., and Schimpf, L. G., *The Design of Tetrode Transistor Amplifiers*, I.R.E., University of Connecticut, Storrs.
- May, A. S., see Friis, R. W.
- May, J. E., Jr., *Low-Loss 1,000-Microsecond Ultrasonic Delay Lines*, National Electronics Conference, Chicago.
- McClure, B. T., *Formative Breakdown Delays in Noble Gases at Small Overvoltages*, Gaseous Electronics Conference, Schenectady, N. Y.
- McMahon, W., *Dielectric Effects Produced by Solidifying Certain Organic Compounds in Electric or Magnetic Fields*, Conference on Electrical Insulation, Pocono Manor, Pa.
- Merz, W. J., *Guanidine Aluminum Sulfate Hexahydrate - A New Ferroelectric Material*, Conference on Electrical Insulation, Pocono Manor, Pa.
- Mumford, W. W., *Some Microwave Components*, University of California, Berkeley.
- Mumford, W. W., *Microwave Noise Figures*, I.R.E., San Francisco Section, and University of California, Berkeley.
- Pearson, G. L., *The Bell Solar Battery*, I.R.E. Albuquerque Section, Albuquerque, N. M.
- Pedersen, L., *Bell Laboratories' Place in the Bell System*, Rotary Club, Lawrence, Mass.
- Perreault, G. E., *Reed Switch Relays*, A.I.E.E. Fall General Meeting, Chicago.
- Pierce, J. R., *A Cross-Section of Research in Electrical Communication*, Washington Society of Engineers, Washington, D. C.
- Prince, M. B., *Silicon Power Rectifiers*, A.I.E.E. Basic Science and Communication Division, New York Section; and Silicon p-n Junction Solar Energy Converter, Conference on Solar Energy - The Scientific Basis, Tucson, Arizona.
- Raisbeck, G., *Bell Solar Battery*, Seminar of the Chemistry Division, Argonne National Laboratory, Lemont, Ill.; Akron District Professional Engineering Society, Ohio; WXEL-TV, Cleveland; WEWS-TV, Cleveland; Assembly of Engineering Students, Akron University, Ohio; A.I.E.E. Cleveland Section; and Ohio Bell Telephone Company Engineering Employees, Cleveland.
- Riesz, R. R., *Human Engineering and User Preference*, Baltimore Engineers Club; and Human Engineering, Winston-Salem Engineers Club, N. C.
- Rigterink, M. D., *Inorganic Chemistry in Communications*, American Chemical Society, North Jersey Section, Elizabeth.
- Ryder, R. M., *Germanium and Silicon Transistors and Junction Devices*, National Electronics Conference, Chicago.
- Schimpf, L. G., see Linville, J. G.

## Talks by Members of the Laboratories, Continued

Shannon, C. E., Game Playing Machines, Medal Day Exercises, Franklin Institute, Philadelphia.

Tapley, T. E., Origins of Noise, A.I.E.E. New York Section, New York City.

Tanner, T. L., Current and Voltage Metering Magnetic

Amplifiers, National Electronics Conference, Chicago.

Terry, M. E., Finding Optimum Conditions by Experimentation, National Bureau of Standards, Washington, D.C.

Thayer, P. H., Jr., Nike I — A Guided Missile System for AA Defense, A.I.E.E. Pittsburgh Section.

---

## Papers Published by Members of the Laboratories

Following is a list of the authors, titles, and place of publication of recent papers published by members of the Laboratories

- Allison, H. W., see Moore, G. E.
- Baker, W. O., see Winslow, F. H.
- Barstow, J. M., Color TV — How it Works, I.R.E. Student Quarterly, **2**, pp. 11-16, Sept., 1955.
- Beck, A. C., Measurement Techniques for Multimode Waveguides, Proc. I.R.E., MRI, **4**, pp. 325-326, Oct. 1, 1955.
- Bozorth, R. M., Getlin, B. B., Galt, J. K., Merritt, F. R., and Yager, W. A., Frequency Dependence of Magnetocrystalline Anisotropy, Phys. Rev., Letter to the Editor, **99**, p. 1898, Sept. 15, 1955.
- Bozorth, R. M., Tilden, E. F., and Williams, A. J., Anisotropy and Magnetostriction of Some Ferrites, Phys. Rev., **99**, pp. 1788-1798, Sept. 15, 1955.
- Bullington, K., Characteristics of Beyond-the-Horizon Radio Transmission, Proc. I.R.E., **43**, pp. 1175-1180, Oct., 1955.
- Bullington, K., Inkster, W. J., and Durkee, A. L., Results of Propagation Tests at 505 Mc and 4,090 Mc on Beyond-Horizon Paths, Proc. I.R.E., **43**, pp. 1306-1316, Oct., 1955.
- Durkee, A. L., see Bullington, K.
- Galt, J. K., see Bozorth, R. M.
- Garn, P. D., and Halline, Mrs. E. W. Polarographic Determination of Phthalic and Anhydride Alkyd Resins, Anal. Chem., **27**, pp. 1563-1565, Oct., 1955.
- Getlin, B. B., see Bozorth, R. M.
- Goss, A. J., see Hassion, F. X.
- Green, E. I., The Story of Q, American Scientist, **43**, pp. 584-594, Oct., 1955.
- Halline, Mrs. E. W., see Garn, P. D.
- Harrower, G. A., Measurement of Electron Energies by Deflection in a Uniform Electric Field, Rev. of Sci. Instr., **26**, pp. 850-854, Sept., 1955.
- Hassion, F. X., Goss, A. J., and Trumbore, F. A., The Germanium-Silicon Phase Diagram, J. Phys. Chem., **59**, p. 1118, Oct., 1955.
- Hassion, F. X., Thurmond, C. D., and Trumbore, F. A., On the Melting Point of Germanium, J. Phys. Chem., **59**, p. 1076, Oct., 1955.
- Inkster, W. J., see Bullington, K.
- Lovell, Miss L. C., see Pfann, W. G.
- Matreyek, W., see Winslow, F. H.
- Merritt, F. R., see Bozorth, R. M.
- Moore, G. E., and Allison, H. W., Adsorption of Strontium and of Barium on Tungsten, J. Chem. Phys., **23**, pp. 1609-1621, Sept., 1955.
- Pape, N. R., see Winslow, F. H.
- Pfann, W. G., and Lovell, Miss L. C., Dislocation Densities in Intersecting Lineage Boundaries in Germanium, Acta. Met., Letter to the Editor, **3**, pp. 512-513, Sept., 1955.
- Pierce, J. R., Orbital Radio Relays, Jet Propulsion, **25**, pp. 153-157, Apr., 1955.
- Thurmond, C. D., see Hassion, F. X.
- Tidd, W. H., Demonstration of Bandwidth Capabilities of Beyond-Horizon Tropospheric Radio Propagation, Proc. I.R.E., **43**, pp. 1297-1299, Oct., 1955.
- Tilden, E. F., see Bozorth, R. M.
- Trumbore, F. A., see Hassion, F. X.
- Uhlir, A., Jr., Micromachining with Virtual Electrodes, Rev. Sci. Instr., **26**, pp. 965-968, Oct., 1955.
- Weibel, E. S., Vowel Synthesis by Means of Resonant Circuits, J. Acous. Soc., **27**, pp. 858-865, Sept. 1955.
- Williams, A. J., see Bozorth, R. M.
- Winslow, F. H., Baker, W. O., and Yager, W. A., Odd Electrons in Polymer Molecules, Am. Chem. Soc., **77**, pp. 4751-4756, Sept. 20, 1955.
- Winslow, F. H., Baker, W. O., Pape, N. R., and Matreyek, W., Formation and Properties of Polymer Carbon, J. Polymer Science, **16**, p. 101, Apr., 1955.
- Yager, W. A., see Bozorth, R. M.