

Type-N Carrier Telephone System

E. K. VAN TASSEL

Transmission Systems Development

It has been recognized for many years that extending carrier systems into the short-haul telephone field would be highly desirable. Increased demand for circuits, the advent of toll line dialing, and the shortage of critical materials — all have combined to make it imperative that existing telephone facilities be used to the utmost of their capacities. Because of the increased demand for circuits, the Laboratories was faced with the problem of developing an economical method of providing new circuits without adding new wire. This indicated, therefore, a multi-channel cable carrier system that could be applied economically to distances of the order of twenty miles.

Many of the existing carrier systems are designed for use on very long toll circuits and are capable of spanning the continent. The equipment used in these systems, however, does not lend itself to economical usage for short distances. Many new designs of components and new manufacturing techniques are now available, thus making it possible to build economical terminals and repeaters for much shorter distances — those below 100 miles long. Throughout the Bell System there are tens of thousands of circuits between 15 and 200 miles in length that can be supplied by a carrier system,

and it was for these circuits that efforts were directed toward the development of a new system, designated the type N.

One objective of this system can be illustrated by considering the type-K carrier system^o. Type K employs two cables, one for each direction of transmission. These cables must be carefully balanced for reduction of crosstalk; in addition, noise suppression filters are needed on all non-carrier pairs. Obviously, for effective application, the new system should be designed for use in a *single* cable, capable of using a majority of the conductors without special treatment of the cable.

Another objective — that of simplifying engineering, installation, and maintenance — is to associate in one package the complete equipment for one terminal. This single package should include the fusing, alarms, and power supply resistors, in addition to the associated talking and signaling facilities.

The type-N carrier system is capable of transmitting twelve two-way telephone conversations on a single four-wire quad in a paper insulated cable, and meets the other objectives for a low cost multi-channel system.

^o RECORD, April, 1938, page 260.

In addition to reductions in cost, the NI system has established new standards within its range of operation. Notable among these is stability of net loss. In a built-up connection in any system, the net loss is the sum of the net losses for each of the circuits used in this connection. In a particular built-up connection, there may be any number of circuits between two and twelve, with three being the most frequent. To insure that the total net loss is not too large in connections having several circuits, it is necessary to keep the net loss of each circuit small; less than 3 db. It follows, therefore, that the smaller the net loss in each circuit, the more stable that circuit must be. Stability in the NI

came evident that the most important single feature needed for the system was the compandor[‡], a device available in commercial form, but only for use on the longer carrier systems. A development program was therefore begun to produce a more economical design that could be built into the system. This new compandor, discussed below, will be more completely described in a subsequent article.

Use of the compandor makes possible solutions of a number of cable problems. Even with transmission over a single cable in both directions, it is not necessary to use crosstalk balancing networks between pairs, and the need for noise suppression filters is removed. It permits more economi-

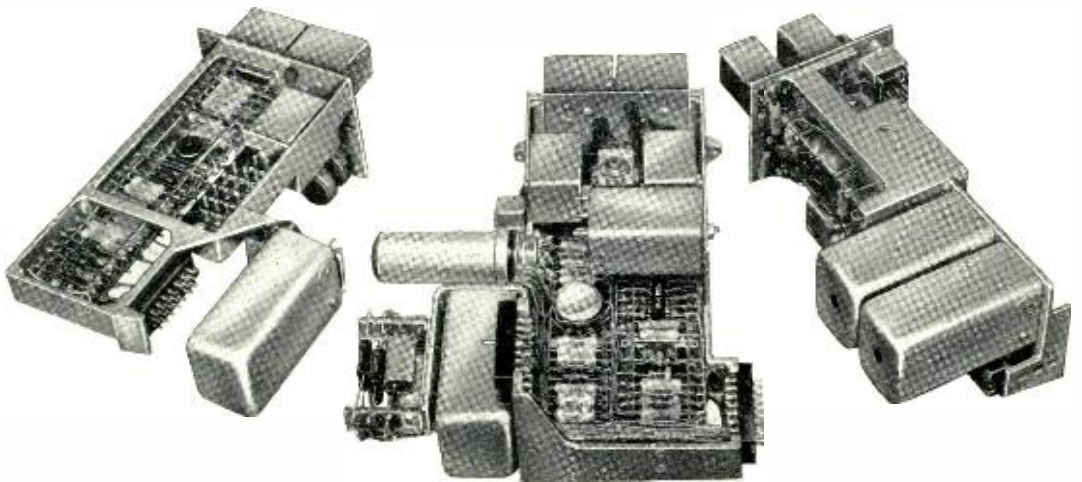

Fig. 1—Sub-assemblies of a typical NI channel unit. Left, the compressor sub-assembly; center, expandor-signaling sub-assembly, and right, the carrier frequency unit.

system is accomplished by an individual channel regulator, in addition to the common regulation for all channels.

All of the existing carrier art, built up over a period of more than twenty years, was reviewed in the light of the new requirements. Several new circuit elements not previously used in carrier systems were available or could be made available. Among these were the germanium varistor^{*} and the tantalum electrolytic capacitor[†]. Early in the development, however, it be-

cal filters, overcomes the effects of modulation produced in the amplifiers, and permits the repeaters to have less feedback—in fact, the compandor has more than a score of advantages.

Equipment arrangements were miniaturized throughout, extending the work on miniaturization started during the war. As compared to previous carrier systems, the order of reduction in size is about eight to one. This reduction in size is accompanied not only by reduction in cost of the equipment, but with improved performance. A new form of component arrangement, known as “cubic” mounting, has been developed, in which, for ready access, several

^{*} RECORD, December, 1948, page 485. [†] RECORD, October, 1950, page 448. [‡] RECORD, December, 1934, page 28.

sub-assemblies are associated by plugs and jacks. The resulting units are in turn plugged into a wired framework.

There are three general types of units that can be plugged into the wired framework — channel units, terminal group units, and repeaters. Each of these in turn is divided into sub-assemblies to make it easy for maintenance men to test each component. Figure 1 shows the three sub-assemblies that form a channel unit. Two of these three, the compressor and the expander sub-assemblies, are identical for all twelve channels; hence they are freely interchangeable between systems and between channel units within the system. The third unit (on the right) is the carrier frequency unit and is the same for all channels except for the crystal in the carrier frequency oscillator and the receiving channel band filter. This ability to use the same equipment units and the same apparatus components in many places throughout the system is a real advantage to the manufacturer and to the customer.

As previously mentioned, the new system employs a cable pair in each direction. Either pair or quadded 16-, 19-, 22-, or 24-gauge cable conductors can be used, with suitable variation in repeater spacing. The nominal spacing of repeaters is 7.5 miles for 19-gauge and 6 miles for 22-gauge. No limitation is placed on the percentage of cable conductors on which N carrier can be applied in a toll cable; accordingly, as many as 1800 channels can be obtained from a 300-pair cable.

It is permissible to use two N systems in tandem to make up a toll trunk. For built-up connections, where several toll trunks are connected in tandem, it may be possible to have four or more Type-N carrier telephone systems in tandem.

An important use of N carrier is in exchange plant areas, where a large percentage of small-gauge, high capacitance cables are used, heavily loaded to reduce the net loss. Many circuits to suburban areas adjacent to large cities are now routed over toll trunks because of the higher loss of the exchange type circuits. Type N can, therefore, be used to afford a low-loss, high-grade exchange circuit that can be switched

in the manner that is usual for tandem and similar telephone circuits.

Let us follow a conversation through the system. Referring to the block schematic of Figure 2, the voice comes into the terminal at the left, where, by means of a resistance hybrid, it is transmitted to the "compressor"* input. This circuit amplifies the speech of weak talkers more than it does the loud talkers; thus we have "compressed" speech (volume range reduced). This is passed through a low-pass filter to remove frequencies above 3100 cycles. At this point, the 3700-cycle signaling frequency is added and, together with the voice, is modulated by the desired carrier. Carrier frequencies for the twelve channels are separated by 8 kc, the first channel being at 168 kc and number 12 at 256 kc. The carrier and both side bands from the channel carrying our conversation are combined with the outputs of the eleven other channel units and applied to the transmitting group unit. Figure 3 shows the frequency allocations used in the type-N system.

There are two types of terminals, one transmitting "high" groups (164 to 260 kc) and the other transmitting "low" groups (44 to 140 kc). In the high group transmitting terminal, the outputs of all twelve channels are combined and a "slope"† of 7 db introduced across the band. Then the combined channels are amplified and applied to the cable pair for transmission to the next repeater.

In the low group transmitting terminal, the combined outputs of all twelve channels are group modulated into a band from 44 to 140 kc by means of a group carrier at 304 kc. Here, also, a "slope" of 7 db is inserted and the whole group amplified for transmission to the cable.

A noise generator, which is amplified noise from an electron tube, is built into the transmitting units. This generator introduces a controllable amount of noise into the system which is used to mask undesirable cable crosstalk, but which gives

* RECORD, December, 1934, page 98.

† This "slope" means that the higher frequencies will be transmitted with more power than will the lower frequencies. Specifically, channel 1 is transmitted 7 db weaker than channel 12.

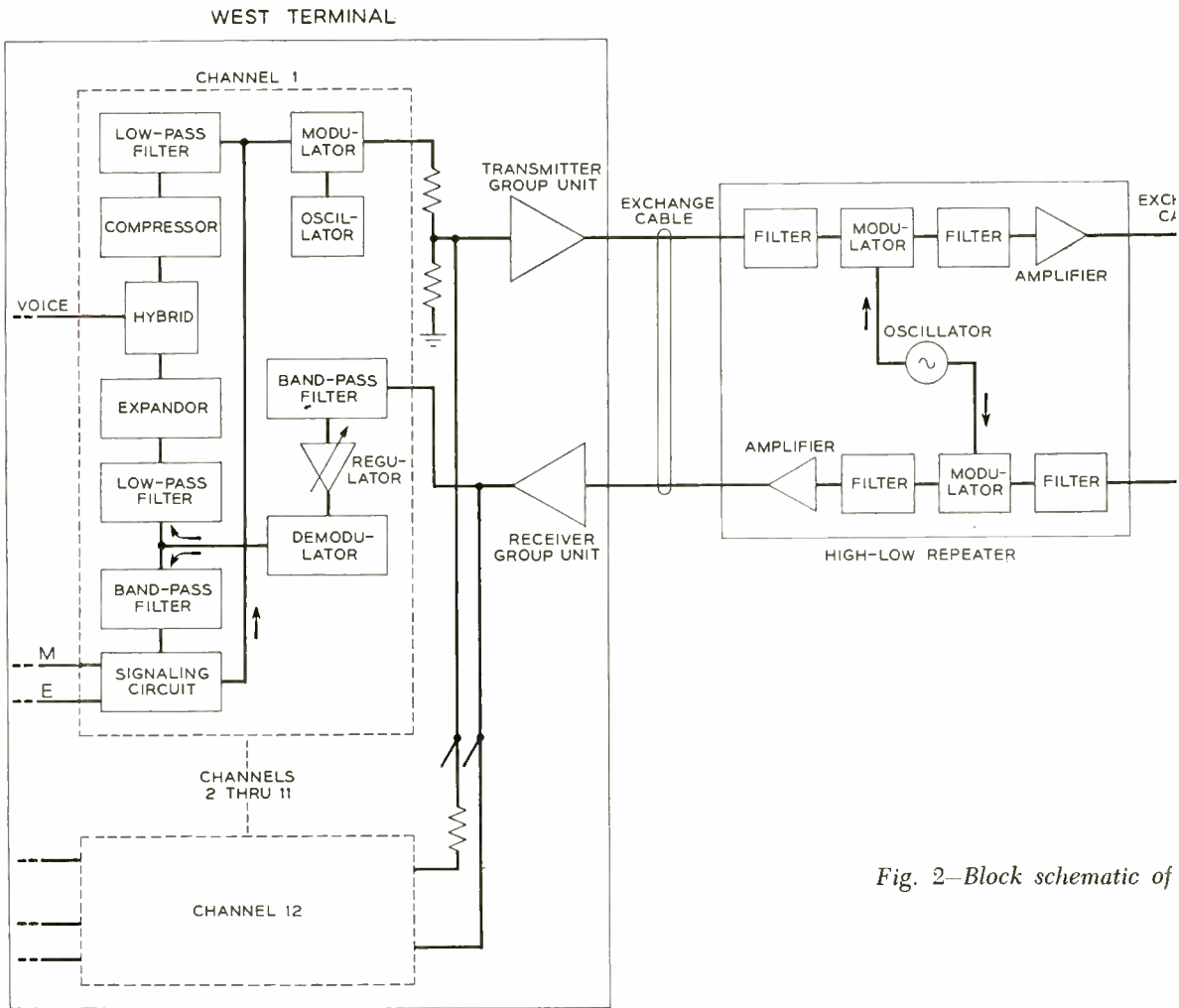

Fig. 2—Block schematic of

a total circuit noise well within the usual tolerance limits.

At a repeater point, we have a problem to prevent crosstalk from the output of one repeater from getting into a paralleling voice pair and thence back into the input of other repeaters. In the K system, where two cables are used, the inputs and outputs of the same repeaters are connected to different cables, to break up this path. In the N system, with both directions in one cable, this crosstalk path is broken by making the repeater *output* frequency different from the *input* frequency. This is known as "frequency frogging," a term derived from railroading, where a train on one track can

cross over to another track. In the N1 system, each repeater receives one of the groups (either low or high) and then modulates this group into the other allocations. This means two types of repeaters, a low-high repeater (receives low group and transmits high group) and a high-low repeater (receives high group and transmits low group). By choosing the group carrier to be the sum of the corresponding frequencies, the same group carrier is used throughout the system. Figure 3 illustrates the frequency allocations and the frequency inversion introduced by the repeater.

Another advantage in the use of frequency frogging lies in the effective equali-

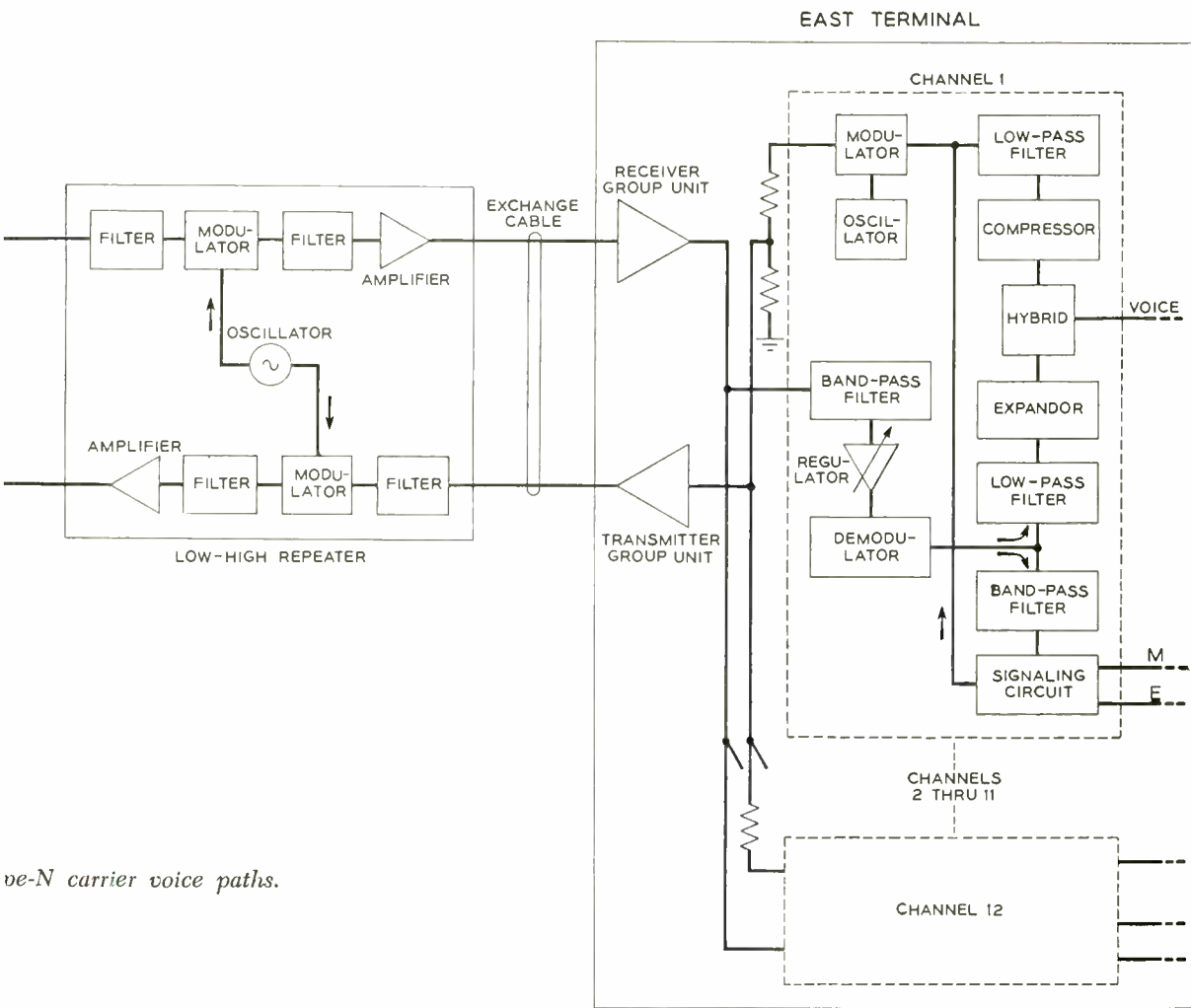

ve-N carrier voice paths.

zation of attenuation of different frequencies. Channel 1 is attenuated by the first cable span as it travels down the line at 168 kc. In the next section, channel 1 is shifted by frogging to 304-168, or 136 kc; the sum of the loss at 168 kc plus the loss at 136 kc is equivalent to 6 db per mile. Similarly, channel 12 is attenuated in the first section as it travels at 256 kc. In the next section, it is located at 304-256 or 48 kc, and the sum of these two losses is also equivalent to 6 db per mile. Thus, the loss inserted by two cable spans is relatively independent of frequency, and hence repeaters are not required to compensate for cable "slope."

Although the loss through two cable spans is relatively independent of frequency, it is still true that one span attenuates the high frequencies about 14 db more than it does the low frequencies. To illustrate how the carriers are attenuated and amplified along the line, and to show the use of the 7 db equalizer (the 7 db "slope" mentioned previously) in the transmitting group unit, a level diagram is shown in Figure 4. By sending out the carriers at unequal levels, it is possible to divide the effect of this 14 db cable slope so that all repeaters will transmit their carriers at a nominal slope of 7 db.

All carriers reach the input to the trans-

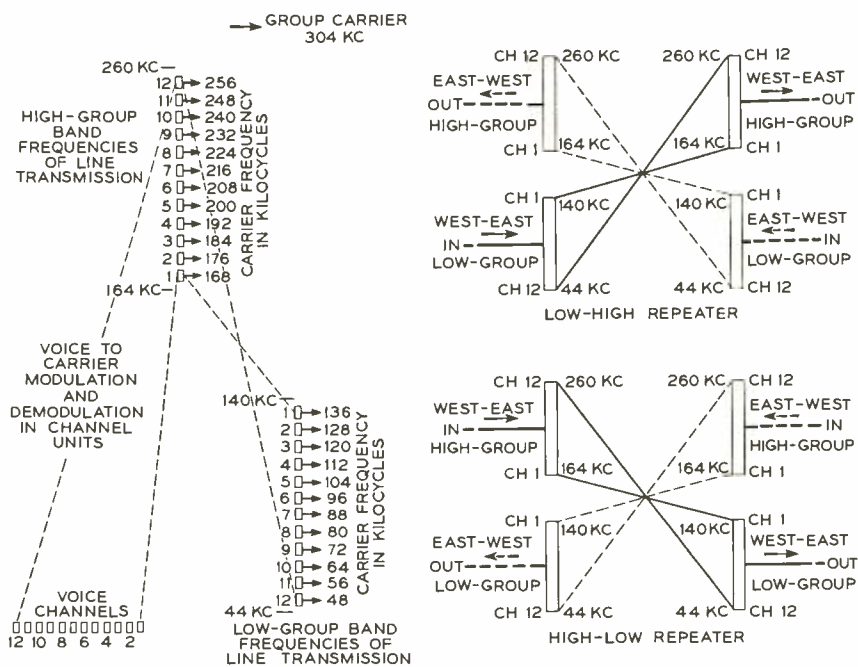

Fig. 3—N1 carrier frequency allocations for terminals and repeaters.

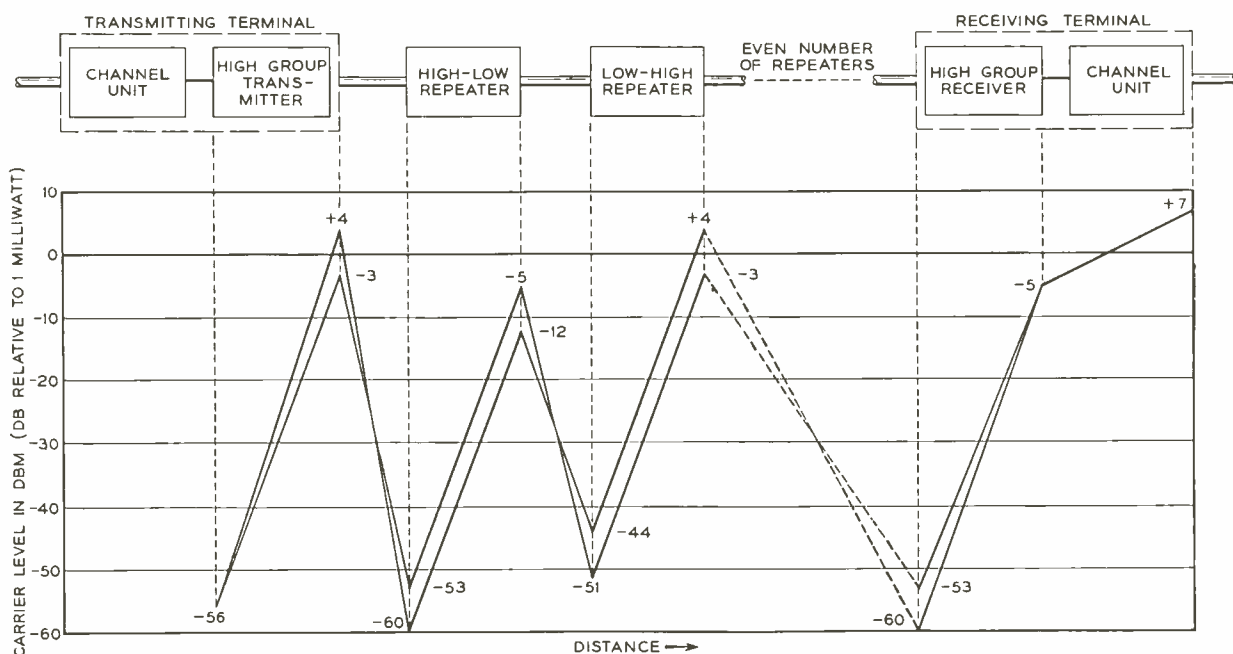

Fig. 4—Level diagram.

mitting group unit at -56 dbm* (Figure 4). In passing through this unit, a slope of 7 db is inserted, so that at the output, channel 12 carrier is $+4$ dbm, and channel 1 carrier is -3 dbm. Cable attenuation increases with frequency; therefore, when the carrier arrives at the first repeater, the relative magnitudes of the carriers are reversed and channel 12 is -60 dbm, while channel 1 is -53 dbm. The 48 db gain of the repeater is the same for all channels; hence channel 1 is transmitted at -5 dbm and channel 12 is transmitted at -12 dbm. At the output of the second repeater (in this example a low-high repeater) the carriers are back to the same value that existed at the output of the transmitting group unit, making transmission through the two cable sections and two repeaters roughly independent of frequency.

Continuing to follow our conversation through the system (Figure 2), after passing through the repeater, the speech arrives at a terminal, where the received signals are either "low" group or "high" group, depending upon whether the number of repeaters is even or odd, and whether the transmitting terminal was a high group terminal or a low group terminal.

If low group signals are received, these are first group modulated back to the high group (164 to 260 kc), passed through a 7 db equalizer to remove the 7 db slope

* dbm = decibels relative to 1 milliwatt as a reference.

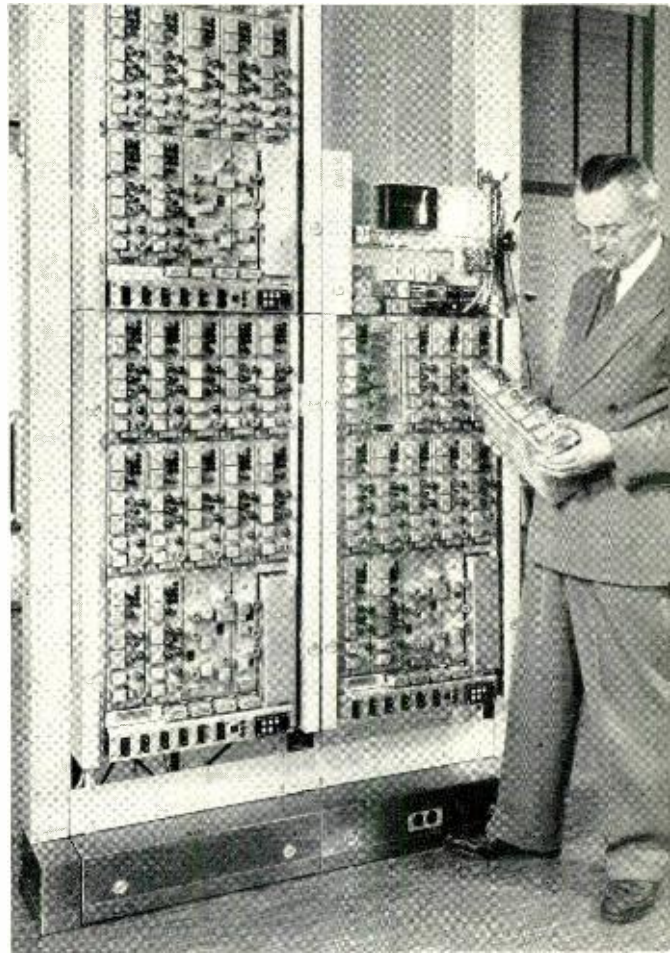

Fig. 5—Terminal equipment is mounted on standard bays. L. Pedersen is examining a channel unit which he has removed from its normal position near the top of the terminal on his right.

THE AUTHOR: After receiving a B.S. degree from Michigan State College in 1926, and an M.S. degree two years later, E. K. VAN TASSEL joined the



Technical Staff of the Laboratories. His first two years here were spent as an instructor in the Technical Assistants' Training Course, after which he transferred to the Systems Development Department where he became concerned with applications of carrier transmission to cable. Continuing in this work until the outbreak of World War II, he then became involved in the design of, and reduction in size of 60-mc intermediate frequency amplifiers. This was followed by the development of early warning search radar equipment, including the AN/TPS-1B used in the Pacific area. Since the war, he has returned to carrier development, particularly short haul type-N and type-O systems. More recently, he has become engaged in the application of carrier to rural telephone lines where he is in charge of a group doing exploratory work in this particular field.

inserted in the transmitting group unit; then amplified in a regulating feed-back amplifier. At the output of this receiving amplifier, all channels are nominally at the same level and are fed into the receiving channel band filters. These filters separate the twelve carrier frequencies and their associated sidebands into the individual channel units.

In a normal operating system, the magnitude of the carrier coming from the receiving group unit will vary due to temperature changes along the cable and departures from ideal in the frequency characteristics of the repeaters. An individual flat gain channel regulator is, therefore, inserted at this point to adjust the magnitude of the carrier to constant value.

With each individual carrier maintained at its correct value, the signal is demodulated to voice frequency and the 3700-cycle signaling tone split off from the voice channel. Our conversation is then passed through a 3100-cycle low-pass filter and into the expander.

The expander is a circuit which inserts a large loss to weak talkers and very little loss to loud talkers. This is to correct for the compression inserted by the compressor mentioned earlier; the combined operation of the compressor and expander is referred to as the "compandor." ° The output of the expander is then transmitted through the resistance hybrid to the listening subscriber.

Compactness of the terminal equipment is well illustrated by Figure 5. L. Pedersen is shown inspecting a channel unit which he has removed from its location in a terminal just to the left of his right hand. In fact, this photograph shows three complete terminals plus the order wire which is used for all the systems on a given route.

In N1 carrier systems that have short repeater spacings, it is frequently necessary to locate some repeaters outdoors along the cable, rather than in some telephone central

° Loc. cit.

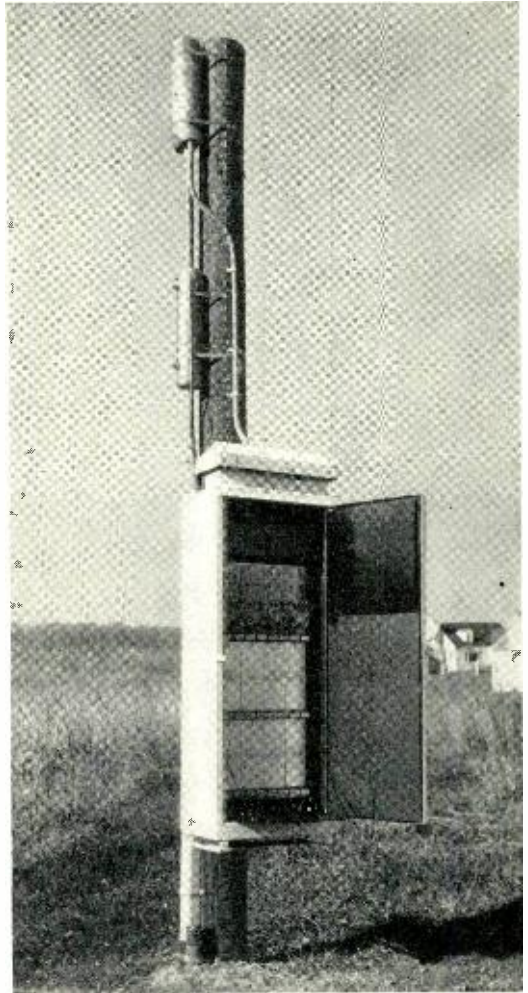

Fig. 6—A pole mounted repeater with the cabinet door open and four repeaters at the top. Facilities are available for mounting eight additional repeaters in the cabinet.

office. Figure 6 shows a pole-mounted cabinet in which twelve two-way repeaters may be housed. Power for each repeater is supplied over the same wires used for the carrier signal transmission. In this way, it is only necessary to provide power supplies at every third repeater in the system instead of at each repeater.

Electron Microscopic Study of Sintering in Thermistor Flakes

A new type of thermistor element, called a thermistor flake, was recently developed for applications requiring both large thermistor surface area and quick response to temperature change. Flakes with the desired characteristics, and only some ten microns, or four ten-thousandths of an inch thick have been produced, but it was felt that their noise characteristics might be improved by modifying the sintering treatment used in their manufacture. To determine the best method of treatment, the surface of the flakes was studied by C. J. Calbick with an electron microscope after they had been sintered to various temperatures. Some of the resulting photomicrographs are shown in the accompanying illustrations. This set was shown at the National Science Photographic Exhibition in Washington last December, and has since been touring the country. It represents the first electron microscopic investigation of sintered material, and because of the high resolution of the electron microscope gives significant information regarding sintering of this class of materials.

As prepared by H. Christensen, the test flakes are formed by first mixing equal volumes of oxide particles^o of two sizes with a plastic solution, spreading this mixture on a flat surface by means of a bar properly adjusted in height, and then allowing it to dry. The film thus formed is stripped from the flat surface, cut into squares approximately five millimeters on a side, and then fired to the selected temperature at the comparatively rapid rate of 55 degrees C per minute. Immediately after the desired temperature is reached, the flakes are cooled at about the same rate to room temperature. These test specimens

are now ready for electron-microscopical study.

The electron microscope is a transmission-type instrument, and thus the electrons must pass through the specimen actually mounted in the microscope. Since the 10-micron flakes are far too thick for direct examination, a replica of the surface is made. Such a surface replica is an adequately thin film with local variations in thickness corresponding to the surface structures under study. For use in the electron microscope, the thickness of these replicas should be of the order of a millionth of an inch, or—more precisely—they should have a mass thickness between five and ten micrograms per square centimeter. A simple example is a plastic film such as collodion, which dries in such a fashion that it is thin over the peaks and thick over the valleys of the underlying surface. For use in the microscope, the film is peeled from the surface and supported on fine-mesh screen.

For the present study, silica replicas were used. The flake was pressed into the surface of a lucite or polystyrene block at a temperature of 150 degrees C and pressure of 2000 pounds per square inch. After cooling, the flake was dissolved in hydrochloric acid, leaving an imprint or mold of its surface in the plastic block. This was then mounted in an evacuated chamber and silica was deposited on its surface by evaporation. After the block is removed from the vacuum, the coating of silica is scored into small squares. The plastic block is then immersed in a solvent, and after a time the small silica squares drift free and are picked up on pieces of fine-mesh screen. After they have been rinsed and dried, these silica replicas are ready for electron-microscopic examination.

^o RECORD, December, 1940, page 106.

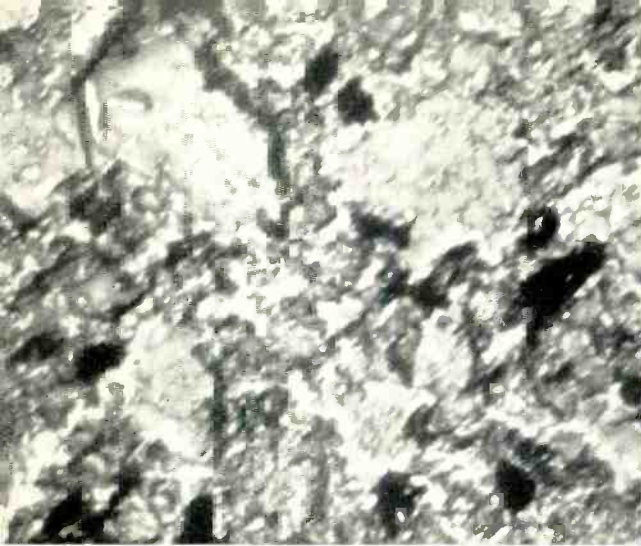

Fig. 1—720 degrees C—Initial condition with little sintering. Magnification 13,000X.

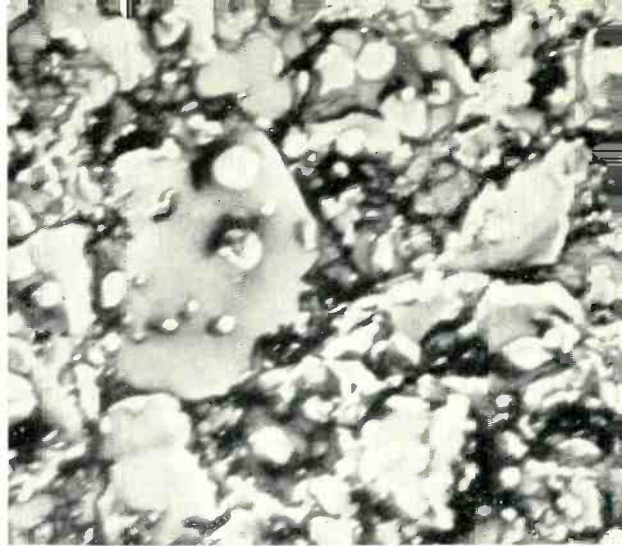

Fig. 2—800 degrees C—Small particles begin to grow together and to be absorbed. Magnification 13,000X.

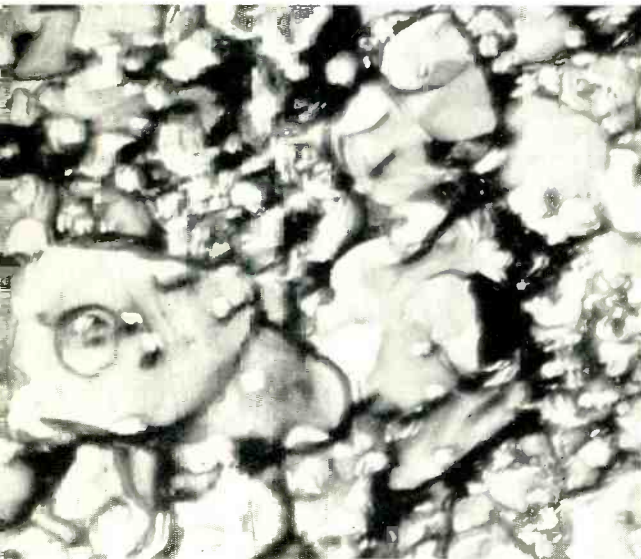

Fig. 3—900 degrees C—Further growth and absorption. Magnification 13,000X.

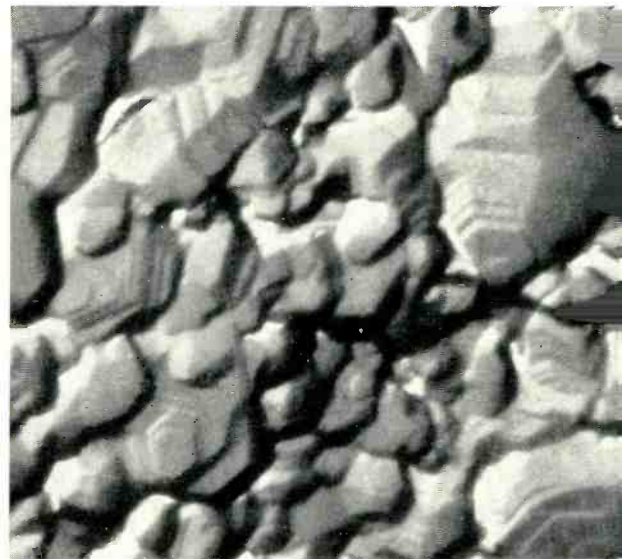

Fig. 4—1000 degrees C—Particles develop into recognizable crystals. Magnification 13,000X.

Fig. 5—1100 degrees C—Spaces between particles close, leaving isolated pockets. Magnification 13,000X.

Fig. 6—1150 degrees C—Crystallographic surfaces become pronounced. Magnification 13,000X.



The electron microscope has very great resolution and depth of focus because of the extreme short wave length of the electrons used—about a hundred thousandth of that of visible light. It can perhaps resolve surface features as small as ten angstrom units, or a millionth of a millimeter, if the object has sufficiently fine detail and enough contrast. For adequate contrast, however, replica films must be a few hundred angstroms thick, and hence distances smaller than 100 angstroms are not usually resolved. Even this, however, is between twenty and fifty times the resolving power of the optical microscope.

The small squares into which the replicas are cut are about one-eighth inch on a side and the screen on which they are placed has square openings perhaps five thousandths of an inch on a side. The square area that is reproduced in the accompanying photographs is approximately 0.00026 inch on a side, and thus a large number of photomicrographs could be made within the confines of a single mesh of the screen.

The great depth of focus of the electron microscope (about 0.02 mm) also permits the use of stereoscopic observation. This must be done photographically by taking two pictures with the specimen tilted at different angles to yield the equivalent of binocular vision. The resultant three-dimensional views are often very striking and instructive or even indispensable to correct interpretation. The half-tone process of reproduction in printed articles is unfortunately not suitable for reproduction of stereoscopic pairs because the half-tone screen becomes objectionable with the enlargement generally used in stereoscopic viewing.

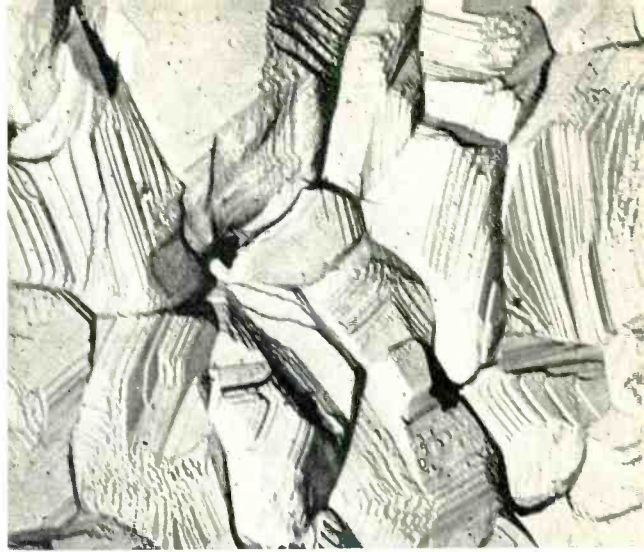

Fig. 7—1200 degrees C—Crystallites are selectively incorporated into others. Magnification 13,000X.

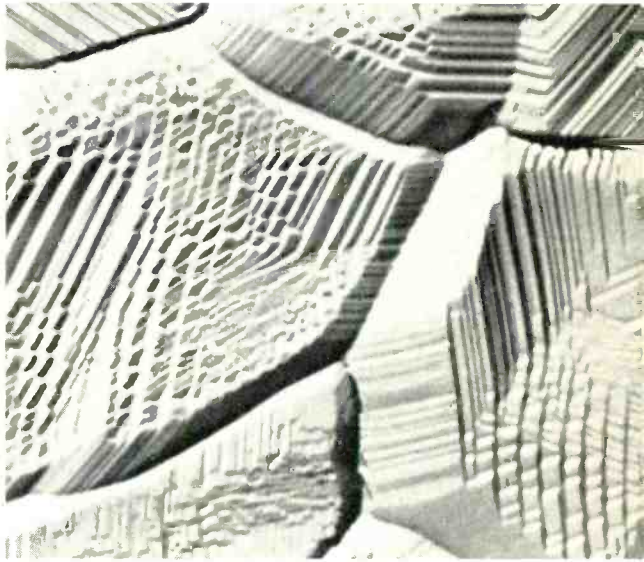

Fig. 8—1250 degrees C—At the highest temperature, the crystallites are large and closely packed, and the surface structure is strikingly terraced. Magnification 13,000X.



Fig. 9—An alternative treatment uses greatly prolonged heating at 1030 degrees C without the higher temperatures. This produces an extremely compact structure with superior electrical properties. This treatment was developed as a result of electron microscope studies.

An Early Demonstration of Color Television

Engineers are not always considered to be good prophets. However, this closing sentence from a 1930 paper by H. E. Ives and A. L. Johnsrud represents a notably accurate prediction:

"It is obvious, however, from the discussion which has been given of the problems encountered, that television in color is intrinsically far more complicated and costly than television in monochrome and hence is likely to wait much longer for practical utilization."¹

Public acceptance of monochrome television in the past few years has been such, however, as to accelerate remarkably the development of television in color.

The demonstration of color television by Ives and Johnsrud in Bell Telephone Laboratories took place twenty-three years ago, on June 27, 1929.² Almost a year earlier, on July 3, 1928, television in color had been demonstrated by Baird in England. Each of these demonstrations contained significant features.

The method employed by Baird was sequential. That is, the scene to be televised was scanned completely first in blue, then in red, and finally in green. The result of this process was that the transmission channel was used in sequence to handle the signals corresponding to the primary colors. If as many color pictures as monochrome pictures were transmitted per second and if the geometric resolution of the two types of picture were the same, the color picture required three times the bandwidth of the monochrome picture.

The method employed by Ives and Johnsrud was simultaneous. That is, there were three parallel channels, one for each of the three primary colors. It might be expected that this would require each channel to have the same bandwidth as a monochrome television signal. Nearly ten years ago, however, it was proposed that much less detail is necessary in the blue image of a color television picture than in the red and green images, and consequently the band-



Transmitter used at the Laboratories' demonstration of color television on June 27, 1929.

width required for transmission is smaller.³ More recently M. W. Baldwin, Jr., has shown that indeed the detail required in both the blue and the red images is much less than that required in the green image.⁴

The exploitation of this difference in detail required in the primary images is much more practical in a simultaneous system than in a sequential system. The signals in the sequential system occupy the same transmission channel in turn, and consequently it is a complicated matter to benefit from this peculiarity of the eye. The signals in a simultaneous system may be band limited independently and multiplexed for transmission in whatever way seems most desirable. For these reasons industry is giving continued consideration to the simultaneous system and is studying actively the problem of the multiplex transmission of the signals.

The design of the color television system that Ives and Johnsrud reported was forward-looking in that it made use of the principles of colorimetry. The receiver primaries were chosen to duplicate as closely as possible the primaries used three-quarter

(Continued on page 297)

The AMA Computer

A. E. HAGUE

Switching Systems Development

Of the various circuits in an Automatic Message Accounting Center,[°] the computer, which follows the assembler[†] in processing order, is the largest and most complicated. Its chief functions are to compute the chargeable time for detail-billed calls and the number of message units for bulk-billed calls, to discard "don't answer" and "busy" calls, to sort out the calls according to type, and to perforate condensed output entries from which all unessential informa-

tion has been excluded. For these various functions it requires four cabinets of relay equipment with lamps and control panels, a reader,[‡] and fourteen perforators—two in each of seven cabinets, as shown in Figure 1.

The input tapes of the computer come

[°] RECORD, *February*, 1952, page 70. [†] RECORD, *May*, 1952, page 227. [‡] RECORD, *June*, 1952, page 237.

Fig. 1—The AMA computer includes, from left to right and back-to-back, four cabinets of control equipment, a reader, and fourteen perforators, two in each of the seven cabinets.

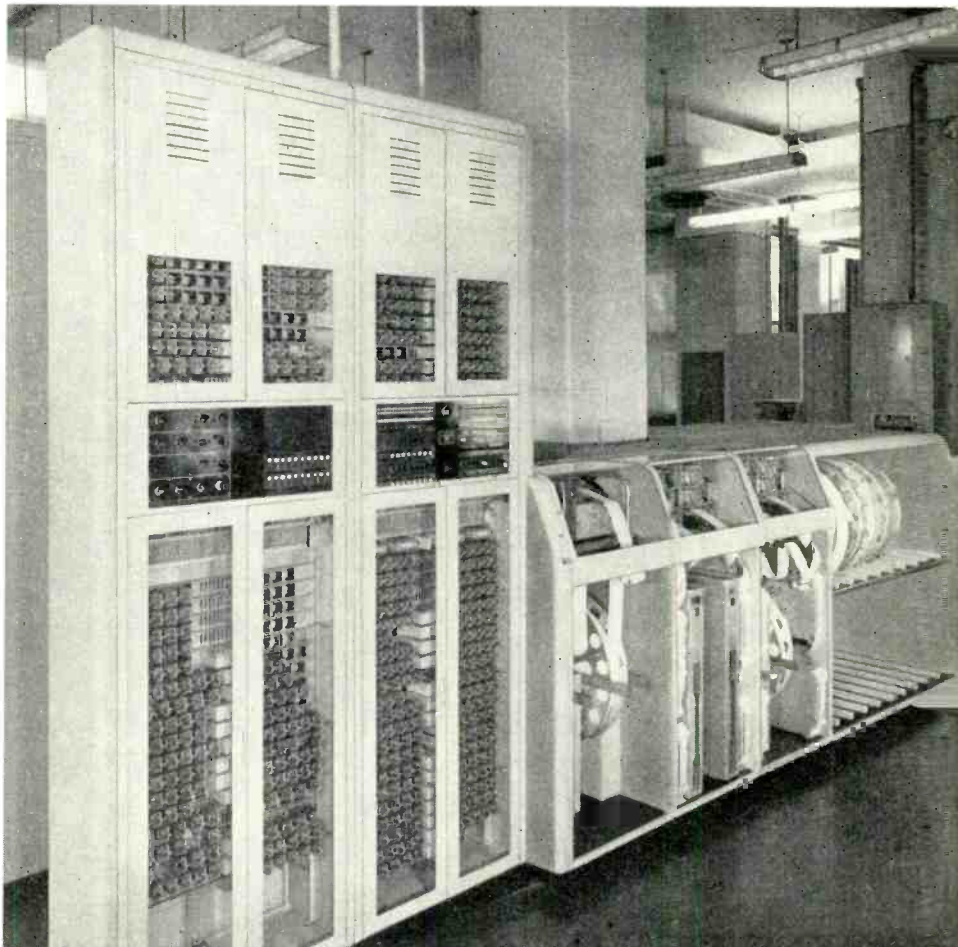

from the assembler which, as the first in the series of accounting center machines, receives the tapes perforated at the central office. These central office tapes contain the initial, answer time, and disconnect time entries of each call. All three entries for any one call are marked by the same call identity index, and are in chronological order but intermingled with similar parts of other calls. Reading the central office

chargeable for the call. Once these calculations have been made, the disconnect time entry is no longer needed in the accounting procedure, and the answer time is used only with detail-billed calls to serve as an additional identification for the call. The call identity index, having been used by the assembler, is also no longer needed. As a result, these items can be eliminated, and the entries to be perforated on the output

TYPE OF ENTRY	INFORMATION RECORDED					
	A	B	C DIGITS		D	F
DETAIL OUTPUT (ON TOLL, MU DETAIL, AND OBSERVING TAPES)	ENTRY INDEX 1	OFFICE INDEX 0-9	CALLING NUMBER			
	0	0	THOUSANDS	HUNDREDS	TENS	UNITS
	0	0-3, 5-8	0-8	0-9	0-9	0-9
	0	0	0	0	0	0
	0	0	0	0	0	0
MESSAGE UNIT OUTPUT (10-99 MU)	ENTRY INDEX 2	0	CALLING NUMBER			
	0	0	THOUSANDS	HUNDREDS	TENS	UNITS
	0	0	0	0	0	0
	0	0	0	0	0	0
	0	0	0	0	0	0
MESSAGE UNIT OUTPUT (1-9 MU)	ENTRY INDEX 1	MESSAGE UNITS 1-9	CALLING NUMBER			
	0	0	THOUSANDS	HUNDREDS	TENS	UNITS

Fig. 2 - The three major types of output entries performed by the computer.

tapes in reverse, for a purpose to be explained later, the assembler rearranges the entries in such a manner as to bring together the scattered elements of each call in consecutive lines on one of its output tapes. These become the input tapes for the computer.

From the disconnect and answer entries the computer calculates the chargeable time, and for message unit calls calculates in addition the number of message units

tapes of the computer can be correspondingly compressed. For bulk-billed calls where the number of message units is not greater than nine, only a single line is required for the output entry, which includes one digit for the number of message units and four digits for the calling telephone number. When there are more than nine message units, a two-line entry is perforated, with the calling telephone number in one line and the number of message

units in the other. Output entries for all telephone calls that are recorded in detail are reduced to a single entry of five lines from the four-line initial entry and two one-line time entries on the central office tapes. The significance of the various lines and digits in this five-line output entry is shown in Figure 2.

One of the important processes in the accounting center consists in sorting or grouping messages according to type. Part of this sorting process is performed by the

sorting operation reduces by one stage the amount of work to be done by the sorter, which processes the tapes after they leave the computer and brings together all the messages dialed by the same calling line within a given period.

A block schematic indicating the major components of the computer is given in Figure 3. In general, the process consists in reading the lines of the input entries pertaining to each call one after another, recording the information contained in each

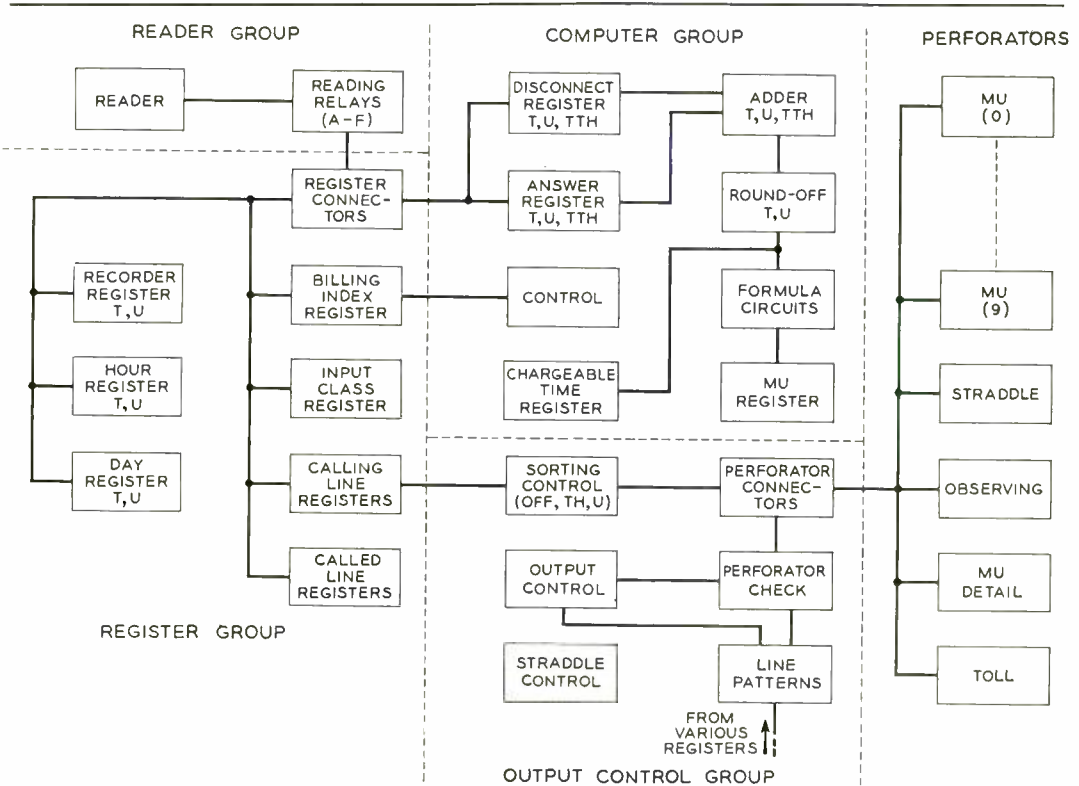

Fig. 3—Block schematic of the computer.

computer, which classifies its output entries as toll, message unit, message unit detail, etc., and then further sorts the message unit calls according to a digit of the calling line number. The office digit of the calling line number is used for sorting whenever the input tapes include calls from more than one central office served by the same marker group. When only one central office is involved in the marker group, the message unit calls are usually sorted according to the units digit of the calling line number. This

line in the appropriate registers, computing the chargeable time and, in the case of bulk-billed calls, the number of message units for the call, and then perforating an output entry on one of the fourteen perforators. An overlap operation is provided, however, so that an output entry may be perforated while the next input entry is being read. This is indicated in Figure 4. For message unit entries, where the output entry consists of only one or two lines, there is no delay at all due to output perforating.

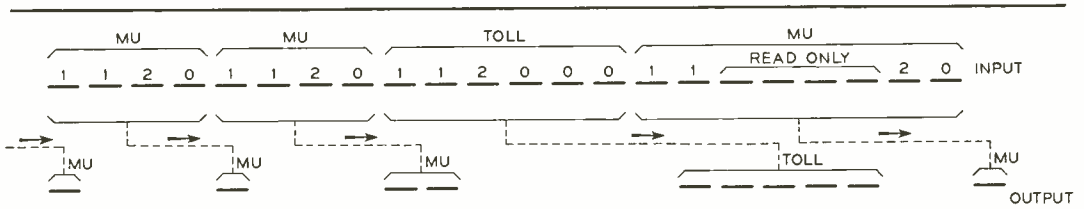

Fig. 4—Overlap operation in the AMA computer.

The input entries are read line by line in continual succession and the complete output entry for one call is perforated while the timing entries for the next call are being read. While the five-line output entry of a detail-recorded call is perforated, the progress of the input tape is held up four timing intervals, or a total of one quarter of a second, to permit the output entry to be completed before the input tape is advanced to read the initial entry of the succeeding call.

The timing intervals just referred to are determined by the motor-driven interrupter of the reader. Sixteen times a second the reading fingers move in to read the tape and a group of contacts are closed. The resulting pulses guide the operation of the computer and the perforation of the output tapes. Normally the reader is advanced on each pulse, but when a five-line output entry must be perforated, the advance of the reader is held up; the reading fingers move in and out and the contacts close and open but the input tape remains stationary.

The first entry of a call encountered on the input tape is the disconnect time in tens, units, and tenths of minutes relative to the hour, which is registered as a separate item from hourly entries on the tape. Next comes the answer entry, and then the initial entry, this inverse sequence being produced by the tape reversal at the assembler stage in order that computation may proceed without awaiting the initial entry. As the disconnect time entry is read, it is recorded at once in the disconnect register, and the input tape is advanced to the next line, which is the answer time entry. As the latter entry is read, it is at once recorded in the answer time register. Both of these registers are in the computer section of the circuit, and as soon as the answer time has been recorded, the computer subtracts it

from the disconnect time to determine the elapsed time. This elapsed time is then passed to the "round off" circuit where a definite amount is subtracted to allow for any possible delays in recording the disconnect time at the central office. The remaining interval is then rounded off to the next higher minute to produce "chargeable" time.

In the meantime, the reader has advanced to the first line of the initial entry of the call. This includes the entry index showing the general class of the call — message unit or detail — and the billing index, which provides the final distinction regarding the specific type of the call and also indicates the particular rates to be used for the initial and overtime periods of message unit calls. As soon as the latter index is read, it is recorded in the billing index register, which interprets it and passes the resulting information to the control circuit of the computer. If the information indicates a detail-billed call, the computer passes the rounded off or chargeable time to the chargeable time register for later use in perforating the output entry. If the billing index signifies a message unit call, the control circuit of the computer selects the appropriate one of a number of formula circuits, of which there is one for each combination of initial and overtime rates in use. The chargeable time is then passed to this formula circuit, where a single stage translation evaluates the time in terms of message unit charges. This one operation is the equivalent of dividing the total chargeable time into initial and overtime periods, evaluating each in terms of message units, and adding the two results together to give the total number of message units chargeable for the call. This number is then transferred to the message unit register.

If the call being processed is a message

unit call, the next line read by the reader will be the second or last line of the initial entry. This includes the calling office and line number, which will be recorded in the calling line register. For such a call, all the information needed for perforating the output entry is now in the registers of the computer. During the next impulse from the reader, therefore, while the disconnect entry for the succeeding call is being read, one line of the output entry is perforated on one of the ten perforators, as shown in Figure 4. Which perforator is used depends, as has already been stated, either on the office number or on the units or thousands digit of the line number.

For detail recorded calls there will be three lines of the initial entry to be read after the receipt of the message billing index has allowed the chargeable time to be transferred to the chargeable time register. Only after these three lines have all been read and the information recorded in the proper register can the output entry be started. Actually, however, one additional pulse period of the reader is allowed before the output entry is started. This is to make sure that the next line on the input tape pertains to the next call and is not a repeated line of the call just being processed. Thus in the call sequence shown in Figure 4, perforation of the output for the toll call does not begin until the answer entry of the next call is being read on the input tape.

After the disconnect and answer entry of a call have been recorded and the elapsed time calculated, the disconnect and answer registers can be released, and are thus available for recording the corresponding entries of the next call. This permits the overlap operation already illustrated in Figure 4. Here, short horizontal lines represent the pulse periods of the reader — each one-sixteenth of a second long. Since the third call indicated is a toll call, its five-line output entry will require more time to perforate than the reading of the next two timing entries. As already stated, output perforation of the toll call begins after the disconnect entry of the next call has been read. While the next four lines of the output entry are being perforated,

therefore, the input tape is not allowed to advance. Four pulse periods must be allowed before the input tape is again started and the remaining part of the next entry is accepted by the registers.

One of the major sections indicated in Figure 3 is concerned with perforating the output tapes. There are connectors for each of the fourteen perforators, and there are selecting circuits to determine which one is used. The ten-message unit perforators are selected either by the calling office or the calling line number as already noted. Three of the remaining perforators, the toll, message unit detail, and observing all have the same type of input entries, and which perforator is selected depends on either the entry index or the message billing index, or both. Message unit detail calls are

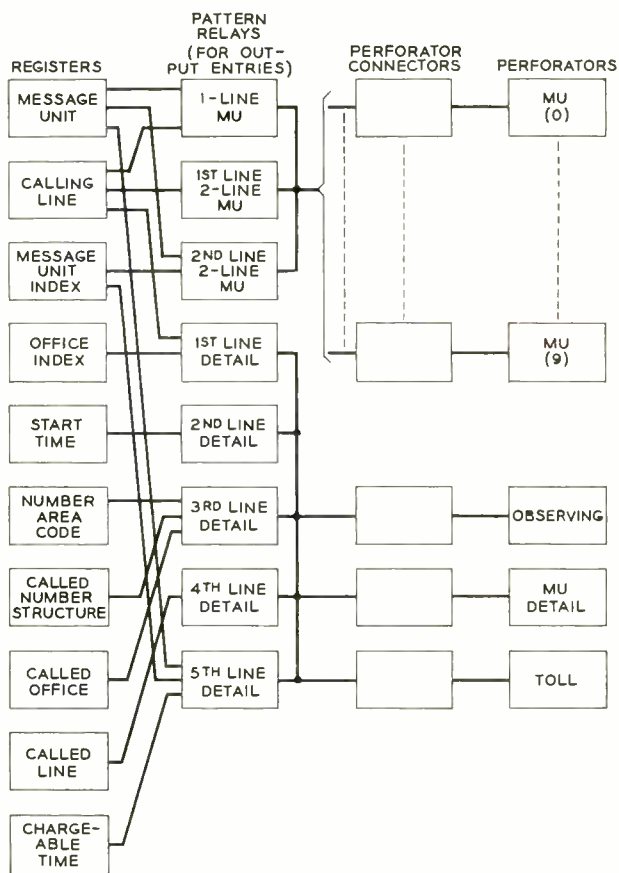

Fig. 5—Block schematic indicating some of the line pattern relays and their association with the registers and perforator connectors.

billed on a message unit basis from output entries perforated on the regular message unit tapes, but an additional output entry for each such call is perforated on the message unit detail tape to preserve the details of the call, including the message unit charges and the chargeable time. Service observing calls are those on which a check is being made by the operating personnel, and such calls have a detailed form of output perforated on the observing tape in addition to the regular output on one of the other tapes. On the straddle perforator are recorded those calls whose entries are not all contained on the tapes being processed. Some part of each such call will be on the tape in question, while the rest will be found on the tapes of the preceding or following period. Entries on the straddle tape have to be assembled later as a separate step.

Besides selecting the proper perforator, the output control circuit must also select a line-pattern relay for each line perforated on an output tape. These line pattern relays are connectors that establish paths from various registers to the perforator connectors. There is one pattern connector for each type of output line that may have to be perforated. In simplified block form, Figure 5 indicates their association with the registers and perforator connectors for detail and message unit calls. Other combinations of line patterns are used for straddle

calls. A comparison of Figure 5 with Figure 2 will show that the line pattern relay for each output line connects the registers containing the information for that line through to the proper perforator connector.

"Don't answer" and "busy" calls (except those in the service observing category) are discarded by the computer. Such calls will have an initial entry on the input tape but no preceding disconnect or answer entries. When the computer receives an initial entry without having previously received the disconnect and answer entries, it releases its registers and the reader proceeds to the next entry, discarding the uncompleted call.

The computer includes a large number of checking features, as do other circuits of the AMA system. Among the elementary checks are those to insure that two and only two reading relays are operated for each digit, that the reader and perforators advance when they should, that the proper perforating magnets are operated for each output entry, and so on. However, a major consideration in the design of the computer has been the prevention of overcharging. Extensive additional checks have therefore been provided to insure that all elements relating to charging, particularly those requiring cancellation of all or part of the charges, have been taken into account before the output proceeds. If all conditions are not met, the machine stops and gives an alarm.



THE AUTHOR: A. E. HAGUE has been concerned with dial telephone systems since joining Western Electric's Engineering Department—now Bell Laboratories—over thirty-eight years ago. From 1913-17 he was a member of the circuit testing group, and after returning from overseas military service in 1919, he became a member of the circuit design and development group. He is currently engaged in the development of a computer for AMA. Mr. Hague received a B.S. degree in E.E. from Purdue University in 1912.

JKT— an All-Purpose Station Wire

C. C. LAWSON
Outside Plant Development

New subscriber installations are being wired with a new type of station wire which is superior in both appearance and performance. Consisting of insulated conductors enclosed in a plastic jacket, this wire, known as JKT, is readily stapled in position to blend inconspicuously with base boards or trim.

The individual twenty-gauge conductors have steel cores for strength and copper outer shells for conductivity. Such a conductor has 40 per cent of the conductivity of solid copper. Currently, to conserve copper, the conductivity has been reduced to 30 per cent by thinning down the outer shell. This has been done with negligible sacrifice in performance since this wire usually makes up only a small part of the total loop circuit. The conductors are insulated with polyvinyl chloride which is highly resistant to moisture and the insulation on each is distinctively colored for ready identification. The insulated conductors are twisted together in the process of covering



Installer D. Keegan of the New York Telephone Company staples JKT wire to run inconspicuously along doorway trim.

them with an ivory or brown extruded cylindrical jacket of polyvinyl chloride, which gives extra mechanical and electrical protection. In laboratory tests JKT wire has proved consistently tougher than the older types of station wire.

A significant factor in improving appearance is the special method of attachment using flat wire staples, having a round crown to fit the wire contour and a lacquer finish to match the color of the wire jacket. These staples are bonded together at their edges forming a single bar to facilitate loading in the magazine of the stapler. As is shown in the illustration above, the staples are driven singly over the wire by means of a spring-actuated hammer in a hand-operated stapler. The power for the drive is provided by squeezing the handle of the stapler toward the frame of the tool. This action raises a plunger and its asso-

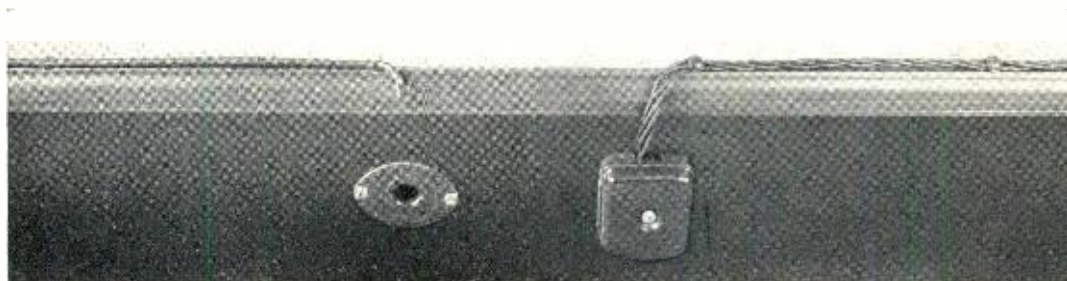

Fig. 1—JKT Station Wire (left) shown compared with earlier, twisted type (right).

ciated driving blade against spring pressure until the release point is reached; the energy in the spring is then imparted to the plunger and driving blade which drives the staple home. The driving force is uniform and, when firmly in place over the wire, the stapler drives staples sufficiently deep to hold the wire securely even on hard wood. With soft wood less pressure is used to hold the stapler in place over the wire so that part of the driving force is expanded in pushing the stapler away from the surface.

In many modern apartment buildings there are no base boards and the door frames are metal; only the plastered walls are left in which staples can be driven. Because plaster does not grip a staple as wood does, a new staple was developed with a slight horizontal cut on the outer surface of each leg about $\frac{1}{8}$ inch above the point. As the legs are driven in, the portions below the cuts splay out in the plaster, firmly clinching the staple. To drive this staple, a hammer-operated stapler was developed, as shown in Figure 2. It is a front-loaded tool equipped with a magazine holding 22 staples. The staples are ejected from the tool by means of a hammer blow on the driving head. The length of driving stroke of the plunger or driving blade is controlled by a rubber washer under the head of the driver. This tool is considerably cheaper than the hand-operated stapler and because of its small size is useful in close quarters.

For duct and conduit installations JKT station wire is a considerable improvement over the special duct wire formerly supplied



Fig. 2—Hammer-operated stapler permits attachment of JKT wire to plaster.

and is lower in cost. Adequate strength for pulling in is provided by the copper-steel conductor while the thermoplastic insulation and jacket have excellent resistance to moisture absorption and mold attack. The smaller over-all size of this wire in comparison to the earlier wires and its smooth contour facilitate installation in ducts. JKT wire may be run in the open beyond the duct whereas with the former wire it was necessary to splice on a piece of station wire or tape the exposed duct wire to improve the appearance of the run external to the duct.

The strength and sturdiness of this wire are helpful in business establishments where the wire is frequently run from the wall or from an underfloor duct to desks; breakage of the earlier wires during relocations or moving of the desks during cleaning operations has been a source of frequent troubles.

In order to insure that JKT station wire is delivered to the installer free from kinks, bends and dirty spots, and to facilitate installation and handling of the wire on the job, a new method of packing has been developed, as shown in Figure 3. Sufficient wire for the longest runs anticipated (300 feet) is supplied in coils, individually packed in dispenser-type cardboard cartons. On the job, wire is removed directly from the center of the coil through a hole in the top of the package so that it is no longer necessary to uncoil and lay out on the floor

Fig. 3—How the JKT wire is delivered to the installer.

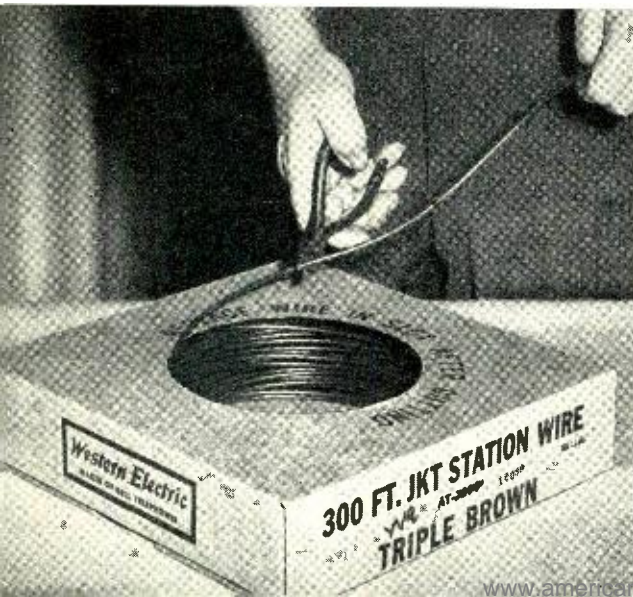

the whole length of wire needed for an installation. By reducing kinks and keeping the wire clean, this technique aids in improving the appearance of installations.

With the new wire the telephone installer is likely to have less rewiring to do when houses and apartments change hands. The old style twisted wire had a tendency to

catch paint from the redecorator's brush only to let it drip on base boards and molding. Too often the telephone man has been called in to replace wire torn out by painters. With its single jacket the new wire is expected to avoid interference with the painter's job and so cut down the demand for replacements.

THE AUTHOR: CLEMENT C. LAWSON received the B.S. degree in Chemistry from the Sheffield Scientific School of Yale University in 1925. Fol-



lowing work with the Travelers Insurance Company and Metropolitan Life Insurance Company investigating industrial health hazards, he joined the Laboratories in 1929 and was assigned to the Outside Plant Development Department where he has worked on such products as clay conduit and motor vehicle finishes and participated in investigations which led to the elimination of "splicers' rash" and to the adoption of the desiccant method of drying cable splices. In the wire development group he worked during the war on the design and development of special wires and cables for the armed forces. Currently, as Wire Development Engineer, he has charge of the group responsible for the development of insulated outside distributing and station wires and of line wires and strand. Mr. Lawson is a member of Committee A-5 of the A.S.T.M. and is the representative of the Telephone Group on Committee C-8 of A.S.A.

(Continued from page 288)

ters of a century earlier by James Clerk Maxwell in his experiments in color vision. Similarly the spectral sensitivities of the three photocells were adjusted to be like the three color mixture curves Maxwell had obtained using these three primaries. This use of the fundamentals of colorimetry now is considered commonplace, and the data for the mixture curves is much more precise than obtained by Maxwell.

The scene to be televised was scanned by a moving beam of light in these early experiments. This method has been abandoned for televising live scenes, but it has been found to have merits for producing television signals from film. Instead of an intense light behind a scanning disc, modern apparatus uses the spot-scanning tube. In this latter version of scanning, the result is accomplished by using a special form of picture tube. One such scanner for black-and-white film was developed in the Laboratories a year ago.⁵

BIBLIOGRAPHY

- ¹H. E. Ives and A. L. Johnsrud, "Television in Colors by a Beam Scanning Method," *J. Opt. Soc. Am.*, **20**, pp. 11-22, Jan., 1930.
- ²H. E. Ives, "Television in Colors," *Bell Labs. Record*, **7**, pp. 439-444, July, 1929.
- ³Alfred N. Goldsmith, U. S. Patent No. 2,335-180, Nov. 23, 1943.
- ⁴M. W. Baldwin, Jr., "Subjective Sharpness of Additive Color Pictures," *Proc. Inst. Radio Engrs.*, **39**, pp. 1173-1176, Oct., 1951.
- ⁵A. G. Jensen, R. E. Graham and C. F. Matcke, "Continuous Motion Picture Projector for Use in Television Film Scanning," *J. Soc. Motion Picture and Television Engrs.*, **58**, pp. 1-21, Jan., 1952.

One cannot question the technical features of the system of color television demonstrated by the Laboratories in 1929. Within the limitations of available techniques and apparatus it represented an important milestone in the progress of television. The Ives-Johnsrud prophecy was remarkably realistic.

W. T. WINTRINGHAM

Patents Issued to Members of Bell Telephone Laboratories During March and April

- 2,587,635 Spaced-Pulse Sender, C. A. Lovell and D. B. Parkinson.
- 2,587,817 Telephone System, A. J. Busch and H. J. Michael.
- 2,588,103 Wave Guide Coupling Between Coaxial Lines, A. G. Fox.
- 2,588,226 Wave Filter, A. G. Fox.
- 2,588,240 Pulsing Circuit, E. W. Houghton.
- 2,588,249 Wave Polarization Shifter System, W. E. Kock.
- 2,588,315 Heating Apparatus, A. W. Ziezler.
- 2,588,375 Automatic Accounting Device, E. W. Flint, A. E. Hague, A. E. Joel, Jr. and R. O. Rippre.
- 2,588,397 Spaced-Pulse Impulse Sender, C. A. Lovell and D. B. Parkinson.
- 2,589,130 Permutation Code Group Selector, R. K. Potter.
- 2,589,135 Submarine Signaling Device, I. S. Rafuse.
- 2,589,158 Mobile-Radio and Wire System, E. M. Staples.
- 2,589,184 Electronic Impedance Equalizer, M. K. Zinn.
- 2,589,658 Semiconductor Amplifier and Electrode Structures Therefor, J. Bardeen and W. H. Brattain.
- 2,589,662 Radio Telephone Receiving System, B. G. Bjornson.
- 2,589,704 Semiconductor Signal Translating Device, W. E. Kirkpatrick and R. W. Sears.
- 2,589,711 Off-Channel Squelch Circuit for Radio Receivers, L. Y. Lacy.
- 2,589,739 Electrical Oscillator Having Open-Ended Coaxial Resonator, W. G. Shepherd.
- 2,589,800 Telephone Signaling System, W. D. Goodale, Jr. and W. H. Martin.
- 2,589,806 Selective Signaling System, C. N. Hickman.
- 2,590,228 Method of Adjusting Polar Relays, J. T. L. Brown.
- 2,590,234 Automatic Selection of Receiving Channel, H. B. Coxhead.
- 2,590,248 Voltage Sensitive Circuit, W. H. T. Holden.
- 2,590,262 Trunk Frame Designation Transfer, R. K. McAlpine.
- 2,590,263 Electrical Control Apparatus, E. D. Mead and O. S. A. Mesch.
- 2,590,500 Telephone Ringer, H. A. Bredehoft and M. S. Richardson.
- 2,590,514 Pulsing Circuit, J. W. Dehn and W. H. T. Holden.
- 2,590,584 Sea-Water Battery, R. L. Taylor.
- 2,590,625 Sorting Device, A. E. Joel, Jr.
- 2,590,885 Spaced-Pulse Impulse Sender, D. B. Parkinson.
- 2,590,945 Trunk Circuit, R. B. Curtis.
- 2,590,996 Relay, H. A. Miloche.
- 2,591,032 Methods for Growing Ethylenediamine Tartrate Crystals, A. C. Walker.
- 2,591,579 Permanent-Signal Indicating System, J. Michal.
- 2,591,580 Special Trunk Circuits for Transmitting Tones to Calling Subscribers, J. Michal.
- 2,591,842 Electron Discharge Apparatus, F. B. Llewellyn.
- 2,591,856 Pulse Echo Distance Indicator, B. M. Oliver.
- 2,592,228 Decoder for Pulse Code Modulation Receivers, E. W. Adams, Jr.
- 2,592,308 Non-Linear Pulse Code Modulation System, L. A. Meacham.
- 2,592,549 Anode Structure for Electron Discharge Devices, S. O. Ekstrand and V. L. Ronci.
- 2,592,615 Current Supply Apparatus, J. R. Stone.
- 2,592,652 Magnetic Transducer Head, F. G. Buhrendorf.
- 2,592,683 Storage Device Utilizing Semiconductor, F. Gray.
- 2,592,716 Self-Correcting Amplifier, W. D. Lewis.
- 2,592,721 Filter Using Magnetostrictive Rings, E. E. Mott.
- 2,592,729 Method of Etching Ethylenediamine Tartrate Crystals, E. S. Pennell.
- 2,593,095 Cavity Resonator Mode Suppression Means, H. B. Brehm.
- 2,593,109 Cold Cathode Gaseous Discharge Device, C. J. Craft.
- 2,593,113 Regenerative Frequency Shifting and Pulse Shaping Circuit, C. C. Cutler.
- 2,593,155 Cavity Resonator, J. P. Kinzer.
- 2,593,234 Cavity Resonator, I. G. Wilson.
- 2,593,330 Variable-Frequency Relaxation Oscillator, M. E. Mohr.
- 2,593,463 Frequency Stabilized Microwave Oscillator, J. P. Kinzer.
- 2,593,694 and 2,593,695 Wave Analyzer for Determining Fundamental Frequency of a Complex Wave, E. Peterson.
- 2,593,698 Apparatus for Determining Pitch Frequency in a Complex Wave, R. R. Riesz.
- 2,594,014 Crossbar Tandem Office for Step-by-Step Telephone Areas, W. T. Haines and J. B. Newsom.

(Continued on page 312)

The Sorter for Automatic Message Accounting

F. N. ROLF

Switching Systems Development

At some stage in the telephone message accounting process* it is obviously necessary to bring together all the messages chargeable to a particular customer for the billing month. In the AMA system this is the function of the sorter which receives the tapes from the computer† described previously. The sorter consists of a reader, ten perforators‡ (two in each of five cabinets) and a relay rack containing about 300 relays together with a key and lamp panel. The input tapes for the reader are those prepared by the computer, and are of two general types. One type includes only message unit calls and has a mixture of one-line and two-line entries; the other type includes only detailed calls, and its entries all have five lines. Each entry of either type includes the number of the calling subscriber, but the telephone numbers are in random order. The function of the sorter is to prepare new tapes containing the same entries that were on the input tapes but arranged in the order of the calling subscribers' numbers.

Sorting is accomplished in four stages: one stage for each of the four digits of the calling subscriber's number. The first stage sorts the entries according to the value of the units digit; the second stage, according to the tens digit; the third, according to the hundreds digit; and the fourth according to the thousands digit. Assuming a set of four-digit numbers arranged in random order, as in column 1 of Table I, the arrangement of the numbers after the first, second, third, and fourth stages of sorting would be as in columns

2, 3, 4, and 5, respectively. Digits 3, 4, 5, and 6 have been omitted from the numbers of Table 1 to simplify the tabulation. It might seem off-hand that sorting should begin with the thousands rather than with the units digit. If this were done, however,

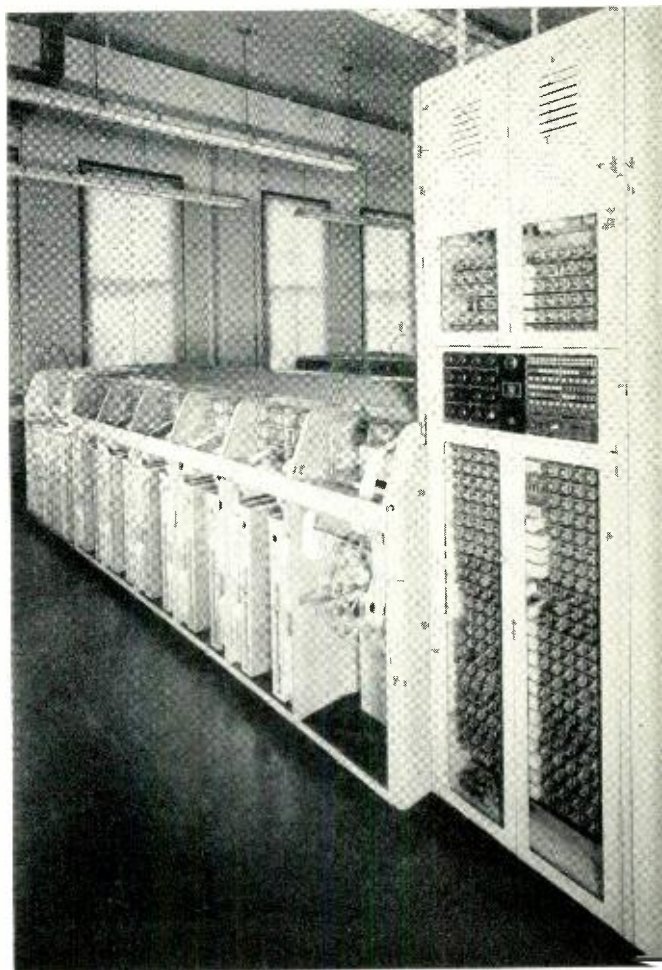

The sorter includes an enclosed relay rack, the reader cabinet, and five perforator cabinets.

* RECORD, February, 1952. † Page 289 of this issue. ‡ RECORD, November, 1951, page 504.

the numbers after the four stages of sorting would be in order when read from right to left instead of the normal order of from left to right. Column 6 of Table I gives the numbers in the order in which they would be found had the sorting started with the thousands digit.

Sorting in the various stages is brought about by using each of the ten perforators for recording the entries with a particular value of the digit being sorted at the time. The perforators are designated 0 to 9, and during the first sorting stage, all entries with a units digit 0 in the calling number will be perforated by the number 0 perforator. All entries with the digit 1 in the units place will be perforated by the number 1 perforator, and so on. This is indicated by the bracketing of the various columns in Table I.

At the end of the first stage of sorting, the tapes are removed from all ten perforators and spliced together in numerical order. This composite tape then becomes the input tape for the stage two sorting. It is placed in the reader, and the sorting is carried out exactly as for the first stage,

except that now it is the digit in the tens place that determines the perforator to which each entry is allotted. At the end of each successive stage, the newly perforated tapes are spliced together in order, and become the input tapes for the next stage. The composite tape resulting from the fourth stage becomes the input tape for the following stage in the accounting center procedure. After the tapes have been used to control the next sorting stage, those resulting from the first, second, and third sorting stages may be discarded. Only the original input tape and the composite tape resulting from the fourth sort are retained as records.

So far as each entry of the input tape is concerned, the function of the sorter is to cause the perforator to reproduce the same entry on an output tape. The sorting function comes in only in selecting the particular one of the ten perforators to be used for perforating each entry. Reproducing functions of the sorter require that leads from the contacts of the 28 reading fingers be associated with the 28 perforator magnets of a perforator so that each reading contact that closes will cause the corresponding perforating magnet to operate. The essential circuit elements by which this is brought about are indicated in Figure 1. For each line of an entry, one of the ten cut-in relays will be operated as described later. As soon as the cut-in relay operates, ground from control contacts in the reader is extended through front contacts of all operated reading relays, and through corresponding front contacts on the cut-in relay that has been operated, to operate the associated perforating magnets of the perforator. In this way the complete line of the entry on the input tape is duplicated on the output tape of one of the ten perforators. Following this, both the reader and the perforator are allowed to step ahead one line.

Which perforator cut-in relay should be operated for each line of the input tape depends on one of the digits of the calling subscriber's number. The calling-line number always appears as the C, D, E, and F digits in the first line of an entry, as indicated in Figure 2. These digits are perforated in the 2-out-of-5 code used through-

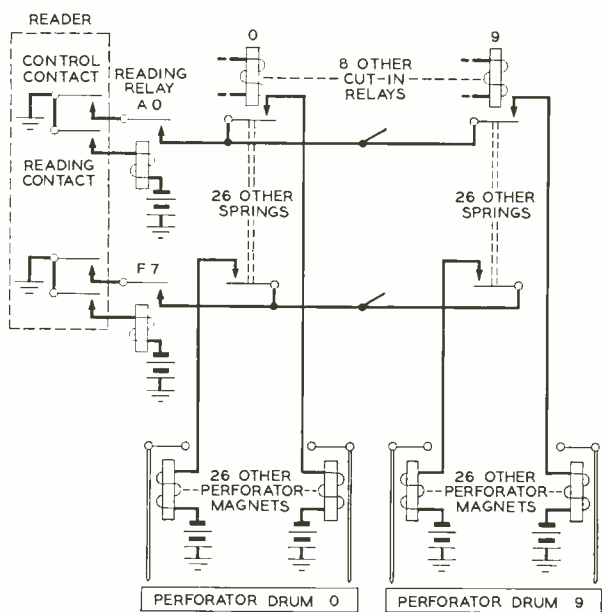

Fig. 1—Simplified schematic of that part of the sorter circuit used in perforating an output tape with the same information that appears on the input tape.

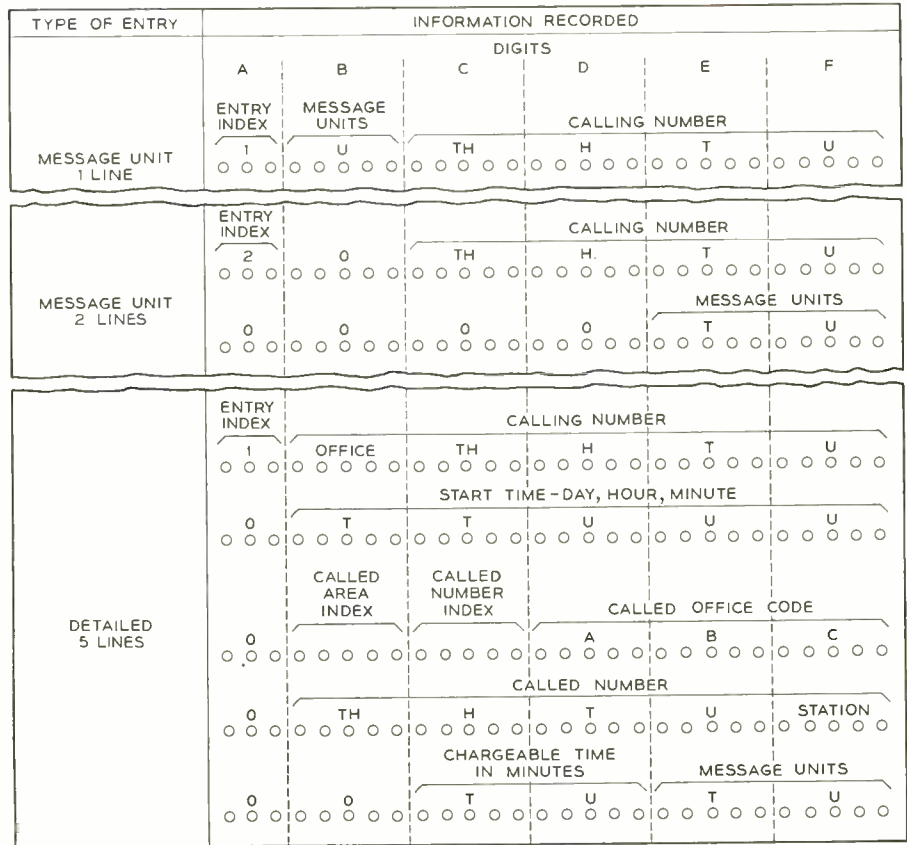

Fig. 2 - The three types of entries that appear on the input tapes for the sorter. Message unit tapes have both one-line and two-line entries, while detailed tapes have five-line entries.

out the AMA system, and indicated in Table II on page 304.

A set of springs on the five reading relays associated with each of the digits C, D, E, and F is wired in such a way that ground applied to a single input lead will appear on one of a group of ten output leads. The ten output leads are numbered 0 to 9, and the circuit is so arranged that for any particular pair of relays operated, the ground appears on the output lead indicated by the translation table of Table II. One form of translating circuit of this type is shown in Figure 3.

For each stage of sorting, under control of a key set at the beginning of the sort, ground from a control contact of the reader is applied to the input lead of the translating circuit of the digit that is to control the sort. Similarly, the ten output leads from that translating circuit are connected to the cut-in relays of the perforators. If, for example, the tens, or E, digit is to control the sorting, ground will be applied to the input lead of the translating circuit on the

E digit reading relays when the reading contacts close. If for the particular entry encountered, the second and fourth holes were perforated, which have the values 1 and 4, respectively, ground would appear on the number 5 output lead, and as a result the cut-in relay for the number 5 perforator would be operated. By means of the circuit shown in Figure 1, the complete information on the line being read would be perforated by the No. 5 perforator.

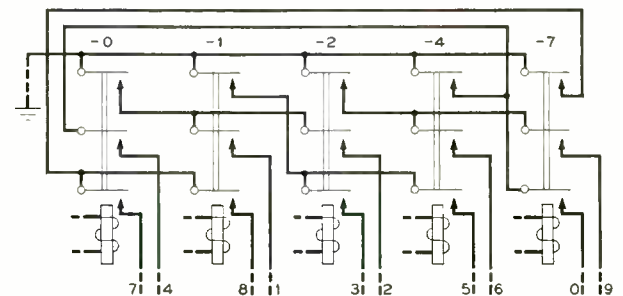

Fig. 3—One of several possible forms of circuit for translating from a "2-out-of-5" to a decimal code.

TABLE 1 — TWENTY FOUR-DIGIT NUMBERS IN RANDOM ORDER IN COLUMN 1 ARE SHOWN IN COLUMNS 2, 3, 4, AND 5 AS THEY ARE ARRANGED AFTER THE 1ST, 2ND, 3RD, AND 4TH SORTING STAGES. COLUMN 6 SHOWS THE ORDER IN WHICH THE NUMBERS WOULD BE ARRANGED AFTER FOUR SORTING STAGES IF THEY WERE CARRIED OUT IN REVERSE ORDER

1 <i>Random Numbers</i>	2 <i>After Units Sort</i>	3 <i>After Tens Sort</i>	4 <i>After Hundreds Sort</i>	5 <i>Completely Sorted</i>	6 <i>Sorted in Reverse Order</i>
9190	0 { 9190	0 { 8802	0 { 1009	0 { 0217	0 { 9110
0277	0 { 8780	0 { 2807	0 { 2018	0 { 0277	0 { 8780
8780	0 { 9110	0 { 7908	0 { 7077	0 { 0281	0 { 9190
1829	1 { 0281	1 { 1009	1 { 8091	1 { 0789	1 { 0281
0281	1 { 8091	1 { 9110	1 { 9110	1 { 1009	1 { 8091
9192	2 { 9192	1 { 0217	1 { 9190	1 { 1829	2 { 8802
7908	2 { 9722	1 { 2018	1 { 9192	1 { 1929	2 { 9722
9722	2 { 8802	2 { 9722	2 { 0217	2 { 2018	2 { 7282
7077	2 { 7282	2 { 1829	2 { 0277	2 { 2807	2 { 9192
8091	7 { 0277	2 { 1929	2 { 0281	7 { 7077	7 { 2807
1009	7 { 7077	7 { 0277	7 { 7282	7 { 7282	7 { 0217
7798	7 { 2807	7 { 7077	7 { 9722	7 { 7798	7 { 7077
2807	7 { 0217	7 { 7077	7 { 8780	7 { 7908	7 { 0277
8802	8 { 7908	8 { 8780	8 { 0789	8 { 8091	8 { 7908
2018	8 { 7798	8 { 0281	8 { 7798	8 { 8780	8 { 2018
1929	8 { 2018	8 { 7282	8 { 8802	8 { 8802	8 { 7798
9110	9 { 1829	9 { 9190	9 { 2807	9 { 9110	9 { 1009
7282	9 { 1009	9 { 8091	9 { 1829	9 { 9190	9 { 1829
0217	9 { 1929	9 { 9192	9 { 7908	9 { 9192	9 { 1929
0789	9 { 0789	9 { 7798	9 { 1929	9 { 9722	9 { 0789

If all entries consisted of only a single line, the two circuit arrangements just described would be all that would be required except for certain checks and safeguards that must be included. There are two general types of input tapes. One includes only bulk-billed calls, and its entries have either one or two lines. The other includes only detailed billed calls, and all its entries have five lines. There is no need for the sorter circuit to automatically distinguish between these two types of tapes, except to block and give an alarm if the wrong type of tape is inserted, since switches on the control panel are operated manually before the beginning of a sort to indicate the type of tape that is being used.

It is necessary, however, to distinguish automatically between one-line and two-line entries on the message unit tapes, and to perforate the two lines of a two-line

entry on the same perforator. With detailed billed calls, it is necessary to make sure that all five lines of an entry are perforated by the same perforator. These various types of entries are indicated by the A digit of the first line, and the sorter uses this index to guide its operating procedure.

On the message unit tapes the entry index of a one-line entry is 1, and when this entry index is encountered on a message unit tape, the circuit recognizes a one-line entry. When 2 is encountered as the A digit, the circuit recognizes a two-line entry, and the second line of the entry, which will have an A digit of 0, will be perforated by the same perforator. With detailed billed tapes, the entry index 1 of the first line indicates—as with message unit entries—the line that will determine which perforator to use, and all the following lines of the entry, which have 0 for the A digits, will be perforated by the same per-

forator. An A digit of zero always indicates a supplementary line with any type of entry and thus may be used as an indication that the same perforator should be used for recording it. In addition, however, a counting circuit is brought in to count the lines of an entry to make sure that the proper number of lines is recorded.

A very much simplified diagram indicating the over-all action of the sorter is given in Figure 4. Besides the translating circuits wired through contacts of the C, D, E, and F reading relays, already referred to, there are circuits wired through other

springs of all the reading relays that will be closed when two and only two of the B, C, D, E, and F group relays are operated, and when one and only one of the three relays of the A digit group are operated. These various check circuits are indicated in block form on the diagram.

When the cam-controlled reading fingers move in to read a line on the input tape, 11 of the 28 reading contacts will close (one for the A digit and two each for the B, C, D, E, and F digits). All the control contacts, marked P on the diagram, will also close as will the K contacts. Ground through the

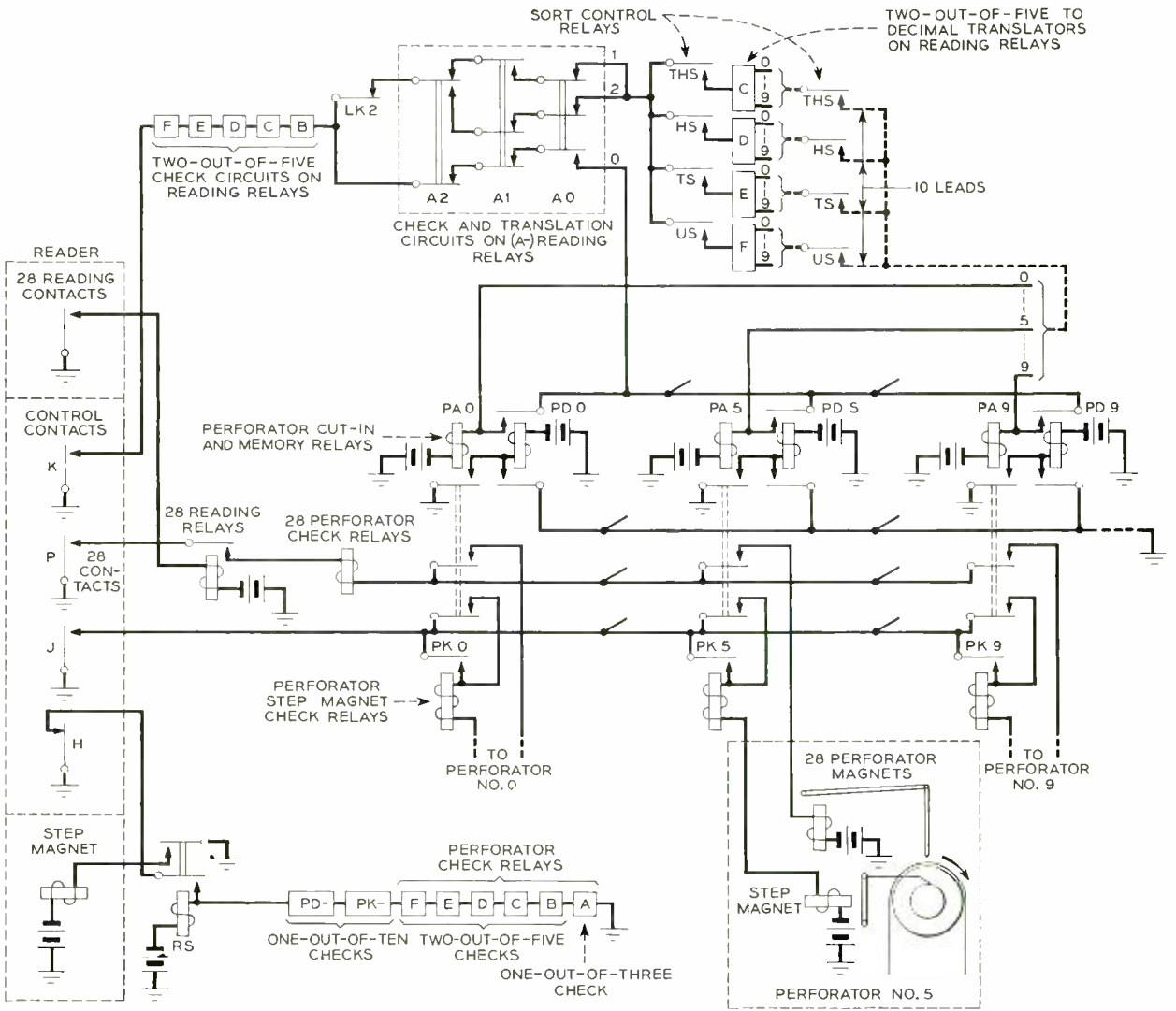
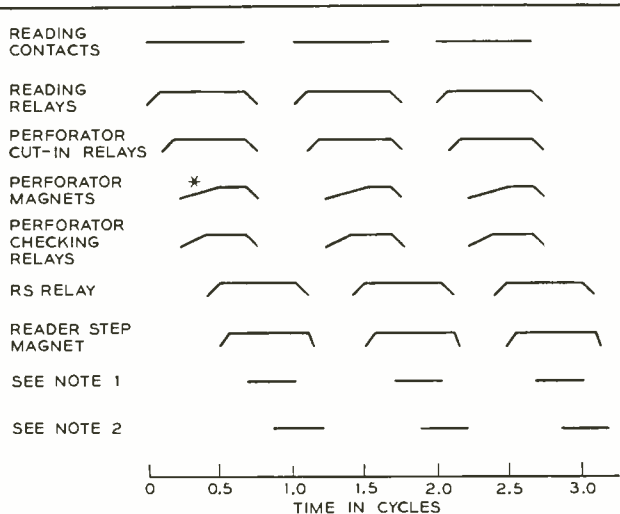

Fig. 4—Simplified schematic of the sorter.



* PUNCH MAGNET IS OPERATING AND PERFORATING PAPER.

NOTES:

1. READER DRUM STEPS DURING THIS INTERVAL PROVIDED STEP MAGNET HAS BEEN OPERATED.
2. PERFORATOR DRUM STEPS DURING THIS INTERVAL PROVIDED PERFORATOR ADVANCE MAGNET HAS PREVIOUSLY BEEN OPERATED AND IS PERMITTED TO RELEASE.

Fig. 5—Time diagram of the sorter operation.

κ contact will be passed through the check circuits on the springs of the reading relays, and, if the A digit is one or two, to the translation circuit on the reading relays for the digit that is to control the sorting. As a result, the ground will appear on the lead to the cut-in relay, PA, for the proper perforator. This operates the cut-in relay, and the proper perforating magnets will be operated from grounds on the control contacts P. Ground from the J contact of the reader passes through a spring on the cut-in relay, through a PK check relay, to operate the step magnet of the selected perforator.

In series with each perforating lead is a check relay, and the groups of check relays for each of the six digits of a line have circuits wired through their springs that will be closed only if the proper number of relays in each group is operated: two for the B, C, D, E, and F digits, and one for the A digit. The closure of these circuits indicates that current is flowing to the proper perforating magnets. As shown at the lower left of Figure 4, ground is passed through these check circuits, through a checking circuit on the PK relay that is closed if one and only one of the PK relays is operated, and through a similar check circuit on the

PD relays, to be described later, to operate the RS relay and prepare the reader for stepping to the next line. Relay RS locks itself operated until the next reading cycle begins.

The contacts of the reader are operated and released sixteen times a second by a power drive, and the circuit operations described above all take place in about 40 milliseconds. When the reading and perforating contacts open at the end of a reading cycle, the operated reading relays, the operated PA relay, and the perforating magnets release. Contact J of the reader, however, does not open until shortly after the other contacts, and thus the stepping magnet of the perforator is not released until after the perforating magnets have been released and the perforating pins have had time to withdraw from the tape. A time diagram showing the operation of the various relays for a succession of reading cycles is given in Figure 5.

To take care of multiple line entries, a PD relay is associated with each PA relay and is operated by it. If a message unit tape is being sorted and the entry index of the line being read is a 1, the PD relay will release when its associated PA relay releases, and the circuit action will be as described above. If the entry index had been a 2, however, indicating a two-line entry, the holding ground for the PD relays would have been closed by circuit elements not shown, and the LK2 contact, shown at the upper left of the diagram, would have opened as the reader stepped to the next

TABLE II— KEY TO THE "2-OUT-OF-5" TO DECIMAL TRANSLATION

<i>Pair of Holes Perforated in Tape</i>	<i>Corresponding Decimal Digit</i>
0 and 1	1
0 and 2	2
1 and 2	3
0 and 4	4
1 and 4	5
2 and 4	6
0 and 7	7
1 and 7	8
2 and 7	9
4 and 7	0

line. Because of its holding circuit, relay PD would therefore remain operated after its PA relay had released. This in no way affects the perforation of the line just read, but when the reader contacts close on the next line, the path to the translation circuit is opened at contact LK2. If the A digit of this next line is 0, however, as it normally would be, a circuit through the check circuit on the A reading relays will be closed, and over it the same PA relay will be operated through a front contact of its associated PD relay that had been held operated. A similar action takes place when sorting entries of a detailed message tape. In both cases, the counting circuit already referred to counts the lines, and after the proper number has been recorded, the PD and LK2 relays are released, and the sorter is ready for a new entry.

Besides the checking circuits described above, others are so arranged that troubles encountered in reading the input tape, whether sorter troubles or mutilations in the tape, prevent a perforator cut-in relay from operating. The sorter stops and sounds an alarm, and the operator can read the line on which it stopped by means of twenty-eight reading lamps associated with the reader to determine whether the tape or the sorter is at fault. When a line is read properly, but because of some other trouble it is not properly perforated, the RS relay fails to operate and the sorter stops. In this case, since perforation has taken place, the perforator step magnet is prevented from releasing until the trouble is

corrected. This guards against the repetition of any line on the output tape and is an important safeguard. As a further precaution, this feature of the sorter is automatically checked at the beginning and end of each sorting stage. Other lamps are provided on the control panel to assist the operator and the maintenance personnel in the event of trouble. When a stoppage occurs, the operator is able to tell immediately whether it was caused by a faulty input tape or by an internal sorter trouble which requires maintenance action. In the latter case, the lamps give an adequate indication to the maintenance personnel of the exact nature of the trouble.

Every AMA tape has a section of "splice pattern" at each end. This is a series of identical lines conveying no information, used to permit feeding the tape into the reader and to permit splicing without interfering with call entries. Between the call-entry section and the splice pattern at each end of the tape is a series of "tape identity" entries which completely identify the tape as to central office, date, type of tape, and the stage in the accounting process where it was produced. All this information is automatically checked by the sorter by matching it with the switches on the control panel set by the operator, to insure that the proper type is being used. When the input tape to the sorter consists of a number of sections spliced together, the sorter counts the sections, checking that they are all present and that they have been spliced in the correct order.

THE AUTHOR: F. N. ROLF has been a member of the Switching Development Department since joining the Laboratories in 1937, except during World War II when he was engaged in radar development. At present he is designing circuits for AMA. His earlier work was on crossbar tandem switching circuits, AMA, and the No. 1 crossbar system. Mr. Rolf received a B.S. degree in Engineering from Haverford College in 1935 and a B.S. degree in E.E. from Massachusetts Institute of Technology in 1937.





LOADS OF PULL

A permanent magnet so powerful that it can lift forty times a man's weight in iron, is among the latest additions to electronics research at Murray Hill. P. P. Cioffi, who is seen probing its field with a fluxmeter search coil in the above illustration, developed this unusual magnet to supply the intense field needed to guide electrons in experimental traveling wave tubes. The big advantage of a permanent magnet is that it doesn't require the large currents which are needed to energize electro-magnets.

A feature of the magnet is the exceptional uniformity of the field between its poles. Inserted in this uniform field, a steel rod balanced on a roller does not move toward one of the poles, as would happen in a conventional magnet, but remains delicately poised between them. This uniformity is achieved by means of the horizontal plates which are seen connecting the poles above and below the rod. Serving as flux guides, the plates determine the direction and intensity of the field between them. With each tapered in thickness from the end toward its center, the plates become uniformly magnetized and produce a field of uniform intensity in the space that is between them.

For a travelling wave tube the magnet supplies a field of the intensity and uniformity necessary to focus an electron beam. The flux guides are spaced to accommodate the waveguides of the radio frequency circuit of a tube.

The two 65-pound, semi-circular sections of Alnico which compose the new magnet were cast and processed under the direction of D. H. Wenny, in Murray Hill's metallurgical laboratory.

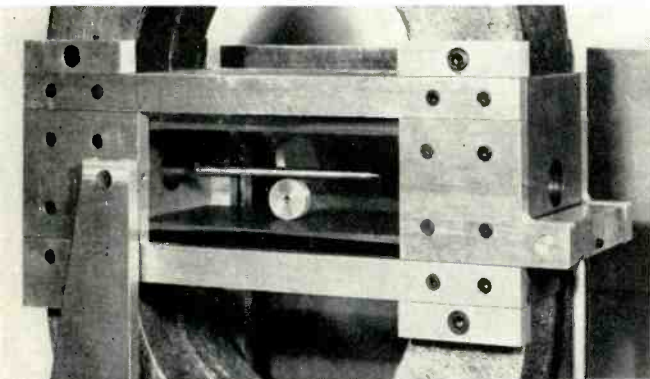

Supported by a roller a steel rod stands motionless between the poles of the magnet.

Dr. Buckley Resigns as Chairman of Science Advisory Committee

Effective June 1, Dr. O. E. Buckley, former President and now Chairman of the Board of the Laboratories, resigned his post as Chairman of the Science Advisory Committee of the Office of Defense Mobilization on the advice of his physician. Dr. Buckley will continue to serve as a member of the Committee and as a consultant to the ODM.

President Truman has appointed Dr. Lee A. DuBridge, President of the California Institute of Technology, to succeed Dr. Buckley, and he has also named Dr. J. B. Fisk,

importance, particularly as they relate to the national defense program.

Regretfully accepting Dr. Buckley's resignation of the chairmanship, President Truman wrote that he was happy that Dr. Buckley could continue to serve as a member of the Committee.

President Truman's letter to Dr. Buckley continued in part: "The value of the service you have rendered in this position of high responsibility is greatly appreciated by the Defense Mobilization Director and myself. In addition to the many construc-



O. E. BUCKLEY



J. B. FISK

Director of Research in Physical Sciences of the Laboratories, as a member of the Committee. Other members of the Committee are Dr. Detlev W. Bronk, Dr. James B. Conant, Dr. Hugh Dryden, Dr. James R. Killian, Dr. Robert F. Loeb, Dr. J. Robert Oppenheimer, Dr. Charles A. Thomas, Dr. Alan Waterman, and Dr. Walter Whitman.

The Science Advisory Committee was established more than a year ago to be available to the President and Director of ODM for advice on broad matters of scientific

tasks you have performed for the Office of Defense Mobilization, you have established a pattern for an advisory committee that has given valuable help and promoted cooperation. It has done this in a way that has won the favor of all the operating Government agencies with which you have dealt. Evidence has come to me that it has also won the favor of scientists generally.

"For what you have done in the service of your Government, I give you my wholehearted thanks . . ."

E. C. Molina Honored by Newark College of Engineering

E. C. Molina, who retired as Switching Theory Engineer January 1, 1943, received the honorary degree of Doctor of Science from the Newark College of Engineering June 6. The degree was presented "in recognition of his inventive capacity, world-renowned accomplishments in mathematics, scientific writings, and scholarship."

Dr. Molina joined the Inspection Depart-



E. C. MOLINA

ment of the Western Electric Company in 1898, which at that time was at 463 West Street. In 1901, he transferred to the Engineering Department of the A T & T and four years later transferred to the Circuit Design Department where he engaged in the design of circuits for automatic telephone systems. Among his important contributions in this field was the development of a translating system that permitted lines designated on a decimal basis to be interconnected by switches functioning on a non-decimal basis. In 1919 he transferred to the Department of Development and Research to take charge of the application of the theory of probability to trunking problems. When this department was consolidated with the Laboratories in March, 1934,

he returned to the West Street building.

On his retirement, Dr. Molina undertook a variety of complex mathematical problems (largely classified) for the National Defense Research Committee. Since the war, he has occupied a lectureship at Newark College of Engineering.

Through self-study of mathematics and physics, Dr. Molina contributed notable inventions and has attained world-wide recognition in the field of mathematical probability. He is a pioneer in the application of mathematical probability to the design of machine switching central offices, and the economic provision of equipment and trunking facilities in communication systems. He is a recognized world authority on the works of Laplace and Poisson in classical probability; an authority and champion of Bayes and Laplace in the theory and application of inverse probability; and the maker of the comprehensive and widely used Poisson Tables.

Shewhart Medal Awarded to G. D. Edwards

At the sixth annual convention of the American Society for Quality Control, held May 22-24 in Syracuse, the Shewhart Medal was presented to G. D. Edwards "in recog-



G. D. EDWARDS

Bell Laboratories Record



Mr. Craig Awarded LL. D. Degree

With the historic columns of the original administration building as a background, four Bell System presidents re-live old school experiences at the University of Missouri. The occasion was the school's 110th annual commencement exercises. Left to right: E. J. McNeely, Northwestern Bell Telephone Company; Cleo F. Craig, American Telephone and Telegraph Company; M. J. Kelly, Bell Telephone Laboratories; and W. V. Kahler, Illinois Bell Telephone Company. The commencement address was delivered by Mr. Craig, who also received an honorary Doctor of Laws degree.

...nition of his contributions to the science of quality control as a director of basic pioneer development work; his expert guidance of the war-time program which resulted in widespread introduction of new acceptance quality control procedures in military procurement; and his leadership in organizing the American Society for Quality Control and in developing it into a strong professional society. His many activities have contributed heavily to the advancement of quality control as a new engineering profession."

In his response to the presentation, Mr. Edwards spoke on *Some Basic Concepts of Quality Control*.

Established by the A. S. Q. C. for outstanding leadership in the field of modern

quality control, the first medal was struck in honor of W. A. Shewhart and presented to him at the Boston Convention in May, 1949. In June, 1950, the medal was presented to H. F. Dodge, and now Mr. Edwards has been similarly honored. The Society was founded in 1946, and during the first two years of its existence, Mr. Edwards was President.

Also at the Syracuse meeting, E. B. Ferrell presented a paper entitled *The Technique of Preventing Defectives*. Mr. Ferrell is a National Director of the Society and Vice-Chairman Elect of the Metropolitan Section. Presiding at the meeting when Mr. Ferrell presented his paper was C. E. Fisher, Field Engineer, St. Louis, who is also a National Director of A.S.Q.C.

W. E. Kock Honored

W. E. Kock, Director of Acoustics Research, was awarded the honorary degree of Doctor of Science by the University of Cincinnati at the University's commencement exercises in June. Dr. Kock holds two degrees from the University of Cincinnati and a Ph.D. from the University of Berlin. Before coming to the Laboratories, he was a teaching Fellow at Cincinnati, a Fellow of the Indian Institute of Science, and Director of Electronic Research for the Baldwin Piano Company. He is a member of the American Institute of Physics, and a Fellow of I. R. E. and of the Acoustical Society. He joined the Laboratories in 1942 and has been in charge of acoustics research since 1948.

ASA Host to International Standards Organization

During the weeks of June 2 and June 9, the American Standards Association played host to delegates of the International Standards Organization in New York City. The meetings of the delegates were held June 11-14, at Columbia University.

Representing the United States at the meetings was a Subcommittee of ASA Sectional Committee B1, known as Subcommittee 11 on International Co-operation with the ISO. A. C. Millard represented the telephone group on Subcommittee 11.

During the week of June 2, Subcommittee 11 held meetings with the British and Canadian delegates to formulate common ideas and views for presentation to the ISO.

American Physical Society Meeting

A number of Laboratories engineers and scientists took part in the Washington Meeting of the American Physical Society held May 1, 2, and 3. Presiding at some of the sessions were J. B. Fisk at the session *Entropy and Information*; A. H. White at the Symposium of the Division of Electron Physics on *Unusual Electron Physics*; S. Millman at the session on *Molecular-Beam Experiments — Paramagnetic Resonance*; and J. A. Hornbeck at the session *Electron Physics—Including Gas Discharges*. Among the papers presented were the following:

High Field Mobility in Germanium with Impurity Scattering Dominant, by Miss E. M. Conwell and E. J. Ryder, presented by Miss Conwell; *The Electrical Properties of Silicon p-n Junctions Grown From the Melt*, by K. B. McAfee and G. L. Pearson, presented by Mr. McAfee; *Silicon p-n Junction Diodes Prepared by the Alloying Process*, by G. L. Pearson and P. W. Foy, presented by Mr. Pearson; *Ionization and Dissociation of Diatomic Molecules by Electron Impact*, presented by H. D. Hagstrum at the *Symposium on Chemical Physics; Measurement of Magnetostriction in Single Crystals*, by R. M. Bozorth and R. W. Hamming, presented by R. M. Bozorth; *Surface Properties of Germanium*, an invited paper by W. H. Brattain; and *Germanium and Silicon Single Crystals* by G. K. Teal.

Conference on Standards

During the week of June 2, while the International Standards Organization was meeting in New York, representatives of America, Britain and Canada met to consider standardization of screw threads, machine fits and drafting practices. This was a continuation of the Ottawa Conference on the same subject, which was held in 1945. The three countries signed an accord for the unification of screw threads in November, 1948.* It is proposed to continue this work to include Acme and Buttress threads, pipe threads, gas cylinder threads, cylindrical fits and drafting standards. This meeting was attended by representatives of the various government departments and the national standardizing bodies of each of these countries; namely, the British Standards Institution, Canadian Standards Association, and the American Standards Association. The American Society of Mechanical Engineers also participated. The meeting was called by Dr. John Steelman of the Office of Defense Mobilization and the detailed planning and arrangement of agenda were in charge of Dr. E. C. Crittenden of the National Bureau of Standards and J. R. Townsend. Mr. Townsend is Consultant to the Director of the ODM and Chairman of the Standards Council of the ASA.

* RECORD, March, 1952, page 10.

The Bell System's Largest Patent

The patent on a code translator and printer described in the November, 1950, issue of the RECORD as one of the "longest patents on record" has now been ousted from its place in the limelight. The new champion is the patent covering the number five crossbar system, comprising 238 sheets of drawings and 218 columns of printed matter.

As may be seen in the photo, the actual patent is a large-sized book of 347 pages, with the usual decorative cover of United States Patents. Not merely a few prosaic sheets of printed matter, a patent is a nicely bound book of drawings, specifications, and claims. The cover is the Letters Patent, complete with seal.

Miss Cordelia Mattice was the patent attorney responsible for the preparation of the application for this patent. Since the patent covers the entire crossbar system, it is quite comprehensive and the preparation of the application required the better part of a year.

Technical Papers in July B.S.T.J.

The July issue of *The Bell System Technical Journal* contains the following papers: *Network Synthesis using Tchebycheff Polynomial Series*, Sidney Darlington.

A Carrier Telegraph System for Short-Haul Applications, J. L. Hysko, W. T. Rea, and L. C. Roberts.

The Type-O Carrier System, Paul G. Edwards and L. R. Montfort.

Efficient Coding, B. M. Oliver.

Statistics of Television Signal, E. R. Kretzmer.

Experiments with Linear Prediction in Television, C. W. Harrison.

Generalized Telegraphist's Equations for Waveguides, S. A. Schelkunoff.

Photoelectric Effect of Ionic Bombardment of Silicon, E. F. Kingsbury and R. S. Ohl.

The RECORD to be Microfilmed

Bell Telephone Laboratories has recently entered into an agreement with University Microfilms, Ann Arbor, Michigan, to make available to libraries issues of the RECORD

July, 1952

in microfilm form. One of the most pressing problems facing all types of libraries today is that of providing adequate space for a constant flood of publications. Periodicals pose an especially difficult problem because of their bulk and number. Microfilm makes it possible to produce and distribute copies of periodical literature on the basis of the entire volume in a single roll at a cost ap-

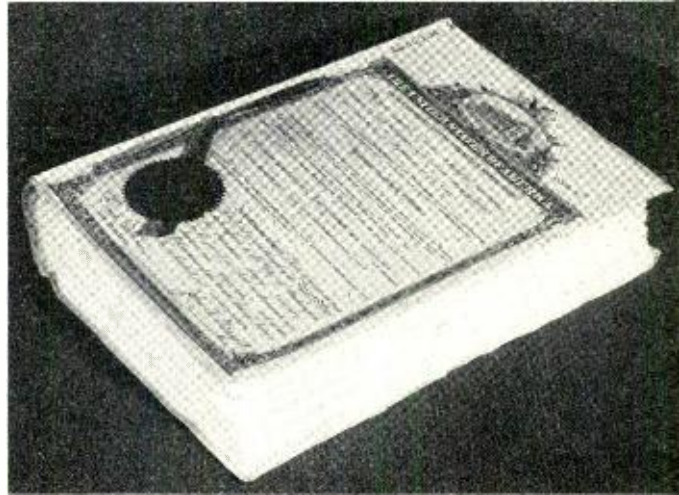

This patent comprises 238 sheets of drawings and 218 columns of printed matter.

proximately equal to the cost of binding the same material in a library binding.

Under the plan, the library keeps the printed issues unbound and circulates them in that form for from two to three years, which corresponds to the period of greatest use. When the paper copies begin to wear out or are not called for frequently, they are disposed of and the microfilm is substituted. Inquiries concerning purchase should be directed to University Microfilms, 313 North First Street, Ann Arbor, Michigan.

Scientific Rehabilitation of Equipment

Each year some one hundred million dollars' worth of equipment going into the Bell System plant, or about one tenth of the total "Plant Additions," has seen service before. It has been made satisfactory for re-use, however, by scientific rehabilitation carried out principally in the Western Electric Company Repair Shops. To this very great extent the heavy load on the produc-

tion lines for new apparatus is lightened without lowering the high quality standards required for Bell System service.

The Laboratories have a part, albeit a small one, in this work of insuring the dependability of re-used plant, in that requirements governing the condition of recovered and repaired apparatus and equipment, and many aspects of the maintenance of the equipment, are developed by the Laboratories. Our part in this large scale rehabilitation of equipment will be discussed in a future issue of the RECORD.

Out-of-Hour-Lecture

The seventh in the series of informative lectures given during the past fall and spring to acquaint employees with Laboratories activities was given by E. L. Getz at West Street on April 21, Whippany, April 22, and Murray Hill, April 24. The subject was *Nationwide Customer Dialing—Englewood, New Jersey, Trial*. This lecture reviewed the purpose of this pilot installation, the planning for it, and the necessary arrangements. Inauguration of the new service took place in November, 1951, whereby telephone subscribers in Englewood, served by a No. 5 crossbar office, are now able to dial directly to San Francisco and a number of other cities in various parts of the United States. Mr. Getz described these various activities and illustrated the results of the trial, using slides.

R. M. BURNS addressed the Phi Beta Kappa Association of Northern Ohio at their annual meeting April 28 in Cleveland. The title of his address was *Science and Scientists in Telecommunication*. Dr. Burns traced the history of the developments in communication, stressing the importance of basic achievements in science that have contributed to the rise of modern technology. Until the 17th century, experimental science was practically unknown, but from that time on an increasing interest in experimental observation has led to modern science as we now know it. Experimentation and theoretical explanation—not always by the same minds—have made possible the remarkable growth of present-day technology. Dr. Burns also stressed the importance of the widely varied fields of science

and engineering communication developments. Emphasizing the serious shortage of trained scientists, Dr. Burns urged that qualified young students be encouraged to embark on scientific careers, and that their interest in science be sustained by modernized and properly presented curricula.

R. L. TRENT spoke on *Transistors* at a dinner meeting of the New York Alumni Chapter of Eta Kappa Nu, May 21. In his talk, Mr. Trent described how transistors are made, and how they are used in circuits, accompanying his remarks with demonstrations of their use in oscillators and amplifiers. A question and answer period followed his lecture.

Laboratories Patents

(Continued from page 298)

- 2,594,019 Current Supply Apparatus, E. W. Holman.
- 2,594,078 Electronic Marker for Cathode-Ray Indicator Tubes, R. R. Scoville.
- 2,594,087 Radio Receiver Selection System, R. O. Soffel.
- 2,594,300 Space-Pulse Type Impulse Sender, K. S. Dunlap and C. A. Lovell.
- 2,594,325 Spaced Pulse Impulse Sender, C. A. Lovell.
- 2,594,336 Electrical Counter Circuit, M. E. Mohr.
- 2,594,389 Double-Lockout Interconnecting System, E. Bruce.
- 2,594,409 Directive Antenna, C. B. H. Feldman.
- 2,594,449 Transistor Switching Device, R. J. Kircher.
- 2,594,495 Magnetic Recording System for Call Data in Automatic Telephony, J. B. Retallack.
- 2,594,505 Calling Line Identification and Registering System, F. J. Scudder and E. Vroom.
- 2,594,530 Amplifying System, C. H. Young.
- 2,594,890 Contact Protection Arrangement, W. B. Ellwood.
- 2,594,897 Cathode Structure for Electron Discharge Tubes, L. M. Field.
- 2,594,923 Call Data Recording Telephone System, R. E. Hersey.
- 2,594,949 Preset Type Impulse Sender, J. J. Madden.
- 2,594,993 Telegraph Hub Electronic Loop Repeater Circuit, W. T. Rea.
- 2,595,106 Recording Telephone System, F. J. Scudder.
- 2,595,163 Electronic Voltmeter Test Circuit for Measuring High-Resistance Leaks, W. E. Niederau, D. Ritchie, Jr. and P. L. Wright.
- 2,595,208 Transistor Pulse Divider, J. T. Bangert.