



Fig. 1—A B-17 Flying Fortress of the Air Sea Rescue unit of the U. S. Air Force parachutes a life-boat to personnel in distress. A split instant after this photograph was taken the line connecting the plane to the boat activated the parachute. Dispatching such flights as the above is one of the many uses of the Military Flight Service Network.

*Military Flight service network**

W. O. ARNOLD *Switching Engineering*

In 1946, the Bell System installed the military flight service network, which consists of over 20,000 miles of private four-wire telephone lines. This coast-to-coast network is operated by the United States Air Force to coordinate and control the movements of military aircraft. As such, it is an outgrowth of a similar network[†] furnished for the Civil Aeronautics Administration to regulate civil and commercial air traffic.

Need for this new network arose immediately after World War II, when our air forces returned to the United States from their war stations. As the number of military aircraft flying out of home bases multiplied, it became increasingly apparent that the prob-

lems of handling military aircraft differed considerably from those of nonmilitary aircraft. The principal differences were that military aircraft must be capable of dispatch to any destination without regard to charted airways, and that the varying types of missions flown by the Air Force require a more intricate traffic control pattern. A rescue mission employing helicopter aircraft would be dispatched in a manner entirely different from that of a flight of F-80 Shooting Stars on a cross-country training mission.

For military flight control, the country is divided into nine military flight service areas, with each area being controlled by a Military Flight Service Center. These centers are interconnected by a teletypewriter network over which most of the messages to distant centers are transmitted. The four-wire telephone network described here

* This article has been approved for publication by the U. S. Air Force. All photographs courtesy of the U. S. Air Force.

† RECORD, November, 1949, page 394.

serves primarily to connect the various flight service centers to the airbases, radio stations, and CAA Air Route Traffic Control Centers in their territory, but switching facilities are provided to permit the network of one area to be connected to that of an adjacent area when occasion demands. To this extent, the four-wire network takes on the characteristics of a nationwide system.

Initially, the military flight service network was arranged to operate more or less independently of the CAA air route traffic control network. Operating experience, however, soon indicated that because of the increased speeds of the modern jet aircraft, closer coordination of flight clearances between the military and civilian air traffic control agencies was required. This coordination was achieved by providing new two-point private lines, known as "interservice

lines," between the military flight service centers, and the nearest CAA regional air route traffic control centers. These new four-wire private lines connect each of the military flight service centers to one or more CAA air route traffic control centers, and are arranged to be switched to the multistation lines of the military flight service network.

A formalized diagram of the four-wire network associated with one flight service center is shown in Figure 2. There may be as many as ten four-wire multistation lines radiating from the flight service centers to the various locations in the area, and each line may be connected to as many as ten stations—either airbases or radio stations. In addition, there may be as many as five interservice lines to CAA air route traffic control centers, and one "on the field" circuit which connects the flight service center to stations on the field

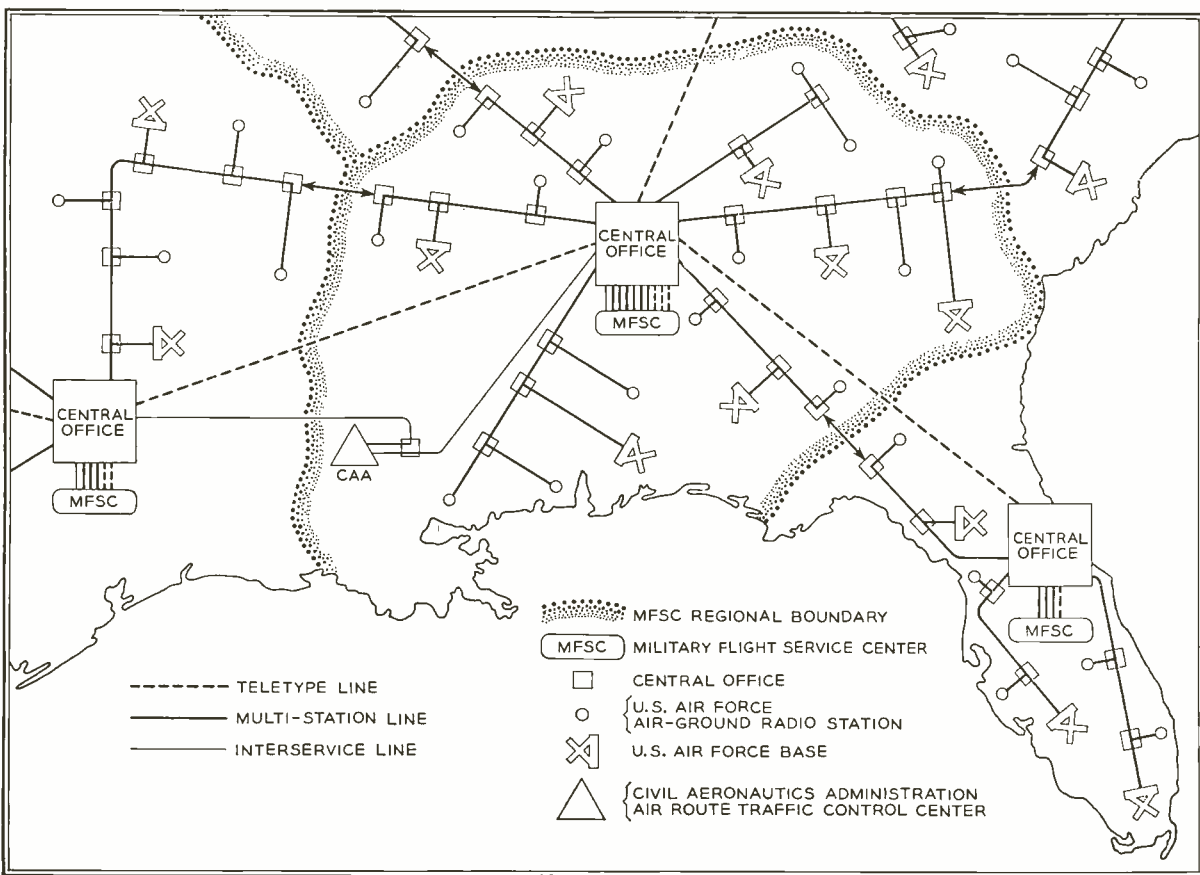

Fig. 2—Formalized diagram of the four-wire network associated with one flight-service network.

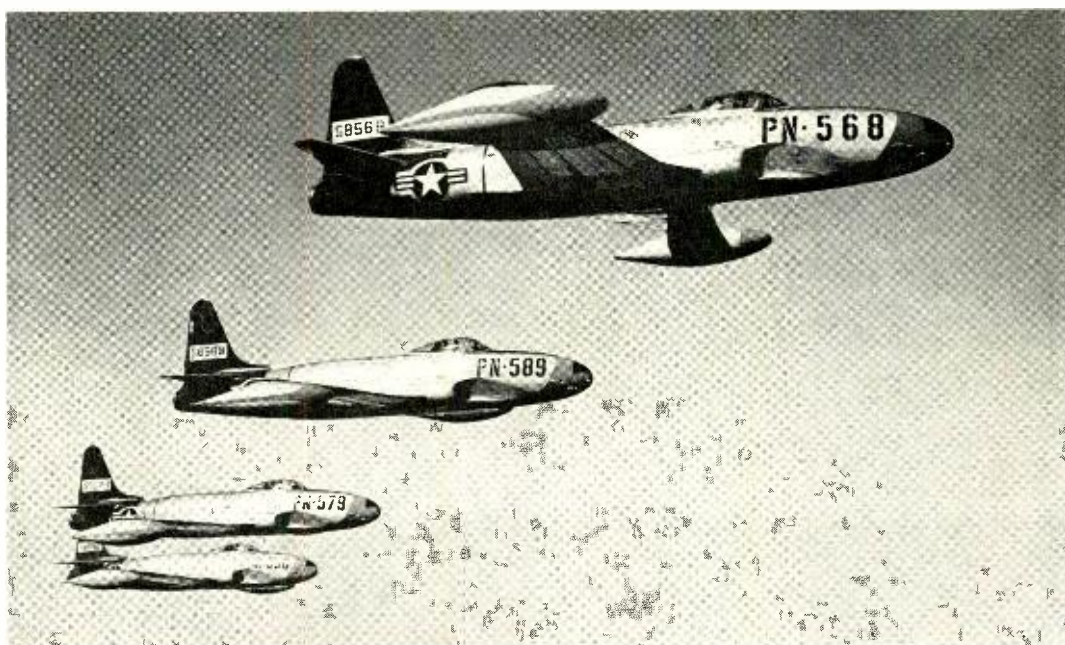

Fig. 3—A flight of P-80 Shooting Stars of the 94th Fighter Squadron—a unit of the Tactical Air Command's First Fighter Group.

(airbase) at which the service center is located. All connections to the backbone, and all switching connections are made at central offices through which the lines pass. For the most part, however, switching is done only at the central office nearest to the flight service center. The only exceptions are offices near the border of an area where provision is made for connecting a multistation line of one area to a similar line of another area. At the central office associated with the service center, however, a switching array, under control of the flight service center, permits any of the multistation lines to be connected to any of the interservice lines. To accomplish these switches, all the four-wire lines are connected to four-way bridges, which extend the line through the central office, and permit two drops from it—one for the station loop, and one for the switching array. At central offices where no switching is done, the last-named drop is not used and is terminated in an impedance.

At the flight service center, each of the attendant's positions is equipped with a key box similar in appearance to that of the 101 type key equipment,^o and this, together with

the switching equipment at both the central office and the service center, comprises the 102A key equipment. Since each of the five keys in this unit may be operated to either of two positions, it is used to give access to two lines, and thus the complete unit serves ten lines. When more than ten lines are required, additional units are installed. Busy lamps are associated with each key position, and remain lighted while a line is in use. To place a call, the attendant merely operates the appropriate key in the proper direction and then over his handset calls the name of the station or the person wanted. All stations on the line, except those at the flight service center, are equipped with loudspeakers, and thus all hear the call. When the call is answered, the loudspeaker is cut off, and conversation is held by handset. Loudspeakers are not employed for calling into the service center or into the CAA air traffic control centers. An incoming call to these centers is signalled by ringing, and is indicated by a flashing of the line and busy lamp of the calling line.

The switching plan provides for connecting arrangements at both the central office, and the flight service center. Switching between an interservice line and a multista-

^o RECORD, August, 1937, page 370.

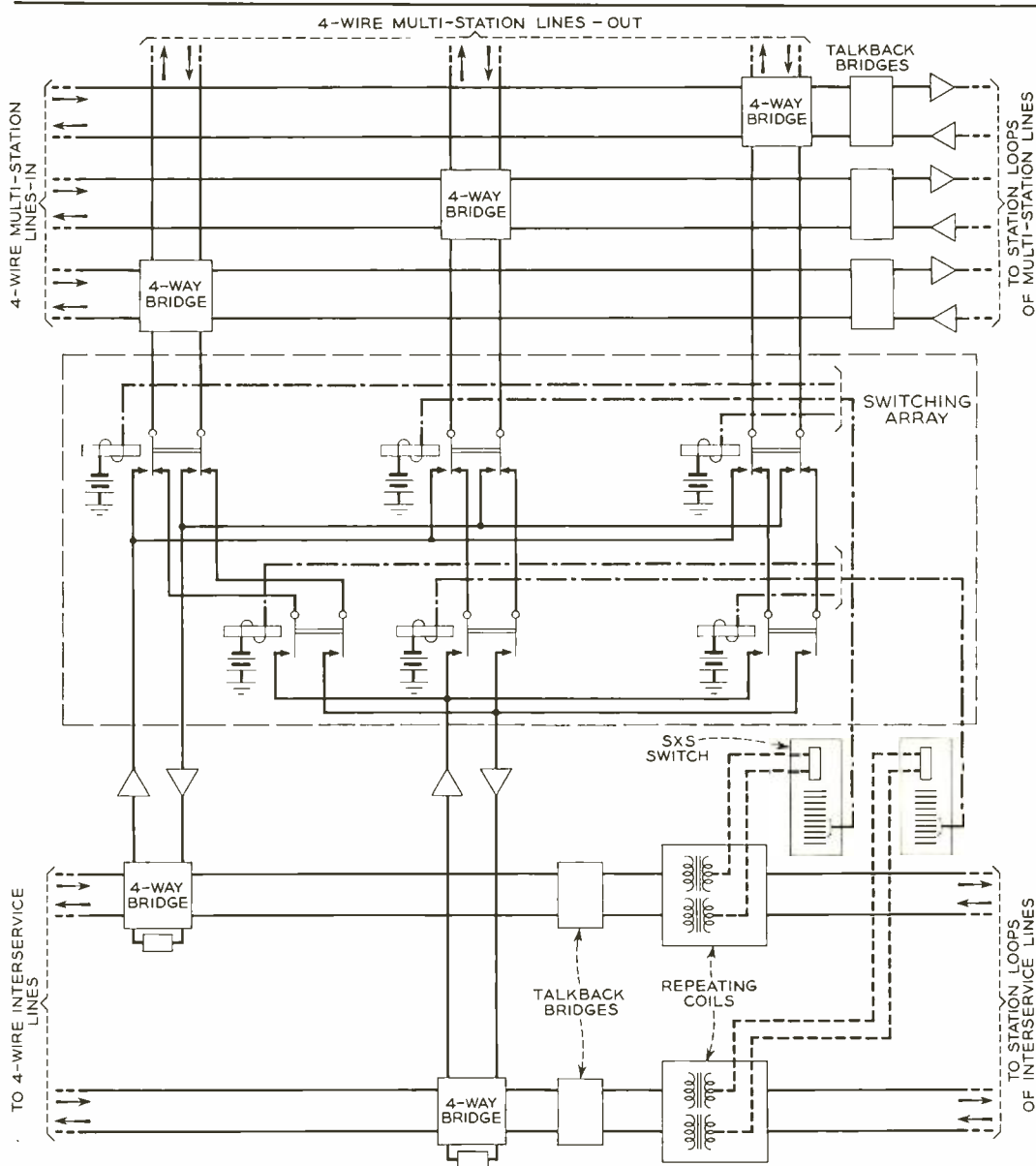

Fig. 4—Simplified schematic diagram of circuit at a central office where switches are made between multistation and service lines.

Fig. 5 (on opposite page)—Simplified schematic diagram of circuit at the flight service center.

tion line is accomplished at the central office by the step-by-step selectors indicated in Figure 4. These selectors, which are associated with the interservice line, complete a switched connection by operating a relay in the switching array. This, in turn, connects the switching drops of the respective four-way bridges together. The selectors are op-

erated, over a phantom derived from the interservice line, by dial pulses from the attendant's positions at the flight service center.

Similar step-by-step selectors, indicated in Figure 5, are used at the flight service center to augment the busy lamps in the key boxes for the multistation line to which the

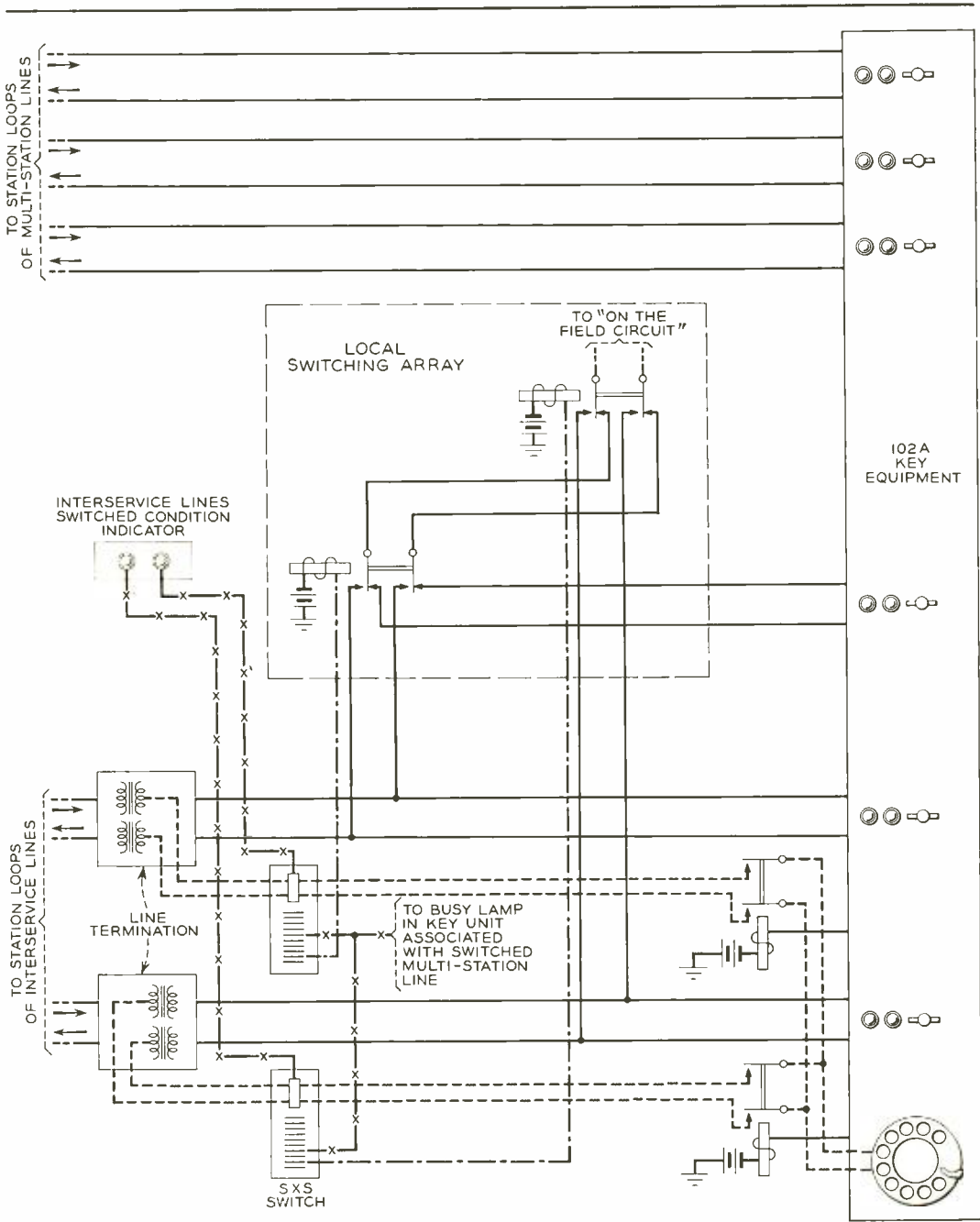

interservice line is switched, by lighting one of a centrally located group of "switched condition" indicators whenever an interservice line has been connected to a multistation line, and also to switch the "on-the-field" circuit to an interservice line. Two associated step-by-step selectors, one at the service center and one at the central office, are operated

simultaneously by the dial; one makes the switch at the central office and the other lights the busy and switched condition lamps at the flight service center. When the code of the "on-the-field" line is dialed, the interservice line is switched to the "on-the-field" line at the service center. During this period, the selector at the central office is operated

to an idle bank terminal, signifying that an interconnection is not desired at the central office.

Approximately 350,000 messages relating to flight movements are handled each month by the military flight service network. These messages may be delivered directly to the aircraft via air-ground radio, or to the air base that is the destination of the aircraft. A typical message includes such information as: the type and serial number of the aircraft, its point of departure, method of flight, destination, air speed, departure time, en route time, fuel aboard, and pilot's rating.

For example: Air Force B-25-0247—from Paterson VFR to Cleveland, thence airways to Mitchell, air speed 210, departure 1300E, en route 5, fuel aboard 9, pilot's rating 30.

This message would be filed by a pilot at the local Operations Headquarters after the pilot had carefully checked all factors pertaining to the flight. The pilot, in this instance, decided to dogleg his flight, proceeding under visual flight rules cross-country to Cleveland, and thence along the CAA airways to Mitchell Air Force Base. Operations at Paterson Air Force Base on reading this message would call the Paterson Military Flight Service Center over his "on-the-field" line, and ask for a connection to the nearest CAA air route traffic control center, which is at Cincinnati.

The attendant at the military flight service center thereupon tells Paterson operations to stand by, and selects the interservice line to Cincinnati. He dials the number of the "on-the-field" line. After dialing is completed,

the "on-the-field" line is switched to the interservice line, and a three-party conversation ensues between the CAA air route traffic control center, the military flight service center, and operations. Operations then relates the movement message to both services simultaneously. On receipt of the message, CAA checks for clearance at Cleveland for the Cleveland to Mitchell leg of the flight via the airways. CAA at Cleveland clears the flight to the airways at 1420 E.S.T., and requests the aircraft to report on arrival over Cleveland marker. This message is relayed by CAA-Cincinnati to military flight service, who in turn clears take-off time as 1300 hours. The pilot and crew having prepared their aircraft for take-off may be standing by on the taxi strip when the clearance arrives. In that event, operations would call the control tower operator who would call the pilot via air-ground radio to give him clearance and take-off instructions.

After the flight has cleared and is airborne, the military flight service proceeds to send the message to the flight service center nearest to the point of destination. The message is again relayed from this military flight service center to the aircraft's point of destination by calling over the multistation line. Thus, with the planning phases of this flight now completed, we have some idea as to the function of the military flight service network, and the associated problems which the Laboratories considered in order to provide a rapid means for extending this network to the CAA Air Route Traffic Control Network by four-wire switching.



THE AUTHOR: W. O. ARNOLD received his S.B. degree from M.I.T. in 1937 and the M.S.E.E. degree the following year. In 1941, after almost three years of teaching electrical engineering at Cooper Union, he entered the Army. As an officer, he developed facilities for defense against enemy air attack. Overseas, he was associated with the U. S. Air Force units that supported Montgomery's 8th Army in driving Rommel's Panzers from the African desert. It was this field experience which later permitted him to return to the Air Forces' Watson Laboratories, where he was associated with the development of new communications and navigational facilities for the Air Forces. Since 1945, when he became a member of the Technical Staff of the Laboratories, he has been planning new developments for PBX and station systems. Many of these developments, as exemplified by this article, have been for the air transportation industry.

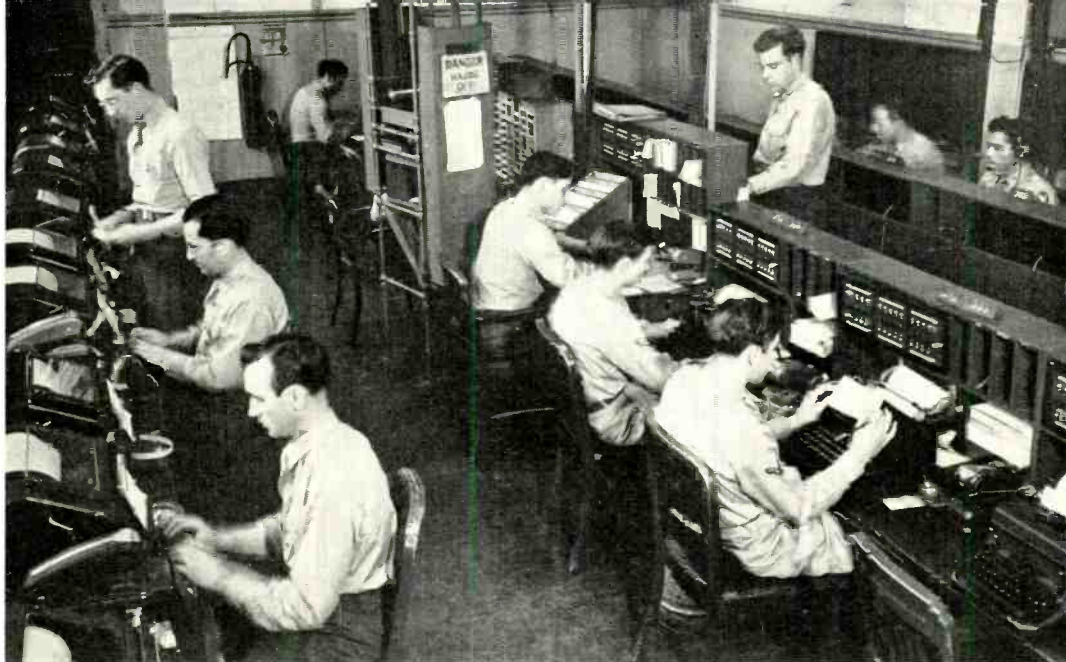
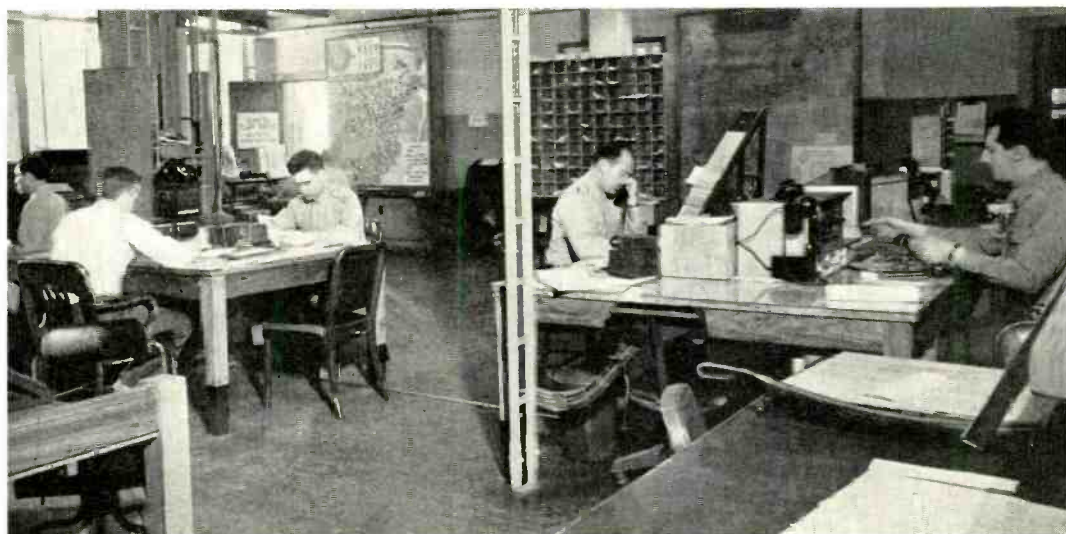

Fig. 6—Two Views of the Olmsted Flight Service Center

The communications section, above, is provided with teletypewriter and telephone facilities for receiving and filing flight movement messages as described in the accompanying article. After the movement message, or flight plan as it is commonly called, has been accepted, the aircraft is cleared for take-off, and "Communications" then relays the flight plan to the communications section of the flight center having jurisdiction over the aircraft destination. The 102A key equipment can be seen on the shelf in front of the position attendants. Although

the dials are not visible, these positions also control the switching of interservice lines to multistation lines.

If the flight plan is not in acceptable form on receipt at the center, or if, for some reason, it must be changed after the aircraft has become airborne, the movement message is sent, by belt conveyor, or messenger, to the flight service section, shown below. This group consists of experienced pilots who from their expert knowledge of flying conditions can make split second decisions when an emergency arises.



Metallized paper capacitors

R. K. EVENSON
*Transmission
Apparatus
Development*

Among recent developments which are contributing importantly to the reduction of apparatus size and cost in the Bell System is the metallized paper capacitor. In the past the low voltage capacitors which constitute the bulk of the use in the telephone plant have consisted of metal foil electrodes separated by two or more sheets of paper. The new metallized paper type employs lacquered paper with an electrode deposited on one side in the form of a very thin metal film.* A capacitor unit is made by winding two such sheets together so that the electrodes are separated by a single thickness of paper. As illustrated in Figure 2 the resulting capacitor units are, depending on the operating voltage, as small as 25 per cent the size of their counterparts of conventional construction with the same impregnant. For example, in the new 500-type telephone set, the use of metallized paper construction has reduced the size of a talking capacitor unit by about 65 per cent, releasing valuable space for other apparatus.

In the older type capacitors a dielectric failure punctures the paper to produce a permanent short-circuit. To insure safe operation, therefore, the paper thickness and number of sheets are built up sufficiently to make failure unlikely. When failure occurs in a metallized paper capacitor, the thin metal film electrode is removed from the defective areas in the paper without serious damage to the paper. The capacitor is, therefore, self-healing. For this reason a single layer of lacquered and metallized paper is sufficient for many low-voltage uses in the telephone plant in place of the two



Fig. 1—Vacuum vapor-plating machine with bell jar and side panel removed. The plating occurs in the upper section normally covered with the evacuated bell jar. Below are located oil diffusion pumps, transformers, speed control and the water-cooling coils.

or more layers of paper required between metal foil electrodes in the older style capacitors.

In the manufacture of the new capacitors metallized paper is wound into capacitor units, which are assembled in a rack and pressed. While still in the rack under pressure, the units are dried in a vacuum to a very low moisture content, as is customary with conventional type units, and then vacuum impregnated with mineral wax or other compound. After impregnation most of the units have low insulation resistance and some are short-circuited. They are given an electrical clearing process to melt or evaporate the metallic coating away from areas which are shorted or of potentially low dielectric strength caused by thin spots, holes, or conducting particles in the paper.

Cleared capacitors have initial characteristics comparable to those of conventional paper and foil capacitors. For example, a 1-mf capacitor at 25 degrees C has an aver-

* RECORD, September, 1949, page 317.

age insulation resistance of 8000 megohms and a ratio of reactance to resistance (Q) of about 150 at 1 kc. It withstands about one and one-half times its rated voltage for short intervals of time and rated voltage for indefinitely long periods without further momentary failure or sparking.

The metal coating is so thin that a very small amount of moisture can produce considerable corrosion of the metal electrode, leading to loss of capacitance and increase in power factor. Therefore, the unit must be well dried, and then kept dry throughout its useful life. For example, in the 452A condenser for the 191 type coin collector, the unit is potted in an extruded aluminum can in such a manner that the unit is entirely surrounded by a layer of microcrystalline mineral wax to exclude the entrance of moisture. Adhering to the container, the potting wax provides a moisture barrier over the operating and storage temperature range of the capacitor. The volume of the com-

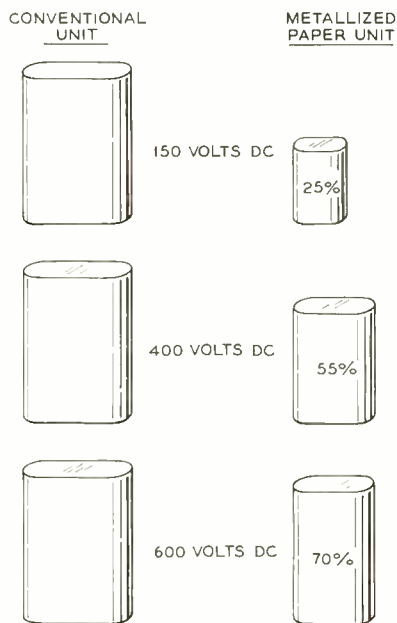

Fig. 2—Comparative volumes of conventional and metallized paper capacitor units.

power rule,” according to which the life is inversely proportional to approximately the fifth power of the applied voltage. Thus, capacitors able to withstand double rated voltage for at least six months without failure may be expected to operate for at least fifteen years at rated voltage in service.

Although they do not fail outright, metallized paper capacitors spark momentarily when operated at a high voltage. Such sparking would cause intolerable noise in the telephone plant, for example, in a coast-to-coast connection which may involve as many as 5000 capacitors. During this momentary sparking only a very small amount of metal is removed from the failure area and the reduction in capacitor charge is usually insufficient to operate the failure-indicating fuses or circuit breakers used in conventional life test circuits.

To determine the maximum voltage at which these capacitors may be operated free of sparking, new life test techniques had to be worked out. Groups of capacitors are tested at several voltages, each group being in series with an electronic circuit sensitive enough to record the number of instantane-

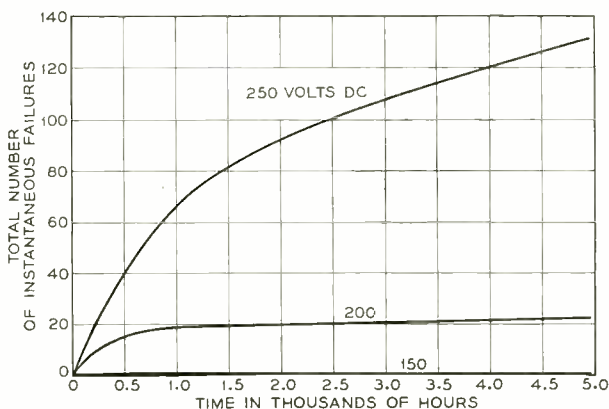

Fig. 3—Instantaneous failure rate. Each curve is for a group of eight 2-mf units.

plete 452A condenser, is about half that of a conventional type paper and foil capacitor of similar rating.

In determining the life performance* of conventional capacitors under d-c potentials it is customary to test representative samples on voltages of one and one-half to two and one-half times their voltage ratings and to note the time required for them to fail by short circuiting. The expected life at rated voltage is then estimated from the “fifth

* RECORD, August, 1946, page 296.

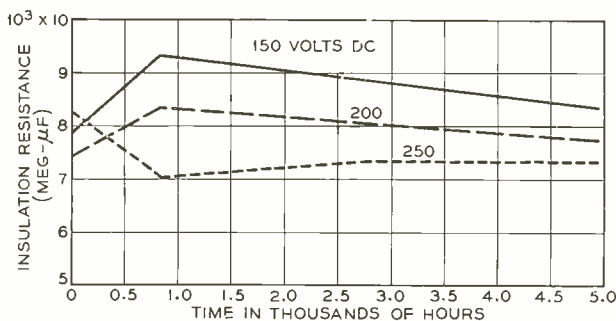

Fig. 4—Variations of insulation resistance.

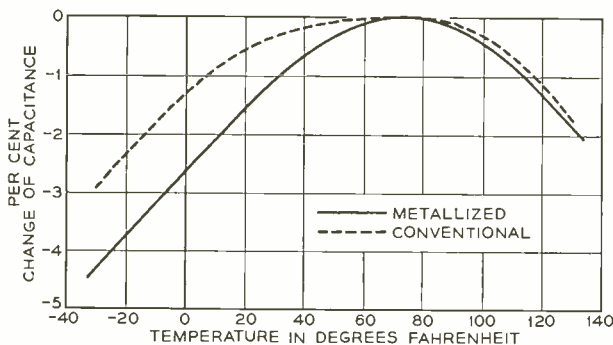

Fig. 5—Capacitance versus temperature.

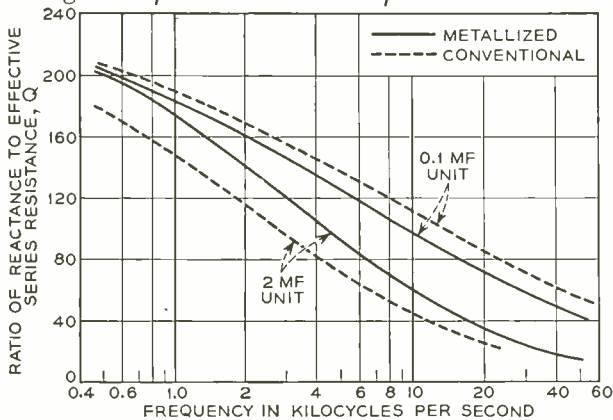

Fig. 6— Q versus frequency.

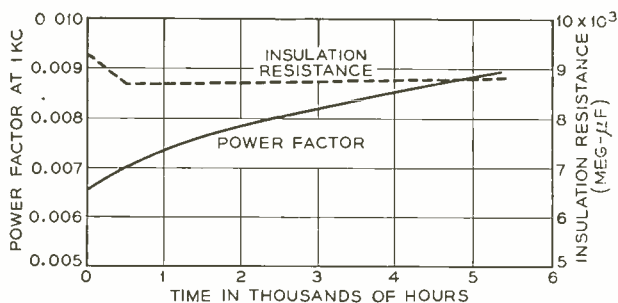

Fig. 7—Insulation resistance and power factor versus time on test at 180 volts, 60 cps.

neous failures. From the total number of failures recorded in a given time it is possible to determine a voltage where the rate of sparking is negligibly small. Typical results of these tests are shown in Figure 3 for a group of capacitors having a total capacitance of about 20 mf.

No simple relationship has been found between the time required for a given number of sparks and the applied voltage. There is, however, a threshold voltage below which sparking occurs only very rarely. On the basis that the group of 2-mf capacitors at 150 volts had no instantaneous failures in 5000 hours, they were rated at 125 volts d-c for use with circuits requiring noise-free operation. Tests show that the noise for metallized paper capacitors is of the same low order as that observed with any of the conventional capacitors.

Insulation resistance is a sensitive measure of deterioration of the dielectric in a capacitor on d-c circuits. Figure 4 shows the change in insulation resistance during the life test covered in Figure 3. Although 250 volts produced a considerable number of momentary failures in 1000 hours, the degree of permanent damage to the dielectric in the capacitor was small, as judged by the small decrease in insulation resistance during the test period. The loss in capacitance caused by the removal of the metallic coating from the failure areas was less than 1 per cent. At 150 volts the insulation resistance actually increased slightly over the 1000 hour period. In setting up the voltage rating of these capacitors, stability in insulation resistance as well as freedom from sparking are taken into account.

Since many paper capacitors in the telephone plant are used in tuned circuits, the capacitance change with temperature and time must be small. In this respect metallized paper capacitors perform like conventional designs. Figure 4 shows typical curves for the change in capacitance with temperature of a 2-mf capacitor of conventional design and a metallized paper capacitor using the same wax impregnation.

In Figure 6 are shown curves for the conventional and metallized capacitors showing the variation in Q , which is important in tuned circuits. The lower Q for the 2-mf

THE AUTHOR: Shortly after his graduation from Iowa State College in 1947 with a B.S. degree in Electrical Engineering, R. K. EVENSON joined the Transmission Apparatus Development Department of these Laboratories. Here he has been working on the development of capacitors—particularly of the metallized paper capacitor described in this issue of the RECORD.



metallized paper capacitor is caused by the greater electrode resistances associated with the length of the unit, which is greater than that of the 0.1-mf unit. The comparative data on the conventional foil and paper capacitors were obtained on capacitors having a single laid-in terminal placed near the center of the foil length.

Typical results for the change in the insulation resistance and power factor for 180-volt a-c 60-cps life test conditions for a 2-mf capacitor of single layer construction are shown in Figure 7. Subsequent examination revealed that the capacitors had self-healed

without damage, although current surges during a momentary breakdown are not limited to as low a value as in the d-c life tests.

The results of these tests indicate that metallized paper capacitors can be substituted for the conventional paper and foil type without risk of degrading the performance of telephone circuits. Their small size makes their use attractive where space saving is important. Besides the 452A condenser for the 191-type coin collector, four different units of this type are being used in the 425A network for the new 500 type combined station set.

Liss Peterson Honored



Word has been received by the Laboratories that L. C. Peterson of Transmission Research has been elected a Fellow of the Royal Society of Letters and Science at Gothenburg, Sweden. He was cited "for important contributions to the field of theoretical telecommunication and especially for his theory of noise generated in vacuum tubes."

Mr. Peterson graduated from Chalmers University of Technology in 1922, studied at Charlottenburg and Dresden and joined A T & T in 1926. Five years later he came to the Laboratories where he was first concerned with the coaxial system and later with electronics. Since 1945 he has been engaged in transmission research including studies of the car.



Historic firsts:

The retardation of a moving clock

For over thirty years one of the crucial consequences of Einstein's restricted theory of relativity remained unverified. No positive proof had ever been found that the unit of time on a moving body contracted in the ratio of the square root of $(1 - v^2/c^2)$ to 1, where v is the velocity of the body, and c the velocity of light. The existing evidence in its favor was all negative.

No experiments had ever indicated that clocks did not slow down when in motion, nor that they slowed down at any rate other than that accepted in the relativity theory, but a positive test would have been much more satisfactory. The need for one had been recognized from the start, but the difficulties in making it were so great that many felt it was not likely to be achieved. Even at velocities as high as 1,000 miles per second, the shortening of the time unit is only of the order of 0.001 per cent; at more readily obtainable velocities it is much too small to measure. These difficulties were finally overcome, however, and a positive measurement of the shortening was made by Dr. Herbert E. Ives of these Laboratories. His results were reported to the National Academy of Sciences in April 1938. Thus, for the first time, this key prediction

of restricted relativity was positively verified.

Einstein's restricted theory of relativity of 1905 was largely founded on the null results obtained by Michelson and Morley in their efforts in 1887 to detect the motion of the earth through the ether. Adopting the suggestions of Fitzgerald, Lorentz, and Larmor, it assumed that an object in motion contracts in the direction of motion in the ratio of β to 1, where β equals the square root of $(1 - v^2/c^2)$, and that there is no contraction in a direction transverse to the motion. Under these assumptions, it follows that the unit of time of a moving body also contracts in the ratio of β to 1.

The Michelson and Morley experiments, however, did not at all prove that a body contracted only in the direction of its motion, but merely that the ratio of the contraction in the direction of motion to the contraction transverse to the direction of motion was β . This same ratio would have been found, however, if there were a contraction in both directions so long as their ratio was of the required value. If the contraction in the direction of motion gave any of the infinite number of values of the ratio $\beta^{(n+1)}$ to 1, where n is any positive integer, while the contraction transverse to motion

were any of the infinite number of values of the ratio β^n to 1, then just so long as the same values of n were used in the two expressions, the ratio of longitudinal to transverse contraction, would have been β , which was all that the Michelson and Morley experiment had indicated.

Although all of these values for the shortening of a body in the direction of and transverse to the motion would have satisfied the Michelson and Morley results, only one set of values—no shortening transverse to the motion and a shortening in the ratio of β to 1 in the direction of motion—would justify a shortening of the time unit in the ratio of β to 1. If a positive determination of the shortening of the time unit could be obtained, therefore, the length shortening predicted in restricted relativity would be supported by positive evidence.

The experiment performed by Dr. Ives consisted in general terms in measuring the decrease in the frequency of the light emitted by positive ions of hydrogen that had been accelerated to a speed of the order of 1,000 miles per second. The ions were generated in a hydrogen arc between the filament and a positive grid of a special tube, and they were then accelerated in being drawn toward and through one or more negative grids. By suitably placed mirrors,

the light given off by the moving ions, both in the direction of their motion and in a direction opposite to their motion, was brought to a diffraction grating and thence reflected to a recording camera. Light from stationary ions in the arc also followed the same path.

By the Doppler principle, the frequency of the light from the moving particles in the direction of their motion would be increased, and that in the direction opposite to their motion would be decreased. Without the relativity contraction, therefore, the spectrum would have shown a line for the stationary ions and lines shifted equal distances to each side of it for the light in opposite directions from the moving ions. If there were a shortening of the time unit of a moving body, on the other hand, the position of both lines from the moving ions would be shifted equal amounts toward the red end of the spectrum, and the amount of shift is a function of the shortening, and could be precisely calculated.

Dr. Ives' results showed that there was such a shift of the lines, and that it was of just the amount to be caused by a shortening of the time unit in the ratio of β to 1. Thus positive evidence of the absolute amount of the shortening accepted by restricted relativity was first obtained.

A recent recognition of the work of Dr. Ives described above appears in the latest addition to The Library of Living Philosophers, which is entitled Albert Einstein—Philosopher-Scientist. In a chapter reviewing the work of Einstein, Louis de Broglie points out that "... some of the beautiful experiments of Mr. Ives have made possible verifications of the relativistic formulas of the Doppler effect, and thus, indirect verification of the existence of the retardation of clocks of which they are a consequence."

No. 5 crossbar AMA translator

T. L. DIMOND
*Switching
Systems
Development*

In the No. 5 crossbar system, the subscriber lines terminate on verticals of crossbar switches on the line link frames. They are identified for switching purposes by the number of the frame on which they appear and their position on that frame. This position on the frame is defined by specifying the horizontal group, and the vertical group and file in which the vertical is found. The scope of the divisions of the frame is shown in Figure 1. There are ten horizontal groups and from six to twelve vertical groups on each line link frame. Each vertical group consists of five vertical files.

The series of numbers specifying the line link frame, vertical group, horizontal group, and vertical file, is known as the equipment number, but there is no fixed relation between this equipment number and the direc-

tory number. The reasons for this lack of relationship have to do mostly with keeping an even distribution of traffic through the frames and with providing flexibility for changes in assignment of directory numbers.

Since the marker obtains the equipment number in the process of handling an originating call, it is readily available to the AMA equipment. However, directory numbers rather than equipment numbers are required by the AMA equipment in billing the charges for a call. A translator is therefore required to convert the equipment number to a directory number. This translator is an electrical directory with the equipment numbers appearing in an orderly array each with its associated directory number.

After a subscriber picks up his handset to place a call, the marker seizes the calling

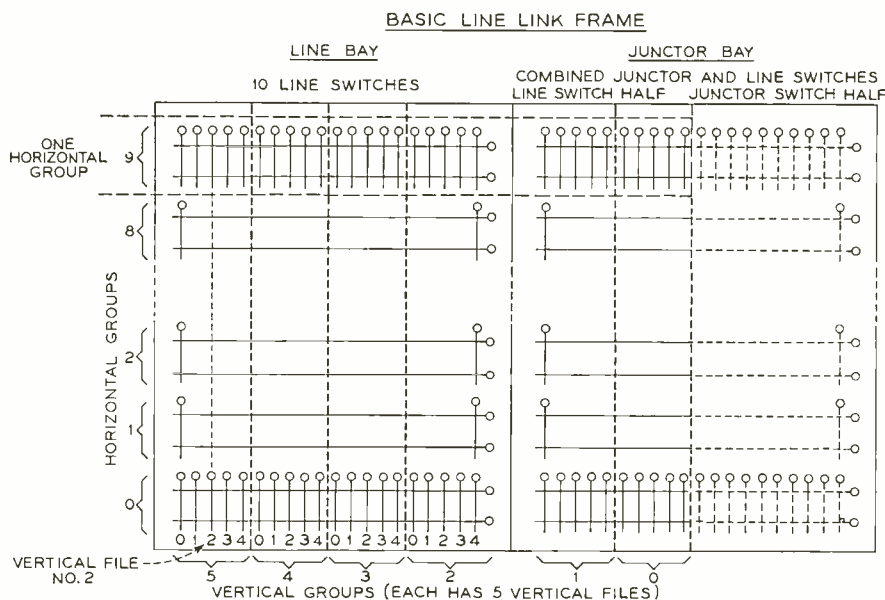

Fig. 1 — Division of lines on a line link frame into vertical groups, horizontal groups, and vertical files.

NOTE: THERE MAY BE SUPPLEMENTARY BAYS OF LINE SWITCHES (10 OR 20 VERTICALS EACH)

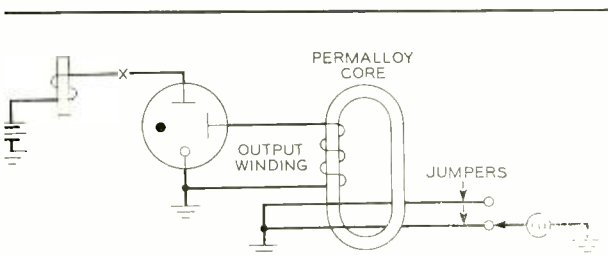

Fig. 3—Simplified diagram indicating method of using the coil shown in Figure 2 for translating.

line link frame, finds the calling line, connects it to an originating register, and tells the register the equipment number. The register records this number and, if the call is from a two-party line, determines whether the tip or ring party is calling. After the subscriber has dialed, the register obtains a marker and gives it the calling equipment number, including tip or ring party identification, and the called directory number. The marker in turn passes this information to the outgoing sender, which records it. After the marker completes this job, the sender controls the selection of the called number and at the same time obtains a transverter, which is part of the AMA equipment, and gives it the information. The transverter uses this information to obtain a translator to which it passes the equipment number. From this information the translator determines the directory number and returns it to the transverter, which causes it to be placed on the AMA tape in the form of five digits: one to indicate the office, and one each to indicate the thousands, hundreds, tens, and units digits of the subscriber's directory number.

The new element of the translator is the coil shown in Figure 2 and is shown schematically as applied to a circuit in Figure 3. The winding of the coil is connected to the control anode of a gas filled tube. If a surge of oscillating current is sent through one of the jumpers, an oscillating voltage is induced in the winding. This voltage ionizes the tube, thus allowing it to pass current between the cathode and the main anode, and operate the associated relay.

The method of using these coils in the AMA translator is shown in Figure 4. At the top of this figure is the surge circuit which

generates the jumper current. Below is a relay tree that selects one of the terminals in the equipment number terminal bank. There is one terminal in this bank for each equipment number.

From each terminal, a jumper is threaded through one coil in each of the five rows of

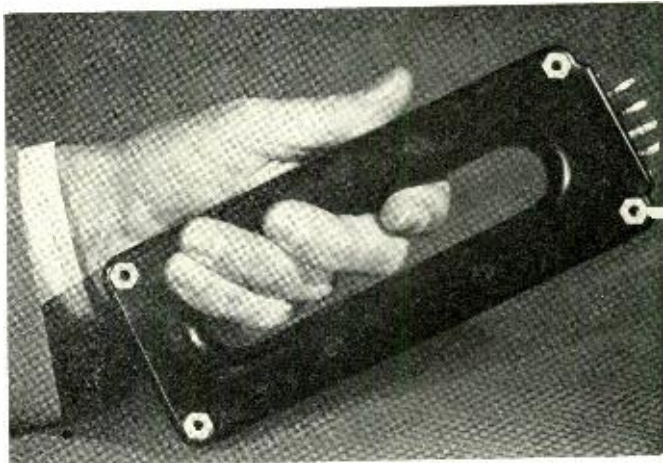

Fig. 2—The coil used with AMA; one of the essential elements of the "Diamond" ring translator.

coils and terminated in ground. The coil used in the top row indicates the number of the office in which the calling line is located. The coils used in the other four rows are chosen in accordance with the thousands, hundreds, tens, and units digits of the associated directory number.

When the transverter is connected to the translator, it operates relays in the relay tree which select one of the thousand equipment number terminals and connects it to the surge circuit. When this connection is made, a path is closed from ground through the jumper, the relay tree, and the back contact of relay *ssr*. This ground suddenly changes the potential of point *A* from minus 48 volts to ground. This voltage change is carried through a coupling condenser to the control anode of the *ssr* tube which is caused to pass current, thus operating relay *ssr*. Relay *ssr* now closes a discharge path for the oscillatory discharge of capacitor *C* through inductance *L* to ground. The discharge circuit is closed by the mercury contact relay *ssr* rather than by the contacts of the tree circuit because the high current (about 3 amperes peak) in the surge might damage ordinary relay contacts, especially if there is

any contact chatter. Any chatter which occurs in the relay tree contacts subsides during the operating time of relay sst.

The surge current in the selected jumper induces a voltage in the output windings of the coils through which the jumper passes. The associated gas-filled tubes fire from this voltage, and cause relays in the transverter corresponding to the directory number to operate. The translator connector then releases, disconnecting the transverter from the translator.

The relay tree is shown schematically in Figure 5. By using the line link frame number and the vertical group number, the transverter grounds one of the twenty *c* leads to operate the proper *c* relay. Tip parties and ring parties are assigned to separate translators. The transverter also operates one of the *vf* relays corresponding to the vertical file number of the calling line, and operates horizontal group relays in accordance with the horizontal group number.

The *c* relay uses fifty contacts to select from the thousand equipment number terminals the particular fifty of the vertical group of the calling line. The *vf* relay selects ten of the fifty terminals selected by the *c* relay, and the horizontal group relays select one of the ten terminals selected by the *vf* relay. Thus, by this process, one terminal out of 1000 is connected to the surge circuit, whereupon the operation proceeds as above.

Since the jumpers are changed rather frequently and since the terminals in the equipment number terminal bank are fairly closely spaced, it is felt to be worthwhile to design the translator so that inadvertent shorts between adjacent terminals will not cause severe reaction. With all the jumpers connected to a common ground bus as indicated at the bottom of Figure 4, such a short might result in the failure to translate the equipment numbers for a large number of lines, and the fault might be difficult to find. Suppose, for example, there were a short between the equipment number terminals for jumpers *A* and *B*. An attempt to translate the equipment numbers associated with either of these terminals would, of course, give the translation of both because of the short. This in itself is not too serious since only two lines are involved and the

trouble could soon be located. The serious feature of such a short is that the short forms a closed loop consisting of the two jumpers. As a result, a surge in any jumper passing through one or more of the coils threaded by either of the shorted jumpers will induce a surge in the closed loop and thus besides operating the proper tubes for the translation will also operate those associated with the jumpers of the closed loop. With the short between jumpers *A* and *B*, for example, when jumper *D* is energized, a surge voltage is induced in jumper *A* because it threads tens-coil No. 6 in common with the *D* jumper. A current is therefore induced in the *A* and *B* jumpers, which energizes several coils besides the desired ones. This does not cause charging irregularities, however, because the transverter recognizes the operation of more than the correct number of tubes as a trouble condition. It would not accept the translation but would call in a trouble recorder. The fault would be difficult to locate, however, because the equipment number of the line that caused the trouble recorder to be called in may not be anywhere near the equipment numbers whose terminals are shorted in the bank.

To avoid such a situation, the formation of closed loops by shorts must be prevented. To this end, ground is provided through a bank of 1000 terminals physically arranged just as are those of the equipment-number terminal bank. Jumpers are run between corresponding terminals of the two banks. The method of supplying ground to the terminals of the ground bank is indicated in Figure 6. The *esw* relay is operated by the horizontal group relays of the relay tree whenever the equipment number being translated is in an even horizontal group. Similarly the *osw* relay is operated if the horizontal group is odd. The *vf* relays are the same relays as the *vf* relays shown in the relay tree. When a translation is to be made, the *esw* or *osw* and *vf* relays together supply ground to only a certain fifty of the thousand ground-supply terminals, and no two of these fifty are adjacent. *esw* and *vfo*, for example, ground the even terminals in the bottom row of Figure 6.

With this arrangement there can be no closed loops due to shorts between adjacent terminals in the equipment number terminal

bank. If the shorted terminals are horizontally adjacent, then one must be in an odd horizontal group and the other in an even and, therefore, only one of the jumpers can be supplied with ground because of the *ESW* and *OSW* relays. If they are vertically adjacent then only one can be supplied with ground because only one *VF* relay is operated, and each horizontal row of terminals is supplied from a different *VF* relay. With no closed loops there can be no tubes falsely

operated, and therefore the circuit will translate satisfactorily in spite of the short.

Not only does this scheme prevent false operation, but it causes a trouble record to be made indicating that a short exists. If jumpers *A* and *B* are crossed either in the equipment-number or ground-supply terminal banks, then when the *A* jumper or any other jumper on the same ground supply lead is selected, the ground furnished by the *VFO* and *ESW* relays will close a cir-

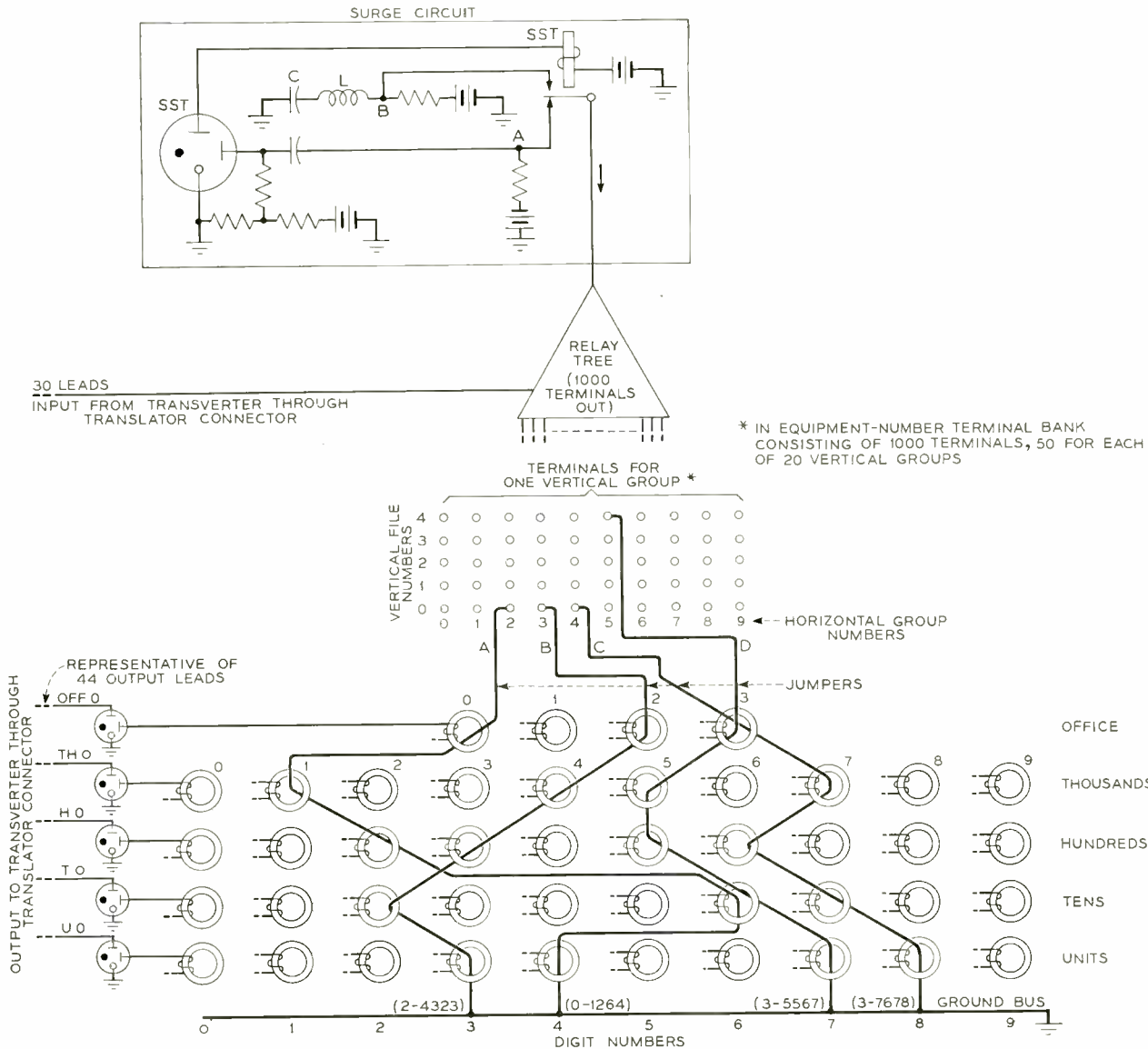

Fig. 4—Simplified circuit schematic of the AMA translator. This schematic shows jumpers set up to identify terminals of directory numbers 2-4323, 0-1264, etc.

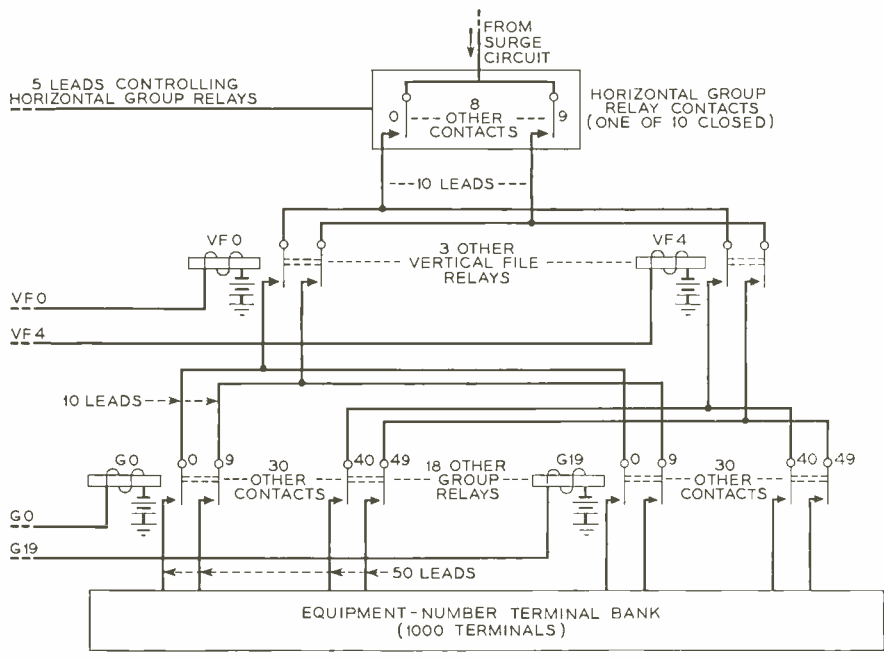

Fig. 5 - The relay tree of the translator, which distributes the terminal for the equipment number that is to be translated.

circuit through the short and through the back contact of relay osw to operate the cross-detecting relay in the transverter. This causes a trouble record to be made but does not interfere with the translation.

It may be wondered why it is necessary to indicate when a short exists since it does

not interfere with the translation. The answer is that a single short cannot cause a closed loop but two shorts may. For this reason it is desirable to indicate a short as soon as it occurs so that it can be cleared before another occurs which, in combination with the first, might cause translation fail-

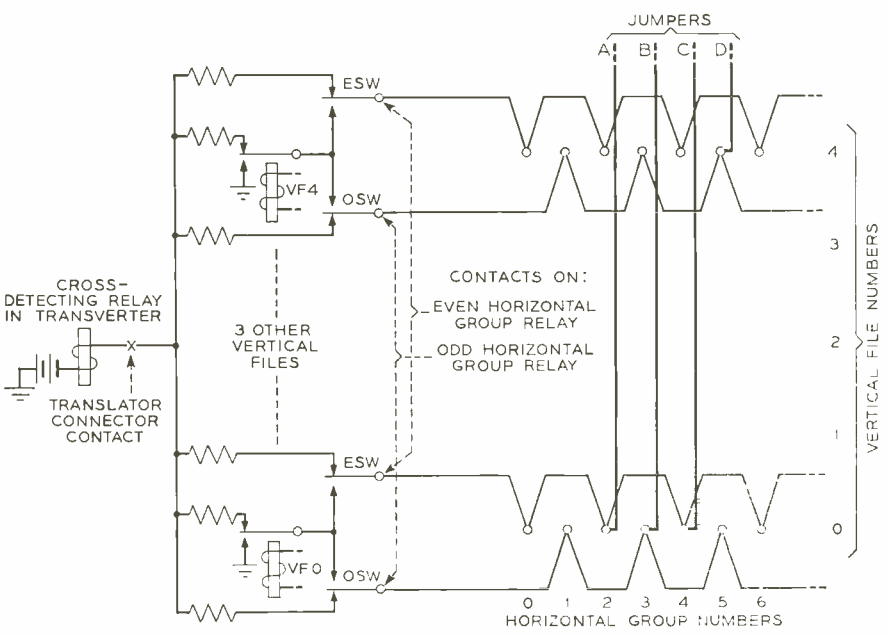

Fig. 6 - Simplified sketch indicating the method of distributing ground to the terminals of the ground bank.

ures on a large number of telephone lines.

A translator frame is shown in Figure 7. At the top, not shown in the photograph, is the translator connector, which has a capacity for five transverters. In the middle of the frame are the relays making up the relay tree. The bulk of these are the multi-

whole assembly of coils and terminals is within easy reach of a maintenance man standing on the floor.

One of the difficult equipment and apparatus problems was the design of the coil structures and the general layout in such manner that the jumper could be readily

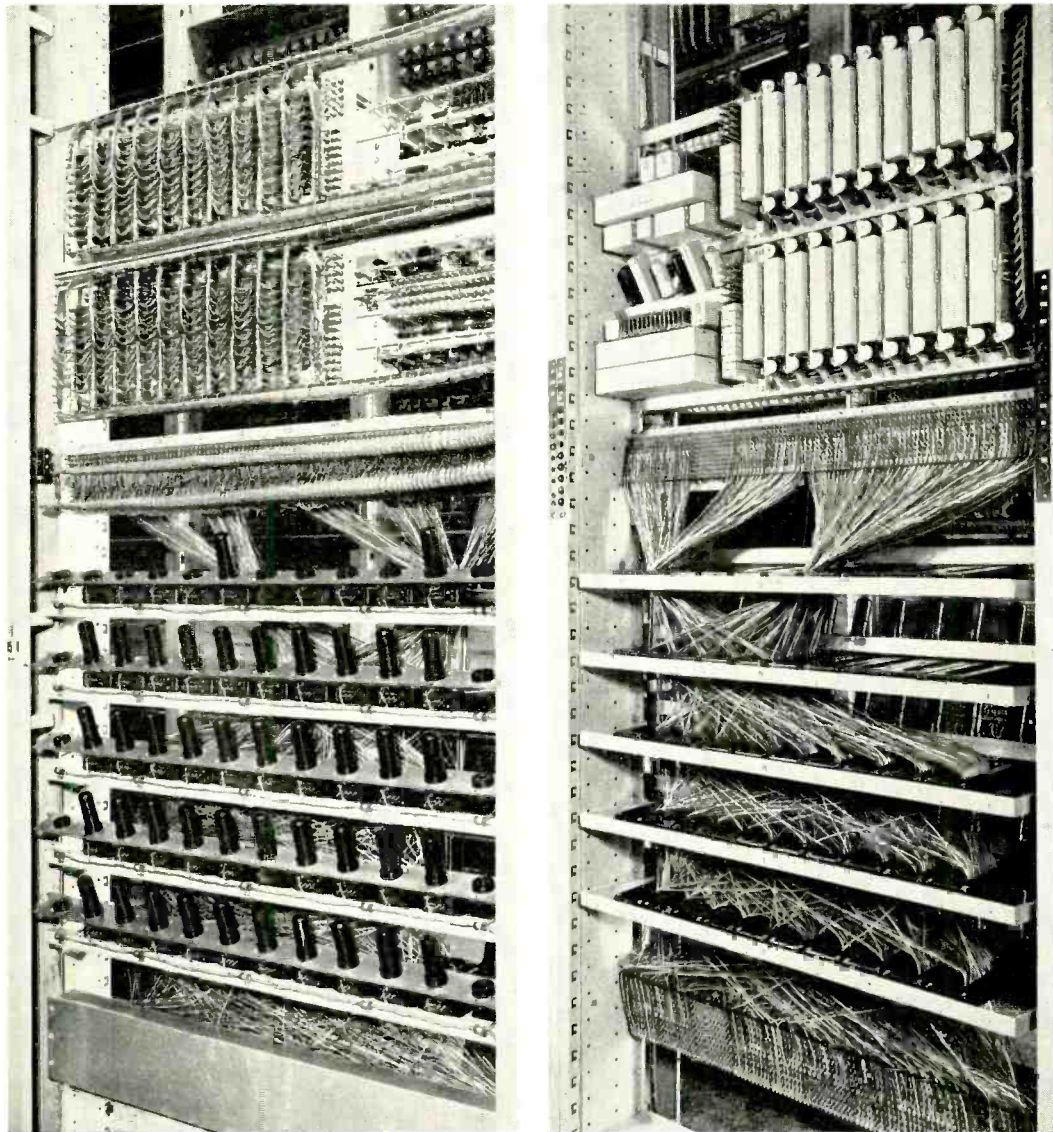

Fig. 7—Lower part of a translator frame; tube side at left, and coil side at right.

contact c relays. Below the relays are the terminal strips making up the equipment-number terminal bank. The coils are mounted next. The tubes are mounted immediately behind the coils. Near the bottom is the ground supply terminal bank. The

removed. With the arrangement finally devised, the jumper can be removed by loosening both ends and pulling. One reason for terminating the jumpers in the same relative locations in both terminal banks is to make this possible without tracing the jumper

through the coils to find its ends. The coils, one of which is shown in Figure 2, are enclosed in bakelite cases with smooth rounded jumper windows to reduce friction. It was found that an oblong window accommodates more jumpers than a round window of the same area. The maximum that can be placed in the coil is 600.

As a further aid in changing jumpers, the terminals in the equipment number and ground supply banks are of a new solderless type. These are shown in Figure 8. Each consists of a slit punching into which the stripped end of a jumper is slipped. A complete turn of the jumper is then made around the terminal so that any movement of the jumper will not disturb the electrical connection. The pressure between the jumper and terminal is very high, insuring a good, low resistance contact. Tests show that this terminal allows an appreciable reduction in connection and disconnection time.

The basic type of translator employing the kind of coil described above is known in the Bell System as a ring translator because of the shape of the coil. Its main advantage over more conventional types of translators is that it reduces the number of

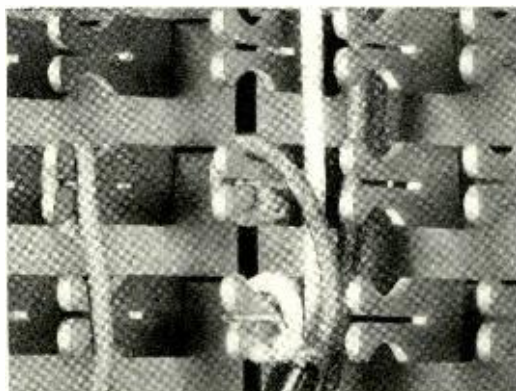

Fig. 8—A close-up of one of the terminal banks of the translator showing the new type of terminal employed.

jumpers and connections. This saving in jumpers represents appreciable savings to the Telephone Companies because on the average each jumper is removed and re-run once each three years.

The same translator circuit as described above is used in the No. 1 crossbar system, although the equipment details are slightly different. The basic ring translator scheme has also been applied to computers.



THE AUTHOR: T. L. DIMOND received his B.E. degree from the University of Iowa in 1926, and at once joined the Technical Staff of these Laboratories. His first work, after an absence of a few months for field work with the Western Electric Company, was with the step-by-step and PBX testing laboratories. Three years were then spent on fundamental pulsing studies, dealing especially with the development of the reverte pulsing circuits used in No. 1 Crossbar. Then followed a period of analyzation and design work on dial, manual, PBX and toll circuits. In 1938 he began design work on community dial office circuits including the 355A. He later worked on toll and community dial systems. From 1942 to 1945 he engaged in high-frequency communication work for the Armed Forces and then engaged in design work on the No. 5 crossbar system. At the present time he is in charge of a laboratory group engaged in exploratory studies of switching systems.

Test amplifier for coaxial systems

R. M. JENSEN
*Transmission
Apparatus*

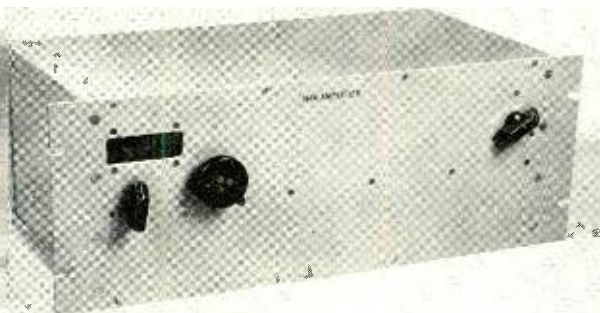

Fig. 1A—144A amplifier.

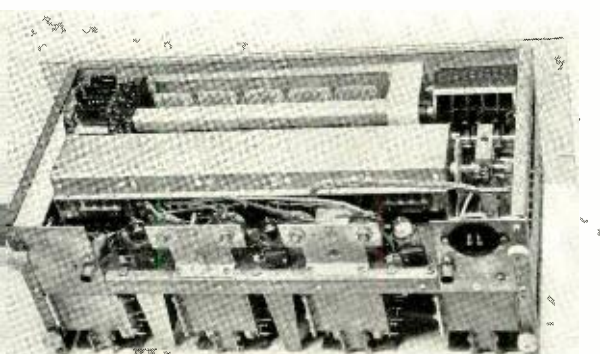

Fig. 1B—Top view showing tuning capacitor and band switch.

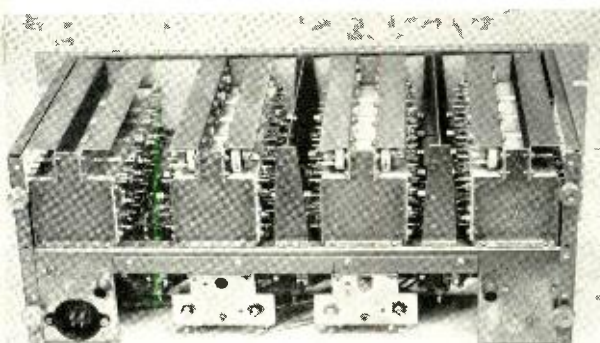

Fig. 1C—Bottom view showing interstage network assemblies.

Important to the smooth operation of a telephone system are the reliability, accuracy and ease of use of its testing equipment. To this end, the Laboratories constantly develop new test sets designed to utilize the latest improvements in apparatus and in measurement techniques. A recent development of this kind is the 44A transmission measuring system for the measurement of single frequency signals, noise and crosstalk in coaxial systems. An important part of this coaxial test set is the 144A amplifier shown in Figure 1.

Similar in function to the radio frequency section of a radio receiver, this amplifier selects a narrow band of frequencies anywhere in the range from 50 kc to 3500 kc with gain up to 40 db. For a given setting of the gain control the mid-band gain is constant over the entire frequency range. The 144A Amplifier, however, has to cover about 20 times the frequency range of a standard radio broadcast receiver. Just as a radio receiver must discriminate against interference from undesired broadcasting stations, this selective amplifier is required by the testing procedure to discriminate against unwanted sources of energy which would invalidate the measurements. Examples of the highly discriminatory bands it delivers are shown in Figure 2. With its measured noise level below 122 dbm* over the entire frequency range, this amplifier enables the 44A transmission measuring system to detect signals as low as 110 dbm.

As shown in the block schematic of Figure 3, the amplifier consists of amplifier tubes and tunable networks aided by equalizers. The pass band desired is obtained in two

* Decibels below 1 milliwatt.

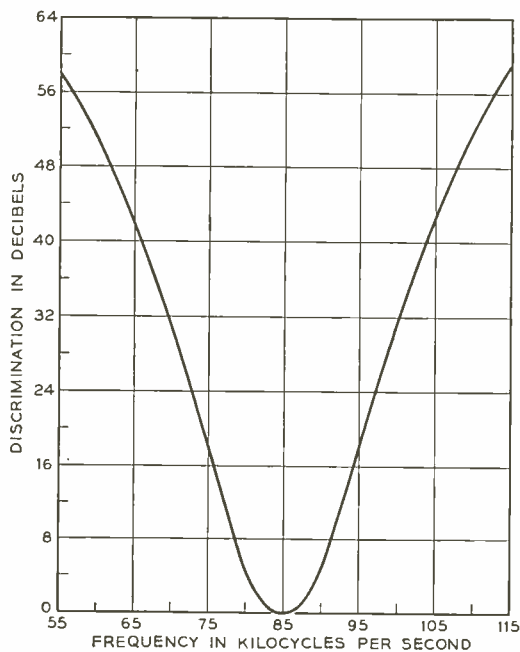

Fig. 2A—Typical discrimination characteristic at 85 kc.

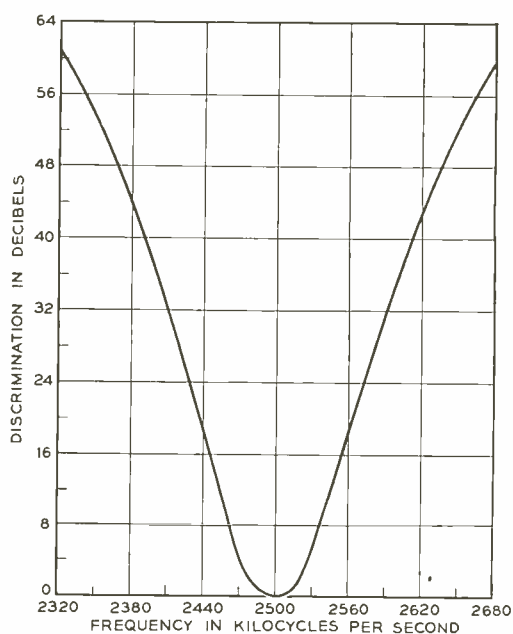

Fig. 2B—Typical discrimination characteristic at 2500 kc.

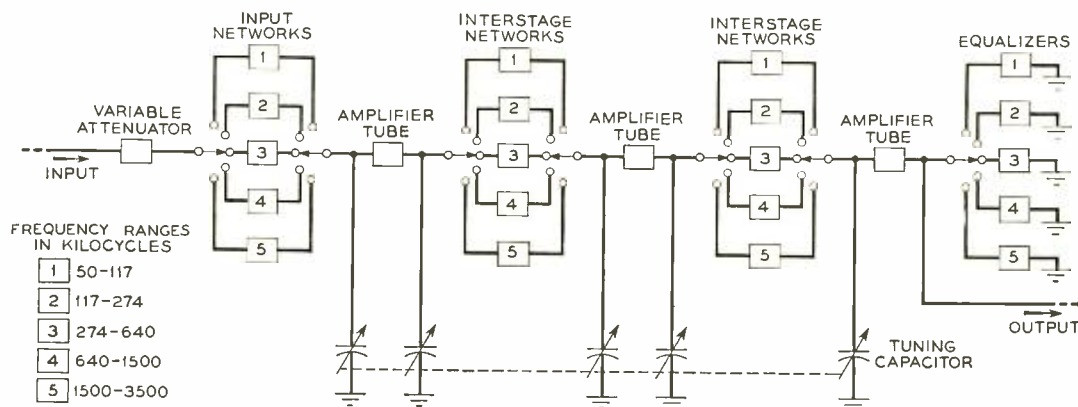

Fig. 3—Block schematic of 144A amplifier.

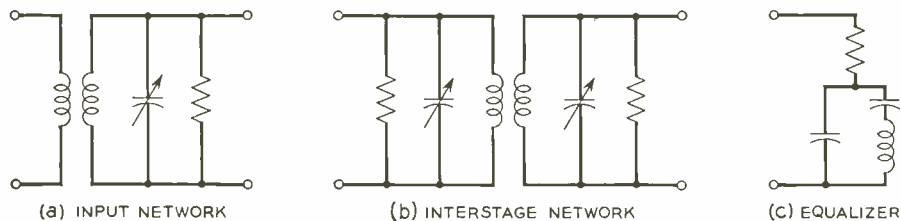

Fig. 4—Schematics of networks and equalizer.

steps. First, one of five frequency ranges is selected by switching in the appropriate combination of input and interstage networks and an equalizer. Within this frequency range the desired band is then selected by means of the gang-operated variable capacitors.

The function of the input network, Figure 4, is to provide discrimination against strong unwanted signals likely to cause tube modulation. It also provides substantial transformer step-up which results in effective gain and raises the signal level above tube noise level. Four-fifths of the required discrimination is provided by the interstage networks, Figure 4. A characteristic of this type of network is that its impedance level is a function of its band width. Since it was required that the bandwidth of each of the five frequency ranges be different, the impedance level, and hence the gain, is also different. This gain variation is compensated for by variable- μ tubes the bias of which is regulated by switching the bias resistors. Another characteristic of this network is that its impedance level is also a function of the capacitance of the tuning capacitor. The variation in gain which results within a band from this effect is compensated for by the corrective equalizer, Figure 4. Through the variable attenuator, Figure 3, the over-all gain of the amplifier is controlled in 10 db steps up to a maximum of 40 db.

Exceptional precautions in the design of component apparatus were necessary to secure the required sensitivity, stability and uniformity of amplification. An anti-backlash worm drive insures smooth tuning and accurate resetability in the five section, variable capacitor which is of the straight-line-frequency type, Figure 5A. Invar and mycalex parts insure very small capacitance-temperature coefficients. Silver plating on the current-carrying parts, along with mycalex insulation and carefully designed wiper contacts insure very low dissipation in this capacitor which is made by the Cardwell Company. It is used as the secondary, or continuously adjustable, frequency band selector.

The five position switch shown in Figure 5B is the primary frequency range selector. It is of the cam operated, knife blade type

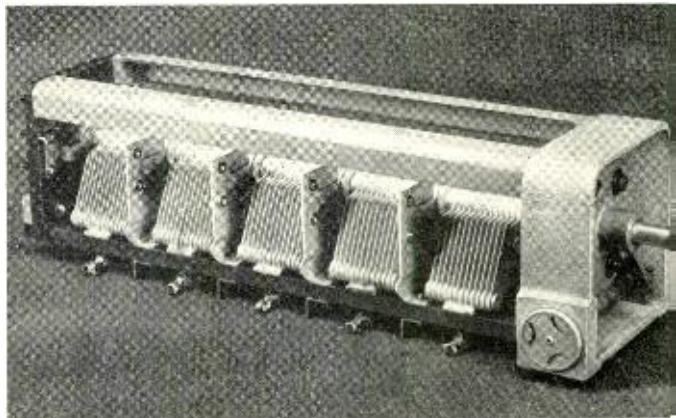

Fig. 5A—Tuning capacitor.

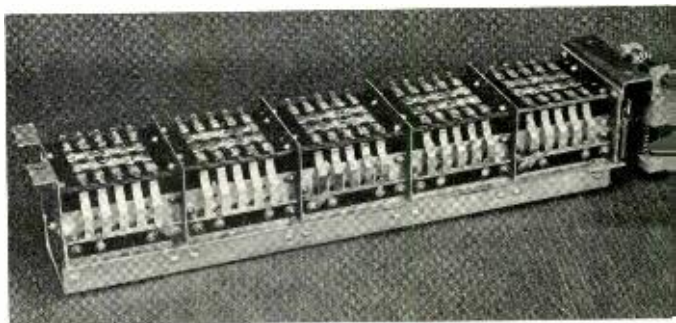

Fig. 5B—Band switch.

made by the Hammarlund Company and is substantially constructed to assure positive contacts and long service life. Shielding, and short paths through contacting parts, minimize undesirable coupling between various parts of the amplifier circuit. The switch includes contacts which short-out interstage units not used for the particular range selected; other contacts switch the corresponding bias resistors on the variable- μ tubes.

An easily readable frequency dial of translucent vinylite is wrapped around a rotating, skeleton drum, directly coupled to the main shaft of the tuning capacitor. For observation of the dial in dim light, five pilot lights are mounted inside the drum. When the band switch connects in a particular frequency range it also switches on the pilot light which illuminates the appropriate section of the dial.

As may be seen from Figure 1 ease of manufacture was kept in view throughout the development of this amplifier. The numerous components are assembled and

wired into sub-unit assemblies which are then arranged on a skeleton frame supported by a 7 x 19 inch relay rack panel. This arrangement permits most of the components to be assembled and wired in the open. The relatively few connections between the var-

ious subassemblies permit easy removal of any assembly for replacement of defective components. The over-all assembly is protected from dirt by an aluminum cover which also provides electrical shielding from outside interferences.

THE AUTHOR: R. M. JENSEN graduated from Purdue University in 1937 with a B.S. degree in Electrical Engineering. He then joined the Technical Staff of the Laboratories and worked in the Special Products Department on the design of audio equipment and subsequently with the Quality Assurance Department. In 1939 he transferred to the Transmission Networks Department where his time during World War II was devoted to the design of tuned amplifiers, coaxial filters and crystal-controlled oscillators. Since the war his time has been spent primarily on the design of networks and tuned amplifiers for carrier telephone systems.



426A Electron Tube

A recent addition to the series of miniature cold cathode tubes manufactured by the Western Electric Company, Allentown Plant, is the type 426A tube. It is a three-element inert-gas filled tube developed especially for use as a "ringer" tube in the new 500-type telephone sets, in the same functional capacity as the older and larger 372A tube. It is also intended to replace the 405A tube in the 309-type sets.

The tube is also suitable for use in relay, voltage regulator, or rectifier circuits.

Since the new tube is installed in the compact base of the 500 type telephone set, it has been necessary to build into a miniature envelope the electrical characteristics of the larger 372A tube. An additional design requirement was that of making the tube sufficiently rugged to give dependable life under the new service conditions. An opaque coating is applied to prevent stray light from adversely affecting the operating characteristics of the tube.

Average characteristics of the 426A tube are as follows:

- Starter breakdown voltage 72 volts
- Starter voltage drop at 3 milliamperes 60 volts
- Anode voltage drop at 10 milliamperes 70 volts
- Required transfer current at 110 anode volts (min.) . . . 200 microamperes
- Ionization time, starter gap . . . 3 milliseconds
- Deionization time, main gap . . . 6 milliseconds



Dr. and Mrs. Marston Bates, Mrs. Lilian Grosvenor Coville, Mrs. O. E. Buckley, Mrs. L. A. Wilson, and Dr. Buckley, in the foyer of the Murray Hill Laboratory.

Dr. Bell's Granddaughters Visit Murray Hill

On December 14, Dr. Buckley was host at Murray Hill to two granddaughters of Alexander Graham Bell—Lilian Grosvenor Coville and Nancy Bell Fairechild Bates—and to Mrs. L. A. Wilson, Mrs. Buckley, and Dr. Marston Bates, a member of the staff of the Rockefeller Foundation.

Following luncheon, visits were made to various laboratories including the transmission development laboratory, and the Transistor laboratory. The guests were also interested in hearing of the work on ferro-electric crystals, and learning about the new station set. They were particularly interested in their visit to the acoustic laboratory where they saw the free space room and the microwave lens laboratory. Their tour included also the metallurgical laboratory and the crystal laboratory.

In a letter of appreciation to Dr. Buckley,

Lilian Coville wrote:

"Grandfather would be more excited and pleased than anyone else if he could see what you have built up. I kept imagining how his eyes would flash at the magic . . . He always told us that the real world of science was more thrilling than the magic of fairy stories, and he was right."

Nancy Bell, in a similar vein, wrote:

"It was a most thrilling experience from start to finish . . . the fulfilling of a long held desire. Personally I came away with a renewed confidence in the achievements of humans—a confidence much needed nowadays . . ."

Nancy Bell Bates is author of the book *East of the Andes and West of Nowhere—a Naturalist's Wife in Colombia*. The *New Yorker* magazine recently carried a delightful article by Lilian Coville on *My Grandfather Bell*.



Manfred Brotherton plays the part of a city editor in a movie made by the State Department in Morristown, New Jersey, to portray the democratic way of life for audiences in other lands. Also appearing were C. C. Lawson and W. H. Brattain.

Laboratories Develop Mechanism for Ten-Cent Calls

Ordinarily changes in telephone rates do not require specific engineering contributions by the Laboratories. But when it became necessary to increase the local public telephone charge from a nickel to a dime, the Laboratories were called on for a redesign of the coin collector mechanism and appropriate revisions of central offices circuits. In due time, production was begun by Western Electric, and in September, 1950, coin boxes in Sioux Falls, South Dakota, were changed over to require a ten-cent deposit. Late in December, coin boxes in certain Illinois cities were changed, with the balance of the state to follow; on January 2 most of Minnesota; and on January sixth all of the New York Telephone Company's coin boxes were cut over. The modified coin collector requires a minimum deposit of ten cents to obtain access to the central office; this deposit may be made with two nickels or one dime. No access is obtained with a single nickel, and if the call is abandoned after a deposit of only one nickel, the coin is automatically refunded when the receiver is hung up. After the initial deposit of ten cents has been made and connection established with the central office, the collector reverts to a five-cent device and single nickels can be deposited for overtime or toll charges, as called for.

Externally, the modified collector is the same as the familiar coin collector of the past. Inter-

nally, several changes have been made. An entirely new chute has been designed to replace the present standard neoprene coated lead chute.* The new chute is fabricated from corrosion resistant steel. While the handset is off the switchhook, the first nickel is held in the runway. The deposit of a second nickel releases it mechanically and permits both coins to operate the coin trigger. A contact is closed by the trigger which operates the line relay in the central office; when dial tone is sent out or when the operator answers, the nickel path is altered so that single nickels can be registered for overtime or toll calls. On completion of a call, the collector is reset for its next use.

During the period of converting coin collectors in preparation for collecting ten cents, a small clip disables the ten-cent mechanism and permits the collector to operate as a five-cent device. New ten-cent collectors (coded 191 type) were shipped from the factory with this clip in place. During the latter part of 1950, the New York Telephone Company incorporated this apparatus in all their pay stations. At cutover, which occurred on January 6 in New York State, the installers had only to remove the clip from the collector and to change the instruction card.

Development of the new coin collector was carried on principally by F. A. Hoyt, L. T. Holden and R. K. Thompson of Station Apparatus Engineering, with advice and assistance from other members of their department and from members of Station Instrumentalities Engineering. Circuit phases of the problem were co-ordinated by George Sandalls, Jr. of Switching Engineering, and modifications to particular circuits that were involved made by a number of engineers of Switching Systems Development.

Announcing the new charge, the New York Telephone Company pointed out that the value of a local call has increased greatly since 1906, when the nickel rate was set. In New York City, which contains two-thirds of the company's 135,000 coin telephones, a caller in midtown Manhattan can now reach a total of 3,600,000 telephones throughout the city and in some parts of New Jersey, compared with 2,400,000 before the increase and less than 200,000 telephones in 1906.

The company spokesman also stresses the fact that the cost of providing telephone service has increased sharply since 1906. "When higher schedules of telephone rates were found neces-

*RECORD, September, 1947, page 341. A picture of this chute appeared on the cover of the July 1950 issue.

sary last May to meet these higher costs," he said, "it seemed only fair that users of coin telephone service should bear their share of the increase."

He also noted that many everyday items have more than doubled in price during the 45-year life of the nickel call. "Back in 1906, a loaf of bread cost 5¢, a quart of milk 7¢, 5 pounds of potatoes 8¢, a pound of butter 29¢ and round steak, of all things, was then 15¢ a pound," he said.

Organization Changes at Whippany

To handle more effectively the growing program of military development, the Military Electronics Department has been made a general department of the Laboratories. W. C. Tinus, formerly acting director, is now Director of Military Electronics Development, reporting to Vice President Quarles.

W. A. MacNair, Director of Switching Research, in addition to his present assignment in the Research Department, is appointed Director of Military Systems Engineering, reporting to Mr. Tinus. A. K. Bohren, who now becomes a Military Development Engineer, and J. F. Wentz, also Military Development Engineer, with their respective organizations will report to Mr. MacNair.

W. H. C. Higgins is appointed Director of Military Equipment Development, reporting to Mr. Tinus. His staff will be J. M. West, military development engineer, and R. R. Hough, L. W. Morrison and J. W. Smith, newly promoted to that rank.

Albert Tradup is appointed Director of Military Communications Engineering and will report to Mr. Tinus. In addition to the organization now reporting to Mr. Tradup, C. H. G. Gray will report to Mr. Tradup as Military Transmission Engineer.

W. J. Adams, Manufacturing Information Engineer, and E. H. Bedell, Military Development Engineer, with their respective organizations will continue to report to Mr. Tinus.



W. C. TINUS

The services of E. L. Nelson, Military Development Engineer, have been requested by the U. S. Government. Pending final disposition of this matter, Mr. Nelson will report to Mr. Tinus on special assignment.

Mr. Tinus entered the Laboratories in 1928 after graduation from Texas A. & M., and ten years later moved to Whippany. Until the war, he was concerned with development of radio equipment for transport planes. When the possibility of radar was first visioned, to him was assigned the project of building such a device. As success came, and with it specialization, he worked principally on naval radars.

When R. E. Poole was made Director of Development at the Sandia Laboratory of the A.E.C., Mr. Tinus succeeded him, and has been Acting Director of Military Electronics for the past year.

E. H. BEDELL

W. H. C. HIGGINS

W. A. MACNAIR

ALBERT TRADUP

W. J. ADAMS





P. J. AZARELO



G. J. BEATTIE



G. F. BOYLE



R. L. CARMICHAEL



J. A. CEONZO

Called to Active Duty

Up to December 31, 1950, twenty-two members of the Laboratories have been granted leaves of absence to enter various branches of military service.

Peter J. Azarelo, clerk, who came to the Laboratories in July 1945, entered service last November and is now in the Army.

George J. Beattie, shop hand, worked just a month before enlisting in the Army in December.

Guy F. Boyle, a member of the Plant Maintenance Force, came to the Laboratories in January, 1943. He has been a reservist in the Marine Corps since returning from two and a half years of World War II duty in April, 1946; he reenters the Marine Corps as a Corporal.

Robert L. Carmichael, Member of the Technical Staff, was a reservist in the Air Force. He came to the Laboratories in March, 1950, and was called back to the service in August, returning as a Staff Sergeant.

Joseph A. Ceonzo, Technical Assistant, was at the Laboratories for a year before joining the Navy in January, 1943. As a reservist with

three years' war experience, he returned to the Navy as a Chief Petty Officer last August.

Frank R. Criger, Technical Assistant, came here in December, 1948, being a reserve Sergeant in the Marine Corps. He was recalled to duty in November.

James V. Cunningham, assembler and wireman, came to the Laboratories in June, 1941. Eighteen months later, he began a hitch in the Navy that lasted almost four years. Now he returns to the Navy as a Electrician's Mate 1st Class.

Victor Czarniewski, Technical Assistant and reservist in the Navy, spent four and a half years at the Laboratories before being called back last October as a Chief Radio Man.

Clifton K. Dale, senior assembler and wireman, had come to the Laboratories in October, 1945, being a reservist in the Navy. In August he returned to the Navy as Chief Electrician's Mate.

Charles H. Dalm, draftsman, joined the Laboratories in 1941, but about sixteen months later entered the Navy and spent almost four years in the service. He returns now as a Chief Petty Officer.

THOMAS FAHY

C. E. FORD

P. J. GEOHEGAN

EDWARD GOLDSTEIN

LEAH HALL

J. M. JACKSON

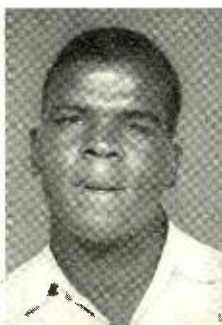



F. R. CRIGER



J. V. CUNNINGHAM



V. CZARNIEWSKI



C. K. DALE



C. H. DALM

22 Labs People Now in Service

Thomas Fahy, a helper in the restaurant, was employed exactly fifteen months before being called to service in the Army in October.

Charles E. Ford, another restaurant helper, had been employed three years and two months when he was called for the Army in December.

Patrick J. Geoghegan, building service group, enlisted in the Army in July after being employed by the Laboratories since June, 1948.

Edward Goldstein, Member of the Technical Staff, was reservist in the Signal Corps when he came to the Laboratories in July, 1949. He returns as a First Lieutenant.

Leah J. Hall, Technical Assistant, our first woman enlistee since World War II, was at the Laboratories from September, 1948, until October, 1950, when she enlisted in the Navy.

Jesse M. Jackson, Technical Assistant, returns to the Navy. He began his Laboratories career in January, 1942, leaving for military service in June of that year. He spent three and a half years in active duty during World War II.

John C. Juhl, a Shop Hand from March to

November, 1950, was a reservist in the Navy. He returns to the service as a Machinist's Mate.

Richard E. Levesque, photostat operator, came to the Laboratories in June, 1947, and was called to the Army in November.

Arthur R. Magee, negative process operator, joined the Laboratories in May, 1948. As a reservist in the Air Force, he returned in August as a First Lieutenant.

Michael J. Murphy, building service group, came to the Laboratories in November, 1948. He was called to the Army in October.

John R. Nelson, Technical Assistant, was another reservist in the Navy. He came to the Laboratories in April, 1941, entered the Navy in January, 1943, for a three-year period, and returned to the Navy as Electronics Technician First Class in October.

Robert L. Norton, draftsman, is again in the Air Force as a First Lieutenant, having had a little over three years service flying bombing raids over Germany in World War II. His Laboratories career began in December, 1941; lasted until February, 1943; and was resumed in April, 1946.

J. C. JUHL

R. E. LEVESQUE

A. R. MAGEE

M. J. MURPHY

J. R. NELSON

R. L. NORTON



Port Authority Bus Terminal

Catherine Tully, R. A. Hecht, and R. F. Elliott are three of the many Laboratories people who benefit by the new Port Authority Bus Terminal. Beginning on December 15 last, their bus from Teaneck, N. J., enters the terminal directly from Lincoln Tunnel Plaza over a 1500-ft. overhead ramp, saving the time previously spent in the congested Times Square area. Besides, while they formerly had to stand outdoors in all kinds of weather, they now wait indoors for the bus. In addition, the Eighth Avenue subway has an entrance right in the building.

Within the new terminal there are 184 public telephones, constituting the largest initial installation of public telephones in the Bell System. Nearly 700 miles of telephone wires were

tensions to Port Authority offices in the building. Each bus line operating from the terminal has its own telephone system.

The building's telephone system represents an improvement over earlier installations. While other buildings may have more public telephones, they started with smaller installations and built their facilities gradually. The new terminal building has avoided exposed wiring and the "sandwiching in" of public telephones wherever space permitted.

Baker Williams Warehouse Sold

The Laboratories has sold the seven-story structure it has used for warehouse purposes at 380-392 West Twelfth Street. Known as Baker-Williams Warehouse, it is located on a plot



Installing coin telephone booths in the new Port Authority Bus Terminal.

installed in a vast system of conduits and under floor ducts—planned by telephone men working closely with the architects right from the start. A video cable has been incorporated in the wiring system so that bowling tournaments from the terminal's alleys can be televised. Special wall niches were provided for the coin telephone booths, which have their own ventilating units. Seventy-seven illuminated signs indicate where the telephones are located.

The telephones, spotted in 47 strategic locations, consist mainly of coin stations, but in the center of the main concourse is an attended public telephone center with twenty-two booths. A twelve-position information center is expected to handle a million and a half calls per year. After midnight, calls for information are transferred to the terminal's one-position private switchboard that serves one hundred dial ex-

176 by 80 feet, adjoining Building T and contained 40,000 square feet of storage. It has been our warehouse since 1920.

World's Telephones Top 70,000,000

During 1949 the number of telephones in the world increased by 7 per cent to 70.3 million according to *Telephone Statistics of the World*, published by A T & T. More than 61 per cent of them are in North America and of these 67 per cent are dial operated. The United States led all other countries with 40,709,398 instruments—more than all other nations combined. Great Britain ranked second with 5,177,370 and is the only foreign country with more telephones than New York City's 2,956,832.

In the United States there is one telephone

Bell Laboratories Record

for every four persons as compared with an average of one for every 75 elsewhere. In addition, we enjoy a more even distribution between town and country than other nations. By the beginning of 1950 more than two-fifths of our telephones served places with less than 50,000 population. In the five-year period, farm telephones increased by over 50 per cent.

With telephone service closer to hand, we are using it more. In 1944 we made 254 calls per capita. By 1950 the figure had risen to 355 as compared with 123 for Australians and 35 for Frenchmen. Also we are talking longer, the average toll call increasing one-half minute.

Dodge Named Outstanding Citizen of Mountain Lakes

In recognition of "an outstanding contribution to the welfare of this community through unselfish service for seventeen years as a member and Chairman of the Municipal Planning Board through the formative years which have made Mountain Lakes a model community," Harold F. Dodge has been designated "Outstanding Citizen" of the year by the Lakes Square Club of Mountain Lakes. The presentation was made by one of Mr. Dodge's former associates in the Laboratories, Halsey Frederick, who is also a former mayor of Mountain Lakes. Mr. Frederick told how Mr. Dodge served the Borough for 17 years, starting his official duties on the Planning Board in 1931. Mr. Dodge continued to serve the Borough until 1948, when he chose to retire from this work.



H. F. Dodge receives the Mountain Lakes award from Halsey Frederick.

Besides being active in Borough government circles, Mr. Dodge has served the Mountain Lakes Y.M.C.A. of which he is a former president. During World War II, Mr. Dodge served with the Aircraft Warning Service and was active in other defense programs.

Changes in Organization

TRANSMISSION DEVELOPMENT

J. R. Wilson has assumed additional responsibilities as a member of a special committee of the Research and Development Board of the Department of Defense. To assist Mr. Wilson in the administration of the work of his Department, S. B. Ingram, Electronic Apparatus Development Engineer, will act as Administrative Assistant to Mr. Wilson. Mr. Ingram will remain in charge of Department 2960, and in addition, will be in charge of Department 2920.

J. P. Molnar has been transferred from the Physical Research Department to the Electronic Apparatus Development Department as Electronic Apparatus Development Engineer reporting to J. R. Wilson, Director of Electronic Apparatus Development. Mr. Molnar will be in charge of a new Department 2940 which will be responsible for the development of high-power electron tubes, particularly those for military use. C. E. Fay and M. S. Glass and the groups reporting to them are transferred from Department 2960 to this Department 2940.

SWITCHING RESEARCH

W. D. Lewis of Radio Research has been appointed Assistant Director of Switching Research, reporting to W. A. MacNair.

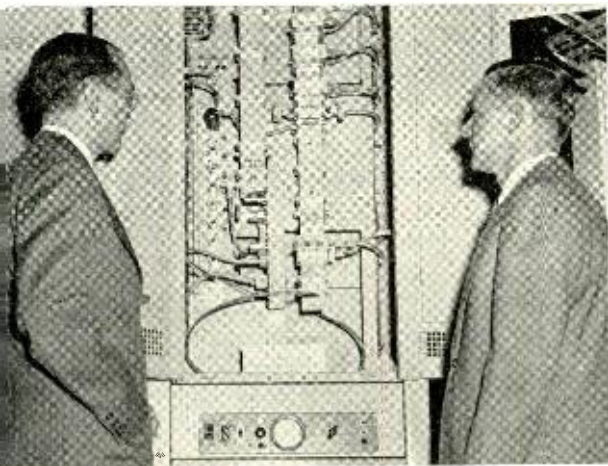

A. C. Dickieson (left) and T. J. Grieser inspecting TD-2 microwave transmitter-receiver bay prior to demonstration of this equipment to members of A.I.E.E.-I.R.E. at their joint meeting.



D. D. MILLER

J. F. BALDWIN, JR.

RETIREMENTS

Among those retiring from the Laboratories are D. D. Miller with 41 years of service; J. F. Baldwin, Jr., and J. W. Gooderham, 39 years; J. W. Woodard, 34 years; E. Dietze, 33 years; and Florence Conley, 28 years.

DANIEL D. MILLER

Joining Western Electric in 1909, Mr. Miller had a year's training at Hawthorne, and transferred to the Engineering Department at West Street in 1910. Western Electric was actively installing telephone train dispatching systems, and he took part in this work as a portion of his installation experience. The first of his patents was concerned with this system.

As a member of the old Physical Laboratory, Mr. Miller began a career of design and development of electromagnetic devices that has occupied him ever since. In his early days at West Street, the art of switching was being greatly advanced through the flat type relay, which brought economies of mass production and easy maintenance, and paved the way for the intricate but compact central offices of today. He has had a finger in the design of well over 50 of our standard relay types, and has seen the relay pass from a somewhat primitive contrivance to the extremely reliable device of present times.

In 1917, Mr. Miller was placed in charge of the design and development of many types of wound apparatus including, besides telephone and telegraph relays, resistors, selectors, switches, message registers, and associated precious metal contacts; switchboard cords and cables were added later. Machine switching systems were then being developed, with the need for relays capable of performing many functions different from the ordinary opening or closing of circuits—relays that would offer high impedance to voice frequency currents while responding to the normal operating current; relays to

operate slowly or release slowly; polarized types, responsive to the direction of the actuating current, and relays to operate on a-c signaling currents. During this decade, too, permalloy came into the picture and he applied this improvement to relays, both as part of the magnetic structure and as shielding against magnetic interference from other relays. Most of his total of some 25 patents are in connection with the designs of the relays mentioned.

In the early days of electromagnetic design, very little theoretical study had been given to them. As a result of his work on these devices, Mr. Miller wrote a book, in 1921, entitled "Design of Electromagnets," and this book was used for many years for training purposes. Out-of-hour courses using it were given, with Mr. Miller the instructor for the first two years.

Later on, the engineering activities on panel and step-by-step central office apparatus were added to the responsibilities of his groups. During World War II, he worked on rockets and mine control apparatus.

Following the war, he returned to his former activities in the design and development of electromagnetic apparatus in the Switching Apparatus Development Department. He took an active part in the development of an improved line relay and message register for dial systems, and improved designs of polarized relays for telephone and telegraph use.

One of Mr. Miller's chief hobbies is music. For many years he played first trumpet in the Bell Laboratories orchestra; in his early life, before coming to Western Electric, he had played in large traveling minstrel shows. Typical of an engineer, Mr. Miller engaged in research work on trumpet mouthpieces, analyzing tones with the cathode ray oscilloscope, directing his efforts toward the training of players.

Mr. Miller's retirement follows an absence of about a year on account of illness. At present Mr. and Mrs. Miller and their son and daughter reside in Teaneck, New Jersey.

J. FRANK BALDWIN, JR.

Telephone plugs and jacks are as old as the telephone itself; in fact, the word "jack" is a corruption of "jackknife switch" which was used in the Scribner switchboard of 1879. For about 50 years these two things made temporary connections between lines. With the growing complexity of military electronics, World War II saw the widespread use of plugs, jacks and connectors of various designs among which were types which automatically disconnected the communication equipment when it was to be disposed of under critical conditions. Hence a

new order of reliability was required to which Frank Baldwin and his engineers made notable contributions.

Teaching for a while after graduation from the University of Delaware (B.S., 1908) Mr. Baldwin became a Western Electric installer at Philadelphia in 1910. The next year he took a partial student course at Hawthorne after which he engaged in a development of loading coils for the first trans-continental system. In 1914 he came to New York on coil engineering and after World War I was engaged in the design of terminal equipment for the first carrier telephone and telegraph systems and the first Key West-Havana system. Shortly thereafter he was put in charge of this work along with the development of mobile public address systems, horns for sound picture systems and on various Naval fire control apparatus.

In 1927 Mr. Baldwin was put in charge of development work on plugs, jacks, terminal strips, protectors, indicators, etc., and a few years later coaxial connectors, keys and other miscellaneous central office apparatus were added to his responsibility. Some of these items, small and obscure, are nevertheless vital to the operation of the telephone plant. This is particularly true of plugs and jacks. These little things meet heavy and exacting service, and yet they must be small to save switchboard space. Because they run into millions, production economies are important. Over the years Mr. Baldwin and his group have been responsible for improvements in the field of existing designs of this apparatus as well as the development of miscellaneous new designs to meet the more varied and severe requirements of the dial, carrier, radio telephone and telegraph systems.

Mr. and Mrs. Baldwin will continue to live in East Orange.

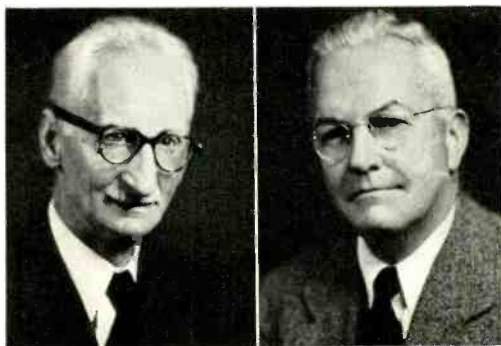

J. W. GOODERHAM

J. W. WOODARD

JOHN W. GOODERHAM

Back in the days of local battery telephones, the "battery wagon" made its rounds annually with a stock of dry cells or the zincs, acid, and repair parts for the wet cells at each telephone. John Gooderham started his telephone career in 1902 on one of those wagons, which served Bell Telephone patrons in Seattle. After he had risen to be wire chief, he took four years at University of Washington in electrical engineering. In 1917 he joined the analyzation group at Hawthorne.

Since 1919, when Mr. Gooderham came to West Street, he has been engaged in fundamental development studies covering a wide range such as dial office service observing, automatic testing equipment, pulsing circuits, methods of registration, anti-side tone circuits, radio noise suppression, and the development of automatic ticketing. During the war he was associated with the development of the Electrical Gun Director. Since the war his work has been in connection with the development of the Accounting Center of the AMA system and more recently in

On this battery wagon in Seattle Mr. Gooderham got his start. He sits second from the left.





FLORENCE CONLEY EGINHARD DIETZE

the development of nation-wide toll dialing. Twenty-two patents bear his name, with others pending.

Westerners at heart, the Gooderhams are going back there, but to La Jolla, California, instead of Seattle. There they can play shuffleboard and shoot pictures the year round, and be near many of their relatives. Their son is now in the Army.

JOHN W. WOODARD

Before "Woody's" Bell System career began at Hawthorne in 1917, he had already had six years with independent operating companies. After three years, he transferred to West Street where he has since been in equipment development work. For a long time he had charge of the current development group, which provides engineering services to Western Electric and the Telephone Companies on non-standard circuits and equipments. Some years ago, standardization and methods were added to his responsibilities. Later, he dropped current en-

gineering and added the Systems drafting department. Last August in preparation for retirement he gave up all those activities and took on apparatus specification work.

All four of the Woodards' children are married; one son and a son-in-law are with the Laboratories. There are seven grandchildren to delight his heart. Mr. and Mrs. Woodard are great fishermen and they expect to spend some time traveling in their trailer in search of good angling.

EGINHARD DIETZE

On graduation from University of Michigan (B.S. in E.E. 1917) Mr. Dietze entered A T & T where he soon was making transmission studies of telephone circuits. Since 1919, when D & R was formed, he joined the local transmission group. This work he continued in the Laboratories; it involved theoretical and field work on the design of telephone station circuits and instruments, and the development of testing methods and apparatus such as a reverberation meter and a sound meter. He was also associated with studies made on the effects of improved operators' transmission facilities and service conditions on the accuracy and speed of telephone service, with the development of methods of transmission rating to operators' equipment and circuits; with investigations of methods of excluding street noises from operating rooms and the development of window ventilators with acoustic filters; field observations and demonstrations in selected central offices; and in cooperative work with the Associated Companies.

During the war Mr. Dietze was a member of N.D.R.C. and head of its calibration section

These girls from various West Street groups volunteered to serve the Pioneer Life Members at their luncheon in New York. They are left to right, first row, Stella Zarakas, Edith Nielsen, Muriel Walter, Julie Dalm and Elaine Golding. Center row, Gloria Dodaro, Joan Bertche, Carol Hugget and Jean Breslin. Back row, Joan Hoffman, Dorothy Sherry, Mary Jane Paradiso and Isobel Relay.





Teletype messages transmitted from other parts of the world to Washington and from Washington overseas are screened for officers holding conferences in the Pentagon Building. For security reasons, printed messages have been blocked out.—U. S. Army photograph.

on Sonar. Since then, he has been connected with the transmission design of the 500-type telephone set and other new station sets. For some years he was chairman of the IRE committee on acoustic terminology; when it was merged with a similar A.S.A. committee, he became one of the joint chairmen. A glossary of acoustic terms prepared by the committee is about to be published.

Mr. Dietze's retirement comes after a long illness. He and Mrs. Dietze are now living in Bradenton, Florida, where he is finding opportunities to cultivate his twin hobbies—painting and color photography.

FLORENCE CONLEY

Now that she is retiring, Florence Conley has made plans to live in Florida where her husband, an Army civilian employee, is being transferred. They are now at Silver Springs prospecting for land on which to build the ranch type house of their dreams. They have some very definite ideas about houses, having built the bungalow they now own in Lynbrook, Long Island. Mrs. Conley has a flair for interior decorating and has been gathering sample materials for her plans for some time past. She is also interested in gardening and in church work, so her retirement promises to be a busy one.

Mrs. Conley joined the Purchasing Department twenty-eight years ago as a typist. After two years she transferred to the Accounting Department where she headed a small group of typists for a time. Since 1940 she has been a member of the Patent Staff Department, first as typist and then stenographer. In recent years she has been responsible for the typing and clerical work on Patent Control Records.

“Telcon” Rooms at the Pentagon Building in Washington

One advantage of teletype is the opportunity that it gives to study the message while formulating a reply. This is especially important when the subject under discussion involves military operations that are being carried on half-way around the world from the Center of Command.

In a “Telcon” Room in the Pentagon Building at Washington, high Army, Navy, and Air Force officers with their subordinates gather daily for top secret conferences with General MacArthur and his staff who are assembled in a similar Telcon Room in Tokyo. By means of teletypewriters equipped with viewing screens, as shown in the photograph, both halves of their “conversations” appear in printed form where all in the room can see them. Instead of being carried by telephone lines, the impulses from the teletypewriters are transmitted by radio in both directions.

Radio waves, being common property for all to listen to, made necessary some “scrambling” device to produce only gibberish until unscrambled at the desired receiving end. The Laboratories' telegraph group developed the devices for performing these functions, and Western Electric Company and Teletype Corporation manufactured the equipment.

Facilities are available for simultaneously carrying on three conferences between the Pentagon Building and Field Headquarters of our Military Services. Thus, Washington can have “talks,” for example, with Tokyo, Berlin, and Alaska at one time, if necessary.



R. R. Cordell, Commander of the newly formed Whippany Radio Post No. 329 presents "Pat" Rooney with a check for \$25.00 from the Legionnaires for the Doll and Toy fund at Whippany. Miss Rooney was chairman of the Doll and Toy Committee at Whippany for the past year.

American Legion Post No. 329 at Whippany

The idea of forming an American Legion Post at Whippany originated during a lunch hour conversation of veterans of World War II. Inasmuch as distance was the reason for Whippany veterans not joining the Bell Telephone Post in New York, R. E. Haggerty, H. K. Meyer and R. R. Cordell contacted the American Legion in connection with forming a post at Whippany. In addition, they contacted all veterans who are located at Whippany and outlined plans to them.

The first meeting was held in October, 1950, in a small building outside the Whippany gatehouse. Morris County Commander and Adjutant assisted in organizing the post. Mr. Haggerty was elected Acting Post Adjutant and Mr. Cordell Acting Post Commander.

In the second meeting the following members were elected: R. R. Cordell, *Commander*; R. E. Haggerty, *Senior Vice Commander*; A. H. Diegler, *Junior Vice Commander*; J. P. Swart, *Adjutant*; H. G. Hohner, *Finance Officer*; J. A. Donlevy, *Chaplain*; H. K. Meyer, *Historian*; M. W. Dring, *Sergeant-at-Arms*; and W. H. Bauer, *Service Officer*.

During the period between the first and second meetings, funds were raised to cover ex-

penses associated with organizing Whippany Radio Post No. 329. Of the amount raised, the sum of \$25.00 was donated to the Laboratories' Doll and Toy Committee.

There are now 20 members with a prospective membership of at least 50. At present, the post is busy forming committees to promote Americanism, to assist and inform veterans of their rights under existing laws, to visit disabled comrades, and to help local charities.

Two Million Telephones Added in 1950

The Bell Telephone System is well prepared to do its full part in meeting the national emergency as a result of five years of record construction costing five billion dollars, the American Telephone and Telegraph Company said recently in its year end business review.

During 1950, the Bell Companies added nearly two million telephones, making a total of 35,300,000 in service. This is twice as many as in 1940, and about three out of four telephones are dial operated as compared to 59 per cent when World War II started. The long-distance network was increased this year by a million and a half circuit miles. Since the end of 1945, the network has grown from 16 to 27 million circuit miles.

Leroy A. Wilson, president of the American Telephone and Telegraph Company, said rapidly expanding communications requirements for the military and for defense production will continue to be the No. 1 telephone job in 1951. In addition, he said every effort would be made to meet civilian needs.

One of the important undertakings of the last year was the start of the installation of telephone facilities for an Air Defense radar network rimming the country. Thousands of miles of private line networks are being provided to the military. Local and toll telephone facilities are being furnished to military bases and training camps throughout the country, and to civilian defense organizations.

Telephone users held approximately 140,000,000 telephone conversations a day over Bell Companies' lines. This is an increase of eight million calls per day over 1949. The increase in out-of-town calls is proportionally greater, with a marked increase during the latter part of the year following the outbreak of hostilities in Korea, and the rapid expansion of the defense program of the country.

New and improved methods are being extended rapidly to take care of growing demands. For example, with the installation of additional equipment during 1950, operators

can now dial out-of-town calls straight through to telephones in more than 1,000 localities. About one-third of the long distance calls are now being handled by this direct method.

The television network of coaxial cables and radio relay stations was doubled during 1950 to 18,000 channel miles of circuits. Both the cable and relay links are capable of transmitting television and radio programs as well as telephone messages.

The 250,000 telephones installed by the Bell System in rural areas during the past year brought the total gain in new rural telephones since 1945 to 1,500,000.

Demand for new telephone service also showed the effect of increased communications requirements growing out of the defense program. Some six million telephones were put in

service in 1950 in order to achieve the net increase of two million instruments. In spite of this accomplishment, however, Bell Companies still have some 800,000 orders on file for new service, and 1,700,000 requests from party line customers for better grades of service.

Mr. Wilson said that with a large, continuing construction program and no let-up in demand for service, additional financing has been authorized by the stockholders so that the Bell System may be in a position to obtain new capital for expansion when it is needed.

"To attract and protect the savings of investors, earnings must be maintained at adequate levels," Mr. Wilson said. "This must be done in order that the Companies may continue to succeed in providing the service the nation depends on during these critical times."

February Service Anniversaries of Members of the Laboratories

40 years
J. Barton
Anna Kiernan

W. E. Harnack
F. H. Hibbard
A. W. Kishpaugh

C. J. Langzettel
G. W. Meszaros
Joseph Michal
E. T. Mottram
J. E. Nielsen
A. G. Olson
Helen Racz
P. A. Reiling
R. C. Vreeland

15 years
J. J. Cozine
W. S. Eno
E. Habit
S. Korba
G. E. Linehan
K. H. Lloyd
C. E. Martin
J. U. Meats
S. E. Pulis

C. J. Lundquist
C. J. Nennering
R. J. Nielsen
C. G. Peterson
H. E. Richards
J. Rodgers
W. Wiegmann

35 years
H. F. Beck
K. G. Coutlee

30 years
L. B. Cooke
J. R. Fisher
W. E. Kahl
H. Kuhn
W. Kuhn
I. A. McCorkendale
O. L. Michal
G. F. Sohnle

20 years
R. Coviello
A. E. Eberenz
J. Godwin
J. Griffin
B. J. Kelly
L. W. Morrison
W. J. Rosoff
Elizabeth Williams
H. F. Winter

10 years
S. Bara
C. M. Cannon
R. H. Canton
F. F. Gruber
H. Hurray
J. J. Lander
F. Lindberg

25 years
Ethel Carr
S. C. Del Vecchio
M. F. Fitzpatrick
J. C. Hoffmann
H. K. Krist



JAMES BARTON
40 years



A. W. KISHPAUGH
35 years



H. F. BECK
35 years



W. E. HARNACK
35 years



K. G. COUTLEE
35 years



F. H. HIBBARD
35 years



*C. E. Swenson completing the mill-
ing machine operation on a new tool.*

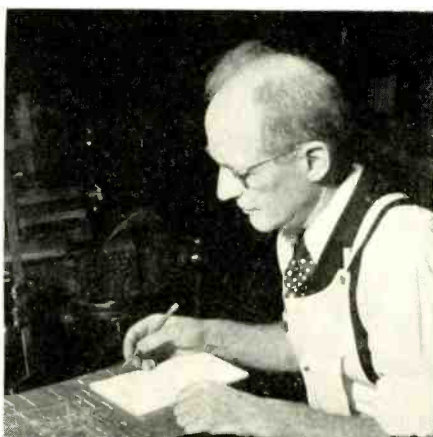

*Mr. Swenson studies a blueprint for
a tool-making job.*

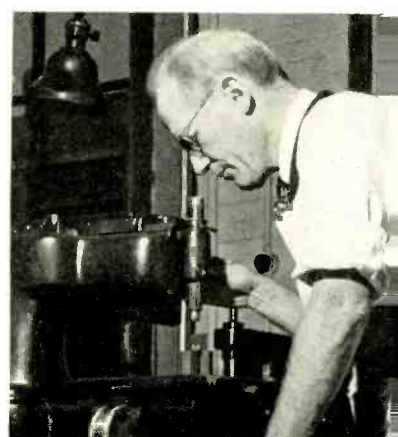

*Microscopic measurement and
specification of the tools.*

HOW C. E. SWENSON FILLS HIS DAY

The Personnel files show C. E. Swenson as "instrument and tool maker—precision." That is top billing in the Development Shops Department. It is also the realization of the dream of a Swedish immigrant lad, who has been on his own since he was fourteen. When he was seventeen, his sister paid his passage to America. He spent six years in a tool room of an outside concern. Then in 1918 he joined the Laboratories' Development Shops. During World War I he served as a stretcher bearer and later wrote a book on his experiences. Returning to the Development Shop, he has advanced steadily through the years, which he has spent for the most part in the Precision Room. Among the jobs he has enjoyed most were the early work on sound picture development, the sprocket and

precision gear work on the Fastax camera, and the several radar projects he worked on during World War II.

The Swensons live in Bergenfield where they raised their two sons. Ralph, the older, is taking advanced study in agriculture at Cornell University, while Roy, a dentist, is a lieutenant in the Navy at Newport, Rhode Island.

After a day in the Shop, Mr. Swenson goes home by subway and bus to a dinner that's highlighted by his wife's Swedish cooking. His hobbies are reading and writing, especially poetry. An informed citizen, he lets his representatives in local, state and national governing bodies know by letter how he feels on pertinent issues of the day. He is an active Pioneer and a member of the Bergenfield Police Department.

*Mr. Swenson gets coffee
in the cafeteria from
Mary Cummings.*



*Lunchhour chess with H. H. Hagens (center) and
H. G. W. Brown, left.*



*Mr. Swenson's oldest
friend in the Shop
Edward White.*





Mr. Swenson leaves 168th St. station before boarding a bus for his home in Bergenfield.



Mrs. Swenson greets her husband at the end of a day's work.

With soft music for background, the Swensons settle down for a quiet evening at home.



At his desk, thesaurus at hand, a rhyming dictionary nearby, C. E. Swenson writes poetry.



Looking over family portraits, the Swensons recall their trips to Sweden.





Stamp Club members at dinner at "The Captain's Table" honored Julian Blanchard, extreme right, upon his retirement. Following the dinner the group attended the Associated Stamp Dealers Exhibit at the 31st Regiment Armory.

Archery at West Street

Despite the loss of many members of the Archery Club at West Street, because of transfers to Murray Hill, the West Street group continues its activities by shooting every Wednesday evening at Washington Irving High School. The club plans to enter the National Archery Association Olympic Bowman tournament again this year; this is a mail match, and last year the club placed in the upper third of all groups participating. Besides the Wednesday evening shooting period, the club occasionally holds a luncheon meeting in the West Street dining room. The picture below was taken following the luncheon just prior to the Christmas holi-

days. Laboratories people interested in archery are urged to join the group.

News Notes

DR. BUCKLEY addressed an executive conference held at West Street on January 11. He outlined the Laboratories' achievements of 1950, and the challenging opportunities of 1951.

COINCIDENT with the removal of his residence from Englewood to Summit, D. A. QUARLES resigned as chairman of the Bergen County Sewer Authority. A farewell dinner was tendered him by his former colleagues of the Authority. During his long residence in Englewood Mr. Quarles served as both councilman and mayor.

The West Street Archery Club. Standing left to right, D. R. Thomas, W. F. Mack, S. J. Harazim, A. L. Jeanne, W. J. Rutter, W. G. Laskey, Secretary, and P. Mucci. Seated, C. O. Brosch, Treasurer, Margaret Monahan, E. G. White, Chairman, Alice Jastram, and W. Cernik, Vice-Chairman. Absent when the picture was taken were Helen Cruger, Assistant Secretary, and D. F. Cuneo.



IN RECENT YEARS great strides have been made in physical measurement techniques which throw light on molecular structure. These techniques are of interest to the Laboratories in revealing structural differences which affect the performance of materials. The ability, for example, of handset housings and other plastic parts which come in for rough treatment, to withstand shock, depends on how their molecules are packed together. Valuable hints as to the elements which make plastics tough are being obtained through a new and powerful method in which pulses of high frequency waves are shot into the material. At the Physics Colloquium, Brown University, H. J. McSkimin discoursed on this method in *Pulse Techniques for Determining the Mechanical Properties of Materials at Ultrasonic Frequencies*.

AS A PROMISING TOOL for chemical analysis the mass spectrograph was discussed by N. B. HANNAY and J. A. BURTON at the Argonne National Laboratory in Chicago. They also attended a meeting of the American Physical Society which was held in that city.



The book in which the cataloguer Loretta Kiersky is stamping the number "50,000" is entitled *Electrons and Holes in Semi-Conductors*, by William Shockley of Physical Research. It is interesting to note that, in an article in the *Western Electric News*, April, 1924, it is stated that the library then contained 7,000 books.



Working under difficulties. G. V. Ryan, shown above, is crawling out of the door to the main stack, while Paul Smarsly (left) and C. J. McDonald are waiting to enter.

After the job was completed, the men had some refreshments. In the photograph at the right, Paul Smarsly is pouring coffee for S. P. Leahy. G. V. Ryan is pouring his own, while in the rear, waiting their turn, are (left to right) William Dolbear, James Collins, Sigmund Fronczak and James Galbraith.

Heatless Day at West Street

On December 13 the main stack damper for the steam boilers became loosened from its shaft and stuck in the closed position. This occurred at about 3 a.m. and, of course, it was necessary to draw the fires immediately from the three boilers then in service. By about 6 o'clock, the stack had cooled off enough to be entered and repairs were begun. Working under difficulties in such a cramped space, members of the Plant Department finished the repairs in the afternoon and services of the boilers were restored about 4 p.m. The members of the Plant Department are entitled to great credit for the dispatch with which the repairs were completed.





Christmas Activities of the Choral Groups

This smiling group of Murray Hill Songsters posed informally after the final performance of the Christmas Concert. At the piano with Capitola Dickerson, accompanist, is their director, H. Thomas Miller. The Murray Hill chorus ended their busy season with two noon-hour programs in the Arnold Auditorium. The concert was enthusiastically received; especially well liked was Mr. Miller's composition, *A Christmas Story*, dedicated to the Murray Hill chorus and performed by them.

With the successful completion of the Fall and Christmas schedule, the chorus immediately began preparations for an equally full Spring program. Rehearsals have begun but there is still time for new members to join in the singing. A program of tuneful music is being readied for the Annual Spring Concert in May and more of Mr. Miller's compositions and arrangements are scheduled. The chorus will perform at Lyons Veterans Hospital again, and they have been invited to sing at a future meeting of the New Jersey Council, Telephone Pioneers of America.

In New York, the West Street Chorus presented their annual program in the auditorium under the direction of R. P. Yeaton, with Grace Wagner as accompanist. The chorus also gave a concert at the New York Savings Bank on December 19. The group will sing for the Pioneer Life Members at their meeting on Feb-

ruary 1. Plans are now underway for a spring program, which includes a concert some time in April.

At Whippany, the choral group shown below presented a variety program in their cafeteria on December 20. Featured in the program were a solo by Rita Zoch, soprano, a duet by A. F. Duerr and J. E. Monahan and a vocal quartet consisting of B. J. Thomas, W. L. Shaffer, E. I. Ingerson and R. O. Sinclair.

The Whippany group also sang before the Scotch Plains Newcomers Women's Club. The group gives a concert about every six weeks or two months in the cafeteria at Whippany and also sings for various outside organizations about once a month. At the present time, they are planning a program for the latter part of January as their next concert to be held in the cafeteria. E. I. Ingerson is chairman of the group. B. J. Thomas is the director and W. L. Shaffer is the associate director.

Growth of an Idea

Although it is frequently stated that bad news travels fast, a good idea may travel equally fast and result in a very worthwhile accomplishment. A great deal of credit is due to H. S. Hopkins, paymaster at West Street, and Ida Wiberg of Apparatus and System Engineering,



for gifts made to St. Albans Naval Hospital during the Christmas season.

In her activities as a Pioneer woman, Ida Wiberg had been actively collecting books for the World War I veterans in the hospital at Manhattan Beach. Recently, these men have been moved into the new Veterans Administration Hospital at Fort Hamilton, Brooklyn, where a fully equipped library and other recreational facilities are available.

Mr. Hopkins mentioned to some of the drafting room people that, due to the influx of the veterans of the Korean conflict at the St. Albans Naval Hospital, Long Island, the demand for books, cigarettes, and other recreational facilities was increasing. It was thought that the situation could be helped by making up a collection of gifts for these veterans for Christmas.

The idea spread like wild-fire. The Card Catalogue Files sent in approximately twenty-four packages of games, cards, razor blades, cigarettes, and books. The several file and drafting groups took up money collections. Patent Department people sent in their personal books plus a cigarette donation. The Women Pioneers also sent a cigarette donation.



Martha Janus is tying packages for the veterans of the Korean war now convalescing at the St. Albans Naval Hospital.

With the money thus received, fifty gifts were purchased and the final collection totaled about 450 books and over 80 gifts. It was intended that these presents would be distributed by a group of Laboratories' girls during the week between Christmas and New Year, but on December 20, the Red Cross sent out

an urgent call for all gifts and books to aid in the mammoth distribution schedule for December 21. As a result of this too short notice, the plan for the distribution by Laboratories' people had to be cancelled and the gifts were distributed to the veterans by the Red Cross.

The collection committee consisted of Bridget Del Vecchio, Jean Van Dusen, Mildred Malone, Clair Halpine, Cecelia Boland and Dorothy Carlson.



Dolls and toys were distributed to 45 orphan homes, nurseries and hospitals by the West Street Doll and Toy Committee. One of the recipients was the St. Barnabas Home and the photograph shows (left to right) Mary Cross Frank, Peggy Monahan, Virginia Wallerd and Jean Van Dusen giving dolls to three shy youngsters. Mrs. Frank is committee chairman.

Murray Hill Orchestra Entertains at Camp Kilmer

More than 500 officers and men stationed at Camp Kilmer in New Jersey were entertained by the Murray Hill popular orchestra and entertainers, the evening of December 18. In a two-hour variety show, the company of 35 Laboratories people, directed by C. H. Wallschleger, presented orchestral selections including numbers by the Dixieland Band and the Rhythm Trio; vocals by Connie Carlson, Adele Aboutok and Bert Kossman; a tap dance by Doris Michel; accordion solos by Terry Rillo and John Dry and a Charleston routine by Dot Carlson, Mildred Read and Jean Wilson. As the finale the orchestra presented their football medley featuring the Majorettes: Mildred Lax, Virginia Chaffiotte, Doris Michel, Irene Kelly, and Sylvia Dahl.

Arrangements at Camp Kilmer were made through Lieutenant Telford, Special Services Officer. A. J. Akehurst represented the orchestra and also operated the sound equipment and special lighting effects. The Misses Jean and Joan O'Keefe, Mae Giannini, Pat Corcoran, Marion

Nauss and Trudy Theel dressed in evening gowns, added a moving touch of color to the festivities when they distributed programs especially designed for the occasion by H. G. Geetlein and C. H. Wallschleger.

“Acoustical Designing in Architecture”

During a leave of absence from the Laboratories, C. M. Harris of the Acoustical Research Group collaborated with Professor V. O. Knudsen, U.C.L.A., in the writing of the book entitled *Acoustical Designing in Architecture*.^{*} The book is honored by being selected as one of the one hundred best technical books in the 1949-50 list prepared by R. R. Hawkins, Technical Librarian of the New York Public Library.

Intended as a practical guide to good acoustical designing in architecture, the book has been written primarily for architects, students of architecture, and others interested in a comprehensive, but nonmathematical treatise on this subject. Useful design data are presented in such a manner as to enable the text to be used as a handbook.

The general principles and procedures on which acoustical designing should be based are considered in the first half of the book. Specific applications of these principles in the second half include the design of auditoriums and other large public buildings, homes, apartments, and radio, television, and sound recording studios. The Arnold Auditorium at Murray Hill is shown as an example of non-uniform absorptive treatment and splays to insure proper diffusion of sound. Complicated mathematical formulas are translated into physical explanations, and comprehensive tables give useful data on sound absorptive materials and sound insulative structures.

Submarine Cables

O. B. Jacobs gave the second in the series of out-of-hour lectures December 18 in the West Street Auditorium and on December 20 at Murray Hill. The subject was *Submarine Cables*. Mr. Jacobs reviewed the progress in the submarine cable art since its birth a hundred years ago, emphasizing the developments that have taken place in the last twenty years and which culminated in the laying of the first deep water type cable equipped with built-in repeaters. These repeaters are integral parts of the cable under the armor, and are flexible enough to bend around the sheaves and brake drum of

^{*}John Wiley & Sons, New York, 457 pages, \$7.50.

a cable ship. Two cables of this type were laid during 1950 between Key West and Havana, using carrier transmission in the band from 12 kc to 108 kc, providing 24 wideband high-grade telephone circuits. A newly released motion picture film showing scenes of the manufacture of the repeaters and laying operations was shown.

News Notes

EACH MEASUREMENT TECHNIQUE has its peculiar field of usefulness. For example, in tracing the granular changes produced in a metal when annealed, the methods of optical microscopy are usually adequate. But to detect sub-granular formations suspected of causing noise in thermistors it takes the higher magnification of electron microscopy to do the job. Optical and electronic methods as aids to the chemist were discussed in a talk by C. J. CALBICK before the Chemical Society of Lafayette University.

K. G. COMPTON visited Materiel Command at Wright Field with representatives of the Signal Corps from Fort Monmouth to discuss the effect of moisture on communications and radar equipment. In Washington he spoke on *Field Conditions and Environmental Factors* before a symposium on the preservation of material and packaging at a meeting of the panel on Ordnance materials of the research and development board. J. M. WILSON spoke on *Simulated Tropical Conditions in the Laboratory*. J. R. TOWNSEND was Chairman of the panel.

TO REMIND Americans of the reservoir of talent in people now in their twenties and thirties, *Life* magazine recently published pictures of thirteen men and women chosen by the magazine as outstanding young citizens. The Laboratories are honored by the inclusion of Claude Shannon, of Mathematical Research.

THE WIDE range of interests of the Laboratories Technical Staff is reflected in the new fourth edition of Pender's and McIlwain's *Electrical Engineers' Handbook*, Communication and Electronics volume, published by John Wiley and Sons, Inc., New York. Twenty-six Laboratories' specialists are listed as contributors. In the fields of magnetics, varistors, thermistors, photoelectric and piezo-electric devices, are R. M. Bozorth, R. A. Chegwidden, N. Y. Priessman, H. E. Ives and W. P. Mason. Authors of sections on transmission theory and devices include D. S. Peck, P. H. Richardson, A. J. Grossman, J. C. Schelleng, G. C. Southworth, J. P. Kinzer, I. G. Wilson, S. A. Schelkunoff, and W. B. Hebenstreit. Measurements and measuring instruments, P. S. Darnell, A. H. Schafer, A. Volz, W. A. Marrison, J. G. Ferguson,

H. J. Fisher, E. Peterson, and E. W. Houghton. Contributors to sound and recording are W. A. Munson, J. C. Steinberg, H. L. Henning and L. Vieth.

Advance planning for the telephone plant sometimes hinges on developments programmed by the Laboratories. One of these situations, concerned with open-wire carrier took L. R. MONTFORT and E. H. PERKINS to a conference with Northwestern Bell engineers at Omaha. They were accompanied by P. C. DeMuth of O & E.

B. McMILLAN spoke on *Information Theory* at a meeting of the Institute of Mathematical Statistics in Chicago. At the Cleveland meeting of the American Association for the Advancement of Science, Mr. McMillan showed how basic mathematical reasoning can help engineers in his talk *Non-Calculational Mathematics in Engineering* and K. K. DARROW spoke on *Planck and the Early Quantum Theory*. Dr. Darrow also spoke to the Washington Section of A.I.E.E. on *Elementary Particles*. H. W. BODE attended a regular meeting of the American Mathematical Society in Gainesville, Fla.

AT THE TONAWANDA plant R. W. BOGUMIL, D. R. BROBST and L. R. SMITH attended a Quality Survey on enameled wire—one of the regular Surveys which the Laboratories conducts on apparatus produced in large quantities. Messrs. Bogumil and Brobst also discussed the manufacture of general purpose hook-up wire.



On his first day as a draftsman at Whippany, A. Duym (center) meets the people with whom he is going to work. Here, A. T. Jensen, Drafting Supervisor, introduces him to W. A. Landy.

February, 1951



J. R. KIERAN
1891-1950

W. D. SMITH
1874-1951

Recent Deaths

JAMES R. KIERAN, December 26

An extended illness was followed by death in December of James R. Kieran, who would have observed his twenty-ninth service anniversary in March. Mr. Kieran was a storekeeper, who worked in the main storeroom in Basement D. During his many years there, he became well known to those at West Street whose work required the use of gases such as oxygen, hydrogen and nitrogen. He handled as a part of his work the supply of these essential items, ordering and storing them and assuring their ready availability.

Mr. Kieran was born in Green Ridge, Staten Island, and attended St. Francis Xavier School. He worked as a shipping assistant for several New York firms, then served overseas with the Army in World War I. He joined the Laboratories as a stock helper on March 30, 1922.

W. D. SMITH, January 13

Mr. Smith, who retired from the Laboratories in 1939, began his telephone career with the Western Electric Company in 1918. He had formerly been associated with the late Thomas Nash, New York architect, planning city and country residences, churches and institutions. With Western Electric he worked with the radio development group. Following World War I he was in charge of the apparatus design drafting room where he remained until 1930. One assignment during this time was the design and supervision of construction of Colonel E. H. R. Green's radio broadcasting station, WMAF, at Round Hills, Mass. Mr. Smith transferred to the engineering and drafting group of the Plant Department in 1930 and until his retirement did building drafting and engineering of alteration work at West Street and architectural design of several buildings for various laboratories in New Jersey.



The final score is eagerly watched by, left to right, Mary Carpino, Betty Engstrom, Simone Baxter, Virginia Mooney, Betty Kofel, Pat Callahan, Joan Burke and Mary Jane Comly.



WHIPPANY GIRLS BOWLING

Betty Engstrom is just about to make a strike (she hopes).

Adding the score sometimes gets to be a problem. It is requiring the attention of, left to right, Jeanette Schlatter, Betty Reilly, Marie Luhr, Rita Zoch, Margaret Edwards, Jane Luckey and Pat Munther.



H. M. OWENDOFF, at Detroit, conferred with the Ford Motor Company and Industrial Wire Cloth Products Company, manufacturers of carburetor air cleaners, on the 3A frequency analyzer and 4A level recorder which are being used to track down sources of noise in automobiles. Over-all sounds in the automobile are picked up by a microphone and analyzed for frequency and intensity. With the aid of mechanical pickups, dominant components are traced to air filters and other noise generators.

TO MAINTAIN highest quality and efficient production of Bell System resistors, a resistance committee has been meeting periodically for a number of years. Consisting of two members from the Western Electric Company and two from the Laboratories, its meetings are held either at the Laboratories or at one of the Western Electric Plants. E. M. BOARDMAN, R. M. C. GREENRIDGE, and E. C. HAGEMANN recently went to Allentown for the latest meeting. Mr. Greenridge and Mr. Hagemann are the Laboratories members of the committee, while Mr. Boardman attended as a special consultant.

J. H. SCAFF has been elected Vice Chairman of the Institute of Metals Division, American Institute of Mining and Metallurgical Engineers. R. D. HEIDENREICH became President of *The Electron Society of America*.

TO MAKE raw material specifications simpler to copy and easier to interpret, efforts are being made to gather common requirements into single "envelope" specifications. To work out envelope specifications covering general requirements and methods of test for copper and copper alloy wrought products, G. R. GOHN attended a meeting of a special subcommittee of A.S.T.M. Committee B5 held at the General Electric Company, Schenectady.

WAS THAT number 3451 or 3541? If you guessed wrong and the number you dialed was unassigned, your call must be intercepted. Because there are a substantial number of such calls, and the operator's response is always the same, economy may be found in using a recorded message. Such a system is now on trial at Hartford; it has been visited recently by P. R. GRAY, W. C. MEYER and H. W. STRAUB of DSA Switchboard Systems, and H. W. AUGUSTADT and R. O. L. CURRY of AUDIO FACILITIES.

WHEN STUDENTS in the switching course given by A. E. RITCHIE at M.I.T. were divided into two sections for a discussion period, one section was conducted by S. H. WASHBURN. Text material for this course has been prepared in Switching Systems Development by a group which includes Mr. Washburn.

M. W. BOWKER consulted with LONG LINES ENGINEERS at Hartford, Conn., on pressure gradient data being collected on 50-mile cable sections continuously pressurized from each end of the section. Modifications of standard methods of interpretation of the data and of leak locating methods made necessary by this type of pressurized system were considered.

IN THE MOST COMMONLY used method of installing aerial telephone cables, the cable is "lashed" by a helical wire wrapping to its steel supporting strand, that has been previously strung on the pole line. This wire lashing is applied by a machine that is pulled along the cable and strand between poles. At each pole, the machine has to be lifted from one span to the next by a lineman, and the lashing wire has to be cut and terminated. In a new method of cable installation now under development, termed "prelashing," the cable and strand are placed simultaneously by drawing them from their supply reels through a cable lashing machine set in a fixed position. The lashing machine, reels of cable and strand, and apparatus for tensioning the strand are mounted on a trailer so as to form a mobile unit. The "prelashed" strand and cable are supported at each pole by temporary rollers. A lineman then climbs each pole and exchanges the temporary rollers for permanent attachments of the standard type. S. M. SUTTON, O. L. WALTER, and J. W. KITTNER participated in a field trial of the prelashing method in the Cleveland area of the Ohio Bell Telephone Company during December.

TYPE N CARRIER is a new 12-channel system which is intended for smaller distances than have been thought economical for type-K carrier. A number of pre-production systems have been built at Kearny and installed in various parts of the country. A. J. AIKENS has visited one of these, at Harrisburg to investigate difficulties and make final adjustments. He has also visited eastern Maryland, to study the probable effect on a proposed type-N system of nearby radio stations which use the same part of the spectrum. He also made tests on a newly installed system between Boston and Gardner.

AS ECONOMY and speed of service bring into use more complicated systems, the demand for careful coordination of existing systems becomes more pressing. An interesting example of this was uncovered by C. W. LUCEK and A. LUDWIG in a recent out-of-town trip. A single frequency dialing system had been extended into a central office equipped with non-associate apparatus. Noise from that office had a bad effect on the single-frequency pulses. The engineers suggested a change which cured the trouble.

February, 1951

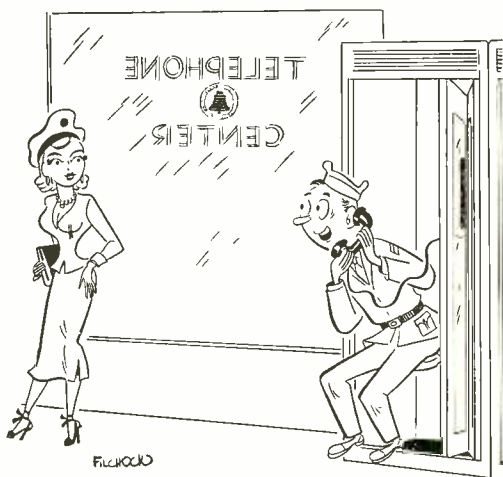

"Hold the line a second, dear. I have something in my eye."

IF CHARGING facilities for a central office storage battery are closely enough regulated to float the battery continuously, its life may be greatly extended. A new type of 200-ampere regulated rectifier is now being installed at the Hyde Park, Mass., office of the New England Company; J. A. POTTER visited that point recently to observe its performance. While in Boston Mr. Potter visited R. E. FRIEDLEY, our field engineer stationed there.

WITH THE GROWING DEFENSE LOAD on electrical manufacturers, it is important that Western Electric locate reliable alternative sources. To this end, R. H. Ross of Power Development accompanied C. B. Graeff of Western Electric Purchasing on a visit to several midwest makers of small motors.



As others see us. From W. E. Installation's "Observer."

WHEN A MICROWAVE LINK is used to extend a network to an outlying single television station, power is supplied by the local lighting company and an engine-driven generator is installed as a standby source. Failure of the main power starts the generator. Some engineering problems were discussed by V. T. CALLAHAN with Long Lines engineers at Cherry Valley, N. Y., where a microwave link branches off from the Albany-Syracuse radio relay system to serve a TV station at Binghamton.

TWO A.I.E.E. SECTIONS have heard talks by members of Switching Systems Development. JOHN MESZAR talked on A.M.A. at Baltimore and E. G. ANDREWS on computers at Erie. Mr. Andrews attended a conference on electron tubes in computers, held at Atlantic City.

DURING THE Christmas week panel discussion held by the Speech Association of America at the Hotel Commodore, G. E. Peterson gave a talk on "Equipment for Research in Speech." His talk was a part of the program concerned with speech equipment for teaching and research. Mr. Peterson described recently devel-



Engagements

- *Adele Aboutok—Robert Files
- *Norma A. Angerhauser—William Ziegler, Jr.
- *Jane Ammerman—Neil C. Blanton
- *Isobel Armstrong—Thomas Garvett
- *Elizabeth Carlton—Rod Portine
- *Mary Jane Comly—*Richard Watters
- *Kathleen Cosgrove—James C. Harkness
- *Gloria Dodaro—Steve Santacroce
- *Phyllis Klimko—Ralph Manners
- Catherine Klotz—*Edwin Irland
- *Ethel Lane—*Frank R. Monforte
- *Lillian O. MacNeill—Anthony F. Rivera
- *Elisabeth Lee Salmon—Sgt. Cecil D. Garrett
- *Rita Schmidt—C. Broadwell
- *Alberta D. Shoemaker—*Robert Tomb
- Norann Speer—*Henry A. Cubberly
- *Gertrude Theel—Lester Kitchell

Weddings

- Ann Hirshberg—*Edward David, Jr.
- *Jean Kelly—John Forst
- *Beverly Raquet—Edward J. Otten

*Members of the Laboratories. Notices of engagements and weddings should be given to Mrs. Helen McLoughlin, Section 11A, Extension 296.

"Telephone Hour"

NBC, Monday Nights, 9:00 p.m.

February 5	Marian Anderson, <i>contralto</i>
February 12	Robert Casadesus, <i>pianist</i>
February 19	Ferruccio Tagliavini, <i>tenor</i> , and Pia Tassinari, <i>soprano</i>
February 26	Bido Sayao, <i>soprano</i> , and Giuseppe Valdengo, <i>baritone</i>
March 5	Nelson Eddy, <i>baritone</i>
March 12	Jussi Bjoerling, <i>tenor</i>
March 19	Clifford Curzon, <i>pianist</i>
March 26	Ezio Pinza, <i>basso</i>

oped devices such as the sound spectrograph and the sound spectroscope, and described the part that the free space room at Murray Hill plays in the speech research at the Laboratories. He also reviewed the use of delayed feedback in speech studies, and problems arising in speech analysis.

AT A CONFERENCE in the Arnold Auditorium, Dr. Albert Szent-Györgyi gave an account of his theory of muscular structure and action. This theory is based on the properties of protein and long-chain organic molecules; electrical effects play an essential role in the theory. Dr. Szent-Györgyi was the Nobel prize winner in physiology and medicine for 1937. He is at present Director of Research of the Institute of Muscle Research of the Marine Biological Laboratories in Woods Hole, and is connected with the National Health Institute at Bethesda, Maryland.

FIRST SAMPLES of a new lightweight steel loading coil case which requires only one-third as much steel as its predecessors were inspected by J. E. RANGES and H. A. STONE at Hawthorne.

UNLIKE most engineering structures, a telephone switching system cannot be tested under heavy artificial loads; engineers must wait until the public is in a telephoning mood to give their system a real workout. Such an opportunity came for the new No. 5 crossbar office at Englewood during the recent holidays, when a combination of bad weather, youngsters home from school, and the normal Saturday shopping peak brought a heavy overload. R. E. HERSEY and A. O. ADAM visited the Englewood office then and were gratified at its performance.

F. K. HARVEY, who appears in the facing advertisement, develops and measures structures for bending, guiding and focusing sound waves. These arrays, many of which were originally designed for microwave use, are similar in both appearance and operation to their familiar optical counterparts in lenses and prisms.