

## *A novel accelerometer*

R. W. KETCHLEDGE

*Submarine*

*Cable*

*Engineering*

Electronic tubes are delicate devices, and when apparatus employing them is to be used in mobile equipment, it must be designed to reduce the shocks reaching the tubes to tolerable amounts. Often the most difficult part of such a design is to determine the magnitude of the shocks that may be encountered. The recently installed submarine telephone cable\* to Havana employs electronic repeaters housed in the cable itself. Once the cable is lying safely on the bottom of the ocean, no shocks of serious magnitude are to be expected, but in arming the cable, and in laying it from the cable ship, many things might happen that would result in shocks of considerable size. The cable is uncoiled from the hold, and passes around drums and over sheaves on its way out of the ship. In this journey the tension may build up to several tons, and there is a possibility that the cable will strike the deck or some of the laying apparatus with considerable force. Before completing the design of the repeater, therefore, it was necessary to determine the magnitude of the shocks that might be encountered in the cable-laying procedure. Using apparatus described in the following paragraphs, these were determined by tests at the Laboratories and also during preliminary cable laying tests off the Bahama Islands in the spring of 1948.

\*RECORD, June, 1950, page 269.

December, 1950

Devices for measuring shock are called accelerometers, and many types have been employed. Each is usually designed to meet a specific set of conditions, and thus may not be suitable for a different set. An accelerometer for measuring shocks in cable repeaters would not only have to be small enough to fit inside the repeater housing,

*Fig. 1—H. Alfke inserting one of the accelerometers in the end of a telephone repeater.*



and capable of giving an indication over many miles of cable, but it would have to respond to shocks in any direction transverse to the cable. Longitudinal shocks are absorbed by the cable itself, but shocks in a plane at right angles to the axis of the cable would directly and in almost their full magnitude be transmitted to the repeater within it. Practically all accelerometers previously available register shocks acting only along a line, and thus are not suitable where the shock may come from more than one direction. A new type of accelerometer had to be designed therefore. The device produced is shown being installed in a repeater housing in Figure 1.

The word accelerometer means, of course, a device for measuring acceleration. From the fundamental equation of mechanics—force equals mass times acceleration—the force acting on any device or part when it is subjected to shock is equal to its mass times the acceleration it is given, and since the masses of the components are constant and inherent in the design, the force acting on a part is directly proportional to its ac-

celeration. Since for a given acceleration the force acting on each element of a device, such as a vacuum tube, will vary with its mass, and thus be different for each element, it is simpler to determine what acceleration the device will safely withstand and then to make sure that it is not subjected to accelerations greater than this, rather than to determine the forces acting on each individual part.

The new accelerometer uses the piezo-electric effect to determine acceleration. As pressure is applied to a piezo-electric crystal, a voltage appears across its faces, and this voltage is used as a measure of the pressure applied. Five plates of ADP crystal\*—each 2 inches long,  $\frac{1}{2}$  inch wide and  $\frac{1}{10}$  inch thick—are placed one on top of another with electrodes between them. Ceramic discs are cemented to the ends of this assembly, which is then slid into a steel cylinder. The arrangement in simplified form is indicated in the upper part of Figure 2. Thin steel diaphragms, gasketed against a shoulder in the steel cylinder, are placed against the ceramic discs, and a cover plate is screwed over the end of the cylinder. Between the diaphragms and the cover is a chamber about an eighth of an inch wide that is filled with mercury through a hole provided for in the cover, after which the opening is sealed.

When such a unit is suddenly accelerated, a pressure will develop in the mercury which is proportional to the product of the acceleration by the mass of the mercury. Since mercury is a liquid, this pressure will be exerted equally in all directions, and thus will act, through the diaphragm and the ceramic disc, on the ends of the crystals. This pressure causes a potential difference to appear across each plate.

Metal foil is placed in contact with each face of each crystal, and the foils on the faces of negative polarity are all connected together as are those on the faces of positive polarity. The average voltage thus appears across a pair of wires, and is conducted to the end of the cable over the central conductor and sheath. With this device, accelerations from a small fraction of  $g$  up to 2,000  $g$  may be measured, where  $g$  stands

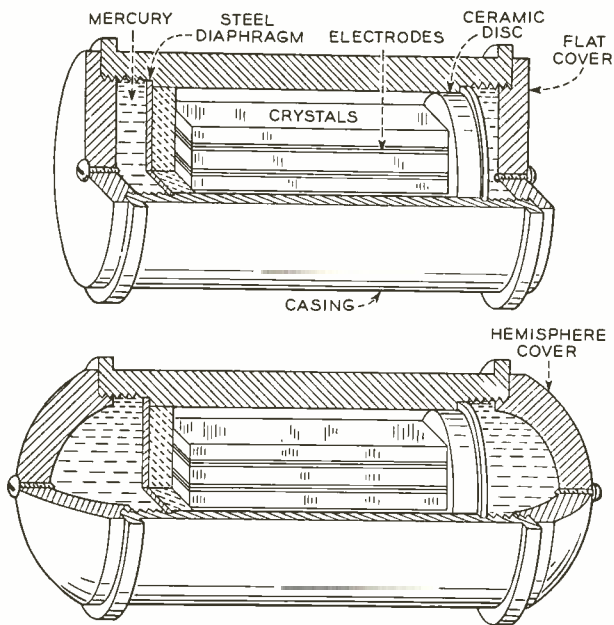

Fig. 2—Simplified cross-section of accelerometer unit for submarine cable repeater, above, and a similar accelerometer but designed for measuring accelerations in any direction, below.

\*RECORD, July, 1946, page 257.

for the gravitational acceleration of 32.2 feet per second per second. At 2,000 g, the electrical power delivered by the accelerometer is of the order of a milliwatt. During a test, an oscillograph is used to make a record of the voltage, and thus of the accelerations experienced. Typical oscillograms are shown in Figure 3.

Pressure, of course, is force per unit area, and in Figure 4, the mercury chamber is

shown divided by dotted lines into separate columns of mercury parallel to the direction of acceleration in such a way that the cross-section of each column is one unit area. The pressure at any point along this column is equal to the product of the acceleration by the mass of the mercury beyond this point in the direction of acceleration, and is thus not uniform throughout the chamber. In column A, for example, the pressure at point x

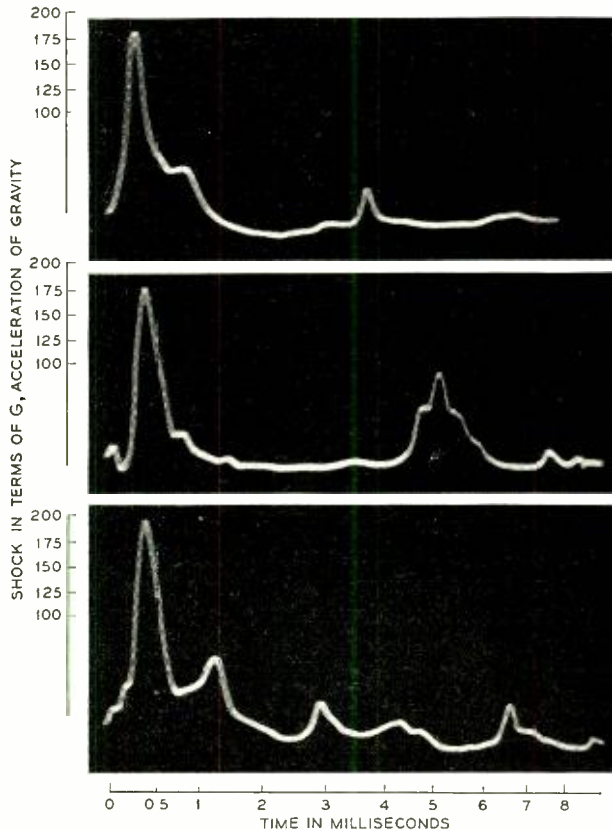

Fig. 3—Typical handling shocks experienced in tests at Bell Telephone Laboratories. Top—a 180g shock merged with a smaller secondary shock probably due to the cable's not striking uniformly along its length. (A small secondary shock is also present.) Middle—a 170g shock in which the cable appears to have struck evenly, producing a rather smooth shock followed about four milliseconds later by a second and smaller shock. Bottom—a 200g shock of approximately  $\frac{1}{4}$  millisecond duration followed by considerable secondary vibration. In all three oscillograms, the cable was traveling from 80 to 100 inches per second, and thus 4 or 5 milliseconds corresponds to a travel of less than half an inch. All secondary shocks are thus attributable to the first impact and not to bouncing of the cable.

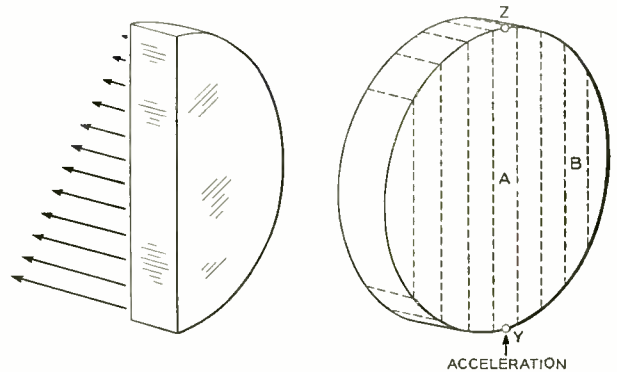

Fig. 4—Distribution of pressure in mercury chamber due to accelerations.

will be equal to the mass of the entire column times the acceleration, while at point z it will be zero. In the center it will be just half that at x because the mass beyond the center is just half that beyond y. In column B, there will be a similar distribution of pressure, but the pressure throughout will be less because the column of mercury is shorter. The pressures on the diaphragms which are transmitted to the crystals thus vary over the surface of the diaphragms, and the total voltage generated by the crystal corresponds to the average of the pressure over the entire face of the crystals. Although the pressure is not uniform throughout the chamber, the average pressure is always proportional to the acceleration.

Since the pressures generated are proportional to the length of the column of mercury in the direction of acceleration, the pressures generated by longitudinal acceleration would be small because of the shortness of the mercury columns in the longitudinal direction. If an accelerometer were desired equally responsive to accelerations in all directions, the mercury chamber would

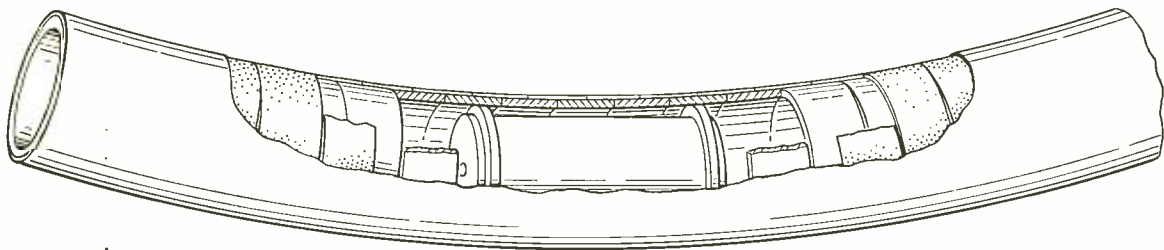

Fig. 5—Simplified sketch of the accelerometer in a submarine cable repeater.

be made hemi-spherical as shown in the lower part of Figure 2. With mercury chambers of this shape at each end, the length of the mercury columns, and thus the pressures, are the same for all directions of acceleration. For both types, mercury is selected as the liquid because its specific mass is higher than that of any other liquid, and thus the pressure developed for a given acceleration will be greater.

The repeater housing into which these accelerometers are placed is constructed as shown in Figure 5. Inside a thin copper tube, employed primarily to exclude water, is a series of steel rings  $\frac{3}{8}$ -inch wide. Over these rings, and centered over the lines at which adjacent rings touch, are placed very thin steel bands. Since the repeaters are directly inserted in the cable, they must be capable of being bent around drums and over large sheaves as the cable is being laid. Under such circumstances, the outer copper tube readily takes up the required arc of curvature, while the catenation of steel rings in-

side form a series of short chords. It will be noticed from Figure 2 that there is a circumferential rectangular ridge around the accelerometer housing near each end, and the outer diameter of these ridges is just large enough to fit inside the steel rings. As the cable bends, the rings tilt on these ridges, and thus permit the cable to follow an arc while the accelerometer remains straight.

Although this accelerometer was built for studying the shocks occurring in laying telephone cable, it should find much wider use—particularly in the form shown in the lower part of Figure 2. On airplanes or any mobile equipment, accelerations in any direction could readily be measured by fastening an accelerometer of this type rigidly to some part of the structure. It would seem also that such an accelerometer might be effectively used as a seismograph. Rigidly fastened to the underlying rock, or even placed at the bottom of a well, it would pick up accelerations in any direction.

**THE AUTHOR:** R. W. KETCHLEDGE attended the Massachusetts Institute of Technology where he received the degrees of B.S. and M.S. in E.E. in 1942. Upon graduation he joined the Systems Development Department of the Laboratories. During the war he worked on various projects including new sonar techniques, and other special underwater sound devices, an aircraft position indicator, and infrared detection devices. In 1946 he was assigned to repeated submarine cable work, and was concerned with a variety of special testing and development projects. Since 1949 Mr. Ketchledge has been in charge of a group developing regulators for the L3 coaxial system.



# Pulse conversion in No. 5 crossbar

H. J. MICHAEL

Switching  
Development

Most DSA<sup>1</sup> and toll switchboards are equipped with pulse-sending apparatus to permit them to complete calls directly to dial offices. Depending on the types of offices in the direct switching area, this pulse-sending apparatus may be a dial or one of several types of key sets. When some of the offices to which the operator may have to complete calls require one type of pulsing, and others another type, a group of senders is commonly associated with the switchboard that will accept the pulses sent out by the operator's dial or key set and then send out to the distant office the type of pulsing it requires. Such an arrangement is generally more satisfactory than to provide two or more pulse-sending devices at each position of the switchboard and require the operator to determine the type of pulsing needed for each call she completes. These senders form a separate group for use exclusively by the switchboard.

With the introduction of the No. 5 crossbar office with its inherently great flexibility, however, it has been possible to provide arrangements that permit the No. 5 crossbar equipment, where it is in the same building as the switchboard, to be used for calls of

this type, and thus the provision of a separate group of switchboard senders becomes unnecessary. Since the function of the crossbar circuits in such applications is primarily to accept one type of pulsing from the switchboard and convert it to another type for transmission over a trunk, the process is called pulse conversion. Ordinarily the amount of this type of traffic is comparatively small, and it may thus be handled by the No. 5 office with little if any increase in the size of the register and sender groups.

When an operator plugs into one of the trunks requiring pulse conversion, the procedure so far as she is concerned is the same as though she had plugged into a trunk not requiring pulse conversion. No special traffic instructions are required. The trunk circuit itself, however, is arranged to seize automatically an idle incoming register,<sup>2</sup> which will record the pulses from the operator's key set and certain other information. The register then seizes a marker and transfers the information to it. The marker, in turn, causes an idle sender<sup>3</sup> of the proper type to be connected to the trunk

<sup>1</sup>RECORD, December, 1945, page 466. <sup>2</sup>March, 1950, page 104. <sup>3</sup>November, 1949, page 385.

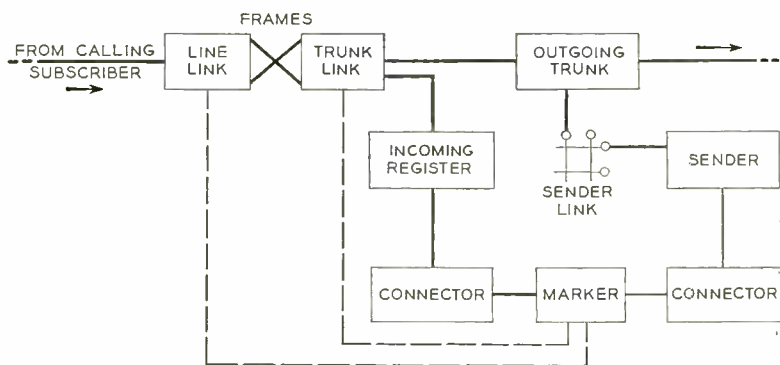

Fig. 1 — Block diagram of major circuits involved in handling an outgoing dial call.

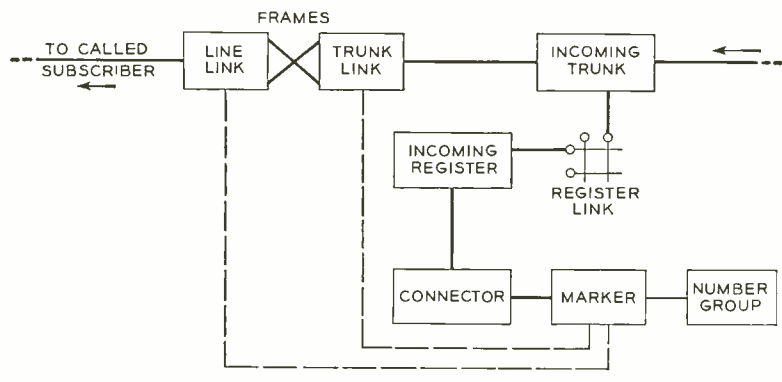

Fig. 2—Block diagram of major circuits involved in handling an incoming dial call.

into which the operator has plugged, and transfers the required information to it. The sender transmits pulses of the proper type over the trunk, connects the trunk through to the switchboard, and then disconnects itself. The register and marker will have disconnected themselves shortly after the association of the sender. The marker is held for only about a quarter of a second, and the sender only long enough to transmit the necessary pulses over the trunk.

All this sounds very straightforward and regular, but as a matter of fact, the marker in handling a pulse conversion call must follow a different procedure from many of those it carries out in completing an ordinary No. 5 crossbar call. The difference lies in the fact that the marker must first treat the pulse conversion call as though it were an incoming call, and then as if it were an outgoing call. This is possible largely because in the No. 5 crossbar system a single type of marker is capable of handling both incoming and outgoing calls.

The steps taken by a No. 5 crossbar marker in handling an ordinary outgoing call are indicated in Figure 1. The marker is seized by an originating register, which has previously been connected to the calling line by this or another marker. It then connects to an idle trunk-link frame that has an idle trunk of the desired route, and seizes one of them. Having selected and seized a suitable sender for completing the call, the marker connects it to the selected trunk. After transferring the needed information to the sender, it then disconnects. Before disconnecting, however, it had also found an idle path from the calling line on the

line-link frame to the selected trunk on the trunk-link frame, which is always one of its major functions in handling a call through the No. 5 crossbar office.

Its procedure in handling an incoming call is indicated in Figure 2. In this case, the calling incoming trunk seizes an idle incoming register, and the register, after it has recorded the information regarding the connection desired, seizes an idle marker. The marker then connects to the trunk-link frame to which the calling trunk is connected, and to a number group circuit to determine the location of the line called. It then connects to the line-link frame indicated and finds an idle path from it to the trunk-link frame. It is then free to disconnect.

In handling a pulse conversion call, the marker, as previously mentioned, goes through some of the steps it follows for incoming calls, and some it follows for out-

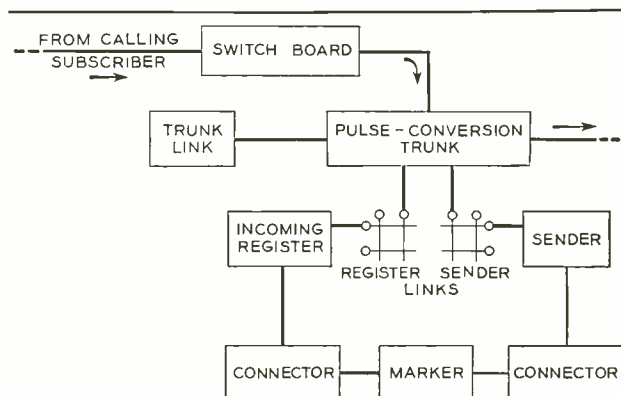

Fig. 3—In handling a pulse conversion call, the circuits used for incoming and those used for outgoing calls are both employed.

going calls, but it never has to connect to line-link frames or find idle paths between a line-link and a trunk-link frame. Its procedure is indicated in Figure 3.

The pulse conversion trunk partakes of the characteristics of both an out trunk and an incoming trunk: it is connected to a register link as is the incoming trunk and to a sender link as is the out trunk. An incoming register is seized when the operator plugs into a trunk, and after the pulses have been recorded, the incoming register selects an idle marker and transfers the information to it. The marker selects and seizes a suitable sender, and then—by way of the register link, the conversion trunk and the trunk-link frame—it operates the proper hold magnet in the sender link to connect that trunk to the sender already selected. It then transfers its information to the sender, and disconnects.

On all these drawings the paths over which the marker is seized and those that are pre-established without selective action on the part of the marker are shown by heavy solid lines. Those paths that the marker selects are indicated by light solid lines, while the auxiliary paths over which

the marker gains access to the various circuits are indicated by dashed lines.

For an ordinary outgoing No. 5 crossbar call, the marker selects the trunk and the sender to be used with it. For an ordinary incoming call it selects only the path between the line-link and trunk-link frames. With a pulse conversion call, on the other hand, it selects only the sender, since the trunk has been selected by the operator, and the trunk in turn selects the incoming register. The marker is seized by the incoming register and gets the information from it as with an incoming call, and then selects a sender as in handling an outgoing call. It does not have to make a trunk selection nor find idle paths between a line-link and a trunk-link frame, however, and thus the work it does is not as extensive as with an ordinary crossbar call. Furthermore, the main switch frames of the No. 5 office are not held busy after the call has been established. The demands placed on the No. 5 office by this service are thus not great, and yet considerable economy is secured by eliminating the necessity for a special group of senders for the manual board.



December, 1950

**THE AUTHOR:** H. J. MICHAEL joined the Laboratories in 1929 and became associated with a group concerned chiefly with studies relating to telephone quality, including analysis of the physical characteristics of speech and telephone conversation. In 1940 he transferred to the Switching Development Department and worked on voice frequency dialing and multifrequency key pulsing. During the war he worked on underwater weapons and was cited by Admiral Nimitz. Since the war he has been associated with the group designing the No. 5 crossbar system. Mr. Michael is a graduate of New York University with degrees of B.A. in mathematics and M.S. in physics.

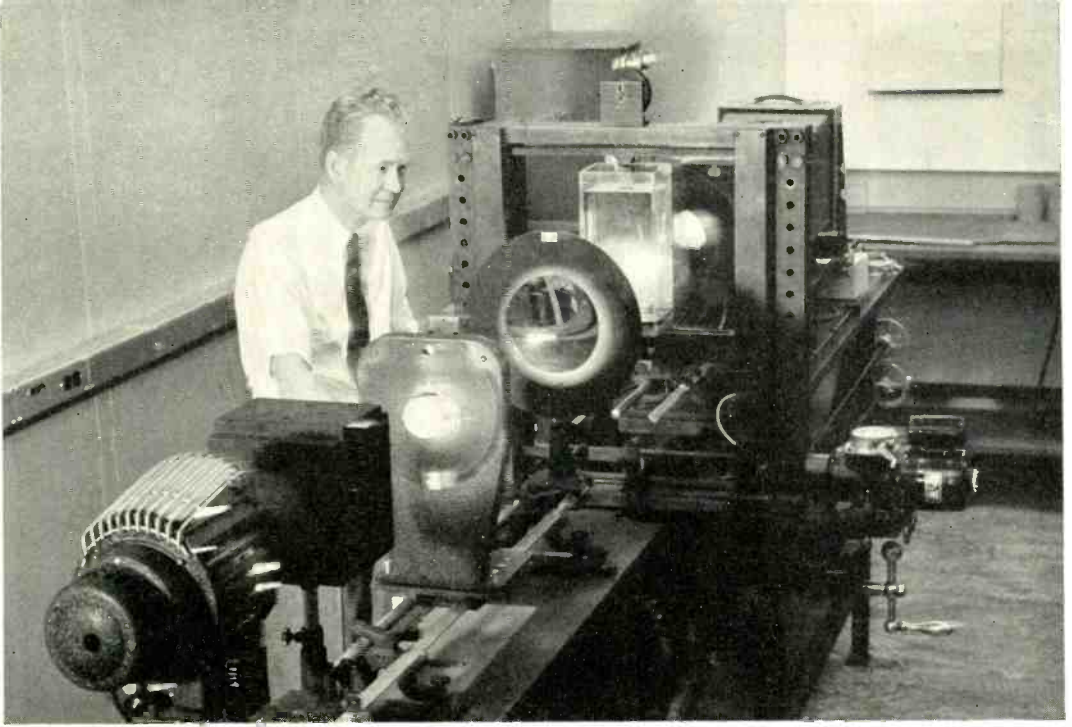

## *Making unseen stresses visible*

Occasionally telephone parts are subjected to stresses which may result in breakage. To minimize this danger, engineers seek information concerning the nature of these stresses as a guide to the most reliable and economical design.

In parts of complex shape, the stress distributions are practically incalculable. With the photoelastic test set shown above, however, stress distributions are made visible and the stresses can readily be calculated. The technique employs a model of the structure under study; it is made of a transparent plastic with special optical properties. When this model is placed under stress and examined under polarized light,

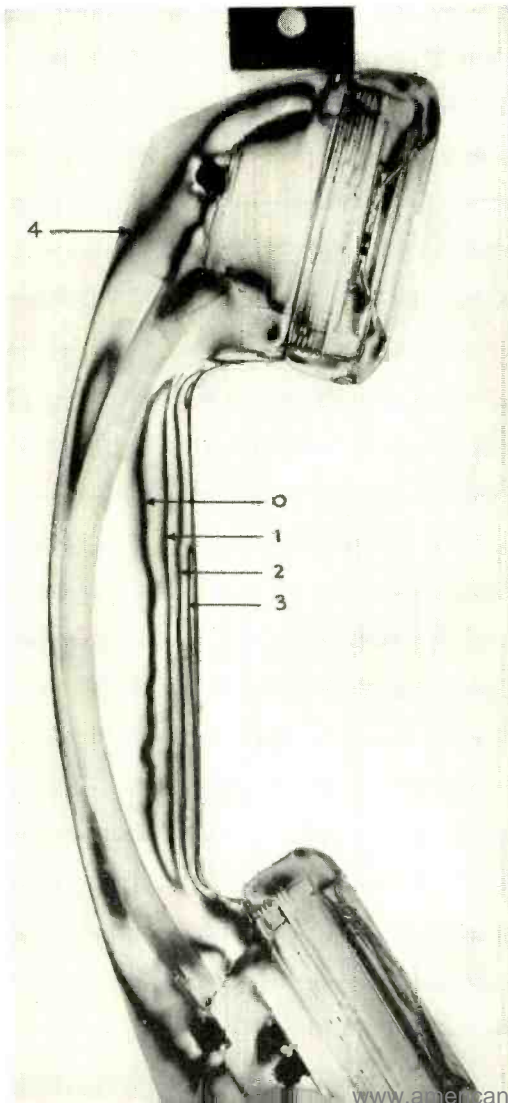

*Fig. 1—Handset under compressive forces approximately simulating those which occur when a handset is dropped on end. The optical interference fringes numbered 1, 2, and 3 disclose contours of calculable increments of compressional stress which is zero along fringe (0). Fringe (4) at top represents extensional stress. Other fringes disclose residual stresses in the material.*

*Bell Laboratories Record*



a pattern of lines or fringes\* can be seen. From this pattern, the magnitudes and directions of the stresses at all points in the model may be calculated. If the load system is distributed on the model in the same way as that to be applied to the part under study, then, by the principle of similarity, the stresses which will be set up in the structure itself may be determined.

\*RECORD, February, 1950, page 62.

*Fig. 2—T. F. Osmer mounts a plastic model of the F-type handset between compression jaws, in a transparent box. To prevent reflection of the polarized light beam from the handset, the box is filled with a liquid of the same refractive index as the plastic.*



## *N-1 carrier system goes into service*

One of the most significant of Bell Telephone Laboratories' post-war developments, the N-1 cable carrier telephone system, went into commercial use recently over the 46-mile span between Harrisburg and Sunbury, Pa. N-1 is the new system especially designed by the Laboratories to bring the advantages of carrier telephony to short haul traffic. It is expected to have widespread application throughout the Bell System.

Through its ability to provide 12 high-quality telephone circuits simultaneously on only two pairs of wires, carrier telephony greatly adds to the carrying capacity of cables; thus it avoids the installation of many new cables. These advantages have been realized in the well-known K-carrier system over long distances for a number of years, but the cost of the carrier terminal equipment has prevented its economical application to short haul circuits.

To overcome this problem, Bell Laboratories engineers with R. S. Caruthers as project engineer combined several basic transmission methods in an entirely new and

extremely effective way. This was made possible by a number of advances in the art of producing small-size, low-cost (so-called "miniatured") apparatus. At the same time, some entirely new ideas have been developed and integrated into the system. The result is N-1, a very economical carrier system capable of bringing the benefits of this type of transmission to distances ranging from 20 to 200 miles.

An outstanding advantage of the N-1 system is that it requires only one cable to handle transmission in both directions, whereas previous systems require two cables, one for each direction.

The new N-1 system uses simple "double-sideband" modulation. This permits a marked reduction in filter costs and thus terminal costs. Another major feature is a new type of built-in "compandor." By reducing the effects of noise and crosstalk, this device has eliminated the need for complex cable-balancing equipment and much special testing, whose general principles have

*(Continued on page 555)*

# *Automatic transmission measuring set*

**J. M. HUDACK**  
*Transmission  
Apparatus  
Development*

One of the devices developed in recent years to cut down the labor of laboratory testing is the automatic transmission measuring set shown in Figure 1. In approximately 30 seconds this set automatically measures and records the transmission characteristics of an amplifier or a network over a frequency range from 20 to 20,000 cycles or from 100 to 100,000 cycles. Records covering portions of either of these frequency ranges may be made in a correspondingly shorter time. This set is finding considerable use in the audio facilities laboratory for the measurement of the gain or loss of amplifiers and associated equipment currently under development.

The original incentive to develop such a set came from the network and filter development laboratories where exploratory measurements of transmission loss are often needed. It was desired to reduce the time and labor required in making measurements at a number of selected frequencies by the point-by-point method. In addition to the advantages of savings in time and labor, continuous transmission *vs* frequency characteristics often reveal variations that might not be found even by the most careful selection of single test frequencies. During the war, sets operating on the principles described in this article were employed to secure masses of transmission data in Sonar research. Today, a comparable set is part of the measuring equipment in the acoustics laboratory. Several similar sets are used in the various transmission networks laboratories at Murray Hill for the testing of networks and filters.

The principle of operation may be understood by referring first to Figure 2 which shows the essential elements required for the simplest kind of a single-frequency measure-

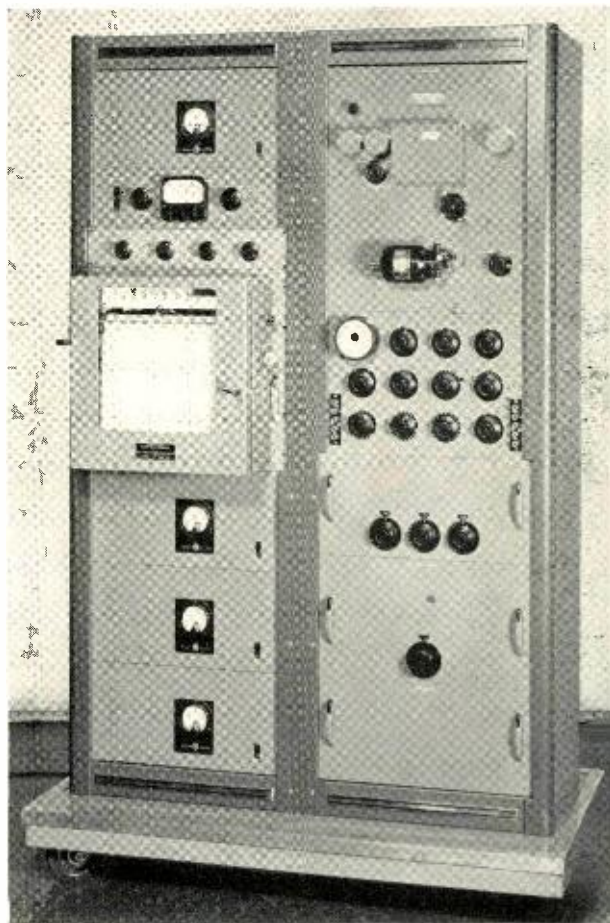

**Fig. 1—The W-11156 automatic transmission measuring set.**

ment of transmission loss. The oscillator at the left feeds a signal of known level and frequency into the network under test. The attenuated signal emerging from the network is picked up, filtered, and then fed into a calibrated voltmeter, the reading of which tells directly the transmission loss of the network.

In principle the new set is made to record the gain or loss of an amplifier or network automatically by elaborating on the essential elements referred to above. An oscillator of the heterodyne type is used to provide the test frequency range over which a characteristic is desired. A detector which is automatically tuned to the test frequency is used to receive, amplify and filter the output of the network under test; a pen recorder indicates the results.

In making a measurement of this kind it is desirable to employ a low-pass or band-pass filter in the receiving detector in order to suppress harmonics of the test frequency. This is especially necessary in measurements on amplifiers or networks which may attenuate the fundamental while transmitting the harmonic frequencies with little or no attenuation. Such a filter is also necessary to eliminate modulation products and harmonics generated in the detector and its amplifier stages. However, the construction of a filter with both a continuously variable pass band and the high discrimination required against unwanted frequencies would be impractical.

In the automatic transmission measuring set, this difficulty is avoided by causing the test signal to be filtered at a constant, fixed frequency, regardless of the input frequency. Advantage thus can be taken of the narrow band and high discrimination obtainable with a fixed-frequency, crystal band-pass filter. The method employed involves the three-step heterodyning process illustrated in Figure 3.

The test signal frequency  $F$  is produced in a heterodyne oscillator by combining the outputs of two local oscillators. One is a 650-kc crystal-controlled fixed-frequency oscillator, and the other a variable-frequency

oscillator, producing  $(650-F)$  kc. The tuning capacitor of the latter may be driven continuously by a synchronous motor or may be set manually. The two frequencies are supplied to amplifier-modulator A where they combine to produce modulation products, all



Fig. 2—Simplified circuit for single-frequency measurement of transmission loss.

of which are filtered out except the desired product  $F$  which is transmitted through the network under the test. Changing the  $(650-F)$  kc oscillator changes the output frequency  $F$ , cycle for cycle.

From the network, the test signal frequency passes through a receiving amplifier with adjustable gain controls into modulator B. The same variable frequency  $(650-F)$  kc from the heterodyne oscillator also is supplied to this modulator to produce modulation products of which only the 650-kc component is desired. It is particularly important that the frequency  $(650-F)$  kc be eliminated from the output of modulator B, since its value approaches that of the desired output frequency (650 kc) when  $F$  becomes very small. This  $(650-F)$  kc is minimized by balancing in the modulator circuit.

In modulator C the 650 kc, and whatever other modulation products remain, combine with 553 kc obtained from a high stability local oscillator to produce additional modulation products, all of which are transmitted to a 97-kc crystal filter with a pass band only 20 cycles wide. This filter effectively eliminates all the modulation products except the 97-kc signal, which is amplified and then de-

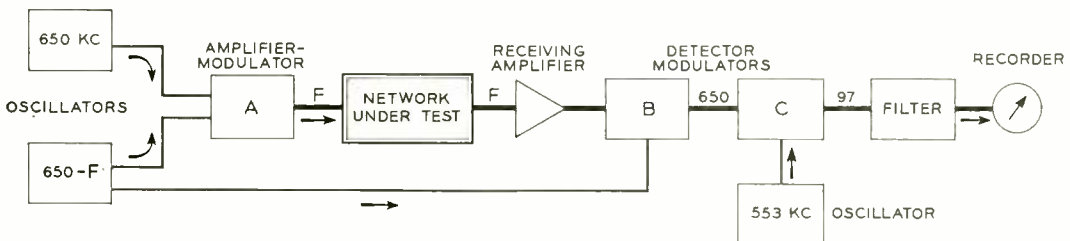

Fig. 3—Block diagram of automatic transmission measuring circuit.

livered to a level recorder having a 50-db dynamic range. The chart paper is driven through the recorder by means of a synchronous motor.

Fig. 4 illustrates the accessibility of the elements in this transmission measuring set. The receiving amplifier, modulator, amplifier modulator, and recorder panels are suspended on ball-bearing drawer slides and are pivoted to permit the chassis to be inverted for convenience in servicing. The arrangement is such that all these panels can be kept in operation while so inverted. The whole assembly of this measuring set is mounted in steel cabinets which are on casters for easy transportability.

To obtain a frequency response characteristic, the apparatus to be measured is connected in the set at the terminating panel,

where adjustments are made so that its input and output impedances are properly matched and the proper input voltage is applied. The heterodyne oscillator is set at the desired starting frequency and the recorder chart is placed so that the recording pen rests upon the point representing this starting frequency. Then, the motor control switches are closed and the set automatically records the characteristic desired.

Two or more records can be made on the same chart by returning the oscillator and recorder chart to the starting points and repeating the record. When the second record is made a pen with ink of a different color can be substituted to identify and contrast the two characteristics.

Occasionally, a record is required with considerable detail over a small portion of the frequency range. For such records several different speed adjustments are provided in both the oscillator and recorder. Thus, small portions of the characteristic of an experimental filter or sharp variations in an amplifier's characteristic revealing unsuspected resonances may be analyzed in detail. When modifications are made in the device under test to improve its performance, the characteristic may be repeated quickly for comparison, making possible an immediate evaluation of progress in the evolution of a design.

Frequently it is important to know to what extent harmonics are generated in a network, amplifier or other device. To use the set to get this information any suitable laboratory oscillator is used to supply the signal or fundamental frequency. In addition the (650-F) kc output of the heterodyne oscillator is utilized and this is applied to the detector in the normal manner. The recorder pen is placed on the chart at the point representing the starting frequency of the analysis and the heterodyne oscillator is set at the same frequency. The motors for the oscillator and recorder then are set in motion. The recording pen indicates the magnitude of each of the harmonics present as the detector is automatically tuned in succession to these frequencies through the continuous variation of the (650-F) kc oscillator. In a similar manner, noise generated in the device under test may be measured.



Fig. 4—Accessibility of elements facilitates servicing.



**THE AUTHOR:** J. M. HUDACK joined the Laboratories in 1916 as a member of the Transmission Research Department. Beginning at an early date he assisted in development work on testing apparatus. From 1924, when he received a B.S. degree at Cooper Union, until 1928 he was with the Special Products Division of the Apparatus Development Department where he was engaged in work on power line carrier telephone, public address, and loud speaker equipment. Since 1928 he has been engaged in the development of oscillators, amplifiers and detectors for use in making transmission measurements. During World War II this work centered on the development and proving-in of automatic transmission measuring apparatus for underwater sound studies.

In this case, no signal is applied to the device and the  $(650-F)$  kc output from the heterodyne oscillator is used to tune the detector continuously over the frequency range. If it is desired to evaluate the noise in bands wider than 20 cycles a filter with greater band width may be substituted for the one normally used.

Another important use which can be made of the set is in the measurement of two-frequency intermodulation in audio systems. Here, two fixed frequencies at predetermined levels are applied to the input

terminals of the device under test in place of the normal signal frequency  $f$ . The heterodyne oscillator, as before, furnishes only the  $(650-F)$  kc frequency to the self-tuned detector. The heterodyne oscillator scale and the recorder paper are spotted at the desired starting frequency and the motors are set in motion as described previously. The recorder then will indicate the amplitude of all of the sum and difference products of the two fundamental frequencies and their higher harmonics that are generated in the device that is under test.

*A coaxial cable, developed by the Laboratories and manufactured by the Western Electric Company, with the outside lead and paper covering removed to show the eight coaxial tubes and the additional paper-insulated wires. Held between the gloved fingers are the plastic discs which separate and insulate the inner wire from the outer copper tube. Extreme cleanliness and careful attention to detail are required in the manufacture and handling of these discs to avoid operating trouble in the cable.*

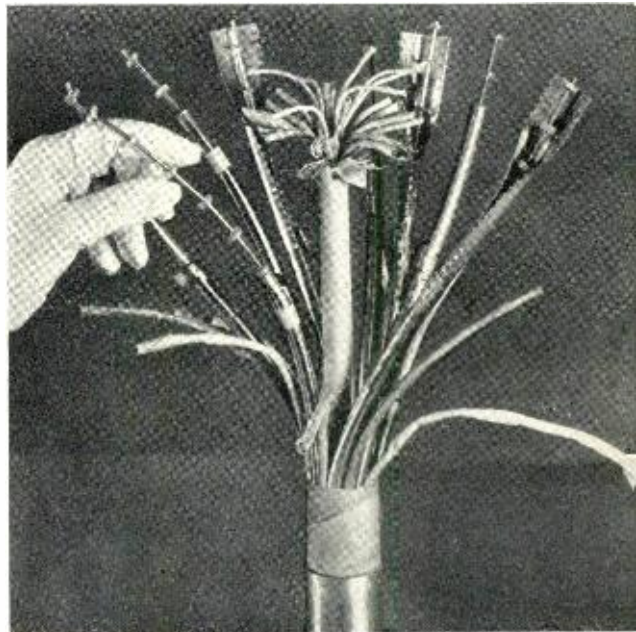

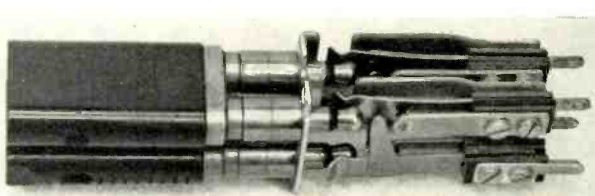
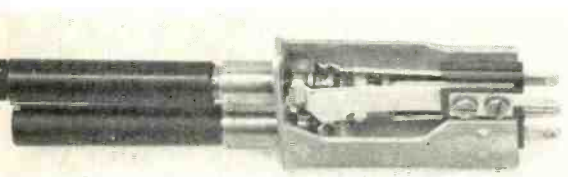

## The new 482A patching jack

A new patching jack, coded No. 482A, has been developed to replace the older 410A jacks used in the four-wire voice frequency patching and monitoring bay on carrier circuits. The 482A jack is shown at the left in the illustration above and the 410A jack at the right.

Space economy is obtained by using one new jack for the tip and ring conductors instead of two of the older type. Although requiring only half the mounting space, the new design provides equal contact reliability and the same electrical characteristics. Collaborating on the design were A. J. Wier, Transmission Systems Development Department and M. O'Connell, Switching Apparatus Development Department.

Space saving is well illustrated by the photograph of the two bays in the trial installation at Newark, New Jersey, shown at the left. White signal plugs in the six panels at the left and at the top of the right-hand bay indicate the older 410A jacks; the three

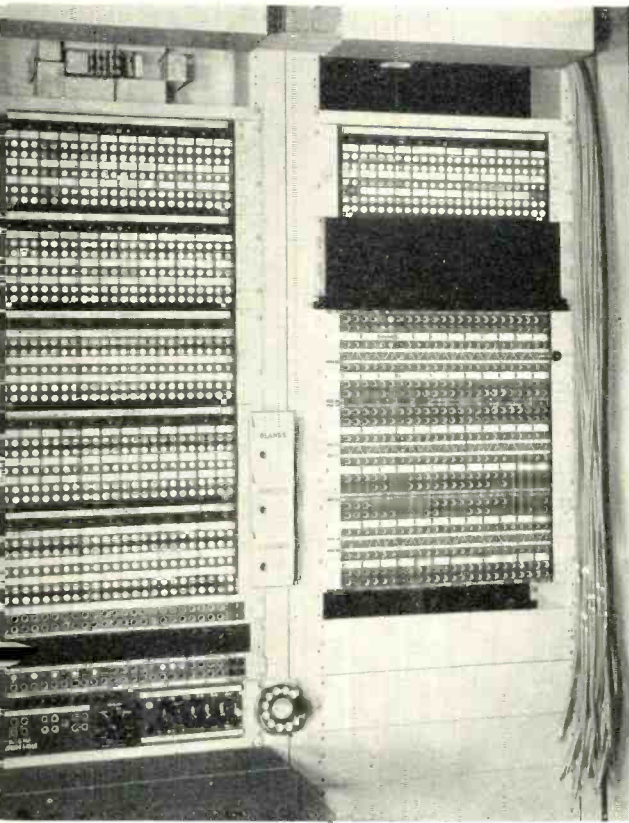

Installation of 482A and 410A jacks at Newark.

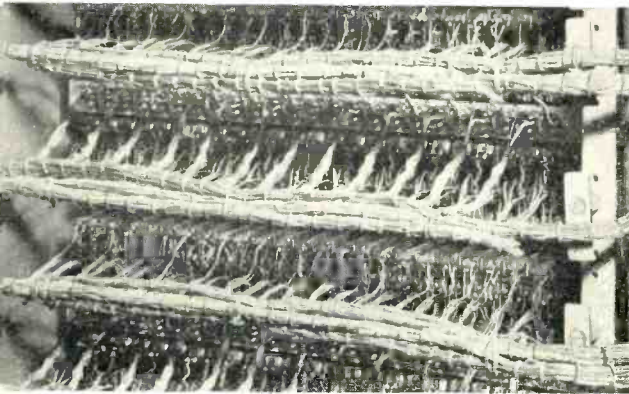

Left—Sewn cable forms at the rear of the four-wire voice frequency bay equipped with 410A jacks. Right—Use of new fanning strips with the 482A jacks provide greater accessibility as well as neater appearance at reduced cost.

panels without the white signal plugs on the right-hand bay contain the new jacks and accomplish the equivalent work. Wiring of the new jacks with the associated apparatus introduced a space problem at the rear of the bay. The illustration shown at the bottom of the opposite page on the left illustrates the method of wiring of the older 410A jacks. This method resulted in limited

access for maintenance of the apparatus. Development of a new fanning strip, however, resulted in an orderly and readily accessible arrangement of connections at reduced cost. These fanning strips are shown at the bottom of the opposite page, at the right. This fanning strip was developed by P. T. Haury and A. J. Wier, both of Transmission Systems Development.

---

## *Bell System prepared for national emergency*

The Bell System is well prepared to meet the present emergency. The plant is twice as large and greatly improved over ten years ago. New methods of communication, not even in the plant at the start of World War II, have been introduced and are being used extensively.

There is, however, more to be done—both in providing service to those who are waiting and in meeting the demands of the present emergency. Telephone men and women realize the nature and importance of the job that lies ahead. Plans have been made, and the Bell System is moving right ahead with the work.

Operator toll dialing, coaxial cable, and radio relay are examples of new developments. Today one-third of the long distance calls in the United States are “dialed” directly by switchboard operators. There are 3½ million circuit miles of coaxial cable in operation. Ten radio relay networks, totaling over 5,000 channel miles, are in service along heavily-used long distance routes. Four more networks were inaugurated during September which carry radio relay from the East Coast as far west as Omaha and bring to nearly 8,000 the total number of channel miles. A transcontinental route is scheduled for completion next year.

Another new development is mobile telephone service—also a valuable asset to the nation’s emergency potential. Ten years ago only one city in the United States had this service; today there are 140.

Much is being done to make telephone plant and property as “trouble proof” as possible. Safeguards are being taken to prevent access by unauthorized persons where important mechanical equipment is housed.

Key manholes have been locked. Emergency power supply has been provided in substantially all locations.

Telephone traffic control bureaus have reviewed their rerouting practices in the event of sudden loads or emergent situations. Routes for long distance traffic, river cable crossings, and important sections of exchange cable are being carefully scrutinized to insure that alternate routes are provided where needed. Special emphasis is being given to military locations.

Emergency telephone restoration plans are being established in key cities. Facilities in communities around the perimeter of these cities are being rearranged and new routes provided so as to tie in directly with substitute long distance centers.

The Telephone Companies are cooperating closely with the government on many special communications projects. Important among these is the provision of telephone facilities for the Air Defense Communication System or “radar network.”

Thousands of miles of private line networks have already been provided to the military. Also, it is the job of the Bell System to furnish local and toll facilities to widely scattered military bases and training camps over all the country. This is a big job—it will require much construction—but the System is moving ahead with it.

The Telephone Companies are working closely with civilian defense authorities on disaster plans, and on defense warning networks. Local telephone people have assumed key responsibilities in these projects. The existing nationwide network of circuits will be of immeasurable help in coordinating the national civilian defense job.

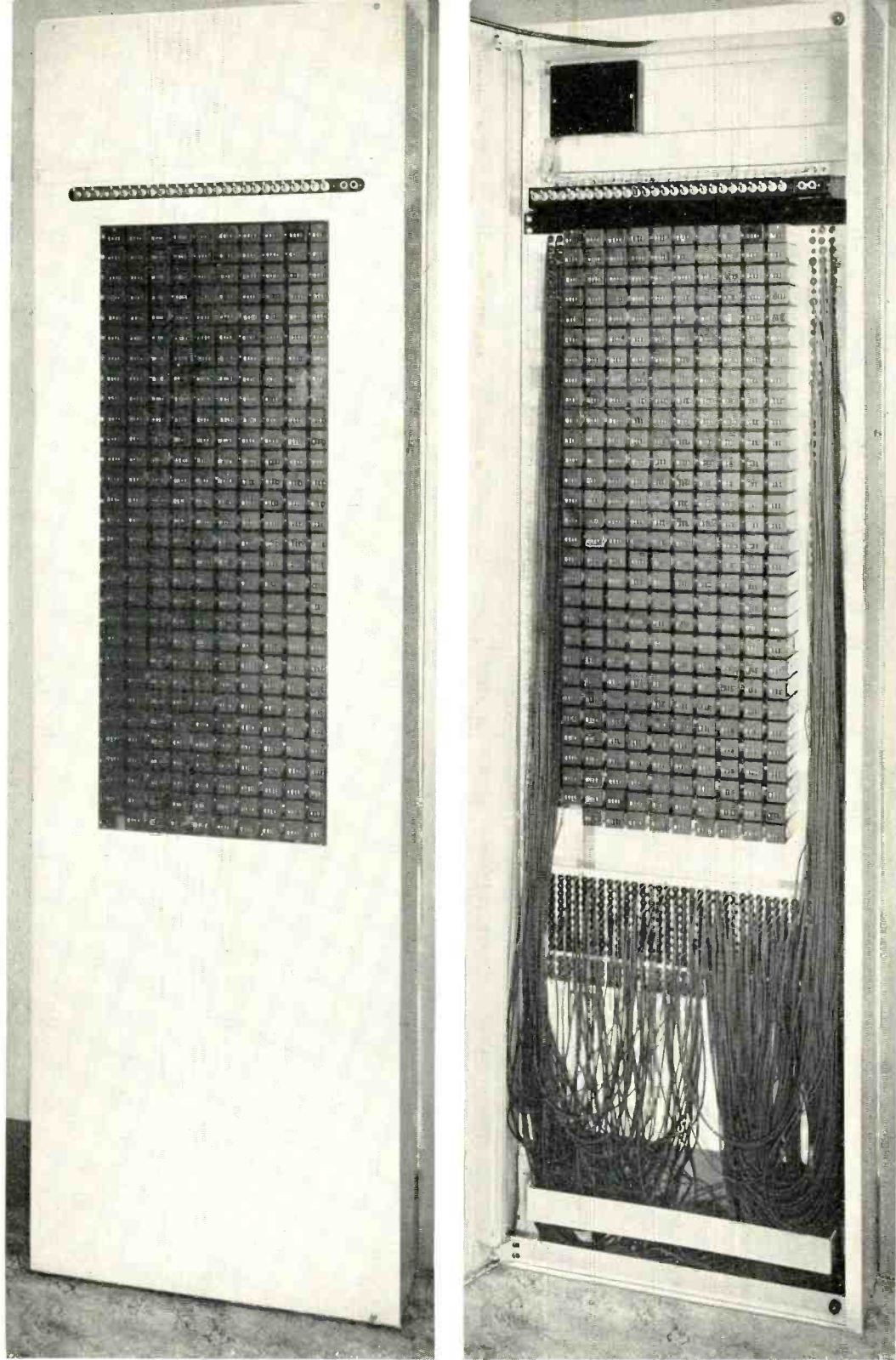

Fig. 1— Left, one of the new traffic register cabinets with doors closed. Right, opening the door of a traffic register cabinet gives access to the cords by which the various registers are connected to the required circuits.



# Traffic registers

## for No. 5 crossbar

W. WAGENSEIL

Switching

Systems

Development

In dial as well as manual central offices, registers are provided for measuring traffic. Each register is a small electro-magnetic counting unit with number wheels which turn one position each time a pulse of current is sent through the winding by the operation of other equipment in the office. Registers show the number of calls originated and completed and the loads handled by various groups of equipment units or operators, and give indications of congestion. The general data showing trends in subscribers' usage are useful in shaping business policies, and the more detailed data are needed for central office administration and engineering. The latter include assignments of lines to balance loads and thereby obtain full use of the equipment; scheduling of operators; and ordering of new equipment of proper types and amounts to care for growth or traffic shifts.

Because the Traffic Department is particularly interested in the data provided by traffic registers, they like to have them located in operating rooms at a convenient height from the floor for easy reading, with all registers of a type grouped together. Furthermore, it is desirable to purchase only as many registers as are required for each office at any given time. It is also desirable to have the traffic register cabinet blend in with new operating room appointments and occupy as little space as possible.

To meet these requirements and to obtain manufacturing economies, a new circuit and a new traffic register cabinet, shown in Figure 1, have recently been designed. The new steel traffic register cabinet mounts directly against the wall and will be used in new offices instead of the earlier wooden traffic register cabinets, shown at the left in Figure 2. These were located two and one-half feet

away from the wall to permit access to the permanent cables connected to the rear of the registers. With the old arrangement a traffic register distributing frame, shown at the right in Figure 2, was required in the terminal room to connect the various registers to the desired circuits by cross-connecting jumpers. This distributing frame is not required where the new cabinet is provided.

With the new arrangement, one basic register unit is used. It is shown in Figure 3 and only as many of these units as are needed are ordered by the Telephone Companies. On each unit are ten registers, ten register pin jacks, and one supply pin jack. One end of each register winding is surface wired to its individual register jack. The other terminals of the ten registers are strapped together and connected to the supply jack. These register units are mounted on the cabinet framework that also mounts a field of pulse jacks. Switchboard cable leads are permanently connected to the pulse jacks from equipment requiring traffic registrations. As shown at the right in Figure 1, inexpensive Western Electric Company single-conductor cords are used to connect any traffic register via its jack to any equipment via its jack-field pulse jack. Similar cords are used to connect the battery supply jack for each group of ten registers to one of the battery supply jacks of the jack field that provides either direct battery or battery under control of one of the switches mounted immediately above the registers. The traffic registers themselves are of the new 14 type that operate in such a short interval of time that pulse-help relays are not ordinarily required. For some registrations, however, such as sender group busy registrations, it is necessary to have auxiliary relay equipment, which is mounted on

a miscellaneous relay rack frame in the terminal room.

The use of 14-type registers and inexpensive cords makes it possible to meet the Operating Companies' requirements for a traffic register cabinet, one which occupies a small amount of space, contains only the number of registers required for the office at a given time, and can be located in the operating room with all of the registers at

a convenient height for easy reading. The traffic register cabinet is only 7 $\frac{1}{2}$  inches deep and can be maintained entirely from the front. It is thus mounted against a wall with no provision for access to the rear of the cabinet. It will accommodate any number of registers from ten to three hundred. The Western Electric Company provides only as many register units as are required for each office without penalizing either

*Fig. 2—Left, a traffic register cabinet of the earlier type. Right, part of a traffic register distributing frame.*

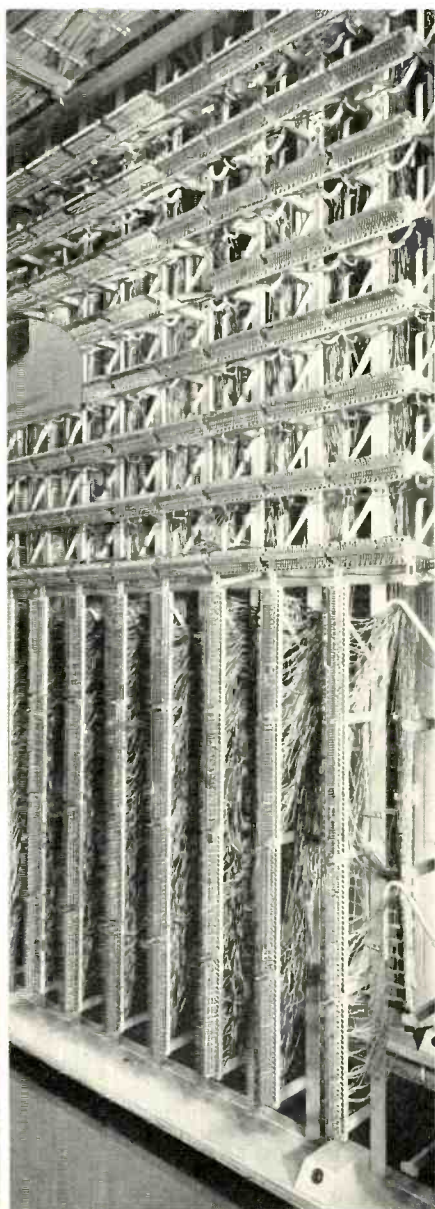
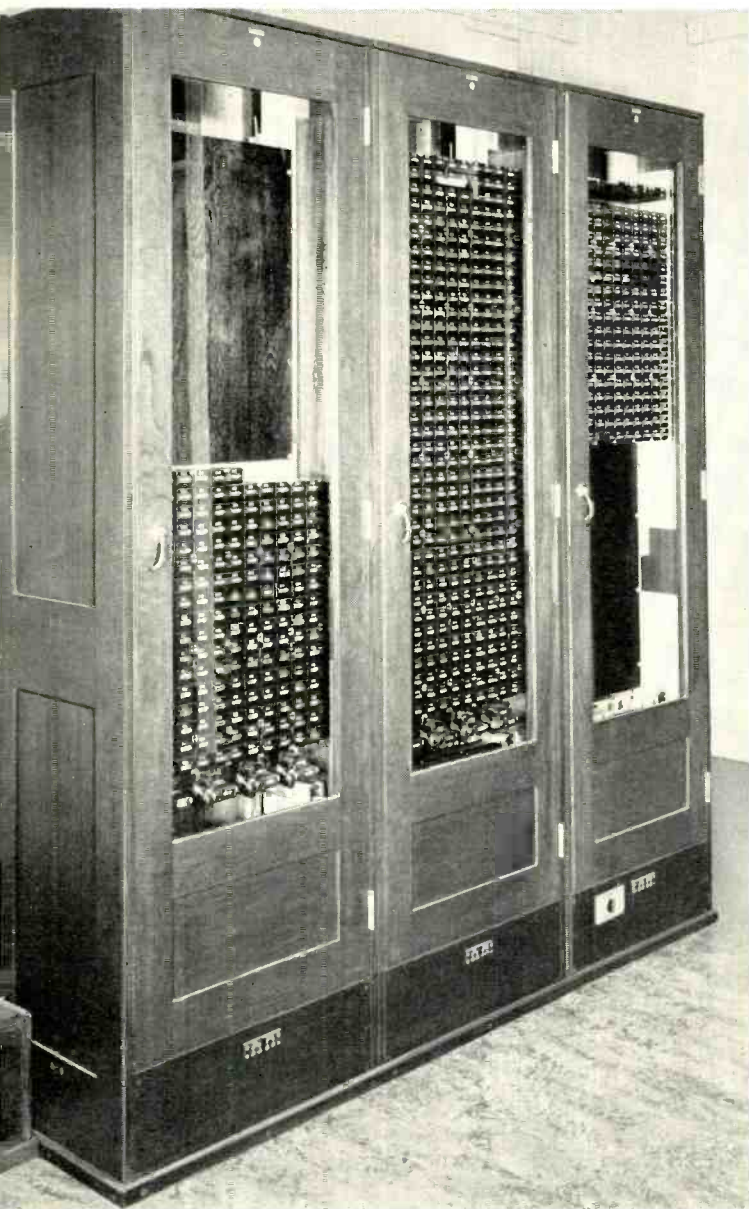

*Fig. 3—A traffic register unit includes ten registers and their connecting jacks.*

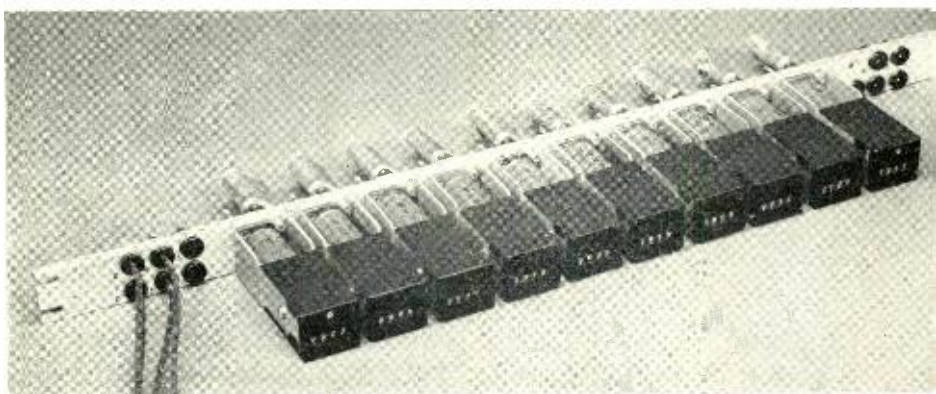

large or small offices. The installer or maintenance man assigns or reassigns incoming cable leads to different registers by changing patch cords as required so that all registers of a type are always grouped together and so that the most often read registers will be located at the most convenient height. A record of the permanent assignment of switchboard cable leads to jacks in the jack field, and of the patch cord connections, is kept on a card hung on the rear of the door of the traffic register cabinet. Because side panels are provided only on end cabinets, any register can be patched to any lead terminated either in the cabinet where the register is located or in an adjacent cabinet.

The new arrangement provides other desirable features. The maintenance man can remove an entire plate of registers for inspection or maintenance without interrupting service and without bending any local

cable forms. Registers that are connected to equipments that operate often can be disconnected during periods when readings are not being taken by operating the switches immediately above the registers. This prolongs the life of these registers. The installer can easily provide for either right- or left-hand opening of the cabinet door. Both the door and the side panel may be painted the same color as the wall to which they are secured, thus making them inconspicuous. Jacks connecting to a talking line are located next to the switches so that one traffic employee can pass the register readings to a second employee, the recorder, seated at a desk.

When the central office building does not contain an operating room, the traffic register units, the jack field and the keys are mounted on a standard 23-inch relay rack frame in the switch room. This contributes to the uniformity of the basic arrangement.

**THE AUTHOR:** W. WAGENSEIL received the B.S. degree in Engineering Mathematics from the University of Michigan in 1936, and at once joined the Equipment Development Department of these Laboratories. He was at first associated with the trial installation group, but after a short period transferred to the analyzation group and later to switching equipment development. In 1941, he started work on equipment designs for war apparatus, but from July 1942 to January 1944, he devoted his entire time to shock and vibration problems affecting war equipment. He later went to Washington as civilian advisor to the Navy Department on shock and vibration problems. Since 1945 he has been engaged in the development and standardization of originating and incoming registers, outgoing sender equipments, and frames and cabinets for traffic registers for the No. 5 crossbar system.



# A video monitoring probe

Local wire video loops in the Bell System make use of special shielded video pairs or existing paper insulated pairs terminated in an impedance of 110 ohms and may also include video amplifiers, clamper amplifiers, repeating coils, and other equipment as required. Monitoring jacks are provided for in-service observations on the circuit at the input and output of each amplifier as well as at other points. These jacks are isolated from the transmission circuit by resistors to minimize the effect on through circuit trans-

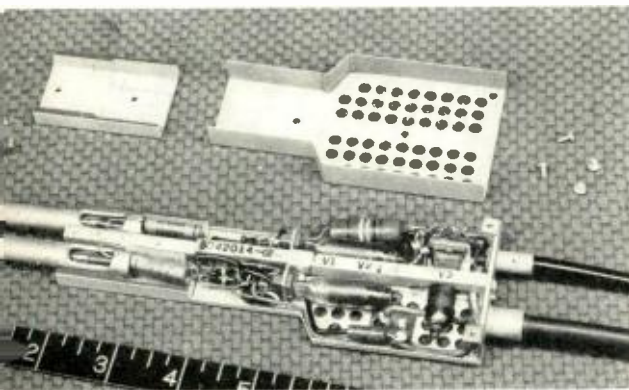

Fig. 1—The high impedance video monitoring probe with its cover removed.

mission that might occur from accidental connection of a low impedance to the monitor jacks.

To further reduce the reaction on the circuit being monitored, a high impedance amplifier probe coded J44103A has recently been developed by C. N. Nebel and P. T. Sproul. Illustrated in the accompanying photographs, this probe contains a three-tube two-stage amplifier providing a high-impedance balanced input and relatively low-impedance (500-ohm) unbalanced output to feed a picture monitor, oscilloscope, or other test equipment. The first stage of the probe has two tubes in push-pull and feeds the cathode follower output stage. The frequency response is substantially flat from low frequencies to over 4 megacycles, and the amplifier has approximately 0 db gain.

At the plug end, the probe is only  $\frac{1}{2}$  inch thick and  $1\frac{1}{2}$  inches wide, and thus may be inserted into a crowded jack field without interfering with other patch cords. For portable use, power is supplied through one of the connecting cords from a small power supply, the cover of which serves as a storage compartment for the probe. A separate coaxial cable provides the transmission path to the required test equipment.

To meet the dimensional requirements mentioned above, use has been made of sub-miniature tubes having characteristics very similar to the 6AK5°. Resistors and condensers of the miniature type have also been used wherever possible. The front section holding the standard coaxial plug is made of fibre to reduce the input capacity and thereby increase the input impedance.

°RECORD, November, 1944, page 605.

Fig. 2—The power supply used with the probe has room for the probe and the connecting cable in the cover.

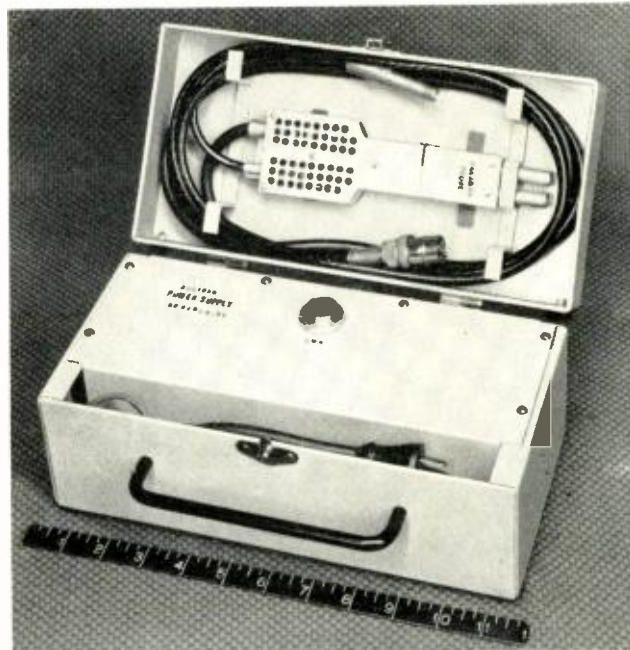

# An electrical vocal system

L. O. SCHOTT  
*Transmission  
Research*

A new research tool for studying speech sounds has been built in the form of an electrical circuit analog of the human vocal system. H. K. Dunn calculated the requirements for such an analog from measurements on X-ray photographs of the human

vocal tract<sup>o</sup>, and an electrical vocal system based on these requirements was designed by the writer. The electrical vocal tract is like an artificial transmission line in com-

<sup>o</sup>*Jl. Acous. Soc. Am., Nov., 1950.*

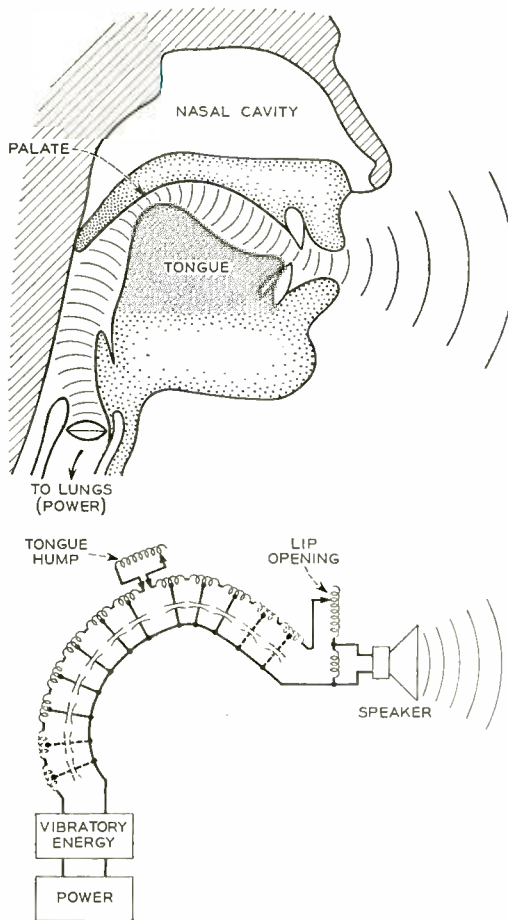

Fig. 1—Position of human vocal organs in pronouncing "u" above; and equivalent adjustment of the electrical vocal tract below.

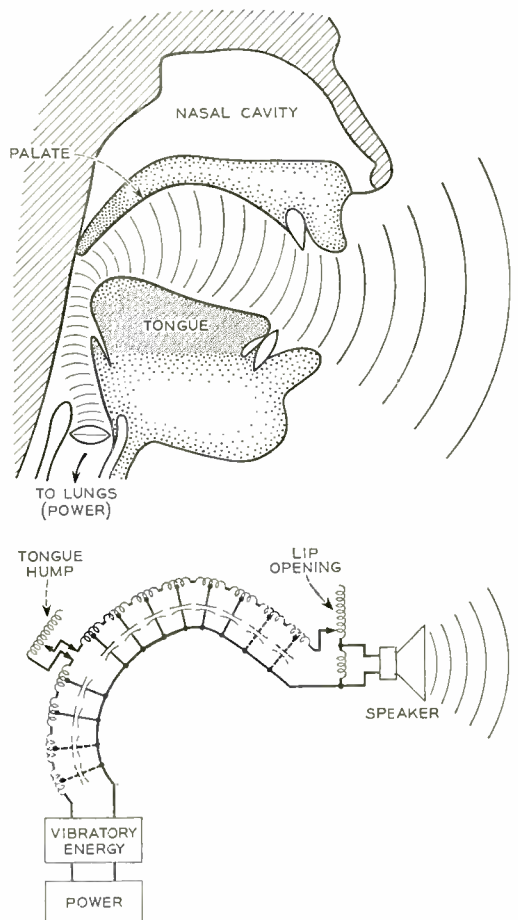

Fig. 2—Position of human vocal organs in pronouncing "Ah," above; and equivalent adjustment of the electrical vocal tract, below.

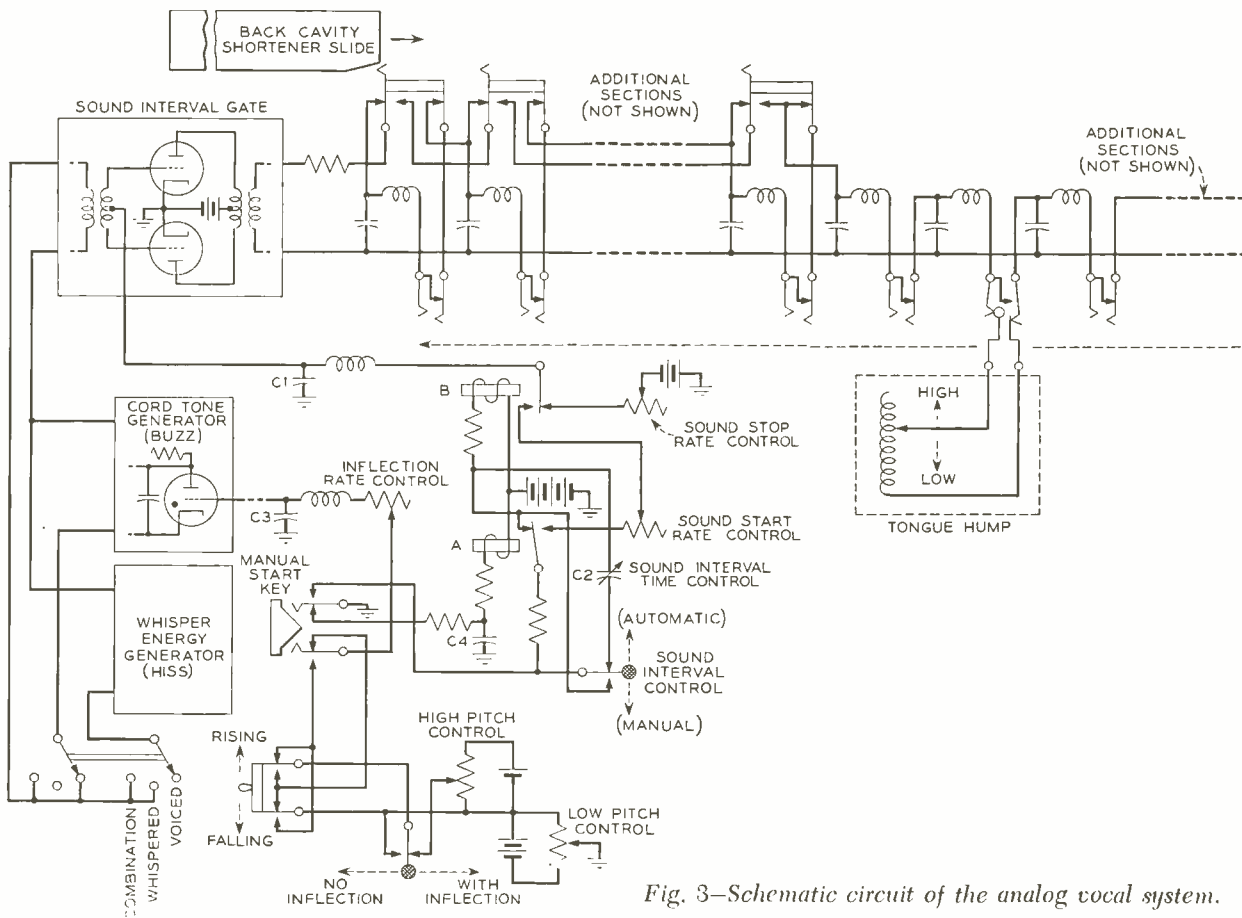
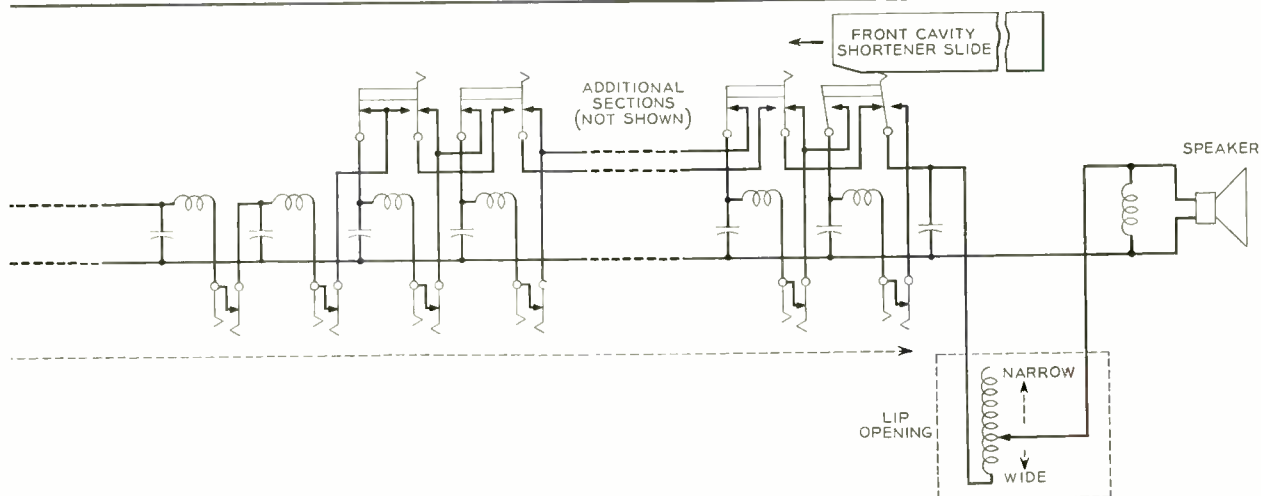

Fig. 3—Schematic circuit of the analog vocal system.

prising a number of sections of series inductance and shunt capacitance. It is designed to simulate the throat and mouth passage, and includes provisions for the equivalent of several of the main articulators: the tongue hump, the lip opening, and the tract length. The articulators can be adjusted so that resonance regions are set up much like those of the resonance cavities in the human vocal tract. This artificial tract, in combination with a suitable energy source and a loudspeaker, has so far produced vowel sounds of very creditable quality, and, with further pursuit of the general technique, it is certain that the machine will be able to produce others of the speech sounds as well. Elements of a research tool have thus been made available to enable studies of the generation of speech sounds by adjusting an electrical circuit in a manner analogous to that in which the muscles adjust the vocal

tract and articulators for human speech. The function of each articulator may be examined separately and independently of all others. Some operations may be carried out that are well-nigh impossible for the human system to perform.

As one produces the phonetic "u" (as in school), ordinarily the best quality sound will be made when the lips are well-rounded and nearly closed and when the tongue is humped with its peak nearly touching the roof of the mouth a little back from center, as shown in the top part of Figure 1. In the electrical circuit analog shown in the bottom part of Figure 1, approximately the same conditions are set up—the LIP OPENING inductance is adjusted to a high value, having an effect that corresponds to a narrow constriction of the lips, the TONGUE HUMP inductance is inserted at a particular position along the tract, and the hump induct-



ance is adjusted to a high value having an effect that corresponds to the narrow constriction formed by the tongue hump and the roof of the mouth. In contrast, the "ah" (as in father) is produced with the tongue hump further back, with a wider tongue hump constriction (lower inductance value), and with the lips wide open (lower series inductance), as indicated in Figure 2.

The over-all electrical circuit of this system is shown in Figure 3. The vocal tract analog circuit is across the top. The line network consists of twenty-four "L" sections of series inductance and shunt capacitance, approaching the conditions of a distributed-constant line. The acoustical equivalent of this line is a cylindrical chamber six square centimeters in cross-sectional area and twelve centimeters in length. Each of the twenty-four sections thus represents a half centimeter length of vocal tract. The fixed cross-sectional area (six square centimeters) is, of course, a compromise assumed for the approximate analog, for it is evident that the cross-sectional area of the real vocal tract is not fixed along its entire length. Means are provided on each end of the line for removing sections so that the effective tract length may be adjusted. These means are labeled BACK CAVITY SHORTENER and FRONT CAVITY SHORTENER. The TONGUE HUMP inductance can be inserted at any half centimeter section point. This is a lumped element in the circuit; and that involves another compromise in the design, for it is evident

that the real tongue hump imposes a distributed effect along the real vocal tract. The tongue hump divides the tract into two parts, called the BACK CAVITY and the FRONT CAVITY. The LIP OPENING arrangement is an adjustable inductance network which terminates the line in the same way that the constriction of the lips terminates the acoustical cavities of the mouth; it also provides a suitable simulation of the radiation characteristic of the lips.

At the left of Figure 3 are the energy source and control circuits. At the top is a SOUND INTERVAL GATE device for turning the energy on and off. Next below are two sources of energy, BUZZ or vocal-cord tone energy, and HISS or whisper energy. Ordinarily the vowel sounds are voiced, and for these the buzz energy is used. This energy is generated by the familiar sawtooth, or relaxation type, oscillator. The output from this oscillator can be shaped to simulate that from the vocal cords, with a fundamental frequency that is related to the pitch of the voicing and with a rich content of harmonics. The other energy source, the hiss, is used when the vowels are to be whispered or when consonants like the unvoiced fricatives "f" and "s" are made. This energy is provided by a thermal-noise generator whose output components are random and not harmonically related. For certain tests in connection with producing mixed sounds, like the voiced fricatives "v" and "z," both of these energy sources are used.



*Fig. 4—The analog vocal system being operated by O. O. Gruenz, who assisted with the assembly of this portable arrangement.*

The circuits to the right of the energy source in Figure 3 are for controlling the sound interval and the pitch and inflection of the voicing. These are important if we wish the synthetic sounds to appear natural, that is, as we are accustomed to hearing them. With the circuit connections as indicated, a natural sound will be produced when the **MANUAL START KEY** is operated. On pressing that key, relay B operates, relay A releases after the charge on the capacitor C4 has been quickly dissipated, and a negative voltage charge on capacitor C1 is gradually dissipated, thereby opening the sound interval gate circuit and permitting buzz energy to flow into the electrical vocal tract.

The rate at which the gate opens is controlled by the **SOUND START RATE CONTROL**. After a predetermined and suitable interval, adjusted by the **SOUND INTERVAL TIME CONTROL** capacitor C2, relay B will release. This allows a negative voltage charge to build up on capacitor C1 which, in turn, closes the gate circuit and shuts off the flow of buzz energy. The rate at which the energy is turned off is controlled by the **SOUND STOP RATE CONTROL**. In the meantime, while the energy is being turned on and off, the frequency of the buzz is being raised to simulate a slight pitch increase, or a rising inflection. The frequency of the buzz generator is controlled by the voltage on the grid of the oscillator tube; and this is regulated by the charge potential on capacitor C3. The low pitch voltage is set by the **LOW PITCH CONTROL**, and the higher pitch voltage, toward which the generator responds during the sounding interval, is adjusted by the **HIGH PITCH CONTROL**. The rate of change from the low to the higher pitch can be set by the **INFLECTION RATE CONTROL**.

Several switches are provided that can be operated to alter the energy control conditions just described. One switch reverses connections so that sounds may be produced with a **FALLING** inflection. Another is for switching to a **NO INFLECTION** condition, to produce sounds that appear very mechanical and with a kind of poor robot quality. Another switch transfers the sound interval time control from the automatic actions of relay B to manual control at the start key. Still another switch is for changing the synthesizing energy from buzz to hiss, or to a combination of buzz and hiss.

By these means, a machine is available that permits a wide variety of experiments on speech sounds, with the human system serving as a guide to direct the course of experimentation and improvement. From determining the conditions for producing the highest quality sounds, we may digress to study the shadings of sounds and the formations of the fleeting hybrid sounds that play an important role in the flowing speech we are accustomed to hear. The adjustments of the articulators may be studied one at a time, or in combination, as desired—a number of sounds that are not common in the



English language but are common in other languages have been produced in work of this kind. The voicing of a sound may be adjusted to the low pitch for a man or to the higher pitch for a woman; and the amount of pitch inflection and its rate of change can be adjusted and shaped. Further, we may experiment with the shapings of the onset, the sustained, and the decay portions of the sounding intervals.

It should be noted that this electrical vocal tract system differs radically from other synthesizers of speech sounds, such, for example, as the familiar voder<sup>1</sup>, the synthesizer of the vocoder<sup>2</sup>, or the playback for visible speech.<sup>3</sup> If speech is analyzed by passing it through a number of contiguous band-pass filters, and the energy in each

provided which, in frequency and composition, approximately duplicates that produced by the vocal cords or by the passing of air through the throat. This energy is then passed through an electrical circuit designed to be analogous to the human vocal tract; adjustments in the circuit can be made to correspond to the various tongue, lip, and mouth positions; and, with any given set of adjustments, the combination will act to select those components from the energy that are needed to produce the related particular sound. In other words, the over-all circuit closely duplicates in electrical form the mechanical system of the human speech organs. While the earlier system built up the speech sounds from component bands of frequencies to produce the frequency and energy

Fig. 5—Close-up of the vocal tract of the analog vocal system.

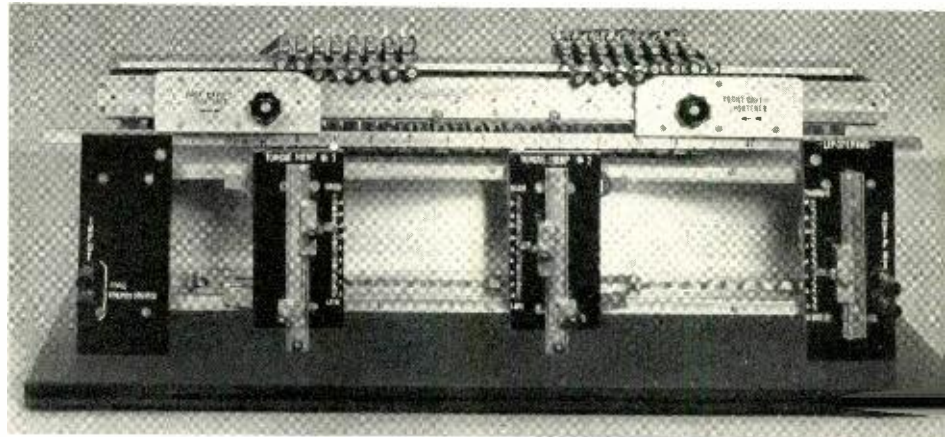

band measured, then the same speech sounds could be created anew, without the aid of the human speech mechanism, merely by combining these specific amounts of energy in the same bands of frequencies. The accuracy with which the sounds are reproduced—assuming the energy in the various bands is accurately known—depends primarily on the number of bands into which the speech is divided. In the former systems of synthesizing speech, this is essentially the method used.

In the vocal tract system as described in this article, on the other hand, an entirely different method is employed. Energy is

distribution found in the speech being duplicated, the vocal tract system creates the speech just as does the human system but by using electrical rather than mechanical elements.

The assembly of parts in the present system is shown by the photograph in Figure 4. The electrical vocal tract with an oscilloscope rests on the table top, and below there are the energy sources, the interval gate and controls, the pitch and inflection controls, a power supply, amplifiers, and a loud-speaker. A close-up view of the electrical vocal tract alone is shown by the photograph in Figure 5. It will be noticed that there are two tongue hump units shown in this picture—the second unit was added recently so that the “r” and “l” sounds could be made. The inductance coils and capaci-

<sup>1</sup>RECORD, December, 1936, page 98; February, 1939, page 170. <sup>2</sup>RECORD, December, 1939, page 122. <sup>3</sup>RECORD, August, 1948, page 333.

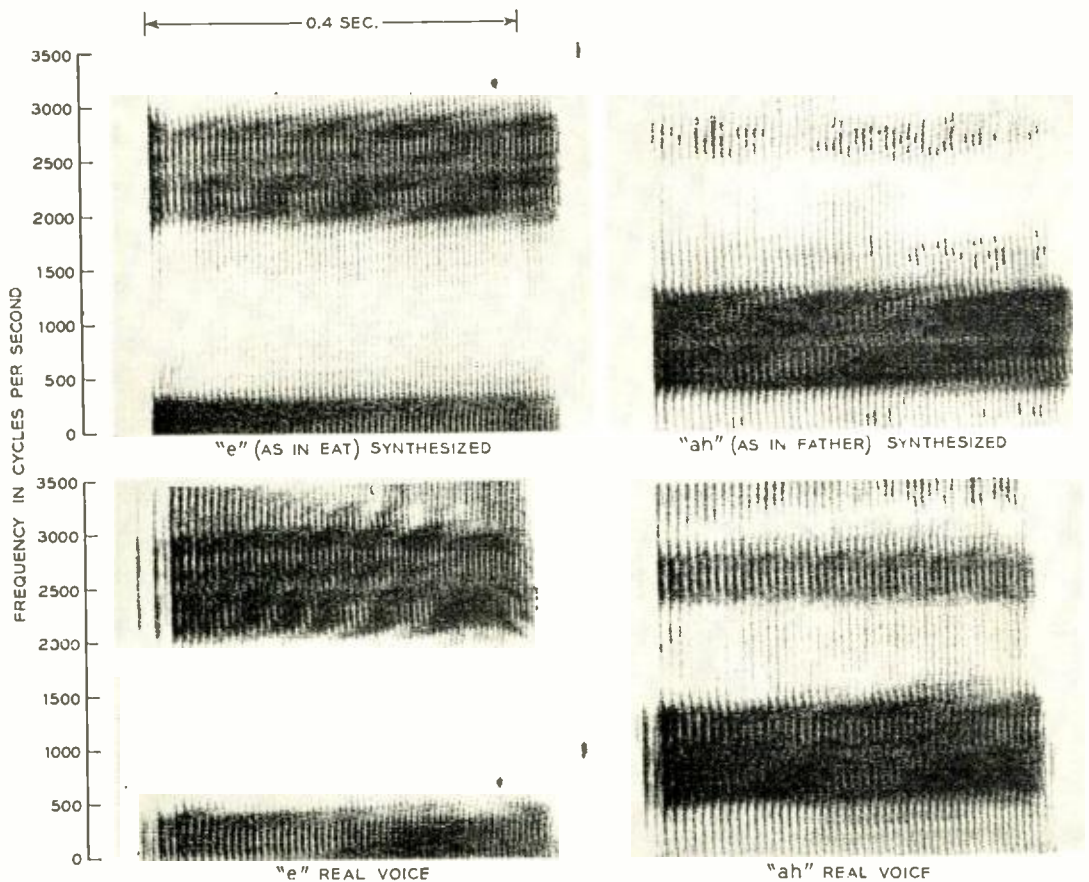

Fig. 6—Spectrograms of vowels as synthesized by the electrical vocal system, above; and as pronounced by real voice, below.

tors of the system are on the back side and cannot be seen in this picture. In the mechanical design of the vocal tract, the attempt was made to have all of the adjusters arranged so as to suggest the operations involved. The back cavity shortener slide and the front cavity shortener slide are rigged with an index bar to show the effective tract length in centimeters at all times. The two tongue hump units are each arranged on separate panels that can be slid along with detent action so that the hump inductance may be inserted at any section point in the vocal tract line; and these longitudinal movements are restricted to the range of the effective tract length. Each hump inductance is tapped to its array of vertical contacts with a slide switch contactor that is moved upward for raising the hump (increasing the inductance value) and downward for lower-

ing. The lip opening adjuster inductance is tapped to an array of vertical contacts on the fixed panel at the right and its slide contactor is moved upward to simulate upward movement of the lower jaw and consequent closure of the lips.

In the system described here, circuits have not been added for simulating the nasal cavity that would be required for making the "m, n, and ng" sounds. Also, complete facilities are not available for generating the consonant sounds—the voiced and unvoiced fricatives, like "z" and "s," and the voiced and unvoiced plosives like "b" and "p." In the main, efforts so far have been concentrated on the interesting features of the vowel sounds.

Some sample spectrograms of synthetic vowel sounds produced by this machine are shown in Figure 6, in comparison with spec-

tograms of vowel sounds spoken by the writer. On each spectrogram, the vertical scale is for frequency from zero up to 3500 cycles, the horizontal scale is for time, and the markings show the frequency-time regions where the sound energies were reinforced (or permitted to pass) by the resonance effects from the vocal tract. The markings are denser where the energy concentrations were greater. The vertical striations resulted from the use of a wide band analyzing filter in the sound spectrograph\* that was employed in making these spectrograms. The spacing of these striations is related to the pitch of the voicing; the wider

\*RECORD, January, 1946, page 7.

the spacing, the lower the pitch. It will be noticed that these vowel sounds were produced with a slight rising inflection. Between the spectrograms of the synthesized sounds and those of the real voice sounds, there are some striking similarities and some obvious differences.

It is expected that with a machine of this general type it may be possible to obtain improved measurements of the similarities and differences among speech sounds and among the individuals or machines that produce them. These matters, and the techniques springing from them, hold considerable interest for the communication engineer.



**THE AUTHOR:** LIONEL O. SCHOTT graduated in Electrical Engineering from the University of Missouri in 1928. He then joined the D & R Department of the A T & T, where he was engaged principally in development and research on voice-operated devices for application to wire and radio circuits. After 1934, when the D & R was merged with the Laboratories, these activities continued until 1937, when he began concentrating on toll transmission studies. In 1942, he returned to development and research on devices in speech transmission systems. This led, in 1943, to his connection with the visible speech program, and more recently, into the related matters of the speech and hearing processes.

## *N-1 carrier system goes into service*

*(Continued from page 537)*

been described by C. W. Carter, A. E. Dickieson and D. Mitchell in a paper presented before the A.I.E.E. in 1946.

N-1 employs different frequency bands for the two directions of transmission and these are interchanged, or inverted, at each repeater, which is also an innovation. This, too, helps to minimize crosstalk, in addition to providing other advantages.

Much of the equipment is specially packaged to reduce engineering and installation costs, and all of the major units are designed on a plug-in basis. This is expected to reduce manufacturing and maintenance costs, and to improve service by speeding up trouble-

clearing operations. Equipment planning has been under the direction of J. A. Coy and C. Pedersen.

Two of the new systems have been installed between Harrisburg and Sunbury. Each has five repeaters, spaced about eight miles apart, to amplify or boost the currents carrying the conversations from one city to the other. Four of these are in pole-mounted boxes, with the fifth in a small building, erected especially to house the N-1 equipment, midway between the two cities. Laboratories trials have been in progress in Wisconsin for some time.

A number of articles on the system will appear in forthcoming issues of the RECORD.

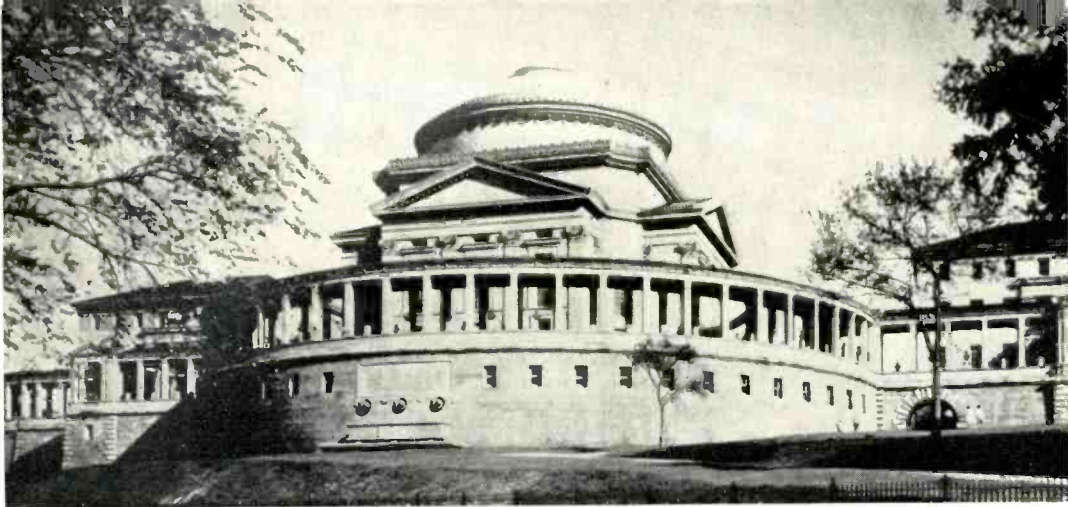

*The Hall of Fame for Great Americans on the campus of New York University.*

## Dr. Bell Elected to Hall of Fame

Alexander Graham Bell was elected to the Hall of Fame for Great Americans at New York University on November 1. He and five others, Dr. William Gorgas, Woodrow Wilson, Susan B. Anthony, Theodore Roosevelt and Josiah Willard Gibbs were the only candidates in a group of 186 who received the necessary majority of votes of the electors. The election is eleventh in a series held every five years, and brings to 83 the number of distinguished Americans to be enshrined in the Hall. Only seven candidates may be admitted at one time. Each of the candidates must have been dead twenty-five years, and have been an American by birth or naturalization.

## Jewett Laboratories Dedicated at Rockford College

A distinguished name in Bell System history was accorded further honor with the dedication on October 28 of the Jewett Laboratories, model science building of Rockford College, Rockford, Illinois. The new laboratory building is named for the late Dr. Frank B. Jewett, first presi-

*Two students observe the exhibit featuring the growing and processing of crystals donated to Rockford College by the Laboratories.*



dent of Bell Telephone Laboratories, and his wife, Dr. Fannie F. Jewett, who was graduated from Rockford in 1899 and was active in alumnae affairs until her death in 1948.

Many eminent scientists and educators attended the dedication ceremonies, at which Dr. Robert A. Millikan gave the main address. He paid tribute to both the domestic and professional lives of the Jewetts. In Dr. Jewett, he found "a moral character in his conduct which was rare even in a scientist."

Dr. Ralph Bown took part in the dedicatory program. In view of Dr. Jewett's outstanding service in the Bell System, a crystal display was donated to the College by the Laboratories and set up in the new building. This was presented by Dr. Bown. The display, designed by H. J. Kostkos in collaboration with R. A. Sykes and A. C. Walker, features the growing and processing of EDT and laboratory-grown quartz crystals, and their use in communications equipment.

The two sons of Dr. and Mrs. Jewett, Harrison Jewett of Upton, L. I., and Frank B. Jewett, Jr., member of the Rockford college board of trustees, also attended the dedication of the laboratories.

*Ralph Bown, Robert A. Millikan and Roger Prorise (Illinois Bell) in front of the Jewett Laboratories at Rockford College.*





*Fabian Bachrach*

## **Kearny Comptroller To Succeed William Fondiller**

In anticipation of the retirement of William Fondiller, Assistant Vice President, which will occur on December 31, Burton R. Young has been appointed an Assistant Vice President. Mr. Young, who works comptroller of Western Electric at Kearny, assumed his new post on December 1. On Mr. Fondiller's retirement, the organization presently reporting to him will report to Mr. Young.

For the past fourteen months of his thirty years' company service, Mr. Young has been Kearny's works comptroller. Born in New York City, Mr. Young attended the High School of Commerce there, later completing courses at Columbia University and Pace Institute. Mr. Young joined the Western Electric Company in its New York office in 1920, as auditor's clerk. He was made an assistant auditor three years later and auditor in 1925, visiting distributing houses, installation divisions and Bell Telephone Laboratories. In 1929 he joined the statistical division, where he compiled information on financial results of operations. Auditing contracts with large suppliers and

supervising the preparation of financial statistics occupied him from 1940 to 1943, when he became one of Western Electric's accounting representatives in the re-negotiations of military contracts. During a two-year period ending in 1948 he traveled nearly a hundred thousand miles to make numerous appearances before public utilities commissions in support of applications for telephone rate increases. Following that assignment he was for a year in charge of all Western Electric auditors, and then for another year was at Kearny, in charge of all accounting at that Works.

In his new post Mr. Young will direct the operation of the Accounting, Treasury, and Purchasing Departments. Through the Area Managers' organizations he will be responsible for a great variety of services such as plant operation and engineering, shop services, mail, messengers, files, stockrooms, photographic and drawing reproduction. One of his groups is the point of contact for commercial relations with Western Electric and A T & T.



*In company with John Souhami of the Army Information Service three Japanese professors visited the Laboratories at West Street and Murray Hill on October 11. In the course of the afternoon spent at the New Jersey location, this photograph was taken while the visitors were intrigued with the electronic exhibit details on the Concourse. From the left: Mr. Souhami, Yosushi Watanabe, Nobuyoshi Kato, A. R. Brooks and Yoshihiro Asami.*

## **We See by the Papers, That—**

On November 8, 1900, fifty years ago, the editor of this column arrived in New York City and shortly thereafter went to work for Dow Jones. On November 8, 1900, the stock of American Telephone & Telegraph was selling on the Boston Stock Exchange at about the same price the stock is now selling on various exchanges throughout the country—\$150 per share. Since that time, the authorized capital stock of A T & T has increased from a million shares to 35 million through sales of additional shares of stock. Beginning in July, 1900, the annual dividend rate on this stock was set at \$7.50 a share, and since 1922 the rate has been maintained at \$9 a share. In 1900 the company was barely beginning its long program of public financing with an exchange of stock with the original American Bell Telephone Co. At that time the company had slightly less than a million instruments in use. Today the total is in excess of 34,326,000. A closer parallel between industrial expansion, taking the number of instruments in use and the price of the capital stock, would be difficult to find. Both are about 35 to one.

While the editor of this column was covering A T & T for *The Wall Street Journal* during the 1920's and the great depression of the

thirties, he kept on hand for future use a form statement of the company's coming dividend declarations. They never varied, a fact which has made the stock of A T & T perhaps the prime investment in the nation today. Fifty years ago there were 7,536 stockholders. Today A T & T has 971,000, including 40,100 trusts, corporations, charitable institutions, etc., with an average holding of 28.5 shares. This largest single corporation in the world, with plant and equipment worth nearly \$10 billion and annual operating revenues of about \$3 billion, today serves a nation of more than 150 million persons. And these people, through A T & T's systems, now carry on an average of 142 million telephone conversations per day.—Oliver J. Gengold, in *The Wall Street Journal*, November 8, 1950.

## **Canadian Bell Exhibit**

When the Bell Telephone Company of Canada "Panorama of Telephone Progress" exhibit opened for the Telephone Pioneers' Convention in Montreal, displays designed and produced in the Laboratories were among the attractions. The exhibit is a presentation of equipment selected from the historical collection of the Bell Company of Canada. It depicts the progress of telephony from the experimental instruments of Alexander Graham Bell and other pioneer inventors to the complex systems of today.

At the request of the Canadian Company, J. T. Lowe and Henry Kostkos of the Laboratories assisted in the general design and arrangement of this exhibit. Displays, designed and built under the direction of Mr. Kostkos, include a large working model of a cutaway handset, giant repeater tube, hearing test, Transistors, and crystal filters.



*During his stay in San Francisco while visiting the West Coast, J. R. Pierce (center) addressed a group of Pacific Tel and Tel people on microwave and television activities. He is shown with J. W. Powell, chief engineer (right) and D. I. Cone.*

## E. E. Schumacher Visits Europe

Earlier this year Earle E. Schumacher, chief metallurgist of the Laboratories, was honored by an invitation from the British Institute of Metals to deliver the 21st Annual Autumn Lecture during the four-day September meeting held at Bournemouth. This lecture is a highlight in British metallurgical yearly events and the lecturer is always chosen because of his prominence in world metallurgical circles.

Following this comprehensive presentation of his major subject, *Communications Metallurgy*, Mr. Schumacher made an extended trip throughout Europe, studying the state of metallurgical science and technology as presently practiced there. In the course of his conferences and visits to plants and universities, he crisscrossed England, France, Holland, Germany and Switzerland. In his seven weeks of intensive travel he visited 31 establishments.

The first-hand knowledge of current European metallurgical thought and practices, and the many invaluable personal discussions with foreign metallurgists and educators, proved of great interest to him. Everywhere he was courteously received as a representative of Bell Telephone Laboratories.

## Dr. Shockley Visits Korea

At the invitation of the Weapons Systems Evaluation Board, William Shockley of Solid State Physics made a trip to the Korean theatre in September and October. After a few days briefing in Washington, Dr. Shockley left there on September 16, arriving in Taegu on the twenty-third. While there, he went up to Taejon for two days. En route home, he met L. Vieth, R. R. Galbreath and J. R. Power, who had gone to Japan on another mission. While in Tokyo, he delivered a lecture on germanium research at the University of Tokyo and later had dinner with General Back, Chief Signal Officer of SCAP, who spoke highly of the contributions of Bell System men in that organization. Leaving Tokyo on October 7, he reached home on the tenth.

## Trends in Electronic Components and Assemblies

A talk on the subject of *Trends in Electronic Components and Assemblies* was given on November 1, 1950 by E. I. Green to the New York Section of the I.R.E. Mr. Green first summed up the conclusions of a recent joint A.I.E.E.-I.R.E.-R.M.A. Symposium on *Improved Quality Electronic Components* that new standards of reliability in electronic equipment are essential for military success, for industrial expansion,

and for domestic satisfaction in the use of electronic products.

He then outlined a number of trends illustrative of progress being made toward improved electronic components and assemblies. Trends toward new materials, miniaturization, life extension, greater stability, greater precision, higher operating temperatures, unitized design, pre-formed circuits, and plastic encasement were noted, with examples of each. Among the examples cited were: coils with ferrite cores, giving a Q twice that obtainable with previous magnetic material; borocarbon film resistors, providing a much lower temperature coefficient than previous deposited carbon resistors as well as making possible much higher resistance values; Transistors, that afford small size and weight, low power consumption, ruggedness and expectancy of long life; electrolytic capacitors with tantalum electrodes, giving smaller size, longer life, and greater stability than previous aluminum electrolytics; sea bottom repeaters for the Key West-Havana submarine cable, in which extraordinary measures have been taken to extend life expectancy; power supply transformers designed to operate at 200 degrees C, with weight only about one-third that of previous designs; and Type-N carrier equipment, employing unitized design and miniaturized components.



Major General W. A. Scott, Director of Signals of the British War Office, visited the Laboratories at West Street and Murray Hill on October 27. R. K. Honaman was host to the General and his party on a tour through the Laboratories at both locations. Included in the party were left to right seated, Major General Scott, Colonel C. B. King, U.S.A. and Colonel G. S. Coles, Chief Signal Officer, British Joint Staff Mission; and standing, Lieutenant Thornley, U.S.A.



Once in a while, Judy, 2, and Susan, 4, have breakfast with their daddy at their home, 11 Wendell Place, Clark Township, New Jersey. At the right, Dick arrives at the Murray Hill Laboratories by bus.

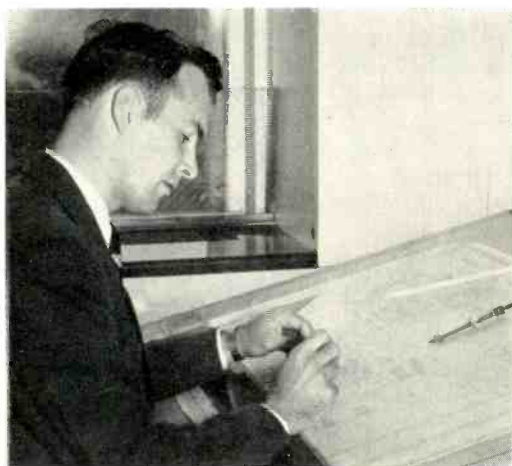

Dick completes a layout drawing.

## A DRAFTSMAN'S DAY AT MURRAY HILL

Dick Benkert came to the Laboratories in 1940. Called to service in the Armed Forces in 1942, he spent almost three years in active duty, eight months being in Europe. As First Lieutenant, bombardier in the Eighth Air Force, he flew 35 missions over Germany.

Returning to the Laboratories in 1945, he is now engaged in mechanical layout drafting on various types of telephone apparatus. He receives instructions from the design engineer, either verbally or by means of sketches and gets an opportunity to do some designing himself.



Left—The Apparatus Standards book furnishes the correct tolerances for shaft and hole fits. Center—A modern filing system makes it easy to find associated piece part drawing numbers. Right—Prints of needed drawings are furnished by the file clerks.



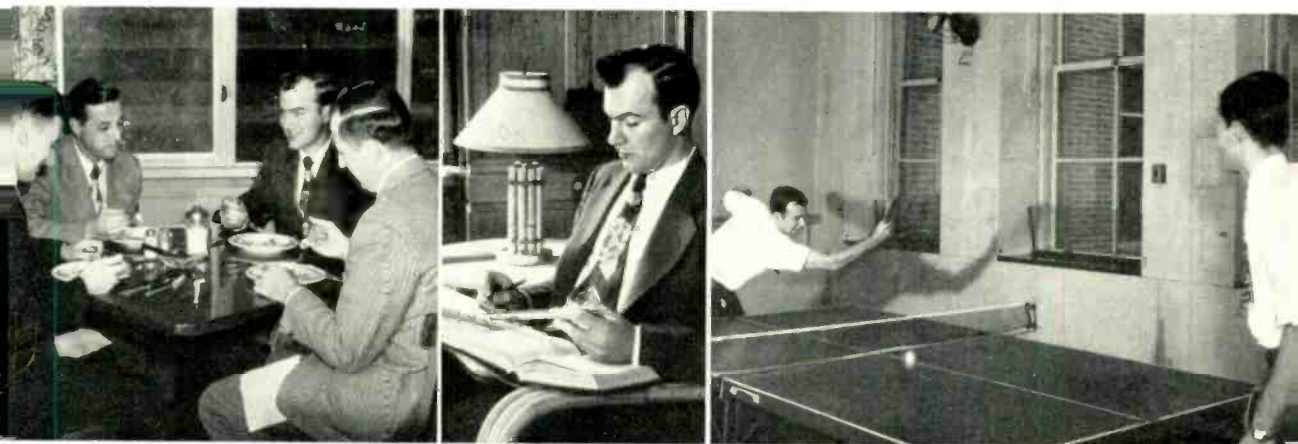

*Left—At noon, Dick lunches with his fellow draftsmen. Center—After lunch, Dick has an opportunity to study. He is attending Newark College of Engineering at night. Right—On other days, Dick plays some table tennis.*

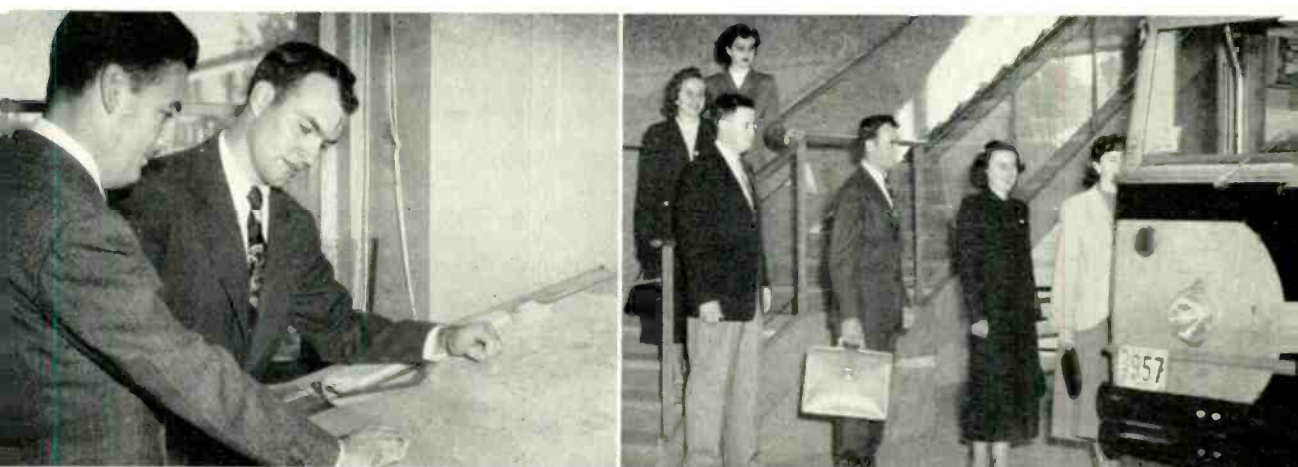

*Left—Dick discusses a point of design with the engineer on the project. Right—Homeward bound.*



*Left—After the evening meal, and before the youngsters go to bed, Dick spends a few minutes with them. Center—On Friday night, Dick gets ready for a Saturday fishing expedition. Right—Some Saturdays are spent cleaning up. Susan helps her daddy rake leaves.*

**December, 1950**

**561**



During inspection of the premises at Murray Hill, the I. C. M. A. members had a main interest in the new restaurant facilities. F. E. Dorlon and T. J. Crowe described the equipment.

## Restaurateurs See Facilities at Murray Hill

At the Restaurant Managers' Convention in Atlantic City in 1949, F. E. Dorlon, Manager of the Murray Hill Restaurant, and P. C. Wolz, Assistant Superintendent Industrial Relations, Eastman Kodak Company of Rochester, proposed establishment of a subdivision of company-owned and operated restaurants. The purpose is to emphasize the maintenance of the highest quality standards in industrial feeding.

In addition to Bell Telephone Laboratories and Eastman Kodak Company, representative firms joining the Industrial Cafeteria Managers Association, as it was named, were: General Electric Company, Caterpillar Tractor Company, Firestone Tire & Rubber Company, Western Electric Company, Armstrong Cork Company, Owens Illinois Glass Company and National Cash Register Company. As the idea

picked up momentum, the list has steadily grown and at the last semi-annual meeting, the number of companies represented was 26.

One day of the business session was spent at the Murray Hill Laboratories and the succeeding day at the Kearny Works of Western Electric. For the Murray Hill visit, a number of interesting items among the variety of types available were covered in a short tour preceding the luncheon and extended business meeting.

## Changes in Organization

H. W. Gillette, General Employment Manager, has been appointed Personnel Representative, located at Whippany and reporting to M. L. Wilson, Personnel Manager of New Jersey Operations. H. D. Wilson will assume the duties formerly held by Mr. Gillette, and has been appointed General Employment Manager, reporting to R. A. Deller, Employment Director.

## December Service Anniversaries of Members of the Laboratories

40 years  
W. A. Bollinger  
P. L. Wright

35 years  
F. C. Kahnt  
M. A. Weaver

30 years  
A. J. Daly  
C. L. DuBois

R. J. Kent  
C. F. P. Rose  
W. C. Somers

25 years  
E. I. Bulman  
Margaret Fullerton  
J. P. Kinzer  
H. R. G. Tosch  
R. Zimmerli

20 years  
Elizabeth Beck  
J. P. Coggins  
P. J. McGroary  
A. S. Windeler

15 years  
C. E. Greene  
A. Kendall  
C. J. Kuhl

Irene Longley  
J. J. Naughton

10 years  
J. R. Bedkowski  
Eileen Gilburn  
J. J. Lordan  
E. J. Moskal  
H. A. Stein

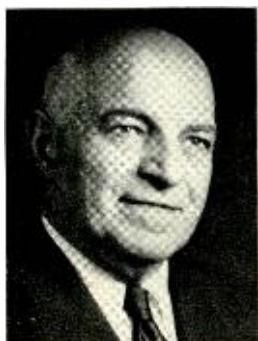

W. A. BOLLINGER



M. A. WEAVER



P. L. WRIGHT



F. C. KAHNT

## Influenza Vaccinations

As the RECORD went to press, 685 members of the Laboratories had received vaccination against influenza at their request. The Medical Department was not proposing to recommend vaccination unless an epidemic appeared to be in the making. However the vaccine was made available to the many who requested it, and to those whose physicians suggested that they receive it.

## News Notes

OTHERS receiving collegiate degrees that were not included in the November RECORD are JEAN BERTELS and J. C. BERKA, both B.E.E., College of the City of New York; H. A. CUBBERLY, B.M.E., and C. J. KEYSER, B.E.E., Cooper

Union; A. A. CURRIE, R. HAMMELL, W. H. KOSSMAN and W. H. YOCOM, M.S., Stevens Institute of Technology; and R. F. EWALD, B.M.E., J. A. SEIFERT, B.E.E., and E. J. ZILLIAN, B.S., Polytechnic Institute of Brooklyn.

A NEW TECHNIQUE has been devised for examining relay contacts. If a heated thin sheet of vinylite is placed on the surface of a relay contact, it will adhere, and when it is withdrawn, it will bring away any particles of dust, lint, etc., leaving the contact with a clean surface. The substances that adhere may then be studied under a microscope or analyzed chemically to discover what they are. T. F. EGAN and H. J. KEEFER used this technique in examining new relay contacts in Tonawanda, New York, particularly to evaluate individual relay covers versus group covers.



## TELEPHONE BUSINESS HELPS OTHER BUSINESS

*Heard on the Telephone Hour October 9*

*Storekeeper:* Good afternoon. Can I help you?

*Young Man:* My watch seems to be on the blink. Loses about ten minutes a day.

*Storekeeper:* You have it with you? Ah, yes.

*Young Man:* I'll leave it and stop by later in the week.

*Storekeeper:* That won't be necessary. It'll just take a moment.

*Young Man:* You mean you . . . . ? Oh, I see. That gadget. What in the world is that?

*Storekeeper:* It's an electronic timing device. It will tell me in just a few seconds how fast or slow your watch is running.

*Young Man:* Well, what do you know! But this little name-plate has "Western Electric" on it. That's part of the Bell System, isn't it?

*Announcer:* Well, perhaps I can help clear that up. The device the watchmaker used has in it a number of circuits that were developed by Bell Telephone Laboratories for use in telephone service.

They were soon found to have other uses. And so a new small business came into being to make watch-timing machines. Telephone research made this new business possible, but otherwise it is entirely independent of the Bell System. Jobs were created. And hundreds of watch repair shops were given a new tool to work with.

Other stories could be told about phonograph needles. And calculating machines! And diathermy equipment! And locking door handles and many other things.

Yes, the business of the Bell System helps many a small company in this country. Some of them got their start because of telephone research. Others prosper from purchases of materials needed by the Bell companies. Western Electric buys these materials from 24,000 suppliers in 2,500 cities and towns. All this means jobs. And it's jobs that enable all of us to buy the things that Americans enjoy beyond the dreams of other nations, including telephone service.

This mutual helpfulness is the very stuff of which America is made. And so all of us who live and work in America may well be glad we have a telephone industry that is financially able to serve the people well and move steadily forward. It is in the interest of all of us to keep it that way.



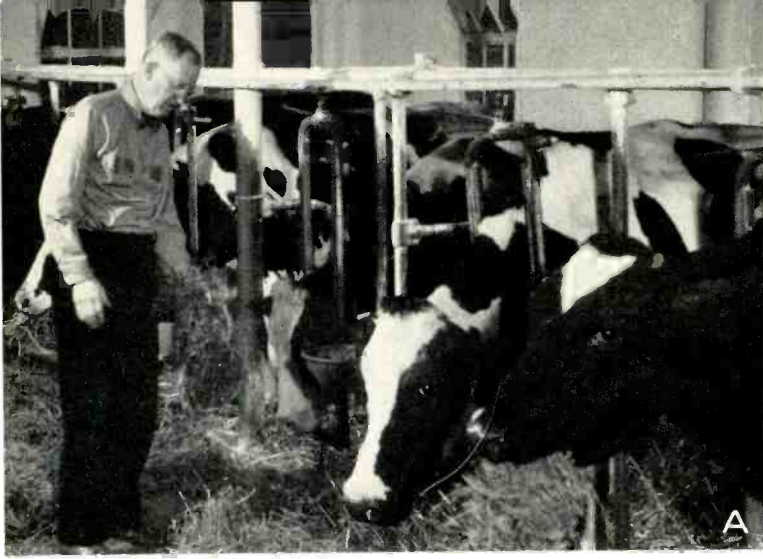

## How Not to be Bored

By Blanche McKeown

(From "This Week," October 22, 1950. Reprinted by permission of United Newspapers Magazine Corporation and the author)

*"If a man does not make new acquaintances, as he advances through life, he will soon find himself left alone. A man, Sir, should keep his friendship in constant repair."*

—SAMUEL JOHNSON

I'M A librarian in a large Southern City, and all day long I'm faced with elderly people who are sometimes confused, unhappy and resentful over their situation.

All this has started me thinking. I'm not old yet, but I'm not exactly in my first youth either, and I've begun wondering what I'll be like in a few years. It seems to me the key to the problem is boredom. Many older people are bored because they are lonely and idle, left to think too much about themselves.

What's the best cure for boredom? I found the answer in the quotation above. It's to forget yourself through activities which bring you in touch with people and ideas outside yourself.

And so, as my own special insurance against boredom, I've devised this four-point program, and I can testify that it really pays in terms of everyday happiness:

1. Join a church and become actively interested in some phase of its work.
2. Select one charitable activity and really work with it. Giving money is fine, of course, and good for the soul, but just as important is

direct personal work which brings with it many new friends and associations.

3. Interest some young person in your line of work, and teach him to love it as you do.

4. Select some hobby that promises to be increasingly rewarding as you grow older.

With the help of these activities, I hope to go on building a state of mind which will make old age a pleasant, relaxed, contented period instead of a time of frustration. When the day comes for me to step aside to make room for the younger generation, I want to do it gracefully, without regrets or jealousy. I intend to keep on having a future instead of merely a past.

To illustrate Blanche McKeown's philosophy the RECORD has selected five Pioneers, now retired:

A—Amos F. Dixon before retirement decided to go in for farming, began to buy land, took agricultural courses.

Now he has four hundred acres, 65 milch cows. Mr. Dixon also represents his district in the New Jersey Legislature.

B—Halsey Frederick (left) is chairman of the trustees of the proposed Riverside Hospital at Boonton. Need was proved by a survey and a campaign for funds is in preparation.





C—Adeline Knoeller spends her retirement making clothes for the Salvation Army's Door of Hope, through her church sewing guild.

D—If your tastes run to less activity, take a look at C. W. Lowe, who takes color pictures on



his travels, shows them to his many friends.

E—Harvey Fletcher (right) tells two Columbia students how stereophonic sound is produced. Currently Dr. Fletcher is giving a course in the physics of music.

## Murray Hill Chorus

The Murray Hill Chorus this year inaugurates a new practice in presenting its first public Christmas Concert on December 15. The program, in which audience participation will be a feature, will be presented at Chatham High School in New Jersey. Sacred and traditional music has been programmed. Following the concert by one week, the annual noon-hour Christmas program at Murray Hill will be heard on December 21. On the evening of the same day, the Chorus will present selections from the concert at a meeting of the Metropolitan Camera Club in the Hotel Statler. Another December appearance will take place at Lyons Veterans Hospital where the songsters hope to brighten the spirits of the patients.

The Christmas Concert will be the first appearance of the Chorus under the leadership of H. Thomas Miller, new director.

## Stamp Club News

Stamp Club members at West Street have heard E. A. Thurber, C. J. Keyser and W. S. R. Smith of the Club as speakers for recent noon-hour meetings in the Conference Dining Room. Mr. Thurber, in his discussion of *Perforates and Imperforates*, explained the various methods and machines used in separating stamps and cited instances where perforation errors increased the value of stamps. As Club Exchange Manager, Mr. Keyser selected *The Handling of Exchange Books* for his topic. *Secret Marks*, Mr. Smith's subject, was illustrated by photographic enlargements which he brought along to show the various markings on stamps by

means of additions to engraved and re-engraved plates.

The Stamp Club will have three luncheon meetings this month. On December 4, Evelyn Fitzsimmons will speak on *Covers*; on December 11, C. H. Rock of Bankers Trust Company will be the guest speaker; and on December 18, W. Kuhn will discuss *Christmas Seals*.

## News Notes

R. A. SYKES has been appointed to the Munitions Board Electronics Equipment Industry Advisory Committee, Task Force on Crystals. He attended a meeting of the Electronics Industry Advisory Committee of the Munitions Board in Washington, and with I. E. FAIR attended a joint meeting of R.T.M.A. Subcommittee on Quartz Crystals and ASES in New York City.

A GROUP of forty-two Fidelity Union Trust Company officers and supervisors inspected the Murray Hill facilities on October 25. In the auditorium R. K. HONAMAN talked to the party on the scope of the Laboratories and the manner in which the research and development effort fits into the Bell System requirements; A. F. BENNETT described the 500-type telephone set; R. M. RYDER gave a Transistor demonstration; D. H. WENNY and K. M. OLSEN described metallurgical methods; and R. M. BURNS, the synthesis of piezoelectric crystals. A short tour was conducted by H. B. ELY, A. R. BROOKS, A. J. AKEHURST and T. N. POPE.

F. R. LAMBERTY with W. A. CLARK of the A T & T attended a convention of the United States Independent Telephone Association at Chicago.

## RETIREMENTS



O. A. SHANN



G. H. STEVENSON

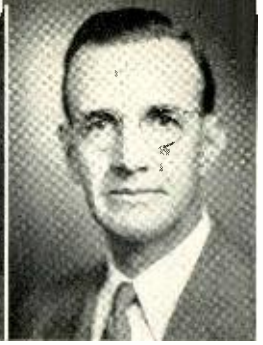

F. H. BEST

Among those retiring from the Laboratories are F. H. Best, O. A. Shann and G. H. Stevenson with 39 years of service; Robert Norden-  
swan, 37 years; Julian Blanchard and J. B. Kelly, 33 years; C. A. Frank, 32 years; F. A. Kuntz and D. R. McCormick, 31 years; W. K. Burke and Mary A. Mulhern, 30 years; M. S. Mason, 29 years; and F. W. Cunningham, 28 years.

### OSCAR A. SHANN

After four years in the engineering departments of the New York Central and Pennsylvania Railroads in connection with the then new electric cars and locomotives, Mr. Shann in 1912 joined the Engineering Department of the Western Electric Company at West Street.

His first job was to make the drawings of an electrically operated and controlled oscillograph mechanism. Then he went on to a desk job in connection with the design of manual station apparatus and some central apparatus such as switching keys and protectors.

In 1918, Mr. Shann was transferred to a newly created radio design group and was assigned to work with L. M. Clement on the design of a radio set for army overseas service. When this work was completed, he returned to manual telephone apparatus design and became supervisor of a group handling telephone set engineering and development. Shortly thereafter, coin collection design problems were added.

About 1928 the growth of this work increased to such an extent that two groups of engineers were formed under Mr. Shann embracing not only telephone sets and coin collectors but also telephone booths and accessories. Later a third group, handling the exploratory phases of development work on a completely new coin collector, was added. Mr. Shann continued in charge of this program until shortly after removal of the job and personnel to Murray Hill.

During World War II Mr. Shann transferred to design of hydrophones and other underwater signaling devices for the Navy. When these activities ended he again returned to the station apparatus development activities, including studies of coin collector robbery and "beating" problems, locks and other special protective

devices for telephone paystations. Part of his time was devoted to handling employee suggestions relating to station apparatus as well as outside patents and ideas submitted for purchase. Forty-six patents record his own contribution to the telephone art.

After retirement from the Laboratories, Mr. Shann plans to engage in consulting work on coin machine apparatus and lock mechanisms and on some patent development work relating to these items.

### GEORGE H. STEVENSON

Joining us soon after he came over from Scotland in 1911, George Stevenson took up the design of filters and networks. To this art he contributed the constant-impedance network, which is the subject of one of his 19 patents. He also worked on early radio receiving and oscillating circuits and designed the basic circuit for a volume control shaped to the audibility curves.

In 1923, Mr. Stevenson transferred to the Patent Department where for twenty-seven years he did patent work in the fields of radio and networks. His ability in analyzing complicated patent situations, demonstrated on many assignments, again proved itself in connection with inauguration of the radio relay and mobile radio services.

Mr. Stevenson's article *Stabilized Feedback Oscillators* appeared in the *Bell System Technical Journal* in 1938. He graduated from Glasgow University in 1906.

### FRED H. BEST

His is really two careers: before 1940, Fred Best was a transmission engineer; afterward a mechanical designer. Having entered the A T & T Engineering Department with an E.E. degree from Cornell in 1911, he made transmission tests on the transcontinental line and on its completion became supervisor of a group of engineers working on transmission maintenance of long-distance and exchange circuits. That lasted until World War II; in the meantime (1934) Mr. Best and his associates were transferred to the Laboratories.

When, with the approach of war the Labora-

ories began to take up military development, many engineers were asked to jump in and help out in unfamiliar fields. Mr. Best's assignment was to a data transmission system for artillery which required considerable mechanical design. He was so successful in this that he was asked to go into Electronics Research to take part in mechanical design of magnetrons and klystrons. When the war ended, he elected to remain in that work and recently has been designing spatial-harmonic amplifier tubes. He has also pioneered in the mechanical design of traveling wave tubes and a microwave cathode-ray tube.

Mr. Best will presently become a civilian engineer for the Air Force at its Long Range Proving Grounds near Cocoa, Florida. He and Mrs. Best look forward to the warmer climate; their only regrets are to be so far away from their four children (one with Long Lines, one with us in the Research Drafting Department at Murray Hill) and to be seeing their nine grandchildren only occasionally.

#### ROBERT NORDENSWAN

Four years after he came to the United States, Bob Nordenswan in 1913 joined our apparatus drafting group, but was soon assigned to the engineering of transmission instruments. During World War I he worked on battle telephones for the Navy and on submarine and subterranean sound ranging systems. After the war he had charge of a group responsible for the design of large horns and of handsets. While developing the handset it was his hand which squeezed a lump of modeling clay into a shape which determined that of the handset handle.

Later Mr. Nordenswan joined the Specialty Products design group where he was concerned with the development of phonograph pickups, audiphones, audiometers and music distribution systems for hotels. In 1938 he transferred to electromechanical apparatus development on the production design of message registers, mounting plates and soldering irons. During the war he designed timing devices and interrupters for Bell System and for military uses, and subsequently he has been working on apparatus for distributing tickets in toll offices, mounting plates and other central office apparatus.

Mr. and Mrs. Nordenswan live on upper Riverside Drive. Because his hobby is color photography, they will do a bit of sightseeing, then find a place to live just outside the city, where his new associates will find in him a quiet steadiness of purpose, a strong practical resourcefulness, and a friendly cooperative spirit.

#### JULIAN BLANCHARD

During World War I Dr. Blanchard joined our electronics group to work on the development and production of vacuum tubes. He had a bachelor's degree (1905) from Duke University and the doctorate of philosophy from Columbia, as well as teaching experience at both institutions.

In 1930 Dr. Blanchard became a staff assistant in the department of radio research. During the next few years, in addition to special investigations and reports on radio and vacuum tube matters, he aided in the preparation for the Laboratories' participation in various international radio congresses, in committee work on electrical standards, and in editorial work on technical papers for publication. Over the years he

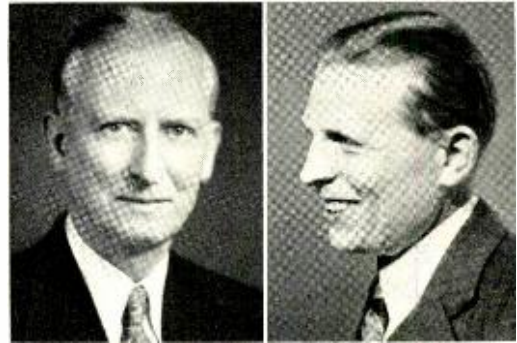

JULIAN BLANCHARD ROBERT NORDENSWAN

has gathered a large amount of useful reference data on the development and progress of radio and electronics, some of which has resulted in published papers.

Upon our entry into World War II, Dr. Blanchard assisted in the organization of the Laboratories School for War Training, and during the first few months of its operation was assigned to laboratory instruction and to the supervision of laboratory apparatus and equipment. After that he was engaged in the writing of radar manuals until the close of the war, for which he received the Navy Department's Emblem and Certificate of Appreciation.

During parts of 1947 and 1948 he served as our point of contact, in New York and in Washington, with the government office which collected reports on German technical developments. Since then he has been a member of the Patent Department.

A dyed-in-the-wool hobbyist, Dr. Blanchard will continue, upon retirement, with his specialty of stamps and paper money having similar designs, a field in which he is an active collector and a recognized authority. He is a charter member and Secretary of the Essay-

Proof Society, and expects to continue his contributions on paper money to its quarterly publication, the *Essay-Proof Journal*, of which he is assistant editor and business manager. He also hopes to find time to write a history of his family, to top off his genealogical hobbying. For the present he will continue to live in Greenwich Village, in near reach of his Laboratories friends.

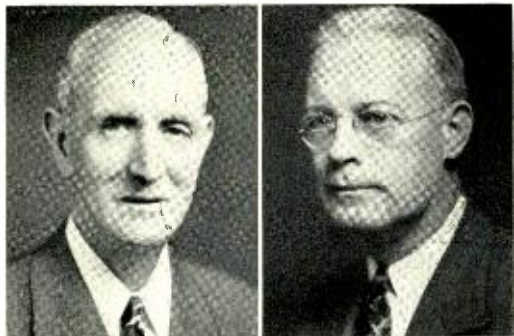

C. A. FRANK

J. B. KELLY

#### JOSEPH B. KELLY

Joining the Research Department in 1917 after graduation from Penn State (B.S. in E.E.), Joe Kelly at first engaged in transmission studies. In 1924 he began his work on the development of audiometers and audiphones for the hard-of-hearing, including the problem of measuring children's hearing in public schools.

Late in 1935 Mr. Kelly became executive assistant to the Physical Research Director. Four years later he transferred to Western Electric where he was engaged in sales promotion of hearing aids and audiometers. In this he worked closely with the Laboratories, audiphone dealers and members of the medical profession. In June, 1940, he returned to the Laboratories and after a year with Publication transferred to the acoustical group of the Physical Research Department. There he worked on means to aid hard-of-hearing children in the schools. During World War II he worked on military devices involving acoustics. In 1945 he transferred to Electronics Development, where he helped to develop thermistors for carrier systems, and selenium rectifiers for power supply. With Power Development, to which group he transferred at the end of last year, he worked on applications of these rectifiers.

Mr. and Mrs. Kelly will forsake Maplewood for a warmer climate. If Joe finds there some deafened school children whom he can help, he will be content.

#### CHARLES A. FRANK

After ten years' practical experience as a tinsmith, Charlie Frank came to work here in that capacity, in 1918. Two years later he was reclassified as a sheet metal worker. For the next twenty-eight years he was one of the crew who waged war on Old Father Time in his efforts to disintegrate our building. As metalwork lived its life, Charlie and his associates went to work with shears and pinchbars, took out the old and put in the new which they had made in the Building Shop.

Mrs. Frank is the former Mary Cross, a member of our Reproduction group. The Franks have an apartment near our West Street building where they expect to remain. Mr. Frank's hobby is deep sea fishing.

#### DANIEL R. MCCORMACK

When he entered our General Methods Department in 1919, Dan McCormack brought with him seven years' experience in railroad office work. His first assignment here was a study of the West Street restaurant, as a result of which purchases and collections were transferred to Purchasing and Financial, respectively. His next job was to develop and install a departmental case cost system whose basic principles are still in application. After two years, Mr. McCormack was put in charge of mail, messenger, telegraph and central files; soon after, he installed the handling of mail at West Street on an unused elevator fitted with sorting racks.



D. R. MCCORMACK

F. A. KUNTZ

When Transcription was placed under his supervision, Mr. McCormack set up "Telephone Dictation," by which a telephone call is answered by a typist. At first letters were typewritten directly; later, dictated to a stenotypist. Mr. McCormack, in his supervision of the reproduction groups, installed facilities for photographic reproduction which are recognized in the trade as outstanding. He had charge of the installing of facilities for copying tracings, and



making black line or direct positive prints. Two years ago Mr. McCormack returned to General Methods, where he has had much to do with setting up a microfilm procedure which allows bulky records to be replaced by film copies.

An active member of the Bell Laboratories Club since its organization, Mr. McCormack has been a committeeman, vice-president and finally president. He has been chairman of the Entertainment Committee of the Pioneers.

The McCormacks live in Plainfield, New Jersey, the town in which Dan was born, where they will continue until early in 1951 when they will set forth on a tour of the United States.

#### FRANK A. KUNTZ

After eleven years' experience elsewhere, Frank Kuntz entered the Laboratories in 1919. From that time until 1937 he specialized on telephone booths and accessories; many of his



MARY MULHERN

W. K. BURKE

eleven patents are in that field. Transferring to the repaired apparatus group, he prepared the requirements which guide Western Electric shops in this work. During the war he was first at Whippany and later at Graybar-Varick on mechanical design of radar units. Since then he has been working on repaired apparatus, particularly on mobile radio telephone apparatus.

Mr. Kuntz is a graduate of Catholic University, Washington, D.C. (B.A. 1907, B.S. in E.E. 1908) and has long been active in its alumni affairs. He received the honorary M.S. degree in 1948, and is currently a member of the alumni executive committee. The Kuntzes have four sons and five grandchildren and live in Woodhaven, Queens.

#### MARY A. MULHERN

Retirement will bring Mary Mulhern a more active role in her church and community. Through the years she has watched Flatbush develop from farming area to suburbs and has helped its growth by giving time generously to

civic activities and church guilds. She has held office in the Catholic Women's Benevolent Society and in a local Democratic club. All of them stand to gain more now that she has more time and experience to give, after a business career in various Bell System Transcription Departments, beginning with Operations and Engineering, followed by Development and Research at A T & T, and, since 1934, in the Laboratories at West Street.

Miss Mulhern plans to expand on two projects, her garden and her special work of mercy, visiting the sick. Just now her family is on from Oklahoma for a Thanksgiving visit. She will visit them later next year and then spend a short vacation in Florida. In the past she has travelled extensively in this country and has visited England, France and Cuba. Her most memorable trip was to the Eucharistic Congress in Dublin, Eire.



M. S. MASON

F. W. CUNNINGHAM

#### WILLIAM K. BURKE

In one World War, Bill Burke served his country as a fireman first class in the Navy; in the later one, he was an expeditor in Purchasing. Getting materials for military production was, he concedes, more important, but he enjoyed the Navy life more. In between, he was in our Blueprint group, first as an operator, later as a clerk. Recently, he has been doing clerical work in Purchasing.

The Burkes will move from Inwood to California. Mr. Burke is an ardent builder of miniature railroad equipment; in his new home he looks forward to plenty of outdoor activity as well.

#### MAYNE S. MASON

By the time Mr. Mason entered A T & T in 1921, he had already had quite a career in study, teaching and research. His studies were at the University of Illinois (B.S. in E.E. 1911; M.S. in E.E. 1913); his teaching was at Rutgers; and his research was with the Illinois Engineering

Experiment Station, at General Electric, and at Mellon Institute. As a Signal Corps officer in World War I he was an executive in a School of Military Aeronautics. His first work in the Department of Development and Research of the A T & T was on transmission—such things as conference circuits, call circuits and inductive coordination studies.

In 1934 Mr. Mason came to the Laboratories where he worked on grounding problems and pole line construction investigations. In 1939 he transferred to Personnel where he was engaged in technical employment, personnel planning, and military relations. Late in 1944 he went to the School for War Training, continuing with administrative responsibility for radio, carrier, and television schools for Bell System personnel.

Later, in the Switching Engineering Department, he worked on the switching require-

#### FREDERICK W. CUNNINGHAM

Entering the Laboratories just as broadcasting was getting started, Fred Cunningham became a field engineer in the broadcast group. Three years later he was in charge of this work which expanded to include police radio and to cover apparatus development, the selection of suitable station sites, sales assistance, the supervision of installations, subsequent consultation and contacts with the Federal Communications Commission. During the war he was also in charge of mechanical design groups responsible for the development of military electronic equipment, of field change kits for radar equipments for the armed services and for the preparation of technical information on such items. Since the war, he has been a liaison between the Laboratories and the Western on broadcast activities, following their transfer to the latter. He has also supervised the work of

*Honoring Philip Curran of the power service group at his fortieth anniversary luncheon were these eleven guests. Their service with his totalled 341 years, as noted on the little oak tree near the Irish cottage centerpiece. Seated around the table are W. C. Somers, W. Fondiller, Mr. Curran, S. B. Cousins, H. C. Atkinson and L. P. Bartheld. Standing are B. A. Nelson, A. Megraw, P. Higgins, J. Rohr, J. Wursch and G. Johnson. Shining ha'penny coins bearing the harp were given as souvenirs of the luncheon.*



ments for the New York State Police radio-telephone network. During this time he also took part in an experimental installation of subscriber sets.

The Masons live in Montclair and have two daughters. Mr. Mason is president of the Montclair Society of Engineers and is active in civil defense. He is a past national president of Eta Kappa Nu, and in 1929 conducted their first national salary survey for electrical engineering graduates. After his retirement Mr. Mason plans to be an engineer with a company which makes electrical brushes and contacts and self-lubricating bushings.

subcontractors in the preparation of a vacuum tube catalog and of instruction books on military electronic equipments.

Dr. Cunningham is a graduate of Princeton (B.S.—1907), (E.E. 1909), and of Wisconsin (Ph.D. 1911). A widower, he has his daughter and her family for company in his home in Maplewood. His son, a naval officer, was lost during World War II. Dr. Cunningham is a Senior Member of I.R.E., has served on its board of directors and on a number of its committees, and has presented two papers before it. He has been vice-president of the Princeton Engineering Association.

## P. J. McGrory Rescues Aged Woman



P. J. McGrory, Plant Department foreman at Murray Hill, recently helped remove two aged men from a burning house in Basking Ridge, near his home. When they were safely out, some one remembered a ninety-seven year old woman bedridden in the upper floor of the house. McGrory battled his way alone to the woman and carried her out in his arms before the fire department arrived.

Mr. McGrory is a member of the Murray Hill Fire Brigade and has completed Laboratories Red Cross first aid training courses.

### News Notes

THE FIRST IN A SERIES of four groups of transmission engineers from the Bell Telephone Company of Pennsylvania spent four hours at Murray Hill early in November. Some current research and development projects were described to them by R. M. RYDER, P. G. EDWARDS, A. G. GANZ, W. L. TUFFNELL, J. W. KENNARD, M. W. BOWKER, A. C. WALKER and D. H. WENNY.

R. H. COLLEY presented a paper on *Wood Preservation and Timber Economy* at the inaugural convention of the Forest Products Institute of Canada at Ottawa on October 30. The Institute has been formed to promote the exchange and correlation of information from research, development, administration and

teaching sources in order to promote the best possible handling of the forest and the most economical production and use of forest products in the Dominion. Mr. Colley's paper dealt with the essential part wood preservation plays in holding down the drain on the forest and in assuring maximum economy in such vital wood-using industries as transportation, power and light, communication and mining. Mr. Colley also sat in with the executive group of an advisory committee—made up of representatives of science and industry—that has been recently formed to help the Forest Products Laboratory of Canada plan an integrated research and development program. At this meeting, as at the convention, special attention was paid to the problem of developing and standardizing laboratory and field methods for evaluating modern wood preservatives.

THE NATIONAL RESEARCH Council Conferences on *Crystal Imperfections and Grain Boundaries* was held October 12-14 at Pocono Manor. The following talks were given: W. T. READ, *Experimental Information on Slip Lines and Dislocation Models of Grain Boundaries*; and J. BARDEEN and C. HERRING, *Diffusions in Alloys and the Kirkendall Effect*. W. SHOCKLEY was chairman of the conference.

F. A. POLKINGHORN was guest speaker at a meeting of the Bloomfield Branch of the American Association of University Women, in the Bloomfield Public Library. Mr. Polkinghorn, who returned earlier this year from a two-year mission as director of research of civil communications for general headquarters in Tokyo, gave his impressions of the Japanese people and showed color slides of Japan.

*The West Street Chorus will present their annual Christmas program in the auditorium on December 21 under the direction of R. P. Yeaton. There will be familiar carols with audience participation and traditional, as well as unusual carols by the Chorus. A cordial invitation is extended to everyone. On December 19 at 12:30, the Chorus will give a short Christmas program at the New York Savings Bank, Eighth Avenue and Fourteenth Street, New York.*





Mrs. H. S. Hopkins, wife of the West Street paymaster, demonstrates to a visitor the page-turner invented by F. T. Reck. This was exhibited at the JOB—Just One Break—exhibit for the handicapped at the International Business Show held in October at Grand Central Palace. Mr. Reck, standing next to Mrs. Hopkins, demonstrates the R. F. Mallina page-turner. Other demonstrators were Vivian Alling, H. J. Braun, H. S. Hopkins, Nancy Nelson, H. G. Reimels, Dorothy Thompson, Stella Vasilopoulos and Regina Zell.

Topping all records, Ida Tassi, Doll and Toy Club representative for the Restaurant, has had sixty dolls dressed by herself and her friends; sixteen of them were dressed by the Restaurant members. All are on display in the showcases at West Street. Another twenty-four dolls were dressed personally by Mrs. Peter Stevens, wife of a Development Shop member, as is her custom annually.



STANLEY PAULOSKI has been named Health Commissioner of Paterson, New Jersey. He took the oath of office on October 11 from Mayor De Vita at City Hall. Mr. Pauloski, a member of the Accounting Department at Graybar, has been active in Polish-American affairs in his town and is an officer in the Pulaski Democratic Club.

A. R. THOMPSON and H. J. KOSTKOS attended a two-day Bell System Public Relations Conference on motion pictures and displays in Philadelphia. The Laboratories' representatives discussed the type of information and assistance on new developments in connection with which they are working with the Associated Companies on their motion picture and display projects. Mr. Kostkos described and illustrated new Laboratories displays, including the combined voice mirror and voice meter, phototransistor demonstration, an improved hearing test for mass audiences, and microwave transmitting and receiving equipment.

J. J. MARTIN is one of the contributors in the recently published *Design and Production Volume, 12th Edition, Kent's Mechanical Engineers Handbook*. He prepared an article in the non-metallic materials section on *Plastics*.

A. J. WIER of the Laboratories, and F. R. JAMES of the General Installation Department of the Western Electric Company recently went to Jacksonville, Florida, to follow the unpacking and erection of duct type bays carrying channel bank equipment for the LI carrier system between Jacksonville and Atlanta. These new bays were described in the *RECORD* for May of this year, and although they have been used extensively over the country, this was the first commercial installation for which they had been fully equipped in the factory. It was important, therefore, to find out how fully loaded bays of the new construction would withstand the stresses that would be involved in transportation and erection.

A. BRONØE, president and general manager of Telefonfabrik Automatic of Denmark, visited West Street and Murray Hill on November 1. Mr. Bronøe is the leader of a group of European industrialists who, under the auspices of E.C.A., are studying American management methods. He was especially interested in the Laboratories approach to management problems.

THE FOLLOWING TALKS were presented at the Gaseous Electronics Conference held by the Division of Electron Physics of the American Physical Society in New York October 19-21: F. E. HAWORTH, *Electrode Reactions in the Glow Discharge*; L. H. GERMER, *Experiments*

*Upon the Initiation of an Electric Arc*; J. A. HORNBECK, *Mobilities of Rare Gas and Molecular Ions*; J. P. MOLNAR and J. A. HORNBECK, *Mass Spectrometric Studies of Molecular Ions in the Rare Gases*; G. H. WANNIER, *Diffusion of Ions in a Strong Electric Field*; and A. V. PHELPS, *Studies of Lifetimes of Metastable Atoms in the Afterglow of Rare Gas Discharges*. The following Laboratories people also attended this conference: A. H. WHITE, K. K. DARROW, G. E. MOORE, H. W. ALLISON, H. D. HAGSTRUM, P. W. ANDERSON, R. C. FLETCHER and R. W. HULL.

W. M. GOODALL, J. B. JOHNSON, J. F. MORRISON, G. N. THAYER, W. C. TINUS, and W. T. WINTRINGHAM have been named by the Institute of Radio Engineers to the grade of Fellow. Presentation of the awards will take place during the annual banquet in March, 1951.

D. K. RIDER has been appointed chairman for New Brunswick and neighboring communities of the University of Michigan's campaign for \$6,500,000 to finance atomic research. The University, a pioneer in atomic research, plans to establish the first over-all research project into atomic energy for peace-time uses to be set up by a non-governmental agency.

THE QUALITY of electroplating, which plays a big part in protecting telephone apparatus against corrosion, depends importantly on employing proper control standards. These standards and the latest plating techniques and test methods were discussed at a meeting of A.S.T.M. Committee B-8 at Buffalo attended by A. MENDIZZA. While in Buffalo he also attended the Annual Fall Convention of the Electrochemical Society.

R. M. BURNS visited the Tonawanda Works, Buffalo, to observe the manufacture of enameled wire. While in Buffalo he also attended the Convention of the Electrochemical Society of which he is a former President and is now General Advisor and Consultant.

LABORATORIES METALLURGISTS find that the high elastic stability needed in certain vibrating parts can be secured by suitable heat treatment. At the National Metal Congress, Chicago, M. E. FINE discussed this subject in a paper co-authored with W. C. ELLIS and entitled *Young's Modulus and Its Temperature Dependence in 36-52 Per Cent Nickel-Iron Alloys*. Mr. Fine gave another paper *Correlation Between Electrical and Thermal Conductivity in Nickel and Nickel Alloys*. Mr. Fine visited the Hawthorne Works of Western, to discuss metal problems. Mr. Ellis visited the Institute for the Study of Metals at the University of Chicago.

## RECENT DEATHS

JAY E. SHAFER, October 23.

In 1919 Mr. Shafer came to the Laboratories shortly after he had received the B.S. degree in physics from Pennsylvania State College. For his first eight years of Bell System service he was engaged in the research testing of magnetic



J. E. SHAFER  
1894-1950

FRANK FRASCA  
1878-1950

materials. He then transferred to Apparatus Development and brought his magnetic experience into switching apparatus design and development. During the rest of his career Mr. Shafer was a relay man, with the exception of the war years when he engaged in the design and development of airborne potentiometers.

His contributions to the relay field were notably in connection with polarized relays, electrolysis switches, various kinds of magnets used in switches, message registers and U and Y type relays. He was in charge of developing improvements in insulating and winding methods for coils used in switching apparatus.

Mr. Shafer was a contributor to the RECORD and an active member of Bell Laboratories Club, particularly the rifle club.

FRANK FRASCA, October 30.

At the time of his retirement in early 1943, Mr. Frasca had completed thirty years of service. He was hired as a repair machinist in the engine room of the West Street building. Shortly after, he transferred to Newark as mechanic on the first semi-mechanical central offices employing panel machine switching equipment and spent five years in the Mulberry, Waverly and Market offices. Following his return, he was in the engine room for the next five years and then transferred successively to the tool room, the Development Shop and the crystal laboratory of what was then Commercial Products Development where he engaged in cutting and grinding quartz crystals. At the time he retired he was a lathe mechanic in the Development Shop.



## Murray Hill Popular Orchestra

Thursday noon, October 26, witnessed the Murray Hill Popular Orchestra giving its fourth semi-annual half-hour shows before two full house groups of Murray Hill people. The theme was "Popular Songs of the Roaring Twenties."

Those responsible for the successful production of this show included: Ray Smith and Bill Suydam, lights; Art Akehurst, Charles Kennedy and Rudy Kennedy, projection; Joe Fisher, sound; George Eberhardt, recording; Dot Mason and Walter Hill, program and lettering. The orchestra music was provided by Henry LeCour, Ray Chegwidlen, Chick Wallschleger, Bert Kossman and John Potter, saxes; John DeFeo, Tony Presti and E. C. McDermott, trumpets; Larry Speck, U. A. Matson and Frank Crutchfield, trombones; Harry Geetlein, piano; Frank Dempsey, drums; and Ray Biazzo, bass and vibratarp. Others taking part were Adele Aboutok, torch singer; Dorothy Carlson, Jean Wilson and Mildred Read, "The Charleston" dancers; and Sylvia Anderson, Millie Lax, Virginia Curry, Elinor Brodhead and Doris Michel, majorettes.

## News Notes

J. R. TOWNSEND attended a meeting of the Ordnance Committee of the Research and Development Board in Washington. Mr. Townsend also visited Hawthorne with I. V. WILLIAMS, L. E. ABBOTT and J. R. BOETTLER to discuss materials substitutions, processes and welding problems. While in Chicago, Mr. Abbott attended a meeting of the American Welding Society and Mr. Boettler attended A.S.T.M. meetings on powder metallurgy.

J. B. HOWARD, H. PETERS and G. N. VACCA attended the convention of the Rubber Division of the American Chemical Society in October in Cleveland. A clipping in the *Cleveland, Ohio, Press* for October 11 notes "Better telephone service is promised by the rubber chemists . . . G. N. Vacca says the increasing use of neoprene, a synthetic rubber coating for outdoor wires, has already cut maintenance costs thirty-five per cent." Mr. Peters also conferred with engineers of Western Electric, General Tire and Rubber Company, and Dow Corning Company on rubber.

## WHY do they do it?

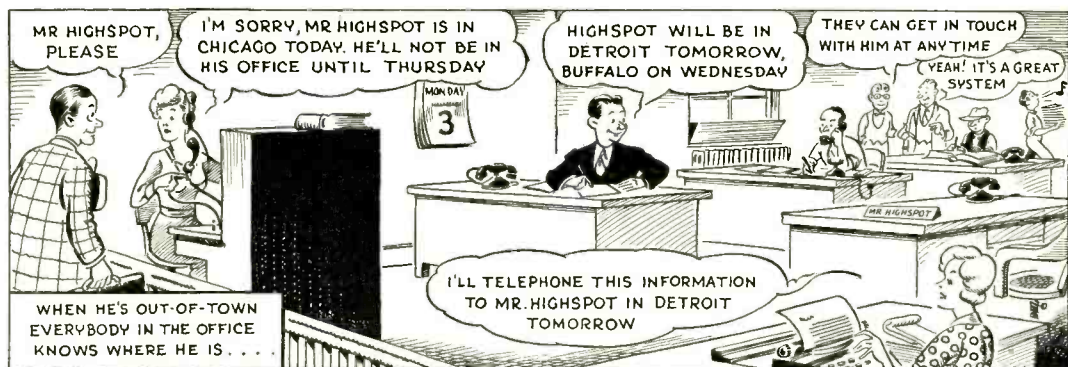

*IDEA! Whenever you leave your desk, tell someone where you are going and when you'll return.*



## Life Member Club Gathering

Most successful of the Pioneer Life Member Club meetings was the annual Fall social gathering held October 19 at West Street. Program for the day included talks by J. R. Reed, vice president of Association Section No. 10, and S. T. Cushing, Secretary of the Pioneers. Following a luncheon served in the Auditorium, C. W. Lowe and R. J. Fisher showed slides of various trips they have made, including Mr. Fisher's trip around the world. A PBX board operator was on hand to make calls for Life Members who wished to have friends drop in to visit in the Auditorium. H. A. Frederick, president of the Club, conducted the meeting for which R. H. Kreider made arrangements.

## News Notes

THE INCREASING importance of Quality Control in a defense economy was stressed during the Third Conference Series in Statistical Quality Control which is being held at Rutgers. E. B. FERRELL is one of the speakers during the series which is considering the basic

techniques of quality control applied to practical problems and organization of production.

A RELATIVELY NEW instrument for analyzing gases is the mass spectrometer. Operating by ionizing an unknown gas, the resultant ions produce photographic traces characteristic of the elements of which the gas is composed. Because of the newness of the instrument and the small number in existence, users of the device meet occasionally to discuss analytical procedures. E. E. FRANCOIS attended a meeting for this purpose at the duPont experimental station in Wilmington, Delaware.

RUBBERS AND PLASTICS—known to chemists as polymer solids—need to meet a wide range of requirements in the telephone system. In aerial cables, for example, polyethylene must withstand oscillatory motions set up by wind but as spacers for the central wire in coaxial cable, it is subject to steady strain. Interestingly, too, when a coaxial cable runs near steam pipes under city pavements, these spacers may also have to withstand elevated temperatures. Chemists are constantly on the lookout for ways to control the

## By Cassel in "Voiceways"

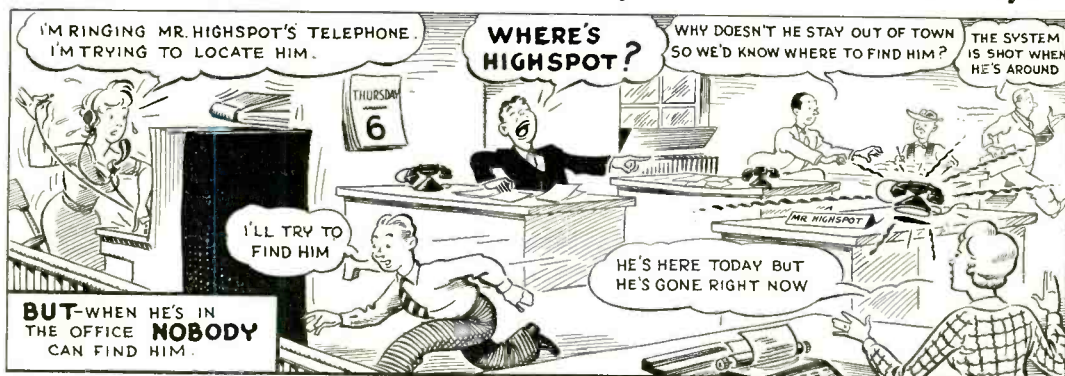

*It will speed up our telephone service and help to keep our customers happy!*

---

## “Telephone Hour”

NBC, Monday Nights, 9:00 p.m.

December 4	Ferruccio Tagliavini, <i>tenor</i>
December 11	Michael Rabin, <i>violinist</i>
December 18	Robert Casadesus, <i>pianist</i>
December 25	John Charles Thomas, <i>baritone</i>
January 1	Lucille Cummings, <i>contralto*</i>
January 8	Jussi Bjoerling, <i>tenor</i>
January 15	Lily Pons, <i>soprano</i>
January 22	Jascha Heifetz, <i>violinist</i>
January 29	Ezio Pinza, <i>basso</i>

\* From Carnegie Hall

---

molecular structure on which performance critically depends. W. O. BAKER explored this subject in his paper *Structure of Polymer Solids* given as one of the Akron Polymer Lectures at the University of Akron.

VARIATIONS in the hue, saturation and lightness of aluminum finish which pass unnoticed in individual units of equipment can greatly mar appearance when the units come together in a telephone office. Such variations can, however, be easily detected and controlled through optical techniques. W. J. KIERNAN went to Cleveland to hear lectures on this subject at the Optical Society of America's annual meeting.

THE RTMA (Radio and Television Manufacturers Association) sponsors standards for the industry. These standards are somewhat similar to the Joint Army-Navy (JAN) specifications that were introduced during the war to insure a definite quality of apparatus for electronic equipment built for the Armed Forces. As a member of a committee of RTMA composed of makers and users of capacitors, A. J. CHRISTOPHER attended a meeting in Syracuse to discuss standards for ceramic capacitors for transmitter applications.

TELEVISION PROGRAMS that originate in a stadium or other area of temporary use, require shielded cables running from the pick-up station to the permanent cable connection locations. A cable containing balanced and shielded pairs insulated with polyethylene is used for this purpose. The Point Breeze plant of the Western Electric has recently begun manufacture of this cable, formerly made in part by the Tonawanda plant. W. J. KING and D. R. BROBST visited Point Breeze to discuss manufacturing problems on the cable.

TANTALUM electrolytic capacitors (described in the RECORD, October, 1950, Page 448) provide large capacitance in a small space. Tantalum

replaces aluminum as the electrode metal, and this aids in a large measure to improve reliability of these capacitors. The Fansteel Metallurgical Corporation in North Chicago has recently begun large scale production for Bell System use. M. WHITEHEAD and B. M. BOWMAN visited that Company to discuss inspection procedures and manufacturing problems arising in the early stages of this work.

U. B. THOMAS discussed problems involved in the manufacture of the new calcium-lead battery with one of its suppliers, the Gould-National Batteries, Inc., Depew, New York. Mr. Thomas also attended the Fall Convention of the Electrochemical Society in Buffalo and presented a paper *Float Characteristics of Lead Batteries*. He was re-elected Secretary-Treasurer of the Battery Division, an office he has held since the Division was first organized in 1947. R. M. BURNS, Past President of the Electrochemical Society, W. BRADLEY and J. H. BOWER also attended the convention.

H. W. HERMANCIE visited central offices in Pittsburgh, Cincinnati, Cleveland, Chicago, and Buffalo, in connection with various maintenance problems involving base metal contacts as well as dust studies in connection with relay contact performance. C. W. MATTSON made trials of a proposed sequence switch cleaning technique in the Monroe Central Office of the Illinois Bell Telephone Company in Chicago.

APPEARING in the facing advertisement are JEAN KENNEDY of the Murray Hill library and R. P. SMITH of Station Apparatus Development.



### Engagements

- \*Priscilla Pecon—William Westphal
- \*Evelyn Selzer—\*Joseph J. Yurkovic
- \*Gloria Marcesca—Norman Janwich

### Weddings

- \*Evelyn Brady—Edward T. Wojoiechowski
- Marie Kellner—\*Howard J. Rohr
- \*Janet Marceau—Alexander Alleva
- \*Eleanor D. Maynard—Kenneth Spooner
- \*Stella Sparaecio—Nicholas Esposito
- Verna Spinelli—\*William F. Schollmeyer
- \*Members of the Laboratories. Notices of engagements and weddings should be given to Mrs. Helen McLoughlin, Section 11A, Extension 296.