



Exploring Magnetic Fields

By LILLIAN SHAPIRO
Transmission Development

IN SOME commonly used cathode ray tubes, the electron stream is guided by controlled magnetic fields. These fields may be produced by magnets or by current flowing through either an air-core or magnetic-core coil. Two fields at right angles to each other are frequently employed so that the electron stream may be swung to any point on the front of the tube by varying the relative strengths of the two fields. Ideally, these fields should be uniform and rectilinear, but actually such uniformity is rarely obtainable. Except along the axis of the field, the lines of force tend to be curved, and the intensity varies outward from the axis, but in differing degrees at various cross-sections.

The behavior of the electron stream under the influence of these fields will vary, depending on the distribution pattern of the field, and it is important, therefore, that the pattern be known. It may, of course, be calculated, but there are always too many small irregularities and uncertainties to permit a very exact calculation of the distribution. It is usually preferable to measure the direction and strength of the field at a large number of points. Plots of the field at various cross-sections could then be made, and a complete three-dimensional picture of the distribution obtained. Since the total cross-sectional area of the effective part of field is small, often being under 2 inches in diameter,

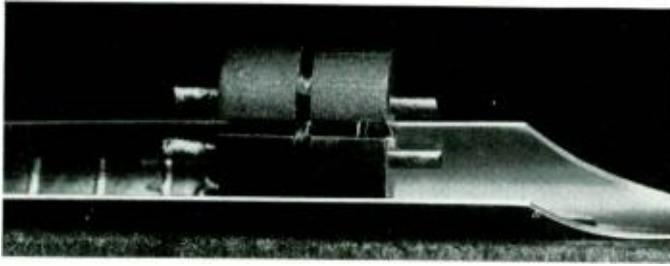

Fig. 1—Micro-coil mandrel used in measurements

it is difficult to secure a large number of accurate readings of field strength.

When constant (or d-c) fields are used, such as would be induced by a magnet or d-c current through a winding, an obvious way to measure the field strength would be to use a very small coil of wire that could be rotated at a high speed. The voltage induced in such a coil is proportional to the number of turns it includes, the area of the winding, the speed of rotation, and the field strength, and since the former three factors are known, the field strength may be evaluated. Although this procedure is practical, attempts to produce a coil that can be rotated and still be small enough to give a reading at what is essentially a point, met with somewhat limiting mechanical difficulties.

In measuring a-c fields, the mechanical problem is much less severe. The search coil can be stationary, since an alternating field will induce a voltage in it, the voltage being, within limits, directly proportional to the frequency. This voltage will be greatest when the plane of the coil is at right angles to the flux, and will be zero when the plane of the coil is in line with the flux. If the coil could be turned in any direction, it would be possible to determine both the direction and intensity of the field at any point.

With such a coil and suitable auxiliary apparatus, the distribution pattern of the field could be determined in either of two ways: by a polar determination that measures the strength and direction of the field at each of a large number of points throughout the volume concerned; or by a Cartesian determination that at each of the points determines the strength of the field in each of three directions at right angles to each other, that is, along the x, y, and z axes.

Both are used, but the latter is more convenient. The z axis is taken as the axis of the cathode ray tube, while the x and y axes are transverse.

The exploring coils must be exceedingly small so that the field measured will essentially be that at a point and yet have a sufficient number of turns to induce a measurable e.m.f. A special winding machine and technique were developed to produce them. Two coils with the axis of one at right angle to that of the other are wound on a common mandrel.

This assembly, with an outside diameter of only about one-fifth inch, is slipped into the end of a very thin walled plastic search tube in such a way that one of the coils is concentric with the tube. As this search tube is moved along the axis of the tube, this latter coil will always be in position to measure the component of the flux along the z axis, while the other coil may be used to measure the components along the other two axes, turning the tube first so that the coil is perpendicular to the x axis and then turning it 90 degrees to bring it perpendicular to the y axis.

Since such a search tube cannot actually be inserted in a cathode ray tube, exactly equivalent conditions are simulated by

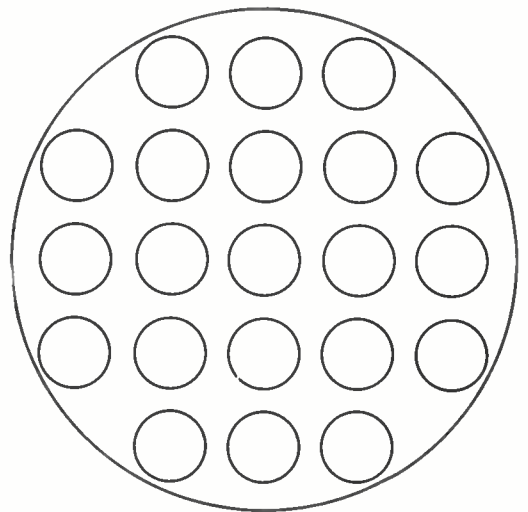

Fig. 2—Cross-section of plastic cylinder

using a solid plastic cylinder with an outside diameter the same as the cylindrical section of the cathode ray tube. This plastic cylinder is accurately drilled longitudinally with twenty-one holes as indicated in Figure 2. It is then slipped inside the deflection assembly of the cathode ray tube just as the tube itself would be. The magnetic fields set up in the plastic cylinder are thus exactly the same as those in a cathode ray tube when the same deflection assembly is used.

The search tube carrying the exploring coils is inserted successively in the twenty-one holes of the cylinder, and a number of readings is taken in each so as to record the field at successive positions along the length of the tube. At each position, a reading on the coil that is concentric with the tube gives the z component of the field. Readings of the x and y components are made with the transverse coil, which may be rotated to any desired position merely by turning the tube. On the end of the tube remote from the exploring coils, there is a protractor from which the x and y axes may be determined.

One of the holes in the plastic block is exactly down the center as indicated in Figure 2. The maximum field in this hole is usually rectilinear, with a component along one axis only, and is generally opposite the center of the windings inducing the field under measurement. The ordinary procedure is to take the first reading at this point. The direction of this field, which may be considered as along the x axis, is determined by turning the transverse exploring coil until a null reading is obtained, and the angular position of this null reading is determined from the dial. This represents the y axis, and ninety degrees from this position is the x axis. This determines the angular positions on the dial for the x and y axes, which will be used for all subsequent readings. The transverse exploring coil is then turned to be at right angles to the x axis so as to obtain a reading of the maximum field. All other readings can then be given as a percentage of this maximum which may ultimately be calibrated for actual field strength.

After the maximum field at the center has been determined, the coil is moved along the z axis in the same hole, and readings taken of all three components at short

intervals. Where the field strength is changing rapidly, readings may be made at intervals as small as .05 inch, distance being read on the graduated brass rod that carries the search tube. Farther out from the center, where the field is weaker and is changing less rapidly, the distance between readings may be increased. Similar sets of readings can then be taken throughout the length of the remaining twenty holes.

The field distribution of electro-magnets normally using a d-c field can be closely approximated by measuring the field resulting from a low-frequency alternating current. Also with some permanent magnet assemblies an equivalent electro-magnet system can be readily assembled and measured with an a-c drive. A frequency of about 200 cycles is ordinarily used. Sometimes a lower frequency is desirable. The sensitivity of the search coil is the limiting factor.

To obtain a satisfactory set of readings, all factors must be accurately controlled. Not only must the holes in the test block be accurately drilled, but the oscillator must be held at a constant frequency to very close limits, since the voltage generated in the search coils varies directly with frequency. The detector must be sensitive enough to record the minute signals, and at the same time be insensitive to noise pick-up. A number of mechanical and electrical difficulties have yet to be completely overcome, but with the present equipment, comprehensive field data have been secured for a number of deflection systems.

THE AUTHOR: LILLIAN SHAPIRO received the B.A. degree from Brooklyn College in 1942, and after a year and a half with Federal Telephone and Radio joined the High Frequency Engineering Department of these Laboratories. Here her work, besides that described in this article, has been chiefly on secret war projects. Since coming to the Laboratories, she has taken



courses in radio and in engineering at Brooklyn Polytechnic and at New York University.



Scratch Adhesion and Mar Testing of Organic Finishes

By R. J. PHAIR
Chemical Laboratories

TO FUNCTION satisfactorily as a protective medium, an organic finish must adhere firmly to the base to which it is applied. If the coating is also to serve a decorative function it must be tough enough to resist marring during production handling and service life. Rough estimates of the adhesional level and the mar resistance of a finish can be made with the finger nail or a knife, but more dependable methods have to be used when quantitative results are required.

With a machine made by the Laboratories, the adhesion of paint films is evaluated by pushing them beneath a rounded stylus mounted in a pivoted beam which is loaded increasingly until the film is stripped from its base or resists five kilograms. Determination of mar resistance is made by substituting a phonograph needle for the stylus and drawing the finish repeatedly

beneath it, each successive time with increasing load, until the upper surface of the film is ruptured. Much of the operating technique is common to both determinations and the following discussion of the adhesion test applies to mar resistance evaluation with the few differences mentioned.

For these tests, finishing materials are usually applied to panels from $\frac{1}{2}$ " x 2" to $4\frac{1}{2}$ " x 6" in surface area and from $\frac{1}{32}$ " to $\frac{1}{2}$ " thick. After aging, the specimens are conditioned for at least twenty-four hours at 77 degrees F. and 50 per cent relative humidity prior to testing under these same temperature and humidity conditions.

The testing machine is levelled by the set screws in its base, with the movable table directly in front of the operator. This puts the balance arm release at his right and permits moving the finish specimens readily under the scratching tool. After this

tool has been mounted in its holder, which is set at 45 degrees to the horizontal, the balance arm is adjusted to a level position when the tool is in contact with the finish specimen. The adjustment is made by raising or lowering the entire pivot assembly at the main support column. Before weights are placed on the platform, the arm is raised and locked.

The stylus for scratch-adhesion determinations, Figure 1, is made of 0.0625-in. drill rod carefully bent to give a 0.256-in. outside diameter. After bending, the steel is hardened, highly buffed, and chromium plated. It is checked after each five hundred operations and replaced, if any change in surface condition has occurred.

In measuring scratch-adhesion levels, the movable table, which slides on a ball bearing support, is drawn toward the operator. The panel is then placed in position beneath the stylus and a minimum load of 0.5 kilogram is put on the balance platform. The arm is cautiously lowered until the stylus makes contact with the finish, which is then pushed with a slow steady pressure away from the operator. The balance arm is again locked in its raised position. This procedure is repeated with 0.5 kilogram increases in load until the film is removed and the base surface exposed or until the maximum load of 5 kilograms has been attained. The panel is moved slightly to the side after each passage to bring a new section of the finish under the scratching tool.

The term "scratch-adhesion" is employed to define the minimum load in kilograms which causes removal of the film rather than the unmodified word "adhesion" because the property measured is associated with and influenced by the cohesion and plasticity of the coating as well as its adhesion to the

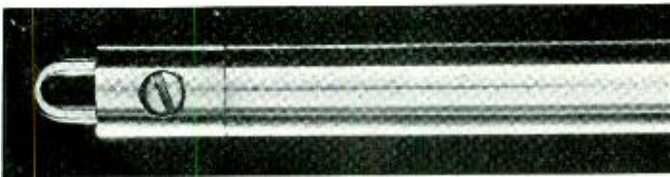

Fig. 1—The stylus with which the adhesion of finishes to their backing is tested is highly polished chromium-plated drill rod. It is made of 0.0625-in. stock and its outside diameter is 0.256 ± 0.004 inch

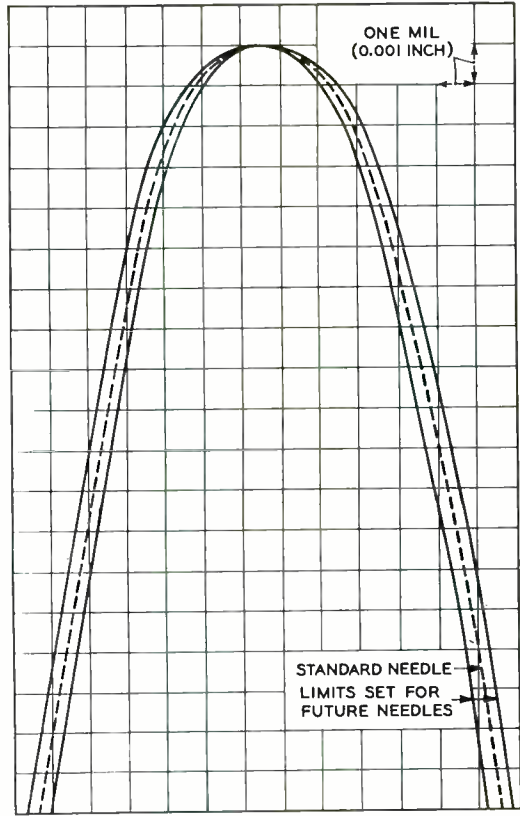

Fig. 2—Shadowgraphs of the needle used in mar tests have to come within specified limits

base. Failures may result from poor adhesion between the paint and its base, which causes them to separate; deformation of the film by the scratching head to such an extent that the film flows away completely from under it, thus exposing the base; or poor cohesion of the film, which makes it disintegrate by powdering or crumbling under the stylus. The value obtained with the instrument is, therefore, the sum of all these effects but in

most cases, since the cohesive level is fairly high and plasticity is minimized, the results are considered as adhesion levels. Numerical values from 0 to 1,000 grams are usually interpreted as poor; from 1,500 to 2,500 grams as fair; 3,000 to 4,000 grams as good; 4,500 to 5,000 grams as very good and above 5,000 grams as excellent.

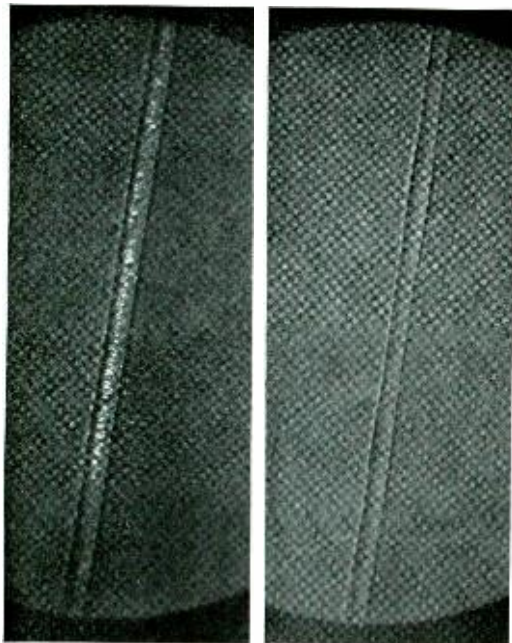

Fig. 3—When illuminated along its length and viewed under a microscope, the deepest section of a mar scatters light where failure has occurred, as shown at the left. A magnified depression-scar which has not penetrated the finish is shown at the right

In mar testing, the rounded tool is replaced by a chromium-plated needle. Shadowgraphs of the needles selected for the test have to come within the dimensional limits shown by the curves of Figure 2. They are also checked before use by comparing the mar they make on the surface of a sample finish with that of a standard needle. Only those which give the same results as the standard are selected.

The procedure differs from that employed in adhesion testing in that the panel is drawn toward rather than away from the operator; a 50-gram minimum load with 50-gram increment increases is used; and the

end point is reached when the upper surface of the paint film has been ruptured.

A breakdown point is distinguished from depressions in the finish by holding the marred specimen nearly at eye level in flat lighting so that no highlight reflections are visible. The least weight required to make a line which shows a distinct whitish reflection from the subsurface of the finish, but not from the base, is the mar value. Care is taken to avoid reflections from the side walls of depressions in the finish which are not cut through.

The mar point can also be observed by inspecting the marks under a microscope of 80 to 100 power. The deepest section of a depression will scatter the light where marring has occurred, as is shown at the left in Figure 3, if it is illuminated along its length and at an angle of about twenty degrees from the plane of the specimen. The appearance of a depression mark without marring is illustrated at the right in Figure 3. Mar values of 200 grams or more are usually indicative of sufficient resistance to withstand the scarring actions encountered in normal assembly of telephone apparatus.

THE AUTHOR: R. J. PHAIR graduated from the Newark College of Engineering in 1943 with the



B.S. degree in Chemical Engineering. During the previous eight years, he attended night school with this goal in mind. Mr. Phair entered the Laboratories in 1928 as a messenger. Later he did drafting before joining the Chemical Research Department in 1938 to work on organic finishing

problems which has included contributions to the development and refinement of finish-testing instruments and test methods.

Reflex Oscillators

By J. R. PIERCE
Electronic Apparatus Development

IN ELECTRONIC apparatus operating at very high frequencies, the usual negative-grid triodes, tetrodes and pentodes are often replaced by vacuum tubes in which the transit time of electrons plays a basic rôle. Such devices have rapidly come into extensive use to meet the needs of war for ever higher frequencies. Their general principles of operation have been known for some time; one long-transit-time device, the Barkhausen oscillator, has been described in the RECORD.* During the war, the Laboratories have made available for military use several types of long-transit-time tubes called reflex oscillators. In certain applications these have a number of electrical and mechanical advantages over other somewhat similar devices.

In its basic principle of operation, the reflex oscillator is simple. Consider first the arrangement shown in Figure 1. The electrodes are assumed to be enclosed in a highly evacuated container as with a conventional triode, but the grid is positive with respect to the cathode, and the repeller, which corresponds to the plate, is negative. Electrons leaving the cathode in a steady stream will be accelerated by the grid. Some of them will be stopped by it, but others will con-

tinue through its meshes and proceed toward the repeller. Since the repeller is negative with respect to the grid, however, all of the electrons that pass through the grid will be turned back before they reach it, and will stream back steadily and pass through the grid in the opposite direction. In both directions, the flow of electrons will be uniform,

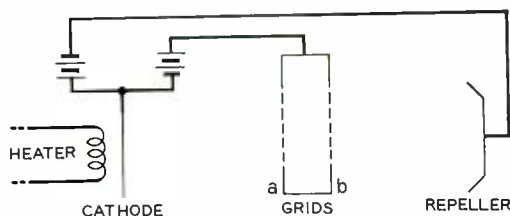

Fig. 2—With two grids arranged as a closed box, the action of the complete double grid is the same as that of the single grid of Figure 1, but between the two grids A and B, the velocity of the electron will be increased or decreased in accordance with the radio frequency field between them, and the electrons will thus pass toward the repeller with varying velocities

and the electrons will continuously take energy from the circuit as they approach the positive grid from either direction and will give energy to the circuit as they depart from it.

Now suppose that this grid is replaced by two grids set into the top and bottom of a metal pillbox, as indicated in Figure 2. Electric current flowing around such a closed "cavity" or "resonator" produces an electric field between the grids, and yet there will be no field whatever outside of the resonator. The principle of such resonators is very simple. The two grids may be thought of as part of the capacitance of a resonant circuit, and the annular connection between them made through the walls of the pillbox, which act as a single turn coil, provides the inductance. When such a

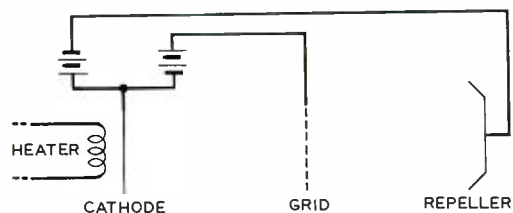

Fig. 1—In an ordinary triode, the plate is positive and attracts electrons that pass through the grid, which is usually negative. If the plate is made negative and the grid positive as above, electrons will be accelerated by the grid but will be repelled by the negative plate, which may thus be called a repeller

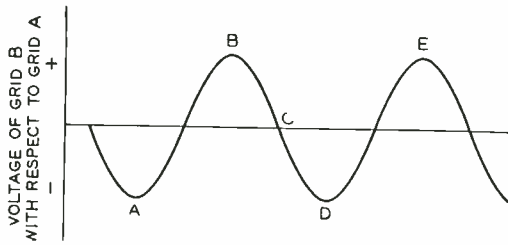

Fig. 3—Radio frequency voltage between grids a and b of Figure 2. During the interval from A to B, the electrons are being increasingly accelerated, and during period B to D, increasingly retarded

resonator is used, the action of the radio frequency field on the electron stream in the tube is confined to the short space between the two grids.

In the structure shown in Figure 2, the accelerating effect between the cathode and grid, a, and the retarding effect between grid, b, and the repeller are the same as in the cathode-grid and grid-repeller regions of the arrangement shown in Figure 1. In the space between the two grids, however, the oscillating electric field affects the electrons. The grids are closely spaced so that the time of passage of an electron from one to the other is a small fraction of a period of oscillation. Depending on its direction at the moment, the field will be accelerating or decelerating, and thus successive groups of electrons will be alternately speeded up and slowed down. As a result of this action of the field between the grids, the electron stream is velocity modulated, and electrons pass into the drift space between grid b and the repeller with different velocities, depending on the time in the oscillating cycle at which they pass through the field between the grids. Because of this, the period during which the electrons will remain in the drift space will vary for different electrons.

This action can be likened to that of a man standing on the ground and throwing balls vertically upward. In such a

situation, the force of gravity corresponds to the opposing force of the repeller. Balls thrown upward with a high velocity will require a longer time to return to the ground than those thrown with a small velocity. If a series of balls were thrown up at one-second intervals, but with steadily increasing velocities, they would return to the ground more than one second apart, while if the balls were thrown with steadily decreasing velocities, the times of their return to the earth would be closer together than one second. By properly selecting a series of decreasing velocities, a whole series of balls thrown up at regularly spaced intervals could be made all to return to the ground at exactly the same time.

With the oscillating electric field of Figure 2, these two effects alternate. Those electrons passing through the grid space during the interval A to B of Figure 3 will be spaced farther apart when they return to the grid because of the increasing velocities with which they left it, while those passing through the grid space during the interval B to D will be bunched closer together on returning. The electrons returning to the grid of the tube will thus alternately be bunched and dispersed.

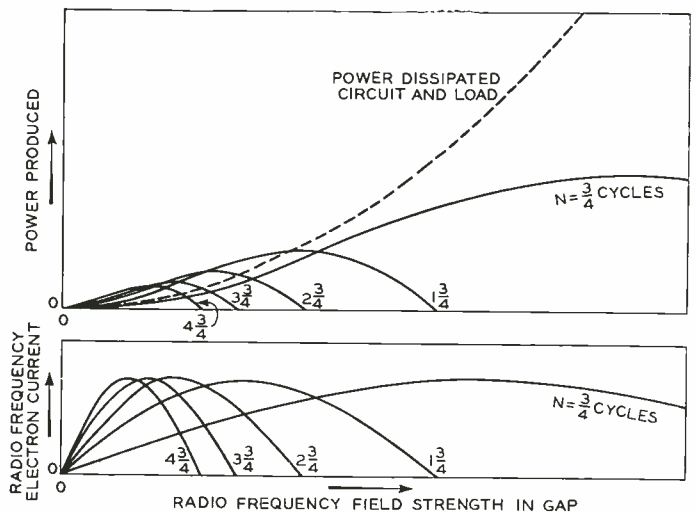

Fig. 4 (below)—Relationship between radio frequency field strength in gap and radio frequency current for repeller voltages giving drift times of $\frac{3}{4}$, $1\frac{3}{4}$, $2\frac{3}{4}$, $3\frac{3}{4}$, and $4\frac{3}{4}$ cycles
Fig. 5 (above)—Relationship between radio frequency field strength and output power for the same repeller voltages as in Figure 4

As the electrons pass through the grid space on their return journey, they will give energy to the oscillating circuit or absorb energy from it, depending on whether the electric field at that moment opposes or assists the electron stream, and the amount of energy transferred will depend on the density of the electron stream and on the strength of the field. If the circuit conditions are so arranged that during the brief interval while a returning bunch of electrons is passing through the grid space, the field is a maximum in the opposing direction, a comparatively large amount of energy will be absorbed from the bunched electrons, far more than is transferred to electrons over the scattered section of the returning stream. As a result, pulses of energy are conveyed to the circuit at the oscillating frequency.

To have the bunches pass through the field when the field is maximum opposing, the interval between the instant an electron leaves the grids and that at which it reaches them on its return trip should be $n + \frac{3}{4}$ cycles of the oscillating frequency, where n is any integer including zero. This may be seen from Figure 3. Since bunching occurs over the region B to D , the leaving time for the center of the bunch can be taken as point c . Returning electrons will encounter an opposing field whenever grid b is positive relative to grid a , and thus during the upper half-cycles of Figure 3, and the maximum opposing field is at the tops of these half-cycles. If the electron bunch repassed through the field at point E , therefore, or at any succeeding positive peak, it would encounter maximum opposing field. The interval from c to E , however, is $\frac{3}{4}$ cycle; that to the next positive peak is $1 + \frac{3}{4}$, and so on. For point E , the n in the above expression is zero. For the next positive peak, it is 1, and so on. This drift time of the electrons, from grid b toward the repeller and back, depends on the voltage of the repeller, and may be adjusted as desired.

The degree of bunching depends in turn both on the voltage of the repeller and on the strength of the accelerating field between the grids. With the repeller voltage set to give a drift time of $1 + \frac{3}{4}$ cycle, for example, the degree of bunching will first increase as the field strength is increased, will reach a maximum at some particular value,

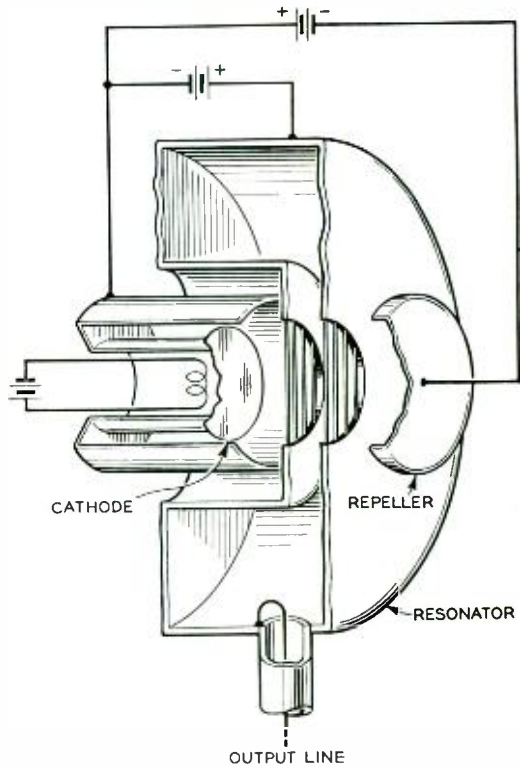

Fig. 6—Cross-section of internal structure

and then will decrease because of an effect that may be called "over-bunching." Returning to the analogy of the ball-thrower, when a sequence of balls is thrown upward with decreasing velocities, the first being thrown at the greatest velocity and the last at the least, it is obvious that if one particular velocity is given to the first ball, it will return to the ground at the same time as the last. If the first ball were thrown at a lower velocity, it would return before the last ball, and full bunching would not have been obtained. If, on the other hand, the first ball were thrown at a greater velocity, it would not return until after the last one, and again bunching would not be a maximum; "over-bunching" would occur.

This situation as applied to the reflex oscillator is illustrated by the curves of Figure 4. Here, distance along the abscissa represents the voltage between grids A and B , that is, the strength of the electric field between the grids times the distance between them, and that along the ordinate represents the degree of bunching, which

may also be referred to as the strength of the electron current, since greater bunching, representing a greater concentration of electrons, corresponds to a greater current. Each curve represents the relationship for one repeller voltage selected to give an optimum drift time such as $\frac{3}{4}$ cycle, $1 + \frac{3}{4}$ cycle, and so on up to $4 + \frac{3}{4}$ cycles. All the curves rise to the same maximum value since the maximum bunching is the same for all drift times, but the field or voltage required to produce maximum bunching decreases as the drift time increases. The power transferred from the electron stream to the circuit is proportional to the product of current and voltage. As the current changes slowly with voltage near the current maximum, maximum power will not occur at maximum current but at a voltage a little higher than that giving maximum bunching. Power will be greater for shorter drift times, since the voltage to produce maximum power is greater for shorter drift times and the current is the same. The solid curves of Figure 5 represent power.

Power may be taken from the oscillating circuit by means of a coil coupling the magnetic field of the resonator of Figure 2. Part of the power will be absorbed by the load connected to this coupled coil, and part will be absorbed by the losses in the resonator itself. The total power dissipated in load and resonator is proportional to the square of the voltage between the grids. For any given set of conditions, therefore, the total power could be represented by the dashed curve of Figure 5.

Steady oscillation will take place at points where the dashed curve crosses a solid curve, since at these points the output just equals the input. Maximum power will be obtained when this intersection is at the peak of one of the curves. For the conditions shown, the dashed curve never crosses the curve for $\frac{3}{4}$ -cycle drift time, which means that with the load and circuit losses represented by the dashed curve, the tube would not oscillate with a repeller voltage giving a drift time of only $\frac{3}{4}$ cycle.

An important characteristic of the reflex oscillator is the electronic tuning of which it is capable. With a drift time of $n + \frac{3}{4}$ cycle, the current is in direct opposition to the electric field between the grids, and thus

the effect of the electron stream can be regarded as a negative conductance shunted across the resonator. If now the repeller voltage is changed so that the drift time is no longer exactly $n + \frac{3}{4}$ cycle, the radio frequency current is no longer in exact phase opposition to the radio frequency voltage. The electron stream no longer produces a pure negative conductance, but rather an admittance, with a susceptance as well as a negative conductance. The susceptance tends to alter the frequency of oscillation just as would a capacitance or inductance connected across the resonator. Thus, if the repeller voltage is changed, the frequency of oscillation is also changed.

Figure 2, used to explain the operation of the reflex oscillator, is in a highly schematized form. The actual oscillators are constructed more as shown in Figure 6. The resonator or resonant circuit, shown as a flat pillbox in Figure 2, is actually a re-entrant metal anulus of the form shown in Figure 6, and the grids are stretched across circular openings in the centers of the opposite faces. At one point on the periphery of the anulus, a copper tube is connected that serves as the outer surface of a concentric conductor. The central conductor is connected to the anulus at the point where the tube is fastened, makes a single loop inside the anulus, which links the magnetic field, and then passes through the tube. It is by coupling to this loop that the output power is obtained. The actual proportioning and arrangements of the various elements, and the type of containers, vary with the particular use to which the tube is to be put.

THE AUTHOR: J. R. PIERCE received the B.S. degree from California Institute of Technology in 1933, and continuing his studies there, received his Ph.D. in 1936. He then joined the Technical Staff of Bell Telephone Laboratories where he has been engaged in the development of electronic devices—in recent years primarily to meet the needs of apparatus for our armed services.





To Leipzig and Back

By A. J. BORER

LATE last year an equipment on which I had been working was accepted by the Army and was shipped overseas for service trials. So on December 29, 1944, after the usual "processing," I boarded a commercial transport plane at La Guardia Field which flew non-stop to Foynes, Ireland; a connecting plane brought me to London less than twenty-four hours after leaving New York. When the equipment was unpacked and set up it functioned perfectly; the next month I spent in demonstrating it to Army officers, American and British, and in training enlisted men in operation and maintenance. During this time I lived at a hotel in a small town and had first-hand experience with the British food shortage. Compared to that, our current shortages are the acme of luxury; a portion of mutton, the Briton's staple, was hardly enough for a thin sandwich.

By the end of January, we—the equipment, the GI's, and I—started for France. Southampton, where we embarked on an LST, was badly battered, but the two miles in to Le Havre from our landing point were

desolation itself. Not a building along the road was habitable—in fact, there wasn't a building left—just piles of stones. From Le Havre, we went forward to Supreme Headquarters at Rheims, where a test showed that the equipment needed no re-adjustment after its long truck haul. Then we moved forward to an operating position and I left the equipment and the Army to get acquainted with each other. A second equipment had arrived in England and I was to bring it back with me. However, a tricky case of trouble recalled me in a hurry, so I had the rare pleasure—with some misgivings—of flying from London to Rheims in the plexiglas nose of a bomber. My companion was a pathfinder pilot and he told me quite a lot about the details of his art, with plenty of examples below us to point out.

The trouble was soon cleared, and I made a quick trip to Paris. On the return to the front we passed through Liege; soon darkness overtook us, but we pushed on, hoping to reach Bruhl. An M.P. at Duren told us the road was not under observation so we

might use our lights. A few miles farther, we were waved down by another M.P. who inquired, with the usual M.P. embellishments, how we would like to stop a Kraut shell around the next turn. The road came out from behind a hill, and had been well registered by artillery from across the Rhine. Driving in fog and rain with blackout lights was impossible, so we turned around and went back to Duren. The next morning we drove on to Bruhl, where my headquarters were to be. We were issued a nice soft floor to spread our bedding rolls, but we were not told of a battery of 155's in the back yard. Just as I was dropping off to sleep that night, they fired a salvo and if I hadn't been well rolled in, I would probably have hit the ceiling. You can imagine how much we slept the rest of the night.

Our equipment was attached to a Corps headquarters of General Hodges' army and so I was a part of the drive south of the Ruhr pocket and then through Kassel, Göttingen, Naumburg and so into Leipzig. German soldiers were still scattered through the countryside and were coming in or being brought in by our troops constantly. One of them was a pathetic figure—a 13-year-old boy who was unarmed and had nothing in his haversack but a couple of crusts of bread. Nobody paid much attention to single unarmed men and this lad walked right up to Headquarters to surrender. The mess sergeant gave him a couple of big sandwiches and I interrogated him; his home was in nearby Naumburg and he had been put into the army with no training.

For a while we were in Nordhausen, site of one of the atrocity camps, but on the advice of the soldiers who had seen it, I stayed away. Our equipment excited keen interest, and the few instruction books I had were in great demand. One of the visitors was Major Hitch of British Army Ordnance, who had been stationed at the Laboratories; he spoke highly of the M-9 Electrical Gun Director. Incidentally, I saw practically no enemy aircraft all the time I was in Germany. One interesting bit I picked up was the story that in 1941 the Germans decided their technology was

ample to win the war, so they disbanded most of their research groups and put the personnel into the army. When they began to capture American equipment in 1944, they realized that they had been outstripped and hurriedly began to reactivate their laboratories.

With the war over, my job was ended and I had a week's "goof-off" in Paris while awaiting transportation home. During that time I met D. B. Parkinson, of the Murray Hill laboratories, and spent an evening talking shop with him. On May 2 I left Paris on an Army Transport Corps plane and after a day's layover in the Azores reached New York on May 4.

Security does not permit me to tell the nature of the equipment, nor any of the interesting experiences I had with it. However, it is possible to say that it did all we expected of it; and since the Army has ordered a number of them, I can end this with "mission accomplished."

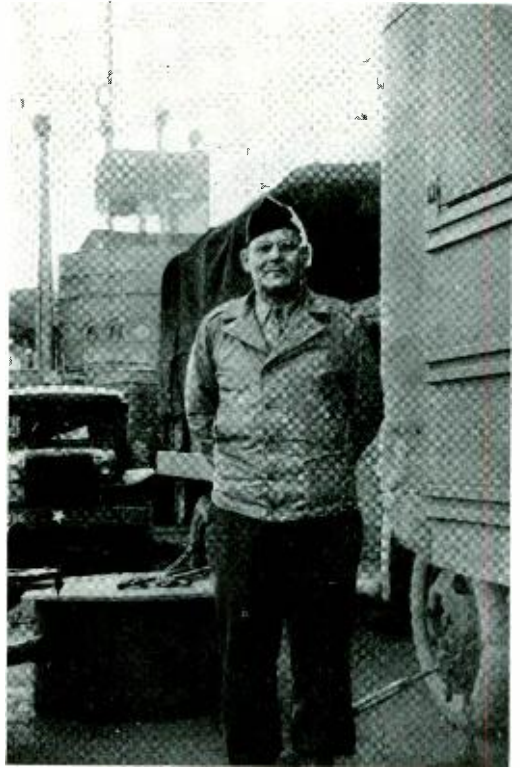

A. J. Borer on an LST crossing the Channel

A T & T Announces Plans for Two-Way Vehicular Telephone Service

PLANs for a general mobile radio-telephone service which would bring the advantages of two-way voice communication to drivers of motor vehicles were announced recently by the American Telephone and Telegraph Company. Applications have been filed with the Federal Communications Commission for authority to install radio-telephone stations in the following cities: Baltimore, Chicago, Cincinnati, Columbus, Denver, Houston, Milwaukee, New York, Philadelphia, Pittsburgh, St. Louis, Salt Lake City and Washington, D. C.

In addition, surveys are being made to determine the need for and the feasibility of mobile radio-telephone service in many other cities of the country, including Akron, Atlanta, Beaumont, Birmingham, Boston, Cleveland, Dallas, Dayton, Des Moines, Detroit, Fort Worth, Green Bay, Indianapolis, Kansas City, Little Rock, Los Angeles, Louisville, Memphis, Miami, Nashville,

Newark, New Orleans, Oklahoma City, Portland, Ore., Providence, San Antonio, San Francisco, Seattle, Toledo, Tulsa and Wichita. The Bell System companies plan to make the new service available first in cities where public necessity is greatest.

Telephones on automobiles, trucks or other mobile units such as boats and barges will be connected with the general telephone system, so that a subscriber to the general two-way mobile service can talk from an equipped vehicle to any one of the millions of telephones served directly by or connected with the Bell System. Likewise, the occupant of an equipped vehicle can be called from any one of the millions of telephones.

In general, here's how mobile radio-telephone service is expected to work in cities:

Calls to and from motor vehicles will be handled by special operators. The conversation will travel part of the way by telephone

PROPOSED VEHICULAR TELEPHONE SERVICE IN CITIES

The customer (1) asks to be connected with mobile service. His call goes through the local telephone office (2) and on to the control terminal (3) where a special operator signals the vehicle he wants (4) by radio. The driver answers, his voice traveling by radio to the nearest receiver (5), thence by telephone wires, via the control terminal (3) and the local telephone office (2) to the customer's telephone (1). If the vehicle had been in the vicinity of another receiver (6) when called, the driver's answer would have traveled through the dotted telephone line to the control terminal (3). Large cities will be served by a number of these

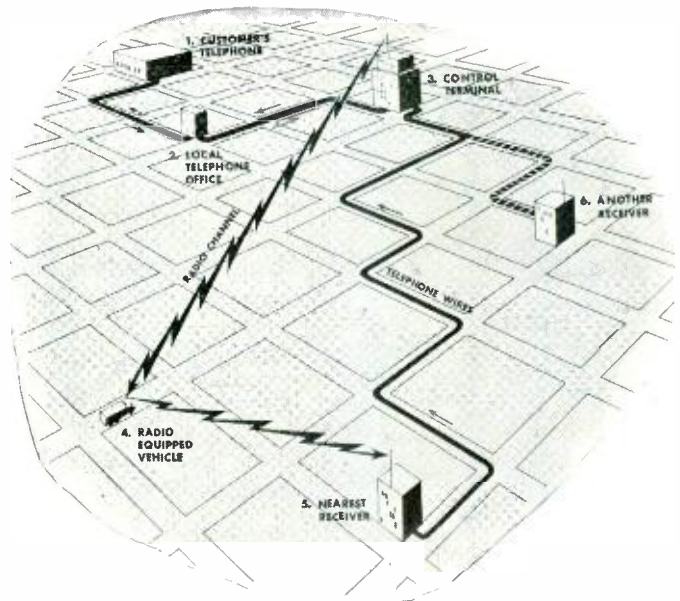

receivers to pick up the signals of the relatively low-powered sets on vehicles.

PROPOSED TWO-WAY VEHICULAR TELEPHONE SERVICE FOR THE MORE IMPORTANT INTER-CITY HIGHWAYS

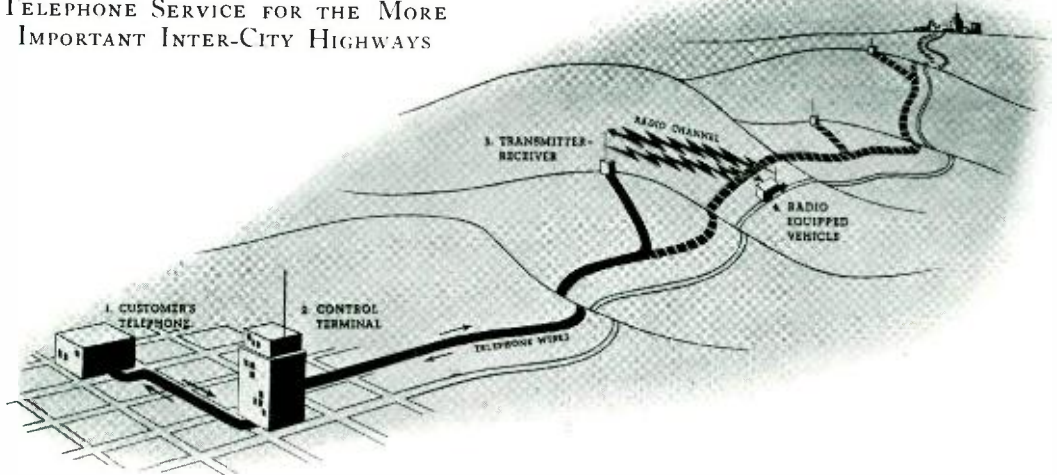

A customer (1) asks to be connected with mobile service. The special operator at the control terminal (2) routes the call over telephone wires to the transmitting-receiving station (3) which sends the signal on to the vehicle (4) by radio. A call originating at the vehicle would follow the same route in reverse. If the vehicle were beyond the range of the transmitter-receiver (3), the operator at the control terminal (2) would try the other transmitting-receiving stations farther down the highway until the driver answered the signal

wire and part of the way by radio. If a caller at his desk wants to talk to the occupant of a certain automobile, he first dials or asks for the vehicular operator. He gives her the call number or designation of the vehicle. She sends out a signal on the proper radio channel by dialing the code number assigned to that particular vehicle. An audible or visual signal indicates to the car occupant that he is wanted. He picks up his dashboard telephone and the conversation starts. Under his fingers as he holds the telephone handset is a "push-to-talk" button which permits him to switch at will from receiving to sending.

The operator of a mobile unit can originate calls merely by picking up his telephone and pushing the "talk" button. This signals the vehicular operator and she "comes in on the line." He gives her the telephone number he wants and the call goes through as usual.

In large metropolitan centers it is probable that a number of fixed receiving stations will be employed, located throughout the area so that the relatively low-powered mobile radio sets will be within range at all times. The receiver nearest to the mobile

unit will pick up the voice signals and send them on their way by telephone wire. It is planned also to have more than one transmitter in order to give full coverage.

For years the Bell companies have furnished two-way radio-telephone service for coastal and harbor boats, ship-to-shore service for ocean-going vessels and also shipping on the Great Lakes and inland waterways. A limited two-way vehicular service has for some time been provided in New York and Boston for emergency use by certain public utilities companies.

Urban mobile service will operate as separate radio-telephone systems for each metropolitan area served. A metropolitan system will be arranged to serve not only cars, trucks, buses and harbor and river craft operating within the area, but also other mobile units such as trolley cars, elevated trains and railway engines operating within the metropolitan area.

Preliminary surveys in a large number of cities indicate that mobile service will be used initially by business concerns or individuals operating vehicles or other mobile units within metropolitan areas where it is important that headquarters keep in touch

with their various drivers or vice versa. The list includes:

Ambulance services, armored car services, burglar and fire alarm services, construction contractors, doctors, express companies, food distributors (meat packers, dairies, bakeries, etc.), newspapers, oil companies, pick-up and delivery services serving department stores and other retail establishments, public service companies (electric light and power, gas, water, steam, transportation and communication), refrigerator services, taxicab companies, trucking companies, boats in adjacent rivers and harbors, and railroad switch engines.

Three classes of mobile service are contemplated:

1. A general two-way telephone service between any regular telephone and any mobile unit, with a three-minute initial period and the usual one-minute overtime period.

2. A special two-way dispatch service between a particular telephone at the dispatching office and specified mobile units. A direct line from the dispatcher to the telephone central office would be furnished as part of this service. A one-minute initial period and the usual one-minute overtime period would probably apply here.

3. A one-way signaling service to mobile units, to notify the operator of the unit that he should comply with some prearranged instruction, such as calling his office from the nearest public telephone.

Radio signals in the frequency range between 152 and 162 megacycles have been assigned for the urban mobile service. In general, transmission of these frequencies is greatly improved by mounting transmitting

and receiving antennas on high buildings or on other commanding elevations.

The Bell System plan is to use transmitters of about 250-watt power in the metropolitan centers. The mobile units will have power of about 15 watts. Each mobile unit will use a single antenna for both sending and receiving.

Another type of mobile radio-telephone service which will be tried would furnish two-way voice communications to motor vehicles operating on intercity highways and to boats on adjacent waterways. This service would require transmitting and receiving stations along the highways to be served. The mobile units would be equipped for receiving and sending, and with signaling equipment similar to that to be used for urban service.

In addition to trucking companies, bus lines, long-distance movers and railroads, prospective users of highway mobile service include barge line companies and towing companies operating on inland waterways, coastal shipping companies, oil and natural gas pipeline companies, and public service companies—electric light and power, gas, water, transportation, etc.

The technical and operating problems of highway mobile service are being given consideration. Introduction of that service, however, is expected to follow along after the inauguration of urban mobile service.

Widespread development of the urban service must depend to a large degree upon war conditions because manufacturers of the required apparatus are concentrating the major portion of their manpower, facilities and materials available upon war communications equipment.

A new Western Electric hearing aid, Model 63, is now available. Small size and light weight—about six ounces—are features. Two sensitive fingertip controls permit the wearer to select not only the proper volume, but also to adjust the characteristics of the set to compensate for nerve-type hearing loss and tune out certain unwanted background sounds. Powerful amplification, over a wide band of frequencies, is provided by three miniature electron tubes; each tube is replaceable without soldering.

M. R. McKenney Appointed General Patent Attorney

M. R. McKenney became General Patent Attorney of the Laboratories and head of its Patent Department on June 25, 1945, succeeding E. W. Adams, who became General Patent Attorney of Western Electric Company. E. V. Griggs, in accordance with his own desire, will continue as Assistant Patent Attorney of the Laboratories, reporting to Mr. McKenney.

* * *

After Mr. McKenney received his degree of B.S. in Electrical Engineering from the University of Maine in 1915, he remained there as an assistant instructor most of the next school year. He then spent ten months



*M. R. McKenney, General Patent Attorney,
Bell Telephone Laboratories*

on patent work with the Splitdorf Electrical Company in Newark. He joined the Patent Department of Bell Telephone Laboratories early in 1917 and was assigned to work on patent matters relating to automatic switching systems and apparatus. In May, 1918, he entered military training at Camp Devens and shortly thereafter was transferred to the Field Artillery Officers' Training School at Camp Taylor. Before his course had been

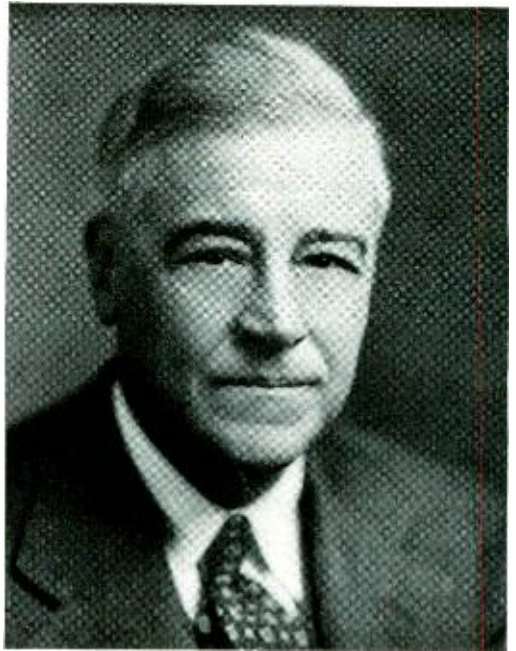

*E. W. Adams, General Patent Attorney,
Western Electric Company*

completed the Armistice was signed, and he soon returned to the Patent Department.

Since that time, with the exception of a period of a little more than two years from 1930 to 1933, when he was on special assignment as counsel in litigation proceedings, Mr. McKenney has been continuously concerned with panel, step-by-step and crossbar systems. He is a member of the bar of the State of New York.

* * *

Mr. Adams graduated from Illinois Institute of Technology in 1908 with the degree of B.S.E.E. He then studied law at the National University Law School and obtained his LL.B. two years later. Continuing these studies, he received the degree of M.L.P. at George Washington University the next year. For the four years following his graduation from Illinois Institute, he was an Assistant Examiner in the United States Patent Office. He is a member of the bars of New York State and District of Columbia.

In 1912, Mr. Adams entered the Patent Department of the Western Electric Company, and from 1913 to 1916 was in Antwerp and London for the International Western Electric Company. On his return

from Europe he again joined the Western Electric Patent Department. In 1925 and 1926 another foreign assignment took him to London and the Continent where he prosecuted and maintained European patents owned by the Western Electric Company. Following that, he became Assistant General Patent Attorney of the Laboratories, and in 1937 became its General Patent Attorney.

C. R. Burrows Goes to Cornell

C. R. Burrows of the Radio and Television Research Department has been appointed Professor of Electrical Engineering and Director of the School of Electrical Engineering at Cornell. He will assume his new duties about September 1. Dr. Burrows has been associated with the Laboratories since 1923 when he worked here during the summer prior to receiving his B.S.F. degree from the University of Michigan in 1924. After graduation he returned to the Laboratories and continued work on long-wave transmitters.

Early in the development of short-wave radio he entered that field and made analyses of this type of propagation, which formed the bases for short-wave transoceanic service. From 1930 to 1938 he was in charge of a group investi-



gating ultra-short-wave propagation. Since 1938 he has been working on the development of ultra-short-wave transmitters. Mr. Burrows received the A.M. degree from Columbia in 1927 and the Ph.D. in 1938 and the E.E. degree from the University of Michigan in 1935.

Charles A. Parker Honored

Charles A. Parker was presented the award for Meritorious Civilian Service by General McClelland "For exemplary performance of his service to the AAF as Expert Consultant to the Air Communications Officer. Mr. Parker brought to his position a thorough and well-rounded background as a com-

munications engineer, and as such gave expert advice and assistance in converting the XXVI Fighter Command from high-frequency to very high-frequency radio system for the control of fighter aircraft. He participated in the organization of the Office of the Air Communications Officer—Air Technical Service Command, and handled all matters pertaining to responsibility for fixing communications facilities at Class III installations. In that connection he planned, composed and finalized Army Air Force regulations, which covered the engineering, construction, operation and maintenance of fixed communications facilities and systems in all command echelons and Air Technical Service Command. He reengineered the communications network of the Air Transport Command.

"His exceptional ability to correlate existing and foreseeable problems into long-range planning of major importance and quickly to analyze and solve technical problems and those involving organizational procedures has constituted an affirmative and valuable contribution to the war."

On his return, Mr. Parker, who had been on a personal leave of absence from the Laboratories, was transferred to the A T & T at 195 Broadway.

Overseas Service Resumed

Radio-telephone services to Europe, blacked out for the average American by World War II, began making a comeback in



AAF Photo

Brig. Gen. H. M. McClelland presents the Meritorious Civilian Award to C. A. Parker

June with sharp rate reductions taking place. Services to Switzerland, Portugal and Spain again became available for public calling on June 15, while a similar resumption with Great Britain took place on June 23. On July 1 service was extended to Italy to include social calls in addition to official and press messages but limited to include only Rome and its vicinity.

Before the war radio-telephone service between New York and London, the first overseas circuit established, had the greatest use of all such Bell System services. To judge by the first few days of conversation between Great Britain and these shores, this record gives promise of standing, and even increasing. When general service reopened there were hundreds of calls filed in advance on both sides of the Atlantic. The first few days of operation found besieged traffic forces in New York and London doing their

best to speed calls overseas. Whereas five circuits carried the calls before 1939, a maximum of seven circuits is now available.

Last Month's Cover

The RECORD has had several calls about the "aureole" effect shown in the photograph of the plane about to take off from a carrier. The complete caption accompanying this official Navy photograph read: "Poised for the take-off from a U.S. carrier, this Grumman *Hellcat* gathers about itself an 'aura' caused by the motion of its propellers. Rapid change of pressure and consequent drop in temperature, most pronounced at the tips of the 'prop's' three blades, creates a condensation of moisture. Rotating in accord with the blades, the 'halo' moves aft, giving depth and perspective to the phenomenon. Atmospheric conditions must be just right for the creation of this effect."

July Service Anniversaries of Members of the Laboratories

	<i>10 years</i>	R. C. Edson	Annie Sulyma	J. F. Martin	O. R. Miller
	Virginia Kahse	R. H. Erickson	E. C. Torkelson	M. B. McDavitt	R. A. Miller
	K. J. Kraft	J. F. Ferko	Mary Torrey	Ella Munk	Mary Mulhern
	Shirley Lawton	R. J. Ficken	Agnes Viskupic	Ernest Nelsen	K. O. Olson
	Edith Martini	J. C. Fletcher	A. H. White	N. C. Norman	W. A. Phelps
	J. M. Niedzwiecki	E. S. Greiner	E. G. White	A. C. Norwine	Robert Pope
	W. H. Seckler	A. B. Haines		Mary O'Brien	George Puller
	F. J. Shiel	K. E. Hammer		John Pasanen	E. W. Rahn
	E. C. Thompson	A. D. Hasley		Helen Quinn	A. R. Rienstra
	Dorothy Wellinghorst	Edward Hughes		Katharine Robbins	G. A. Waters
		G. D. Ipsen	<i>20 years</i>	S. R. Russell	Arthur Westenberger
		A. H. Johnson	W. R. Bennett	Wilma Sabolsak	O. H. Williford
		J. D. Kleinkauf	Nelson Botsford	Clinton Shafer, Jr.	J. R. Wilson
	<i>15 years</i>	Bridget Kopacewicz	J. W. Brubaker	J. M. Vesely	E. B. Wood
	H. W. Allison	G. G. Lavery	C. W. Christ	W. E. Wandell	
	A. B. Anderson	L. W. Mackey	C. A. Collins	H. T. Wilhelm	
	R. R. Andres	J. M. Manley	B. H. Cornell	K. M. Winkworth	
	W. M. Bacon	Jean Mascari	G. H. Corrigan		<i>30 years</i>
	J. H. Beiner	C. W. Mattson	C. H. Dagnall		C. H. Achenbach
	H. H. Benning	C. B. McKennie	J. C. Davenport, Jr.		John Jessich
	R. R. Blair	Robert Molitor	H. K. Dunn	<i>25 years</i>	Fred Mezger
	J. R. Brady	W. W. Mumford	J. W. Emling	H. C. Baarens	G. F. Shulze
	Charles Breen	J. A. Normann	C. A. Fischer	J. A. Carr	W. B. Strickler
	H. B. Brehm	J. J. Oestreicher	A. J. Gaborc	A. F. Conk	
	W. J. Carroll	A. C. Pfister	Clarence Gerbig	H. J. Elschner	
	H. T. Carter	G. S. Phipps	W. E. Grutzner	G. L. Gottron	
	J. E. Corbin	John Raptoulis	G. B. Gucker	C. M. Hebbert	<i>40 years</i>
	H. E. Crowell	C. H. Sample	Florence Hanson	J. C. Herber	H. G. Bandfield
	S. A. Darby	A. K. Schenck	Albert Hartmann	R. W. Hoffmann	C. A. Grant
	J. J. DeBuske	Irma Scott	D. B. Herrmann	L. M. Ilgenfritz	Joseph Juley
	J. M. Dietz	Walter Senitoritch	C. C. Hipkins	J. W. Kennard	Arthur Raynsford
	L. B. Dixon	A. G. Souden	L. S. Hulin	J. M. Labaugh	Henry Wagner
	A. B. Doornheim	V. G. Sprague	A. P. Jahn	Albert Lang	E. B. Wheeler
	F. E. Drake	K. H. Storks	G. D. Johnson	D. W. Mathison	
			W. J. Kiernan	Thomas McLaughlin	
			Paul Kuhn		



O. E. BUCKLEY

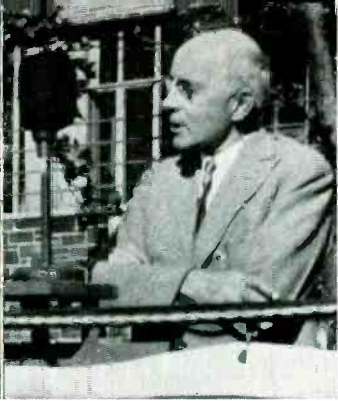

F. B. JEWETT



M. B. LONG



R. K. HONAMAN



D. A. QUARLES



R. A. HAISLIP



A. B. KVAAL



A. J. SNYDER

Annual Meeting of the Frank B. Jewett Chapter Telephone Pioneers of America





Pioneers Enjoy Picnic and Inspection Tour at Murray Hill Laboratories

NEARLY eleven hundred members of the Frank B. Jewett Chapter No. 54 of the Telephone Pioneers of America attended the annual meeting, picnic and inspection tour at the Murray Hill Laboratories on June 23. A short business meeting was held at 5:15 p.m. Dr. Buckley, President of the Chapter, took the occasion to tell the Pioneers of some of the features of the Murray Hill Laboratories and to outline the plans for the new building, construction of which is expected to be started shortly.

Following reports of the officers and committee chairmen, the following officers were elected to serve for the coming year: *President*, M. B. Long; *Vice-President*, D. A. Quarles; *Secretary*, R. J. Heffner; *Treasurer*, A. O. Jehle. Elected to the Executive Committee for two-year terms were Hazel Mayhew, B. W. Kendall, and H. H. Lowry. The other members, serving for another year, are W. Bodenstedt, C. A. Conrad and J. B. Kelly.

Honored by the presence of Dr. Jewett, now retired and for whom the Chapter was named, Dr. Buckley called on him to say a few words.

A picnic supper was then served to all members and guests. After this, inspection tours of the Laboratories and grounds, lasting until about 8:30, were made.

Before and after the meeting, a specially installed high-fidelity reproducing system played a program of varied musical selections. As a feature of the inspection tour, the entire proceedings of the business meeting, recorded on tape, were reproduced in one of the sound laboratories.

The highly successful arrangements of the party were made by the Entertainment Committee of the Chapter under the chairmanship of R. K. Honaman. The Committee was augmented for the occasion by a group of about seventy-five people located at the Murray Hill Laboratories.



News Notes

O. E. BUCKLEY was a member of the reception committee appointed by Mayor F. H. La Guardia to honor General Dwight D. Eisenhower at the reception and banquet on June 19 at the Waldorf-Astoria. Attending the banquet with Dr. Buckley were M. J. KELLY, R. L. JONES, A. B. CLARK, D. A. QUARLES, W. FONDILLER, R. W. KING, R. BOWN, H. H. LOWRY and W. H. MARTIN.

* * * * *

CONCURRENT with the termination of the Office of Civilian Defense on June 30, similar activities at the Laboratories ended. On December 29, 1941, G. F. FOWLER was appointed Emergency Protection Coördinator with responsibility for coördination of the Laboratories emergency activities in connection with air raid precautions and procedures, admission to buildings and protection of personnel and property. DR. BUCKLEY, when notifying group leaders of the termination of activities, wrote, in part:

"You in turn offered your services in organizing a most complete unit of volunteer workers in several groups, at our various locations, as prescribed in detail by the Office of Civilian Defense. . . . I wish to express to you and through you to each member of your group my appreciation for your coöperation."

* * * * *

ANN MENIG, Chief Operator of the Laboratories, and Mary O'Malley of the New

*When it's rush time
on Long Distance*



PLEASE LIMIT
YOUR CALL TO
5 MINUTES

NEW YORK
TELEPHONE
COMPANY



"The Telephone Hour"

NBC, Monday Nights, 9:00 p.m.

August 13	<i>Fritz Kreisler</i>
August 20	<i>Maggie Teyte</i>
August 27	<i>Marjorie Lawrence</i>
September 3	<i>Jascha Heifetz</i>

York Telephone Company, who operates the board for the A T & T and Western Electric at 195 Broadway, were invited to meet with the chief operators of the Western Electric Company at 195 Broadway during the week of June 11 to discuss operating problems, particularly those involving the use of tie lines between New York, Chicago and Baltimore. During the conference visits were made by the following Chief Operators to several exchanges, including the Laboratories' West Street Exchange on June 14: Lottie Augustine, Hawthorne; Kathleen Flannery, Haverhill, Mass.; Helen Hoffman, Point Breeze; Ann Mellin, Kearny; Ann Menig, Bell Laboratories; and Mary O'Malley, 195 Broadway.

* * * * *

THE GREATER PART of Holland's automatic telephone networks has been so badly damaged by the Germans that at least ten years will be required to restore it. During their retreat the Nazis deliberately destroyed the main automatic exchanges in the southern, eastern and northern sections to paralyze Allied communications. However, the telephone system in the western part suffered little damage, thanks to the efforts of loyal telephone workers who fought German attempts to destroy the exchanges just before the capitulation. The greatest damage was found in the southern provinces, where only 48 of the 162 automatic telephone exchanges formerly in operation are now in working order.

The busiest exchanges were the ones hardest hit and, as a result, 75 per cent of the subscribers in that area are without service. Of the 157 hand-operated exchanges, only 66 escaped damage. In the northern and eastern provinces of Holland the damage to the automatic telephone exchanges was somewhat lighter.



Lt. Col. McCann Receives the Order of the British Empire

Lt. Col. Thomas A. McCann, now serving with Supreme Headquarters, Allied Expeditionary Force, was decorated on May 31, 1945, with the *Order of the British Empire*. A copy of the citation reads:

"The possession of all possible information relative to the German Signal organization and to conditions having a bearing on communications in the area of Operation 'Overlord' was a necessary basis for Supreme Headquarters AEF Signal planning.

"Lt. Col. McCann, chief of the sub-section charged with the task of obtaining, studying, presenting and distributing all such information, has carried out his vital work extremely ably. He threw himself whole-

heartedly into his task, and under his untiring and inspiring leadership no avenue of information was left unexplored, no clue however slender ignored, and an exhaustive survey was made of every factor which might affect the signal situation.

"To the excellence and accuracy of Lt. Col. McCann's work a considerable proportion of the success of Signal planning is due."

Lieut. Colonel Malcolm A. Specht

"I'm a part of the Third Army, a very minute part of course, but nevertheless a proud one. I crossed the Rhine on a pontoon bridge the day after it was built. The exploits of the Third Army are too well publicized for me to try to tell you more than that. We are now so far within the Reich that I can hardly see how, when this reaches you, the decision will not have already been made. But what a job still lies ahead! I am discouraged when I think that the Army may want me to help in that thankless reconstruction task.

"Here are a few aspects of things and personal observations which may be of interest. Germany is quite a beautiful country. I was surprised at the high standards of living which many even medium-sized cities show — running water, very tastefully selected furnishings, rich decorations, showers, sewage disposal in the houses, modern shops, wide streets, fine gardens, excellent road nets out-



Four men from the Laboratories (left to right), James B. Kennedy, Francis R. Merritt, Ralph Nelsen, and Martin Nielson, are all in the 805th Signal Service Company stationed at Guam, Admiral Nimitz' headquarters

side. The farther we have come from the French border the less obvious have the front-yard manure piles become. The land appears to be fertile where cultivated, but there is considerable woodland. It is hard to see why the German was not content to remain within his own fine country, but had to covet what was his neighbors' and, to me, less desirable.

"The German people have not suffered for want of food. All their larders are full and they appear to be well fed. Items like butter, sugar and soap, which are at such premium in France and Britain, have not been, and are not now, particularly difficult to obtain. Of all the people of the war that I have seen, the British seem to have suffered most."

Ethel McAlevey

"Just a few lines to tell you that the Bell Telephone Laboratories were represented by one Ethel McAlevey of the Wac in the 'Little Red Schoolhouse in Reims.' Of course said Sergeant was away from where the 'big doings' were taking place but not too far away to be in on the excitement and even to have a peak at the Nazis as they entered. Now to take care of the necessary detailed work to be done and then home again."

George F. Brown

"We arrived on Iwo Jimo D plus one and it was still plenty hot. Being on board a sea-plane tender on an operation like that was the same as having a grandstand seat at a ball game. We operated there for a while until our job was done and then set out on a new operation.

"It is too bad that you people who work on the equipment we use cannot get the chance to see how it behaves in action. Your

Members of the Laboratories W

Name	Dept.	Theater of Operation	Duration of Leave	Date Reinstatement
AUX. MARION F. ADLER	2920*	United States	5 mo.	8-18
PVT. FRED E. ALEXANDER	7610*	United States	2 mo.	1- 7
1ST LT. DICK S. BARLOW	3540	United States	7 mo.	9-21
GILBERT A. BECK, S 1/c	2742	United States	8 mo.	3-19
PVT. LEON BLACKMAN	7610*	United States	1 yr. 1 mo.	1-17
PFC. CLEMENT BOSCH	7330	United States	8 mo.	3-2
1ST LT. WM. H. BURGESS	3320	European	2 yr. 5 mo.	6-18
PVT. HORACE J. CAMP	7120	United States	3 mo.	12-21
2ND LT. GREGORY CHABRA	2660	United States	2 yr.	2- 8
PVT. MARTIN CLOHESSY	7521	United States	5 mo.	9-11
CAPT. RODMAN D. DE KAY, USNR	3250	Am.-Eur.-Pac.	4 yr.	6-11
JAMES S. DEVANNEY, S 1/c	7330*	Am.-Eur.-Pac.	1 yr. 6 mo.	10- 2
PVT. THOMAS S. DIAB	7610	United States	5 mo.	11-36
CAPT. ROBERT L. DIETZOLD	1125	United States	5 mo.	9-14
PFC. WM. V. FLUSHING	3250	European	2 yr. 4 mo.	6-25
PVT. THOMAS FRATELLO	7521*	United States	10 mo.	11- 2
LT. COL. WM. J. GALBRAITH	3600	Am.-Pac.	3 yr. 8 mo.	6-11
WALTER E. GILL, S 2/c	7545*	United States	7 mo.	1-10
PFC. ANDREW J. HANNAN	7330	United States	4 mo.	3-29
PVT. HAROLD F. HARTWELL	7110*	United States	7 mo.	2- 7
PVT. FROST G. HIGBIE, USMC	2735†	United States	8 mo.	7-10
PFC. JOHN P. HOULIHAN	7521	European	3 yr. 3 mo.	7- 9
CHARLES S. JACKSON, S 1/c	7521	American	10 mo.	11-27
2ND LT. GLOVER D. JOHNSON	2730	United States	6 mo.	9-19
ALBERT JOST, EM 2/c	7521	American	3 mo.	10-29
MAJ. WILLIAM KES	2660*	European	3 yr.	12-20
1ST LT. WM. M. KNOTT	2720	United States	4 mo.	11-23

*Has left the Laboratories.

radar and communications gear are right up at the front doing their part. Keep up the swell work. Let's have more, lots more of it here. Give my best to all the folks with whom I worked out in Murray Hill."

John H. Anderson

"Arrived in Germany after visiting England and France and am with the 9th Army. While in England I received my current rating of T/5. I have run into the coincidence of serving in several organizations with Labs men again. When I was in Boston Harbor I took basic training with ED O'HARA; in Texas M. A. SPECHT was Executive Officer of the group I was in; and I recently found out that PETER MCGANN is a Labs man and he is in the same battery as I am. The climate and country of Germany are very beautiful but I'm hoping for a quick return to the unpredictable weather of New York and vicinity."

Returned from Military Service

Name	Dept.	Theater of Operation	Duration of Leave	Date of Reinstatement
CHARLES J. KUHN	7521	Pacific	4 yr.	6-13-45
BELLE MADDOCKS, S 1/c	3220*	United States	2 yr.	2-12-45
WM. J. MEEHAN	7521	Pacific	3 yr. 1 mo.	4-10-45
PAUL P. MELKONIAN	7551	United States	11 mo.	1-17-44
FERRY MUNDO, A.S.	7524*	United States	1 mo.	2-7-44
COMD. JAMES B. NEWSOM	3340	United States	1 yr. 7 mo.	4-16-45
JOHN NICHOL	7521	United States	2 yr. 2 mo.	6-2-43
ROBERT J. NIELSEN	2660	United States	1 yr. 8 mo.	10-30-44
JOHN M. O'NEILL	7521	United States	2 yr. 6 mo.	11-8-44
CASIMIR J. OSIECKI	1330	United States	1 yr. 1 mo.	10-10-44
PAUL F. PETERSEN	3220*	United States	1 yr.	10-1-41
CLAYTON W. RAMSDEN	2113	United States	2 mo.	5-1-42
LT. ROBERT T. ROONEY	2760	Eur.-Pac.	4 yr. 7 mo.	5-23-45
FERRY W. SCHAEFER	7310	United States	2 mo.	12-16-40
JOHN F. SCHNEIDER	7340	United States	1 yr. 5 mo.	3-5-45
HARRY E. SEAMAN	2742	United States	1 yr. 5 mo.	1-8-45
JOSEPH A. SEIFERT	6110	United States	2 mo.	7-7-43
N. E. SIENKO, FIREMAN 2/c	7620	Pacific	1 yr. 6 mo.	9-25-44
CHARLES S. SIMKO	7620	United States	9 mo.	5-14-45
SEWELL E. SMITH	7610*	United States	6 mo.	4-26-43
LT. HARRY W. SODERSTROM	2920	United States	1 mo.	7-25-42
ARTHUR D. SOPER	6100	Am.-Eur.-Pac.	2 yr.	4-10-44
JOHN H. STELLJES	2121	European	3 yr. 11 mo.	6-25-45
J. WM. E. STEVENS	3340	United States	2 yr. 3 mo.	8-15-44
EF CARL E. STONE	7610	European	4 yr. 3 mo.	6-7-45
WM. J. TIERNAN	7350*	United States	1 yr.	10-18-43
T. DANIEL H. WENNY	1210	United States	4 mo.	9-14-42

anted personal leave to resume education.

John H. McConnell

"I came to Bermuda last July and was assigned to the radio transmitter building as Officer in Charge with the title of Assistant Radio Matériel Officer. My duties consisted of assuming responsibility for all the radio and allied equipment on the base and on vessels stationed here. A month later I was made Radio Matériel Officer.

"The job I liked best was making a detailed technical report on the radio and certain other electronic equipment used on a captured German submarine, the U505. This ship is a first line operational ship and was captured by a carrier and destroyer-escort task force between here and Africa. It was top secret for some time but the facts have been released recently. I operated and tested most of the apparatus and found it was good practical material, very compact and quite adequate. I had lunch on board one afternoon and dined on captured Ger-

man wieners and sauerkraut topped off with a dessert of cookies and synthetic stewed strawberries that were almost better than the real thing. The German bread, also ersatz, was horrible. So was their ersatz coffee.

"I have been appointed to a position in the disbursing office of the Naval Air Station where I am stationed. I observe and work on much Western Electric equipment and although it is excellent apparatus, I am not nearly so much impressed by the material itself as I am by the Western Electric Instruction Books and Bulletins. There is an almost unbelievable variety of material to be maintained and a good source of accurate information on the subject apparatus is essential to proper maintenance. I

believe that much of the splendid performance achieved by certain Western apparatus is due not only to good design but also to the excellent service data furnished. I think of the Labs a lot and I conduct a fairly reliable, if far spaced, correspondence with Mr. MOORE and Mr. TEBB. I receive the RECORD regularly and I read GEORGE GALBANY'S account of his experiences with interest."

Charles D. Briggs

"Things here are going along all right. I am in a Joint Assault Signal Company. We participated in the Kerama-Retto and Ie Shima operations. We had previously been in the Guam and Leyte operations. The newspapers have undoubtedly kept you well informed regarding the Okinawa and preliminary invasions, so I won't venture to inform you as to what is going on here. It is hot during the day and cold at night, like winter and summer rolled into one day."

Lieut. Urbanski Killed in Action

Lieut. Everett T. Urbanski, who had previously been listed as missing in action, was killed in action when his plane crashed at Kriftel near Frankfort, Germany. A member of the Eighth Air Force stationed in England, Lieut. Urbanski was trained at Susquehanna University in Pennsylvania and at Nashville where he was commissioned a lieutenant in March, 1944. From there he proceeded to Craig Field, Alabama, and on to the Saratoga Army Air Base, Florida, for the last phase of fighter training in P-40's.

Lieut. Urbanski was a member of the Development Shops Department since March, 1942, when he joined the Laboratories. He was granted a military leave of absence on January 29, 1943. Besides his wife and two children, Carol Ann, two years old, and Michael, three months old, he is survived by his father, a sister and two brothers, one of whom is in the Navy.



Lieut. Everett T. Urbanski, 1924-1945

Lt. Col. Harry W. Holmlin Awarded Bronze Star

Lt. Col. Harry W. Holmlin, Corps of Engineers, was awarded the Bronze Star on May 10 for meritorious service "in connection with military operations against the enemy, from February 14, 1945, to April 30, 1945, in Belgium and Germany. Col. Holmlin, as Commanding Officer, Engineer Combat Battalion, demonstrated outstanding ability in his superior accomplishments of

difficult tasks during the operation and movement of the division over a distance of 440 miles, by maintaining roads, by building bridges, and by carrying on assault operations across streams under enemy fire."

Colonel Holmlin wrote: "I'm still Division Engineer of the Fighting 69th. Met the Russian Division Engineer in April and liked his vodka! Busier than ever now awaiting redeployment."

Lieut. Col. William J. Galbraith

Lieut. Col. William J. Galbraith has returned to the Laboratories after having spent three years and eight months in the Signal Corps. A lieutenant in World War I and a member of the Infantry Reserve, he was called into service with the rank of Major and was assigned to the Signal Corps Publication Agency at Fort Monmouth where he served for twenty months. He was then transferred to the Asiatic-Pacific theater of war and spent some time in Panama en route to Delhi, India, where he was assigned to the Theater Signal Officer's Headquarters. Here Col. Galbraith succeeded Lt. Col. Ward K. St. Clair, also a Laboratories man, who was seriously ill, in that theater. His next assignment was in Assam as liaison officer between the Signal Corps and the Military Railway Service. Col. Galbraith returned to the Laboratories



Brigadier General R. V. Maraist awarding Bronze Star to Lt. Col. H. W. Holmlin on May 12 at Nurnhof, Germany



LT. W. H. BURGESS LIEUT. R. T. ROONEY

on June 11, 1945. Two of his brothers, one a captain and the other a colonel, are with the Army; one is now in Germany, and the other, a veteran of Corregidor, is a prisoner of war who, when last heard from, was with General Wainwright and is presumably in Manchukuo.

Lieut. William H. Burgess

Lieut. William H. Burgess is back with the Laboratories after two and a half years in the service. He received his discharge from the Air Forces on May 9. Lieut. Burgess was in Italy with the 15th Air Force for eleven months as a P-38 Lightning Fighter pilot. Some of his missions were bombing the Ploesti oil fields in Roumania, for which he received the Distinguished Unit citation, and escorting high Army officials to Bucharest five days after it was captured by the Russian Army. Lieut. Burgess, in addition, was awarded the Air Medal with four oak leaf clusters, and the European-African-Middle Eastern campaign ribbon. While in Italy he spent several of his leaves in Cairo and Capri.

Lieut. R. T. Rooney

Another serviceman to return to work at the Laboratories is Lieut. Robert T. Rooney of the Signal Corps. Lieut. Rooney enlisted in the Army in 1940 and was stationed in Iceland, until he returned to the States to attend Officers' Candidate School at Fort Monmouth.



LT. COL. W. J. GALBRAITH

After training in Florida he went to New Britain and to New Guinea, where he was wounded at Sador during one of the two major engagements in which he participated. Lieut. Rooney has been awarded the Purple Heart.

John Stelljes

Sergeant John Stelljes of the Signal Corps was released from the Army on the point system while he was home on an emergency furlough from the European theater of war after the death of his brother in service. Having taken a year's military training in the Army before the war, Mr. Stelljes re-



CARL E. STONE

JOHN STELLJES

turned to the Laboratories for six months and was again called up. After training at Fort Lewis, Washington, for a year, he was sent to Africa, then to Italy and finally on to France. His campaign ribbons bear four campaign stars for the battle of Naples, the drive on Rome, and for the battles of Southern France and Central Germany.

Chief C. E. Stone

Carl E. Stone is back in the finish shop at the Laboratories doing the work he formerly did before he entered the Navy in March, 1941, as a third-class petty officer. Chief Stone served with the Atlantic Fleet for two years and spent some time in Iceland before Pearl Harbor. After becoming a Chief Signalman he was assigned to Fort Schuyler, New York, a post which he also held for two years until he



Harold Phares completed seventy combat missions as a radio gunner on a B-25 Bomber

was transferred to Camp Perry, Virginia, and subsequently released from service at the request of Bell Laboratories.

John A. Whitaker

"I am aboard a flat top, the U.S.S. *Steamer Bay*, and doing fine. We have been very lucky in all operations. We have been in the invasion of Luzon and also at Iwo Jima. Our ship has been under attack by enemy planes, though have not received any serious damage from them. We have some Japanese flags painted on our bridge, some of which were shot down during attacks by the ship's gunners and others by our pilots in their fighter planes."

Harold Phares

Harold Phares has flown his 70th combat mission in the Mediterranean area with the 321st Bomb Group in Italy. He served as a radio gunner with that veteran B-25 Mitchell Bomber Group on the Adriatic sector in Italy.

In its 28 months of overseas service the battle-seasoned 321st medium bomber unit has supported six amphibious operations and has been awarded eight battle participation stars. This group has sent out 18,000 bombers against enemy targets. On V-E Day the group was awarded its second War Department unit citation for its successful attack on the shipping in Toulon harbor, three days following the invasion of France.

As this issue was going to press, Sergeant Phares called at the Laboratories to visit his friends and former co-workers.

The following people on military leave of absence have recently been promoted:

Henry Algarin, MM 3/c; Pfc. G. G. Bailey; Cpl. C. T. Bolger; Sgt. B. E. Brown, Jr.; Sgt. I. C. Brown; Lt. (jg) Doris H. Colsh; Sgt. L. F. Cooper; Pfc. Martin J. Corley; S/Sgt. J. H. Devereaux, Jr.; R. F. Graham, ART 3/c; E. M. Johnson, ART 3/c; Lois V. Jones, HA 2/c; T/S J. B. Kennedy; Sgt. Robert Klem; Cpl. E. A. Lichtenberger; H. S. Loeber, ART 2/c; T/3 Ethel McAlevy; Cpl. J. J. McCallion; J. J. McKeon, S 2/c; S/Sgt. R. W. McMurrough; Major C. E. Nelson; Pfc. E. W. O'Hara; S/Sgt. Andrew Olsen; Sgt. Kay R. Parsons; Sgt. Richard Rafferty; B. P. Ransom, RT 1/c; Pfc. W. H. Scheer; Lt. (jg) W. B. Schellerup; Cpl. R. J. Seymour; Pfc. P. J. Smith; Pfc. Bartholomew Stiratelli; Sgt. W. A. Sumner; L. W. Telfer, EM 3/c; Frances V. Tracy, S 1/c (AerM); Marjorie C. Urban, S 2/c; D. J. Van Slooten, RT 2/c; and J. A. Whitaker, AMM 2/c.

W. B. SNOW and R. G. WATLING, who have been on personal leaves with the National Defense Research Committee, have returned to the Laboratories.

WILLIAM N. LEUFER visited the Laboratories on a recent furlough. He was stationed at Camp Croft, North Carolina, where he was in the Honor Guard when President Roosevelt's body was taken through there en route to Washington. He has since gone overseas.

LIEUT. WILLIAM H. CHRISTOFFERS has returned from overseas duty in New Guinea, and is now instructing aerial navigation at Clinton, Oklahoma.

MILTON DUDECK is in Officers' Candidate School at Maxwell Field, Alabama.



George J. Wolters, center foreground, was working in New Guinea on communications problems like the one shown, before he was transferred to the Philippines

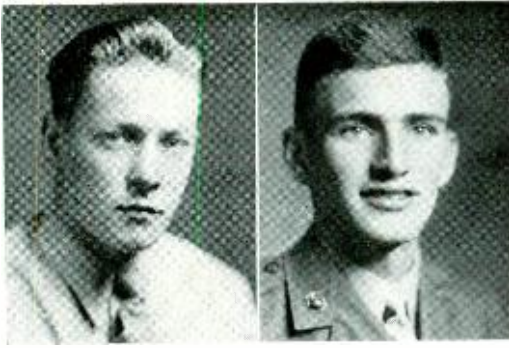

R. A. SCHRODER

C. W. HUGHES

"LAST DECEMBER," writes ALFRED W. JOHNSON, "we returned from eighteen months in the Aleutians for leave and reassignment. Thirty days went all too quickly. Now, with temporary shore duty in not too sunny California, my wife (the former ELAINE BAUMAN from the Accounting Department) and I enjoy life on almost civilian lines."

RICHARD FORREST has been assigned to the 15th Army Group headquarters in Italy; THOMAS J. GILCREST is now on duty at a German Prisoner of War Camp located in Illinois.

RAYMOND A. SCHRODER has visited the Laboratories during his recent leaves from Camp Shanks where he is processing troops returning from overseas.

FLORENCE GORDON has started training as a surgical technician. She will have an eight-week training course in theory and

Leaves of Absence

As of June 30, there had been 993 military leaves of absence granted to members of the Laboratories. Of these, 70 have been completed. The 923 active leaves were divided as follows:

Army 514 Navy 303 Marines 29

Women's Services 77

There were also 19 members on merchant marine leaves and 18 members on personal leaves for war work.

Recent Leaves

United States Army

Howard J. Laucella Edward J. May
Eloise A. Outten

practical work, one month in a hospital and then, some time in October, a permanent station.

ARTHUR BRANDT is another BTL man who is being trained in B-29's.

RICHARD A. SHINE in the Coast Guard is stationed in Boston, Mass.

LT. DORIS H. COLSH of the Waves is due to report to Washington, D. C.; JOHN H. DEVEREAUX, JR., has been transferred to overseas duty with the Signal Corps.

ROBERT F. GRAHAM writes: "I am still in the middle of learning all about the various pieces of airborne electronics equipment used by the Navy. Much of this equipment originated in BTL, and what it can do is a never-ending source of amazement."

CAPT. ERNEST C. GRAUNAS moved some time ago from New Guinea to the Philippines. "Have been too busy to appreciate Manila or the surrounding areas. In fact, I would much rather visit and tour U. S. A."

R. C. LOCKWOOD, a Pharmacist's Mate, was at Munda in the New Georgia Islands.

WILLIAM J. CONNER is still with the Navy V-12 Unit at Muhlenberg College.



C. F. WEISS

CARL SMEDBERG

CHIEF CARL SMEDBERG visited West Street recently after two years overseas in the Navy. He was in charge of a precision shop doing repair work on range finders, fire control apparatus and similar equipment at bases in Africa, Sicily, and Italy. He is back in this country for reassignment after a thirty-day leave.

CHARLES F. WEISS is going to Yeoman School at the Great Lakes Naval Training Center; FRANK R. SANTASIER is stationed at the Naval Base at Shoemaker, California; FRANCIS X. SULLIVAN is with an engineer battalion at Fort Belvoir, Virginia.



MANFRED KRISCHIK HENRY ALGARIN

AFTER BEING overseas for over a year in the E.T.O. on an LST, FRANK A. KODITEK is being sent to college to take up engineering.

KAY PARSONS of the Wac is flying as a radio operator with the 204th Air Transport Service in Kansas and throughout the Second Air Force area.

WILLIAM A. SUMNER is at an AAF plant in Marietta, Georgia, where "my team and I are working on a secret W. E. equipment and at the same time getting experience and helping production."

STANLEY P. MASCHKE was recently promoted to sergeant. He is overseas in the India-Burma Air Service Command at the Bengal Air Depot as a radio repairman.

GLORIA GILROY of the Marines is stationed at Parris Island, South Carolina; PETER A. BYRNES has been transferred to Ft. Lauderdale, Florida, where he is taking a course in operation of Fire Control gear; PAUL R. BROOKMAN is stationed at the Naval Research Laboratories in Washington working on B.T.L. designed equipment.

LIEUT. CHARLES M. REDDING, USNR, in his four years in service, has served in the Bureau of Ordnance at Washington and as an officer on a Destroyer Escort in the Atlantic and Mediterranean. Recently he left San Francisco for the Pacific as commanding officer of an LST.

HENRY ALGARIN is with the Navy at Norfolk, Virginia.

LIEUT. WILLIAM C. SYLVERNAL, an Eighth Air Force B-17 Flying Fortress pilot, stationed in England, participated in heavy bombing attacks on vital industrial and military targets in Germany.

WILLIAM H. SCHEER is with the 3rd Army in Czechoslovakia, "a very beautiful coun-

try that has a low standard of living." To date he has not been advised whether he will be transferred to the Pacific or retained for the army of occupation.

MAJOR ALLEN H. WHITMAN is at present Communications Officer at a base somewhere in the Philippines.

LIEUT. ROBERT J. KOEHLIN visited the Laboratories on a recent leave to see his new-born daughter. He is with the Transportation Corps at Newport News, Virginia.

MAJOR FOSTER B. BLAKE visited here while on leave from the AAF Overseas Replacement Depot, Greensboro, N. C.

ELLSWORTH A. LICHTENBERGER is with the Army Airways Communication System somewhere in the Philippines.

LT. GEORGE N. ELTZ writes: "My fighting days are about done over here—just when I was having such a wonderful time. I sure hope they don't keep me here, but they intend to keep some air power here in Germany to scare any troublemakers away."

WILLIAM ANDERSON has finished training in Radio Matériel School and has been assigned to the U.S.S. *Vella Gulf*, a carrier escort, for duty.

LT. CHARLES J. McDONALD is still in the Philippines chasing Japs.

THEODORE F. TAYLOR of the Paratroops is recovering from an arm injury at the regional hospital at Fort Benning.

LETTERS have also been received from:

Ens. J. V. Elliott, M. L. Glaab, Lieut. A. E. Lawson, F/O W. V. Hoshowsky, R. C. Bogstahl, A. J. Monaghan, J. J. Viggers, E. A. Steppuhn, Robert Graham, Edwin Birger, W. E. Thacker, Major W. J. Flavin, R. H. Funck, H. S. Loeber, E. J. Hughes, David Webster, E. M. Johnson, L. Kramer, Ens. J. F. Martin, W. J. McKee, P. A. Byrnes, P. R. Brookman, and J. Naughton.



LT. H. M. BAILEY MAJ. A. H. WHITMAN

Bachrach

Distaff

“Symbolically, the work or activities of women, or woman’s authority or domain”—Webster

“Can If You Can”

The War Food Administration has issued a warning to civilians that the supply of canned fruit and vegetables available to them this year will be from 25 to 40 per cent less than in 1944. Some canned foods such as tomatoes and snap beans will be available in only half the quantity there was a year ago.

The WFA urges that home canners raise their goal to 100 or 125 quarts of fruits and vegetables per person this year. It also suggests that city dwellers, who know how to can, buy fruits and vegetables locally when they are available, and can them.

* * * * *

RACHEL RAWSON came to Bell Laboratories as a result of an aptitude test at Stevens Institute, which pointed toward engineering, this after a background which included nursing, secretarial work, advertising copywriting and publicity. She took

RACHEL RAWSON



her nurse’s training at the University of Texas Medical School in Galveston and upon graduation she became superintendent of a small emergency hospital in Oklahoma, her home state. A year later she came to New York where a three-month secretarial course enabled her to join an advertising firm. From secretary to copywriter was not a difficult step—and she wrote ads for nationally advertised products for five years.

Rachel tells us that she always felt that advertising was not her real work—and after the three-month “Introduction to Engineering” course at Stevens following the aptitude test, she was sure that engineering was. An eight-month Government-sponsored course in engineering at Defense Training Institute enabled her to obtain the job she now has with the Laboratories.

As a member of the Transmission Development Department, she works on the development of oscilloscopes for testing radar and other types of electronic equipment in the Graybar-Varick building.

Outside of her work, Rachel’s main hobby is radio. She repairs all her friends’ radios—as well as building new ones when she has the time. Her other hobbies are painting, ceramics, playing the accordion, and tennis. She has exhibited her oil paintings with the “Independent Artists of Today”—and at the recent



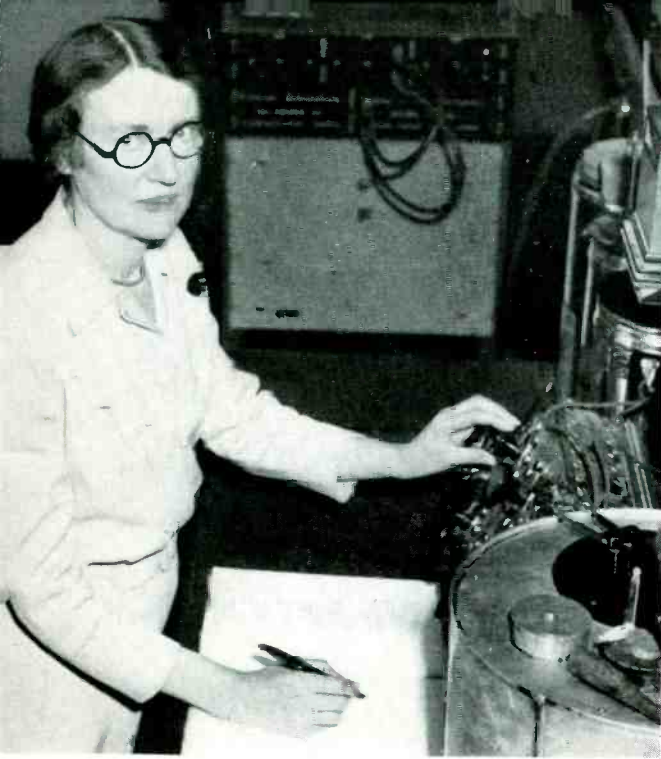

FLORENCE PURDON

Laboratories exhibition she was winner of both second and third prizes in the oil painting group. Rachel attributes her interest in the art field to the influence of her husband, who is a commercial artist.

* * * * *

FLORENCE PURDON is with the group at Murray Hill working on thermistors. She helps to make disc thermistors, keeps the records and makes up display boards and charts for the group.

Born in North Dakota, Miss Purdon received a B.A. degree from the University of

LEONA CHAMBERS



North Dakota and taught high school for a year. She then came East and took a decorative design course at Cooper Union Art School in New York. She worked in the engineering statistical department of United Electric Light and Power Company before she and her sister opened a shop in Morristown, New Jersey, where they made lamp shades and other decorative articles for the home.

When the war started and materials in the shop became scarce, Miss Purdon decided to do war work, and in 1943 she came to the Laboratories and is now in the Electronic Apparatus Development Department.



BARBARA STOLLERY

IF BARBARA STOLLERY "just doesn't have a thing to wear," during the evening she'll just make herself a new dress to wear the next morning. Besides making all her own clothes, Barbara embroiders designs on many of them; knits for the Red Cross and for herself; makes purses and earrings to match her dresses; and also makes men's bow ties with their names knitted into the ties. Barbara lives in Chatham, New Jersey. She is one of the mail girls at the Murray Hill Laboratories.

LEONA CHAMBERS is a member of the Development Shops Department at West Street, where she makes detailed parts for use in war equipment. She came to the Laboratories over a year and a half ago and, after completing the six-week training course, she continued to work in the 4-C Development Shop until September, 1944, when her work location was changed to her present assignment in one of the smaller local shops. Working from blueprints, she operates such machines as the milling machine, lathe and drill press.

Leona was born in Maine and worked for a time in Boston before coming to New York. She has completed her Red Cross First Aid Course, likes bicycle riding and swimming. Her brother, who is in the Army, fought through the Okinawa campaign.

* * * * *

STRICTLY CONFIDENTIAL is the work BEA PANOS is doing at Murray Hill. As a technical assistant she does secret war work in the chemical laboratory there. She came to the



BEA PANOS

Laboratories two and one-half years ago after working for a pharmaceutical company in Summit, New Jersey.

Bea is making good use of her free time—she has enrolled in the American Red Cross Nurses' Aide course. Three of her evenings each week are devoted to this. She likes

Engagements

*Gerard A. Gawel—Lillian Clougherty

*William R. Klesse—Elizabeth M. Glaab

*Ronald F. Wick—Lucile L. Hall

Arthur Bruvik, U.S.M.S.—*Marguerite S. Jensen

Weddings

Andrew J. Quinn, U. S. Army—*Constance Kaval

*Robert G. Treuting—*Mary Elizabeth King

John Mayer, U. S. Army—*Florence R. Rehman

Steven G. Raftery, U. S. Army—*Mary B. Sullivan

*Alfred Wickstrom, U. S. Army—Vera Charlton

*Lieut. S. Milton Ray, U. S. Navy—Ida Dugan

James J. Venezia, U. S. Navy—*M. Jean Geddis

*Members of the Laboratories. Notices of engagements and weddings should be given to Mrs. Helen McLoughlin, Room 803C, 14th Street, Extension 296.

horseback riding, tennis, and bowling. Bea's other interests range from Sunday School to designing her own hats. She sings in her church choir and is superintendent of the primary Sunday School there.

* * * * *

JEANNE SULLIVAN, a technical assistant in the quartz crystal development laboratory at Murray Hill, is shown in the photograph determining, with polarized light, the electrical axis of a quartz plate used to control the frequency of radio apparatus. To avoid handling, the crystal is held by a suction tube while mounting it on the stage of the

JEANNE SULLIVAN



instrument. A second suction tube, shown at the left, holds the crystal during the test. Jeanne was graduated with the B.S. degree from the New Jersey State Teachers' College and has received a certificate in Electrical Engineering at the Newark College of Engineering. She is a member of the National Honorary Literary Society. Jeanne edits and publishes a little magazine of her own poetry four times a year. She is also interested in astronomy and baseball.

* * * * *

ETHEL BRADLEY of the Bureau of Publication and her husband, LIEUTENANT STANLEY BRADLEY, were reunited after a thirty-month separation when he returned recently



from Europe. He took part in the Tunisian campaign, swam ashore on Sicily from a burning ship, landed in Normandy on D+1, and was captured in August, 1944. Eventually he arrived at an officers' camp in Poland. Last January, with other prisoners of war, he was marched northwest to Luckenwald, where they were liberated by the Russians. He returned by truck and airplane to LeHavre and thence by ship.

The Bradley romance began in the Laboratories where, in 1940, Stanley was a messenger assigned to the Bureau of Publication when it was on the 11th floor.

News Notes

G. DEEG and H. F. HOPKINS visited the Hawley Products Co. at St. Charles, Ill., and the Western Electric Co. at Hawthorne to confer on the manufacture of loud-speaker diaphragms.

C. J. FROSCHE was at Wright Field on low-pressure laminating problems.

C. S. FULLER attended the annual conference on high polymeric substances at Gibson Field, Md., where he served as chairman of a round-table discussion.

A. C. WALKER and W. L. BOND visited the Western Electric plant at Hawthorne in connection with the cutting and dimensioning of synthetic crystals.

W. E. CAMPBELL presented a discussion of carbon brush wear at a meeting of the research committee on lubrication at the American Society of Mechanical Engineers.

C. A. WEBBER and W. J. KING were at Hawthorne on matters pertaining to cables and connectors.

R. T. STAPLES discussed cables at Hawthorne and, at Point Breeze, Mr. Staples and H. H. STAEBNER took up cord development problems.

G. M. THURSTON visited the Western Electric Company at Philadelphia in connection with the standard crystal oscillator test set. At the Aircraft Radio Laboratories, Wright Field, and at Washington, Mr. Thurston and R. A. SYKES discussed specifications for crystal units.

I. F. KOERNER and W. E. SMITH visited the Westinghouse Electric Corporation at Mansfield, Ohio, on thermostats and at its plant in Derry, Pa., on ceramic parts.

AT THE RADIATION LABORATORY of the Massachusetts Institute of Technology A. R. D'HEEDENE and I. C. TILLOTSON discussed the construction of filters.

IN RECOGNITION of having received the degree of B.E.F. from Brooklyn Polytechnic, a group of colleagues invited R. H. KLIE to dinner and a theater party on July 2. Mr. Klie, who was transferred from the New York Telephone Company, has been attending school while working for the Laboratories.

THE LABORATORIES were represented in interference proceedings at the Patent Office in Richmond by R. C. TERRY before the Primary Examiner.

7th War Loan

The total amount of War Bonds purchased during the recent campaign at the Laboratories amounted to \$1,191,752. The issue price of bonds purchased through regular payroll allotments in April, May and June was \$799,140.75; the issue price of bonds purchased through the special twelve-week and three-month allotment plans in May, June and July was \$123,750.00; and the total campaign cash sales amounted to \$268,861.50.

During "Bond Week," June 18 to 25, booths were located at West Street, Whippany and Murray Hill to encourage further purchases. The booth at West Street was attended by DOROTHY ARMSTRONG, ELIZABETH CHAMBERS, MARY HARRING, EDITH KLEM, BEA MESSANA and HELEN SCHAEFER and that at Whippany by PATRICIA ARTHUR, HARRIET FILMER, ANN GWOZDZ, IVY MATTINSON and MARION MERCK. The girls who attended the booth at the Murray Hill Laboratories are shown in the above photograph which was taken at the request of the Summit Bond Committee to assist in their Township Drive. They are MARY ELIZABETH KING (left, seated) and MARY ANN SCHINDO and, standing, MARILYN MCGUIRE (left) and MURIEL BEY.



R. MUELLER was in Chicago to study transformer difficulties.

T. H. CHEGWIDDEN and J. A. ASHWORTH visited the Republic Steel Company, Warren, Pa.; the Carnegie Steel Co., Vandergrift, Pa.; the American Steel and Wire Co., Cleveland, Ohio; and the American Rolling Mill Co., Zanesville, Ohio, and Middletown, Ohio, to discuss the problems in the making, testing and procurement of silicon steel.

MR. ASHWORTH was also in Bridgeport, Conn., to discuss the cathode ray tube shield at the Contract Welding and Manufacturing Company.

R. A. HAISLIP attended the first of a series of Regional Outside Plant Engineering Conferences held at St. Louis, Missouri, under the sponsorship of the A T & T.

C. S. GORDON recently visited Ogden, Utah, with representatives of the Signal Corps.

C. H. AMADON established a field trial of weed and brush suppression methods at Monticello, N. Y., in cooperation with the New York Telephone Company.

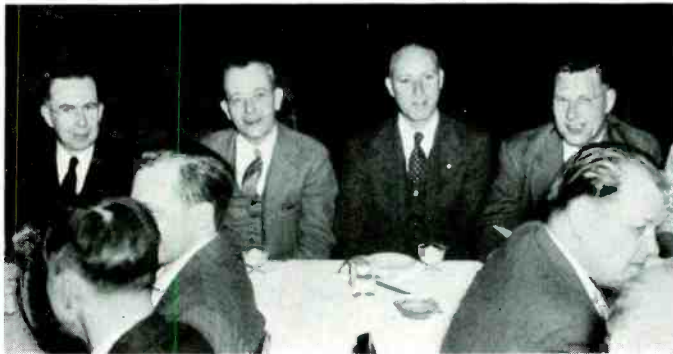

Some of the 80 friends and associates of R. D. Gibson and Frank Lohmeyer who helped them celebrate their 25th service anniversaries with a luncheon. Left to right: H. B. Fischer, R. D. Gibson, Frank Lohmeyer and R. H. Ricker

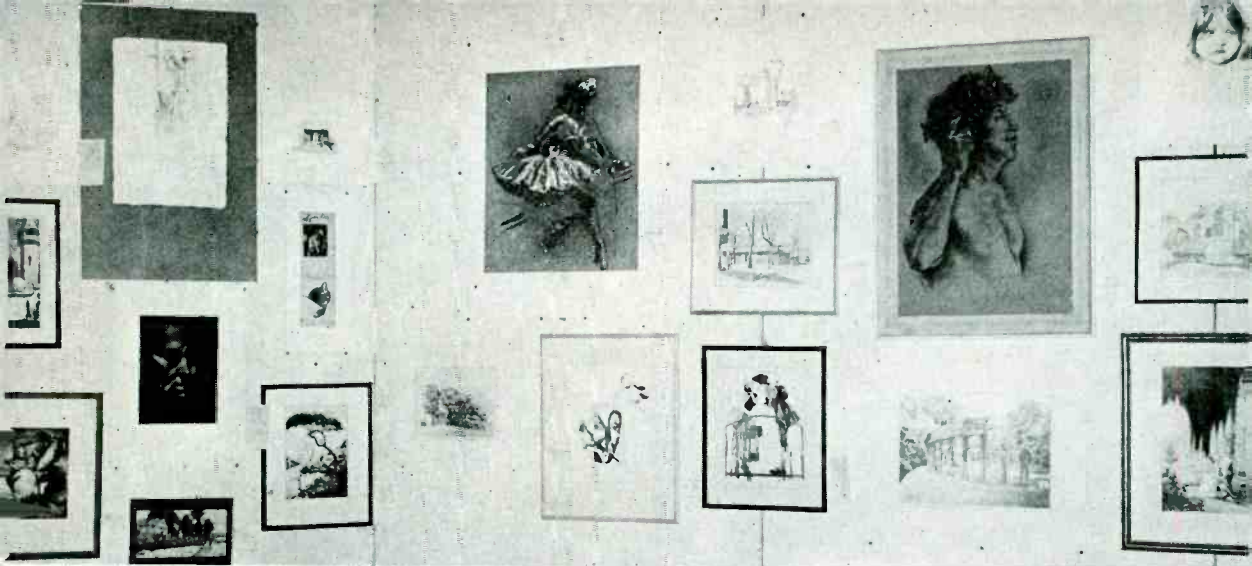

EXHIBIT OF THE ARTS GROUP OF
THE BELL LABORATORIES CLUB

The photograph above shows some of the exhibits in the monochromatic group; that at the left oil paintings with William Stumpf (left) and a visitor, Carl Martin, Signal Corps, Dayton; and the one below water-colors and pastels.

The exhibit committee consisted of I. J. Frisch, chairman, Fred Frampton, G. F. Hall, Edith Nolan and S. C. Smithers



Art Club Exhibit

An art exhibit was held from June 12 to June 18 in the auditorium at West Street by the Laboratories Club Arts Group. Sixty members contributed 173 examples of sculpture, oils, water-colors, pastels, lithographs, etchings, and other forms of monochromatic work.

The judge of the exhibit, Isaac Lane, Muse of "Artists of Today," a Newark artists' group, awarded the following prizes: in the oils group—first, Catherine Lamb; second and third, Rachel Rawson; in the water-color and pastel group—first, M. K. Zinn; second, John Van Giesen; third, L. E. Pipetz; in the monochromatic group—first, W. A. Depp; second, Ralph D. Rabin; third, Shirley Schiffman; and in sculpture—first, Frances Dell'Isola; second, J. C. Campana; third, Nell Radder.

The Arts Group of the Bell Laboratories Club was formed in March, 1945. Its membership of 125 people includes some from Murray Hill and Whippany. Weekly meetings were devoted to sketch classes and lectures.

An exhibit of paintings, drawings and sculpture was also held by the Murray Hill



Left to right, I. J. Frisch, committee chairman, with first prize winners W. A. Depp, Catherine Lamb, M. K. Zinn and Frances Dell'Isola

Art Group in the lounge there during the week of June 26, under the chairmanship of G. P. Spindler. Exhibits from Whippany and New York were also included.

* * * * *

F. J. GIVEN and A. J. CHRISTOPHER went to the Army Electronics Standards Agency on June 7 to study the application of JAN specifications to capacitors.

J. E. RANGES engineered the repair of thermoplastic insulated loading coil cases on the Atlanta-Meridian coaxial cables at the Western Electric Distributing House Shop at Atlanta.

The Murray Hill Art Group also held an exhibit following the one in New York. Here we see Betty Davidson and Jules Wiesmann viewing the display



G. Q. LUMSDEN and representatives of the Supplies Inspection Department of Western Electric Company started the operation of plant control methods for pentachlorophenol solutions at Savannah. Mr. Lumsden also studied the behavior of creosoted pine poles treated with modern creosotes in cooperation with the New England Telephone and Telegraph Company at Northampton, Mass.

E. B. WOOD and H. E. MARTING were at the Army Electronics Standards Agency in regard to wire problems.

A. D. HASLEY attended a Pulse Transformer Committee meeting at the M.I.T. Radiation Laboratory on June 7 and 8.

MANUFACTURING PROBLEMS on a special transformer took G. V. LAGO to Chicago and Zanesville, Ohio.

L. B. HILTON and W. J. KIERNAN went to the Haverhill plant of the Western Electric Company to look into the question of impregnation methods for retardation coils.

C. T. WYMAN discussed network problems at Hawthorne.

H. L. B. GOULD studied the insulation of thin tape molybdenum permalloy cores at the Haverhill plant of the Western Electric Company.

C. H. AMADON and R. H. COLLEY, with representatives of the Bell Telephone Company of Canada and the Forest Products Laboratory of Canada, witnessed the start of extensive field trials aimed at the control of interior decay and ant attack in northern cedar poles in the territory north of Toronto.

DR. COLLEY also visited the Lake States Forest Experiment Station at St. Paul and the Forest Products Laboratory at Madison, Wisconsin, for conferences on fiber stresses and treating methods for little-used pole species with a view to extending the present pole supply.

W. A. BISCHOFF is the author of an article entitled *ASA Speeds Drawing-Drafting Project* published in the June issue of *Industrial*



Noon Mystery at Murray Hill

Standardization. Mr. Bischoff is chairman of the ASA War Committee on Drawings and Drafting Room Practice.

A. ALBANESE, J. M. FRASER, R. H. KLIE and A. F. RUPPEL recently received degrees of B.E.E. from the Polytechnic Institute of Brooklyn.

F. A. WAHLE and H. J. WALLIS spent several days at the Point Breeze plant of the Western Electric Company on war projects.

H. M. BARNES, H. J. STRELESKY and J. J. KAVANAGH were in Washington to discuss various phases of trial equipment in Georgia central office.

H. J. BERKA was at the National Airport, Washington, where he made a lighting survey.

MOTOR PROBLEMS were discussed when A. F. BURNS visited the Hawthorne plant of the Western Electric Company, the Fractional Motors Company, the Speedway Manufacturing Company and the Eicor Corporation in Chicago.

C. J. CANKI discussed problems of small motors at the Thomas B. Gibbs Company in Delavan, Wis., and the Speedway Manufacturing Company in Chicago.

H. M. SPICER and H. T. LANGABEER were at the A. & J. M. Anderson Manufacturing Company in Boston in connection with control equipment.

C. L. DEELWATER visited the Haydon Manufacturing Company, Forestville, Conn., where he discussed small motors.

C. E. WHITNEY tested aircraft alternators and exciters at the Power Equipment Company in Detroit.

Please put your RECORD in the "Correspondence-Out" box when you are through with it so that it can be sent to a Serviceman's family.