

at the ...  
San Diego, California

# BELL

# LABORATORIES RECORD

INDEX

VOLUME 23  
*from January 1945 to  
December 1945*

FEB 27 1946

PROPERTY OF THE LIBRARY  
U.S. NAVY PROTECTIVE LABORATORY  
SAN DIEGO 52, CALIFORNIA

# BELL LABORATORIES RECORD

---

---

*Editor*

PAUL B. FINDLEY

*Science Editor*

PHILIP C. JONES

*Associate Editor*

R. LINSLEY SHEPHERD

*Circulation*

LEAH E. SMITH

*Assistant Editors*

HELEN MCLOUGHLIN

PHYLLIS FOSS

BELL TELEPHONE LABORATORIES, INCORPORATED

463 West Street, New York 14, N. Y.

---

---

## *LIST OF ISSUES IN VOLUME XXIII—1945*

No. 1	January . . . . .	Pages 1- 32
" 2	February . . . . .	33- 64
" 3	March . . . . .	65- 96
" 4	April . . . . .	97-144
" 5	May . . . . .	145-192
" 6	June . . . . .	193-240
" 7	July . . . . .	241-280
" 8	August . . . . .	281-320
" 9	September . . . . .	321-360
" 10	October . . . . .	361-408
" 11	November . . . . .	409-456
" 12	December . . . . .	457-504

BELL LABORATORIES RECORD

JANUARY 1945

VOLUME XXIII

NUMBER I



## Tank Radio Set

By J. G. NORDAHL

*Radio Development Department*

**B**ESIDES the more extensive employment of airplanes, which has required radio equipment both in quantity and type not dreamed of at the time of World War I, one of the outstanding features of the present war is the enormously increased use of motorized equipment. A large part of this equipment, particularly tanks and command cars, requires radio communication for its most effective use. As in 1917, Bell Telephone Laboratories was called upon to develop the required apparatus. What was wanted was radio equipment to give communication between mobile units, between mobile units and various headquarters, and between personnel within the larger units. In the fall of 1940 the development of suitable equipment was undertaken, and within a few months the first models were

available for study by the Signal Corps. Thorough tests showed the equipment to be highly satisfactory, and at the present time well over 100,000 of them are in use by our Armed Forces.

Standardization is particularly important in apparatus for combat use, since the variety of replacement parts must be kept small. In designing a mobile radio unit, therefore, it was necessary to provide equipment that was adaptable to the smallest command car as well as to the largest tank. This requirement has been met by the design of four basic units: a BC-604 radio transmitter, a BC-603 radio receiver, a BC-605 interphone amplifier, and an FT-237 mounting to which combinations of the operating units may be attached. By selecting from these units, three standard sets are

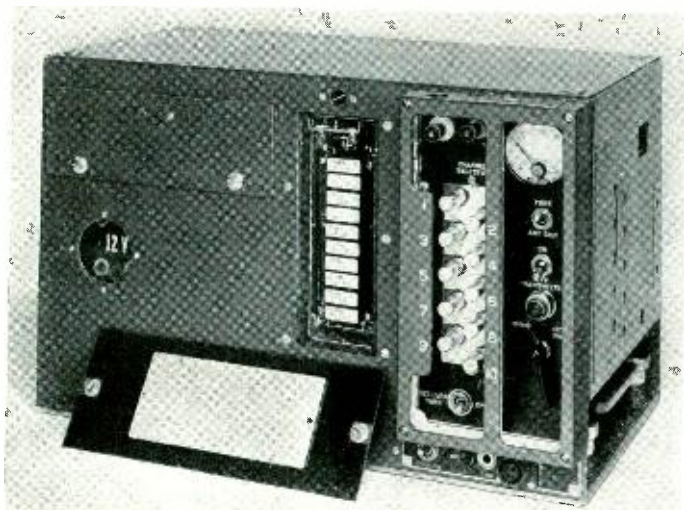

*Fig. 1—The BC-604 radio transmitter showing the screws for fastening to the mounting at the lower part of the right end*

available. The SCR-508 includes a radio transmitter and two radio receivers. The voice-frequency amplifier of the transmitter is designed to be used as an interphone amplifier, and thus this set includes all the facilities needed for the largest tank or command car. The SCR-528 includes a transmitter and one receiver, and thus incorporates radio transmission and reception and interphone communication, but only one radio channel can be monitored at a time. The SCR-538 includes one radio receiver and an interphone amplifier, and thus provides radio reception and interphone service, but radio transmission is omitted.

Besides these major units, a special interphone control box has been designed for use at stations within the vehicle that are remote from the radio set. It provides jacks for microphones and headsets, a knob for controlling headset volume, and a control switch. This switch is normally kept on the RADIO position, where it permits those with telephone sets to hear anything coming over the radio channels. When a switch on the radio transmitter is turned from RADIO to INTERPHONE, the officer at the transmitter can talk directly to the inter-

phone stations, and they can reply by pressing the TALK switch on their microphone. When the transmitter switch is on RADIO rather than INTERPHONE, however, the interphone stations cannot talk over the interphone system except by turning the switch on the control box to INTERPHONE, but this is permitted only in emergencies under combat conditions. Under this latter "emergency" condition of operation, the radio transmitter is disabled to prevent radiation of the speech passing over the interphone circuits.

This radio equipment differs from previous sets used for equivalent services in that it

provides push-button selection of any of ten crystal-controlled frequencies and employs frequency modulation instead of the more common amplitude modulation. The exigencies of modern warfare require that mobile units such as tanks and command cars be able to transmit and receive on a large number of frequencies. On any one task assignment, not more than ten will ordinarily be used, but many more should be available. A compartment at the upper left of the front of the BC-604 transmitter, shown in Figure 1, is provided which will carry all the crystals that may be needed. The ten crystals likely to be needed for the current operation are removed from this compartment and plugged into sockets in

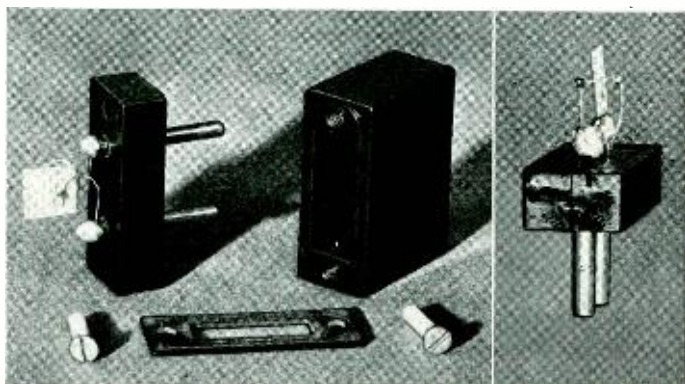

*Fig. 2—One of the crystal units used with the BC-604 transmitter: side view of crystal at left and edge view, right*

the vertical compartment just to the left of the control panel. After a brief tuning operation for each crystal, any one of the ten frequencies may then be selected by operating the proper push-button shown just to the right of the crystal units.

Besides these ten buttons, the control panel includes only an ON-OFF switch, the RADIO-INTERPHONE switch already referred to, two other switches and a meter used only when tuning or servicing the transmitter, and a switch for changing the microphone circuit gain to care for the difference in acoustic noise level between tanks and the relatively quiet command cars. Either a carbon or a magnetic-type microphone may be used with the transmitter or the interphone control box, and a separate jack is provided for each type. The control panel is protected by a raised frame to prevent damage or operation of the controls by anyone falling against the front of the transmitter. A similar guard is provided for the receiver and the interphone amplifier.

Frequency modulation was adopted to take advantage of the lower noise level that can often be obtained with this type of transmission, and also to obtain the simpler circuit that it permits in the transmitter. Further simplification in the transmitter was secured by using a small non-linear coil, originally developed in a larger size as a source of carrier frequencies for broad-band carrier systems,\* to secure the desired modulation, which technically is of the type known as phase modulation rather than frequency modulation. The development of a modulating and harmonic generating system using this coil made the usual vacuum-tube modulating circuit unnecessary, and greatly decreased the size and complexity of the circuit, thereby reducing the maintenance to a minimum.

Push-button control for the transmitter was made practicable by the use of quartz crystals for frequency control. Here, also, considerable development work was required by Bell Laboratories engineers to make crystal control feasible. By taking advantage of the new CT crystal cut which was still in the Research Department at the beginning of the development, the crystals for the new transmitter were made only

\*RECORD, July, 1937, p. 357.

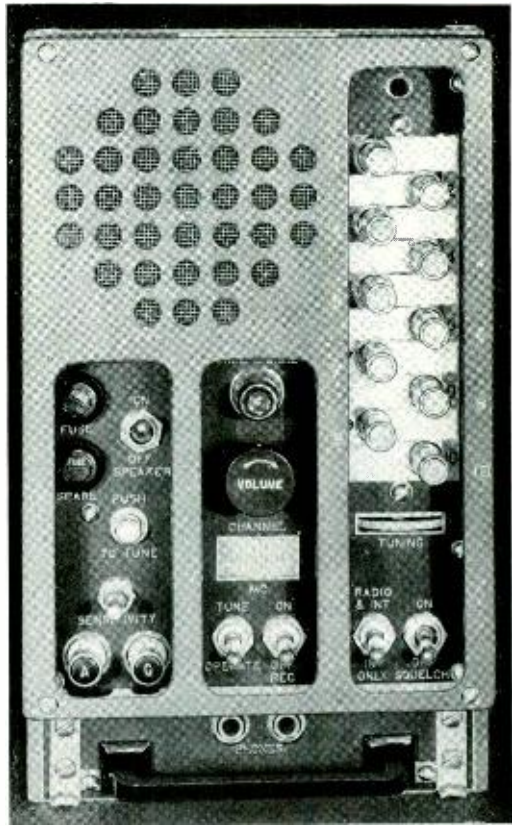
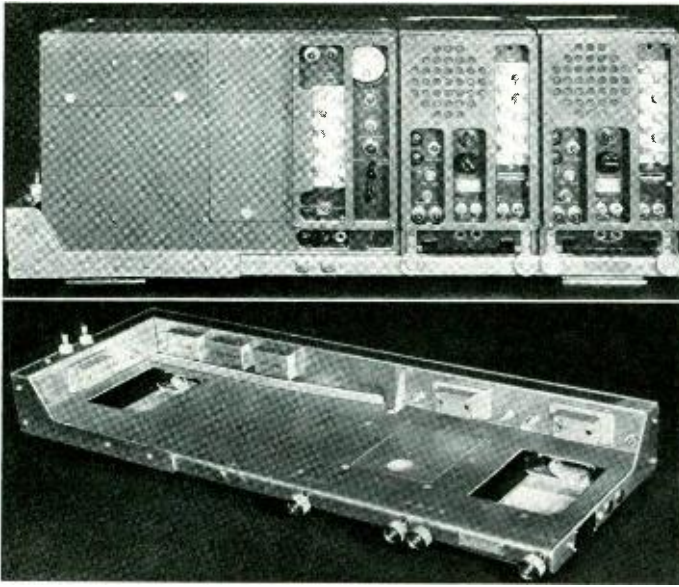

Fig. 3—Front view of the BC-603 radio receiver. Above the volume control on the control panel is a pilot lamp that lights at the time the signal is received

about seven millimeters square and less than a millimeter thick. The amount of quartz required is therefore small, which has proved to be a most important consideration in view of the very large number of crystals required. Another advantage of the new crystal cut is that it has a zero-temperature coefficient at one temperature within the operating range, and from  $-40$  degrees to  $+130$  degrees F. its change in frequency is less than 0.02 per cent. Still greater constancy is secured by maintaining the temperature of the crystal compartment above 65 degrees F. by a heating coil and thermostat. Satisfactory operation of the transmitter, however, does not depend on this temperature control.

Such very small and thin wafers of crystal are naturally delicate, and to secure a suitable mounting for them—a matter of careful



*Fig. 4—The FT-237 mounting shown in the lower view is used for all three sets and was designed to fit in the left sponson of a light tank, which is the smallest space available for radio equipment on any of the mobile units. The SCR-508 radio set is shown at the top*

design and precise manufacture for any crystal—required much research and development, as well as a very considerable amount of production engineering. Nearly ten million of these crystals have been made up to the present time for the “Tank” radio set alone. One of the crystal units used in the BC-604 transmitter is shown in Figure 2.

Like the transmitter, the BC-603 receiver, shown in Figure 3, is push-button controlled for ten frequencies, but also may be tuned manually throughout the band after releasing the push-buttons. The set is pre-tuned to each of the ten frequencies before the vehicles start out, but re-tuning to other frequencies is a simple process. The set incorporates a loudspeaker and two jacks for headsets. The controls normally used, besides the buttons for channel selection, are an ON-OFF switch, a volume control, and switches to disconnect the loudspeaker and the head receivers. The other controls are a switch to operate a beat oscillator, which is used during the initial setting of the push-button selector, a SQUELCH ON-OFF switch, to reduce the volume at the headset when no signal is

being received, and a SENSITIVITY control, which is used to adjust the operating point of the squelch circuit. The loudspeaker is connected directly to the receiver output, and is not affected by operation of the headset switch. This latter switch has a RADIO & INT (erphone) position and an INT ONLY position. When the switch is in the former position, both radio and interphone signals can be heard, but when it is in the INT ONLY position, the headset is disconnected from the radio receiver, and receives only interphone signals.

The BC-605 interphone amplifier is the equivalent of the voice-frequency amplifier of the transmitter, and is used only with those sets that do not employ a radio transmitter. This amplifier fits the same space and plugs into the same receptacles as the receiver.

All units are designed to operate on either a 12- or 24-volt battery, and include a dynamotor operated from the battery to generate the high voltages required. A separate dynamotor is provided for each battery voltage. Both occupy the same



**DON'T DESIGN YOUR OWN ANTENNA !  
- STICK TO WHAT'S RECOMMENDED.**

space, and since they are of the plug-in type, a change is a simple matter.

The FT-237 mounting, shown in Figure 4, is bolted to the tank or command car and employs semi-stiff rubber pads to absorb a certain amount of shock. The individual units are very rugged in construction, and

**KINDNESS Pays!**

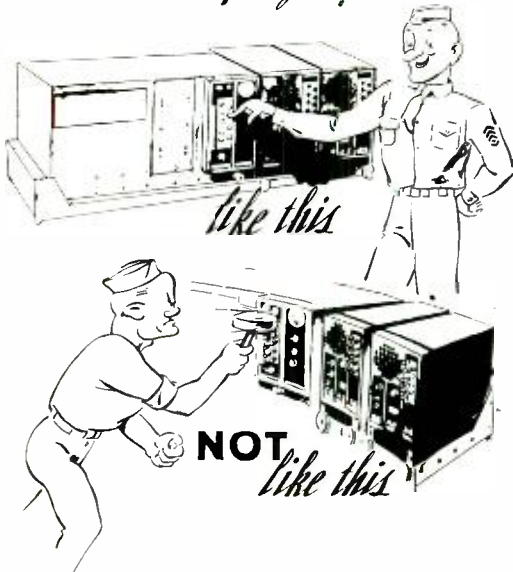

The cartoons on this and the preceding page were taken from the Technical Manual covering the installation, operation and maintenance of the radio sets described in the article

require no further protection. Each unit plugs into jacks and aligning pins along the back or end of the mounting, and is held down to the mounting by clamping screws. A transmitter and two receivers attached to the mounting form the SCR-508 radio set as shown in the upper part of Figure 4.

Another radio set, similar in appearance and circuit to that described above, was developed for the Field Artillery. It operates in a higher frequency band, and has crystals available for 120 channels. This is the SCR-608 radio set shown in the drawing on the cover of this issue.

Every detail of this equipment was carefully studied and tested to meet and suc-

**THE AUTHOR:** J. G. NORDAHL received the B.S. Degree in E.E. from the University of Washington in 1925 and immediately joined the technical staff of the Bell Laboratories where he was associated with the development of broadcast and other radio transmitters. From this group he transferred to the radio receiver development group where, at the beginning of our work on aircraft communications, he designed some of the first models of airplane receivers. From 1928 to 1940 he was engaged in the development of radio transmitters for commercial and Navy airplanes and for point-to-point, marine, and vehicular applications. His work during the latter part of this period was concerned with FM equipments and this led to his work on the radio sets described in the accompanying article. Mr. Nordahl is now engaged in a broader development of FM radio sets for Army uses.

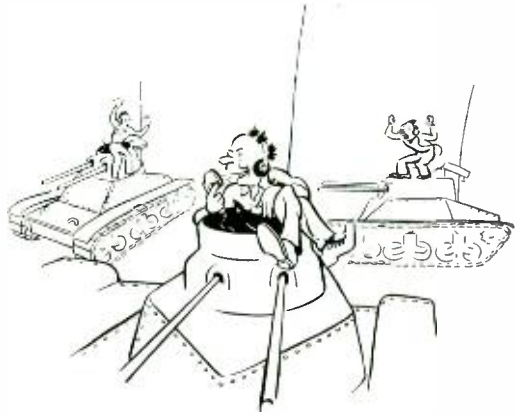

**CHEW THE FAT AT THE MESS  
-NOT AT THE MIKE!**

cessfully withstand the difficult conditions of combat use. Experience with the completed sets on all battlefronts has justified the care that has been taken, and has proved the underlying principles on which the sets were developed to be sound.





devised the constant current modulating circuit which has since been widely known as the Heising modulator. Working on a principle different from those of the earlier modulators, and employing only two stages, it was efficient and simple. This circuit was incorporated in the airplane sets developed in 1917 and in thousands of Western Electric radio equipments built for the Armed Services. For moderate power only two tubes are required: a voice amplifier and a carrier

generator. The size, weight, number of parts, and power were all reduced 75% from what would have been necessary with a set following transoceanic design; and the simplicity in adjustment was such that operating instructions could be reduced to a very few rules. The invention of this modulator made the radio telephone practical; and its basic principles have been incorporated in most of the transmitters of moderate power up to the present time.



U. S. Navy Photo

---

## United States Fleet Headquarters of the Commander in Chief

To the Men and Women  
of Bell Telephone Laboratories:

**O**N THIS fourth wartime Christmas I wish to extend greetings and thanks, in behalf of the fighting men of the fleet, to you whose loyal support on the production lines is helping to carry them to victory.

In a very real sense, our past successes have been paced by the great productive effort on the home front. They have been won through maximum cooperation between the assembly line and the firing line. It is imperative that this fine teamwork continue to the end of the struggle.

We must now redouble our efforts, for only by sustained hard work and hard fighting can we hope to shorten the war. I am confident that each one of you at this Christmas season will rededicate yourself anew to your individual wartime tasks in order that victory may be achieved as soon as possible—and that “Peace on earth, good will toward men” may be regained for all the nations of the world.

(Signed) ERNEST J. KING

Admiral, U. S. Navy

December 12, 1944



## Tensioning Open Wire for J-Carrier Systems

By J. A. CARR  
*Outside Plant Development*

wires is also made difficult because the transpositions involve an exchange of pin positions of the two wires of a pair, within less than a foot, as shown in Figure 2, instead of allowing the wires to change gradually over two spans, totaling 260 feet, as is done in the case of voice-frequency lines.

The method of installing and sagging wires employed until recently consumed considerable time in meeting these requirements. The usual procedure was to pull the wires over the crossarms in lengths of from one-half to three-quarters of a mile and apply tension through a tackle until the sag specified for the current temperature

was approximately obtained in each span. The sag in the two wires of a pair was equalized by connecting their ends to a short rope which was then passed through the tackle pulley.

With this arrangement, transposing was begun at the end remote from the tackle. A lineman stationed on the pole where the first transposition was to be made determined the sag in each wire of a pair by lining up the lowest point of the span with a target marked in inches and held by another lineman on the adjacent pole. The sags were adjusted and equalized by telephoning instructions to a man at the tackle who pulled in or let out wire as required. The lineman on the transposition pole pulled slack successively in each wire so that it could be placed across the diagonal of the transposition bracket and inserted in the grooves of the insulators, thus forming the transposition. More sighting and adjustments were often necessary to balance the sags and this

**W**IRE lines remain a familiar sight, particularly in open areas, even though toll-cable lines have been rapidly extended in recent years. The usefulness of these open-wire lines has been augmented, moreover, through the addition of high-frequency carrier systems which have considerably increased the number of communication channels they carry.

These added systems have imposed exacting structural requirements on the open-wire plant. To hold noise and crosstalk to a minimum, the wires of a pair must be transposed frequently and sag irregularities between them minimized. Transpositions on carrier lines average about fifteen per pair-mile of wire line, but they may be made at nearly every pole in some circuits. The average sag differences between the wires of a pair must not exceed three-quarters of an inch for type-J carrier circuits, although about three times this average is admissible in an individual span. Adjusting sags in the

procedure had to be repeated at each subsequent transposition point.

In a new method, which has been developed by the Laboratories, the set-up is similar but the procedure is made much simpler and faster by substituting a less cumbersome tool, the chain hoist, for the rope tackle. A spring balance, Figure 1, is also introduced to provide a ready means of checking the tension.

The procedure is simplified by establishing the proper sag in each wire of a pair throughout a long section at one operation before any transpositions are set up and then retaining this sag without further adjustments in the subsequent operations. This is accomplished by taking account of the geometry of the eight-inch transposition bracket, Figure 2, which is dimensioned to require approximately three inches more wire across the diagonal from insulator to insulator than along the side between insulators. Thus the necessary additional length of wire can be provided when each trans-

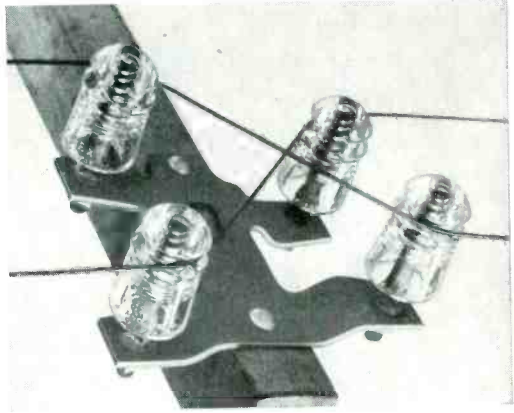

*Fig. 2—Wires of a pair are spaced eight inches apart and transpositions are made with the wires supported on brackets at slightly different levels. The transfer to opposite pin positions, requiring approximately three inches more wire across the diagonal from insulator to insulator, is made in a length of less than one foot instead of two span lengths or about 260 feet as in other systems*

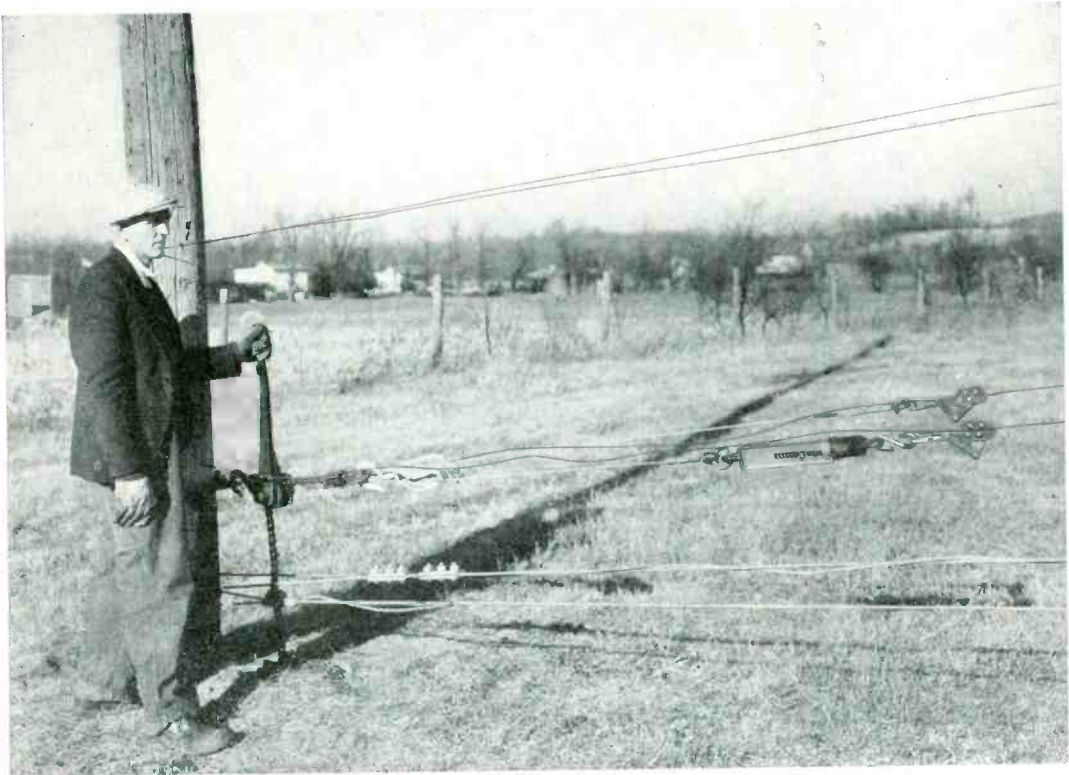

*Fig. 1—For tensioning J-carrier wire a chain hoist is used. A spring balance shows the tension and a tackle equalizes the pull*

position is made, by releasing three links of the chain, since each link is one inch long.

This method requires only one lineman at a transposition point, instead of two. He attaches snubbing clamps, as shown in the headpiece, to the insulators on the transposition bracket to hold the tension constant in the direction of the completed construction. Several inches of slack are then released at the distant chain hoist and pulled to the transposition point by a special slack puller equipped with an equalizer to insure, without measurement, an approximate equality of sag between the wires of a pair. This permits the wires to be transposed and placed in the insulator grooves without changing the established tension. All slack over the three inches required to make the transposition is then pulled back by the chain hoist to restore the wires to the prescribed tension. After removing the slack puller and snubbing clamps, the transposition is complete.

By this method, wires about a mile in length have been placed and transposed in straight and approximately level sections of lines, with average sag differences between the wires of a pair of a small fraction of an inch. Where corners are involved and grades are steep, some reduction in these lengths

may have to be made, but the wires can be strung in longer sections than formerly.

Experience has indicated that this new method improves noise and crosstalk conditions by decreasing sag irregularities, and there is also a saving of at least one-third of the time formerly required to place and sag a pair of wires. This time saving permits more prompt completion of the work, especially on large jobs, and results in a marked saving in construction costs.

---

THE AUTHOR: JAMES A. CARR received the B.S. degree in Electrical Engineering from the



Virginia Polytechnic Institute in 1919. He was an instructor in Electrical Engineering at the Massachusetts Institute of Technology the following year. In 1921 he joined the Development and Research Department of the American Telephone & Telegraph Company where he

remained until 1927 when he transferred to the Laboratories. Mr. Carr has been engaged principally in systems development work in the Outside Plant Development Department.

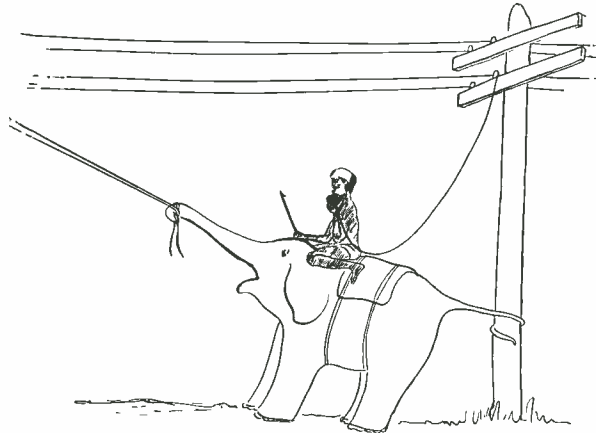

# Daylight

**A**LTHOUGH December 21 is the shortest day of the year, the sun does not rise latest on that day nor does it set earliest. The latest sunrise actually occurs about January 6, while earliest sunset is about December 8, but on these two days, the day is only six or seven minutes longer than on the 21st.

A similar phenomenon occurs during the time of the longest day of the year, which is June 21. The latest sunset, however, is about June 28, while the earliest sunrise is about June 14. The difference in the length of the day between these two later days and the 21st, however, is only about one minute.

These facts are illustrated

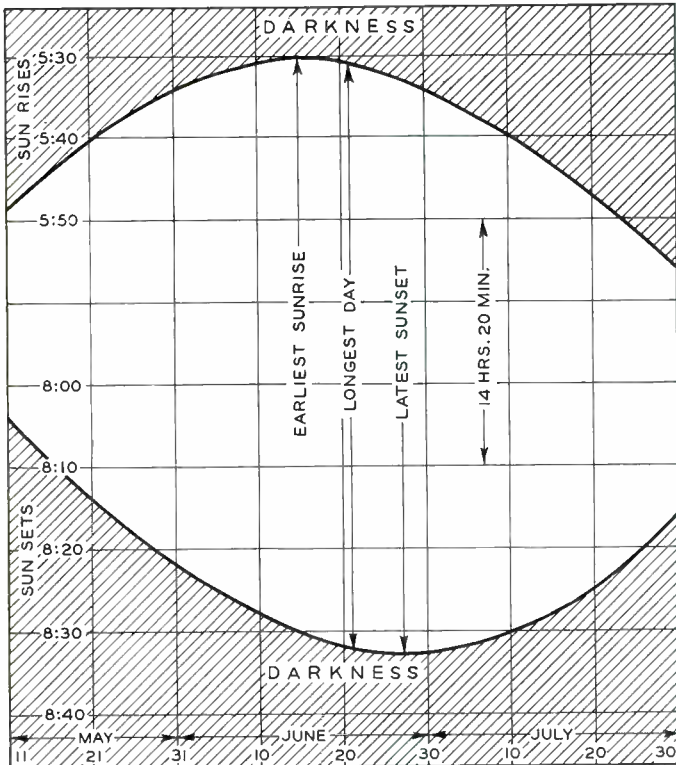
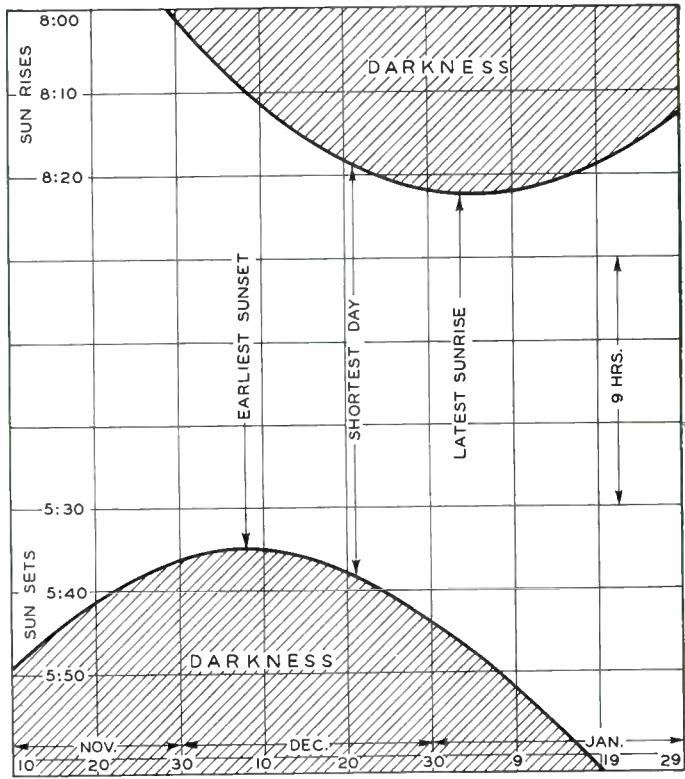

by the two accompanying diagrams originally prepared by J. O. Perrine of the A T & T—one for the season of the shortest day, and one for that of the longest. The graphs are plotted for war time, which is one hour later than standard time. The time is that for the standard time meridians—the 75th, 90th, 105th, and 120th, corresponding to Eastern, Central, Mountain, and Pacific Times. For locations east or west of the standard meridians, the times will be earlier or later by four minutes for each degree of longitude.

The times of sunrise and sunset, and the length of the period between them, will also vary considerably with the latitude. The charts are drawn for a latitude of 40 degrees, which is that of Philadelphia; Springfield, Ohio; Denver; and

about 30 miles south of Reno, Nevada. For latitudes north of 40 degrees, the sun will rise earlier and set later in the summer, and rise later and set earlier in the winter, while for latitudes less than 40 degrees, the differences will be in the opposite direction.

### Western Electric Company's 75th Anniversary

During November nearly 100,000 men and women, comprising the nation-wide family of the Western Electric Company, observed the organization's 75th Anniversary. Western Electric—the manufacturing, purchasing and supply unit of the Bell

System—has become, during World War II, the Nation's largest producer of communications and electronic equipment for the Armed Forces.

As part of the anniversary observance, employees of the company in key cities from coast to coast saw a feature-length motion picture entitled *Heritage for Victory* which dramatizes the growth of the organization over three-quarters of a century and demonstrates how Western Electric's cumulative skill, technique and experience has increased during these 75 years. This film was shown to members of the Laboratories during the week of December 11.

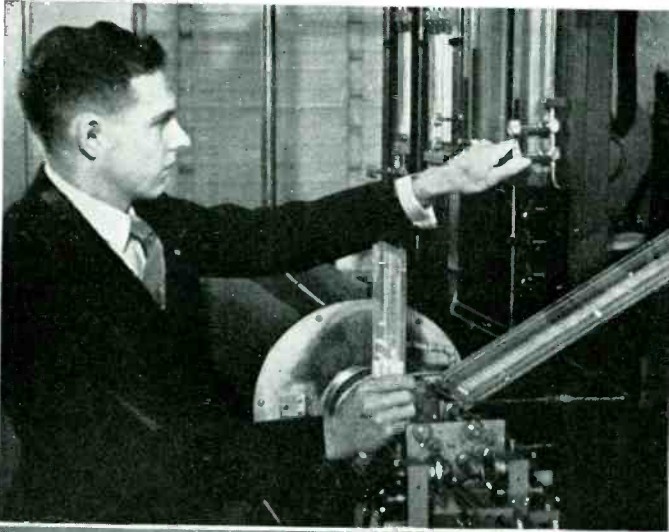

*Several scenes taken at West Street and at Murray Hill appeared in the feature-length Western Electric motion picture "Heritage for Victory" which was shown recently in the West Street auditorium and at the Murray Hill and Whippany Laboratories*

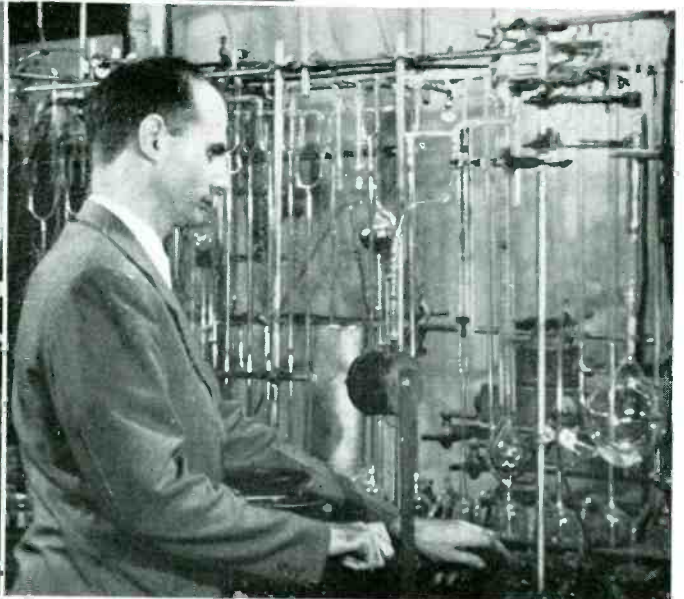



*Bell Laboratories participated in the Western Electric Company's 75th Anniversary show at the Hotel Astor by providing exhibits of war developments. J. R. Erickson, J. W. Pollio and F. L. Crutchfield explained features of the equipment. Above, left, Fred Lack demonstrates the use of the lip microphone to his wife and daughter*

### Spiral-Four Unscathed by Bombs

A spiral-four carrier system in England has been in continuous operation since May, 1944, with 60 miles of cable suspended from poles, according to a War Department press release. Recently several bombs were dropped in the immediate vicinity of the pole line and although open-wire lines on the same pole line were damaged and put out of service, the spiral-four cable was found to be undamaged.

Three telephone, four teletypewriter and two d-c ground-return simplex circuits are provided on this system. The repeaters are spaced approximately 20 miles from the terminals and located in private buildings. In order to facilitate maintenance, an alarm and signaling circuit operating over one of the simplex circuits is used for signaling between the carrier terminals and intermediate repeaters. Since this carrier system was first installed it has given excellent service with only a two-minute interruption in service on one occasion caused by a tube burning out.

The spiral-four cable is hung unsupported between poles except at highway crossings and through some towns where the cable is

supported by messenger wire. The cable is fastened to the poles by means of open helix spring hangers which are placed on drive hooks. The method has been useful, for when a pole is struck by a vehicle the spring hanger jumps off the hook, allowing the pole to fall free of the cable. This has happened in two cases and necessitated only replacing the pole.

### Patents Issued

During the month of November the United States Patent Office issued patents on applications previously filed by the following members of the Laboratories:

W. O. Baker	H. C. Harrison
B. S. Biggs	R. V. L. Hartley
N. Botsford	C. N. Hickman
J. G. Chaffee	W. H. T. Holden
S. Darlington	R. H. Hose
R. C. Davis	F. A. Hubbard
S. Doba, Jr.	R. F. Mallina
J. O. Edson	W. H. Matthies
W. C. Ellis	S. O. Morgan
L. Ferguson	N. Y. Priessman
C. J. Frosch	W. G. Shepherd
G. W. Gilman (2)	A. G. Souden
M. C. Goddard	A. H. White
S. G. Hale	F. M. Wiese

E. E. Wright

## News of the Movie Club

The Bell Laboratories Motion Picture Club inaugurated its sixth season on October 4. The invited exhibitor for the occasion, Leo Hefferman, president of the Metropolitan Motion Picture Club, presented his color film *South of 36 North*, depicting many points of interest in Florida. George Ward, announcer for Radio Station WNYC, gave an accompanying spoken commentary.

Recently the Club screened the amusing *The Will and the Way*, Hiram Maxim Award Winner in 1940 and, on the same evening, *Sunstruck* by George Mesaros. *Sunstruck* received honorable mention in the 1944 Amateur Cinema League contest.

The Club's mid-season contest will again be conducted this year, with prizes of War Stamps for the four best films. Entries may be 8 or 16 mm, monochrome or color, of any



G. Q. Lumsden, in the top photograph, demonstrates ground line treatment of standing poles at the Chester Field Station. The spectators are representatives of the Bell of Canada, and of the New England, Michigan, Ohio, New Jersey, Chesapeake & Potomac, and Southern

Bell Companies, the Long Lines and O & E of the A T & T, and the Laboratories. Lower left, R. H. Colley discusses the completed treatment on a chestnut pole section. The party then inspects a new form of rural construction—a "pin-socket" pole line





Over 80 members of the Laboratories attended the dinner to honor C. R. Englund, recently retired

length, and there is no restriction to the number of films a contestant may enter. However, only one prize will be awarded to any contestant. Pictures entered in previous contests, whether or not they have been prize winners, may be entered.

Pictures entered will be eligible for entry in the annual contest, conducted next May, unless they have already been awarded prizes in previous annual contests. Closing date for entries, which should be submitted to H. L. Bowman, is January 18.

### J. J. Harley Awarded Amateur Motion Picture Award

In 1937, Percy Maxim Lee, daughter of the late Hiram Percy Maxim, instituted an award in memory of her father. The acquire-

ment of this connotes that the winner's film is the best non-theatrical motion picture presented in that year and is the most coveted award an amateur may receive in America. This year J. J. Harley received the trophy for his motion picture *In His Own Judgment*. Filmed entirely in color, Mr. Harley spent almost all his spare time over a period of two years on it. It will be presented at the Laboratories at a meeting of the Bell Laboratories Motion Picture Club at a date to be announced later.

### Western Electric in Paris Resumes Operation

According to recent advices from Paris received in New York by the Western Electric Export Corporation, preliminary indi-

### December Service Anniversaries of Members of the Laboratories

<b>10 years</b>	D. W. Bodle	<b>20 years</b>	Helen Cruger	Michael Tompa
Vera Carron	O. L. Boothby	Clement Bosch	S. T. Curran	C. C. Towne
T. J. Corcoran	C. A. Brigham	G. A. Brodley	E. N. Danes	C. W. Van Duyne
Evelyn Fitzsimmons	Patrick Currie	E. W. Conger	Carl Deelwater	Markley Wean
C. M. Jason	J. V. Domaleski	C. J. Gerth	W. S. Gorton	C. A. Wingardner
Dorothy Johnston	D. T. Eighmey	Charlotte Hamilton	A. H. Hilternen	
J. H. McConville	C. W. F. Hahner	H. E. Johnson	R. F. Massonneau	<b>30 years</b>
	J. F. Hanley	H. M. Lahm	D. R. McCormack	W. A. Knoop
	C. W. Jones	Joseph McTaggart	E. W. Newman	
<b>15 years</b>	R. P. Muhlsteff	H. M. Spicer	A. J. Parsons	<b>35 years</b>
Attilio Baltera	A. J. Rack		Joseph Popino	C. S. Demarest
C. A. Bengtsen	H. A. Sauer	<b>25 years</b>	A. D. Soper	
	Carmelo Vassallo	B. A. Clarke	L. E. Stolzenberg	

cations are that little damage was done to the French Company's Paris installations and that normal operation may soon be resumed. Of the ten French employees of the Paris office who became prisoners of war at the time of the French capitulation in 1940, two have since been released for ill health and have returned to their old jobs and one, who escaped, was sent to the branch office in Tunisia to put him at a safe distance from the Germans. It has also been learned that the staff of the Paris office is rendering meritorious service to the Army's Psychological Warfare Branch in that area. Formerly known as the Societé de Materiel Acoustique, Inc., the Algiers branch is already operating under the Company's new name, Western Electric Company (France), which will be adopted by the Paris and Brussels offices as soon as registration documents can be forwarded there.

The Western Electric Company of Italy, which was being administered by a Seques-

A limited number of reprints of the article *The Career of Frank Baldwin Jewett—An Appreciation by John Mills*, published in the October issue of the RECORD, are available upon written request to the West Street Library.

trator appointed by the Fascist government following Italy's declaration of war on the United States, is now functioning almost normally again under supervision of the Property Comptroller of AMG according to a letter from Signor D. Dona dalle Rose, manager, at the Company's Rome office.

The Western Electric Export Corporation is working in close coöperation with the Motion Picture Bureau of the Overseas Branch of the OWI and is supplying urgently needed theater materials through that organization to these liberated areas.

## "THE TELEPHONE HOUR"

(NBC, Monday Nights, 9:00 P.M., Eastern War Time)

### JANUARY 8, 1945

Waltzing Matilda	<i>Cowan</i>
Annie Laurie	<i>Scott</i>
Marjorie Lawrence	
Valse from "Serenade for Strings"	<i>Tschaikowsky</i>
Orchestra	
This Day Is Mine	<i>Ware</i>
Marjorie Lawrence	
In the Village	<i>Ippolitoff-Ivanoff</i>
from "Caucasian Sketches"	
Orchestra	
Narrative and Curse	<i>Wagner</i>
from "Tristan and Isolde"	
Marjorie Lawrence	

### JANUARY 15, 1945

Jingle, Jangle, Jungle Bells	<i>Arranged</i>
Orchestra	
Recit.—Ella giammai m'amo	<i>Verdi</i>
Aria Dormiro sol nel manto mio regal	
from "Don Carolos"	
Ezio Pinza	
Remember Me	<i>Seaver</i>
Ezio Pinza	
Overture to "William Tell"	<i>Rossini</i>
Orchestra	
Aria of the Tambour—Major	<i>Thomas</i>
from "Le Caid"	
Ezio Pinza	

### JANUARY 22, 1945

Furiant from "Schwanda"	<i>Weinberger</i>
Orchestra	
Think on Me	<i>Scott</i>
Bidu Sayão	
Valse Bluette	<i>Drigo</i>
Orchestra	
El Merção de les Esclavas	<i>Sandoval</i>
The Rats	<i>Vene</i>
Bidu Sayão	
Bolero	<i>Ravel</i>
Orchestra	
Waltz from "Romeo and Juliet"	<i>Gounod</i>
Bidu Sayão	

### JANUARY 29, 1945

Dance of the Tumblers	<i>Rimsky-Korsakoff</i>
from "The Snow Maiden"	
Orchestra	
After Sundown from "Tallahassee Suite"	<i>Scott</i>
Jamaican Rumba	<i>Benjamin</i>
Masks from "Romeo and Juliet"	<i>Prokofieff-Heifetz</i>
Jascha Heifetz	
The Skaters' Waltz	<i>Waldteufel</i>
Orchestra	
Hungarian Dance No. 1	<i>Brahms</i>
Ave Maria	<i>Schubert</i>
Jascha Heifetz	

Bell Laboratories' Club has no more tickets for these programs because its limited supply has already been distributed to applicants.

W. J. Albershiem  
 Anne Ashton  
 J. F. Ballard  
 M. E. Brandin  
 M. Brotherton  
 A. T. Calvano  
 R. H. Day  
 A. F. Duerr  
 L. Feinstein  
 H. W. Finne  
 E. Fischer  
 A. W. Frey  
 A. A. Galasso  
 H. F. Gartner  
 H. Grutzner

# Red Cross Blood Donors



K. W. Hansen  
 W. F. Hoover

C. T. Huhn

H. Hurray  
 W. C. Jensen

W. A. Krueger  
 J. G. Matthews  
 C. F. McAteer  
 K. H. Melick  
 J. S. Munies  
 T. J. O'Connor  
 Tedi Primiano  
 G. L. Pross  
 E. W. Kahn  
 P. Randolph  
 C. G. Reinschmidt  
 D. J. Ryan  
 H. J. Sheridan  
 E. G. White  
 L. H. Whitman

## Radio Pinch-Hits for Telephone Lines

When the hurricane of October 18 and 19 temporarily halted practically all long distance telephone service into Miami by causing several breaks in the important St. Augustine-West Palm Beach line, A T & T Long Lines overseas radio telephone facilities were called upon to handle calls between New York and Miami for a period of five hours during the evening of October 19. By 11 o'clock that night fast-working linemen had repaired the breaks in the line which had been caused largely by objects driven against the wires and poles by high winds. This use of radio telephone facilities for continuing domestic long distance service in emergencies is another example of Bell System measures for service protection.

During the Florida storm, the transmitting stations used were at Ocean Gate, N. J., and at Ojus, Fla., and the receiving points at Netcong, N. J., and Hialeah, Fla. In selecting antennas for the purpose, the Long Lines chose New Jersey facilities which, during certain hours of the day, handle service to Lima, Peru. They are so "aimed"

that they can be operated satisfactorily with the stations in Florida.

At the Florida end of this emergency circuit, facilities were selected which during a part of the day are employed in handling radio telephone calls to Nicaragua and Costa Rica. Since their normal path of transmis-



*Over 3,300 dolls, toys and games were collected by the Doll and Toy Committee and distributed to underprivileged children by 55 institutions and welfare agencies in New York City. Here we see some of the many games that were included*

sion and reception is southward, the antennas at Ojus and Hialeah were reversed by making electrical changes at the stations.

The circuit between New Jersey and Florida was not the only radio channel to be used in maintaining telephone service in Florida following the hurricane. After the Jacksonville-Key West line failed on the causeway crossing the Florida Keys, portable radio transmitters and receivers were set up to bridge a gap in the line between Key West and a point 20 miles east.

### Greater New York Fund Raised Over \$4,620,000 in 1944

The Greater New York Fund's 1944 Campaign among business concerns and employee groups in behalf of 408 local hospitals, health and welfare agencies has reached and passed its 1944 financial goal. As of December 6, with nearly a month to go before the books closed, 21,308 business concerns and employee groups had contributed \$4,620,275. This contrasts with the 1944 minimum goal of \$4,500,000 and total contributions for the twelve months of 1943 of \$4,333,973. The Laboratories' part in this was \$12,621.51 for 1944 compared with \$8,185.75 for the previous year.



Clarence G. Stoll, president of the Western Electric Company, has been elected president of the Telephone Pioneers of America for 1945

## STOPPING DISTANCES on Various Road Surfaces at 20 M. P. H.

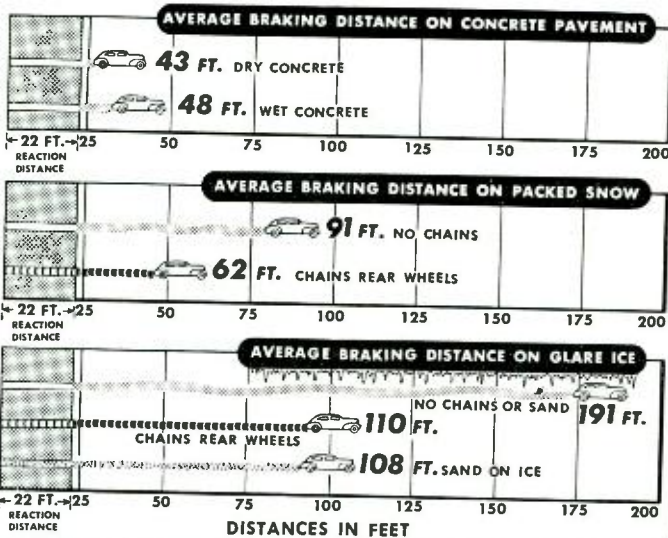

WINTER DRIVING FACTS  
War production and safety authorities are concerned because last winter's traffic death rate in the snow belt was 53 per cent above the preceding summer rate. Chart shows National Safety Council research facts. A car travels 22-foot "Reaction Distance" while driver reacts and applies brakes after seeing reason to stop. Major winter hazards are skidding and reduced visibility. Are your brakes, tire chains, windshield wiper, defroster and lights in good condition for winter driving? Neglect of any one may mean sliding to the junk pile or hospital!

## WHERE THE FLYING BOMBS LANDED IN THE KENT SECTION OF ENGLAND

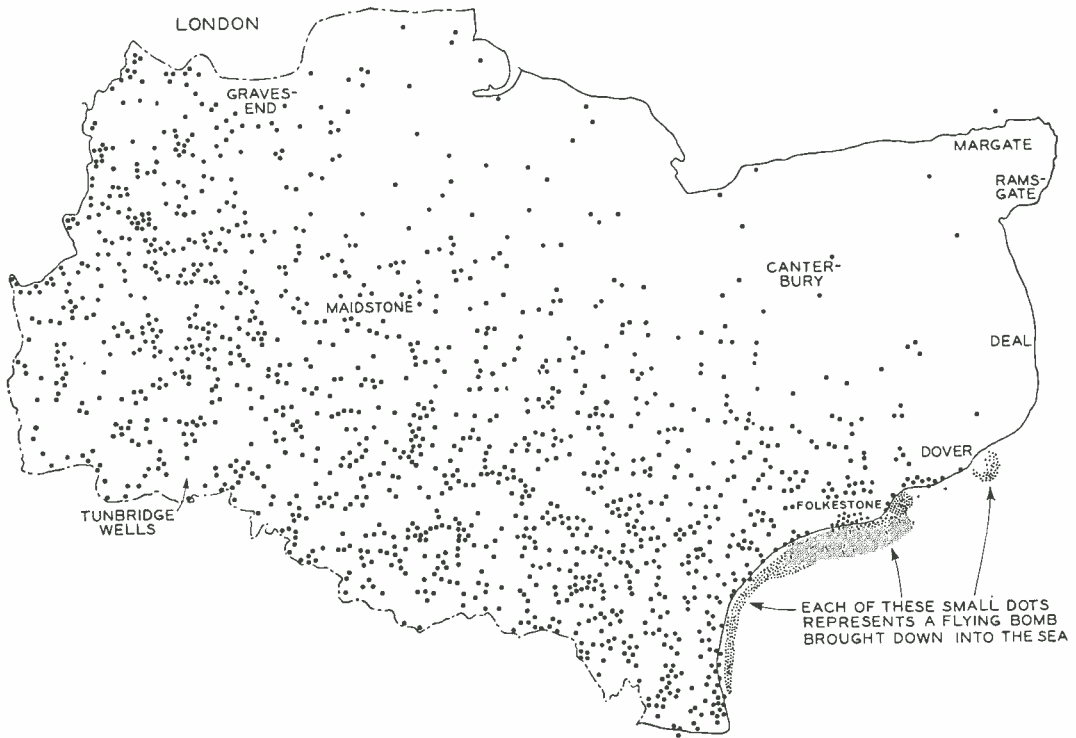

*This map shows where each flying bomb landed in the Kent section of England and vividly portrays how Kent earned the name of "Bomb Alley." The number of bombs shown fell within a period of about 80 days. Many of those brought down at the coast were by anti-aircraft guns as discussed in the article "Electrical Director Helps Bring Down Buzz-Bombs," published in the October, 1944, issue of the RECORD. The original map appeared in the "Kent Messenger," the county paper of Kent*



*On October 19, 1944, 114 members of the Systems Development Drafting Department gathered at Zimmerman's on 46th Street to fête six of their number who had attained twenty-five years of Bell System service during 1944. A. B. Kvaal presented appropriate souvenirs to (left to right) L. W. Drenkard, A. O. Easton, C. Gittenberger, J. M. Harriott, A. L. Hogan, and E. S. Wolek from their associates. G. C. Berndt, temporarily at Point Breeze, was likewise remembered*

January 1945

## Signal Equipment Being Salvaged at Front

The Salvage and Service Branch of the Signal Supply Division is pushing vigorously the program for the salvage, recovery, and servicing of all signal equipment in the European theater of operations. It had a remarkable inception as a one-man organization. The man was Lieutenant Colonel Guy N. Church, and his sole responsibility at the beginning was to recover wire.

At first everything had to be borrowed—trucks, equipment, officers and men—but these were all rounded up and the teams went to work with a will. Wire began to roll in at the rate of approximately 25 to 30 reels of W-110-B field wire per day, and 25 reels of Spiral-4 cable per day.

As the armies advanced, the territory to be covered was doubled, and redoubled. Further aid was made available, temporarily, and until recalled for its primary

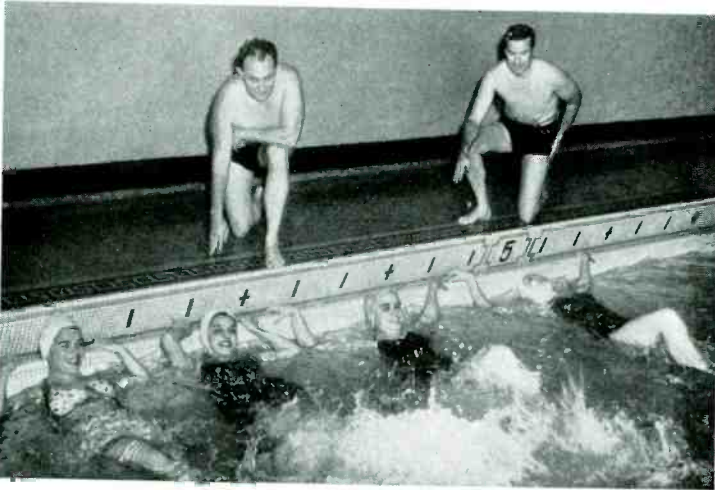

*Indoor swimming classes are being conducted this winter at the Summit Y.M.C.A. pool for members of the Murray Hill laboratory. These classes are under the auspices of the Red Cross with J. B. De Coste, L. Ferguson and W. C. Buckland as instructors. Marjorie Sampson, Mary Gargiulo, Mary Wiggins and Mildred Hoogstraat demonstrate inverted flutter kick and L. Ferguson gives instruction in sculling*



mission, this new unit did fine work, recovering several thousand miles of Spiral-4 and field wire, all of which was duly serviced by a repair unit. The temporary "loan" of the extra unit was for a period of only 3½ weeks, but near-miracles were accomplished.

After the Salvage and Service Branch had been established, Personnel Division made arrangements for teams to be used permanently in signal salvage work, and developed plans to have those teams available within a short time. Up to the day of a recent report nearly 5,000 reels of Spiral-4 and 15,000 miles of field wire had been picked up.

### "Hi, Mom, It's Me!"

The story of how 5,000 soldiers, returned from combat fronts, were provided with an 8-booth attended public telephone station in 13½ hours is told by Frederick H. Dochtermann in an article in the *Telephone Review*. "On a recent Wednesday afternoon we were advised by the Colonel in Charge of the Signal Section at this installation of the New York Port of Embarkation that a shipment of 5,000 men was expected to arrive some time during the afternoon of the following Friday. They were returning from months of tough combat service. We knew that their first thought would be how to contact their loved ones."

By begging, borrowing, and improvising they managed to set up an 8-booth attended public telephone station in exactly 13½



About twenty associates of W. A. Knoop (right) helped him celebrate his thirty years of service at a recent luncheon. Here we see J. R. Wilson and Mr. Knoop

working hours. The first day 1,521 calls were handled, for an average of 45 to 50 calls per hour. "Hello, Mom, it's me!" was heard a thousand times. This remark alone made well worth while any amount of time, trouble or effort required to provide this service for these men.

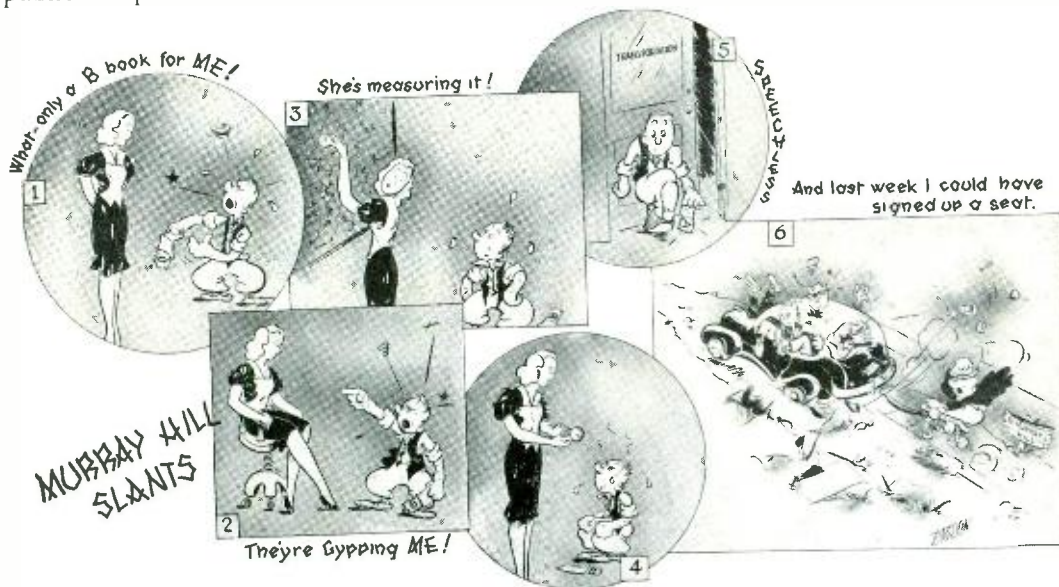

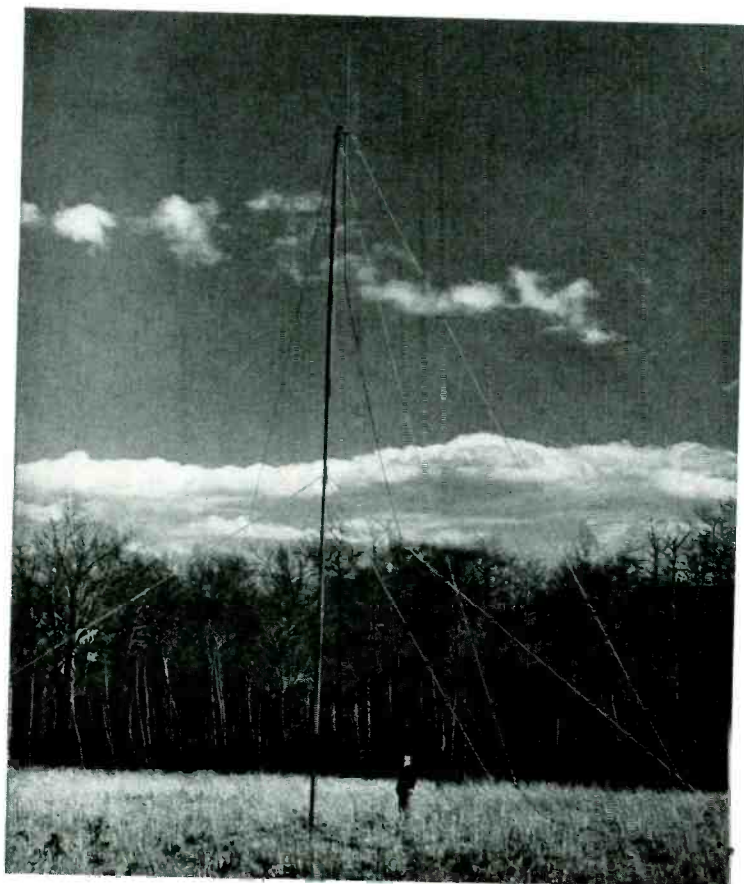

## Plywood Radio Masts for Signal Corps

mast of molded plywood tubing in eight  $6\frac{1}{4}$ -foot sections could be built to meet the requirements. Masts of this type are now being obtained by the Signal Corps. Two sizes of tubing are used in each of mast, one with an outside diameter of four inches and the other of  $3\frac{1}{2}$  inches. A boom made of two sections 3 inches in diameter is used to raise the mast. An assembled mast with the antenna in place is shown in the photograph at left. The antenna can be raised or

**I**N CONNECTION with certain investigations of radio systems which the Laboratories conducted for the Air Forces and Signal Corps, it became apparent that there was need for a 50-foot antenna mast that was portable and could be easily erected on any terrain. After a thorough study of the problem, and of the strengths and weights of various materials, it was decided that a

lowered after the mast is erected.

The plywood tubing is obtained from the U. S. Plywood Corporation. The complete mast, including the necessary fittings, guy ropes, stakes, etc., all assembled in a canvas carrying case, is built by the Maryland Engineering Company in accordance with specifications drawn up by the Laboratories. A mast in its carrying case is shown below.

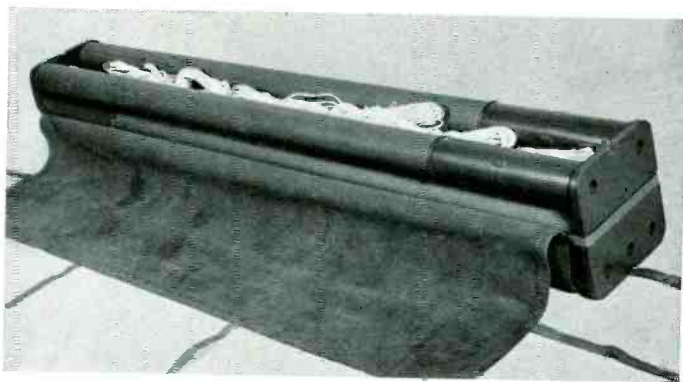



# Junctor Grouping in Crossbar Toll

By G. E. DUSTIN  
*Switching Equipment Engineering*

**I**N THE crossbar toll system, two sets of frames, called incoming and outgoing frames, comprise the toll train.\* Junctors are the groups of wires that interconnect them, and they run from the secondary verticals of the incoming frames to the primary verticals of the outgoing frames. The junctors connecting one incoming to one outgoing frame form a junctor group. Since the number of frames may change from time to time as the load on an office increases, the number of junctors in a group will necessarily vary because the total number of junctors leaving any one incoming frame is fixed by the number of secondary verticals. With 20 verticals per

switch and 10 switches per frame, there is a total of 200 junctors leaving each incoming frame, and they will be divided evenly among the outgoing frames. If there were only five outgoing frames, there could be 40 junctors to each, while if there were 10 outgoing frames, there could be only 20 to each. With 20 outgoing frames, which is the maximum number incorporated in a toll crossbar train, there would be only 10 junctors to each under these conditions.

This analysis gives the maximum number of junctors per group when there are 200 available from each incoming train, but the actual number required to give a desired grade of service is determined by probability theory, and will vary from 50 to 20 for

\*RECORD, April, 1944, p. 355.

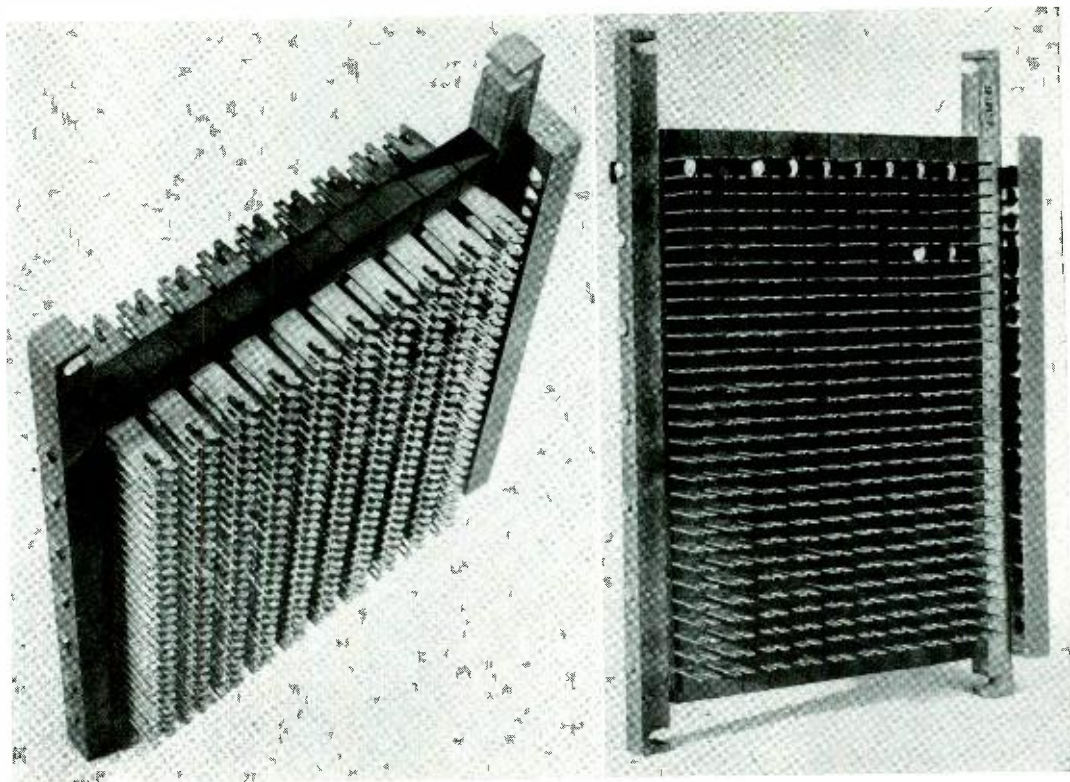

Fig. 1—Terminal strip used with the JGF, as seen from above and from the front

intertoll trains, depending on the number of outgoing frames in the train. Since with more than 10 outgoing frames the groups would have less than 20 junctors when only 200 are available at each incoming frame, extension frames are provided whenever the office requires, or may require with growth,

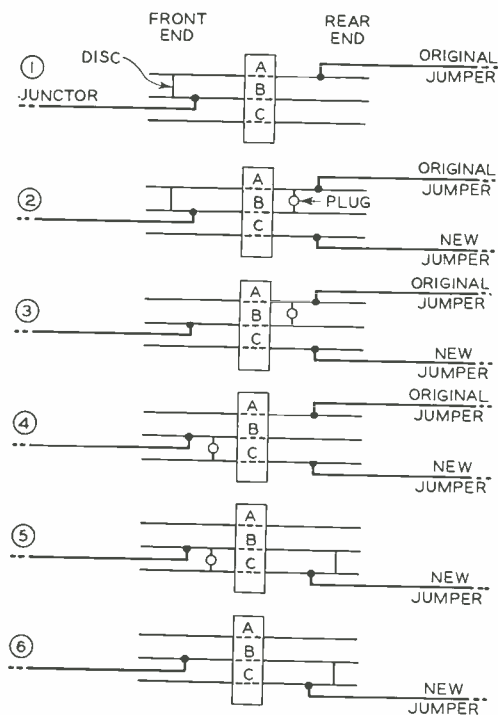

Fig. 2—Six steps in cutting in a new frame on the JGF. Only one lead of one junctor is indicated in each sketch

more than 10 outgoing frames. The extension frames make 400 junctors available at each incoming frame, but the traffic arriving at the secondary switch of an incoming frame is not sufficient to provide a load for 400 junctors. When extension frames are used, therefore, the incoming frames are arranged in pairs called "incoming groups," and the corresponding secondary verticals of each frame of an incoming group are connected to the same junctor.

A crossbar toll office might, as an example, be originally installed with eight outgoing frames with a prospect of growing to an ultimate of 20 frames. For the original installation, there could be a maximum of 50 junctors from each incoming group to each

outgoing frame, but as the size of the office increased, the size of the junctor groups could be decreased because, with more outgoing frames, the number of calls from any one incoming group to any particular outgoing frame will be less. The amount of traffic any incoming frame can handle is fixed by the number of links and junctors, and this fixed amount of traffic is divided among the outgoing frames. The amount of traffic and the number of junctors to handle the traffic to each outgoing frame is thus on the average roughly inversely proportional to the number of outgoing frames. As the number of frames in an office is increased, therefore, the grouping of the junctors must be rearranged.

Using the methods of ordinary telephone practice, such changes would be provided for by wiring the junctors from the incoming groups to one set of terminal strips and those from the outgoing frames to another set. Grouping could then be accomplished by running jumpers between the two sets of terminals. With such a conventional arrangement, the amount of work involved in regrouping junctors to take care of a change in the size of the central office would be considerable, however, and would require a long cut-over time.

Consider, for example, a toll train with six incoming groups and 12 outgoing frames, which is to be increased to seven incoming groups and 14 outgoing frames. With 12 outgoing frames, 30 junctors are employed in each group, and since there is one group of junctors from each incoming group to each outgoing frame, there is a total of  $6 \times 30 \times 12 = 2,160$  junctors. Since six incoming groups have terminals for 2,400 junctors, there will thus be 240 sets of terminals—40 on each incoming group—that are not used. With 14 outgoing frames, on the other hand, only 25 junctors per group are employed, and thus the total number of junctors will be  $7 \times 25 \times 14 = 2,450$ . Of this number, 50 will be run between the new incoming group and the two new outgoing frames, and since these can be run while the frames are being installed, they will not affect the cut-over time. Of the junctors between existing frames,  $6 \times 25 \times 12 = 1,800$  need not be changed, and  $6 \times 20 \times 2 = 240$  junctors from the unused terminals of the existing in-

coming group to the two new outgoing frames may also be run without affecting the cut-over time. This leaves  $2,450 - (50 + 1,800 + 240) = 360$  junctors that are involved in the cut-over. To run 360 new jumpers, including unsoldering and soldering, where each junctor has five leads, would be a long and involved proceeding if the ordinary form of terminal strip were employed. To make a quicker cut-over possible, a special form of junctor grouping frame, referred to as the JGF, has been developed.

The terminal strip, Figure 1, used with the JGF employs three terminal punchings for each junctor lead, marked A, B, and C. Each end of each punching has two prongs, one being notched for soldering and the other being slotted. Between two adjacent slotted punchings, a metal disc may be inserted and soldered in place to form a connection. How such terminals permit a rapid change of junctor grouping is illustrated in Figure 2.

Sketch 1, at the top, shows the arrangement for one lead of a junctor for the original installation. One of the leads of a junctor from an incoming group is soldered to the front end of the B punching, and a jumper to a similar set of punchings that has a cable lead to an outgoing frame is soldered to the rear end of the A punching. A disc soldered between the A and B punchings at the front end completes the connection. When an increase in the number of frames in the office requires that these intercon-

nections at the JGF be changed, the first step taken is shown in sketch 2. The new jumper is soldered to the back end of the C punching, and a specially designed plug is inserted between the A and B punchings on the rear side. Then the soldered disc between the A and B punchings at the front end is removed as shown in sketch 3. Up until this time, no change of connection has actually been made, and the office is still operating on the original basis. By merely removing the plug from between the A and B punchings at the rear end, and inserting it between the B and C punchings at the front, as shown in sketch 4, the change in junctor connections is made. To make the connection permanent, a disc is soldered between the B and C punchings at the rear, as shown in sketch 5, and the original jumper is removed. This is followed by the removal of the plug from the front end of the junctor as shown in sketch 6, and this part of the work is completed.

Each junctor has five sets of punchings like those shown in Figure 2, and the plugs used have 10 contacts, and make connections for the 10 leads of two junctors at the same time. The double-pronged terminal punchings are built into terminal strips as shown in Figure 1. Each such terminal strip has 30 rows of 10 terminal punchings each, and thus each three rows provide the three terminals for each of the five leads of two junctors, and a complete terminal strip of 30 rows thus provides for 20 junctors. A

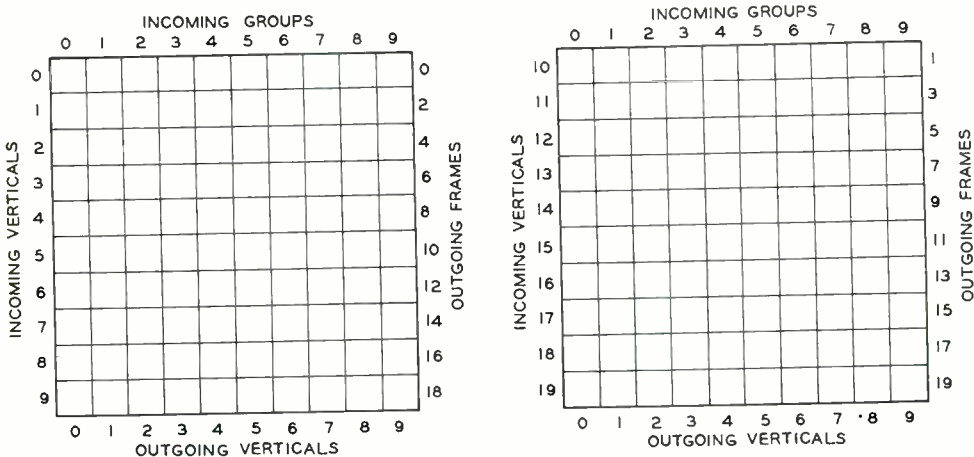
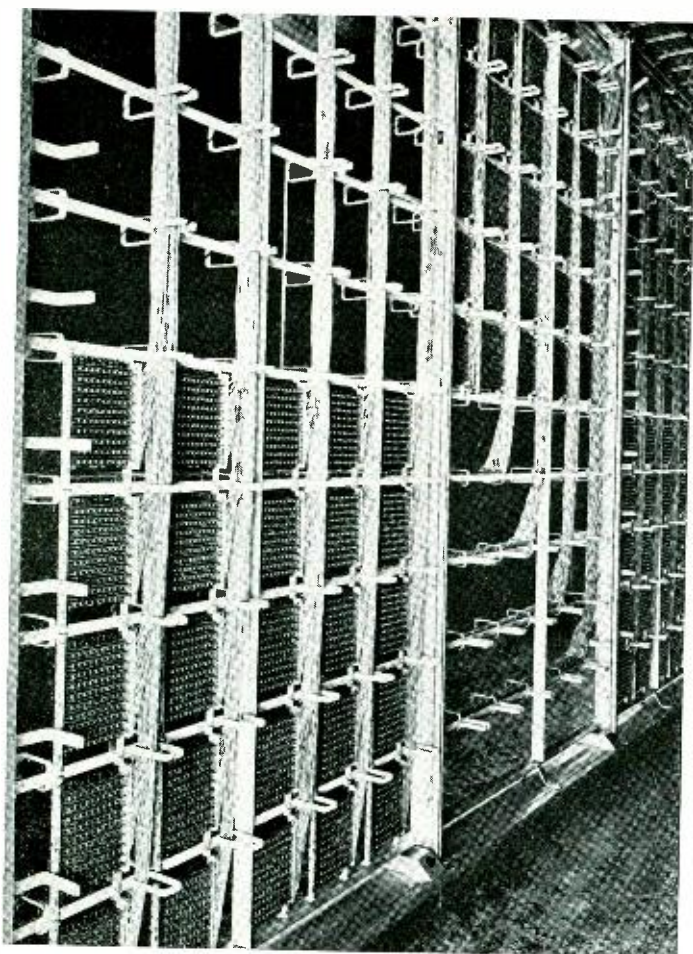

Fig. 3—Arrangement of two bays of the JGF. Each of the 100 squares of each bay represents one terminal strip with terminals for 20 junctors



*Fig. 4—Left half of JGF at Philadelphia*

complete JGF for a 20-frame unit has space for 200 of such terminal strips arranged in two bays as indicated in Figure 3, and thus provides for 4,000 junctors, which is the maximum ever used for a single train. Junctor cables from incoming groups are connected to the front ends of the terminals, while those from the outgoing frames are connected to the rear ends. The junctors from each incoming group are connected to the terminal strips in one vertical column on each bay: the No. 0 verticals from the 20 secondary switches of each incoming group are connected to the top terminal strip of a column, the 20 No. 1 verticals to the next lower terminal stop, and so on, as indicated by the numbering at the top and left of Figure 3.

The junctors from the outgoing frames

are distributed in a somewhat similar manner, but along horizontal rows rather than vertical columns, and junctors from all odd-numbered frames are connected to one bay of terminal strips, and from all even, to the other, as indicated by the numbering at the right and bottom of the bays.

How the junctors are connected and jumpered for varying sizes of offices is perhaps best illustrated by assuming first the hypothetical case of two bays of JGF completely equipped with terminal strips for a complete initial installation of 20 incoming and 20 outgoing frames. The junctor cables from the 10 incoming groups would then be connected to the front ends of the B terminals of all the terminal strips in accordance with the numbering scheme indicated, and the junctor cables from the 20 outgoing frames would be connected to the rear ends of the B terminals. Any two corresponding columns of terminal strips on the two bays thus carry the 400

junctor cables from one incoming group, and the horizontal rows of terminal strips of each bay carry the junctor cables to one outgoing frame. Each terminal strip thus carries the group of 20 junctors from one incoming group to one outgoing frame. For example, the terminal strip in the third row from the top and fourth column from the left of the left-hand bay carries the 20 junctors from No. 2 incoming group to No. 3 outgoing frame.

With such an arrangement, no jumpers at all would be required, since all connections between the junctor cables for incoming and outgoing frames would be made directly by the B punchings of the terminal strips. Suppose, however, that an actual office had originally only five incoming groups and 10 outgoing frames, but that an increase to as

many as 10 incoming groups and 20 outgoing frames might be expected. Suppose further that the original installation were to have 40 junctors per group. Since there are only five incoming groups, the right halves of each bay of terminals would have no junctor cables from incoming frames connected to them, and since there are only 10 outgoing frames, the bottom halves of each bay would have no junctor cables to outgoing frames. The junctors on the upper left-hand quadrant of each bay would be connected directly through the B punchings, as in the first example, and would not need to be changed as the office increased in size, while the two lower right-hand quadrants would have no junctors at all connected to them. The two upper right-hand quadrants would have only junctor cables to outgoing frames, and the two lower left-hand quadrants would have only junctor cables to incoming frames.

Since the junctors in the upper left-hand quadrants would never have to be changed, there is no need of installing terminal strips in these positions at all, since the junctor cables can be run directly from the incoming to the outgoing frames. Jumpers would be run from the terminal strip in the lower left quadrants to those in the upper right quadrants, and it is these jumpers that would be subject to later change. No terminal strips would need to be installed in the lower right-hand quadrants at the time of the

original installation since they would have no use. Two terminal bays, unequipped in the upper left and lower right quadrants, would thus appear as in Figure 4.

Suppose it becomes necessary to add one more incoming group—No. 5—and two more outgoing frames—No. 10 and No. 11. The junctor cable from the No. 5 incoming group would be brought to the JGF and connected to the vertical columns of terminal strips marked No. 5 on Figure 3. Since the upper five terminal strips in this column of each bay already have junctor cables to outgoing frames connected to their B terminals, which are connected by discs to the A terminals to which jumpers run to the terminal strips in the lower left quadrant, these new junctor cables from incoming frames would be connected to the C terminals to be ready for the cut-over. Since there are no terminal strips installed in the lower right quadrants, four would be set in place in the lower half of column No. 5 in each bay, and the junctor cable from the No. 5 incoming group would be connected to the B terminals.

Similarly, the junctor cables from outgoing frames Nos. 10 and 11 would be connected horizontally along rows marked 10 and 11 at the right of Figure 3 to five existing terminal strips in the lower left quadrants and to four added terminal strips in the lower right quadrants. The missing terminal strips at the junctions of the No. 5 vertical column and the Nos. 10 and 11 horizontal

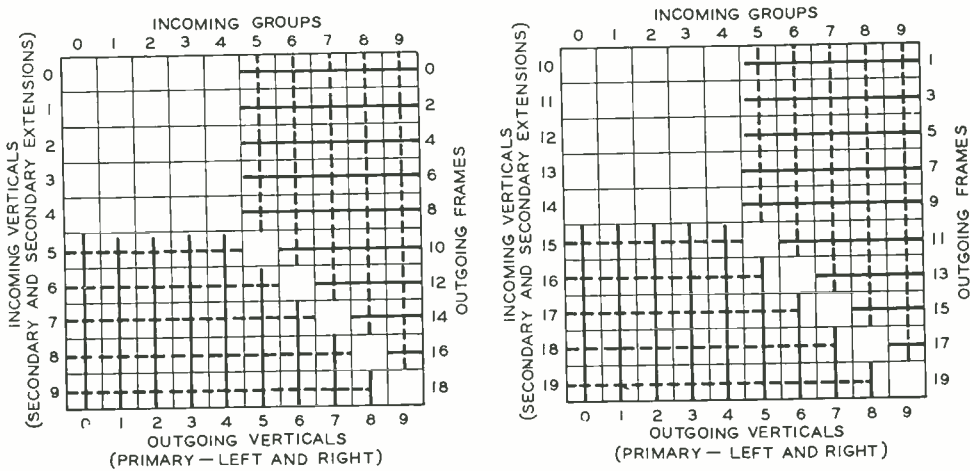

Fig. 5—Diagrammatic representation of the JGF bay as originally equipped for five incoming groups and 10 outgoing frames, and then increased to 20 outgoing frames and 10 incoming groups. Solid lines represent cables to B terminals; dotted lines, cables to C terminals

rows would correspond with the 40 junctors between the added incoming group and outgoing frames, which will never change and thus may be cabled directly.

After the cut-over, the 10 terminal strips in the left halves of the horizontal rows 10 and 11 would have no jumpers because junctor cables from incoming groups 0 to 4 on the B terminals would connect directly to junctor cables to outgoing frames 10 and 11 on the C terminals, and they would never be changed subsequently.

A similar process would be carried out for each subsequent addition. After 20 frames have been installed, there would be no jumpers on the JGF at all. Each connection would be made between the B and C terminals of the same terminal strip. This is represented in Figure 5, where the blank squares represent terminal strips not installed, solid lines represent cable connections to the B terminals, and the dashed lines represent cable connections to the C terminals.

In the above discussion, 40 junctors per group have been assumed. In ordinary practice, only 30 are used in such a situation, since 30 junctors per group will handle the traffic, and to install more would be unnecessary labor and expense. For terminating trains, as few as 10 junctors per group may be used, which means that extension frames are never required.

In finding an idle path through a toll train, the markers must locate an idle incoming link, an idle junctor, and an idle outgoing link, which together will make up the connection. The available junctors for one particular call are in the group connecting the incoming group to which the calling trunk is connected to an outgoing frame, at which trunks to the desired destination are located. Markers can test as many as 20 junctors at a time, and thus when there are more than 20 junctors in a group, they are divided into subgroups for the marker tests, and the marker tests the first subgroup, and then if no idle junctors are found there, the second subgroup. Where there are more than 40 junctors in a group, there will be a third subgroup. The first subgroup is always composed of those junctors

that will not need regrouping at any subsequent enlargement of the office. These will consist of those junctors that run directly from frame to frame without passing through the JGF or those connected to opposite sides of the same terminal strips in the JGF as a result of the addition of frames.

When new frames are to be cut into service, changes must also be made in the markers, since the distribution of second and third subgroup junctors will be changed. Cut-over must be accomplished without interfering with traffic, and this is done by taking the markers out of service one at a time just prior to cut-over, rearranging the wiring that controls the testing of the second and third subgroups, and then blocking the marker so that it will test only the first subgroup junctors. After the junctor redistribution is completed by transferring the cut-over plugs as previously explained, the markers are returned to service arranged to test all junctors in accordance with the new distribution. There will thus be a brief period when the markers test only first subgroup junctors, but as these final steps of the change may be made during a light-load period, the handling of the traffic is not appreciably affected.

---

THE AUTHOR: G. E. DUSTIN graduated from Iowa State College in 1918 with the degree of



B.S. in E.E. After a year of service in World War I, he joined the American Telephone & Telegraph Company, and shortly thereafter set up and operated in a number of cities the original service-observing equipment for step-by-step dial offices. Subsequently, he was associated

with the development of step-by-step circuits and equipment in the Department of Development and Research. He continued this work after the D & R was transferred to the Laboratories. Since then, his work has included the study of trunking problems for crossbar as well as step-by-step systems.



# Coördinate Cross-Connectors for Automatic Toll Ticketing

By P. W. SHEATSLEY  
*Equipment Development*

**I**N THE automatic toll ticketing system, the "identifier" determines the numbers of the calling subscribers by connecting to a group of "thousands" and "hundreds" coils as already described,\* and it determines the class of the calling subscriber by connecting to a set of class coils at the same time. There are two conditions that must be provided for, however, to give the identifier all the information it needs. The two subscribers on a two-party flat-rate line have different numbers. At the distributing frame terminals, the pair of wires for the line is connected to the connector terminals for both of the numbers involved, and thus the identifier would find tone on two "hundreds" and two "thousands" coils if some means were not provided to enable it to distinguish between a tip and a ring party. This is done by providing two sets of "hundreds" and "thousands" coils, and the sender—which determines whether it is a tip or ring subscriber that is calling—tells the identifier which set of coils to use. Provisions must be made, therefore, for connecting tip numbers to tip coils and for connecting ring numbers to ring coils.

Certain subscribers, moreover, are supposed to place their ticketed calls through an operator, and if by some error they should reach an automatic ticketing trunk, they should be blocked and referred to an operator. Such subscribers may not form a separate class reached by a separate group of line finders, but may be of any class, and thus their special nature cannot be identified as in the other classes of calls. A simple method of solving both of these problems was provided by the use of coördinate-type cross-connectors at the thousand-number frames.

\*RECORD, December, 1944, p. 633.

There are many places in a telephone office where provisions must be made for interconnecting lines and equipment; and opposing sets of terminal strips, called distributing frames, are widely used for this purpose. By soldering a jumper between a terminal of each set, any directory number can be connected to any piece of equipment. At times it is desired to connect a large group of numbers to one or another of a few common circuits, and for this purpose one set of terminals is connected together to form a bus, and any number jumpered to one of the terminals of this bus makes the required connection. It is a cross-connection of this latter type that is required for classifying numbers as tip, ring, or "denied-service" numbers, but since numbers may frequently

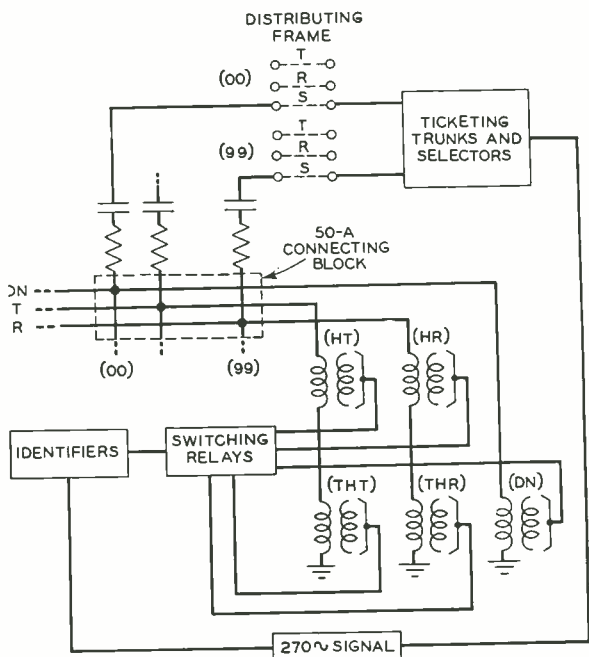

Fig. 1—Simplified schematic of the arrangement of coördinate strips and coils

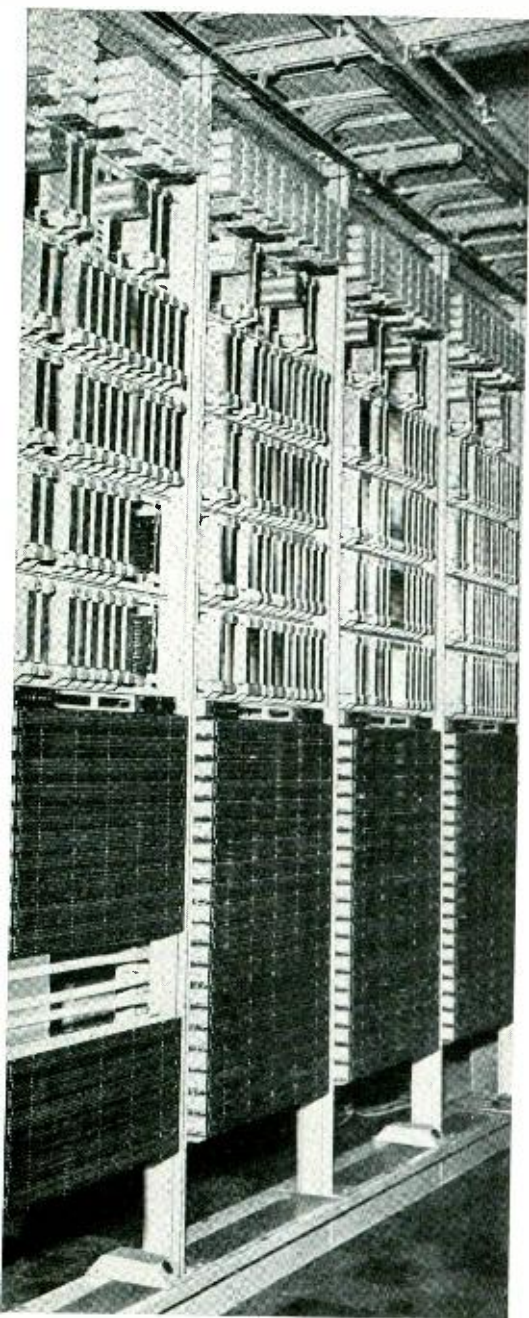

Fig. 2—The lower half of the illustration shows how the connecting blocks are mounted

change their classification in these respects, it is desirable to avoid the necessity of wire-and-solder connections. The equipment unit that made this possible is the 50A connecting block shown in Figure 3.

This unit consists of a sheet of insulating

material about  $34\frac{1}{2}$  in. long and 2 in. wide, with five horizontal metal strips running the length of one side and 100 metal strips running across the width on the other side. These latter strips are arranged in groups of ten, and at each of the 500 intersections of horizontal and vertical strips the horizontal bars and the insulation are drilled, and the transverse bars are drilled and tapped, so that screws inserted through the horizontal strip can be fastened to the transverse strip. One hundred numbers are connected through condenser-resistance networks to the transverse strips of each such panel, and by inserting a screw into the proper intersecting point, each number may be connected to one or another of the five horizontal strips.

The insulating plates with their coordinate strips form the front cover of a metal can, and the condenser-resistance networks mounted in pairs in a condenser type casing are placed side by side in the can with the terminals projecting through slots in its back. Twenty of these connecting blocks, mounted one above another, as shown in Figure 2, provide for 2,000 numbers, and five of such groups provide for a complete 10,000-number office.

In the Culver City office, only the upper three of the horizontal strips are used, and to one of these all "denied service" numbers are connected, to another all the tip numbers, and to the third, all the ring numbers. The tip and ring bars for each group of 100 numbers are connected to a hundreds coil, and ten of each group of hundreds coils are connected to its own thousands coil, and the thousands and hundreds digits tests are made on only one of the sets depending on whether a tip or ring number is calling. This fact is determined by the sender\* for each call, and the sender signals the identifier to tell it which set of coils to use.

All the "denied service" strips are connected to a single test coil, to which the identifier connects at the same time it tests the thousands coil. If a signal is encountered on this denied-service coil, the sender is notified, and no further identification tests need be made since the call will be routed to an operator. A simplified schematic indicating the arrangement of the coordinate strips and the coils is shown in Figure 1.

\*RECORD, October, 1944, p. 550.



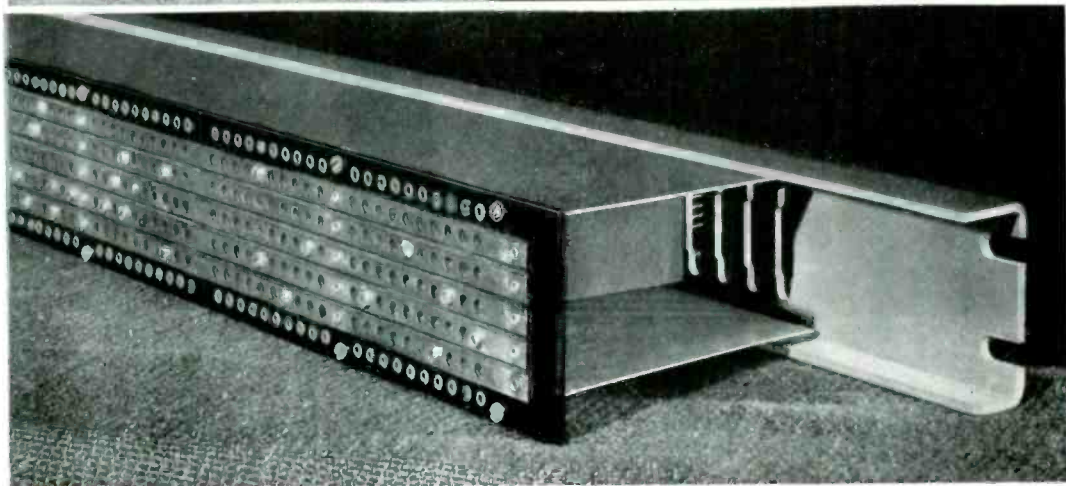
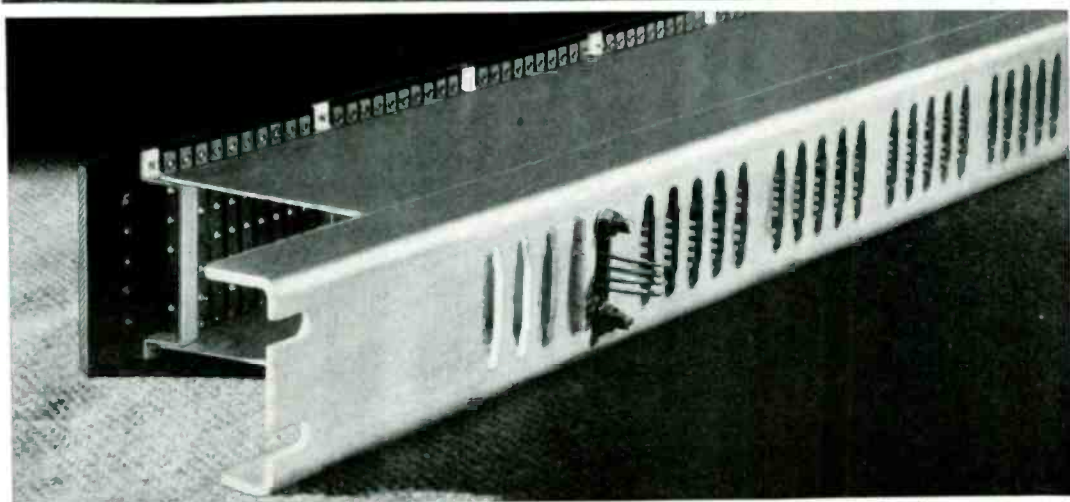
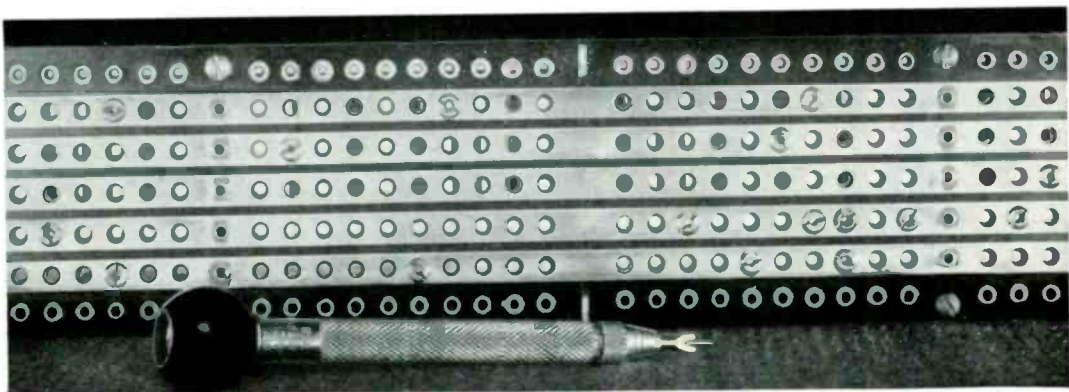

*Fig. 3—The 50A connecting block consists of a sheet of insulating material about  $3\frac{1}{2}$  in. long and 2 in. wide, with five horizontal metal strips running the length of one side and 100 metal strips running across the width on the other side. One of the screwdrivers for making cross-connections is shown in the foreground of the top illustration*

Each group of twenty 50A connecting blocks is mounted on the lower part of one of the thousand-number frames as shown in Figure 2, and above them are the hundreds and thousands coils and the relays through which the identifiers connect to them. The screws used for making the cross-connections are hollow, and the screwdrivers employed, one of which is shown in the upper part of Figure 3, have a small projection that fits into them. This simplifies the insertion and removal of screws by holding the screw to the screwdriver. At the top and bottom of each of the short vertical strips and at the two ends of the horizontal strips are hollow rivets that serve a double purpose. They hold the strips to the insulating plate and also are used for making the wire connections to the strips. The end of the wire is inserted through the center of the rivet, and a drop of solder holds it in place and makes the connection.

With these connecting blocks mounted on the lower part of the frames, they are always accessible for making changes as the status of the various lines is changed. The two

lower horizontal strips, although not used for the present installation of the crossbar toll system in Philadelphia, are available should any additional classifications of service be required at some future time.

---

THE AUTHOR: P. W. SHEATSLEY graduated from Ohio State University in 1915 with the degree of B.M.E. He



He joined A T & T in 1915 and coöperated in the development of telephone central-office apparatus and equipment. He made contributions in dial system frame and rack equipment; main distributing frames for the larger buildings; and fire protective equipment and

methods for central-office use. When the D and R was consolidated with the Laboratories in 1934, Mr. Sheatsley joined the Local Central Office Facilities Department. More recently he has been engaged in dial system work in the Equipment Development Department.



## SYNTHETIC RUBBER PRESSURE-SEAL

Vital to the successful operation of airborne communication equipment used by our Armed Forces, this ordinary-looking rubber ring has the unusual temperature range and the abrasion and oil-resisting properties required to make it an effective pressure seal under the extreme conditions encountered in high altitude flights. It is a synthetic rubber compound within a bronze ring, a development of G. G. Winspear. Natural rubber could not be used for this application and much experimentation was required to obtain the necessary combination of properties.