

Teletypewriter Test Sets

By W. Y. LANG
Telegraph Development

SIGNALS transmitted by teletypewriter sending units are usually combinations of marking and spacing impulses with current flowing during the marking but not during the spacing interval. In the five-unit start-stop code each character has a start interval which is normally spacing; five selecting intervals, each equal in length to the start interval and each of which may be marking or spacing to give a code combination corresponding to the character sent; and a longer stop interval which is normally marking. As these impulses travel over a telegraph circuit the time intervals between the start impulse and those succeeding it may be changed by the line or the terminal equipment. Teletypewriters must be capable of receiving signals correctly even though fairly large amounts of these impulse distortions are present. A testing device which will transmit distorted signals is therefore required to

check receiving mechanisms and determine optimum adjustments.

Distortions in teletypewriter signals are classified in three groups: bias, characteristic distortion, and fortuitous distortion. Bias, due to asymmetry in the circuit, causes all marking impulses to be lengthened or shortened. The increase or decrease is substantially equal in all the marking impulses and the amount of bias is the lengthening or shortening expressed as a percentage of the unit pulse. As interpreted by a teletypewriter, the lengthening or shortening is what it would be if the bias affected only the beginnings of the marking impulses. Characteristic distortion differs from bias in that the amount of the distortion may vary from impulse to impulse and is dependent on the combination of the preceding impulses. Fortuitous distortion is normally non-repetitive and is caused by random interference such as crossfire, lightning or power induction.

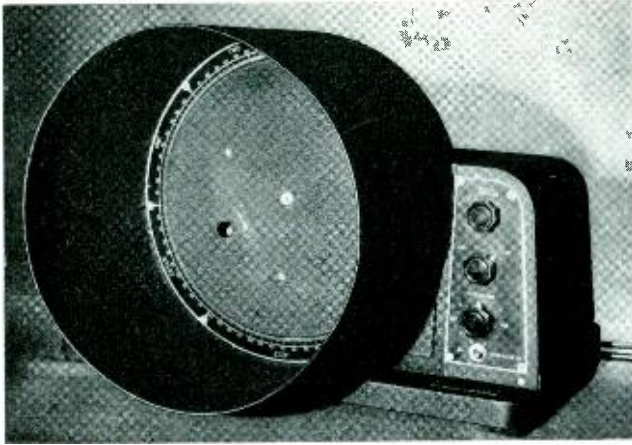

Fig. 1—The V.A teletypewriter test set produces signals with controlled amounts of distortion to determine how much distortion a teletypewriter under test will tolerate and still record messages correctly

It may affect a single impulse or several impulses in a signal combination or even several different combinations of signals.

A distributor which will send signals affected by bias is comparatively easy to design but it is not practical to make one to produce characteristic distortion because it depends on signal combinations previously transmitted. If a start pulse of normal length is used, however, and the relation between the beginning of the start pulse and the ends of the marking pulses is varied, the variation has approximately the same effect on a teletypewriter receiving mechanism as characteristic distortion—and, to some extent, as fortuitous distortion. Since this distortion affects the ends of the marking pulses rather than their beginnings, it is called “end distortion.”

Experimental arrangements for testing the receiving margins of teletypewriters were designed many years ago

by engineers of the Laboratories and of the Teletype Corporation. Studies were also made at the Laboratories to provide simpler testing equipment for checking receiving margins of teletypewriters in telegraph central offices and in maintenance shops. At the same time the Teletype Corporation engineers were working toward simplification of similar equipment for checking teletypewriters in their own plant. The desirability of perfecting the design of apparatus of this type for Bell System service was taken up with the Teletype Corporation and it was suggested in

this connection that provision be incorporated in the bias distributor for sending a second type of distortion—the end distortion referred to above. The Tele-

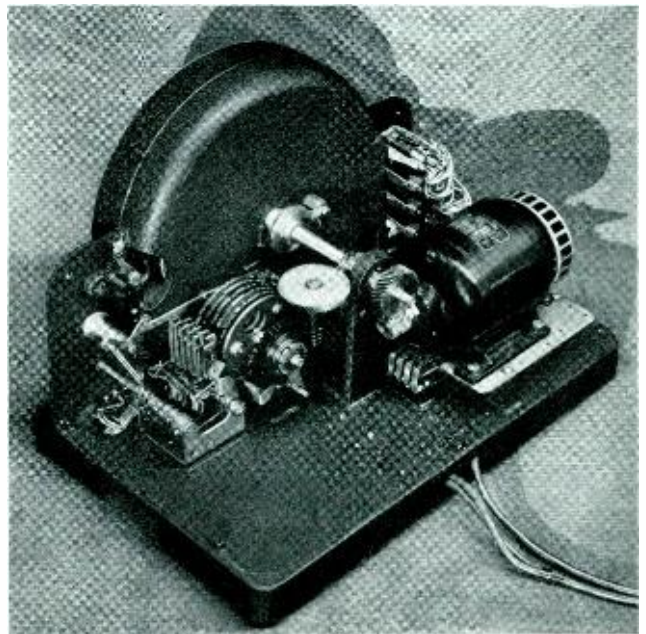

Fig. 2—Rear view of the test set with the cover removed, showing, at the front, the code discs and the selector cam which permits sending single characters or a test sentence. A synchronous or governed motor controls signal speed

type Corporation undertook an investigation to simplify the equipment and to incorporate improvements such as the ability to send signals having either end distortion or bias, and also to reduce the inherent inaccuracies in the apparatus. The outcome of this work was the 1A teletypewriter test set, a front view of which, with the viewing head removed, is shown in the headpiece of this article. The complete 1A teletypewriter test set is shown in Figure 1.



Fig. 3—Teletypewriter signals are transmitted through two segmented rings over which brushes rotate. Adjusting the outer ring with respect to the inner one determines the amount of signal distortion. Rings for the neon lamp are nearest the center

This test set transmits code impulses corresponding to teletypewriter characters and distorts their timing relative to the start pulse by segments on two concentric rings over which conducting brushes are motor driven at a constant speed. By adjusting the outer ring with respect to the inner one and connecting the segments of the two rings either in series or parallel, signals may be pro-

duced with any desired amount of marking or spacing bias, or marking or spacing end distortion. At one end of the rotating brush arm there is a neon lamp which may be lighted during the marking impulses to produce a flash which is seen as an illuminated arc near a scale outside of the segmented rings. The timing of the pulses may be checked by the length of arc.

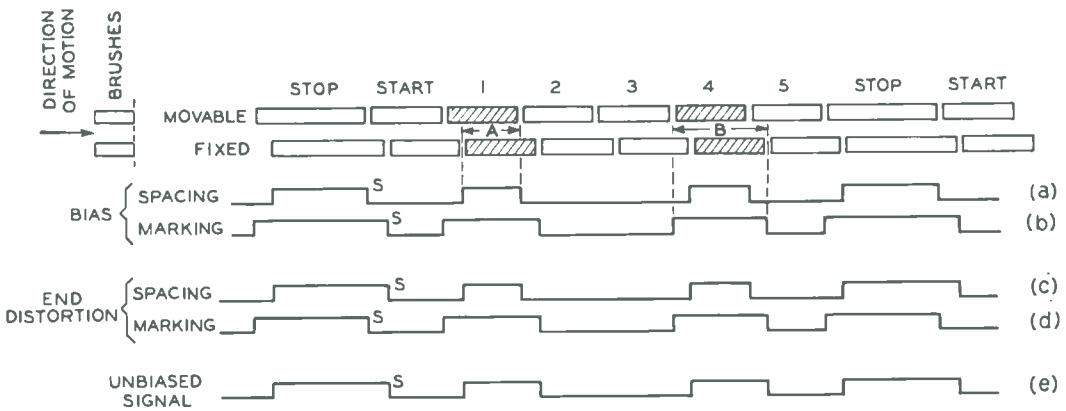

Fig. 4—To explain how distorted signals are sent by the test set the segments of the signal rings are shown in line at the top with the movable one one-quarter segment in advance. The corresponding distortion when segments 1 and 4 are marking is shown by the irregular lines. The teletypewriter interprets the timing of the signals as if the starting points marked "S" were in line

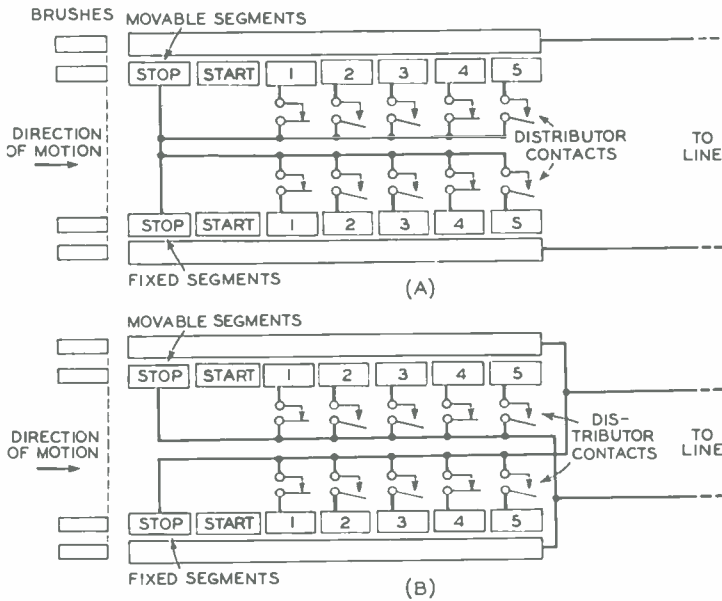

Fig. 5—Connections of the ring segments required to produce bias: A, for spacing; B, for marking

At the left of the face there are keys for selecting the type of distortion and for connecting the neon lamp to observe the length of signals received from the test set or from an external distributor. A switch controls the driving mechanism. To the right are knobs for adjusting the amount of distortion and for short-circuiting the outgoing line, for selecting the characters to be transmitted and also, for special tests, a switch is provided to eliminate the stop pulse.

At the front of Figure 2 are the code discs and contacts and the character selector cam which chooses the combinations for blank, T, O, M, V; the letters' shift function; or a test sentence like "The quick brown fox jumps over a lazy dog's back

distort the signals and the circuit is completed through the pair next inside. A third pair nearest the center carries the circuit for the neon lamp which may be connected to flash while the distortion of the signals is being adjusted. The brush-

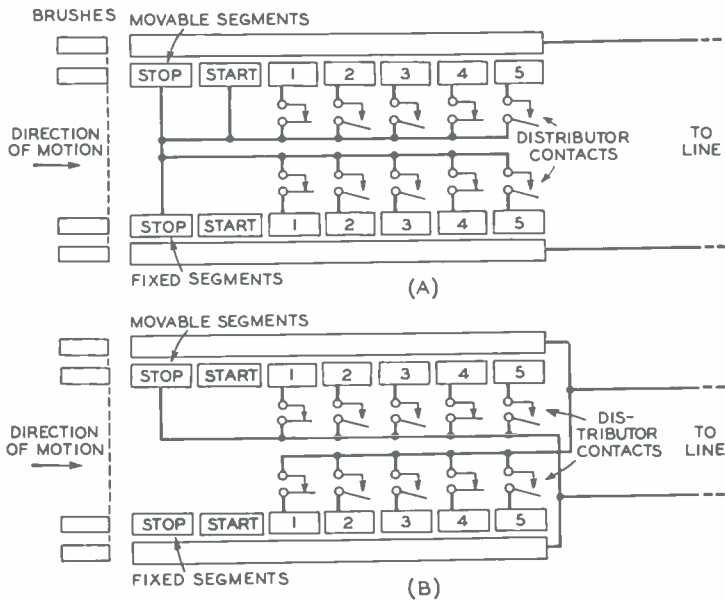

Fig. 6—Connections of the ring segments for end distortion: A, spacing; B, marking

1234567890." The contacts to select the type of distortion and to perform other functions and the motor are at the rear.

The gear and pinion which drive the distributor are fastened to their shafts by a tapered sleeve which is compressed when the gear is tightened. This reduces distortions which might be caused by eccentricity of the gear on its shaft.

The distributor face with its six rings and rotating brushes is shown in Figure 3. The segmented outer rings

arm holder is balanced to reduce vibration and there is a pulley and wedge arrangement directly behind the face casting to prevent rotating the brush arm in the reverse direction and consequently damaging the brushes.

Selecting mechanisms for teletypewriters and regenerative repeaters are equipped with a stopping device for the selector-cam sleeve which is known as a range finder. It is equipped with a scale graduated in per cent of a signal segment and with a lever to permit positioning the arm of the selector cam over a relatively large arc. A change in the "stop" position of the selector cam changes the angular travel from the starting point of the cam to the selecting point of the impulses.

In checking a teletypewriter mechanism for receiving margins, the position of the range finder is shifted while signals are sent and the limits for correct typing are noted. From the scale readings obtained with marking and spacing bias and marking and spacing-end distortion, the receiving margins of the selector mechanism can be calculated and the adjustments determined, if any are required.

Characteristics of the distorted signals sent by the 1A test set are illustrated in Figure 4. The segments of the two concentric signal rings are shown in line at the top with the movable ring shifted one-quarter of a segment to the left. The length of the distorted signals, when segments 1 and 4 are marking, are represented by the higher portions of the irregular lines below. For spacing bias the corresponding segments of each ring are connected in series as shown in Figure 5A. When segment 1 is selected the current path is from the common ring, shown as a solid strip at the top, to the movable segment 1, then through the contact and strap wires to the contact of the fixed segment 1 below. The two stop segments are directly strapped. Signal cur-



Fig. 7—The 100A teletypewriter test distributor is used primarily to check telegraph lines from subscribers' premises to the central office. The distortion produced is fixed at 20 per cent. It sends current reversals, for circuit testing, as well as distorted signals

rent than passes only when the brushes are in contact with both the upper and lower segments. The length of the signal is shown at A, Figure 4, and by the section of the irregular line (a) directly under it.

For marking bias all of the segments with the exception of that used for starting are connected in parallel as indicated in Figure 5B. When the brush reaches movable segment 1 current begins to flow and continues until the brush leaves fixed segment 1 below. The length of the signal is shown at B and on the line (b) of Figure 4.

End distortion of the signals is illustrated by lines (c) and (d) of Figure 4. For the spacing condition the segments are connected, as shown in Figure 6A, the same as for spacing bias except that the start segment of the movable ring is connected in the circuit. This keeps the

start and stop signals normal. When set for marking end distortion the stop segment of the movable ring is connected in the circuit, Figure 6B, and all the other segments are in parallel which gives start and stop signals of normal length. The line (*e*) at the bottom of Figure 4 represents an undistorted signal.

The 1A teletypewriter test set has proved to be valuable in testing and adjusting teletypewriters in repair centers and in the field. It is used in some of the smaller offices in place of the 119-type signal bias set* to supply signals for testing of circuits to subscriber stations and for line testing. It is also used at the Teletype Corporation's factory for testing new teletypewriters before their shipment.

Because of its size and weight, the 1A set cannot be used conveniently in portable service, such as at outlying subscriber stations in connection with the 161A1 telegraph station test set.† For such use the Laboratories has developed, and the Teletype Corporation is now producing, a smaller and lighter device known as the 100A teletypewriter test distributor. A view of the 100A design is shown in Figure 7. This distributor weighs only twelve pounds. It produces the signals required in maintenance work at subscriber stations, namely, telegraph reversals, which are a uniform stream of unit marking and spacing pulses, and repeated teletypewriter characters. The teletypewriter characters may be undistorted or may have a fixed value of 20 per cent bias or end distortion. By means of the

*RECORD, Feb., 1937, p. 193. †May, 1940, p. 365.

keys shown at the front of the distributor, the signals may be changed from teletypewriter characters to reversals, the distortion may be bias or end distortion, and the distortion may be marking, zero or spacing. The distributor face has three segmented rings and these are arranged so that when teletypewriter signals are sent the segments of the inner ring are strapped together to form a continuous ring and the outer rings provide the open-and-closed intervals. When reversals are sent, one of the outer rings has its segments strapped together and the inner ring provides the open-and-closed intervals.

The 100A test distributor fills a need for a small accurate source of telegraph test signals and indications are that it will be fairly widely used in the field.

THE AUTHOR: Soon after joining the design drafting department in 1920, W. Y. LANG took the course for Technical Assistants and then attended City College and Columbia University. For a year, beginning in 1922, he was with the Apparatus Specifications Department, after which he joined the Precision Apparatus Laboratory. From 1927, when he became a member of the Technical Staff, he was engaged in the design of printing telegraph apparatus until war projects began to occupy his time last year.



W. Y. LANG



Historic Firsts: Wave Filters

FILTERS, to a photographer, are optical systems selective in their transmission of light waves that can be interposed between lens and scene to favor certain colors. By analogy, the name "filter" was applied to the networks which G. A. Campbell patented in 1917, to select electric currents on the basis of wave lengths.

Campbell's wave filters take many forms, for his invention was broad and basic. In general, they are artificial transmission lines—as in the diagram below—formed by a succession of sections, each a network of inductances and capacitances. In general, also, they are of three types: high-pass, which discriminate against all components of current with frequencies below a designed "cut-off"; low-pass, which transmit only currents below a specified frequency; and, most importantly, band filters which pass only frequencies between assigned values.

His invention made possible many important advances in all the arts where complex currents carry signals or speech. Carrier-current transmission, for example, depends upon band-pass filters to select desired bands of frequencies from a complex current involving several



GEORGE A. CAMPBELL

simultaneous messages.

Throughout the years since Campbell's epoch-making invention Bell Laboratories has made many important contributions to filter theory and to its analytical methods; also, many new types of filters have been invented and perfected. Much of the advance has come from intensive development studies and ingenious designs of the coils and condensers which form the filter sections.

That work was profitable because the more closely a filter's circuit elements can approximate the ideal of pure inductance and pure capacitance, the more sharply can it discriminate between wanted and unwanted frequencies. Near its cut-off point, for example, a one per cent change in frequency can cause a hundred-fold difference in transmitted power. (For comparison: a human ear listening to a pure tone of concert pitch A cannot perceive a pitch change much smaller than one per cent.) In the high-frequency range, when quartz crystals are used as resonant elements, a precision of discrimination can be reached such that a 10,000-fold change in power follows a 0.1 per cent change in frequency. Filters of this type are used in coaxial cable systems.

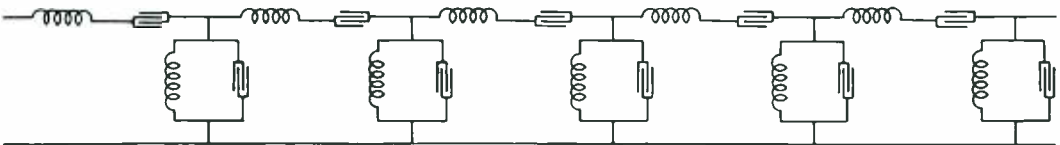

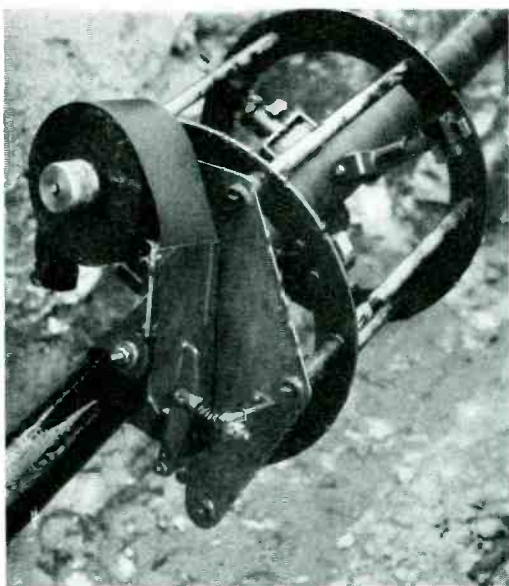

Asphalt is flooded over the cable and followed by a wrapping of felt-like tape to protect against corrosion. The cable wrapping machine, rotated by hand, applies protective tape in a spiral over the asphalt. Adjustments, provided for several tape widths and position of rollers, permit wrapping all cable sizes

The cable wrapping machine can be used in a trench where the cable is lifted and supported, during the wrapping operation, on timbers which span the trench. This method is used only in locations where the trench is too wide or the terrain too rough for the easy passage of the underrunning carriage



An underrunning carriage lifts the cable to a convenient height for applying the protective coating and then from its rear sheave drops the treated cable into the trench



Cable Wrapping Machine

By J. M. HARDESTY
Outside Plant Development

THERE are occasions when pole lines and aerial cables have to be replaced with underground construction. This may be done by installing new cable in conduit or by plowing-in a cable protected at the factory against soil corrosion by layers of asphalt paper and jute. Under present restrictions on materials new cable is difficult to obtain. This limitation has been avoided in a method recently developed by the Laboratories. The aerial cable is lowered from the poles and then equipped for burial by applying a coating of asphalt and a wrapping of felt tape. This will save critical materials and it can be done without service interruptions. The tools developed for doing the work are not yet in production but will include a cable

lowering guide to drop the cable from the strand to the ground, a wrapping machine to apply the protective covering to the cable and a carriage to lift the cable for wrapping and then to drop it into the trench. The lowering guide, shown above, supports the cable and prevents excessive bending when the lineman rides the strand to remove the cable rings. As the guide moves forward the cable drops in a wide arc to the ground where it is prepared for burial as shown on the opposite page.

Parts of the same process can be employed where corrosion is occurring in underground cables. In these locations the subway is opened and the exposed cables are wrapped and relaid, as buried cables, in the same trench.



Pulsing Methods of the Dial System for Dial-to-Dial Calls

By H. C. CAVERLY
Switching Development Department

FOR a system of telephone switching that does not require an operator to complete calls, some method must be provided for controlling the switches that establish the desired connection. In the dial system first to come into commercial use—the step-by-step system—it was provided by the subscriber dial, which controls a normally closed contact directly in the line circuit. This con-

under the control of these dial pulses. The type of circuit employed is indicated in Figure 1. A magnet *v*, controlling a ratchet device, moves the switch wiper up one step each time it is operated and released. When a subscriber line is connected to such a circuit by a closure of the switchhook contact, relay *A* operates and immediately operates relay *B* through a front contact. The subscriber now pulls his dial around to the digit he wishes to dial, and releases it. While relay *A* releases at the first opening of the dial contact, relay *B*, which is of the slow-release type, holds operated during the open period of the pulses. The release of *A* with *B* operated connects ground to the *c* relay in series with the *v* magnet, and both

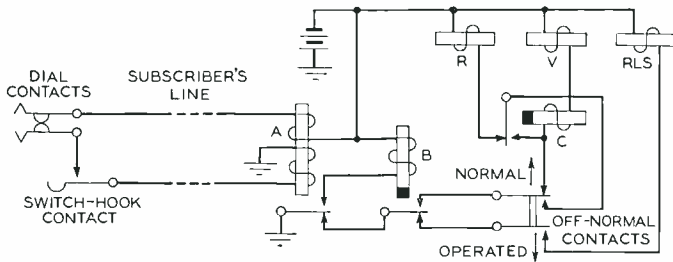

Fig. 1—Simplified schematic of dialing circuit for a step-by-step connector

tact remains closed as the dial is pulled around to the digit desired, but as the dial is released, the contact is opened and closed a number of times corresponding to the digit. When the dial is pulled around to 1, which is opposite the first finger hole, the contact is opened and closed only once; when it is pulled around to zero, however, which is opposite the last finger hole, the contact is opened and closed ten times. The return speed of the dial is such that pulses are sent at the rate of about ten per second, and the open period is somewhat longer than the closed.

Step-by-step switches are designed to perform the selecting operation directly

operate. As the wiper moves up in response to the operation of *v*, the off-normal contacts are operated, but the connection to the winding of *c* is maintained through a front contact of *c* and a make-before-break contact of the off-normal assembly. When the dial contact now closes, relay *A* again operates, breaking the ground connection to relay *c* and to the *v* magnet. The latter releases, but *c*, being of the slow-release type, remains operated during the short closed period of the dial contact preceding the next pulse.

Both *B* and *c* remain operated during the following pulses, but each opening of the dial contact operates *v*, and each

closing releases it. At the end of the series of pulses, A and B will remain operated, but C will release after a short interval. In the meantime, the switch wiper has been moved up to the contact level corresponding to the digit dialed. If the particular step-by-step switch involved is a "selector," the wiper will now move—by a circuit not shown—horizontally over the ten contacts of the level it has reached until it finds the first idle trunk. If the switch is a "connector," having subscriber lines directly connected to its terminals, the rotary action of the wiper will be controlled by the pulses of the final digit dialed through the R magnet. The first opening of the dial contacts for this final digit will release A, and ground through the back contact of A will operate magnet R. Relay C will not be operated because of the operated condition of the off-normal assembly. Magnet R will operate once for each dial pulse until the desired line is reached. The switch will remain in the final position until the calling subscriber hangs up. This opens the line circuit, releasing both A and B, and thus places

ground on the release magnet, RLS, which restores the switch to normal.

In the development of the panel system this simple decimal pulsing system was retained for transmitting the called number from the subscriber station to the central office, but an entirely different method was adopted for controlling the movement of the switches. This flexibility in choice of methods was obtained by the use of senders, which can receive information in one form, store it, and send it out in a different form. Furthermore, with the aid of the decoders to which the senders have access, that part of the information which identifies the called office may be translated into entirely different digits arbitrarily chosen in each originating office so as to give the most efficient routing possible to the office that is called over the trunking network.

How the digits dialed by the subscriber are recorded in the sender has previously been described.* The final result is the operation of one or more of a set of register relays for each digit.

*RECORD, June, 1929, p. 395.

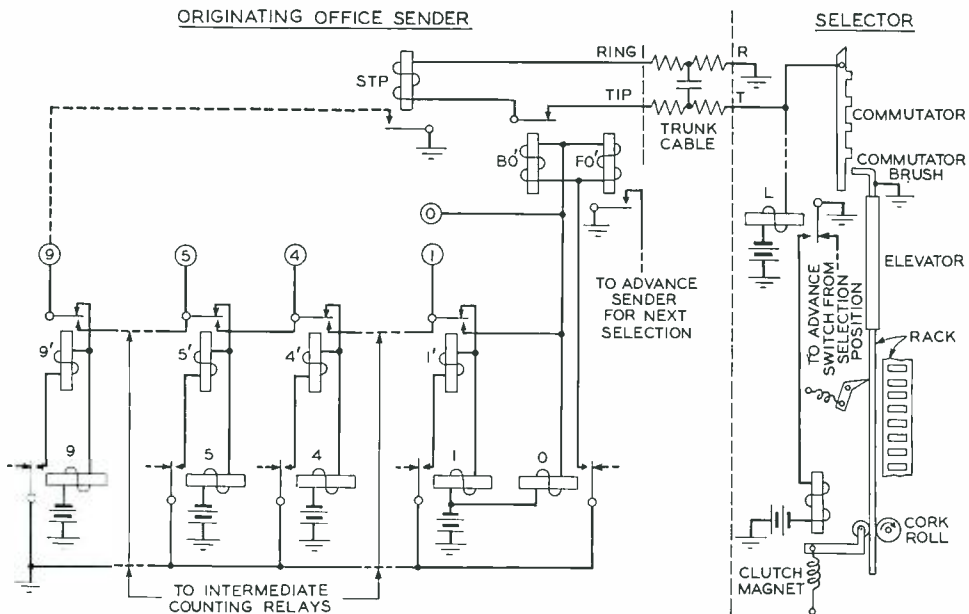

Fig. 2—Simplified schematic of revertive pulsing circuit from panel selector to sender

The translating features of the sender gave the designers of the panel selector a free hand in choosing economical mechanical and electrical arrangements, unrestricted by the limitations of a decimal method of selection. As constructed, each selector elevator carries five brushes, and each brush, as the elevator moves upward, may pass over 100 sets of contacts divided into groups. At the terminating office, for example, two selectors are involved—an incoming and a final selector. There is a brush and a group selection at the incoming selector, and a brush, tens, and units selection at the final selector, all under control of the sender at the calling office. When the incoming selector is seized, the elevator is started upward, and as it travels, it sends series of pulses back to the sender, which counts the pulses and stops the elevator when the proper position is reached. This is called reverteive pulsing, because the pulses are transmitted back from the controlled end of the circuit to the controlling end. This particular method of pulsing has previously been described.*

For convenience in reference, a simplified schematic of the circuit employed is given as Figure 2. The dotted section of line from the front contact of the STP relay passes through a steering circuit and thence through contacts of a set of register relays before reaching the counting relays shown in this diagram. There

*RECORD, June, 1929, p. 395.

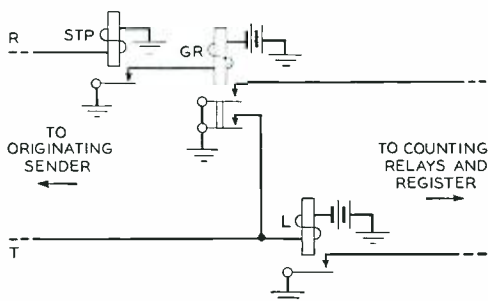

Fig. 3—Simplified schematic of pulsing circuit in terminating senders

is a set of register relays for each selection to be made, and the steering relay guides the connection to the proper set of register relays for each successive selection. Depending on the particular combination of register relays operated, the lead from the STP relay will be guided to one or another of the terminals 0 to 9 of the counting relays. As soon as the panel selector has been seized, and an elevator started upward, a succession of pulses is returned to the sender and is counted by the counting relays. These are operated successively beginning with the pair to which the lead from the STP relay has been connected, and when relay 30' operates, after the last pulse has been completed, the upward motion of the selector is stopped.

This counting circuit is essentially the same as that used by the sender in counting the dial pulses from the subscriber, but counting is done in the reverse order. Dial pulses are counted from the first to the last sent, and the position of the counting relays when the pulses cease gives an indication of the digit dialed. With reverteive pulses, a predetermined number is set up on the counting relays, and after this number of pulses has been sent back by the selector and counted, the selector is stopped. The pulses themselves are formed differently, since dial pulses are caused by brief openings of the line circuit, while with reverteive pulses, one side of the trunk is grounded and the other side is alternately connected to battery and ground. The net effect is the same, however, since in both cases the pulses are formed by periodically interrupting the flow of current over the line. The speed of reverteive pulsing under the favorable electrical conditions which exist on interoffice trunks is much greater than that of dial pulsing from subscriber stations. While dial pulses are sent at a rate of about ten per second from subscriber stations, reverteive pulses have a speed of some thirty per second.

In the crossbar system,* selection is accomplished by the operation of crossbar switches after suitable idle paths have been found. This location of suitable paths and the operation of the crossbar switches is carried out by markers,† of which there are two types: one for originating offices and one for terminating offices. Since in many locations both panel and crossbar offices would be used in the same area, however, it was desired to retain revertive pulsing as the means of transmitting subscriber numbers from originating to terminating offices so that a call originating in a panel office could be completed to a crossbar office or vice versa. This is accomplished by the use of senders‡ in both originating and terminating offices in the crossbar system. Originating senders, like the senders of the panel system, count and record the pulses that are transmitted from the subscriber's dial and employ revertive pulsing for transmitting the number of the called subscriber to the terminating office.

Terminating senders are interposed between the terminating markers and the originating senders to record information transmitted by revertive pulsing and to translate it into signals that the terminating marker may use in controlling the selection. To crossbar originating senders, or to panel senders, these terminating senders thus behave as panel selectors. They send a sequence of revertive pulses as soon as they are seized, and the pulses are counted and the sequence is momentarily stopped in accordance with the numbers recorded in the senders at the originating office. The revertive pulses must also be counted and recorded in the terminating

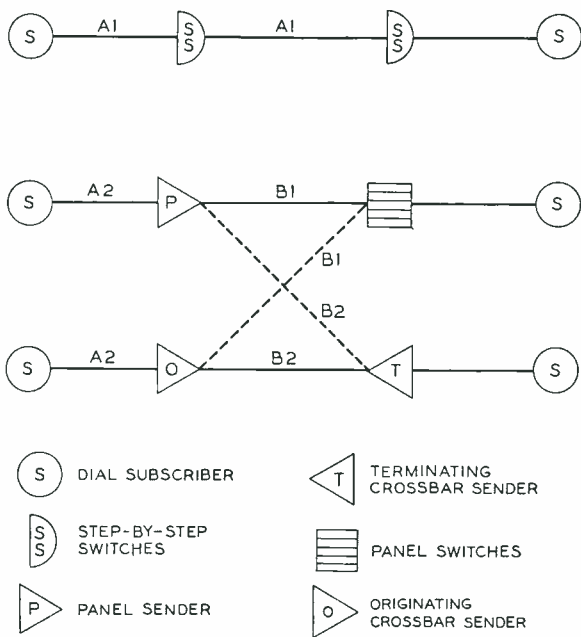

Fig. 4—Applications of various dial-to-dial pulsing systems for completing calls

sender so that the information they convey may be turned over to the terminating marker.

The pulses are counted at the originating senders by circuits similar to those already described. They are sent from the terminating sender by the simple circuit shown in Figure 3. This circuit takes the place of the circuit at the right of the dotted line in Figure 2, and it transmits revertive pulses to the originating sender by alternately grounding and connecting battery to the tip lead while the ring lead is held grounded continuously. Relay L remains operated during the period of pulse transmission, held either over the trunk and back to ground at the STP relay in the terminating sender, or directly from ground through a front contact of GR. The pulses are sent by the action of relays STP and GR. Relay STP operates when the sender is seized, and in turn operates GR. When GR operates, however, it places ground on the tip lead, and thus releases STP. This pulsing continues until the BO' relay of Figure 2, or its

*RECORD, Feb., 1939, p. 173.

†RECORD, June, 1939, p. 327; July, 1939, p. 356; Aug., 1939, p. 373.

‡RECORD, April, 1939, p. 234.

equivalent at the originating sender, opens the circuit. The pulses are transmitted to the counting relays at the terminating sender by relay GR.

There are thus two types of pulsing employed in completing calls that are dial throughout: dial pulsing, which may be called type A, and revertive pulsing, which may be called type B. If a pulsing system is considered to include both the pulse sending and pulse receiving circuits, there are really two varieties of each of the two basic types. These may be differentiated as A1 and A2, and B1 and B2, and the conditions under which they are used are indicated in Figure 4. For both systems A1 and A2, the sending device is the subscriber dial, but for A1, the receiving circuit is the step-by-step circuit shown in Figure 1, while for A2, it is either the counting and register relays of the panel sender, or the counting relays and the registering crossbar switch of the crossbar system. For both systems B1 and B2, the receiving circuit is a set of counting relays in the originating sender, but the sending circuits differ for the two systems. For B1, it is the commutators and brushes of the panel selectors, while for B2, it is the all relay circuit of Figure 3.

Dial-to-dial calls comprise the great majority of calls in dial areas, and are the simplest from the point of view of

pulsing methods. Since there are usually some manual offices in a dial area, and there are always dial "A" boards, toll boards, and PBX boards, all of which employ manual operators, it is necessary to provide methods for completing both manual-to-dial and dial-to-manual as well as dial-to-dial calls, and because of the more varied conditions, the pulsing systems are more numerous. These dialing systems will be described in a forthcoming issue of the RECORD.

THE AUTHOR: Beginning his telephone career with the New England Company, H. C. CAVERLY's first work was subscriber's station installing, on which he worked for three years. He was appointed manager of the Southbridge exchange in 1903, and in 1906 assumed similar charge at Marlboro. In 1909 he went to Worcester as private-branch exchange and central-office installer, and came from that city to the Laboratories in 1919. His work with the Systems Development Department has been devoted entirely to sender development.



H. C. CAVERLY

Dialing Habits of Telephone Users

ONE of the interesting investigations of the Laboratories which wartime problems have interrupted is a study of the habits of telephone users in dialing numbers. Under the direction of L. J. Stacy a circuit arrangement of electrical stop-clocks was set up and a com-



plete study of the performance of 200 persons recorded before the work was stopped. Records were made for several typical numbers of the time taken by each individual to locate the proper digits, wind up the dial and send the number. The overall time for sending a seven-digit number was found to be about twelve seconds. Information secured in this study has already been of value in guiding the rearrangement of available step-by-step apparatus in certain offices to carry an increased load.

Above: V. F. Blefary dials into the test apparatus

Left: F. C. Griese records the reading of the stop-clocks

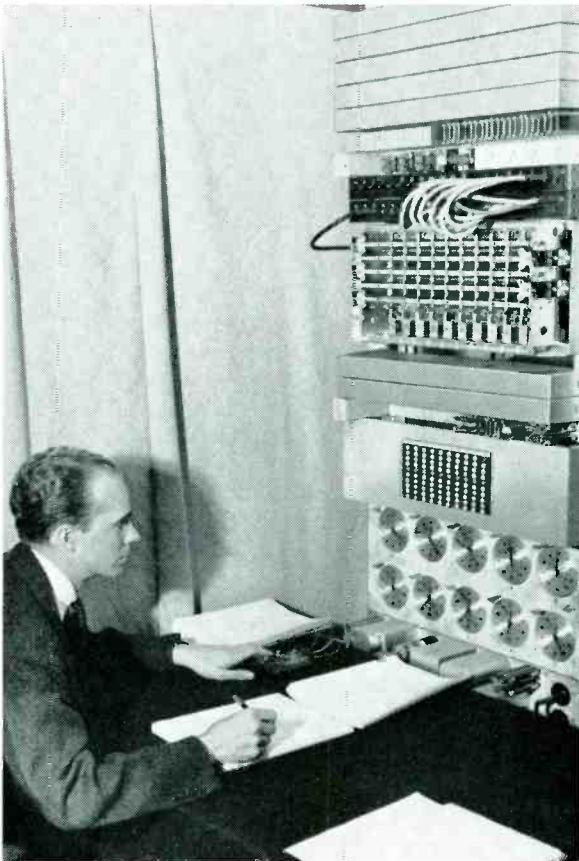



Communication System Along Alcan Highway Now More Than Two-Thirds Completed

THE second and longest link of the Alcan Highway communication system has recently been completed. It connects Dawson Creek, British Columbia, with Whitehorse in the Yukon territory of Canada—a distance of 900 miles. Over each of two pairs of steel-core wire both voice and telegraph will be transmitted. The third and final link, running some 650 miles from Whitehorse to Fairbanks, Alaska, is already being actively constructed by crews working from both ends. Work on the first section—from Edmonton, Alberta, to Dawson Creek—was put into service on December 1 as already described in the March RECORD.

Each pair of wires over the entire length of this 2,000-mile communication

line will provide a d-c telegraph circuit, a voice-frequency telephone circuit, and a C5 carrier system. One of the carrier channels on one line will be used for a 40C1 voice-frequency carrier telegraph system supplying twelve telegraph channels to be used for teletype service. In general, the carrier channels will be used for through transmission while the d-c telegraph and the voice circuits will be used for communication between local points and for maintenance. Between Dawson Creek and Whitehorse are ten repeater sections and from each repeater station a line crew and truck patrol, such as is illustrated in the photograph above, travels in each direction halfway to the adjacent stations.



*A—An easy stretch along the
“American Burma Road”*

B—Difficulties in the construction of the Alcan Highway become readily apparent from this view of the road taken some 80 miles below Whitehorse

C—The soil formation along much of the Alcan Highway consists of a few feet of muskeg—a composite consisting chiefly of decayed vegetable matter—resting on perpetual ice. As a result, the trees are shallow rooted and fall with very little urging. As many as 33 trees have been removed from the line in a single day over one section. The high-strength steel wire employed prevents such falls from breaking the wires, but short circuits are caused and are promptly removed by patrolling line crews



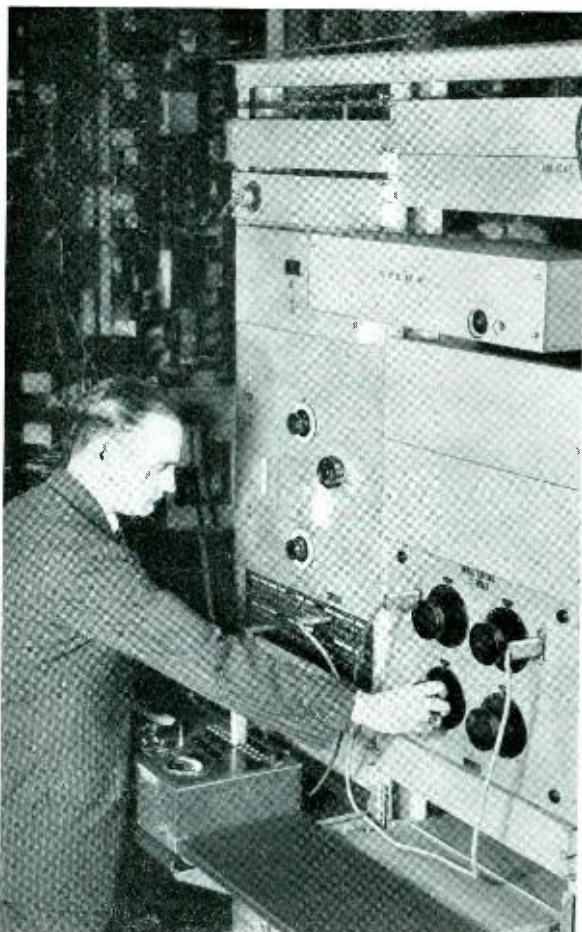

Noise Measurements in Vacuum Tubes

By J. J. DEBUSKE
Transmission Development

quiet tube by an average tube would increase the power output of the amplifier by an amount due to tube noise.

Several measuring sets for determining tube noise have been devised on this principle. The one described here was set up to meet the need for a fast and simple method of measuring, under actual operating conditions, the noise contributed by a tube in the first stage of the line amplifier in K1 carrier systems. The measuring equipment is shown at the left; and its block diagram in Figure 1. The 135-ohm termination is connected to the input circuit of amplifier No. 1, which is the K1

IN LONG distance transmission systems, there must always be an adequate margin between signal and noise. Noise introduced at the point where the signal level is at its lowest—that is, at the input to each amplifier—will limit the permissible line attenuation, and hence the length of line between repeater stations. Close control of tube noise is therefore of importance in keeping down the cost of the system without sacrificing telephone quality.

Noise output of an amplifier whose input circuit is a pure resistance is the sum of the effects of thermal noise in the input resistance and of tube noise. If the amplifier had a perfectly quiet tube in its first stage, the noise measured by a meter in the output circuit would be due to the thermal noise. Replacing the

carrier-line type. This input circuit consists essentially of a transformer with impedance ratio 135:30,000 and a 30,000-ohm termination on the high side which is connected to the grid of the tube under test. An attenuator, a filter, a second amplifier and a calibrated thermocouple meter, which serves as a power measuring device, complete the equipment.

It has been shown by J. B. Johnson experimentally and H. Nyquist theoretically that thermal noise-power may be expressed by the relation $4kT\Delta f$ where k is Boltzmann's gas constant (1.37×10^{-16} ergs per degree), T is the absolute temperature, and Δf the width of the frequency band of the measuring equipment. Substituting the operating values for temperature and frequency

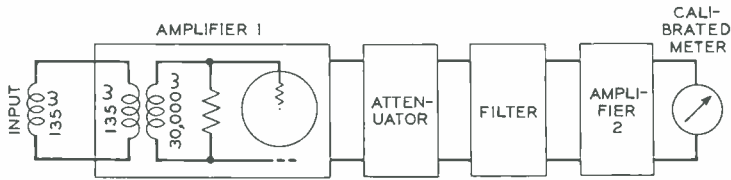

Fig. 1—The tube under test is placed in the first stage of amplifier 1. An attenuator, a filter, a second amplifier and a calibrated thermocouple meter complete the equipment

noise-power and the total noise-power. It is shown in Figure 2 plotted against total noise-power. Since the input transformer is not ideal, corrections must be made for its effect on the input termination. Tube-noise-power is

band it appears that the thermal noise-power at the input of the amplifier is 3.4×10^{-14} milliwatts. This is 134.7 db below one milliwatt. Since the input of the amplifier is terminated by a matched impedance only half the noise-power, which is 3 db less, is delivered to the amplifier.

If an ideally quiet tube could be inserted in the first stage of amplifier No. 1, the thermal noise would produce a reading of one milliwatt on the calibrated thermocouple meter when the overall gain of the measuring set had been adjusted to 137.7 db. Any actual tube in this position will give a larger reading due to its tube noise. The db change in attenuator setting required to bring the meter reading back to one milliwatt indicates in db the total noise-power above thermal noise referred to the input of the measuring set. The tube-noise-power is the difference between the thermal

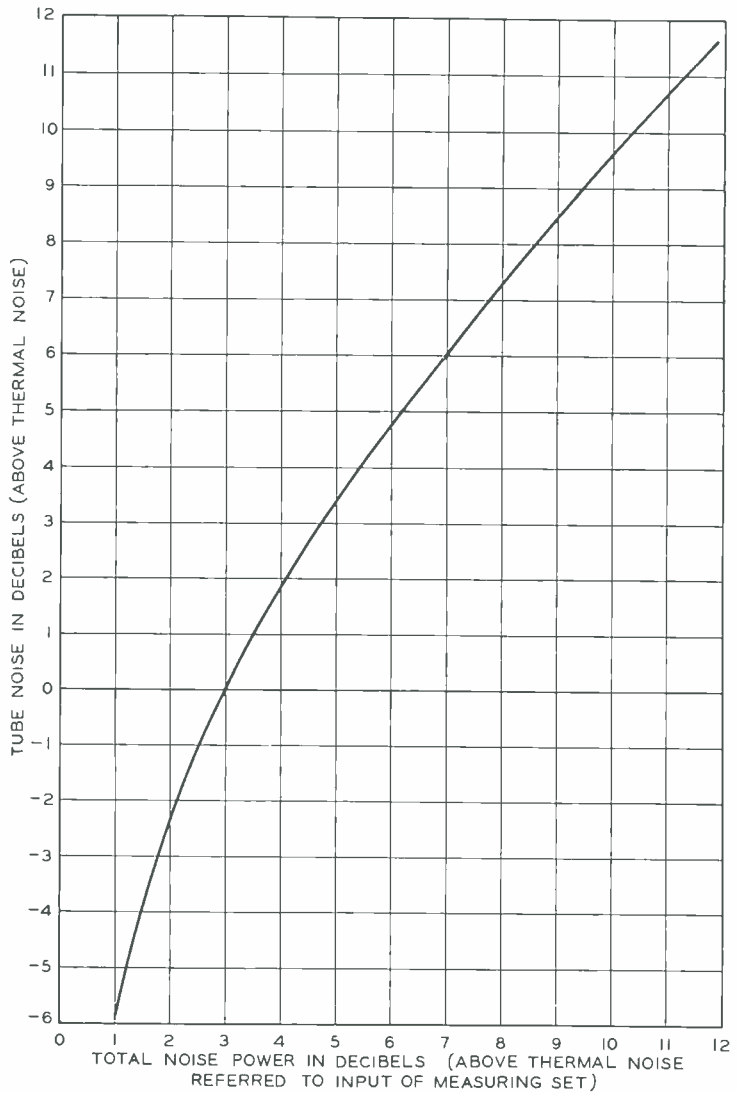

Fig. 2—Chart for converting total noise-power, referred to the input of the measuring set, to tube-noise-power. Inasmuch as the input transformer of the measuring set is not ideal, corrections must be made for its effect on the input termination. Tube-noise-power is shown in Figure 3

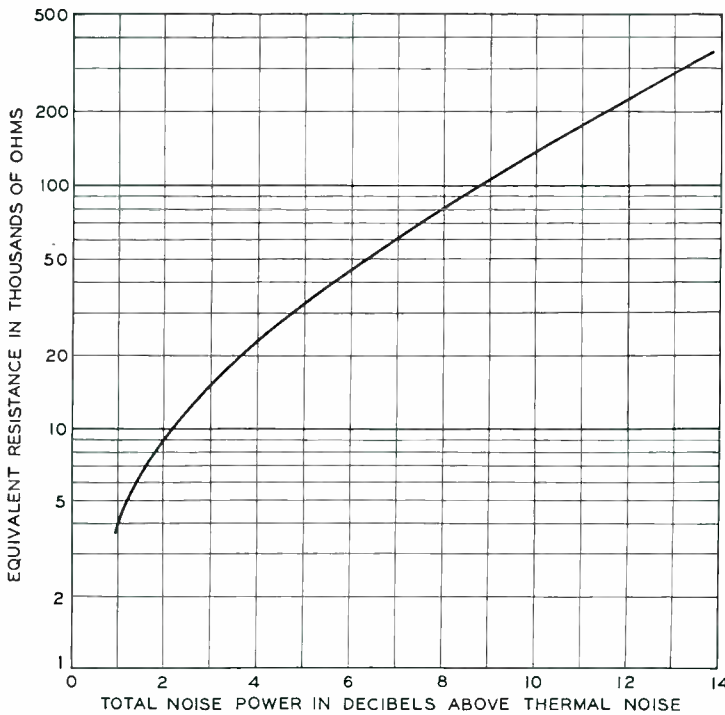

Fig. 3—Chart for converting tube-noise-power, referred to the input of the measuring set, to ohms equivalent resistance

shown in Figure 3 expressed in ohms equivalent resistance. In other words, this resistance is the ohmic resistance that is required in the grid circuit of the equipment to generate thermal noise which is equivalent to the noise voltage developed by the tube.

Another noise measuring set, designed by G. L. Pearson, differs in that the amplified noise voltage of the tube under test is adjusted by an attenuator to give a suitable reading on the output meter when there is no terminating resistance in the grid circuit of the tube. By adding grid resistance until the noise output is doubled, the tube noise voltage E becomes equal to the thermal noise voltage and may be calculated from the expression, $E^2 = 4KTR$, where R is the added grid resistance and may be represented as the ohms equivalent resistance

of tube noise. Where the noise characteristics of various types of vacuum tubes are required, the arrangement of Pearson is desirable. The two methods of measurement are functionally similar in that the equivalent input circuits of both sets may be represented by a grid resistance and an assumed resistance representing the ohms equivalent resistance of tube noise. In Pearson's arrangement, however, the measurement is made by varying the amount of grid resistance while in the first measuring equipment that was described the grid resistance remains constant.

THE AUTHOR: J. J. DEBUSKE joined the Systems Development Department of the Laboratories in 1930 as a messenger. In 1936 he became a Technical Assistant in the carrier telephone and repeater laboratory where he tested and maintained equipment. Since 1941 Mr. DeBuske has been concerned with carrier telephone repeaters. He received the B.S. degree in Electrical Engineering from the Newark College of Engineering in 1941 and became a Member of the Technical Staff this year.



J. J. DEBUSKE

NEW HEADSET PERMITS SIGNAL MEN TO WEAR HELMETS

A new headset, designed by the Laboratories and made by the Western Electric Company, has been provided for our fighting forces by the Signal Corps. L. W. GILES, WALTER KALIN and F. E. ENGELKE were the Laboratories engineers who were concerned with the project.

Now being manufactured in large quantities by the Western Electric Company, this set furnishes the answer to the problem of how signal men can wear headsets under the new-type steel helmets which come well down over the sides of the head.

The new and smaller set replaces the regular headphones which forced Signal Corps men to go into battle zones bare headed. It not only permits them to have protection against head wounds, but keeps out the noise of battle and affords better reception.

Somewhat similar in appearance to the hearing aids worn by civilians, the device has a small, soft plug that fits into the outer orifice of the ear, and thus is a more effective seal against outside noises than was the bulky receiver with large rubber caps. It has

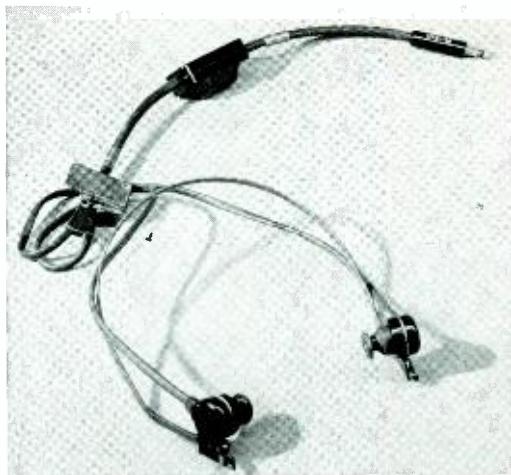

The small receiver set with its clothes clip and a transformer which permits it to be used with a high-impedance output circuit such as a radio set

a flat, narrow headband made of semi-spring steel—which can be bent to the shape of the head.

In tropical lands, this set is more comfortable than the old with its large rubber earcups pressing on sweat-dampened skin. It permits free circulation of air, and it will allow for sanitation, too, through issuance of a new pair of plug inserts to each new wearer. The inserts that are employed are made of neoprene, said to be even better than rubber.

Miniature receivers that are provided have a higher sensitivity and fidelity of tone than did the old headphones. This is due in part to the fact that the insert focuses the sound directly into the ear channel. The set uses far less material than the old one and can be used interchangeably with all ground signal equipment.

A clothes clip on the cord enables the operator to attach it to his shirt, thus keeping any pull on the cord from being transmitted to the receiver.

TRANSPORTATION

In the past few months the efficiency of cars used for commuting to New Jersey locations has steadily increased, due to the cooperation of owners and riders with Transportation Committees. So successful have been these efforts that many of the gasoline



A soldier wearing the new small head receiver set under his helmet

allotments were at an absolute minimum when OPA reduced the value of B and C coupons. At first no appeals were entertained, but after about a month representatives of OPA of the Newark District made inspections of the Murray Hill and Whippany plants and designated employees of these plants as eligible for restoration of the cut in the value of B and C coupons where deemed necessary by the Transportation Committee. Future gasoline rations will therefore be provided on the basis of actual mileage approved by the Committees—a measure showing full cooperation of OPA.

Practically all plants averaging 3.5 passengers per car were placed on the approved list. Other plants required special investigations and approvals. The 3.5 figure was recently reached at Whippany but irregular hours and unidentified cars have kept the Murray Hill average at approximately 3 passengers per car.

To ascertain the effects of unidentified cars on our averages, a special car sticker has been designed to be placed on each car registered with Transportation Committees

at various New Jersey work locations. This sticker contains a bell for each regular rider in the car and all cars not displaying such a sticker will eventually be required to register before entering Laboratories work locations. OPA representatives have expressed special interest in this plan and a considerable number of favorable comments have been received upon it.

As is the case with all rationing, trouble experienced by our Transportation Committees in getting members of the Laboratories to cooperate has been due to the feeling that other companies' Transportation Committees were more liberal. However, those Committees have not been approved by OPA and all their gas mileage rations are therefore automatically cut 20 per cent.

A spot check on approximately 700 automobiles used by Laboratories people to reach Murray Hill and Whippany showed that half had been driven over 30,000 miles and eight per cent over 60,000 miles. This group of cars would easily handle essential transportation for some time if efficient group commuting practices were followed and the cars were pooled. However, as the

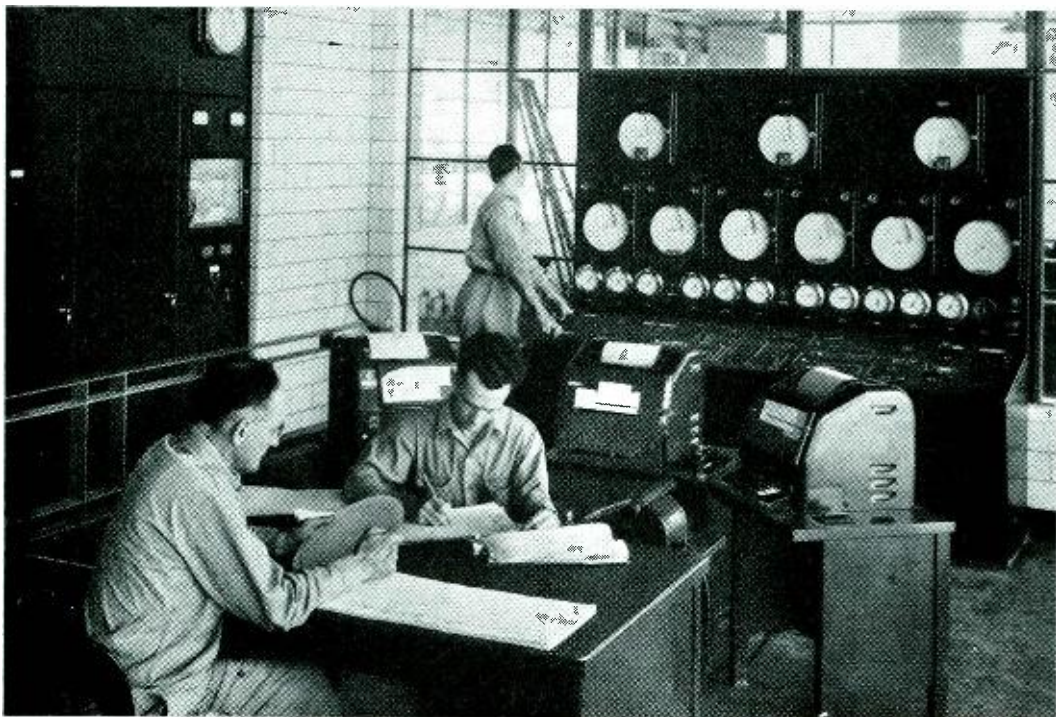

Teletypes are in every pumping station along the newest oil pipe lines

case stands, many of the better cars are driven short distances daily and many of the high-mileage cars are driven longer distances. Therefore, the distribution problem that may have to be faced if and when the repair problem becomes more acute is to make sure that the right car is in the right place.

As to tires, the supply of new tires looks somewhat skimpy for the next three to six months after which time newly available synthetic rubber will be made into new tires for essential driving. Many members of the Laboratories who are qualified to apply for new tires may be delayed in obtaining them because their Rationing Board's quota has been used. Each Board is given a monthly quota; applicants who do not obtain tires one month are automatically placed at the head of the list for the following month.

As to gasoline, obviously any amount of gas we can send across the ocean helps hold down the toll of lives, so we at home must get along on as little as possible.

OIL AND TELETYPEWRITERS

All oil pipe lines have a communication system paralleling them. The three most recent lines—Bayou, which runs mostly northward from a seaport in Western Florida; Plantation, which runs northeast from Baton Rouge to Greensboro, North Carolina, and "Big Inch," the 24-inch line which runs from Longview, Texas, to Phoenixville, Penna.—are controlled by messages sent over private teletype systems furnished by Long Lines. Operations are directed by a dispatcher, who communicates with each pumping station by typing out his message. Thus a positive record of each order and report is kept at two points at least. Since economy dictated the use of existing Bell System lines as far as possible, the teletypewriter circuits are much longer than the pipe lines they serve.

In front of the dispatcher is a tape, which moves at a speed proportional to that of the oil in the pipe. Whenever oil of a different character is started through the line, the fact is noted on the tape. As the head of the new "tender" approaches each station, the attendant is warned by teletype so he can open and close valves in proper sequence, to divert the oil into the proper tank.



Major General Harry C. Ingles

MAJOR GENERAL INGLES NOW CHIEF SIGNAL OFFICER

On the retirement of Major General Olmstead, command of the Signal Corps has been given to Major General Harry C. Ingles. Graduating from West Point, he was commissioned a second lieutenant of infantry and attained the rank of lieutenant colonel in 1935. He attained his present rank, which is for the emergency, in December of last year.

General Ingles' first service was in the northwest and on the Mexican border. During World War I he was an instructor in the training of signal officers. After the war he attended and graduated from the Army Signal School, was an R.O.T.C. instructor at the University of Minnesota, and was Signal Officer in Manila. From 1924 until 1926 he was director of the Signal School at Fort Monmouth and was either a student or an instructor in various Army schools until 1932 when he returned to Fort Monmouth. From 1935 until 1939 he held various staff assignments including membership in the Signal Corps Board. He was assigned in November, 1940, to Headquarters of the Third Army and in March, 1942, was sent

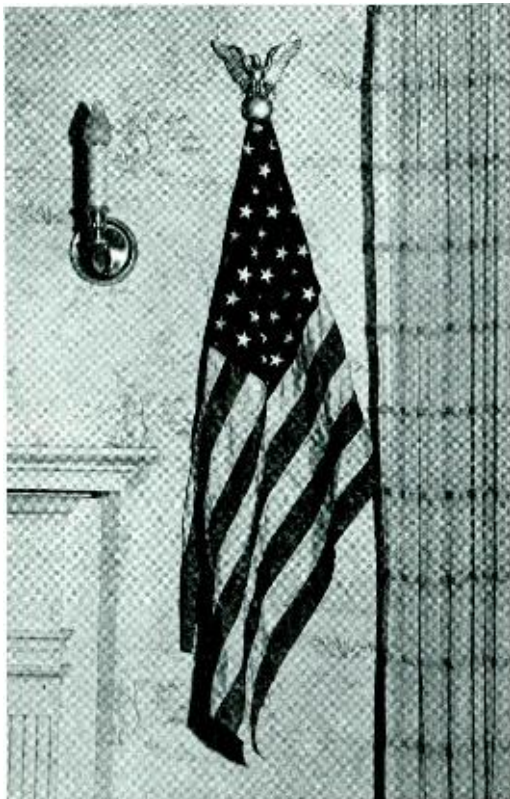

Our National Emblem should have a place in every home. To that end, a nation-wide committee has been formed, one of whose activities has been to make available a moderately priced flag suitable for home display. Three sizes are stocked by the Club Store of which the largest is shown here

overseas. Subsequently he became Deputy Commander of the United States forces in the European theater of operations, from which he was assigned to his present post.

Coincident with General Ingles' appointment, the War Department has announced a reorganization of the Signal Corps into five operating services, as follows:

Engineering and Technical Service—Major General Roger B. Colton

Procurement and Distribution Service — Major General William H. Harrison

Personnel and Training Service—Brigadier General J. V. Matejka

Army Pictorial Service—Colonel Kirk B. Lawton

Army Communications Board — Brigadier General F. E. Stoner

OUTDOOR TELEPHONE BOOTHS FOR RESIDENTIAL AREAS

Among the changes which the war is bringing to the telephone business is the use of outdoor telephone booths in residential areas. If most of the homes had telephone service, as would normally be the case, there would be little need for public telephones, and the neighborhood drug or candy store would house them. But in war housing developments, residence telephones seldom can be installed, or stores built, either, so coin boxes are installed outdoors. Sometimes they are on the porch of a building; in other cases they are set right on somebody's side lawn.

After a field check discloses the need for the service, and the probable center of demand, home owners are canvassed for permission to make an installation on their property on a regular agency agreement basis. In Detroit there are 85 such booths in service, with more on order. Collections indicate about twenty outward calls per box per day.

SCHOOL FOR WAR TRAINING

THE FOLLOWING LETTER has been received from the latest section to complete its course in the School for War Training:

MEMBERS OF THE STAFF:

As our ten-week period of training at the BTL.SFWT draws to a close several plans have been suggested relative to the nature of our parting gesture. Some feel that a dinner in your honor would be most appropriate—others would follow time-honored tradition with a plaque of appreciation.

Since your primary effort, and ours, is toward the successful completion of the war, we ask that you accept in behalf of the American Red Cross the enclosed cashier's check, which might otherwise have been used to defray the expenses of a dinner or a plaque.

We hope you'll accept this expression of our deepest appreciation for the courtesy, coöperation, and good fellowship extended to us while we were here.

May your efforts, and ours, help speed the war to the end which will establish freedom and justice for all.

The check was for \$68.50.

NEWS NOTES

WILLIAM H. HARRISON has been promoted to the rank of Major General and transferred from the Army Service Forces

to the Signal Corps, where he will be Chief of the Procurement and Distribution Service. Formerly vice-president and chief engineer of A T & T on military leave, General Harrison has now resigned and has severed all connections with that company.

THE WESTERN ELECTRIC COMPANY has leased a large part of the Packard Automobile Building at 54th Street and 11th Avenue, in New York City, for occupancy for the manufacture of electronic products. The total floor space to be occupied amounts to 232,000 square feet. Initially it is expected that 300 people will be employed, and eventually this may increase to as many as 2,000. Western Electric has also leased for a period of four years the Holland Laundry Building in Jersey City near the Bayonne city line. The building contains 70,000 square feet and will be used for the manufacture of communications equipment.

W. FONDILLER, R. L. JONES, R. G. MCCURDY and W. J. SHACKLETON visited Hawthorne on June 22.

K. K. DARROW attended the 255th meeting of the American Physical Society held at the State College of Pennsylvania on June 18 and 19. At the Pacific Coast meeting of the Society, held at Stanford University on July 10, Dr. Darrow presented an invited paper on *Entropy and Probability*.

A. G. SOUDEN visited the Western Electric Company at Hawthorne on core problems.

F. S. MALM, J. H. INGMANSON, G. G. WINSPEAR and V. T. WALLDER attended the A.S.T.M. meeting in Pittsburgh, June 29 and 30.

R. R. WILLIAMS, A. R. KEMP, B. S. BIGGS, W. O. BAKER, J. W. MULLEN II, J. H. HEISS and W. S. BISHOP visited Akron to attend a general meeting on synthetic rubber development and research.

C. C. HIPKINS and C. H. SAMPLE attended the A.S.T.M. meeting held at Pittsburgh. At this meeting Mr. Sample presented a paper on the *Use and Measure of Salt Spray Testing as Applied to Electrodeposited Finishes*. He also visited Hawthorne to discuss corrosion and finishes.

A. W. DASCHKE discussed range meters at the General Electric Company in Boston. He also visited the Western Electric Company in Hawthorne regarding meters for testing equipments.

AT THE ANNUAL MEETING of the Edward J. Hall Chapter of the Telephone Pioneers of America held June 25, 1943, officers for the coming year were elected as follows: President, I. R. Jenny, Long Lines; Vice-President, J. W. Campbell, O & E. The Secretary and Treasurer were reelected. LEAH SMITH was elected to membership on the Executive Committee. I. MONTAMAT read a report of a Committee to form a separate Chapter of the Pioneers for the Bell Telephone Laboratories. The formation of such a chapter has been approved by the Executive Committee of the Edward J. Hall Chapter and a recommendation to this effect has been sent to the National Committee for action.

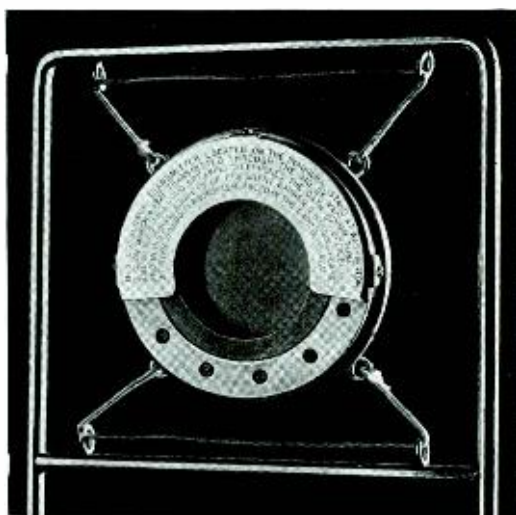

OUR EDITORIAL FACE IS RED

Accuracy is an ideal in the technical journalism of the Bureau of Publication, just as it is in the rest of the Laboratories' work; mistakes in the RECORD have been infrequent, and of the kind which is obvious to a careful reader. The editorial staff were chagrined to learn from a number of readers that the picture in the article "Historic Firsts—The Condenser Microphone" is really of a double-button carbon microphone. The correct picture, shown above, is of the microphone used at President Harding's inauguration on March 4, 1921.

Bound volumes of the RECORD will carry the right picture, and a few corrected copies are available for exchange by those who maintain a permanent file.

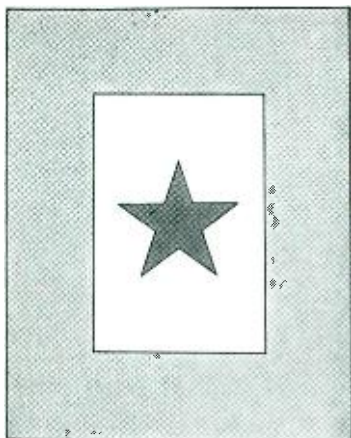

In the Nation's Service

As of June 30 there were 537 members of the Laboratories on military leaves of absence. These men and women are divided among the various services as follows:

Army 367 Waves 17 Wacs 8

Navy, Marines and Coast Guard 145

Wilson Taylor

"I can tell you where I am now as well as some of the things I went through. To begin with I am very near Bizerte. My outfit was the first into Bizerte to get the snipers out and see that it was safe for the rest of the boys to go in. We worked for six hours, then it got dark and all of a sudden we ran into some machine gun fire. The enemy used some tracers and I was just in a place where they could see me and they did. They started firing. I hit the ground and the fire went about 4 inches over my head and stomach. It sure is a good thing I am thin and not like ANGEL.

"That was the first time I was fired upon but we had a lot of artillery fire. One morning after going to bed early we woke up to find that the Germans were only about two blocks away and on a hill looking at us,

which made it very uncomfortable for us. But as JUNE says, lots of things are military secrets and you folks will have to wait until I get back, which I hope will be very soon. (*Angel and June are members of the Restaurant at West Street.*)

"You asked if I miss the old gang, boy and how. I am OK and have been very lucky. God has been with me and I am sure He will stay. I have only lost one finger and even that could have been avoided. I am glad to get out with no more than that happening to me, so do not worry too much.

"Do not forget to keep sending us the things we need and we will do the rest to keep America free and safe for all of us."

Edward A. Fern

"I am on an island in the South Pacific, in very good health, but lonesome for the old



ARTHUR JACKSON, JR.

D. F. CUNEO

F. A. KODITEK

W. P. HARNACK



IRENE M. BIER



LT. K. E. WATERS



R. H. CANTON



H. C. DeVALVE

drafting room. All the gang still write to me. It helps a man out when he's far away from home yet his pals still write to bolster his morale. I would like to thank all the boys and girls in the drafting room for not letting this Marine down. Even when I can't write they still keep sending me the news. I'm in the service six months and everything is still going along swell."

Irene M. Bier

"As you can see I am in a rather hot spot. (*Irene is in Milledgeville, Georgia.*) The weather here is terrific. However, I joined this 'Man's' Navy to take a man's place, so I shall act accordingly. All of us are taking the heat, long hours of study and general routine in the best of spirits. As a Storekeeper I often hear Bell Telephone Laboratories' name mentioned for its work."

Lieut. Col. Albert M. Elliott

"I have just completed a year's duty as Signal Officer, Southern Sector, Eastern Defense Command. The work is constantly enlarging in scope and interest. For variety there have been several trips outside the U. S. surveying sites for new installations.

"My Bell System consciousness is pleasantly roused when operators at telephone and radio installations enthuse on equipment which bears the Western Electric Company nameplate. Southern Bell has done wonders

in what was a sparsely telephoned area but is now full of air fields and camps, all heavy telephone users."

Arthur Jackson, Jr.

"I am delighted when I receive those swell issues of the RECORD every month. They are very interesting. I'll admit I didn't read them very much when I worked in Department 7524, but I read them now and find them full of things I didn't think were there. I am in a Medical Unit, but I am going to Cooks and Bakers School and hope to make ratings at the end of my training."

Capt. Ernest Graunas

"I have been in Australia for some time. The ocean trip at Uncle Sam's expense was an enjoyable one. My work is interesting and I enjoy the hospitality of the Australians. Would like to hear from members of my former department."

William R. Carolan

"Well I'm back to yardbird again after a few months' reprieve. But I guess I'll be back up there with KES and the big boys after I get out of this. I forgot to tell you we changed to those wonderul suntan uniforms the other day. Since then I've twice been mistaken for a Good Humor man and once for a gas station attendant. How I hate those things. It seems that whenever I stand

really something. Twenty or more push-ups, followed by chins, running and millions of other back-breakers that I can't even describe. Boy—we stagger for a while after that. Course they have eased up somewhat now because of the last class which just came in; they look awfully soft. I looked them over very completely expecting to find LYNCH but no Lynch. Where is that guy?

"This place is a perfect set-up. We live as well, and with less worries, than we did as civilians. Excellent food, comfortable quarters (four fellas in three rooms), nice class buildings. You catch on, nice set-up. Come on up, you are welcome. Ninety hours a week, \$75 per month, no overtime."

R. T. Duffey

"Here's another of those 'it can only happen to Duffey' incidents. On my first day at the obstacle course I ran along like—(well you know what I run like)—and suddenly came to a water obstacle which some second lieutenant invented, I believe. Anyhow a shavetail was standing there. Across the stream, creek, or whatever it was, they had a rope strung. Being a man of good sense I



J. F. MARTIN

LT. J. H. PENNSTROM

realized I couldn't possibly make it hand over hand on the rope. He kept saying, 'Go on, what are you afraid of?' but somehow I couldn't get myself together. One of the guys fell in and only went up to his knees. When the lieutenant got mad and said to me, 'Go on that rope or confound you, you'll walk through' I calmly stepped in and strolled across. As a result he went with me for the rest of the way (so I wouldn't kill myself I guess) and didn't say a word. I must remember to tell him about my career with the Laboratories—that might help him to understand."

* * * * *

CATHERINE LENNON has been granted a personal leave of absence in order to attend the Second Service Command Signal Corps School at Paul Smith's College, Saranac, New York. One of the twenty-one women chosen from two hundred applicants, she is studying radio and code and at the end of this course will start her Wac training.

MAJOR EMIL ALISCH of the Infantry has been transferred to Camp Van Dorn, Miss.

GEORGE JAY WOLTERS, writing from maneuvers in Louisiana, says he's proud of the way Labs men in the service are making their presence felt on the other side. George hopes to be transferred to the Signal Corps.

GEORGE E. FUCHS, an instructor in radio, changed companies at Fort Monmouth.

EDWARD H. BUEB of the Coil Winding Shop is a Corporal at Fort Monmouth.

JAMES V. CUNNINGHAM, formerly a power plant man, has received a third class petty officer's rating and has been assigned to the Submarine School at New London. Before reporting there, James was on furlough and made several trips to West Street.



Sigmund Fronczak at Trafalgar Square in London where he spent a furlough recently

GEORGE BICKARD is in a statistical control unit at Fort Wright, Washington.

LT. KENNETH E. WATERS sends his regards to his gang in the 9C Drafting Room from somewhere overseas.

FROM COCHRANE FIELD where he gets plenty of chance to fly, JOSEPH A. JOYCE writes that the one thing he wants most is to be where his buddies are—overseas. He's hoping he'll get his chance at those Nips.

CONTROLLING the firing of guns on a warship is the job R. H. FUNCK is learning at the Great Lakes station.

FRANK A. KODITEK of the Complaint Bureau is studying navigation, routines aboard ship and the duties of a Quartermaster at the Newport, Rhode Island, Naval Training Station.

WILLIAM WIEGMANN is with the A.A.F. at Michigan State College.

FROM CAMP PARKS, California, where he is in the military training department, JAMES M. CULLEN sent a note saying he'd rather be back working for a living than instructing on small arms.

WAC HELEN ELBERSON is running a ton-and-a-half truck for her Uncle Sam.

BECAUSE he keeps running into so many Bell System men at Fort Monmouth, CHARLES R. STORIN says it's hard to tell whether it's the Army Signal Corps or a telephone convention.

RADIO TECHNICIAN THOMAS J. SLATTERY has been sent to Tennessee on maneuvers.

EDWARD P. HULLAH is at Colorado Springs, Colorado.

FROM TONOPHA, Nevada, PAUL P. MELKONIAN writes that he enjoys knowing what is going on in the East and he sends his regards to Mr. LEAMER and his friends at Murray Hill.

A WORD of encouragement to those of us whose loved ones are in service comes from CHARLES E. KLEIN of the Medical Corps who assures Laboratories members that Army Medical care is the best. "Our motto



Louise Parietti and Kay Parsons of Building R at their barracks

of 'Service Above Self' is lived up to 100 per cent," he writes.

ELWOOD N. RIKER, preparing to solo soon out at Camden, Arkansas, finds the people of that town the most friendly he's come across in the south.

NO LONGER a member of the Air Force, WILLIAM V. FLUSHING has begun an eighteen months' engineering course at the University of Connecticut.

HERBERT C. DEVALVE is studying out at Colorado State College.

AS AN M.P. it is ALFRED STILLER's job to go to various camps to pick up prisoners who have gone A.W.O.I. and bring them to his station at Greenville, Pennsylvania.

ROGER W. WALTER, Army Air Force Pre-Meteorology student, is studying at Bowdoin College, Maine.

ROBERT N. CANTON is at Iowa State University.

CAPT. I. C. OSTEN-SACKEN has written recently from MacDill Field, Florida.

CAPT. F. B. MONELL, whose work in Detroit keeps him more engineer than soldier, sends greetings to all his friends at the Laboratories and to all his former associates now scattered over the world.

ROBERT J. DROUT is at Biggs Field, Texas.

LAWRENCE O'DONOGHUE has begun the study of Radar at Camp Davis.



JAMES V. CUNNINGHAM LT. OWEN N. GIERTSEN



Emil Sesso (center) and his associates who make drawings for Air Corps equipment were thrilled to hear from Captain Mario Sesso, Emil's brother and a bomber pilot from the South Pacific, how important was the Western Electric radio telephone in his plane. Others in the picture are R. I. Forrest, George Meszaros and L. J. Mase

AS AN APPRENTICE Chief Petty Officer, at Sampson, N. Y., with 110 men under him, ARTHUR V. FROLIC has had his hands full since joining the Navy.

AMONG THE VISITORS to the Laboratories recently was JOHN F. MARTIN who has just started intermediate flight training at Naval Air Base.

EAGERLY AWAITING a transfer to a pre-flight school, GREGORY CHABRA, recently classified as a pilot, has been bunking with GERARD E. DAVIS, also a Bell Labs man.

MAJOR W. E. STEVENS has been assigned to the Army Air Force at Mitchel Field.

HERMAN E. MANKE wants to let his friends know his new address is Orlando, Florida, where he's flying A20G's, AT11's, AT17's and BD7's.

MICHAEL F. GRIFFIN's letters from the Bainbridge, Md., Training Station to the boys and girls in Building R are considered among the best of those coming into the Electronics Shop.

A VISITOR to the Laboratories recently was JOHN F. GULBIN, a student glider pilot at Lubbock Field, Texas. Jack, who went into the Service in September, 1940, with the National Guards, is a Staff Sergeant.

ROBERT E. HENNEBERG is a special M.P.

being trained for the escort guard who will go overseas to pick up prisoners and bring them back to this country.

BERTRAM H. SOMMER's letters from his training ship at sea come addressed to Mr. and Mrs. Everybody, at B.T.L. He signs them Bert, Rear Admiral "U.S.B.F." U. S. Bathtub Fleet. Bert has been firing guns and abandoning ship so much that he doesn't even get excited now when the signal

for these drills comes over the loudspeaker.

HARRY F. JOHNSON, who paid a call recently on his friends at the Labs, is now with the Amphibian Engineers at Camp Edwards. He is a Western Electric man.

ON LEAVE after having completed his training for the Air Force at Yale University, LIEUT. WILLIAM A. VON GLAHN visited the Laboratories. He has since been assigned to the Baer Field Fort Wayne Troop Carrier Command as a Maintenance Engineering Officer.

COMMISSIONED a second lieutenant at the Pan-American Airways Navigation School,



H. F. JOHNSON



W. M. FLUSHING

Coral Gables, JOHN H. PENNSTROM, JR., has been assigned to the Troop Carrier Command, otherwise known as "Paratroops." He visited West Street before leaving for his new assignment which he hoped would be the South Pacific.

DONALD F. CUNEO has been transferred from St. Simon's Island, Georgia, to an airplane instruments school in Chicago.

THESE MEMBERS of the Laboratories have also written to the RECORD:

William T. Reck, Edward Filipovits, Joseph C. Young, Edward J. R. Lang, Charles L. Semmelman, Bernard C. Guinter, James J. Viggers, Philip E. Watts, Alfred O. Schmitz, Daniel J. Brady, Andrew F. Bartinelli, William P. Harneck, William R. O'Neill, John M. Marko.

NEWS NOTES

C. S. KNOWLTON, at the Leland Electric Company, Ohio, studied motor generators.

MOTOR AND RECTIFIER questions took F. F. SIEBERT to the General Electric Company at Lynn, Mass.

H. T. LANGABEER tested rectifier inverters at Eau Claire, Wisconsin.

V. T. CALLAHAN visited D. W. Onan and Sons, Minneapolis, and the U. S. Motors Corporation at Oshkosh, Wisconsin, regarding gasoline engine sets.

J. H. MULLIGAN, JR., of the Systems Development Department, received his B.E.E. degree from Cooper Union School of Engineering on June 12. He was awarded the Henri D. Dickinson prize of \$125.00 in war bonds for the best record in the senior year. During his senior year he was President of the Cooper Union Student Branch of the American Institute of Electrical Engineers.

K. M. WEEKS has been transferred from the General Accounting Department to the Personnel Department as Assistant Secretary of the Employees' Benefit Committee, reporting to J. S. EDWARDS, Secretary. Mr. Weeks takes the place of G. A. BRODLEY who was recently appointed Assistant Treasurer of the Laboratories.

"THE TELEPHONE HOUR"

(NBC, Monday Nights, 9:00 P. M. Eastern War Time)

AUGUST 16, 1943

Under the Leaves	Orchestra	Thomé
The Time of Lilacs	Gladys Swarthout	Chausson
Enchanted Lake	Orchestra	Liadoff
Dancing in the Dark from "The Band Wagon"	Gladys Swarthout	Schwartz
Cossack Dance from "Mazeppa"	Orchestra	Tschaikowsky
L'Antoueno	arr. Cantaloube	Auvergne Folk Song
Gladys Swarthout		

La Ronde des Lutins	Bazzini
Siboney	Lecuona
Grace Moore and Chorus	

AUGUST 30, 1943

Tales from the Vienna Woods	Strauss
Havanaise	Saint-Saëns
Jascha Heifetz and Orchestra	
Sicilienne	Bach-Auer
Old Vienna	Godowsky-Heifetz
Caprice No. 20	Paganini-Kreisler
Jascha Heifetz and Orchestra	

SEPTEMBER 6, 1943

AUGUST 23, 1943

For the Children (Large and Small)	Traditional
Nursery Rhyme	
Vilia from "The Merry Widow"	Lehár
Waltz from "The Nutcracker Suite"	Tschaikowsky
O Mi Babbino Caro from "Gianni Schicchi"	Puccini
Grace Moore	

Ballad of Adamastor from "L'Africaine"	Meyerbeer
Valse from "Serenade for Strings"	Tschaikowsky
At the Balalaika from "Balalaika"	Posford-Stohart
The Lord Chancellor's Nightmare from "Iolanthe"	Sullivan
Beautiful Galathea Overture	Von Suppé
How Do I Love Thee	Lippé

Men of the Laboratories

(Chosen by I.ot)

A RESEARCH WORKER on electrical networks is WILLIAM BOGHOSIAN, who entered the Laboratories in 1936 after receiving his M.S. degree in electrical engineering from the University of Pennsylvania and teaching for a year at Ohio State. For a time he was a



WILLIAM BOGHOSIAN

member of Transmission Networks, then transferred to Mathematical Research. One project on which he spent considerable time was the mathematical study of feedback amplifiers for radio transmitters. To his current war work he has brought a strong grasp of theory and a quick perception of what circuits can be made to do.

Mr. Boghosian is one of our recent fathers, having a son five months old; his home is in Forest Hills. Before war work absorbed so much of his time, he took a number of courses in the out-of-hours program and also at Columbia.

* * * * *

ARTHUR D. BEERS, known as "Art" to all of his friends at Whippany, did not wait for war to get into the army. But after a year's training, a leg injury sent him to the

hospital for several months. Then came Pearl Harbor. Three days later, Art was mustered out to become a war worker at our radio laboratories because of his Signal Corps experience in communications maintenance. Now he assembles intricate circuits and assists in making them work at the Whippany laboratory.

Art has been married nearly two years now. His home is in nearby Morristown. His favorite hobby is bowling, but softball proves so attractive at Whippany that he often belts one out and takes his chance on base running. Nearly twenty per cent of Art's salary goes for war bonds, and he has on several occasions donated blood on short notice.

* * * * *

STARTING to work when he was sixteen did not put an end to JOE WURSCH's education; at first he was in a chemical house, so he took up chemistry; then he went into a machine shop and took a four-year course at Hebrew Technical Institute, from which he graduated. In 1929 he entered the De-



ARTHUR D. BEERS

velopment Shop, and later transferred to Building Maintenance, where he works on elevators, pumps and compressors. As a recreation, he builds ship models, one of which is shown on this page.

At one time Joe was a boys' club leader in the neighborhood house of a Manhattan church. There he met the girl he married; they live in their own home in Hollis.

With his associates, Joe is responsible for twelve elevators in the West Street block, one in Building R, and three in the adjoining warehouse; six are for passengers, one for mail, the rest for freight.

NEWS NOTES

H. D. BREINER of the Outside Plant Development Department received a Bachelor of Electrical Engineering degree from Brooklyn Polytechnic Institute in June.

COOPER UNION has granted degrees to two members of Transmission Apparatus Development Department, a B.E.F. degree

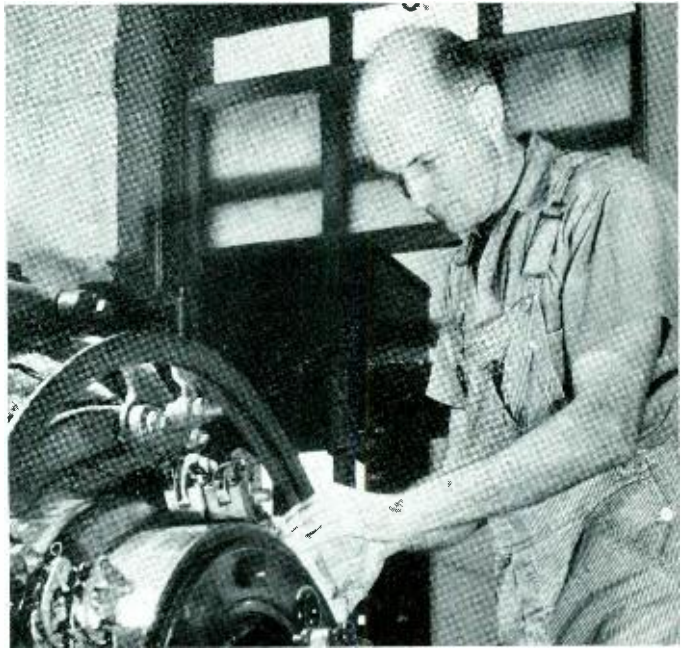

JOSEPH F. WURSCH

A. N. HOLDEN, C. J. CHRISTENSEN and S. O. MORGAN represented the Chemical Department in a conference on crystal growing with the Brush Development Company at Cleveland. Mr. Holden also discussed the growing of crystals at M.I.T.

QUARTZ CRYSTAL problems took C. J. CHRISTENSEN to Hawthorne.

INDUSTRY-WIDE RESEARCH and attendant financial collaboration in the textile industry on a national and unprecedented scale were foreshadowed on May 27 when the board of directors of Textile Research Institute, Inc., unanimously approved plans for a five-point program of cooperative industrial research. A. C. WALKER of the Laboratories is a member of the board of directors of the Institute whose plans "are a direct outcome of the growing recognition that the technical basis of the industry is being revolutionized."

THE BOARD OF TRUSTEES of Princeton University reelected J. I. BARNES to membership on the Advisory Council of the Department of Mathematics.

THE JUNE ISSUE of the *Journal of Applied Physics* and the June 12 issue of *Nature* carry an article by FRANKLIN L. HUNT on the *New Murray Hill Laboratory of Bell Telephone Laboratories*.

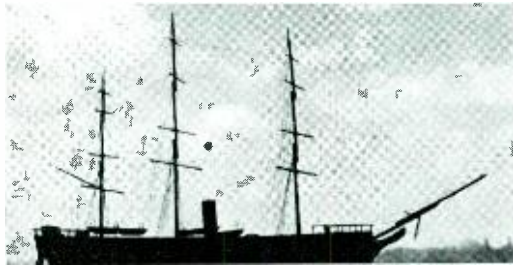

A ship model by Joe Wursch

to B. C. MEYER, and an M.F. degree to R. P. MUHLSTEFF.

D. F. TRUCKSESS has received honorable mention in the 1942 A.I.E.E. National Prize Award for the best initial paper. The award was based on his paper, *Regulated Rectifiers in Telephone Offices*.

J. H. INGMANSON, V. T. WALLDER and J. B. HOWARD visited the Western Electric Company at Point Breeze to discuss development problems on rubber-covered wire.

OBITUARIES

FRED R. McMURRY, a member of the Technical Staff in the Switching Engineering Department,



FRED R. McMURRY
1879-1943

died on June 28. After attending the University of Illinois for a year Mr. McMurry transferred to Columbia University from which he received the A.B. degree in 1900. He entered the Bell System in 1904, first with the New York Telephone Company. He transferred to the Installation Department of the Western Electric Company in 1906 and then to its Engineering Department shortly thereafter. Since 1914 practically all of his time has been devoted to the development of printing telegraph apparatus of all types and he contributed much towards making available the necessary apparatus required for the rapid expansion in this field. From 1931 he had been responsible for directing and maintaining technical contacts between the Laboratories and the Teletype Corporation in Chicago.

* * * * *

CHARLES W. MILLS, a supervisor in the plant and mechanical service group at the Whippany Laboratory, died on June 18. He joined the Commercial Products Development Department at Whippany in 1929 as a building and grounds utility service hand and in 1942 was placed in charge of the night maintenance group. Before coming to the Laboratories Mr. Mills was with R. B. McEwan & Son from 1915 to 1917, in the United States Navy from 1917 to 1920 and then was in



C. W. MILLS
1894-1943

business for himself. For a number of years he had been Assistant Fire Chief of the Town of Whippany's Volunteer Fire Department.

* * * * *

HENRY HOVLAND, a former member of the Technical Staff in the Switching Development Department, died on June 26. Mr. Hovland retired on February 28, 1942, and a biography and photograph published on that occasion will be found in the March, 1942, issue of the RECORD.

NEWS NOTES

S. A. SCHELKUNOFF'S lecture, *Guided Propagation of Ultra-short Waves*, presented before the Basic Science Group of the New York section, A.I.F.E., has been published in the June issue of *Electrical Engineering*. Dr. Schelkunoff's lecture was the fourth in a series of six in the Symposium on *Ultra-short Electromagnetic Waves*.

The Laboratories were represented in interference proceedings before the Primary Examiner at the Patent Office in Richmond by N. S. F. WING and G. T. MORRIS.

THE NEW EDITION of *The Engineer's Manual of English*—an excellent text by Professors Sypherd, Fountain and Brown—quotes almost in its entirety an article by JOHN MILLS on *The Impact of Science on Art*, originally published by *Technology Review*.

R. H. ROSS went to the A. G. Redmond Company, Owosso, Michigan, and to the Pioneer General Electric Motor Corporation, Chicago, on dynamotors. While in Chicago he also visited the A. F. Dormeyer Manufacturing Company on motors.

F. F. LUCAS was in Washington on June 22 at the request of the Bureau of Ships, Navy Department.

B. L. CLARKE has been reelected Chairman of the General Division of A.S.T.M. Committee on Chemical Analysis of Metals.

N. Y. PRIESSMAN and J. A. BECKER attended the first meeting of the A.I.E.E. Subcommittee on Metallic Rectifiers in Cleveland on June 25. They also visited the Union Switch and Signal Company and the Westinghouse Electric and Manufacturing Company in connection with problems of copper oxide rectifiers.

D. E. TRUCKESS discussed vibrators when he attended the meeting of the *War Committee on Radio* at Wright Field.



A



B



C



D



E

VOLUNTEER FIRE DEPARTMENT AT THE MURRAY HILL LABORATORY

A—Volunteer firemen from the Technical Staff and Plant Department manning the Laboratories' fire engine at Murray Hill. There are four squads of twelve men

B—W. L. Whinn adjusts the valves on the pump while A. H. Joyiens stands by

C—D. G. Sandford and C. L. Ehrenfeld practice making a Y connection

D—J. M. Mills and T. J. O'Rourke

E—A. Kendall, N. S. Whitehead, N. F. Marinaro and T. J. Prendergast practice the handling of two streams

August 1943

475

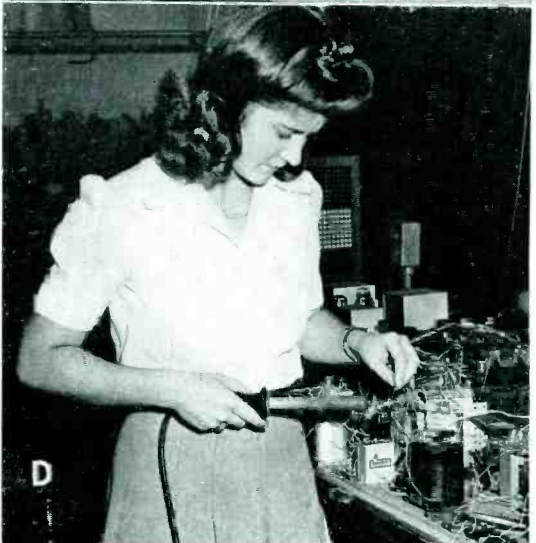

A—Women in this section of the Murra Hill Development Shop are doing bench work or working on various machines. Left to right: Viola J. Klischer, Ellen C. Mitchell, Evelyn A. Kelly, Ethel B. Williams, Lillian W. Pictroski, Adele E. Aboutek, Patience M. Bernath, Julia M. Vicendese, Isabel C. Anderson, Helen H. Looek, Grace L. Schneiderman, Ludwig Evers, Margaret S. MacLaine and R. Millicent Pruden

B—Susie Terracciano is measuring the spacing between the grids of an electronic device

C—Eleanor Mussler does mathematical computations for secret signaling devices

D—Jeannette E. Granger built the oscillator detector and amplifier which she is soldering

Women of the Laboratories

MRS. ELIZABETH SEXTON takes naturally to Laboratories work because she is the daughter of L. H. JOHNSON of the Systems Development Department. Most of the time since August, 1941, she has spent traveling about the country with her husband who is a Flight Surgeon in the Army. Now that he is overseas Mrs. Sexton keeps up her end of the family war effort by serving as a Technical Assistant at Murray Hill. She is shown here winding fine resistance wire for small heater units used in thermistors. After graduating from the Maryland College for Women, Mrs. Sexton taught English and history for several years in a girls' private school. She goes to the opera regularly and is fond of riding. Dressmaking, another of her hobbies, is a helpful accomplishment in these days of restricted living.

* * * * *

PHYLLIS D. FOSS of the Benefit Plan Operation Department is responsible for interviewing applicants for military and other leaves of absence and for preparing the



PHYLLIS D. FOSS

facts for submission to the Employees' Benefit Committee for approval. It is also her job to inform them of the conditions under which the leave is granted and of the requirements for reinstatement. She arranges for securing departmental approval of the leave and for final pay; collects Laboratories passes; issues special leave of absence passes; mails checks representing the differential

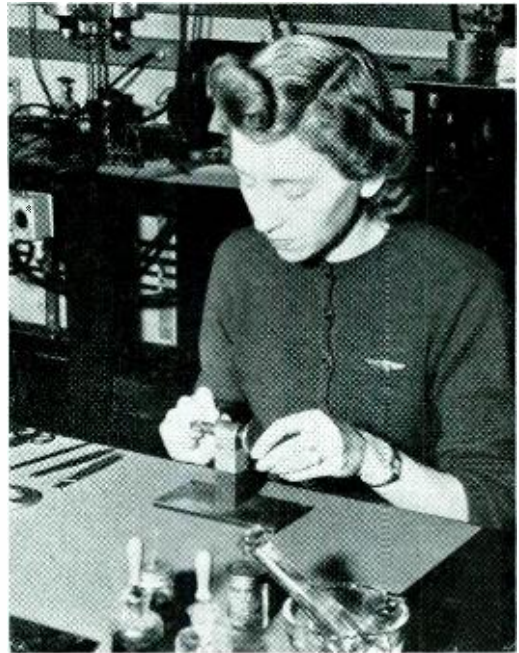

ELIZABETH SEXTON

pay to which service men and women are eligible; and compiles monthly reports of leave of absence activity. She is assisted by ETHEL MONCURE and JANICE BLAUVELT.

Murray Hill and Whippany applicants for leaves are interviewed locally and the information is forwarded to West Street for further consideration. Many of those on leave drop in to see her and there is always a volume of correspondence going out to them. Phyllis sees that the Laboratories RECORD and their departments are furnished with the proper mailing addresses. Upon the indi-



EMILY S. O'CONNOR

vidual's return, she ascertains the possibility of reinstatement for leaves other than military, arranges a medical examination in all cases, and sees that those reinstated are restored to the Payroll.

A descendant of the settlers of Salem, Phyllis grew up in nearby Lynn, Massachusetts. She is the daughter of C. W. Foss and the sister of C. A. Foss, both of the A T & T. While at Tufts College, from which she received her degree in English in 1941, she also studied flying. In fact, she was the only girl to ever receive a private pilot's license under the Civilian Pilot Training Course at Tufts College.

It was in her first job as Registrar of the Fletcher School of Law and Diplomacy that she acquired the experience that has proven so useful at the Laboratories. While there she also studied art at night. When the job ended she bicycled from Vermont to Montreal, and in the fall came to work at West Street. This year on her vacation she went to Virginia whence she traveled by automobile to Arkansas with a friend who opened a USO center for war workers there. Since returning Phyllis has completed on canvas a scene of Little Rock.

* * * * *

THE BUSY HANDS OF EMILY S. O'CONNOR at the West Street P.B.X. board weave lines

of communication between the Laboratories and vital contacts on the outside. For Emily, who realizes how essential is the work of a telephone operator in these times, there's a special incentive in her job. Every call she puts through not only brings the war that much nearer to victory, but it also speeds the safe return of her husband, a Merchant Marine on the high seas.

Emily, the youngest of seven sisters, is a graduate of Bayonne High School and of Jersey City Normal School. Before coming to the Laboratories in 1939 she worked as a telephone operator for the Jersey Central and the Pennsylvania Railroads. At her apartment in Jersey City she fills the lonesome evenings by knitting and crocheting things to make their home more attractive for her husband's return.

* * * * *

"ALL OUT for victory!" is the slogan at KATHRYN NOLAN's home and the entire family lives by it. Kathryn runs a bench lathe in our Development Shop; her father is a rigger in a shipyard and her mother a drill press operator in a defense plant. But that's not all! Her husband is in the Army; her younger brother a Merchant Marine and an older brother a pump engineer in a ship salvage company. When the war broke out Kay gave up her job as a bookkeeper to do vital war work at the Laboratories where she is learn-



KATHRYN NOLAN

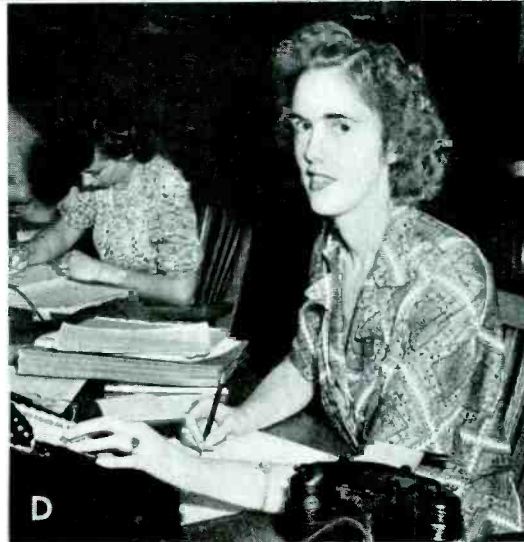
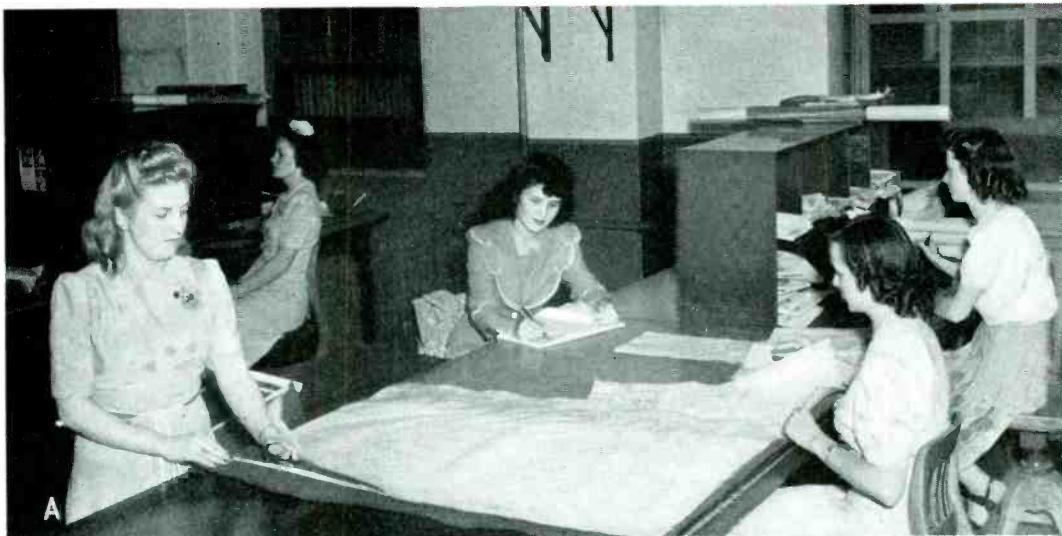

A—Girls in the Blueprint Room are trained to do many jobs in this department. In this picture, left to right, are Catherine McInerney trimming prints; Cecile McNeal who assembles orders; Irene Croce, marking identification numbers on prints; Mary Cusack, assembling prints; and Mrs. Caroline Ahlman folding prints for filing and other purposes

B—Eileen Russell puts the final touches on a cable terminal which she built

C—Draftswoman on the preparation of schematics and circuit drawings for secret military developments is Irene Ryan

D—Virginia L. Roy works on the transmission computation of resistance networks for secret military devices for the Armed Forces

August 1943

ing to do small detail work on parts of models used on war projects. When her picture was taken, Kay was making studs for a transformer. Because she is also learning to read the micrometer and blueprints she finds the precision and detail that her job calls for far more enjoyable than production line work.

Kathryn attended Resurrection School in Brooklyn and was graduated from Central Commercial High in Manhattan. She lives in Brooklyn with her family and besides writing to her husband and collecting pictures of her prettiest sister, Kay's chief hobby is her six-year-old brother. Teaching Bobby to skate and to ride his first two-wheel bike, taking him to the zoo or hearing his lessons gives her more than enough exercise and lots of fun after her long hours in the Model Shop.

NEWS NOTES

WINSTON F. KOCK has been elected national vice-president of Eta Kappa Nu, national honorary electrical engineering



BLOOD DONORS

J. G. Compagnoni
S. H. Cooper
Loretta Hart
A. L. Johnsrud

D. F. O'Sullivan
Evelyn Sfougaras
Mary Tilton
J. W. West

society, and is the youngest man to fill the post in the society's history.

H. H. GLENN, D. R. BROBST and F. S. FARKAS of Transmission Networks were in Chicago at different times during June on resistance networks.

C. A. WEBBER and W. J. KING were also at the Western Electric Company in Chicago on cable problems.

J. R. TOWNSEND was elected Vice-President of the American Society for Testing Materials at the annual meeting held in Pittsburgh on June 28.

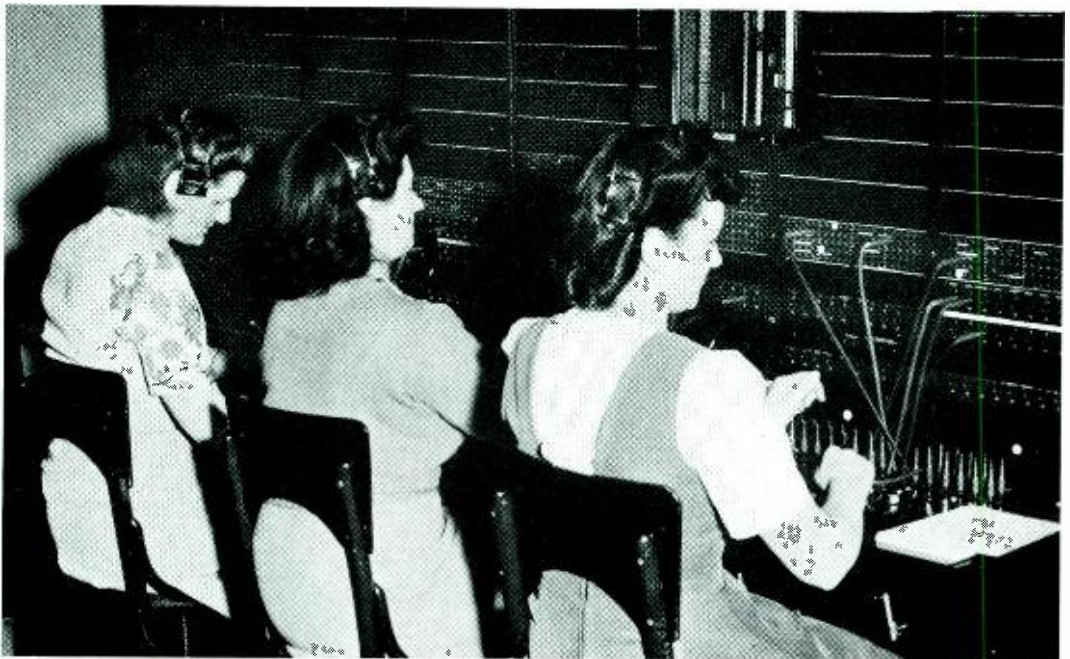

MANUAL BOARD AT MURRAY HILL LABORATORY

Manual switchboard associated with the dial system at the Murray Hill Laboratories. All incoming telephone calls and outgoing calls to points beyond the Summit extended scope area are handled through this switchboard. Extension-to-extension calls, calls to West Street via tie lines, and calls within the Summit extended scope area may be dialed directly. The attendants from left to right are Dorothy Carlson, Eleanor Mahle and Margaret Kerrigan

FRANCIS A. HUBBARD addressed the Women's Branch, Maplewood Committee for Service Men, at the Municipal Auditorium on July 1. He described the general features of Radar, likening it to a watcher who scans his surroundings through a telescope to which is attached a flashlight that has a narrow beam.

Variable-Frequency Bridge-Type Frequency-Stabilized Oscillators, a paper by W. G. SHEPHERD and R. O. WISE presented at the winter convention of the I.R.F., was published in the June issue of the Institute's *Proceedings*.

G. C. SOUTHWORTH'S paper, *Beyond the Ultra-Short Waves*, presented before a joint meeting of the A.I.F.E. and I.R.E. on February 17, was published in the July issue of the *Proceedings of the I.R.E.*

D. T. MAY RETIRES

DAVID T. MAY, Mechanical Apparatus Engineer of the Switching Apparatus Development Department, retired at his own request on July 31 after completing over thirty-eight years of service in the Bell System. After receiving the B.S. degree in Mechanical Engineering from the University of Illinois in 1905, Mr. May spent four years as an engineering student with various departments of the Western Electric Company in Chicago. He then came to West Street and engaged in the testing activities of the Physical Laboratory.

His interest in electrical protection apparatus and systems began in 1911 and most of the twenty-five patents granted in his name were in this field. During his early years at West Street he was engineer in charge of work involving the design of special testing apparatus and protective devices, transmission tests on long telephone cables, and inductive interference from electrified railways. During this period he made important contributions to the development of the porcelain-type protector block now in general use throughout the telephone system. While continuing his responsibilities in matters relating to electrical protection



D. T. MAY

apparatus and the study of inductive interference he also was placed in charge of groups engaged in electrical and mechanical analysis of telephone apparatus. By 1929 this analysis work had grown to include manual and dial central-office apparatus, together with station apparatus and much special apparatus from what is now the Commercial Products Development Department. Later on he took over, in addition, the supervision of materials investigations.

While retaining responsibility for groups engaged in apparatus analysis investigation, Mr. May, as Mechanical Apparatus Engineer, became responsible in 1935 for the development and design of manual switchboard apparatus. More recently under his direction a number of coaxial connectors and special plugs and sockets for use by the Armed Forces were developed.

Mr. May was a member of various Technical Committees. He was a Laboratories' representative on the Electrical Protection Subcommittee of the Association of American Railways and also on project committees of the Joint Subcommittee on Development and Research of the Edison Electric Institute and the Bell Telephone System. For a time he also represented the Laboratories on A.S.T.M. and A.S.A. Committees. He is a member of the A.I.F.E. and Telephone Pioneers.

* * * * *

ON A VISIT to the Bird Manufacturing Company, Boston, W. G. LASKEY took up problems of glass bearings for meters.

C. S. GORDON, R. A. HAISLIP and C. D. HOCKER visited Point Breeze June 23 to discuss wire development problems.

G. Q. LUMSDEN and R. H. COLLEY were in Alexandria, Virginia, on June 3 to witness breaking tests of timber conditioned by accelerated drying methods recently developed by the Taylor Colquitt Company. Dr. Colley attended an executive committee meeting of the American Wood-Preservers' Association in Chicago on June 24. He also visited the Valentine Clark Corporation in St. Paul in connection with development work on red pine and jack pine crossarms.

C. D. HOCKER, J. B. DIXON and A. P. JAHN attended the annual meeting of the American Society for Testing Materials held in Pittsburgh.

J. A. CARR and D. C. SMITH observed trial installations of communication lines set up by a Field Signal Battalion in Florida.

T. G. FISCHER and R. G. KOONTZ visited Hawthorne to discuss engineering and drafting practices for war projects.

AT THE Norfolk Naval Base Torpedo Training School, M. A. FROBERG attended power equipment conferences.

R. J. NOSSAMAN visited Fort Monmouth on May 31 to confer with representatives of the Signal Corps on the preparation of technical manuals.

J. M. DUGUID reviewed power problems at the Western Electric Company and at the A. F. Dormeyer Manufacturing Company in Chicago.

MOTOR DESIGN problems took C. L. DEELWATER to the Racine Universal Motor Company in Wisconsin. On his return he also visited the John Oster Manufacturing Company in Illinois to discuss similar problems.

JULY SERVICE ANNIVERSARIES OF MEMBERS OF THE LABORATORIES*

Research Department

H. W. Augustadt—15	C. B. Dalphin—15	J. V. Kelly—30	J. L. Sherry—20
F. P. Balacek—15	C. B. H. Feldman—15	F. C. Koch—20	L. J. Sivian—25
A. C. Beck—15	R. W. Folsom—15	A. D. Liguori—25	A. R. Soffel—15
W. L. Bell—15	R. M. Foster—25	J. G. Matthews—15	Wm. Spangenberg—25
J. B. Bishop—15	G. W. Gilman—20	R. L. Mazarella—20	W. D. Stratton—15
W. L. Black—25	Casimir Glazar—15	F. C. Ong—15	R. L. Taylor—15
J. G. Chaffee—20	W. M. Goodall—15	L. G. Petrich—15	Wilbur Van Haste—15
P. A. Ciampa—20	I. E. Harrison—20	A. C. Peyman—15	A. C. Walker—20
J. E. Clark—20	W. J. Hill—25	R. J. Phair—15	J. G. Walker—15
W. L. Cowperthwait, Jr.—15	J. F. D. Hoge—25	A. L. Samuel—15	E. J. Walsh—15
	K. G. Jansky—15	W. M. Sharpless—15	W. A. Yager—15

Apparatus Development Department

I. E. Abbott—15	T. E. Davis—15	H. M. Knapp—15	Madeline Samek—15
C. F. Benner—15	H. G. Geetlein—15	S. J. LaRoche—15	Charles Schneider—20
D. G. Blattner—30	W. B. Harris—15	Edward Migdal—10	H. S. Sheppard—25
W. F. Brown—15	O. J. Jambory—20	E. E. Mott—15	B. E. Stevens—15
W. F. Clemency—20	Helen Kerr—20	C. E. Nelson—20	S. M. Sutton—15
J. D. Cummings—20			R. E. Thiemer—15

Systems Development Department

I. G. Abraham—20	C. R. Gray—20	E. A. Kuenzler—20	J. J. Strodt—15
Josephine Albrecht—15	Pauline Heid—20	A. B. Kvaal—25	C. E. Sunderland—25
E. M. Boardman—15	H. W. Herrington—20	H. D. MacPherson—35	Hazel Toth—20
J. H. Butcher—15	E. T. Herwig—25	L. J. Mase—15	W. E. Viol—35
I. S. Cooper—10	R. N. Hunter—25	Byron McDermott—15	C. D. Walker—20
T. L. Corwin—20	V. L. Johnson—20	F. T. Meyer—30	H. A. Wenk—15
R. E. Crane—20	A. S. King—15	H. I. Miller—20	D. H. Wetherell—20
Otto Drost—20	R. E. King—20	H. B. Nienstedt—25	G. W. Wheeler—15
O. D. Engstrom—20	R. G. Koontz—20	Esther Rentrop—15	D. H. Williams—15
A. D. Fowler—15	Francis Kuchas—20	J. R. Stone—20	H. O. Wood—25

General Accounting Department

Walter Steinmetz—20	J. W. Stoner—25
---------------------	-----------------

Plant Department

Joseph Fischer—15	W. A. Niewandt—15
C. A. Frank—25	H. G. Roeser—15
Catherine McGarry—15	H. A. Skou—15
Patrick McLaughlin—15	Philip Venneman—25
	Joseph Wall—15

Patent Department

G. C. Lord—20	F. E. Ward—25
---------------	---------------

General Service Department

R. G. Dolbear, Jr.—15	S. B. Rickett—15
A. C. Laite—20	T. E. Roche—15

*Biographies of 25-year service people that have not as yet appeared will be published in future RECORDS.

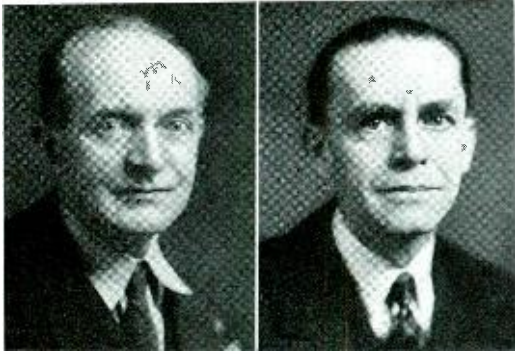

S. J. FULTON

H. H. BOGART

TWENTY-FIVE-YEAR SERVICE ANNIVERSARIES

Samuel J. Fulton, Staff Assistant. Butler Bros., 1904-16; MacBeth-Evans Glass Co., 1916-18; Bell Laboratories, 1918. U. S. Army, June to Nov., 1918, Battalion Headquarters, Camp Upton, and Officers' Training at Camp Gordon. m. Mary Wise; ch. Adele Louise, James Peter; r. Ramsey, N. J.

Mr. Fulton was with the Accounting Department for about two years and then transferred to the service group of the Systems Development Department and later to the methods group of the Equipment Development Department. Since 1938 Mr. Fulton has been in the Systems Administrative Department handling service requirements on all vehicles used by Systems Development. He has also been concerned with space requirements of the Department, particularly at West Street.

Howard H. Bogart, Clerical Supervisor. Pace Institute, 1920-22. Hudson Wire Co., 1906-18; Bell Laboratories, 1918. mem. Telephone Pioneers. m. Alice Wren; r. Chelsea section of New York City.

Mr. Bogart has been in the General Accounting Department throughout his service in the Laboratories and has been engaged in various aspects of accounting activities. At the present time he supervises the preparation of billing rendered by the Laboratories covering services performed for its various customers. Included in the duties under his supervision are the recording of the cost of cases, the editing of shipments and the preparation of various confidential reports of work done for the Government.

Nicholas J. Velardi, Technician. Brown and Sharpe, 1915-16; Starrett and Company, 1916; Gem Safety Razor Corp., 1917-18; Bell Laboratories, 1918. mem. Telephone Pioneers. m. Mary Manis; r. Yonkers, N. Y.

For several years Mr. Velardi was associated with mechanical problems encountered in early picture transmission work. Later he was concerned with the development of sound-on-disc recorders and reproducers and a variety of electromechanical devices. During the years just prior to the war his sphere of activities applied to experimental work on various phases of coin-collector design. Since then, in the Station Apparatus Development Department at Murray Hill, he has been engaged in the construction of experimental apparatus for war purposes. Mr. Velardi served as a part-time instructor in Machine Shop Practice for several years in various vocational schools in New York City. His intimate knowledge of mechanical processes has led to his becoming, in addition to his regular duties, an authority whose advice and counsel are frequently sought on difficult design problems.

Herbert Hoyle, Member of Technical Staff. International Correspondence School, 1915-18; Mechanics Institute, 1918-20. Packard Motor Co., 1915-16; Pullman Co., 1916-18; Bell Laboratories, 1918. mem. Telephone Pioneers. m. Madeline Rogers; ch. Herbert (Manhattan College, B.E.E., 1943), Madeline, Thomas, George; r. Flushing, L. I.

Mr. Hoyle joined the Inspection Branch of the Western Electric Engineering Department in 1918 where he was employed in the inspection and handling of complaints on telephone plant power apparatus, domestic appliances, and inspection testing apparatus. In 1923 he was transferred to the drafting organization of the Apparatus Development Department where he worked on layouts of public address, laboratory testing, and radio broadcasting equipments. In 1928 Mr. Hoyle was made a specifications engineer, in

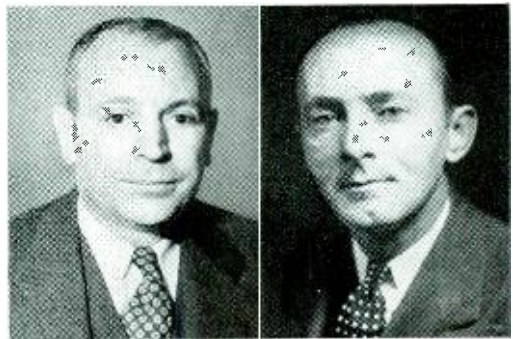

N. J. VELARDI

HERBERT HOYLE

the Apparatus Development Department, in which capacity he edited specifications covering the manufacturing information for various types of telephone and commercial apparatus. He is now a member of the specifications engineering group of the Commercial Products Development Department, having been one of the original members of this group when it was organized in 1937. For the past two years Mr. Hoyle has been engaged in the editing of specifications covering radio communication equipment for the Armed Forces.

Carl E. Swenson, Instrument and Toolmaker, Precision Bliss Company, 1912-18; Bell Laboratories, 1918. mem. Telephone Pioneers. m. Elsie Seagram; ch. Ralph Ellis, Roy Alfred; r. Bergenfield, N. J.

Mr. Swenson came to our Development Shop as a lathe hand in the machine group. He transferred to the Precision Room when this was established in 1924. Since then as an instrument and toolmaker, he has been concerned with the precision making of parts for picture transmission equipment, sound pictures, television, high-speed motion picture cameras and the usual run of projects going through the Shop. More recently most of his time has been spent on war projects.

John P. Greene, Service Supervisor. Otis Elevator Company, 1911-18; Bell Laboratories, 1918. m. Sara Whalen; ch. John Joseph (Army Air Corps), Mrs. Margaret Greene Devlin, Marian Patricia; r. Yonkers, New York.

After a short period as shop production clerk and a year and a half on stock records, Mr. Greene transferred to the General Service Department where he is now in charge of two laboratory and order service groups of the Local Service Department. His

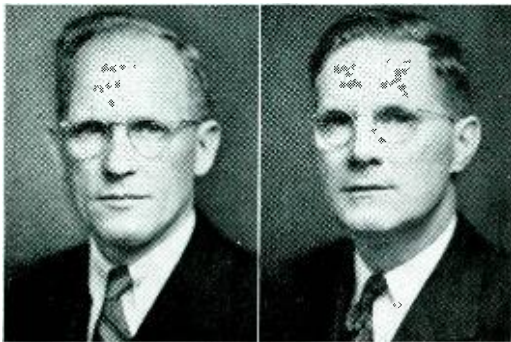

C. E. SWENSON

J. P. GREENE

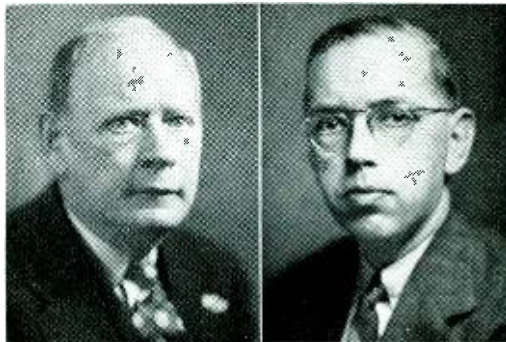

E. J. SAUSE

A. C. MILLARD

responsibilities cover the first six floors at West Street and the Laboratories' space in the Davis Building.

Edward J. Sause, Member of the Laboratories Staff. W. H. Deghuee, Export Lumber, 1898-1917; Owen-Magnetic Automobile Co., 1917-18; Bell Laboratories, 1918. Mem. Telephone Pioneers. r. Freeport, L. I.

After four years with the order analysis group of the old Model Shop, Mr. Sause, in 1922, transferred to the Commercial Relations Department. His first work in this Department was with the cost analysis group and later with the estimating group. More recently he has been concerned with estimating costs on equipment for both telephone and war projects.

Arthur C. Millard, Member of Technical Staff. Brooklyn Poly; several years of night courses. Bell Laboratories, 1917-26; Vitaphone Corp., 1926-27; E.R.P.I., 1927-36; Bell Laboratories, 1936. mem. Telephone Pioneers. m. Dorothy Van Winkle; ch. Jack Henry; r. Plainfield, N. J.

During the last part of World War I Mr. Millard worked on submarine and aircraft detection systems. He then was associated with the development of the phonograph recording system. He was also concerned with the development of sound pictures and in 1926 joined the Vitaphone Corporation. A year later he went with E.R.P.I. where he was engaged in the installation of theater equipment; serviced these equipments; and then worked on the development of the combined phonograph and radio project. Mr. Millard returned in 1936 and since then has been concerned with precision measurements and more recently with a comprehensive study of all types of fastening devices.

WE SEE BY THE PAPERS, that

American bullets will carry the "kiss of death" to many Axis soldiers from scrap metal collected from m'lady's boudoir. The lipstick is going to war. Brass casings which hold these aids to allure can be made into brass casings for cartridges. In the Bell Telephone Laboratories in New York, where more than 1,000 women are employed, a movement has been started to convert discarded lipsticks into war materia. It is suggested that the women sacrifice their lipsticks—except their favorites, which they may need for refills—as well as old compacts and doodads, to be made into bullets. Red, white and blue bullet-shaped containers have been placed in the Laboratories lounges and larger rest rooms to receive all such discarded items.—*News, Ironton, Ohio, May 12, 1943.*

Beginning with this issue announcements of engagements and weddings will appear in the RECORD. Notices of these should be sent or telephoned to Mrs. Helen McLoughlin, Assistant News Editor, Room 1103, Extension 296, West Street.

Engagements

J. J. Walsh—Beatrice A. Balbach
J. E. Rorhe, U. S. Army—Fenella B. Langenau
W. J. Donnelly, U. S. Army—Mary C. McDonald
T. J. Corey, U. S. Army—Mary Alice McGrath
J. J. Trezza—Helen R. Scott
Edward Watkinson—Marion Stout
E. J. McCormack, U. S. Army—Leonora G. Wood

Weddings

H. J. Mallard—Marie Blackwood
Louis Koenig, Jr.—Margarete Bruckschlogl
Richard Ortolan, U. S. Army—Lillian M. Carter
T. G. Blanchard—Ruth De Boer
W. T. Northacker—Kathryn M. Demas
Herbert Varian—Anne D. Dzurba
Ellsworth Van Horn—Mildred A. Emmons
Herman Manus, U. S. Coast Guard—Kathryn Frohwein
Ellis Bloomfield—Lois Kolter
K. K. Darrow—Elizabeth Marcy
P. J. Murphy, U.S.M.C.—Mary E. McConnon
Cornelius Lynch—Catherine O'Hanlon
G. Walter Stuart, U. S. Army—Blanche L. Richards
C. J. Sullivan—Mary Schuler
J. J. Shindle—Anne T. Stenson
L. G. Young—Tillie Stump

One of the best examples of the practical work of Radar was seen during the historic flight of Rudolf Hess, "the Number 3 Nazi," from Germany to Scotland. The RAF Radar station near the coast of Lanarkshire reported the presence of "an unidentified plane, probably German," while Hess was still about 50 miles from the Scottish coast. Later the report said: "The plane is probably a Messerschmitt." The locator continued following the rapid course of the plane and finally it reported that it was losing altitude about 12 miles from the estate of the Duke of Hamilton. The last report telephoned to RAF headquarters mentioned the "one mile square block" where the plane had fallen. With this information, it took authorities only a few minutes to get to the farmhouse where Hess had been captured by an alert Scottish farmer the instant that he emerged from his parachute trappings.—*Telegraph and Telephone Age, June, 1943.*

A new type of women war workers—not Wacs nor Waves, but "WITS"—trained in the War Industries Training School of Stevens Tech, Hoboken, from which they take their initials, was described yesterday by Robert H. Baker, assistant director of the government-sponsored school, where a new 12 weeks' course open to men and women will start June 21.

These women, high school and college girls, are working as engineers' aids and assistants in many war plants throughout the country. Facts and figures compiled about them in New York and New Jersey, where most of the Stevens War School graduates are now employed, show that they are making good in jobs above the routine trade level. . . .

The Bell Telephone Laboratories in New York and at the Murray Hill Laboratory in New Jersey employ several of the Stevens School trainees.—*Hudson Dispatch, Union City, N. J., June 16, 1943.*

COASTAL RADIO TELEPHONE—In an article with this title (*Bell Lab. Rec.*, 21, No. 7; March 1943), H. M. PRUDEN describes the present status of the radio telephone service between shore and vessels off the coast of the United States or within its harbors, which has undergone considerable growth and development during the past decade.—*Nature, London, June 26, 1943.*

BELL LABORATORIES RECORD

Editor

PAUL B. FINDLEY

Associate Editor

PHILIP C. JONES

News Editor

R. LINSLEY SHEPHERD

Circulation

LEAH E. SMITH

BELL TELEPHONE LABORATORIES, INCORPORATED

463 West Street, New York 14, N. Y.

LIST OF ISSUES IN VOLUME XXI

No.		Pages
1	September, 1942	1- 28
"	2 October, 1942.	29- 60
"	3 November, 1942	61- 84
"	4 December, 1942	85-108
"	5 January, 1943	109-128
"	6 February, 1943	129-176
"	7 March, 1943	177-224
"	8 April, 1943	225-276
"	9 May, 1943	277-332
"	10 June, 1943	333-388
"	11 July, 1943	389-436
"	12 August, 1943	437-486

Index to Authors, Volume XXI

A

ANDERSON, F. B. . . .	Tuned Null Detector	347
-----------------------	-------------------------------	-----

B

BEAUMONT, W. M. . . .	Handling Night Calls at a Dial PBX	25
BELLOWS, B. C. . . .	Stretching Toll Facilities for the Emergency	110
BIONDI, F. J.	Recording Plastometer for Organic Plastics	18
BOYLES, C. T.	Salvaging for Victory	70
BROTHERTON, M. . . .	Paper Condensers of the Bell System	123
BRYMER, S. J.	No. 7 Information Desk	91
BUCKLEY, O. E.	Greetings to Members of Bell Telephone	
	Laboratories	109
BUSCH, A. J.	Class-of-Service Signals in the Crossbar System	334

C

CARLSON, C. P.	Equipment Features of the VI Repeater	352
CAVERLY, H. C.	Pulsing Methods of the Dial System for	
	Dial-to-Dial Calls	448

D

DARROW, K. K.	Influence of Physics on Chemistry	284
DEBUSKE, J. J.	Noise Measurements in Vacuum Tubes	456
DENNIS, F. R.	Alarm and Comparison Circuits for Reference	
	Frequency Equipment	149

E

EDWARDS, G. D.	Quality Control in Ordnance Inspection	20
ELIASON, O. C.	Testing and Rating Air Filters	243
ENGSTROM, O. D. . . .	Spread-Scale Recorder	66
ERWIN, E. L.	3A Code-Call Circuit	54

F

FAIR, I. E.	Using High Crystal Harmonics for Oscillator	
	Control	237
FINCH, J. M.	Proving-in a Paper Micrometer	121
FLINT, F. W.	Central DSA Switchboard	77

H

HAARD, R.	Giant Camera	356
HARDESTY, J. M. . . .	Cable Wrapping Machine	447
HERCKMANS, A.	New Telephone Set for the Hard of Hearing	45
HILL, C. M.	Greensalt Preservative for Telephone Poles	62

I

INSLEY, N.	Resistance Lamps	399
--------------------	----------------------------	-----

K

KNANDEL, G. J.	Automatic Teletypewriter Switching Office	49
KOPP, O. H.	Crossbar Terminating Equipment for Multi-Office Operation	395

L

LANG, W. Y.	Teletypewriter Test Sets	439
LUMSDEN, G. Q.	Greensalt Treatment of Poles	117

M

MCCURDY, R. G., AND SAMUELS, M. M.	Rural Telephone Service Using Carrier on Power Lines	145
MCLEAN, D. A.	Acid Neutralization in Insulating Papers	136
MCWILLIAMS, C. W.	Panel Apparatus Improvements	141
MAHONEY, J. J., JR.	Waiting for Lightning	86
MALM, F. S.	Rubber Research Laboratory at Murray Hill	226
MILLS, JOHN	Behind the Spectacular	276
	Choose Your Own Age	387
	Design for Using	332
	Employee-Member	436
	Unavoidable Transients	486
MOTLEY, J. G.	Partition Flexibility at Murray Hill	6
MUNSON, W. A.	How Little Do We Hear?	341

P

PASCARELLA, A. J.	Philosophy of Toll-Test Boards	278
PRESCOTT, C. H., JR.	Solubility of Metals in Mercury	104
PRUDEN, H. N.	Coastal Radio Telephone Systems	183
PULLIS, G. A.	Neutralizing Induced Voltages in Toll Signaling Circuits	403

R

RIGTERINK, M. D.	Ceramics for High-Frequency Insulation	290
RIORDAN, J.	Cable Splices and the Hostess Problem	114

S

SAMUELS, M. M.	(See McCurdy, R. G., and Samuels, M. M.)	
SCHRAMM, F. A.	Bridging Filter for Open-Wire Lines	93
SKELLETT, A. M.	Trigger Action from Secondary Electrons	233
SOHNLE, G. F.	Speeding Communication for the Alcan Highway	188

STANSEL, F. R.	New Frequency Divider for Obtaining Reference Frequencies	97
STORKS, K. H.	Electron Diffraction by Large Molecules	390
SUNDE, F. D.	Lightning Protection of Buried Cable	294

T

THOMAS, G. B.	Increased Personnel	301
TOOLE, W. C.	Civil Relief for Service Men	360

W

WALDECKER, W. O.	Purchase Order Writing	248
WALKER, A. C.	Abrasion Test for Textiles	15
WEBER, V. J.	New Reference Frequency Equipment	73
WOODARD, J. M.	Super PBX for War Service	130

Index to Subjects and Titles, Volume XXI

A

Abrasion Test for Textiles	<i>Walker</i>	15
Abstracts and Comments		
Margin for Victory	<i>Hooper</i>	182
Quarterly of Applied Mathematics		398
Remarks of Dr. O. E. Buckley (On Radar) on the Telephone Hour, May 17, 1943		333
Successful Man	<i>Dixon</i>	144
Acid Neutralization in Insulating Papers	<i>McLean</i>	136
Air Conditioning		
Testing and Rating Air Filters	<i>Eliason</i>	243
Alarm and Comparison Circuits for Reference Frequency Equipment	<i>Dennis</i>	149
Alarm Systems		
Automatic Alarm System Used to Insure Continuity of the Numerous Services at Murray Hill (Picture)		339
Alcan Highway		
Communication System Along Alcan Highway Now More Than Two-Thirds Completed		454
Speeding Communication for the Alcan Highway	<i>Sohnle</i>	188
Apparatus and Equipment (see kind, as: Micrometers; Reference Frequency Equipment; Voltmeters; etc.)		

Army-Navy Production Award Presented to the Laboratories	31
Second Award	July, page 2 of cover
Automatic Teletypewriter Switching Office	<i>Knandel</i> 49
Awards and Citations	
Army-Navy Production Award Presented to the Laboratories	31
Second Award	July, page 2 of cover
Development of Special Equipment for Submarines	March, page 2 of cover
Vail Medal Awards for 1942	411
William Wilson Honored by I.R.E.	139

B

Bell Laboratories and the War	1
Bell Laboratories Projects	
Dr. Buckley Addresses the Supervisory Staff	408
Bell System and Signal Corps Affiliated Plan	198
Bell Telephone Laboratories School for War Training	134
Book Notices	
Electromagnetic Waves (Schelkunoff)	232
Electromechanical Transducers and Wave Filters (Mason)	393
Booths	
Outdoor Telephone Booth	113
Outdoor Telephone Booths for Residential Areas	462
Telephone Service for Small Army Detachments	306
Bridging Filter for Open-Wire Lines	<i>Schramm</i> 93
Brushes	
Panel Apparatus Improvements	<i>McWilliams</i> 141
Buildings	
Partition Flexibility at Murray Hill	<i>Motley</i> 6
Bushings	
Panel Apparatus Improvements	<i>McWilliams</i> 141

C

Cable Wrapping Machine	<i>Hardesty</i> 447	
Cables		
Four-Conductor Cable for U. S. Signal Corps	251	
Insulation		
Cable Wrapping Machine	<i>Hardesty</i> 447	
Lightning Protection of Buried Cable	<i>Sunde</i> 294	
New Transcontinental Cable Between New York and San Francisco Opened		153
Splicing		
Cable Splices and the Hostess Problem	<i>Riordan</i> 114	
Testing		
Study of Cable Sheath Abrasion (Picture)	133	
Waiting for Lightning	<i>Mahoney</i> 86	

Cables (Continued)		
Transcontinental		
Transcontinental Telephone Cable Placed in Service		116
Cameras		
Electron Diffraction Camera at Murray Hill for Investi- gating the Crystal Structure of Surface Films (Picture)		289
Giant Camera	<i>Haard</i>	356
Capacitance		
Paper Condensers of the Bell System	<i>Brotherton</i>	123
Carrier Systems		
Bridging Filter for Open-Wire Lines	<i>Schramm</i>	93
Four-Conductor Cable for U. S. Signal Corps		251
Rural Telephone Service Using Carrier on Power Lines	<i>McCurdy and Samuels</i>	145
Type C5		
Communication System Along Alcan Highway Now More Than Two-Thirds Completed		454
Type K		
New Transcontinental Cable Between New York and San Francisco Opened		153
Central DSA Switchboard	<i>Flint</i>	77
Ceramics for High-Frequency Insulation	<i>Rigterink</i>	290
Chemistry, Analytic		
Electron Diffraction by Large Molecules	<i>Storks</i>	390
Circuits		
Alarm and Comparison Circuits for Reference Frequency		
Equipment	<i>Dennis</i>	149
Central DSA Switchboard	<i>Flint</i>	77
Communication System Along Alcan Highway Now More Than Two-Thirds Completed		454
New Frequency Divider for Obtaining Reference Frequencies	<i>Stansel</i>	97
Speeding Communication for the Alcan Highway	<i>Sohnle</i>	188
3A Code-Call Circuit	<i>Erwin</i>	54
Civil Relief for Service Men	<i>Toole</i>	360
Class-of-Service Signals in the Crossbar System	<i>Busch</i>	334
Coastal Radio Telephone Systems	<i>Pruden</i>	183
Code-Call Circuit, 3A	<i>Erwin</i>	54
Coils, Retardation		
Neutralizing Induced Voltages in Toll Signaling Circuits	<i>Pullis</i>	403
Communication, Ship-to-Shore		
Coastal Radio Telephone Systems	<i>Pruden</i>	183
Communication System Along Alcan Highway Now More Than Two-Thirds Completed		454
Communication System of a B-24 Liberator Bomber (Picture)		435

Condensers		
Acid Neutralization in Insulating Papers	<i>McLean</i>	351
Paper Condensers of the Bell System	<i>Brotherton</i>	123
Cords		
Telephone Cords Repaired With Matching Acetate Cloth Tape (Picture)		351
Crossbar Systems (see Dial Systems)		
Crossbar Terminating Equipment for Multi-Office Operation	<i>Kopp</i>	395
Crystals, Quartz		
Using High Crystal Harmonics for Oscillator Control .	<i>Fair</i>	237

D

Detectors (see Measurements and Measuring Instruments)		
Dial Systems		
Central DSA Switchboard	<i>Flint</i>	77
Class-of-Service Signals in the Crossbar System	<i>Busch</i>	334
Crossbar Terminating Equipment for Multi-Office Operation	<i>Kopp</i>	395
Panel Apparatus Improvements	<i>McWilliams</i>	141
Pulsing Methods of the Dial System for Dial-to-Dial Calls	<i>Caverly</i>	448
Sequence Switch Cam		92
Dialing Habits of Telephone Users		453
Dielectric Constants		
Molecular Rotation in Organic Solids (Illustration, p. 129)		140
Dielectrics		
Ceramics for High-Frequency Insulation	<i>Rigterink</i>	290
Drafting Full Speed Ahead		101
Dust		
Testing and Rating Air Filters	<i>Eliason</i>	243

E

Editorials		
Behind the Spectacular	<i>Mills</i>	276
Choose Your Own Age	<i>Mills</i>	388
Design for Using	<i>Mills</i>	332
Employee-Member	<i>Mills</i>	436
Unavoidable Transients	<i>Mills</i>	486
Electron Diffraction by Large Molecules	<i>Storks</i>	390
Electron Emission, Secondary		
Trigger Action from Secondary Electrons	<i>Skellett</i>	233
Electrons. Diffraction		
Electron Diffraction by Large Molecules	<i>Storks</i>	390
Influence of Physics on Chemistry	<i>Darrow</i>	284
Employees		
Increased Personnel	<i>Thomas</i>	301

Equipment		
Bridging Filter for Open-Wire Lines	<i>Schramm</i>	93
Crossbar Terminating Equipment for Multi-Office Operation	<i>Kopp</i>	395
No. 7 Information Desk	<i>Brymer</i>	91
Resistance Lamps	<i>Insley</i>	399
Sequence Switch Cam		92
Stretching Toll Facilities for the Emergency (Illustration, p. 122)	<i>Bellows</i>	110
Subset Housing Made to Study Lines of Flow of Plastic Material in the Molding Die		120
Equipment Features of the V1 Repeater	<i>Carlson</i>	352

F

Filters		
Bridging Filter for Open-Wire Lines (133A)	<i>Schramm</i>	93
Historic Firsts: Wave Filters		445
Testing and Rating Air Filters	<i>Eliason</i>	243
Finch Edge-Tear Stirrup		
Making a Tear Test With the Finch Edge-Tear Stirrup (Picture)		61
Simplified Tear Test		58
Flux		
Testing Soldered Joints to Determine the Presence of Chloride Flux (Illustration, p. 277)		282
Four-Conductor Cable for U. S. Signal Corps		251
Frequency		
Control		
Alarm and Comparison Circuits for Reference Frequency Equipment	<i>Dennis</i>	149
New Frequency Divider for Obtaining Reference Frequencies	<i>Stansel</i>	97
Measurements		
New Reference Frequency Equipment	<i>Weber</i>	73
Frequency Analyzer Used by an Explosive Manufacturer		305
Furnaces, Induction		
Controlled Atmosphere Induction Furnace at Murray Hill (Illustration, p. 225)		247

G

Giant Camera	<i>Haard</i>	356
Greensalt Preservative for Telephone Poles	<i>Hill</i>	62
Greensalt Treatment of Poles	<i>Lumsden</i>	117
Greetings to Members of Bell Telephone Laboratories from Oliver E. Buckley		109
Guadalcanal		
Marines' Cemetery on Guadalcanal (Frontispiece)		85

II

Handling Night Calls at a Dial PBX	<i>Beaumont</i>	25
Handsets		
Improved Elevator Telephone		242
New Telephone Set for the Hard of Hearing	<i>Herckmans</i>	45
Harmonics		
New Frequency Divider for Obtaining Reference Frequencies	<i>Stansel</i>	97
Using High Crystal Harmonics for Oscillator Control	<i>Fair</i>	237
Headsets		
New Headset Permits Signal Men to Wear Helmets		459
Hearing		
How Little Do We Hear?	<i>Munson</i>	341
Hearing Aids		
New Telephone Set for the Hard of Hearing	<i>Herckmans</i>	45
Historic Firsts		
Condenser Microphone		394 and 463
High-Vacuum Electronic Tube		283
Permalloy		340
Wave Filters		445
How Little Do We Hear?	<i>Munson</i>	341

I

Improved Elevator Telephone		242
Improved Telephone Service for Servicemen		363
Increased Personnel	<i>Thomas</i>	301
Influence of Physics on Chemistry	<i>Darrow</i>	284
Information Desk, No. 7	<i>Brymer</i>	91
“Information Operator, Please”		154
Ingles, Major General, Now Chief Signal Officer		461
Inspection of Ordnance Material		
Quality Control in Ordnance Inspection	<i>Edwards</i>	20
Insulating Materials		
Ceramics for High-Frequency Insulation	<i>Rigterink</i>	290
Insulation, Paper		
Acid Neutralization in Insulating Papers	<i>McLean</i>	136
Insulators		
Samples of Insulators Mounted in Representative Loca- tions as an Aid to Study of Aging Effects (Picture)		346

K

Keystone System		
Purchase of Keystone System Authorized by F. C. C.		307

L

Laboratories, Research		
Research Laboratories in Industry. Excerpt from		
Broadcast by O. E. Buckley		48
Rubber Research Laboratory at Murray Hill	<i>Malm</i>	226

Lamps, Resistance	<i>Insley</i>	399
Legal Protection		
Civil Relief for Service Men	<i>Toole</i>	360
Lenses		
Giant Camera	<i>Haard</i>	356
Lightning Conductors		
Waiting for Lightning	<i>Mahoney</i>	86
Lightning Protection of Buried Cable	<i>Sunde</i>	294
Line Concentrating Units		
Automatic Teletypewriter Switching Office	<i>Knandel</i>	49
Line Construction		
Speeding Communication for the Alcan Highway	<i>Sohule</i>	188

M

Machine, Cable Wrapping	<i>Hardesty</i>	447
Making a Tear Test with the Finch Edge-Tear Stirrup (Picture)		61
Marines' Cemetery on Guadalcanal (Frontispiece)		85
Materials Engineering		402
Materials, Salvage		
Salvaging for Victory	<i>Boyles</i>	70
Matthies, W. H., Retires		304
Measurements and Measuring Instruments (see also kind, as: Frequency Measurements; Transmission Measure- ments)		
Proving-in a Paper Micrometer	<i>Finch</i>	121
Recording Plastometer for Organic Plastics	<i>Biondi</i>	18
Tuned Null Detector	<i>Anderson</i>	347
Metals		
Solubility		
Solubility of Metals in Mercury	<i>Prescott</i>	104
Wear		
Materials Engineering		402
Micrometers		
Proving-in a Paper Micrometer	<i>Finch</i>	121
Microphones		
Historic Firsts: The Condenser Microphone		394 and 463
Radio Operator Using a Western Electric Close-Talking Microphone (Picture)		437
Military Communication		
Signal Corps and the Laboratories		178
Molecular Rotation in Organic Solids (Illustration, p. 129)		140
Molecular Structure		
Influence of Physics on Chemistry	<i>Darrow</i>	284
Multi-Office Operation		
Crossbar Terminating Equipment for Multi-Office Operation	<i>Kopp</i>	395

Multivibrators		
New Frequency Divider for Obtaining Reference		
Frequencies	<i>Stansel</i>	97
Murray Hill		
Controlled Atmosphere Induction Furnace at Murray		
Hill (Illustration, p. 225)		247
Partition Flexibility at Murray Hill	<i>Motley</i>	6
Rubber Research Laboratory at Murray Hill	<i>Malm</i>	226

N

National Defense		
Bell Laboratories and the War		1
Neutralizing Induced Voltages in Toll Signaling Circuits	<i>Pullis</i>	403
New Frequency Divider for Obtaining Reference		
Frequencies	<i>Stansel</i>	97
New Headset Permits Signal Men to Wear Helmets		459
New Reference Frequency Equipment	<i>Weber</i>	73
New Synthetic Rubber Developed		300
New Telephone Set for the Hard of Hearing	<i>Herckmans</i>	45
Noise		
Rural Telephone Service Using Carrier on Power Lines	<i>McCurdy and</i> <i>Samuels</i>	145
Noise Measurements in Vacuum Tubes	<i>DeBuske</i>	456
Null Detector, Tuned	<i>Anderson</i>	347
No. 7 Information Desk	<i>Brymer</i>	91

O

Oil and Typewriters		461
101A-102A Teletypewriter Line Concentrating Units		
Automatic Teletypewriter Switching Office	<i>Knandel</i>	49
Ordnance Inspection, Quality Control in	<i>Edwards</i>	20
Oscillators, Electro-Mechanical		
Using High Crystal Harmonics for Oscillator Control	<i>Fair</i>	237
Outdoor Telephone Booth		113
Outdoor Telephone Booths for Residential Areas		462

P

Panel Apparatus Improvements	<i>McWilliams</i>	141
Paper Condensers of the Bell System	<i>Brotherton</i>	123
Paper. Testing		
Acid Neutralization in Insulating Papers	<i>McLean</i>	136
Making a Tear Test with the Finch Edge-Tear Stirrup		
(Picture)		61
Proving-in a Paper Micrometer	<i>Finch</i>	121
Simplified Tear Test		58
Paracon		
New Synthetic Rubber Developed		300

Partition Flexibility at Murray Hill	<i>Motley</i>	6
Permalloy		
Historic Firsts: Permalloy		340
Personnel (see Employees)		
Philosophy of Toll-Test Boards	<i>Pascarella</i>	278
Plastics		
Molding		
Subset Housing Made to Study Lines of Flow of Plastic Material in the Molding Die		120
Organic		
Recording Plastometer for Organic Plastics	<i>Biondi</i>	18
Plastometer (see Measurements and Measuring Instruments)		
Poles		
Greensalt Preservative for Telephone Poles	<i>Hill</i>	62
Greensalt Treatment of Poles	<i>Lumsden</i>	117
Polymers		
Electron Diffraction by Large Molecules	<i>Storks</i>	390
Private Branch Exchanges		
Super PBX for War Service	<i>Woodard</i>	130
Proving-in a Paper Micrometer	<i>Finch</i>	121
Pulsing Methods of the Dial System for Dial-to-Dial Calls	<i>Caverly</i>	448
Purchase Order Writing	<i>Waldecker</i>	248

Q

Quality Control in Ordnance Inspection	<i>Edwards</i>	20
Quarterly of Applied Mathematics		398

R

Radar		362
Radio		
Frequency Control		
Using High Crystal Harmonics for Oscillator Control	<i>Fair</i>	237
Ultra Short Wave		
Ultra-High Frequencies		194
Radio Detecting and Ranging (see Radar)		
Radio-Frequency Voltmeter		126
Radio Telephone Apparatus		
Coastal Radio Telephone Systems	<i>Pruden</i>	183
Recorder, Spread-Scale	<i>Engstrom</i>	66
Recording Plastometer for Organic Plastics	<i>Biondi</i>	18
Reference Frequency Equipment		
Alarm and Comparison Circuits for Reference Frequency Equipment	<i>Dennis</i>	149
New Reference Frequency Equipment (Assembly W10815)	<i>Weber</i>	73

Repeaters, V1 and 22A2		
Equipment Features of the V1 Repeater	<i>Carlson</i>	352
Research Laboratories in Industries. Excerpt from		
Broadcast by O. E. Buckley		48
Research, Scientific		
Bell Laboratories and the War		1
Resistance Lamps	<i>Insley</i>	399
Rubber, Artificial		
New Synthetic Rubber Developed		300
Rubber Research Laboratory at Murray Hill	<i>Malm</i>	226
Rural Telephone Service Using Carrier on Power Lines	<i>McCurdy and Samuels</i>	145

S

Salvaging for Victory	<i>Boyles</i>	70
School for War Training		134
Sequence Switch Cam		92
Signal Corps and the Laboratories		178
Signaling, Telephone		
Class-of-Service Signals in the Crossbar System	<i>Busch</i>	334
Neutralizing Induced Voltages in Toll Signaling		
Circuits	<i>Pullis</i>	403
Signals, Teletypewriter		
Teletypewriter Test Sets	<i>Lang</i>	439
Simplified Tear Test		58
Solubility of Metals in Mercury	<i>Prescott</i>	104
Sound		
Frequency Analyzer (RA281) Used by an Explosive		
Manufacturer		305
Intensity		
How Little Do We Hear?	<i>Munson</i>	341
Speeding Communication for the Alcan Highway	<i>Sohnle</i>	188
Spread-Scale Recorder	<i>Engstrom</i>	66
Steatite		
Ceramics for High-Frequency Insulation	<i>Rigterink</i>	290
Stills, Glass		
Solubility of Metals in Mercury	<i>Prescott</i>	104
Stretching Toll Facilities for the Emergency		
(Illustration, p. 122)	<i>Bellows</i>	110
Subset Housing Made to Study Lines of Flow of Plastic		
Material in the Molding Die		120
Super PBX for War Service	<i>Woodard</i>	130
Switchboards		
DSA (Dial System A)		
Central DSA Switchboard	<i>Flint</i>	77
PBX, 701 and 740		
Handling Night Calls at a Dial PBX	<i>Beaumont</i>	25

Switchboards (Continued)		
Philosophy of Toll-Test Boards	<i>Pascarella</i>	278
Stretching Toll Facilities for the Emergency (Illustration, p. 122)	<i>Bellows</i>	110
Switching		
Automatic Teletypewriter Switching Office	<i>Knandel</i>	49
Pulsing Methods of the Dial System for Dial-to-Dial Calls	<i>Caverly</i>	448

T

Telegraph, Printing (see Teletypewriter)		
Telegraph Systems, 40C1 Carrier		
Communication System Along Alcan Highway Now More Than Two-Thirds Completed		454
Telephone		
Calls		
Handling Night Calls at a Dial PBX	<i>Beaumont</i>	25
Pulsing Methods of the Dial System for Dial-to-Dial Calls	<i>Caverly</i>	448
Service		
Improved Telephone Service for Servicemen		363
Michigan Bell Offering Service on a Temporary Basis		251
New Telephone Set for the Hard of Hearing	<i>Herckmans</i>	45
Telephone Service for Small Army Detachments		306
Telephone Systems (see Carrier Systems; Dial Systems)		
Teletypewriter		
Oil and Teletypewriters		461
Teletypewriter Test Sets	<i>Lang</i>	439
Testing (see also Abrasion Test; Cables. Testing; Paper. Testing; Textile Testing)		
Philosophy of Toll-Test Boards	<i>Pascarella</i>	278
Samples of Insulators Mounted in Representative Loca- tions as an Aid to Study of Aging Effects (Picture)		346
Teletypewriter Test Sets	<i>Lang</i>	439
Testing and Rating Air Filters	<i>Eliason</i>	243
Testing Machines		
Izod Testing Machine Tests Aircraft Equipment Materials (Picture)		316
Testing Soldered Joints to Determine the Presence of Chloride Flux (Illustration, p. 277)		282
Textile Testing		
Abrasion Test for Textiles	<i>Walker</i>	15
3A Code-Call Circuit	<i>Erwin</i>	54
Toll Facilities		
Communication System Along Alcan Highway Now More Than Two-Thirds Completed		454
Philosophy of Toll-Test Boards	<i>Pascarella</i>	278

Toll Facilities (Continued)		
Speeding Communication for the Alcan Highway	<i>Sohnle</i>	188
Stretching Toll Facilities for the Emergency (Illustration, p. 122)	<i>Bellows</i>	110
Transcontinental Telephone Cable Placed in Service		116
Transmission Lines		
Rural Telephone Service Using Carrier on Power Lines	<i>McCurdy and Samuels</i>	145
Transmission Measurements		
Spread-Scale Recorder	<i>Engstrom</i>	66
Trigger Action from Secondary Electrons	<i>Skellett</i>	233
Tuned Null Detector	<i>Anderson</i>	347
Typewriters, Electric		
Purchase Order Writing	<i>Waldecker</i>	248

U

Ultra-High Frequencies		194
United States Army Signal Corps		
Bell System and Signal Corps Affiliated Plan		198
Signal Corps and the Laboratories		178
Using High-Crystal Harmonics for Oscillator Control	<i>Fair</i>	237

V

Vacuum Tubes		
Historic Firsts: The High-Vacuum Electronic Tube		283
Noise Measurements in Vacuum Tubes	<i>DeBuske</i>	456
Radar Vacuum Tube Deposited in Bell Laboratories' Vaults		389
Voltsmeters		
Radio-Frequency Voltmeter		126

W

Waiting for Lightning	<i>Mahoney</i>	86
Wave Guides		
Ultra-High Frequencies		194
Wire Maintenance Crew of a Signal Battalion in Action		
During Army Maneuvers (Picture)		177
Wood Preservation		
Greensalt Preservative for Telephone Poles	<i>Hill</i>	62
Greensalt Treatment of Poles	<i>Lumsden</i>	117