

BELL LABORATORIES RECORD

JUNE 1943

VOLUME XXI

NUMBER X

THIS war is being fought on many fronts, and the scientific front is one of the most important of them all. To insure that we shall win, our scientists must always keep one jump ahead of those of the enemy in the invention and development of new military instruments.

It is significant, therefore, that the scientists of the United States are effectively mobilized to do their part. Most of the work they do must be kept secret, but recently some information has been released on one of the products of their scientific effort—a new tool of war which has brought much disaster to our enemies.

This new tool is Radar—R-A-D-A-R—a device for detecting and locating enemy ships and airplanes. Radar works by sending out a beam of radio waves which, when it hits an object, is reflected and caught on the rebound. Thus the reflected radio wave gives warning of the enemy's approach. But it does more—it tells his exact distance and direction. The direction is that of the incoming reflected wave, and the distance is determined from the time it takes for the radio wave to make the round trip out to the enemy object and back. Knowing both direction and distance, guns can be trained on an enemy ship or airplane, even though hidden from sight by darkness or fog.

Radar takes many forms and sizes for different conditions of use, but all work on the same fundamental principle. Like all complicated devices, it is not a single invention but the product of many inventors and designers.

Three years before Pearl Harbor, Bell Telephone Laboratories was already working with our Army and Navy in the development of military radar. Other industrial laboratories joined in this effort. Through the National Defense Research Committee, an organized attack on radar problems was made by a group of leading scientists recruited from universities. All told, some two thousand scientists and engineers in Army, Navy, university, and industrial laboratories joined hands in the development of radar.

Bell Telephone Laboratories, a pioneer in the study of radio transmission and reflection, was in an outstanding position to contribute to the new art of radio detecting and ranging. All we had of technical knowledge and skill was thrown into the common pool. Wholeheartedly, we joined our efforts with those of other research groups in this country and England.

The radars which our forces are using today are the result of this joint effort coupled with the skill and workmanship of the several manufacturers who are enlisted in production. Prominent among the makers of radar is the Western Electric Company, manufacturing unit of the Bell System.

We of Bell Telephone Laboratories are proud of our contributions to this new instrument of war—one of many on which we have worked. We are proud, too, to have played a leading part in this greatest demonstration of teamwork that scientists have ever made.

—Remarks of Dr. O. E. Buckley on
the Telephone Hour, May 17, 1943.

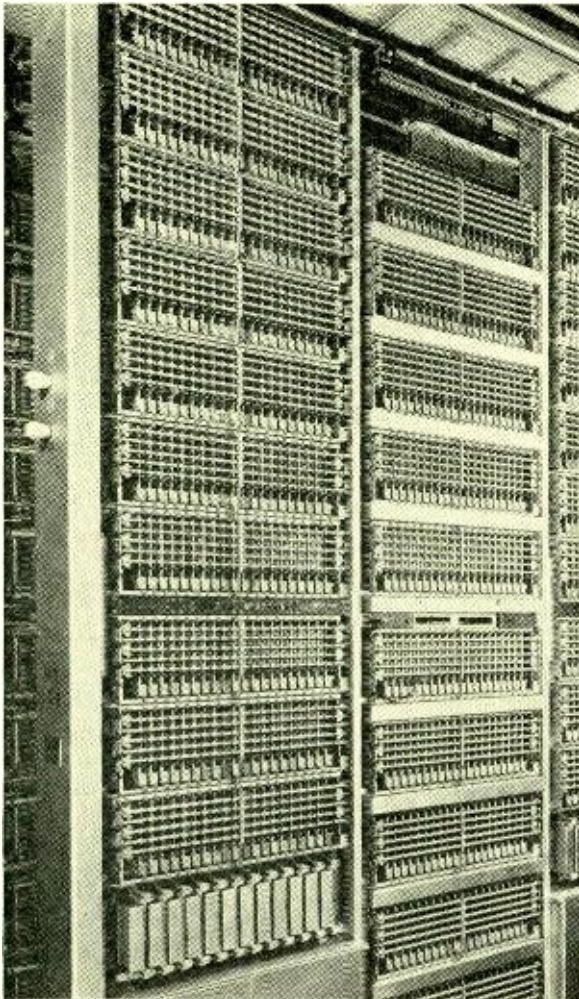

Class-of-Service Signals in the Crossbar System

By A. J. BUSCH
Switching Development

the town of origin. As a result, the senders may have to recognize an average of six different classes of service for each community served by the crossbar office. Where the telephone usage is small it may be desirable to serve as many as four communities by a single group of senders and markers. To care for situations such as these, provisions have recently been extended to permit senders and markers to recognize as many as twenty-four classes of service.

The class signal originates at the line-link frame where the calling line is identified. It is transmitted via the sender-link frame to the subscriber

IN CONTROLLING the completion of calls, senders and markers of the crossbar system must know the class of service pertaining to the calling line. For each community there are usually three or four such classes of service but in some areas there may be as many as six or even more. One example of six classes is shown in Table I. It frequently happens, also, that a number of nearby towns in a large suburban area are all served by a single central office. While an average of six classes of service may apply to each community, the charges for calls to various towns may differ with

sender when the calling subscriber line is connected to it. This signal is then stored in the sender where it is used for various purposes, and is also retransmitted to the originating marker when the sender associates itself with a marker after the office code digits have been dialed.

Information as to the class of service is transmitted from the line-link controller to the sender over ten class-of-service (cs) leads. They are divided into two groups: one group including leads cs0 to cs5 inclusive, and the other, leads cs6 to cs9 inclusive. Since there are four leads in one group and

TABLE I—CLASSES OF SERVICE THAT ARE RECOGNIZED BY CROSSBAR SENDERS AND MARKERS

Class 1—Suburban flat rate individual Suburban flat rate two-party
Class 2—Restricted flat rate individual Restricted flat rate two-party
Class 3—Restricted flat rate four-party
Class 4—Message rate individual including PBX
Class 5—Message rate two-party
Class 6—Coin, public, and coin, semi-public

six in the other, and since $4 \times 6 = 24$, any of the twenty-four classes can be indicated by grounding one lead in each of the two groups. The leads grounded for the various classes of service are shown in Table II. With this arrangement it is necessary only to ground two leads in the line-link controller to indicate any one of twenty-four classes of service to the sender.

The line-link controller is provided with a group of cs relays, and each relay, when operated, grounds two leads to indicate a class of service. Each of the cs leads that is grounded at the line-link controller operates a cs relay in the sender, and the sender determines the class of service from the particular two cs relays operated.

These operated pairs of cs relays in the sender are used also to transmit the class of service to the marker when the sender is connected to it. Instead of transmitting the class of service to the marker over ten leads, however, it is transmitted over five leads. While fewer leads are used to the marker, several additional relays are required in the marker to bring about

the complete translation of the class-of-service signal. The difference is merely that the circuit arrangement of the marker accommodates itself more readily to a different method of transmission.

The transmission method from line-link to sender is based on the number of possible combinations of two wires when one is from a group of four, and one from a group of six. There are just twenty-four such combinations, and the sender is arranged to recognize each combination of two cs relays that are operated together as one particular class of service.

For transmitting from sender to marker, however, the method is based on the combinations that can be arranged from a single group of five

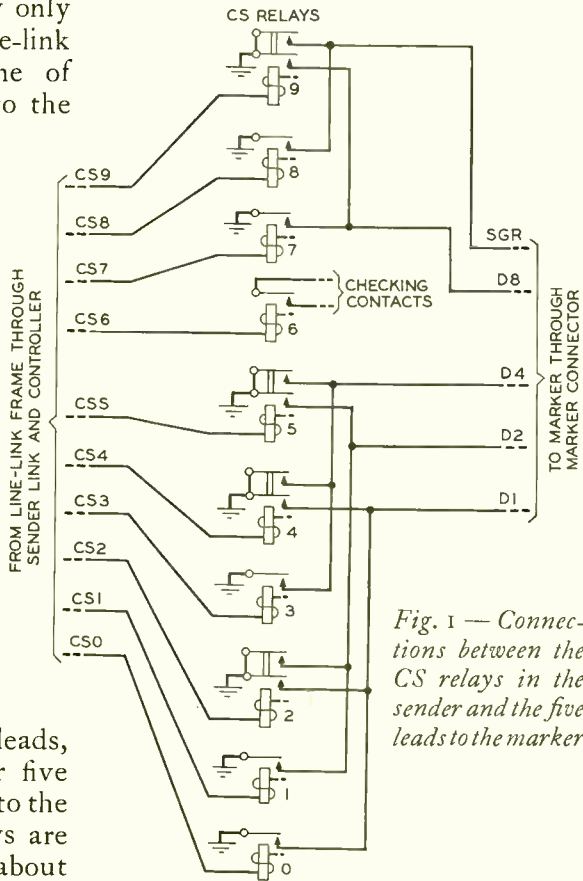

Fig. 1 — Connections between the CS relays in the sender and the five leads to the marker

TABLE II—COMBINATIONS OF GROUNDED CS LEADS FOR EACH TWENTY-FOUR CLASSES OF SERVICE

CS Leads	Class of Service	CS Leads	Class of Service	CS Leads	Class of Service	CS Leads	Class of Service
0 and 6	1	0 and 7	7	0 and 8	13	0 and 9	19
1 and 6	2	1 and 7	8	1 and 8	14	1 and 9	20
2 and 6	3	2 and 7	9	2 and 8	15	2 and 9	21
3 and 6	4	3 and 7	10	3 and 8	16	3 and 9	22
4 and 6	5	4 and 7	11	4 and 8	17	4 and 9	23
5 and 6	6	5 and 7	12	5 and 8	18	5 and 9	24

wires taking one, two, three, or four at a time. The five wires from the sender to the marker are designated D1, D2, D4, D8, and SGR, and the possible combinations are shown in Table III. There are thirty of such combinations altogether, but only twenty-four are needed; the six marked with a star are not employed.

Translation from the ten-wire to the five-wire code is made by using the contacts of the CS relays in the sender as shown in Figure 1. Each

TABLE III—COMBINATIONS OF FIVE WIRES CONSIDERED ONE, TWO, THREE, OR FOUR AT A TIME

One at a time	Two at a time
D1	D1, D2
D2	D1, D4
D4	D1, D8
*D8	D1, SGR
*SGR	D2, D4
	D2, D8
Three at a time	D2, SGR
*D1, D2, D4	D4, D8
D1, D2, D8	D4, SGR
D1, D2, SGR	*D8, SGR
D1, D4, D8	
D1, D4, SGR	Four at a time
D1, D8, SGR	*D1, D2, D4, D8
D2, D4, D8	*D1, D2, D4, SGR
D2, D4, SGR	D1, D2, D8, SGR
D2, D8, SGR	D1, D4, D8, SGR
D4, D8, SGR	D2, D4, D8, SGR

*These combinations are not used.

TABLE IV—OPERATED CS AND D RELAYS CORRESPONDING TO TWENTY-FOUR CLASSES OF SERVICE

Class of Service	CS Relays Operated in Sender	D Relays Operated in Marker
1	0, 6	1
2	1, 6	2
3	2, 6	1, 2
4	3, 6	4
5	4, 6	1, 4
6	5, 6	2, 4
7	0, 7	1, 8
8	1, 7	2, 8
9	2, 7	1, 2, 8
10	3, 7	4, 8
11	4, 7	1, 4, 8
12	5, 7	2, 4, 8
13	0, 8	1, SGR
14	1, 8	2, SGR
15	2, 8	1, 2, SGR
16	3, 8	4, SGR
17	4, 8	1, 4, SGR
18	5, 8	2, 4, SGR
19	0, 9	1, 8, SGR
20	1, 9	2, 8, SGR
21	2, 9	1, 2, 8, SGR
22	3, 9	4, 8, SGR
23	4, 9	1, 4, 8, SGR
24	5, 9	2, 4, 8, SGR

operated CS relay except CS6 grounds one or two of the five leads to the marker, and since there are always two of the CS relays operated for any code, ground may be placed on one, two, three or four of the five leads to

Fig. 2—Circuit in marker for translating signals sent from the sender

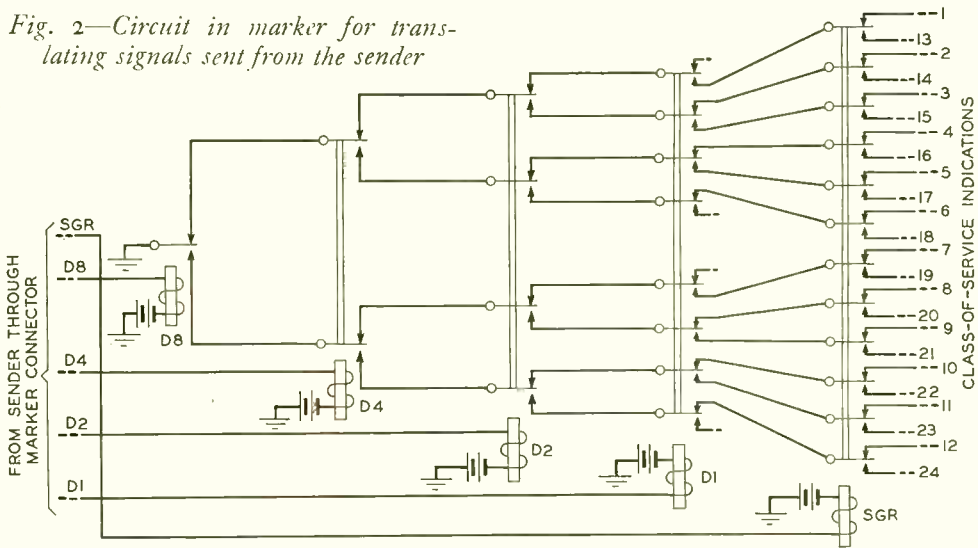

the marker. The pairs of cs leads grounded for the various codes were given in Table II, and the combination of grounded leads to the marker as a result of these various pairs of operated cs relays is shown in Table IV.

In the marker, class of service is indicated by a ground on one of twenty-four leads. To translate the various combinations of grounds on the five leads from the sender to a single grounded lead of a group of twenty-four, the circuit shown in Figure 2 is employed. It will be noticed that each lead is shown connected

to one relay, which is numbered to correspond to the lead. To secure the large number of contacts required on the SGR relay, two relays connected in parallel are used in the actual circuit, and in certain other respects the actual circuit differs from that shown here, but functionally the arrangement is as indicated.

Although the senders and markers are arranged to recognize a possible twenty-four classes of service, only four cs relays are provided in each line-link controller. Lines of the same



A. J. BUSCH joined the Laboratories in 1922 immediately upon receiving the E.E. degree (*cum laude*) from the Polytechnic Institute of Brooklyn. After completing the student course, he was engaged in laboratory testing and analysis of both manual and panel telephone circuits for two years. An equal period was spent in designing manual circuits and from 1926 to 1933 he engaged in the design of panel selector circuits. Since 1933 he has designed circuits for both the local and No. 4 toll crossbar systems. He is now in charge of a group concerned with war projects.

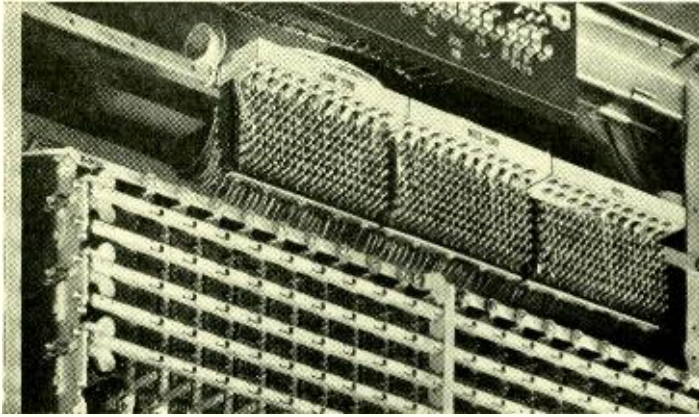

Fig. 3—Cross-connecting terminals at top of primary line-link bay

service class are usually grouped together, and a single line-link frame is arbitrarily limited to lines of not more than four classes. Since it is not desirable to restrict the line-link frames to any particular classes of service, however, the eight leads from the four cs relays of the controller are brought to soldering terminals, and the ten cs leads running to the sender are brought to a set of terminals facing them. By cross connections at these terminal strips, any of the four cs relays may be made to correspond to any of the twenty-four possible classes of service. This arrangement is indicated at the right of Figure 4.

The cs relays in the line-link controller are operated by the LT relays. As already described in the RECORD,* there are ten of these LT relays in each line-

*May, 1939, p. 269.

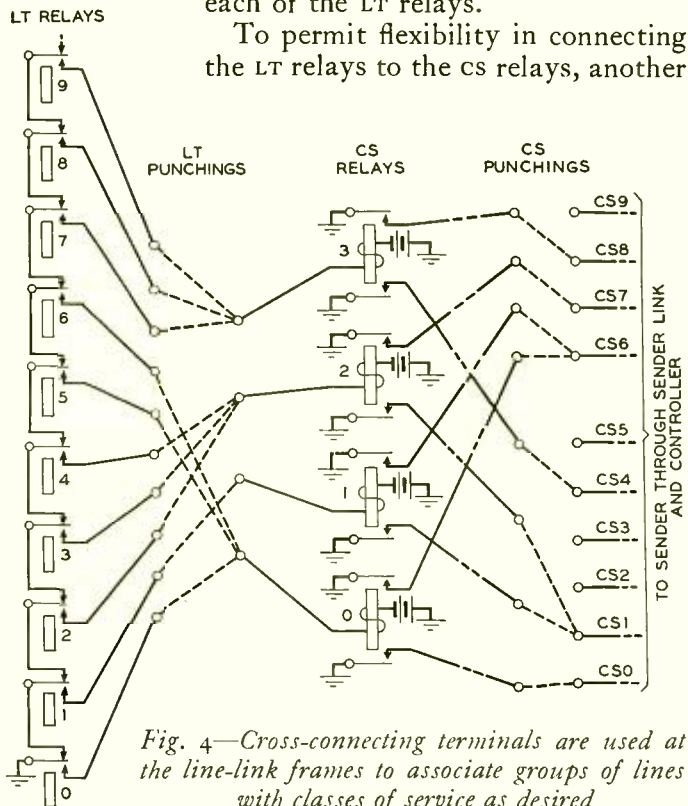

Fig. 4—Cross-connecting terminals are used at the line-link frames to associate groups of lines with classes of service as desired

link controller, and one always operates for each call placed. The lines are connected to the verticals of the crossbar switches in groups of ten, and the corresponding lines of each such group all operate the same LT relay. Since the controller handles only one call at a time, however, it is necessary only that lines of

the same class are connected to corresponding positions of the various groups. A single line frame may have from twenty to seventy of such groups, and as a result there will be from twenty to seventy lines for each of the LT relays.

To permit flexibility in connecting the LT relays to the cs relays, another

set of cross-connecting terminals is provided as shown at the left of Figure 4. These are called the LT punchings, while those between the CS relays and the CS leads to the sender are called the CS punchings. Both of these sets of terminals are mounted at the top of the primary line-link bays as may be seen in the photograph at the head of this article. A close-up view of these terminals is given in Figure 3. Here the CS punch-

ings are at the upper left of the right-hand terminal strip and the LT punchings are immediately below them. The remaining punchings on the terminal strips are used for other purposes.

In offices serving only a small number of classes of lines, the CS relays are not provided in the line-link controllers. The leads from the LT relays are cross-connected directly to the CS leads to the sender, only one of the latter leads being grounded for a call.



To insure continuity of the numerous services at Murray Hill, such as electricity, water, compressed air, and ventilation, an automatic alarm system is installed that gives immediate indication of any condition that should be remedied. These alarms, as well as the fire alarms and the watchman reporting system, are all brought to this desk at the Control Center



Historic Firsts: Permalloy

IN 1916 the development of ferromagnetic materials was practically at a standstill; no radical advance was in prospect either of theory or practice. It was generally assumed that there was no more magnetizable material than pure iron, although certain steels, or iron

with a little silicon, might be better adapted to special purposes. From this dormant condition the art was awakened by G. W. Elmen's invention of permalloy. His experiments in Bell Laboratories showed that a material with an ease of magnetization (permeability) to weak magnetizing forces many times greater than any iron could be obtained from certain alloys of iron and nickel when properly heat treated. This characteristic of high initial permeability is, of course, important in telephony.

The invention attracted immediate attention in engineering circles and stimulated other inventions. In our Laboratories it was followed by a complete survey of alloys involving combinations of iron, nickel and cobalt. Among these are the perm-invars, so named because their permeability is *invariable* over a considerable range of magnetizing force.

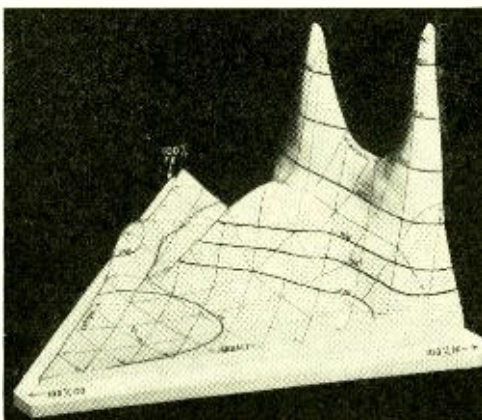

Model showing permeabilities of annealed alloys of iron, nickel and cobalt

Permalloys also were obtained with improved characteristics by introducing small amounts of other elements, as in the case of molybdenum permalloy. Today there are many magnetic substances each adapted to specific purposes; permalloy is only one of this large group but as the

first it opened a new field for engineering development.

On the scientific side the unexpected characteristic of permalloy renewed interest in the problem of the physical basis of magnetism. Within our Laboratories there was increased attention to this field of research and many important contributions have been made to the science of ferromagnetism. These have dovetailed with a large number of academic researches and with various engineering developments so that today there is a serviceable theory. This advance on the scientific side would, of course, have come about ultimately without the invention of permalloy for it is inherent in the modern study of atom structure, but permalloy gave it an enormous impetus because it indicated undreamed-of engineering possibilities and showed the incorrectness of some well-established ideas.



How Little Do We Hear?

By W. A. MUNSON
Acoustical Research

HEARING is one of the five senses, and although it is distinct in name and sensation from the other four, its cause is of the same nature as that for the sense of touch. For both, the acting stimulus is pressure. While a simple steady pressure on the hand will result in a tactile sensation, however, the pressure on the eardrum must be vibratory if a sensation of sound is to result.

One of the fundamental studies in acoustics is that to determine the minimum stimulus that the ear can detect. Attempts to determine this basic stimulus have been made by many groups over a long period of time, and the results have varied widely. This divergency of results might be expected because there are physiological and psychological factors to be considered as well as the physical ones. A survey of all published results and a complete new set of measurements using the most modern and improved techniques was undertaken some time ago by L. J. Sivian and S. D. White of these Laboratories.

The difficulty in securing accurate values is great. In the first place there are differences in the hearing mechanisms of various individuals tested. Except for those with some definite hearing defect, these differences largely depend on age; as one grows older the response of the ear becomes less, chiefly at the higher frequencies. Measurements of minimum hearing stimulus thus vary with the age of

those being tested. Another difficulty is in measuring the minimum stimulus. Two references have been widely used. One is the rms pressure of the sound wave at a point in a free sound field where the listener's ear will later be placed. This is the simpler of the two, and is particularly applicable to studies of the usual mode of hearing, that is without the use of telephone receivers or similar devices. The other is the pressure at the eardrum. This latter reference avoids uncertainty as to how the pressure, measured in the air previously to the listening test, would be modified at the eardrum by the head and ear of the listener, and is particularly useful in studying the mechanism of hearing. It involves great technical difficulties, however, since the space in front of the eardrum is small and almost inaccessible.

Based on their own measurements and on extensive analyses of measurements published by others, Sivian and White drew two curves to represent the minimum hearing stimulus. One, based on the pressure measured at the drum, is called the curve of minimum audible pressure—abbreviated M.A.P.; the other, based on measurements of the sound field at the point where the listener's head will subsequently be placed, is called the curve of minimum audible field, abbreviated M.A.F. These two curves are shown in Figure 1. The differences between them are attributed to distortion of the free sound field that takes place when the observer enters.

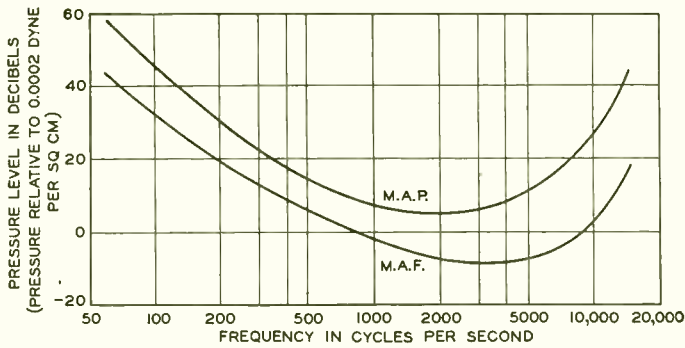

Fig. 1—Curves of minimum hearing stimulus as determined by Sivian and White

His body forms a discontinuity in the impedance the wave encounters in free air, and whenever a change in impedance is met, a change in pressure results.

Regardless of which of these two curves is used, the pressure involved is very minute—less than a thousandth of a dyne per square centimeter. A pressure of this order of magnitude distributed over the eardrum results in a force of the order of only a hundred-millionth of an ounce. As an organ for detecting pressure changes, the ear is thus far more sensitive than our tactile organs, since a touch of this lightness would be imperceptible. Even at the upper limit of hearing, the force is only some thousandths of any ounce. Vibrating pressures greater than this become tactile rather than audible and result in the sensation of pain.

The ordinate scale of Figure 1, on which the stimulus of the sound is read, is pressure level in db referred to a pressure of 0.0002 dyne per square centimeter. A decibel, however, by definition is ten times the logarithm of the ratio of two powers. It is thus a unit of power ratio, and the incorporation of pressure with the decibel scale seems out of place. This seeming anomaly is readily accounted

for by the fact that power under any given set of conditions is always proportional to the square of the pressure. Any one pressure under a given set of conditions defines one power. This relationship may be written in the form (1) $w = kp^2$ where w stands for power, p for pressure, and k is a constant de-

pending on the units used and on other conditions of the measurement. In expressing a power w_1 , with its corresponding pressure p_1 , in terms of db relative to some reference power w_0 , with its corresponding pressure p_0 , we write:

$$db = 10 \log \frac{w_1}{w_0} = 10 \log \frac{kp_1^2}{kp_0^2}$$

The k 's in the right-hand expression cancel, and since the log of the square of a number is two times the log of the number, the above expression finally becomes:

$$(2) db = 10 \log \frac{w_1}{w_0} = 20 \log \frac{p_1}{p_0}$$

All sensory responses vary not directly as the stimulus but more nearly as the logarithm of the stimulus, and the use of a db scale, which is logarithmic, is thus very convenient. The fact that a db is proportional to the logarithm of a ratio of powers rather than of pressures is no particular objection since power and pressure are always inter-convertible by means of equation (1). As a matter of fact, the stimulus of sound is frequently given in terms of the power of a wave in free air. From a source of sound, the waves spread in all directions, but since the only part of this total flux of energy that is effective in

causing sound in a listener's ear is the small portion that strikes the drum, it is the intensity of the wave, or the power crossing a unit area such as a square centimeter, that is used as a measure of the stimulus. For air at a temperature of 20 degrees C. and a pressure of 76 cm. of mercury, k in equation (1) is 2.4×10^{-3} and the relationship between intensity and pressure becomes: (3) $i = 2.4 p^2 \times 10^{-3}$, where p is the rms pressure in dynes per square centimeter—and i the intensity in microwatts per square centimeter. This relationship solved for p is: (4) $p = 20 \times \sqrt{i}$.

For any value of pressure, therefore, there corresponds a power intensity, which may be calculated from equation 3. These intensities are very small, however. That for a pressure of 0.001 dyne per sq. cm. is 2.4 thousandths of a millionth (2.4×10^{-9}) of a microwatt per square centimeter. To avoid using such small exponential fractions as 10^{-9} , it is customary in

acoustical work to use a reference intensity of 10^{-10} microwatts per square centimeter for which the corresponding pressure is 0.0002 dyne per sq. cm.

The intensity level of an acoustic wave is defined as ten times the logarithm of the ratio of the given intensity to the reference intensity, and is expressed in db, which is the accepted unit for expressing ten times the logarithm of a ratio of two powers. An intensity level, strictly speaking, is thus a measure of the power intensity of an acoustic wave, but it is also a measure of the pressure because of the relationship between power and pressure given above. The power intensity and pressure corresponding to various intensity levels are shown in Figure 2. The curve for pressure has a slope of twice that of the curve for power because it is the square of the pressure that is proportional to power.

The intensities derived from the ordinate scale of Figure 1 are thus the

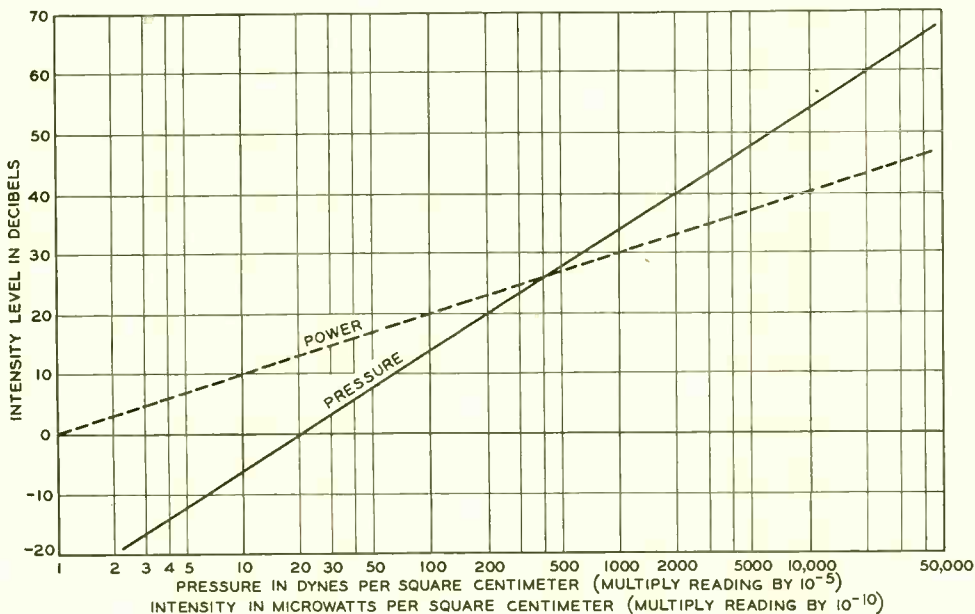

Fig. 2—Power and pressure levels corresponding to various intensity levels

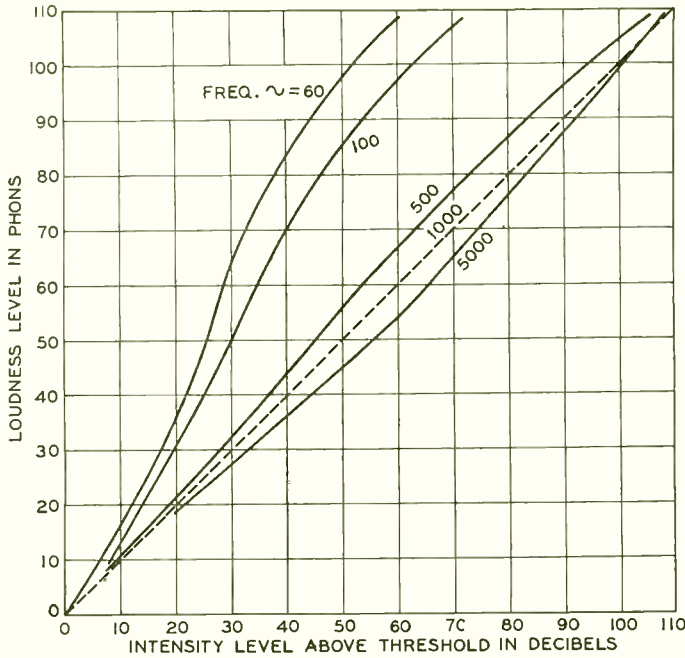

Fig. 3—Relationships between loudness level in phons and intensity level above the threshold for various frequencies

intensities of a sound wave in free air. They are not necessarily a measure of the power actually absorbed by the ear mechanisms. Power is a function of both pressure and impedance, and equation (3) incorporates the impedance of free air. The same pressure acting against the impedance of the ear mechanism might result in an entirely different power. This situation is true of all power applications. There may be an electric potential of 110 volts at a particular socket, but the amount of energy used depends on the resistance of the lamps inserted. A larger lamp, having a lower resistance, will consume more power than a smaller one with high resistance. Since for any one person the ear mechanism is fixed, the pressure alone is a sufficient indication of sound stimulus under any given set of conditions.

The curves of Figure 1 represent

the so-called threshold of hearing, since any air wave with an rms pressure above the threshold value enters our consciousness as sound, and the sound becomes louder, the higher the pressure. Since it is the loudness rather than the pressure that we are directly conscious of, some scale for measuring loudness is also desirable. Loudness, however, is not a simple physical quantity like pressure. Between it and pressure there is interposed the complex mechanism of the ear, the system of acoustic nerves, and

our psychological response to nerve stimulation. Much study has been devoted to the subject, and many suggestions were made and tried out before a satisfactory solution was reached. Because of the curved characteristic of the threshold, it seemed possible from the first that the loudness of sounds of different frequencies might not correspond directly with the pressure.

The results of a large amount of work was summarized some years ago by Harvey Fletcher and the author. It was decided to use the loudness of a 1000-cycle tone as a reference. This frequency is widely used as a test tone throughout the Bell System, and it has the advantage of being very close to the frequency range for which the ear is most sensitive. Since in general the relationship between the magnitude of a sensory response and its stimulus is logarithmic

mic, it seemed desirable to use a logarithmic scale, and for convenience the loudness level of a 1000-cycle tone was arbitrarily taken to be the intensity level. Loudness level at any other frequency or combination of frequencies is taken to be equal to the intensity level of a 1000-cycle tone that sounds equally loud. Although loudness level is measured on a logarithmic scale, and thus corresponds in magnitude to a db scale, the unit is called a phon instead of a db to indicate that the thing measured is basically different from power.

At 1000 cycles the threshold of hearing in a free field is just about at 0 intensity level, which also justifies making the loudness level and intensity level equal by definition at this frequency. At 1000 cycles, therefore, an increase in intensity level results in an equal increase in loudness level. This equality is found not to exist at other frequencies, however. This is obvious from Figure 1. A 100-cycle tone, for example, at an intensity level of 32 db is just at the M.A.F. threshold, and is thus of 0 loudness level, while at 1000 cycles a tone of 32 db intensity level is at 32 loudness level. In comparing loudness

with intensity, therefore, and in most other acoustic work, it is preferable to refer the intensity to that at the threshold for the particular frequency involved. If the intensities above threshold are compared with the corresponding loudness level, the results found are those indicated on Figure 3. At 1000 cycles, the curve expressing the relationship between the two levels is a 45-degree straight line because of the definition of loudness level. At other frequencies, however, the relationship is a curved line, and may be either above or below the 1000-cycle line. The departure is the greatest at the low frequencies. At 60 cycles, for example, a tone 60 db above the threshold in intensity is at 109 loudness level. At 5000 cycles, on the other hand, a tone 60 db above threshold in intensity is at a loudness level of only 54. For all frequencies above 500 cycles, the curves lie between those for 500 and 5000 cycles.

To the question "How Little Do We Hear?" the only safe answer is: "It all depends." What we hear is a sequence of periodic pressure changes in the air, but how small the pressure changes may be, given a normal young ear, depends on the rapidity of

W. A. MUNSON specialized in physics at the University of California at Los Angeles. He graduated there in 1927 and joined the Acoustical Research group of the Laboratories the same year. Since then he has been engaged in articulation studies and investigations of the loudness and masking effects of pure and complex tones.



the changes. The ear is most sensitive when the pressure cycles are occurring at rates between 1000 and 5000 times per second, since we can then detect changes less than a thousandth of a dyne per square centimeter. At both higher and lower frequencies, the sensitivity falls off. The studies that

have determined these minimum perceptible pressure changes, and the many others that have established units of measurement and adequate techniques and apparatus, have provided the foundations for the extensive studies of hearing that have been carried on in the Laboratories.

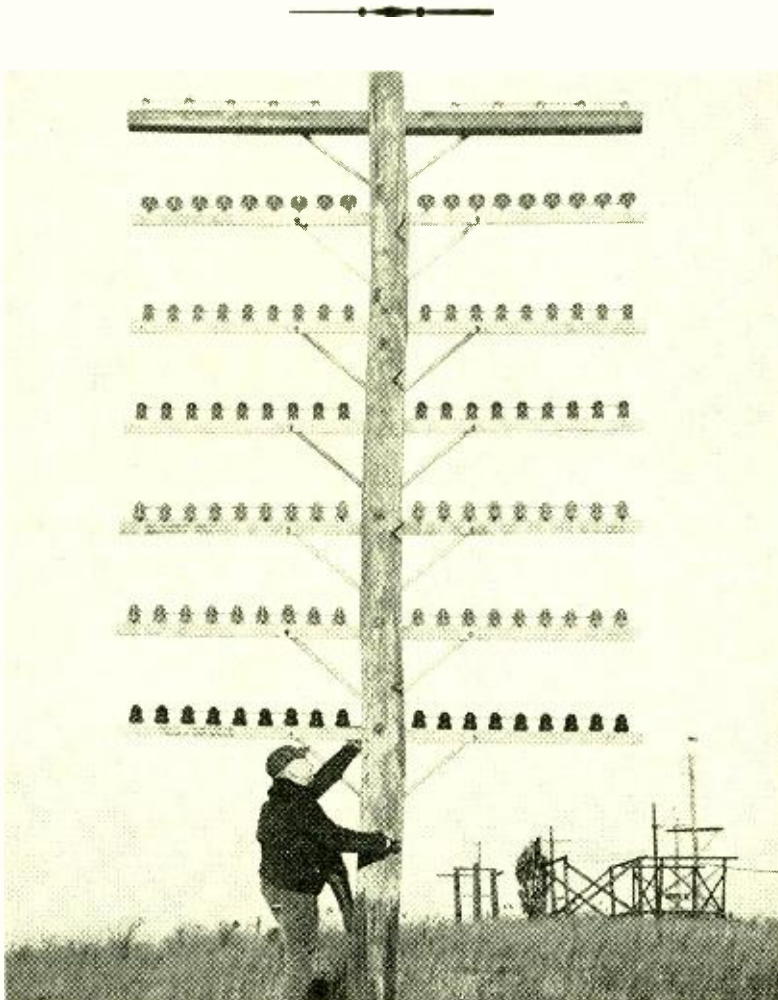

To study the aging effect of smoke, fog, dust and rain on the surface of insulators designed for open-wire lines, samples are mounted on test cross-arms in representative locations in coastal, industrial and rural areas. Periodically the insulators are returned to the Laboratories for comprehensive tests

A Tuned Null Detector

By F. B. ANDERSON
Transmission Development

NULL detectors rank with the oldest electrical measuring devices. They were employed with the original Wheatstone bridge,* and have been used with bridges of all sorts ever since. With the early d-c bridges, the null detector took the form of a galvanometer; as long as the bridge was not balanced, a current would flow and cause a deflection of the galvanometer, but with the bridge perfectly balanced, no current would pass through the galvanometer, and the resulting zero, or null, reading indicated that balance had been obtained. More recently bridges have been developed for measuring a-c impedances, and the galvanometer has often been replaced by vacuum-tube amplifiers with either meters or telephone headsets to give the balance indication. With the expansion of communication systems during the last quarter of a century other forms of measurements using a null indicator have come into common use with the result that the null detector together with the oscillator that supplies the testing current are among the most common laboratory devices.

The range of voltage impressed across the terminals of such a de-

*RECORD, Dec., 1929, p. 167.

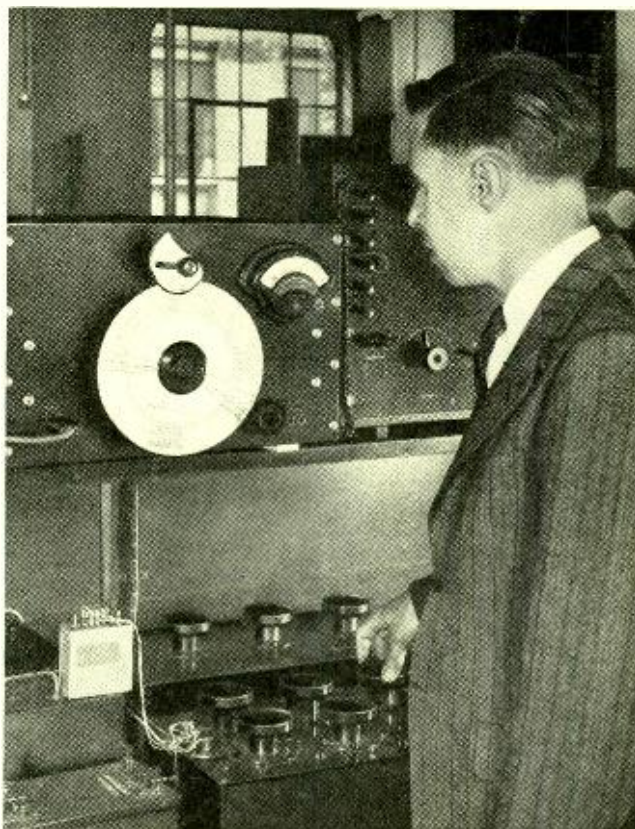

tor is very large, and if the detector is sensitive enough to give a good null indication, it cannot satisfactorily handle the relatively large voltages existing when the bridge is considerably out of balance, as at the beginning of a measurement. With the galvanometer employed with d-c bridges, a series of shunts were available for connecting across the galvanometer terminals. Low-resistance shunts would be used during the early stages of the measurement to shunt most of the current away from the galvanometer. Only as final adjustment was approached would all shunts be removed. Amplification control of one form or another is also required with all a-c null detectors, and as the balance is adjusted, the gain must also be adjusted to keep

the sensitivity of the detector in step with the improving balance.

A complication that has accompanied detectors for use on a-c measurements is the matter of tuning. They should respond only to the frequency of the testing current, which is usually supplied by an oscillator. If they are not accurately tuned and well shielded they may respond to harmonics which may be present or other stray alternating potentials and fail to indicate the null when they properly should. Since both tuning and volume adjustment are auxiliary manipulations that do not directly advance the actual measurement being made, anything that will reduce the attention they require is very desirable. It was chiefly with these objectives in mind that a new tuned null detector has been designed. It eliminates volume adjustment entirely because it compresses a volume range of over 100 db into a variation of the reading of a simple milliammeter, and it reduces tuning to a very simple operation that does not require the

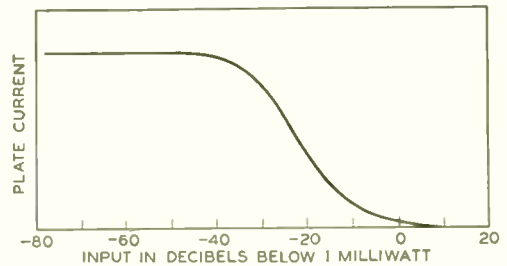

Fig. 1—Input-output characteristic of each of the three stages of the null detector

use of calibration charts or curves.

The basic element of the volume control circuit is a pentode feedback amplifier with an input-output characteristic roughly as indicated in Figure 1. For inputs less than 40 db below one milliwatt, the plate current remains essentially constant at its maximum value, but as the input increases above -40 dbm, the plate current decreases as shown, becoming essentially zero at an input of 0 dbm. This characteristic is secured by connecting a diode rectifier between the plate and grid in such a way that as the input increases above -40 dbm,

a certain portion of the plate current, rectified by the diode, will increase the negative bias of the control grid and thus reduce the plate current. The grid to plate voltage gain in the region of 0 dbm input approaches unity, so that several stages may be cascaded for input ranges in excess of 40 db.

In the new detector circuit, three such tubes are connected in cascade. Each has a gain of approximately 40 db, and thus the

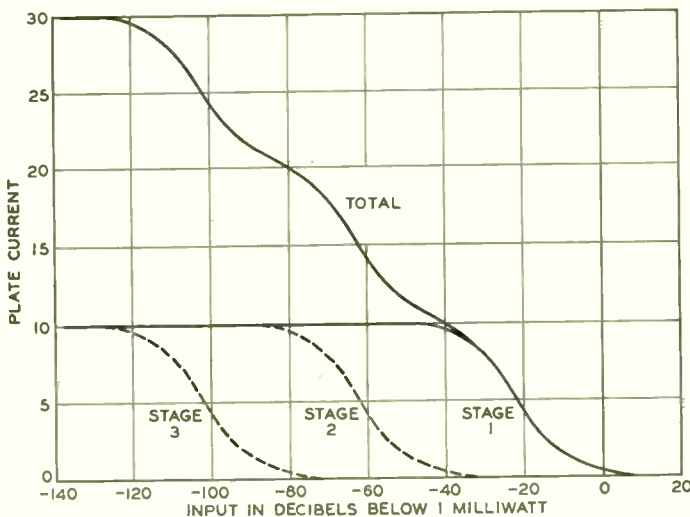

Fig. 2—Relationship between input and total output current for a three-tube detector

total gain for the circuit is 120 db, but because of the feedback arrangement, each tube will supply maximum plate current while its input is less than -40 dbm, and its plate current will decrease as its input increases from -40 to 0 dbm. The total output current is the sum of the plate currents of the three tubes, and thus is related to the input as shown in

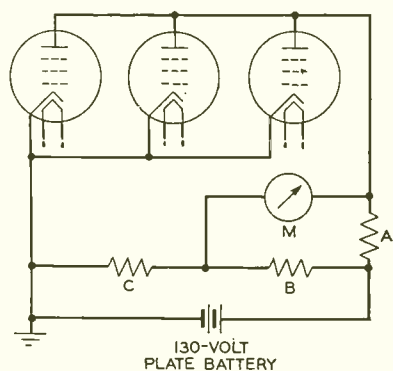

Fig. 3—Simplified schematic of meter circuit showing how an increasing output current results in a decreasing meter current

Figure 2, which gives the relationship between the total output current and the input to the first tube for a detector consisting of three tubes. With an input of -40 dbm, for example,

the first tube will give its maximum plate current, but since its gain is 40 db, the input to the second tube will be 0 dbm, and neither it nor the third tube will provide appreciable plate current. Had the input been -80 dbm, the first two tubes would each have supplied maximum plate current, and the third tube, essentially none. The overall characteristic is shown in the solid curve, while the dotted curves show the plate currents for tubes 2 and 3 for various inputs to the first tube.

Although it is very desirable to avoid the necessity of volume adjustment, which this circuit accomplishes, it is also desirable to have the indicating meter decrease its reading as balance is approached so that the degree of unbalance may be indicated by the meter reading. With an output characteristic as shown in Figure 2, a meter reading output current directly would have just the reverse of the characteristics desired, since the current is greatest for the lowest input and approaches zero as the input increases toward 0 dbm. To secure a meter indication that decreases as the input decreases, the meter is connected as shown in Figure 3. With no



F. B. ANDERSON graduated from the University of Pennsylvania in 1926 and immediately after entered the Systems Development Department of the Laboratories. He has specialized chiefly in the design and testing of feedback amplifiers and gain regulators for carrier telephone systems, and of improved measuring instruments and apparatus for many purposes.

plate current flowing, voltage drop across resistance A is a minimum, and the meter indication is proportional to the drop across resistance B. This is the maximum voltage across the meter. As plate current begins to flow, the voltage across the meter is reduced by the voltage drop of the plate current through resistance A. By properly adjusting the values of A, B, and C in relation to the meter employed and the maximum plate current, the meter reading may be made to decrease gradually as the input to the detector decreases from 0 dbm to -120 dbm. A typical characteristic is shown in Figure 5.

Tuning is accomplished by three air condensers, one for each stage of the detector, which are varied simultaneously by a single dial. The detector is designed for operation at 1 kc or at any frequency between 3 and 150 kc, and to permit the single tuning control to act over this entire range,

an eleven-point six-gang switch is provided that divides the total frequency range into sub-ranges by switching in different sets of coils and condensers in the output circuit of each stage. The tuning dial is provided with eleven concentric scales, one for each of the sub-frequency ranges, and the eleven-point gang switch, which is mounted immediately above the tuning dial, carries an Archimedean spiral with eleven index lines along its edge so spaced that as the switch is turned an index is brought tangent to the proper scale on the tuning dial. This arrangement is shown in the photograph at the head of this article. To tune the detector, therefore, it is necessary only to turn the switch carrying the spiral index scale to the proper sub-frequency range, and then to turn the tuning dial to bring the desired frequency indication under the index on the spiral shown at the left.

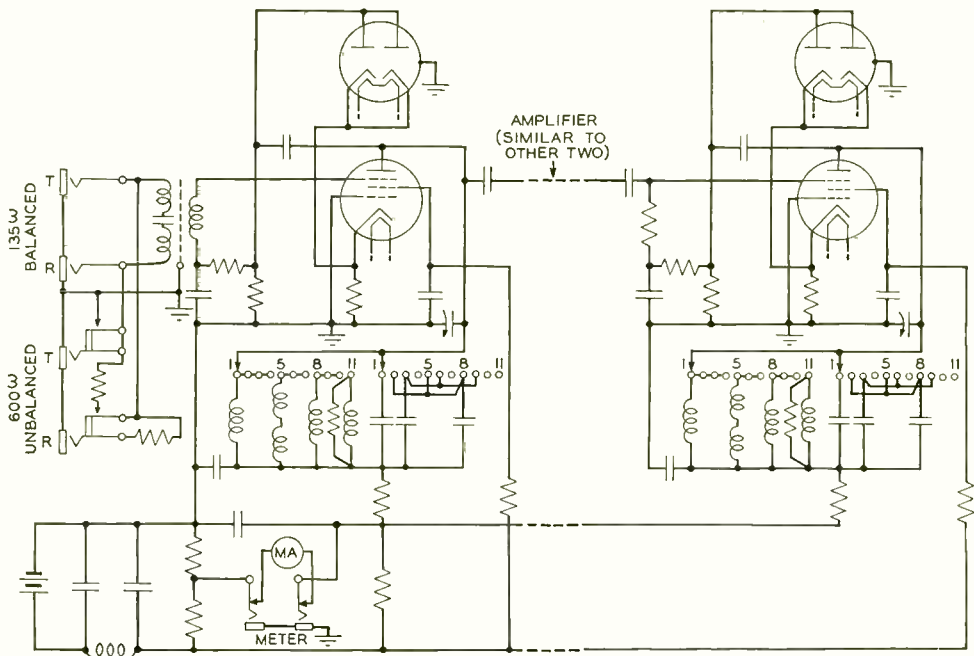

Fig. 4—Simplified schematic of tuned null detector

The circuit arrangement of the detector is shown in somewhat simplified form in Figure 4. Two input circuits are provided: one a balanced circuit of 135 ohms and the other an unbalanced circuit of 600 ohms. An indicating meter is provided on the front of the detector as shown in the photograph at the head of this article, but jacks are provided so that an external meter may be used if preferred. The bridge resistances are proportioned so that either the meter on the detector or a model 24 Weston meter will cover full-scale range with the currents available. A discrimination of the order of 60 db against second harmonics and 80 db against third harmonics is secured at low inputs, and the detector may be operated

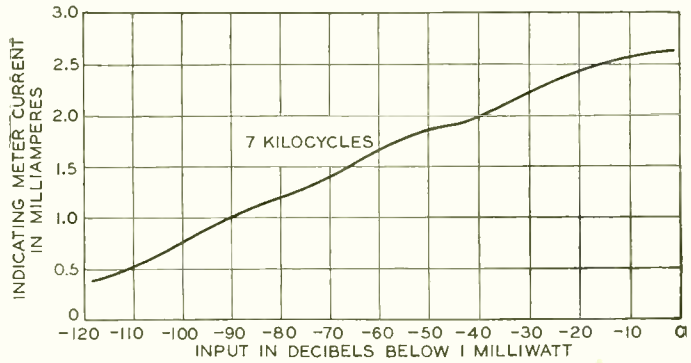
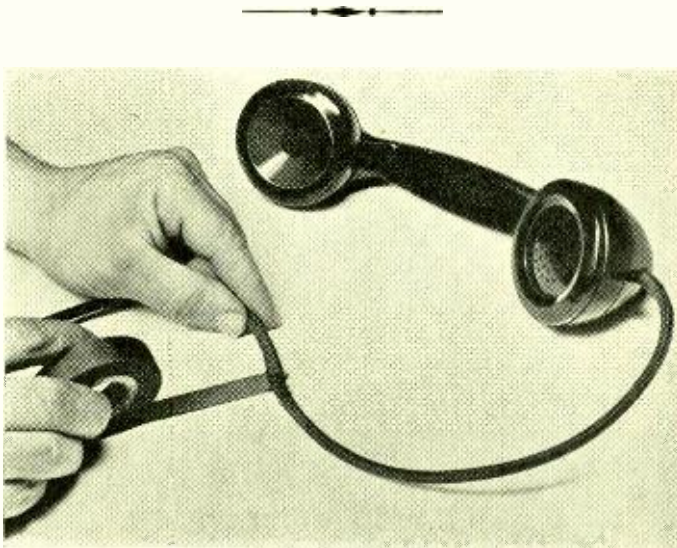
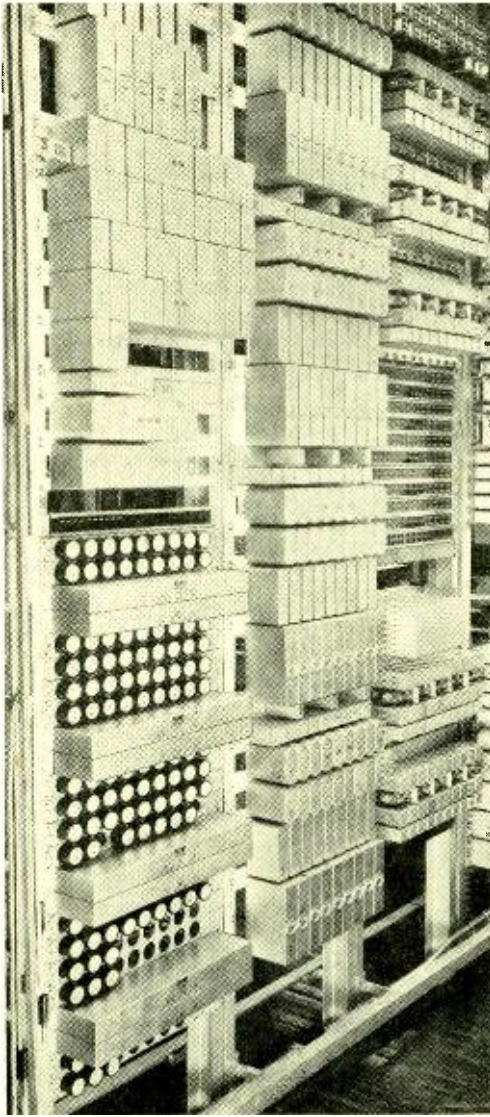

Fig. 5—Typical relationship between meter current and input to the tuned null detector

close to the driving oscillator without experiencing crosstalk. The sensitivity is about the same as that obtainable with earphones and a heterodyne detector operating at its highest sensitivity. The simple tuning and the complete freedom from volume adjustments obtained in this detector make it a measuring instrument that is decidedly superior to the auditory method under many conditions.



Acetate cloth tape is wrapped around worn places on telephone cords to lengthen the cords' lives. It matches the color of the cords so well that it can hardly be noticed



Equipment Features of the VI Repeater

By C. P. CARLSON

Toll Equipment Development

in mind. Their availability, however, has played an important part in the improvement represented by the new repeater. It would obviously have been uneconomical to modify the existing 22A2 repeater each time a small improvement was made, but as such modifications accumulate, a time ultimately comes when a completely new design becomes worthwhile.

Perhaps the most important of these changes are the adoption of heater-type tubes, the application of stabilized feedback, and a number of improvements in apparatus design such as the use of stud-mounted apparatus with dimensions in the mounting plane that are multiples of $1\frac{3}{4}$ inches. Such units are mounted on only one side of a relay rack with the wiring all on the other side, and since their dimensions are always multiples of $1\frac{3}{4}$ inches, the wiring may be simplified, and standard mounting plates may be used. Small and light resistance units, which may be suspended directly from the apparatus terminals, have also contributed to economy and compactness. As a result of these changes, and of the modifications that have been incorporated in the circuit as well, the new repeater will save about one-third the cost and floor space of the previous type.

The 22A2 repeater was mounted on a special seven-inch panel, with apparatus on both sides. As a result the

ONE of the factors leading to the development of a new voice-frequency repeater* was the accumulation of a large number of changes in design of the various pieces of apparatus that comprise a repeater. These various changes in apparatus design and in methods of assembly, of course, affect a wide variety of equipment and were not made primarily with the VI repeater

*RECORD, Sept., 1941, pp. 20 and 24.

wiring was grouped into cable forms, part of which was run at right angles to the plane of the panel and part parallel. Apparatus covers were required on both sides. With the VI repeater, however, the apparatus is all on one side with its terminals projecting through the panel to the wiring, which is all on the other side, and run directly from terminal to terminal; and no covers are required. Moreover, placing the filters and equalizers with the line equipment rather than with the amplifiers, and consolidating the hybrid and repeating coils has so reduced the space required that ten amplifiers, with their elements arranged vertically, may be mounted across a 19-inch relay rack, while a single 22A2 repeater occupied the entire width.

Ten amplifiers constitute five repeaters, and a five-repeater unit of the VI type is shown at the right in the upper part of Figure 1, where a 22A2 repeater is shown at the left for comparison. The corresponding rear views, lower part of Figure 2 (with the cover removed from the 22A2 re-

peater), show the manner of running the wiring to the top of the apparatus units. In the VI arrangement, each horizontal mounting plate carries only one type, or at most two types, of apparatus.

Repeater units are mounted one above another on a 19-inch rack, and twelve repeaters of the 22A2 occupy as much space as forty of the VI. This difference is not all gain, because space is required elsewhere for the filters and equalizers that are not incorporated in the VI repeater unit. There is the large net saving in space already referred to, however, and in addition there is the great advantage of having all apparatus requiring routine maintenance or adjustment more compactly grouped together.

Still further advantages arise from the new circuit. The basic element is really two amplifiers, rather than two amplifiers, two equalizers, two filters, and two hybrid coils as with the 22A2 repeater, and the amplifier units are all identical—only very minor connection changes being required to accommodate the various types of bat-

Fig. 1, above—Five VI repeaters (amplifiers only) at the right, and a single 22A2 repeater (with equalizers and filters as well as amplifiers) at the left, as viewed from the front

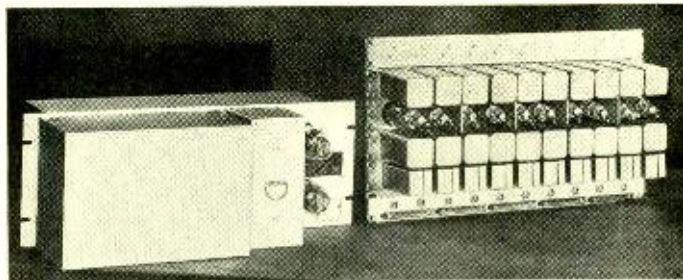
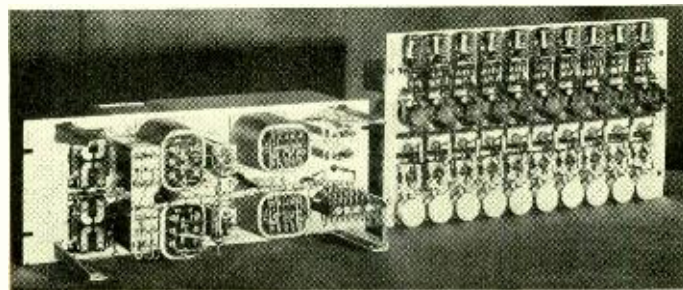

Fig. 2, below—Rear views of the VI and 22A2 repeaters shown above



tery supply. Two bay arrangements are provided for 19-inch bays—one with forty and one with thirty-five repeaters. The latter provides additional space on the bay for ballast lamps or resistances, which are required for some battery supplies, and also for a telephone set used for maintenance purposes. With the 22A2 repeater, on the other hand, twelve bay arrangements were required, and further modifications were sometimes made in these. Since with these earlier repeaters the hybrid coil was part of the repeater unit, the wiring differed for the various types of ringing as well

as for various types of battery supply. With the VI repeater, the ringing connections are made at the line bays and thus the type of ringing does not affect the repeater itself.

Besides these changes in the repeater bays, the arrangement of the line equipment has also been radically modified to take advantage of the circuit changes and of the new equipment available. Repeating coil equipment for line circuits associated with 22A2 repeaters is shown in Figure 3. Repeating coils are mounted on both sides of the panel, two being required for each circuit, but all the condensers

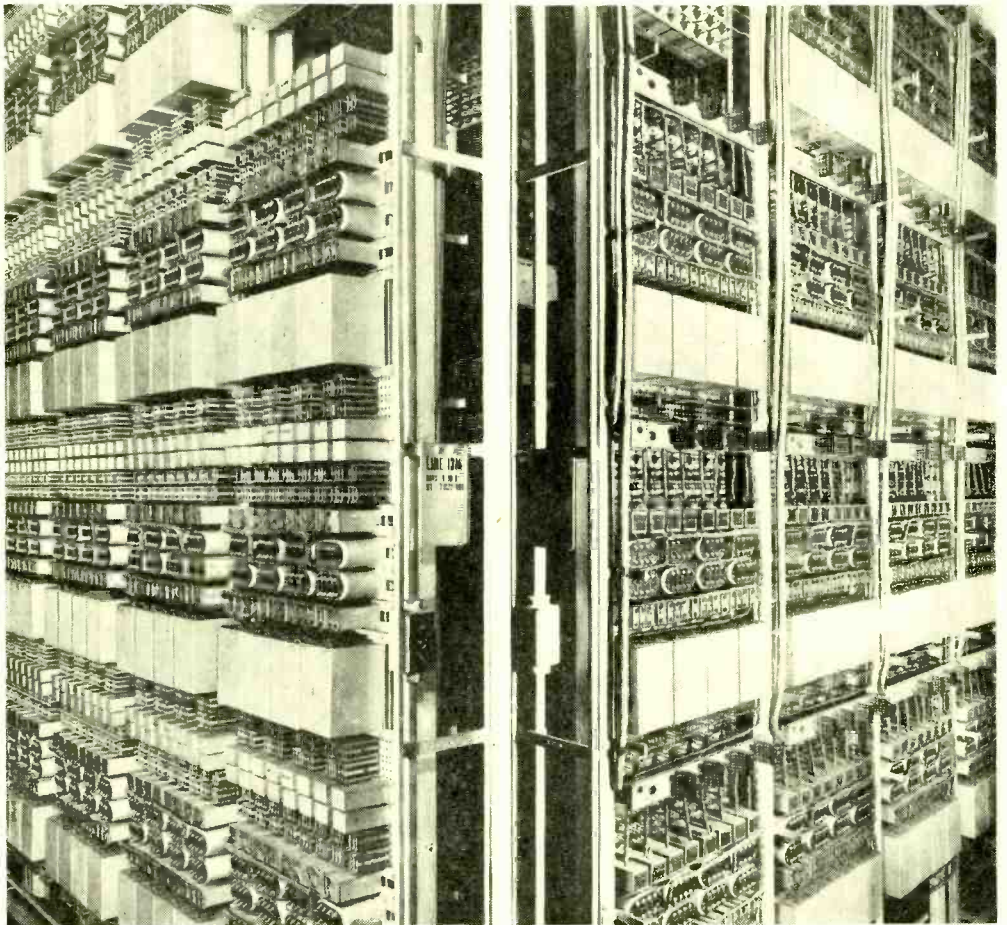

Fig. 3—Arrangement of line equipment for 22A2 repeater

and resistances are on one side. The three-dimensional wiring is evident here, as on the repeater panel. The balancing networks are all also mounted on both sides of the bay.

For the VI repeater, the line equipment is arranged as shown in the headpiece on page 352. The apparatus for each circuit is mounted in one vertical column. By the use of new designs and materials, the repeating coils, which serve also as hybrids, are

smaller and are wired from the rear, as is all the rest of the apparatus. This arrangement permits short vertical connecting leads down the back of each group. Resistances are fastened directly to the terminals of the repeating coils instead of requiring a separate panel. These various improvements, besides securing economies in cost and space, result in equipment that is much better looking, and more in harmony with modern design.



C. P. CARLSON spent the summer of 1925 in the Research Department, where he took part in investigations of vibrating systems. The following year he received the degree of B.S. in Electrical Engineering from the University of Michigan and joined the trial installations group of the Systems Development Department. In 1928 he transferred his activities to the development of toll systems equipment, particularly voice repeaters and associated signaling, line, and balancing equipment. Recently he has been chiefly concerned with equipment for the armed services.

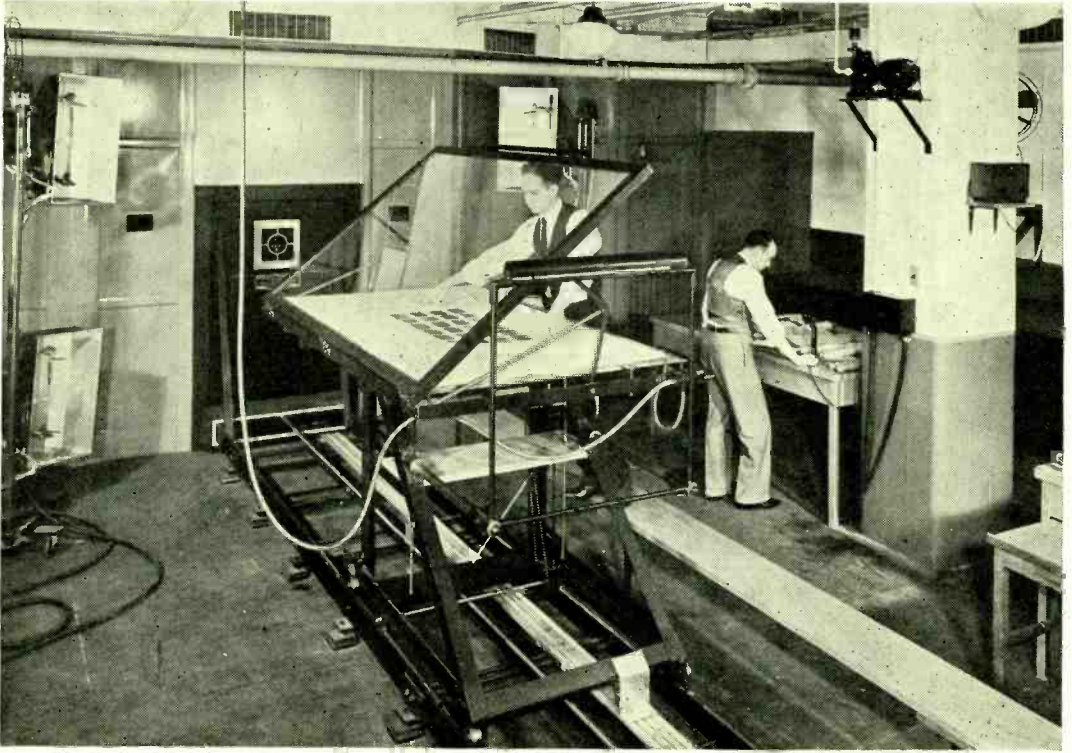

The Giant Camera

By RICHARD HAARD
General Service Department

THE largest camera of its kind in the country is in the Photocopy Department, making as many as 800 negatives a day. It was made to our specifications by the Rutherford Camera Company, and has one of the largest lenses of its kind in the country—a Goertz apochromat with a 72" focal length. The camera also has three other smaller lenses, and all four may be used interchangeably. With this camera a three-and-a-half-by-six-foot negative may be made as easily and quickly as an eight-by-ten. The camera is so large that the photographer works inside of it—in complete darkness except for a dim red light.

This new giant camera is the latest step in a steady evolution in drafting and reproducing methods. Tracings, which are the graphic records of every development made, are among the more important products of

the Laboratories. These tracings are expensive, frequently costing hundreds of dollars apiece, and if they were used for every blueprint made from them, their life would be greatly shortened by the heat from the printing and the necessary handling.

Methods of reducing the cost of tracings have been under almost continuous study.* One of the economies made some years ago was the use of pencil drawings, thus saving both the tracing cloth and the cost of inking. A pencil line, however, does not make a good reproduction when prints are made by transmitted light, as in the ordinary blueprinting method, and it was thus found desirable to photograph the tracings, and to print from the negatives rather than from the tracings themselves. Instead of photographing the tracing on film, however, a haloid paper is

*RECORD, Nov., 1927, p. 88; April, 1934, p. 238.

used, and prints are then made from these paper negatives, which are made more transparent by oiling.

Another advantage of photographing is that the material copied does not need to be on transparent paper. Marked-up blueprints or drawings on cardboard or any non-transparent material may be reproduced.

Until recently, the largest tracing that could be photographed without a special procedure was 30" x 40", while the new camera increases this maximum range to 42" x 72". This much greater length is particularly advantageous because many of our drawings are excessively long—at times reaching 45 feet—and the longer the section that may be copied at one time, the fewer will be the splices in the completed print.

The new camera consists of two rooms with the lenses mounted in a sliding panel in the separating wall, as shown in Figure 1. One is a dark room that has a giant "plate holder," called the "camera back," running on a track on the floor that extends through the wall carrying the lens, and into the "light" room. In this latter room, the easel

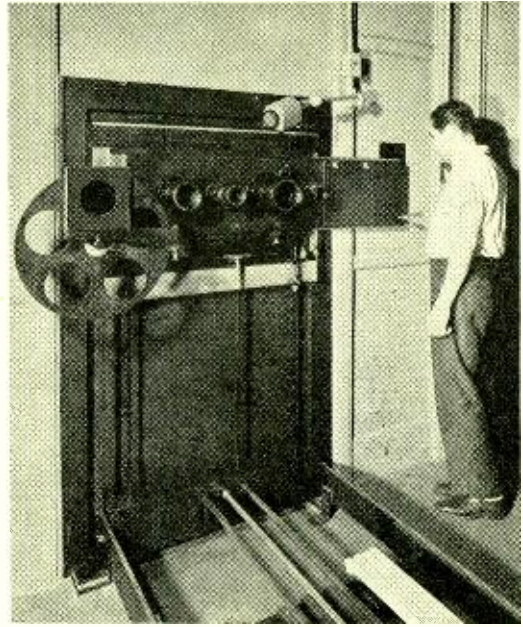

Fig. 1—The "Giant Camera" consists of two rooms with the lenses mounted in a sliding panel in the separating wall. The general arrangement of the rooms is shown below

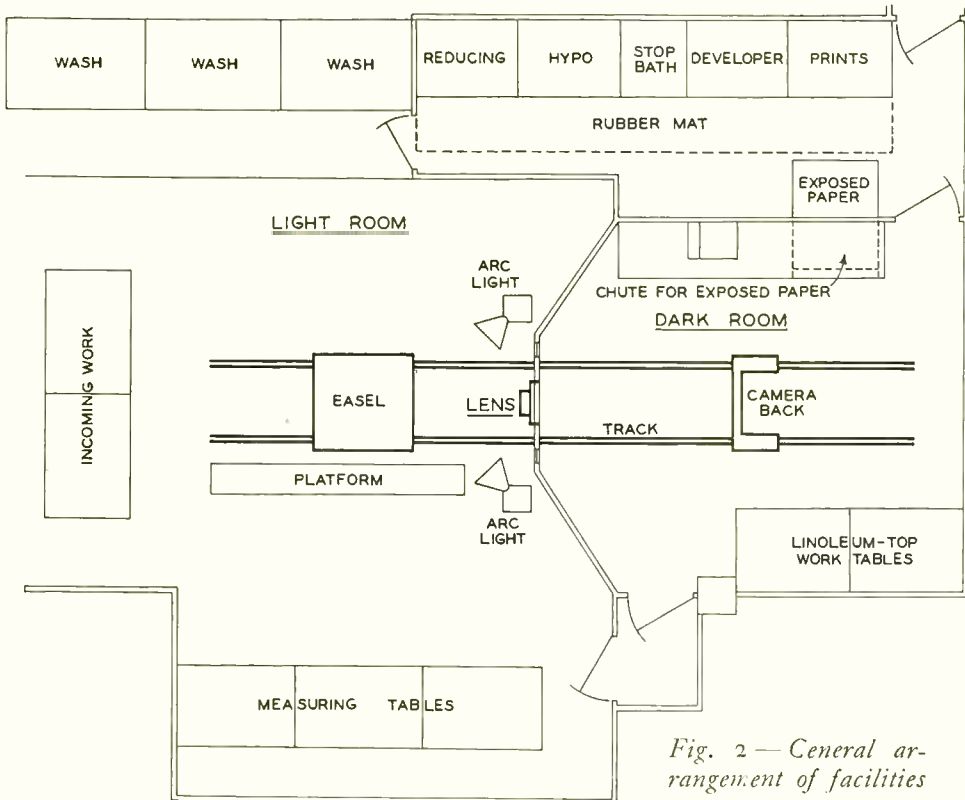

Fig. 2—General arrangement of facilities

that holds the tracing to be copied runs on a carriage on the same track. The general arrangement of these two rooms and of the adjacent developing and printing rooms is shown in Figure 2.

The easel that carries the tracing, shown in the photograph at the head of this article, is of the vacuum type. The flanged edges of the glass cover fit against rubber gaskets when the cover is lowered, and the vacuum which is then applied holds the drawing flat against the glass face of the easel so that all curves will be accurately reproduced. After this the easel, which is pivoted at the front edge of the carriage on which it rests, is tipped up into a vertical position. It is well balanced, and is equipped with piston devices that check its motion at the end of the swings so that tilting it up or turning it back is a simple and rapid procedure. Because of the height of the top of the easel carriage, which is half of the length of the easel above the track, a bench 2 feet high runs the entire length of the track to enable the operator to place the tracings on the

easel. Two powerful arc lights on each side of the track near the lens provide illumination.

The "camera back" in the dark room, as shown in Figure 3, is arranged for two widely different sizes of negatives. The vertical plate against which the paper is placed is perforated with fine holes, and a vacuum acting through them holds the paper flat. If the negative to be made is smaller than the perforated back, rubberized curtains are drawn from the top and bottom and from the two sides to block off all holes except those covered by the paper. The vertical bars, evident in Figure 3, right, control the two side curtains.

Four men form the normal operating crew of the camera. In the light room, a man at one of the work benches measures the drawing, and from the size of the print called for, calculates which of the four lenses should be used. Using a loud speaking telephone system interconnecting the dark and light rooms, he tells the operator in the dark room the results of his calculation. Four horizontal scales run the length of the tracks in

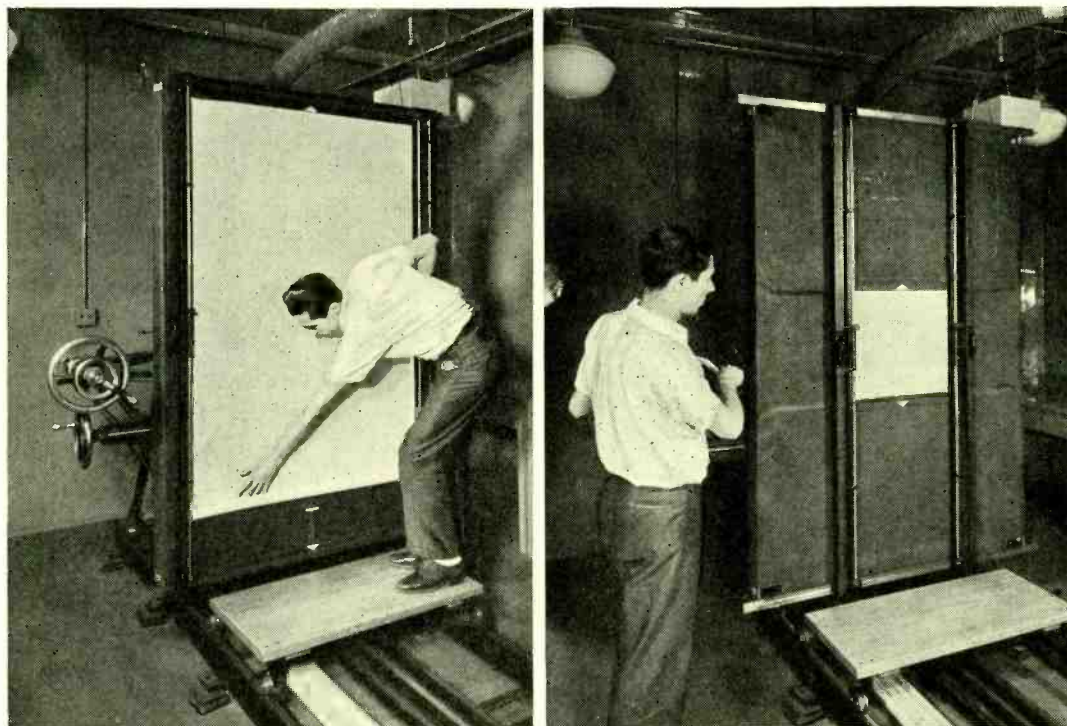

Fig. 3—Left, "camera back" arranged for full-size negative. Right, for smaller negatives, curtains are drawn as shown

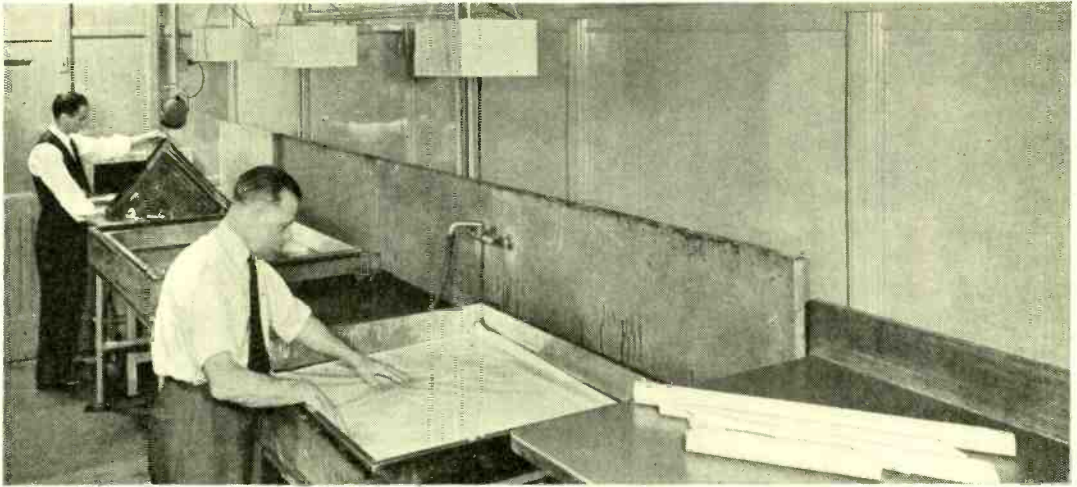

Fig. 4—In the developing room, the exposed negative is developed, washed and fixed

both rooms and are used in setting the positions of both easel and "camera back" in accordance with the size of the drawing and the amount of reduction required. One scale is marked for each lens. After the operator in the dark room has mounted the proper size paper on the "camera back" and selected the proper lens, he moves the "back" to the designated marking on the scale for that lens. In the meantime, another operator in the light room has placed the tracing in the

easel, tilted the easel up, and moved the carriage to the scale mark given him by the operator who has sized the drawing.

After the dark room operator has finished his operation, he looks through a small red glass window in the wall to the right of the lens, and as soon as he sees the easel is in place, he operates a switch that turns on the arc lights. He then rotates a filter into position in front of the lens to cut down all but a negligible amount of light, uncovers the



Fig. 5—After final washing, negatives are dried on the power-driven machine at the right and then passed through the oiling machine at left

lens, and looks at the faint image of the tracing on the sensitized paper. Using hand wheels at one side of the "camera back," he then shifts the vertical and horizontal position of the lens to properly center the image on the paper. Following this, he removes the deep filter, or replaces it with one that will best bring out the lines on the drawings, and makes the exposure. He stops the exposure by turning off the arc lights, which also acts as a signal to the operator to place the next tracing in the easel.

The dark room operator then removes his exposed paper and slides it through a chute to the adjacent developing room, Figure 4, where it is developed, washed, and fixed, and then placed on a glass-top under-lighted table for inspection. Any weak spots are

brushed with ferricyanide so that they will print stronger. The negative is then passed through another chute to the washing tanks in the outer room. After the washing period, the prints are dried on the power-driven drier shown at the right of Figure 5, and then passed through the oiling machine at the left. This spreads a thin film of oil on the back to make the paper more transparent, and thus to decrease the printing time. Any excess oil is then wiped off and the negative is ready for printing.

Besides this giant camera, the Photocopy Department also has a smaller camera of similar type, three photostat machines and a printing machine for making reproduced tracings. Over 20,000 negatives and prints are turned out in a typical month.

Civil Relief for Service Men

By W. C. TOOLE
Legal Department

SINCE as far-back as 1802 Congress has through its enactments recognized the need for relieving members of the armed forces from anxiety and annoyance respecting legal matters at home. Commencing with a law which prohibited arrest of soldiers for debts, the national legislature has from time to time enlarged upon the protective measures until at present a person entering the armed forces may do so with assurance that legal matters having to do with civil life will be taken care of until his return. Even the present law originally enacted in 1940 was improved upon by two amendments in 1942.

It is recognized that full cancellation of civil obligations would impose inequities not only on those left behind but also on those members of the armed forces who themselves are the creditors of others entering into the service of the nation. The protection afforded, in the main, therefore, is by way of suspension of liability rather than through the annulment of obligations and there is no intention to relieve anyone for all time from paying his just debts.

Following is an outline of some of the principal provisions for civil relief.

PERSONS TO WHOM BENEFITS ARE APPLICABLE

The benefits apply to all members of the Army of the United States, the United States Navy, the Marine Corps, the Coast Guard, Waacs, Waves, Spars, Women Marines, and all officers of the Public Health Service detailed for duty with the Army or the Navy.

PROTECTION OF PROPERTY NOT FULLY PAID FOR

If a service man is buying real or personal property, such as a home or furniture or an automobile, under an installment contract, and is not able to keep up his payments, the judge who hears the case is permitted several courses of action. He may order a stay until after the war, or order a contract terminated with repayment to the buyer of a fair part of the installments. In case the home is owned subject to a mortgage he may similarly stay foreclosure proceedings or make some fair arrangement to conserve the interests of those concerned. And of course he may order any property seized or foreclosed if he finds that the ability of the purchaser to meet his debts has not been materially affected by his military service.

Taxes on real estate unpaid at the time of the home owner's entry into service, or which become due thereafter, will ordinarily be allowed by the court to run until after the war, with interest at 6% a year provided the property is still occupied by the service man's dependents or employees. Should permission to sell be given by the court, the owner can redeem the property within six months after his return from service by paying the taxes plus interest.

TERMINATION OF LEASES

A person entering the armed forces may terminate a lease previously signed for an apartment or a house occupied by him or his dependents. This is done either by handing a written notice to the landlord or by mailing the notice to him. However, the termination of a lease providing for monthly rental payments cannot be made effective until thirty days after the next rental payment is due. In the case of other leases, the termination becomes effective on the last day of the month following the month in which the notice is given.

EVICION OF DEPENDENTS

During the time a person is in the armed forces his wife or other dependents may get behind in their rent. If this happens and the rent is \$80 a month or less the landlord will not be permitted to evict them without a special court hearing. The judge may allow as long as three months for the making of some new arrangement for a place to live.

PERSONAL OBLIGATIONS

When a person in the armed forces is involved in any court matter the judge may postpone the proceedings or any execution or order and also may vacate or stay any attachment or garnishment. The stay may be until three months after the return to civil life; this subject to such terms as may be just, whether as to payment in installments of such amounts and at such times as the judge may fix or otherwise.

LIFE INSURANCE POLICIES

Some life insurance policies specify that the holder is not covered while engaging in

certain military activities. All other policies may be kept in force up to \$10,000, with approval, in every case, by the Administrator of Veterans' Affairs, through a suspension of premium payments to which the companies are required to assent. If the policy matures as a death claim or otherwise, the insurance company is to deduct from the amount of insurance the unpaid premium plus interest.

If at the end of the period to which the arrangement applies the cash surrender value of the policy is less than the unpaid premium and interest, the Government will pay the difference to the insurance company and will then look to the insured person for reimbursement of the amount involved.

INCOME TAXES

Members of the armed forces have until six months after coming back to civil life to pay their Federal or New York State income taxes if they file with their returns evidence that their ability to pay earlier is materially impaired due to being in service. Those who are outside of the United States are not required to file any Federal returns until the 15th day of the third month after they come back to this country. All except commissioned officers are permitted, in preparing their Federal returns, to deduct from their gross income their regular exemptions, and in addition, the pay they receive from the Government up to \$250.00 if single; up to \$300.00 if married. Family status for such purpose is as of the end of the taxable year. Pay that is received from the Government is totally exempt from the New York State income tax regardless of the recipient's rank in the armed forces.

CONCLUSION

While in the ways above indicated persons in the armed services are to have their legal matters held in abeyance, nevertheless, when the war is over they will be required to meet their suspended obligations. Meanwhile, in the event of difficulty, they should consult members of the legal profession wherever possible for advice or assistance in lessening anxiety during the period of service and the burden to be carried upon return to civil life.

RADAR

(Text of a statement, cleared by Army and Navy, and issued by Western Electric Company for the information of its employees)

RADAR, until now more zealously cloaked in secrecy than the Norden bombsight, has been officially revealed to be one of the foremost scientific developments of the war.

Not even a rumor of its existence had been allowed to reach the public, until the War Department announced the astounding ability of radar to discover targets invisible because of darkness, smoke or clouds, and then to provide data for guns to direct an exact fire pattern on such targets at the maximum reach of the largest known guns.

A military miracle maker, radar is the code name for "radio detecting and ranging." It is an electronic instrument which projects a beam of radio impulses through space at the rate of 186,000 miles a second and, in much the same manner as the beam of a powerful searchlight discloses the location of a signboard at night, these impulses reveal the presence of distant objects such as airplanes, submarines, and battleships by rebounding to the observer. Here a cathode

tube acts as an interpreter and makes these electronic signals visible to the human eye.

When trained on enemy planes, still so distant as to be beyond reach of anti-aircraft, radar reports the three elements of their position necessary for exact plotting (1) distance, (2) angle of elevation, (3) angle of azimuth. When the planes are within firing range, these data are then used to predict the precise point where shells should burst.

Unaffected by darkness, clouds or fog, radar is an infallible sentinel, a deadly gunner, and is now placed on U. S. Naval ships and other craft, as well as on fighting fronts, to warn of approaching enemy aerial or seaborne units. Credited by Lord Beaverbrook with winning the Battle of Britain, radar, in the South Pacific, has been responsible for enemy losses of millions of dollars' worth of ships, planes and submarines.

Radar was developed on the basis of years of research and experiment in electronics, independently in the United States and Great Britain. Credit for the development



Five years ago, these horns were used with the absolute altimeter in experimental observation of ships passing through the Narrows

must be shared by many of the foremost scientists of the two nations, both civil and military. In the United States the research institutions of both the Navy and the Army were vigorously pursuing investigations leading to the perfection of radar as a military instrument. Leaders in these investigations were Dr. A. H. Taylor for the Navy and Major General Roger B. Colton for the Army. More than two years before Pearl Harbor the Army and the Navy enlisted the services of Bell Telephone Laboratories which had already embarked independently on researches in radio location, and the Laboratories' fundamental work in radio transmission over a period of many years has contributed substantially to Western Electric's leadership in this field.

The fact that radio waves can be reflected just as light waves and sound waves had long been known and the phenomenon had been used, for example, to measure the electrical reflecting surface in the upper atmospheric layers known as the ionosphere, just as mariners sometimes use an echo of the ship's whistle to establish their distance from the face of a cliff. Only with the advent of the ultra-short radio waves in the early 1930's did it become possible to observe reflections from objects as small as an airplane. This was done in 1932 when engineers observed that an airplane flying about 1,500 feet overhead produced a noticeable "flutter" of about four cycles per second.

In 1938 Western Electric introduced the absolute altimeter commercially for use in aircraft. This instrument, based on development work by Lloyd Espenschied and R. C. Newhouse which began several years before, employed the principle of shooting radio waves against the ground and timing their return to give the exact height of an aircraft above the terrain. In the same year, D. K. Martin, also of the Laboratories, using a modification of the absolute altimeter enclosed in a hornlike directional antenna system of galvanized sheet iron, made a series of experiments at 15th Street in Brooklyn overlooking the Narrows leading into Manhattan's upper bay. He observed that radio waves directed against ships passing through the Narrows were thrown back into the receivers. This might be called a form of radar.

With the formation of the National Defense Research Committee, radar became one of the most active lines of investigation by a large group of scientists. A mission of British scientists to this country made a complete disclosure of the status of their art, with reciprocal disclosures by the N.D.R.C. group. One episode in the development was the sending to England in 1941 of Ralph Bown to study performance under actual war conditions.

Still in limited use in the U. S. Armed Forces when America entered the war, radar is now standard equipment for both Army and Navy. An official statement says of it, "radar is used by static ground defenses to provide data for anti-aircraft guns for use in smashing Axis planes through cloud cover, and by airplanes and warships."

Radar operators in the Armed Forces are trained technicians, able to install and maintain, as well as operate, the apparatus. To assist in the training of a sufficient number of these technicians to man the equipments coming off assembly lines, the Laboratories has set up a School for War Training, staffed by its engineers and using instructional material which they have prepared.

In addition to manufacturing radar in quantity for the Armed Forces, the Western Electric Company has assigned a large number of radar engineers to act in an advisory capacity in the field.

IMPROVED TELEPHONE SERVICE FOR SERVICEMEN

To afford the best telephone facilities to our Armed Forces, the Bell System installed many more attended public telephone locations in military and naval establishments from August, 1942, to April, 1943, bringing the number to 138, with plans definitely made for 78 more.

Besides the increased number of attended locations in military and naval establishments, 129 public telephone locations operated by attendants were also recently installed in railroad and bus terminals, in USO and Servicemen's Clubs and in other locations where servicemen gather. Plans for 19 more stations at such locations have been made to give the kind of telephone service the boys require.



WELCOME INCOMING CLASS OF WAR TRAINING SCHOOL

Three hundred officers and enlisted men in three service branches of the Army, entering courses in the Laboratories' School for War Training to study latest types of radio equipment and electronic devices developed for war uses, were welcomed at a dinner held on April 13. Among the guests of honor were prominent officers of the Army and officials of Western Electric and the Laboratories.

In the picture at the head of this page appear, left to right—Brigadier General W. T. Larsen, Army Air Forces, Anti-Submarine Command; R. K. Honaman, Director of the School for War Training; Colonel W. S. Morris, Chief of Schools Branch, Training Division, Army Service Forces; Dr. O. E. Buckley, President of the Laboratories; and Colonel John G. Booton, Ordnance Officer, Eastern Defense Command and First Army. Bottom, left to right—Lieutenant Colonel M. W. Kendall, in charge of Ordnance Training, British War Office, London; C. R. Smith, Acting Manager, Radio Division, Western Electric Company; Colonel L. H. Watkins, Commanding Officer, Training and Operations, Second

Service Command; and C. G. Stoll, President, Western Electric Company. In addition to the persons appearing above there were also at the guest table: W. F. Hosford, Vice-President, Western Electric Company; Lieutenant Colonel J. J. R. Weiss, Army Air Forces, Technical Training Command; Major A. G. MacAlister, Military Training Branch, Signal Troop Division, Office of the Chief Signal Officer; and J. S. Ward, Government Contract Service, Western Electric Company.

WATCH YOUR TIRES

This is what OPA tells its tire inspectors to look for. You can look too; and if you look now instead of waiting for the next compulsory inspection, you may save a tire.

The point at which a tire can be most economically recapped is when the tire is worn smooth approximately $\frac{3}{4}$ of the total width of the tread, and not beyond the point when there still remains $\frac{1}{8}$ in. of tread rubber above the breaker strip or outside ply of cord.

A tire can be recapped, provided it has not been worn through more than the breaker plies and two body plies of cord



fabric for a total length of not more than four inches in a truck-type tire, or worn through two body plies (truck-type tire) or one body ply (passenger-type tire) for a total length of not more than four inches on a tire which does not have breaker plies, provided the tire is otherwise in good condition. These represent the extreme points of allowable wear beyond which a tire should not be driven unless recapped.

A tire can be repaired provided it does not require more than three sectional repairs and the break or cut is not longer than one-half the width of the cross-section of the tire, and the injury is not below the point where the side wall of the tire contacts the top of the rim flange. Oftentimes one or two sectional repairs will be the practical limit beyond which repairs should not be made.

A tire cannot be repaired or recapped if it has ply separation; has broken or exposed bead wires; has failed at the bead reinforcement plies; or has fabric separations of the inside plies.

—*Quoted from OPA Tire Inspectors' Manual, issue of January 20, 1943.*

F. R. LACK VICE-PRESIDENT OF WESTERN ELECTRIC

Frederick R. Lack, on May 11, was elected a vice-president of the Western Electric Company, the office he resigned last November to become Director of the Army and Navy Electronics Procurement Agency with offices in Washington. He will now resume the direction of Western Electric's Radio Division in New York.

Mr. Lack entered Western Electric in 1911 as an assembler. Following his Signal Corps service in France during World War I he was assigned to development work in radio telephony. Later he supervised the installation of a radio telephone link between Peking and Tientsin.

For several years a member of Bell Telephone Laboratories, Mr. Lack engaged at first in studies preliminary to the short



F. R. LACK

wave transatlantic radio. As a part of these studies he carried on a research program on the use of piezo-electric crystals in radio frequency generators. This work led to the use of quartz crystal oscillators in the transatlantic radio, broadcasting, and aviation, police, and marine radio. During this phase of Mr. Lack's career he also had charge of designing and building the ship equipment for the Bell System's first commercial installation of ship-to-shore radio telephone on the *Leviathan*.

In charge of vacuum-tube development from 1935 to 1939, when he became manager of Western Electric's Specialty Products Division, Mr. Lack directed the engineering of tubes for use on ultra-high-frequency radio and for high-power operations fundamental to the manifold applications of radio in war operations.

SECOND WAR LOAN DRIVE

Members of the Laboratories purchased more than \$193,950 face value of War Savings Bonds (with a quota of \$168,000) during the drive which was completed on May 1. A total of \$107,550 of "E" bonds were issued by the Treasurer and \$10,750 of bonds of other series delivered. Members of the Laboratories reported by serial number purchases outside of \$65,850 of "E" bonds and \$9,850 of other types. These bonds were in excess of those being currently purchased by payroll allotments. Approximately 1,420 participated, buying 1,930 bonds.

In addition there were many cases where bonds were purchased outside the Laboratories but the serial numbers were not reported. These were not included in the total. From the original promises, it is estimated that at least \$20,000 of bonds were so purchased but not reported.

The original bulletin board notice gave the conclusion of the bond drive as of May 13. During the first thirteen days of May, 196 members bought an additional \$25,650 of bonds above payroll allotment, making a grand total for the drive of \$219,600.

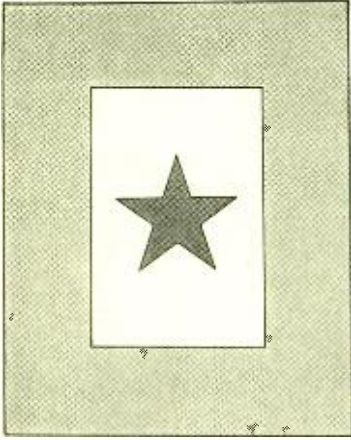

In the Nation's Service

As of April 30 there were 496 members of the Laboratories on military leaves of absence. These men and women are divided among the various services as follows:

Navy, Marines and Coast Guard 135

Army 343 Waves 13 Waacs 5

Major Robert L. Kaylor

MAJOR R. L. KAYLOR of Transmission Engineering, describing how our planes downed Jap Zeros in battle as a "seven-ring circus," is quoted by United Press as saying:

"Wherever I looked I could see dog-fights—planes dashing into our ack-ack and through low clouds. Most of our planes were on their way into the air for action at the time. I saw two Jap planes emerge from a dog fight and run like hell for the horizon."

The dispatch from an Advanced Air Base in the South Pacific on April 10 told how American P38 Lightning pilots turned to their own use a tactical trick which has been exploited by Jap Zero pilots, and by it defeated the Japanese raid on shipping in the Guadalcanal-Tulagi area. Four of the Lightnings shot down seven of the 11 Zeros at 35,000 feet by outclimbing the enemy and then doubling back on the Zeros' tails when they had reached their stalling height. The other four Zeros fled back at 25,000 feet where they were destroyed by Grumman Wildcats. The action was one in which the Japs lost 34 of their 98 attacking planes.

Florence Lutgen

FLORENCE LUTGEN, one of the first fifteen Aerographers graduated by the Waves, is now a Third-Class Petty Officer. After studying map analysis, meteorology, instruments and codes at Lakehurst, she has been assigned as aerographer's mate at the Naval Lighter-than-Air Base, Glynco, Georgia, where she will encode and decode weather messages, collect data, observe clouds, and help make weather maps.

Lieut. Commander Rodman de Kay

"My ship, a destroyer escort, will be in commission before the middle of this month. She takes the name of a ship sunk some time ago while attempting to help one of our carriers after she was damaged."

George Galbavy

"From the time I left Fort Monmouth until our boat landed in Australia I shed twenty pounds. However, I've managed to regain the lost weight in the form of hard muscle, due to the abundance of dairy products and other good foods here. Our boat trip was rather tense but uneventful. Perhaps you are wondering why most of my letters are typewritten. I've tried pen and ink but it is so hot here that perspiration usually blurs my writing. The sun is so strong that a good pair of sun glasses is absolutely necessary. I am keeping my hair cut to a quarter of an inch all over because of the excessive heat. One favorable thing



MAJOR R. L. KAYLOR

AUSTIN SUNESON



WALTER BACHMANN

NICHOLAS BRADY

about the climate is that the nights are cool, fortunately, for sleeping. Traveling around so much, I've picked up a few tips that would make a traveling salesman envious. But when I get back to the States I shall be thankful to 'stay put' at the Labs. Believe me, I've seen all of the world I care to see."

Walter Sokolsky

"The first day that I put on my dress uniform was the day that I began to like the Army. We wear our dress uniforms to attend the lowering of the flag and also the company's colors. It is the proudest moment in a man's life when he marches with thousands of his buddies to the flag lowering. Bands are playing the "Star-Spangled Banner," we salute the flag, then stand at attention as the flag is lowered. The bands play on and lead us for a march around the field. It sort of does something to you which is hard to express."

From the South Pacific

"We have had a number of air raids—and find them not at all as I had imagined. The siren will blow and wake us up; I'll get my clothes on and either lie down on the floor and go to sleep again or, if the mosquitoes are too bad, crawl in under my mosquito bar and go to sleep there. Then after perhaps a half hour the all-clear sounds, we undress and go to bed again; or maybe Tojo really comes over, and the ack-ack wakes us up. Then

we rush outside to see the fun. Sometimes it really is fun, until they get about right overhead; then we tighten our steel helmets and duck into a slit trench, mostly to get out of the way of dropping shell fragments. We have found some around occasionally after a raid, although nobody has been hit by one and probably won't be.

"Once three Japs were caught early by the several searchlights and followed until they were out of our sight. I think one was shot down, although he was still staggering along when he got out of our sight. Two or three times in the five months I have been here we have heard a swish-swish-swish as bombs were falling; for a minute we were scared, and ducked fast, but the very closest they came was over half a mile away from where I was at the time. We regard it as rather mild and diverting excitement, and there is really very little danger. You see, in bombing at night with a big area all around, a bomb would have to be pretty darn good to hit any little slit trench—Bill Spahn would probably give us a probability figure something like '1 in 10 to the thirty-fifth.'

"Good on ya Yank for writing, Fair Dinkum, Cheerio, A Labs man at the Front."

Joseph F. Daly

"The RECORD has been a priceless jewel in entertainment and technical reference. . . . I have been promoted from a Technical to a Master Sergeant. . . . I hope in the near



George Galbavy (left) and his captain check over their equipment, salvage the still usable parts and make needed equipment from old parts somewhere in Australia

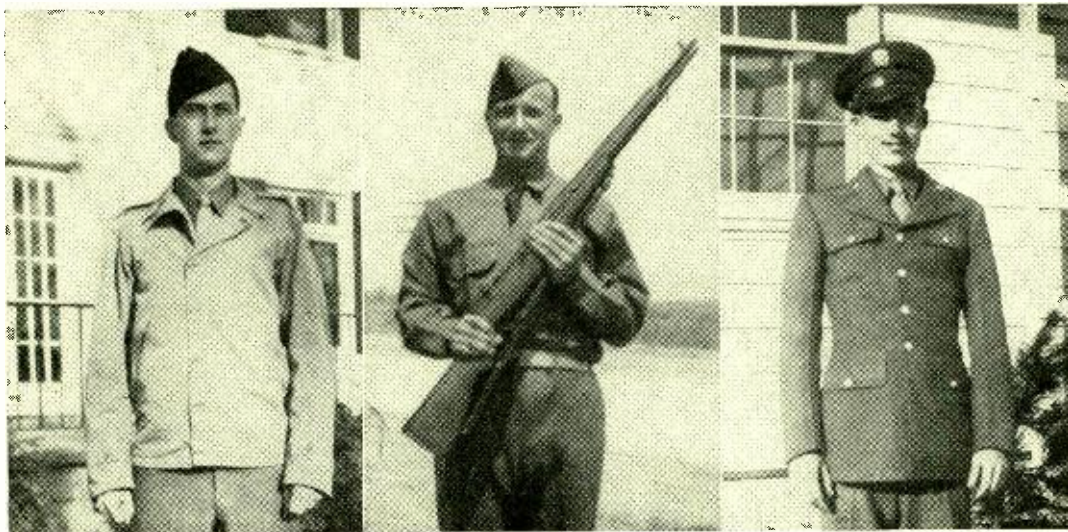

RALPH A. BENSON

LIEUT. C. J. McDONALD

JOHN J. LORDAN

future to be able to send a fair description of my new station. So far this island compares with the islands of the Southwest Pacific."

Lieut. Robert J. Koechlin

LIEUT. KOECHLIN has moved up to the front battle lines in the active South Pacific theater of war. A Ranger leader, he has been especially trained with his men in swift-moving, hard-hitting commando tactics on Hawaii for the past six months. Obstacle courses, long hard hikes over mountains and boat landings were part of the job; learning to slice off a Jap's head with one

swish of a knife, or to spin it and gore a Jap at six paces was another. "A bloody, bruising business," Bob wrote, "but I'll be the better warrior for it." Meanwhile he has been sweating out another set of bars, though he thinks that's a secret. An Infantryman, Bob trained at Fort Bragg; was shipped immediately with one of the first American garrisons to the British West Indies where he proved himself; after eight months he returned to Fort Benning and was commissioned. He was married at Benning and stationed there for a short time. Later, after a ten-day leave, he was assigned to

MEMBERS OF THE LABORATORIES GRANTED LEAVES OF ABSENCE TO ENTER MILITARY SERVICE SINCE THOSE REPORTED LAST MONTH

UNITED STATES ARMY

Edward H. Bueb
Philip P. Crowe
Marshall S. Glaab
Charles S. Graham
Patrick Harrington
Henry G. Hohner

John H. Isleib
Robert E. Komuves
Matthew J. Marra
George J. McArdle
John O. Olesko
Helen L. Olin

Arthur T. Olsson
Robert W. Search
Charles R. Storin
George E. Tirone, Jr.
Philip A. Walz
Richard C. Williams

UNITED STATES NAVY

Henry Algarin
Helen Anisko
Irene M. Bier

Jean S. Brewer
Carmen D'Amico
Elizabeth A. Fitzsimmons

Arthur V. Frolic
Edward O. Fuchs
Evelyn R. Josd

UNITED STATES MARINES

Bernard C. Guinter

Robert R. Stephens

Hawaii. Although Bob did not mention it in his letter, we understand that he has received a commendation for bravery.

Wilson Taylor

"It was a surprise to get a Christmas card in the mail today, March 4, but I was happy to get it from you folks because I had thought you had forgotten me, since I am now in Africa. Are there any of the other fellows over here? If so, let me know the addresses and I will look them up. I sure would appreciate having someone write to me and will promise to answer any letters I get. I would give a lot for one of the meals you folks serve there and hope to have plenty when I get back." (*Wilson was in the Restaurant.*)

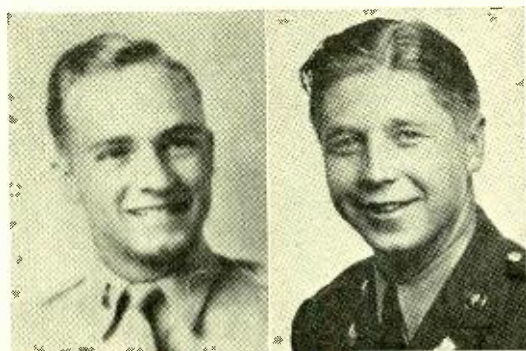

LIEUT. R. J. KOECHLIN HERBERT W. HALL

Joseph Ceonzo

"Bob, take it from me, don't be afraid of the draft. This military life is the nuts. I'm in the best condition possible. It means nothing to run a mile. We get swell food and plenty of it. My shipmates are top notch. I'm seriously thinking of switching to the regulars and staying in the Navy after the war. Now, don't think I'm a recruiting officer, but when you go in, don't begrudge your fate. Just take everything in stride. Some lecture, eh what?" (*Robert Henneberg took his advice and joined.*)

Lieut. Charles J. McDonald

"I am writing from our mess hall surrounded by a violent crap game. This sleeping in the open and good solid food make me feel good. My mail is starting to reach me here in Australia and it certainly

June 1943



PETER V. LODATO JOHN P. HOULIHAN

helps to ease my mind and that lonely feeling in my heart. What's new at the Labs? I certainly miss Basement B and the gang; I can't wait for the day to come when I can get back. Tell Goebel that the sound of his melodious voice would sound like sweet canaries to me now. Ask the boys to support the Red Cross. They're doing a wonderful job right up to the front lines."

Gordon Taylor

"One afternoon last week we went over to the pressure tank; stripped to the waist; climbed in and sat on the benches along the sides of the tank. The pressure was built up slowly to fifty pounds per square inch. Several fellows had to get out, but on the whole it wasn't bad. The pressure was let down and that was all for the afternoon. Next morning we went to the tank again and were given a short lecture on the use of the Monson Lung. We went down twelve feet in a bell; we did that twice. Then we made two escapes from a lock at eighteen feet, and two

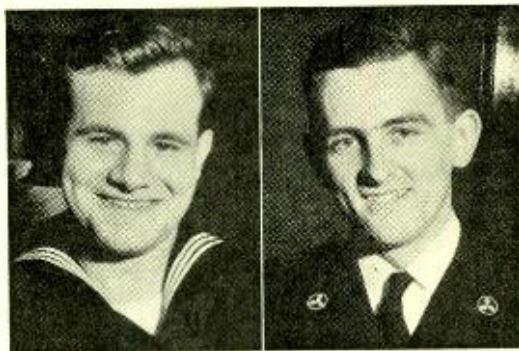

JOSEPH A. CEONZO RUSSELL L. VALENTINE

369

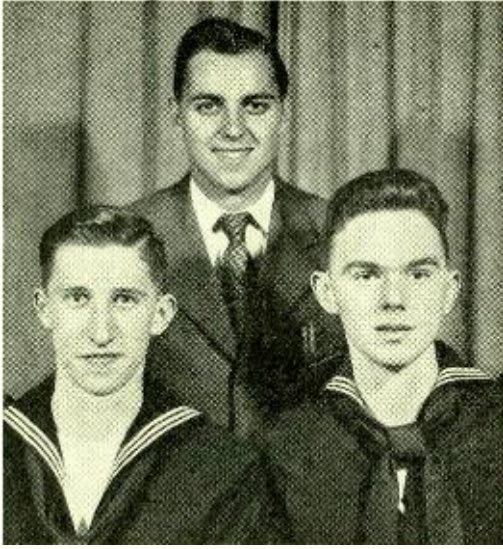

ALBERT L. VABULAS
ROBERT H. FUNCK HARRY B. COMPTON

more escapes at fifty feet." (*Gordon is at the New London Submarine Base.*)

Peter E. O'Donnell

"Early in February of this year after I received my shipping orders, I left the States from the port of embarkation at New Orleans and arrived safely at my point of destination several weeks ago. I am attached to a Finance Office, U. S. Army, working in the Officer's Pay Section. My quarters are very comfortable and the meals are exceptionally good. As I am in a tropical climate, swimming, tennis and baseball are the popular sports."

Robert Cordell

"One of the men in the Army Finance Office and I went to the big city after working hours to do window shopping. The town is very different from any in the States. The houses are all the same and look more like barracks than anything else. There is one main street and all the stores are there. Natives call all the soldiers 'Charlie.' I believe the only English the children know is 'Moneys Charlie.' Today being Sunday, I went to church as usual. The sermon was rather short, but it is nearing Easter and I can remember the Easter sermons from back home. I remember the choir back in

the Baptist Temple and all the Easter music they had. Here we sing about five hymns during the service and I enjoy that very much. My old cracked voice hasn't improved any but I like to sing just the same." (*Bob used to deliver our pay checks, remember?*)

Donald Cuneo

DONALD CUNEO, formerly of our machine shop at 32 Sixth Avenue, now has the opportunity of meeting fliers who return for advanced training from Guadalcanal, Alaska and Africa to his station, the Naval gunnery base at St. Simon's Island, Georgia. As plane captain it is Donald's job to make planes ready for target practice, to repair them, and when necessary to make parts needed. During tryouts he manages to get in a lot of flying which he likes.

* * * * *

PERSONAL LEAVES of absence have been granted to BERTRAND H. SOMMER and JOHN T. TRAVERS to enter the Merchant Marine.

HERMAN A. LARLEE, who has been on a personal leave of absence for civilian service with the Signal Corps, returned to the Laboratories on April 2.

CHARLES VOSS, on a visit to Research Drafting recently from Bowman Field, Kentucky: "I'm taking a Radio Operators course at the TWA School. I found that my training at the Labs was a great help in giving me background for my work here."

HERBERT W. HALL, a former member of the Laboratories, is an armorer with the Air Corps at Roswell, N. M., where he maintains bomber racks in planes.



LIEUT. C. R. SCHRAMM ENSIGN F. ELSTEIN



LIEUT. E. WALSMAN ROBERT R. CORDELL

HARRY COMPTON, ALBERT VABULAS and ROBERT FUNCK of Systems Drafting all visited their old gang on the same day. Compton, a radioman, has been sent to Portland, Oregon; Vabulas, aviation cadet, to Chapel Hill, North Carolina; and Funck, fire watch, to Great Lakes.

PROMOTION OF CAPTAIN DAVID F. CICOLELLA to the rank of Major was announced recently by the Army Air Forces School of Applied Tactics, Orlando, Fla.

ROBERT BURNS, in the Air Corps at Miami, "I hope you guys and gals are buying war bonds. Even the soldiers here buy 100% (i.e. 10% are bought by every squadron). Maybe it's because if you don't subscribe they call you out in front of the whole squadron and ask why. (Such salesmanship.)"

GREGORY CHABRA, now at Syracuse Army Air Base, "Well at last I'm flying! It certainly feels good. I think perhaps I will change my mind about becoming a pilot. Since I've been in the Air Corps, I've heard lectures and seen movies that have convinced me, along with the majority of other students, that the navigator is really kingpin of the plane. So navigation's my choice."

JOHN BOYLE, writing from Navy Pre-Flight School, Athens, Ga., "It takes very little to satisfy a fellow in the service. I believe all a fellow needs is some good chow and

a few letters from his friends at home."

MARIE KEOUGH, a yeoman in the Waves, is at the Naval Training School in Mill-edgeville, Georgia.

MAJOR WARD ST. CLAIR of the Signal Corps, now in Philadelphia, is associated with the Plant Engineering Agency.

A GROUP of Laboratories boys, including FRED SCHWETJE, DAVID GREENHAGEN and THOMAS PEPE are stationed at the Naval Pre-Flight School, Chapel Hill, N. C.

ROBERT FLINN, having been placed in Communications, hopes to get more radio training. "At Camp Hood we learn to 'Seek, Strike and Destroy' any and every enemy tank, using anything from our regular weapons to our fingernails. Our regular weapons are mainly 'Bazookas,' the 'half-track' and the 'M-10', all able to completely destroy a tank with a single hit. And, of course, we have special side weapons and equipment."

WALTER FARNHAM is studying at Airplane Mechanics School at Sheppard Field.

MAJOR K. O. THORP has been assigned as Army Air Forces Resident Representative at Consolidated Vultee Aircraft Corporation, Nashville, Tenn.

LIEUT. STEPHEN DUMA, in the U. S. Marine Corps at Quonset Point, R. I., now taking a six-month course leading to a Radar Specialist, "Upon completion of this



Ruth Robinson, who handles military matters for the Benefit Department, is giving Frank Wanits, home on furlough, his 1942 statement of earnings

training, my duties involve test flying various types of aircraft employing Radar and some experimental work on Radar in the Laboratory. Flying over New York on one of my flights, I felt slightly homesick when I saw BTL again. If I ever fly a helicopter I'll drop in to say hello."

MORGAN F. HICKEY has been promoted to sergeant in a Military Police Company at Augusta, Georgia.

CARL SMEDBERG at Camp Barry, Great Lakes, is guarding an anti-aircraft unit. "It's my duty to keep all people not connected with the guns away. The apprentice seamen are learning how to use the guns. If any of them should do the wrong thing all of us would go sky high."

PETER LODATO is at Miami Beach. "As for the training itself, I find it very interesting. Everything in the Army seems to tend to develop more coöperative and unselfish individuals. It also teaches you to be a self-reliant individual. One thing impressed upon you is that the more we grasp in our training, the better are our chances of coming back."

FRANK C. WANITS called in to see his friends in the 4-C Shop before taking up his assignment in San Diego. Frank studied Diesel engines at the University of Missouri, and is now a Second-Class Petty Officer.

ENSIGN FRANCES ELSTEIN, commissioned at Northampton, Mass., on March 9, was formerly a Mathematical Assistant in the Circuit Research Department before joining the Waves. One of the eight in a class of 450, Frances has been assigned to a nine-months' course of study in Aerological Engineering at U.C.L.A.

Others from whom cards or letters have been received include:

J. deG. Cuyler, A. C. Reynell, J. C. Applegate, P. L. Hollod, W. R. Grant, W. B. Adam, C. H. Dalm, F. R. Hulley, F. R. Hanlon, A. M. Kurutz, W. P. Knox, J. R. Walsh, E. N. Riker, E. J. Burns, W. V. Hoshowsky, W. J. Conner, Carole M. Finch, Austin Suneson, Benjamin Maksym, Charles Muccio, R. C. Benkert, S. Fronczak, Philip Watts, H. J. Geisler;

Lieut. Everett Walsman, R. A. Benson, W. L. Farmer, W. M. Prall, L. M. Nielsen, J. M. O'Neill, R. D. Horne, J. J. Lordan, P. W. Foy, H. J. Brown, R. A. Hauslen, W. P. Harnack, Jr., R. C. Shopland, C. H. Matthews, W. R. O'Neill, T. J. O'Neill, Lieut. D. F. Tuttle, Nicholas Brady;

R. J. Drout, Thomas Fox, A. E. Lawson, Major Emil Alisch, E. A. Steppuhn, J. C. Stuhlman, R. H. Koehn, R. C. Fiala, T. B. Horton, H. E. Manke, Herbert Baker, E. A. Lichtenberger, C. E. Greene, J. T. Grissom, A. F. Bartinelli, T. J. Gilcrest, E. J. Filipovits, H. W. Raimert, Lieut. C. M. Redding, D. J. Brady, F. W. Starzer, G. G. Bailey, E. A. Hulst, J. V. Cunningham and W. A. Farnham.

MAY SERVICE ANNIVERSARIES OF MEMBERS OF THE LABORATORIES*

Research Department

C. W. Anderson—15 John Fierst—20
M. A. Collins—15 H. R. Jeffcoatt—25
Lawrence Ferguson—20 R. W. Widman—10

Systems Development Department

T. V. Borlund—20 Joseph Irish—40
Betty D. Brennan—15 Louise Jentschke—25
C. O. Cross—30 Catherine Lennon—20
Janet Dein—20 Ruth D. Leonard—15
James G. Ferguson—20 H. L. Mueller—25
F. T. Forster—20 R. B. Schanck—30
C. J. Yunger—15

General Accounting Department

H. H. Bogart—25 Mignonette Krieger—20
C. J. Gallon—25 J. S. McDonough—25
Harry Gessner—25 Gladys F. Paret—20

Apparatus Development Department

S. G. Hale—15 A. C. Millard—25
E. W. Holman—15 E. R. Morton—20
Estelle Lee—20 N. J. Velardi—25
A. C. Magrath—35 A. H. Yeager—20
F. A. Zupa—25

General Service Department

Anna M. Cooper—15 J. P. Greene—25
T. C. Cruger—35 John Kelly—20
Gladyce K. Farber—15 Ellsworth Van Horn—20

Plant Department

Joseph Doherty—15 A. I. Heitzman—20
C. C. Engelbart—10 Thomas Smith—20
C. E. Swenson—25

Patent

H. P. Franz—25

Commercial Relations

W. E. Reinhardt—15

*Unpublished biographies of those who have completed 25 years of service will appear in future issues of the RECORD

NEWS NOTES

FRANK B. JEWETT, leading scientific figure in the field of telephonic communications, was given the signal honor by the National Academy of Sciences April 27 of being reelected its President for another four years which will end June 30, 1947. The reelection of the chief executives of the National Academy has been a rare occurrence and Dr. Jewett's continuance in that office was unanimously urged by the Academy membership because of his work in connection with the war.

This means that Dr. Jewett will continue to serve, by virtue of his National Academy presidency, on the National Defense Research Committee. He was appointed to this position on June 27, 1940, by President Roosevelt.

O. E. BUCKLEY attended the annual meeting of the American Philosophical Society at Philadelphia, on April 23 and 24, and the annual meeting of the National Academy of Sciences in Washington, April 26 and 27. During this meeting of the National Academy of Sciences, the John J. Carty Medal and Award was conferred for the fourth time since its establishment by the American Telephone and Telegraph Company. The latest recipient of the medal and honorarium (in this instance \$4,000) is Dr. Edwin Grant Conklin, distinguished zoologist. Dr. Buckley is Chairman of the Committee on the John J. Carty Fund.

Filtered Thermal Noise—Fluctuations of Energy as a Function of Internal Length, an article by S. O. RICE, was published in the April *Journal of the Acoustical Society*.

MURRAY HILL BOWLING LEAGUE LUNCHEON

For his skill in bowling, C. J. Frosch recently received the Spindler Prize at a luncheon given by the Chemical Laboratories Bowling Club at Murray Hill. The prize was blown in glass by G. P. Spindler, and is presented each year to the man with the highest score for the past season. To salve the feelings of the low man, Mr. Spindler also fashioned this year a small bluebird in glass. A. C. Walker "got the bird" and is seen holding it while looking longingly at Mr. Frosch's prize.



Men of the Laboratories

(Chosen by Lot)

A NAVIGATOR in the U. S. Power Squadron School, A. W. GALLY likes to spend his weekends cruising along Long Island Sound in his power boat but his duties as shop supervisor at Murray Hill will keep him close to shore this summer. After graduating from the Stuyvesant High School, New York City, Mr. Gally attended Mechanics Institute evenings for four years and continued at Cooper Union until the demands of war work obliged him to stop. He joined the Laboratories as an apprentice instrument maker in 1928 and has been a supervisor since 1941. Technical books on Shop Practice are Mr. Gally's main reading interest. He is married and his home is located in Madison, N. J.

* * * * *

VICTOR LUNDAHL sailed the seven seas in windjammers before he joined the Laboratories twenty years ago. Since then he has kept an active interest in sailing vessels by constructing models of a dozen of them, in-



A. W. GALLY

cluding several on which he served. However, against even that background, glass blowing can intrigue Mr. Lundahl's interest because it's for the Physical Research group which is responsible for the construction and assembly of all sorts of experimental vacuum tubes and electronic devices, many of them now for war projects. His memories go back to World War I when he was the last man to leave a sinking ammunition ship in the English Channel; and his imagination goes

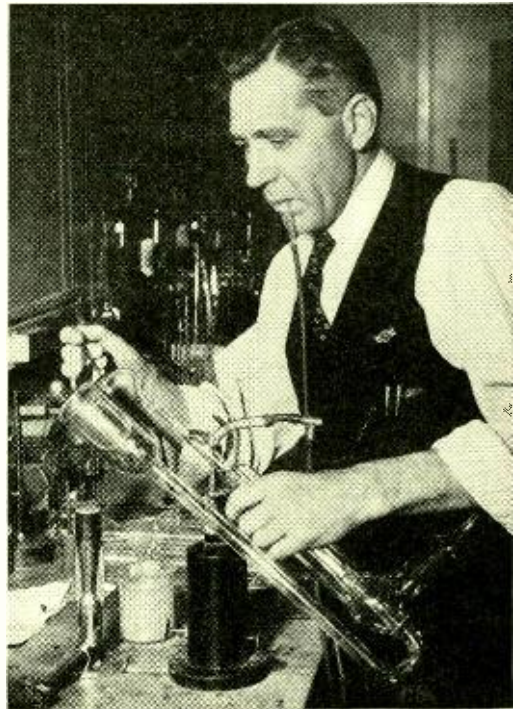

VICTOR LUNDAHL

forward to the day when his son will come back from the Army at the end of this war. How his intricate glasswork, no two jobs of it alike, helps to bring that day closer, he doesn't always know, but he's proud that his glass blowing and his buying of War Bonds make him part of the team, even if someone else makes the touchdown.



CARL PETERSON

WHEN CARL PETERSON graduated in 1941 from Emerson High School, he lost no time in crossing the river to the Laboratories. Having studied drafting, he soon transferred from the messenger force to Systems Drafting. Some day he will go into the Army; then, he hopes, he will have a chance to work with some of the aircraft radio systems whose equipment designs have taken form on his board. Meanwhile he is plugging away at his work and taking the out-of-hour training courses offered by the Laboratories in telephone practice. All of that leaves little

time for recreations, but still Carl manages to do some swimming and to sing in the church choir.

* * * * *

LAST AUGUST the Laboratories undertook an urgent secret project which required the design of new circuits and equipments and field tests of the system. The results were so promising that the Laboratories was asked to produce a substantial number of equipments prior to the time that the Western Electric Company could begin production. The middle of April was set for the date of completing this lot. On April 16, the inspector placed his stamp of approval on the last equipment and the picture below was taken on that date. While the project was under the direction of L. W. MORRISON, JR., it was due to the efforts of all the men associated with him that such a record could be made. Among them should be mentioned P. P. CROWE, H. A. BENNETT, R. S. HAWKINS, J. R. BRADY, A. R. KOLDING, S. DOBA, J. W. RIEKE and L. W. MORRISON who made the circuit designs; A. A. BURGESS, L. J. SCOTT, F. R. DICKINSON and J. H. CRAIG, who designed the equipment; and H. J. WALLIS, R. I. GAME, H. H. DEBOER, F. P. WIGHT and R. S. SKINNER who supervised construction. Western Electric installers also worked on the project.



Left to right—A. A. Burgess, P. P. Crowe, H. A. Bennett, R. S. Hawkins, J. R. Brady, A. R. Kolding, S. Doba, J. W. Rieke and L. W. Morrison. J. J. Jansen is finishing off the last Jap cruiser, symbolizing completion of the last unit

Women of the Laboratories

MARION CAMERON GRAY of Ayr in the Burns country, Scotland, for many years the only Laboratories woman with a Ph.D., is a graduate of Edinburgh University where she received her master's degree in three years. She went to the university on a scholarship, "but so did nearly everyone else," she adds modestly. Marion came to this country on a Bryn Mawr scholarship for European women, and was awarded her doctorate in mathematics two years later. Returning home she taught physics at Edinburgh for a year and for three years was Mathematical Research Assistant at the Imperial College of Science, London.

The custom of studying math and physics together in Scotland has been a decided advantage to Marion in the work she has done since coming to the Bell System. After leaving London, she joined the D & R Department, working under Dr. George A. Campbell whom she had met while at Bryn Mawr; she was transferred to the Laboratories in 1934 where her work has been on mathematical problems connected with elec-



DR. MARION C. GRAY

tromagnetic wave theory. Marion has written articles on mathematics and radio propagation for the *I.R.E. Proceedings*, *London Mathematical Society Journal*, *Physics* and the *Philosophical Magazine*, and she does abstracting regularly for *Mathematical Reviews*. Besides being an associate of the Institute of Radio Engineers, she is a member of the American, London and Edinburgh Mathematical Societies.

An inveterate knitter like most of her clan, Marion is not sure whether she reads



MARY KELLY

while she knits or knits while she reads, but has done both since she was a child. Her knitting is usually sox, sweaters and mufflers for the Red Cross; her tastes in reading are catholic. While in Scotland her sports were bicycling all over the country on her holidays, and tennis. Later upon going to London, she explored the surrounding country on her walks, a walk being a 20 or 25-mile ramble, and found the museums and the city itself a source of endless treasure;



Winifred Daniwicz turns over part of the scrap lipsticks and compacts to R. C. Fisher of the salvage group

on that score London far surpasses New York, but to balance things, she adds, New Yorkers are far friendlier. Marion had been living alone until three years ago, when her sister's children, David 7, and Marion 5, came with their mother to stay with her for the duration. Of the hobbies she used to enjoy, bridge is the only one she still has time for; her spare time nowadays centers on home and the children.

* * * * *

THE THEATER and opera have been MARY KELLY's hobbies since she was a child growing up near the bright lights of mid-Manhattan. Now hindered from coming to New York as often as she'd like by dimouts, blackouts and train schedules to Millburn, she has canceled her subscriptions to the opera and concerts and has turned to recordings and the radio to satisfy her love of music. A recent bride, her new name is Mrs. Brennan; her home and entertaining are her other interests. Mary graduated from Washington Irving High School and lived for many years on Washington Heights. She came to the Laboratories from the Western Electric and after three years as a stenographer was promoted to secretary, working at West Street until the opening of Murray

June 1943

Hill. As secretary to the Chemical Director of the Laboratories who also reports to the government's Office of Rubber Director, Mary's work is very closely tied to the war and to the problems of producing synthetic rubber.

* * * * *

ALTHOUGH GENEVIEVE JONES' coil winding machine is called "automatic," considerable skill must be acquired to be able to set it up and to locate the wire properly on the cores according to specifications. Most of the coil work she does is for experimental jobs, so there is great variety in her work and she is learning to understand the requirements for each coil as directed by the engineer's blueprint.

A graduate of Howard University, Miss Jones is a registered pharmacist in Delaware and before coming to the Laboratories she worked as a pharmacist, a laboratory technician and a chemist's aide. She is now a registered apprentice in New York and is preparing to take the Board Examination in Pharmacy. Genevieve also hopes to take her Master's Degree in Chemistry. Her hobbies are photography and dancing. However, her real interest at the moment is in the contribution she is making toward winning the war by doing work that seems to her vital.



GENEVIEVE JONES

IF YOU'RE GOING on a business trip and need money or express checks for meals, hotel and transportation, or if you want to be reimbursed for money you've spent, it is BESSIE O'DONNELL'S responsibility to handle the financial records and payments. Few of us realize the painstaking work necessary to keep such accounts; these transactions must be completely checked and recorded and approvals verified before payments can be made; individual ledger sheets are maintained for each employee. In these days with hundreds of accounts active, her phone rings constantly and people stop at her window to ask, "How does my account stand now?," "Have you received my last voucher?," "How much do I owe?" These are but a few of the many questions she must be able to answer. While this is Miss O'Donnell's main job, she has always shouldered her share of other financial responsibilities, such as cashiering, keeping Red Cross and Greater N. Y. Fund Contributions, and the breakdown of monthly checks for distribution. She has also entered wholeheartedly into Bell Laboratories Club and Telephone Pioneers activities.

Besides keeping Red Cross records here, she contributes actively to that organization by rolling bandages two nights a week at the Brooklyn Heights Chapter near her home. A



BESSIE O'DONNELL

native Brooklynite, Miss O'Donnell graduated from Our Lady of Lourdes Academy and studied finance at night. Bowling and swimming are her main recreations with reading a close follow-up; she will be looking for new vacation lands now that cruises are out for the duration.

* * *



PRISCILLA GRUTZNER

CHARLES GITTENBERGER

AS THE WAR CUTS into manpower, women are playing increasingly important parts in industrial drafting rooms. Girls who studied art have been laying down the brush for the ruling pen. One of them, Mrs. PRISCILLA GRUTZNER of the Bronx, studied art at Washington Irving High School. The work of these girls varies from the simpler lettering, tracing, and circuit drawings to the more complicated layout and assembly work.

If you know of a girl who might be interested in this kind of work, ask her to get into touch with Women's Employment at 744 Washington St. in New York City or at the Murray Hill Laboratory.



LORETTA SPACEK

LORETTA SPACEK of our Patent Department gives much of her spare time selling war bonds and stamps at the A.W.V.S. booth at Reuben's Restaurant. She worked for one hundred hours before earning the right to wear the snappy uniform which is her pride.

* * * * *

EARLY LAST NOVEMBER the Laboratories' Doll Committee under the leadership of MARY REDDINGTON packed a hundred com-

fort bags, filled with such things as soap, cigarettes, playing cards and stationery. Included was a post card addressed to someone who had contributed to the project. One of these cards came back almost at once, indicating that the bag had been put to use quickly. Nothing further was heard until recently when two V-mail letters were received, one by Nellie Schofield, the other by Margaret Wardlaw. Nellie's was from George Beer, of Pittsburgh, now somewhere in the Middle East, who wrote, "I received a kit with your name in it after we were on the boat. The kit was the same as a Christmas present for me as I didn't get anything for Christmas." The letter Margaret received came from Jack Denny, now in Iran, and read, "Several months ago our outfit left the States for overseas service. Since then I received a kit with your name on it and

The 4-A Apparatus File held a dinner to which were invited all former members of the Files for the past twenty-five years. Ninety-seven attended, some of whom came from points as far away as Syracuse and Baltimore. At right—Hilda Buhler, Hazel Mayhew, Elsie Brown and Rose Kingsbury. Below—Beginning with Margaret Blanchard, the girls are Lea Magneson, Helen Mason, Katherine Martin, Mary Sloan, Gerd Tanis, Shirley Lawton, Eleanor Guerci, Blanche Hering, Catherine Kopp, Viola Banks and Virginia Takacs.



several much needed items. The few small things people at home call necessities are luxuries to us boys. I, for one, appreciate your gift and the work of the Red Cross."

* * * * *

THE TELEPHONIST at the Mineola O.C.D. in the American Legion building is ELLEN WERNER of the Mail Department. She is on call at all times and reports to her post during practice blackouts and raids, and in emergencies, to take incoming calls from wardens and auxiliary police and to relay calls to proper authority.

* * * * *

F. E. DORLON and MARJORIE FORREST of the Murray Hill Restaurant are testing the top grades of canned food from various suppliers before buying the stock allowed under rationing regulations. Few of us realize the lengths to which our Restaurants go to give us the very best food. Each year, just after the canning season, and this year just before rationing, the Restaurant buys one can of each choice grade of food from the top ranking suppliers; the labels are removed and both the can and label coded for supplier and cost by someone other than the testers so that their judgments will be unbiased. With a stack of sauce dishes and spoons ready, the cans, let's say,



ELLEN WERNER

of apricots are opened and pieces of the fruit from each supplier put in a separate dish. Testing for the firmness of the fruit, uniformity, ripeness, flavor, weight of syrup, the choice usually narrows down to two or three brands; by weighing the contents or counting the number of pieces to the can, other things being equal, the Restaurant will choose the one that will give you, the customer, the most and the best for your money. On the day this picture was taken string beans, tomatoes, peas and pears, items on which the Restaurant supply was low, were being tested.

THE FRIENDLIEST JOB IN CIVILIAN DEFENSE

If you are looking for a friendly job in your community, why not aid in the block organization work of the Civilian Defense Volunteer Office? The reports from Block Leaders already signed up prove this work is rewarding. What do Block Leaders do? Well, first they make friends with the families assigned to



Food testing in our Restaurant

them and determine what volunteer work in Civilian Defense they want to do. For instance, one Block Leader thought up a scheme which enabled a sick girl to contribute to the war effort—she is now happily making scrap books for the wounded soldiers. Another Block Leader found a girl who had a brother in North Africa. She wanted to do the hardest job Civilian Defense could give her, and is thrilled to be a linen-room helper in a hospital—a very necessary job which is hard to fill. Other Block Leaders have encouraged local church and club groups to undertake Red Cross knitting and sewing projects, and all have sent their local Blood Donor score soaring.

The next thing Block Leaders do is to find out what their families' wartime problems are—rationing, salvage, Victory Gardens, what to do with the children if mother has a defense job. They have the addresses of local salvage depots and ration boards, can show a housewife how to process tin cans and will tell her where she should take her contribution to the Book Drive.

Any woman over 21 is qualified to do this work. A short course of instruction plus your Block Leader's kit provides you with the proper information which includes a complete outline of the opportunities for volunteers in Civilian Defense.

This is only a brief account of the varied aspects of a Block Leader's work. Women members of the Laboratories interested may write or telephone their local Civilian Defense Office for a pamphlet describing the entire Block Organization Plan.

* * * * *

C. B. GREEN attended the American Physical Society meeting at Ohio State University on April 30 and May 1.

J. A. BECKER presented a paper entitled *On a Theory of the Rectifying Action in Copper Oxide Rectifiers* at a symposium on semiconductors at the American Chemical Society meeting in Detroit, on April 13.

K. K. DARROW spoke before the A.I.E.E.

group at the College of the City of New York, and also at Wellesley College, on *Interrelation of Mass and Energy* and before the American Philosophical Society at Philadelphia on *Entropy*. He also attended the meetings of the American Physical Society and of its Council at Columbus. On May 17 Dr. Darrow discussed *Transmutation and Radioactivity* in a lecture, the second in a series of six, under the auspices of the New York Institute of Finance at the New York Stock Exchange.

CABLE PROBLEMS took C. A. WEBBER to



At "capping" exercises in the Overlook Hospital in Summit Phyllis Jordon and Jean Nevius of the Murray Hill Laboratory became Nurses' Aides after a ten-week course of instruction which included four weeks of hospital service

Chicago and Washington; R. T. STAPLES to Boston; and H. H. STAEBNER to Baltimore. Mr. Staebner also discussed cords on his trip.

G. T. KOHMAN and W. E. CAMPBELL also attended the Electrochemical Society meeting. While in Pittsburgh they made studies on panel-bank contacts. Mr. Campbell attended the meetings of the American Chemical Society at Detroit and the American Society of Mechanical Engineers at Davenport, Iowa. While in Detroit he conferred with Prof. Harkins of the University of Chicago and Prof. Bartell of the University of Michigan on the problem of wetting metals by oil; while in Iowa he officiated as chairman at a conference with members of the Engineering Staff of Rock Island Arsenal on protection of machined metal surfaces for short-time storage.



R. C. JOHNSON

W. C. REDDING

RETIREMENTS

FIVE MEMBERS of the Laboratories retired recently—RICHARD C. JOHNSON of the Equipment Development Department on May 31 under the Retirement Age Rule; W. CHESTER REDDING and LEROY S. FORD of the Outside Plant Development Department on May 21 and May 31, respectively, and WILLIAM T. BOOTH of the Transmission Apparatus Development Department on May 25, at their own request with Class A pensions; and NELSON BLOUNT of the Station Apparatus Development Department on May 30 with a Class D pension.

Mr. Johnson received his S.B. degree from Harvard in 1902. He spent three years in other industries and then joined the Equipment Drafting Department of the Western Electric Company at the Clinton Street plant in Chicago. A year later he left and went with the Illinois Steel Company at South Chicago. In 1910 he again joined the Equipment Drafting Department of Western Electric and until 1915 engaged in the design of cabling and cable-rack layouts. He then spent two years with Stone and Webster, Boston, on power plant layouts and equipment design.

In 1917 Mr. Johnson returned to his old work at Hawthorne, transferring two years later to New York in what is now the Systems Development Department. Here he designed cabling layouts for the first panel offices installed in New York—Pennsylvania and Academy—and in Kansas City, Omaha and several other cities and soon became a supervisor in this type of work. Since 1926, in the Equipment Development Department, Mr. Johnson has been concerned with the engineering requirements for cabling, cable

racks, distributing frames, fuse boards, and relay and message register racks, these requirements later becoming Bell System standards.

Mr. Redding was continuously engaged in the development of lead-covered cable during his thirty-two years of service with the Bell System. He graduated from Worcester Polytechnic Institute in 1905 and received the E.E. degree in 1906. He then became associated with the American Steel and Wire Company at Worcester, Massachusetts, and engaged in the design and manufacture of power cables. In 1911 he joined the cable development group in the Engineering Department of the Western Electric Company in New York. A little over a year later he transferred to Hawthorne where for the next five years, with the exception of an interval of one year spent in New York, he had charge of groups handling the design and development of various types of lead-covered telephone cable.

Since 1918 Mr. Redding has been in charge of a group engaged in general engineering of lead-covered cable and providing a point of contact with the American Telephone and Telegraph Company for the other groups of Laboratories' cable development and design engineers located in the various plants of the Western Electric Company. In addition to the general engineering work, this group conducts cable trial studies at the Chester Field Laboratory and at various points in the operating field.

Mr. Ford received from Worcester Polytechnic Institute in 1905 the B.S. degree and the E.E. degree the following year. He joined the Laboratories in 1909, after three years in electric railway engineering. He has



L. S. FORD

W. T. BOOTH

since been almost continuously associated with lead-covered cable development, most of the time supervising work carried on by Laboratories' personnel in Western Electric plants. From 1919 to 1926 he was in temporary charge of the cable development group during Mr. Anderegg's assignment abroad. Previous to his retirement Mr. Ford was at Kearny where, as Assistant Cable Engineer, he supervised work carried on both there and at Point Breeze on general engineering problems of lead-covered cable designs.

As a young man Mr. Booth gained considerable telephone experience with the Western Electric Company, which he joined in 1899, and later with several small telephone manufacturing organizations. During this time he attended Cooper Union and received a B.S. degree in 1905. Soon after his return he was assigned to the staff of the European Chief Engineer and sent to Europe. In 1914 Mr. Booth came back to America and was placed in charge of one of the apparatus design groups. Later he was engineering representative to the Signal Corps and Navy and worked on airplane radio and field signaling sets.

Following the war he assumed charge of the Machine Switching Apparatus design group and continued in this capacity until 1925. At that time he was assigned to work on cost savings and special investigations. As an outgrowth of these activities the Laboratories undertook engineering investigations of repaired apparatus which was placed under Mr. Booth's supervision. As Repaired Apparatus Engineer he was also responsible for the preparation of certain maintenance practices dealing with station telephone and teletypewriter apparatus and the commercial design of varistor apparatus. Investiga-



NELSON BLOUNT

tions of electrolytic condensers were also carried out.

Mr. Blount entered the Engineering Department of Western Electric Company in 1923. Until 1928 he was a member of the Apparatus Development Department. He was then transferred to the transmission instrument development group, which at that time was a part of the Research Department. He continued his association with this group when during the gen-

eral reorganization in 1940 it joined the Apparatus Development Department. Mr. Blount played an important part in the design work on the E and F types of station handset as well as other handsets intended for special applications. He was also responsible to a large degree for the design work on several types of hearing aids, microphones, headsets and special telephone instruments for use by the Army and Navy.

* * * * *

ON APRIL 27 at the twenty-second annual exhibition of advertising art at the Art Directors' Club of New York, A. R. THOMPSON served on the jury of awards and helped

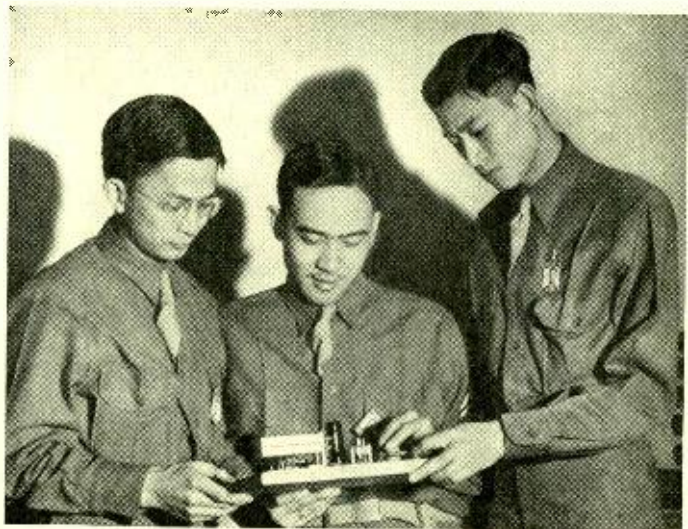

Three American soldiers of Chinese extraction receive training in radio devices in the School for War Training operated by the Laboratories. Left to right—Pfc. Oon Dong, Cpl. You Wong and Pvt. Bing Lee. They are part of a group of ten now in the School

to select the winners of Medals and Awards for Distinctive Merit for the best advertising art of the past year.

R. M. BURNS was elected President and H. E. HARING Vice-President of the Electrochemical Society at the 83rd annual meeting in Pittsburgh. On April 22 Dr. Burns spoke on *Corrosion and the War* at the Science Club of Virginia Polytechnic Institute.

AMONG THE OTHER LABORATORIES MEN who attended the American Chemical Society Convention at Detroit were A. R. KEMP, F. S. MALM, H. PETERS and J. B. HOWARD. Mr. Kemp and Mr. Peters presented a paper entitled *Unsaturation of Butadiene and Related Polymers as Determined by Iodine Chloride Addition*. Mr. Kemp and Mr. Malm also visited Hawthorne to discuss rubber and plastic problems.

C. J. CHRISTENSEN spent two days at Hawthorne discussing ceramics.

M. D. RIGTERINK attended the meeting of the American Ceramic Society that was held in Pittsburgh.

W. A. YAGER and E. J. MURPHY went to Pittsburgh to attend the Electrochemical Society meeting at which Mr. Murphy presented a paper on *Gases Evolved in the Thermal Decomposition of Paper*.

B. L. CLARKE addressed the New York section of the American Chemical Society on *Some Practical Applications of Statistics to Analytical Chemistry* at its annual meeting at the Pennsylvania Hotel on May 7. Dr. Clarke, elected vice-chairman of the Society, will become chairman automatically on July 1, 1944. W. A. SHEWHART led the discussion at the meeting.

Scientific and Industrial Applications of Metallography was the subject of F. F. LUCAS' address before the April 14 meeting of the Notre Dame chapter of the American

"THE TELEPHONE HOUR"

(NBC, Monday Nights, 9:00 P. M. Eastern War Time)

JUNE 7, 1943			
Simple Aveu	Orchestra	<i>Thomé</i>	
Posthumous Valse		<i>Chopin</i>	
Danza Espagnola		<i>Granados</i>	
Scherzo—Valse		<i>Chabrier</i>	
	Robert Casadesus		
Russlan and Ludmilla Overture	Orchestra	<i>Glinka</i>	
Concerto No. 4 in C Minor—Finale	Robert Casadesus and Orchestra	<i>Saint-Saëns</i>	
JUNE 14, 1943			
The House on the Hill	Frederick Jagel	<i>Charles</i>	
Arkansas Traveler	Orchestra	<i>Traditional</i>	
Connais Tu Le Pays from "Mignon"		<i>Thomas</i>	
Upstream		<i>Malotte</i>	
Che Gelida Manina from "La Bohème"	Helen Traubel	<i>Puccini</i>	
Aire de Gato from "Primera Suite Argentina"	Frederick Jagel	<i>Massa</i>	
Thine Alone from "Eileen"	Orchestra	<i>Herbert</i>	
	Helen Traubel and Frederick Jagel		
JUNE 21, 1943			
Dancing Doll	Lily Pons	<i>Poldini-La Forge</i>	
A Pretty Girl Is Like a Melody	Orchestra	<i>Berlin</i>	
I'll Follow My Secret Heart	Lily Pons	<i>Coward</i>	
Rondo Capriccioso	Orchestra	<i>Mendelssohn</i>	
Caro Nome from "Rigoletto"	Lily Pons	<i>Verdi</i>	
JUNE 28, 1943			
Play Gypsies, Dance Gypsies from "Countess Maritza"	Nelson Eddy	<i>Kalman</i>	
Jardin d'amour	Orchestra	<i>Traditional</i>	
The Blind Ploughman		<i>Clarke</i>	
Frog Went A'Courtin'		<i>Traditional—arr. Brockway</i>	
	Nelson Eddy		
Egmont Overture	Orchestra	<i>Beethoven</i>	
The Moon Is High in the Sky from "Aleko"	Nelson Eddy	<i>Rachmaninoff</i>	
JULY 5, 1943			
La Calinda from "Koanga"	Orchestra	<i>Delius</i>	
Hebrew Melody	Jascha Heifetz and Orchestra	<i>Achron</i>	
March from "Prince Igor"	Orchestra	<i>Borodin</i>	
Concerto in D Minor— and Finale	Jascha Heifetz and Orchestra	<i>Wieniawski</i>	



BLOOD DONORS

I scarcely feel the needle in my arm
Or see the doctor standing at my side;
I only know a tenderness, long lost,
And mingled with it, fiercely native pride.

A tenderness, that this small part of me
May help one of my fellow men to live.
The pride, that though I cannot be with them,
Yet here, at last, is something I can give.

For, ever in my mind I see them pass—
Those school-friend faces now across the seas.
And who can call me selfish if I pray
My blood, if they should need, might go to these?

But, oh, one face is missing from their ranks,
One well-loved voice again I'll never know.
And ever cries my heart—he might have lived
Had you fulfilled this duty long ago!

—Carl H. Claudy, Jr., C. & P. Tel. Co.

Society for Metals at South Bend, Indiana.

AT A SEMINAR of members of the Staff of Airborne Instruments Laboratory, Mineola, H. E. MENDENHALL discussed *The Evolution of Electronic Tools and Applications—Prior to World War II*. He was introduced by W. H. BRATTAIN who has been loaned from the Laboratories for work at Airborne Instruments Laboratory.

A. G. GANZ was at Hawthorne on transformer problems.

J. P. WHISTLER visited the Point Breeze plant of the Western Electric Company on transformer questions.

AS CONSULTANT on impedance measurement problems, H. T. WILHELM was in Cambridge, Mass., for two days.

A. J. GROSSMAN also went to Cambridge to attend the colloquium of the Radiation Laboratory at M.I.T.

D. G. BLATTNER and W. C. SLAUSON visited Hawthorne on Y-type relays.

C. W. McWILLIAMS spent several weeks at Hawthorne in connection with special apparatus. In this work he was later joined by D. D. MILLER.

C. D. HOCKER and A. P. JAHN, on April 28, took part in the inspection of metal-coated samples of the American Society for

Testing Materials which are undergoing atmospheric tests at Sandy Hook, N. J. Mr. Jahn continued in similar inspection activities at Bridgeport, Conn., Pittsburgh, and State College, Pa.

P. T. HIGGINS was at the Leeds and Northrup Company, Philadelphia, to make special telephone apparatus studies.

R. H. COLLEY was elected president of the American Wood-Preservers' Association on April 27 at the annual meeting in Chicago.

C. L. KRUMREICH spent some time at Hawthorne recently on the engineering of head receivers and microphones.

STEP-BY-STEP bank and wiper contacts were studied by G. H. DOWNES and P. W. SHEATSLEY at Richmond.

W. W. BROWN is at Hawthorne on problems pertaining to the application of non-critical materials used in the construction of operators' chairs.

F. H. CHASE has been to Terre Haute and Evansville, and to Hawthorne, in connection with K2 carrier systems.

H. T. LANGABEER discussed power questions with the Signal Corps at Washington.

AT THE WESTERN ELECTRIC COMPANY, Chicago, studies on the testing and manufacturing of rectifiers were carried on by H. J. BERKA.

F. T. FORSTER observed battery tests under way at Buffalo.

H. M. SPICER investigated motor and control problems at the Point Breeze plant of the Western Electric Company.

MOTOR PROBLEMS were also the reason for the visit of C. S. KNOWLTON and C. T. MILLER to the General Electric Company at Schenectady.

A. F. POMEROY has been appointed a member of the Papers Committee and of the Technical Committee on Symbols of the Institute of Radio Engineers.

MARY BRAINARD, in charge of women's employment for New York locations of the Laboratories and an alumna of Mount Holyoke, was a guest speaker at the forum *Women in War Jobs—and After* held by the Mount Holyoke Club of New York on April 7.

JOHN MILLS addressed the New York Institute of Finance on *The Scientific Method* at the New York Stock Exchange on May 10, as the first speaker in a series of six lectures on Electronics.

OBITUARIES

MISS MARY TORKAS of the Central Service Department died on April 16. Born in Manhattan, Miss Torkas graduated from the Commercial course at Washington Irving High School in 1929 and immediately entered the Laboratories as a typist. She soon learned stenotyping and since then had been in the stenotype telephone dictation.

* * * * *

PATRICK MONAHAN, a foreman in the Building Service Department, died on May 8. Mr. Monahan came to the shops of the Western Electric Company in 1906 and in 1913 was transferred to Building Service Department. Later advanced to foreman, he held this position until his death.

* * * * *

A. F. DOLAN, a former staff assistant in the Commercial Products Development Department who retired in 1941 after thirty years of service, died on April 26. A biography of Mr. Dolan, published at the time of his retirement, will be found in the April, 1941, issue of the RECORD.

WE SEE BY THE PAPERS that,

The statistical method of controlling product quality during manufacture, originated in 1922 by DR. W. A. SHEWHART of the Bell Telephone Laboratories, has until comparatively recently made little headway in the (*British*) engineering industry. . . . The



MARY TORKAS, 1911-1943

last world war dealt a death blow to the old engineering craftsman, whose skill and knowledge made this country (*Britain*) at one time "the industrial workshop of the world." . . .

During the uneasy interregnum of the last twenty years all the emphasis in production has been placed on "methods," whereas in the past it lay on "workmanship" . . . the emphasis today is on "methods plus workmanship"; that is to say, on quantity and quality. This was in fact the burden of a recent parliamentary speech by Mr. Lyttelton. . . . It is in strengthening the second prong of this vital drive that statistical methods, already of proved service in other industrial fields, have recently come to the aid of the engineering industry.—*Electrical Review (London)*, February 26, 1943.

The engagement of MISS DOROTHY HUBER, and John F. Brody, petty officer, third class, U. S. Navy, was recently announced. No wedding date has been set, since Seaman Brody is stationed somewhere on the Atlantic Ocean. A graduate of Dickinson High School, Jersey City, Miss Huber is employed in the offices of the Bell Telephone Laboratories, New York.—*Hudson Dispatch*, April 13, 1943.

GEORGE B. THOMAS, JR., who is associated with the Bell Laboratories, has taken up residence (in Hotel Holley).—*The Villager*, April 15, 1943.

J. Herbert Woolley, Millburn defense chairman, called on township chemists and chemical engineers today to volunteer for the newly established gas reconnaissance group. He hopes to have one gas officer in each of eight local OCD zones. The council has set up a committee of five, headed by A. C. WALKER of the Bell Telephone Laboratories.—*Newark News*, April 20, 1943.

Girl engineers, draftswomen and technicians on war projects are holding down man-sized jobs in the Bell Laboratories that are doubly important because they have re-



PATRICK MONAHAN,
1884-1943

leased experts for important posts in the armed forces.—*Brooklyn Eagle*, April 25, 1943, which carried stories on Beatrice Mead, Marie Vincent and Amelia Arra.

Assigned to the University of North Carolina, Chapel Hill, N. C., for flight training, is Naval Aviation Cadet DAVID GREENHAGEN, nineteen. Before his appointment as a Naval Aviation Cadet he was employed by the Bell Telephone Laboratories in New York City.—*Yonkers, N. Y., Herald-Statesman*, April 30, 1943.

Miss Margaret D. Nelson became the bride of RICHARD LELAND SANDFORT of Sedalia, Mo., yesterday afternoon. The groom attended Baker University, Baldwin City, Kan., and the Ecole des Arts, Paris. He is now with the Bell Telephone Laboratories School for War Training.—*Springfield, Mass., Republican*, May 3, 1943.

Announcement has been made of the marriage of Miss Lois

Margaret Schoonover to Major Louis Richard Kent, Medical Corps, U. S. A., which took place Wednesday afternoon in Washington. Major Kent, whose father is patent solicitor for the Bell Telephone Laboratories in New York, was graduated from Oberlin College with the A.B. degree in 1935 and from Cornell University Medical College in 1939. Major Kent served a two-year internship at Youngstown Hospital. He is stationed at Camp Mackall, Hoffman, N. C., as regimental surgeon and commanding officer of the Medical detachment.—*New York Times and Brooklyn Eagle*.

An executive of the Bell Laboratories reminds "Trade Winds" of the telephone exhibit at the World's Fair and the Voder—the electrical device which talked as its operator fingered its keys. The demonstrator used to call for suggestions from the audience of

words for the Voder to pronounce. One day a voice from the balcony called out "sphinx." The Voder, which was probably being operated that day by Van Cartmell, shot back, "Well, if it does you don't have to say so. If you don't like it, scram!"—*Saturday Review of Literature*, May 8, 1943.

Miss Frances Denison was married yesterday to MR. HAYDEN WILEY EVANS, of



W. A. Tracy, Plant Operation Department, reads and then presents to our chauffeurs the Greater New York Safety Council's award for safe operation of the Laboratories cars during 1942. Left to right—John Landers, John Hanley, Martin Quinn, Mr. Tracy, William Gebhard and Albert Jost

New York. Mr. Evans was graduated from Ohio Wesleyan University and the University of Michigan. He is a member of the technical staff of the Bell Telephone Laboratories.—*Herald Tribune*, May 9, 1943.

VICTORY GARDENS

The following vegetables may be planted in June:

Bush Beans, Pole Beans, Bush and Pole Limas, Beets, Sprouting Broccoli, Brussels Sprouts, Cabbage, Carrots, Cauliflower, Celery, Chicory, Sweet Corn, Popcorn, Cucumbers, Endive, Kale, Kohl-Rabi, Okra, Parsley, Potatoes, Pumpkins, Summer Radish, Salsify, Squash, Swiss Chard.

Choose Your Own Age—*an editorial by John Miles*

THE men of the Stone Age did not realize that they were living in that period for the name was applied ages later in historic retrospect. The last well-defined age, that of steam, started with Watt's invention of the steam engine. Perhaps that age is over and we are in a new one; but probably we are too close in time to appreciate the transition.

To some of us we seem to be in an age of electrical communication. There are dial-switching mechanisms and teletypes which respond electrically to impulses from a distance; there are television sets and picture apparatus which reproduce changing scenes; Geiger counters which record bursts of cosmic rays; radio waves which, beside carrying speech and signals, can tell the story of the ionosphere, or serve in Radars to give away the location of enemy ships and planes; and all the myriad of measuring instruments which can instantly report to distant observers. All these are illustrations of electrical communication.

To the publicity man in an aircraft company we are in the age of air-borne transportation; to power engineers, one of Diesel engines; to some metallurgists, well along in an age of alloy steels and entering one of light-weight metals; to chemists, an age where our lives will be conditioned by new substances compounded of old atoms; and to some physicists, with their cyclotrons,

one of new atoms formed from old nuclei. Each technical group, but especially each advertiser, selects a flattering name and pins a rose on itself. Electronics, for example, is the most recent candidate for the name of our age.

Only time will tell what it will be called. Perhaps, despite all the marvels and rapid advances the name will reflect not changes in engineering techniques and material surroundings but changes in human relations so basic as to constitute a universal Renaissance. Time is ripe; communication is world wide and fast; men are on the march; and never before have so many of the world's inhabitants been so closely inter-related and interdependent.

Choose your name for our age, Ladies and Gentlemen. But don't take your choice too seriously. The name will not last; neither will the age; but the latter will be lasting in its effects. And in it each of us is playing some part, influencing the future for better or for worse.

If you must have a name and would choose it from the standpoint of material things, rather than human values, I suggest: the Age of Research. All that modern chemistry can do, all that can be accomplished by the control of the electron and by electromagnetic waves and all the new materials, machines and processes of our day are products of research.