

WILMINGTON  
INSTITUTE

AUG - 4 1934

FREE LIBRARY

# BELL LABORATORIES RECORD



TRUNKING  
AND PROBABILITY  
E. C. MOLINA

TRANSMISSION  
MEASURING SYSTEM  
K. LUTOMIRSKI

PRECISION FILTERS  
P. S. DARNELL  
W. E. KAHL

AUGUST 1934 Vol. XII No. 12

# BELL LABORATORIES RECORD

---

*Published Monthly by* BELL TELEPHONE LABORATORIES, INC.

PAUL B. FINDLEY, *Managing Editor*      PHILIP C. JONES, *Associate Editor*

*Board of Editorial Advisors:*

C. S. DEMAREST	W. FONDILLER	H. A. FREDERICK	O. M. GLUNT
H. H. LOWRY	W. H. MARTIN	W. H. MATTHIES	JOHN MILLS
D. A. QUARLES	J. G. ROBERTS	G. B. THOMAS	R. R. WILLIAMS

---

SUBSCRIPTIONS are accepted at \$2.00 per year; foreign postage \$0.60 extra per year. Subscriptions should be addressed to Bell Laboratories Record, 463 West Street, New York City

---

## *In this Issue*

Frontispiece . . . . .	353
The amount of gas evolved from a metal is measured by noting the increase in weight of an absorbing agent suspended on a quartz spring	
Trunking as a Problem of Probability . . . . .	354
<i>E. C. Molina</i>	
Standardizing Basic Electrical Units . . . . .	358
<i>S. J. Zammataro</i>	
Dissipation Constants in Solids . . . . .	363
<i>H. Walther</i>	
Toll Transmission Measuring System for the No. 8 Test and Control Board . . . . .	367
<i>K. Lutomirski</i>	
Electrical Constants of the Ground . . . . .	372
<i>C. B. Feldman</i>	
Retardation Coils for Precision Filters . . . . .	375
<i>P. S. Darnell</i>	
Adjusting Precision Filters . . . . .	379
<i>W. E. Kahl</i>	

# BELL LABORATORIES RECORD



VOLUME TWELVE—NUMBER TWELVE

*for*

AUGUST

*1934*



# Trunking as a Problem of Probability

By E. C. MOLINA  
*Switching Theory Engineer*

THERE are two fundamental and inherent problems of electrical communication: that of electrical transmission of intelligence, and that of switching and controlling the channels for such transmission. A major problem of the second class is that of trunking, which embraces not only those outside-plant lines commonly called trunks, but also trunks internal to an office, and all cord circuits or links that constitute elements of the circuit connecting two subscribers so that they may communicate with each other.

Whereas the transmission engineer's interest in a circuit is how it will transmit the voice of a talking subscriber, the trunking engineer is interested in the quite different question as to whether an idle circuit is available when a subscriber applies for one. In other words, while one engineer delves into such things as propagation and attenuation coefficients, the other is on the lookout for those contingency factors arising from the haphazard character of human demands. With the problem restricted to the trunking of local and nearby toll calls, the trunking engineer's goal is to find a switching system which, at a minimum cost, is capable of serving immediately all but a negligible proportion of originating calls.

Three contingency phenomena are controlling in the problem of trunking: the random incidence in time of originating calls, variations in length of time a connection is maintained,

called the holding time, and the mode of distribution of calls among the totality of paths or circuits which make up a switching system. A simple example will illustrate how the first two of these factors affect the probability that any one of a group of 100 subscribers served by a group of nine line finders\* will find a circuit available when he places a call.

A simplified schematic of the circuit arrangement is shown in Figure 1. It will be assumed that while the calls are placed at random in time, the average rate of calls is 1.2 per hour per line. Thus for the group of 100 lines there would be 120 calls placed in an hour but their incidence would be random. It will also be assumed that the holding time is two minutes. That is, if a subscriber obtains a line finder immediately on placing a call, he will hold it for two minutes, and if he does not obtain one at once he will wait two minutes and then withdraw his call. If while waiting for a call his line is seized by a finder, he will hold the connection for the remainder of the two-minute period beginning when he placed the call.

Concentrating our attention now on any one subscriber of the group, what is the probability that when he lifts his receiver his line is not seized immediately? Let the point X in Figure 2 represent the random instant when the particular subscriber considered originates a call. Because of the two minute holding time, calls placed more

\*RECORD, *May*, 1930, p. 412.

than two minutes before X will not affect the availability of line finders at the instant X, and obviously calls placed after X have no effect. If, however, at least nine calls originate within this two-minute interval, there will be no line finder idle when the subscriber places his call. The probability that this particular call is not served immediately is thus identical with the probability that at least nine of the other 99 lines originate calls in the two minutes preceding X.

Since two minutes is  $1/30$  of an hour, and by assumption each line originates calls at random at the rate of 1.2 per hour, the probability,  $p$ , that a specified one of them will originate a call within the specified two minutes is  $1/30 \times 1.2$ , or  $.04$ . If then  $n$  is allowed to represent the number of lines under consideration, 99 for the case assumed, the probability,  $P$ , that within the specified two minutes at least  $t = 9$  calls will be originated is given by the expression  $P = \sum_{x=t}^{x=n} \binom{n}{x} p^x (1-p)^{n-x}$

where  $\binom{n}{x}$  stands for the number of combinations of  $n$  things taken  $x$  at a time. This expression is troublesome to evaluate but by substituting Poisson's incomplete exponential binomial limit for it, the value of  $P$  is found to be  $.020$ .

In the Poisson expression  $n$  and  $p$  occur as the product  $np$ , which is called  $\alpha$ . Since  $p$  is the probability that a specified line will place a call within the specified two minutes, and  $n$  the number of lines, obviously  $\alpha$ , the product of  $n$  and  $p$ , is

the average number of calls which may be expected to originate in the specified interval. Looked at in another way,  $\alpha$  is also the expected average number of simultaneous conversations going on at a random moment. The Poisson expression involving  $t$  and  $\alpha$  is  $P = \sum_{x=t}^{\infty} \frac{\alpha^x e^{-\alpha}}{x!}$ .

In actual practice the value of  $P$  is specified in advance, and then the number of trunks  $t$ , or line finders in the example taken, is determined for various values of  $\alpha$ . For  $P = .01$  a curve showing the relationship between  $t$  and  $\alpha$  is given by the solid line in Figure 3. If a value of  $\alpha$  is divided by the corresponding value of  $t$  the resulting quotient is the average number of simultaneous calls that can be handled per finder by  $t$  line finders with a probability of  $.01$  that a subscriber will not find an idle finder when he places a call. This figure is thus a measure of the efficiency of the group, and a curve of efficiencies for the assumed conditions is indicated by the dotted line of Figure 3.

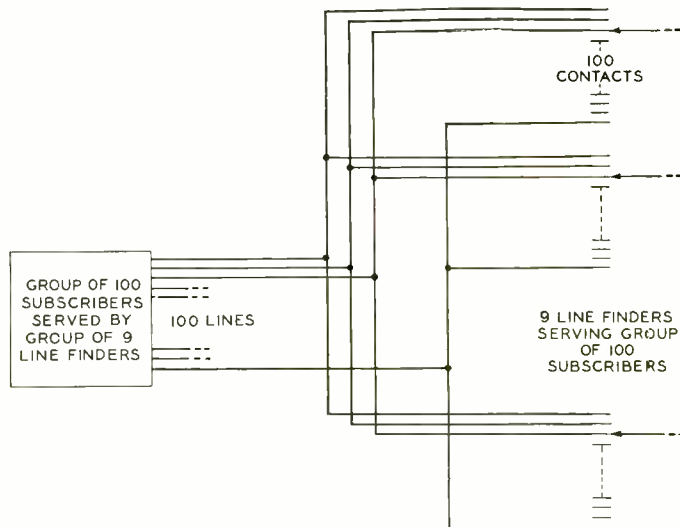

Fig. 1—Simplified schematic of a group of 100 subscribers served by a group of 9 line finders

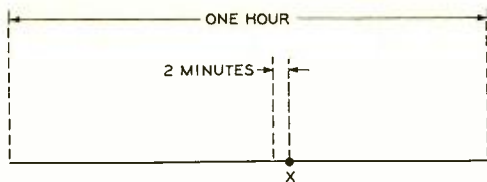

Fig. 2—A subscriber placing a call at time  $X$  will find a line finder available if less than nine calls have been placed in the two-minute period preceding  $X$

The shape of this curve shows that the greater the number of line finders in a group, the greater is the efficiency, or the greater the average number of simultaneous calls that can be carried per finder. It is because of this higher efficiency of larger groups that in the panel system each group of finders serves subscriber lines in groups of 400, instead of 100 as assumed in the problem discussed. It will be noted, however, that the rate of increase in efficiency decreases as the size of the group increases, so that the curve approaches a horizontal asymptote. There is therefore a point beyond which it no longer pays to increase the size of the group. The location of this point depends on a multiplicity of factors such as the type of switching system, the unit switch cost, and wiring difficulties, and has to be carefully determined for each set of conditions.

Probability theory is thus an invaluable aid to the trunking engineer in determining the number of elements which a switching system of given type must embody to meet a specified grade of service. Sometimes it even goes further than this and indicates the desirability of an entirely different switching sys-

tem. It was in such a role that probability theory led to the adoption of the trunking arrangement of the panel system.

In systems such as the step-by-step, the chain of switches which takes part in establishing a connection functions in accordance with our decimal system of enumeration. Since in a decimal system there are ten digits, each selection chooses one of ten groups. Step-by-step selectors and connectors are designed to allow these decimal selections, the connectors giving two decimal selections, one immediately after the other. On the first, the brush is stepped up to one of ten possible levels, and on the second it moves around to one of ten possible connections on that level. Thus there are 100 connections to each switch, so that 100 subscriber lines are run to the connector, the switch that performs the final selection. The number of connectors in a group must thus be of a size sufficient to handle 100 lines.

A 100-line group is comparatively small and as has already been pointed out the efficiency of the connector group supplying it would be correspondingly low. To obtain the higher efficiency of larger groups, it is necessary to get away from the decimal selection. This is done in the

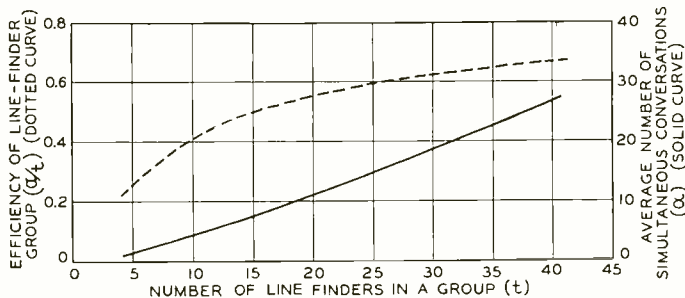

Fig. 3—Relationship between the number of line finders in a group and the average number of simultaneous conversations carried by line finders, (solid line,) and between the line-finder efficiency and the number of line finders

panel system by designing a final selector which has 500 subscriber lines connected to it. The number of 500-line selectors in a group is naturally larger than one serving only 100 lines, and is thus more efficient.

To be able to handle 500 lines on the final selector, however, it is necessary to adopt a non-decimal selection. An ordinary subscriber, on the other hand, is familiar only with the decimal system, and must, therefore, be permitted to dial on a decimal basis. Probability theory, however, has no respect for the subscriber's preferences in the matter and refuses to retract its verdict concerning the efficiency of

large groups. In the panel system, the engineers overcome this impasse by the design of the sender: a group of relays which register the decimal number dialed by the subscriber, and then translates the registered number to the non-decimal basis required for the panel system. The sender, instead of the subscriber, then guides the selection of the line wanted on a non-decimal basis. By these means the facts established by probability theory have been harmonized with the subscriber's preferences for counting with his ten fingers, and a system both efficient in operation and pleasing to the subscriber has been developed.

## TRENDS IN ENGINEERING RESEARCH

*The greater part of engineering research has been carried on in the past in commercial organizations. While some such dignify with the name of research even crude empirical control of materials or processes, there are at the other extreme concerns which carry on scientific and engineering research of a high order. The commercial organization has, by its very nature, a point of view which is likely to be restricted. In the narrow sense it is responsible to its stockholders for a profit, and this leads to a restriction of its research to the immediately profitable. In a larger sense it is responsible to its employees for security against the fluctuations of employment consequent upon shortsightedness, and it is responsible to the public for the best possible ultimate development of the products or services it supplies. A recognition of this broader responsibility carries with it an appreciation of the value of research on a more comprehensive and farsighted basis. That the more mature and socially sound point of view has appeared at all in our capitalistic scheme is a reassuring fact which is worthy of greater emphasis than it receives. To my mind the American Telephone and Telegraph Company, with its recognition of its responsibility to its stockholders, its employees, and its subscribers, is outstanding. Wherever this advanced philosophy guides the management, will be found research laboratories in a highly developed state of advancement, for the interests of all in the proper progress of an industry can be safeguarded in no other way.*

—From an address by Vannevar Bush at the installation of the M. I. T. Chapter of Sigma Xi.



## Standardizing Basic Electrical Units

By S. J. ZAMMATARO

*Telephone Apparatus Development*

**W**HENEVER we make an electrical measurement we are relating the electrical behavior of the thing being measured to that of mercury and silver through the international system of units. In this system, resistance and current are chosen as the fundamental quantities, and the definitions of the units of these quantities are based on the properties of mercury and silver, respectively. The international ohm is the resistance at the temperature of melting ice of a column of mercury of uniform cross-section having a length of 106.300 cm. and a mass of 14.4521 grams. The international ampere is

the current which will deposit silver electrolytically at the rate of 0.001118 gram per second. The units of all the remaining electrical quantities are derived from these fundamental units and the mechanical units of time and length through the well known laws that interconnect them.

In this country the Bureau of Standards maintains the fundamental international units, and passes them on to the electrical industries and commercial standardizing laboratories through a calibration service. While the international ohm is readily circulated by calibrating suitable resistance coils, it is impractical to transmit



the international ampere in any such manner. What the Bureau actually furnishes is the international volt by calibrating primary cells that are portable and designed to give a definite emf. Accordingly, for general measurement purposes, the primary standards are those of resistance and of emf.

Within any given branch of the electrical industry, the quantities that are of basic importance depend on the peculiar nature of the use to which electricity is put. In the power field, for example, large quantities of electrical energy are generated and transmitted at a single low frequency. Here, the problem of design and control is primarily concerned with the measurement of voltages, currents, and power. A telephone system, on the other hand, must transmit wide frequency spectra of small bits of electrical energy with substantially equal efficiency for each component frequency. The basic properties of materials and apparatus that affect the relative efficiency of transmission over a frequency band are effective resistance or conductance, inductance, and capacitance. These quantities, therefore, together with frequency constitute the basic electrical units for much of our work.

Primary standards representing our basic electrical units are established and maintained in the Electrical Measurements Laboratory. All working standards employed in our telephone plant are ultimately referred to these primary standards through a centralized system of calibration controlled here. Values for our primary standards of frequency, effective resistance, capacitance, and inductance are built up from two initial quantities—time and d-c resistance. Both of these quantities are determined at Washington. Received in the form of radio

signals from the Naval Observatory, time is compared with the time of motor-driven clocks controlled by our primary frequency standards. The reciprocal relation between time and frequency allows us to establish our primary frequency values. On the other hand, our primary effective resistance values come directly from the d-c resistance values received from the Bureau of Standards. Their precision depends on skill in designing and constructing standards of negligible or calculable a-c increment.

From effective resistance and frequency we proceed next to derive primary capacitance values through the relationship that connects these quantities in a Wien Bridge measurement, as shown in Figure 1. Finally, we establish primary inductance values in two ways: the inductance may be interrelated to the primary quantities of resistance and capacitance through an Owen Bridge measurement, shown in Figure 2, or it may be derived from frequency and capacitance by means of the resonance

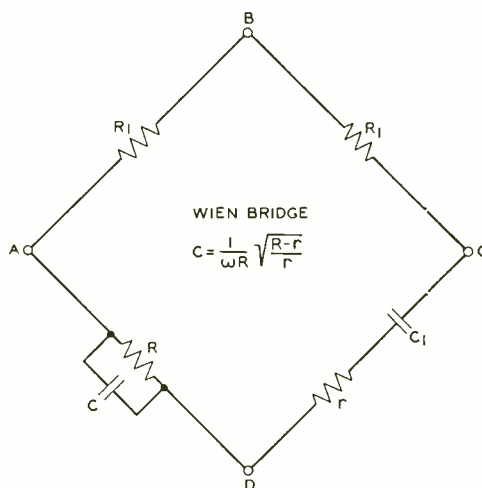

Fig. 1—Capacitances are standardized by means of the Wien Bridge, which gives capacitance in terms of resistance and frequency

bridge, shown in Figure 3. The sequence of these measurements is shown diagrammatically in Figure 4.

Our primary frequency standards consist of elaborately constructed 100,000 cycle quartz-crystal-controlled oscillators, mounted in special compartments to minimize the temperature changes to which they are subjected. Each standard is arranged to control a synchronous motor-driven clock through a 1000-cycle sub-multiple of the crystal frequency. A special contact mechanism and beat recorder enable us to compare the crystal frequency against time signals to one part in a hundred million. An absolute frequency precision of one part in a million is obtained.

From this 100,000-cycle primary standard, additional standards of 10,000 and 1,000 cycles are produced by sub-multiple vacuum-tube oscillators, and standards of 100 and 10 cycles are produced by sub-multiple motor-generators controlled by the 1000-cycle source. From these standard frequencies, all others may be calibrated by direct comparison, by the

use of the cathode-ray oscillograph.\*

The value of d-c resistance is furnished by the Bureau of Standards in the form of a calibration of several fixed resistance units especially designed to have high constancy with time and atmospheric conditions.

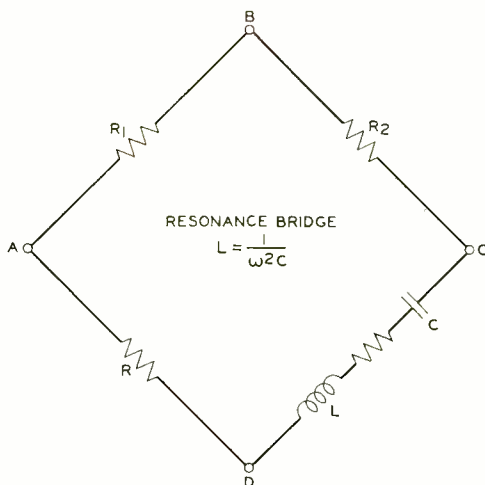

Fig. 3—With the resonance bridge, inductance is determined in terms of capacitance and frequency

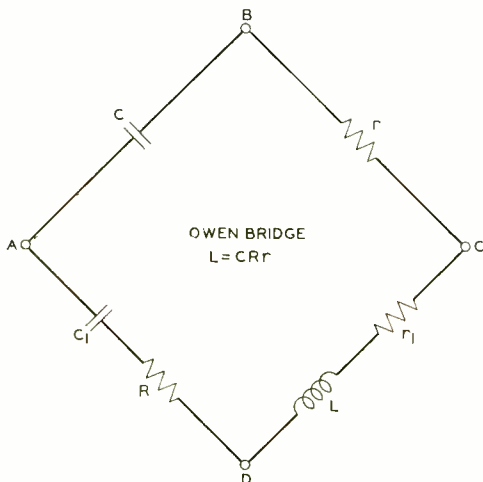

Fig. 2—With the Owen Bridge, inductances may be measured in terms of capacitance and resistance

These standards are of the common Bureau of Standards construction, shown in Figure 5, the coils being wound on metal spools to prevent deformation of the winding and minimize strains in the wire. The units are hermetically sealed in a metal case filled with oil that is free from air and moisture. Once a year the standards are shipped to Washington for recalibration and the latest values are used to correct the calibration of our primary d-c resistance bridge, Figure 5. This procedure enables us to calibrate our own working standards to accuracies better than five parts in one hundred thousand.

In passing from the d-c resistance reference standard to that for effective resistance, we merely design our units

\*RECORD, April 1927, p. 281.

of resistance so that the a-c increment is negligible and the d-c calibration holds for a-c operation also. The two principal factors that cause variation of resistance with frequency are skin effect and residual reactance. To keep down skin effect, a-c standard are wound with very fine wire. To minimize residual reactance, the winding is mounted on supports of insulating material instead of metal, and is specially formed to have minimum inductance and distributed capacitance. A typical 1000-ohm a-c standard having a woven winding of No. 44 gauge wire mounted on an isolantite spool has a residual of less than 2 microhenries. The ordinary inductive winding would have several hundred microhenries for a 1000-ohm unit. At audio frequencies the precision of such a carefully designed a-c standard is practically comparable with that of a d-c standard. For very high frequency operation it is necessary to check such standards for both resistance and phase-angle variation by comparison with resistance units of simple geometrical form whose a-c characteristics are readily computed. These geometrical standards usually consist of linear or rectangular shaped units of fine wire for low values, and sputtered metal film and carbon rod or film for high values.

Our primary capacitance standards consist of a group of individual dry stack mica units having extremely small phase differences. The units are potted in asphalt moisture-proofing compound and in turn housed in shielding cans for maximum stability. Changes due to aging are practically negligible since the

standards have had a life of over ten years. The bridge method is employed to determine their values because such a measuring circuit yields a high degree of precision when the quantities are required under a-c conditions.

Associated with appropriate a-c resistance standards, the capacitance standards are arranged in pairs to form the series and shunt impedance arms of the Wien Bridge of Figure 1. The bridge circuit is completed by connecting these arms to our primary comparison bridge, which is normally used to calibrate directly working standards of capacitance, as shown in the photograph at the head of this article. This permits us to utilize our most refined bridge construction and spares the need of building special apparatus. The values of the primary capacitance standards and of the associated resistance standards are specially proportioned so that the balance of the Wien Bridge is most sensitive and comes within one cycle of our 1000 cycle primary frequency standard. Interpolation to obtain the exact frequency to produce a balance can then be made by a special beat indicator to one ten thousandth of a cycle.

To insure high precision, several different Wien determinations are made using different sets of capacitance and resistance standards. In the past several years, as our technique has improved, the capacitance deter-

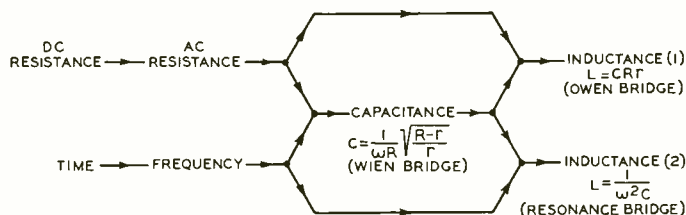

Fig. 4—Diagrammatic representation of the building up of standards of frequency, a-c resistance, capacitance, and inductance from the basic standard of time and d-c resistance

minations have yielded results consistent to better than one part in a hundred thousand. The primary values of capacitance thus established are in turn used to correct the internal "step-up" or substitution calibration of our wide range primary capacitance bridge, in the same manner that the fixed d-c standards are used to correct our primary d-c bridge calibra-



*Fig. 5—The primary d-c resistance bridge showing the Bureau of Standards type of resistance standards in the left foreground*

tion. Evaluation of errors from all possible sources indicates that the corrected calibration of our capacitance bridge is within one or two parts in ten thousand of the absolute value.

While the calibration of the capacitance bridge is based on the 1000-cycle values of our primary capacitance standards, it is assumed to hold at all frequencies for that part of the range using air condensers, which extends up to 0.01 mf. The calibration of the mica condensers above this value is had at any frequency by "step-

ping-up" from the air condensers.

The standardization of inductance might be derived from our primary standards of resistance and frequency in a kind of Wien Bridge circuit in the same manner as capacitance. But to build up a precise technique for such a method is not justifiable because the role of inductance standards in our system of precise measurements is substantially restricted on account of their inferior characteristics as standards. Their large bulk and instability with frequency make it impractical to construct a primary calibrating inductance bridge of the comparison type with the range and accuracy of our primary capacitance bridge. Hence, even if we were to determine a few isolated primary values of inductance from resistance and frequency, we could not use them directly to establish a wide range of values since this is possible only by sub-dividing or "stepping-up" a wide range comparison bridge. Consequently, we do not maintain single-valued primary inductance standards corresponding to the groups of fixed primary standards of capacitance and resistance.

Having once standardized capacitance, we can use it to measure inductance, either in combination with frequency as in the resonance bridge, Figure 3, or in combination with resistance as in the Owen Bridge, Figure 2. Both of these methods are employed in our standardizing laboratory for they possess peculiar conjugate advantages in covering the whole field of inductance. Unlike our Wien Bridge arrangement, the standardizing resonance and Owen Bridges are arranged to determine a wide range of inductance values so that they are actually used as primary calibrating bridges in the same sense as our primary capacitance bridge.



## Dissipation Constants in Solids

By H. WALTHER

*Physical Research*

WHEN a bar of carefully annealed aluminum is held in the middle and struck at one end, the sound emitted by it may be heard for more than a minute. If the same is done to a bar of lead, the absence of any musical note is usually dismissed with the remark that the bar is "dead." Now, of course, the aluminum bar is just as dead as the lead bar, if both are regarded as inanimate objects; and the lead bar is just as much alive as the aluminum if both bars are considered in terms of their constituent atoms or electric charges.

Then why do we hear the ring of the aluminum bar and not the lead? The answer lies in their difference in behavior toward mechanical vibration.

In the aluminum bar the longitudinal vibration produced by the blow is relatively vigorous and is sustained because internal resistance to motion of elongation and contraction is small. The energy imparted to it is gradually radiated into the air and some of it reaches our ear. In lead, on the other hand, internal resistance to strain motion is enormously large as compared to aluminum. The result is that the vibration is in the first place only great enough to be barely audible, and furthermore dies out so fast that within one tenth of a second the displacement at the ends of the bar is reduced to about one millionth of its original value. In this case practically all the energy is *dissipated* within the bar, and goes to raise the temperature

of the material. The amount of heat generated, of course, is very small indeed, due to the extremely small amplitudes of motion involved. For instance, in a lead bar  $\frac{1}{2}$ " in diameter and 30" long, a light blow at the end produces an amplitude of motion of about  $10^{-7}$  cm. The corresponding rise in temperature would be roughly  $10^{-14}$  degree centigrade per second, a rate of heating which if sustained under perfect insulation, would require three million years to raise the temperature of the bar by one degree!

As low as this rate of dissipation of energy in lead seems, it actually is unusually high among solids. To distinguish between various solids in this respect there is used what is known as the *dissipation constant* of the material. This quantity is based on vibrational

measurements of a particular sample of the material and is defined as the ratio of mechanical reactance to mechanical resistance of the sample. Mechanical resistance and reactance are terms quite analogous to the more

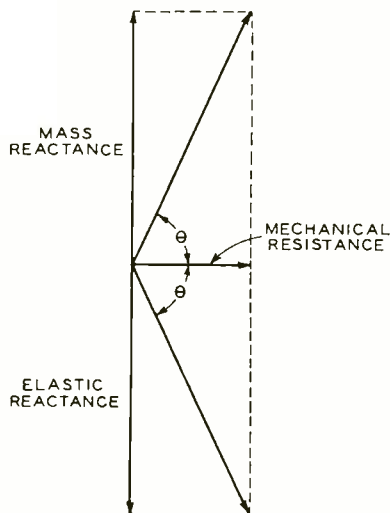

Fig. 2—The vector diagram for a bar vibrating at resonance always contains a resistance vector. The phase angle  $\theta$  of either of the impedance vectors will then be less than  $90^\circ$ , and since  $Q = \tan \theta$ , the dissipation constant will always be finite

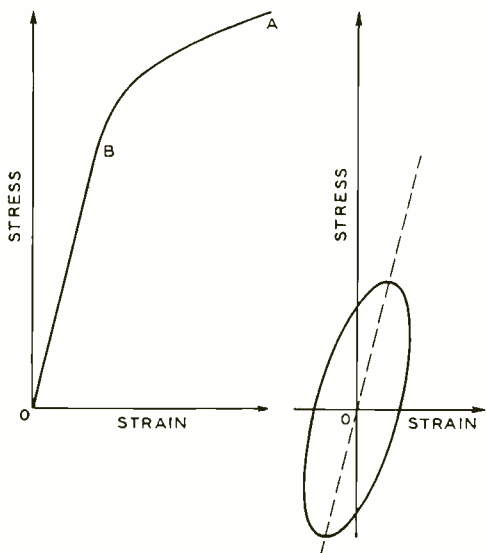

Fig. 1—Although most engineers think of the stress-strain diagram as a single line  $OA$  curving beyond the elastic limit  $B$ , more refined measurements show that for even the smallest deflections the diagram is a closed loop. The area of this loop is a measure of the internal resistance and the slope of its sides at any point is a measure of the elastic reactance

familiarly known corresponding electrical terms. Thus in a bar vibrating longitudinally, the mechanical resistance measured at one end is simply that quantity which when multiplied by the square of the velocity of motion of that end gives the power dissipated in the bar. Just like an electrical system, a mechanical system involves two reactances. One is the mass reactance, which is the product of effective vibrating mass by  $2\pi$  times the frequency; and the other is the elastic reactance, which is that quantity which when multiplied by  $2\pi$  times the frequency gives the force per unit displacement. The two reactances are numerically equal when the bar is vibrating at one of its natural fre-

quencies, and so it is immaterial which one is used in the calculation of the above ratio. The elastic reactance, also called stiffness reactance, is the more convenient one to use. In a bar vibrating longitudinally, the elastic reactance is proportional to Young's modulus  $E$ , and the resistance is proportional (by the same factor of proportionality) to  $\omega\mu$ , where  $\omega = 2\pi f$  and  $\mu$  is the internal viscosity\* of the material. So that numerically the dissipation constant of a solid is given by

$$Q = \frac{E}{\omega\mu}$$

The viscosity  $\mu$  varies approximately inversely as the frequency, and since  $E$  is found to be independent of frequency, the quantity  $Q$  is a constant as far as frequency is concerned. From a physical standpoint, the magnitude of  $Q$  then is a measure of the relative magnitudes of reactance and resistance present in a given sample

of the material. Thus far no material free from mechanical resistance has been found. The determination of  $Q$  does not necessitate a direct knowledge of  $E$  and  $\mu$ , however. These two quantities may be calculated from easily made measurements of response at certain frequencies, as shown in Figure 3. When the amplitude at resonant frequency  $f$ , and the frequencies  $f_1$ ,  $f_2$  at which the amplitude is  $1/\sqrt{2}$  times this value are known, we have the relationship

$$Q = \frac{f}{f_2 - f_1}$$

\*RECORD, November, 1929, p.94.

In the simplest case then the dissipation constant can be obtained directly from three measured frequencies.

Considerable work has been done in these Laboratories on several phases of the subject. The headpiece shows H. C. Rorden with the apparatus used for measuring internal dissipation of solids. The slender bar to be measured, shown in the center of the picture, is supported at its middle on a rigid mounting. A magnetic receiver structure is placed near each end. An oscillator connected to one of the receivers is tuned to the resonance frequency of the bar. The resulting longitudinal vibration of the bar induces a voltage in the second receiver, which is amplified, rectified, and read on a meter. The tuning of the driving current is controlled by the precision condenser on Mr. Rorden's right, and the response of the bar is

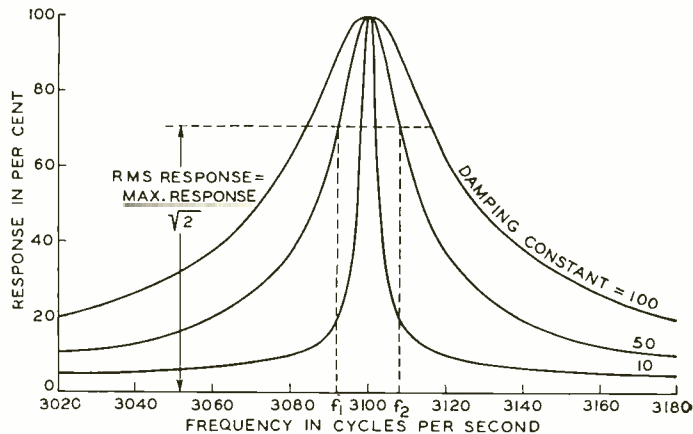

Fig. 3—Typical frequency-response curves for resonant bodies. The general expression is

$$Q = \frac{f}{\left[ \frac{r}{\sqrt{1-r^2}} \right] (f_2 - f_1)}$$

where  $f_1$  and  $f_2$  are two frequencies at which the response is the same fraction  $r$  of the maximum response  $R$ . The expression

in the square brackets becomes unity when  $r = \frac{R}{\sqrt{2}}$

read on the meter beside the condenser.

A list of typical solid materials reveals a very large range of values for the dissipation constant. A minimum of 30 for the Q of a hard piece of lead and a maximum of 50,000 for a soft piece of aluminum are not unusual. It is necessary to state whether a given material is hard or soft because when lead with a Q of 30 is softened by annealing, the Q may be increased to a value of 200. Similarly when a soft piece of aluminum with a Q of 50,000 is severely cold-worked by rolling or bending, the Q may be reduced to 8,000. Again, of two bars of steel identical in size, shape, and composition, but one of them hardened by heating and quenching and the other softened by careful annealing, one finds upon tapping their ends that it is the soft one which rings the longest. The dissipation constants of most solids are found between the two extremes of lead and aluminum just mentioned. The table below gives values of Q for most of the solids investigated thus far. The figures indicate orders of magnitude rather than specific values, because, as pointed out above, considerable variation is possible for a given material under various conditions of internal strain.

Quartz, fused	over 100,000
Aluminum	50,000
Brass	40,000
Duralumin	30,000
Iron	20,000

Permalloy (80% Nickel)	9,000
Silver	6,000
Copper	3,000
Nickel	2,000
Zinc	1,900
Glass	1,600
Carbon (Graphite)	900
Tin	800
Lead-Calcium (.04% Ca)	600
Lead-Antimony (1% Sb)	100
Hard Rubber	50
Lead	30

It is interesting to note that the order in the list bears apparently no relation to other physical properties. Thus we have two of the softest metals occupying positions near opposite extremes of the table. Two solids like zinc and glass, on the other hand, differ greatly in hardness, and in electrical resistivity; still their mechanical dissipation constants are nearly the same. Again, carbon and tin are almost alike from the standpoint of mechanical dissipation; yet if we should arrange the list according to melting points, we should find the one at the head and the other at the bottom of the list. But the apparent non-correspondence with the more well known physical properties, and the extremely large range of values of dissipation constants, might furnish a means for investigating hitherto unsolved problems involving different kinds of solids and different states of internal strain or structure for a given solid.





## Toll Transmission Measuring System for the No. 8 Test and Control Board

By K. LUTOMIRSKI

*Toll Circuit Development*

FOR some time vacuum tubes have been used in many types of testing apparatus to amplify the weak testing currents so that they will operate a milliammeter, since testing methods which employ meters are generally more accurate and faster than those which use a receiver and the ear in making determinations. Until recently, however, it was necessary to use these meters in indirect measuring methods by which the results were obtained from calibrated dials rather than from the meter itself. New arrangements have now been developed by which the results of transmission, noise, crosstalk, and other measurements may be read directly from a rugged quick-acting meter calibrated in db, this meter being designed to have a substantially uniform scale. In addition to speeding up testing, the

new arrangements permit more flexible assemblies of the testing apparatus so that the meter and the control features can be incorporated in the test boards used for general circuit maintenance, the major portion of the apparatus being located elsewhere. Previous arrangements did not permit this separation of the parts, and the transmission testing facilities were of necessity located in separate test boards.

A simple form of such a direct reading transmission measuring system has been included in a new type of test board\* which is particularly suitable as a place for making transmission tests, since it provides direct access to all of the circuits terminating in the office under the conditions which obtain in service. By restricting the transmission testing done at this board

\*RECORD, July, 1934, p. 337

to single frequency transmission measurements on complete circuits, features have been introduced which have resulted in material economies. A single oscillator and control panel is used to supply the standard testing power to every position of even the largest test boards in such a way that there is no interaction between positions. The oscillator and its control panel together with the amplifier-rectifier required for each receiving circuit are mounted some distance from the board. A meter, a key-controlled pad for extending the range of the meter, two calibrating dials, and keys for connecting the transmission measuring circuits to the testing cords in the test board are the principal additional apparatus required in the test board to provide for transmission measuring. The calibrating and adjusting of the oscillator is done at intervals, usually of 8 to 24 hours.

Transmission measuring in the past has been done by aid of the 6-A transmission measuring set which is arranged at special transmission test boards, as shown in Figure 1. The circuit employed is indicated by the simplified schematic of Figure 2. In brief, the method consists in sending over the circuit to be lined up a definite

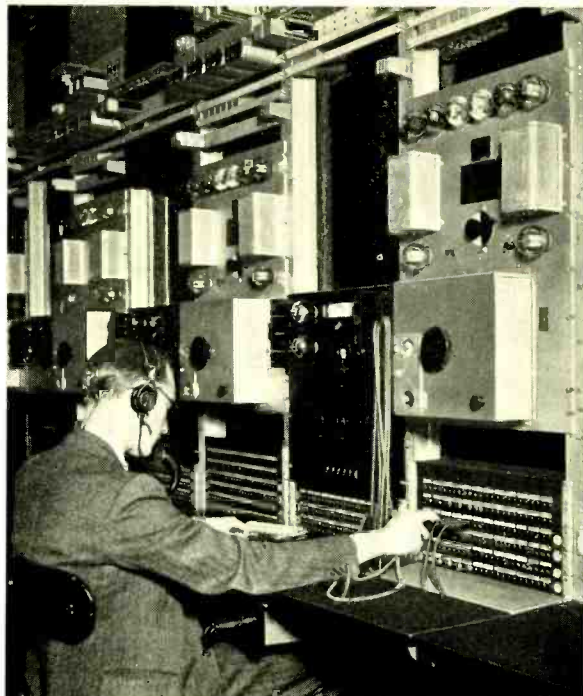

Fig. 1—At a 6-A test position is an oscillator, used as a source of the testing power, a meter for reading power sent and received, and the necessary keys, dials, and jacks by which the connections to the circuit to be tested are made and adjustments accomplished

amount of power obtained from an oscillator mounted at the test position, and measuring the net loss or gain at various points on the circuit. Each test board includes both sending and receiving equipment, but for any one test the attendant at the sending end of the circuit adjusts the sending power to the proper value while the loss is measured at the receiving point.

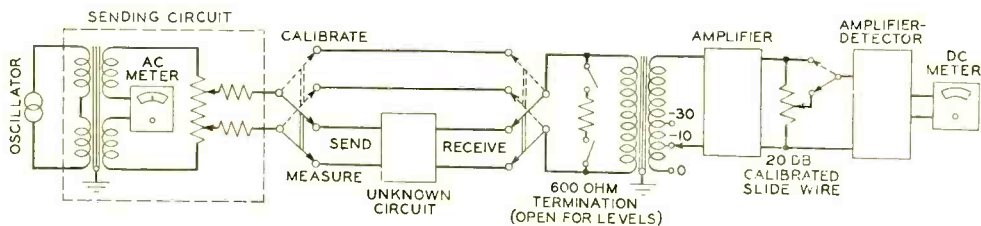

Fig. 2—Simplified schematic of 6-A transmission measuring circuit

The receiving equipment consists of a high impedance input transformer, an amplifier, a slide-wire attenuator calibrated in db, a detector-amplifier, and an indicating meter. In preparation for a measurement, the sending circuits at each end are adjusted to supply the standard testing power of one milliwatt, and then the receiving measuring equipment is calibrated. This is done at the receiving end by connecting a sending circuit directly to the receiving circuit, as shown by the upper path in Figure 2, and adjusting the detector-amplifier until the pointer of the meter is at mid-scale. The sending circuit at the sending end is then connected to the line to be tested, and the measuring circuit at the receiving end is connected to the receiving terminals of the same line. The attenuator is then moved until the meter is at mid-scale, when the net loss or gain in the circuit can be read from the attenuator dial, which indi-

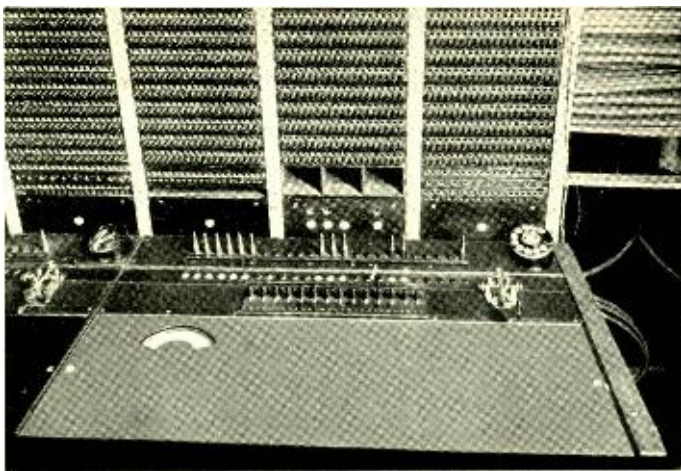

Fig. 4—A direct-reading db meter is built into the keyshelf of each transmission-measuring position

cates the db gain or loss that had to be inserted to bring the meter to a mid-scale reading.

Although the results obtained from this method are satisfactory, the measuring set is slow to operate because of the large amount of checking and calibrating that has to be done, and also because the lines to be tested are not directly accessible to the testing position. Only a single meter is employed at each position, and it is used both to measure the oscillator output and to indicate the received power.

This necessity of switching the meter back and forth consumes time, particularly as the pointer has to be adjusted to mid-position for a transmission measurement. Also considerable adjusting is required since each adjustment is likely to affect those made previously. For accurate results several adjustments have to

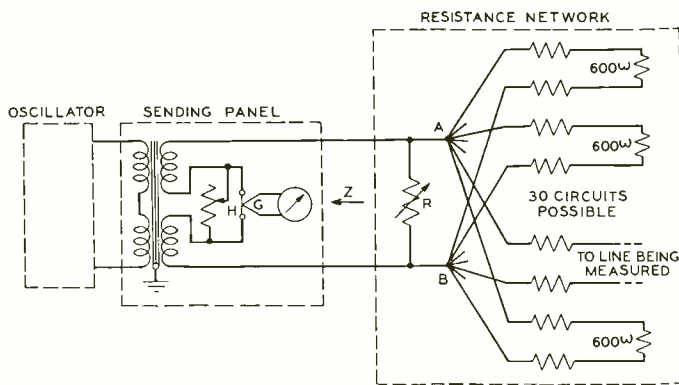

Fig. 3—An oscillator and sending panel are mounted on a relay rack remote from the test and control board

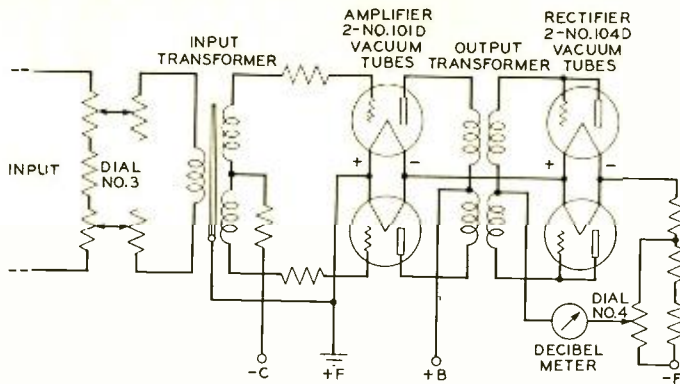

Fig. 5—Amplifier-rectifier circuit used with new transmission-measuring circuit

be made for each measurement. To avoid the necessity of such frequent adjustment, and thus to speed up transmission measurements, the new measuring set was developed.

By far the greatest amount of testing is done at 1000 cycles; other frequencies are used for only occasional tests. The equipment for the new measuring circuit has been greatly simplified, therefore, by employing a single oscillator, adjusted to 1000 cycles, which supplies the entire test board. This oscillator and the sending panel associated with it are mounted on a relay rack remote from the test board.

The circuit arrangement is shown in Figure 3. The oscillator supplies sufficient output to provide one milliwatt to more than

thirty circuits, which is more than is usually required at any one board. Each of the testing circuits is bridged with an impedance of 600 ohms when not in use, and the transformer in the sending circuit steps down the impedance of the oscillator to a very low value. This, in conjunction with a resistance network, minimizes the effect of variations of the impedances of the lines from 600

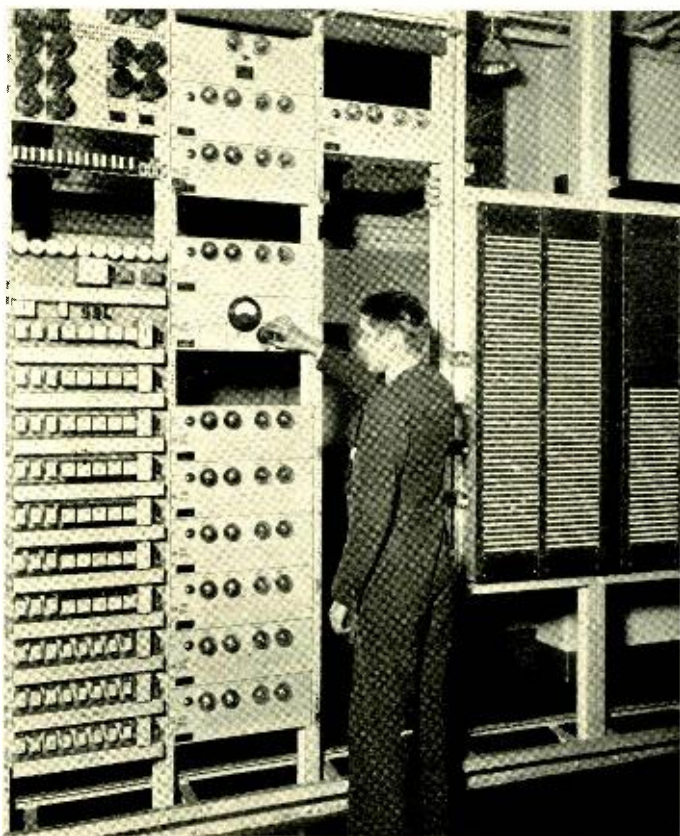

Fig. 6—Mounted on a relay rack, the oscillator is at the top, the sending panel at a height convenient for adjusting the output and reading the meter, while the amplifier-detectors occupy the remaining space

ohms. A thermocouple meter, permanently mounted on the sending panel, measures the output of the oscillator.

One of the features of the new measuring set is the direct-reading db meter, which is a part of the receiving circuit. This meter is built into the keyshelf of the measuring position as may be seen in Figure 4. The receiving circuit itself, shown in Figure 5, consists of a push-pull amplifier coupled through a transformer to a full wave rectifier. A sensitivity-control potentiometer, dial 3, and a scale-adjustment potentiometer, dial 4, are mounted in the face of the board for the convenience of the attendant. The scale-adjustment potentiometer makes it possible to compensate for variations in tube characteristics.

The amplifier-rectifier is calibrated by sending a milliwatt into it through a 10 db pad and adjusting its sensitivity by means of dial 3 so that the

meter reads mid-scale which is marked zero loss. The set is then capable of measuring losses from zero to 5 db and gains up to 5 db. If the pad is removed the set will measure losses between 5 db and 15 db. The amplifier-rectifiers are mounted on the relay rack with the oscillator and sending circuit, as shown in Figure 6. The db meter is specially designed to have a substantially uniform scale reading in db. To make this possible the pole faces have been shaped according to a predetermined curvature.

Experience with several of these test board installations shows that a testing speed of several circuits per minute is obtained on routine tests as compared to about two minutes per circuit with previous arrangements. This saving in time is due to the direct reading high-speed meter and to the provision of this measuring system in a test board which has excellent facilities for picking up circuits.



# The Electrical Constants of the Ground

By C. B. FELDMAN

*Radio Research*

IN transmitting short radio waves over long distances the useful energy travels by way of the ionized region of the upper atmosphere. The waves conveying it depart from the transmitter, and arrive at the receiver, at an angle with respect to the earth. Under these circumstances the ground near the transmitting and receiving sites affects the waves, and it becomes of practical importance to know the values of the dielectric constant and resistivity of the ground in the neighborhood of those sites.

Two methods have been developed to determine these properties. In the more direct method, samples of earth are removed from the plot under examination, and the impedance of a cell filled with the earth is measured. In the other, the properties of the ground are inferred from the observed effects of the ground on radio waves.

The cell used for measurements by the first method is a condenser consisting of concentric gold-plated cylinders, shown in the center foreground of Figure 1. The impedance of this condenser when filled with earth is compared with that of a parallel combination of adjustable resistance and ad-

justable capacity. A tuned circuit loosely coupled to a shielded oscillator is used to determine when the impedance of the simulating unit is identical with that of the earth cell (Figure 2).

To preserve the natural degree of compactness of the earth to be studied, a sampling cup is used to remove from the ground an amount of earth just sufficient to fill the cell. First the cell is plugged into the circuit, and the tuned output voltage and the setting of the tuning condenser are noted. The cell is then replaced by the simulating unit, and the latter is adjusted until the same resonant output voltage occurs at the same tuned setting of the condenser. From the values of resistance and capacity finally read from

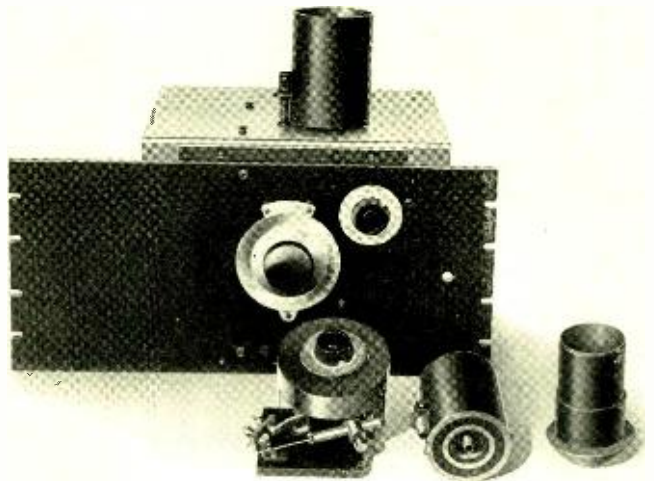

*Fig. 1—The simulating unit, earth cell, and sample cup, used in direct measurements of the electrical properties of the ground, are shown from left to right*

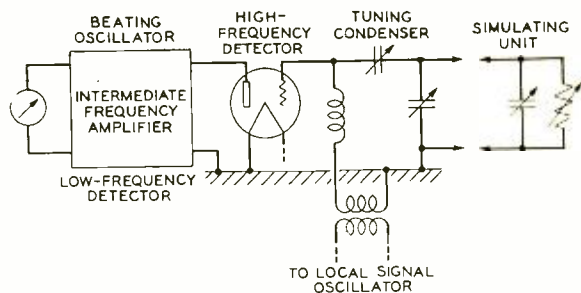

Fig. 2—In this circuit the impedance of the earth cell is compared with that of the simulating unit

the simulating unit, the values of the resistivity and dielectric constant of the earth can be calculated, when the earth cell has been calibrated. The calibration was made by comparing the simulating unit with the cell when the latter was filled with distilled water, with alcohol, and with carbon tetrachloride, substances whose electrical properties are known.

The direct method of measurement is well adapted to the study of the variation of the properties of the ground from place to place, but it is not altogether reliable as a method for determining the effective values of these properties which determine the behavior of the ground toward radio waves. The properties of the ground on a transmitting or receiving site vary considerably from point to point and it is difficult to be sure that enough samples have been taken to assure a fair average. Even more importantly, the properties of strata underlying the surface have at times considerable effect on radio waves, and when these properties differ greatly from those at the surface, the effective values desired may be far from the values determined by mea-

surements at the surface. The desired values can, however, be obtained by measurements on radio waves propagated over the ground in question.

The "ground wave", that portion of the radiation from an antenna which is propagated parallel and near to the surface of the earth, rapidly assumes and thereafter retains a characteristic form. In addition to the main vertical component of electric field, there is a small horizontal component, and the two are slightly out of phase. Vectors representing them at various points at a single instant are shown in Figure 3.

It can be seen that, as the wave passes any one point, the resultant vector will rotate, and its end will trace an ellipse whose major axis is not perpendicular to the surface of the earth (Figure 4). Theoretical analyses\* show that two properties of this field—the ratio of the maximum vertical component to the maximum horizontal component, and the phase difference between them—can be jointly used to determine the electrical constants of the ground. By simple geometry the ratio and the phase difference of the components can be determined from the ratio of the axes of the ellipse and its inclination.

\*By Sommerfeld and others

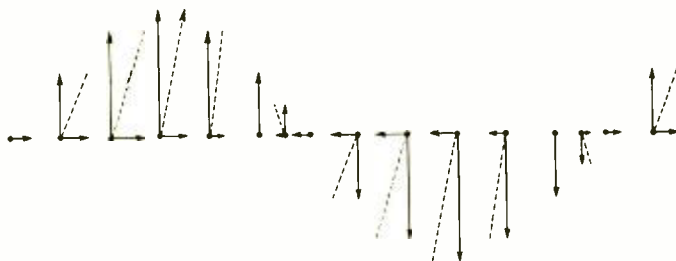

Fig. 3—The ground wave is characterized by an electric field whose main vertical component is accompanied by a small horizontal component not exactly in phase

These latter quantities can be measured by a receiving antenna of the doublet type (Figure 5) connected to a measuring set. The strength of the signal induced in such an antenna is proportional to the component of electric field parallel to it. A small portable transmitter is used to provide the signal. The antenna is rotated in the vertical plane of propagation, and measurements are made of the maximum and minimum signals received, and of the angle at which the antenna is turned while receiving the minimum signal. The ratio of the former quantities is the ratio of the axes of the ellipse, and the latter angle is ninety degrees greater than the tilt angle of the ellipse.

On account of the non-uniformity of natural ground, single measurements are not very reliable. Instead, a survey of a particular site must be made, comprising measurements at various locations and with the transmitter at various points. Variation of the wavelength of the signal within a small range is also desirable, and the effects of dry and rainy weather should be taken into account. By such a survey, it is possible to "iron out" the irregularities and to obtain values representing a nearly equivalent homogeneous ground.

Such a procedure carried out at a

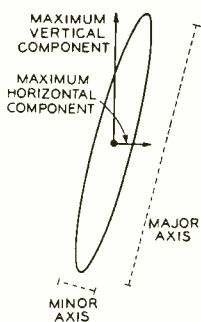

Fig. 4—The electric vector of the field of the ground wave traces a tilted ellipse

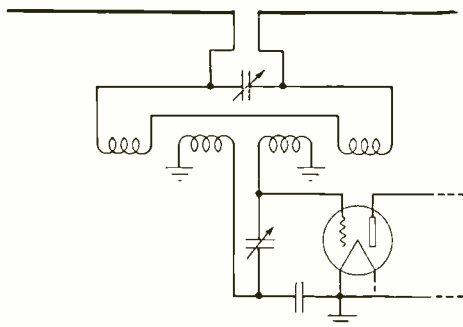

Fig. 5—To measure the ratio of the axes, and the tilt angle, of the elliptical field of the ground wave, a rotatable antenna is used, consisting of two rods connected through a repeating coil to the receiver

typical site determined the phase difference to be about 16 degrees, and the ratio of the vertical to the horizontal components of electric field to be 5.3, at a wavelength of 15 meters. These values correspond to a conductivity of  $1.5 \times 10^{-13}$  electromagnetic units, or a resistivity of about 6800 ohm-centimeters, and a dielectric constant of 25. Similar measurements made at the transatlantic receiving station at Netcong yielded a value of phase difference of 9 degrees, and a value of the ratio of 2.9. The corresponding resistivity is about 33,000 ohm-centimeters and the dielectric constant is 8.

In comparing the values of ground constants obtained by the two methods, they are found to agree very well for the ground at Netcong which is comparatively little stratified. At Holmdel, certain sites have been found to be so stratified that close comparison is impossible. Data obtained at another site suggests that highly conducting ground, beneath poorly conducting ground, is especially likely to "show through", for the constants obtained by the ground wave method agree well with direct measurements of the sub-soil.





# Retardation Coils for Precision Filters

By P. S. DARNELL.

*Telephone Apparatus Development*

IN carrier communication circuits a single pair of conductors is made to provide a number of distinct communication channels by the provision of a separate carrier frequency for each channel. At both ends of the line, band-pass filters are employed to separate the channels. These are designed to pass with very little attenuation all frequencies between certain limits, known as the cut-off frequencies, and to attenuate greatly all frequencies beyond these limits. Since the carrier side band corresponding to each channel must be placed within narrow limits in the frequency scale, the cut-off frequencies of the filters which pass these side bands must be held to very close limits. If the pass bands of these

filters were not properly located, the transmitted side bands would be effectively narrowed, and in addition interchannel cross-talk might result. Since the cut-off frequencies depend on the values of the capacitances and inductances comprising the filter, as discussed in an accompanying article,\* close requirements on the filter transmission characteristic necessitates that the condensers and coils used therein be held closely to their specified values.

Under ordinary manufacturing conditions the precision of condensers can be held to about .3 per cent, but the precision of coils cannot usually be maintained closer than 1.1%. Because of certain modulation require-

\*By H. E. Kahl, p. 379



Fig. 1—Coils for precision filters are wound in two sections and then placed in a rectangular container of moulded material

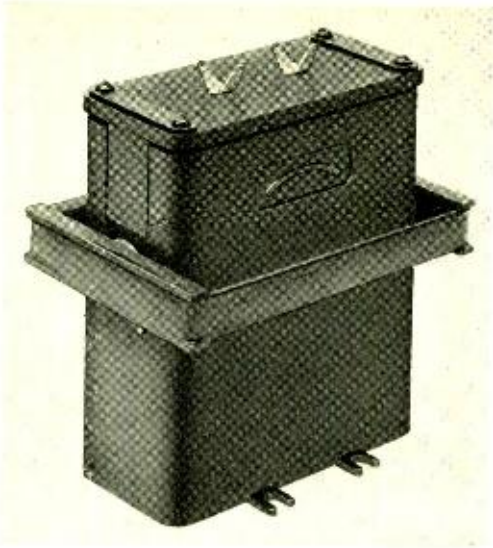

*Fig. 2—The adjusting coil fits over the container of the main coil and is pivoted to it*

ments and economic advantages, solenoidal air-core coils are ordinarily used in precise carrier filters. As a result the coils must be shielded in the final assembly to prevent stray fields from affecting adjacent circuits. The shield is of non-magnetic material, and since it forms a conducting path around the coil, it reduces the inductance of the coil. Part of this reduction can be allowed for by designing the coils for somewhat greater inductance than would be required without the shields, but due to variations in the coil diameters and small uncontrollable variations in the relative positions of the coil and shield, a residual uncertainty of about .7% remains which must be added to the manufacturing variation. The overall possible error of the coil when in its shield is thus 1.8%. The sum of the coil and condenser errors is thus about 2.1%, and the resultant variation in the filter characteristics would be slightly over 1%, whereas in certain carrier systems precision as high as 0.25% is required.

Since the greatest part of this error

lies in the coils, it was evident that an attack on the problem of greater precision could most hopefully be made at that point. It had always been necessary to adjust the values of the coil inductance after winding, and for that purpose more turns were initially wound than would probably be needed. After preliminary test, the requisite number of turns were then removed. The subsequent potting of the coils introduced further slight variation, so that the final error might be as much as the 1.1% mentioned above. A method of making a final adjustment after the coil has been potted has been developed, and is in use by the Western Electric Company.

The coils are wound on spools which are placed in rectangular containers as shown in Figure 1. As already mentioned in discussing the effects of shielding, any closed conducting path of non-magnetic material around the coil has the effect of reducing the coil inductance. Advantage is taken of this fact in obtaining the required adjustment. An auxiliary short-circuited coil is wound on a form that fits over the coil container and fastens to it, on pivots, on the two narrow sides. The arrangement is shown by the photograph of Figure 2, and diagrammatically in Figure 3. The effectiveness of this adjusting coil in reducing the inductance of the main coil is a function of the amount of magnetic flux that effectively links with the turns of the adjusting coil. The path of the flux is indicated on the sketch, and it is evident that with the coil horizontal the effective flux linkage is zero and that as the coil is turned, as in the position indicated, the amount of flux linkage between it and the main coil increases.

With such a coil it is possible to adjust the inductance of the main coil

with very high precision. The limiting factor is the precision with which the position of the adjusting coil can be set. The relation between the position of the adjusting coil and its effect on the inductance of the main coil is shown in Figure 4. To give the coil the ability to adjust either up or down from the nominal value, the main coil is designed to give the nominal inductance when the adjusting coil is at a position which allows equal adjustment, either up or down. This is called the nominal position and the scales of Figure 4 are marked accordingly.

Because of the non-linear relationship indicated by the curve, the precision of adjustment is greater in some positions than in others. When the

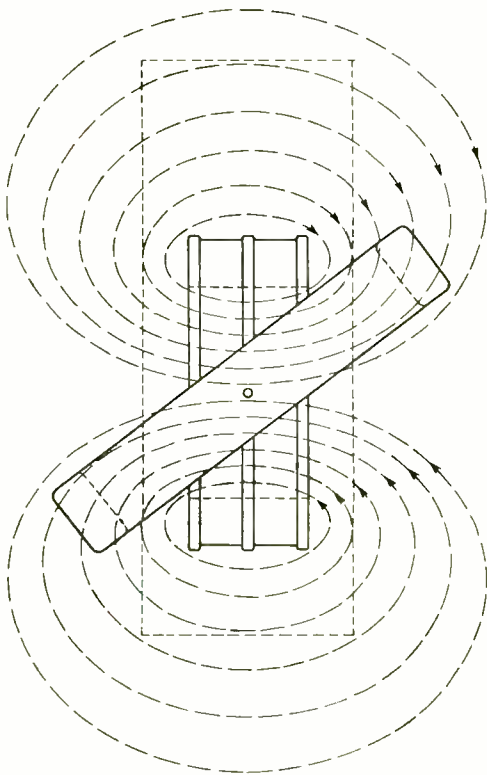

Fig. 3—Diagrammatic representation of the interrelation between main and adjusting coils

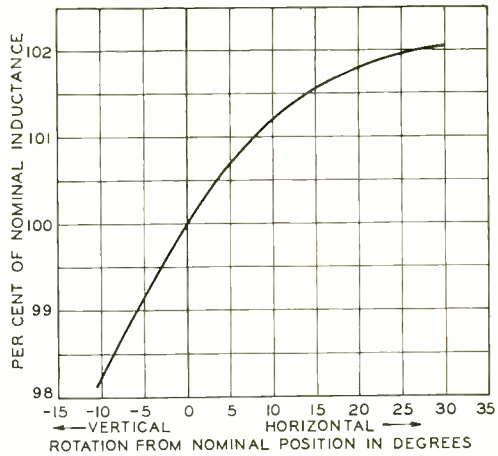

Fig. 4—Relation between change in inductance of main coil and angular motion of adjusting coil

adjusting coil is horizontal an angular movement produces a relatively small change in inductance while as the coil approaches more nearly the vertical position, the same change in angle produces a much larger change in inductance. The greatest precision in adjustment is thus obtained at the horizontal position. Assuming that the angle of the coil can be set to within one half degree, which can readily be done, the corresponding precision of inductance adjustment is .012% with the rotor five degrees from its horizontal position, and .1% with the rotor in the upper position.

To permit clamping the adjusting coil accurately in the position set, the pivots by which it is supported are cone shaped, and a sliding central section at each end of the case is also cone shaped at the bottom and may be pressed down against the conical support of the coil by adjusting screws at the top of the case. This arrangement is shown in Figure 2. By screwing down these end plates after the rotor has been set in position, it is securely held in place.

The assembling procedure is to put the coil in the case and to set the adjusting coil in the nominal position, which is indicated by a short straight arrow moulded on the end of the case as may be seen in Figure 2. The inductance of the coil is then measured and is brought to approximately the nominal value by removing turns. After this the container is filled with sealing compound and the coil is ready for the final adjustment by use of the short-circuited coil as described in the following article.

To insure satisfactory performance of these high precision coils, not only must accurate adjusting features be provided, but the coil itself must be most carefully designed and built to minimize all undesirable characteristics. What is desired in a coil for precise filter networks is a pure inductance, but pure inductances cannot be obtained. Any coil will have resistance, and thus produce a dissipation of energy, and it will also have capacitance, and the combined effect

of inductance, capacitance, and resistance varies with frequency. Although neither resistance nor capacitance can be eliminated, they can be made very small and so proportioned that their effect is minimized. The conductor with which the coil is wound is composed of a large number of individually insulated fine copper wires twisted together and covered with textile insulation. The size of both the individual and the overall conductor must be selected to give the most desirable results over the frequency range for which the coil is to be used. To keep the distributed capacitance low, the coil is wound in sections with paper between layers of the conductor and the leads from the coil to the terminals are kept as far apart as possible.

Due to these refinements in design, and to the careful manufacture and testing in the Western Electric shops, it is now possible to secure filters whose accuracy fully meets the requirements of modern carrier systems.



# Adjusting Precision Filters

By W. E. KAHL  
*Telephone Apparatus Development*

THE loss-frequency characteristics of band-pass filters, used to separate the various channels in carrier communication circuits, depends largely upon how closely the can be held to a precision which theoretical resonance frequencies of component series and parallel resonant branches can be realized. A typical band-pass filter containing eight resonant branches is shown schematically in Figure 1. The resonance frequency of a two-element branch is equal to  $\frac{1}{2\pi\sqrt{LC}}$ , and thus to hold this frequency within close limits the values of inductance and capacity — L and C — must be accurately controlled.

The greatest source of error in the product LC has been due in part to the limits of adjustment for retardation coils. With the development of the short-circuited adjusting coil, described in an accompanying article\*, means were available for securing the desired inductance of a retardation coil to far greater precision than had been possible heretofore. Because the resonance frequency is proportional to the product of L and C, the adjustment provided for the retardation coil is able to do more than to secure the desired value of inductance. It makes it possible, by securing the desired value of the product of L and C, to correct for small errors in the capacitance as well as in the inductance. If the value of the capacitance is somewhat too large, the

inductance can be made proportionately too small and vice versa, so that the value of the product of L and C may be set to the same precision as the value of L alone.

In making the final adjustments, therefore, associated coils and condensers are assembled and wired as they will be in the completed filter, and the adjusting coil of each inductance is moved in turn until the proper resonance frequency is secured for each circuit branch. This is determined by a circuit known as the L-C bridge, and the complete adjustment is known as the L-C adjustment. This bridge, shown schematically in Figure 2, is a comparison type bridge which is in balance only when the inductance and capacitance being measured are in resonance. The oscillator is set at the desired resonance frequency, and the adjusting coil is then moved, in conjunction with the variable resistance, until a balance is obtained.

When completely assembled, the elements of a filter are installed in completely enclosing shields, and as discussed in the accompanying article, the shields reduce the inductance of the coils. As a result, if the coils were adjusted outside of the shields

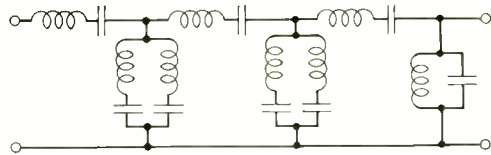

Fig. 1—Schematic of band-pass filter

\*By P. S. Darnell, p. 375.

they would not be in proper adjustment when inside them. To secure the full advantage of the adjusting coil, therefore, some means had to be devised for adjusting the coils under shielded conditions. Since the shields employed are completely enclosing and have soldered seams, adjustment after the coils were finally installed was out of the question. It was found, however, that an effect similar to that of the completely enclosing shield could be obtained in a fairly simple manner.

The coils and condensers forming the resonant elements of the filter are mounted on wood sub-panels, which are placed within the filter shields.

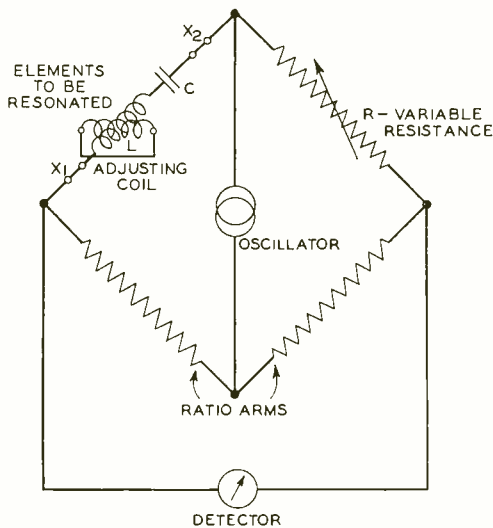

Fig. 2—Schematic representation of the L-C bridge which, in conjunction with the adjusting coil, permits each component resonant circuit of a filter to be set to the correct resonance frequency

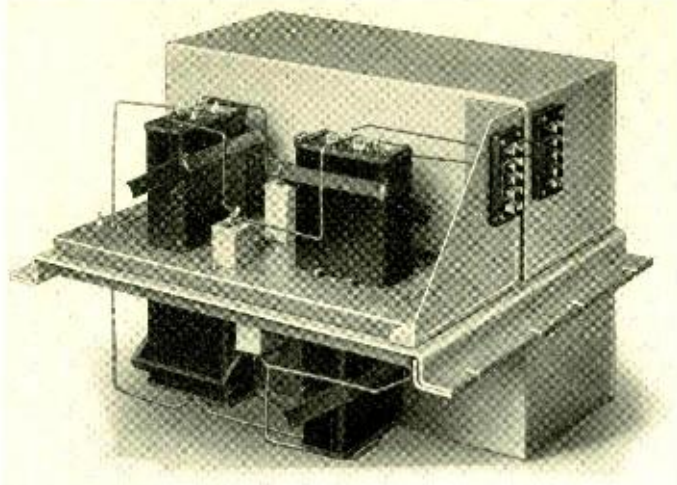

Fig. 3—One possible arrangement of coils and condensers mounted on their sub-panel and with shielding cut away

The number and arrangement of the coils and condensers on these sub-panels varies somewhat but a typical arrangement is shown in Figure 3, where part of the shielding is cut away to show the coils and condensers. It was found that if a shield were built of the same dimensions as those used with the filter, but with one end open, it would have the same effect on the inductance of the coil near the closed end as the completely enclosing shield. It was possible, as a result, to build open-ended shields into which the sub-panels could be slid while the coils were being adjusted. The actual arrangement provided is shown in Figure 4. Two of the open-ended shields, spaced apart a distance equal to the length of the sub-panel, are mounted on a common base.

After the coils have been set to their approximate nominal inductances with the adjusting coils in the mid position, they are mounted on their sub-panels and wired to their associated condensers. The panel is then slid into one of the compartments of the adjusting shield, the compartment

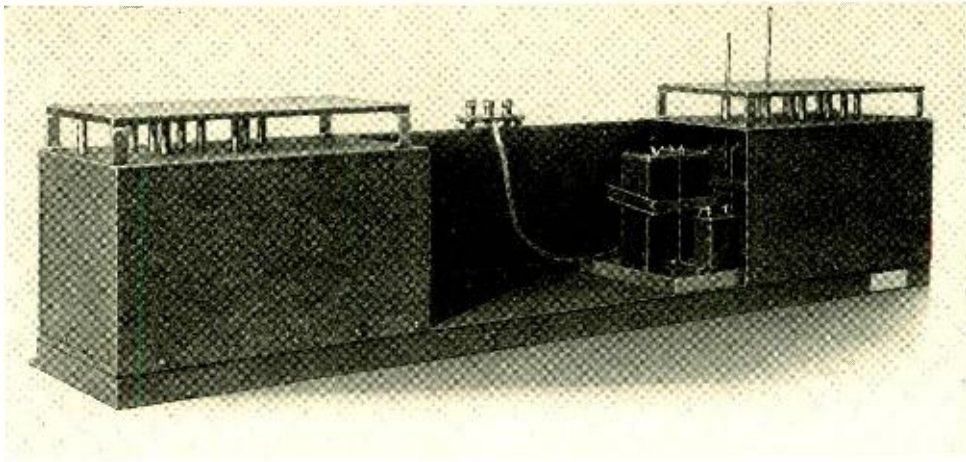

Fig. 4—The provision of two open-ended shields on a common base permits the two coils on a sub-panel to be rapidly adjusted under shielded conditions

chosen depending on the physical location of the coil to be adjusted. To be able to make the adjustments while the coil is within the shield, it was necessary to provide two hard rubber rods, projecting through holes in the top of the shield, with which the adjusting coil could be moved. These holes are arranged so that the rods rest on the tops of opposite sides of the adjusting coil. By pushing on one or the other of these rods the coil may be moved to any desired position. This process is repeated for each coil to be adjusted.

During this adjustment the locking screws that are used to clamp the adjusting coil in place are left loose so that the coil can be moved. After the adjustment has been made, the panel is slid into the open center of the shield and the locking screws are tightened. The

panel is then put back in the shield for a final check to make sure the adjustment has not been changed while the adjusting coil was being clamped.

The precision of adjustments of filters by the L-C method is far superior to anything obtained before. The transmission loss characteristic of filters can now be held to manufacturing limits of  $\pm .2\%$  in frequency

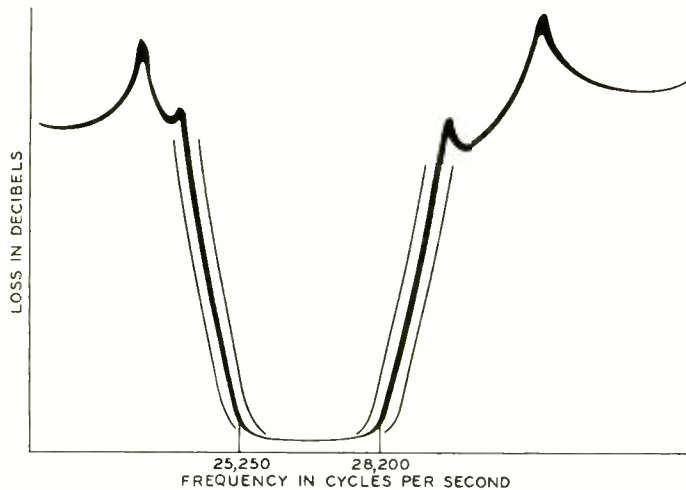

Fig. 5—Frequency characteristics of a band-pass filter showing relationships between the precision obtainable with the L-C adjustment and that obtainable with the former practice

whereas previously about  $\pm 1.0\%$  was the best precision obtainable. To cite a specific example, Figure 5 illustrates the spread of transmission characteristic for band pass filters of the type shown schematically in Figure 1. The shaded area indicates the region in which all transmission characteristics will lie when filters are adjusted by the LC method. The extreme solid curves represent the best limits realizable without LC adjustment.

The new method of adjustment results from the development of the new adjusting coil, which permits very close setting of the inductance, and from the development of the apparatus adjusting shields which allow the setting to be made under the shielded conditions that will exist in

the finished filter. This new method has the advantage of adjusting in one operation for errors in both inductance and capacitance, or rather in their product, which is the distinguishing feature of the LC adjustment, and can be extended to branches having more than one resonance frequency if more than one coil is in the branch.

This method of resonance adjustment has already spread beyond the field of carrier filters for which it was developed. Other types of filters, attenuation and delay equalizers, impedance correctors, in fact all apparatus employing solenoidal non-magnetic core coils and requiring precise attenuation, impedance, or phase characteristics have already profited by its development.

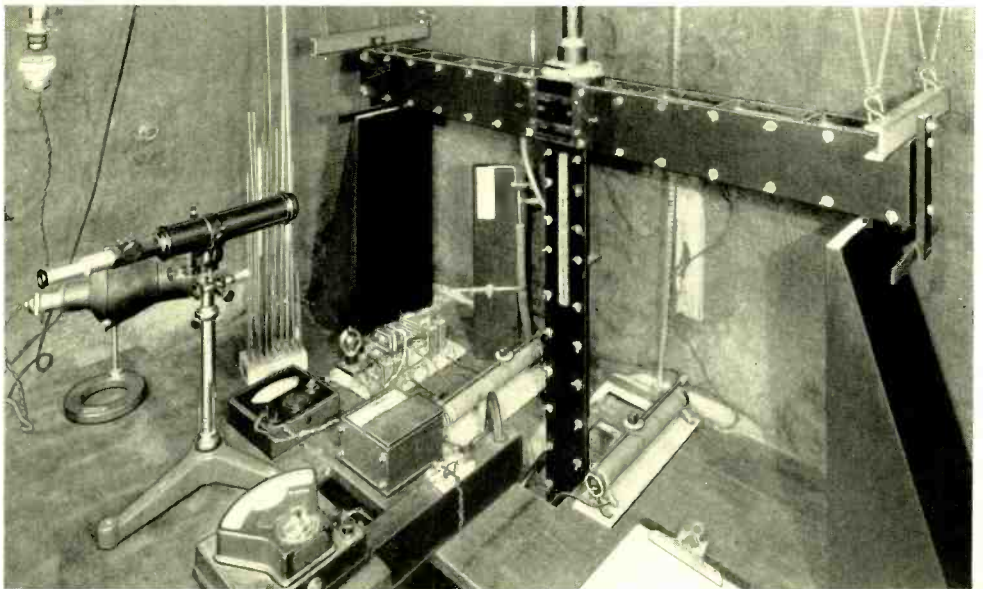

*Determining the dissipation constants of materials subject to alternating strains at extremely low frequencies and deflections. The material, in the form of a long wire, is enclosed in a partially evacuated box and twisted through a small angle by the momentum of a long horizontal bar with adjustable weights at the ends. Values of viscosity and Young's modulus determined in this manner are comparable with those obtained at higher frequencies as described by Mr. Walther elsewhere in this issue.*



(000) (000) (000) (000) (000) (000) (000) (000) (000) (000) (000) (000) (000) (000) (000) (000) (000) (000) (000) (000)

## Contributors to This Issue



the Inspection De-  
 partment of the  
 Western Electric Com-  
 pany, 463 West Street  
 in New York, the  
 American Telephone  
 and Telegraph Company  
 in 1901. Four  
 years later he joined  
 the Circuits  
 Department where  
 he engaged in  
 the design of  
 automatic tele-  
 phone systems  
 among the important

and its telephone applications. With the recent combination of the Department of Development and Research and the Laboratories, Mr. Molina has returned to the West Street building.

C. B. FELDMAN received from the University of Minnesota the degree of B.S. in 1926, and the degree of M.S. two years later. He came at once to the Laboratories and has been conducting studies of wave propagation, especially over radio transmission paths.

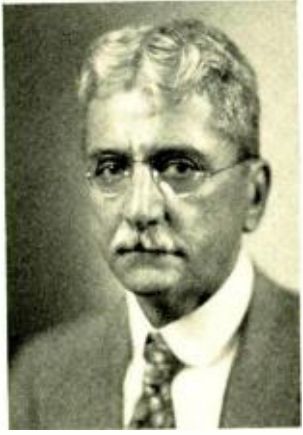

*E. C. Molina*

ENTERING the Apparatus Development Department in 1921, W. E. KAHL joined the group which designs filters, equalizers and other transmission networks. As an incident of the development of those devices for the Type C carrier system, he devised the method of network adjustment which he describes in this issue of the RECORD. He was concerned with the carrier networks for the auditory perspective



*C. B. Feldman*



*W. E. Kahl*



*P. S. Darnell*



*H. Walther*



*K. Lutomirski*



*S. J. Zammataro*

demonstration in 1933, and more recently he has been working on networks for the new telephotograph system. He graduated in 1924 from the Student Assistants' Course given in the Laboratories.

AFTER RECEIVING the degree of B.S. in Electrical Engineering from the University of Pennsylvania in 1922, P. S. Darnell joined these Laboratories. His first work the investigation of the effects of temperature and humidity on switchboard wire and cable, in connection with which he studied the means of producing and controlling desired atmospheric conditions. In 1925 he received the M. A. degree from Columbia University, and transferred to the group developing retardation and loading coils. In 1928 he took charge of the group developing filter coils, loading coils, and magnetic materials. The work of this group was later divided, and he is now supervisor of the group developing coils for use in networks.

IN 1922 H. WALTHER started work in the Development Shop as an instrument maker. Seven months later he was transferred to the Research Department where he became active in the early stages of the development of microphones for broadcasting. He later was engaged in the development of electromechanical oscillators, mechanical amplifiers, vault detectors and hearing aids, and in the adaptation of the phonograph recorder to commercial use. In 1925 he received the

B.S. degree in electrical engineering from Cooper Union. Later he undertook work under the Educational Department's plan for post graduate study at Columbia University and in 1932 received the A.M. degree. At present he is engaged in the study of internal viscosity of solids.

K. LUTOMIRSKI studied from 1911-1914 and 1918-1921 at the Technical University of Delft (Holland) graduating in 1921 with a degree of e. i. (electrotechnisch ingenieur). During the war he was in charge of military signaling systems in Holland. In 1922 he worked for the telephone company of the Hague (Holland). In 1923 he came to the United States where he joined the laboratories of the Western Union Telegraph Company, and later the Local Systems Development Department of these Laboratories. Some two years later he transferred to the Toll Systems Department and is at present in charge of toll transmission measuring systems.

BEFORE graduating from Cornell, S. J. Zammataro spent three summers on coil design with the Engineering Department of the Western Electric Company. After getting his E.E. degree in 1921, he returned to these Laboratories and for four years was engaged in testing work in the Special Products Laboratory. He later became interested in alternating current bridge measurements and now supervises this work.