

WILMINGTON  
INSTITUTE

DEC 18 1933

FREE LIBRARY

# BELL LABORATORIES RECORD



100-KILOWATT  
VACUUM TUBE  
H. E. Mendenhall

WEATHER PROOFING  
TELEPHONE WIRES  
W. J. Lally

MODULATION  
IN TRANSFORMERS  
E. T. Hoch

DECEMBER 1933 Vol. XII No. 4

# BELL LABORATORIES RECORD

---

*Edited by the Bureau of Publications:*

PAUL B. FINDLEY *Managing Editor*  
PHILIP C. JONES *Associate Editor*

*Board of Editorial Advisors:*

O. E. BUCKLEY    W. FONDILLER    H. A. FREDERICK  
O. M. GLUNT    H. H. LOWRY    W. H. MATTHIES  
JOHN MILLS    D. A. QUARLES    J. G. ROBERTS  
W. B. SANFORD    G. B. THOMAS    R. R. WILLIAMS

BELL TELEPHONE LABORATORIES, INCORPORATED  
463 West Street, New York, N. Y.

---

## *In this Issue*

Frontispiece . . . . .	97
In this resistance furnace, crucibles rise through the interior of the alundum tube shown in the foreground while their contents are being heated.	
100 Kilowatt Vacuum Tube . . . . .	98
<i>H. E. Mendenhall</i>	
Lubricating Brushes for M-Type Generators . . . . .	103
<i>R. D. de Kay</i>	
Weatherproofing of Telephone Wire . . . . .	108
<i>W. J. Lally</i>	
Equalizers in Open-Wire Carrier Circuits . . . . .	113
<i>A. L. Stillwell</i>	
Minimizing Modulation in Transformers . . . . .	117
<i>E. T. Hoch</i>	
Transmission Measuring Circuit for Transformers . . . . .	120
<i>J. S. Elliott, Jr.</i>	
Telephone Manufacturing Information . . . . .	123
<i>L. E. Parsons</i>	

# BELL LABORATORIES RECORD

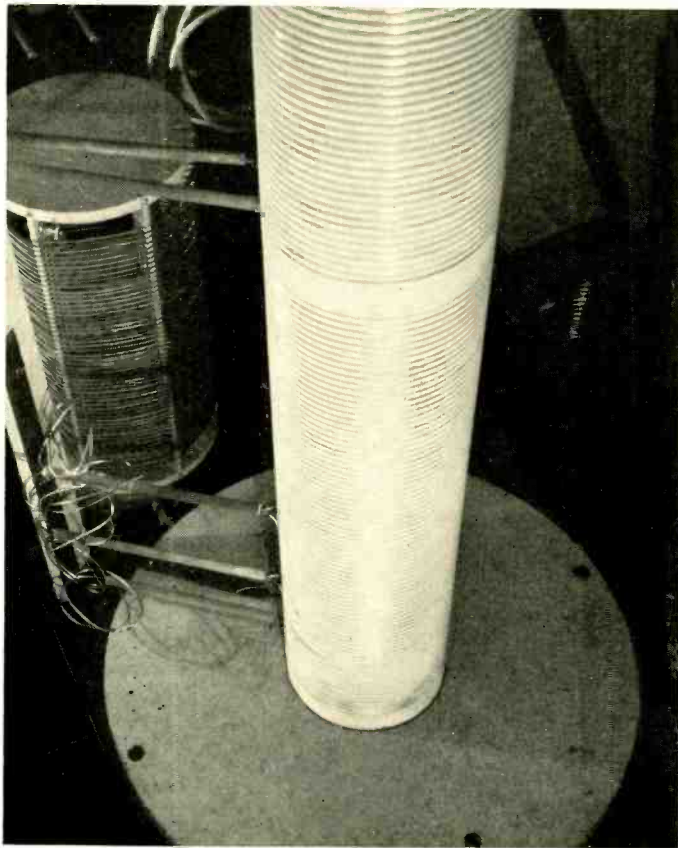

VOLUME TWELVE—NUMBER FOUR

*for*

DECEMBER

1933





## A 100 Kilowatt Vacuum Tube

By H. E. MENDENHALL  
*Vacuum Tube Development*

OVER five hundred vacuum tubes in parallel were used for the first transatlantic radio telephone conversation\* in 1915. Since then vacuum tubes have undergone almost continuous development. The application of water cooling has permitted much larger capacities, and the present long wave transatlantic channel employs but thirty tubes, each of fifteen kilowatt rating. Further improvements in design and manufacturing technique have made possible still higher ratings. A tube is now available—the 265A—which has an anode dissipation of 100 kw. Six of such tubes will provide a greater output than the thirty employed for the present transatlantic service.

This radical increase in capacity,

\*RECORD, October 1925, p. 43.

which has made it possible to obtain outputs of as many kilowatts as have formerly been obtained in watts, has been made possible by two developments—both of which originated in these Laboratories. The limitation to capacity is largely a matter of dissipating the heat generated in the tube. By employing water for cooling the anode surfaces, however, the amount of heat that can be carried away has been greatly increased. This method of cooling has in turn been made possible to a large extent by the development of a satisfactory copper-glass seal.

Neither water cooling nor the copper-glass seal were used for the first time with the new tube, but the technique of employing both of them has been recently improved by V. L.

Ronci and his associates, and the success of the new tube depends to no small extent on the recent advances made in these two developments. A simplified cross-section of the new tube, shown in Figure 1, shows the construction. The copper tube forming the anode is slightly flared at each end, and then these flared ends are carefully machined to a thin knife edge. Next, the anode is supported on an expanding mandrel of a lathe-like machine whose end chucks rotate coaxially and in synchronism. An open ended glass bulb is then mounted in one of the end chucks, and flames for heating the entire mass, and other flames to provide a high concentration of heat, are lighted and the machine is started.

The clean copper surface adjacent to the glass is first allowed to oxidize until the correct surface condition is obtained. This oxide layer must have sufficient elasticity to take up the strains caused by slight differences in the coefficients of expansion of copper and glass. Next, the glass is softened and spread over the copper surface by an ingenious roller tool supported on the center axis of the machine. This same tool also carries a nozzle through which is forced a stream of nitrogen to blow the glass bulb into the final shape desired. Following this, the process is repeated for the bulb at the other end of the anode. After the seals have been made, the ends of the bulbs are temporarily closed with an ionization manometer sealed to one of the bulbs, and the completed anode assembly is evacuated and baked. Manometer readings are then taken periodically over an extended interval to make sure there are no small leaks in the copper or the seal before the filament and grid structures are sealed in.

The cooling water passes at high velocity in the narrow space between

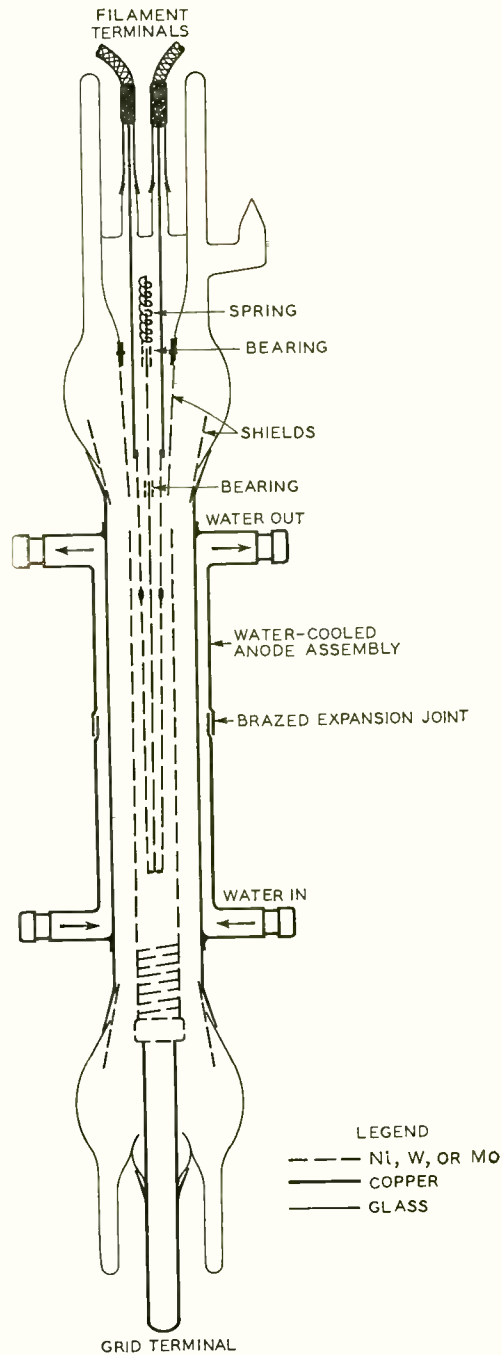

Fig. 1—Simplified cross-section of the 265A tube

the copper anode and an outer copper sleeve which is brazed to it before the copper-glass seal is made. Two water ports at each end of the outer sleeve give entrance and exit to the water, and also serve as points of support for the tube. This outer sleeve when brazed to the anode is in two parts. These two parts slightly overlap near the middle and are left open until the final degassing of the finished tube has been completed. Were it not for this provision, the high temperatures attained by the tube during the degassing process would cause a differential expansion of the copper anode and the outer copper sleeve, which being in direct contact with the air is much cooler, and would cause harmful strains in the copper structure.

The design of the filament structure is unique in employing no insulating supports at the ends of the V's, and in a very simple arrangement for maintaining the filaments under tension. The apexes of the three filament V's hang downward and are passed over tungsten hooks within a molybdenum cap which fits loosely over a shoulder on a heavy central support rod. This rod passes through two bearings—seven inches apart—at its upper end, and is free to slide in them

so that its weight maintains a tension on the filaments. Additional tension is obtained by a large coiled tungsten spring at the upper end which, fastened to the frame, exerts a downward pressure on the rod. The molybdenum supports of the upper ends of the filament V's are cross-connected and welded to the two copper leads which in turn are silver soldered into copper rods hollowed out to thin-walled tubing extending to the glass seal. This construction allows a further drop in temperature of the materials between the filaments and the copper-to-glass seals. The main support of the filament structure is obtained from a large copper-to-glass seal enclosing the upper filament rod bearing. This end of the filament assembly is enclosed with nickel sheet to provide a protective electrostatic shield to prevent destructive discharges at the high operating anode potential of 18,000 volts. Other vital points such as the anode seals are also protected by electrostatic shields.

The three filament V's are connected in parallel and have an active length of more than four feet. About 4000 watts is required for heating, which maintains the filaments at a temperature above 2500° K and gives an elec-

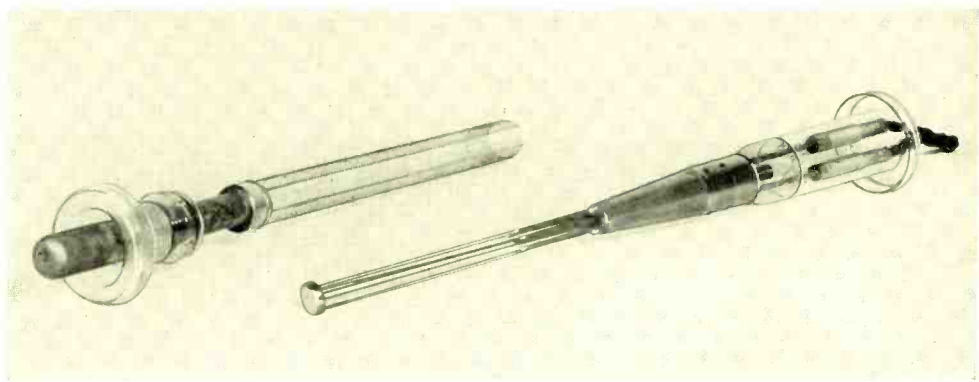

*Fig. 2—Grid and filament structures of the 265A tube*

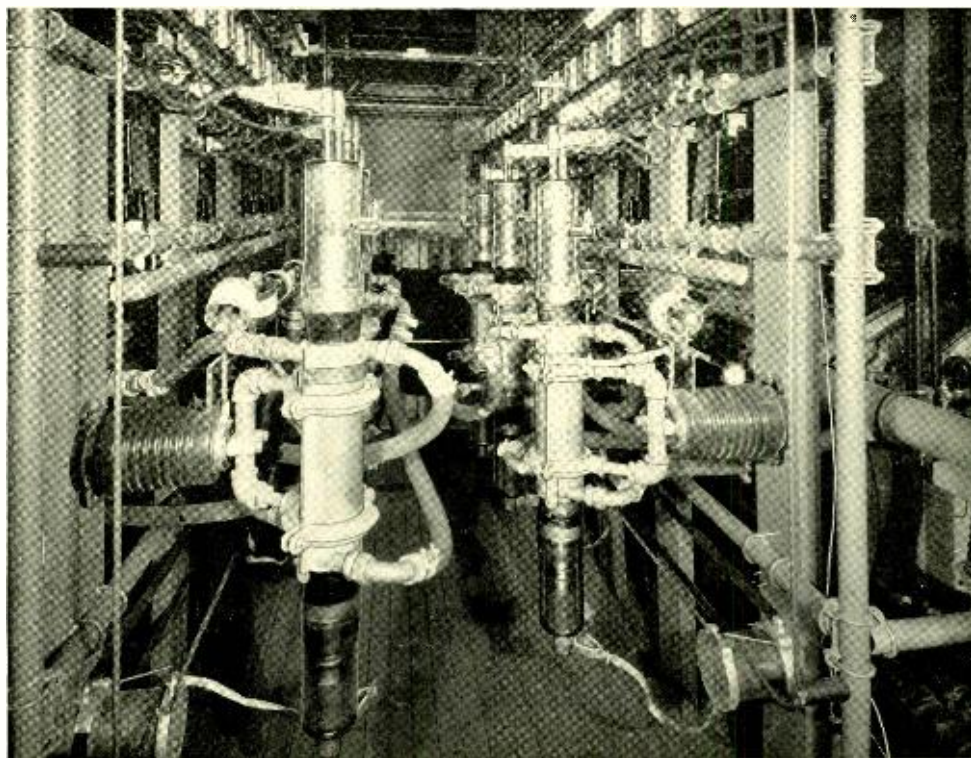

*Fig. 3—265A tubes installed in an experimental transmitter at Whippany*

tron emission of over thirty amperes.

The grid structure, which is supported from the opposite end of the tube, is shown with the filament structure in Figure 2. The grid must be kept below a temperature of  $1100^{\circ}$  K to prevent the emission of primary electrons when it is negative with respect to the other electrodes. This is accomplished by using relatively more and larger grid verticals and fewer laterals than are normally used, and in employing a large copper support structure which is cooled by the natural upward draft around the tube. Heat readily flows down the large cross-section of the grid verticals to the copper support, which has a bright heat shield to reflect from it the heat from the filament that would otherwise be absorbed.

The completely assembled tube, which is over four feet long, requires a long exhaust process, involving constant attendance for about 24 hours. Special split ovens are placed around the glass parts of the tube, and the metal parts are heated by external torching, filament glowing, and grid bombardment. During the pumping process the entire structure is maintained at very high temperatures, much higher than exist during ordinary operation, so as to free the high-melting-point metals from occluded gases. The temperature of the anode becomes so great that high velocity air streams for cooling are required to keep it from collapsing. The nickel shields within the tube are degassed by induction heating. It is these high temperatures that necessitate a break in the outer



copper sheath to prevent large differential expansion. At the end of the degassing processes the two parts of this outer sleeve are brazed together since it and the anode will hereafter be at approximately the same temperature due to the cooling water.

One of the completed tubes is shown in the photograph at the head of this article, and a group is shown in Figure 3 installed in an experimental trans-

mitter at the Whippany laboratory which has been the proving ground for these tubes. For shipment the tubes are packed in sturdy crates with spring suspensions so that the tube practically floats in the compartment. The flexible copper braid for the filament leads, which carry approximately 200 amperes when the filaments are lighted, are anchored back to a band support collar when not in use.

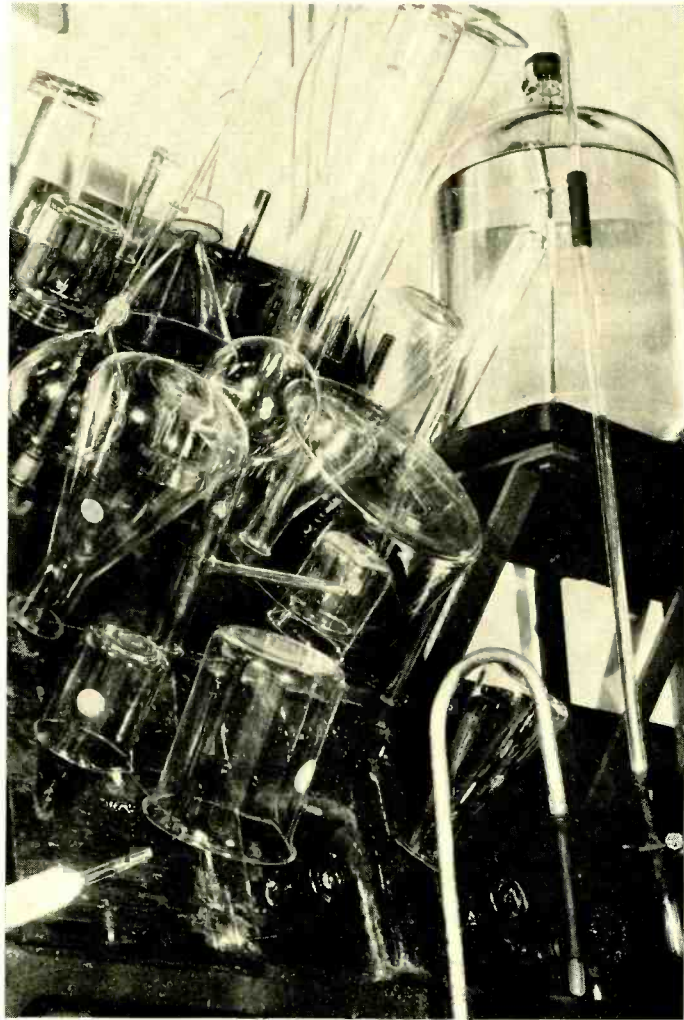

*Glassware gets but little rest in the Chemical Laboratories, and that little chiefly while drying*





# Lubricating Brushes for M-Type Generators

By R. D. de KAY  
*Equipment Development*

WHEN a machine is designed for a certain use and method of operation, it is not always easy to change one of the component parts to adapt the machine to changed conditions. An instance of this is the brush used for M-type generators, shown in Figure 1. Efforts have been made recurrently for a number of years to employ a new type of brush for these machines, and yet it is only recently that a satisfactory substitute has been obtained. Even this accomplishment was made possible partly by other developments which somewhat simplified the requirements to be met. The M-type generator, used for over a third of a century for charging batteries in central offices of the Bell System, is a highly specialized machine. The primary thought in the minds of its designers was that it would be charging batteries which were supplying talking current to subscribers, and that disturbing electrical noise must be prevented from affecting the common supply current, with consequent disturbance of telephone conversations.

The designers performed their task in a remarkably ingenious manner, and produced a machine that was outstanding in its freedom from noise. The number of commutator bars was several times greater than is employed in similarly rated commercial machines, and instead of being placed in slots in the rotor, the armature conductors were placed on its surface—

a form of construction very difficult to wind but one which almost entirely eliminates the noise known as slot ripple. The general features of the construction of this generator have already been described in the Record\*. To minimize electrical noise and at the same time obtain good commutation with low brush voltage drop, the brushes were made of a fine-mesh copper or brass gauze, wound tightly and squeezed into a rectangular shape. They were long, and so flexible that any minute irregularities in the surface of the commutator, which might otherwise cause sparking, were taken up by the inherent springiness of the brush.

Such gauze brushes, although not uncommon at the time the type M generator was designed, have practically gone out of use with commercial machines in recent years. They have the disadvantage of requiring that the commutator be lubricated at short intervals. For this purpose, it has been customary in telephone plants to lubricate the commutator about once an hour with a mixture of vaseline and dynamo oil. In those days the practice was to run on the battery during the night and to charge the battery only during the day. Since an attendant was always present during the daytime, the necessity of lubricating did not seem a serious handicap.

Some time ago, however, a new

\*RECORD, December 1927, p. 113.

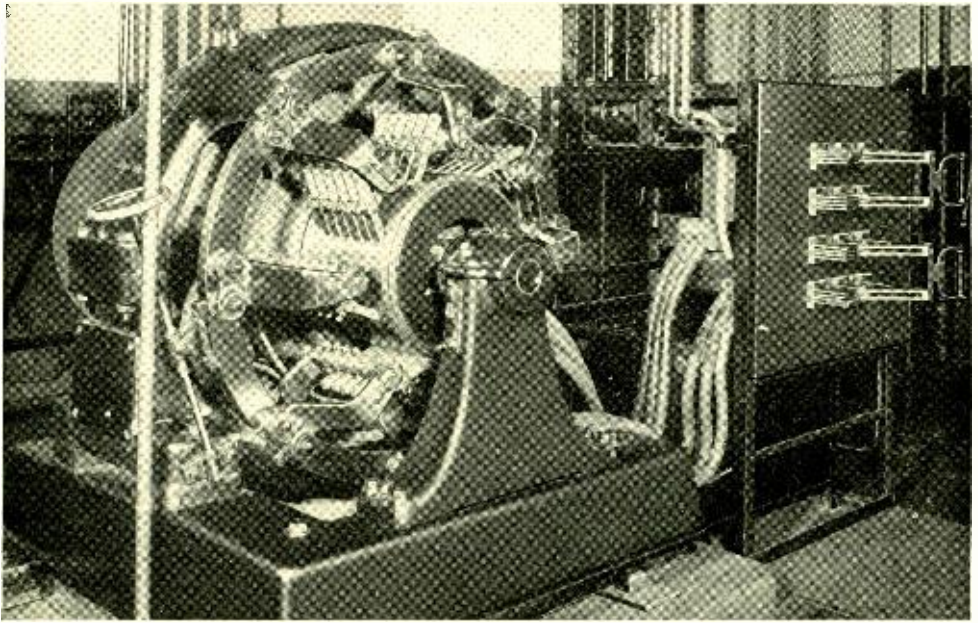

*Fig. 1—The original type M generator had long brushes made of brass or copper gauze*

method of operation began to come into use, which somewhat modified the situation. A method known as “floating” was initiated, which requires that the generator run continuously at a constant voltage—supplying the telephone load and also a small current to the battery sufficient to replace the battery standby losses. If a carbon or metal mixture brush could have been substituted for the gauze brush or if an automatic lubricating device could have been attached to the machine the resulting elimination of the hourly lubricating routine would have yielded appreciable operating economies. Trials of different brush materials were made in the following years, both on the factory test floor and on machines in operating offices, but invariably the commutator bars would become bridged by deposited material, and the output would be excessively noisy. Some brushes would cause the commutators to

overheat, others would pick up copper from the commutator bars, while still others would not wear down the mica insulation between bars sufficiently to prevent the condition known as “high mica.”

As a result of these tests it became apparent that the requirements of successful operation, which were satisfactorily met by the gauze brush, were not met with carbon or graphite brushes. To make the brushes ride properly and to prevent noise, the commutator had to be lubricated and at the same time it had to be kept free from conducting material to prevent bridging of the mica separating the segments. The vaseline and dynamo oil used with the gauze brushes gave adequate lubrication and at the same time was not conducting, and so did not form a conducting path across the mica. Excess lubricant runs off at the low brush rigging, and leaves the commutator at all times spread with

an even coating. With carbon or graphite brushes, although satisfactory lubrication is obtained from the material worn from the brush itself, this material is conducting and—adhering to the commutator—forms a conducting path between adjacent segments. Sparking under the brush invariably results.

While tests were being made of various types of carbon brushes, the problem was also being attacked from a different direction. From time to time trials were made of automatic lubricating devices with the intention of retaining the existing gauze brushes and of applying the fluid lubricant to the commutator by machine methods rather than by hand. It was hoped that by this means the generators could be made to run for 24 hours or more continuously without attendance.

Drip oilers of commercial design were used in various offices, but it was found that in order to prevent clogging of the fine orifice through which the oil drained, it was necessary to set the device at such a high rate of flow that an excessive amount of oil was delivered to the commutator. In some cases, this was accepted as a necessary evil and drip pans were placed under the commutator to catch the excess oil, but, in general, it was considered that this was not a desirable method. Trials were also made of various oiling devices consisting of pieces of felt or leather acting as wicks but here too, after many trials, complete success was not attained.

The introduction of commercial sets with accompanying noise filters\*, in 1927, modified the situation and lent fresh impetus to the search for carbon brushes. So effective were the new filters that noise produced by the gen-

\*RECORD, April 1927, p. 276.

erator became of minor importance. In offices where these filters were employed, therefore, it was felt that the only requirement that need be placed on a brush for the type M generator was satisfactory commutation. With these less severe requirements, a satisfactory carbon brush—

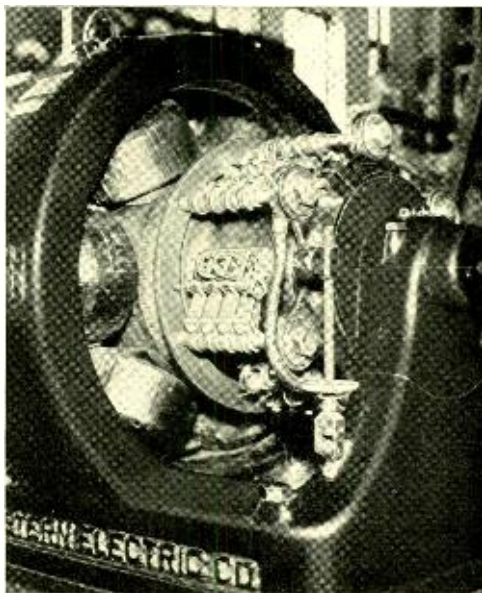

Fig. 2—An installation of carbon brushes on a type M generator showing supporting ring for inner end of brush studs

one of high metal content—was eventually found. Even with it, however, the commutator showed some signs of lack of lubrication, but this difficulty was overcome by employing one graphite brush per stud. The graphite brush would deposit some material which served as a lubricant and the metal-filled brushes following in its track wiped off a sufficient amount to prevent the mica's being bridged.

Trials with these new brushes brought out certain requirements that had to be met for satisfactory operation. The commutators must be turned down to a smoothness that does not



show more than .002" deviation on a surface indicator. The brushes must be supported very rigidly, and also, as in the case of the metal gauze brushes, must be set on the correct neutral point, which requires a different rocker arm position from that used for gauze brushes because of the different length of the brush holders. To secure a sufficiently rigid mounting on some of the larger machines, where the studs carrying the brush holders are long and supported at only one end, it was found necessary to employ a large fiber supporting ring fastened to the unsupported end of each stud as shown in Figure 2. A special box type holder was designed for all but the smallest generators so that the new brushes could be put on existing generators without adapters of any sort, which had been necessary in the trials. For the smallest generators it was found possible to use commercially available brush holders and adapters on which to mount them.

During the search for a suitable brush to replace the hand lubricated gauze brush, twenty-six brush materials, representing the product of ten different manufacturers, were tried. Many of these were tried several times with different conditions of undercutting, of flush mica, and of angle of inclination of the brush. Each trial required not only special conditioning of the commutator before and sometimes after the trial, but the making of special brush holder adapters for each machine. Although the original ob-

jective of a practically noiseless carbon brush was not obtained, the investigation was successful in yielding a brush that could be applied to existing type M generators, provided the offices were equipped with filters in the battery discharge leads.

About the time that a successful carbon brush combination was found, however, the investigation of a means of lubricating commutators equipped with gauze brushes was also bearing fruit. A trial of a special design of leather wiper on the commutator, through which oil passed from a reservoir above, was found to give fairly satisfactory service and following this a still better method was developed. This consisted of drilling holes in the gauze brushes on the uppermost stud of the generator and inserting in these holes pencil-shaped reservoirs of thin brass tubing, open at the top and plugged at the bottom with solder, having a carefully measured orifice in the solder through which wool yarn was drawn to act as a wick. The arrangement is shown in Figure 3. The reservoir and yarn does not extend down to the bearing surface of the brush, but the oil from the reservoir after passing through the yarn at a rate controlled by the diameter of the orifice spreads out through the bottom of the gauze brush and is evenly distributed at the contact surface of the brush and commutator. After many trials, the best average diameter for the hole was finally determined. It is practicable,

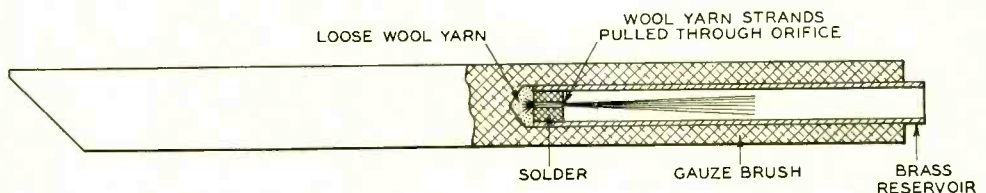

Fig. 3—Self-lubricated gauze brush for M type generator

however, for the individual maintenance forces to make the diameter of the hole larger or smaller by a simple soldering and drilling operation. The reservoirs are set loosely in the brushes and may be removed for cleaning or readjustment as desired. In general enough oil is held by the reservoirs to permit the generators to be run over night without attendance. The use of noise filters is not necessary when M-type generators are so equipped, of course, since the action of the gauze brushes is in no way changed by using this method of applying the necessary lubricant.

Both the carbon brush and the lubricating brush have their own particular advantages. The initial cost

of fitting the lubricating reservoirs into only a small part of the existing brushes on any one generator is relatively slight compared to the higher cost of furnishing a complete new set of brush holders and carbon brushes. Due to this and also to the necessity of making very careful adjustments, to the resurfacing of the commutator generally required when installing carbon brushes, and to the comparatively short life of the carbon brushes, it is believed that the M-type generators now in telephone offices will, in the great majority of cases, be equipped with the lubricating gauze brushes rather than carbon brushes when it is desirable to reduce the attendance on these machines.

### ELECTRICAL PHENOMENA IN GASES

*In reviewing ELECTRICAL PHENOMENA IN GASES by Dr. K. K. Darrow, the most recent book in the Laboratories series, NATURE (London) for August 19, 1933, says:*

*"The title of this volume indicates, not necessarily a wider scope than that of the classic treatise familiar to all, but the need for stressing a difference of outlook. Dr. Darrow rightly remarks on the advantages of regarding the current in, say, an arc between electrodes as but a minor feature of the hurly-burly of disrupted atoms, free electrons and positive ions which helps to determine the complex phenomena observed. His book, opening with a very clear account of ionization and excitation, proceeds through a discussion of interception and scattering to the end of the first section, which is thus concerned primarily with 'the actions and adventures of the individual atomic particles which underlie electrical phenomena in gases'. The second division of the book deals with drift phenomena, and its component chapters are headed 'Theory of Drift', 'Data of Mobility', 'Diffusion of Ions in Gases', and 'Recombination and Attachment'. Then, as the author genially remarks, with Chap. IX 'the profounder mysteries begin' and more than two hundred pages are devoted to break-down, space-charge, plasma and sounding-electrodes, the self-sustaining glow, and the self-sustaining arc.*

*"The book is well produced, and it is almost unnecessary to add that the presentation of the subject is admirably clear, concise and critical."*



# Weatherproofing of Telephone Wires

By W. J. LALLY  
*Outside Plant Development*

IN the pioneer days of the telephone industry, distribution was effected by the use of a single galvanized iron wire extending from the central office to the subscriber's station, the return circuit being through ground. The wires for the various subscribers were grouped on pole lines extending along the streets and highways, and at each subscriber's premises a wire was "dropped off", i.e., extended from the pole line to the subscriber's house or business establishment. Thus the wire extending from the main distribution line to the subscriber's premises early came to be known as a "drop".

With the growth of the industry, and particularly with the advent of the metallic return system, the number of wires required became so great that space limitations and the matter of appearance made the development of a more compact system of distribution essential. These service demands resulted in the development of the early types of multi-pair cable, and of a special wire for "drops".

The earliest drop wire was a twisted-pair wire with 14-gauge hard-drawn copper conductors, each of the conductors being rubber-insulated and covered with a weatherproofed braid. A 17-gauge copper-clad steel conductor was later substituted for the larger copper conductor, the steel providing the requisite strength and the copper, the necessary conductivity. Subsequent major changes in drop wire have been the adoption of a bronze alloy as a conductor material for the 17-gauge size, and the development of a parallel-type of wire in which the two rubber-insulated conductors, untwisted, are placed within a single weatherproofed braid. At the same time many important though less obvious improvements have been effected in the rubber insulating compounds and weatherproofing materials.

Rubber compounds deteriorate under the influence of sunlight, or other light rich in ultra-violet, due to oxidation stimulated by the actinic rays. This deterioration is exhibited

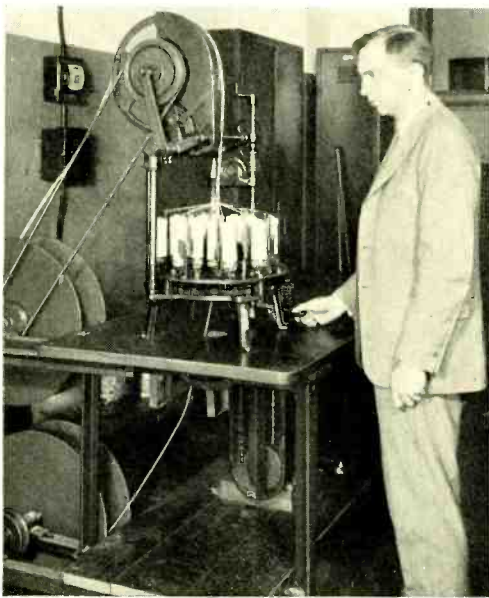
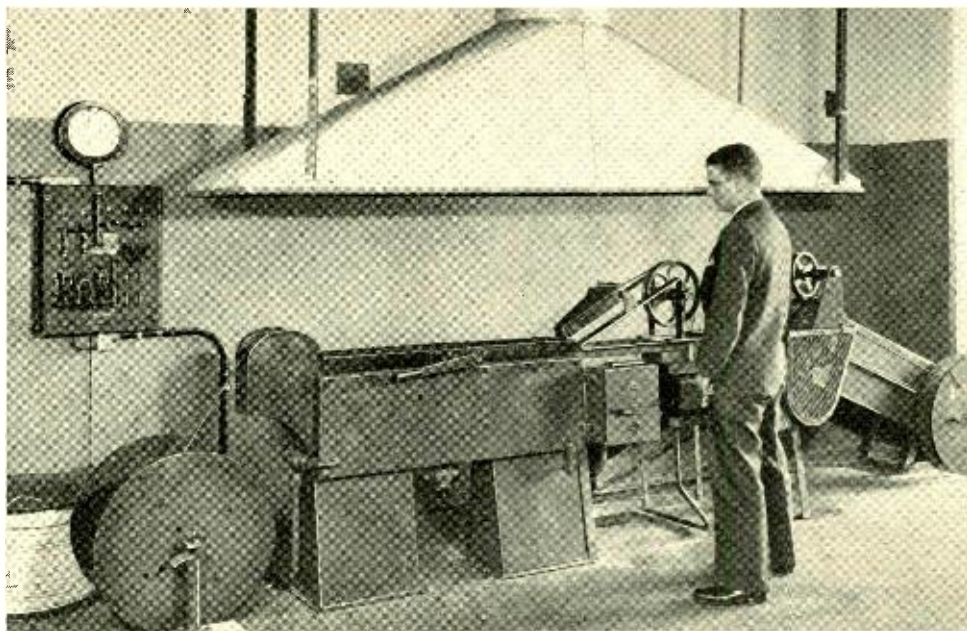

Fig. 1—A braiding machine used for preparing test samples of drop wire





*Fig. 2—Braided wire passes through a tank of impregnating compound and then through powdered mica to form a hard, non-sticking outer coat*

by a tendency of the rubber to crack, the failure commonly being termed "sun-cracking". Weatherproofed braid inhibits this type of failure by serving as an interposing screen between the rubber and the source of light, at the same time shielding the rubber from the oxygen of the air. In addition, it provides protection against abrasion and other mechanical injury.

In the manufacture of drop wire the conductors are first drawn to size and are then provided with a coating of tin, which serves the dual purpose of protecting the conductor from corrosive attack by the sulphur in the insulating compound, and of protecting the latter from the deleterious influence of the copper and its salts. Over the tinned conductor is extruded a covering of rubber insulating compound. In the modernized process developed and used by the Western Electric Company at

its Point Breeze Works for the manufacture of rubber-insulated wire, the extrusion and vulcanization of the insulating compound is a continuous operation. In the manufacture of parallel drop wire by this process, the two conductors are insulated simultaneously and are joined together by a fin of rubber compound. The fin facilitates the duplex extrusion and serves to hold the two insulated conductors together during the early stages of manufacture, thus eliminating the necessity for a subsequent pairing operation.

After vulcanization, the two insulated conductors are covered with a single cotton braid which subsequently is weatherproofed. The braid used for the greater part of the weatherproofed wire employed in the telephone plant is formed from a flat multi-end strand of two ply unbleached cotton yarn. For wire intended for use where numerous

tree contacts cannot be avoided, however, a harder braid of hawser cord, formed by cabling several threads of cotton yarn with a fairly tight twist, is used to provide the greater resistance to abrasion required by this type of service.

The weatherproofing employed by the Bell System for its outside distributing wires comprises thorough saturation of the cotton braid with a crude-oil, asphalt, and montan

coating which is highly resistant to abrasion and to weathering. The coating of mica which is applied over the stearine pitch serves principally to prevent sticking between adjacent convolutions of the wire when the wire is coiled, although some improvement in abrasion resistance is effected by its use, and it also serves to reflect some of the incident sun's rays.

Because of the large quantity of drop wire used by the Bell System and the desirability of securing as long a life for it as is economically practicable, studies of all materials used and of the various processing steps are being continually carried on. Facilities are available at Bell Laboratories for carrying out all the steps in applying the protective coatings and for testing the finished product under accelerated conditions.

A braiding machine, shown in Figure 1, permits braids of various types and of different materials to be applied to test specimens of insulated

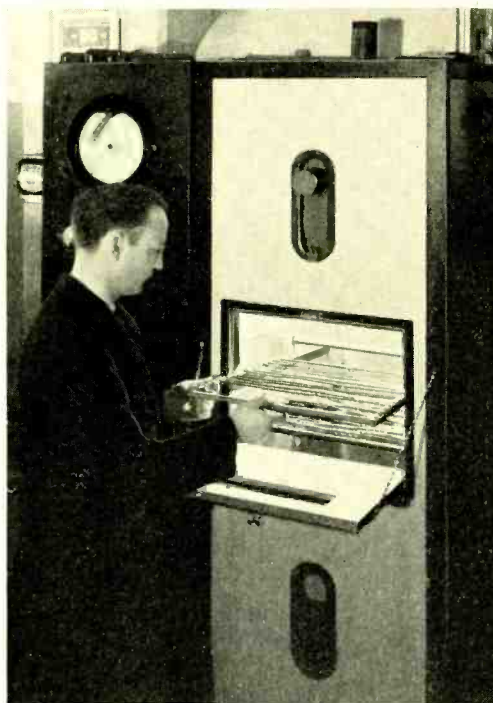

*Fig. 3—Inspecting a rack of samples of weatherproof wire from the artificial weathering apparatus*

wax compound, subsequent application of a continuous smooth coating of stearine pitch over the saturated braid and, lastly, application of a coating of ground mica to the surface of the pitch-finished wire. The saturant used resists migration at high summer temperatures well, and the stearine pitch forms a tough adherent

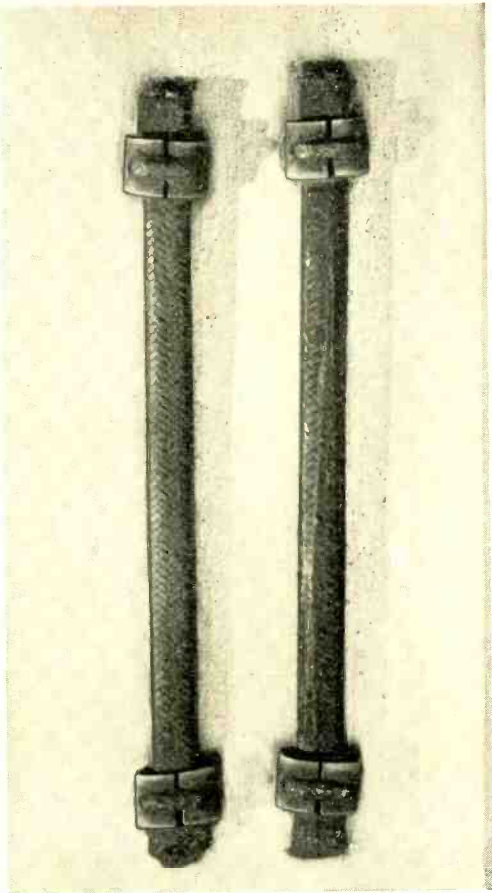

*Fig. 4—Abrasion testing machine for wire braids*

wire. In this way it is possible to study the effect of employing various types of constructions and of the large variety of possible materials. For applying braid saturants and outer coatings, the apparatus shown in Figure 2 is employed. The braided wire is taken from a reel on the left and passed through a tank containing the saturating compound, which is maintained at a suitable temperature. After the braid has been saturated with the asphalt compound, the wire may be again passed through the same machine but with the tank filled with stearine pitch. On emerging from the pitch the wire is passed through wiping dies to remove the excess, and then into a box containing powdered mica while the pitch is still warm and viscous. After leaving the mica box, the wire passes through water-cooled rolls which imbed the mica in the pitch and at the same time cool the wire to prevent adjacent turns from sticking together on the take-up reel.

Since the outer braid is employed to protect the rubber both from the effects of sunlight and of abrasion, two pieces of testing apparatus are employed to gauge its worth. One is the artificial weathering device shown in Figure 3. This is a heat insulated cabinet equipped with an electric heater with automatic control for maintaining any desired temperature up to 200° F. Water nozzles are provided to produce rain spray, and mercury arc lamps to provide ultra-violet radiation. Refrigeration facilities for subjecting the samples to reduced temperature cycles are arranged in a separate unit.

The equipment for testing the abrasion-resisting properties of wire finishes has two rotating aluminum-alloy wheels, the periphery of each



II I

*Fig. 5—Samples of old and new type weatherproofing after two months of artificial weathering*

of which is recessed to hold fifty samples of wire. Held against the samples on each wheel by a constant spring pressure is a furrowed hard-maple strip which serves as the abrader. The device is equipped with a counting mechanism for recording the number of times that each sample passes the abrader. The number of rubs required to wear through the weatherproofed braid to the rubber insulation is used as the index of the abrasion resistance of the sample. This test simulates the effect of tree



limbs rubbing against a wire, and permits rapid evaluation of the resistance of a wire to deterioration under service conditions.

In the continual search for improved weatherproofing materials, these facilities are of great value. Figure 5 is illustrative of the type of information obtained with the accelerated weathering device. The two samples of drop wire shown in this photograph have been exposed to artificial weathering for a period of two months. Sample I is the present standard drop wire, weatherproofed as described in an earlier paragraph; sample II is the same type of wire, but weatherproofed in accordance with the practices in effect prior to adoption of the present standards. The two-month exposure to the artificial weathering cycle is estimated to be equivalent to three years of ex-

posure to natural weathering. It will be noticed that the present standard wire (Sample I) still has a substantial coating of weatherproof finishing compound, whereas the cotton braid of the other wire is almost completely exposed. Prior to the weathering test, both samples were coated with essentially the same thickness of weatherproofing materials.

Data obtained from abrasion tests show that while the present standard wire requires from 56,000 to 66,000 rubs to wear through the braid, the former coatings would wear through in from 3,500 to 19,000. This improvement in abrasion resistance becomes particularly significant when it is considered that abrasion alone is responsible for something like half the total trouble in the drop wire plant.

*A. R. Kemp of the Chemical Laboratories, Chairman of the New York Rubber Division of the American Chemical Society, has invited all who are interested to attend a meeting of the Division on December 15 in the club rooms of the Building Trades Employers Association, 2 Park Avenue. After dinner which will be served at 6:30, Kingsley Gillespie, President of the Stamford Rubber Supply Company, will read a paper on FACTICE IN RUBBER COMPOUNDING, describing some of the uses of this interesting rubber substitute.*



# Equalizers In Open-Wire Carrier Circuits

By A. L. STILLWELL.  
*Telephone Apparatus Development*

FOR satisfactory conversation over a telephone system, it is essential not only that the volume of sound be great enough to be easily heard, but that the sounds be intelligible. One of the chief factors tending to decrease intelligibility is the unequal attenuation which the various frequencies meet in passing over the telephone circuits, which do not inherently transmit equally all frequencies. The attenuation or loss produced by an ordinary unloaded telephone line, for example, is greater for the higher frequencies than for the lower and the difference is proportional to the length of the line. Consequently with long lines, in addition to the gain introduced by repeaters to assure a satisfactory volume of sound at the receiving end, equalizers, associated with the repeaters, must frequently be employed to correct for the attenuation distortion.

Attenuation equalizers are passive networks consisting essentially of retardation coils, condensers, and resistances, and so proportioned that their attenuation-frequency characteristics are complementary to that part of the line characteristics that produces distortion. In this way the attenuation due to line and equalizer together will be substantially the same for all frequencies. Having

thus been attenuated to the same level, all frequencies are increased the same amount by the amplifier which follows, with the result that the output is at the proper level and without distortion due to unequal attenuation.

Insofar as their equalization of line losses is concerned, equalizers do not appreciably increase the total amplification that must be provided.\* Their effect is illustrated in Figure 1 where "A" represents the loss characteristic of the line, "B" that of the equalizer, and "C" that of the line and equalizer combined. The loss caused by the line varies from a small amount "a" for the lowest frequency of the band transmitted to "b", for the highest. The equalizer supplies a loss varying from "c" for the lowest frequency, which is equal to the difference between "b" and "a", to no loss at the highest frequency. When these two

\*For the purpose of simplifying the presentation, in this and the following illustrations the equalizer characteristic is shown as going to zero loss at some particular frequency. Practically, there is a small loss introduced at this point which is compensated for by a corresponding increase in amplification.

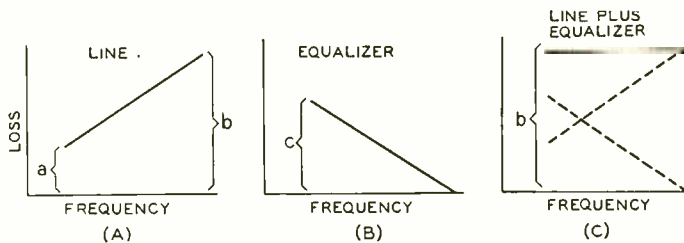

Fig. 1—Equalizer losses are made complementary to line losses so that the sum of the two is constant for all transmitted frequencies

losses are added together, the total loss—and thus the amplification that must be provided—is just equal to “b”, the loss occasioned by the line at the highest frequency.

In general, equalizers are inserted at repeater stations which are spaced so that the gain of the repeater will adequately compensate for the maxi-

messages over frequency bands slightly separated from each other are transmitted over the same line. For such multi-channel systems equalizers, besides compensating for the differential attenuation within each band, must also equalize for the unequal attenuation of the various bands with respect to each other. In some cases this function assumes the greater importance.

In the type C-S carrier system, which is one of the several types employed for open wire lines, six different bands are used for carrying three two-way voice channels. For transmission in one direction, carrier frequency bands repre-

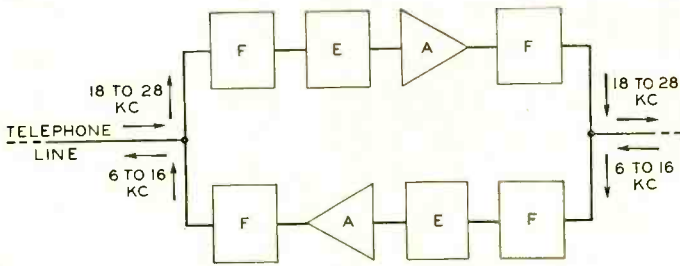

Fig. 2.—At repeater stations a line divides into an east bound and a west bound branch, with one amplifier and one equalizer in each

senting three voice channels occupy the frequency range from about 6 to 16 kc while the three in the other direction occupy the range from about 18 to 28 kc. The circuit arrangement at repeater stations is shown in Figure 2. One amplifier is employed for the three channels transmitting in one direction and another, those transmitting in the other direction. To separate the two groups of frequencies, filters are employed as already described in the RECORD.\* These filters also produce a distortion loss which varies with the frequency, and the equalizers—one of which is used in each amplifier branch—must equalize these distortion losses in the filters as well as those in the line.

With carrier transmission a voice channel approximately 2500 cycles in width modulates a high frequency known as the carrier. This results, after passage through suitable filters, in a band of frequencies substantially the same as the voice band but located either just above or below the carrier in the frequency spectrum. Several such bands conveying their voice

Figure 3 indicates the conditions when the filters are not considered. Here the loss occasioned by the line is shown by the lower heavy curve, and the frequency positions of the three channels in each direction are

\*RECORD, June 1933, p. 296.



indicated by dashed lines. The loss characteristics required of the equalizers are shown by the two upper heavy curves, A and B, each being made complementary to the characteristic of the line for the frequency range over which it acts. When the losses of line and equalizer are added together, the resultant loss characteristic becomes a straight horizontal, but because of the rising characteristic of the line, the total loss of the three lower channels,  $L_1$ , and hence the total gain required, is less than that of the three higher channels,  $L_2$ .

When the characteristics of the filters are considered, the losses to be supplied by the equalizers are modified. Figure 4 shows the same

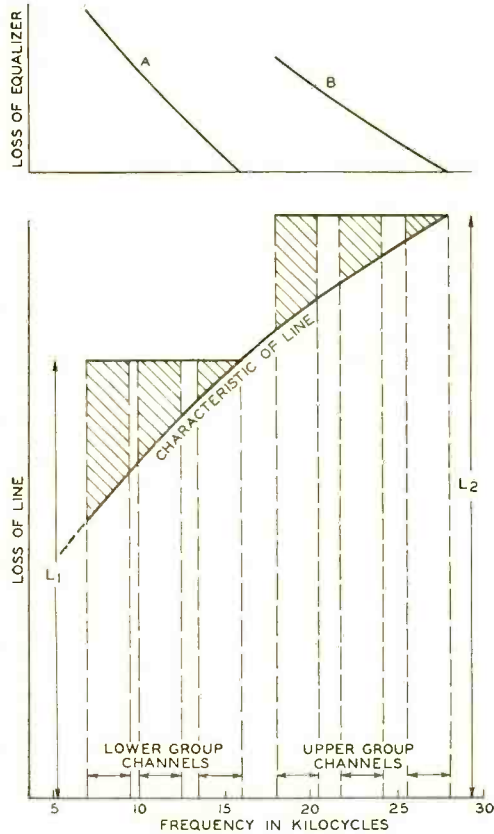

Fig. 3—Line and equalizer loss characteristics for a six channel carrier system

line loss characteristic and the six channels, and in addition, below the line loss curve, are shown the distortion loss characteristics of the directional filters. In general these filters

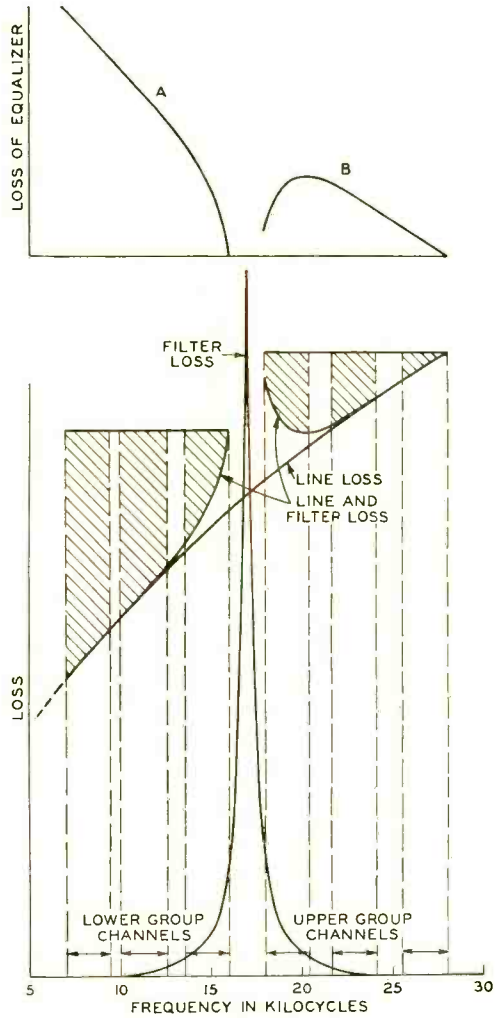

Fig. 4—Filter losses increase the losses at the upper end of the lower group and at the lower end of the upper group

are designed to offer a negligible loss over the transmitted band and a high loss outside the band, but the transition from low loss to high loss is curved, so that the filters introduce some distortion losses in the higher

frequencies of the lower group and in the lower frequencies of the higher group. The sum of line and filter distortion losses is indicated in the illustration, and above is shown the shape of the characteristics which the

without the filter, is less than that of the higher group, the increase is relatively unimportant so long as equal gain is provided for both groups. The total loss of the upper group, since it depends on the highest frequency transmitted, is not affected by the filter distortion, but the compensating loss required of the equalizer is somewhat decreased.

The equalizers employed for such circuits are of the constant resistance, bridged T type, one of which—the 10E—is shown schematically in Figure 5. They present at their terminals an impedance which is a constant resistance for all frequencies. This greatly helps to reduce reflection losses of the repeater. Except for a small constant loss common to equalizers in general, the characteristic of the 10E equalizer is similar to that shown at "A" in Figure 4. The various equalizers give attenuation characteristics which result in the current being constant with frequency to about  $\pm 1.5\%$  when used with the ideal length of line for which they were designed.

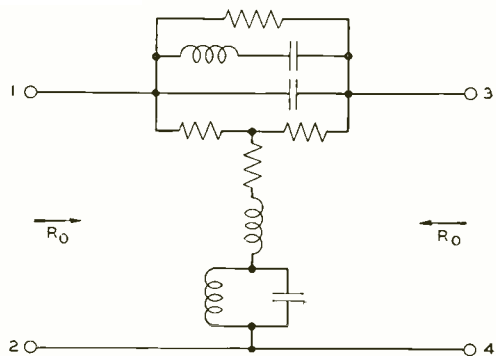

Fig. 5—Schematic of a 10E equalizer, which is of the constant resistance bridged T type

equalizers must provide to produce a constant loss for all frequencies within each group. The effect of the filter distortion loss somewhat increases the total loss of the lower group, but since the total line loss,



# Minimizing Modulation In Transformers

By E. T. HOCH

*Telephone Apparatus Development*

IN general when a simple sinusoidal voltage is applied to a transformer with a magnetic core, harmonics of the fundamental frequency are produced as unwanted by-products. When a more complex voltage is applied to the transformer, there arise not only harmonics of each component frequency but also a host of frequencies whose values are the sums and differences of the impressed components and their harmonics. Modulation effects of this nature distort transmitted speech. Furthermore, occurring in repeating coils used in carrier circuits, they would to a serious degree produce cross-talk between the channels, if it had not been found economically practicable to design coils in which these effects are made negligible.

In a carrier system several conversations are carried over a single pair of wires by using a different band of frequencies for each conversation or speech channel. At the receiving end the various frequency bands are separated by means of filters. Evidently if there were, in the system, apparatus in which frequencies of one channel produced currents of other frequencies, falling in the

range of another channel, the filters of the second channel would not be able to discriminate between these modulation products and the frequencies which were originally present in the second channel.

Even if the resulting cross-talk were not intelligible, it would none the less be undesirable so long as it was audible as noise. In some cases this noise may be required to be sixty decibels below the level of the voice current at the same point in the circuit. If the current in all channels were at the same level, it would only be necessary in such cases to insure that modulation products were at least sixty decibels below the level of the currents producing them.

Voice currents in the various chan-

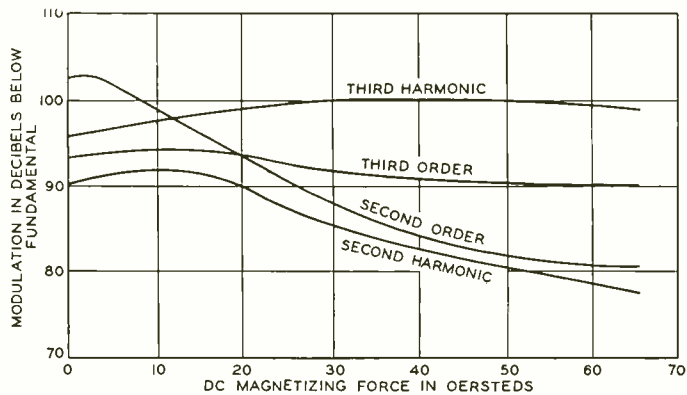

Fig. 1—These measurements of harmonic production and modulation in a coil with a 45% permalloy core, carrying superimposed direct current, show that with increasing direct current the second harmonic of a single frequency, and a second-order modulation product of two frequencies, are both produced in increasing amounts



nels of a carrier system are not all at the same level, however, at most points. The differences in level reach a maximum at a repeater or terminal station. There are cases in which the levels of the transmitted and received currents may differ by as much as fifty decibels. Since the modulation products of the strong outgoing current in one channel may fall within the frequency range of the weak incoming current of another channel, the modulation products should in these cases be kept at least 110 db below the level of the currents producing them, to insure against objectionable cross-talk.

One way of minimizing modulation effects is to make use of the fact that the modulation currents appearing in the output of a transformer with a given turns ratio are limited by the inductances of its windings. If the modulation limit were the only requirement placed on the transformer, it would merely be necessary to increase the number of turns of wire

until the modulation currents were reduced to the specified value. If the turns were multiplied indefinitely, however, the line and load impedances as seen through the transformer would no longer match, because of the impedance-modifying effect of the greatly increased resistance and leakage impedance, and objectionable reflection would occur at the discontinuity\*. Since carrier-circuit repeating coils have very strict reflection requirements, the permissible increases in the resistance and leakage impedance are small. Working to such limits, and simultaneously making large increases in the coil inductances to minimize modulation, would greatly increase the size and cost of the transformers.

Since the modulation is produced primarily by the core material, an alternative method of reducing it is to use a core material of improved modulation characteristics. Modulation is closely related to hysteresis and can thus be reduced by employing a core material having a low hysteresis loss in

the range of flux densities at which the transformer operates. It is primarily by the careful use of these two principles that repeating coils satisfactory for carrier systems have been produced.

Since investigations of modulation in transformers are to a certain degree empirical and the effect of design changes cannot always be certainly predicted, equipment for measuring the modulation currents produced by various coils has been in-

\*RECORD, July 1932, p. 374.

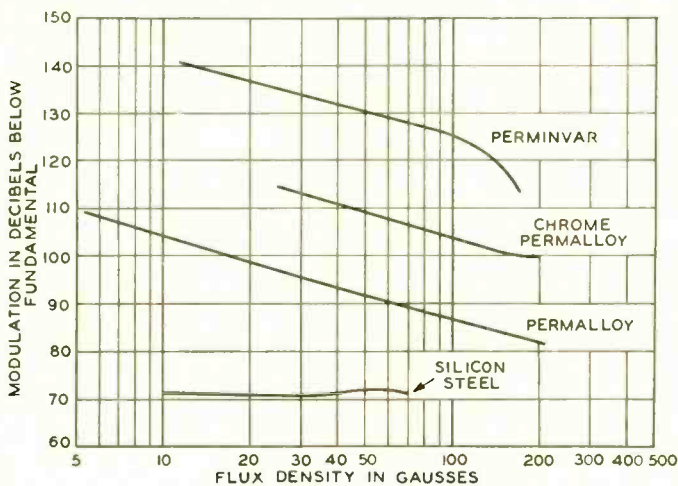

Fig. 2—Coils with different core materials differ widely in their modulation characteristics. The coils all consist of the same number of turns on cores of the same size, and the modulation product measured is the third harmonic of 6000 cycles. The permalloy shown contains 45 per cent nickel.

dispensable to transformer development. This equipment is simple in principle. It consists of a system of filters by which the fundamental currents are suppressed and the modulation product to be measured is passed on to suitable measuring equipment. In practice, however, considerable refinement is necessary because the fundamental current may be a million times larger than the current which it is desired to measure.

It is well known that when a simple sinusoidal current passes

through a transformer with an unpolarized iron core the only harmonics produced in substantial amount are those of odd order, whose frequencies are 3, 5, 7, etc., times the frequency of the fundamental. Furthermore, the amplitude of the higher harmonics is less than that of the lower so that, in general, the harmonic of greatest amplitude is the third. If the coil is required to carry a superimposed direct current, however, or if the core has been polarized by previous currents, the even harmonics may be of importance. Likewise if two fundamentals are simultaneously passed through a coil with an unpolarized core, the third order modulation products will predominate, but if the core is polarized the second order products may predominate. The relative magnitudes of several modulation products as related to DC magnetizing force are shown in Figure 1.

The testing equipment referred to

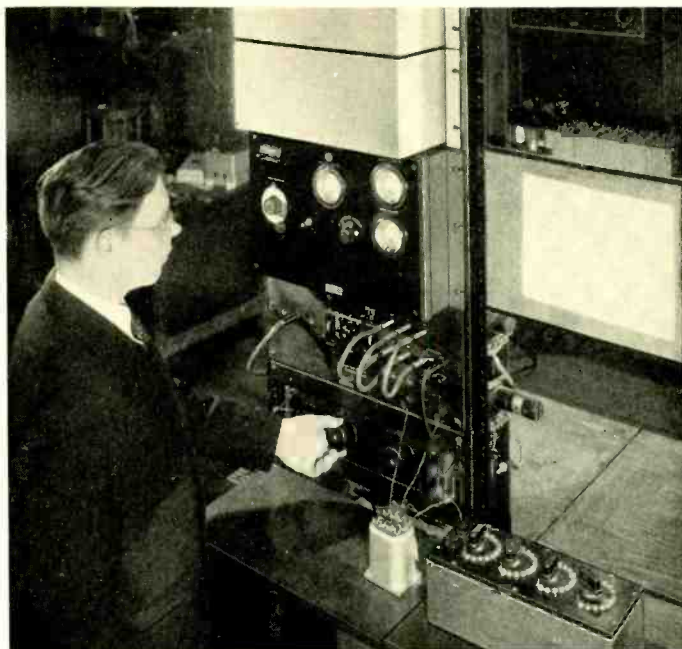

*Fig. 3—E. T. Hoch measuring the modulation produced by a transformer*

has been of great value in making it possible to determine the modulation characteristics of various core materials. Since the modulation varies with the flux density of the core, it must be determined for various flux densities within the range likely to be encountered in practice. The extent of third order modulation for several coils using different core materials but otherwise identical is shown in Figure 2. In this way an extensive investigation of various core materials has been made. The data accumulated have greatly facilitated a choice of the most economical material to meet each particular requirement. The availability of reliable testing means has also aided the development of new core materials, notably the permvars. The use of these materials and of the accumulated data have in turn led to the design of transformers far superior to their predecessors in freedom from modulation.

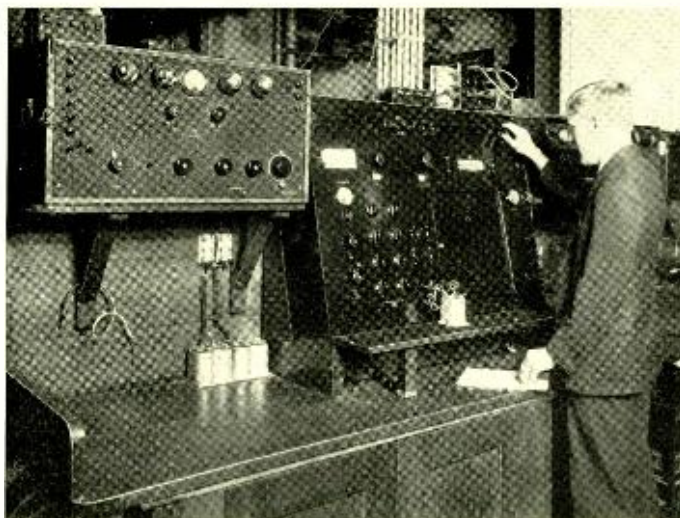

## A Transmission Measuring Circuit For Transformers

By J. S. ELLIOTT, JR.  
*Telephone Apparatus Development*

THE ideal way of insuring the proper performance of any equipment in service is to measure its characteristics beforehand in a duplicate of the circuit in which it is to be used. This method is used for testing apparatus such as repeaters, amplifiers, and filters, the transmission characteristics of which are largely dependent on the circuit in which they are used. Although the performance of a transformer is also dependent on the circuit in which it is connected, it has been possible in the past to secure satisfactory results by specifying requirements on only certain constants of the transformers, such as the self impedance, impedance ratio, and the direct current resistance. Although other characteristics might vary under different conditions, the variations would mostly be within the necessary limits of performance.

With the constant improvement in apparatus and quality of transmission, however, and with the more economical use of circuits by the wide employment of carrier frequencies, higher precision has become necessary in the design of all parts of the circuit. As a result, the variations of other characteristics, such as capacitance and leakage between various parts of the transformer and between the transformer and ground become important, and in some cases the value of one constant would depend on the value of another. While it still would be possible to measure these various constants to determine the performance of a transformer it becomes preferable to measure the overall transmission characteristic.

Although circuits for measuring the performance of transformers have been available in the Laboratories for a



number of years, no apparatus has been available which combined high accuracy, ease of operation, variety of termination, and range of measurement. To facilitate the shop production of transformers which will meet the more stringent requirements, therefore, the Laboratories have recently developed a set that will measure the transmission characteristics of all transformers designed at the present time at frequencies from 35 to 150,000 cycles. The original model which has been retained for laboratory use, was developed and built to insure a satisfactory commercial design.

The purpose of a transmission test is to determine the output voltage of the transformer, under given conditions of input and output impedance and applied voltage, at a stated frequency or over a range of frequencies. The situation is shown in Figure 1. What is really wanted is the ratio of the output voltage,  $e_2$ , to the input voltage,  $e_1$ , which is generally expressed in db. Under the simplest conditions only two meters would be required, but since the circuit must be capable of determining the ratio over a wide range of frequency, of output and input impedance, and of the ratio itself, and further since high

accuracy is required, a more elaborate circuit becomes necessary. The appearance of the circuit developed is shown in the photograph at the head of this article, and its arrangement is given in the simplified diagram of Figure 2.

It provides for comparing the output voltage of the transformer with a voltage obtained by attenuating the input voltage. The step-down ratio in db is thus obtained directly from

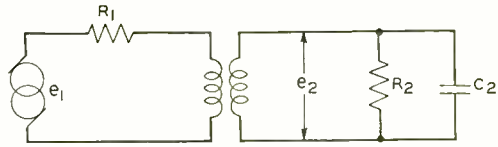

Fig. 1—Simplified arrangement of the conditions necessary for measuring the transmission loss or gain of a transformer

the reading of the attenuator. When an increase instead of a decrease in voltage is to be measured, the same manipulation is maintained by inserting fixed attenuators ahead of the transformer. Other apparatus, not shown in the diagram, is required to accommodate the various types of transformers to be measured, and to provide for superimposed direct current on the primary. The input impedance,  $R_1$ , is variable from 50 to

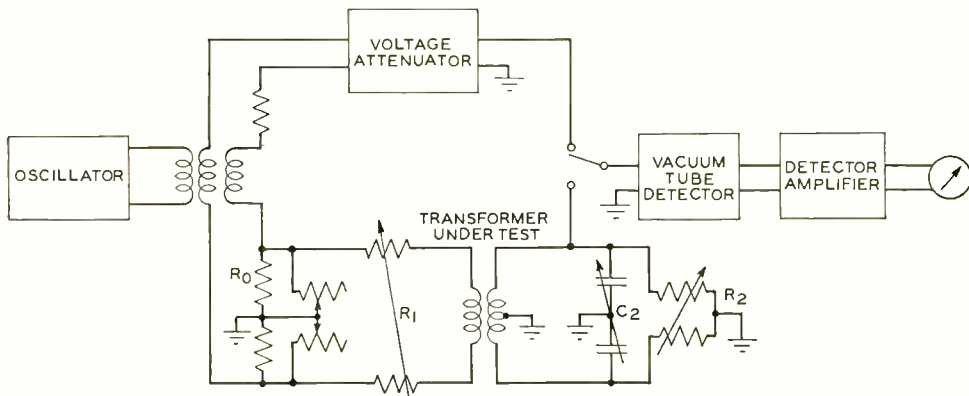

Fig. 2—Simplified schematic of the new test set

20,000 ohms and is made equal to the impedance from which the transformer under test will work in service. The output resistance,  $R_2$ , is adjustable from 10 to 100,000 ohms and is balanced to ground so that the accuracy of measurement will not be affected when, as in measuring balanced transformers, only half of the output voltage is measured. The output circuit is also arranged so that the transformer under test may be terminated in a capacitance, instead of a resistance, if desired, the capacitance termination being used when testing transformers serving as input transformers for amplifiers. The capacitance provided has a range from 14 to 600  $\mu\mu\text{f}$ , and the condenser required is likewise accurately balanced to ground.

The method employed in measuring the step-up or step-down ratios in the transformer requires that the voltage across its input impedance be always in a fixed relation to that across the attenuator, regardless of the input impedance of the transformer. This is accomplished by means of the balanced resistance,  $R_0$ , which has a balanced slide-wire resistance in parallel with it. The adjustable resistance  $R_0$  makes it possible to maintain the same voltage across  $R_1$  regardless of the actual input impedance employed.

One of the most difficult problems in the design of this circuit was the obtaining of an output capacitance as low as 14  $\mu\mu\text{f}$ . Even with the capacitance  $C_2$  completely out of the circuit, there remains across the output of the

transformer the capacitance to ground of the switching key, the wiring, and the input capacitance of the vacuum tube detector, which with ordinary apparatus would have been considerably above 14  $\mu\mu\text{f}$ . It was necessary, therefore, to reduce the contribution of each of these elements to a minimum. The wiring was made as short as possible and a vacuum tube having the lowest possible input capacity was employed. By the use, in addition, of the low capacitance key employed in the longitudinal unbalance measuring circuit\*, the required low value of capacitance was obtained.

The circuit will measure transformers with voltage ratios, either step-up or step-down, up to 40 db with an accuracy of 0.1 db at 1000 cycles. At higher frequencies the various resistances become less accurate and the error in the set gradually increases. However, even at 100,000 cycles a 40 db ratio on a 600 ohm (low-side) transformer can be measured to  $\pm 0.2$  db.

The set is arranged to mount vertically so that the keys and dials are within easy reach of the operator, and at the same time the set is easily accessible from the rear while being assembled and adjusted. To a large extent the construction follows that of the longitudinal unbalance measuring set already referred to. The output meter of the detector-amplifier is mounted on the panel of the set, thus making it easy to read while the controls are being adjusted.

\*RECORD, February 1933, p. 184.



# Telephone Manufacturing Information

By L. E. PARSONS

*Assistant Specifications Engineer*

THE evolution of the telephone from the crude instruments and manual switching of its earlier days to the highly refined apparatus and systems of today has necessarily been followed by a like evolution in the handling of technical information for the manufacture and inspection of the apparatus used. When Alexander Graham Bell wanted his telephone instruments manufactured, he probably walked into the workshop and gave Dr. Watson a rough idea of what was desired, relying upon Dr. Watson to determine the details and upon himself to perform whatever inspection appeared desirable. The technical information in this case probably consisted of rough pencil sketches and perhaps a note book.

Years later when the telephone industry had become nation-wide with the Western Electric Company taking the place of Dr. Watson's workshop, the note book and pencil sketches had also been replaced by thousands of specifications and drawings covering standard apparatus, special apparatus, apparatus of outside manufacture, raw materials, testing methods, and all manner of information necessary to the manufacture and inspection of the many items entering into the telephone system. The introduction of specifications became necessary because each of a large number of specialized workers must be told in detail exactly what was wanted; one group to prepare space and facilities for manufacture;

another to build tools; another to purchase raw materials; another to manufacture the apparatus; and still another to inspect the manufactured article.

Among the many different kinds of specifications issued by the Laboratories, a prominent class is that covering standardized telephone apparatus manufactured by the Western Electric Company. At the time the issuance of these specifications began, it was the practice to include in them a brief statement of the purpose of the device, more or less complete information for its manufacture, and a statement of the testing requirements which the manufactured article should meet. The information for its manufacture might include drawings or a model illustrating the device, or might consist of a comparison of the desired device with some similar one, or a combination of both.

When it became necessary to authorize changes in apparatus already in production, the shop was authorized by means of a letter. Later a form was originated for the change authorizations, and serial numbers were assigned to them to aid in filing and indexing. This system was satisfactory for some time; but with increases in the number of kinds of apparatus, in the specialization of groups concerned, and in the size of the Western Electric Company's plant, it was felt that a still better plan could be devised.



It is apparent that the ideal specification plan would provide a single specification for each piece of apparatus, always complete and up to date. One of the principal difficulties of accomplishing this ideal under the specification plan just described was the necessity of including with each specification a complete set of the up-to-date Laboratories drawings of the assembly and details of the apparatus. It would be a colossal undertaking to keep the many interested groups supplied with up-to-date specifications covering all the various types of apparatus. A change in a screw or an insulator in an E-type relay, for example,

might require reissuing a great many specifications and routing them to a large number of various locations.

The solution of this problem was found in establishing central files for Laboratories drawings at strategic points in the Western Electric Company. The files are kept up to date by the Laboratories, and the specifications refer to these drawings by number. Reference to the issue number is omitted from the specifications; it is always the most recent issue of a drawing that will be found in the files. Thus specifications need not be reissued when the drawings are changed, but only on the less frequent occasions

when major changes are made in the text. If a screw is changed in apparatus such as the E-type relay, it is only necessary to change a single drawing and issue a single change authorization. The authorization no longer becomes part of the specification; it can be discarded after it has notified those interested in the change. Reissues of these drawings are closely controlled by the Laboratories, and drawings are never sent out unless the changes incorporated in them are approved for manufacture.

Still another change in drawing practices was necessary to secure maximum efficiency. It is the function of the Western Electric Company to

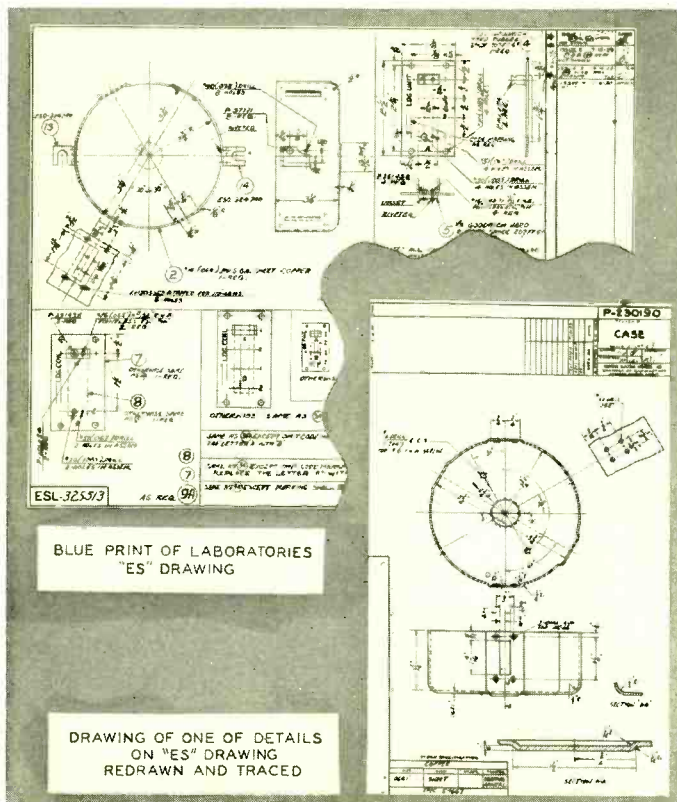

Fig. 1—Under the old scheme of making up manufacturing drawings, the Western Electric Company was obliged to draw entirely new tracings from each Laboratories drawing in order to insert the manufacturing information determined at Hawthorne

specify such limits, additional dimensions and the like as will aid them in the proper manufacture, assembly and testing of the apparatus. Thus the drawings used for manufacture cannot be completely prepared at the Laboratories, and the adoption of a specification system based on standard drawings would involve much duplication unless it were possible to use the Laboratories' drawings as a basis for the preparation of manufacturing drawings, without an appreciable amount of extra drafting.

As a part of the new specification system, therefore, a drafting plan was adopted which accomplishes the desired result, and it is expected that the slight additional drafting cost to the Laboratories will be much more than offset by economies which will result in the Western Electric Company and the Laboratories. Furthermore the interval required for introducing new apparatus drawings has been reduced at least one third.

Briefly this plan, commonly known as the LA and LP\* drawing plan, consists of providing drawings associated with the specifications in such form that they may be converted to manu-

\*Laboratories assembly and Laboratories piece-part.

facturing drawings by reproduction processes, and thus eliminating duplicate drafting. The Manufacturing Department's drawing forms are enclosed within the drawing form borders used by the Laboratories. The Laboratories forwards negative prints of the completed drawings to the Manufacturing Department, which

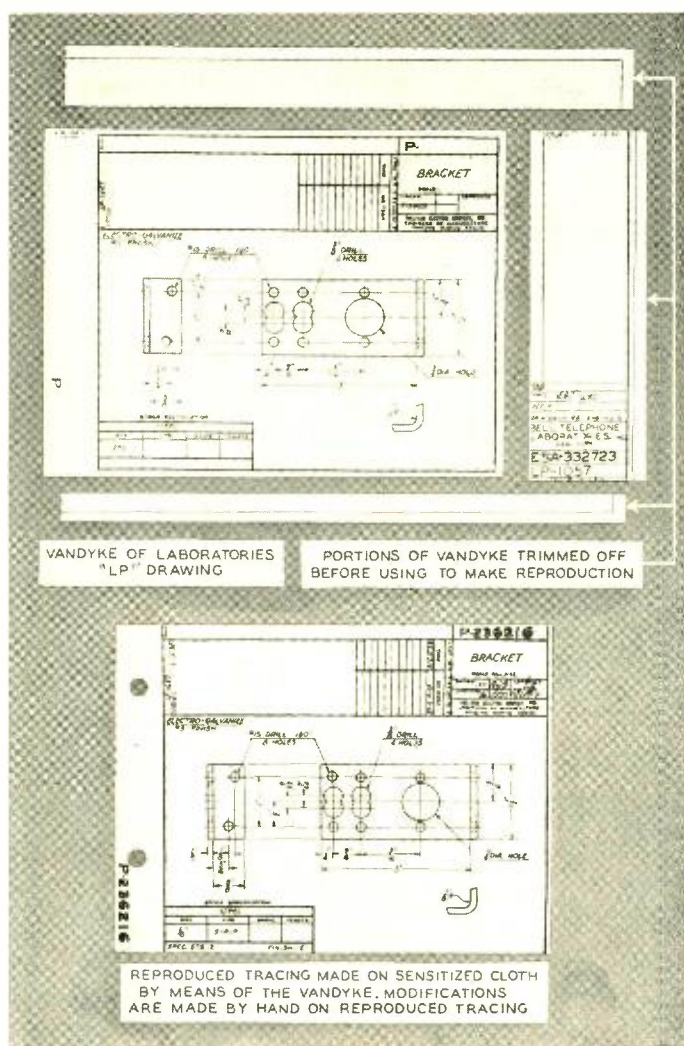
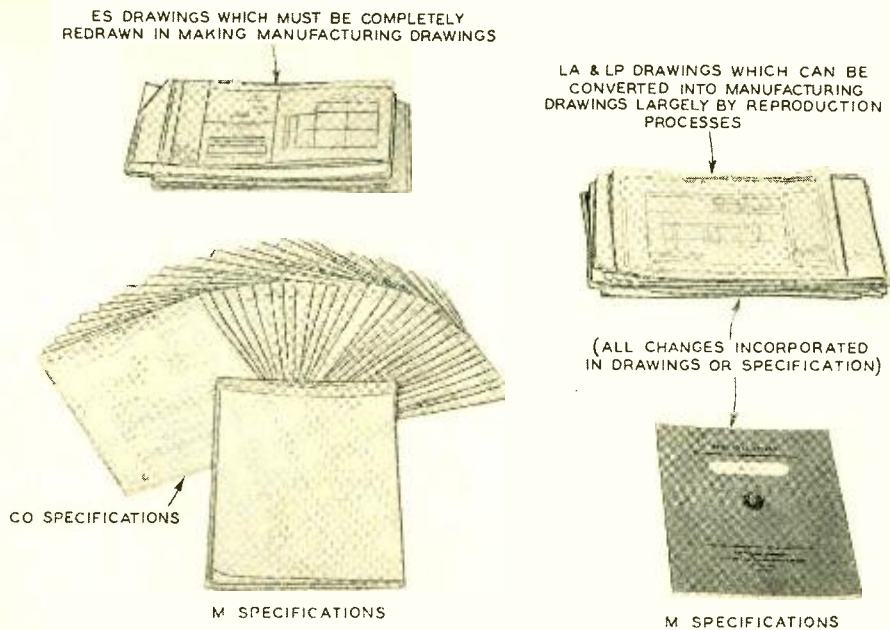

Fig. 2—Under the new plan, the Laboratories sends the Western Electric Company negative prints of its tracings. From these prints the Western Electric Company makes reproduced tracings, and then modifies these to include the additional manufacturing information



*Fig. 3—Comparison of the specifications and drawings which must be reviewed under the old plan (left) and the new plan (right) to obtain up-to-date Laboratories information for two typical amplifiers, in each of which the same number of changes have been authorized. Just as many change orders are issued under both the new and the old plans, but under the new plan they are not required for reviewing the job*

obliterates information unsuitable for shop use, trims off the Laboratories' borders, makes reproductions from the prints thus modified, and finally adds the necessary manufacturing information. The old and new methods are illustrated in Figures 1 and 2.

Although the length of the new type of specification is generally much shorter than the old type, the presence

of a complete assembly drawing and stock list makes the information contained in it far more complete. To review the Laboratories' information regarding a particular piece of standardized apparatus, of Western Electric manufacture, it is now only necessary to examine the specification and the latest issues of the drawings required with it.





## Contributors to This Issue

E. T. HOCH joined the Western Electric Company in 1914, immediately after receiving the B. S. degree in Electrical Engineering from Case School of Applied Science. He spent the following year with the Manufacturing Department in Chicago and the Installation Department in Wilmington. In 1915 he came to New York to join the Engineering Department, now these Laboratories. Here he was first associated with condenser development. Later he became concerned with precision measurements, and took part in investigations of insulating materials. In recent years he has been conducting special transformer studies.

H. E. MENDENHALL received the B.S. degree from Whitman College in 1921, then went to California Institute of Technology to receive the Ph.D. degree in 1927. After a year as

instructor in physics and electrical engineering at the University of Utah, he came to the vacuum-tube research laboratory at West Street. He has been especially concerned with the development of vacuum tubes for transmission at high frequencies and powers.

J. S. ELLIOTT received a B.S. degree from Pennsylvania State College in 1922

and at once joined the technical staff of the Laboratories. With the apparatus development department he was first engaged with routine tests and in making measurements of the electrical constants of apparatus. He then transferred to the condenser design group where he remained until 1927. Following this he engaged in the design of circuits and equipment for measuring the constants of transmission apparatus.

L. E. PARSONS came to the Engineering Depart-



*E. T. Hoch*



*H. E. Mendenhall*



*J. S. Elliott*



*L. E. Parsons*



*R. D. de Kay*



*W. J. Lally*



*A. L. Stillwell*

ment of the Western Electric Company in 1917, after two years as a mining engineer in the West Virginia coal fields and five years of association with the Westinghouse Electric Company. His early work on the design of special apparatus was followed by the design of submarine detection apparatus during the war. He entered the Specifications Department on its formation, taking charge of one of its groups, and three years ago he became Assistant Specifications Engineer.

R. D. DE KAY was graduated from the United States Naval Academy in 1918. He served in the war as engineer officer on destroyers, and after the war as commanding officer. In 1922 he left the navy and joined the power development group of the Laboratories, where he is now in charge of rectifier and machine development.

W. J. LALLY received the Ph.B. degree

from Yale in 1919 and the M.Sc. degree in 1921. He joined the Technical Staff of Bell Laboratories in 1929 after a number of years with outside engineering firms, where among other things he worked on electrical resistance welding and on the development of underground conduit systems. With the Laboratories he has been associated with the Outside Plant Development Department, first engaged in underground conduit development, and recently in wire development.

A. L. STILLWELL graduated from Cambridge University in 1925 with a B.A. degree (engineering tripos). After a year with the Standard Telephones and Cables Ltd. in London, he came to the Laboratories and joined the Filter Group. Since then he has been working on the development of equalizers for carrier circuits. He received the M.A. degree from Cambridge in 1929.