



# *Bell Laboratories Record*

---

*Volume Seven*

MAY, 1929

*Number Nine*

---

## President Gifford Addresses the Laboratories

**P**RESIDENT WALTER S. GIFFORD of the American Telephone and Telegraph Company addressed a group of the men and women responsible for the work of the Laboratories, in our auditorium on April 4. Mr. Gifford was introduced by President Jewett and Vice-President Charlesworth of the Laboratories.

In discussing our work and its relation to the activities of the other associated companies Mr. Gifford first outlined the general policies of the Bell System. He pointed out that although in its general organization and method of carrying on business, the System is in most essential respects similar to other commercial corporations, it differs from them in two important principles. The telephone business is by its nature a practical monopoly and must operate without competition in the usual sense of the word. Its accomplishments are judged not by comparison with others but in relation to what the public thinks may reasonably be expected; and the public is justified in expecting the most telephone service and the

best at the least possible cost. In addition to that fact and to complicate the obligations imposed upon us, the Bell System is owned by a very large and widely distributed group of stockholders, the protection of whose investment must at all times be a primary consideration in the management of the System's affairs.

It has always, said Mr. Gifford, been a near-axiom of industry that competition is the life of trade. In other words, constant rivalry for public patronage tends both to improve the product and to increase the efficiency and economy of its production. As this form of competition is lacking in the work of the Bell System, there must be some other incentive which will be equally effective. We like to think that a large part of this incentive is provided by the spirit of service which has so successfully been built up among members of our Bell System. This alone, however, is not enough. A substantial driving force towards more efficient service arises from our organization of headquarters groups of people whose sole duty is to study and devise improve-

ments, and much of this driving force is provided by Bell Telephone Laboratories. If the Bell System is to realize its ideal of providing the best possible telephone service at the least possible cost, and so continue to build up the public good-will so essential to its existence, great responsibility devolves upon the Laboratories of providing new and better means for realizing this ideal.

Such is the primary obligation of the Laboratories. But, as pointed out by Mr. Gifford, aside from this commercial incentive there is another, less practical but no less important; namely, to increase the field of human knowledge. It used to be thought that if a man were to make his fortune in business, he would have to make it at the expense of his fellows. Fortunately at the present time a new conception of commercial enterprise is taking the place of this cold-blooded philosophy. Now when an individual or a corporation strives to obtain greater income, it is possible to mine the riches of nature instead of struggling to take away the wealth of someone else. From this philosophy springs the idea of industrial research which is more and more being applied to every field of business.

In industrial research Bell Telephone Laboratories has long been a pioneer and leader. Until very recent years, particularly in our own branch of research, we have been almost without competition. Now, however, with the rapid spread of the idea of commercial research other organiza-

tions are in scientific competition with us and are doing important work. If we are to continue our present leadership and to hold the prestige that we have gained, we must be more and more on the alert to find and exploit promptly new scientific knowledge.

This does not mean, he added, that our rivalry with other organizations should cause us to become jealous of their achievements. It is not wise in science to ignore or belittle the work of others. Rather the true knowledge they have gained should be recognized and accepted as a means of furthering our own accomplishments.

Turning from the Laboratories' peculiar problems to continue his discussion of general System policies, Mr. Gifford pointed out that not only is our research work being faced by new problems and new competition from other industries, but the System's relations to the public are gradually being placed on a new footing. Although in former years our problem was to strive to meet the public's overwhelming demands for telephone service, at present it is also coming to be one of creating public demand for new services, new comforts and conveniences in communication. Here, too, the Laboratories has its own part to play. We cannot academically create designs that we think the public ought to want. Instead we must be alive to the public's preferences; and where such preferences are consistent with efficient service, make every effort to see that they are satisfied.

# What's A Good Loud Speaker?

By L. G. BOSTWICK  
*Research Department*

WHAT constitutes a good loud speaker? To answer this question there is needed a more precise method of ascertaining the capabilities of a loud speaker than is provided through a mere listening test. While the ear is, of course, the final judge of the merits of a loud speaker, it is quite unsatisfactory as a means of analysis. One loud speaker may sound better or worse than another with which it is directly compared, but to describe or specify in a definite manner the peculiar characteristics which distinguish one from the other is usually extremely difficult unless the two are widely different. Furthermore, a direct comparison between two devices is necessary, and the magnitude of the difference is always a matter of opinion in comparisons of this sort.

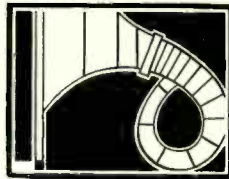

er, and sound reflection, absorption and interference effects due to the measuring room enclosure, may cause large variations in the results obtained. When these factors are not taken into consideration, acoustic measurements may give entirely misleading information. The measurements and discussion which follow illustrate the magnitude and character of some of the more important acoustic considerations involved in determining what constitutes a good loud speaker.

The system used in making these measurements is shown diagrammatically in Figure 1. The available power-output of the oscillator is kept constant at all frequencies by means of a vacuum tube voltmeter. With the oscillator connected to a loud speaker, through the transformer, the gain of the amplifier associated with

On the other hand, acoustic measurements on loud speakers are complicated by a wide variety of acoustic factors which must be properly considered in order that such measurements be indicative of the capabilities of these loud speakers. Such factors as peculiarities in the distribution of the sound energy by the loud speak-

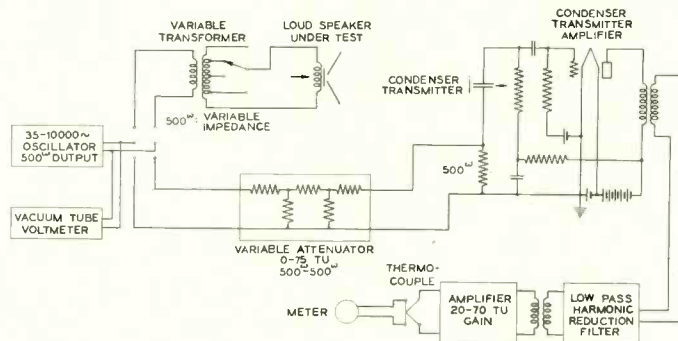

Fig. 1—Schematic circuit of loud-speaker response measuring system

the thermocouple is adjusted at different frequencies until a mid-scale deflection of the meter is obtained as a result of the voltage generated by the condenser transmitter. After each adjustment, the oscillator is switched from the loud speaker to the input terminals of the attenuator, and the attenuator is adjusted to give the same meter deflection. Variations in the attenuator settings with frequency show the variations in the performance of the loud speaker in decibels.\*

Performance curves obtained for the same loud speaker by such a procedure may differ widely, due primarily to three causes. These are: variations with frequency in the energy distribution of the sound field of the loud speaker; wave interference at the condenser-transmitter posi-

tioner to different points on the radiating surface; and variations with frequency in the energy-absorbing power of the measuring room.

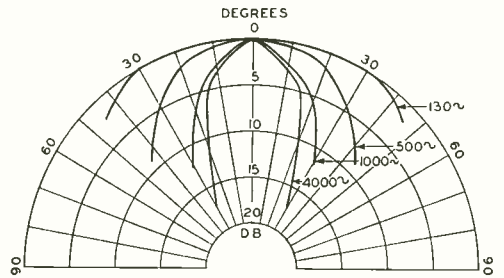

Fig. 3—Polar curves plotted from data of Fig. 2

The magnitude of variations in the sound field distribution can be shown from measurements obtained outdoors in an open field where the effects of any room enclosures are absent.

Such measurements appear in Figures 2, 3 and 4, for a 115 cycle cut-off exponential horn with a loud-speaking receiver of the moving coil type. Figure 2 shows response curves obtained when the condenser transmitter is placed twelve feet from the center of the horn mouth and at different angles from the axis. As the transmitter is moved away from the horn axis, the response

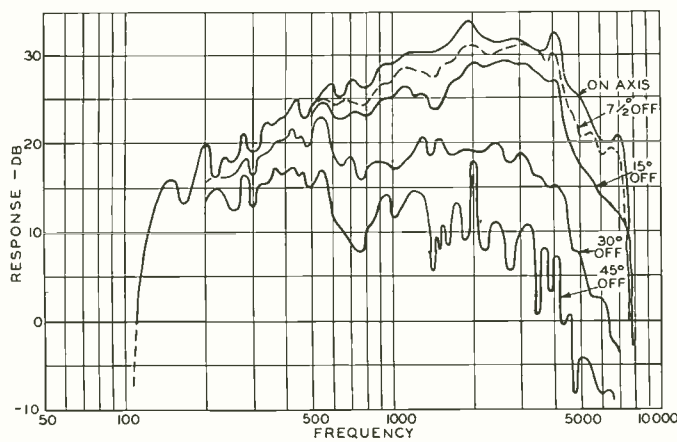

Fig. 2—Response-frequency characteristics of 115-cycle cut-off exponential horn with moving coil receiver. Measured outdoors 12 feet from horn mouth at specified angles to horn axis

tion due to sound reflections from the walls of the measuring room or to a difference in distance from the trans-

mission unit. As the transmitter is moved away from the horn axis, the response at the higher frequencies becomes lower, while at low frequencies the change is slight. This is because the angle subtended by the sound field becomes smaller the higher the frequency, and the sound energy is in-

\* This is now the official name of the transmission unit. See BELL LABORATORIES RECORD, December, 1928, page 137.

creasingly concentrated along the horn axis. Thus a response frequency characteristic of almost any desired trend may be obtained by suitably locating the condenser transmitter. Figure 3 is a polar coordinate curve plotted from the data of Figure 2, showing the sound-field angles for four frequencies.

Figure 4 shows a curve obtained for the same loud speaker, but with the condenser transmitter on the axis only two inches from the mouth. This curve is considerably more irregular than the axis curve of Figure 2. These irregularities can be attributed to interference between sounds reaching the condenser transmitter from different points of the horn mouth. After a distance of about twelve feet has been reached, the sound paths from these points to the condenser transmitter become substantially equal, and therefore, the interference disappears. Thus, the two axial curves in Figures 2 and 4 are quite different.

The effect, on the indoor response measurements, of interference or standing waves due to reflections from the walls of the measuring room is illustrated in Figure 5. These measurements are of a loud speaker with a three-and-one-half-inch diaphragm of the piston type,

with the condenser transmitter located about twelve feet away on a line perpendicular to the center of the diaphragm. The loud speaker and transmitter were located equally distant from and on opposite sides of the center of the room, and mid-way between the ceiling and floor. The bounding surfaces of the room were covered with hair felt one-half inch thick. Although an attempt was thus made to reduce the magnitude of the reflections, the curve obtained is very irregular.

One method of compensating for

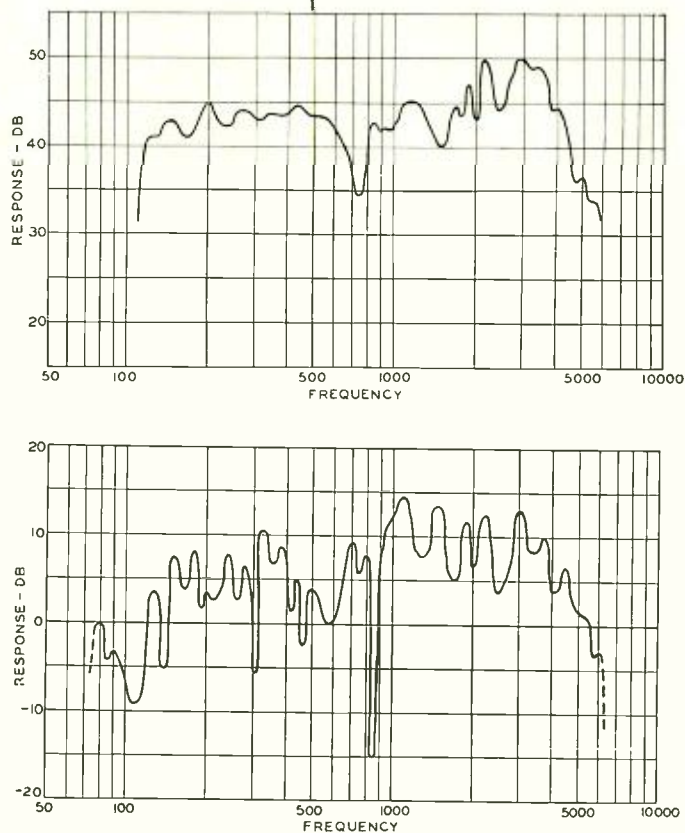
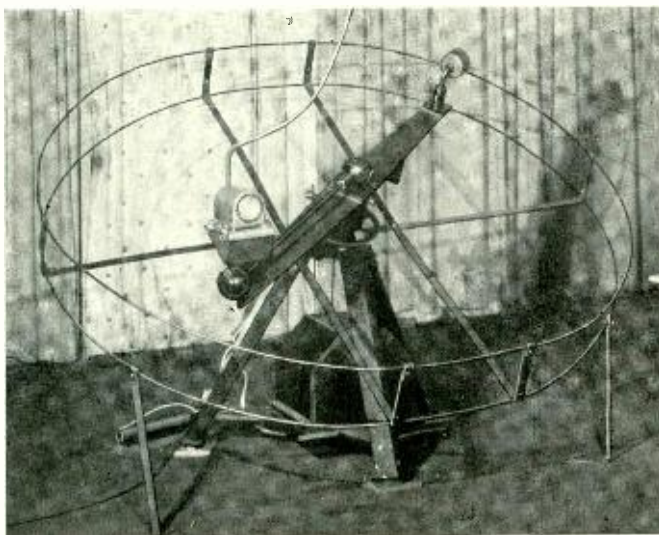

Fig. 4 (above) — Response-frequency characteristic of 115-cycle cut-off exponential horn. Measured outdoors on horn axis two inches from mouth. Fig. 5 (below) — Response-frequency characteristic of 3½-inch piston-diaphragm loud speaker. Measured 12 feet from diaphragm, in highly absorbing room

the effect of standing waves, and of thereby obtaining indoors a curve that is representative of the performance of the loud speaker, is to average the measurements at several positions or within a region rather than at one position. This is accomplished in these Laboratories by a machine pictured in Figure 6. This machine rotates the condenser transmitter in a circle which is nearly six feet in diameter and whose plane is inclined at an angle with the horizontal. Figure 7 shows a curve for the piston-diaphragm loud speaker measured under the same conditions as the curve



*Fig. 6—Machine for rotating condenser-transmitter to make indoor loud-speaker measurements*

in Figure 5, but with the rotating condenser transmitter. The center of the circle was located at the same point as the condenser transmitter for Figure 5. A comparison of the solid curve in Figure 7 with the dotted curve, obtained outdoors for the same loud speaker, shows the extent to which rotating the transmitter in this

manner obviates the effect of wall reflections.

The uniformly greater response at low frequencies of the indoor curve in Figure 7 can be attributed to the fact that the sound absorbing ability of the measuring room varies with frequency. Indoors the energy reaching the condenser-transmitter position directly from the loud speaker is supplemented by energy reflected to the same position from the walls of the measuring room. Variations with frequency in the reflecting or absorbing ability of the walls of the room will, therefore, cause variations in the magnitude of the response measurements. From the difference between the two curves in Figure 7 it is possible to calculate the ratio of the outdoor to indoor energy densities at different frequencies at the transmitter position and to obtain the solid curve shown in Figure 8. The dotted curve is an average curve showing the trend. A comparison of this dotted curve, with the dot-dash curve of the absorbing ability of one-half inch of hair felt, shows an interesting correlation

in the trends of the two curves. The difference in magnitude of the two curves can be accounted for by the fact that the sound passing through the transmitter position probably undergoes several reflections before returning to this position again.

From the above illustrations it is obviously quite impossible to deter-

mine from acoustic measurements whether or not a loud speaker is "good," unless the curves expressing the measurements are qualified by statements regarding the measuring conditions. Especially must information be given as to the position of the condenser transmitter relative to the loud speaker, the method of measurement (whether pressures are measured at one position or averaged within a region), and the size and nature of the medium. In general, response measurements, to be most indicative of the capabilities of a loud speaker, should be made with the condenser transmitter at a distance from the loud speaker commensurate with or equivalent to the most likely listening distance of an observer. In addition, determining which of two loud-speaker response curves is the better requires an interpretation of the auditory significance of the magnitude and position in the frequency spectrum of departures in the curves from a straight horizontal line. Such an interpretation

involves physiological considerations. Although complicated by such a wide variety of factors, the response-frequency characteristic has been found

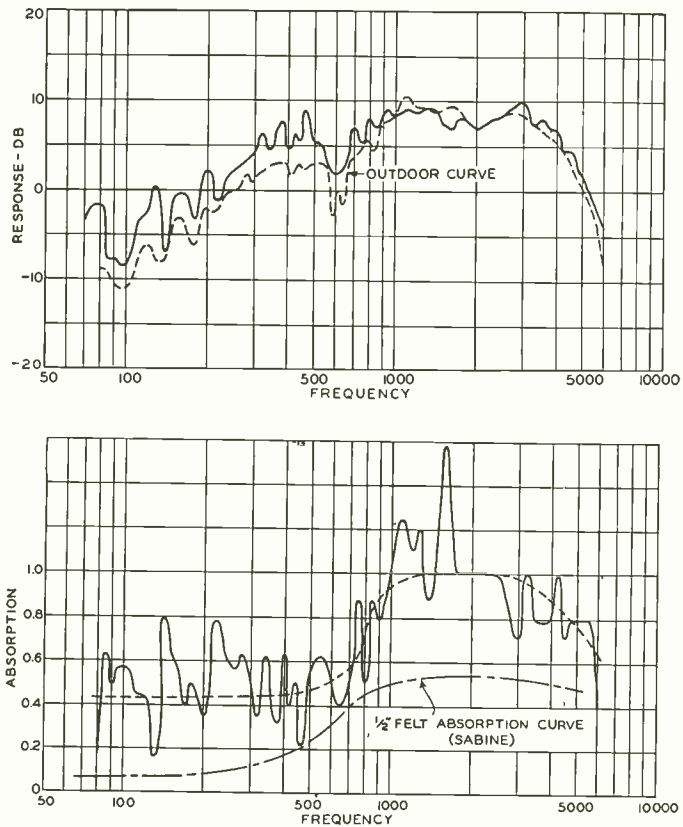

Fig. 7 (above)—Response-frequency characteristic of 3½-inch piston-diaphragm loud speaker. Measured in highly absorbing room and averaged in small region 12 feet from diaphragm. Fig. 8 (below)—Absorption-frequency characteristic of felt-lined room with respect to a region relatively near its center and the sound source. Calculated from data of Figure 7

the most significant single criterion upon which to base a judgment of the merits of a loud speaker.

# Extending the Usefulness of the Oscillograph in Circuit Testing

By I. H. GERKS

*Systems Development Department*

ORDINARY oscillographs of the electromagnetic type are not sufficiently sensitive to permit the proper recording of many electrical phenomena occurring in telephone circuits. To correct this deficiency a specially designed amplifier has been built to supplement the oscillograph when it is necessary to measure very small currents or voltages. With the assistance of this auxiliary amplifier it is possible to record, measure, and study the most minute currents and voltages that are likely to be of interest in telephone circuit engineering.

With the ordinary oscillograph operating under average conditions, approximately 0.001 ampere must be passed through the vibrator coil to give a deflection of one millimeter on the film. This means that a deflection of one centimeter, which is about the least that will give a readable oscillogram, requires a current change of approximately 0.010 ampere through the vibrator. In many circuit problems, current changes of a much smaller value must be studied. With a "B" type relay, for example, operating on a current of the order of 0.001 ampere, it is impossible with the ordinary oscillograph to determine the exact instant at which the current in the winding starts to build up, particularly if the time constant of the circuit (ratio of inductance to re-

sistance) is large. Inability to determine this point accurately makes it impossible to measure operating times satisfactorily. Busy-test clicks in the operator's headset produced by voltages of only a few hundredths of a volt are also difficult to record and measure with an ordinary oscillograph.

Besides the difficulty with very small currents and voltages, conditions are frequently encountered where the current drawn through the vibrator is sufficiently large to alter the characteristics of the circuit to a considerable extent. In such cases the voltage recorded by the oscillograph would be lower than the true voltage because of the shunting action of the vibrator. Also, there are many cases in which variations of a small magnitude in a comparatively large steady current must be measured. To prevent the oscillograph vibrator from being damaged by the large steady current, a low-resistance shunt path across the vibrator must be provided. This shunt makes the oscillograph insensitive to such an extent that the small variations which are to be recorded may be entirely lost.

It was to meet these special conditions that a special two or three stage resistance-coupled amplifier was developed. It consists of three vacuum tubes with the associated coupling and control circuits and the necessary bat-



teries, all mounted in a "tea wagon" for portability. From a circuit standpoint, it is very similar to the familiar resistance-condenser-coupled audio amplifier used in radio receiving sets, but a battery is used in place of the condenser. Its chief advantage is its

amplifier, the current to be measured must be passed through a resistance, and the voltage drop across this resistance impressed on the grid circuit of the first vacuum tube. The sensitivity of the three-stage amplifier is such that a variation of approxi-

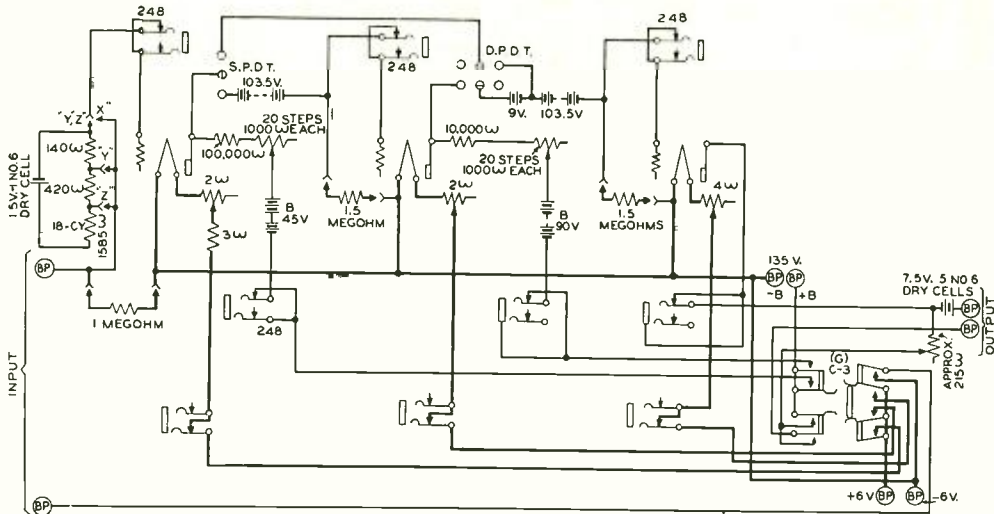

Fig. 1—The new amplifier for the oscillographs may be changed from three stages to two stages by operating the switches designated S. P. D. T. and D. P. D. T.

ability to amplify direct as well as alternating currents. By means of a pair of switches it can be changed from a three-stage to a two-stage amplifier when great sensitivity is not required.

It will be recalled that for a given change in the voltage impressed on the grid of a vacuum tube, there is a corresponding change in the plate current. Consequently, when the instrument is to be used as a current

mately 0.01 volt on the grid of the first tube results in an oscillographic deflection of one millimeter. A variation of a tenth of a volt will, therefore, give a satisfactorily readable oscillogram. To obtain a voltage drop of a tenth of a volt when the input current is 0.001 ampere, an input resistance of one hundred ohms must be used. The insertion of a resistance of this magnitude into the circuit under test is generally permissible, since it will as a rule form but a small part of the total impedance of the circuit in which such small currents are encountered. With an input resistance of this value a current amplification of approximately ten is obtained, and other amplifications are readily obtained by

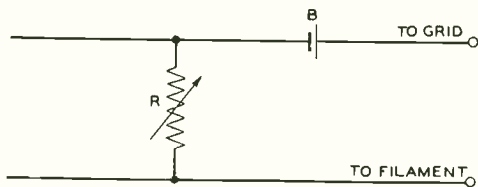

Fig. 2—An adjustable resistance is used as a shunt when small ripples in a large direct current are to be measured



*Fig. 3—The raised cover of the amplifier discloses the copper lining that serves as a shield*

changing, at will, the value of this input resistance.

When the instrument is to be used for measuring small voltage variations, the input terminals of the amplifier are connected directly across the circuit being tested. Since the grid-filament resistance of a vacuum tube, operated with a negative bias

on the grid, is very large, the amplifier acts as a very high impedance voltmeter, leaving the characteristics of the circuit under test practically unchanged. When the total voltage variation above or below ground potential exceeds a tenth of a volt, it is necessary to divide the voltage by means of a high-resistance potentiometer, to avoid overloading the amplifier and introducing serious distortion.

When the instrument is used in a circuit where a small alternating current is superimposed on a relatively large direct current, an auxiliary circuit, such as that shown in Figure 2, may be used to balance out the direct current and permit proper amplification of the small variations which are to be measured. The direct current flowing through the resistance  $R$  causes a voltage drop exactly equal and opposite to the voltage of the battery  $B$ . Any variations in the current, however, upset this condition of balance and introduce a corresponding voltage input to the amplifier. The resistance  $R$ , of course, must be sufficiently low to make no appreciable change in the total impedance of the circuit under test.

The three-stage amplifier was built

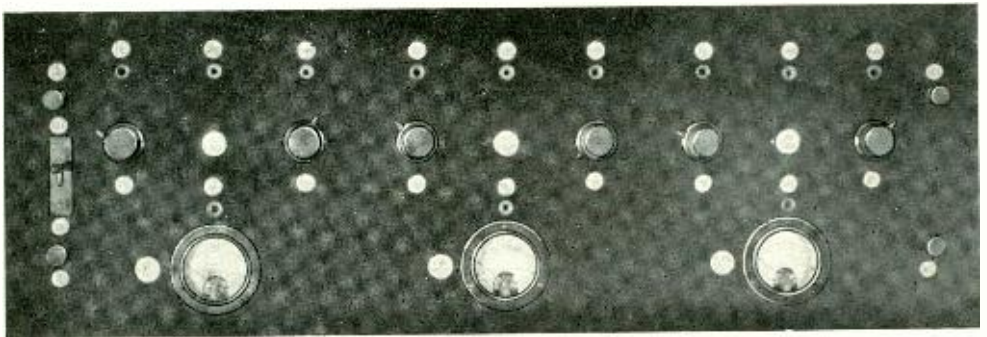

*Fig. 4—To the operator looking down from above, the amplifier presents the appearance shown here*

primarily to extend the range of the oscillograph in the manners just described, and for this purpose it has proved very satisfactory. Since circuit studies involve frequencies varying from zero to about 3000 cycles per second, it is desirable that all frequencies within this range be amplified equally. This requirement has been met by the new amplifier which has a frequency-amplification curve that is practically flat within this range; in fact, the dropping off in amplification does not become appreciable until 10,000 cycles is reached.

Some of the things which can be done with the oscillograph in conjunction with the amplifier that would otherwise be impossible are illustrated by the oscillograms of Figures 5 and 6. Figure 5 shows oscillograms of a few of the standard tones obtained both with and without the amplifier, the first being "audible ringing," the second, "busy back," and the third, "dial tone." It is apparent that no satisfactory study of the wave shape of these tones could be made using only the unamplified oscillograms.

Another, and perhaps the most important, use for the amplifier in the circuit laboratory is in measuring the operating and releasing times of re-

lays where the current is too low to produce a readable deflection. Consider, for instance, a B-24 relay which operates on 0.0008 amperes. Figure 6-A shows the build-up of the current in the winding as it appears with the oscillograph adjusted to its maxi-

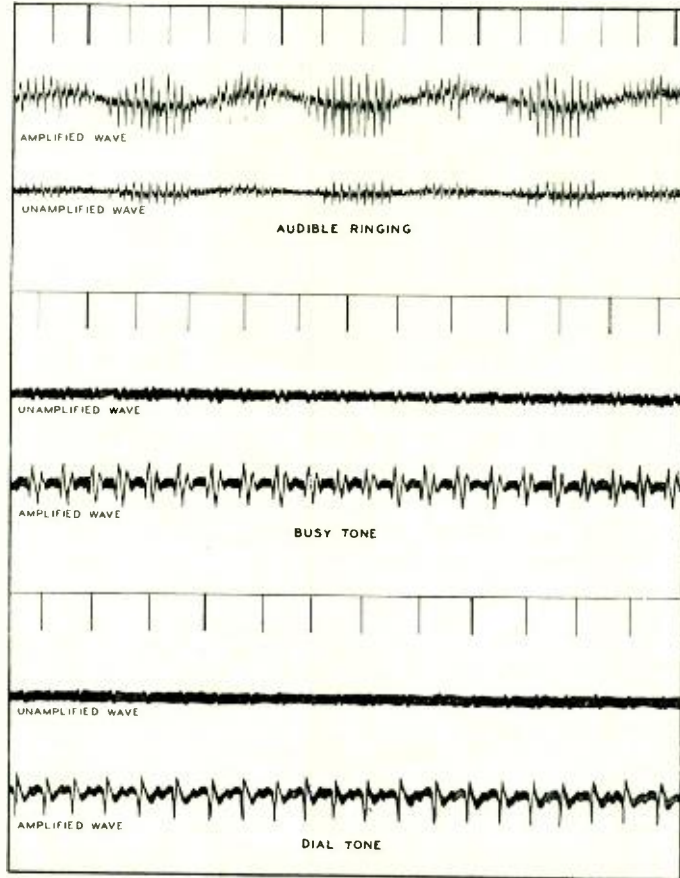
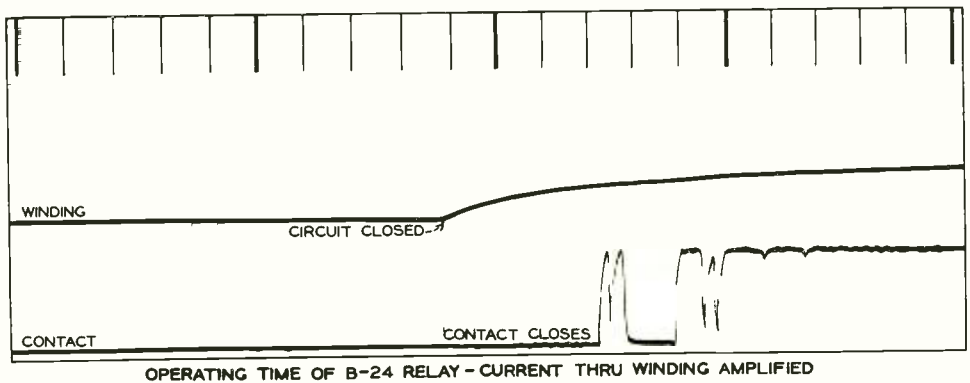
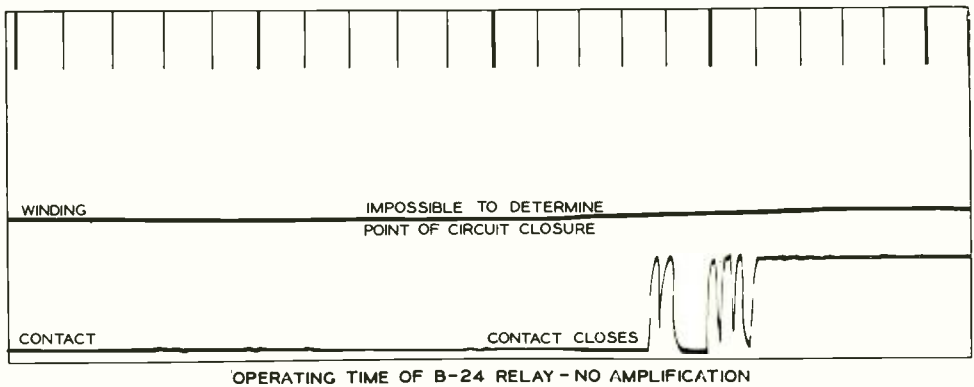

Fig. 5—Oscillograms of three ordinary tones are shown here both with and without the use of the amplifier

lating the amplifier. Figure 6-B shows the same condition making use of the amplifier. From the former it is impossible to tell where the winding current starts to build up but the point is very evident when the amplifier is used.

If the amplifier is calibrated on



*Figs. 6-A and 6-B—Amplification is necessary to show the building up of current in some types of relays*

direct current, it can be used in conjunction with the oscillograph to measure very small transient currents and voltages. Also, if an alternating current milliammeter is inserted in the output circuit in place of the oscillograph, the device becomes a very sensitive alternating current meter and supplements direct reading instruments of this type, which are inherent-

ly insensitive. Although only a few of the more important uses of the amplifier have been touched upon here, the extent of its possibilities has probably been indicated. Its usefulness will, no doubt, be further extended in the future as new circuit problems arise demanding distortionless amplification over a very wide range of frequencies.

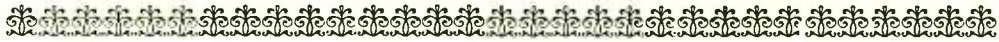

# Patents as a Means of Both Protection and Publication

By H. A. BURGESS  
*Patent Department*

---

A PATENT is a governmental grant of certain rights in an invention. The nature of the rights is fixed by law. The nature of the invention and the scope of the subject matter on which the rights are granted are defined in the patent. These rights constitute the patentee's protection, in that they enable him to prevent the unauthorized use of the invention by others. The patent is also a public document addressed to "all whom it may concern," and thus a publication of the invention disclosed in it. The description of the invention is an essential part of the patent and has as its main requirement that it be sufficiently complete and clear to enable one familiar with the related art to practice the invention.

The rights granted to a patentee are an absolute monopoly for a limited time—in this country seventeen years. The question which, perhaps, first occurs to the mind of anyone not intimately acquainted with the patent system is, "Why should the government, that is, society, be interested in giving to anyone a monopoly right in an invention?"

To answer this question, suppose that a new machine is invented which reduces the cost of production of an article by one-half. This new machine is valuable not so much on account of what it is as on account of

what it is able to do. It may be made of steel, and its intrinsic worth as so many pounds of steel may be very small. It is not the material of the machine which gives it value, but its characteristic and useful action. Whoever copies this machine and puts the copy to use obtains the same benefits as come from the use of the original machine. The copy, therefore, takes on value because it can perform a valuable function. Is it sound economic policy for society to recognize a property right in the characteristic pattern, plan or idea as distinguished from the property right in the machine as so much material? Since the idea is what imparts especial value to the material, society has answered "yes" to this question and has set up the patent laws to protect property rights in inventive ideas.

Knowledge of the plan of this machine can be spread very easily. A description or a sketch is all that may be required to acquaint the whole industry with the new mechanism. On the other hand, the machine may have been developed at very considerable cost of time and money. An adequate return on the investment represented by the development work can only be had by guarding the machine against being copied. If the party who bore the cost of new developments could not derive adequate returns from them, sound economics would dictate

that all parties become copiers rather than originators. The result would be a condition not very productive of improvement through expensive experiment and development studies.

The answer to the question why society is willing to grant a monopoly

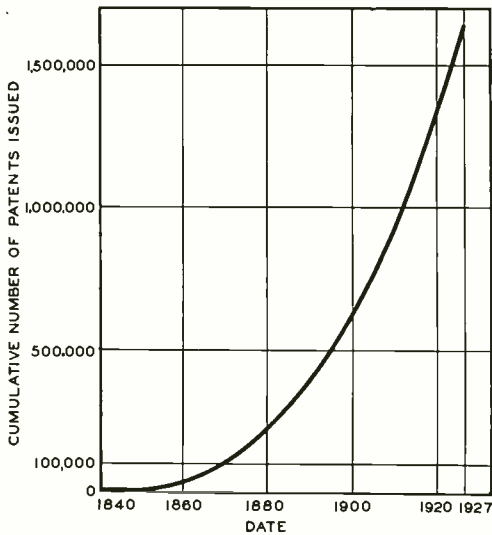

*Curve showing the number of patents which have been issued in the United States since 1840. From 1790, when the first U. S. patent appeared, to 1840 about 10,000 patents were issued*

right to an inventor in his invention is found in the general proposition that society is interested in progress in the industrial arts, and that such progress is prospered as the contributors to it are prospered. It is to the interest of society, therefore, to reward the real contributor or originator of any new practical technical advance. This is what the patent system aims to do, by giving the patentee a monopoly right in the invention. Exclusive control of an invention by keeping it secret is precarious; if the invention is an article of commerce, secrecy is impossible. The

patent relieves the patentee entirely of secrecy measures and allows him to make, use and sell his invention openly and to any extent while still giving him protection against unauthorized use of the invention by others. Society gains the benefits which come from introduction of the invention into commerce. Another important benefit to society is that after the expiration of the patent the public comes into full possession of the invention and may use it without obligation to the inventor.

An important characteristic of a patent is the even balance which it strikes between what the inventor gives and what he gets in return. If an invention which seemed important turns out later to be valueless, the monopoly right in the invention is equally valueless, and neither the inventor nor society has bestowed any benefit on the other. The monopoly right to a valuable invention, however, is valuable, and puts the inventor in the way of gaining a reward for his efforts. In a sense the inventor writes his own patent grant, and the grant proves valuable or not as he contributes much or little to the fund of technical knowledge.

The picture presented by the foregoing illustration is not complete without including consideration of the many inventions which are made but which do not find immediate commercial application. Such are, for example, by-product inventions, resulting directly from study or experimentation, but not meeting the requirements of the particular problem in hand. Such also is the output of the inventor who is not himself interested in making or using the products of his inventive skill. Many of these inventions may be valuable in the

hands of others, and it is, therefore, in the interest of society to provide an inducement for bringing these inventions to light and encouraging their adoption and use. This the patent system accomplishes by giving these inventive ideas the legal status of property in which rights may be transferred or sold.

We hear it commonly stated that the patent laws offer an inducement to invention. While this is undoubtedly true, it does not represent the whole truth. The patent laws are also an inducement to the inventor to make his inventions known. An inventor may make ever so many important inventions, but he gains no recognition by the patent laws until he shows an intention to make them clearly known and ultimately freely available to the public. This is demonstrated continually in cases of litigation between two rival claimants for the same invention. The inventor really the later in point of time may be held to be prior in law, if his opponent has stood by and done nothing while he was diligently perfecting the invention and making it available to the public. Society has manifested no interest in inventions that have been made and filed away in private archives or secretly preserved for possible future use. These inventions might as well not have been made, so far as concerns their effect upon the public good. Society is interested in having inventions brought forward and given public disclosure. Only by so doing does the inventor place himself in position to claim the protection which society stands ready to extend for new and useful inventions.

The importance of the patent as a publication is two-fold. The patent

must provide sufficient data to enable anyone conversant with the related art to practice the invention when the patent expires. The publication also has the immediate effect of acquainting other workers with the advance step represented by the invention, and this acquaintance not infrequently suggests to others a further improvement. Patents thus become an effective agency in the dissemination of technical information. Since their chief concern is the disclosure of what the inventor regards as his personal contribution, they afford a means of registering systematically each forward step in the development of an art. Once the patent application has been filed, moreover, the inventor's record date has been established and he may without prejudice to his rights publish the invention in any way he may choose. The patent system thus permits the prompt publication of inventions in technical journals without loss of protection to the inventor.

It is interesting to consider the importance of a patent system to industrial research organizations such as these Laboratories. There are many such organized groups in this country studying ways and means of promoting the existing industrial arts, and even creating new lines of endeavor. Here we see the patent system operating in two important respects. It gives to the products of the inventive efforts of the group the status of a property recognized by law. The exclusive property in the inventions so made represents value and constitutes part of the economic justification for the costs of the research. Furthermore, the patent system enables the groups to work much more openly than they could if the

only protection for the new ideas came through keeping them secret. Publication of results is perfectly consistent with retention of full rights in the property of the new ideas. This fact enables the different groups to be informed of one another's accomplishments and creates an atmosphere of stimulation, cooperation and healthy rivalry. It also enables due credit to be given to the originators of new ideas.

The broad policy of the American patent system was concisely stated by the Supreme Court of the United States in an opinion handed down about seventy years ago.\* The Court said in part:

"It is undeniably true, that the limited and temporary monopoly granted to inventors was never designed for their exclusive profit or advantage; the benefit to the public or community at large was another and doubtless

\* *Kendall vs. Winsor*—62 U. S. 165.

the primary object in granting and securing that monopoly. This was at once the equivalent given by the public for benefits bestowed by the genius and meditations and skill of individuals, and incentive to further efforts for the same important objects."

At the time of that opinion the telegraph was in its infancy. The telephone was as yet unknown. The next half century was destined to see not only the telephone but the radio operating on a commercial basis. In fact, all communication by electrical means up to and including radio was developed within the span of a single lifetime. Such an acceleration in the creation of new ideas could have come about only through the dissemination of technical knowledge. In this, as well as in furnishing a stimulus to the investigator by rewarding his successes, the patent system has played an important part.



*The National Academy of Sciences, meeting in Washington, has elected to membership Clinton Joseph Davisson of our technical staff, for his researches in electronic physics. Membership in the Academy, which was founded at the instigation of President Lincoln, is considered as the highest honor which can be conferred on an American scientist. Among members who are physicists may be noted Michelson, Millikan, Pupin, Wood, Karl Compton, Lyman and Arthur Compton. Other Bell System members are General Carty and Doctor Jewett, elected as outstanding members of the engineering profession.*





# The Pulse Corrector

By R. C. PAINE

*Systems Development Department*

AS is well known, the voice currents of telephone conversations, diminishing as they pass along from transmitter to receiver, are when necessary magnified at intermediate points of long-distance circuits by repeaters. Not so well known, perhaps, is a comparable need in the step-by-step dial system for reinforcing the trains of current impulses by which the switches are operated. In cities having two or more step-by-step operating centers each inter-center dial trunk has at its originating end a relay which passes on the impulses incoming from the calling subscriber's dial. The pulses are however, distorted by inductances and capacities effective in the trunks over which they pass. Trunks long enough for the distortions to be objectionable are therefore fitted at the terminating end with a correcting circuit which supplies to the switches pulses the same as those produced by the subscribers' dials.

Dial pulses are made up of two periods—one transmitted when the circuit through the dial is open, and the other when it is closed. A characteristic of the pulses which must not vary beyond rather wide limits is the relative length of these periods or, as it is more commonly expressed, the ratio of an open period to an entire impulse. That ratio, generally termed the "per cent break," can by the construction and adjustment of the dials be given any desired value at the calling subscriber's station. Be-

tween that station and the dial office however there are effective capacities and the inductances in addition to resistances; on calls in multicenter areas there are additional capacities and inductances as well as resistances, before the terminating office is reached. Furthermore, mechanical movements of certain parts of the apparatus affect the pulses allowed to reach the switches. The per cent break is therefore not that given by the dial, but is a modification depending on characteristics of the path over which the pulses have passed. Ordinarily no difficulty is experienced, but when the distance between the originating and terminating offices is beyond the normal dialing range, the selectors and connector may receive impulses whose per cent break is high enough to prevent correct operation.

The reason for that situation is the cycle of events which takes place at the arrival of the pulse group controlling a particular switch movement. The pulses do not go directly to the magnets which move the contact arm, but to a pulsing relay from which there are sent out new, stronger pulses whose per cent break depends upon that of the pulses received. In its operation the armature of this relay alternately makes contact on two points—on one during the closed periods of the pulses, and on the other during the open periods. The intermittent current flowing by turns through the circuit branches con-

nected to the two contact points holds the switching circuit closed in two places, by means of slow-release relays. When the per cent break is either too short or too long the armature holds too long at one contact and remains too long away from the

long for satisfactory dialing otherwise. Such adjustment would however be insufficient. Pulses for the subsequent digits, passing through the contacts of the first switch, control the succeeding switches. Since these later switches are accessible to any calls completed in the office, coming in from trunks of any length, they cannot be adjusted for pulses from a particular group of trunks.

One solution of the difficulty would be to divide these subsequent switches, segregating a group through which the only calls passing would be those from the longest trunks, and adjusting those switches correspondingly. Al-

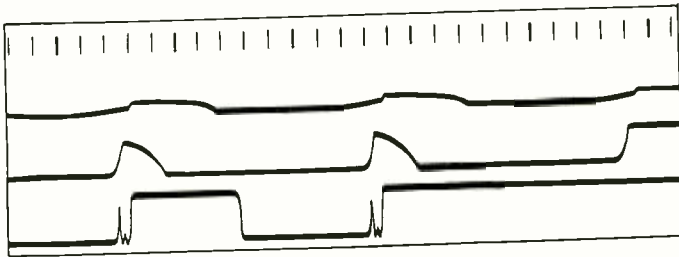
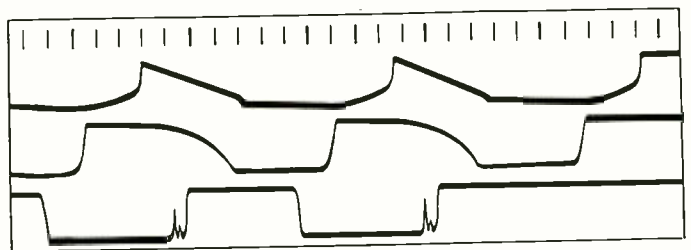

*Fig. 1—Oscillogram of the start of a train of pulses incoming from a long trunk. In this figure, and in Fig. 2, the top curve represents the pulses as received from the trunk; middle, those issued by the pulsing relay A; bottom the pulses transmitted to the subsequent switch by the pulse corrector. Each division on the scale represents 0.01 second. These oscillograms read from right to left*

though workable, such a division of the switches into two or more separate groups is inefficient from the standpoint of traffic capacity. As is well known, each switch in a small group cannot handle as many calls as if it were in a large group, if in both cases the same percentage of calls meet an "all switches busy" condition. Maintenance of any specific standard of service with the switches

other. Current through one of these contacts is thus interrupted for such periods that the associated slow-release relay restores to normal, preventing correct completion of the call. Failure may also result unless the pulses transmitted to the stepping magnets are sufficiently long to insure a step for each pulse.

Each incoming trunk at a step-by-step office is permanently associated with a selector which operates in accordance with the first digit of each group of pulses received. It would be possible to give this switch an individual adjustment to make it operate reliably on pulses from its particular trunk, even though this trunk were too



*Fig. 2—Oscillogram of pulses incoming from a short trunk. Such pulses do not need correction, but were corrected to permit comparison with Fig. 1*

divided into sub-groups would therefore necessitate installation of considerably more switches than would otherwise be needed.

To avoid any such arrangement, and to prevent dependance on extremely close adjustments for correct operation, there has been developed a pulse corrector for use on long trunks. This piece of apparatus replaces the incoming pulses, regardless of their per cent break, by new impulses whose open and closed periods have predetermined values. The occasion for correction, and the means for its accomplishment, may be compared to the situation in telegraphy, where the signals are distorted in their passage over land circuits or submarine cables. For many years regenerative repeaters, as they are known, have been used to re-transmit telegraph pulses incoming to them, after strengthening them and restoring them to their original wave form. Somewhat similar principles are employed in the pulse corrector in bringing to the desired wave shape the strengthened pulses which are sent out.

The mechanism for accomplishing correction consists mainly of a group of condensers and relays, of which a simplification is shown in Figure 3. More units are involved, but the essentials of operation are illustrated by the condenser and five relays shown. The group goes through its operating cycle once for each pulse received, and sends out to the suc-

ceeding switches a new pulse whose open period is governed by the time of operation of one of the relays and the release time of another. The total length of the new pulse is the same as that of the old, namely, the length originally given by the dial; although distorted by the intervening line, the dial pulses are not changed in overall length. Open and closed periods are therefore definitely fixed — the former by the pulse corrector,

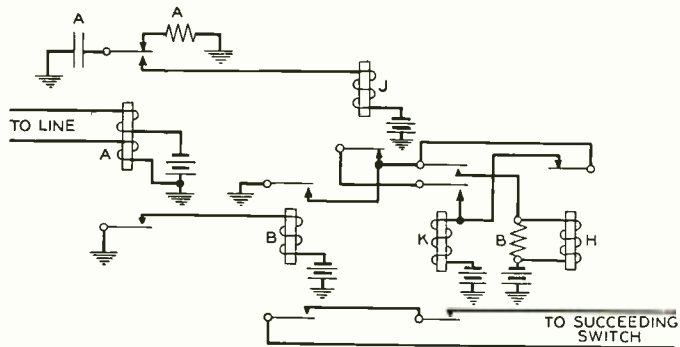

Fig. 3—Simplified diagram of the pulse corrector. Relay K, releasing breaks the circuit to the succeeding switch, to start each outgoing pulse. Thereupon slow-release relay H releases and relay K, reoperates to close the circuit and end the open period of the new pulse

and the latter jointly by the pulse corrector and the subscriber's dial.

The stimulus which starts the cycle of operations is a momentary condition—charging of the condenser shown, at the beginning of the closed period of each incoming pulse. The pulses received may therefore be distorted to a large degree without preventing the sending out of new pulses with the predetermined open and closed periods. The oscillograms show two groups of pulses as received from long and short incoming trunks, as passed on by the pulsing relay, and as made ready for switch operations by the pulse corrector. In one group

the per cent break is about twice that of the other, but the pulses sent out by the pulse corrector are the same in both cases. It is interesting to note from the oscillograms that the corrected pulses are delayed almost a complete cycle from those received. That delay, about a tenth of a second, arises from the fact that the open period of a corrected pulse is not sent out until the pulsing relay has closed for the next incoming pulse.

To insure satisfactory dialing, interoffice trunks in the step-by-step system have usually been limited to a maximum resistance of 1200 ohms. When 19-gauge cable is used, that figure is reached on trunks approximately thirteen and a half miles long. In most cases that distance is adequate; it is mainly in the smaller cities, where the farthest operating centers are seldom more than a few miles apart, that the step-by-step system is advantageous. Local conditions have how-

ever brought about its adoption in certain large communities, and it is used in some cities with a population well over a million. In addition, it is commonly used in cities a number of miles apart but having a rather large volume of intercity calls. It is for these cases, and for others similar, that pulse correctors are valuable. They more than double the maximum trunk resistance at which satisfactory dialing can be maintained without special adjustment of the step-by-step switches. Not only so, but they can be installed at intervals in a connection to increase the pulsing range as much as necessary; this is done on certain connections handled through step-by-step tandem offices. Thus there is an economical and reliable means for transmitting dial pulses over circuits of any length that, being within the limits set by the requirements of supervision and transmission, may be seriously considered for through step-by-step calls.



*Nearly \$82,000,000 is to be spent this year on new Long Lines facilities, an increase of 67 per cent over the 1928 expenditure. About half this sum will be spent on extending the long-distance cable system by 2500 miles. In addition the Associated Companies will add a thousand miles of similar cables.*

*The Long Lines construction program includes supplying a million loading coils and about 24,000 telephone repeaters to be used in connection with new and existing cable lines, the stringing of 74,000 miles of new aerial wire through less populated areas, and new pole lines, calling for an expenditure of \$10,000,000; and the installation of fifty-eight carrier current telephone systems and twenty-four carrier current telegraph systems. To supplement the present telephone facilities to Europe, three additional short wave transoceanic telephone systems will be constructed, and likewise an additional short wave system will be provided for telephone service with South America via Buenos Aires.*

*Prize Winning*  
PHOTOGRAPHS  
*of the Club Contest*

1929

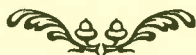

BELL LABORATORIES CLUB

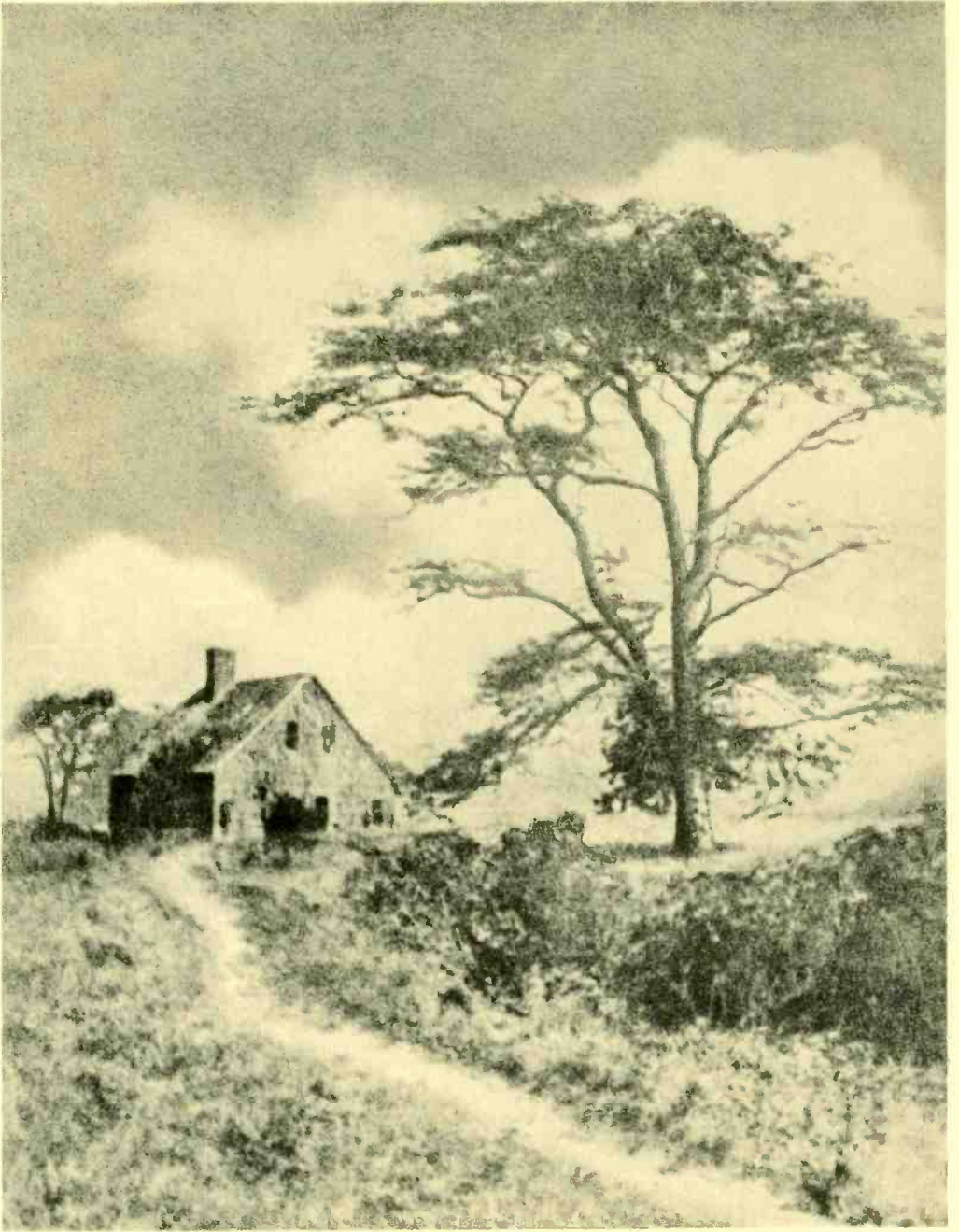

*First prize, landscape class : E. Alenius*



*Second prize, landscape class : G. R. Lum*

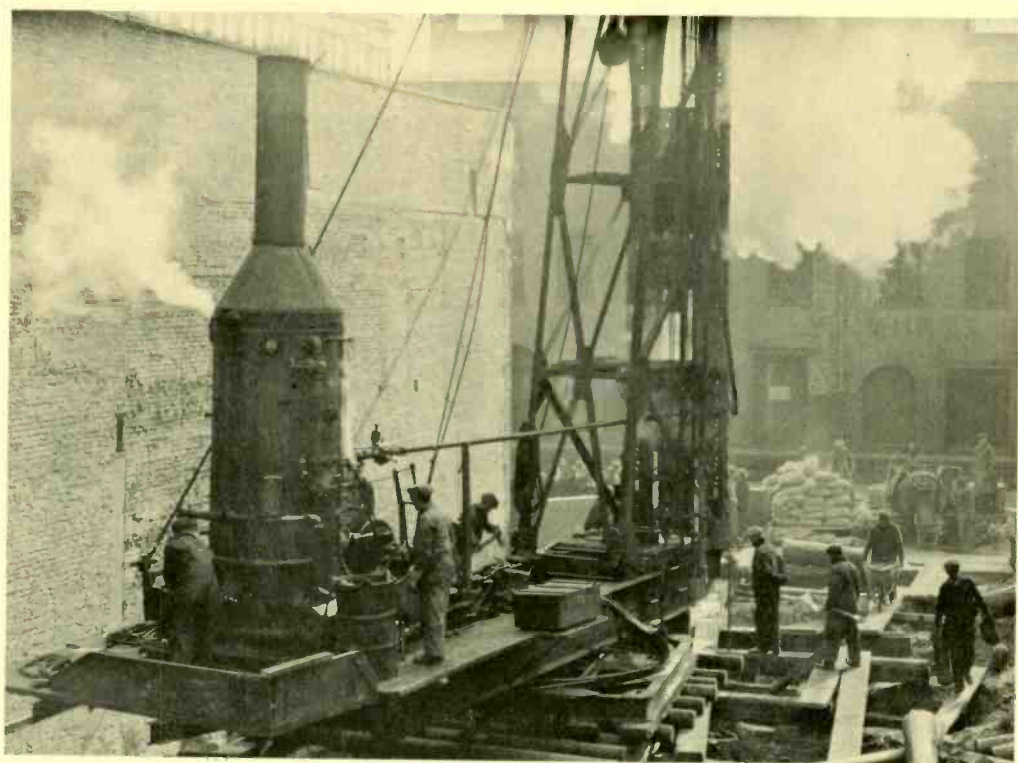

*Third prize, landscape class : J. Popino*

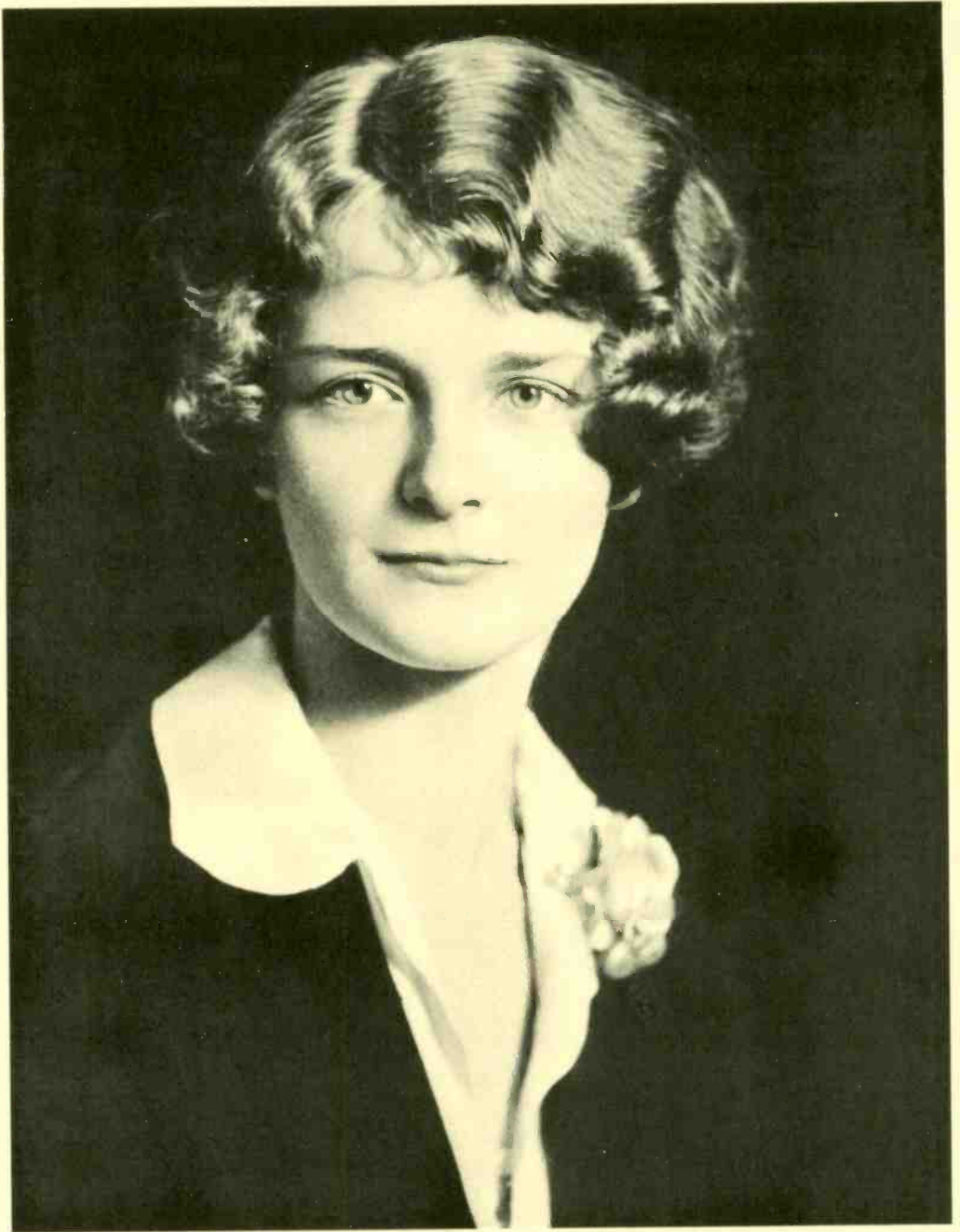

*First prize, portrait class : C. G. Scofield*



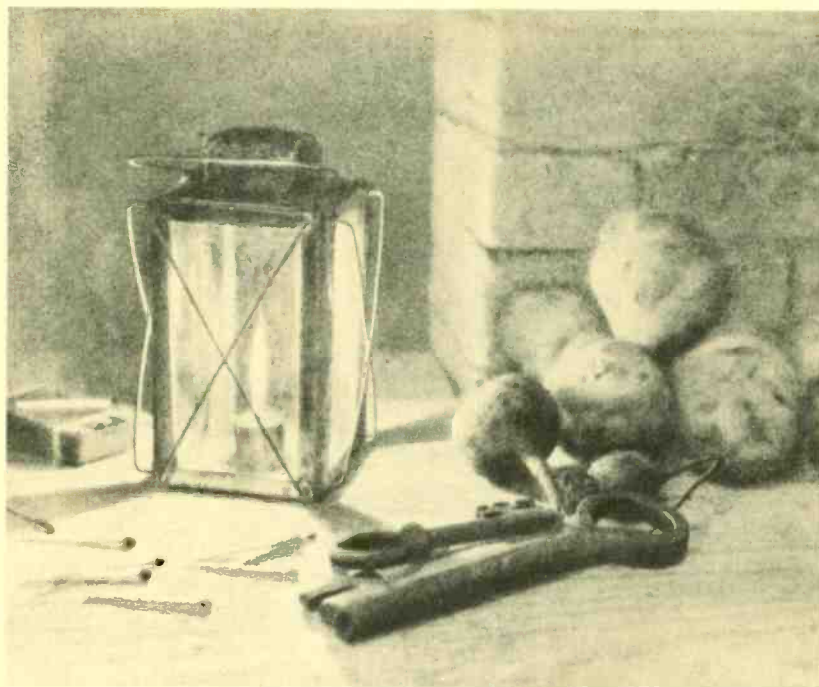

*First prize, still-life class : E. Alenius*

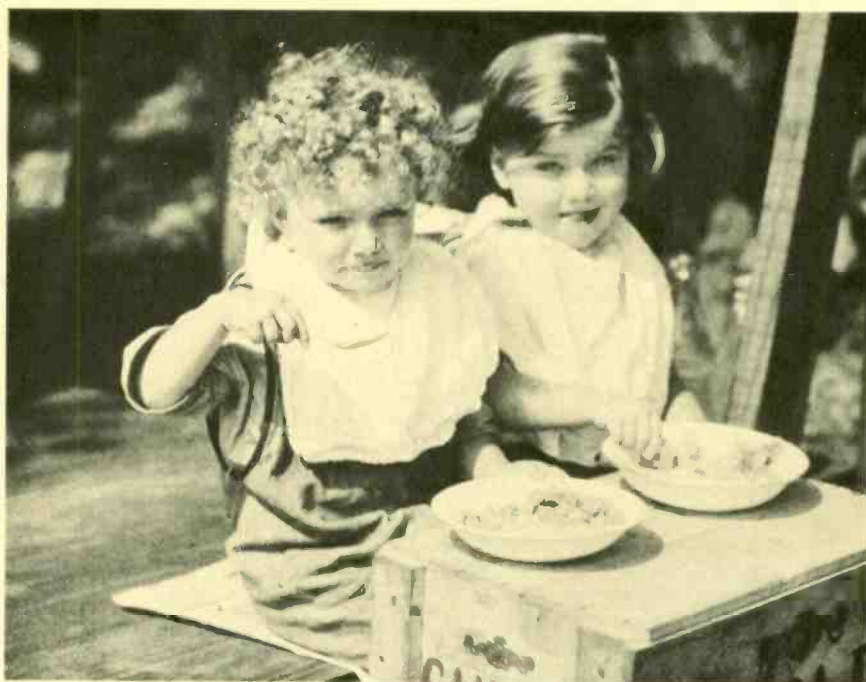

*Second prize, portrait class : G. Scheeler*

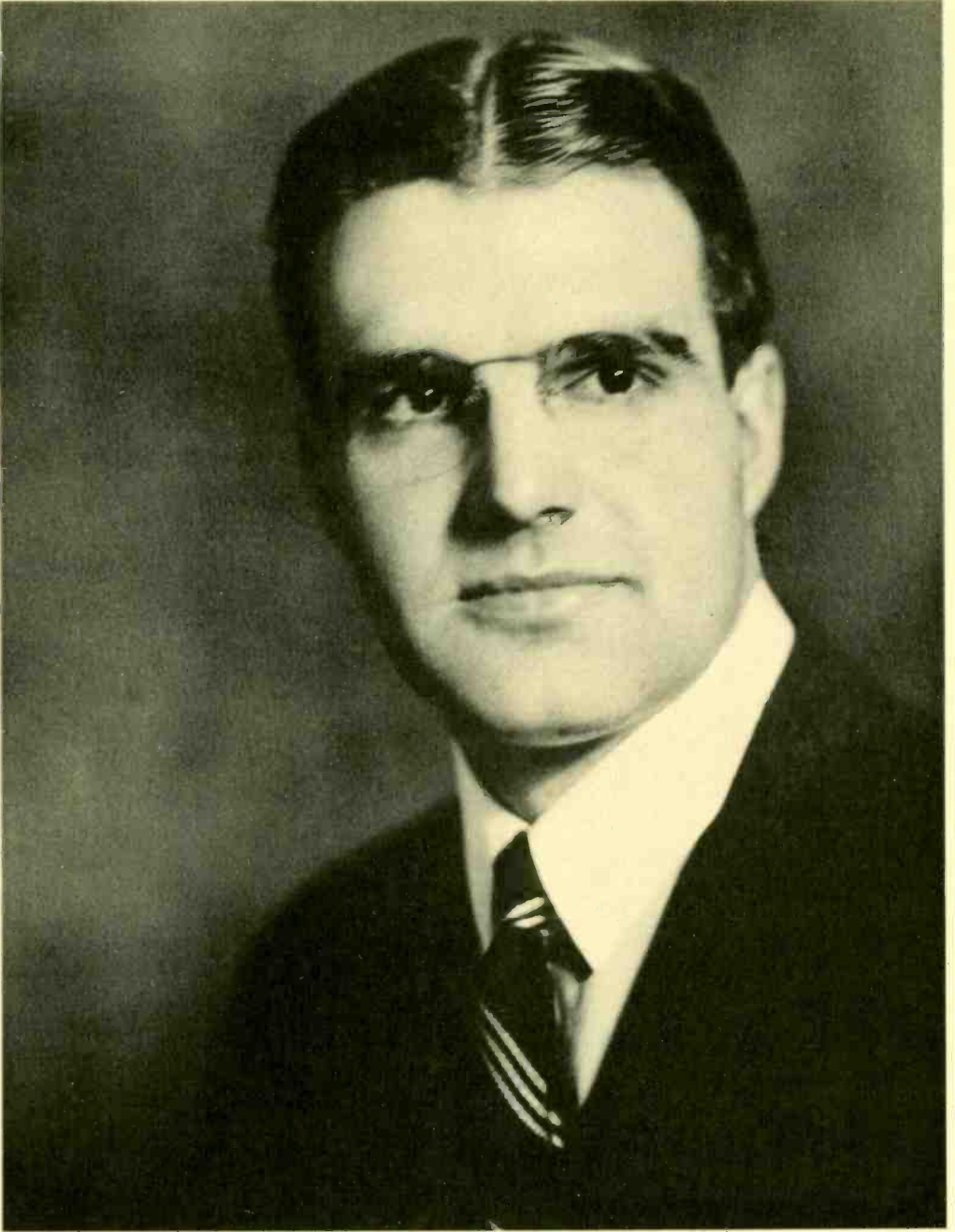

*Third prize, portrait class : C. G. Scofield*

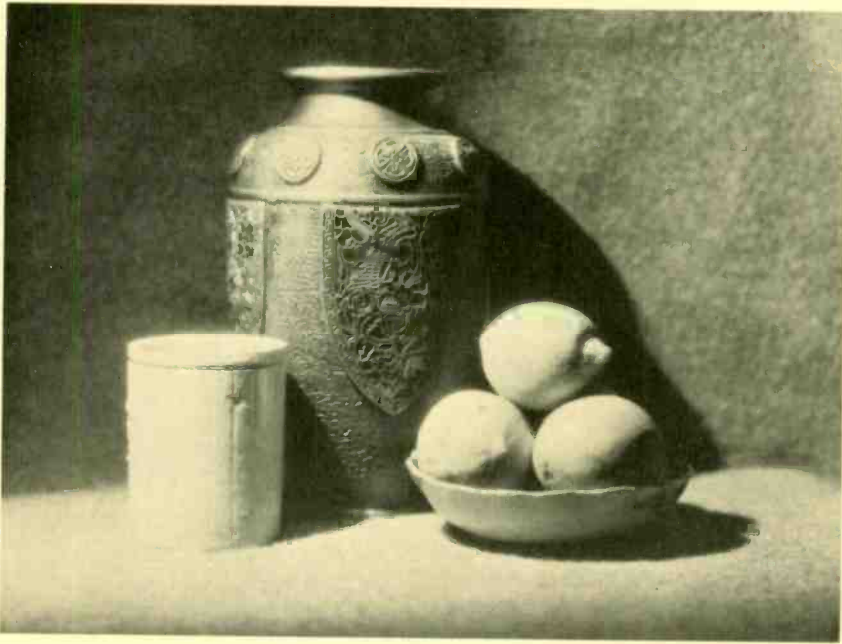

*Second prize, still-life class : C. G. Scofield*



*Third prize, still-life class : E. Alenius*

# Photographic Data

*First Landscape:* Ica camera; Carl Zeiss f 4.5 lens; exposure 1/25 second in sunlight at f 16; Eastman roll film; Bromoil paper and printing; clouds, path, and bushes taken from other negatives made with the same camera.

*Second Landscape:* Contessa Nettel camera; f 6.3 Protar lens; exposure 1/25 second at f 9; Eastman film pack; enlarged on P. M. C. No. 9 Bromide paper.

*Third Landscape:* 8 x 10 view camera; Goertz Dagor lens, 14 foot focal length; Eastman commercial Ortho film; exposure 1/50 second at f 16; part sunlight, mostly heavy shadow; enlarged on Gaevart Bromide rough semi-matte paper.



*First Portrait:* Century studio camera; Vitax f 3.8 lens; exposure 2 seconds at f 6.3 with about 6000 watts diffused Mazda light about 15 feet away; negative made on 4 x 5 inch Eastman Par Speed film and developed in Pyro; enlarged print made on Defender Velour Black rough buff paper, developed in metol-hydrochinon and varnished.

*Second Portrait:* 3¼ x 4¼ Graflex camera; f 4.5 lens; exposure 1/40 second in sunlight; commercial Orthonon film; enlarged on Novabrom rough buff paper.

*Third Portrait:* Same conditions as first portrait.



*First Still-Life:* Ica camera; Carl Zeiss f 4.5 lens; exposure 45 seconds at f 11; Eastman cut film; Bromoil paper and printing.

*Second Still-Life:* 3¼ x 4¼ Graflex camera; f 4.5 Eastman lens; Eastman commercial film; exposure 1½ minutes at f 16 with 150 watt bulb in reading lamp on table; printed on Velour Black semi-matte white paper.

*Third Still-life:* Ica camera; Carl Zeiss f 4.5 lens; cut film; exposure about 30 seconds at f 11; 100 watt lamp about 5 feet from subject; Bromide paper and printing.



## Routine Tests in a Panel Office

By L. M. ALLEN

*Systems Development Department*

**F**AULTS, occurring with telephone equipment, may be divided into two classes: those that disclose themselves to a subscriber or a Telephone Company employee, and those that are discovered by tests. Even though a definite report of the trouble is made, as happens with faults of the first class, it is frequently necessary to make tests to determine the direct cause of the trouble because the fault may not exist in a piece of apparatus directly connected with the subscriber's line or trunk that has been reported, but in some other unit required to complete the connection.

To insure, therefore, that telephone switching mechanisms and circuits are functioning properly, periodic tests are made on the principal units of the system. These are called routine tests. The name means that the tests are made not because of a reported failure, or because of any indication of trouble, but rather to locate equipment that is approaching the failure point. The effort is made to seek out and correct faulty equipment before the defects have become serious enough to give trouble under service conditions. Such faults as broken wires would not, of course, fall in this class, but it can readily be seen that a relay whose adjustment is gradually weakening can, by having a severe test imposed on it, be detected and have its adjustment corrected before it has weakened suf-

ficiently to cause a service failure.

Year by year better and more reliable apparatus and circuits are used, but a telephone system is so extensive and complicated that it is not commercially possible to develop one that could continue permanently free from sources of trouble. Foreign material between contacts so that electrical paths are not properly closed, wear of mechanical parts, and innumerable other things may occur to cause trouble. Each, as it develops, must be located and corrected to keep the system operating properly.

With the manual system, one or more operators are required to complete each connection, and in the event of trouble the operator can record the line and trunk involved so that the trouble may be located. With the dial systems, on the other hand, there is no human supervision on the connections established. Should the calling subscriber experience trouble when establishing a connection and make a second call which is successfully completed, he will very likely fail to report the trouble. Even though it were reported, considerable effort would be required in most cases to determine the source because in establishing a connection from one telephone to another it is highly improbable, except during periods of extremely light load, that the same train of switches would be used on any two of a number of successive calls. To maintain the high standard

of operation required by the Bell System, troubles must be located before they interfere with service, by frequent tests made according to a systematic routine.

Some of the testing circuits are of the automatic type, performing their testing operations without other than

supervisory assistance from an attendant. Such an automatic circuit used to test incoming selectors is shown in Figure 1. Generally, testing circuits of the automatic type are permanently located as close as possible to the circuits that they are designed to test.

The only action necessary on the part of the attendant to place in operation an automatic test frame such as that for incoming selectors is the manipulation of a few keys. When these have been operated the testing circuit associates itself with a district or office selector, temporarily removes it from service, and controls its movements so as to connect the testing circuit with the various incoming selectors that are to be checked. It is, of course, necessary to use a number of district or office selectors in sequence in order to obtain access to all incoming selectors.

After a successful test has been made on one unit, the circuit automatically associates itself with the next by advancing the district or office selector, and proceeds in this manner until all have been tested. The attendant, by operating a key, may—if he desires—cause the test circuit to pass any unit being used for regular service, or he may arrange the test circuit so that when a busy unit is encountered the circuit will wait for the unit to be released and then apply a test, so that all of the units are tested on a single round. On some circuits of this class it is necessary to send a number of calls in order to make a complete test of a unit, since a single test call will not test all the various functions of circuits. When trouble is encountered on any unit being tested, an audible signal is given to call the attendant's attention.



*Fig. 1—An attendant is here shown operating one of the control keys of an automatic incoming-selector test frame*

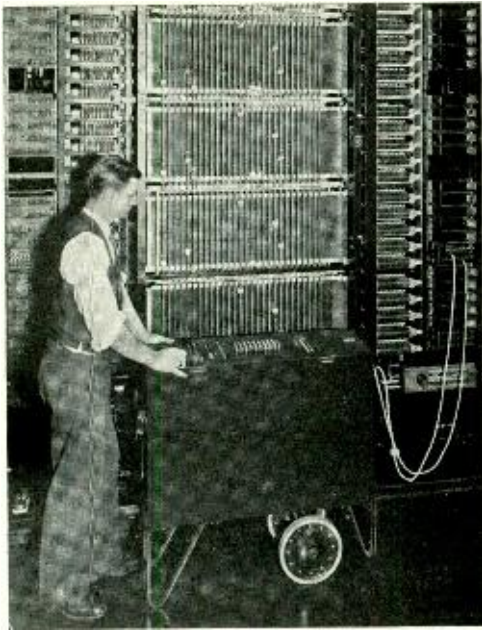

*Fig. 2—A portable test set of the “tea-wagon” type is here being used to test an incoming selector*

Since automatic test circuits require attention only in the event of failure, and for manipulating keys to start each round of tests, a substantial saving in attendants’ time is accomplished; most of the time the test frame is functioning without attention. As a result of the economies effected by their use in the panel system, automatic test circuits are now used for testing senders associated with cordless “B” boards in the step-by-step system and it is possible that in the future automatic testing equipment may prove economical for other step-by-step circuits.

Many factors must be considered to determine when it is economical to provide a test circuit of the automatic class. The decision depends on the number of units to be tested, the frequency with which tests are required, the ease with which an automatic test

circuit can be connected to the unit to be tested, and the relative costs of automatic and manual test circuits.

Where it is felt that a test circuit should be available, but the situation does not warrant an automatic circuit, portable test sets are provided. A photograph of such a set for testing office, incoming, and final selectors is shown in Figure 2. Another



*Fig. 3—Smaller than the “tea-wagons” are the box-type test sets, one of which is shown here in use at a B-position incoming-selector frame*

type of portable set, shown in Figure 3, is employed for testing the incoming selectors used for calls that originate in a manual office. Where a sufficiently large number of units is used, and where some features of the unit could not be tested with an automatic testing circuit, both portable and automatic test sets may be provided. When a portable-type test set is used, it is taken to the location where the unit to be tested appears, and is then connected to the unit to be

tested by means of cords and jacks. Since attendants are at hand when the set is in use, visual indications are given when a successful test has been made or when trouble is encountered.

Routine test-circuits are also used as a method of definitely locating the cause of a trouble, since the maintenance man may observe the action of a unit while test calls are being made.

This is the case with both automatic and portable types. To use the automatic circuits more effectively for this purpose, jacks for controlling the starting of test calls are provided at the frames where the units being tested are located. A series of calls may thus be made under the control of the maintenance man while he is observing the action of the unit under test.



## Graphical Symbols for Telephone and Telegraph Use

By W. L. HEARD

*Systems Development Department*

GRAPHICAL symbols are the means by which information is recorded and transmitted when audible methods are not suitable or desirable. The ideograms of the earlier languages, like the Egyptian hieroglyphs, are such primitive symbols used for conveying general information. These, in the course of evolution, become formalized, and eventually only sound symbols remain, which are the words of ordinary writing. Although ideograms are not used in the modern languages, they perform an important role in the language of engineering drafting.

In making drawings, material objects must be indicated. A complete and correct sketch of each piece of equipment referred to would require too much time and space to be desirable, so that a symbol—a few lines perhaps representing the essential features of the object—naturally takes its place. In the degree to which they resemble the objects they stand for, drafting symbols differ widely. Some could never be mistaken for any but the thing they rep-

resent, but others are highly formalized and difficult to interpret. Symbols of this formalized type are suitable only when all those who will use the drawing are familiar with the conventions used.

For their effective employment, therefore, it is essential that symbols be standardized. There must be an agreement between those who use them as to their form and definition, and once standardized the use of the accepted symbol should be made as nearly universal as possible. To produce this standardization among the symbols used in the telephone and telegraph industry a committee was appointed some time ago under the chairmanship of W. E. Farnham of the American Telephone and Telegraph Company. On this committee were A. B. Smith of the Automatic Electric Company, H. W. Drake of the Western Union Telegraph Company, L. F. Shea of the New York, New Haven and Hartford Railroad, and the writer—representing Bell Telephone Laboratories.

This committee, representing very



fairly the telephone and telegraph industry of the United States, acted as a part of a comprehensive national standardization organization which came into existence over ten years ago. The importance of having national standards can not be over-estimated and with the object of obtaining them, the American Standards Association (formerly American Engineering Standards Committee) was founded in 1917, at the instigation of the technical and scientific societies. Its duties are to investigate suitable subjects for standardization, and to appoint sectional committees, representing the industries and interests involved, which undertake the actual standardizing work. The A. S. A. itself does no actual work in creating the standards, but accepts and gives the stamp of national approval to those finally agreed upon by the sectional committees.

Following this prescribed procedure a sectional committee was appointed early in 1926 to agree upon standards of Engineering Symbols and Abbreviations. Owing to the wide scope of the undertaking, seven sub-committees were appointed to work in different fields, and some of these sub-committees were further divided. The committee on Telephone and

Telegraph Symbols was a branch of the sub-committee on Electro-technical Symbols and Abbreviations. It was appointed in June, 1926, and completed its work late last summer.

As part of its procedure the A. S.

**STANDARDS**  
OF THE  
**American Institute of Electrical Engineers**  
**GRAPHICAL SYMBOLS FOR TELEPHONE AND TELEGRAPH USE**  
(Adopted by the Board of Directors, A. I. E. E., December 7, 1926)

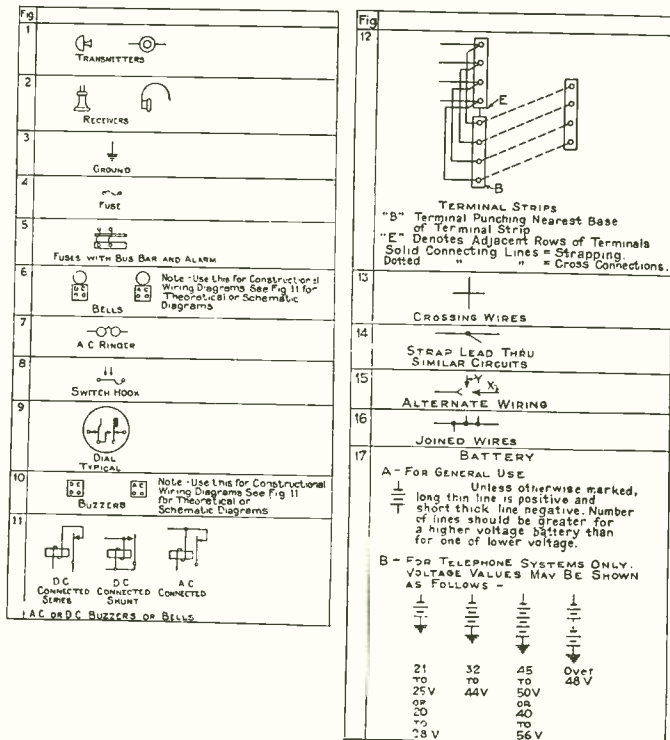

*The complete standard consists of forty-nine figures of which seventeen are shown on this first page. Some of the individual figures, however, have a large number of derivative symbols*

A. appoints one of the national scientific or engineering societies as sponsor for each group of standards, and the American Institute of Electrical Engineers was naturally chosen guardian for the sub-committee of Telephone and Telegraph Symbols.

It accepted the report of the sub-committee in December, 1928, and by doing so made the standards agreed upon the official standards of the

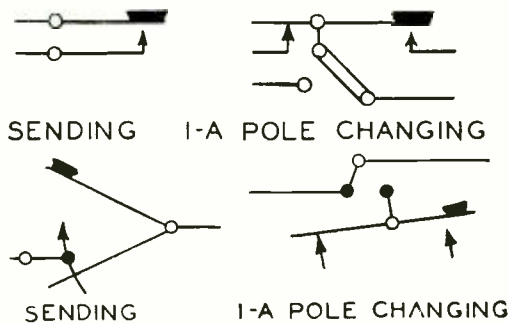

Fig. 1—Symbols for telegraph keys in the adopted standard differ from previous Bell System standards to a greater extent than any of the others

A. I. E. E. These have now been printed and the first page of the standards issued is reproduced in the accompanying illustration. These will shortly be accepted by the A. S. A. and become, in addition, national standards.

In the selection of telephone and telegraph symbols it is natural that those in use by the Bell System should have been adopted to a very large extent. In some cases, however, this did not seem advisable for one reason or another. The symbols for telegraph keys might be cited as an example. On Figure 1 the symbols used until recently by the Bell System are shown at the top, and beneath, those

adopted by the committee. A slight change in the symbol for the telephone headset, shown by Figure 2, was another of the deviations from Bell System practice.

The completed assemblage of symbols combines, therefore, not only what has proven to be a most effective group of symbols during the half century of telephone development by the Bell System, but what a representative committee of the telephone and telegraph industry feels to be the most effective for continued use. By their adoption the language of the telephone drawing has become a standard means of imparting knowledge. Engineering standards and

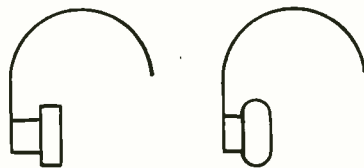

Fig. 2—The change made in the symbol for a telephone headset only changes the Bell System standards to a greater extent slightly alters the proportions

symbols, however, are subject to continual growth and evolution. Any standardization is of only relative permanency, and represents but the best present practice. It is hoped that from time to time valuable suggestions will be received which will result in still further improvement.

# Trouble Indicator

By R. MARINO

*Systems Development Department*

OPERATORS are effective watch-dogs for the manual system. Most forms of trouble can not exist on a line for any length of time without their detecting it, and as soon as they perceive trouble, the maintenance force is notified, and steps are taken to remove it. With the introduction of the dial system this service that the operator performs was lost and it was desirable to devise something to take its place. As a part of a system used to guard decoders\* and their immediately associated equipment from trouble is the trouble indicator.

In a dial system office most of the mechanical equipment is maintained with specially designed auxiliary test circuits. These exercise the apparatus under conditions generally more severe than those met in actual service and if trouble occurs during such a test, it is corrected by a maintenance man. This system of routine testing works very well when the units are small and trouble, as a result, is distributed over a large number of circuits each handling but a small fraction of the total office load. A district selector, for example, handles only 136 calls a day on the average, there being about 1100 of them in a 10,000 line office. Trouble developing in a selector immediately after the completion of the routine test could cause, therefore, only 136 cases of

trouble—assuming daily routining—which is only one-tenth of one percent of the 150,000 calls constituting the average office traffic. Actually, of course, this is an extreme case as maintenance records indicate that the trouble for an entire office from all causes is not much higher than this.

With the decoder, however, the case is quite different. It may handle nearly 80,000 calls a day, so that a persistent trouble condition occurring soon after a routine test might seriously affect a large percentage of the office traffic for the day. Evidently, therefore, the routine test method of maintaining office equipment would not be an economical way of keeping the decoder free from trouble. Trouble occurring on it must be found and eliminated at once. This is done by a circuit which tests the decoder during the progress of every call, and the trouble indicator acts as a permanent sentinel, forever ready to display to the maintenance force any trouble that occurs. As soon as the decoder gets into difficulty, the trouble indicator is automatically connected, an alarm sounded, and the source of trouble flashed out on a group of lamps provided for the purpose.

There is in the decoder an arrangement known as the "second trial" feature which causes it, before acting on any call, to test its own equipment once. If trouble is found—false grounds, open wires, crosses, or ap-

\* *The Decoder* by R. Raymond, May, 1928.

paratus in faulty adjustment—it refuses to act; the sender is signalled to select another decoder before completing the call, and the faulty decoder is temporarily held busy. This “second trial” feature is intended to enable a subscriber to get the number on his first attempt even though

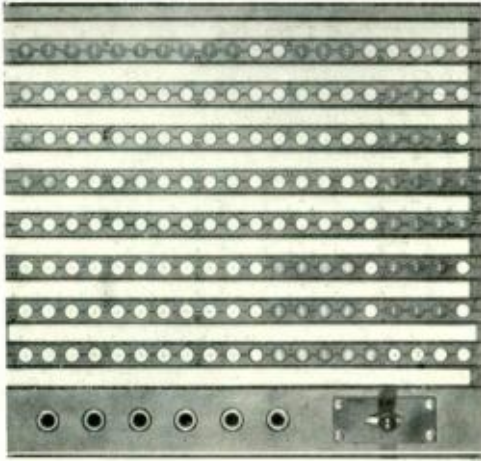

*Fig. 1—From the outside the trouble indicator appears as a group of indicator lamps, red, white, or green in color. The above is a photograph of an early model*

faulty apparatus were connected to the line. Much of the trouble occurring in the decoders is eliminated in this manner without the help of the trouble indicator because it is of a transient nature.

The trouble indicator itself consists of about fifty relays, each of which controls a lamp, and the whole unit is so arranged that it may be connected to any of the decoders through the operation of a multi-contact relay associated with each decoder. There is thus only one trouble indicator in each office. Whenever a decoder fails to complete its operation in a prescribed interval of time this master switching relay is operated and connects the relays of the

trouble indicator to the decoder in such a way that the point of fault in the decoder will be shown by the lamps of the indicator.

This is made comparatively simple by the circuit arrangement of the decoder. Its relays operate successively so that failure of a relay to operate indicates that trouble exists on the connection between the last relay that operated and the one that has failed to operate. The relays of the indicator are so connected to the decoder that its lamps indicate the operation or non-operation of relays in the decoder electrically located at strategic points in the circuit, so that the trouble must be between one of these relays and the next one in the sequence.

The particular group of relays that operates in the decoder depends on the number being called, and the relay sequence for each call may be different. The trouble indicator shows whether or not certain of the relays in the decoder have operated. For most causes of failure it also indicates the office code dialed by the subscriber as well as the number of the decoder, sender, and connector used, as a further aid to the maintenance man. As soon as this information has been locked-in on the indicator, the decoder is disconnected from it and the information remains displayed until it has been manually released.

It is not expected that the maintenance men will investigate every trouble condition recorded on the trouble indicator as many of them are of a transient character and clear themselves without attention. It is only when troubles come in rapid succession that the attention of the maintenance force is likely to be needed. In order to discriminate between transient and permanent trouble, a

double alarm is furnished. One rings when the indicator is first used and ceases when the maintenance man has released it. The other rings only when a second case of trouble has developed before the indicator has been released. This repeated trouble within a short interval of time is the real danger signal as it generally shows

that trouble exists that is not transient.

In this manner, the decoder circuit may always be kept in first class condition without requiring routine tests at short intervals of time as would be necessary were reliance to be placed on routining for keeping the decoders at all times fit for service.

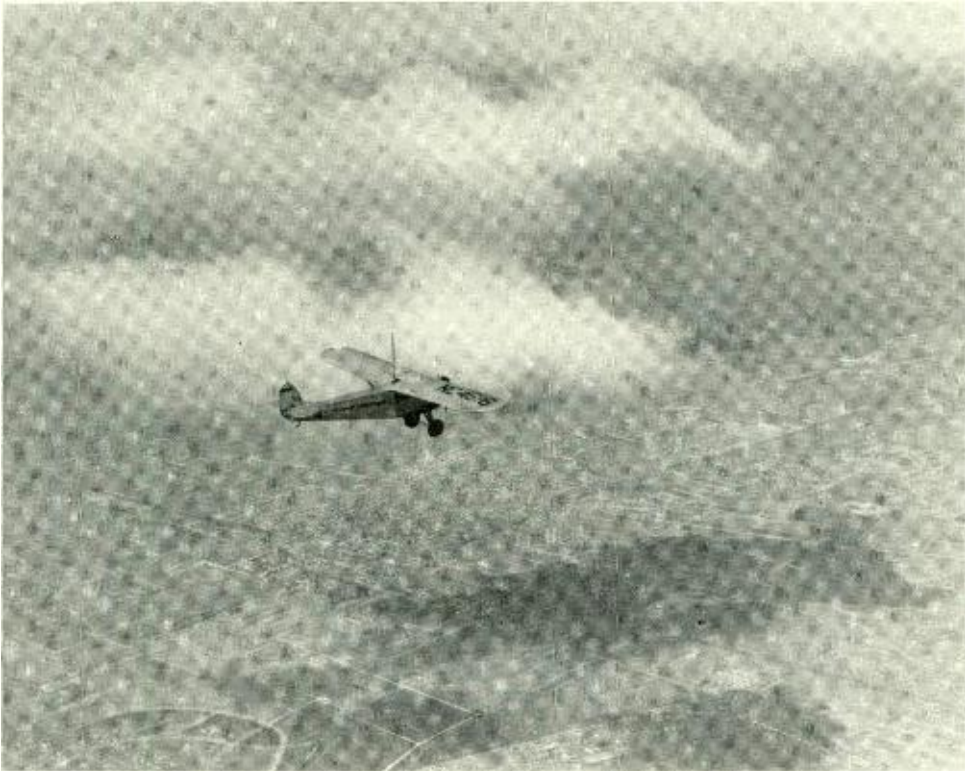

*A laboratory for the study of radio communication*

## News Notes

---

AT THE ANNUAL MEETING of The Museums of the Peaceful Arts held on February 27, 1929, Dr. Jewett was appointed an Honorary Vice-President of the corporation.

F. B. JEWETT AND H. P. CHARLESWORTH attended the Greater New Jersey Dinner given by the New Jersey State Chamber of Commerce and the New Jersey Bell Telephone Company on April 4, 1929, in the auditorium of the new State telephone headquarters building at 540 Broad Street, Newark, New Jersey.

F. B. JEWETT, T. G. MILLER, LLOYD ESPENSCHIED AND O. E. BUCKLEY, all of whom sailed for England on February 9, returned to New York on the Ile de France on March 26. The trip was made in the interests of transatlantic telephone communication and, while abroad, visits were made to England, Ireland, Germany and France. In England discussions were held with various officials of the British Post Office regarding additional long- and short-wave radio channels, as well as the problems in connection with the proposed transatlantic telephone cable. Dr. Jewett also discussed with officials of the French and German Telegraph and Telephone Administrations the question that they had previously raised regarding direct radio-telephone communication between their countries and the United States.

PROFESSOR A. SOMMERFELD of the University of Munich addressed the members of the Colloquium on April 9. His subject was "The Photo-

electric Effect in a Single Atom and in a Metal." At the April 1 meeting, E. F. Kingsbury spoke on "Physical Problems of Making and Breaking Electrical Contacts."

MR. CHARLESWORTH has been appointed to represent the American Institute of Electrical Engineers on the Board of Awards of the Alfred Nobel Prize, which is awarded each year by the American Society of Civil Engineers for the most meritorious technical contribution submitted by a member of one of the four founder societies which represent civil, mechanical, mining and metallurgical, and electrical engineering.

MR. CHARLESWORTH AND MR. MILLS attended the Bell System Publicity Conference held April 10 to 17, at the Mid-Pines Club, Pinehurst, North Carolina.

DURING the All American Aircraft Show, held in Detroit from April sixth to fourteenth inclusive, the Laboratories cooperated with the Western Electric Company in demonstrating the new 6008-A Radio Receiver described in the April RECORD. The party from the Laboratories comprised R. L. Jones, O. M. Glunt, E. L. Nelson, F. M. Ryan, J. O. Gargan, D. K. Martin, R. S. Bair, S. E. Anderson, W. C. Tinus, and H. B. Fischer.

Men prominent in the aircraft industry were taken up in the Laboratories' plane and allowed to listen to the hourly weather reports broadcast from Cleveland, and also to the radio beacon while flying toward the Ford

airport at Dearborn. Among those taken up was Captain F. C. Hingsburg of the Lighthouse Bureau of the Department of Commerce who has charge of radio stations and airways.

#### APPARATUS DEVELOPMENT

D. D. MILLER recently addressed a convocation of the Apparatus Development Department on "The History and Recent Developments in Electromagnetic Apparatus." He described various relays, including the flattened core type invented by Mr. Craft, and emphasized the fact that relays and other electromagnetic apparatus represent the largest item of expense in telephone apparatus. W. Fondiller presided and R. L. Jones spoke on the general organization of functions of the department.

E. C. ERICKSON spent the week of March 25 at Hawthorne developing methods for the measurement of diaphragm dimensions.

H. N. VAN DEUSEN, J. M. WILSON, J. R. TOWNSEND AND C. H. GREENALL attended a conference on specifications for copper alloy sheet materials with representatives of the Northern Electric Company, Western Electric Company and American Brass Company, at Montreal.

J. R. TOWNSEND visited Hawthorne to discuss the manufacture of the light valve for sound pictures and also fatigue of sheet metals.

H. A. ANDERSON discussed the problems of welding loading coil cases and heat treatment of dial parts at Hawthorne during the week of March 18. While in Chicago, he attended with J. R. Townsend committee meetings of the American Society for Testing Materials on die casting and fatigue.

E. MONTCHYK spent the week of

March 18 in Denver studying cleaning methods for step-by-step banks of a local dial office. On the return trip he spent several days at Hawthorne in connection with problems of apparatus development.

D. W. MATHISON made a study of cleaning methods for dial apparatus terminals at Lansing, Michigan, during the week of March 11.

J. N. REYNOLDS investigated enameling processes at the Porcelain Enamel Manufacturing Company at Baltimore, Maryland.

G. W. FOLKNER AND J. N. REYNOLDS visited the new step-by-step installation at Wilmington, Delaware, on April 2.

D. D. MILLER AND H. F. DOBBIN discussed compressed air apparatus with representatives of the National Pneumatic Company of Rahway, New Jersey on March 20.

J. F. HEARN was at Hawthorne in connection with the manufacture of gear-driven sequence switches and die-cast drive-shaft bearings.

G. B. BAKER recently investigated developments in step-by-step relays at Hawthorne and, at the Automatic Electric Company in Chicago.

W. T. PRITCHARD attended a conference on April 4 with representatives of the American Telephone and Telegraph Company and the Bell Telephone Company of Pennsylvania on maintenance apparatus for the panel dial system.

E. B. WHEELER spent a week during March at Hawthorne, in connection with the development of switch-board cable and enameled wire.

A. B. BAILEY directed the installation of the new antenna system at Station WABC of the Columbia Broadcasting System at Broad Channel, New York.

N. BISHOP inspected the one-kilowatt broadcasting equipments of the Fisher Blend Station, Inc., and the Puget Sound Broadcasting Company at Seattle, and the Oregon State Agricultural College at Corvallis. He inspected the one-kilowatt broadcasting equipment and made a survey for the proposed five-kilowatt broadcasting equipment for Louis Wasmer, Inc., Spokane, and supervised the conversion to crystal control of the one-kilowatt broadcasting equipment of the Oregonian Publishing Company, Portland.

B. R. COLE made a survey for a five-kilowatt broadcasting equipment of the Atlanta Journal, Atlanta, Georgia.

J. C. HERBER made a survey for the five-kilowatt broadcasting equipment purchased by Larus and Bro., Inc., of Richmond, Virginia. He inspected the five-kilowatt broadcasting equipment of the Missionary Society of St. Paul the Apostle, Kearny, New Jersey.

O. W. TURNER supervised the installation of the one-kilowatt broadcasting equipment of the Shepard Stores, Boston, Mass. He inspected the one-kilowatt equipments of the Outlet Company, Providence, and the Matheson Radio Company, Gloucester, Massachusetts.

C. D. HOCKER, C. S. GORDON, F. F. FARNSWORTH AND E. M. HONAN attended a committee meeting of the American Society for Testing Materials held in Chicago during the week of March 18. Mr. Hocker extended his trip to Kansas City to visit the clay products plant of the W. F. Dickey Manufacturing Company while Mr. Gordon and Mr. Honan visited Hawthorne to observe wire development.

W. H. S. YOURY spent the week of March 18 visiting the Hermann Oak Leather Company of St. Louis and the R. H. Buhrke Company of Chicago in connection with the manufacture of body belts and safety straps.

F. F. FARNSWORTH AND H. BAILLARD visited the James A. Kiley Company in Boston during the week of March 11 in connection with field tests of paints for automobile trucks. During the following week Mr. Baillard made similar observations in Cleveland, Ohio.

G. Q. LUMSDEN made an inspection of preservative-treated poles in the territory of the Mountain States Telephone and Telegraph Company.

C. SHAFER visited the Southern New England Telephone Company in New Haven during March to make studies of drop wire.

#### INSPECTION ENGINEERING

A. F. GILSON, R. M. MOODY AND D. S. BENDER visited Boston on March 22 to conduct an investigation of switchboard keys.

R. M. MOODY AND H. C. CUNNINGHAM attended a survey conference at Kearny in connection with telephone cords during the week of March 11. Mr. Moody and C. J. Hendrickson visited Hawthorne during the last week of March to attend a similar conference for the study of dial apparatus.

S. H. ANDERSON attended a conference for the study of inspection and quality of protective devices at Hawthorne.

W. E. WHITWORTH, Omaha Field Engineer, visited Denver, Colorado, and Gothenberg, Sidney, and North Platte, Nebraska, in connection with Field Engineering activities.



E. G. D. PATTERSON AND A. F. GILSON visited the Highway Trailer Company in Edgerton, Wisconsin, during the first week of April to conduct quality studies of automotive equipment.

O. S. MARKUSON, AND A. G. HALL of the Outside Plant Development Department, visited Kingston, New York, to observe the installation of the first 1800-pair lead covered cable manufactured at Kearny.

#### SYSTEMS DEVELOPMENT

B. W. KENDALL spent several days in Ottawa, where he testified in connection with patent matters.

H. M. PRUDEN investigated 1000-cycle signaling equipment in Philadelphia and Harrisburg.

E. VROOM inspected pilot-wire regulating equipment at the repeater station in Kingston, New York.

D. M. TERRY, W. F. KANNENBERG, G. H. HUBER, R. W. CHESNUT AND F. A. MINKS have been engaged in testing between Washington and West Palm Beach an improved automatic pilot channel for carrier telephone systems.

C. C. LANE inspected the new telephone typewriter service at Chicago. A. D. Dowd and J. E. Zendt inspected a similar service in Boston.

F. J. SCUDDER AND S. F. BUTLER spent several days at Hawthorne, discussing new tandem installations.

F. A. KORN, A. H. LINCE AND G. K. SMITH visited Atlantic City to investigate new step-by-step equipment at the Marine Central Office, and to observe PBX operation in several hotels.

R. W. HARPER conferred with representatives of the Stromberg-Carlson factory at Rochester on the manufacture of the 506-A PBX.

L. M. ALLEN, F. T. MEYER, J. R. KIDD AND J. R. JACKSON made a trial installation of subscriber sets for rural line equipment, at Albany, Olean and Troy.

J. E. GREENE made a trial installation of out-trunk pre-selector equipment in the Number 5 office at Syracuse.

W. G. SCHIAER discussed improved central testing bureau equipment with engineers of the Western Electric Company at Hawthorne.

R. E. NOBLE AND C. E. BOMAN inspected a new form for supporting frames in central offices at Wilmington, Delaware.

H. M. SPICER discussed various power problems with engineers of the General Electric Company at Schenectady.

#### PATENT

Members of the Patent Department who visited Washington during the period from March 10 to April 9, 1929, were H. A. Flammer, H. P. Franz, E. V. Griggs, A. J. Michel and J. W. Schmied.

#### RESEARCH

W. C. JONES AND N. BLOUNT were at Hawthorne for conferences on the design of transmitters.

P. A. LASSELLE attended a conference at Hawthorne on flame baking of enameled wire.

J. H. INGMANSON attended the meeting of the American Society for Testing Materials in Chicago and also visited Hawthorne in connection with the development of rubber covered wire.

H. H. LOWRY AND W. ORVIS visited certain properties of the Jeddo-Highland Coal Company at Hazleton, Pennsylvania, on March 28 and

29, to investigate a new supply of coal for the manufacture of transmitter carbon.

R. M. BURNS conferred on metal finishes with engineers at Hawthorne, later going to Milwaukee to observe experimental research on paints at the Pittsburgh Plate Glass Company.

L. H. CAMPBELL examined paint testing equipment at the Munsell Color Company in Baltimore.

C. L. HIPPENSTEEL visited Hawthorne to confer on problems of metal finishes, and attended committee meetings of the American Society for Testing Materials in Chicago.

H. E. IVES addressed a meeting of the American Physical Society in Washington, April 18, on "Motion Pictures in Relief."

HARVEY FLETCHER gave a lecture and demonstration in the auditorium on "Speech and Hearing," on Tuesday, March 26, before the Columbia Chapter of Sigma Xi and their guests.

W. A. MARRISON presented a paper on *A High Precision Standard of Frequency* at the symposium on frequency measurements held in New York by the Institute of Radio Engineers on April 3. He also gave a paper, *Oscillograph for Recording Transient Phenomena* at the A. I. E. E. Spring Convention at Cincinnati.

T. C. FRY visited Brown University to interview engineering students of the class of 1929.

F. R. LACK was the author of a paper, *Observations on Modes of Vibrations and Temperature Coefficients of Quartz Crystal Plates*, given before the Institute of Radio Engineers.

AT THE WASHINGTON MEETING of the American Physical Society held April 18 to 20 at the Bureau of Standards and the National Academy of Sciences, papers were presented by

six member of the Research Department. These were: *Determination of the Average Size of the Discontinuities in Magnetization*, by R. M. Bozorth; *Magnetic Properties of Iron Crystals*, by D. D. Foster; *Use of Dielectrics to Sensitize Alkali Metal Photoelectric Cells to Red and Infra-Red Light*, by A. R. Olpin; *The Preparation of Photoelectric Cells with Thin Films of Lithium as the Photoactive Material*, by H. E. Ives; *Thermionic Emission as a Function of the Amount of Adsorbed Material*, by J. A. Becker; and *The Equilibrium between Surface and Volume Concentrations of Dissolved Substances*, by J. M. Eglin.

#### GENERAL STAFF

S. P. GRACE spoke before the Engineers Club of Philadelphia on April 12. On April 18 he addressed the Boston City Club, and on April 23, the Yale Branch and Connecticut Section of the A. I. E. E. at Yale University. R. M. Pease, of the Apparatus Development Department, made the demonstrations.

P. B. FINDLEY's lecture engagements for April included a series of talks at Cleveland on the development of sound pictures. He addressed a luncheon meeting of the Advertising Club of Cleveland on April 17, and on the following day the student body of Case School of Applied Science. In the evening he addressed a meeting of the Cleveland Section, A. I. E. E., to which the public was invited. On April 19, he talked to about two hundred telephone people. W. C. F. Farnell was in charge of the demonstration of sound pictures, and with Mr. Findley was a guest at a dinner tendered by the Ohio Bell to officers of the Institute section.

R. A. DELLER delivered a lecture on television, and demonstrated television apparatus, at Rensselaer, New York. The audience consisted of faculty members and students of Rensselaer Polytechnic Institute.

#### CONTRIBUTORS TO THIS ISSUE

L. G. BOSTWICK received the B. S. degree in electrical engineering from the University of Vermont in 1922. From 1922 to 1926, with the Development and Research Department of the American Telephone and Telegraph Company, he was concerned with general problems on systems for the high quality transmission of speech and music. In 1926 he was transferred to the Research Department of these Laboratories, to work on loud speakers.

H. A. BURGESS received the A.B. degree from the University of Syracuse in 1914. After two years with the Government Bureau of Standards and with the Government Patent Office, he joined the Patent Department of these Laboratories in 1919. Here Mr. Burgess is concerned with patent problems affecting developments in general transmission, carrier transmission and repeater circuits.

AFTER obtaining the degree of B.S.E.E. from Kansas State College in 1911, W. L. Heard entered the employ of the Automatic Electric Company in Chicago. The next year, however, he became affiliated with Western Electric in Hawthorne and remained with them until 1919 when he was transferred to the Laboratories. Both at Hawthorne and in New York, his work has been equipment engineering, and he is now Equipment Methods Engineer.

I. H. GERKS joined the Technical Staff of Bell Telephone Laboratories

on leaving the University of Wisconsin, where he was graduated with the degree of B.S. in 1927. His work here has been with the Systems Development Department chiefly on ringing and tone studies.

R. MARINO received the degree of Bachelor of Science from the College of the City of New York in 1918 and shortly after joined the Laboratories' Technical Staff. Subsequently he received the degree of Electrical Engineer from the Polytechnic Institute of Brooklyn, and that of Doctor of Jurisprudence from New York University. His work with the Laboratories has been in the laboratory end of the Systems Development Department, where he has participated in the development of various machine-switching circuits.

R. C. PAINE joined the Bell System in 1921, in the Installation Department of Western Electric, with headquarters at West Haven, Connecticut. In 1923 he came to the Engineering Department, in the Local Systems Laboratory, and in 1926 was transferred to a group engaged in design of local circuits, in the Systems Development Department. Mr. Paine secured his engineering training at Glasgow University, Worcester Polytechnic Institute, and Webb Institute of Naval Architecture.

L. M. ALLEN joined the Laboratories' technical staff in 1919 after extensive operating experience. With the New York Telephone Company he held various positions from 1906, when he was engaged in maintenance work, till he was transferred to the Laboratories, when he was Night Wire Chief for the Manhattan and Bronx Division. He is now Field Development Engineer in the Systems Development Department.

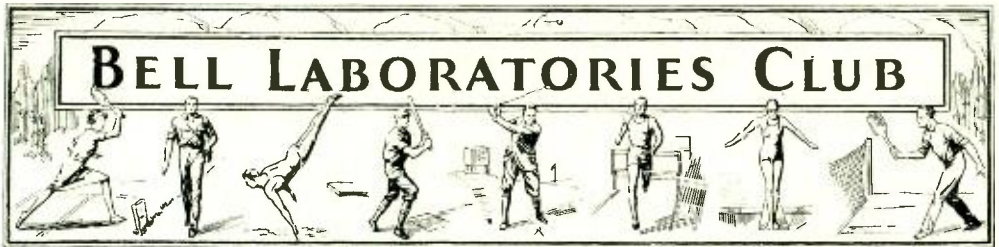

The Equipment basketball team decided that a cup should have three legs to stand properly and, having won two, proceeded to defeat the Tube Shop team on April 2 at Labor Temple, thereby taking permanent possession of the trophy symbolic of the championship of the Interdepartmental League.



The game was fast and furious, featured by some pretty shots, and when it was all over the score stood 29 to 20. The players played in deadly earnest, and for a time it appeared that Referee Maurer, despite his good control in the league games this season, might throw away his

whistle for a more suitable gong. The game was close throughout, causing grave doubts as to whether the bronze trophy, won by the Equipment team in 1927 and 1928, would maintain its majestic place in H. H. Lowry's office. In fact, some of the partisan executives' fears extended to demonstrating between periods some of the more elusive methods of making shots from the floor. Noted among the large number in attendance were H. P. Charlesworth, A. F. Dixon, R. L. Jones, H. H. Lowry, G. B. Thomas and O. M. Glunt.

The members of the winning team, including Messrs. O'Neil, Michal,

Trottere, Kuenzler, Maloney, Reinberg and Arnold, as well as the most valuable player on each of the other teams of the League, will receive wallets as a reward for their distinguished efforts. A. Kontis of the Tube Shop team also was the winner of the silver trophy given to the player scoring the greatest number of points during the season. Kontis was credited with 119 points, eclipsing the next leading scorer, Trottere, by 37 points.

#### WATCHES FOR GOLFERS

Did you ever try to drive a golf ball off the face of a watch? Some pros can do this but we don't expect our Club golfers will want to try it with the wrist watches to be given as prizes at the spring tournament. This will be held at the Salisbury Country Club, Garden City, L. I., on the first two Saturdays in June, the qualifying round taking place on June 1 and the finals on June 8.

The committee feels that it now has a very good record of the scores of most of the Club golfers from previous tournaments. It is planned, therefore, to conduct this tournament in a different way from previous tournaments. All those entering the tournament will be classified according to handicaps and will compete in the qualifying round in three classes. The makeup of the classes will be as follows:

- Class A—Handicaps of 20 or under.
- Class B—Handicaps of from 20 to 32 inclusive.
- Class C—Handicaps of from 33 to 35.

There will be the usual prizes for low gross and low net scores in the qualifying round.

The number of golfers to qualify in each class will be determined by the number of entries in each class. Total number to qualify will be 30.

Another change is to award prizes for the finals on the basis of total scores for 36 holes instead of only final scores as in previous tournaments.

Entries should be filed with D. D. Haggerty or J. C. Kennelty before May 25. The entrance fee is \$2.00.

#### DOWN THE CINDER PATH

Preparations are under way for the track and field meet of the Bell System Athletic League to be held at Erasmus Hall Field, Brooklyn, on Saturday afternoon, June 22. The Laboratories usually produces some very competent talent for the Bell System Meet, and prospects for a good showing are bright.

Prizes, as well as the thrill of competition, will be the lure for our athletes. Men and women are urged to come out for the various events. Try-outs for the Laboratories Club Team will be held at Erasmus Field on Saturday afternoon, May 25. The Laboratories Club may enter three competitors in each event in the League Meet, and a full quota will be selected at the try-outs.

The events to be contested in the meet are as follows:

MEN'S TEAM	
100 yard Dash	Shot Put
220 yard Dash	Broad Jump
440 yard Dash	High Jump
880 yard Run	Tug-of-war
	1 Mile Relay
WOMEN'S TEAM	
60 yard Dash	Quarter Mile Relay
	Basketball Throw

First prize in the League Meet for the winners of each of the men's events, with the exception of the tug-of-war and the mile relay, will be an Elgin wrist watch. The first prize in the relay and tug-of-war events will be a valuable wallet. Silver medals will be given to the winners of second place and bronze medals will reward the winners of third place in all the events. Prizes of equal value will likewise be given to the winners in the women's events. In addition, the Laboratories Club will give suitable prizes to the winners of the events in the try-outs for the Club Team.

N. H. Thorn, L. P. Bartheld and D. D. Haggerty will endeavor to keep things in hand at the meets.

#### HANDBALL PAR EXCELLENCE

The Handball Tournament ended in a blaze of brilliant playing after a succession of hotly contested eliminations, which took place Tuesdays and Thursdays during March. "Tip" O'Neil, winner of the tournaments of 1927 and 1928, again displayed his alacrity on the court and came through in the forefront of the twenty-four men who competed. Some of the match play was of professional character as to speed, accuracy and technique.



In the semi-final, Schmitt met defeat at the good hands of Krazinski after three close games. O'Neil then overcame the opposition of the winner in straight games to clinch the championship for the third successive year.

One object of the tournament was to develop talent for a team to represent the Club in competition with out-

side teams. There is no doubt that the objective was attained with something to spare.

### NOTABLE CHESS

In a setting reminiscent of the country store, with desks and file cases serving for cracker boxes and barrels, and chess for checkers, the players of the Club Chess Team meditatively matched wits with Hawthorne in the annual match by printing telegraph April 6th, and when decks were cleared, far into the night, after ten hours of play, had won the verdict, six games to four.

The Club won four of the games, drew four and lost two. C. F. Sacia, leader of the Laboratories players, was the first to finish and won in eighteen moves. He was followed with like results by H. M. Stoller, H. D. Cahill and T. Slonczewski. Draws were scored by F. A. Voos, D. A. Quarles, H. T. Reeve and G. H. Heydt. Mr. H. Helms, editor of "The American Chess Bulletin," was the referee. The summary:

#### BELL LABORATORIES

Boards

1.	C. F. Sacia	1
2.	F. A. Voos	1/2
3.	H. W. Bode	0
4.	D. A. Quarles	1/2
5.	H. M. Stoller	1
6.	H. T. Reeve	1/2
7.	H. D. Cahill	1
8.	T. Slonczewski	1
9.	G. H. Heydt	1/2
10.	H. W. Wood	0
Total		6

#### HAWTHORNE

1.	J. M. Juran	0
2.	J. Shallcross	1/2
3.	A. V. Cederquist	1
4.	C. R. Masmussen	1/2
5.	F. Asplund	0
6.	R. D. Warth	1/2
7.	A. Birkland	0
8.	H. L. Morgan	0
9.	L. H. Warth	1/2
10.	H. Brandner	1
Total		4

A chess match of extraordinary interest was played on February 28, when Mr. Frank Marshall, noted international expert and United States champion, in simultaneous match play with thirty members of the Club Chess Team defeated twenty-eight players. Mr. H. T. Reeve and Mr. E. G. Andrews, the other members of the team, succeeded in getting a draw with the champion.

Many of these men are members of the Laboratories Club Chess Team playing in the Commercial Chess League of New York, and have shown considerable prowess in winning the championship of the League for six consecutive times over some of the strongest teams in this section.

### BRIGHTON BEACH SWIMMING

Many are the ways that Laboratories people spend their spare time



during the summer months, but there is no doubt that swimming surpasses in popularity all other forms of recreation as soon as the warmer weather arrives.

With this in mind the Executive Committee of the Club has offered Club members and their friends for the past five years an opportunity to enjoy both outdoor and indoor swimming at greatly reduced rates.

Again this year, arrangements have been completed with the Brighton Beach Baths whereby Club members may purchase tickets from the Secretary at one-half the rate charged by the management. Tickets giving Club members all privileges on Saturdays, Sundays and holidays are now available. These tickets are one dollar each for Sundays and holidays and fifty cents each for Saturdays. Club membership cards should be presented with the tickets of admission.

Last season over one thousand Club members and their friends enjoyed the bathing at Brighton Beach and it is hoped that even more will take advantage of this opportunity during 1929. All department representatives can supply these tickets in any quantity.

Shelton Pool tickets will also be available during the summer months at the same rate charged by the hotel management during the fall and winter seasons. Tickets may be purchased from the Club Secretary for seventy-five cents, which is one-half the rate charged by the hotel.

#### THROUGH THE LENS

Our camera contingent became prolific in the Third Annual Photographic Contest and submitted some



150 prints. The awarding of prizes was made difficult by the high standard of work represented. In the Still Life class first and third prizes were awarded to the entries of E. Alenius, and second prize went to C. G. Sco-

field. For still life studies, some camera artists invaded the realm of the fairies and toadstools and captured instead likenesses of wraiths and ogres, much to the chagrin of the judges. In the Portrait class Mr. Scofield's entries took first, second and third prizes, showing original and effective treatment of the subjects. A large number of excellent landscapes were presented, and prizes in this class were divided as follows: first, E. Alenius; second, G. R. Lum; third, J. Popino. The mounting of the prints in many cases showed originality and exceptional good taste. The winning and most worthy photographs were placed on exhibit and received the acclaim of a throng of viewers.

W. A. Wolff of Western Electric and Margaret Horne and H. Maude of the Laboratories were the judges of the contest.

#### TENNIS RACKET

On May 13 our tennis artists will start their activities for the year with the first singles tournament to be held by the Club in many years. The arrangement of the tournament will differ from that of the doubles held last fall in that the players themselves will pay and arrange for the courts, and the matches of each round will be completed in the week following the completion of the previous round. There will be no entry fee. The Club will supply a new set of tennis balls for each match and will offer handsome first and second prizes to the winner and runner-up. A large entry list and keen competition is ex-



pected. In the fall, another doubles tournament will be held.

Some inquiries have been made concerning the possibility of holding a women's tennis tournament. Those who are interested should communicate with Marion Kane. Notices will appear on the bulletin boards.

#### WOMEN'S SWIMMING CLASS

Because of the increasingly large registration for the spring swimming class, it has been decided to devote three evenings a week to swimming at the Carroll Club; Monday, from 7:00 to 7:30 and Wednesday and Thursday evenings from 5:30 to 6:00 o'clock. Since there are now ninety-four girls interested, including thirty recruits from Hudson Street, the Club has engaged the services of Miss Alma Wyckoff, formerly of the Women's Swimming Association of New York, to assist Miss Spranger.

Miss Wyckoff will have charge of the instruction for beginners, while Miss Spranger will continue to teach the advanced pupils.

#### WOMEN'S INDOOR GOLF

The second indoor golf tournament

for women was held at the Miniature Golf Course of America on March 27.

Catherine Maull, who had the low score of 104 strokes in the qualifying round, medal play, received a merchandise order on Peck and Peck.



Miss Maull was entered at scratch in the finals and each of the other contestants was given a handicap equal to three-fourths of the difference between her score and that of Miss Maull.

The first prize in the finals was won by Frances Post, who finished with a net 37; the second prize was awarded to Marie Egan with a net 41; and Marianne Grimm, Helen Norton and Mabel Wirsching tied for third place with a net 43. Each of these was given a prize of equal value.

If enough women are interested, the Club will arrange an outdoor golf tournament for them. Marian Kane, who can be reached on 774, will furnish particulars.